

# ELECTRONIC INDUSTRIES

Nov. 1945  
**ENGINEERING  
AHEAD**

Coldwell-Clements, Inc.

Tube Production Technic

# Make the Brains of Your Electronic Products a Mallory Circuit Selector Switch

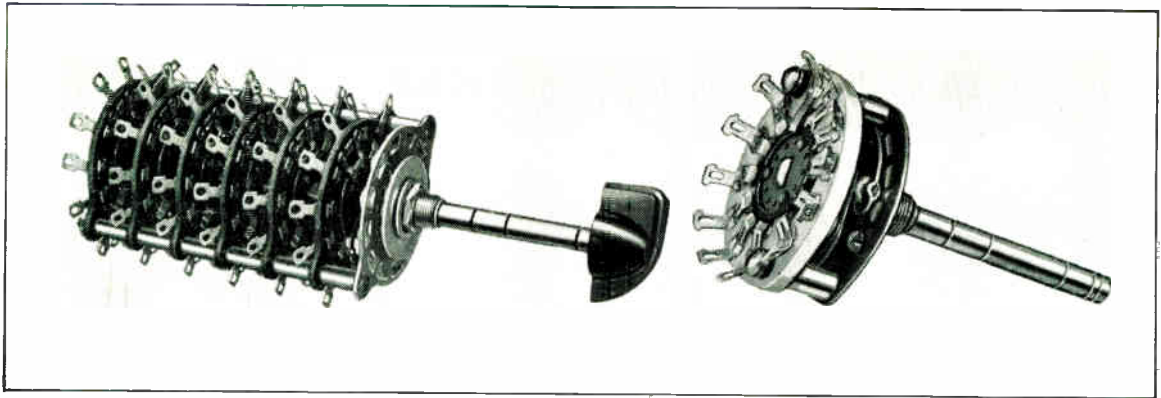

**N**OTHING makes a product more saleable than ease of operation. And nothing will make your electrical or electronic circuits operate more easily . . . more dependably . . . over a longer lifetime . . . than a Mallory Circuit Selector Switch.

These switches, rotary types capable of handling an almost infinite number of circuits as well as both single and multiple push button switches, have *special advantages for use in export products*. They can be fully "tropicalized" to withstand extreme humidity and high temperatures, and to prevent the growth of fungus. For aircraft use or export to frigid climates, special lubricants assure efficient operation in sub-zero temperatures.

*Other advantages include:*

- Better moisture-proofing for insulating sections.
- Improved impregnation to assure high leakage resistance.
- New materials and platings for longer life.
- All electrical contacts with self-wiping silver surfaces.
- "Hill-and-valley" indexing of rotary switches for smooth, positive action.

A large selection of *standard* Mallory switches is available from your nearby Mallory Distributor. Ask him for a free copy of the Mallory catalog, or write us today. We'll gladly help with circuit problems where the right switch may make your design "click."

**P. R. MALLORY & CO., Inc., INDIANAPOLIS 6, INDIANA**

## *Some Switch Applications*

AM-FM or Television Equipment  
Laboratory Equipment  
Test Equipment  
Industrial Electronic Equipment  
Electronic Control Devices  
Medical or Dental Equipment  
Household Electrical Appliances

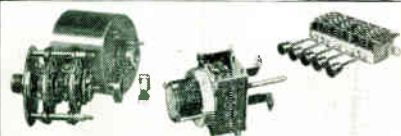

P. R. MALLORY & CO. Inc.  
**MALLORY**



## Industrial and Electronic Switches

# ELECTRONIC INDUSTRIES

Including INDUSTRIAL ELECTRONICS

★ IN THIS ISSUE NOVEMBER, 1945 ★

FRONT COVER—Tube Production Technic .....	4
EDITORIAL .....	73
SILICON CRYSTALS FOR VHF DETECTION CIRCUITS—E. C. Cornelius .....	74
HIGH VACUUM PUMPING .....	77
RESEARCH ADVANCES RECEIVER DESIGN .....	80
RATIO DISCRIMINATOR IS INSENSITIVE TO AM .....	82
PAYING THE ENGINEER WHAT HE IS WORTH .....	84
RADIO FREQUENCY CORES OF HIGH PERMEABILITY—G. O. Altmann and Dr. Hans Beller .....	86
PT MODULATION FOR MULTIPLE TRANSMISSION .....	90
CATHODE BIASED AMPLIFIERS—Paul H. Hunter .....	92
NAVY'S ELECTRONIC ORGANIZATION .....	93
VECTOR ANALYSIS—H. Gregory Shea .....	94
SURFACE SEARCH RADAR .....	98
THRU THE LABORATORY KEYHOLE .....	101
MACHINE TOOL CONTROL—Ray A. Stremel .....	102
NAVY PROXIMITY FUSE .....	104
INDUSTRIAL TESTING WITH HIGH VOLTAGE .....	106
GROUND WAVE RANGE CALCULATOR FOR FM .....	109
TUBES ON THE JOB .....	110
SURVEY OF WIDE READING .....	112
NEW PATENTS ISSUED .....	128
News of the Industry .....	114
Association News .....	116
Washington News .....	118
What's New .....	120
Television Today .....	126
Personnel .....	176
New Bulletins .....	202
New Books .....	220

ORESTES H. CALDWELL, Editor M. CLEMENTS, Publisher

**EDITORIAL STAFF**—Stanley P. McMinn, managing editor; Ralph R. Batcher, consulting editor; William Moulic, electronic theory and design; H. Gregory Shea, industrial engineering applications; Josepha Zentner, Ph.D., patents and foreign reviews; S. Heller, new products; E. T. Bennett, editorial records; Charles Dreyer, art director; Carl Buhner, circuit diagrams; Roland C. Davies, 1290 National Press Building, Washington, D. C., Washington editor; Arthur H. Halloran, 1020 Union St., San Francisco, west coast editor.

**READER SERVICE**—J. Cosin, H. Mirtel; data research, H. Kulik.

**CIRCULATION**—B. V. Spinetta, circulation director; Subscriptions; list compilation: B. Gollub, M. Groening, B. Ruchaisky.

**BUSINESS**—M. H. Newton, business manager; John Samborn, eastern manager; Richard Fitzpatrick, western manager; O. H. Sutter, New England manager; Lee Robinson, district manager; Ben Morris, promotion manager; N. McAllister, production manager; J. E. Cochran, make-up; E. P. Burler; W. W. Swigert, credit manager; W. Kenneth Reynolds, E. Callahan.

**BRANCH OFFICES**—Chicago 6, R. Y. Fitzpatrick, 201 N. Wells St., RAN. 9225; Cleveland 14, Dudley B. Trott, Citizens Bldg., 850 Euclid Ave., Main 8270; Los Angeles 14, Robert W. Walker, Walker & Minton, 403 W. 8th St., VAndike 9348; San Francisco 4, Eli C. Minton, Walker & Minton, 68 Post St., SUTter 5568.

CALDWELL-CLEMENTS, INC. — TEL. PLAZA 3-1340 — 480 LEXINGTON AVENUE, NEW YORK 17, N. Y.

Electronic Industries, November, 1945. Vol. IV No. 11. Regular price per copy 35 cents. Published monthly by Caldwell-Clements, Inc., 480 Lexington Avenue, New York 17, N. Y. M. Clements, President; Orestes H. Caldwell, Treasurer; M. B. Clements, Assistant Secretary. Subscriptions: United States and Possessions, Mexico, Central and South American countries, \$3.00 for one year; \$5.00 for two years; \$6.50 for three years. Canada, \$3.50 per year; \$5.50 for two years; \$7.15 for three years. All other countries \$5.00 a year. Entered as Second Class Matter, September 20, 1943, at the Post Office at New York, N. Y., under the act of March 2, 1879. Copyright by Caldwell-Clements, Inc., 1945. Printed in U. S. A.



*For me?*

Yes, for you  
there could very well be a citation  
which would read  
"For distinguished service  
to the American people..."  
... that is, there could be  
if the nation only realized  
as well as we,  
who have worked with you,  
what a splendid job you have done  
as a radio engineer  
during the emergency

If they only knew  
how you overlooked the word *overtime*  
and how an *eight-hour day*  
lost its meaning  
when we most needed  
to be informed and entertained.

If they only knew  
how you coddled and repaired

the irreplaceable tools  
of your trade  
so that not even one  
valuable broadcasting moment  
was lost in wartime.

If they only knew  
how the station remained awake  
each twenty-four hours  
because of your personal effort.

... Well, perhaps they don't realize  
to whom the thanks belong,  
or their tongues don't give voice  
to their feelings ...  
but in their homes and hearts  
there has been mute appreciation  
for the privilege you extended to all,  
the privilege that could not  
have been forfeited easily,  
the privilege that is used so casually,  
the privilege of switching on the radio.

## AMPEREX ELECTRONIC CORPORATION

25 WASHINGTON STREET • • • BROOKLYN 1, N. Y.



A COPY OF THIS ADVERTISEMENT, SUITABLE FOR FRAMING, WILL BE SENT WITHOUT CHARGE UPON REQUEST

# 7 REASONS

*why this Capacitor*

**BELONGS IN YOUR FIRST LINE PRODUCTS**



1

## LONG LIFE

The superior moisture seal afforded by the molded phenolic case guarantees that these oil-impregnated capacitors will withstand the rigors of sea shipment and tropical service.

2

## SMALL SIZE

Conforming to AWS dimension standards, the cases are 13/16" x 13/16" x 19/64" (CN35) and 11/16" x 29/64" x 7/32" (CN20).

3

## CLOSE STACKING

The flat, rectangular form permits side-by-side mounting in minimum sub-chassis space.

4

## SELF SUPPORTING

Light in weight — and with solid, #18 wire leads — these capacitors are satisfactorily mounted by their connecting leads only.

5

## ALL POPULAR RATINGS

Capacitances from 100 to 50,000 mmfd.; Working voltages from 200 to 1600 V.D.C.

6

## IMMEDIATE AVAILABILITY

Large-scale production facilities — for winding, oil-impregnating, assembling, molding and testing — assure continuous delivery of these dependable capacitors.

7

## LOW COST

Comparing favorably in cost with the paper tubulars they supersede, these non-inductive capacitors offer more service per penny.

*Where failures in bypass and coupling circuits cannot be tolerated, specify and use Tobe Molded Oil-paper Capacitors — Types APC and DPC.*



FIELD OFFICES IN NEW YORK CITY · CHICAGO · DETROIT · GLENDALE, CALIFORNIA

# Speed Your Production With This Money-Saving Automatic Inspector

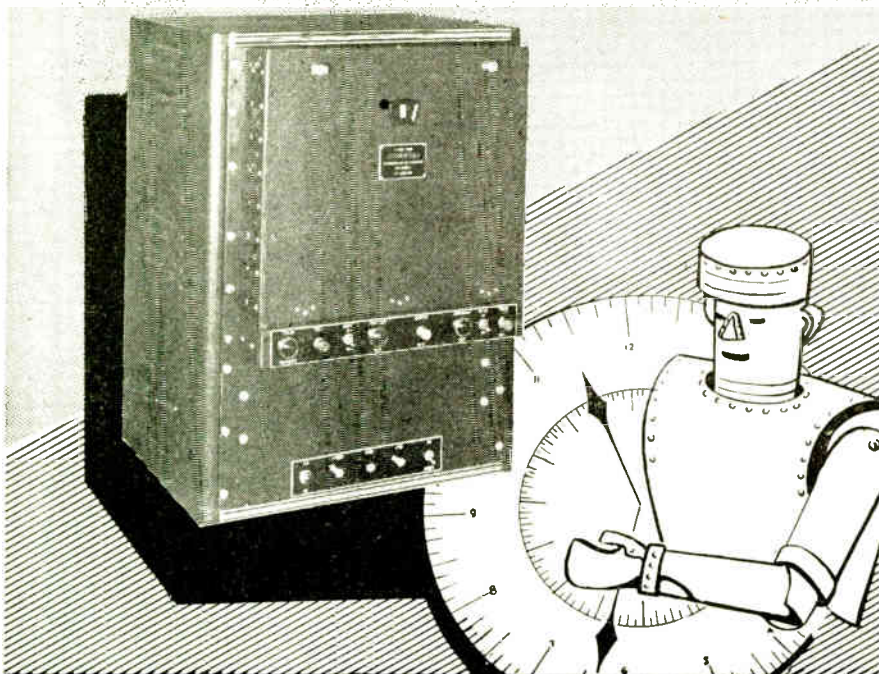

## ROTOBRIDGE

### Checks a Circuit a Second!

Instantaneous and accurate, the Rotobridge functions with robot-like fidelity in checking wiring errors, resistance and reactance values.

Designed for continuous 24-hour duty, the Rotobridge does your bidding exactly. Do you wish a 10% resistance tolerance at one point? A 25% capacity tolerance at another spot? The Rotobridge gives it to you—automatically and accurately.

An error detected? The Rotobridge stops cold, flashes on a red blinking signal, which winks insistently until the defect is attended to.

The Rotobridge can be put to work on several small sub-assemblies or on a complete set, involving as many as 120 circuits. Want to inspect a 30 or 40 tube set-up? Two or three of these robots, working simultaneously, will do the trick . . . in five minutes flat!

*Write for complete details.*

## Communication Measurements Laboratory

120 Greenwich Street • New York 6, N. Y.

### THE COVER

The copper to glass seal operation in the manufacture of Western Electric's 100-kilowatt water-cooled triode shown on the cover demands a technic possessed by only the most skilled of operators. At this point the copper tube, which forms the anode of the vacuum tube, has made a juncture with the open end of the glass bulb and a high concentration of heat is being applied. The ends of the copper tube had been previously flared, machined to a knife-like edge and then oxidized so as to provide sufficient elasticity to take up the strains caused by differences in the coefficients of expansion of the copper and glass. As the glass softens, it is spread over the interior surface of the flared end of the copper tube by means of an ingenious roller tool supported on the center axis of the machine. This tool also carries a nozzle through which a stream of nitrogen is forced to blow the glass bulb to the final shape desired. The same process is repeated for the glass bulb at the other end of the anode.

### Toot! Toot!

Ordinarily it is not considered good form for one to toot one's own horn. Nevertheless there are two articles in this issue of **ELECTRONIC INDUSTRIES** which we believe are worth at least a slight toot. This for the reason that they represent what in newspaper parlance are known as scoops.

First of these is the article reporting Mr. Seeley's IRE paper in which he describes a new form of FM circuit built around what he describes as a ratio detector.

The other is the first comprehensive engineering description of Federal's pulse time modulation system which has been under development for quite some years but which has never before been completely revealed.

So you might please forgive the two brief "toots" up above.

### All Done by Radio!

Here is an advance picture of house-to-house selling in San Francisco, according to that city's Associated Food Distributors. Supply trucks from stores will set up in strategic locations, act as field headquarters for sales clerks with baskets of goods. When clerk can't fill housewife's door order, he communicates with truck by walkie-talkie. When truck can't, field manager radios the store and special delivery is made by motor-cycle.

# G-E all-metal THYRATRON

*Husky*

for day-in, day-out service where high currents are employed.

*Responsive*

to low-power grid actuation, owing to the control-and-shield-grid design.

*Versatile*

in its wide range of industrial uses—for motor, welding, temperature and other controls, and as a grid-controlled current rectifier.



**This rugged G-E thyatron** is a tube you can count on for reliable performance in your plant. Its metal envelope not only makes Type FG-172 shock-resistant, but fits the tube ideally for panel-mounting. Mercury vapor is used in this tube, and in conjunction with the all-metal construction permits passage of high currents efficiently and for substantial periods.

• The 4-electrode—control-and-shield-grid—design gives a high de-

gree of sensitivity, enabling current-flow to be started where available grid power is small or the grid is actuated from a high-impedance source.

• Consult your nearest G-E office or distributor for full ratings, performance charts, and other information on the FG-172 thyatron or other types in G.E.'s complete line of industrial electronic tubes. Or write to *Electronics Department, General Electric, Schenectady 5, New York.*

**There Are 265 Main Supply Outlets for G-E Electronic Tubes, Backed Up by Centrally Located Stocks in Large Cities from Coast to Coast.**

## TYPE FG-172, PRICE \$35.

Hot-cathode, mercury-vapor thyatron with control and shield grids. All-metal construction, convection-cooled. Ratings for motor control service (including other industrial controls except welding) and welding control service are:

	Motor Control	Welding Control
Cathode voltage	5.0 v	5.5 v
Cathode current	10.0 amp	11.0 amp
Anode peak voltage	2,000 v	750 v
Anode peak current	40 amp	77 amp
Anode average current	6.4 amp	2.5 amp

Hear the G-E radio programs: "The World Today" news, Monday through Friday, 6:45 p.m., CBS. "The G-E All-Girl Orchestra," Sunday 10 p.m., NBC. "The G-E House Party," Monday through Friday, 4 p.m., CBS.

**GENERAL ELECTRIC**



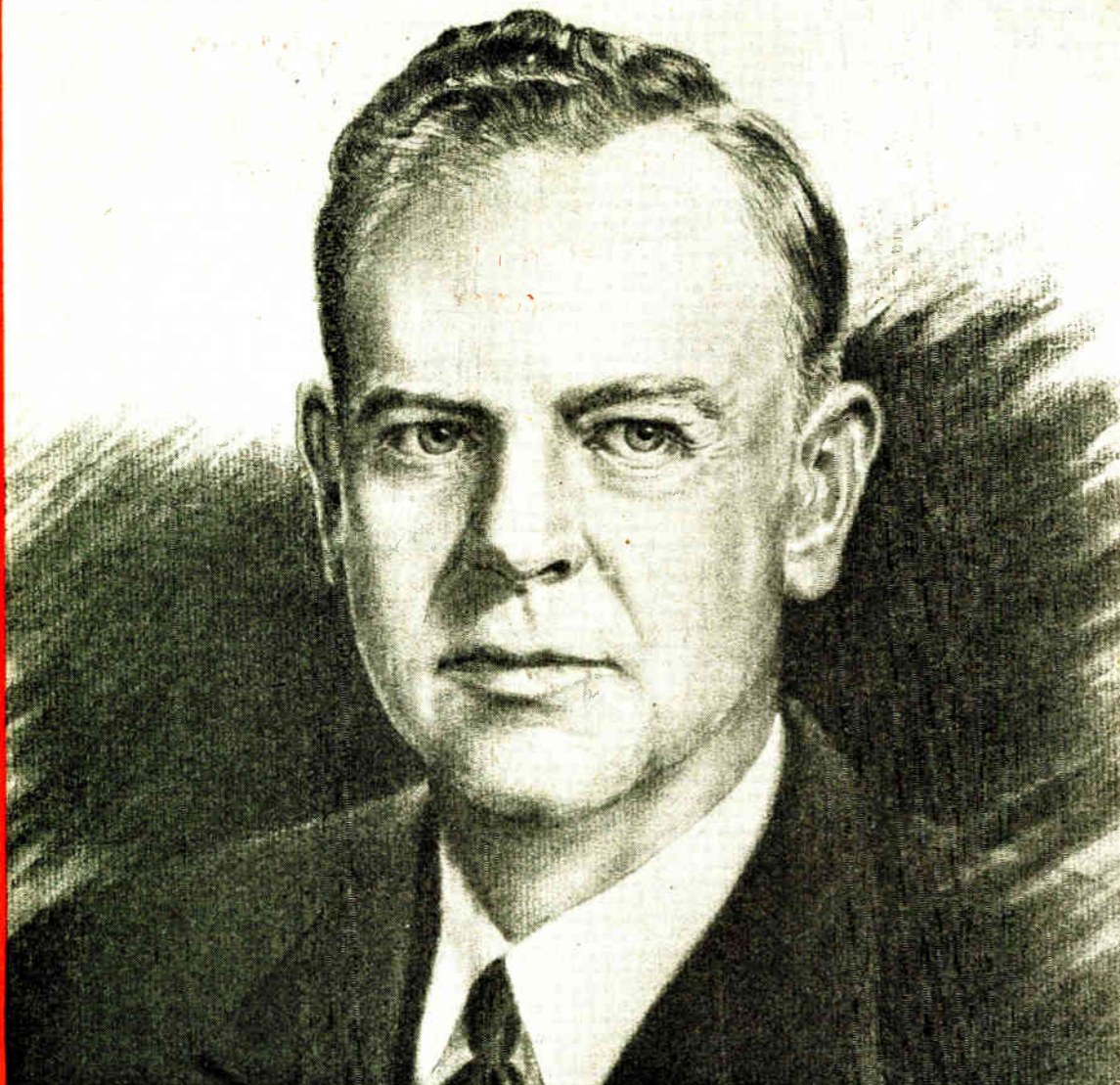

Portrait of Randolph C. Walker by John Carlton

# Engineers of Victory

## NOW SERVE MEN AT PEACE

The creative engineering which armed our fighting men for Victory has no less a responsibility in the years of peace ahead. Now that the war is won, we have the job of making this a better world.

AIREON produced huge quantities of communications and radar equipment and other machinery for waging war. Its achievements were equal to its heavy responsibilities, and its workers established an outstanding record of performance.

AIREON enters peacetime production with a notable engineering organization, highly skilled personnel and great confidence in the future. We have developed many products which will contribute to better living, for the manufacture of which all 15 AIREON plants will continue in production.

In order to extend our usefulness we recently estab-

lished an experimental laboratory in Greenwich. AIREON's creative engineering in radio communications, electronics, musonics and hydraulics will team with production proficiency in contributing devices for future service.

In peace, as in war, AIREON will stand for quality and performance.

*Randolph C. Walker*  
PRESIDENT

**Aireon**  
MANUFACTURING  
CORPORATION

NEW YORK · GREENWICH · CHICAGO · KANSAS CITY · OKLAHOMA CITY · BURBANK · SAN FRANCISCO





## The green light in metals... Revere has them NOW

Revere knows well how precious to the nation each of these post-war days can be, and how crippling to industry and employment could be a shortage of essential metals. That is why, since V-J Day, Revere has been in full production for peace.

Fortunately, Revere metals can serve the needs of creating as well as those of destroying, can make as fine bathroom fixtures as bomb fuses, as excellent radiators for automobiles as for half-tracks. No difficult reconversion problems have stifled the outpouring of Revere metals.

Revere copper, brass, bronze, aluminum, magnesium, steel, are ready now, are already busy in thousands of plants helping shorten the period of reconversion for industry and for the nation.

We are able and eager to do more. One inevitable result of Revere's war effort has been that not only our ability to produce, but our ability to give service, have been expanded many times. Revere research has probed further and deeper. Revere Technical Advisors are armed with greater knowledge and experience. New methods, metals and machines may save precious time or cut all-important cost for users of our metals.

In all these ways Revere is ready now to serve the manufacturing and building industries to help you prove immediately that America is even greater in peace than she proved to be in war. In the same way Revere is ready to serve home owners with its building products which are stocked by Revere Distributors in all parts of the country.

### REVERE COPPER AND BRASS INCORPORATED

*Founded by Paul Revere in 1801*

Executive Offices: 230 Park Avenue, New York 17, N. Y.

Mills: Baltimore, Md.; Chicago, Ill.; Detroit, Mich.;  
New Bedford, Mass.; Rome, N. Y.

Sales Offices in principal cities, Distributors everywhere

*Revere District Sales Offices are located in the following cities:*

- |                   |                       |                     |
|-------------------|-----------------------|---------------------|
| Atlanta, Ga.      | Boston, Mass.         | Buffalo, N. Y.      |
| Cincinnati, O.    | Cleveland, O.         | Dallas, Texas       |
| Dayton, O.        | Grand Rapids, Mich.   | Hartford, Conn.     |
| Houston, Texas    | Indianapolis, Ind.    | Los Angeles, Calif. |
| Milwaukee, Wis.   | Minneapolis, Minn.    | New York, N. Y.     |
| Philadelphia, Pa. | Pittsburgh, Pa.       | Providence, R. I.   |
| St. Louis, Mo.    | San Francisco, Calif. | Seattle, Wash.      |

*The Revere Office nearest you is at your service.*

Listen to the Human Adventure on the Mutual Network every Sunday evening, 9 to 9:30 P. M., Eastern Time

# Wherever You Need DC from AC

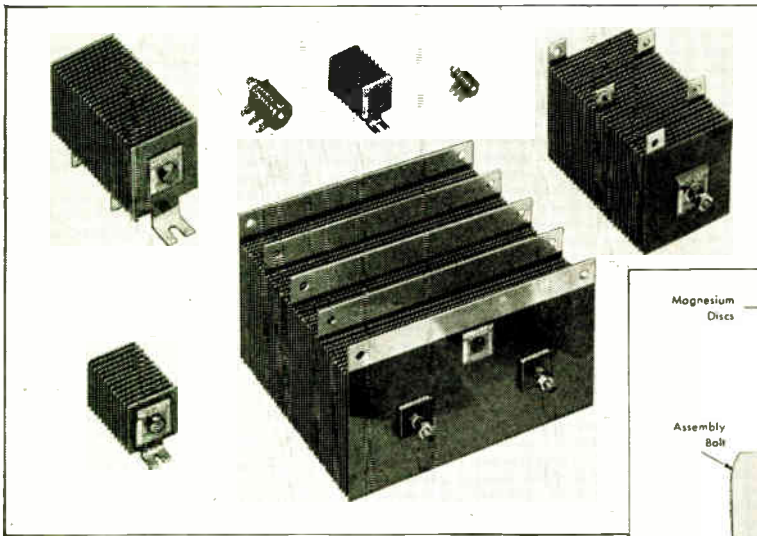

## Specify **MALLORY** Magnesium-Copper Sulphide **Rectifiers**

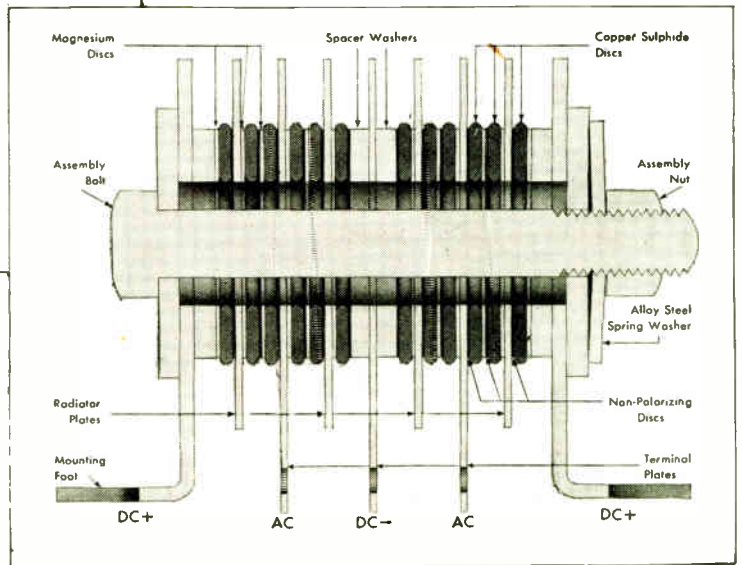

**W**HEN you have an AC source and need low voltage DC, the most efficient answer is apt to be a Mallory Dry Disc Rectifier.

Available in a wide range of sizes and ratings, from tiny "button" rectifiers to large heavy-duty stacks, in capacities from 0.3 ampere to 35,000 amperes DC and up, Mallory Rectifiers give years of silent, trouble-free service. Sturdily constructed, completely sealed to resist atmospheric changes, Mallory rectifiers have no moving parts—nothing to break or wear out—require no maintenance expense.

Design engineers appreciate the fact that Mallory Rectifiers have a constant output over an extremely wide range of ambient temperatures—from -40°F. to +265°F. or higher. These rectifiers can "take it" under heavy current overloads, and have a self-healing film which prevents damage from high voltage surges. Voltage regulation is excellent, and power factor is unity.

Experienced Mallory engineers will gladly help you select the best rectifier for any specific application. Write to us or ask your nearest Mallory Distributor for a free copy of Catalog R615A.

**P. R. MALLORY & CO., Inc.**  
INDIANAPOLIS 6 INDIANA

\*Rectostarter is the registered trademark of P. R. Mallory & Co., Inc., for rectifier units for use in starting internal combustion engines.

### *A Few Applications of MALLORY RECTIFIERS*

#### *Battery Chargers for:*

Automobile                      Radio  
Industrial                        Fire Alarm  
Emergency Lighting  
Mobile Electric Truck  
Railway Car

#### *Power Supplies for:*

Magnetic Chuck              Magnetic Valve  
Generator and Alternator Field  
Impulse Pump                DC Motor  
Relay                              Magnet  
Solenoid  
Clock                              Organ  
Elevator                         Radio Receiver  
Business Machine  
Electroplating                Electrocleaning  
Electrodissociation  
Electrolysis Elimination  
Laboratory Analysis



**P. R. MALLORY & CO. Inc.**  
**MALLORY**  
**RECTIFIERS**

MAGNESIUM COPPER SULPHIDE RECTIFIERS—  
STATIONARY AND PORTABLE D. C. POWER SUPPLIES—  
BATTERY CHARGERS AND AVIATION RECTOSTARTERS\*



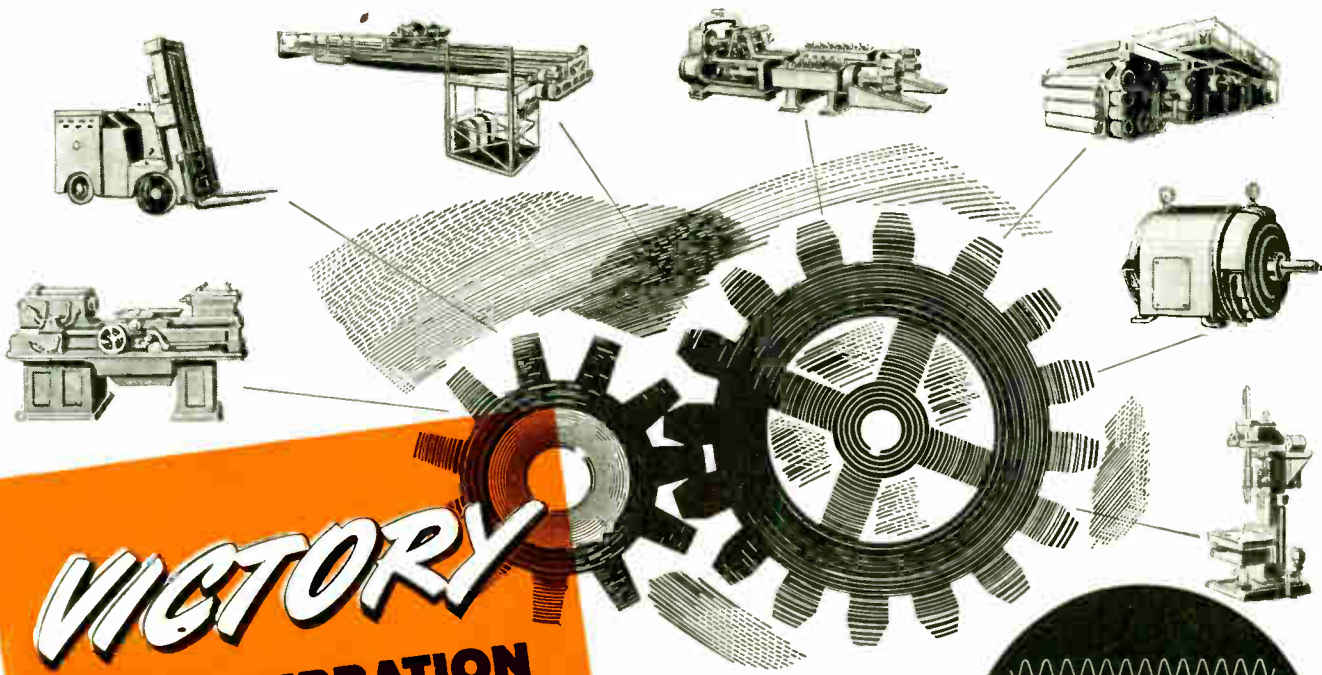

# VICTORY OVER VIBRATION

## In Industry

MAN'S struggle for speed and more speed, in travel and in production, is largely a struggle to combat the interfering and disrupting forces of vibration. Man has no practicable method for the elimination of vibration, but he can do much to control and isolate its harmful effects.

By flexible suspension of the entire machine, equipment life is prolonged by reducing metal fatigue; production is increased, its quality improved, through smoother operation; nervous strain on operators and other workers is greatly reduced. Also material is saved by eliminating base weight used for inertia mass. Other savings in production costs and improvements in efficiency of personnel are attained by separate mountings for motors, gauges, and tools. Lord Mountings combat the destructive forces of vibration as effectively as scientific lubrication combats the wearing effect of friction.

Lord is the Pioneer and leader in the science of vibration control and isolation thru the application of natural and synthetic rubber. Lord Shear Type Mountings and other Bonded Rubber Products are the embodiment of many exclusive techniques and patented features developed through years of research and practical application.

To help you select the proper Lord Mounting for your specific objective, or to design it for you, Lord engineers are at your service.



Every genuine Lord Mounting carries the name "LORD" embossed in the rubber or in raised letters on the forgings.

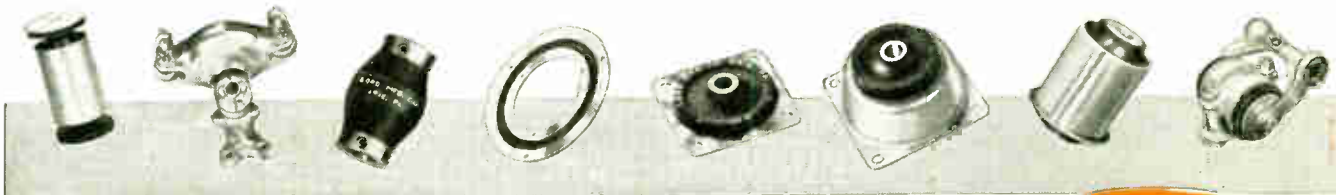

IT TAKES BONDED RUBBER *In Shear* TO ABSORB VIBRATION

**LORD MANUFACTURING COMPANY**

ERIE, PENNSYLVANIA

★ BUY VICTORY BONDS ★

SALES REPRESENTATIVES  
 NEW YORK - 280 MADISON AVE.  
 CHICAGO - 520 N. MICHIGAN AVE.  
 DETROIT - 7310 WOODWARD AVE.  
 BURBANK, CAL. - 245 E. OLIVE AVE.  
 CANADIAN REPRESENTATIVES  
 RAILWAY & POWER ENGINEERING CORP., LTD.  
 TORONTO, CANADA

*Originators of Shear Type Bonded Rubber Mountings*

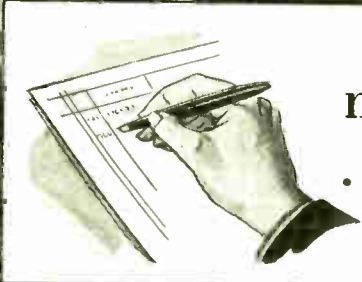

more efficient  
... in miniature

The old quill was picturesque but it lacked the compactness, convenience and dependability of our modern fountain pen. Its development was the usual evolution. Changes and reduction in size made for greater efficiency. The same took place in the development of the modern miniature electronic tube.

While the reduced size of TUNG-SOL Miniatures alone warrants a preference for them, their greater efficiency has resulted in their general adoption, especially for high frequency circuits. Smaller elements make them more rigid. Shorter leads result in lower lead inductance. TUNG-SOL Miniatures have low ca-

capacity and high mutual conductance

The TUNG-SOL interest in electronics is the development and production of more efficient electronic tubes.

Equipment manufacturers are invited to consult with TUNG-SOL engineers on problems of circuit planning and tube selection. Consultation is always confidential.



ACTUAL SIZE

# TUNG-SOL

*vibration-tested*

ELECTRONIC TUBES

TUNG-SOL LAMP WORKS INC., NEWARK 4, NEW JERSEY

Also Manufacturers of Miniature Incandescent Lamps, All-Glass Sealed Beam Headlight Lamps and Current Intermittors

ELECTRONIC INDUSTRIES • November, 1945



# It's Here!

## The NEW TEMCO

*Multi-Frequency*

## COMMUNICATION

## TRANSMITTER

in power ranges  
of

## 100 to 1000 WATTS

in a Single Cabinet

**T**hese new Temco Transmitters are the answer to a long standing need for communication equipment characterized by flexibility in its operational features and capable of covering continuously a wide band of frequencies. Temco Engineers have achieved this by means of a single dial controlled, highly stable exciter unit which is continuously variable from 2-32 megacycles and may be hand operated or motor driven depending upon requirements. This unit permits selection of any of four crystal positions affording crystal control or master oscillator over the entire frequency range. It is self contained having its own power supply and is common to all Temco Transmitters.

The intermediate amplifier and power amplifier stages are normally supplied with motor tuning units. Available on special order is an added tuning feature which permits local or remote selection of ten fixed pre-determined frequencies within the 2-32 megacycle range. In addition, vertical construction is used throughout to permit easy access to all components for minimizing servicing problems.

To fill requirements for power outputs greater than 1000 watts it is only necessary to add another cabinet containing amplifiers producing the power required. Thus original equipment is retained, for, in designing these transmitters every step has been taken to protect customers against obsolescence of equipment and make possible power output increases at will with minimum effort and the least expenditure.

### FEATURES

- **Single Control-Tracked Tuning Exciter Unit** eliminating independent tuning of all low powered R.F. stages.
- **Motorized Tuning Controls** permitting placement of components in chassis positions best suited for maximum circuit efficiency.
- **Eye-Zone Meters and Hand-Level Controls** introducing a highly desirable innovation for ease of operation.
- **Temco Power-Flex Multiple Unit Design** for expanding power output without making obsolete lower power units and retaining uniform over-all appearance.
- **Multiple Cabinet Plan** for power requirements in excess of 1 KW.
- **Dust and Tamper Proof Cabinets.**
- **Forced Draft—Filtered Ventilation.**
- **Handsome, dignified styling throughout.**

# TEMCO

RADIO COMMUNICATION  
EQUIPMENT

TRANSMITTER EQUIPMENT MFG. CO., INC.  
345 Hudson Street • New York 14, N. Y.

# **FACSIMILE COMPONENT PARTS**

**1800-CYCLE SYNCHRONOUS MOTORS**

**FORK OSCILLATORS**

**OPTICAL SYSTEMS**

**SPECIAL TRANSFORMERS**

Available in small quantities for  
engineering purposes after  
February 1, 1946

**TIMES TELEPHOTO EQUIPMENT INC.**

*A Subsidiary of The New York Times Company*

229 West 43 Street

Lackawanna 4-1000

New York 18, N. Y.

# KEN-RAD

## Little Giant MINIATURE TUBES



*Better than ever*

● Power-packed Ken-Rad Miniature Tubes have contributed much to the success of portables and other compact radio units . . . Now important added facilities assure still finer tube performance . . . Through Ken-Rad's effort top-quality tubes, built steadily better, will continue to meet the highest requirements of designers and manufacturers of electronic equipment.

Write for your copy of  
"Essential Characteristics"  
the most complete digest of  
tube information available.

178-D10-8850

# KEN-RAD

DIVISION OF GENERAL ELECTRIC COMPANY

OWENSBORO, KENTUCKY

# DESIGN

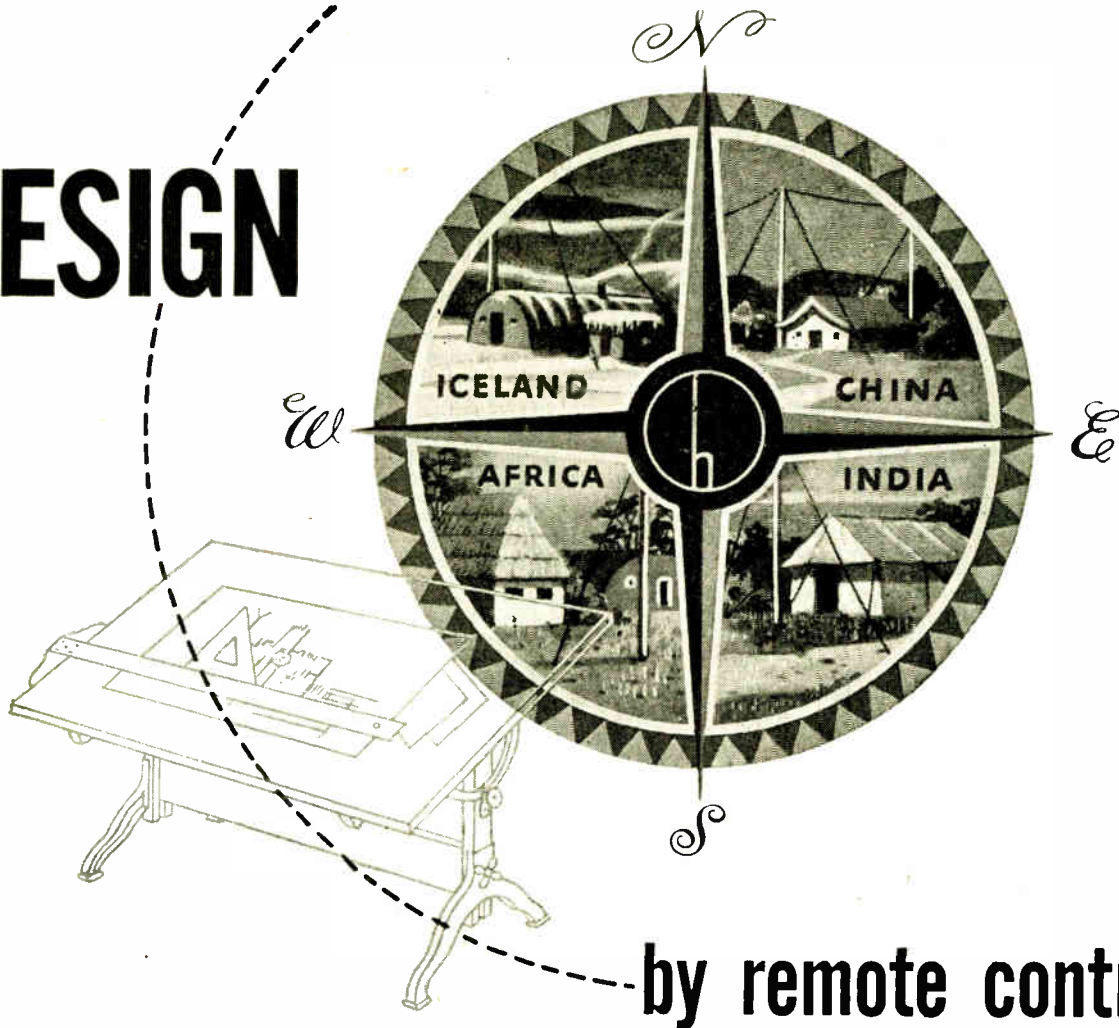

## by remote control

The design of radio equipment that will come from Hallicrafters is already shaping up—determined largely by thousands of hams who, from their remote control locations all over the world, are sending advice and suggestions on new radio ideas to Hallicrafters engineering department.

Thousands and thousands of Hallicrafters pieces of high frequency radio equipment are in use in the armed services. In a high percentage of cases this equipment is used by operators with practical amateur experience. From these qualified experts Hallicrafters has received hundreds of letters telling how Hallicrafters-built equipment stands up under the most vicious battle conditions. Hallicrafters receives regularly many valuable suggestions from hams in the field and at home. From this rich deposit of "design by remote control" will emerge Hallicrafters new line—built to meet ham requirements, designed for the world's most exacting users—the radio amateurs.

# hallicrafters RADIO

COPYRIGHT 1945 THE HALLICRAFTERS CO.



**BUY A WAR BOND TODAY!**

**THE HALLICRAFTERS CO., WORLD'S LARGEST EXCLUSIVE MANUFACTURERS OF SHORT WAVE RADIO COMMUNICATIONS EQUIPMENT, CHICAGO 16, U. S. A.**



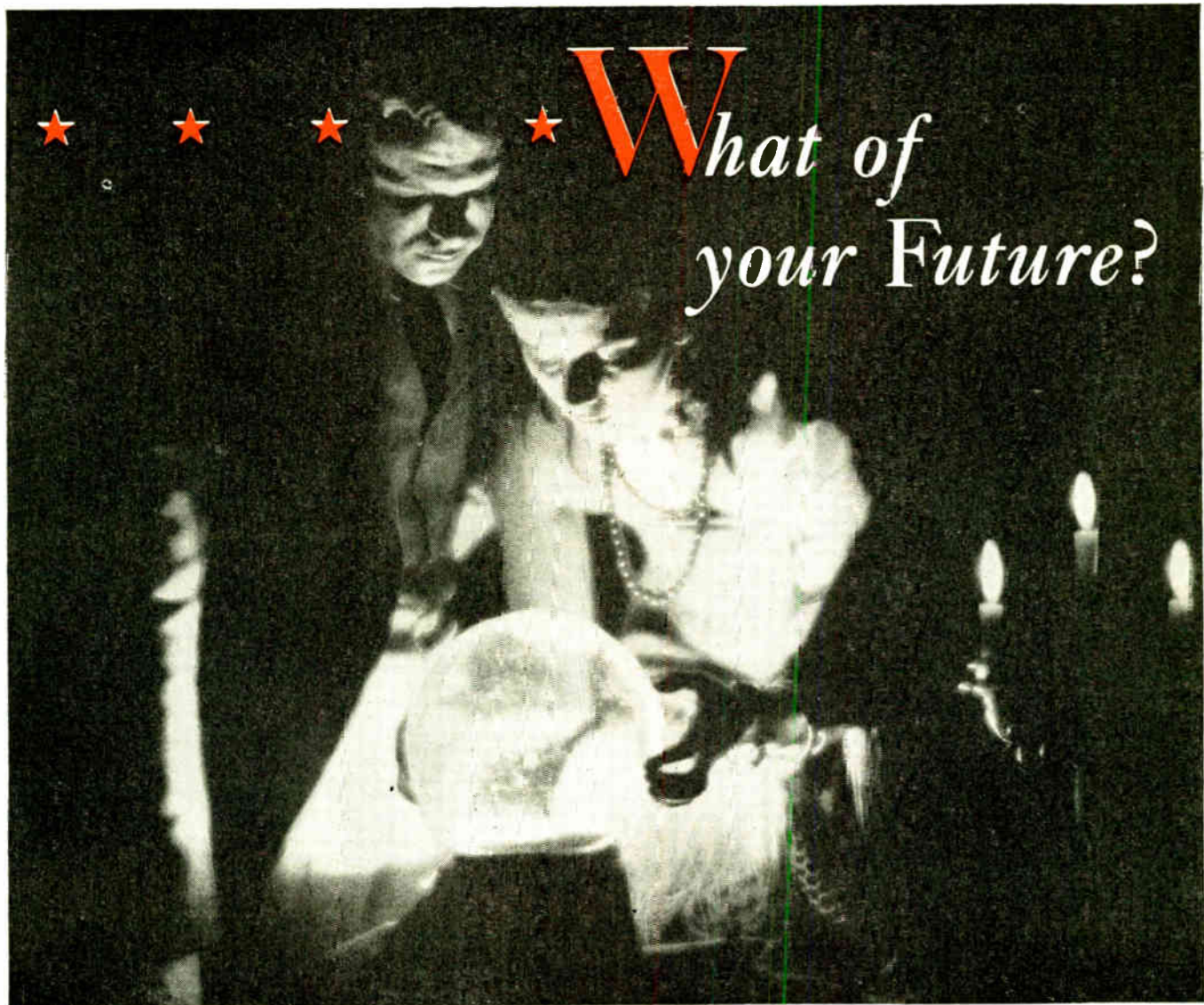

# What of your Future?

● The developments in radar, radio, television, electronic and electrical apparatus of all kinds made during the past four years will have tremendous influence on your future.

The unusual developments in transformer design, application and production,—the further confirmation of Jefferson Electric ability to produce transformers in great quantities with unsurpassed uniformity and accuracy,—

will help insure the successful performance of your post-war products.

Look to your future, now, by consulting the Jefferson Electric staff of transformer specialists. JEFFERSON ELECTRIC COMPANY, Bellwood (Suburb of Chicago), Illinois. In Canada: Canadian Jefferson Electric Co., Ltd., 384 Pape Avenue, Toronto, Ont.

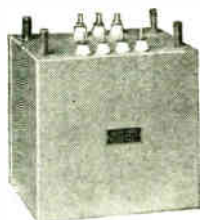

# T R A N S F O R M E R S

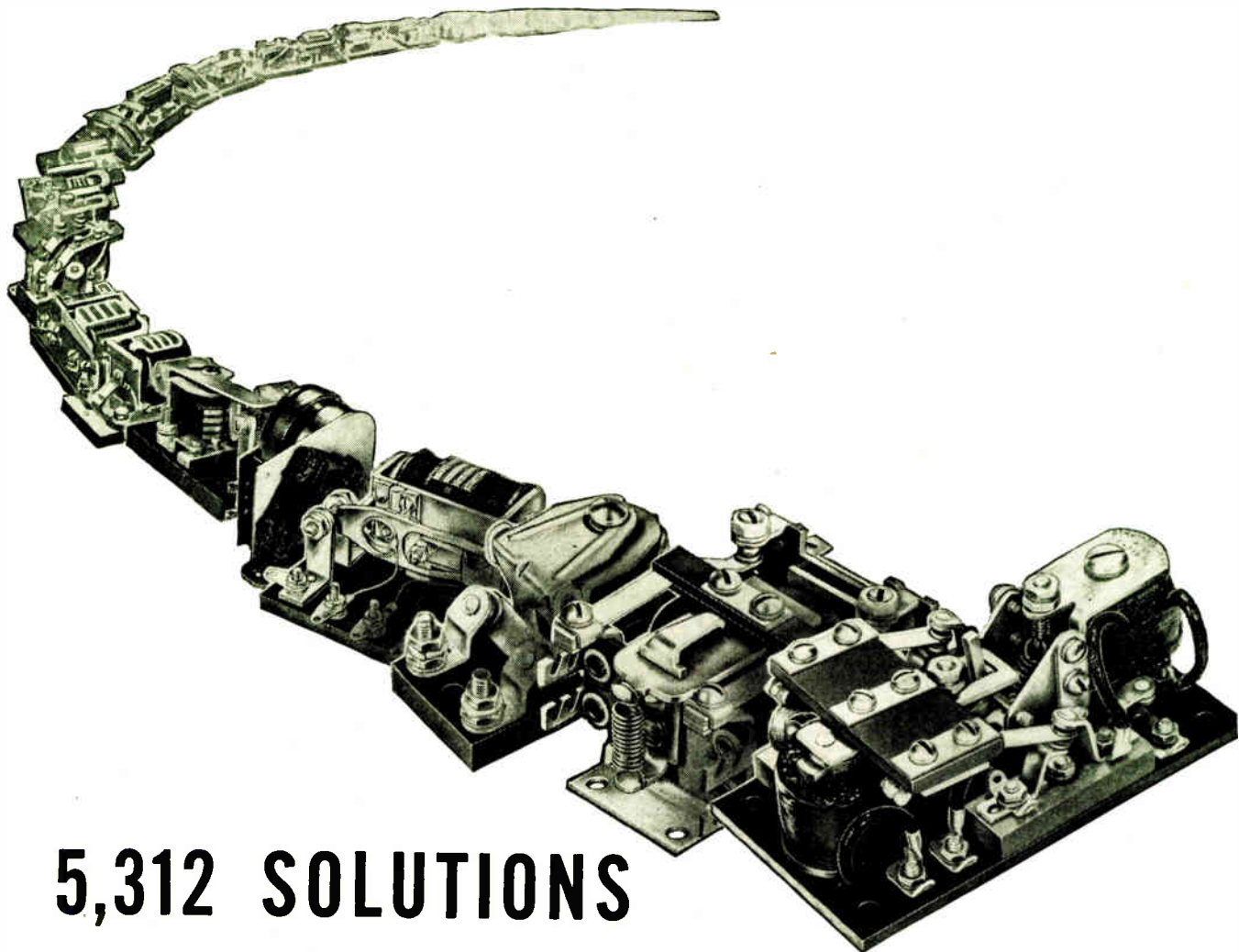

## 5,312 SOLUTIONS TO POST WAR RELAY PROBLEMS

Fit the relay to the job!

To make this readily possible, Struthers-Dunn offers 5,312 *standard* types, each available in countless design adaptations to fit your needs *exactly*. These include thousands of styles, shapes, sizes and ratings in a-c types, as well as hundreds more of the most modern d-c types includ-

ing those capable of withstanding the rigors of war equipment usage.

Beyond the standard Struthers-Dunn types, at your service, are the full facilities of a large, specialized organization which, for 22 years, has concentrated exclusively on "tailoring" relays and timers to specific applications and requirements.

STRUTHERS-DUNN, INC., 1321 Arch Street, Philadelphia 7, Pa.

# STRUTHERS-DUNN

*Relay and Timer Specialists Since 1923*

DISTRICT ENGINEERING OFFICES: ATLANTA • BALTIMORE • BOSTON • BUFFALO • CHICAGO • CINCINNATI • CLEVELAND  
DALLAS • DENVER • DETROIT • HARTFORD • INDIANAPOLIS • LOS ANGELES • MINNEAPOLIS • MONTREAL  
NEW YORK • PITTSBURGH • ST. LOUIS • SAN FRANCISCO • SEATTLE • SYRACUSE • TORONTO

# The New Collins 21A, 5 kw Broadcast Transmitter

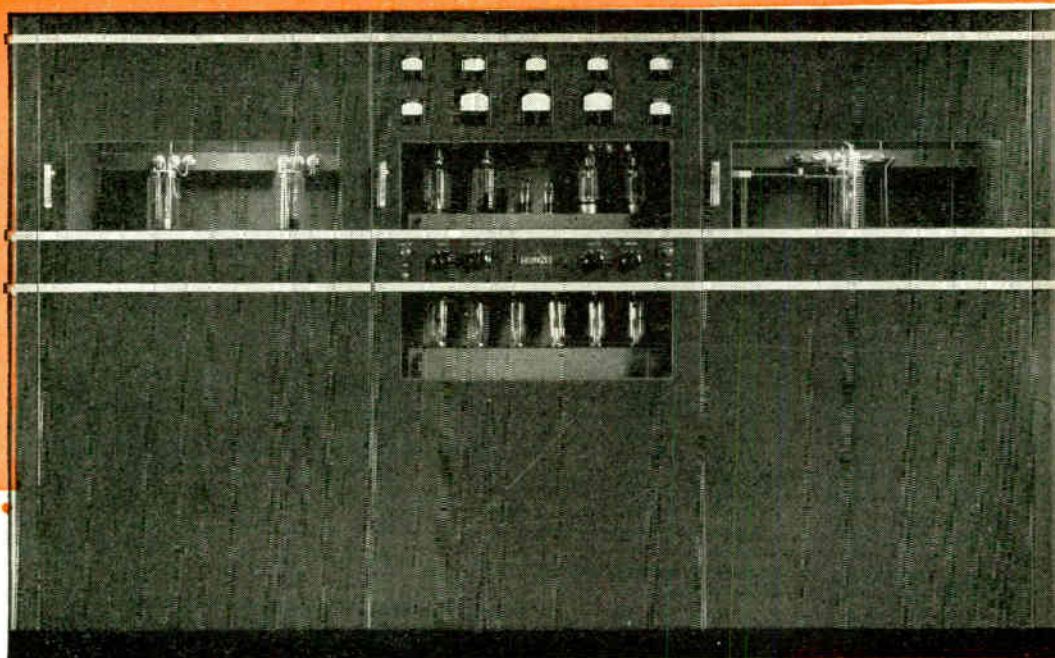

## Fulfilling the Tradition of Collins Quality Leadership

The 21A is a thoroughly developed 5 kw AM broadcast transmitter, and an excellent example of characteristically superior Collins engineering and construction.

Based on sound, well-proved principles of design, the 21A has been completely modernized within recent months. New components of improved design, with longer life and higher safety factors than were previously available, assure reliable continuous operation.

The response curve is flat, within  $\pm 1/2$  db. from 30 to 10,000 cycles. Reduced power to 1 kw is obtained by instantaneous lowering of plate voltages, permitting uninterrupted program transmission.

We will be glad to send you detailed information regarding the 21A, other Collins transmitters, the 12Y remote amplifier, the 12Z four channel remote amplifier and Collins high quality studio equipment. Collins Radio Company, Cedar Rapids, Iowa; 11 West 42nd Street, New York 18, N. Y.



**FOR BROADCAST QUALITY, IT'S...**

COLLINS EQUIPMENT IS SOLD IN CANADA  
BY COLLINS-FISHER, LTD., MONTREAL.



### The Collins 12Y Remote Amplifier

A one channel remote amplifier for unattended operation from a 115 volt a.c. power source, the 12Y provides the advantages of quick set-up, small size, light weight, high fidelity, simple operation, utmost reliability and low cost. It is practically hum free due to the removal of the isolation transformer, which is in the power cable.



Does your oscillograph have single or recurrent sweep frequencies as low as 0.2 cycles per second? *IT CAN...*

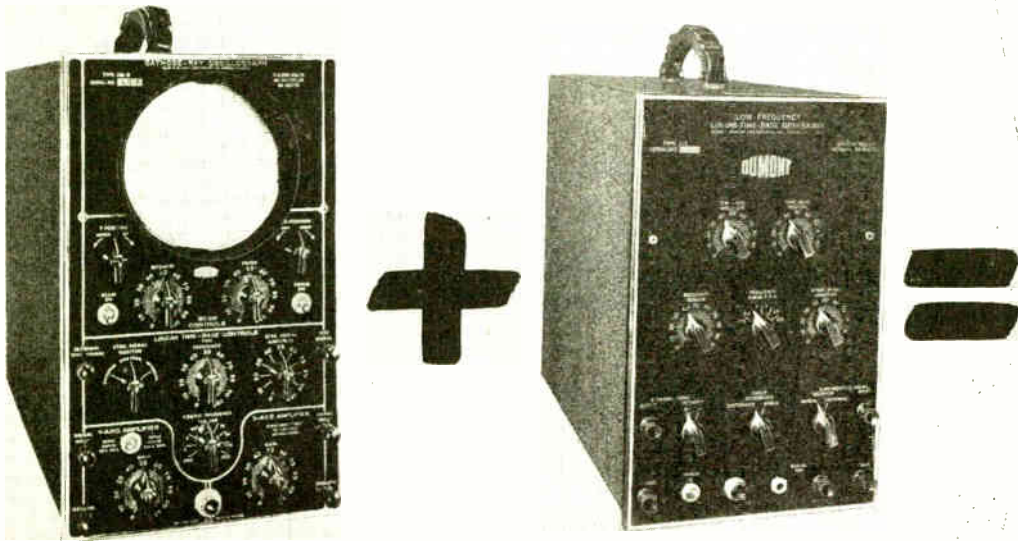

with the **DUMONT** Type 215  
**LOW-FREQUENCY LINEAR-TIME-BASE GENERATOR**

Here's the means for vastly increasing the usefulness of your already useful oscillograph.

This accessory instrument provides a 450 v. d.c. or peak-to-peak undistorted linear-time-base signal voltage of a frequency variable from 0.2 to 125 cycles per second! Special compensating circuit assures linearity.

The single sweep can be initiated either manually or by observed signal. The oscillograph-screen pattern can usually be spread out to three times' full

scale deflection. Return trace blanking signal of either positive or negative phase.

For single sweep, and for low-frequency recurrent-sweep studies, the DuMont Type 215 Low-Frequency Linear-Time-Base Generator used in combination with the DuMont Type 208-B general purpose oscillograph, or equivalent, provides excellent results. Note the typical studies herewith. Definitely "must" equipment.

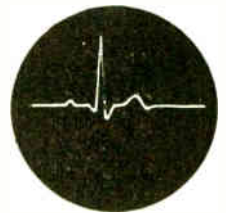

ELECTROCARDIOGRAPHY



FLASH BULB CHARACTERISTICS



MACHINERY VIBRATION STUDY

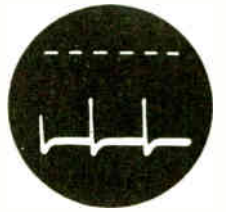

ELECTROENCEPHALOGRAPHY

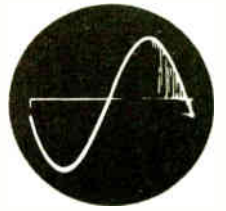

RELAY REBOUNCE STUDY



DIESEL ENGINE CYLINDER PRESSURE



Descriptive literature on request.

© ALLEN B. DUMONT LABORATORIES, INC.

**DUMONT** Precision Electronics & Television

ALLEN B. DUMONT LABORATORIES, INC., PASSAIC, NEW JERSEY • CABLE ADDRESS: WESPEXLIN, NEW YORK



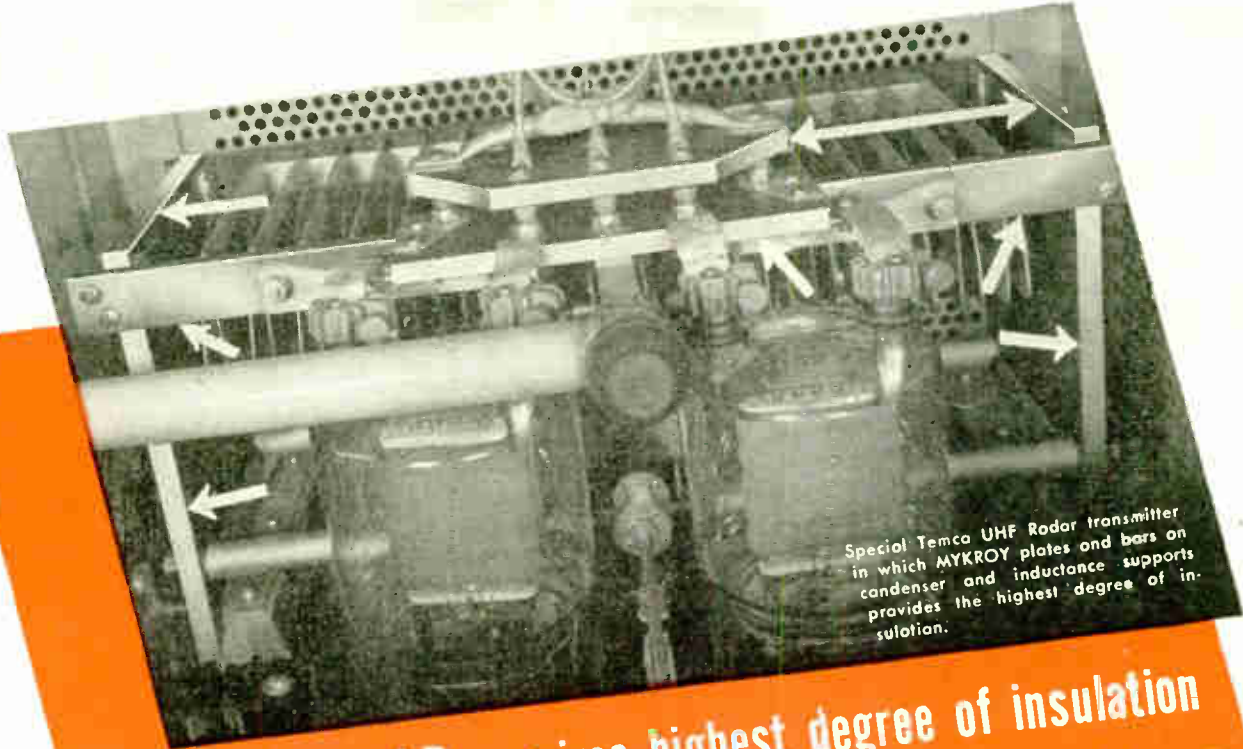

Special Temco UHF Radar transmitter in which MYKROY plates and bars on condenser and inductance supports provides the highest degree of insulation.

Because RADAR requires highest degree of insulation is specified at TEMCO

# MYKROY

PERFECTED MICA CERAMIC INSULATION

"WHEN insulation of the highest order is specified you can always depend on MYKROY to fill the bill," says Morton B. Kahn, President of Transmitter Equipment Manufacturing Company, designers and builders of advanced Radar equipment, "and insulation requirements for Radar set an all-time high for the industry."

Mr. Kahn's opinion is shared by leading engineers and manufacturers everywhere who have also discovered that MYKROY is one of the best and most usable insulating materials ever developed for general and high frequency applications.

Mykroy is a perfected Glass-Bonded Mica Ceramic made entirely of inorganic ingredients, hence it cannot char or turn to carbon even when exposed to continuous arcs or flashovers. Its electrical characteristics are of the highest order and do not shift under any conditions short of actual destruction of the material itself. Furthermore it will not warp—holds its form permanently—molds to critical dimensions and is impervious to gas, oil and water.

Although MYKROY is a new and superior type of insulation it costs no more than many standard dielectrics of lower electrical and mechanical properties. It will pay you, therefore, to investigate MYKROY now in planning your new products. Write for Bulletins 101-104.



High powered Temco VHF radar unit operates over wide frequency range utilizing forced air cooled tubes. MYKROY is used at all points requiring maximum insulation.

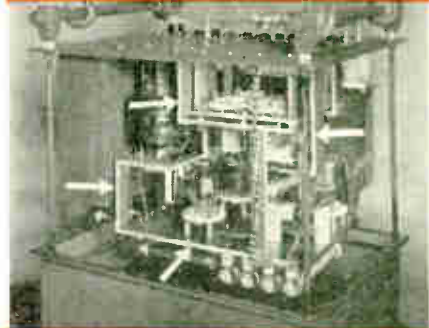

Temco 250KW Radar Pulse Modulator, all parts of which are constantly immersed in oil, operates with a normal plate voltage of approximately 25000 volts. MYKROY is used at all critical high voltage points to insure most-secure dependable insulation and particularly because it is impervious to oil.

MADE EXCLUSIVELY BY

**ELECTRONIC MECHANICS** INC.

70 CLIFTON BLVD., CLIFTON, N. J.  
CHICAGO 47; 1917 N. Springfield Ave., Tel. Albany 4310  
EXPORT OFFICE: 89 Broad Street, New York 4, New York

MYKROY IS SUPPLIED IN SHEETS AND RODS — MACHINED OR MOLDED TO SPECIFICATIONS

# "AEROTROLS"

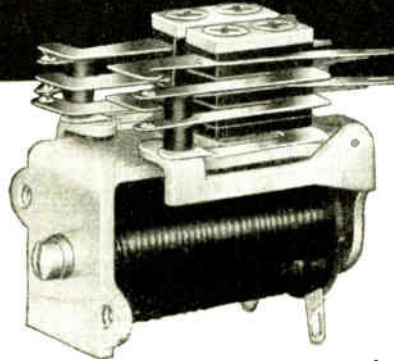

## *The Small Relays with the Big Performance*

- Engineered and manufactured for the necessities of military aircraft operation, Cook "Aerotrols" have opened new fields in electrical and electronic remote control applications in radio-radar, wire communications, mining, manufacturing, testing and innumerable other fields where greater dependability and accuracy must be provided.

- Here are some of the general specifications of the "Aerotrol" "400" Series relays. The size of the "Aerotrol" without springs (the frame, coil and armature) is  $1\frac{5}{16}$ " wide,  $1\frac{7}{16}$ " long and 1" high. Spring assemblies add to overall height, up to 1" for 6 springs. Average weight for two spring pile-ups is  $1\frac{3}{4}$  oz. The coil spool is one piece, moulded bakelite. Heel piece is arranged at the armature end, at which end also, spring solder terminals are located. Coil winding capacity can be provided up to 10,000 ohms and for positive operation on current values as low as 2 milliamperes. Coil treatment normally includes impregnation

with fungus lacquer and Insulex covering, and where required, the coil is treated for high humidity and other tropical conditions.

- "Aerotrols" are small, compact, yet rigidly constructed relays that have proven their dependability, not only in laboratory tests, but in actual operation under the most severe wartime conditions all over the world.

- "Aerotrols" are "application engineered" to provide specific performance suitable to circuit and control conditions. There are many selective features that can be incorporated into these relays. Bushings and insulators can be provided made of Cook patented "Cecotite" ceramics, to provide freedom from carbonization and wear, and to provide permanent stability of original adjustment and rapid frequency of operation. Mounting arrangements can be provided to meet installation conditions, including the plug-in types.

- "Aerotrols" of various types, such as time delay, latching, A.C. or D.C., both single and double pile-ups, can be supplied.

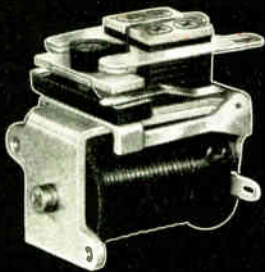

Illustrated above is an "Aerotrol" heavy current relay, with two Form "A" contacts operating on a double armature.

SEND FOR BOOKLET AR-145 FOR INFORMATION ON THE COMPLETE LINE OF "AEROTROL" RELAYS.

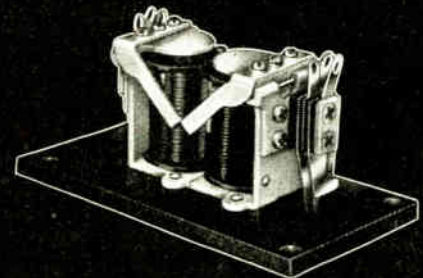

Illustrated above is a latching type "Aerotrol" combining two type "401" "Aerotrols." Any combination of the "400" series relays can be combined into a latching "Aerotrol."



CHICAGO 14, ILLINOIS

# Specialists IN CONTROL

Chicago Telephone Supply Co. has long been known as an outstanding authority and producer in the field of variable resistors. That is why radio manufacturers all over the world prefer to have CTS specialists in control.

CTS saves you production delays and operating trouble by these long established practices:

- Delivery when promised;
- Each resistor carefully tested to assure top performance;
- Uniform quality throughout the shipment;
- A variable resistor engineered for the application.

#### REPRESENTATIVES

R. W. Farris Co.  
406 West Thirty-fourth Street  
Kansas City 2, Missouri  
Phone: Logan 7495

Frank A. Emmet Co.  
2837 West Pico Boulevard  
Los Angeles 6, California  
Phone: Rochester 9111

George A. Coleman  
420 Market Street  
San Francisco 11, Calif.

#### BRANCH OFFICES

S. J. Hutchinson, Jr.  
401 North Broad Street  
Philadelphia 8, Pennsylvania  
Phone: Walnut 5389

#### IN ENGLAND

Chicago Telephone Supply Co.  
St. John's Woods  
103 Grove End Gardens  
London, N. W. 8, England

#### CANADIAN ASSEMBLY PLANT

C. C. Meredith & Co.  
Streetsville, Ontario

#### IN SOUTH AMERICA

Jose Luis Pontet  
Cordoba 1472  
Buenos Aires, Argentina  
South America

Masculina 2624  
Montevideo, Uruguay  
South America

Avda. Conselheira Rodrigues  
Alves 1057  
Villa Mariana  
Sao Paulo, Brazil  
South America

Walter Th. Kammann Willson  
Apartado 1891  
Norte 6 No. 17  
Caracas, Venezuela  
South America



**CHICAGO TELEPHONE SUPPLY**  
*Company*

ELKHART ★ INDIANA

VARIABLE RESISTORS • SWITCHES • RINGERS  
PLUGS AND JACKS • TELEPHONE GENERATORS

*Manufacturers of Quality Electro-Mechanical Components Since 1896*

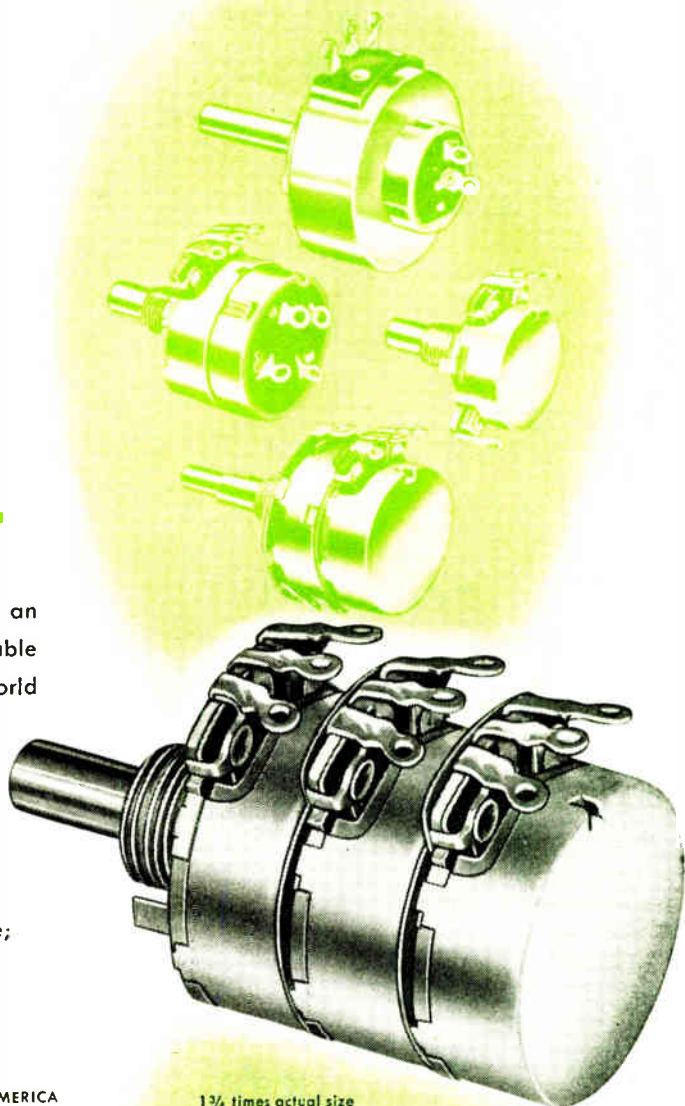

1 3/4 times actual size

This type 3-35 triple section potentiometer is a good example of CTS skill and precision workmanship. All three sections operate from the same shaft. Used as gain control in impedance matching circuits, as volume control with the two extra sections as tone compensation, and other special applications.

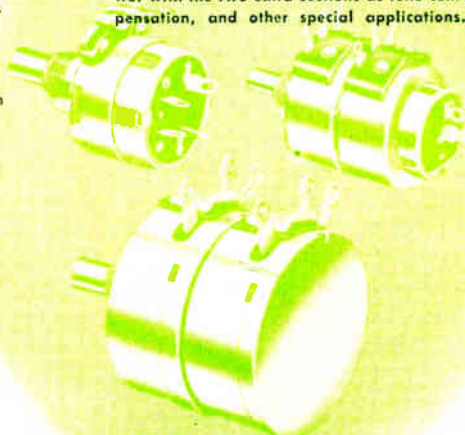

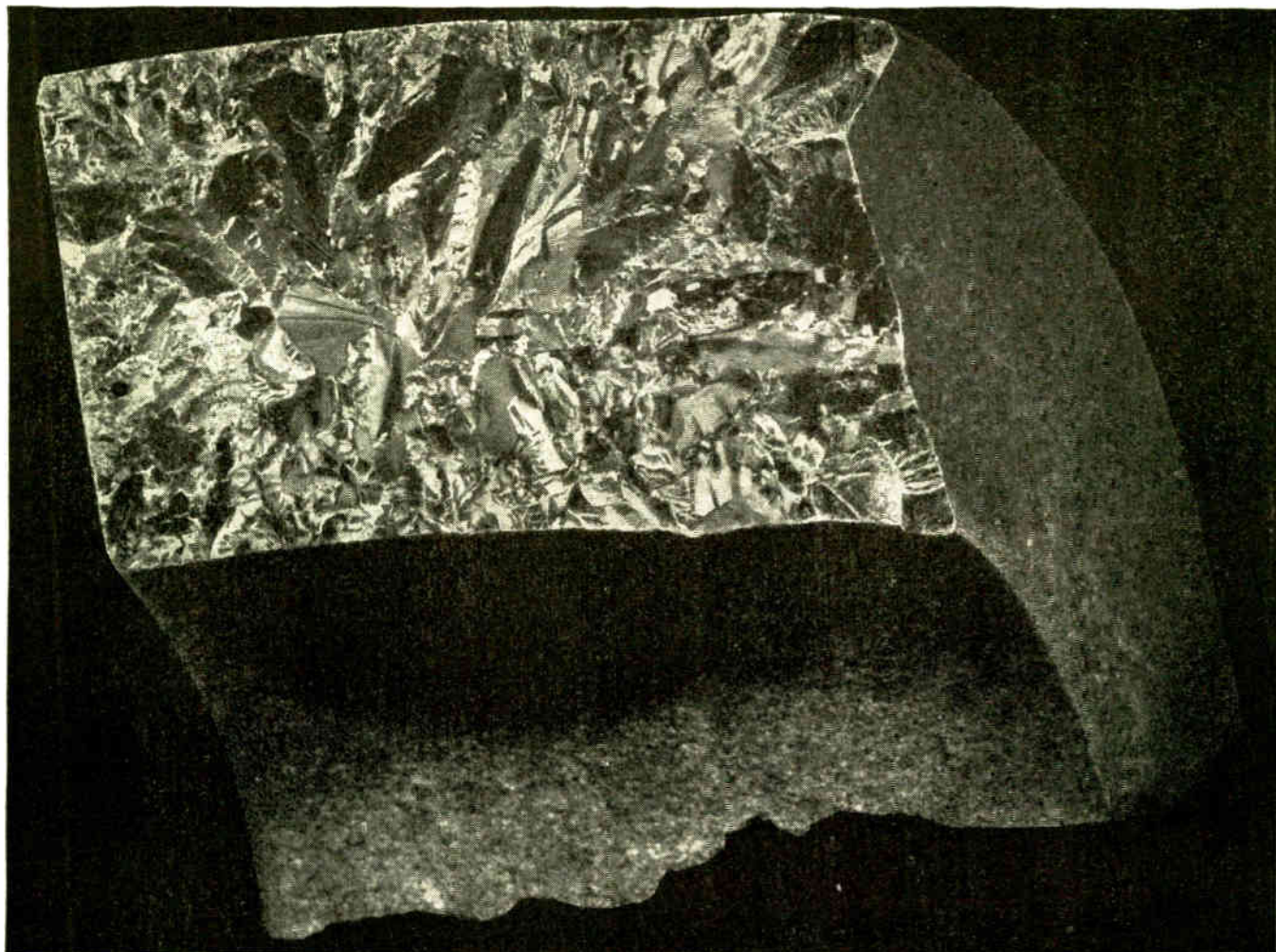

Photograph of a fragment of Alnico V

(This is the third of three advertisements regarding permanent magnet materials)

*What is your magnet made of?*

## ALNICO V

If your product requires a permanent magnet that develops the maximum magnetic energy in limited space and weight, Alnico V is the solution. It is the newest and "strongest" of the Alnicos, the aluminum-nickel-cobalt-iron permanent magnet alloys. Its store of magnetic energy is about five times that of cobalt magnet steel and three times that of the other grades of Alnico. Of the permanent magnet materials commercially available, it is highest in residual induction as well as available energy. Like the other Alnicos, No. V is hard, brittle, non-forgable and non-machinable and is formed by casting.

The improved permanent magnet characteristics of Alnico V are obtained by using

a higher percentage of cobalt and lower percentages of the other elements and a new heat treatment. The treatment consists of normalizing at a much higher temperature than with the other grades, cooling in a magnetic field parallel to the field in the finished magnet and annealing for several hours.

Utilization of the maximum available energy requires that both magnet and magnetic circuit be designed with expert consideration of the magnetic characteristics of Alnico V. For over 35 years, this company has specialized in permanent magnet engineering and production. We invite the consultation of manufacturers who have problems in the use or application of permanent magnets. Write for free technical handbook: *Permanent Magnet Manual*.

★ ★ ★ **THE INDIANA STEEL**

6 NORTH MICHIGAN AVENUE, CHICAGO 2, ILLINOIS



**PRODUCTS COMPANY** ★ ★ ★

Copyright, 1945, The Indiana Steel Products Co.  
SPECIALISTS IN PERMANENT MAGNETS SINCE 1910



A CLASS "C" INSULATION—  
 INORGANIC-CERAMIC—  
 APPROXIMATELY 1/4 MIL THICK—  
 PERMITS CONTINUOUS  
 OPERATION AT 200°C.

# THE WIRE INSULATION

## ... that will not burn!



Sprague CEROC 200 is an inorganic, non-inflammable ceramic wire coating supplied in a preferred thickness of only 1/4 mil and holding vast opportunities for smaller size and lighter weight with greatly increased power for a wide variety of electrical equipment. By using it, mid-gig size windings can be made to do man-size jobs—with safe, conservative operation up to 200°C.

Space factor is higher than that of any other type of wire insulation and, despite its ceramic nature, CEROC 200 can readily be wound to meet most requirements.



MIDGET-SIZE WINDINGS  
 DO MAN-SIZE JOBS!

Write for copy of CEROC 200 Bulletin 505

**SPRAGUE ELECTRIC CO., NORTH ADAMS, MASS.**



# SPRAGUE

# Ceroc 200

(\*Trademark Reg. U. S. Patent Office)

Pioneered and Produced by the Makers of SPRAGUE CAPACITORS and \*KOOLOHM RESISTORS



# OHMITE

ALL CERAMIC • HIGH CURRENT

## Tap Switches

IN 5 SIZES

**MODEL 608**  
100 AMPS. MAX. 300 V.A.C.  
DIAMETER 6"  
2 to 8 TAPS

**MODEL 412**  
50 AMPS. MAX. 300 V.A.C.  
150 V.A.C. BETWEEN TAPS  
DIAMETER 4-3/16"  
2 to 12 TAPS

**MODEL 312**  
25 AMPS. MAX. 300 V.A.C.  
150 V.A.C. BETWEEN TAPS  
DIAMETER 3-5/16"  
2 to 12 TAPS

**MODEL 212**  
15 AMPS. MAX. 150 V.A.C.  
DIAMETER 2-1/4"  
2 to 12 TAPS

**MODEL 111**  
10 AMPS. MAX. 150 V.A.C.  
DIAMETER 1-3/4"  
2 to 11 TAPS

*2 or 3 Units Can Be Connected in Tandem  
for Simultaneous Circuit Switching*

### FEATURES

- Ceramic Construction
- Compact, All-Enclosed
- Slow-Break, Quick-Make
- Silver-to-Silver Contacts
- Self-Cleaning Action
- Low Contact Resistance
- Cam & Roller Mechanism
- High Strength Ceramic Hub
- Insulated Steel Shaft
- Back-of-Panel Mounting

## *Simpler, More Compact*

### HIGH CURRENT CIRCUIT SWITCHING

In these Ohmite load-break switches, as few as 2 or as many as 12 high current taps are compactly arranged yet perfectly insulated. The switches are non-shorting, single-pole, rotary, multi-position units. They provide greater operating convenience in battery chargers, tapped transformers, welders, induction heaters, and other applications. *Write for further helpful facts or engineering aid.*

### OHMITE MANUFACTURING COMPANY

4983 Flournoy Street, Chicago 44, U. S. A.

*Write on company letter-head for Industrial Catalog and Engineering Manual No. 40. Address Ohmite Mfg. Co., 4983 Flournoy St., Chicago 44.*

*Be Right with* **OHMITE**

**RHEOSTATS • RESISTORS • TAP SWITCHES**



# POWER

## HIGH VOLTAGE POWER SUPPLY

This is the RA-38 power supply—another of the numerous valuable items in the group of government radio and electronic supplies offered for general distribution through the Hallicrafters Co., agents for RFC under Contract SIA-3-24.

Output voltage continuously variable from 0 to 15,000 volts. Can be easily adapted to deliver up to 6,000 volts at 1 ampere. Excellent power supply for laboratory work or can be used as power source for broadcast stations, induction heating equipment, vacuum tube life tests and many other industrial applications.

### THESE VALUABLE ITEMS

*Available Now*

or very soon. Write, wire or phone for further information.

- head phones • test equipment • component parts • marine transmitters and receivers • code practice equipment • sound detecting equipment • vehicular operation police and command sets • radio beacons and airborne landing equipment.

# hallicrafters RADIO

HALLICRAFTERS CO., AGENTS OF RFC UNDER CONTRACT SAI-3-24  
MANUFACTURERS OF RADIO AND ELECTRONIC EQUIPMENT

## CLIP THIS COUPON NOW

RFC DEPARTMENT 216, HALLICRAFTERS  
5025 West 65th Street • Chicago 38, Illinois

- Send further details and price on RA-38 Power Supply  
 Send listings of other available items

Especially interested in.....

NAME.....

ADDRESS.....

CITY.....ZONE.....

STATE.....

**WATER-COOLED CAPACITORS  
FOR HOT JOBS**

Substantial savings are made possible by the small space requirements and low price of G-E high-frequency, parallel-plate capacitors. These compact, water-cooled, liquid-filled units are designed especially for use in the resonant circuit of high-frequency electronic oscillators, such as those used in electronic-heater equipments. Features include: low losses at high frequencies, uniformly high dielectric strength, and high current rating per unit volume.

Available in ratings of .0075 to .034 microfarad (capacitance tolerance 5%), and for maximum rms working voltages of 2000 to 9000 volts. Write for Bulletin GEA-4365.

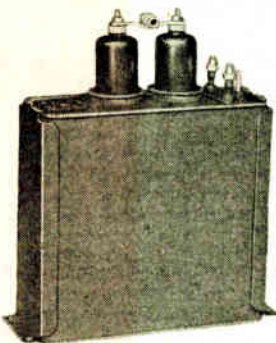

**MIGHTY RESISTORS  
OF G-E MYCALEX**

Physically stronger than porcelain — except under compression — G-E mycalex has higher heat and arc resistance than organic insulating materials; at elevated temperatures its dielectric

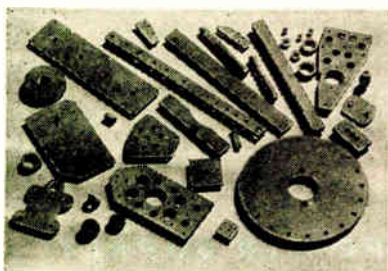

strength is also higher. It is compression-molded into plates, rods, and strips that can be readily machined to finished shapes. Simple shapes are injection-molded directly, with or without metal inserts.

Its low loss at high frequencies makes G-E mycalex particularly valuable in uhf apparatus. Impervious to water, oil, and gas, G-E mycalex neither warps nor shrinks with age. Write for Bulletin GEA-4244.

**TO TEACH  
ELECTRONICS QUICKLY**

Where production workers and foremen have a working knowledge of electronics, production steps up because there are fewer rejects, and less time is spent on repairs. Now you can teach them all the fundamentals without the monumental task of preparing such a course. General Electric offers a talking slidefilm course to teach not only the fundamentals, but also principles of com-



binning tubes and other components into electronic circuits. It is written for easy understanding by personnel lacking a technical background.

Twelve half-hour slidefilms with records, complete in a carrying case, make up the entire course. A meeting place, screen, and a sound slidefilm projector (35mm, 33½ rpm) are all you need. With the 12 slidefilms you get 25 sets of individual lesson guides keyed to the film, and a manual containing instructions for conducting the course. Write for details.

**FROM 0 TO 270 VOLTS  
AT A TWIST  
OF THE WRIST**

For jobs that need smooth, uninterrupted control of voltage and small amounts of power, the G-E variable-voltage auto-



transformer is finding wide application. Maximum output voltage is 270 from a 230-volt power source; half that from 115-volt power supply.

Output voltage is varied by moving a carbon brush around a band on the coil from which the tough insulation has been removed. Calibrations on the easy-to-read dial are widely spaced for easy selection of the output voltage. Strong mechanical construction, light weight, and small size make this G-E variable-voltage autotransformer ideal for bench or panel mounting. Ratings from 243 to 810 va. Write for Bulletin GEA-3635A.

**COILS FORM FASTER  
WHEN YOU USE FORMEX**

High-speed winding, bonding, and baking pose no problem with Formex magnet wire. Its abrasion resistant, polyvinyl-acetal insulation — a tough, flexible film — will turn sharp corners at high speed without cracking. Formex wire speeds up production, cuts down factory rejects and customer complaints.

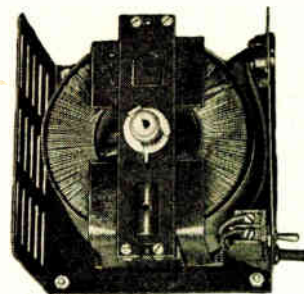

The dielectric strength of Formex magnet wire is high and stays high, during the entire life of your apparatus. For tighter-packed, lighter-weight, lower-cost coils, specify Formex magnet wire, either regular or colored. It's suitable for operation in ambient temperatures up to 105 C — also for jobs where moisture and solvent resistance are needed. Round Formex from 8 Awg to 40 Awg, ultra-fine from 41 Awg to 50 Awg, and rectangular in a full range of sizes. (Bulletin GEA-3911)

# DIGEST

## Timely Highlights on G-E Components

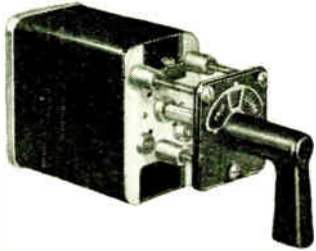

### ONE MOTION CONTROLS MANY CIRCUITS

For transfer and control switching, simple or complex, there is a G-E (Type SB-1) switch to do the job. These switches are rated 600 volts, 20 amp continuous or 250 amp for 3 seconds. Standard models are available with as many as 16 twelve-position stages.

Precision construction makes operation easy, even in special models which have as many as 40 stages. Cam-operated silver contacts are long-lived, proved by more than 1,000,000 test operations without excessive wear. Stages are isolated by dielectric barriers.

Wiring requires only a screwdriver, and ample space is allowed for easy connection. There are two types of locks, both of which permit locking in any position. The standard switches are dead-front, with all live parts protected by a removable cover. Write for Bulletin GEA-1913-D.

### WHEN DELAY HAS A JOB TO DO

This flux-decay, copper-jacketed time-delay relay is specially designed for application in aircraft where small size, reliability, and light weight are of importance.

A time delay of .35 sec is provided. A variety of contact arrangements is available for handling up to 100 amps (inrush current) under the usual conditions of altitude, temperature, vibration, and humidity. Write for Bulletin GEA-3865.

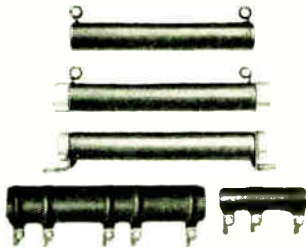
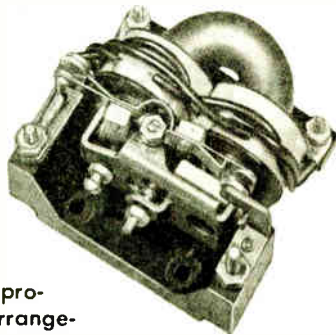

### HOT BUT NOT BOTHERED

Wound on strong, heat-resistant bodies, G-E vitreous-enamelled resistors are little affected by sudden, extreme, temperature changes. From 10 to 180 watts, they are available in most resistance ratings. Resistance remains practically constant, because of

the low temperature coefficient of the resistance wire.

Enamel, fused to a uniform, glassy surface over the wire imbedded in it, forms a durable, water- and air-impervious coating. A wide variety of open and closed styles, terminals, taps, and mountings gives these resistors a broad field of application in electronic apparatus. Write for Bulletin GEA-3911.

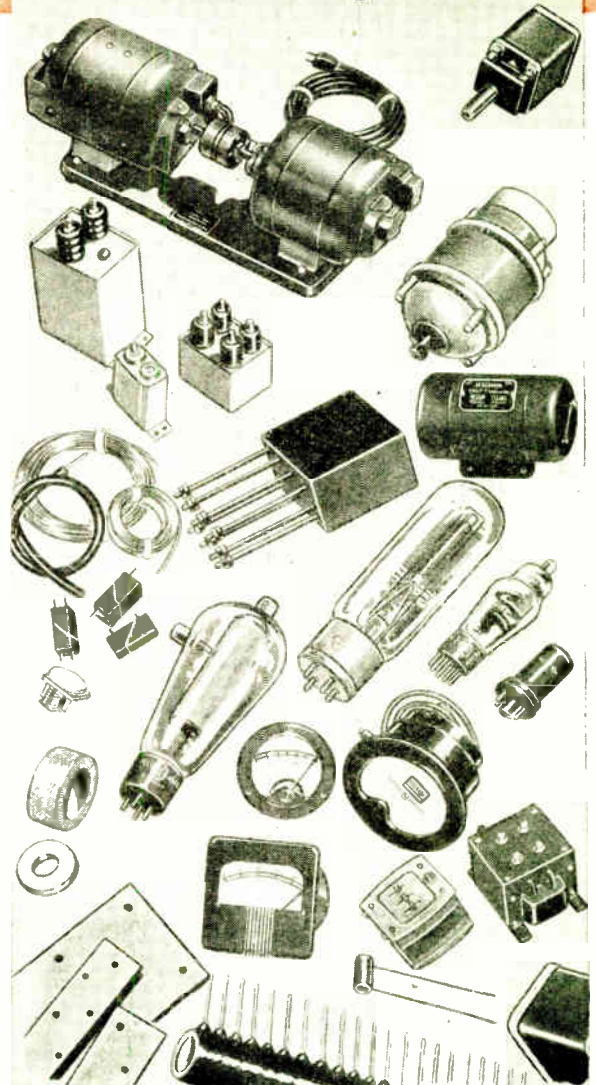

Capacitors • Sensitive control and time-delay relays • Limit switches • Motors, dynamotors, amplidyne • Motor-generator sets • Alnico magnets • Small panel instruments • Formex\* magnet wire • Radio transformers • Switchettes • Selsyns • Chokes • also tubes, crystals, plastics products, insulation materials, and many others

GENERAL ELECTRIC COMPANY,  
Apparatus Dept., Sec. 642-9  
Schenectady 5, N. Y.

8010

Please send me

GEA-4365

GEA-4244

GEA-3911

Details on Electronics Course

GEA-3865

GEA-3635A

GEA-1913D

NAME \_\_\_\_\_

COMPANY \_\_\_\_\_

ADDRESS \_\_\_\_\_

CITY \_\_\_\_\_

STATE \_\_\_\_\_

Buy all the BONDS you can — and keep all you buy

# METAL ASSEMBLIES AND COMPONENTS FOR ELECTRONIC AND MECHANICAL DEVICES

●  
**ENGINEERING**

●  
**DEVELOPING**

●  
**FABRICATING**

●  
**ELECTRO-FORMING**

●  
**PLATING**

●  
**FINISHING**  
●

**B**ERNARD **R**ICE'S **S**ONS

I N C O R P O R A T E D

MANUFACTURERS OF QUALITY METAL PRODUCTS SINCE 1867

OFFICE: 325 FIFTH AVENUE, NEW YORK 16, N. Y.

WORKS: 139-145 NORTH TENTH STREET, BROOKLYN 11, N. Y.

# TRANSTATS ARE THE "TRIGGERS" OF TUNG-SOL'S BOMBARDERS

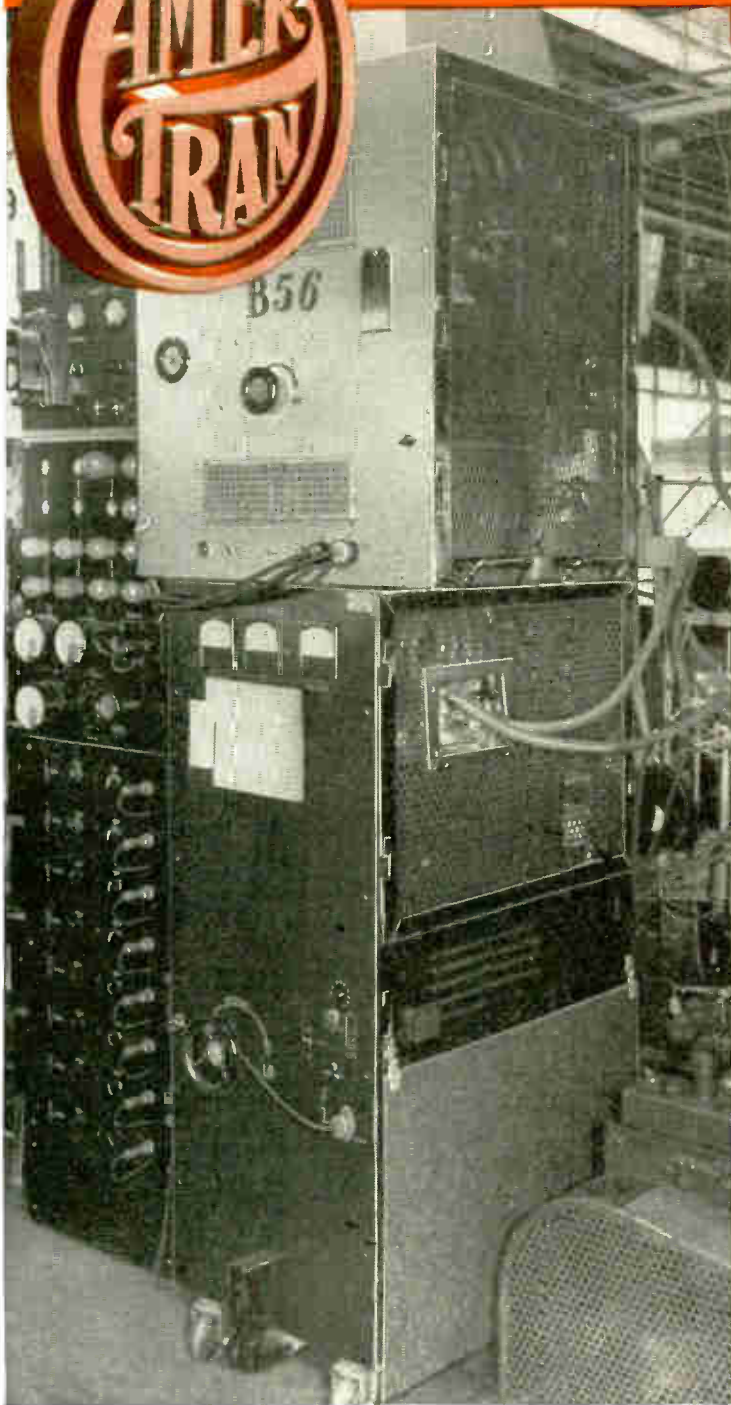

Shown here are Bombardeur (below with black panel) and Induction Heater (above with light panel) at Tung-Sol, Newark, N. J., Plant.



Transtat for 0.3 to 20 KVA.

Whenever heavy alternating currents are controlled at the Tung-Sol Lamp Works, Transtats are put on the job. Tung-Sol builds quality into tubes with the help of Transtats used for Life Testing, Aging and Induction Heating.

To provide the unusual ruggedness and close control needed for this work, the Transtat Commutator is ground out of the periphery of the coil—where the wires are flat and parallel. This produces a glass-smooth, broad brush track. It permits a longer, cooler running brush, prevents arcing and jumping and provides practically stepless control. A transformer-type regulator, the Transtat will not distort wave form, interfere with radio reception or disturb power factor. State rating required when writing for bulletin.

**AMERICAN TRANSFORMER COMPANY**  
178 Emmet Street  
Newark 5, N. J.

**AMERTRAN**  
PIONEER MANUFACTURERS OF TRANSFORMERS, RECTIFIERS AND  
RECTIFIERS FOR ELECTRONICS AND POWER TRANSMISSION

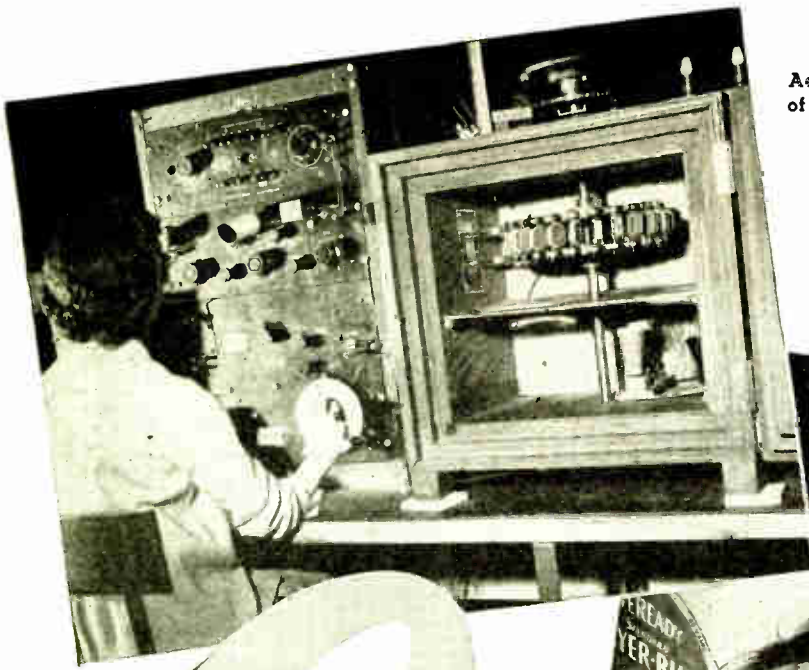

Aerovox high-frequency capacitance bridge test of mica capacitors in heat chamber at right.

Block mica check for power factor. Every piece is checked before splitting and sorting according to thickness.

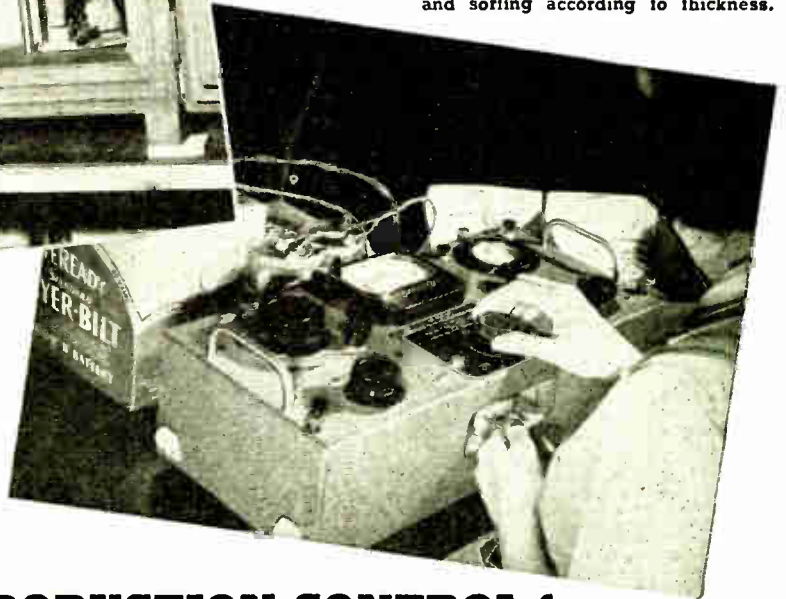

## QUALITY PRODUCTION CONTROL from Alpha to Omega... step by step... with nothing taken for granted or left to chance... spells AEROVOX MICA CAPACITOR

*Craftsmanship*

● Mica capacitors are usually precision units. Capacitance tolerances may be tight. But even more important, critical characteristics such as power factor and "Q" must be met.

AEROVOX QUALITY CONTROL is exercised at every step in production. Incoming block mica is checked piece by piece for power factor and "Q." This proved invaluable

during the wartime mica shortage when new sources of supply had to be used. A spot check simply would not do.

Split micas are checked—electrically, visually, micrometrically. Mica assemblies are checked. Completed mica units are checked on the Q-meter. And since operating characteristics may change with operating temperatures, such units

are checked at given temperatures, by means of precision instruments of recognized accuracy, including Aerovox-designed and -built instruments.

It is this kind of production inspection, along with skilled craftsmanship and engineering "know-how," that accounts for the enviable reputation enjoyed by Aerovox mica capacitors.



*Capacitors*

INDIVIDUALLY TESTED

AEROVOX CORPORATION, NEW BEDFORD, MASS., U. S. A.

SALES OFFICES IN ALL PRINCIPAL CITIES

Export: 13 E. 40 ST., NEW YORK 16, N. Y. • Cable: 'ARLAB' • In Canada: AEROVOX CANADA LTD., HAMILTON, ONT.



# YOU CAN'T KEEP A COLD CUSTOMER SOLD!



**BH SPECIAL TREATED  
FIBERGLAS SLEEVING**

*Tops in Electric Heaters!*

- Won't Fray When Cut
- Flexible and Strong
- Non-Burning to 1200°F

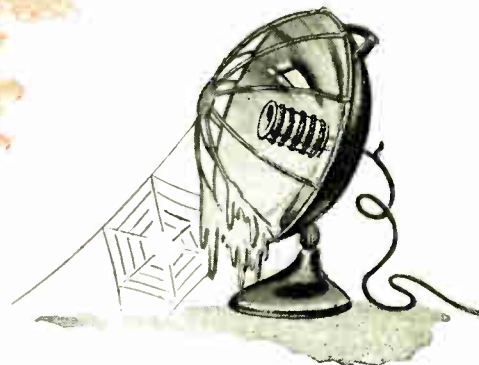
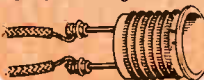

**W**HETHER he's Mr. Big of Industry or plain Mr. Homebody, the performance of your product's electrical insulation can make or break *his* good will, influence *your* future sales. Look at *all* the hazards of faulty or insufficient insulation. See why hundreds of manufacturers are protecting *their* products with BH Fiberglas Sleeving—the insulation that's way ahead in every important requirement, thanks to the *exclusive* BH process.

BH Fiberglas Sleeving is *permanently* flexible and non-fraying, the *original* sleeving to combine these qualities with heat resistance to

1200°F., with high tensile strength, and with resistance to moisture, oil, grease and most chemicals. It's easier to handle and install, and lasts longer in severest service. That's why BH Special Treated Fiberglas Sleeving, for instance, does a trouble-free job when the heat's on—why Mr. Room Heater Customer is sold *for good* when the heater's BH-equipped.

Whatever your product may be, if it depends on electrical insulation, you can count on one of the three BH Fiberglas Sleeveings to meet your strictest needs. Send for free BH samples *today* — test them yourself — expect surprising results!

## 3 GREAT BH FIBERGLAS SLEEVINGS—EACH 3 WAYS BETTER!



**NON-STIFFENING\***

**BH EXTRA FLEXIBLE FIBERGLAS SLEEVING • BH SPECIAL TREATED FIBERGLAS SLEEVING  
BEN-HAR COATED FIBERGLAS SLEEVING**



**THIS**

**NON-FRAYING\***



**NOT THIS**



**NON-BURNING\***

\*Ask for sample folder giving degree above characteristics are combined in these three sleeveings. All standard sizes and colors—available in standard 36-in. lengths and 500-ft. coils.



ALSO SLOW-BURNING IMPREGNATED MAGNETO TUBING • SLOW-BURNING FLEXIBLE  
VARNISHED TUBING • SATURATED SLEEVING • A. S. T. M. SPECIFICATIONS

**BENTLEY, HARRIS MANUFACTURING CO.**

**Dept. I Conshohocken, Penna.**

# PREVIEW OF *Rauland* TELEVISION FOR THEATRES

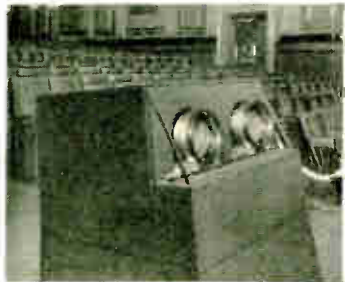
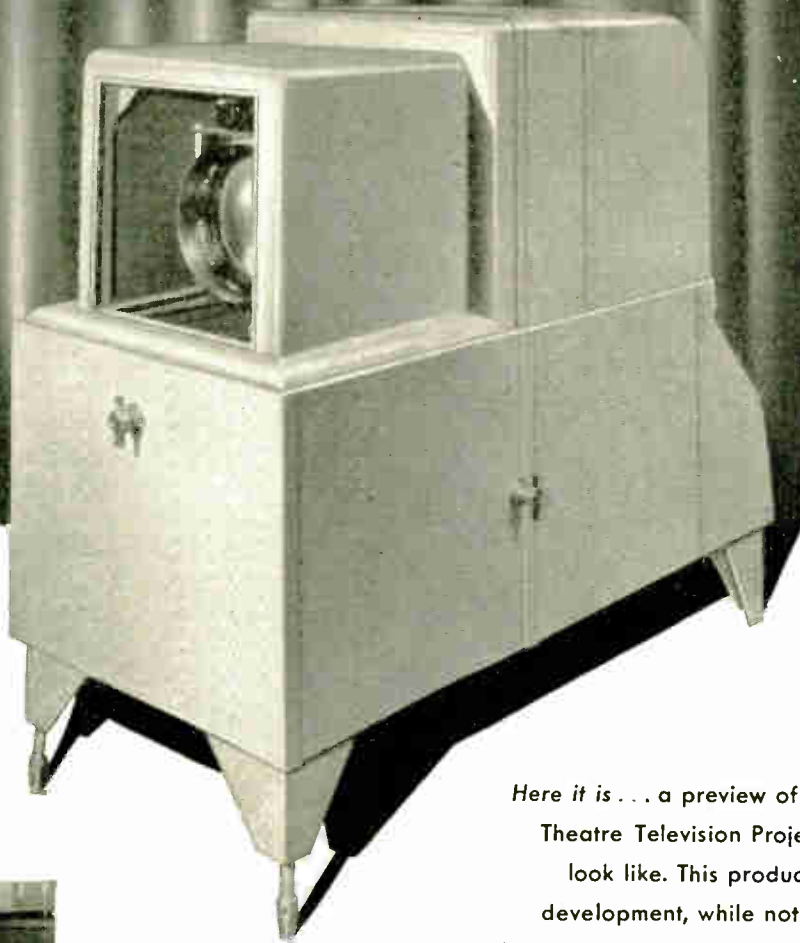

Pictured at left is a television projection installation in a London theatre before the war, operated by Cinema Television Ltd., associated with Gaumont-British, Ltd., and Baird Television. RAULAND owns American rights to all present and future television patents and processes of these British pioneers, thus combining the most advanced television thinking of two continents, to bring the finest in revolutionary entertainment to the American Public.

Here it is . . . a preview of what the RAULAND Theatre Television Projection Equipment will look like. This product of many years of development, while not yet available, is now in daily operation in the RAULAND Laboratory-Theatre, projecting scenes as they occur on a full size theatre screen. Here, advanced refinements are being constantly added to ready this equipment for the time when Theatre Television will make its public appearance.

RADIO • RADAR • SOUND

## *Rauland*

COMMUNICATIONS • TELEVISION

*Electroneering is our business*

THE RAULAND CORPORATION • CHICAGO 41, ILLINOIS

# COMPACT CONTROLS

## with Allied's "E" and "F" Relays

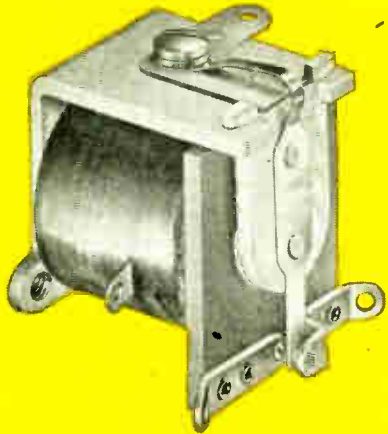

The E relay illustrated is a single pole, double throw arrangement. The standard silver contacts are capable of carrying one ampere at 24 volts DC or 115 volts AC non-inductive. Insulation is bakelite. Alloy contacts are available. Other contact arrangements may be furnished. The E is 15/16" high, 1 1/16" wide and 1 1/16" long. Weight 1 1/8 ounces.

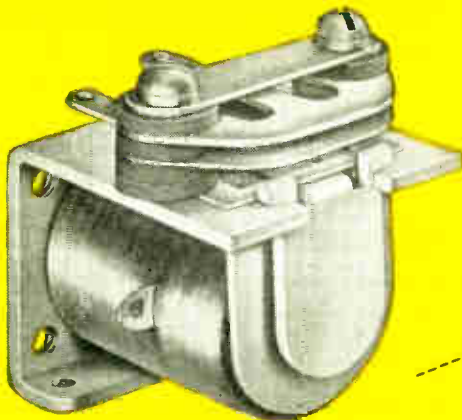

The F relay shown is a single pole, single throw normally open combination. The standard contacts carry three amperes at 24 volts DC or 115 volts AC non-inductive. Bakelite insulation is used. May be supplied on other contact combinations. Silver is standard contact material, alloy contacts can be substituted. The F is 1 11/32" high, 1 3/16" wide and 1 3/32" long. Weight is 1 7/8 ounces.

DESIGNED for electronic controls in which space limitation is a critical factor, the E relay is small enough to fit into an area of approximately one cubic inch. Light too, it weighs about one ounce. The F relay, although available in two pole, double throw, is only slightly larger and weighs less than two ounces.

Used in your electronic assembly these relays will save you space and weight. Moreover you will be assured of positive and quiet operation, for into these relays go the same careful design and manufacturing precision found in Allied's larger relays.

Whatever your relay applications, check with Allied. In addition to sensitive, telephone, power, differential and other types of relays Allied manufactures solenoids and electro-magnetic devices. A number of strategically located plants are available to supply your immediate requirements. Allied's quality standard is in keeping with your post war products . . . write today for more information.



### ALLIED CONTROL COMPANY, INC.

GENERAL OFFICES: 2 East End Ave. (at 79th St.) New York 21, N. Y. *Factories:* New York City (2 East End Ave.) — Plantsville, Conn. Chicago—4321 N. Knox Avenue, Chicago 41, Illinois. In California: Allied Control Co. of California, Inc. 1633 South Hope St., Los Angeles 15, Calif.

# MEN AT WORK

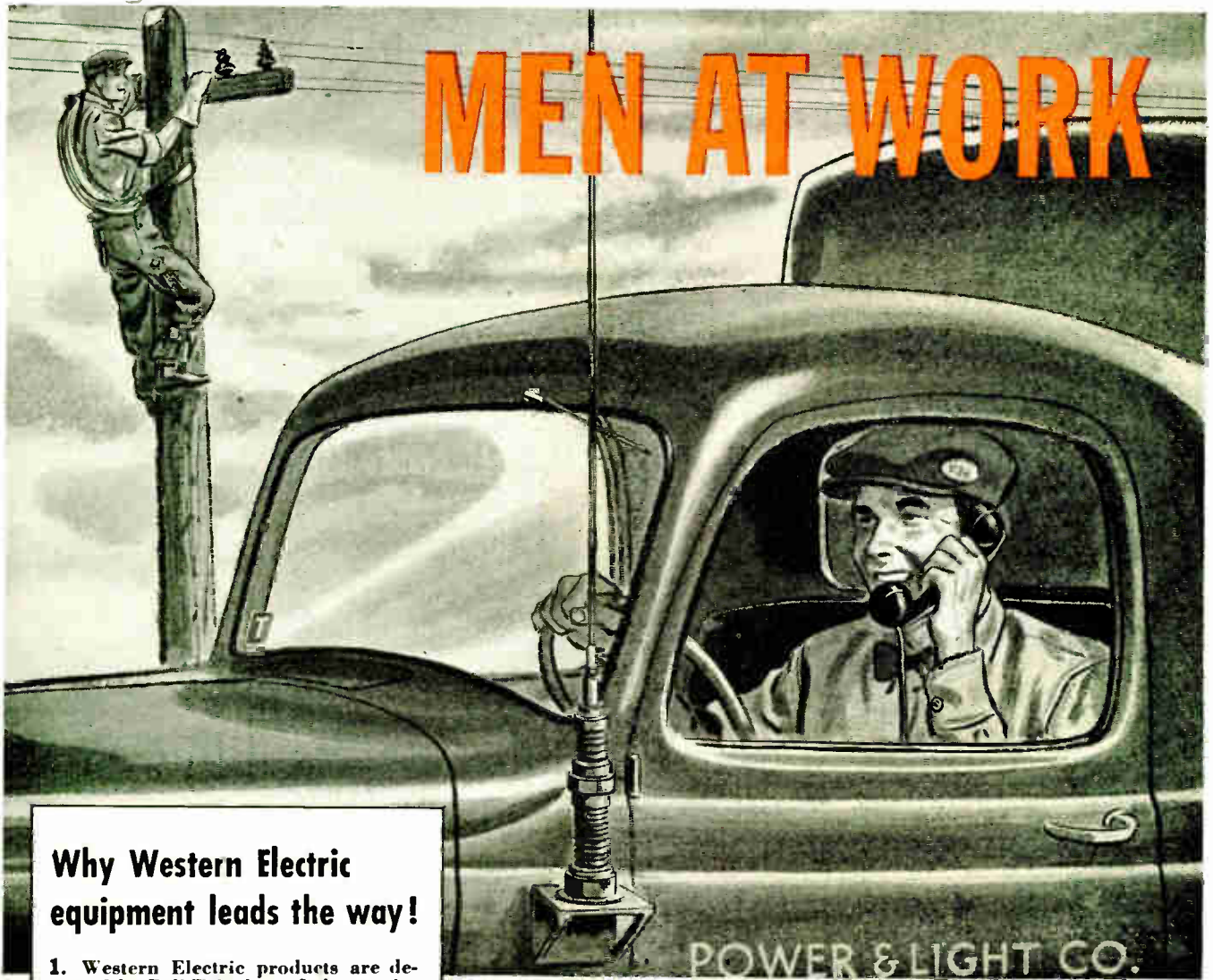

## Why Western Electric equipment leads the way!

1. Western Electric products are designed by Bell Telephone Laboratories — world's largest organization devoted exclusively to research and development in all phases of electrical communication.
2. Since 1869, Western Electric has been the leading maker of communications apparatus. During the war this company was the nation's largest producer of electronic and communications equipment.
3. The outstanding quality of Western Electric equipment has been proved daily on land, at sea, in the air, under every extreme of climate. No other company supplied so much equipment of so many different kinds for military communications.

## Western Electric

Global war has spotlighted and proved to all the world the tremendous value of instantaneous communication by mobile radio telephone. In the air, on land and at sea, it has helped to get the job done faster and to save countless lives.

Men at work or men at play, in the years ahead, will find mobile radio telephone an equally efficient means of keeping

### Western Electric has specialized



AM - BROADCASTING - FM



MARINE RADIO



AVIATION RADIO



MOBILE RADIO

# or MEN AT PLAY



## equipment leads the way!

in quick, easy contact with business headquarters or with home.

For more than a quarter of a century, Bell Telephone Laboratories and Western Electric have pioneered in the field of mobile radio. When manpower and materials become available, count on Western Electric for the finest equipment for mobile communications services.



*Hold all your War Bonds!*

### knowledge in all of these fields



HEARING AIDS



SOUND SYSTEMS



VACUUM TUBES

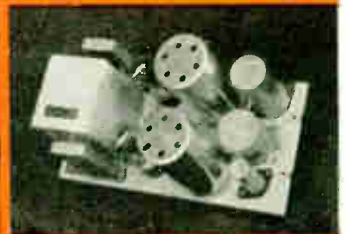

COMPONENT PARTS

POSTWAR MODEL

INTER OFFICE MEMO

*Specify Magnavox Capacitors*

**E**CONOMY in size, economy in cost, and efficiency of operation are features Magnavox Electrolytic Capacitors can promise — and deliver.

★★ *Through the use of a finely divided fabricated aluminum anode and improved processing technique, Magnavox builds capacitors to resist severest operating conditions . . . satisfaction is guaranteed.*

★★ *Since Magnavox standardizes containers into only eight sizes, design and assembly problems are greatly simplified, assuring greater speed and efficiency.*

★★ *Mechanically, electrically and chemically Magnavox capacitors reflect years of trial and error experience . . . that is yours to command. The Magnavox Company, Components Division, Fort Wayne 4, Ind.*



**New Reference Guide**, yours for the asking. Capacitor specifications charted for quick reference. Write on your letterhead.

**Magnavox**  
has served the radio industry 34 years



## CONCENTRICITY...

### For Uniform Transmission Characteristics in High Frequency Lines

IN COAXIAL CABLES, more than in any other types, accurate relationship between the component parts is essential.

Concentricity and uniformity of conductors and dielectric join in Anaconda Coaxials to effectively fulfill the objectives of electrical designers.

Each type is specifically designed to serve best in the intended application. All electrical characteristics are held within close limits to uniform standards assuring accurate surge impedances.

In addition to manufacturing standard types of coaxial cables, Anaconda offers research and engineering facilities to meet needs for specialized types.



**ANACONDA COAXIAL CABLES**  
Anaconda coaxial cables are made in a variety of types to Army-Navy specifications.



# ANACONDA WIRE & CABLE COMPANY

GENERAL OFFICES: 25 Broadway, New York City 4

*Subsidiary of Anaconda Copper Mining Company*

CHICAGO OFFICE: 20 North Wacker Drive 6 • Sales Offices in Principal Cities

ELECTRONIC INDUSTRIES • November, 1945

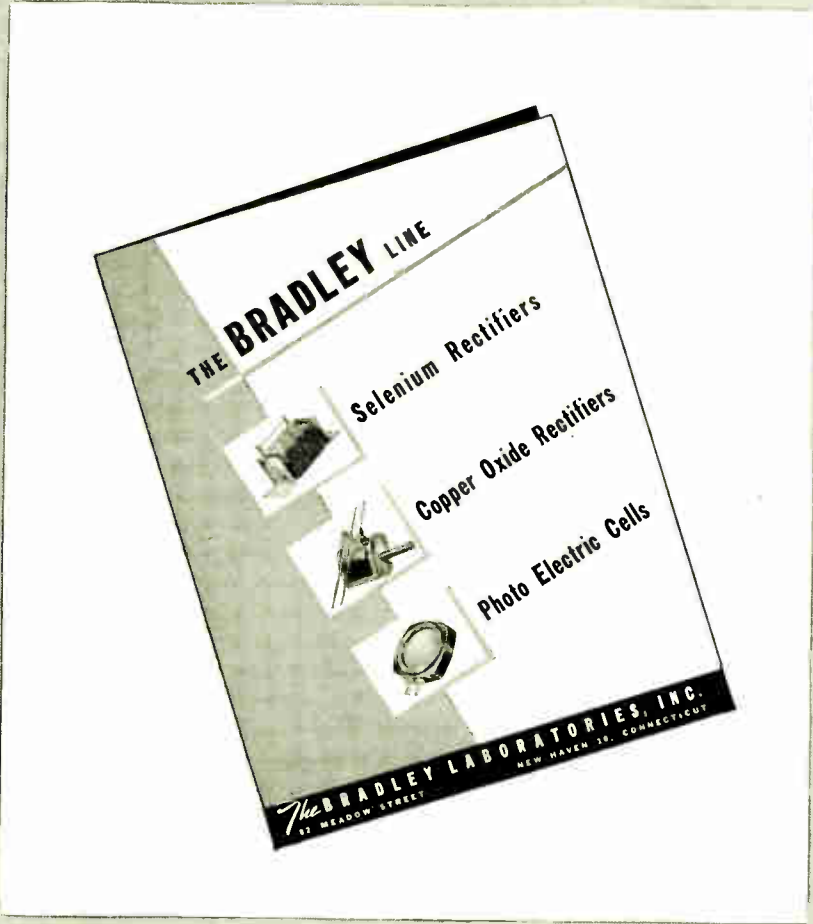

*Write for your copy of  
this new literature-*

**BRADLEY**  
**LABORATORIES, INC.**  
82 MEADOW ST., NEW HAVEN 10, CONN.



# Federal INDUSTRIAL POWER TUBES ARE PERFORMANCE-RATED

**UNDER ACTUAL  
OPERATING  
CONDITIONS**

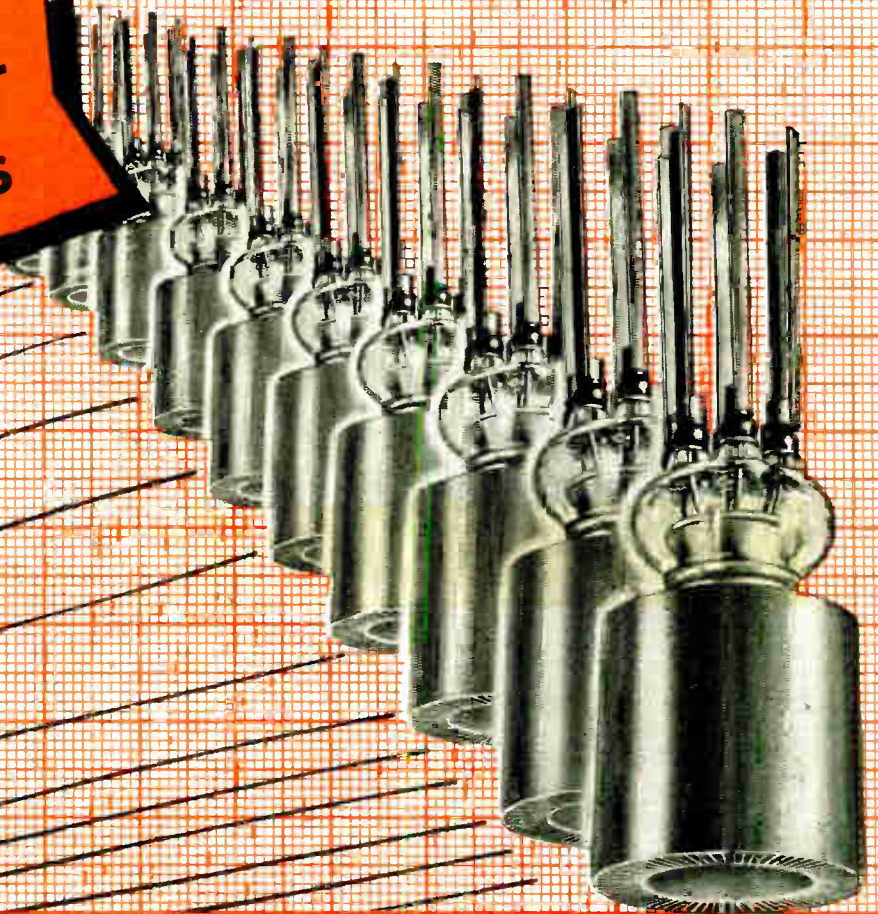

Federal Industrial Power Tubes are rated on the basis of actual performance under the same severe operating conditions found in industry . . .

Not from nominal design center values nor from operation under ideal conditions . . . but from actual tests in industrial heating equipment operating with and without work in the load circuit.

Federal tests include conditions where the character of the work changes during the heating cycle and each exacting test is designed to assure long

service and economical performance from every tube that bears the name . . . Federal.

Write for information about Federal's "better" industrial power tubes.

#### TECHNICAL DATA FOR TYPE F-7C25

Maximum Ratings for Maximum Frequency of 50 Mcs.	
DC Plate Voltage	3500 volts
DC Plate Current	1.25 amp.
Plate Dissipation	2500 watts
Filament Voltage	11.0 volts
Filament Current	27.5 amps.
Overall Height	app. 7"
Maximum Diameter	3½"
Supplied with 6" flexible copper leads, 2 on each terminal	
Type of Cooling	Forced air
(Also supplied for water-cooling, type F-5302)	



*Federal Telephone and Radio Corporation*



Newark 1, N. J.

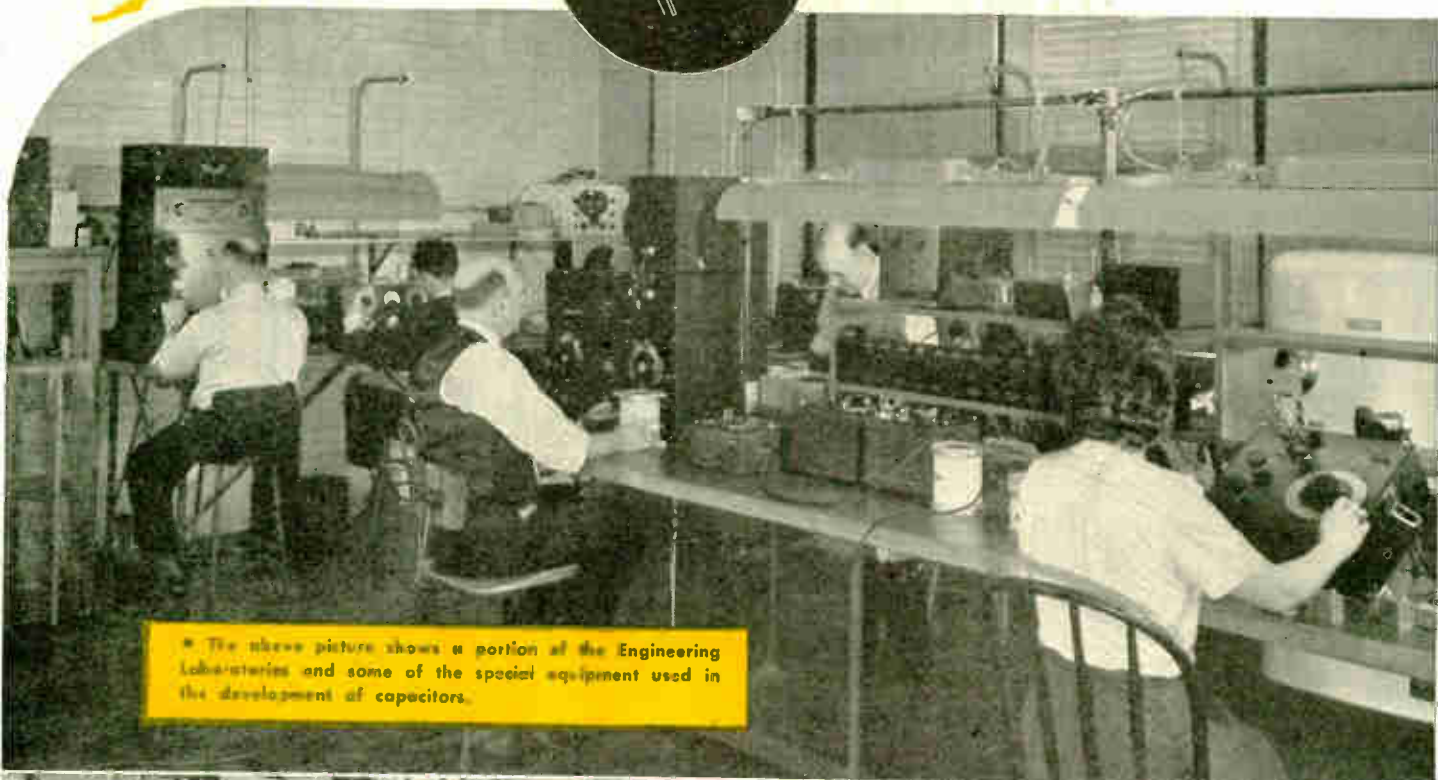

\* The above picture shows a portion of the Engineering Laboratories and some of the special equipment used in the development of capacitors.



\* A portion of the Chemical Laboratories where material control is maintained and other vital research engineering work is done in the development of Sangamo Mica Capacitors.

# SANGAMO ELECTRIC

• • • ESTABLISHED 1898 • • • MICA CAPACITORS • • •

**HOW EXCELLENCE  
IS BUILT INTO**

# Sangamo

## MICA CAPACITORS

*Research AND Engineering*

Excellence of quality in mica capacitors is, of course, greatly dependent upon the materials used and the manufacturing processes employed in their construction. The best materials and the most precise production methods, however, will not produce a quality product unless the basic design is right. Material selection and control, as well as basic design is a function of engineering and research. Sangamo maintains a competent staff of Electrical and Chemical engineers, whose duty it is to insure that each capacitor is designed and manufactured to best perform the particular duty for which it is intended.

Sangamo Engineers are constantly striving to discover new materials—increase safety factors—improve performance characteristics—all to the end that better units will be available to the many users of Sangamo capacitors. New capacitors for new applications in the ever growing electronic field requires constant attention from our engineering staff.

Sangamo is pardonably proud of its Engineering and Research Laboratories and its staff of engineers. To these facilities and to these engineers belong a large measure of the credit for the excellent quality inherent in Sangamo mica capacitors.



**COMPANY** **SPRINGFIELD  
ILLINOIS**

• • • WATT HOUR METERS • • • TIME SWITCHES • • •

# PLASTIC PARTS

... PRODUCED TO YOUR SPECIFICATIONS

## PRINTING DIE CUTTING CEMENTING

Wide experience by all known processes in the application of printing, engraving, silk screening, die cutting and cementing of all thermoplastics.

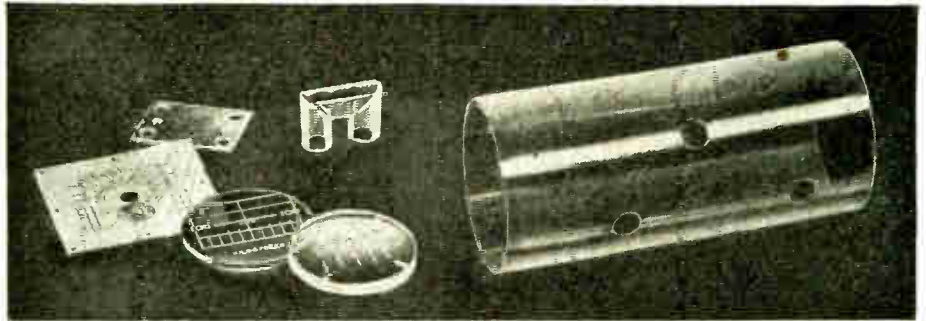

## FORMING

Specialists in deep drawing radio dial windows, embossing, swaging and bending in Acetate, Vinylite and Acrylics.



## MACHINING

Precision threading, screw machine, milling, drilling, turning of Polystyrene, Acrylics, Phenolics, Nylon, Tenite; sheets, tubes and rods; through spindle capacity up to 2½" rod.

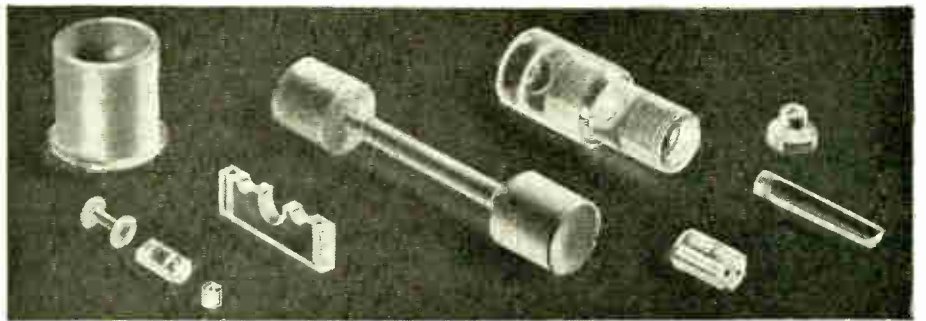

## ASSEMBLY

Our engineers can assist you in problems of design and assembly of your plastic units.

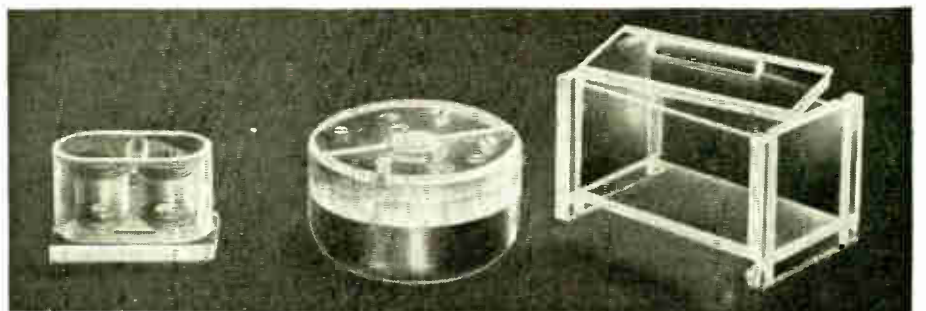

# PRINTLOID, Inc.

93 Mercer Street  
New York 12, N. Y.



**SEND YOUR ORDERS**  
**FOR FAST**  
**SHIPMENT**  
of Dependable

*Runzel*  
CORDS • WIRES CABLES

**FOR ELECTRONICS • COIN MACHINE  
TELEPHONE • ALL TYPES OF NEEDS**

**RUNZEL CORD & WIRE CO.**  
4723 - 31 MONTROSE AVENUE • CHICAGO 41

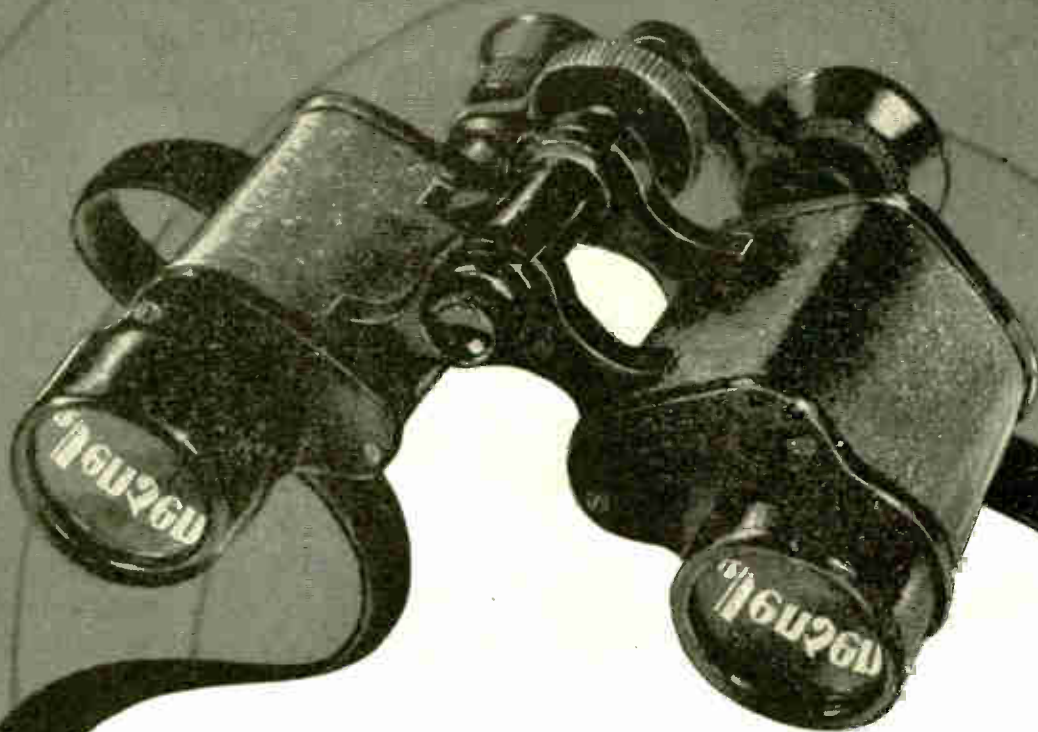

*Watch for important news*  
from **Jensen**

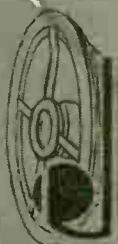

**Jensen**  
SPEAKERS WITH

**ALNICO 5**

FREE to the Armed Forces, Colleges, Technical Schools, Libraries.

**5 MONOGRAPHS AVAILABLE**

1. Loud Speaker Frequency-Response Measurements.
2. Impedance Matching and Power Distribution.
3. Frequency-Range in Music Reproduction.
4. Effective Reproduction of Speech.
5. Nom Type Loud Speakers.

**25¢**  
Each

*Specialists in Design and Manufacture of Fine Acoustic Equipment*

JENSEN RADIO MANUFACTURING COMPANY • 6605 SOUTH LARAMIE AVENUE, CHICAGO 38, ILLINOIS  
IN CANADA—COPPER WIRE PRODUCTS, LTD., 137 RONCESVALLES AVENUE, TORONTO

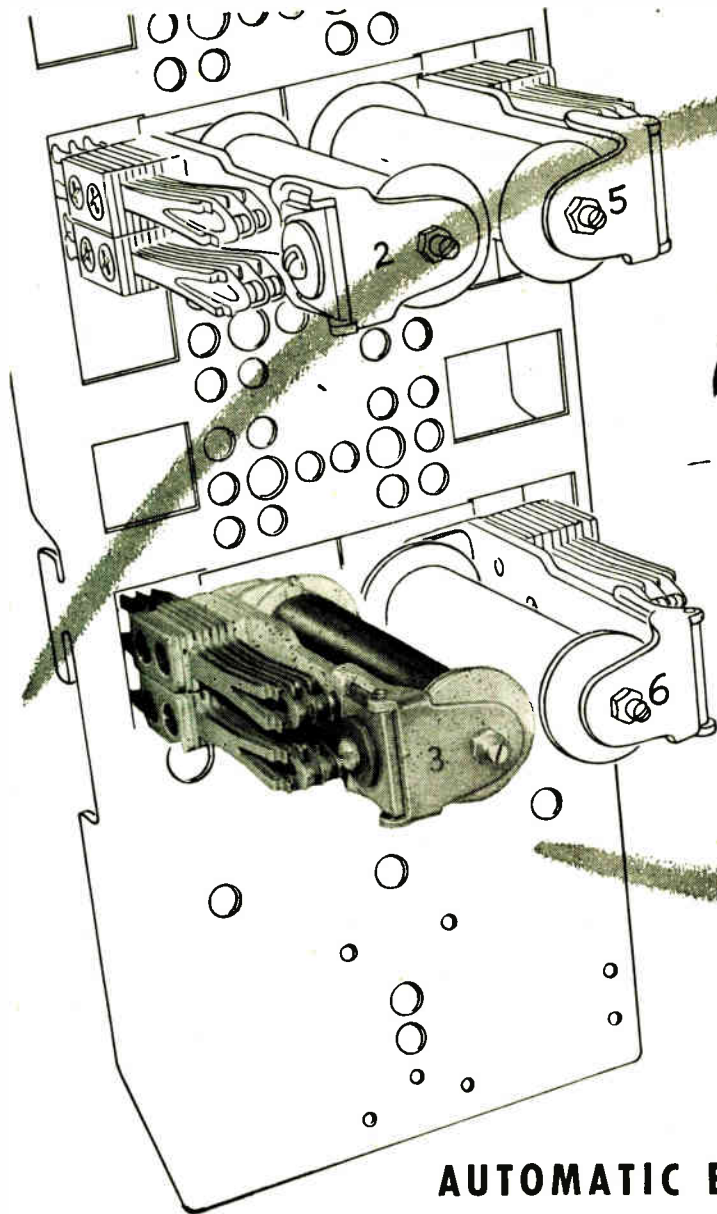

*More*

**THAN 300,000,000  
OPERATIONS**

## **AUTOMATIC ELECTRIC'S CLASS "B" RELAY**

Want real proof of relay ruggedness? Many months ago, several Class "B" relays, taken from regular production, were placed on "life test." Today, with no attention except for occasional lubrication, they are still functioning satisfactorily—and every one has hung up the amazing record of more than 300,000,000 operations! For ruggedness—for all the other features you need, specify Automatic Electric's Class "B" relays.

*Independent twin contacts for dependable contact closure... efficient magnetic circuit for sensitivity and high contact pressure... unique armature bearing for long wear under severe conditions... compact*

*design for important savings in space and weight. Now available for coil voltages to 300 volts DC and 230 volts AC, with capacities up to 28 springs; also with magnetic shielding cover, when specified.*

The Class "B" relay, and many others, are shown in Catalog 4071. Write today for your copy.

*Relays by*

**AUTOMATIC  ELECTRIC**

**AUTOMATIC ELECTRIC SALES CORPORATION**  
1033 WEST VAN BUREN STREET • CHICAGO 7, ILLINOIS  
*In Canada: AUTOMATIC ELECTRIC (CANADA) LIMITED, TORONTO*

**PARTS AND ASSEMBLIES FOR EVERY ELECTRICAL CONTROL NEED**



## Seven Major Features

have established  
CLUTCH HEAD as  
the most modern

screw on the market . . . for safer, speedier production and lower final cost.

- I** The wide roomy Clutch, an easy-to-hit target, inviting operator confidence and speed.
- II** Center Pivot entry to prevent canting; deep positive engagement for protection against slippage . . . safeguarding manpower and materials.
- III** No end pressure. The straight-walled Clutch matched by straight-sided driver disposes of "ride-out" tendency as set up by "tapered" drive home.
- IV** CLUTCH HEAD's exclusive Lock-On unites screw and bit as a unit . . . substituting easy one-handed reaching for fumbling with mechanical fingers.
- V** The rugged Type "A" Bit delivers a longer uninterrupted spell of service . . . and may be repeatedly reconditioned to original efficiency by a 60-second application of the end surface to a grinding wheel.
- VI** Simplified field service . . . because CLUTCH HEAD is the only modern screw operative with the ordinary type screwdriver, or any flat blade, of proper width.
- VII** Here again the CLUTCH HEAD Lock-On saves the day. With the Type "A" Bit, rusted-in and frozen-in screws may be withdrawn undamaged and held secure against dropping for re-use.

Because CLUTCH HEAD is "The Screw That Sells Itself," we invite you to personally examine and test these features. Your re-



quest will bring you, BY MAIL, a package assortment of CLUTCH HEAD Screws and sample Type "A" Bit; also fully illustrated Brochure.

**UNITED SCREW AND BOLT CORPORATION**  
**CHICAGO 8                      CLEVELAND 2                      NEW YORK 7**





Dear P. J.  
Have you ever considered what  
high frequency might do for us in  
reducing size and weight in our  
air conditioning unit?  
I am told that a weight reduction  
ratio of 5 to 1 is not at all unusual.  
The Leland Electric Company makes  
power units of this type. What do  
you think of calling them in?  
Ed

*if it calls for*  
**CREATIVE ELECTRICAL  
ENGINEERING...**  
*call for Leland!*

# THE Leland ELECTRIC COMPANY

DAYTON, OHIO • IN CANADA, LELAND ELECTRIC CANADA, LTD. . . . GUELPH, ONTARIO

Motors, Generators, Motor Gen-  
erators and Voltage Regulators

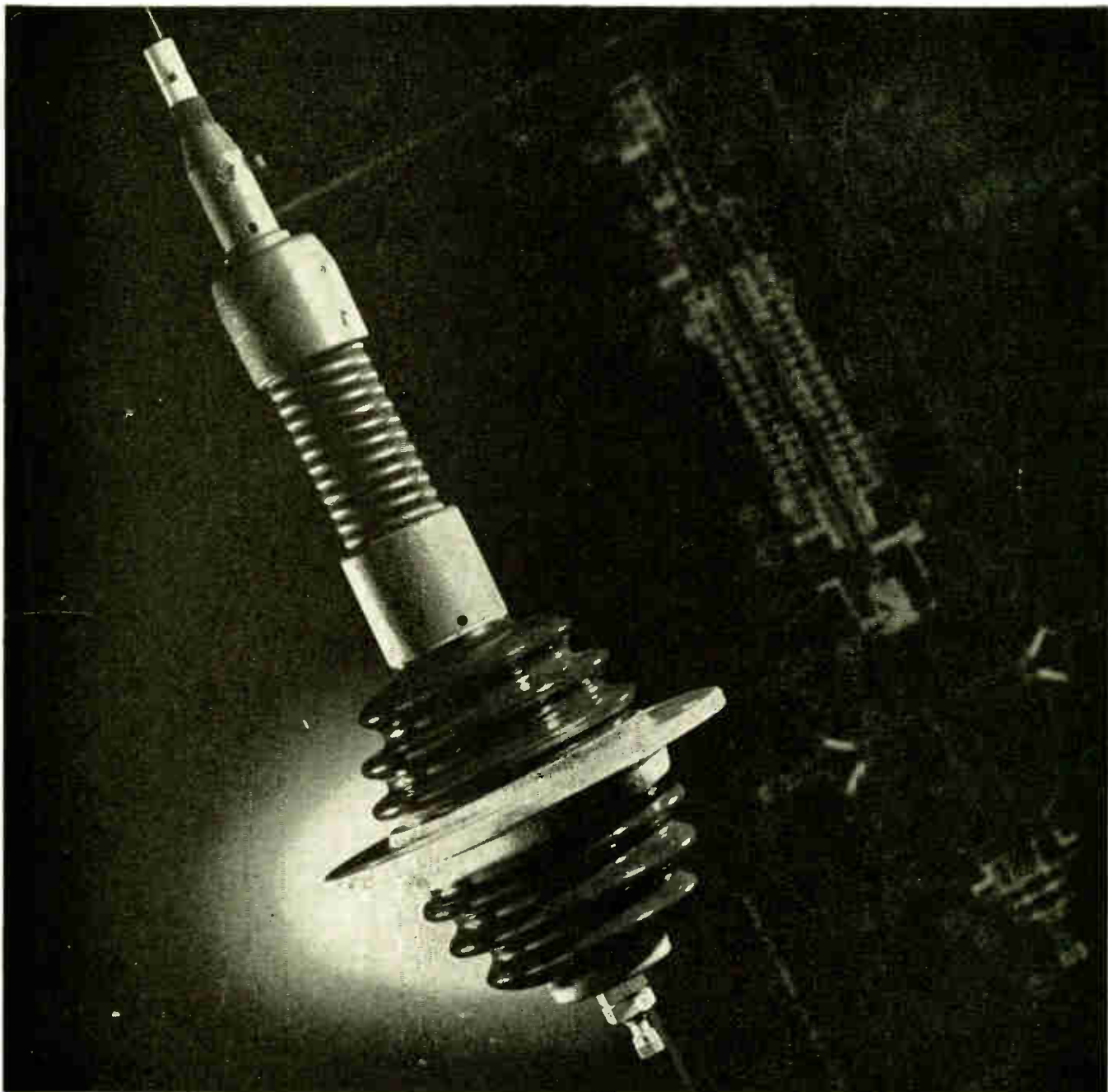

## LAPP-DESIGNED, LAPP-BUILT— TO DO A SPECIFIC JOB

This is an antenna base insulator for use on a communications center transmitter. It is one of several Lapp designs for transmitter and receiver mast bases for military vehicular radio—on jeeps, halftracks, tanks and other rolling equipment.

Whether or not this special-purpose gadget has application to anything you build or propose to build, there's a moral in it for you. In this case, as in hundreds of others, an original and impractical design was modified by Lapp engineers—to provide a part that meets all electrical and mechanical requirements, and that Lapp can build economically and efficiently.

Lapp engineering talent and Lapp production methods are such that we can say, "If it's an assembly that can be made of porcelain or steatite and metal parts, tell us what

the requirements are and how you think it might be made; Lapp will tell you how it can best be made—and will make it." Our right to that claim has been proved over and over in military electronic production; it's going to be a competitive advantage to smart post-war electronic producers. *Lapp Insulator Co., Inc., LeRoy, N. Y.*



# EASTERN AIR DEVICES · INC ·

*proud of the part their products have played  
in bringing about **TOTAL VICTORY**  
pledge themselves to continue  
the same high degree of*

## **ENGINEERING & MANUFACTURING INTEGRITY**

*in products for **PEACE***

*Specialists in the development and manufacture of*  
*fractional HP*  
*and miniature motors,*  
*generators*  
*and blowers.*

*Tachometers,*  
*solenoids,*  
*control apparatus*  
*and special devices.*

*We solicit engineering and production problems*



## **EASTERN AIR DEVICES · INC ·**

585 DEAN ST. · BROOKLYN 17, N. Y.

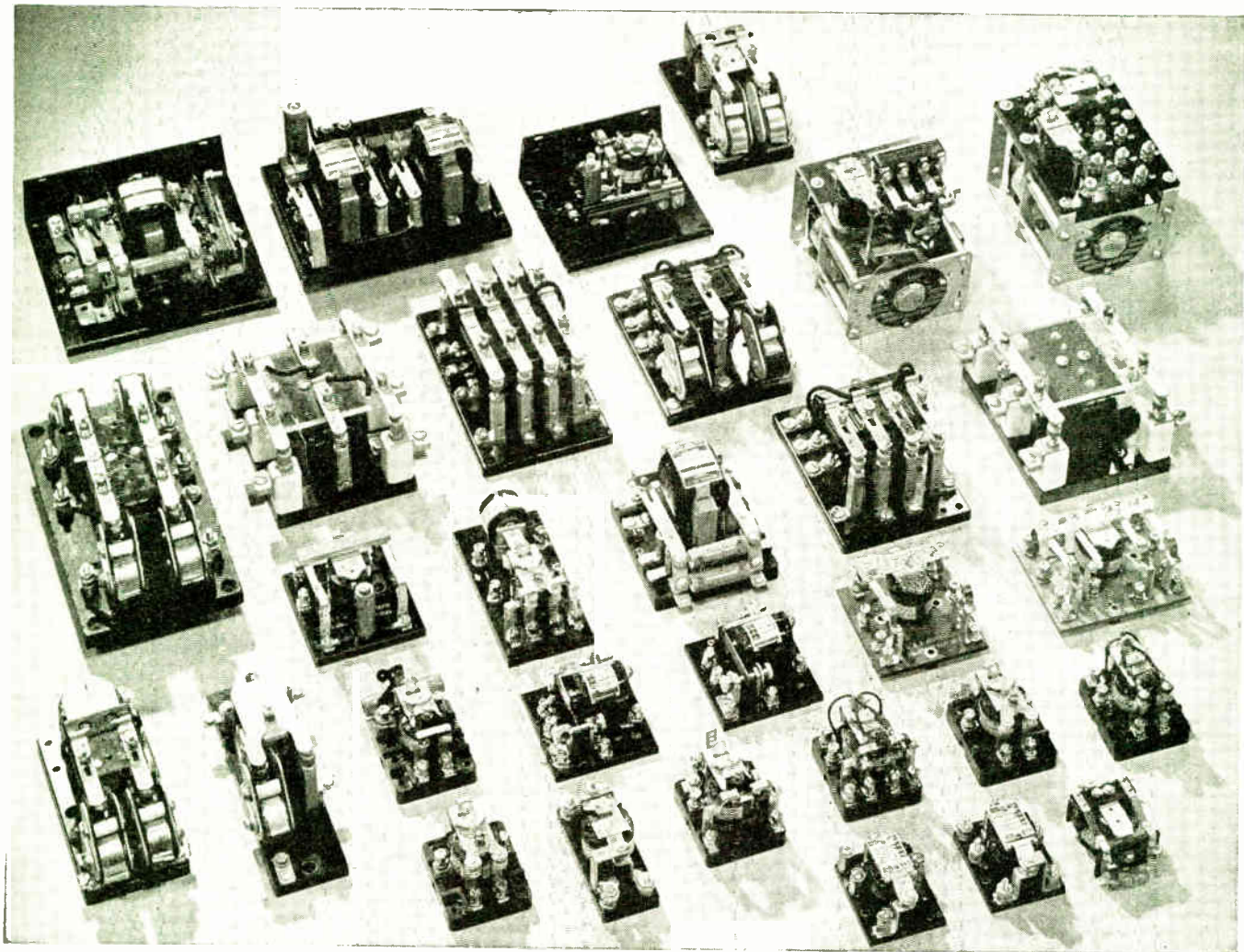

## BULLETINS TELL THE WHOLE RELAY STORY

**Bulletin 105** — "Little Giant Relay" single pole, single and double throw. Controls  $\frac{3}{4}$  HP on 115-230V.

**Bulletin 106** — Midget Relays for light duty available in single and double pole, single and double throw.

**Bulletin 91** — Intermediate Duty Relays in single and multipole arrangements, single and double throw.

**Bulletin 362** — Motor Driven Time Delay Relays for operation on alternating current.

**Bulletin 104** — Midget Relay for tight places—Vibration resistant—Double Pole, Double Throw — Available for 6 to 115 volts A.C. or D.C.

**Bulletin 131 and 132** — Heavy Duty Relays single and multipole, single and double, contacts rated up to 25 amp. on 125-250V.

**Bulletin 251** — Sensitive Type Relays for direct and alternating current operating on .014 watts.

**Bulletin 351** — Thermal Time Delay Relays with thermostat built into relay assembly.

**Bulletin 103** — Aircraft Power Relay. Single Pole, Single Throw for 24 volts at 25 amps. D.C. Withstands high values of acceleration of gravity, shock, and vibration.

WARD LEONARD RELAYS include types and sizes for every application. They all have crisp action, are dependable and durable yet consume but little current. Send for the data bulletins of interest to you.



# WARD LEONARD

## RELAYS • RESISTORS • RHEOSTATS

Electric control  devices since 1892

Offices in all principal cities

WARD LEONARD ELECTRIC COMPANY • 61 SOUTH ST. • MOUNT VERNON, N. Y.



★ ★ ★  
BUY  
VICTORY  
BONDS  
★ ★ ★

magic  
with  
metals  
by  
electronic  
heat

CALLITE

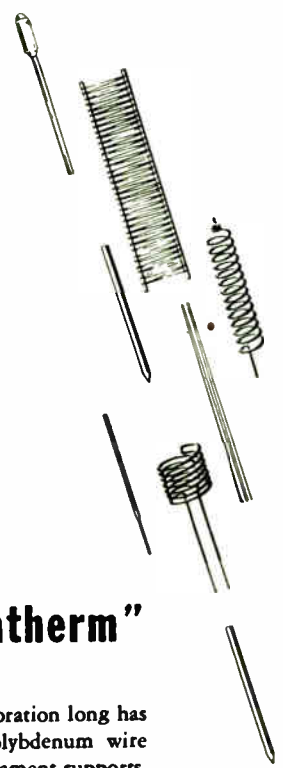

## Callite components help Federal make the "Megatherm"

The Federal "Megatherm" Induction Heating Unit is designed to deliver a 25 kw output continuously at frequencies adjustable within a range of 2 to 5 mc. The use of this frequency range makes possible accurate control of heating depth and permits effective and speedy heating, soldering or brazing of brass, copper, aluminum alloys and steel.

The Federal Telephone and Radio Corporation long has relied on Callite for tungsten and molybdenum wire and fabricated parts such as filaments, filament supports, grid side rods, etc.

Callite processes tube components by methods perfected after years of research and experience. Let us cooperate with you. We may be able to save you time and money. Callite Tungsten Corporation, 544 Thirty-ninth St., Union City, N. J. Branch Offices: Chicago, Cleveland.



**Callite**  
Tube components

Hard gloss leads, welds, tungsten and molybdenum wire, rod and sheet, formed parts and other components for electron tubes and incandescent lamps.

# FOR SUPERIORITY IN POSTWAR PRODUCTS

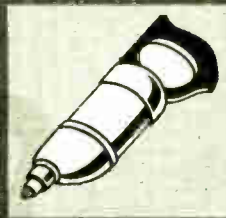
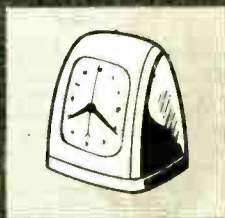

## CHOOSE LOW-VOLTAGE RECTIFIERS

Place your postwar products in a superior class of their own by equipping them with G-E low-voltage rectifiers. There are copper-oxide, selenium or Tungar types and sizes for practically all d-c applications. This makes it possible for manufacturers to design and build their products around the rectifier that is sure to deliver the most efficient, most dependable and most economical performance.

Naturally, all three differ in characteristics, basic materials and construction. Each is better than the other when accomplishing the specific job for which it is designed. Thus the manufacturer of products employing rectifiers must first determine the results to be obtained and the conditions under which the rectifier must function, before making a selection.

Since G-E makes all three — Copper-oxide, Selenium and Tungar — it has no reason to prefer one to the other. It can give you impartial advice on which type is best for your particular requirements. For further information write Section A1157-124 Appliance and Merchandise Department, General Electric Company, Bridgeport, Connecticut.

Hear the General Electric radio programs: "The G-F All Girl Orchestra" Sunday 10 P. M. EST, NBC. "The World Today" news every weekday 6:45 P.M. EST, CBS. "The G-E House Party" Monday through Friday 4:00 P.M. EST, CBS.



**COPPER-OXIDE**—Rugged in construction, provides virtually unlimited life when operated within rated capacities.



**SELENIUM**—Excellent for continuous operation where space is a factor and weight must be held to a minimum.



**TUNGAR**—Efficient and economical for low-voltage applications where life and price are determining factors.

# GENERAL ELECTRIC



*This is not the kind of WAVE GUIDE we supply . . .*

**DE MORNAY  
BUDD *inc.***



EQUIPMENT  
FOR  
97% OF ALL  
RADAR SETS

but we are recognized as experts on wave guides and other transmission line equipment in the micro-wave field. Now that the Radiation Laboratory at M.I.T. has closed shop, we invite all members of the electronic industry to visit our Micro-Wave Research Division. We are the *only* organization offering the services of one of the finest and most completely equipped ultra high frequency labs to the entire electronic industry. Inquiries on your RF problems are invited. Write "MWR" Division.

DE MORNAY-BUDD, INC., 475 GRAND CONCOURSE, NEW YORK, N. Y.  
WAVE GUIDES • DIRECTIONAL COUPLERS • MIXERS  
CO-AXIAL STUB SUPPORTED LINES • ROTATING JOINTS  
R. F. BENCH AND FIELD TESTING EQUIPMENT • AMPLIFIERS  
MODULATORS • I. F. STRIPS • ANTENNAE

**THIS IS WHAT WE <sup>WILL</sup> SELL!**

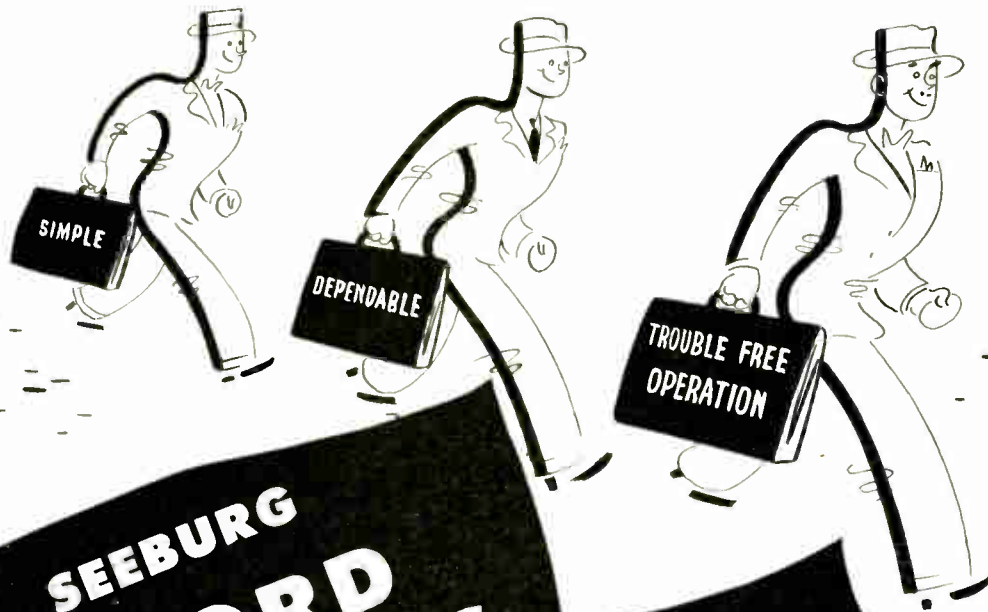

**SEEBURG  
RECORD  
CHANGERS**

*Wire*  
**SEEBURG  
RECORDERS**

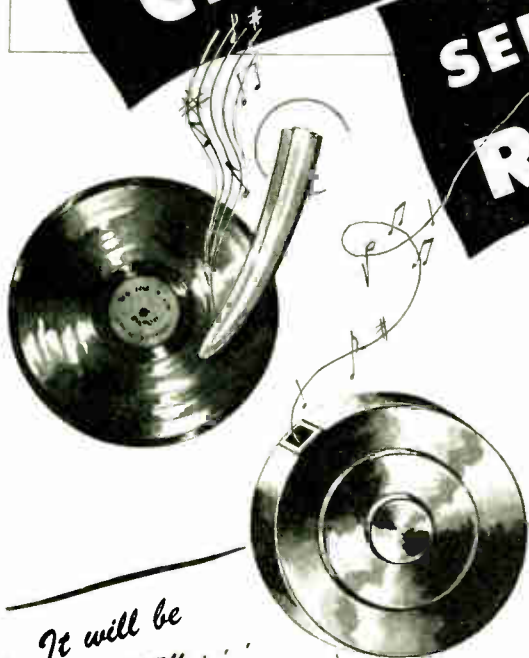

**SIMPLE . . . DEPENDABLE . . .  
TROUBLE-FREE OPERATION**

. . . three vitally important factors in the manufacture of a mechanical device! The post-war line of new Dependable SEEBURG RECORD CHANGERS has been designed with fewer moving parts. As rapidly as restrictions are lifted and materials become available, production on our SEEBURG RECORD CHANGERS will be started.

The SEEBURG WIRE RECORDER is as new and recent as today's newspaper! This amazing electronic engineering achievement is an established and accepted recording medium. One simple control knob operates the SEEBURG WIRE RECORDER to reproduce or record speeches, plays, meetings, music, programs off the air, etc. There are no needles or discs used.

*It will be necessary . . .*

for radio manufacturers to make provision in their circuits to accommodate the Seeburg Wire Recorder and we therefore invite prompt inquiries from interested radio manufacturers.



Awarded to the J. P. Seeburg Corporation for outstanding production of war materials in each of its four plants.

**Seeburg**

**J. P. SEEBURG CORPORATION · CHICAGO**



# HERE'S WHY YOU SHOULD BUY A **Thermatron** ELECTRONIC DIELECTRIC HEATER

**THERMATRON** electronic heat generators are manufactured by a company which has made important contributions to the science of industrial electronics.

**THERMATRON** electronic heat generators are available in a size for every application involving non-metallic materials. They are ruggedly built to deliver consistent operation under exacting production standards.

**THERMATRON** electronic heat generators can help increase your output — lower your production costs — minimize rejects . . . and yet, they need no experienced help to operate them efficiently.

## THREE OUTSTANDING **Thermatron** UNITS:



**"The HEATMASTER"**

Type K-5 — 5 KW. output.  
For plastics, sealing and other production purposes.



**"The WELDMASTER"**

Type K-1 — 1 KW. output.  
For sealing, laboratory or general purpose uses.



**"The HEATMASTER, JR."**

Type K-3 — 2 1/2 KW. output.  
For pre-heating plastics, sealing, laboratory or general purposes.

## **Thermatron** PLUS SERVICES

Field engineers supervise installation of units without additional charge.

THERMATRON engineers assist you on the solution to application problems.

Periodic check-ups are made, and emergency service is available.

Write for new circulars—"Electronic Heating with the Thermatron"—and—"Electronic Heat-Sealing of Thermoplastics".



**RADIO RECEPTOR COMPANY, Inc.**  
251 WEST 19th STREET  
NEW YORK 11, N. Y.



SINCE 1922 IN RADIO AND ELECTRONICS

# FRANKLIN ANNOUNCES ANOTHER TOWARD BETTER

★★★★★ *FLASH* ★★★★★

# EXTRA



**IT'S NEW  
NOTHING ELSE LIKE IT!**

**AUTOMATICALLY EMBOSSED ON  
BACKBOARD TO SPECIFICATION**

**OPENS UP MANY AVENUES TO  
BETTER RADIO SET DESIGNING**

**INVESTIGATE  
SPECIFY  
FRANKLIN  
AIRLOOPS**

- Optimum sensitivity
- High uniform "Q" over entire band
- Inductance to close tolerance without adjustable turn
- Low distributed capacity
- 27% greater effective loop area
- Electrical and mechanical stability
- Backboard and loop in one
- Lower cost
- Elimination of individual loop adjustment on assembly line
- Maximum space utilization (cabinet depth)

## THE *AIRLOOP*

**AIR DIELECTRIC THROUGHOUT**

**ITS ENTIRE LENGTH**

A radio engineers' dream come true . . . Flat sheets of copper die-stamped into perfect super-sensitive loops . . . The greatest development in loop antenna design and manufacture since 1920 . . . Being rectangular the Air-loop has 27% more effective area . . . Better performance at lower cost . . . No set builder can afford to overlook the significance of the Airloop.

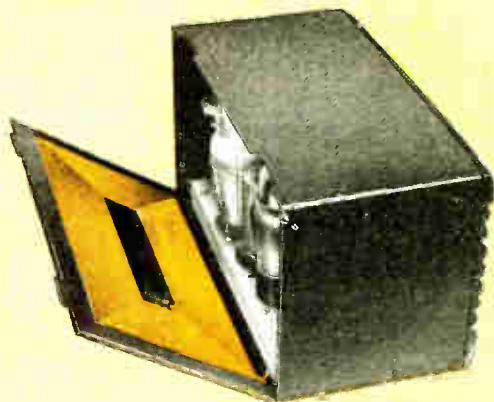

Illustrating the AIRLOOP as installed in a typical table model receiver; note that the AIRLOOP and backboard are one and placed as far away from the chassis as is possible to permit optimum sensitivity, easy access to tubes . . . and no Haywire.

\*Patents pending in U.S.A. and Foreign Countries.

# SENSATIONAL CONTRIBUTION RADIO RECEPTION!

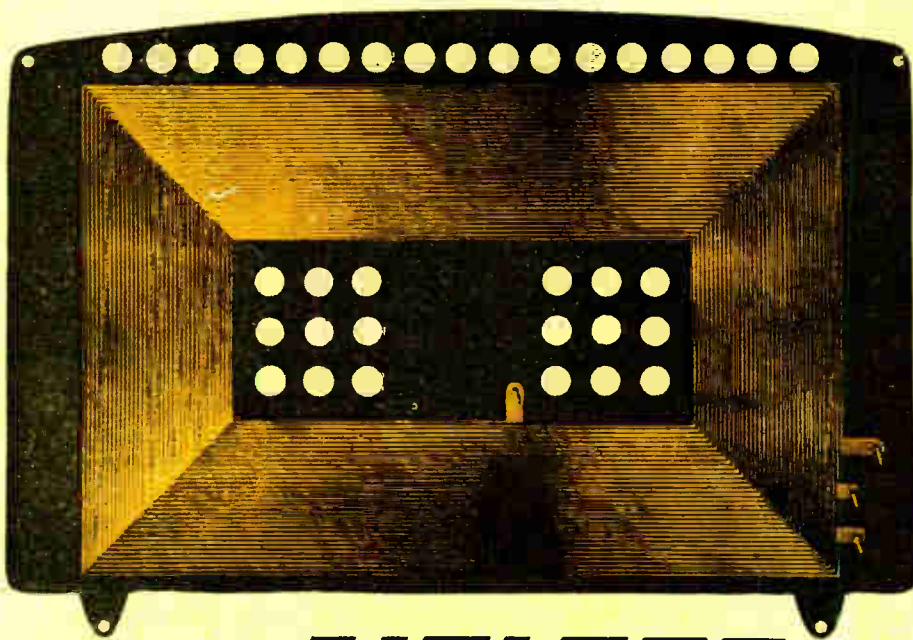

## THE AIRLOOP

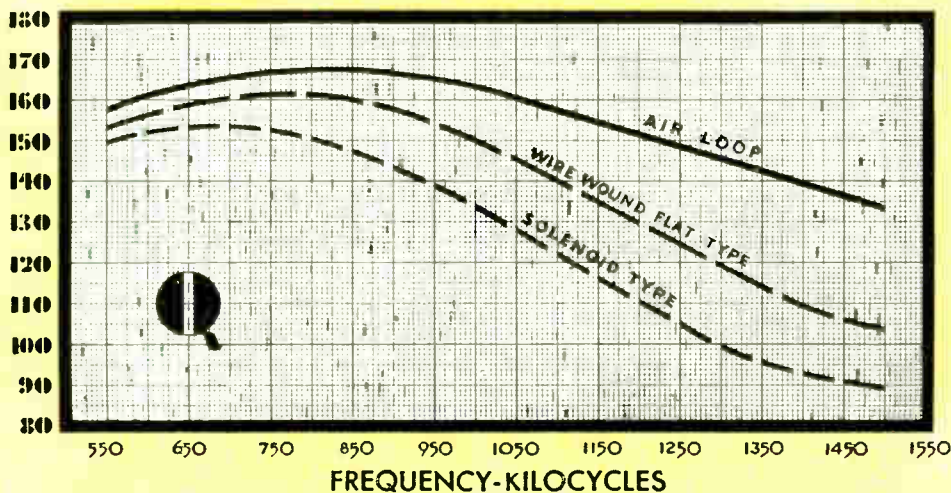

Illustrating the preciseness of AIRLOOP manufacture; note that every turn has uniform air dielectric throughout. Die-embossed on automatic machines, each AIRLOOP is identical in every way... and is the backboard as well as the loop.

### FEATURING AIRLOOP STABILITY . . .

AIRLOOPS have only 5% reduction in "Q" after being subjected to 100% humidity for 24 hours. Such mechanical stability is unequaled by any wound wire type of loop. Since AIRLOOPS require no wax for treatment against humidity, operation is stable at temperatures much higher than conventional wax treated loops can tolerate (wax usually melts at around 70° C.).

Inductance cannot be changed by rough handling in installation or in changing tubes.

### FEATURING AIRLOOP LOW DISTRIBUTED CAPACITY . . .

By actual test, AIRLOOPS have 25% less distributed capacity than conventional loops of equivalent effective area. This means better frequency stability, permits use of smaller gang condenser resulting in lower costs and better performance (sensitivity) at high end of band since low distributed capacity does not lower the "Q" of the AIRLOOP as it does in conventional loops... also "Q" is more uniform over the entire band.

Investigate the AIRLOOP and you will specify them for your receivers.

Franklin **AIRLOOP** corp.  
175 VARICK ST., NEW YORK 14, N. Y.

**ONLY  
PERFORMANCE  
PAYS OFF!**



It's no photo finish with the new HQ-129-X. This new professional - type receiver is way out in front when it comes to performance. Every feature of the HQ-129-X is the outgrowth of years of building commercial receivers.

Write for descriptive booklet — place your order with your dealer today to insure early delivery.



**HQ-129-X** \$129\*  
 AMATEUR NET  
 LESS SPEAKER



WRITE TODAY FOR BOOKLET!

ESTABLISHED 1910

**HAMMARLUND**

THE HAMMARLUND MFG. CO., INC., 460 W. 34<sup>TH</sup> ST., NEW YORK 1, N.Y.  
 MANUFACTURERS OF PRECISION COMMUNICATIONS EQUIPMENT

PRICES SUBJECT TO CHANGE WITHOUT NOTICE

• Many brilliant projects have been started with a K & E Slide Rule and the back of an old envelope. But between a new conception and its practical execution of the vital links are always the engineer and the draftsman. For through their techniques they construct the project on paper with unmistakable clarity and precision. In this their drafting instruments and equipment become part of their own hand and brain, and their partners in creating.

For 78 years Keuffel & Esser Co. Slide Rules, drafting equipment and materials have been partners in creating the greatness of America, in making possible our nationwide railway system, giant airports, fine radios for nearly every home . . . So universally is K & E equipment used, it is self-evident that every engineering project of any magnitude has been completed with the help of K & E. Could you wish any surer guidance than this in the selection of your own "engineering partners"?

In slide rules especially, you will find K & E precision invaluable. For it not only brings you a slide rule that is a joy to use, but it adds to your confidence in making every calculation. You will find Don Herold's booklet, "How To Choose A Slide Rule", amusing and very helpful. Write on your

letterhead to Keuffel & Esser Co., Hoboken, N. J.

# partners in creating

**K & E**  
*Drafting, Reproduction,  
 Surveying Equipment  
 and Materials,  
 Slide Rules,  
 Measuring Tapes.*

  
**...the greatest  
 airports**

  
**...the world's  
 safest trains**

**KEUFFEL & ESSER CO.**  
EST. 1867  
**NEW YORK • HOBOKEN, N. J.**  
 CHICAGO • ST. LOUIS • DETROIT • SAN FRANCISCO  
 LOS ANGELES • MONTREAL

# 108 SERIES Amplifiers

WITH MOUNTING ACCESSORIES

**TYPE 108-B** two-stage Amplifier provides transformer input impedances for either 30 or 250 ohms with nominal output impedance 500 or 8 ohms. Variable gain 65/105 db. with electronic volume control. Frequency response better than  $\pm 1$  db. 30/16,000 c.p.s. Power output +43 V.U. (20 watts) with less than 5% RMS harmonic content. Noise level full gain 56 db. below full output.



**THE 108 SERIES** consist of four different amplifiers available simply by changing one or two small input panels on the master chassis. Except for these input panels all amplifiers have the same transmission characteristics. Input impedance, gain and noise level depending on types listed below.

These units are designed for the highest type audio service having gain-frequency characteristics better than  $\pm 1$  db. 30/16,000 c.p.s. Power output +43 V.U. (20 watts) with less than 5% RMS harmonic content.

**TYPE 108-A** two-stage Amplifier provides transformer input for either 600 ohm or bridging. 600 ohm input fixed gain 61 db. Bridging input variable gain 6/46 db. Noise level 68 db. below full output.

Bridging input variable gain 2/42 db. Channel 2—high gain 30/250 ohm input variable gain 62/102 db. with electronic volume control. Noise level 56 db. below full output.

**TYPE 108-B** as illustrated and described above.

**TYPE 108-C** combines the input channels of the 108-A and 108-B Amplifiers. Channel 1—600 ohm input variable gain 20/60 db.

**TYPE 108-D** two-channel each 30/250 ohm input. Either channel variable gain 62/102 db. with electronic volume control. Noise level 56 db. below full output.

## MOUNTING ACCESSORIES

**TYPE 202-A** Wall Mounting Cabinet permits universal installation of 108 Series Amplifiers to any flat surface. Well ventilated and designed for maximum accessibility, servicing and convenience of installation. Standard aluminum gray finish.

**TYPE 9-A** Modification Group permits 108 Series Amplifiers to mount on standard 19" telephone relay racks. Occupies 7" rack space. Allows servicing from front of rack. Standard aluminum gray finish.

# The Langevin Company

INCORPORATED

SOUND REINFORCEMENT AND REPRODUCTION ENGINEERING

NEW YORK  
37 W. 65 St., 23

SAN FRANCISCO  
1050 Howard St., 3

LOS ANGELES  
1000 N. Seward St., 38

# Space-Saving Midget

and tops in  
precision  
quality

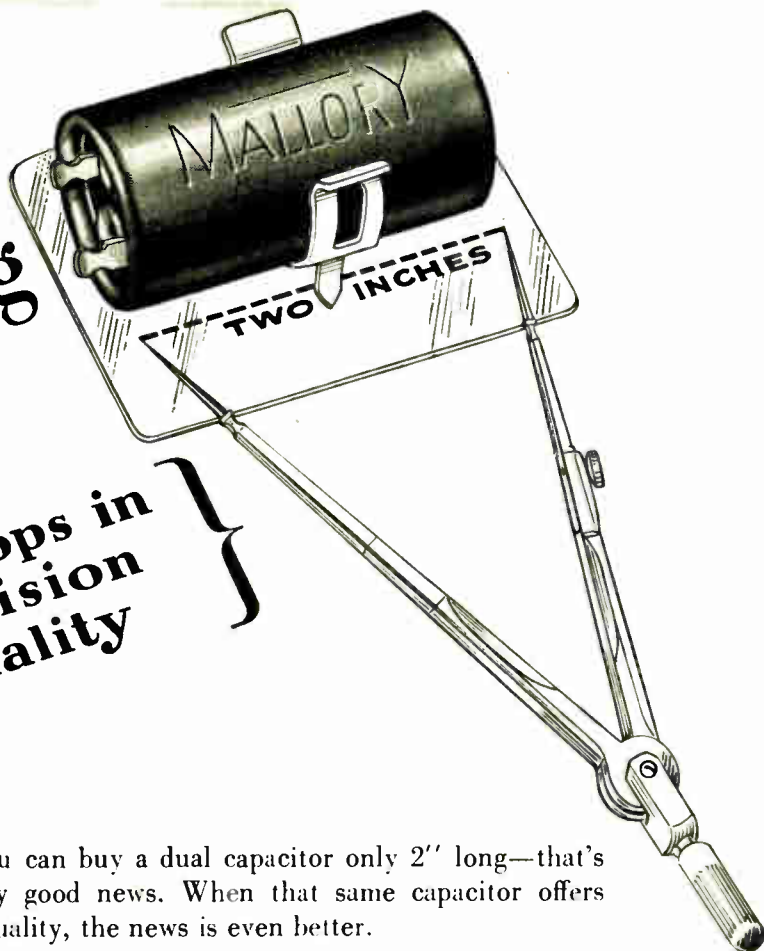

WHEN you can buy a dual capacitor only 2" long—that's definitely good news. When that same capacitor offers outstanding quality, the news is even better.

Mallory's new dual capacitors (actual sizes begin at  $1\frac{3}{16}$ " x  $1\frac{1}{4}$ " and include common negative and separate section types) conform exactly to that description. They're really *tinier* than most cardboard tubulars, but hardly to be compared in *dependability*. Aluminum casing, hermetic sealing, easily accessible lug terminals—these and other features make a whale of a difference!

New *single* Mallory tubular capacitors are also available (sizes in this group are even smaller). But nothing is short-measured in performance standards: ripple current rating, for instance, is *higher* than average.

We'll be glad to send you further particulars about these space-saving, trouble-free Mallory capacitors. There's information, too, on handy new hardware that makes mounting and assembly easier than ever.



Everything you want to know about Mallory Capacitors. Pictures, drawings, electrical characteristics. Available from us, or your nearest Mallory distributor.

P. R. MALLORY & CO., Inc., INDIANAPOLIS 6, INDIANA



P. R. MALLORY & CO. Inc.

# MALLORY

## Electrolytic, Film and Paper CAPACITORS

### 4800 Capacitance Ranges for Standard Tubular Sizes

(These curves allow for  $\pm 5\%$  capacitance tolerance)

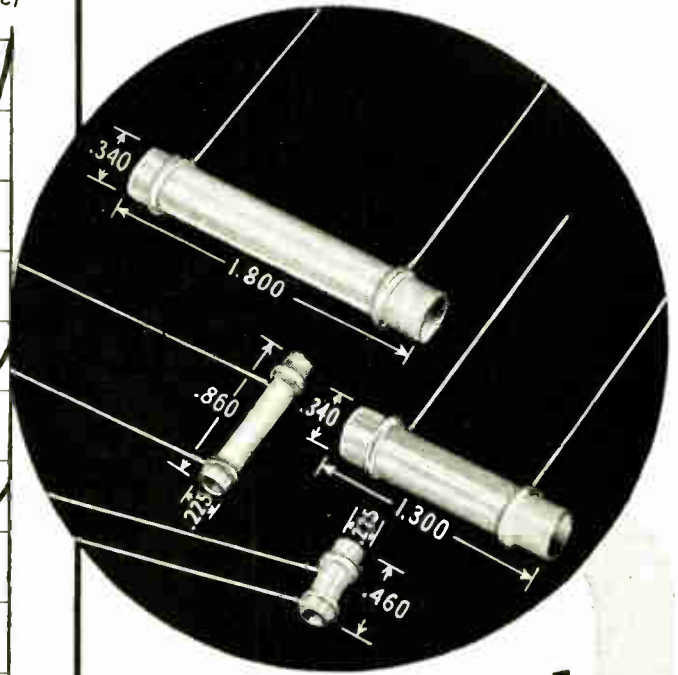
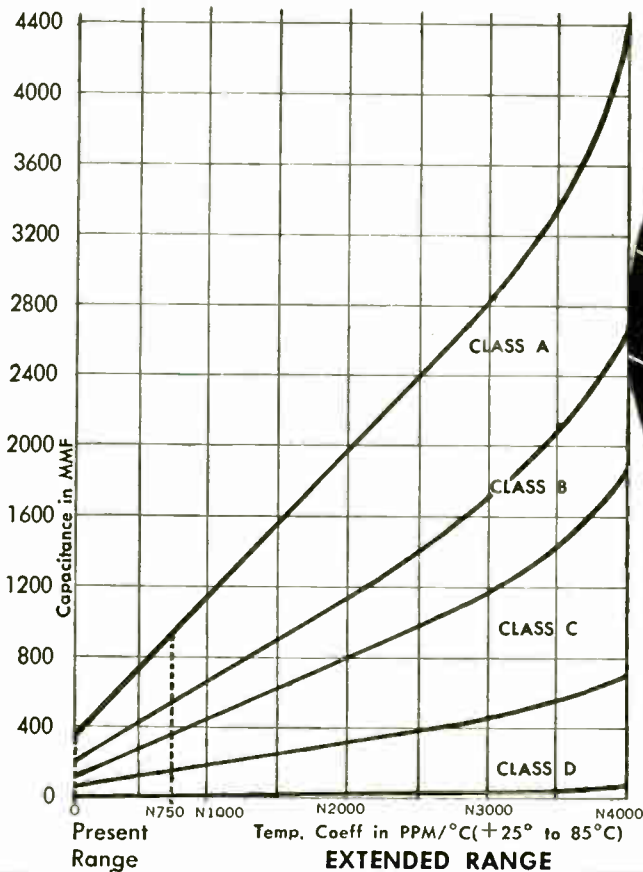

A *New* RANGE OF  
COMPENSATING CAPACITORS

## CONTROLLED TEMPERATURE COMPENSATING CAPACITORS by Centralab

Centralab Tubular Ceramic Capacitors can now be supplied in any desired temperature coefficient from P120 to N4000 parts per million per degree Centigrade.

The range from N750 to N4000 P.P.M. is new, with the same accuracy of temperature compensation curve and uniform electrical characteristics as the present standard ranges.

The new ceramic bodies have somewhat higher dielectric constants and thus provide higher values of capacitance on the same size tube. They are not to be confused, however, with the so called Hi-K or high dielectric bodies that have still higher dielectric constants but less uniform characteristics.

Producers of:  
Variable Resistors — Selector  
Switches — Ceramic  
Capacitors, Fixed and Vari-  
able — Steatite Insulators  
— and Button-Type Silver  
Mica Capacitors.

# Centralab

Division of GLOBE-UNION INC., Milwaukee



• ASK US ABOUT OUR NEW HIGH-TENSILE STRAIGHT BERYLLIUM COPPER WIRE •

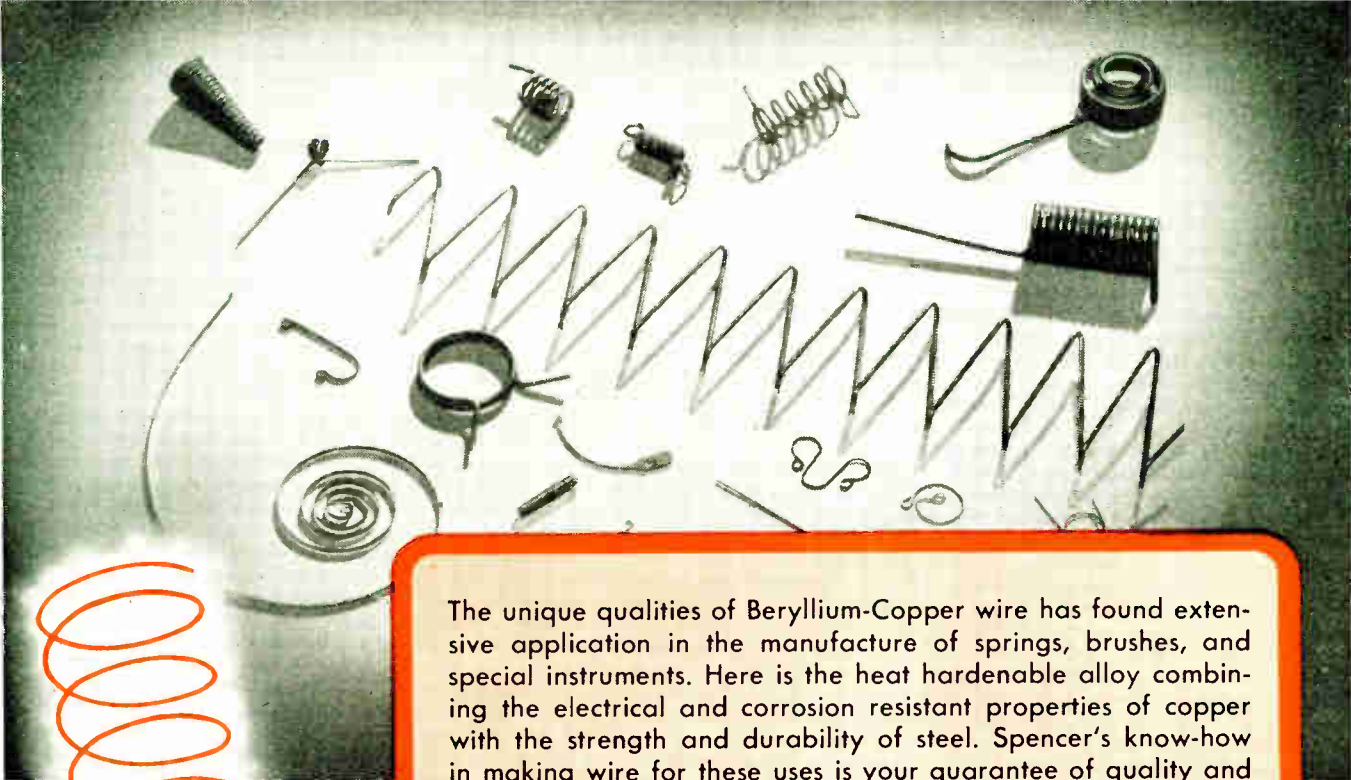

The unique qualities of Beryllium-Copper wire has found extensive application in the manufacture of springs, brushes, and special instruments. Here is the heat hardenable alloy combining the electrical and corrosion resistant properties of copper with the strength and durability of steel. Spencer's know-how in making wire for these uses is your guarantee of quality and performance. Play Safe! Specify Spencer's Beryllium-Copper wire in sizes .001-.050".

## BERYLLIUM-COPPER FINE WIRE . . .

HIGH CARBON STEEL

NICKEL CHROME

PHOSPHOR BRONZE

NICKEL SILVER

STAINLESS STEEL

STERLING SILVER



**SPENCER  
WIRE**

Specify  
**SPENCER**  
for exact specifications

# SPENCER WIRE COMPANY

WEST BROOKFIELD PLANT

WEST BROOKFIELD • MASS.

**"IT GOT HERE  
PERFECTLY DRY"**

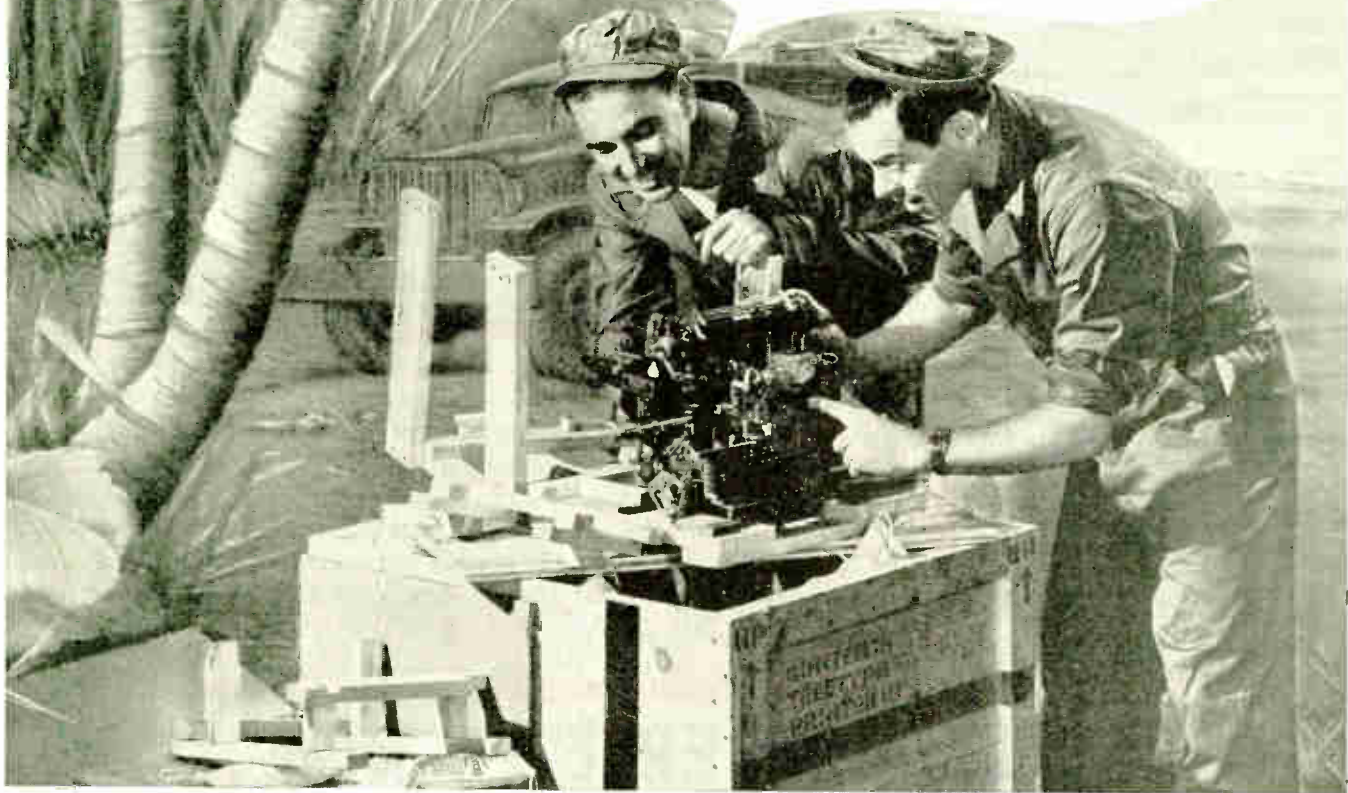

**JAY CEE**

# SILICA GEL

**PROTECTS TELETYPE\* EQUIPMENT  
FROM MOISTURE DAMAGE . . .**

Yes . . . this Teletype printer arrived "perfectly dry" . . . thanks to Jay Cee Silica Gel—which is protecting innumerable over-seas shipments of delicate machines, instruments and weapons from moisture damage.

A few small cotton bags containing this ideal drying agent are enclosed in the box or carton with the equipment. The phenomenal power of Jay Cee Silica Gel to absorb the atmospheric moisture within the container prevents rust or corrosion in transit. Jay Cee Silica Gel is also used in packages of foods, fabrics, chemicals, and other products. Moreover, it has wide application in the air conditioning, refrigeration, and chemical industries. Jay Cee Silica Gel is clear white;

passes a rigid section test, meets exacting Government specifications; is strictly a quality product.

**JOBBERS WANTED**—A few excellent Jay Cee Silica Gel sales territories are still open to jobbers. Write for details.

\* Registered trade mark

**JOLIET CHEMICALS, LTD.**

INDUSTRY AVENUE  
JOLIET, ILLINOIS

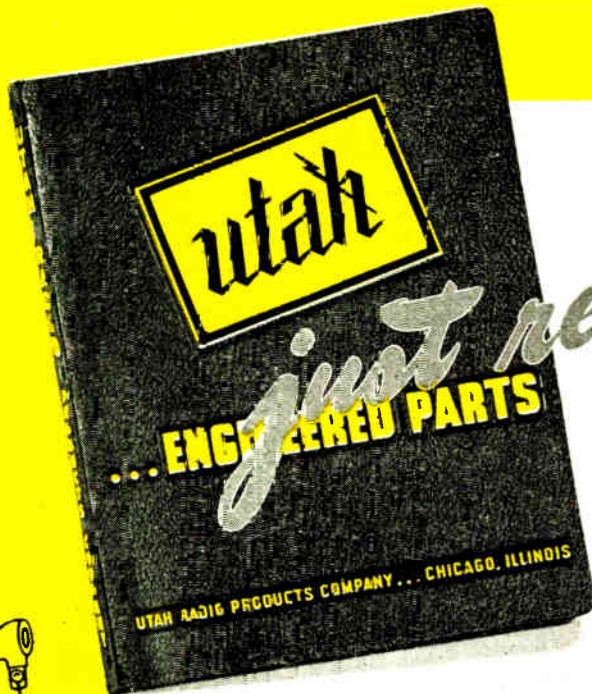

**50 pages of parts  
and  
their technical data**

Standard items are "keyed" with jobber part numbers, making it simple and convenient to order from your local distributor.

Included are:

- **POTENTIOMETERS AND RHEOSTATS** in 5 different sizes ranging from 3 to 15 watts. Simple in design, rugged, and dependable.
- **"T" & "L" PAD ATTENUATORS** in 5 different designs for controlling volume in circuits of microphones, loud speakers, phonograph pick-ups, mixers, audio and public address amplifiers.
- **SWITCHES** that are compact in size, simple in design, and of highest quality material are your assurance of dependable service with economical cost. Standard types and circuits.
- **LEAF SPRING STACK ASSEMBLY SWITCHES**—Low-cost, practical, dependable Contact Switch Assemblies for use in coin machines, record changers, electrical medical instruments or wherever simple leaf switches are required—available to meet innumerable different specifications and arrangements.
- **PHONE PLUGS AND JACKS** are available in various styles. Jacks include the famous "Imp" Type, and the Short and Long Frame Types. Phone Plugs supplied in two- and three-conductor types . . . for practically every type of application.

*This Utah Catalog, No. U.C.-44, is 50 pages loose-leaf bound, and provides the engineer with complete technical data and blueprint details. Copies available without obligation upon written request on your business letterhead and mention of your position. Write today for your copy!*

**Utah**

**UTAH RADIO PRODUCTS COMPANY**

820 NORTH ORLEANS STREET • CHICAGO 10, ILLINOIS

Utah Electronics (Canada) Ltd., 300 Chamblay Road, Longueuil, Montreal (23) P. Q. • Ucoo Radio, S. A. Misiones 48, Buenos Aires

# SYLVANIA NEWS

ELECTRONIC EQUIPMENT EDITION

NOV.

Published by SYLVANIA ELECTRIC PRODUCTS INC., Emporium, Pa.

1945

## RADIO AND ELECTRONIC EQUIPMENT MAKERS GETTING SET FOR FULL-SCALE PRODUCTION

*Will Receive Highest Quality Tubes From  
Sylvania Electric To Meet Pent-Up Demand*

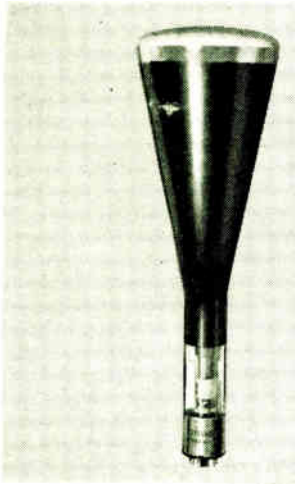

### CATHODE RAY TUBES

With the period of reconversion taking active form and spreading over the nation, the radio industry is looking forward to what promises to be one of the most expansive developments in its history. Millions wait for radio sets of improved design and, consequently, of more complex construction. Industries will turn to greater use of electronic equipment.

Manufacturers are rapidly getting set for full-scale production to meet this pent-up demand. Of course, in radio there's the problem of obtaining an adequate supply of component parts.

However, as far as dependable, pre-



### LOCK-IN RADIO TUBES

cision-built radio tubes are concerned, set makers are assured of receiving the benefits of Sylvania's more than 40 years' research experience and wide-scale production facilities. Note this list:

Television—experience in design and the production of untold thousands of Sylvania Cathode Ray Tubes for war requirements has contributed greatly to peace-time applications.

High frequency sets (FM, Television)—the Sylvania Lock-In Tube is so electrically and mechanically perfect in construction that it can handle

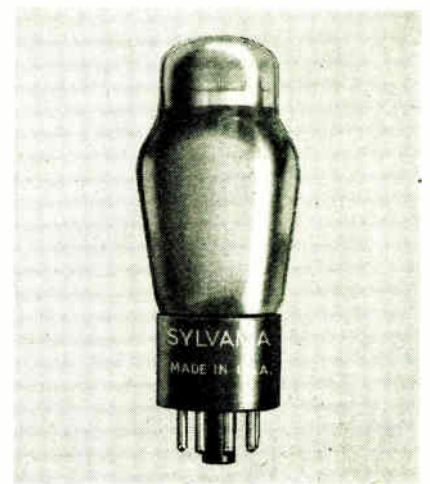

### "GLASS" RADIO TUBES

ultra-high frequencies with ease. Besides, it is more than perfectly suitable for *all* types of radio sets.

Radio—manufacture and distribution of the famous high quality Sylvania lock-in "Glass" and miniature tubes will continue to satisfy the exacting circuit requirements of modern radio receivers.

Electronic devices—the same laboratory and manufacturing resources that served our government so well, are now available to the manufacturer of electronic devices of every description.

# SYLVANIA ELECTRIC

Emporium, Pa.

MAKERS OF RADIO TUBES; CATHODE RAY TUBES; ELECTRONIC DEVICES; FLUORESCENT LAMPS, FIXTURES, WIRING DEVICES; ELECTRIC LIGHT BULBS

Yes,  
Schweitzer

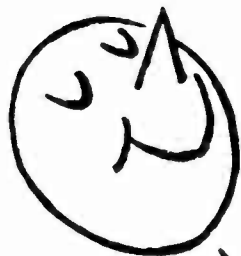

**STRETCHES**  
it THIN...to .00025"

**IF YOUR NEEDS ARE FOR  
REALLY THIN GAUGE PAPER**

We're specialists with long years of experience in the production of thin gauge insulating papers. If you are manufacturing capacitors, coils, transformers or other equipment requiring .00025" gauge papers, or any of our other grades, ranging up to .004" in thickness...remember, Schweitzer can supply your requirements now.

*don herold*

**SCHWEITZER PAPER CO.**

142 MILLER STREET, NEWARK, N. J.  
Plants: Newark, Jersey City, N. J., Mt. Holly Springs, Pa.  
Research Laboratories: Chrysler Bldg, New York, N. Y.

**SPECIALISTS IN THIN GAUGE INSULATING PAPERS**

**LOW FREQUENCIES ACCURACY TO 1/1,000th of 1%**

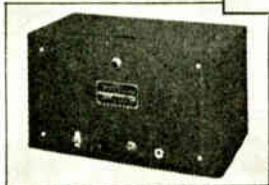
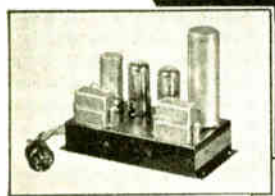
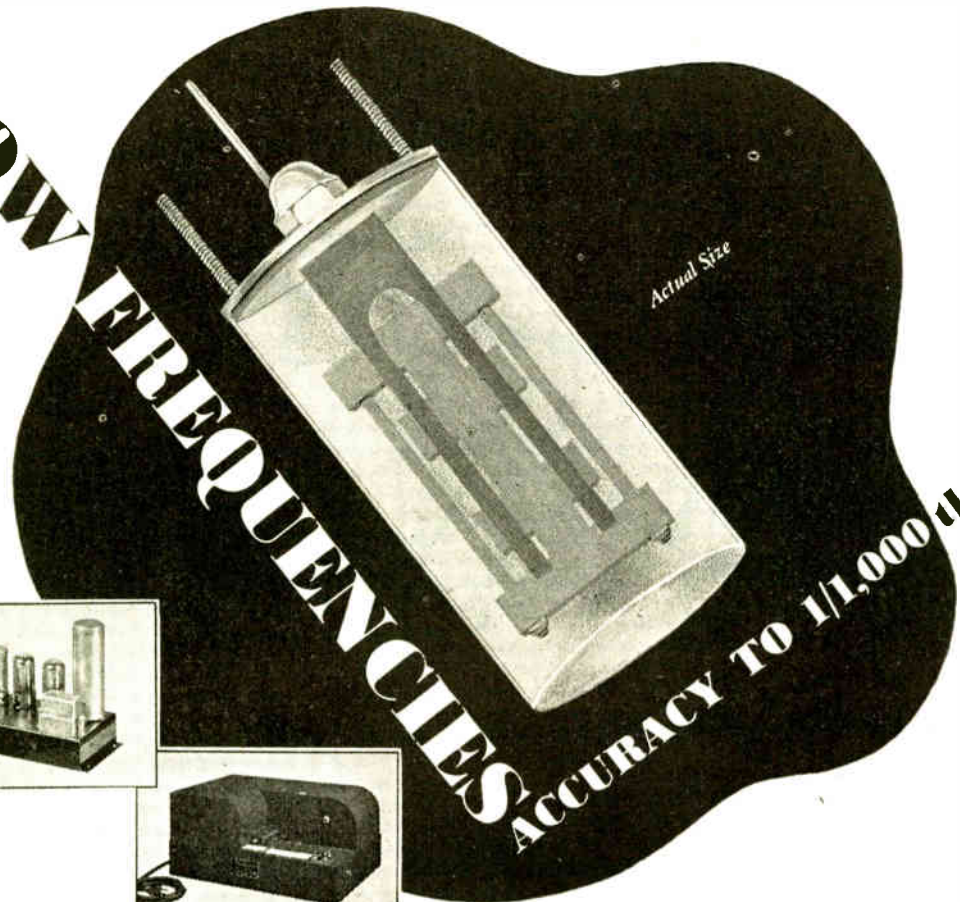

**TOP**  
**FREQUENCY STANDARD**  
*(60 cycle) for use with external power supply*

**CENTER**  
**CHRONOGRAPH**  
*Records time intervals with resolution to .001 second*

**BOTTOM**  
**FREQUENCY STANDARD**  
*(120 cycles) with self-contained power supply*

These tuning forks which include new engineering principles, provide frequencies from 120 to 1,000 cycles directly with an unqualified guarantee of accuracy to 1 part in 100,000 over a wide temperature range. (Better than 1 second in 24 hours). Closer tolerances are obtainable on special order.

These tuning fork assemblies are available only in single or multi-frequency instruments of our own manufacture which are de-

signed to test, measure or control other precision equipment by mechanical, electrical, acoustical or optical means.

The dependability of these frequency standards is being demonstrated for myriad purposes in all climates and under all working conditions.

If you have need for low frequency standards of exceptional accuracy, your inquiries are invited.

**American Time Products, Inc.**  
**580 Fifth Ave.** **New York, N. Y.**

*Dist. of Western Electric & Watch Master Watch-rate Recorders*

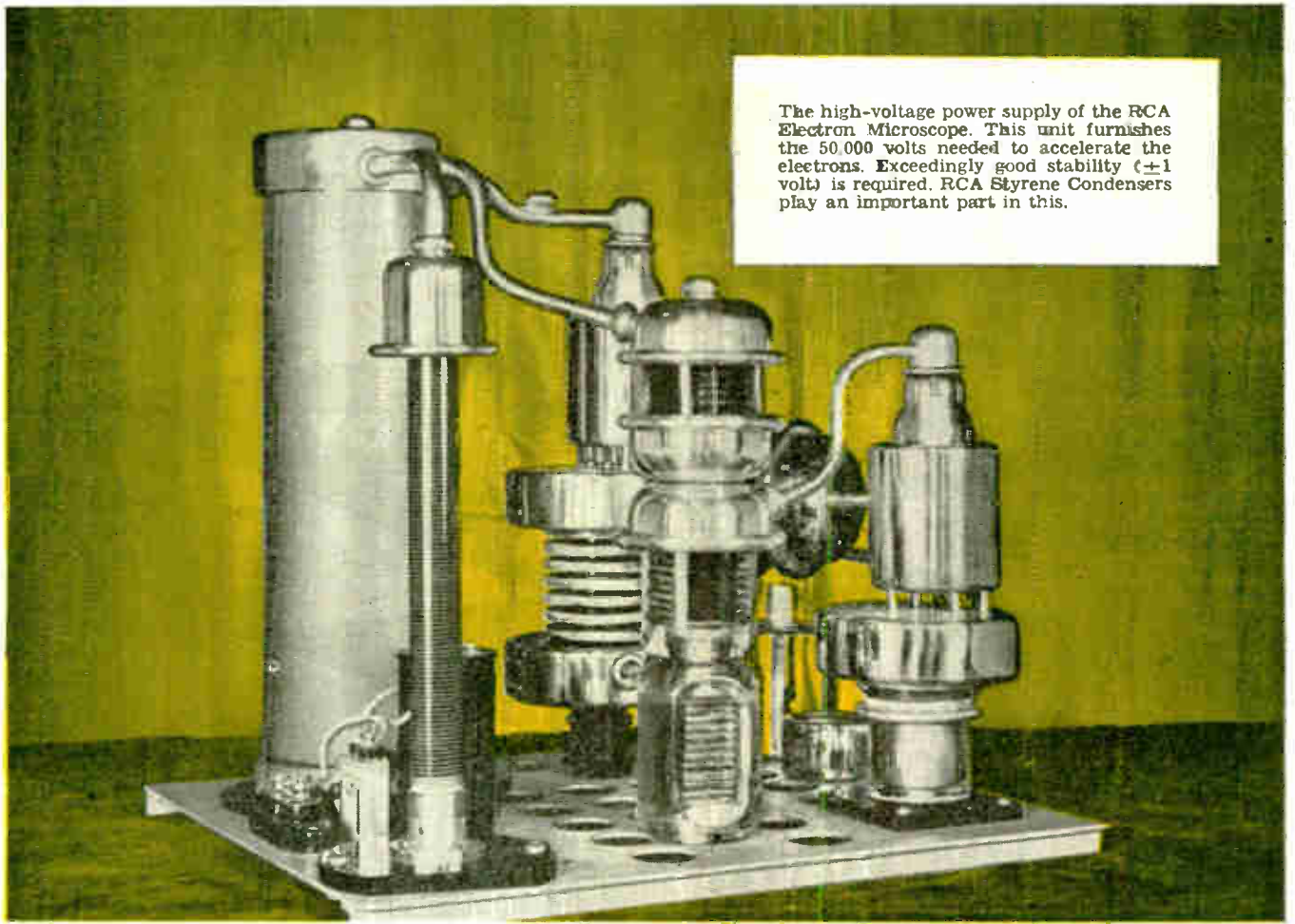

The high-voltage power supply of the RCA Electron Microscope. This unit furnishes the 50,000 volts needed to accelerate the electrons. Exceedingly good stability ( $\pm 1$  volt) is required. RCA Styrene Condensers play an important part in this.

## RCA STYRENE CONDENSERS FOR ELECTRONIC EQUIPMENT

**T**HE latest development in mica capacitors is a new type of Faradon Condenser in which the mica and foil "stack" is imbedded in clear styrene.

The use of styrene, instead of the usual wax, improves the "sealing," thus providing much better stability. Moreover, because the styrene has a lower power factor, the losses are less, and current ratings (for the same temperature increase) are higher.

At the present time limited to use in high-priority equipment, styrene capacitors are expected to find a wide range of uses in postwar transmitting, communication, and electronic equipment.

For complete information on Faradon Capacitors, for any purpose, write to the Engineering Products Department, RCA Victor Division, Camden, New Jersey.

A two-section styrene condenser from the power supply shown above. In some instances, these condensers can be used without case as shown here. Usually, however, they are mounted in standard cases.



BUY MORE VICTORY BONDS



### RADIO CORPORATION OF AMERICA

RCA VICTOR DIVISION • CAMDEN, N. J.

In Canada, RCA VICTOR COMPANY LIMITED, Montreal

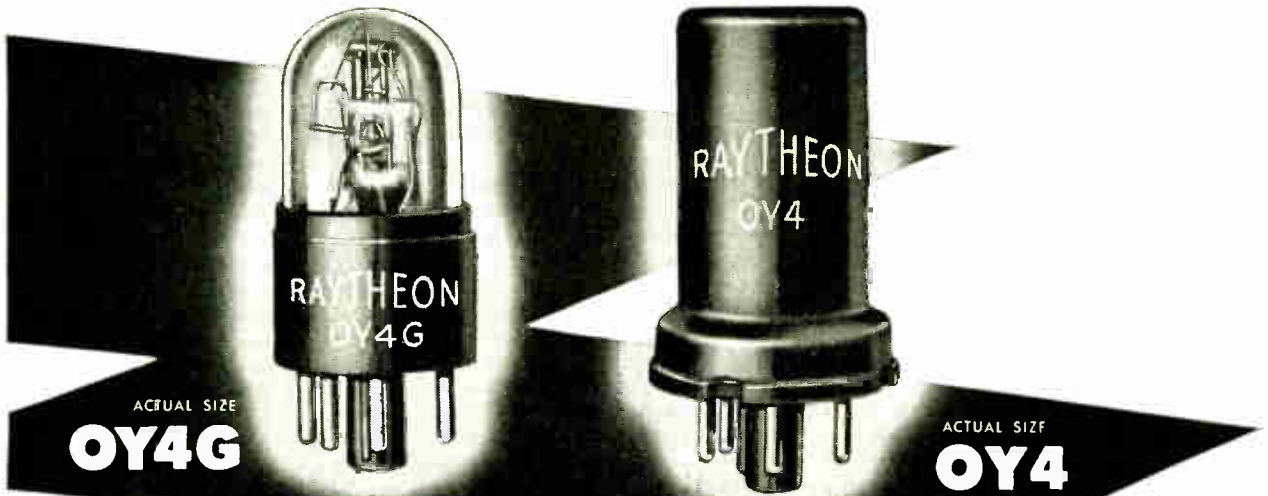

ACTUAL SIZE  
**OY4G**

ACTUAL SIZE  
**OY4**

# RAYTHEON

## IONICALLY HEATED LOW VOLTAGE GAS RECTIFIERS

Readily Available • Smaller Space Requirement • Lower Operating Temperature • Commercial in Cost • Long Life • Quicker Starting

A major deterrent to the further size reduction of radio receivers and other equipment designed for universal operation from a standard 117 volt AC or DC line or internal batteries, has been the size and power dissipation associated with the rectifier tube. The advantages of an ionically heated tube for low voltage applications were recognized early by the Raytheon engineers, who have long pioneered in the field of gas tube development. However, considerable research has produced the OY4 and OY4G which start cold from no more than 95 volts DC. High rectification efficiency is realized from the low internal drop and high peak current ratings. Physically these types have the same dimensions as the familiar OZ4G and OZ4.

Where size is an important factor, use of the OY4G in place of the 117Z6GT, as extensively employed in the three way receivers, will result in a substantial reduction of the space requirements.

Even more important is the differential of approximately eight watts in favor of the OY4 and OY4G because of the ionic heating feature. This saving cuts the input power down by more than 50% for a normal receiver. Consequently, cabinet size can be decreased without danger of excessive heating. Furthermore, the time required for the set to become operative is the same whether on DC, AC or battery — that is, almost instantaneous.

These tubes have been engineered to produce a minimum of the radio frequency disturbances associated with a gaseous discharge. The simple filter circuit indicated below will generally reduce such interference to a negligible value.

If your product does not call for the ionically heated low voltage gas rectifier, there is a Raytheon type designed for your need. And all Raytheon tubes follow the same rigid pattern of advanced engineering with precision manufacture. To get continuing best results, specify Raytheon High-Fidelity Tubes,

### OY4G AND OY4 RATINGS

Half Wave Rectifier—Condenser Input to Filter\*

Maximum Inverse Peak Voltage . . . . .	300 volts
Maximum Peak Current . . . . .	500 ma
Maximum DC Output Current . . . . .	75 mc
Minimum DC Output Current . . . . .	40 mc
Minimum Series Anode Resistance (117V line operation) . . . . .	50 ohms
Approximate Tube Drop . . . . .	12 volts
Maximum DC starting Voltage** . . . . .	95 volts

\*Pins 7 and 8 must be connected together. Rapid intermittent operation is undesirable.

\*\*With starter anode network as shown in circuit.

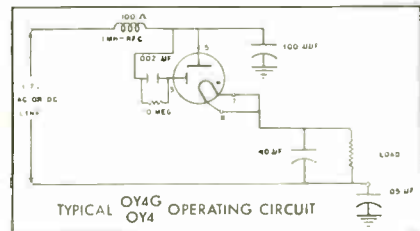

TYPICAL OY4G OY4 OPERATING CIRCUIT

*Radio Receiving Tube Division*

NEWTON, MASSACHUSETTS • LOS ANGELES  
NEW YORK • CHICAGO • ATLANTA



DEVOTED TO RESEARCH AND THE MANUFACTURE OF TUBES AND EQUIPMENT FOR THE NEW ERA OF ELECTRONICS



Resistant to moisture and humidity changes, Phenolite used as stator insulation helps this radio condenser perform uniformly under varying climatic conditions.

**RESISTS MOISTURE**

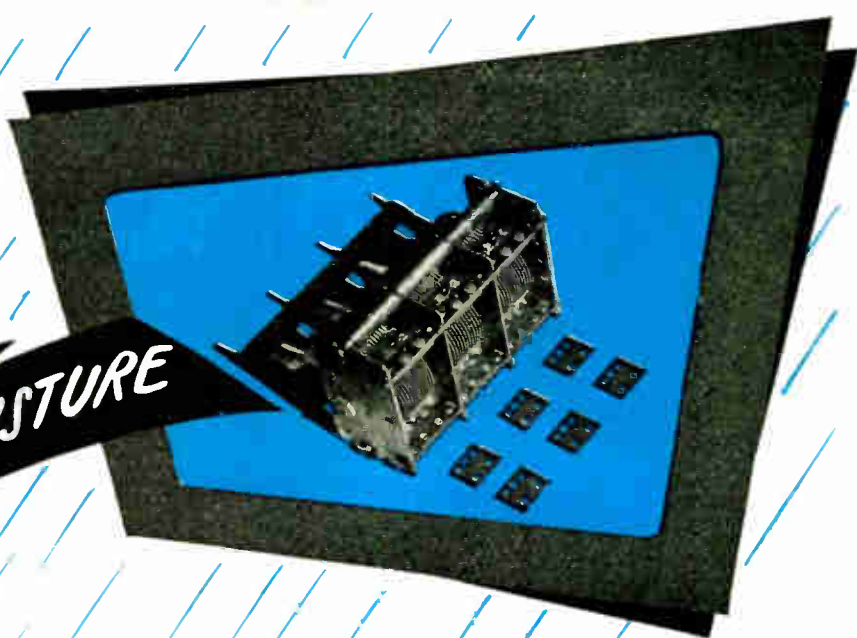

## Low moisture absorption of PHENOLITE improves performance of your product

In the electrical industries, Phenolite laminated Bakelite finds widespread use because of its extreme resistance to moisture and changing humidities . . . its ability to reduce dimensional changes and variations in electrical properties to a minimum.

This desirable quality accounts for its use where a tough, machinable insulation is demanded. But, because of its rare *combination* of outstanding properties, it is also readily adaptable for many more industrial applications. Light in weight (about one-half that of aluminum), it is exceptionally resilient and high in impact strength . . . is resistant to abrasion . . . possesses good machinability . . . resists heat and moisture . . . and is not affected by solvents and oils.

Find out now some of the many ways this versatile material may serve you profitably in your peacetime plans and products. Write for full information and the assistance of one of our trained engineers.

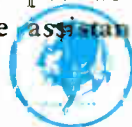

**NATIONAL VULCANIZED FIBRE CO.**

Offices in Principal Cities

Wilmington 99, Delaware



# for every transformer application

FOR THE SET MANUFACTURER

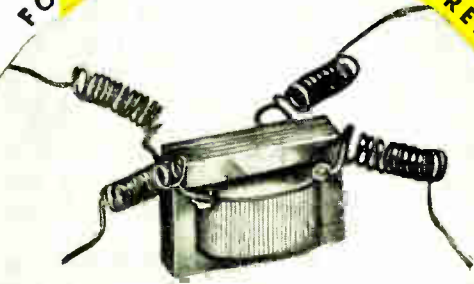

Miniature components to match the new "proximity fuse" miniature tubes. Output and input transformers, and reactors with dimensions 9/16" x 3/4" x 5/8".

FOR THE RESEARCH LABORATORY

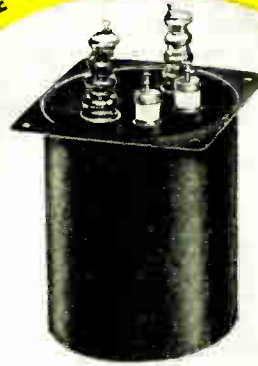

Typical of the special units produced by UTC is this high gain, 100 cycle, matching transformer. Primary impedance 500 ohms, secondary impedance 37,500,000 ohms, shielding suitable for—160 DB signal level.

FOR THE RADIO AMATEUR



UTC Special Series components cover the entire range of amateur and low priced PA requirements . . . attractively cased . . . economically priced.

FOR THE BROADCAST STATION

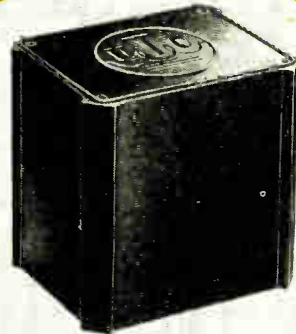

UTC linear standard transformers are the ultimate in high fidelity design . . . frequency response guaranteed  $\pm 1.5$  DB 20 to 20,000 cycles . . . Low wave form distortion . . . Extremely low hum pickup.



ALL PLANTS

# United Transformer Corp.

150 VARICK STREET

NEW YORK 13, N. Y.

EXPORT DIVISION: 13 EAST 40th STREET, NEW YORK 16, N. Y.,

CABLES: "ARLAB"

# ELECTRONIC INDUSTRIES

Including INDUSTRIAL ELECTRONICS

O. H. CALDWELL, EDITOR ★ M. CLEMENTS, PUBLISHER ★ 480 LEXINGTON AVE., NEW YORK (17), N. Y.

## **Get Job Done the Best Way**

Engineers of organizations which have widely promoted electronic methods, now indicate that they are not eager to promote electronic solutions as the only ones for industrial problems. Instead they seek to accomplish results—considering all factors of performance, competitive costs and operating expense, in proper perspective.

These engineering spokesmen look forward to tremendous increases in power supply, instrumentation, industrial control, and heating business based upon electronic components. But, at the same time, they have no desire to encourage emphasis upon electronics as such.

## **For the Best Electronic Defense**

As it progressed, this war was increasingly dependent on electronic devices.

What will the next one (God forbid it!) be like? Our defense laboratories will have to envisage the problem in entirely new dimensions considering that airplanes and guided missiles will have speeds approaching or equaling those of defense projectiles. Their power also will be so great that means of defense must approach 100% certainty. Now is not too early to start.

## **Bigger'n Broadcasting**

Induction and dielectric heating equipment now installed represents about five times the combined tube transmitting output power rating of all commercial broadcasting stations in the U.S. Yet those in the new heating field still regard this to be a minimum figure and suggest that the more accurate ratio might be 9 or 10 times, because the transmitting-type tubes

used are loaded in industrial work to only 50% of their rated capacity.

Also it is emphasized that as rapidly as possible special tubes will be developed for induction-heating purposes, since adherence to transmitter tubes involves too many compromises, too great an expense, and a definite waste of precision assembly and testing facilities. Special tubes, however, are not looked for in less than two years.

## **Electronic Packages**

While a number of electronic manufacturers are sponsoring packaged units of various kinds, in which vacuum-tube equipment finds a place, the experience to date is not entirely happy along this line. For only the simplest of packaged assemblies can be made to perform satisfactorily in the hands of the user who buys them on that basis. Increasingly the viewpoint is that successful use of vacuum-tube equipment in industry calls for installation and field work in close collaboration with application engineers—and this to a greater degree than prevails with most other electrical items!

## **Paying the Engineer**

At this time, when the whole industrial world is seeking fairer bases of compensation, it is certainly appropriate for the radio-electronic engineer to consider principles which will accord him a fuller share of his deserts. Too often the executive, sales and legal departments have reaped unduly of the rewards earned by the engineer's creations.

(More about incentive-payment plans in this issue, pages 84 and 85.)

## **ENGINEERING DIRECTORY NUMBER NEXT MONTH**

At the moment when manufacturers are announcing their new peace-time products and completing 1946 design and marketing plans, the publishers of Electronic Industries announce the Engineering Directory to be published in December as an integral part of the regular magazine. This Directory—an editorial service for the benefit of our engineering readers—will include complete listings of all manufacturers of finished products, raw materials, parts and components, equipment and accessories, laboratory apparatus and production equipment.

# SILICON CRYSTALS FOR

By **E. C. CORNELIUS,**

Development Engineer  
Sylvania Electric Products, Inc., Emporium, Pa.

## Voltage and loading factors which govern operating efficiency of modern "diodes" functioning at high frequencies

• Any compilation of the many advances in electronics during the war years would be incomplete were it not to include the story of the rediscovery and rejuvenation of the crystal rectifier. The capricious cat's whisker-and-galena detector of radio's infancy, after a desuetude of nearly twenty years, has been completely redesigned, both electrically and mechanically. The result is that the crystal "diode," as we prefer to call it, is once more a familiar circuit element; indeed, it is an essential component of u.h.f. and s.h.f. receivers. Moreover, new types will soon be on the market which will exhibit electrical characteristics superior to conventional vacuum tube diodes in many other applications. These advantages, coupled with inherent simplicity and ruggedness, and the fact that no heater supply is required, all give promise that the crystal "diode" will play an important part in postwar electronic equipment.

Almost since the inception of radio, its many devotees, both amateur and professional, have been continually probing into higher and

higher frequency ranges. By the time the clouds of war had darkened the world for a second time, the development of magnetrons and velocity modulated tubes (Klystrons, etc.) had made the utilization of frequencies in excess of 1,000 megacycles an engineering

practicality. The use of ultra and super high frequencies, however, required a revision of means of detection.

The conventional vacuum tubes which had served so well for the past twenty years were no longer satisfactory. Electron transit time effects reach serious proportions in such tubes at these frequencies. In addition, noise voltage and inter-electrode reactances become troublesome. Recently developed tubes permit an extension into higher frequency ranges, but they too soon fail for the same reasons as do the ordinary types. This situation led to a renewal of experiments with crystal detectors.

Spurred by the war, the British led the way in developing the type which has become standard today. In this country, development work was largely carried out at the Radiation Laboratory of the Massachusetts Institute of Technology. The problems of production engineering and manufacture were undertaken by various commercial laboratories of which Sylvania Electric was one of the earliest and most important contributors.

The type finally developed and adopted as standard is shown in Fig. 1. The galena has been replaced by silicon and the whisker has been reduced to a fine tungsten wire spring, pointed with a

Fig. 3—The crystal is suspended from gold-plated contacts and enclosed in ceramic tube

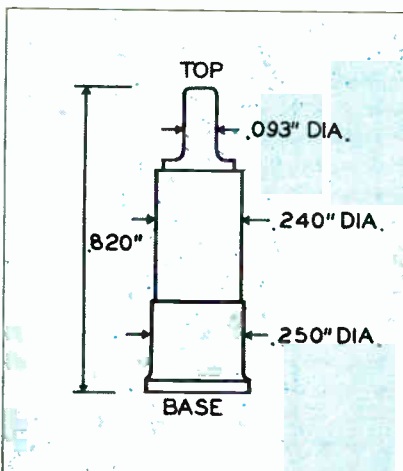

Fig. 1—General appearance and relative size of recently developed silicon crystal "diodes" which have found particular application as rectifiers and detectors in high frequency circuits

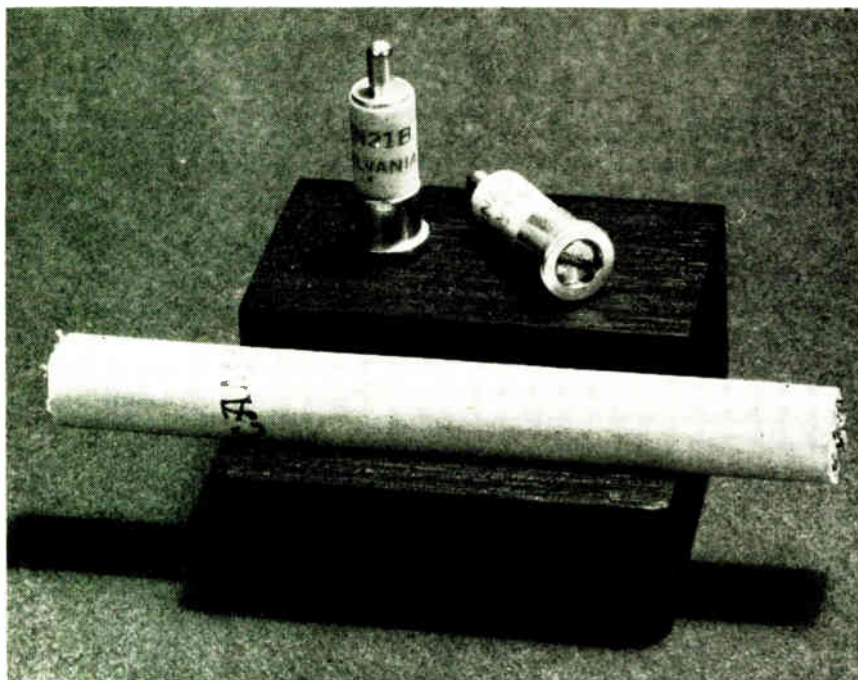
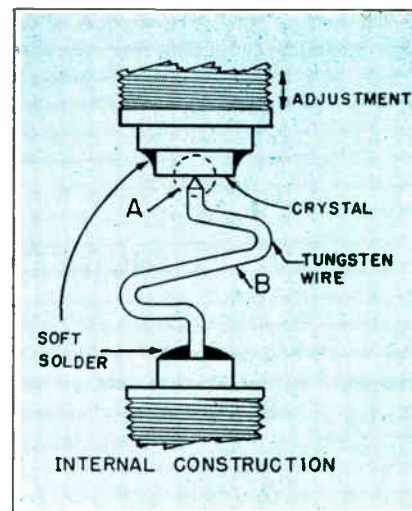

Fig. 2—Internal design of the detector showing crystal and "whisker" mounting arrangement



# UHF DETECTION CIRCUITS

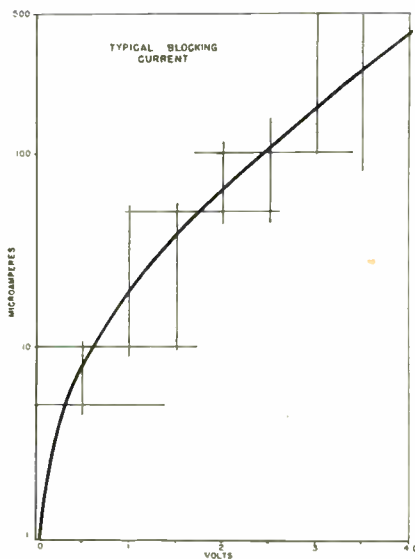

Fig. 5A—Typical blocking current characteristics of the silicon crystal rectifier

high degree of precision. The unit is adjusted for optimum operation at the factory and hermetically sealed in a cylindrical package less than an inch in length and smaller in diameter than an ordinary lead pencil.

In the course of experimentation, many different elements, compounds, and methods of manufacture were investigated. Galena and iron pyrites were electrically stable and gave good results, but their mechanical and chemical instability made them unreliable. Silicon carbide gave good rectification but very poor converter action. Silicon, containing minute but carefully controlled amounts of impurities, was tried and found to give the best results.

The first crystal assemblies were made with broken silicon, straight iron wire and crudely shaped points. The rectifiers constructed in this manner were unstable because the thermal expansion in the iron wire and in the ceramic holder were unequal. Their resistance to vibration and shock was also poor. Further, the jagged surface of the crystal made it impossible always to set the wire point at the desired place.

After further research, a tungsten wire was used because of its uniformity and absence of flow (when made of copper, iron, gold or platinum alloys, the point mushroomed). By bending the wire to obtain a spring action, resistance to vibration and shock was greatly improved. The crystal was polished to a near optical surface, thus permitting placement of the point in any desired area.

The present internal design is shown in Fig. 2. The contact (A) is designed to produce a minimum of shunt capacity and a maximum of uniformity. The wire (B) is shaped to give a maximum of elasticity with a minimum of series inductance. The crystal unit is suspended from gold plated contacts and enclosed in a ceramic tube as shown in Fig. 8. Fig. 4 is a section of the finished cartridge.

The completed unit is rugged as compared to early crystal rectifiers. Its resistance to vibration and shock is comparable to that of an ordinary receiving tube. It can tolerate temperature extremes of  $-40^{\circ}$  or  $+70^{\circ}$  C. Because of its high absorption of energy, water is usually detrimental to microwave equipment, but this cartridge can be immersed in water for several hours and will function perfectly when wiped dry. Tests show that units will perform satisfactorily over a period of years, provided reasonable precautions are observed.

## Rectification action

Many theories have been advanced concerning the behavior of silicon-tungsten rectifiers. Most of these explanations are similar to those applied to the copper-copper oxide type, although they are not in complete accord. A discussion of rectification theory involves quantum mechanics, theory of solids, crystalline structure, etc., and is beyond the scope of this paper. In the following paragraphs some of the observed phenomena are discussed and a simple analogy is drawn.

It can be experimentally determined that:

1. If two metallic surfaces are brought into contact with a properly doped\* piece of silicon so that

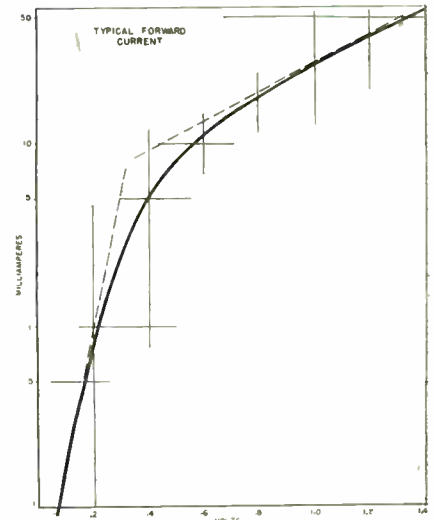

Fig. 5B—Forward current data. Note that scale is 1000 times that shown in Fig. 5A

there is a large area of contact (anode) and a small area of contact (cathode), these two areas will be the terminals of a device which is electrically non-linear.

2. The currents passing at zero frequency will be some complex function of the magnitude and polarity of the voltage applied. This is illustrated in the curves of Fig. 5, which show typical forward and blocking current data. It should be noted that the vertical scale of Fig. 5b is 1000 times that of Fig. 5a.

The nature of this action may perhaps be better understood by studying Fig. 6. Let us imagine that at the contact of the metal with the semi-metal there is formed a blocking layer which acts like many small funnels. In other words, when the direction of electron flow is from the metal into the semi-metal many more electrons flow past the boundary than when the direction of flow is reversed. The action is similar to what would happen if we were to place two identical funnels over suitable containers and set them out in the rain, the only difference being that one funnel is placed in an inverted position. We would naturally find that the container with the upright funnel collected water much more rapidly than the one under the inverted funnel.

We are now in a position to describe how rectification, which is merely a term which is used to in-

Fig. 4—Section of the finished crystal cartridge, identifying various component parts

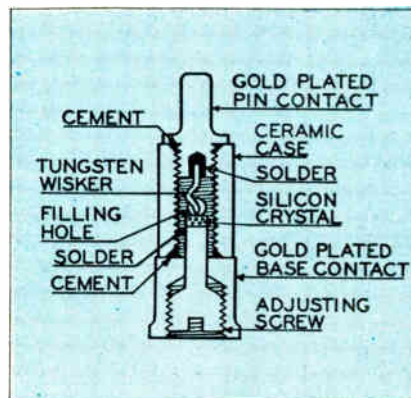

\* Doping is a process by which very pure silicon (a poor detector) is activated by the addition of another material or materials (usually metallic in nature). This doping agent, if properly regulated, will do much to determine the characteristics of the finished crystal since it controls resistance to burning, uniformity of crystalline structure, impedance and stability.

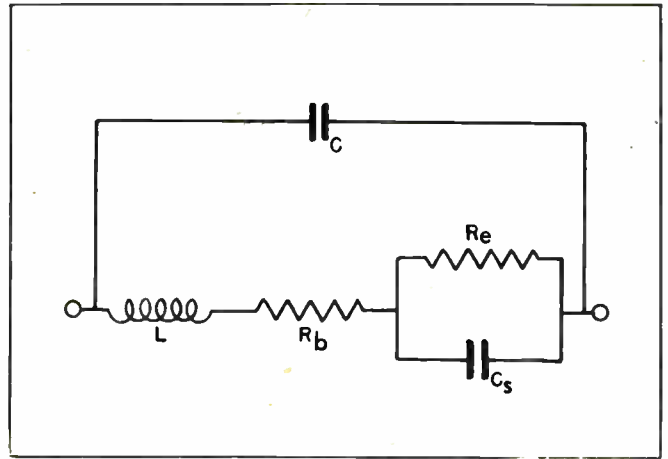
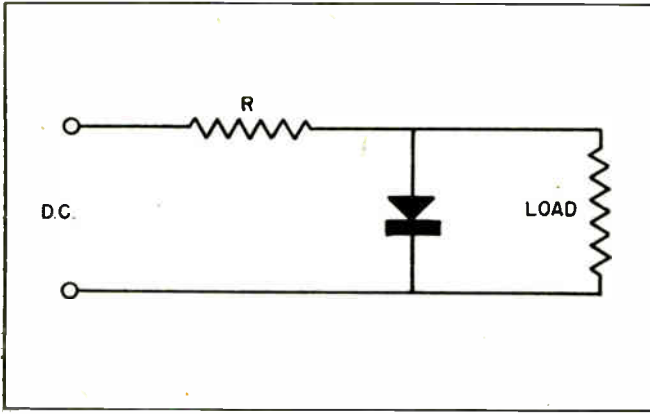

Fig. 8—In such a circuit advantage may be taken of the non-linear characteristics to provide regulator action. Fig 9—(Right) Equivalent circuit.  $R_b$  is the spreading resistance;  $R_e$ , the blocking resistance;  $C$ ,  $C_s$ , and  $L$  the cartridge and storage capacitances and the inductance

indicate that current flows more easily in one direction than the other, takes place. The differentiation is accomplished by providing a greater number of these electronic funnels (i.e., a greater area of contact) on one side (anode) of the silicon than on the other (cathode). The electrons flow freely through the crystal from cathode to anode because the large number of inverted funnels at the anode is sufficient readily to pass the electrons which flow through the small number of upright funnels at the cathode. In the reverse direction, however, electrons flow easily into the silicon from the anode, but are unable to escape through the small number of funnels at the cathode, which now appear inverted. The storage of electrons in the non-flow direction gives rise to a capacitance ( $C_s$ ), which is an inherent property of the crystal and cannot be tuned out by an inductive transformer.

It is difficult to write an equation

for the static characteristics of a crystal. If one considers the forward current only, then the following approximation may be used:

$$I = Ke^n$$

where  $I$  = Forward current

$e$  = Voltage of proper polarity

$K$  and  $n$  are also functions of voltage but may be considered as constants over short ranges. Their values may be experimentally determined from curves such as Fig. 5. Typical values are:

$K = 1/50, n = 2$  for voltages less than 0.2

$K = 1/30, n = 1.5$  for 1 volt

The value  $n = 2$  is reliable enough to be used without calibration if the voltage limitations are not exceeded.

There are two factors which govern the efficiency of a crystal rectifier at low frequencies, namely, voltage and loading. The most efficient loading, i.e., that which gives the maximum ratio of d.c.

voltage delivered to ac voltage applied, is given by the formula:

$$R_L = \frac{a \times 10^3}{e}$$

$R_L$  = optimum load resistance in ohms

$e$  = applied ac voltage (r.m.s.)

$a$  = a constant depending upon the crystal type (for 1N21B,  $a = 2$ )

Departure from the value of loading as given causes approximately a 20% drop in the voltage delivered for a load change of  $R = \frac{1}{2} R_L$  to  $R = 5 R_L$ . A typical curve is given in Fig. 7. In general, rectification efficiency is greatest when a crystal works into a low load.

The crystal can be considered a constant voltage generator with a series internal impedance. Both the impedance and the rectified voltage are functions of the applied ac voltage. The rectified current is

(Continued on page 136)

Fig. 6—Schematic diagram illustrating the manner in which rectification takes place in the crystal rectifier. Fig. 7—Rectification efficiency

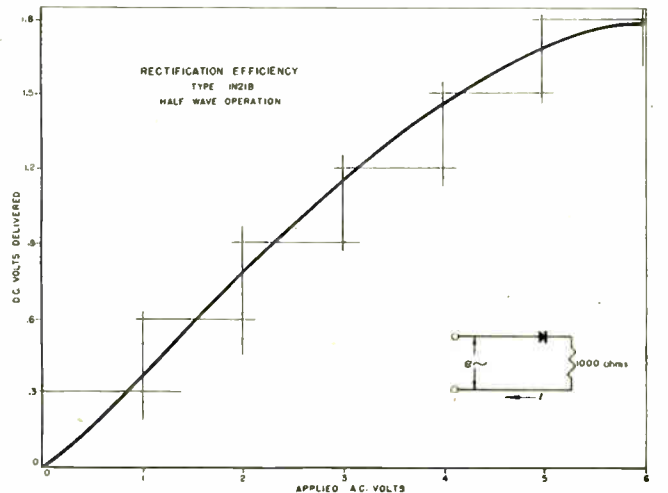
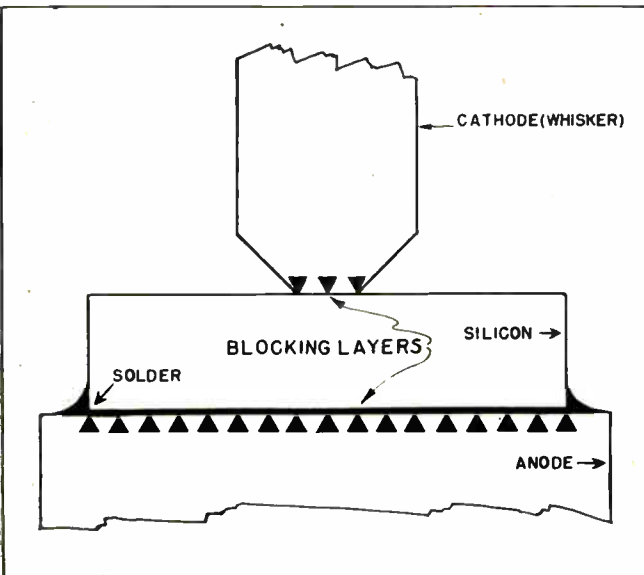

# HIGH VACUUM PUMPING

## Operating principles and mechanical construction of Eimac oil diffusion pump for exhausting tubes to extremely high vacuum

(Additional illustrations appear on two following pages)

● The extremely high vacuum required by modern high-power, high-frequency transmitting radio and radar tubes, led to the development early in the war of the HV-1, Eitel - McCullough's oil - diffusion vacuum pump. It has found wide use among vacuum tube manufacturers and other users of high vacuum apparatus.

Essentially simple despite its appearance, the oil diffusion vacuum pump is another example of a useful modern development of an old and established principle in laboratory physics. Its explanation requires a brief theoretical exposition.

The tube or other apparatus to be evacuated of its gas content is attached to the top of the pump by means of a manifold. The gas is drawn through the manifold to the upper jet of the pump, where the molecules of gas mingle with a stream of oil vapor issuing from the jet and are carried downward and out to the cooler glass walls of the pump. The oil vapor is generated by an electrically heated boiler at the bottom of the pump.

The oil vapor condenses into liquid oil on the walls and returns to the boiler, while the gas molecules, forced downward by the oil vapor and the gas pressure from above, fall under the influence of the middle jet and are forced still further downward.

Near the bottom of the pump, the gas is drawn off through an exhaust tube into a mechanical fore-pump, which must be capable of removing the gas from the system while maintaining the low pressure required at its end of the diffusion pump.

The use of aluminum baffles between the diffusion pump and the high-vacuum system prevents the oil vapor from finding its way into the high-vacuum system, since the oil vapor condenses on the discs which are kept relatively cool by the pump cooling fan. The baffle reduces the pumping speed by as much as one-half.

In addition to requiring exceedingly accurate jet design, the HV-1

(Continued on page 140)

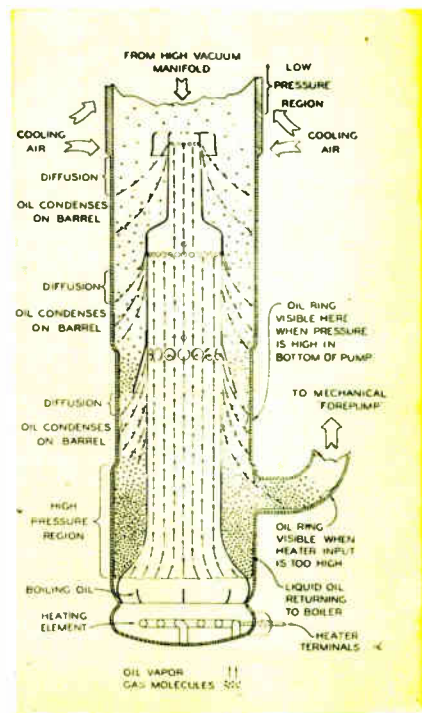
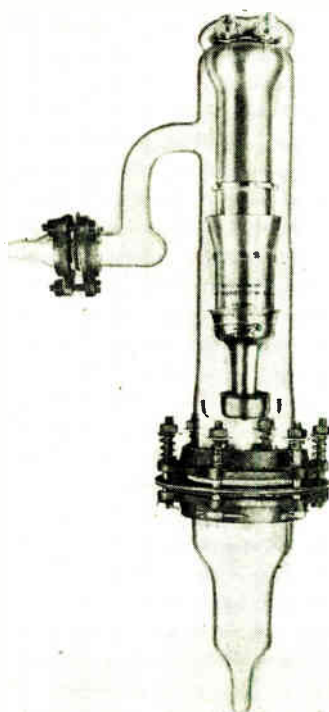

At the left is a view of the complete oil diffusion pump as it is attached to manifolds and at the right is a diagrammatic sectioned view to show its parts and illustrate operating principle Chart showing results obtained under average conditions with and without standard baffle

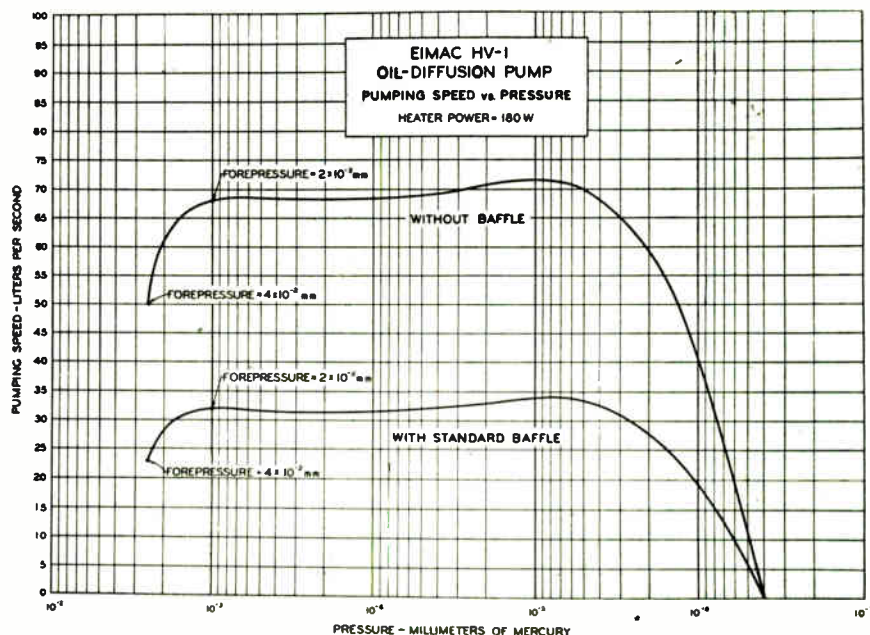

# High Vacuum Tube

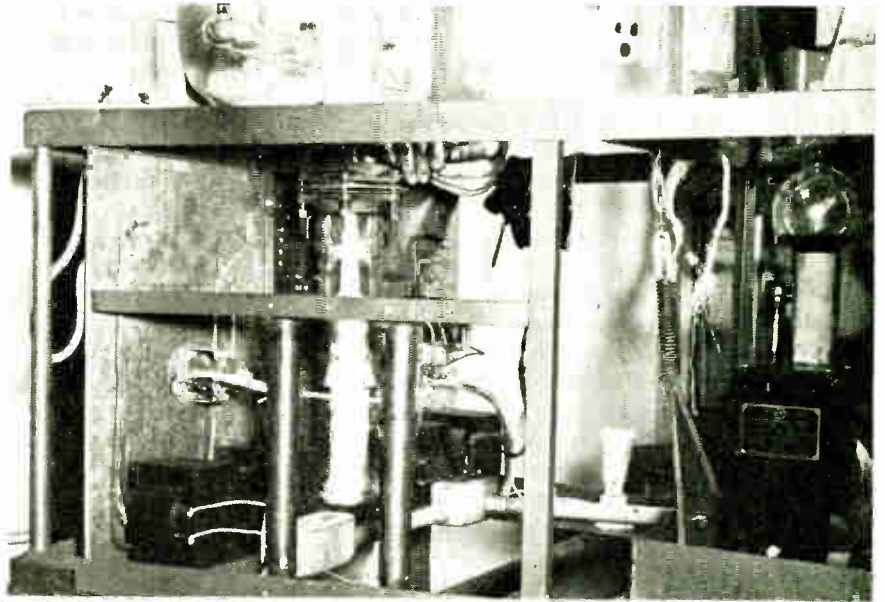
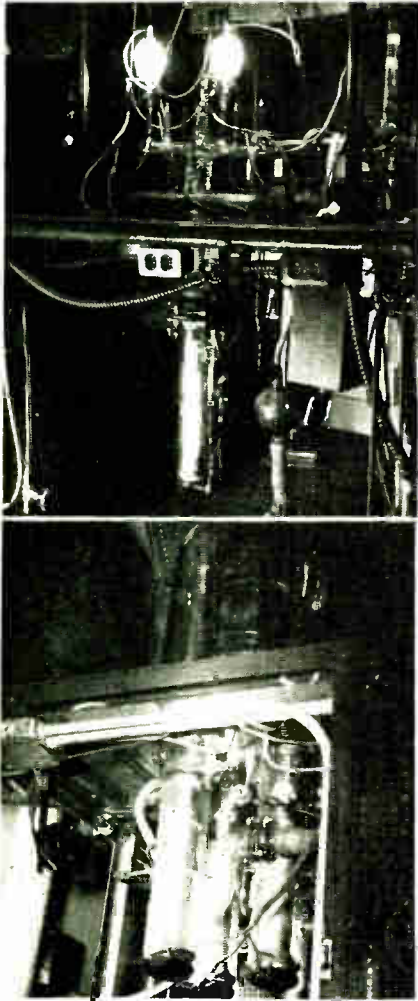

These illustrations covering applications of the Eimac HV-1 oil diffusion pump show: Top left—A typical installation in a stationary system for exhausting transmitting tubes. Center left—A multiple installation in which three pumps are ganged for high-speed exhausting of a vacuum furnace chamber. Bottom left—Method of making multiple installation for increasing pumping speed. Above—One of the pumps being installed in a rotary tube exhausting machine, unconnected forepump at extreme right. Bottom—A standard flanged pipe fitting on the high vacuum end makes possible a wide variety of applications of the pump

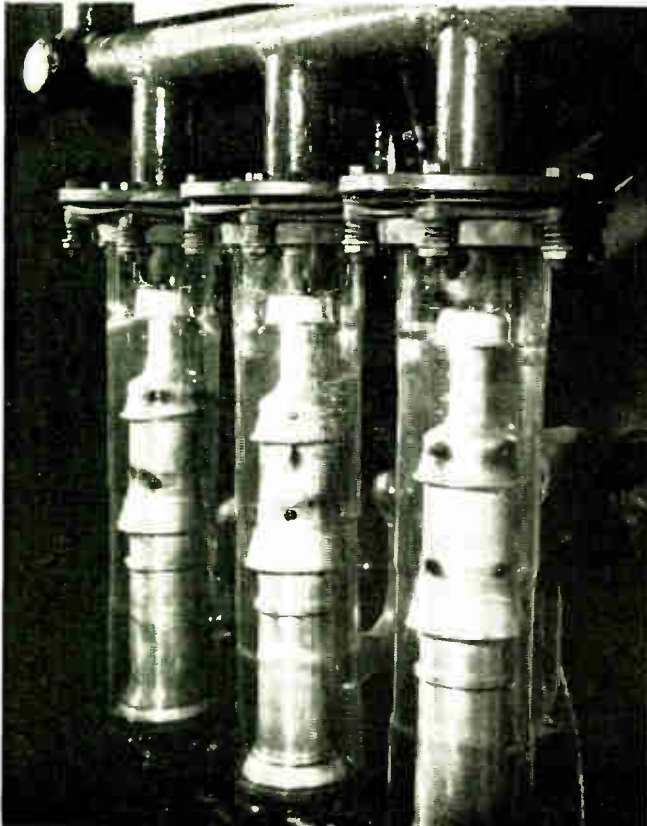



# Exhausting Technic



Left—A vacuum-tight seal is assured at the joint by the application of a film of sealing compound. Right—A duraluminum baffle sandwiched between two neoprene gaskets serves to trap and condense oil vapor, keeping it out of the high-vacuum manifold. Top right—Diffusion pump oil is poured into the barrel to the indicated level. Center—The aluminum chimney is inserted and automatically centered by the self-aligning features of the base top. Bottom left—A small joint, without spring loading on the bolts, joins the discharge end of the HV-1 to the mechanical forepump. The pump can be completely disassembled for cleaning in five minutes or less. Bottom right—The baffle is held between the flanges which also support the barrel. Spring-loaded bolts assure even pressure and alignment and maintain vacuum-tight connection between pump and manifold

*A detailed description of the oil-diffusion pump for obtaining extremely high vacuum in exhausting tubes and for numerous industrial applications appears on the preceding page*

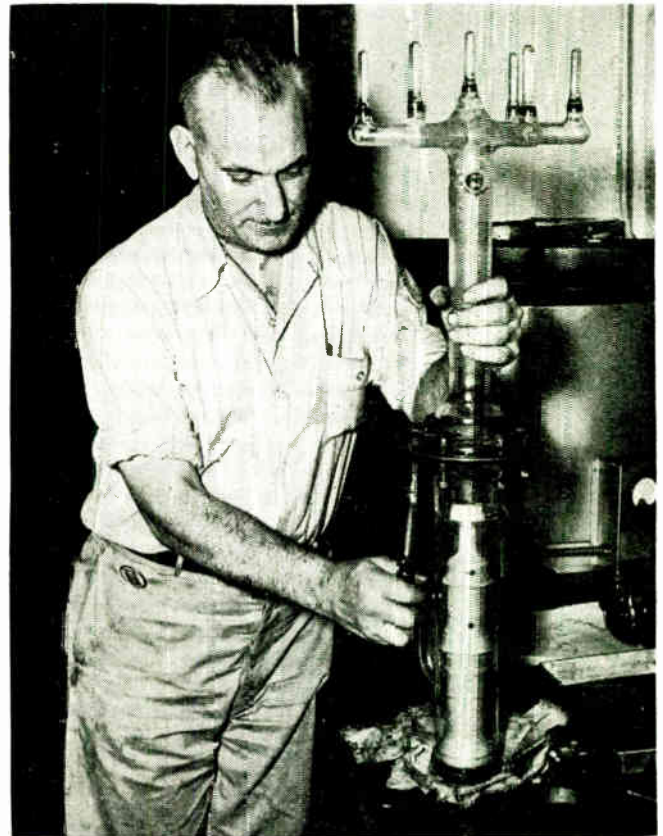
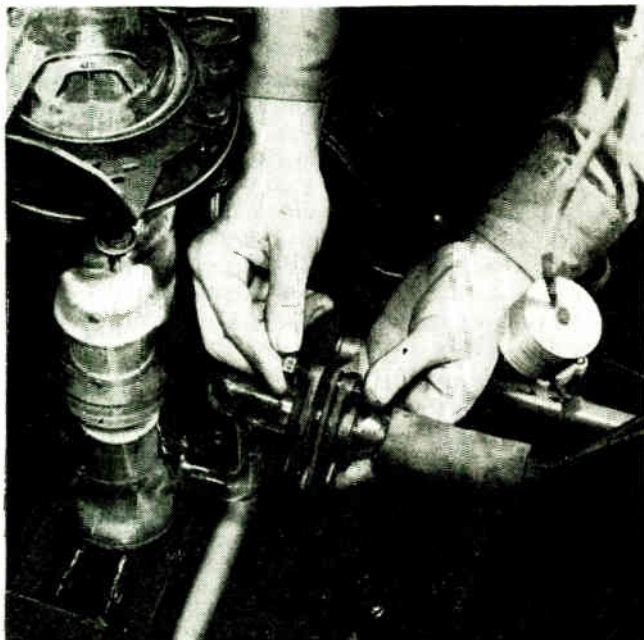

# Research Advances

*Military experience in design and production*



## Carbon Resistors, Ceramic Capacitors

By I. J. Kaar,

*Manager, Receiver Div. General Electric Co.  
Bridgeport 2, Conn.*

The vast increase in carbon resistor productive capacity, and the concentrated development which has been applied to carbon resistors during the war will probably result in more widespread use of insulated types in home receivers. Furthermore, the over-all quality of carbon resistors undoubtedly will be improved. Because of the widespread requirements for ceramic capacitors in military equipment, development during the war has been intense, and has resulted in products, in some respects, far superior to the paper capacitors previously used. It is probably safe to predict that ceramic capacitors will compete very seriously with wound paper types in postwar receivers.

Better metal finishes also are now

available. The anti-corrosion requirements of military equipment spurred the development of metal finishes, and some of these have been produced which are low enough in cost to warrant their use on home receivers. I have in mind here the chemical treatment of plated surfaces. Undoubtedly there will be a much wider use of aluminum and magnesium than in the prewar days. Aluminum producing facilities have been expanded enormously, and the price of aluminum would only have to be reduced only a few cents to make it strictly competitive with steel.

The use of iron cores for IF transformers and for tuning was well established before the war, but underwent considerable impetus for military equipment, and undoubtedly their use will be expanded in home-type receivers.

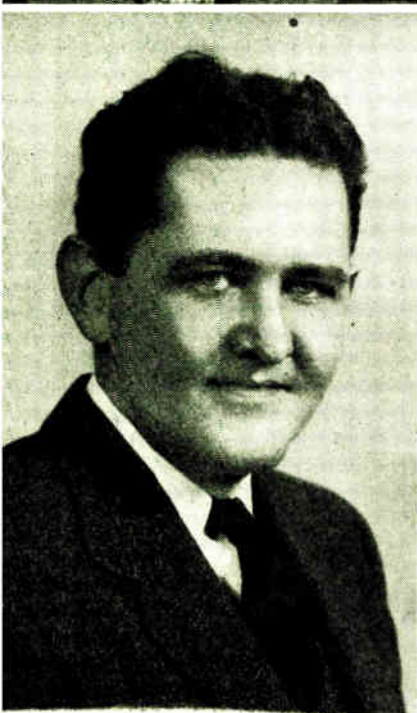

## Sensitivity and Fidelity Improvements

By Palmer M. Craig,

*Chief Engineer, Radio Division,  
Philco Corp.*

Wartime research will contribute to better, finer radio receivers, both for AM and FM, and television sets in many ways. New skills have been cultivated and nurtured in all branches of the industry. Circuits and technics developed to meet special war needs as well as new tubes and components, will allow us to accomplish hitherto impossible results.

In connection with the design and production of radar equipment for the Army and Navy, perhaps the greatest progress of all has been made in developing the technic for measuring infinitesimal qualities far more exactly. All these advances will bear fruit in the postwar period. You are sure to find more brilliant and life-like tone, better selectivity and greater sensitivity in your postwar radio receiver and more life-like reproduction in the new television sets.



## Miniature Tubes and Components

By D. D. Cole,

*RCA Victor Div., Radio Corp. of America*

The concentration of engineering effort on electronic equipment during the war has brought about the development of many new radio components and technics which can be applied to the design of receivers for the home. The most important of these developments has been the rapid expansion in the use of miniature tubes in all types of electronic devices for the armed services and the development of associated miniature components including sockets, rf coils and capacitors.

The new miniature tubes and components have satisfactorily solved the difficulties in the design of FM circuits for the new frequency allocations of 88 to 108 megacycles. The development of new insulating materials for radar equipment has assisted materially in the design of low loss transmission lines for use from the antenna to the instrument. Other advances include the improvement in powdered iron cores for high frequency use and the use of improved impregnating and insulating materials making possible more efficient and lower loss components.

# Receiver Design

will result in better components and circuits

## Better Frequency Drift Compensation

By Dorman D. Israel,

Vice-President in Charge of Engineering and Production,  
Emerson Radio & Phonograph Corp., New York

Of pertinent interest is the fact that wartime operations resulted in few, if any, basic circuit changes. This is a healthy indication that our industry is now approaching an era of greater technical stability. War expediency greatly developed the technic of miniaturizing radio components and equipment. The pocket radio can, therefore, be a sound reality. The development of quartz crystal mass production methods opens the door to stable pre-tuned station selection. This should be adopted first in the standard broadcast band.

The large scale production of

VHF and UHF equipment for war usage has taught the industry how to handle the carrier frequencies necessary in FM and television. Frequency drift compensating methods in these bands are now well enough known and understood to assure reliable equipment from those who will take the necessary care.

Mass production of wide band amplification systems as required for war equipment is directly applicable to video technics in home television receivers. Finally, the vast selection of newly created materials such as plastics, light metals, finishing technics and substantial improvements in those previously available cannot help but spell out a far more satisfactory and desirable product.

## Radar and VHF Circuit Applications

By L. M. Clement,

Vice-President in Charge of Research and Engineering  
The Crosley Corp., Cincinnati

War experience in design of military radio, radar and navigation equipment has resulted in the following improvements which may be incorporated in some domestic FM and television receivers and export receivers for tropical service: Radar and VHF circuit applications useful in FM and television receivers; push-button tuning systems; improved crystal controlled oscillator circuits; HF magnetic cores; im-

proved magnetic materials for loud speakers; smaller and better components and tubes; plastic lenses and correction plates; embossing of plastic record blanks; plastic molded transmission line; plastic insulated wire; fungus and moisture resistant coatings and treatments; hermetically sealed components. Most of these ideas were used to a limited extent prewar but it is anticipated that quantity manufacturing will enable them to be used more generally in expensive equipment and some home and export receivers.

## RF Iron, Silicone Varnishes, Wire Recorders

By Frederick C. Young,

Vice President in Charge of Engineering and Research,  
Stromberg-Carlson Co., Rochester, N. Y.

Outlining the most important changes in circuits as a result of military experience, we have the following comments to make:

1. There have been improvements in radio frequency iron allowing its incorporation in high frequency tuned circuits.

2. There have been developed adjustable capacitors of excellent efficiency for use in the alignment of high frequency circuits. These are made available with built-in temperature compensation.

3. The miniature tubes series was extended to include many types of operation in ac receivers.

4. There have been developed range switches with ceramic insula-

(Continued on page 142)

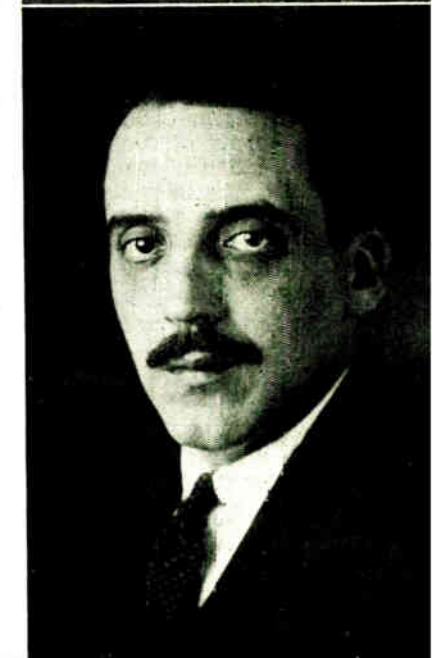

# RATIO DISCRIMINATOR

**By minimizing total discriminator voltage fluctuations, output is made proportional to ratio of two voltages**

• A discriminator circuit whose output is proportional to the ratio rather than the difference of two dc voltages has been evolved and was presented by William Stuart Seeley of the Radio Corp. of America at a recent meeting of the Institute of Radio Engineers. Advantages claimed include a reduced number of tubes, reduction of distortion and noise and the production of a useful automatic control voltage.

In the use of ordinary discriminator circuits in receiving sets to obtain audio signals from an FM wave, three difficulties of considerable moment have troubled designers.

First, amplitude modulation, parasitically introduced either in the transmitter, in the atmosphere during propagation of the signal, or in the receiver tends to cause distortion. This is due to the fact that a change of amplitude causes an instantaneous phase shift equivalent to an additional phase and hence frequency modulation. This is shown in Fig. 1. To prevent this type of distortion, one or more limiting tubes ordinarily are used which clip off the FM waves so they are all of equal amplitude.

Second, the interelectrode capacity between grid and cathode in an electron tube undergoes an apparent change when the tube current changes. For example, this capacitance with no signal and a bias of  $-3$  v might be  $6 \mu\mu\text{f}$ , while with a  $3$  v positive signal it might be  $8.5 \mu\mu\text{f}$ . This change detunes the grid resonant circuit and causes distortion.

Third, it is not easy to obtain an automatic volume control voltage from the output of the discriminator, because, of the two dc voltages obtained from the discriminator

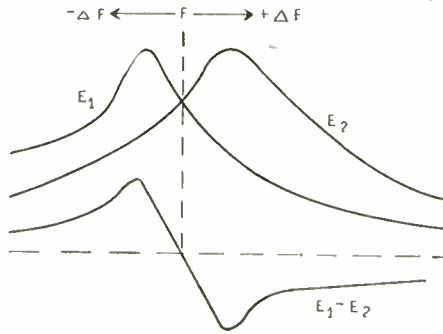

Fig. 2. Ordinary discriminator produces two voltages peaking below and above frequency

action, one has a peak below the carrier center frequency and the other a peak above it as shown in Fig. 2. Hence neither of these is usable.

For reference purposes, the usual discriminator circuit is shown in Fig. 3. Fig. 4 is drawn to illustrate the basic idea of the new circuit. The sum of the voltages indicated by the meters  $E_1$  and  $E_2$  is held constant by the battery. The two diodes are connected in series so that only half the signal wave is rectified.

When two equal signals are applied through  $S_1$  and  $S_2$  large enough to cause current to flow through the diodes,  $E_1$  and  $E_2$  will remain equal and P and B will be at the same potential. If the two signals increase equally, the current will flow through the diodes during a greater part of the cycle time, and the voltage drops in the circuit elements will increase, but  $E_1$  and  $E_2$  will not change.

Suppose however that  $S_2 = 2S_1$ . The sum of  $E_1$  and  $E_2$  will remain the same as before, being equal to the battery voltage, but  $E_1$  and  $E_2$  will change individually so that

$E_2 = 2E_1$ , and this ratio will hold despite reasonably wide amplitude changes.

Furthermore since capacitors  $C_1$  and  $C_2$  are large, having a time constant of about  $75 \mu$  sec. with the diode and transformer secondary impedances, the voltage of P will not change despite momentary losses of signal due to fading.

Fig. 5 shows a development of this circuit for practical use. The battery has been replaced by a high resistance R with audio by-pass  $C_4$ . A signal is fed directly from the last intermediate frequency tube plate to the discriminator network. Here the voltage across the inductance

Fig. 1. Amplitude modulation superimposed on an FM wave causes an instantaneous phase shift which frequency modulates and distorts the carrier

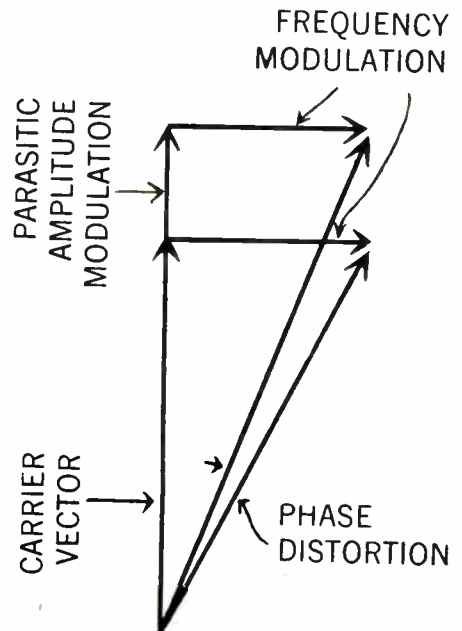
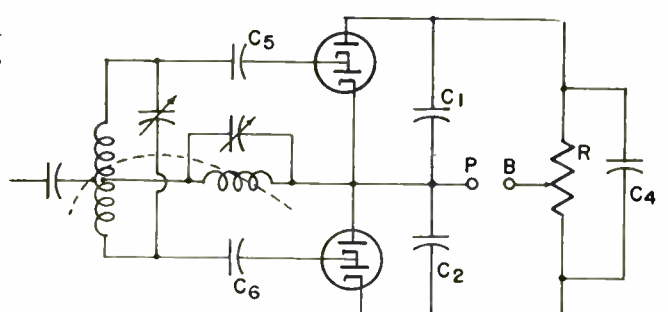
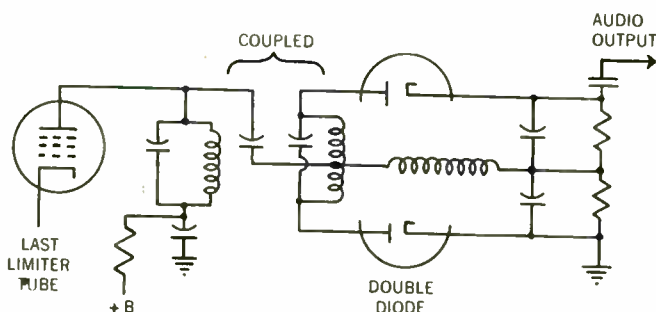

Fig. 3, left. The ordinary discriminator circuit. Here the output is the difference of two voltages. Fig. 8, right. Full wave ratio detector



# IS INSENSITIVE TO AM

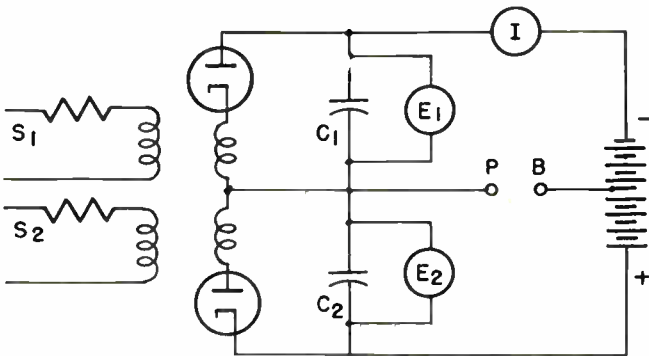

Fig. 4, left. The basic idea of the new circuit.  $E_1$  and  $E_2$  will vary with impressed signals  $S_1$  and  $S_2$ , but their sum is held constant by battery

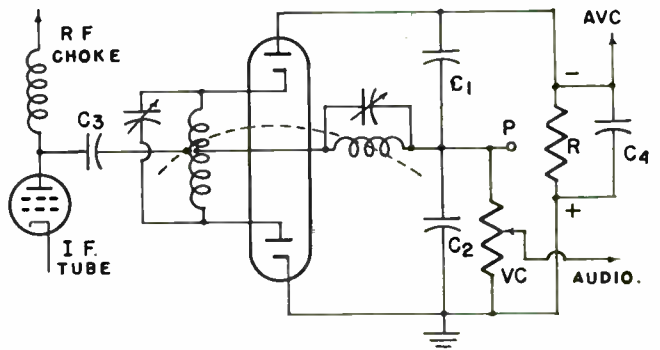

Fig. 5, right. A practical development of the circuit of Fig. 4. Here the large condenser  $C_4$  acts as a stabilizer for the voltage

of the resonant circuit is 90 deg. out of phase with the input voltage when the signal is at center carrier frequency. Therefore the resultant voltages applied to the diodes are equal in magnitude (Fig. 6A).

When the frequency shifts, the resonant circuit is no longer tuned and its voltage vector rotates to a lag or lead angle as shown in Fig. 6B. The resultant voltages become of unequal length and cause similarly unequal potentials across  $C_1$  and  $C_2$  of Fig. 5, giving an audio output at 'P'. Amplitude modulation does not change the total voltage across  $C_1 + C_2$  because of the large condenser  $C_4$  which acts as a holding tank. As shown, the  $C_4$  tank voltage can be used perfectly for automatic volume control.

The condensers  $C_1 + C_2 + C_3$  are sufficiently large to produce normal de-emphasis with the network output impedances. The latter is a function of 'R'. The time constant of the volume control with  $C_1, C_2$  and  $C_3$  is about .002 sec. Thus the voltage at 'P' is held despite momentary signal loss.

With this circuit, no limiters are necessary. It has no threshold action and is quite immune to amplitude modulation no matter what the signal strength. The intermediate frequency amplifier preceding the discriminator can be run at full gain.

Since it is not necessary to saturate a limiter, weak signals can be used, as little as 10 millivolts being enough if there is ample audio frequency gain. This means that detuning due to changes in tube interelectrode capacitance is negligible, a marked advantage.

The value of 'R' is important as low values result in loss of sensitivity and too high values permit distortion. This is because then the

peaks of interference determine the developed dc level.

A point worthy of note is that impedance changes in the resonant circuit, being reflected back into the feeder circuit cause changes of phase relationships to occur with amplitude variations.

Fig. 5 shows the response characteristic of the circuit. The dotted lines are static characteristics, while solid lines are dynamic. In the latter the voltage is held up as shown by the tank circuit.

Amplitude variations of even harmonics in the input cause more disturbances than variations in fundamental in this circuit. To counteract this second harmonic degeneration in the if tube was tried and when used straightened the curves of Fig. 7. However the correction was not warranted by its effect on listeners.

The circuit of Fig. 8 was built to permit full wave rectification. In this circuit, 'R' must be 4 times as large as before. The audio and automatic volume control voltages are both doubled. However, the emission potential of the 4 diodes may be too high for AVC at zero signal. This can be corrected by grounding the center of 'R' by passing each half and using only the negative half for AVC. With this arrangement, the resistance from P to B must be much greater than one half 'R'. Otherwise the AVC voltage will have a peak on one side of the center frequency.

The characteristic curves for this full wave circuit, while straight, do converge. Variation of primary to secondary ratio caused by reflected impedance can be compensated for by inserting series resistance with  $C_4$ . This is necessary if AVC is used.

164

(Continued on page xx)

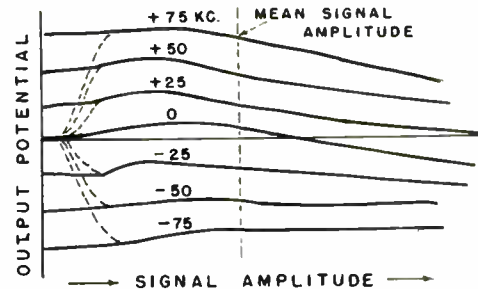

Fig. 7. Response characteristic of the circuit. Some effect from amplitude modulation remains

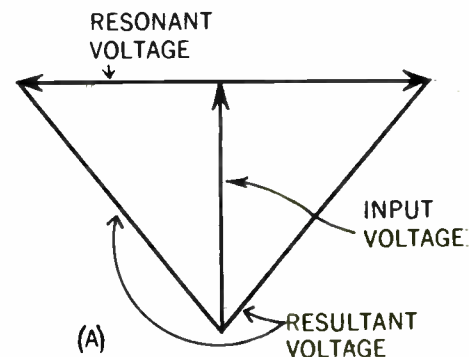
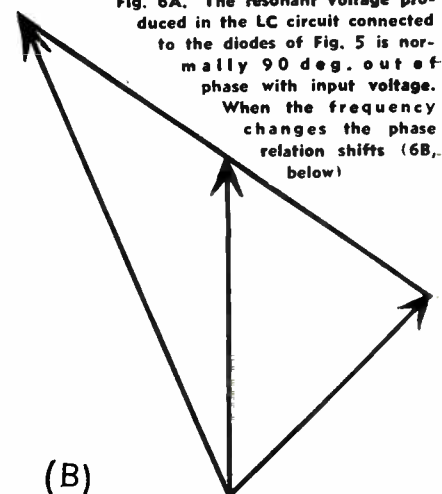

Fig. 6A. The resonant voltage produced in the LC circuit connected to the diodes of Fig. 5 is normally 90 deg. out of phase with input voltage. When the frequency changes the phase relation shifts (6B, below)



(B)

# PAYING THE ENGINEER

**Incentive compensation plans based on achievements and performance. Sales and executive pay as yardstick**

• Several "engineering-help-wanted" advertisements recently have appeared in the electronic press that strike a distinctly new note. These offers have specified that the engineers sought would, in addition to salary, be paid bonuses depending upon their performance, inventions, and other contributions to the employing company's progress.

And as additional incentive, the successful engineering applicant has been offered full financial participation in the concern's prosperity on a basis comparable with principal sales and executive officers of the company.

As a result of these announcements a good deal of discussion has taken place among electronic engineers, and various adaptations of incentive-pay plans have been proposed and outlined by both prospective employers and employees.

## **Proposed plans**

Among incentive methods of compensating electronic engineers in industrial and other plans, incentive payment proposed could be—

Straight-salary plus—

- (1) Bonus based on innovations introduced, taking into account their capital or earning value.
- (2) Bonus based on value of patents obtained for company.
- (3) Bonus based on volume of business of company or department.
- (4) Bonus based on company's net profit.
- (5) Stock interest (with the disadvantages inherent to minority stock holdings).

One engineer who, for a number of years, has endeavored to find an all-around satisfactory plan of compensation, has energetically explored the methods of special compensation, used by some of the large employers of engineers with inventive brains.

In commenting on the five numbered methods just mentioned, this correspondent observes:

**1. Bonuses Based on Innovations Introduced.** All in all, a good method but rather difficult to follow, because usually a year or more elapses between the time the inno-

## **Salary plus % Royalty**

**In order to carry out a highly developed program of growth and expansion, we seek to augment the staff of our creative engineering laboratories with outstanding talent . . . and are prepared to do the things necessary to obtain it.**

**Salaries will at least equal those paid by other leading companies in the field, but in addition, each candidate will receive a graduated percentage royalty on the sale of all products he develops. A portion of this royalty continues even if he later leaves the company.**

—Text from recent engineering help-wanted ad in *Electronic Industries*.

vation is suggested and the time when the financial results accrue. The problems therefore, on the part of management are these:

- (a) How much have we a right to expect from the man when he is paid a straight salary;
- (b) What portion of the profits due to engineer-employee should be paid him? On the part of the employee-originator, if he does not expect such compensation, any amount that comes to him is a pleasant surprise. But if this type of compensation is expected, then human nature being what it is, there are many cases where the recipient is not satisfied with his bonus. (Note that in this case the new idea does not have the status of a patented invention, which means that it is of much less value to the company which, of course, has no protection as in the case of a patent.)

**2. Bonus Based on Value of Patents Attained.** Companies endeavoring to compensate on this basis have usually had difficulties, especially if there are many and various patentees involved. The fundamental reason is that a patent is one of the most difficult of intangibles to evaluate properly. Very few companies, therefore, at present even attempt to give a bonus which is directly tied to the value of the patent because the real value of the patent usually

cannot be determined until after court action and until after a long period of time has passed.

**3. Bonus Based on Volume of Business.** This is a good method affecting not only the inventive employees but outstanding workers who contribute to an increase in volume. This satisfactory method is in use in numerous radio and electronic plants. More about this later.

**4. Bonus Based on Net Profits.** In general this is the same as item 3, except that expenses over which the technical employe has no control may be allowed to absorb all the increases in income due to his energies and contributions.

**5. Stock Interest.** As far as the fundamentals of compensation are concerned this also is the same as items 3 and 4. Payment is simply in different form. A great deal can be said for the advantages both to the company and to the employee of employe stock ownership, although many individual tragedies have resulted from minority stock ownership during periods of stress when the company itself was riding out a financial storm.

In more than twenty years of engineering experience, half of which was spent as a manager of engineering personnel of the inventive type, concrete examples of various means of extra-compensation and the results found in practice have been observed and are here presented only as a basis for discussion since some of the methods may have since been changed:

**ALPHA COMPANY.**—All engineers signed the usual patent agreement assigning patents in the radio field to the company. For each of these patents they were paid one dollar. The company's policy was no direct financial compensation to the inventors, but better and more responsible jobs would result for the men who helped the company by their invention. This was moderately satisfactory; there was no favoritism, but not very much incentive.

**BETA CORPORATION.**—In the research department drives were put on at intervals to get patent disclosures in any of the various fields in which the corporation was

# WHAT HE IS WORTH

THIS CHECK IS IN FULL PAYMENT OF THE FOLLOWING IF INCORRECT PLEASE RETURN ENDORSEMENT IS FULL ACKNOWLEDGMENT NO RECEIPT NECESSARY		
DATE	INVOICE	AMOUNT
	Salary	\$ 250.00
	Bonus on Department Earnings	54.56
	Bonus on Inventions	152.30
	TOTAL	\$ 456.86
	DISCT.	
	NET AMOUNT	

NOT DETACH

PAY TO THE ORDER OF

SUPERELECTRONIC CORP.  
WISTFUL VISTA, N.J.

No. 18125

October 31 1945

**THE CHASE NATIONAL BANK**

----- A. SMART ENGINEER ----- \$ 456.86

-- Four Hundred and Fifty-Six and 86/100ths --

DOLLARS  
SUPERELECTRONIC CORP.

*SW Williams*

active. The engineers were keenly aware of the value of patents to the corporation. In fact, in the depression it was realized that the royalties Beta Corporation received from other manufacturers on the multitude of patents held by the corporation actually helped pay the salaries of engineers. One dollar was paid for each patent assigned and while not promised it was assumed that those men who contributed in this way would have better jobs longer than the average. This was in a time (1930-33) of seriously declining engineering salaries with numbers of engineers being laid off weekly.

**GAMMA COMPANY.**—It is the belief of many engineers, including your editors, that this company, built around its first president, is probably the best example of studied fairness in compensation in the radio field. This president for years has made a study of employee compensation both in this country and abroad. The working conditions are as nearly ideal as possible. As of 1920-1925 bonuses were distributed to all engineering employes who had been with the company six months. These were based on net profits and were distributed two or three times a year.

Some years later the plan changed, as a result of study, to a new system referred to in the radio industry by those who knew about the experiment as the "k system." Each engineer had a base pay rate depending on his responsibilities and capabilities. He received this pay only if during the preceding period the company's profits were those of a normal year. (Just what year was taken for the normal is

not important.) In this case the factor k equalled 1.0. However, if the business was good the factor k could easily reach 1.2, and for a number of poor months it was around 0.85.

The engineers understood and appreciated this system. Naturally when the factor k slumped below 1.0 they did everything they could to help increase profits because it was to everyone's benefit to do so.

**DELTA CORPORATION.**—This corporation has been a strong believer in the individual bonus system. Engineering salaries were somewhat low, sometimes accounting for only 33% of an employee's actual yearly income. Secret bonuses were distributed individually a few days before Christmas each year. At first they were decided upon only by the department head who knew his workers personally. Later, group leaders were called in to advise regarding bonus distributions. The total amount the corporation distributed naturally was directly related to their yearly profits.

In some way secret bonuses often become known, and because of the large percentage of compensation that these were responsible for, many hard workers thought they

were unfairly treated when they discovered what their fellow-workers received. The one-man control system was not good. If a worker displeased this man in some way a week or so before bonus time, the human factor entered unfairly.

At that time the corporation's stock was closely held; the corporation was practically owned by less than a dozen men who ran it. For a number of years the corporation permitted employes who had risen above group leaders to spend their bonus checks for stock. Stock ownership does something to an employee's morale that nothing else will do. The result is a very healthy, live organization.

When the corporation's stock was placed on the market the bonus system changed somewhat. The management was limited in the total amount available for yearly bonuses, to about 10% of net earnings. Group control over the amount of bonus given to various employees has been instituted.

## Conclusions

The disadvantage to the radio engineer working under this plan was, first, inability to make adequate financial plans because as far as he knew his yearly salary was only the agreed-upon amount. In the case of absence of profit there might be no Christmas bonus! The other difficulty of "unfairness in bonus allocation" has already been mentioned.

Possibly we can draw some general conclusions. The young electronic engineer should be encouraged to invent and to discuss his inventions promptly and fully. He

(Continued on page 146)

See also article last month—

## INCENTIVE PAY FOR ELECTRONIC ENGINEERS

Compensation Plans Based on Individual Achievement; Electronic Industries, October 1945, pages 85-86.

# RADIO FREQUENCY CORES

By DR. HANS BELLER\* and G. O. ALTMANN

Production Manager\*, Carbonyl Iron Plant  
General Aniline and Film Corp., Linden, N. J.

**New soft iron powder of fine grain size and high efficiency insulator result in values over 50  $\mu$**

● In order to meet the demand for powdered magnetic cores combining both high permeability and low losses at frequencies up to several megacycles, the authors have developed, at the laboratories of the General Aniline & Film Corp., cores made from a special grade of Carbonyl iron powder.

With it powdered iron cores can be produced with permeabilities of 40 to 70 together with comparatively low eddy current loss coefficients of from 0.6 to  $7.0 \times 10^{-7}$  ohms/henry-cps<sup>2</sup>.

Powdered iron cores are used in a great variety of coils. Their usual purpose is either merely to assure a high Q value or to provide an inductance control or both (1-15).

Recently it has become necessary for some applications that coils should also provide a high magnetic flux, which means that their cores must have a high magnetic permeability in addition to low losses. The cores discussed here fulfill these requirements.

Maintaining low eddy current losses, the highest permeability so far obtainable with domestic magnetic powders, is below 40, and usually from 10 to 30. A recent paper by Oddie (16), for example, describes a variety of radio cores in which permeabilities range from 1.37 to 30.1. The new cores discussed here have permeabilities above 50 without the hitherto\* unavoidable corresponding high eddy current losses.

The new cores were made from a new soft Carbonyl iron powder of small particle size, using a suitable insulating material for dilution and bonding, efficient as such even in very small quantities. The new powder differs from existing Carbonyl iron powder grades in the following properties:

Grade	Carbon Content Percent	Wt. Ave. Diameter Microns
L	0.005-0.03	20
C	0.03 -0.12	10
E	0.65 -0.80	8
New Grade	0.01 -0.03	10

It is known that the permeability increases with packing factor p (ratio of volume of iron to total

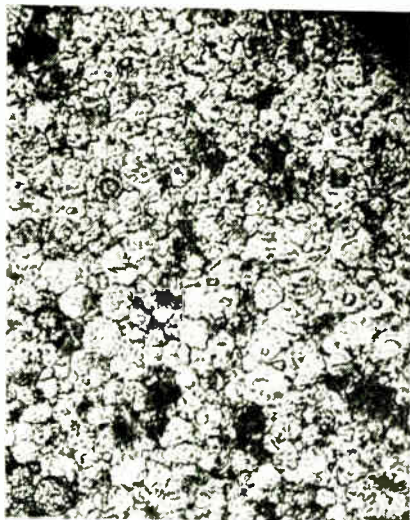

Fig. 2. Photomicrograph of section of a core with  $\mu = 55$  and a density of 7.3. The molding pressure needed depends on wall friction

volume of core). However, with the new cores, it has been found that the permeability depends also on the manner in which p is changed. By increasing the molding pressure at constant dilution, the permeability increases slower than by decreasing dilution at constant molding pressure. This is shown in Fig. 1, in which dilution D = volume of insulating material in percent of core volume.

\*A recent paper by Kiessling and Ludl (12) mentions that cores with apparently similar properties were developed during the war in Germany.

The reason for this behavior is believed to be the increase of what may be termed "effective particle size" whenever a higher packing factor is achieved by decreasing dilution. For, with less coating material an increasing portion of the surface of the core particles becomes bare and hence metallic contact between particles will occur more often. It then appears that two particles in contact have the same effect on overall permeability and losses as one large particle.

On the other hand, packing can be increased by increasing molding pressure and keeping dilution constant. The above defined effective particle size will then increase only if the coating of adjoining particles should be rubbed off during compression which, however, with a strong coating material fails to oc-

Fig. 1. Initial permeability vs. iron-packing factor for various dielectric percentages. This indicates the varying effects of pressure and dilution

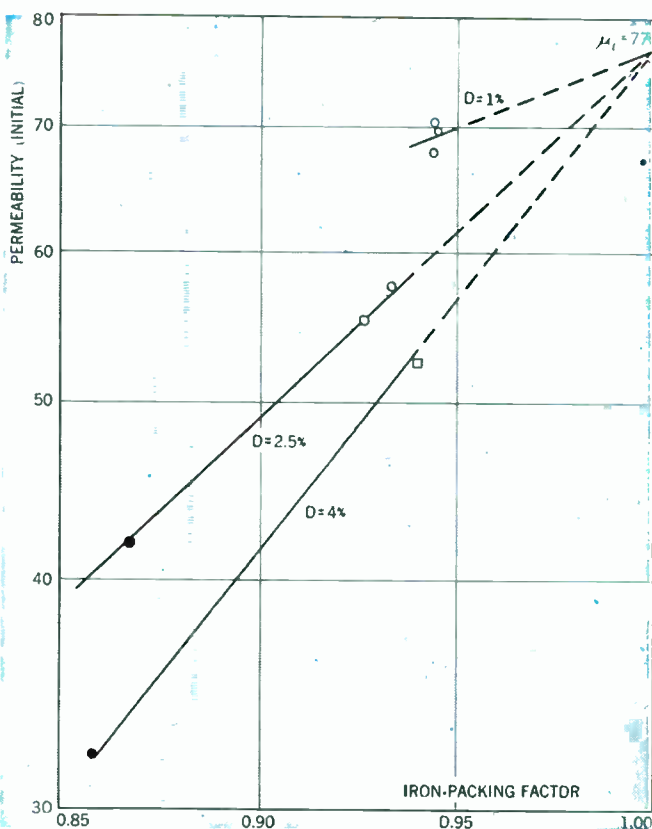



# OF HIGH PERMEABILITY

cur frequently. Consequently, permeability increases slower under these conditions for the same increase in packing.

The intercept for  $p = 1$  is called the intrinsic permeability  $\mu_i$ , according to Legg and Given (17). But while all their points fit one straight line, for which the relation

$$\mu = \mu_i^p \text{ or } \log \mu = p \log \mu_i$$

holds, the family of curves of Fig. 1 depends also upon the dilution as parameter and follows a relation of the form

$$\mu = \mu_i^{1-D(1-p)} \text{ or}$$

$$\log \mu = [1-D(1-p)] \log \mu_i$$

valid only for the region shown, i.e.,  $D \ll 100$  and  $(1-p) \ll 1$ .

At any rate, the formula derived by Page (18) from a calculation of the magnetic moment of a sphere placed inside a solenoid carrying ac,

$$\mu - 1 = \frac{3p(\mu_i - 1)}{3 + (1-p)(1-n)(\mu_i - 1)}$$

with  $\eta = 0.96 p^3$  determined empirically, does not fit these data. It is possible, however, that a more complicated  $\eta$  as function of  $D$  as well as  $p$  would make this formula usable here. Howe's (2) formula also is inapplicable.

Fig. 2 shows a photomicrograph of a core of  $\mu = 55$ , dilution 2.6%,  $p = 0.925$ , molding pressure 85 tsi and density 7.3 g/cm<sup>3</sup>. It should be noted that densities over 7 have very rarely been obtained in powdered iron cores, in the past. They

are a result of the extreme softness of this grade of Carbonyl iron, the characteristics of the binder, and the high molding pressure. It has been observed in the course of these experiments that the molding pressure needed to produce densities of 7.3 apparently is not constant but depends to some extent on factors such as wall friction, as indicated by the following data:

Surface of Toroid* In. <sup>2</sup>	Radial Thickness In.	Axial Thickness In.	Molding Pressure to 7.3g/cm <sup>3</sup> t.s.i.
2.2	0.375	0.38	85
5.4	0.675	0.75	60

\*Exposed to plunger.

### Quality factor

Three toroidal cores, made from the newly developed Carbonyl iron powder, identified as "70", "55", and "40", and showing the mechanical characteristics as indicated in Table I were selected for the present analysis:

Corp. Q-meter, type 160A. The Q values found are shown in Fig. 3 as a function of frequency. It should be noted that the Q values of cores "40" and "55" are relatively high for a coil of this type and that core "70" is lower because of decreased insulation between particles and consequent higher eddy current losses.

The cores were subsequently wound individually as toroids with as many turns of No. 20/38 litz wire as were necessary to give an inductance of 0.10 millihenry. The Q values of these toroids are plotted on Fig. 4 as a function of frequency. Fig. 5 gives an analogous comparison for cores made from different iron powders, having practically the same permeability. The same method of preparation was used for these cores, aiming at optimum Q values.

The Q values for these curves were corrected for losses in the auxiliary capacitors, necessary at 500 kc and below, from data fur-

Core	Permeability	Packing Factor p	Dilution	Porosity (%)	Density g/cm <sup>3</sup>	Axial height cm.
"70"	70	.943	1.6	4.1	7.42	.94
"55"	55	.925	2.7	4.8	7.30	.955
"40"	40	.866	2.5	10.9	6.83	1.025

In addition, all cores had an OD = 2.25 in., and ID = 1.50 in., and weighed 100 grams.

These cores were placed in a solenoid of the shape shown in the inset of Fig. 3, wound with 15 turns of 15/44 litz wire, and the Q values determined in a Boonton Radio

nished by the fabricator, General Radio Co., Catalog K (Decade Capacitor Units, type 380.)

A still more important correction had to be introduced at the high frequency end. In this region, the distributed capacity (for these windings approx. 20 mmf becomes

Fig. 3, left. Values obtained with three different cores placed in the solenoid as illustrated. Note lowered Q due to less insulation in core "70." Fig. 4, right. Values from the same cores, but after they were rewound with as many turns of 20/38 litz as needed to make .10 millihenry

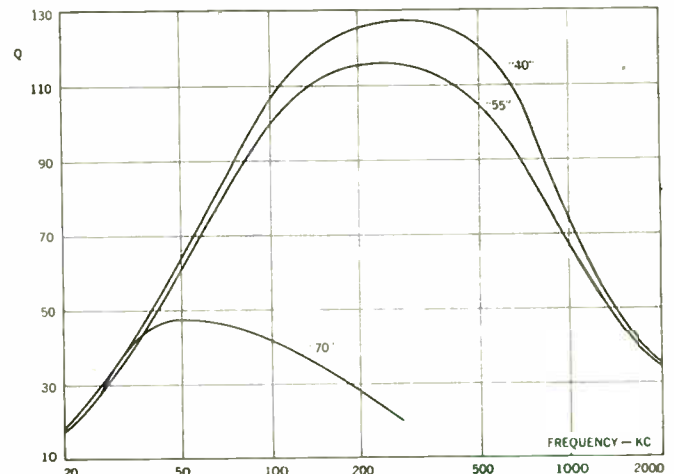
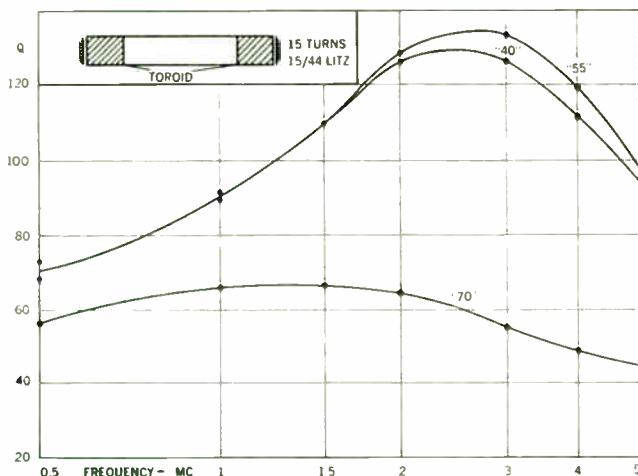

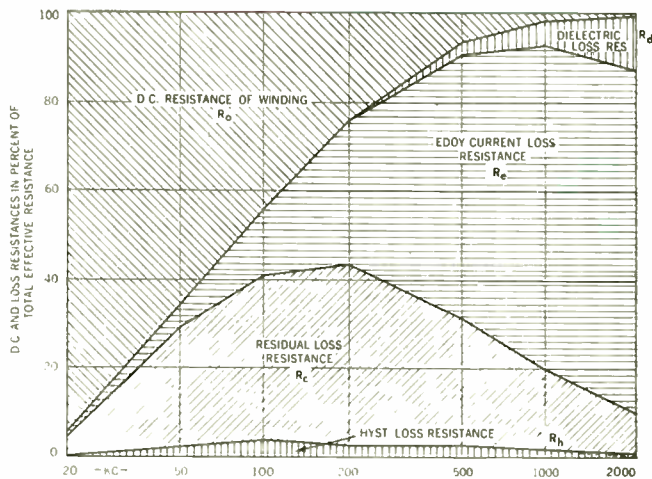
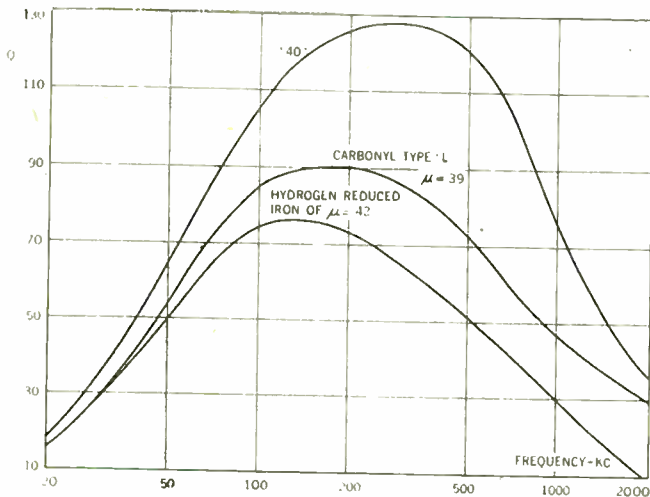

Fig. 5, left. One of the new cores, Type "40" is here compared with cores made from older materials having practically the same permeability. Fig. 6, right. Relative importance of various loss resistances in per cent of total plotted against frequency for one of new cores, "55"

so large that the voltage drop over the tuning capacitor, i.e., the apparent  $Q$ , differs very appreciably from  $Q = \omega L/R$ . If  $C_d$  is the distributed capacitance, calculation shows that the true value is:

$$Q = \frac{Q_{app} + \sqrt{Q_{app}^2 - 4\omega^2 LC_d(1 - \omega^2 LC_d)}}{2(1 - \omega^2 LC_d)}$$

Thus, at 2 mc,  $Q/Q_{app} = 1.48$ .

### Loss analysis

The loss analysis was carried out in accordance with Legg (19), Legg and Given (17) and Kersten (20). The effective high frequency resistance is separated in the following manner:

$R_{eff} = R_0 + r_1 f + r_2 f^2 + r_3 f^3$   
where  $R_0$  is the D. C. resistance of the winding and  $r_1, r_2, r_3$  are coefficients derived from different losses. Thus,

$$r_1 = (aB + c) \mu L$$

$$r_2 = \frac{\sigma L V_w Z^2}{\mu V_c 10^9} + e \mu L$$

$$r_3 = 8\pi^3 L^2 C_d B$$

where

$a$  = hysteresis loss coefficient of the core

$c$  = residual loss coefficient of the core

$e$  = eddy current loss coefficient of the core

$L$  = inductance of coil (0.10 millihenry, except where stated otherwise)

$B$  = flux density of core, corresponding to peak value of current in the winding (gauss)

$\mu$  = permeability (gauss/oersted)

$\sigma$  = conductivity of copper = 58.2 m/ohm mm<sup>2</sup>

$V_w$  = volume of copper wires in winding

$V_c$  = volume of core

$Z$  = diameter of one strand ( $Z^2 = .01014 \text{ mm}^2$ )

$\beta$  = power factor of distributed capacity.

The separation was done in the following way:  $R_0$  was measured on a Wheatstone bridge. The (initial) permeability was obtained from the inductance value at 1 kc ( $L$ ) extrapolated to zero current, and by using the formula of Legg (19) employing the effective magnetic diameter (19):

$$\mu = \frac{Ld 10^9}{4 N^2 A} - \frac{A_a}{A}$$

$$\text{where } d \equiv \frac{d_o - d_i}{\ln d_o/d_i}$$

and where  $A$  = cross-sectional area of toroidal core,  $A_a$  = residual area between winding and core,  $d_o$  = outside diameter,  $d_i$  = inside diameter of toroid and  $N$  = total number of turns of wire.

The hysteresis loss coefficient  $a$  is obtained from loss measurements at various flux densities at constant frequency (10 kc). The inductance

for these measurements was 1.00 mh for all cores. The measurements were made with a General Radio Co. type 667-A inductance bridge, by alternately balancing for ac and dc. The ac null instrument consisted of a voltage amplifier and an oscilloscope. The currents were measured with a VTVM in parallel with the resistance decades in the "standard" arm. A galvanometer was used for dc measurements.

The residual loss coefficient  $c$  was determined from the loss resistance at 1 and 10 kc, extrapolated to  $B = \text{zero}$ . A discussion of the possible origins of this loss can be found in Legg (19) and other papers quoted there.

The first term of  $r_2$ , that is the eddy current losses in the winding, was computed to be approximately  $0.003 \times 10^{-11}$  ohms/cps<sup>2</sup>. References for the formula used in this computation are quoted in Kersten (20).

The eddy current loss coefficients were then determined from the  $Q$  values of Figs. 4 and 5, after subtraction of the above losses, using  $Q$  values at 1 mc and below.

TABLE II

Core	Hysteresis loss coef.		Residual loss coef.		Eddy Current loss coef.	
	$\mu a$	$a$	$\mu c$	$c$	$\mu e$	$e$
"70"	0.99	14.1	1.6	23	7.0	10.
"55"	0.86	15.6	1.8	33	0.73	1.3
"40"	0.89	22.2	1.3	33	0.66	1.6
"40-L"	1.45	37.2	2.7	69	1.00	2.5
"40-H"	1.04	24.8	2.3	55	1.69	4.0
"16.5-E"	0.20	12	0.1	6	0.08	0.49

#### Quantities

#### Units

$\mu a$ .....10<sup>-3</sup> ohms/henry, cps, gauss

$a$ .....10<sup>-6</sup> ohms/henry, cps, gauss & per unit permeability

$\mu c$ .....10<sup>-2</sup> ohms/henry, cps

$c$ .....10<sup>-5</sup> ohms/henry, cps & per unit permeability

$\mu e$ .....10<sup>-7</sup> ohms/henry, cps<sup>2</sup>

$e$ .....10<sup>-9</sup> ohms/henry, cps<sup>2</sup> & per unit permeability

\*40-L is a core made of Carbonyl iron, type L with a permeability of 39.

\*\*40-H is a core made of one of the best grades of commercial hydrogen-reduced iron, with a permeability of 42.

\*\*\*Carbonyl iron type E as taken from Oddie (16), with a permeability of 16.5.

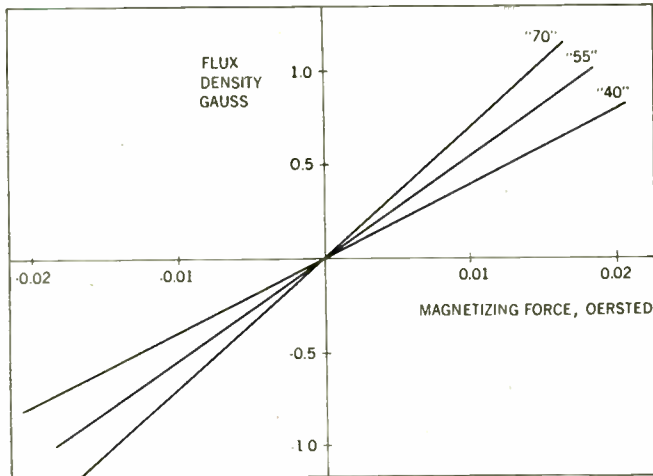

Fig. 10. Hysteresis loops computed from hysteresis loss coefficients. These are assumed elliptical, but are so flat as to form single lines

The dielectric loss term  $r_3$  was determined from additional losses appearing at 2 mc. The power factor  $\beta$  of the distributed capacity was thus determined to be .01 for all cores.

Table II shows the results of these measurements.

There are further losses at 200 kc and below of the order of 0.1 to 0.2 ohms. They are believed to originate also from the auxiliary condensers, possibly from leads and contacts.

To demonstrate the relative importance of the various loss resistances, a plot showing them in per cent of total effective resistance of core "55" as a function of frequency is shown in Fig. 6. It should be noted that the highest  $Q$  value (Fig. 4) occurs at a frequency where  $R_e$  is approximately equal  $R_e$ . The hysteresis loss resistance corresponds to a current of 1 mA.

The effect of temperature on permeability is shown in Fig.

7 for the three cores. The coefficients are given in Table III.

The measurements were made with  $L = 1$  mh on the

TABLE III	
Core	Temperature Coefficient per cent per deg. C
"70"	0.097
"55"	0.076
"40"	0.051
"40-L"	0.042
"40-H"	0.083

inductance bridge with the cores held at the desired temperature by submerging them in oil in a Dewar flask. The values are of the same order as those found by Koch (21) and Colebrook (22). The temperature effect for these cores apparently has the follow-

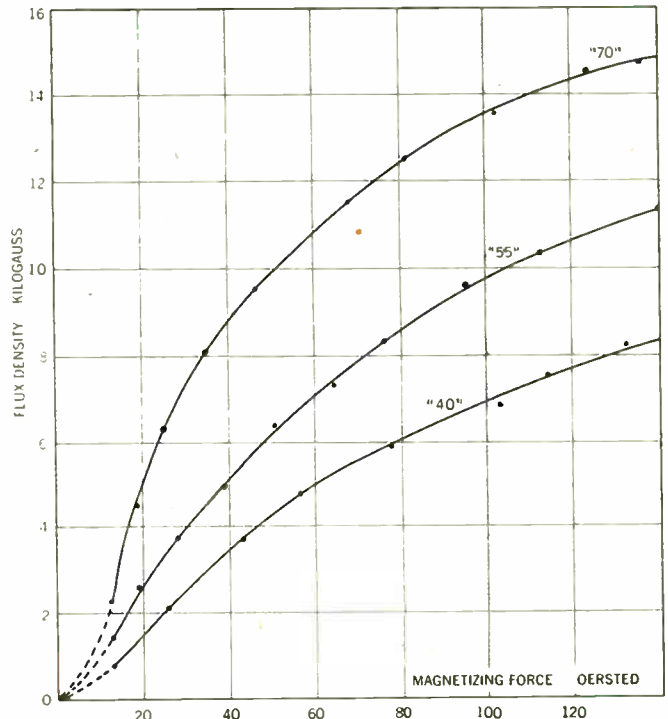
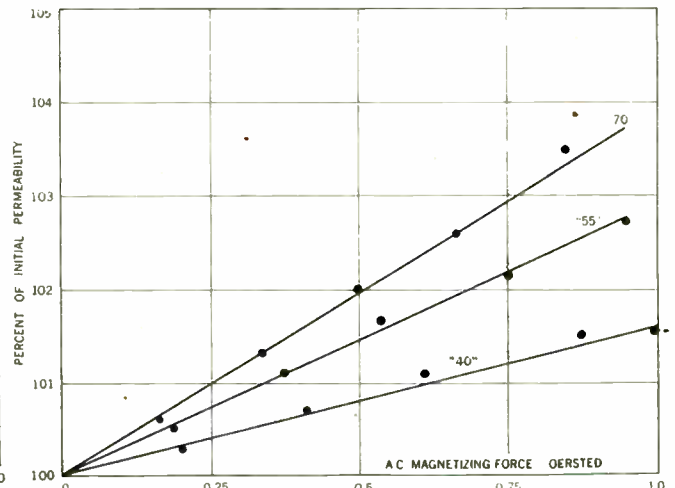
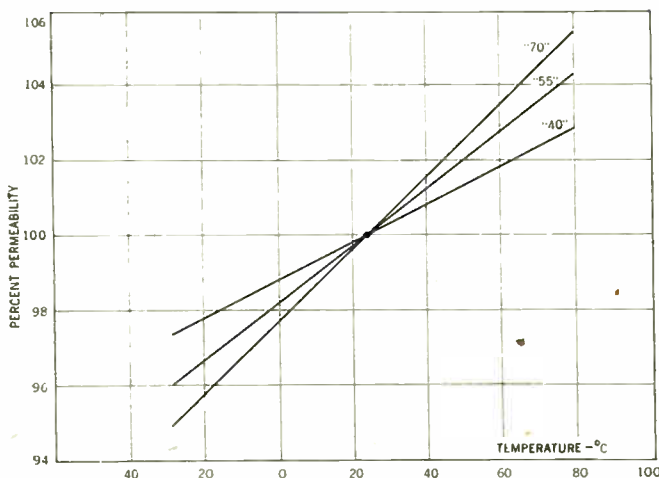

Fig. 9. Magnetization curves of the three toroidal cores as determined by the ballistic method. Note correlation to the initial permeability

ing origin: As the individual particles expand when the temperature increases, the gap lengths decrease, thus increasing the "effective particle size" (see above) and hence permeability. Thus, one would expect higher temperature coefficients for cores with higher packing factors  $p$ , as is actually shown by these measurements. A further consequence of this explanation would be an increase of eddy current loss with temperature. This effect is well known, although as yet unpublished, probably because it is complicated by other temperature effects, some of which are of opposite sign. For example,

(Continued on page 152)

Fig. 7, left. Effect of temperature on permeability is shown for the three new sample cores. Coils were submerged in oil of the right temperature in a Dewar flask. Fig. 8, right. The permeability is here plotted as a function of alternating magnetizing force in Oersted



# PULSE TIME MODULATION FOR

**Time of occurrence of carrier pulses is advanced for positive and retarded for negative portions of the signal wave**

• Amplitude modulation appeared to many persons to be the only imaginable method of varying electric currents to reproduce speech or music until Major Armstrong advanced and popularized frequency modulation. Now that frequency modulation has been with us for a number of years, it appeared that all possible parameters of an electric wave had been explored with respect to their adaptability to the needs of modulation.

alternating current wave into pulse time modulation, changes of time of occurrence of the pulse in one direction correspond to positive halves of the alternating current while changes of time in the other direction correspond to negative halves. The amplitude of the current wave is translated into magnitude of time displacements, while the frequency of the alternating current wave is translated into frequency with which the time dis-

and the fidelity of reproduction. Therefore, since a steep wave front requires a wide band of frequencies for its accurate transmission, pulse time modulation is definitely a wide band system requiring a carrier in the ultra or super high frequency range.

Fortunately, however, it is not necessary to devote an entire band of frequencies to the transmission of one message at a time. Since the message, as pulse time modulated consists of a series of pulses five microseconds apart it is perfectly possible to intermingle several messages and transmit them all at the same time. Thus pulse No. 1 would be used for message No. 1 while pulse No. 2 is used for message No. 2. Pulse No. 3 would again revert to message No. 1. The break time involved is so short that no effect could be noted by a listener. The company has established experimental circuits transmitting twenty-four conversations all at the same time. Other tests have been made with as many as 250 messages going out simultaneously.

In frequency band utilization, this time modulation system is less efficient than either amplitude or frequency modulation. In fact studies made by the company's engineers indicate that in transmitting three-kilocycle telephone speech messages in a three-megacycle band of frequencies only 150 messages could be transmitted by time modulation, while frequency modulation would permit the transmission of 350 messages and amplitude modulation 750 messages. These figures are based on equal signal to noise ratios at the output of the receiver.

Other advantages, however, compensate for this inefficient frequency band usage. The limiting factor in amplitude modulation systems is the distortion introduced by the

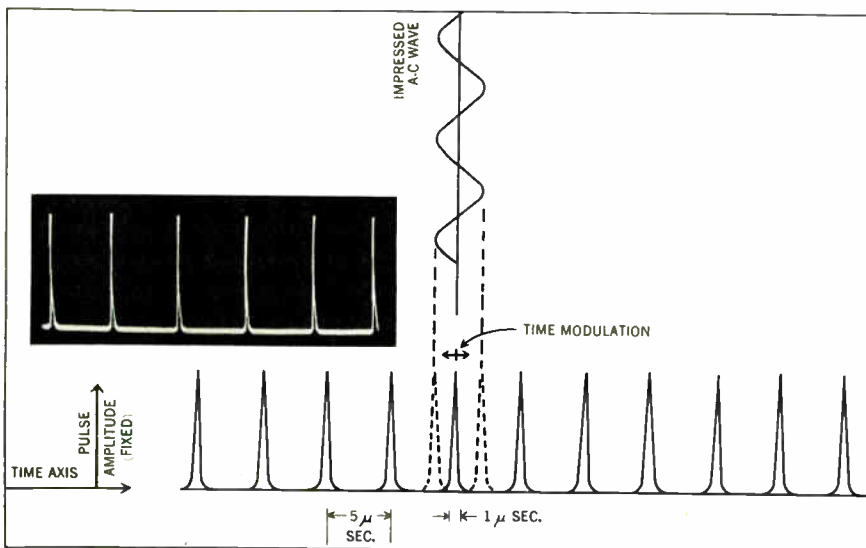

A 1300 mc carrier generated in a lighthouse type of tube working into cylindrical resonators is turned on and off producing sharp pulses at intervals as shown. Modulation makes the pulse occur a little early or late. Pulses are not heard due to high repetition rate

However, with the ending of the war still a third method of modulation, utilizing variations in time, has been removed from the secrecy list. Technical details concerning its basic principle and the methods by which it can be adapted to communication uses have been revealed by engineers of the Federal Telephone & Radio Corp.

Stated briefly, the new method permits the transmission of intelligence by means of a series of pulses of about half a microsecond duration, each separated from the other by a time interval of about five microseconds. Their time of recurrence can be advanced or retarded over a range of approximately one microsecond. This new scheme has been called Pulse Time Modulation.

In translating the positive and negative variations of an ordinary

placement of a pulse moves forward and backward.

In this system of modulation no significance is attached to the exact shape of the pulse or to its amplitude. In fact the amplitude is made uniform by an amplitude limiting circuit. The steepness of the wave front of the pulse, however, that is its rise time and its decay time are of importance in determining the signal to noise ratio

When received, the pulses are impressed on the grid of an electron gun which is normally biased to extinction. The beam, unblocked, rotates in proper position for given signal

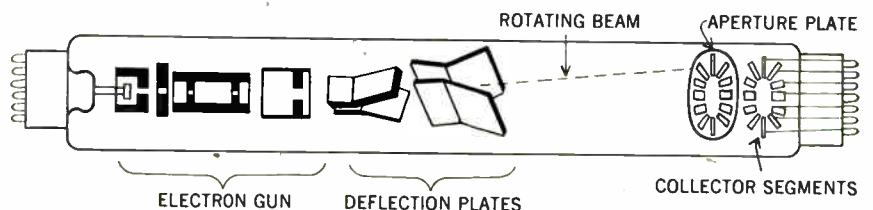

# MULTIPLE TRANSMISSION

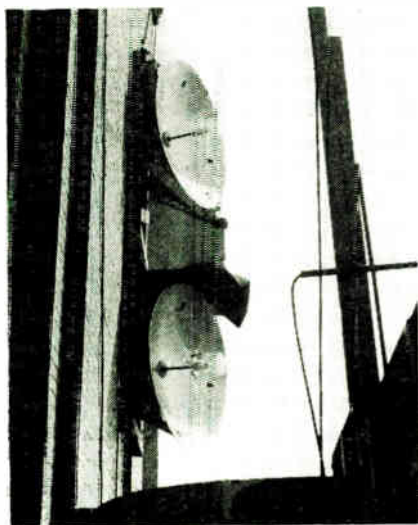

Antennas on top of the building at 67 Broad St. A dipole is at focus of 8 ft. parabola

non-linearity of the tube circuits. Likewise in frequency modulation systems distortions are introduced by the frequency selectivity of the resonant circuits. In pulse time modulation, however, neither of these types of distortion can occur and the addition of more repeaters in a relay chain does not increase the distortion. This obviously provides the system with a considerable advantage in the construction of radio relay chains. Furthermore, the super high frequency carrier circuit being modulated only by being switched on or off to create the pulses can be of an extreme simplicity of design not possible with other systems.

The system was originally patented by A. H. Reeves of Standard Telephones and Cables Ltd. of London, an International Telephone and Telegraph Corp., affiliate and by E. M. Deloraine of the Federal Telephone Laboratories and has been worked on by other affiliated engineers, notably Mr. E. Labin, and others.

In the experimental equipment set up by the Federal Telephone Laboratories at 67 Broad Street, a 1300-megacycle carrier is utilized, being radiated from a simple dipole and beamed by means of a parabolic reflector eight feet in diameter. The high frequency oscillations are generated by means of a 2C43 lighthouse tube inserted in the end of cylindrical circuit elements.

In the receiving set the time modulated pulses are translated into ordinary amplitude modulation for the operation of a loud speaker

by means of a new tube named the Cyclophone. This tube has some of the elements of an ordinary cathode ray tube being equipped with an electronic gun and a double set of electrostatic deflection plates.

By means of an ordinary circular sweep circuit the beam issuing from the electron gun is made to follow a circular path. The target end of the tube differs from that of an ordinary cathode ray tube, however, in that there is a metal plate with a number of radially disposed slits, equal in number to the number of messages which are to be transmitted simultaneously. Behind this plate with the slits, another plate is mounted as a target for the cathode rays.

A normally negatively biased control grid blocks the cathode ray beam except when one of the time modulated pulses arrives. Depending upon where the cathode ray beam is directed with respect to one of the slits at the time when the unblocking pulse arrives there is a variation in the amount of cathode ray beam current passing through this slit and impinging upon the target dynode. By this means time variations are translated into amplitude variations. For ordinary telephone circuits the cathode ray beam is rotated at

8,000 revolutions per second and for a 24 circuit transmission there are 25 slits in the cyclophone (one of them being used for a marker or synchronizing pulse).

At the transmission end amplitude modulated speech signals are changed into pulse time modulated signals by a tube similar to the cyclophone called the Cyclo-odos. In this tube the radially disposed slits of the cyclophone are tilted at an angle with respect to the radius of the slitted plate. The cathode ray beam rotates as in the cyclophone but in this case variations in the amplitude of the modulating current cause variations in the radius of rotation of the beam. Since the slits are tilted at an angle the time when the beam crosses the open face of a slit changes either forward or backward according as the radius of rotation of the beam changes.

Rack in which communications equipment is mounted. It contains the channeling equipment by which 24 phone messages are sent at the same time. System noise is low

In the experimental repeater circuit, signals sent from New York are received and automatically repeated at Telegraph Hill, Hazlet, New Jersey and at Nutley, N. J., whence they return to New York. Photo shows repeater tower

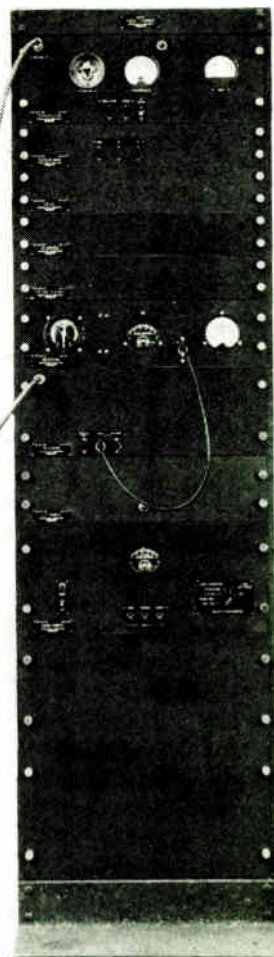
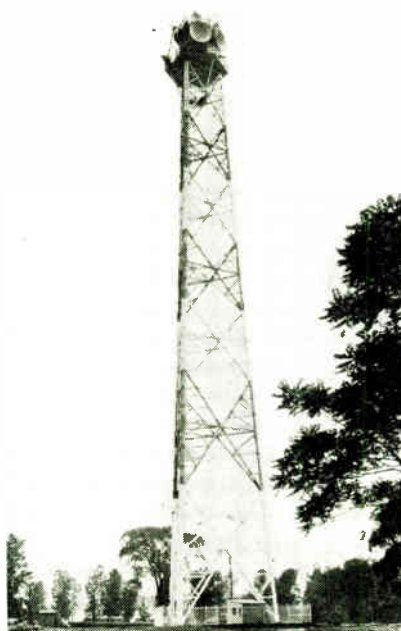

# Cathode Biased Amplifiers

by PAUL H. HUNTER

**Analytical methods for determining the operating point when circuit constants and supply voltages are known**

● Methods of determining suitable constants for the operation of a vacuum tube as a cathode-biased, linear amplifier have been quite thoroughly treated in various texts from the development standpoint. However, little consideration has been given to the problem of locating the operating point of a cathode-biased tube for which all circuit constants, including supply voltages, are known.

To illustrate this distinction between design theory and the analysis of a circuit already designed, Fig. 1 presents the information usually found in a schematic diagram, and Fig. 2 gives the family of plate characteristic curves pertaining to the typical triode shown in Fig. 1. To establish the locus of

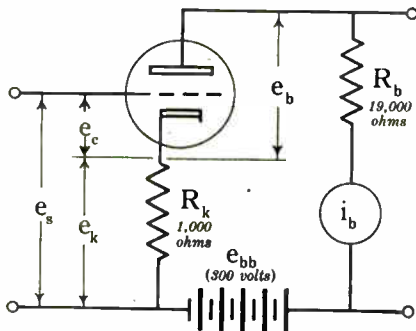

Fig. 1—Common type of schematic diagram including information usually supplied

operation for the given value of plate resistor  $R_b$ , and supply voltage,  $e_{bb}$ , a load line for  $R_b = 19,000$  ohms has been plotted in Fig. 2. The origins of this load line are, as usual, the "short circuit" plate current,  $i_b = \frac{R_b + R_k}{e_{bb}} = \frac{20,000}{300} = 66.7$  milliamperes, and the "open circuit" plate voltage, when  $e_b = e_{bb} = 300$  volts.

This type of graphical construction is useful for both design and analysis of a circuit. However, the location of the operating point, P, for any given value of cathode load,

$R_k$ , involves a technic not usually found in design literature.

Given a value of 1,000 ohms for the cathode resistor,  $R_k$ , the static, or "rest" point, P, can, of course, be arrived at by successive trials. However, a more convenient graphic solution is possible. A form of load line for the cathode voltage and current may be plotted on the family of plate characteristics, by treating these curves as grid voltage coordinates and locating a point on any one of the curves which will satisfy the condition

$$e_g = i_b \cdot R_k$$

For example, the point "A" on the curve for  $e_g = -8$  volts corresponds to  $i_b = 8$  ma. and

$$e_b = i_b \cdot R_b = 8 \text{ ma.} \cdot 19,000 \text{ ohms} = 152 \text{ volts}$$

is located by projection from  $i_b = 8$  ma. to  $e_g = -8$  volts. Since  $e_g = e_k = 0$  when  $i_b = 0$ , it is valid to connect point "A" to the point of zero plate current and voltage. The intersection of the positive slope of  $R_k$  with the negative slope of  $R_b$ , at the curve corresponding to a grid bias of  $-6$  volts, locates the quiescent operating point of the tube for this set of conditions.

Since  $e_g = e_k$  only when the grid is at ground potential, the foregoing analysis yields no direct information on the dynamic characteristics of the circuit when a signal voltage,  $\Delta e_s$ , is applied between the grid and B—terminal (usually at ground potential). In the example, a grid-to-cathode excursion from  $P+4 = -2$  volts, to  $P-4 = -10$  volts would be considered good practice.

To determine the required signal, or grid-to-ground potential,  $\Delta e_s$ , required to drive the grid from  $-2$  to  $-10$  volts with respect to cathode, the amount of cathode excursion,  $\Delta e_k$ , must be found, since  $\Delta e_s = \Delta e_c + \Delta e_k$ . For the desired value of  $\Delta e_c = 8$  volts,  $\Delta i_b$  is found by projection from the  $-2$  and  $-10$  volt points on the load line of Fig. 2. This excursion of  $i_b$  is from 8.6

ma. (when  $e_c = -2$ ) to  $-3.1$  ma. (when  $e_c = -10$ ), which amounts to 5.5 ma. With  $R_k$  given as 1,000 ohms,  $\Delta e_k = R_k \cdot \Delta i_b = 1,000 (5.5 \times 10^{-3}) = 5.5$  volts. Hence,  $\Delta e_s = \Delta e_k + \Delta e_c = 5.5 + 8 = 13.5$  volts, representing the total excursion re-

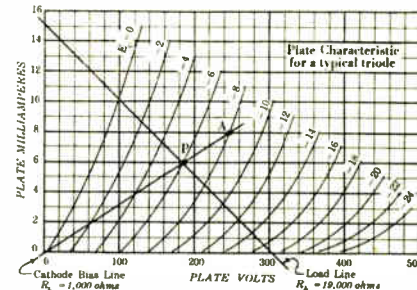

Fig. 2—Family of characteristic curves pertaining to typical triode of Fig. 1

quired of the grid, with respect to B—, or ground.

Since half of this excursion must be positive and half negative, the peak signal voltage equals  $\frac{13.5}{2} = 6.75$  volts, and the equivalent RMS input will be  $\frac{6.75}{\sqrt{2}} = 4.77$  volts. The

voltage amplification is  $\frac{(\Delta i_b \cdot R_b) - (\Delta i_b \cdot R_k)}{\Delta e_s} = \frac{(.0055 \times 19,000) - (.0055 \times 1,000)}{13.5} = 12.4$ .

$$\text{Voltage Amplification} = \frac{(\Delta i_b \cdot R_b) - (\Delta i_b \cdot R_k)}{\Delta e_s} = \frac{(.0055 \times 19,000) - (.0055 \times 1,000)}{13.5} = 12.4$$

This type of analysis can be extended to more complex circuits involving pentodes, non-linear elements, etc. In general, the technic of circuit analysis is a simple reversal of the designing process, but the foregoing illustration demonstrates one of many special methods which apply specifically to analysis. Analytical methods of this type are frequently required in connection with instruction work, maintenance, and design modifications.



**DR. A. HOYT TAYLOR**  
chief coordinator and chief consultant on  
Navy electronics

# NAVY'S ELECTRONIC ORGANIZATION

*Intensified research in echo technics and expansion of relations with industry projected*



**R. A. GORDON**  
Airborne Electronics Division



**L. A. GEBHARD**  
Ship-Shore Radio Division



**DR. ROBERT M. PAGE**  
Fire Control Division



**DR. JOHN M. MILLER**  
Research and Development Division

• Intensification of the Navy's post-war research into electronics, radar and sonar and expansion of its relationships with the industry are foreshadowed in the formation of four new scientific divisions to comprise the Naval Research Laboratory Electronics Activities, by Rear Admiral Harold G. Bowen, USN, Chief of the Navy's Research and Inventions and former Director of the Laboratory.

Coincident with the creation of the four divisions, Dr. A. Hoyt Taylor, who is credited by the Navy as being the "daddy" of radar and who formerly headed the Laboratory's single radio division, has been designated Chief Consultant and Chief Coordinator for Electronics.

Dr. Taylor will be the Chief Consultant on electronic matters for the entire Navy Department and particularly for Admiral Bowen and Rear Admiral A. H. Van Keuren USN, Director of the Naval Research Laboratory. He will coordinate the work of all the four new Divisions because many of the radio, radar, sonar and electronics problems are interlaced between several divisions. In addition, Dr. Taylor will also act as the chief liaison official between the Naval Research Laboratory and the Army and Army Air Forces, Office of Scientific Research and Development, university laboratories and

industrial laboratories and manufacturing companies. It was stressed that the Naval Research Laboratory will in no way engage in manufacturing, but only research and development.

Presaging that the Navy is planning to continue the expenditure of substantial sums for research and procurement with industry after the war, Admiral Bowen stated that "the Naval Research Laboratory divisions will be organized along lines found essential as a result of war experience. They will facilitate bringing top flight technical talent into closer contact with Fleet operating and maintenance problems." It was emphasized that each division will be entirely under the

direction of each superintendent.

Comprising the Naval Research Laboratory Electronics Activities, the new divisions, formed by Rear Admiral A. H. Van Keuren, USN, Director of Naval Research Laboratory, formerly operated as a single radio division under Dr. Taylor.

A pioneer in the development of radar and a well-known authority in the field of electronics and war time applications of radio, Dr. Robert M. Page heads the newly-created Fire Control Division as Superintendent. Dr. Page was graduated and received a Doctor of Science degree from Hamline University, St. Paul, Minn.

Dr. John M. Miller has been  
*(Continued on page 150)*

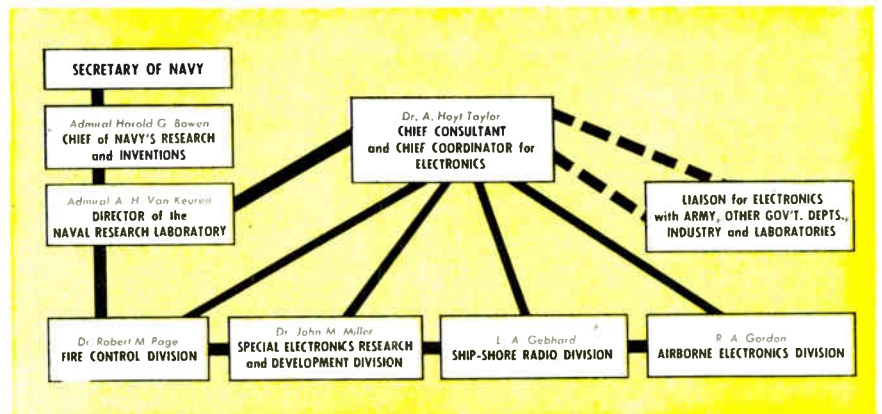

# VECTOR ANALYSIS

By H. GREGORY SHEA

Associate Editor, Electronic Industries

## Review of vector mathematics including divergence and curl for engineers dealing with wave guides and radiation

As microwaves are destined to be used more and more in the postwar electronic world, engineers whose schooling did not include a recent communications course may find themselves at a disadvantage in obtaining a thorough understanding of the physical phenomena occurring at these frequencies. Attempting to bring themselves up to date by study of the literature, they are immediately confronted with the fact that the basic treatment requires a knowledge of Vector Analysis which they do not have. This is such a useful branch of mathematics that, since it is not difficult for engineers acquainted with calculus, none should deny himself the power available by its use.

Since electrical engineers are accustomed to using vectors in diagrams to represent time variations of electrical magnitudes, it should be emphasized that in Vector Analysis, vectors describe quantities acting in one or more (usually three) dimensional space, indicating their direction and magnitude. These do not depend on the coordinate axes used as a frame of reference. In other words these vectors in general are invaria:at with respect to the system of measurement. It is this property which makes them so useful in describing physical quantities, as these behave the same way.

Vectors are ordinarily denoted by bold face type thus "V", while scalars having magnitude but no direction are denoted by light face type "s". A vector can be multiplied by a scalar. This increases its magnitude but does not change its direction. That is, s times  $V = sV$ . Likewise the following are identical as with ordinary algebraic practice:

$$\lambda V = V\lambda; (\lambda + \mu)V = \lambda V + \mu V;$$

$$\lambda(\mu V) = (\lambda\mu)V; \lambda(V_1 + V_2)$$

$$= \lambda V_1 + \lambda V_2$$

and ordinary addition and subtraction of vectors can be carried on

algebraically, with due regard to direction. That is  $V_1 + V_2 = V_3$  (see Fig. 1).

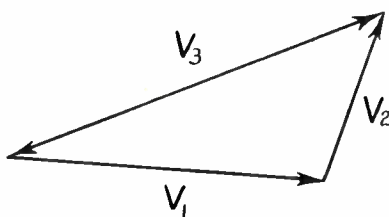

Fig. 1

If O is a fixed point and  $V_1, V_2, V_3$  are vectors pointing in different directions, the end points of vectors OP of the form  $\lambda_1 V_1 + \lambda_2 V_2 + \lambda_3 V_3$  may form a three dimensional space of points.

If numbers  $\lambda_1, \lambda_2, \lambda_3$  exist such that  $\lambda_1 V_1 + \lambda_2 V_2 + \lambda_3 V_3 = O$ , for any three vectors in space, the three vectors are said to be linearly dependent. If this condition can not be brought about, they are linearly independent.

Any three linearly independent vectors can be used to form the basis of a vector space. Ordinarily where such a frame of reference is required, the base unit vectors are chosen at right angles to each other and denoted by the letters  $i, j, k$  used in the  $x, y, z$  directions of rectangular coordinates.

### Multiplication

If two vectors are to be multiplied by each other several possible products exist. The simplest one is called the scalar product, written  $X \cdot Y$  and read X dot Y. This product, a scalar quantity, is obtained by multiplying the length of one vector by the length of the perpendicular projection of the other upon it.

In a rectangular system a vector X whose length and direction are as shown in Fig. 2 can be measured by: length of  $X = |X| = \sqrt{X_1^2 + X_2^2 + X_3^2}$ .

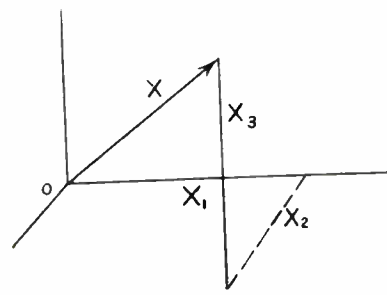

Fig. 2

This can be written more simply  $|X| = \sqrt{Q(X)}$ . Then the scalar product of two vectors X, Y is  $X \cdot Y = \sqrt{Q(X)} \sqrt{Q(Y)} \cos \theta$ , where  $\theta$  is the angle between them. This angle can be found from the following  $\cos \theta = \frac{Q(X, Y)}{\sqrt{Q(X)} \sqrt{Q(Y)}}$ , Q(X, Y) being equal

to  $x_1 y_1 + x_2 y_2 + x_3 y_3$ .

From the above it can be seen that  $\sqrt{X \cdot X} = |X|$ , a scalar. Also  $i \cdot i = j \cdot j = k \cdot k = 1$  and  $i \cdot j = i \cdot k = j \cdot k = 0$

### Vector product

The next possible product of two vectors is the vector product written  $X \times Y$  and read X cross Y. This is also called the cross product of the vectors and is a new vector in a different direction from either of the original vectors, being at right angles to their plane. Its magnitude is equal to the product of the magnitudes of the original vectors and the sine of the angle between them, that is if

$$X \times Y = Z, \text{ then}$$

$$\sqrt{Z \cdot Z} = \sqrt{X \cdot X} \sqrt{Y \cdot Y} \sin \theta$$

Referring to Fig. 3, the directions are such that if the first vector, in this case X is in the direction of the thumb of the right hand, the second Y in the direction of the index, then Z will be in the direction of the third finger pointing up from the palm (Fig. 4). This order of directions is called a right hand triple.



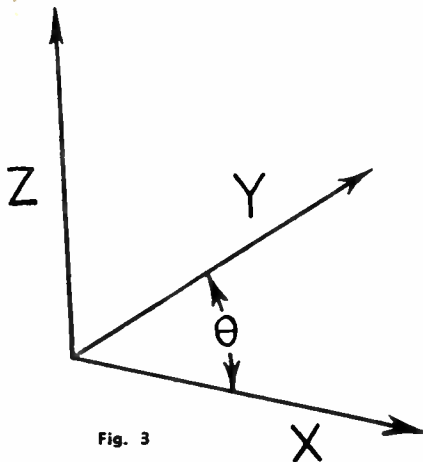

Fig. 3

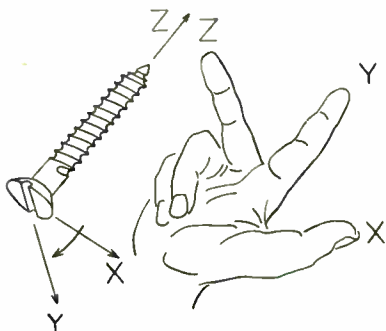

Fig. 4

The same convention is used in representing a plane area by a vector, that is, if the area is bounded by a curve and the tangent to the curve is  $\mathbf{X}$ , while the normal pointing inward is  $\mathbf{Y}$ , the vector representing the area will be in the direction  $\mathbf{Z}$  see Fig. 5.

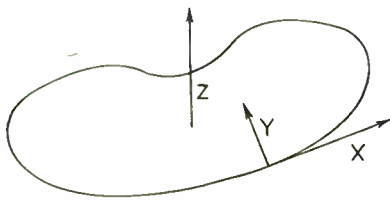

Fig. 5

Another way of stating this relationship of directions is to use the corkscrew or right hand screw illustration. If the first vector  $\mathbf{X}$  is turned clockwise into the second vector  $\mathbf{Y}$ , the vector  $\mathbf{Z}$  is in the direction in which a corkscrew would advance if turned like  $\mathbf{X}$ .

From the definition of the cross product it is evident that the order in which the product is formed is important.  $\mathbf{X} \times \mathbf{Y}$  does not equal  $\mathbf{Y} \times \mathbf{X}$  and it is now necessary to remember in all cross products that  $\mathbf{X} \times \mathbf{Y} = -\mathbf{Y} \times \mathbf{X}$ .

This may seem strange, but it must be remembered that ordinary algebra applies to numbers having

magnitude only and no direction whereas vectors represent direction also. Applying the cross to the  $\mathbf{i}, \mathbf{j}, \mathbf{k}$  base unit vectors, we see that

$$\begin{aligned} \mathbf{i} \times \mathbf{i} &= |\mathbf{i}|^2 \sin 0 \equiv 0 \\ &\equiv \mathbf{j} \times \mathbf{j} \equiv \mathbf{k} \times \mathbf{k} \end{aligned}$$

However, since vectors are mutually perpendicular,  $\mathbf{i} \times \mathbf{j} = \mathbf{k}$ ,  $\mathbf{j} \times \mathbf{k} = \mathbf{i}$ ,  $\mathbf{k} \times \mathbf{i} = \mathbf{j}$ .

A fundamental theorem of vector cross products is that  $(\mathbf{X} + \mathbf{Y}) \times \mathbf{Z} = \mathbf{X} \times \mathbf{Z} + \mathbf{Y} \times \mathbf{Z}$ , that is, the distributive law of multiplication applies.

### Triple products

In addition to the products of two vectors which we have described, there are scalar and vector products involving three vectors.

The scalar triple product  $\mathbf{Z} \cdot (\mathbf{X} \times \mathbf{Y})$  is quite evidently equal to the dot product of two vectors since  $\mathbf{X} \times \mathbf{Y}$  is a new vector at right angles to the plane determined by  $\mathbf{X}$  and  $\mathbf{Y}$ . It does not matter then whether this is written  $\mathbf{Z} \cdot (\mathbf{X} \times \mathbf{Y})$  or  $(\mathbf{X} \times \mathbf{Y}) \cdot \mathbf{Z}$ .

Furthermore, since we are dealing with three linearly independent vectors, any two of them  $\mathbf{X}$  and  $\mathbf{Y}$  for example determine a parallelogram whose area is their cross product (see Fig. 6).

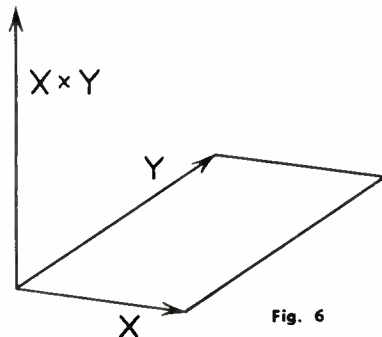

Fig. 6

If a third vector  $\mathbf{Z}$  is added (see Fig. 7) its dot product with  $\mathbf{X} \times \mathbf{Y}$  is the altitude of a parallelepiped times the area of its base, or its volume.

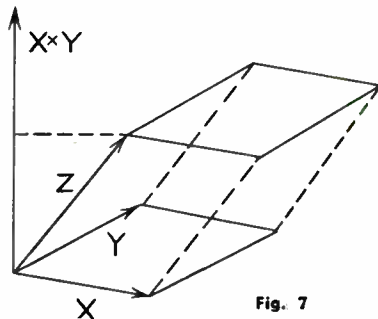

Fig. 7

The volume however, is independent of which face is taken for a base and which for height, that is, as long as the order of cross products is maintained, it is true that  $\mathbf{X} \times \mathbf{Y} \cdot \mathbf{Z} = \mathbf{X} \cdot \mathbf{Y} \times \mathbf{Z} = \mathbf{Y} \cdot \mathbf{Z} \times \mathbf{X} = \mathbf{Z} \cdot \mathbf{X} \times \mathbf{Y}$ .

In view of this it is usual to omit the dot and cross, calling the product a box product and writing it in brackets  $[\mathbf{XYZ}] = [\mathbf{YZX}] = [\mathbf{ZXY}]$ . As long as permutation of the letters is cyclic, the sign of the product will not change.

The vector triple product on the other hand is  $\mathbf{Z} \times \mathbf{X} \times \mathbf{Y} = (\mathbf{Z} \cdot \mathbf{Y})\mathbf{X} - (\mathbf{Z} \cdot \mathbf{X})\mathbf{Y}$  the proof of which is omitted here due to its length. However the relation can be proved by representing each vector by its  $\mathbf{i}, \mathbf{j}, \mathbf{k}$  components and performing the indicated operation.

### Calculus of Vectors

With this brief introduction of algebraic manipulation of vectors, we can go on to the calculus of vectors. If a vector varies and depends on a scalar variable such as time for instance it is usually written  $\mathbf{X}(t)$ .

As in the familiar calculus, there may be a vector which can represent the limit of the ratio of a change in  $\mathbf{X}(t)$  to the change in  $t$  as the latter change approaches zero. By going through the fundamental determination of the limit of a change in  $\mathbf{X}(t)$  as  $\Delta t \rightarrow 0$ , or  $\lim_{\Delta t \rightarrow 0} \frac{\mathbf{X}(t + \Delta t) - \mathbf{X}(t)}{\Delta t}$

one obtains the derivative of a vector

$$\frac{d\mathbf{x}}{dt} = \frac{dx_1}{dt}\mathbf{i} + \frac{dx_2}{dt}\mathbf{j} + \frac{dx_3}{dt}\mathbf{k}$$

This process applied to combinations of vectors yields the following rules of differentiation:

$$\frac{d}{dt}(\mathbf{X} \pm \mathbf{Y}) = \frac{d\mathbf{X}}{dt} \pm \frac{d\mathbf{Y}}{dt}$$

$$\frac{d}{dt}\lambda(t)\mathbf{X} = \mathbf{X} \frac{d\lambda}{dt} + \lambda \frac{d\mathbf{X}}{dt}$$

$$\frac{d}{dt}(\mathbf{X} \cdot \mathbf{Y}) = \frac{d\mathbf{X}}{dt} \cdot \mathbf{Y} + \mathbf{X} \cdot \frac{d\mathbf{Y}}{dt}$$

$$\frac{d}{dt}(\mathbf{X} \times \mathbf{Y}) = \frac{d\mathbf{X}}{dt} \times \mathbf{Y} + \mathbf{X} \times \frac{d\mathbf{Y}}{dt}$$

$$\begin{aligned} \frac{d}{dt}[\mathbf{XYZ}] &= \left[\frac{d\mathbf{X}}{dt}\mathbf{YZ}\right] + \left[\mathbf{X}\frac{d\mathbf{Y}}{dt}\mathbf{Z}\right] \\ &\quad + \left[\mathbf{XY}\frac{d\mathbf{Z}}{dt}\right] \end{aligned}$$

### Fields

In electronic work of a fundamental nature much use is made of the notion of a field.

These fields occur either as scalar or vector fields. For instance the temperature at various points in a room would constitute a scalar field since for each point in the room which can be located by a vector  $\mathbf{V}$

starting from a convenient origin, say one corner, there is a definite temperature. Obviously each point can be described by its coordinates in a rectangular  $x, y, z$  system so that temperature at point  $P$  is a function of  $x, y, z$  or  $f(P) = f(x, y, z)$ .

Likewise, the wind velocity and direction at any point in the atmosphere can be represented by a vector, and the set of these wind vectors constitutes a vector field.

A level surface of a scalar field is a surface connecting all points in the field having the same value. A cold front as mentioned on a weather map would be an example of a level surface of the atmospheric temperature field.

The gradient of a scalar field  $F$  is a vector field. That is, at each point in the scalar field there is a rate of change in the direction normal to the level surface of the field and pointing in the direction of an increase in the field. This function is written

$$\text{grad } F = \frac{\partial F}{\partial x} \mathbf{i} + \frac{\partial F}{\partial y} \mathbf{j} + \frac{\partial F}{\partial z} \mathbf{k}$$

That is, it is the sum of the rates of change with distance of the scalar field in the  $x, y$  and  $z$  directions each multiplied by the unit vector in its direction.

### Operators

It is convenient in this connection to speak of certain mathematical processes as operations. Thus simple addition, multiplication and division are operations. The dot and cross are operators as is the grad. To make it easy to indicate the operation of taking a derivative in three directions as shown above there has been invented a symbol " $\nabla$ " called "del" or "nabla" which is defined as

$$\nabla = \mathbf{i} \frac{\partial}{\partial x} + \mathbf{j} \frac{\partial}{\partial y} + \mathbf{k} \frac{\partial}{\partial z}$$

in terms of this symbol,

$$\text{grad } F \equiv \nabla F$$

### Integration

Vector expressions can be integrated just as scalar expressions and in electrical theory there is much reference to line, surface and volume integrals.

If a curve is represented by the vector equation  $\mathbf{r} = \mathbf{r}(t)$  as for instance  $\mathbf{r} = -\mathbf{i} + 3t^2\mathbf{j} + 5t^3\mathbf{k}$  it is

possible to require the line integral along this curve in either a scalar or a vector field  $F(P)$  or  $\mathbf{V}(P)$ . Thus we would have the following solution of line integrals of scalar or vector fields

$\int_R F(P) d\mathbf{r}$  = a vector,  $\int_R \mathbf{V}(P) \cdot d\mathbf{r}$  = scalar,  $\int_R \mathbf{V}(P) \times d\mathbf{r}$  = vector.

It should be kept in mind that vector notation is a mathematical shorthand which can be used to perform many complex operations in a simple manner, but when the result is to be evaluated it is often necessary to break it down into its constituents.

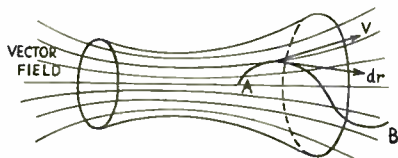

Fig. 8

For example, to evaluate the line integral  $\int_A^B d\mathbf{r} \cdot \mathbf{V}$  between  $A(0, 0, 0)$

and  $B(\frac{1}{2}, 3, 5)$  where  $\mathbf{r} = \frac{t}{2} \mathbf{i} + 3t^2\mathbf{j} + 5t^3\mathbf{k}$  and

$$\mathbf{V} = y^2\mathbf{i} + xy\mathbf{j} + xyz\mathbf{k}$$

it is necessary to state both  $d\mathbf{r}$  and  $\mathbf{V}$  in terms of the same variable, either  $t$ , or  $x, y, z$ .

Thus, the first way would give

$$x = \frac{t}{2}, y = 3t^2, z = 5t^3$$

The point  $\frac{1}{2}, 3, 5$  represents the value when  $t = 1$ . Therefore

$$\begin{aligned} \int_A^B d\mathbf{r} \cdot \mathbf{V} &= \int_0^1 dt \left( \frac{1}{2} \mathbf{i} + 6t\mathbf{j} + 15t^2\mathbf{k} \right) \\ &\quad \cdot \left( 9t^4\mathbf{i} + \frac{3}{2}t^3\mathbf{j} + \frac{15}{2}t^3\mathbf{k} \right) \\ &= \int_0^1 \left( \frac{9}{2}t^4 + 9t^4 + \frac{225}{2}t^5 \right) dt \\ &= \frac{1}{2} \left[ \frac{27}{5}t^5 + \frac{225}{6}t^6 \right]_0^1 \\ &= 15.2 \end{aligned}$$

The second way gives the same result.

While space does not permit examples of surface and volume integrals they are treated similarly.

### Divergence, Curl

Three exceedingly important expressions of vector analysis are the gradient, already mentioned, the divergence and the curl. The latter is sometimes called rotor or rotational.

The divergence of  $\mathbf{V}$  written  $\text{div } \mathbf{V}$  or  $\nabla \cdot \mathbf{V}$  in  $i, j, k$  coordinates would be

$$\begin{aligned} \left( \mathbf{i} \frac{\partial}{\partial x} + \mathbf{j} \frac{\partial}{\partial y} + \mathbf{k} \frac{\partial}{\partial z} \right) \cdot (iV_x + jV_y + kV_z) \\ = \frac{\partial V_x}{\partial x} + \frac{\partial V_y}{\partial y} + \frac{\partial V_z}{\partial z} \end{aligned}$$

when expanded. This is a scalar quantity. In connection with a

fluid moving through a bounded region of space, the divergence of the velocity measures the time rate of increase of mass per unit volume or of density per unit density. For water, if considered an incompressible fluid  $\nabla \cdot \mathbf{V} = 0$  as water can not change density.

To clarify divergence consider the following example. Let there be a pipe filled with air under pressure and assume that a cap is removed from one end. Fig. 9. Then as the

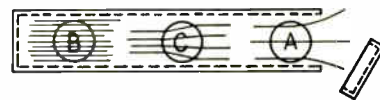

Fig. 9

air flows out of the end of the pipe, the density of air, that is, the mass of air in any closed region  $A$  is less than the mass in a similar sized closed region  $B$  near the closed end of the pipe. The measure of this decrease is the divergence of the velocity. In fact this is a continuous process so in any region  $C$ , for instance, the amount of air entering from the left is of greater mass than that leaving on the right. Or again, consider the explosion of a bomb. The mass of gas entering any cubic foot of space near the bomb is greater than the mass leaving it, i.e., the density is decreasing as the gas expands.

This concept leads directly to the important divergence theorem which indicates that the integral of the divergence of a field over any volume is equal to the net value of the flux of the field crossing the surface which encloses the volume. Expressed mathematically. (Fig. 10).

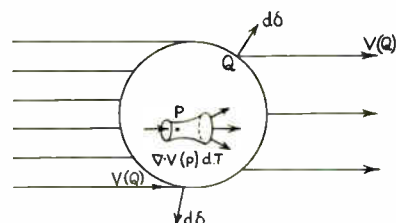

Fig. 10

$\int_T \nabla \cdot \mathbf{V}(P) d\mathbf{r} = \int_\Sigma d\delta \cdot \mathbf{V}(Q)$  where the large  $T$  indicates that the integration is over a volume  $T$ ,  $d\mathbf{r}$  is a differential element of volume,  $\mathbf{V}(P)$  is the value of the vector field  $\mathbf{V}$  at any point within the volume,  $\mathbf{V}(Q)$  is the same at any point on the surface enclosing the volume, and  $\Sigma$  indicates the right hand integration is to be carried on over the surface  $\Sigma$  and  $d\delta$  is the outward pointing normal representing surface elements. This divergence occurs in a region where lines of flow or flux appear to originate.

The curl of  $\mathbf{V}$  is written  $\text{curl } \mathbf{V}$  or  $\nabla \times \mathbf{V}$ . This is equal to

$$\left( i \frac{\partial}{\partial x} + j \frac{\partial}{\partial y} + k \frac{\partial}{\partial z} \right) \times (iV_x + jV_y + kV_z)$$

in *i, j, k*, coordinates

It may be expanded and regrouped to yield

$$i \left( \frac{\partial V_z}{\partial y} - \frac{\partial V_y}{\partial z} \right) + j \left( \frac{\partial V_x}{\partial z} - \frac{\partial V_z}{\partial x} \right) + k \left( \frac{\partial V_y}{\partial x} - \frac{\partial V_x}{\partial y} \right)$$

Obviously, this is a vector quantity. Curl is observed when a stick is thrown on the surface of a swift stream. Not only is the stick carried down stream, but it starts to turn because the part nearer the middle where the water flows swiftest is driven faster. If a small paddle wheel were placed in the stream with its axis vertical it would revolve. Crudely put this is caused by the curl of the velocity of the stream. No matter how small this paddle wheel were made, it would still turn if its bearings were frictionless. Therefore curl exists at every point in the stream. Furthermore, the direction of the curl vector is the direction of the axis of the paddle wheel.

In our illustration of the paddle wheel the thing that makes the wheel turn is the net sum (algebraic sum) of the water velocities around its circumference (Fig. 11)

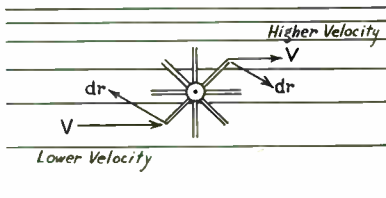

Fig. 11

times the cosine of the angle at which the water strikes the paddles. But this is obviously the line integral of the velocity around the circumference of the wheel, or

$$\int_c \mathbf{V} \cdot d\mathbf{r}$$

where *c* indicates that the integration is around the circumference. This integral is called the "circulation" of the velocity vector. Naturally it gets larger or smaller as the area bounded by the circumference changes so that, to make it depend only on the field we divide the circulation by the area. If this ratio is determined for the limiting condition of shrinking the area to zero, the result is the curl.

This gives a means of deriving the curl. Let us imagine the infinitesimal rectangle of Fig. 12 lying in a magnetic vector field of in-

tensity **H** whose components in the *x* and *z* directions are **H<sub>x</sub>** and **H<sub>z</sub>**.

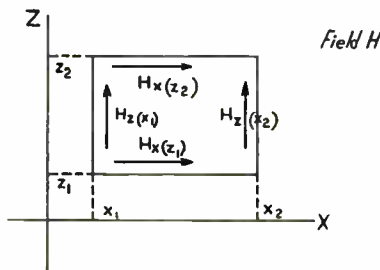

Fig. 12

Starting at the lower left hand and going around counter clockwise, taking the circulation of **H** we have

$$(\mathbf{H}_{x(z_2)} - \mathbf{H}_{x(z_1)}) dz - (\mathbf{H}_{z(x_2)} - \mathbf{H}_{z(x_1)}) dx$$

$$\text{or } \Delta \mathbf{H}_z dz - \Delta \mathbf{H}_x dx$$

But  $\Delta \mathbf{H}_z$ , the change in **H<sub>z</sub>** from *x<sub>2</sub>* to *x<sub>1</sub>*, is the rate of change times the distance or

$$\frac{\partial \mathbf{H}_z}{\partial x} dx$$

Thus we have

$$\frac{\partial \mathbf{H}_z}{\partial x} dx dz - \frac{\partial \mathbf{H}_x}{\partial z} dz dx$$

for the circulation. Dividing by the area, *dx dz*, we have

$$\frac{\partial \mathbf{H}_z}{\partial x} - \frac{\partial \mathbf{H}_x}{\partial z}$$

the curl in one plane. Similar treatment for the other directions yields the three dimensional curl expression given above.

### Stokes' theorem

Since what we have done to find the curl at a point is

$$\frac{\int_c \mathbf{V} \cdot d\mathbf{s}}{\text{Area}} = \nabla \times \mathbf{V}$$

we can, without going to a detailed proof write down the important Stokes' theorem

$$\int_c \mathbf{V} \cdot d\mathbf{s} = \int_s \nabla \times \mathbf{V} \cdot d\mathbf{s}$$

equating the surface integral of the curl with the circulation around the periphery of the surface. This theorem shows that the shape of the surface of integration is of no importance as long as the periphery remains the same. Thus, for instance, the curl integrated over the bottom of a sugar bowl is the same as the curl integrated over the lid since their peripheries coincide.

Any one who has ever watched a mountain stream knows that its course follows the line of steepest descent. This is the grade or gradient of the scalar field of height, and is a vector field since it has magnitude and direction. The gradient, a vector field, has no curl since

$$\nabla \times (\nabla F) = \left( i \frac{\partial}{\partial x} + j \frac{\partial}{\partial y} + k \frac{\partial}{\partial z} \right) \times \left( i \frac{\partial F}{\partial x} + j \frac{\partial F}{\partial y} + k \frac{\partial F}{\partial z} \right) = 0$$

and each term becomes identically zero when expanded

$$= i \left( \frac{\partial^2 F}{\partial y \partial z} - \frac{\partial^2 F}{\partial y \partial z} \right) = 0$$

The converse is also true, that the vector field which has no curl is the gradient of a scalar field. However, it is possible to have divergence of a gradient. This is

$$\nabla \cdot \nabla F = \frac{\partial^2 F}{\partial x^2} + \frac{\partial^2 F}{\partial y^2} + \frac{\partial^2 F}{\partial z^2}$$

if expanded in *i, j, k* coordinates. For this reason it is usually written  $\nabla^2 F$ . It is known as the Laplacian after Laplace, the French mathematician.

The curl has no divergence. Thus  $\nabla \cdot \nabla \times \mathbf{V} = 0$

As above, this can be proved by multiplying out in *i, j, k* coordinates. It also produces a useful corollary, namely, if a vector field has no divergence, it is the curl of another field.

In order to indicate the usefulness of vector analysis as a mathematical tool we will use it to derive Maxwell's first equation.

We know from experiments that electromotive force **E** is developed by a changing magnetic field, and that by definition this force in a circuit is equal to the work done in carrying unit charge once around the circuit. If there is a closed curve representing the circuit, let the force **E** acting on this charge be integrated around the circuit, thus  $\int_c \mathbf{E} \cdot d\mathbf{s}$ .

The changing magnetic field that will produce this EMF is equal to minus the rate of change of total flux linking the circuit. If the circuit surrounds an area *A*, and the flux density is **B** then the total flux is  $\int_s \mathbf{B} \cdot d\mathbf{a}$  and its rate of change is

$$\frac{\partial}{\partial t} \int_s \mathbf{B} \cdot d\mathbf{a}$$

Then we have

$$\int_c \mathbf{E} \cdot d\mathbf{s} = - \frac{\partial}{\partial t} \int_s \mathbf{B} \cdot d\mathbf{a}$$

From Stokes' theorem the first term can be transformed into a surface integral and we have

$$\int_c \mathbf{E} \cdot d\mathbf{s} = \int_s \text{curl } \mathbf{E} \cdot d\mathbf{a} = - \frac{\partial}{\partial t} \int_s \mathbf{B} \cdot d\mathbf{a}$$

Since the derivation is for any surface, the integrands must be equal, so removing the integral sign and transposing we have, in vector notation:

$$\nabla \times \mathbf{E} + \frac{\partial \mathbf{B}}{\partial t} = 0$$

Maxwell's first equation.

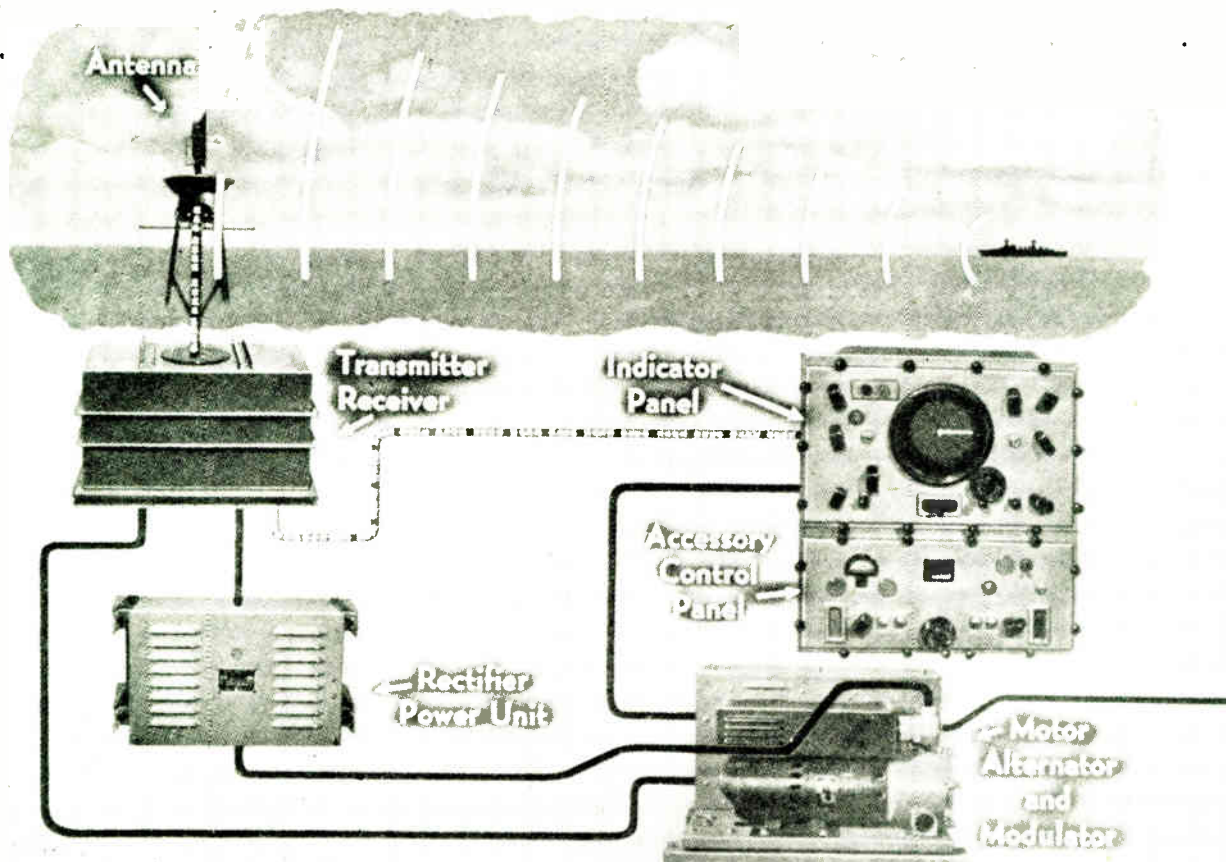

Functional isometric illustration of the Raytheon built type SO surface search radar equipment showing the interrelation of the five basic units that go to make up the complete system, and indicating operation when a target is located and the video signal is passed along to the indicator

# SURFACE SEARCH RADAR

**Technical details of SO type light-weight equipment developed for use in PT boats—Immediate commercial possibilities**

• The first surface search radar manufactured by Raytheon Mfg. Co. for the Navy carried the type designation SG. This early equipment was designed for surface search on all classes of Naval vessels. However, when completed it had a total weight of approximately 2,000 lbs. and could be used only on destroyers, cruisers, battleships and aircraft carriers. The remarkable combat and navigation performance of this class of radar in the early stages of the war resulted in the Navy requiring a light-weight series of radar for all its vessels, and as no radar in development was small enough to be fitted into PT boats, the program for the SO type radar was started.

The SO series radar sets are a medium-powered lightweight, compact surface search type of equipment which will detect objects on or near the surface of the water, in the area around the ship and within the range of the equipment. Detection principles used in SO equipment have other valuable applications in navigation, patrol duty, and task force operations. There are a number of models, such as the SO, SO-1, SO-2, each designed for a particular purpose. Since all types in the series are basically similar in operation, the type SO-1 will be used in this description.

The Raytheon SO-1 is of special interest because it is representative

of the type gear which has immediate commercial application. The cost of the apparatus is relatively modest, particularly when weighed against the substantial economic benefits derived from lower insurance, more reliable schedules, simpler navigation, etc.

Radar of the SO series consists of five basic units and their auxiliary parts. Operation of the equipment has been simplified as far as possible without sacrificing performance.

Targets on or near the surface of the water are shown in a map-like presentation (in polar coordinates) on the screen of the Plan Position Indicator (PPI). The bearing of a target in relation

to the axis of the craft (relative bearing) is determined by aligning the rotatable bearing cursor (vane) with the center of the target trace and reading the bearing on the dial surrounding the tube. Target range is determined in two ways; approximate range is estimated from calibrated range markers, and accurate range is read from a dial on the Accessory Control Unit by means of which a marker line is caused to intercept the target.

A motor driven alternator is used to convert the ship's dc power to 115 volts ac. This ac power operates the modulator, transmitter-receiver, plan position indicator, rectifier power unit and the synchro system. The ac power also operates the optional accessory control unit. The antenna drive motor is operated directly from the ship's power source.

A synchronized rotary spark gap is used to key the transmitter by discharging the dc-charged pulse line in the modulator. With such a system the adjustment of gap timing (phasing) is relatively non-critical, thus simplifying maintenance and making the system substantially independent of changes in motor speed. The potential from the modulator is stepped up by means of a pulse transformer to approximately 9.5 kv., half-wave

rectified, and delivered to a pulse line.

The pulse line (when properly terminated) has the characteristic of discharging completely and with a practically uniform current of approximately 85 amperes in a period of one microsecond. Discharge is effected through the primary of the pulse transformer by a spark gap switch mechanically coupled to the alternator and synchronized to the supply frequency. Thus the alternator output is finally converted into a one-microsecond square-wave voltage across the primary of the pulse transformer, recurring at about 400 times a second (i.e., at intervals of 2500 microseconds).

A low-amplitude sample of this pulse is delivered to the indicator to trigger (synchronize with the transmitted pulse) the radial sweep, the range mark oscillator, the PPI unblanking circuit, and the accessory control unit.

The pulse transformer, located in the transmitter-receiver unit, is so designed that it passes the main pulse and increases its amplitude to approximately 17 kv.

These one-microsecond pulses are applied to the magnetron oscillator at a peak power input of approximately 250 kw. and a repetition rate of about 400 cps. Once

each repetition cycle, power is applied and microwave energy is generated by the oscillator and radiated directly into a pre-tuned rf system.

The rf output is conducted to the antenna through a hollow waveguide transmission line and radiated onto the surface of the parabolic reflector. The reflector concentrates and re-radiates the energy in a narrow beam. The angle of radiation is approximately 10 degrees in the horizontal and 15 degrees in the vertical plane. As the antenna rotates, the beam sweeps over the surrounding surface area.

When the transmitted signal strikes a target, a small part of the energy is reflected back to the antenna. The reflector returns a part of this energy to the waveguide and receiver via the TR box (duplexing cavity) located in the transmitter-receiver unit. The TR box acts as an automatic electronic switch, disconnecting the receiver from the waveguide while the transmitter is energized.

The signal is amplified and detected in the receiver, which is of the superheterodyne type, and delivered through a coaxial line to the indicator as a rectified video signal. Here the video signal is again amplified and applied as intensity modulation of the cathode

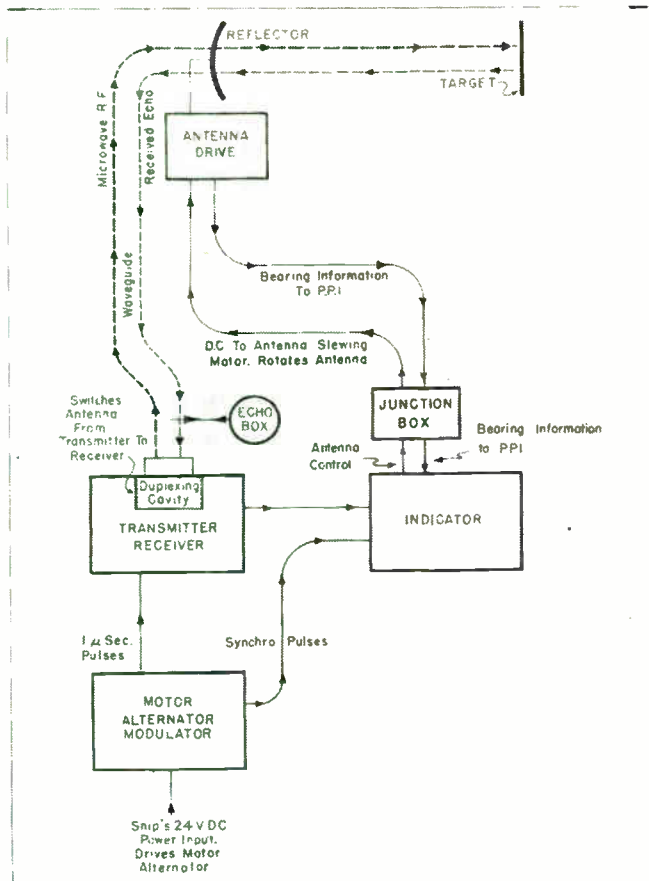

Left is shown a basic functional diagram of the SO-1 surface search radar equipment, which consists of the five units diagrammed together with their auxiliary parts. Below is a photograph of the scope of the equipment illustrating the appearance of Cape Cod, Mass. as it appears on the screen

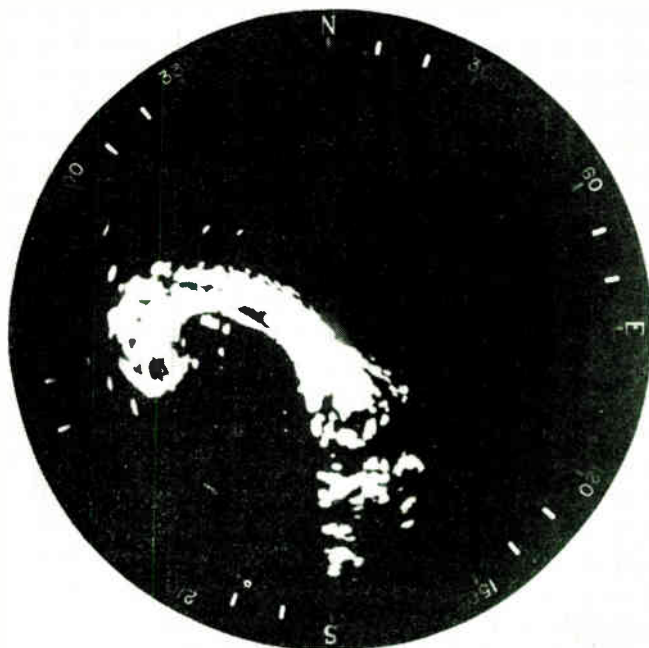

ray PPI tube, finally appearing on the tube screen as a small bright arc or spot.

The radial sweep of the PPI tube starts with the transmitted pulse and reaches the edge of the PPI screen in the exact time required for the rf energy to travel to and return from a target situated at the distant limit of the selected range. Suppose, for example, that while operating on the 20 mile range, a target 20 miles distant is being observed on the PPI screen. The rf energy would then have to travel 40 miles—20 miles out and 20 miles back. Since radio waves travel one nautical mile (2000 yards) in 6.12 microseconds, the PPI sweep would move from the center to the edge of the screen in  $6.12 \times 40$ , or approximately 245 microseconds.

Because of this synchronism between signal and sweep, the distance of the target trace from the center of the screen is directly proportional to the distance of the target from the center of the antenna. Target range therefore can be determined by noting the position of the target trace with reference to the calibrated range marks. More accurate ranging information may be obtained from the accessory control unit by rotating the range crank until the "accurate range mark" on the PPI tube coincides with the echo to be ranged, and reading the range directly from a dial mechanically coupled to the range crank.

Typical installation of the SO radar system, which normally is located in the pilot-house so that information may be instantly available to the helmsman

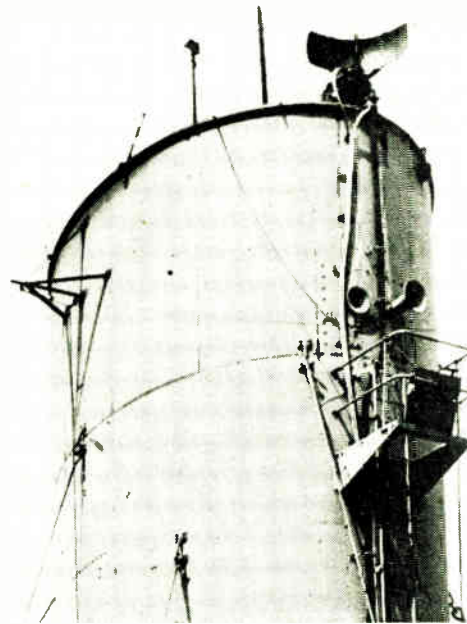
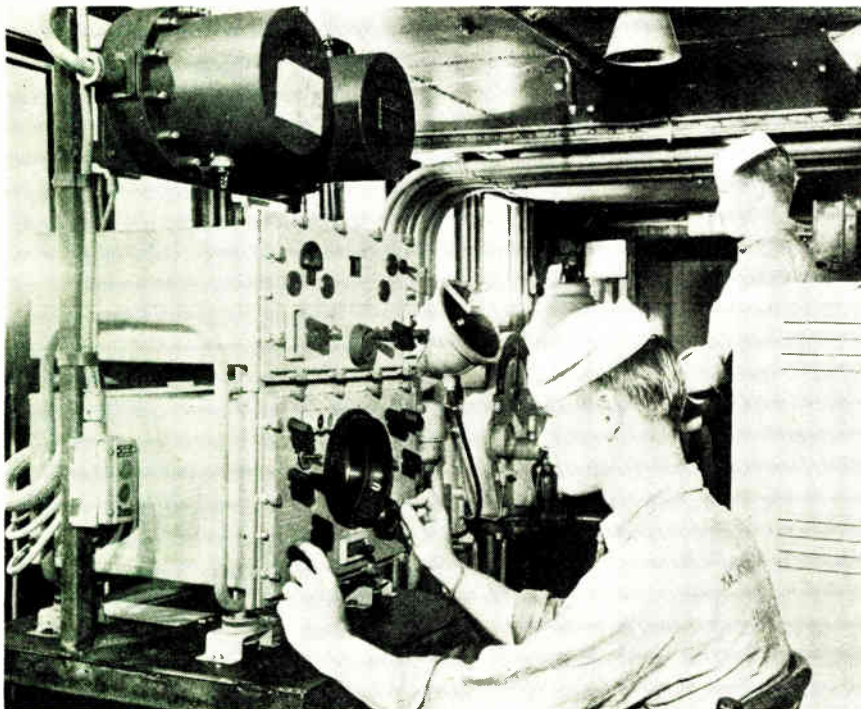

The antenna equipment for the SO series surface search radar equipment as mounted on the dummy smokestack of a troopship. With this arrangement the reflector revolves around the antenna

While the radial sweep is moving outward from the center of the tube in synchronism with the transmitted signal, the trace is made to rotate around the center of the tube in unison with the rotation of the antenna on the mast. Thus the angular position of the sweep always corresponds with the angular position of the antenna. Some equipment is converted to give true-bearing indications instead of relative-bearings. In these installations, the sweep position

corresponds to the true-bearing angular position of the antenna.

This synchronization between the rotating antenna and the rotating PPI sweep is accomplished by means of the synchro system. A synchro generator, geared to the antenna, electrically controls the rotation of the deflection coil producing the sweep.

Rotation of the antenna is initiated by an antenna drive motor energized directly from the ship's supply. The synchro generator is coupled through a 1-to-10 speed-increasing gear train to the antenna spindle. This synchro generator delivers bearing information to the synchro motor which turns the radial sweep coil of the PPI tube through a 10-to-1 speed-reducing gear train. Thus the desired synchronism is obtained once the antenna and sweep coil have been aligned.

At the time of installation the antenna is zeroed; i.e., adjusted so that the PPI sweep indicates zero degrees when the antenna is pointing dead ahead. If an antenna differential system is available to provide true bearing information, either true or relative bearing indications will be given, depending on the setting of a switch.

The range of the equipment depends primarily upon the height of the antenna, the location, size and character of the target, and to a lesser degree upon existing weather conditions. Under average conditions this set is capable of locating targets of fair size as far as the optical horizon; under unusually favorable conditions targets have been detected at the maxi-

(Continued on page 130)

# Thru the LABORATORY KEYHOLE

## Current Research that Forecasts Future Electronic Developments

**HOW THICK IS WATCH-OIL FILM?**—A chronometer lab is working on the problem of oil-film thickness, applying a principle taken from the automotive field where the electrostatic capacity between engine piston and cylinder walls was measured electronically. Watch technicians will use balance-staff and balance-wheel as positive plate, and conducting end-stone as negative. Balance-wheel will be driven by intermittent airblast, with recoil by hairspring.

**REFLECTION 135%**—John T. Shannon of Keese Engineering laboratory, Hollywood, Cal., has developed a fluorescent satin which reflects 135% of incident sunlight, spotlighting its wearer. After 20 years in UV and fluorescent work, Mr. Shannon's own skin is indelibly splashed with pigments, and glows like rainbow under UV.

**"ZERO MICRO-SECOND"**—not "zero-hour" was the way the atomic-bomb engineers referred to moment of explosion of the test bomb at Alamogordo, New Mexico, July 16. About 500 miles of wire was required for the remote firing and recording equipment. A distant lightning flash, by induction, prematurely fired a preliminary bomb setup, introducing a new hazard, afterward guarded against. The flash of the final test-bomb explosion was seen at Amarillo, Texas, 450 miles away, and windows rattled at Gallup, N. M., 235 miles distant.

**U.S. BIG INCH**—Metric experts at the Bureau of Standards are concerned at the "intolerable" discrepancy just discovered between the British and American standard inches—difference, 0.000,004 in. Scientists are split whether to whittle US inch to British, or seek a sort of mid-Atlantic compromise.

**SUPERSONIC SCARECROW**—Huge flocks of birds on building cornices become a nuisance in many cities—Washington, D. C., particularly. Lee Klos of Spokane, Wash., has applied an oscillator note above human hearing, to drive away pigeons, crows, and rodents which are sensitive to these high frequencies.

**RF HAIR-SHIRT?**—Why homing pigeons lose all sense of direction when released near radio stations has long puzzled bird-fanciers. Now comes a theory that just as all conductors in a strong rf transmitter field set up tiny induced sparks, bird's feathers may deliver a multitude of tiny prickles onto sensitive skin, making poor pigeon feel as if he were wearing itchy flannel or hair-shirt, and so distracting bird's attention from homing mission.

**THE LONG VIEW**—In describing plans for General Motors' new \$20,000,000 research center near Detroit,

Dr. Charles F. Kettering, research vice-president, said: "It has been decided to bring together our research, new-product development, new process engineering and styling—all within the confines of a square mile. Here the most theoretical scientist, the most practical workman, can work undisturbed on their developments with the benefit of the most advanced facilities. Out of these ideal conditions will develop new principles which will be turned over to our divisional engineers to be put into final form for mass production."

**LABELING MOSQUITOS WITH UV**—High-frequency-generated ultra violet is being used by the U. S. Public Health laboratories at Washington to study the flying range of mosquitos. On their home grounds the little pests are sprayed with fluorescent liquids and then released. When later examined out in the field under UV radiation, such marked mosquitos glow beautifully with red, blue or green phosphorescence depending on the identifying compound used, and thus reveal the distance and direction they have travelled.

**"CONFERENCE TELEVISION"** is now the subject of experiments in a large Eastern laboratory. This would extend the well-known "conference" telephone hookup by which executives in various cities can be put on a sort of party line, so that all can take part in discussions, vote on actions, etc. But now with the additional advantage that each participant can actually see (and be seen by) the others. Similar experiments were conducted in Germany pre-war, in connection with the television-telephone line in regular service there for several years.

**PHOSPHOR FOR UV**—GE lamp labs at Cleveland announce discovery of new phosphor capable of intensive UV radiation. A thin coating of this new phosphor on present lamps' inner surfaces, will produce germ-killing and health-giving ultra-violet radiations in quantities.

**TRACING METALS IN ANNEALING**—Sequence of atomic energy technic in producing radio-active elements of various types, will soon be felt in metallurgy. Such tracer radioactive elements have hitherto been used primarily in physiological research, including studies of plant and animal nutrition. Now with more powerful radioactive agents, metallurgists can trace movements of particular atoms from one location to another, which becomes of great importance in studying such treatments as annealing.

### ***A Motto for Every Electronic Lab!***

**"The only limit to our realization of tomorrow will be our doubts of today. Let us move forward with strong and oactive foith."**

—The last sentences Franklin D. Roosevelt wrote the night before he died.

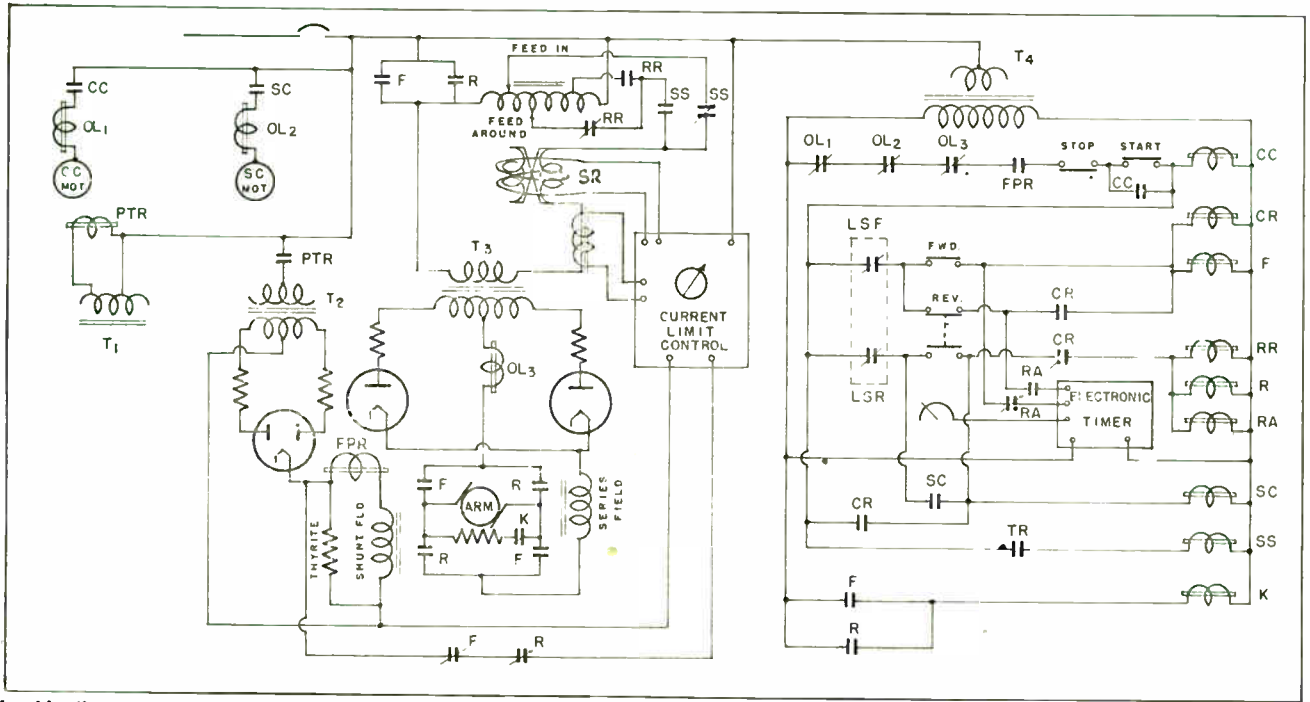

In this diagram of the electronic control applied to a thread milling machine, solenoids CC, CR, F, etc., shown at the right, operate similarly identified contactors located on the wiring plan adjacent to the controlled elements

### VACUUM TUBES IN INDUSTRY

# MACHINE TOOL CONTROL

by RAY A. STREMEL

Chief Electrical Engineer, Yuba Mfg. Co., San Francisco

## Form and thread milling machine made fully automatic in operation through addition of vacuum tube control unit

● Accelerated military schedules and inability to obtain immediate delivery of an additional form and thread milling machine, required that an electronic control be designed and constructed in the Yuba Mfg. Co's plant at Benicia, California. Available for increased production demands was an obsolete Plan-o-Mill. Upon finding a 1½ hp, shunt wound, 1750 rpm, 230-volt dc motor in local stock, it was decided to proceed with the design and construction of an electronic control panel to modernize the out-dated form and thread milling machine.

To understand the electronic and associated control requirements, first consider the Plan-o-Mill operating cycle. The operator inserts the part to be threaded into a holding fixture especially designed for the part, putting it in proper position to the cutter. A sliding table, hand operated, permits location of work relative to cutter before planetary milling.

With the electronic control the milling operation has been made automatic. The work remains stationary, while the cutter driven by

the 3 hp squirrel cage motor revolves in the milling head. The operator having this properly inserted, pushes the button which starts the coolant pump and sets up the control circuit for a cutting cycle. The cutting cycle begins upon actuation of the "Forward" button, which starts the spindle cutting motor and the electronic drive of the feed control.

### Electronic timer

The feed mechanism consists of an inner and outer quill. The inner quill mounted off center moves first at a speed determined by the "Feed In" speed setting and with the center of the multi-type cutter revolving eccentrically as the inner quill rotates, brings the cutter into the work until it reaches its proper depth of cut, as determined by the setting of stops. When the stop setting is reached, the inner quill engages the outer quill. At this point, the outer quill rotates the cutter on a concentric path around the work, maintaining constant depth of cut.

The electronic timer begins its timing cycle when the "Forward"

button is engaged. By experiment, the timing cycle can be set to engage the "Feed Around" speed a second or two after the inner quill engages the outer quill. The operation consists of about 1.3 revolutions around the work at which point an adjustable limit switch simultaneously stops and reverses the feed motor at a high speed, and brings it back to its starting cycle. Then a similar limit switch ends the cycle by dynamically braking the motor.

As a rule, it was found that two, sometimes three cuts, were desirable, in which case it was necessary to adjust the stop (inner quill against outer quill) for a deeper cut each time. To do this, it is only necessary to adjust the stop with a screwdriver and then to push the "Forward" button, and the control went through another cycle. The "Feed In," "Feed Around" and electronic "Feed in Time" do not require any further setting after the first cut.

With reference to the schematic diagram, single phase ac is rectified and applied to the 1½ hp dc motor. The range of speed re-



quired is thirty to one and is available without field control. The field supply transformer, T2, was designed to give 235 volts dc at the shunt field. Transformer, T1, is a filament transformer for all the power tubes used. The single line diagram includes coolant pump motor, CC, and spindle cutter motor. A variable auto transformer was reconstructed to afford two variables, one for the "Feed In" speed and the other for the "Feed Around" speed. There is also a fixed tap to give 270 volts output.

Saturable reactor, SR, is connected in series with the selected output of the auto transformer, current transformer, and anode transformer. The excitation on SR is entirely governed by the rectified current from the transformer.

The current limit control circuit is designed to limit the excitation on the reactor to approximately 152 per cent of full load armature current. Two thyratrons furnish the dc excitation to the saturable reactor. A phase shift method using a small saturable reactor was used to control the output of the thyratrons. When the armature current exceeds 152 per cent, the potential of a control tube is lowered, thus furnishing less excitation on the phase shift reactor of the thyratrons. As a result of lower potential on the dc winding, the voltage to the armature will be proportionately less.

Under usual operating conditions, the current limit feature is not absolutely necessary since the "Feed In" and "Feed Around" speed settings are usually low anyway. Where it became an absolute necessity was in the reversal at the end of the cutting cycle, where the motor had to be reversed instantly from whatever forward speed setting might exist at the moment.

Following through the scheme of operation again, briefly, the "Forward" push button actuates Forward contactor, F. Control relay, CR, which actuates spindle cutter contactor and seals in through its own interlock, selects electronic timer and starts its pre-set timing cycle at the same time. Speed selector relay, de-energized, selects the "Feed In" speed through its normally closed contacts, depending upon setting of "Feed In Time" potentiometer which may be about fifteen seconds. A telephone type relay, TR, within the electronic timer, is energized and closes the speed selector relay, SS, which disconnects "Feed In" speed and selects "Feed Around" speed. This continues in operation until the cutter has traversed approximately 1.3 revolutions around the work, at which time forward limit switch, LsF, opens Forward contactor, F, and control relay, CR. A normally closed contact on CR closes reverse contactor, R, reverse accelerating relay, RA, and reverse relay, RR.

Relay, RR, sets up the circuit for maximum voltage on the variable transformer and reverse accelerating relay, RA. Then it applies the same electronic timer (which has had sufficient time to reset) through RA which has selected a definite time delay setting of 1½ seconds to bring the motor to rest.

At this time, speed selector relay, SS, actuated by TR again closes to select and complete the circuit for a maximum variable transformer output of 270 volts. Drop in tubes and saturable reactor result in approximately 230 volts at full load or less. In the reversing of the motor, the armature current limit setting brings the motor to its maximum speed of 1750 rpm in the shortest possible time at 152 per cent normal full load armature current. Inner quill reverses rapidly moving cutter out of work and contacting back stop of outer quill to reverse and back up lead screw to starting position, at which time the reverse limit switch, LsR, opens spindle cutter contactor, SC, and also drops out the reversing relays, R, RR, and RA, through the spindle contactor, SC, interlock. Contactor, K, drops out and dynamically brakes motor which completes the cycle. The entire reversing operation requires ten to twelve seconds.

Tubes are protected by protective timing relay, PTR, which allows five minutes warm-up time for tube filaments before.

## NAVY'S HISTORIC RADAR INSTALLATIONS

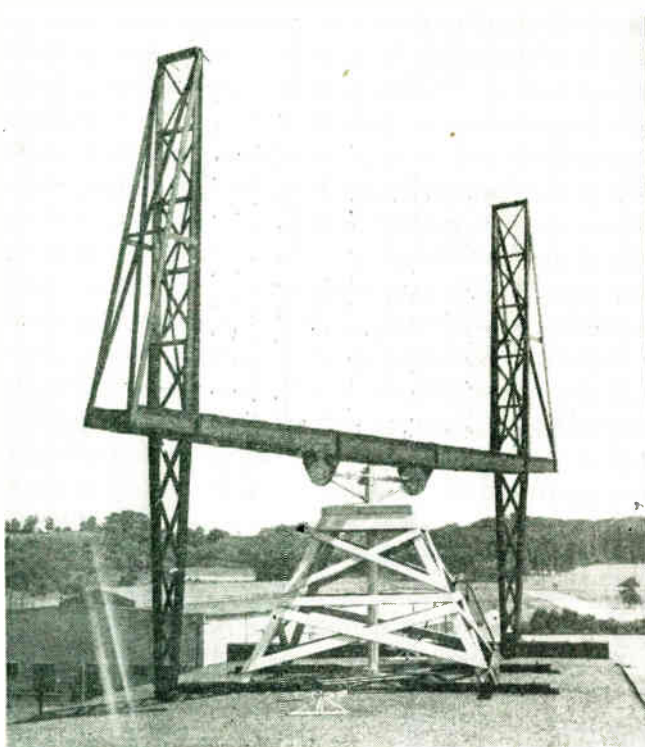

Close-up of the antenna of the first complete radar, installed "topside" a building at Naval Research Lab. in Anacostia during the late 1930's

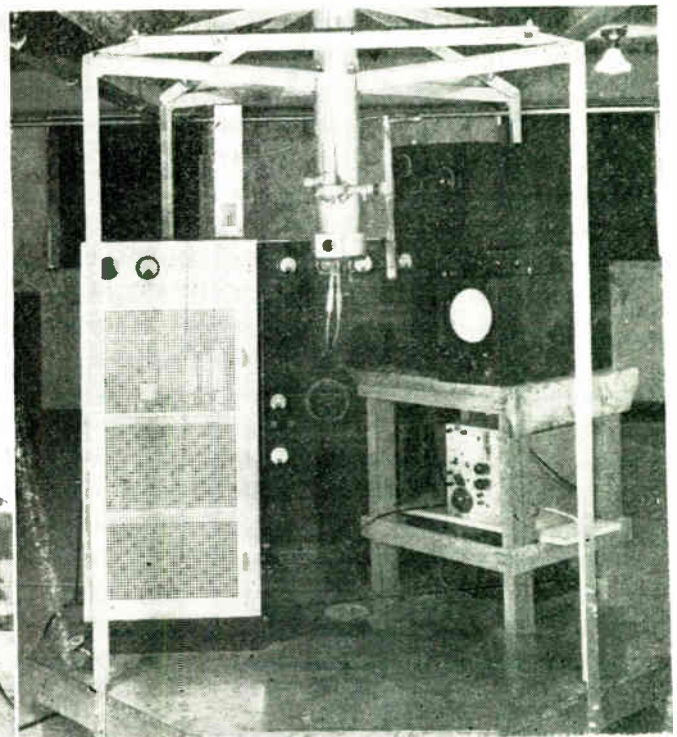

Below decks view of the radar set which was mounted on a rotating platform so that mattress antenna could be oriented (with help of two men)

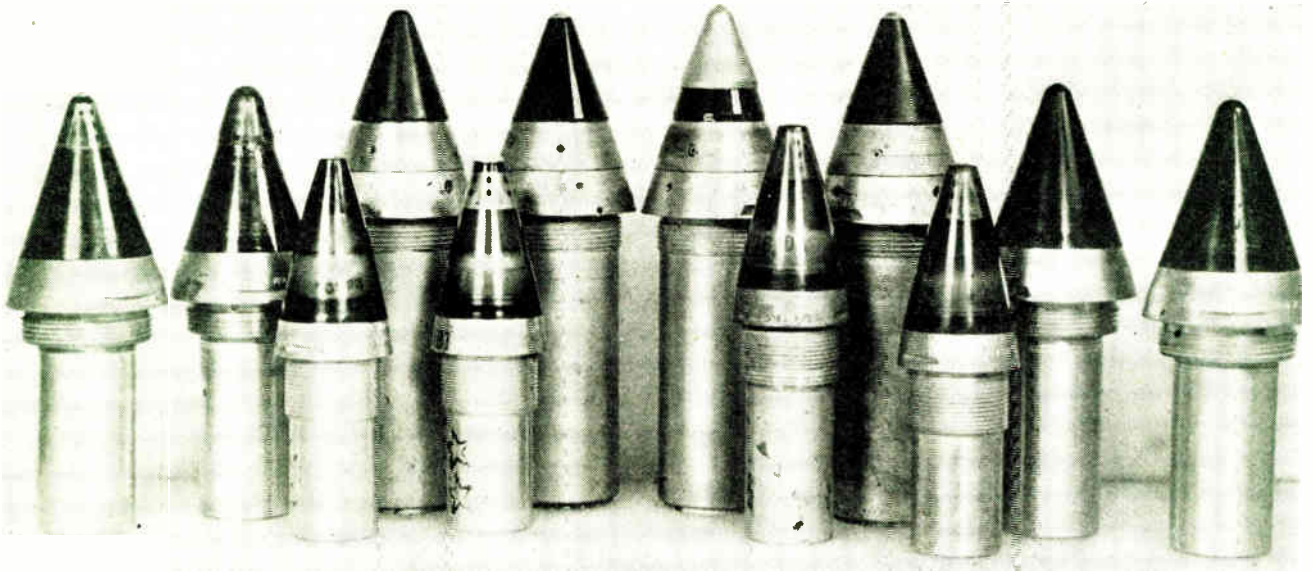

This official US Navy photograph shows some of the many types of VT fuses that were developed for use in 5-in. 38 cal. and 3-in. 50 cal. Navy guns

# NAVY PROXIMITY FUSE

*Design and construction of VT anti-aircraft and other Naval shells automatically exploded by self-contained radio unit*

● That dream of artillery men and AA crews, a fuse for a high explosive shell which would sense when the shell was near enough to its target to cause damage and then explode it, was actually developed and used in great quantities by the United States during the war.

Previous shell fuses were of two types, contact fuses which would cause explosion when the shell actually hit the target and time fuses which were set to explode after a certain period of time when it was hoped the shell would be near the target. Since actual hits in anti-aircraft fire are seldom obtained, time fuses used to be the principal reliance in such shooting. The difficulties of presetting a time fuse to fire the instant a shell is passing near a plane are so great as to vitiate to a large extent the directional accuracy obtained by radar control and automatic firing angle computers.

Variouly called "Pozit," "Vt" for variable time and "Proximity" fuse, the new device has eliminated most time of shell flight calculations. When these new shells with proximity fuses were issued to the anti-aircraft guns along the English coast the sensational increase in kills can best be related in terms of the following statistics. When shooting at the V-1 bomb, during the first week 24 per cent of all

targets engaged were destroyed. This percentage rose to 46 in the second week, 67 in the third and 79 in the fourth week. On the last day in which these bombs were launched against England, 104 were detected by early warning radar but only four reached London.

One of the greatest motivating factors in the development of this fuse was the necessity for protecting the fleet against an aerial attack. In achieving this goal the fuse proved to be a tremendous success. In addition when used with ground artillery, effectiveness of fire was increased enormously because the shell always exploded well overhead where it produced the maximum damage.

When radar was first being developed one of the methods considered other than the finally adopted pulse technic was the emission of continuous signals at high frequencies. Reflected energy from a target, being out of phase with the issuing energy would cause a ripple modulation. While development of such a scheme was finally abandoned as far as radar went, it is this principle that proved successful in the development of the proximity fuse. When the fuse shell approaches near enough to its target the intensity of echo energy increases to the point where the rip-

Cross sectional view of the VT fuse mechanism as installed. Various parts identified opposite

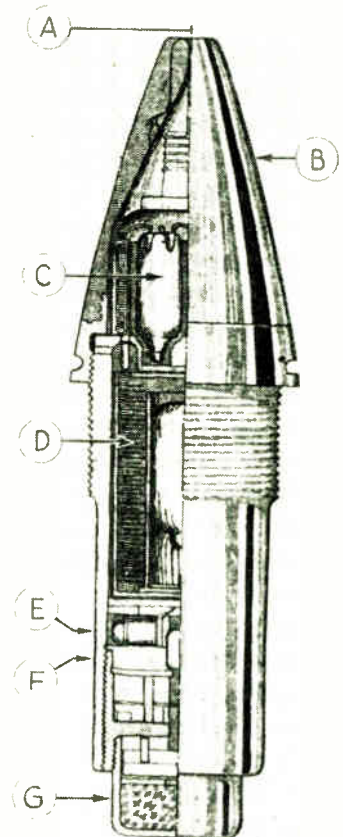

ple or interference waves can be amplified by an audio frequency amplifier in the fuse and fed to a thyratron tube which serves as a switch to initiate the detonation of the projectile.

The fuse operates as a miniature radio sending and receiving station in the nose of the shell. The basic components of the radio proximity fuse are (1) miniature rugged vacuum tubes, strong enough to stand the tremendous pressure of being shot from a gun, as essential elements of simple electrical circuits; (2) a miniature rugged battery to provide electrical power, and (3) safety devices to prevent operation of the fuse until it has traveled a safe distance from the gun.

The detonation of the projectile is accomplished by an electrical detonator much like a dynamite cap. When the thyratron is triggered by the impulse generated by approach to a target, it causes enough electric current to pass through the electrical detonator to make it explode. These explosions set off an auxiliary explosive charge, or booster, carried in the fuse, which

Cross section showing how fuse is fitted into complete shell. Parts shown opposite are: A, antenna cap; B, plastic nose; C, transmitter and receiver; D, power supply reserve battery; E, safety devices; F, self-destruction switch; G, auxiliary detonator

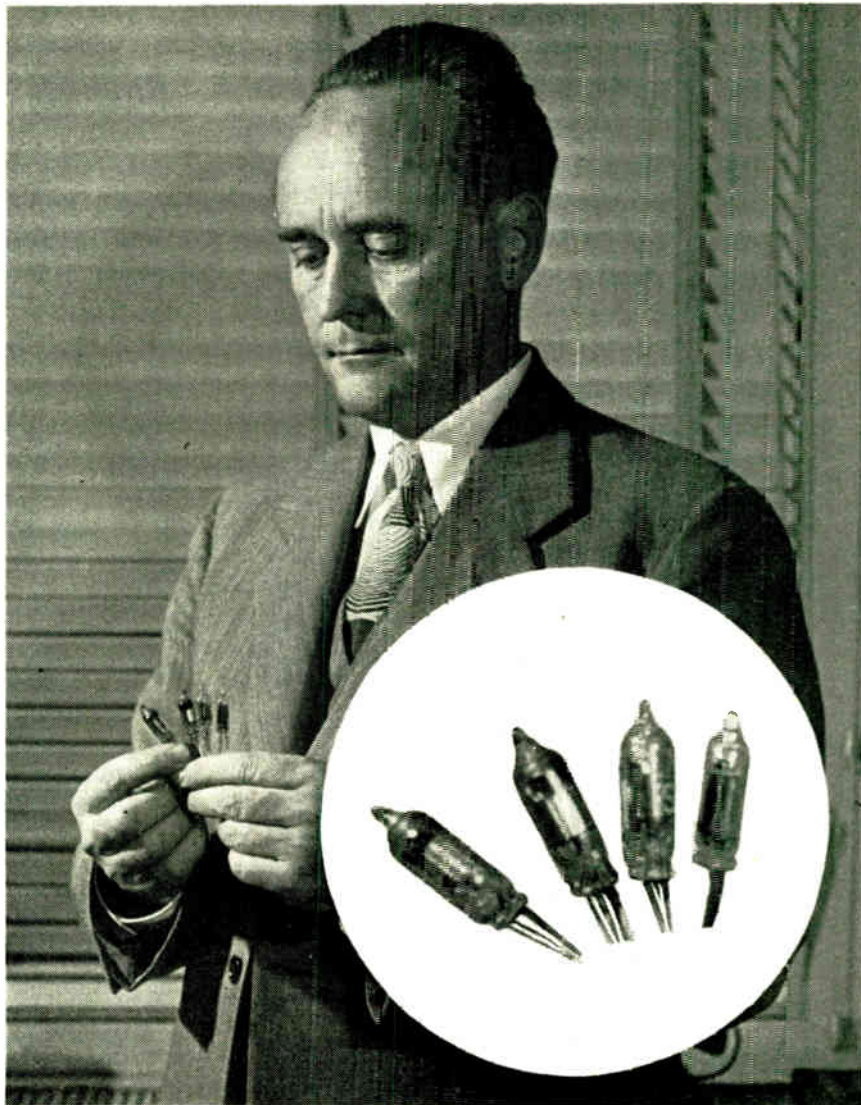

Inset shows a group of the tiny specially developed vacuum tubes upon which operation of the fuse depended. Relative size is indicated by those in the hands of Roger M. Wise, director of engineering of Sylvania Electric Products, Inc., whose company did much of the development work on the tubes and was their largest producer, peak production being about 400,000 tubes daily

in turn detonates the explosive filling in the projectile.

In addition to the primary elements of the fuse there are also included safety devices which prevent operation of the fuse until it has traveled a safe distance beyond the muzzle of the gun. Some models of the fuse also contain a centrifugally operated switch known as "a self destruction" switch which acts to detonate the shell beyond the target if it has passed.

Of course it was recognized at the beginning of the development that the most difficult problem would be the design of tubes which could be shot from guns and still be operative. Rugged tubes which would be used for fuse work might be employed in guns in which the acceleration along the projectile axis might be as high as 15,000 G. ( $G = 32.2 \text{ ft./second}^2$ , the acceleration of gravity). It was decided that

in order to have an adequate safety factor it would be necessary to design rugged vacuum tubes which would be capable of withstanding at least 20,000 G axially.

It was finally found that careful attention to glass quality, the elimination of strains and proper control in the manufacturing processes permitted glass tubes to be designed which could successfully withstand shooting from guns. Careful coordination was required between the tube designers and the engineers responsible for packaging the tubes in the fuse so that proper support could be given to the tube envelope to eliminate undue breakage. This was accomplished by mounting the tubes in rubber cups which were then imbedded in a wax compound to give complete mechanical support.

It was necessary to make a com-  
(Continued on page 132)

# VACUUM TUBES IN INDUSTRY

# INDUSTRIAL TESTING

**Special equipment developed for military inspection purposes, permits insulation resistance determination at potentials up to 200,000 dc**

● Increased power requirements, increased production, higher altitudes, new designs and the general rush brought on by the requirements of war craft, made it quite apparent that better methods of testing ignition system insulation were required. It has long been believed that insulation resistance tests taken at the operating voltage of the system would give an excellent indication of the condition of the insulation. Extensive tests employing the Takk tester both in the aircraft engine factory and in the field during the war have confirmed this opinion. Ignition system performance and insulation life may be more accurately predicted than was possible before the development of portable high voltage precision test instruments.

### No ac errors

The Takk tester serves fundamentally as a high voltage direct current megohm meter. The advantage of the use of this high voltage dc tester is that it permits detection of leakage paths which do not occur at lower voltages. Another advantage of high voltage direct current for testing ignition components lies in the elimination of capacity effects. Since the resistances measured are quite high in good insulation—in the order of



Fig. 1—Self contained, portable model with a dc output up to 15,000 v; insulation readings can be made direct from one dial and chart

megohms—when high voltage ac is used, even a small capacity offers an impedance low enough to cause erroneous current measurements. This is true at ignition pulse frequencies as well as at 60 cycles.

The insulation tester (model 55) shown in Fig 1, made by The Takk Corp., Newark, Ohio, is a portable instrument operating from any 110 volt 60 cycle source and delivers up to 15,000 volts dc. It is designed primarily for testing the insulation of the component parts in the ignition systems of aircraft engines. It may also be used for the testing of other insulation where it is desirable to make leakage tests between 2,000 and 15,000 volts.

The range of the instrument is 10 to 10,000 megohms measured at any voltage between 2,000 and 15,000 volts. The outside dimensions of the instrument are 10 x 11½ x 18½ in. and it weighs 31 lb.

The circuit diagram is shown in Fig.2. The input to the high voltage transformer is controlled by a

variable autotransformer. The secondary voltage is fed into a voltage-doubling circuit, which is filtered by a 15,000-volt 0.02-microfarad output capacitor. An adjustable spark gap limits the output voltage and serves as a warning signal when the primary voltage is adjusted too high. A 10,000-ohm

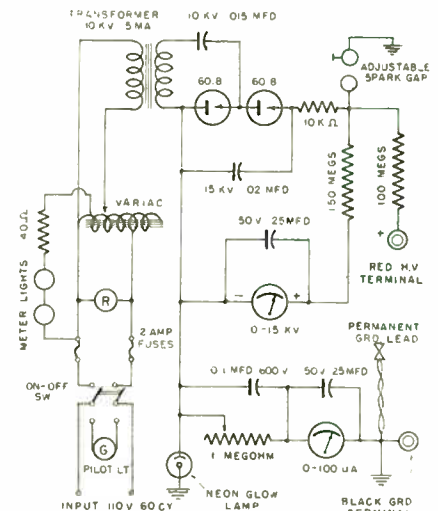

Fig. 2—Circuit diagram of portable unit; two 60.8 tubes are used as voltage doublers

resistor in series with the spark gap reduces the intensity of noise during spark-over. The kilovoltmeter is connected across the high-voltage output of the rectifier.

### Controlled output

Two high-voltage output terminals are provided, one connected directly to the power supply and the other through a 100-megohm series resistor. The output voltage of the directly connected terminal is indicated by the kilo-voltmeter. The output voltage of the terminal incorporating the series resistance plotted against leakage current is shown in Fig. 3. The advantage of this terminal is that it allows non-destructive tests of insulation to be made. The output voltage across the test specimen is inversely proportional to the leakage current. If the insulation under test is in per-

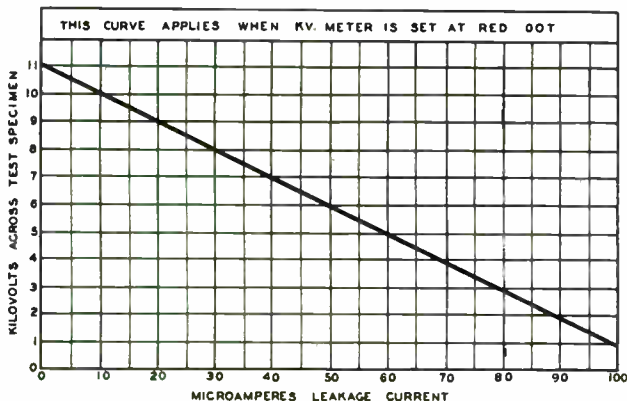

Fig. 3—Graph showing the constant drop in output voltage as leakage current increases, when using the "Red" H V terminal. This prevents destructive break-down of the insulation under test

# WITH HIGH VOLTAGE

fect condition and therefore has negligible leakage current, the voltage stress across the sample is as indicated on the kilovoltmeter.

## Neon indicator

In series with the grounded terminal is a current meter with 0-100 and 0-500 microampere scales. A neon glow lamp is built into the current meter circuit in such a manner that leakage currents in excess of either full scale value will cause it to glow. This also will occur when current pulses in excess of 100 microamperes or 500 microamperes are of such short duration that the current meter pointer is not deflected because of its mechanical inertia. In addition the neon glow lamp protects the sensitive current instrument against short-circuit currents encountered with faulty insulation.

A new form of cold cathode rectifier tube having unusual characteristics is used in this test instrument. As shown in Fig. 4 and Fig. 5, these tubes are of a design particularly suited for voltage multiplying circuits since they are mounted like a fuse and can be reversed, end to end in the equipment, when it is desired to reverse polarity.

## New diodes

These are gas filled diodes with an anode consisting of a graphite coating fused directly on the interior surface of the bulb. The cathode is composed of a group of fine wire points. The rectifying characteristics are obtained by controlling the pressure of the gas and its composition and the number and position and spacings of these cathode points. Certain of these tubes for example will provide out-



Figs. 4 & 5—Newly developed H V rectifiers; fuse type anode and cathode terminals permit reversing output polarity when required

puts up to 10 milliamperes at 20,000 volts in half-wave rectifying circuits. This tube is particularly suited for this service because no damage results if voltages in excess of the rated inverse peak voltage are applied. The discharge that takes place in the tube under these conditions does not harm the tube. Similarly, no permanent harm is done if the dc output of the tube is accidentally short-circuited.

The Type 60.8 Takk-tron shown in Fig. 4 has an overall length of 6¼ in. and a maximum diameter of 3¼ in. The normal operating characteristics of this tube are shown in Fig. 6. When used in the normal circuit, such as that developed for aircraft ignition cable testing work, these tubes will deliver 2 ma with a useful output voltage of 5 kv.

The maximum inverse peak voltage is 21.0 kv while the maximum dc voltage output is 3.5 kv.

## Heavy duty

When much higher voltages are required than those delivered by the aircraft tester, another line of high pressure Takk-trons has been developed. Fig. 5 shows a Type 38.6 tube with a maximum inverse peak voltage rating of 60.0 kv and a maximum dc voltage output of 25 kv. The overall length is 11¼ in. and the maximum diameter of the envelope is 3 in. These tubes contain gas under much higher pressure than those of the Type 60.8.

The development of these new rectifier tubes and the consequent availability of high voltage direct current for testing, research, and product control, has led to the design of various types of high voltage power units. Several typical models are shown in Figs. 7, 8, 9 and 10.

Fig. 7 illustrates Model 56 dc power supply for bench work and test table systems. It has been used

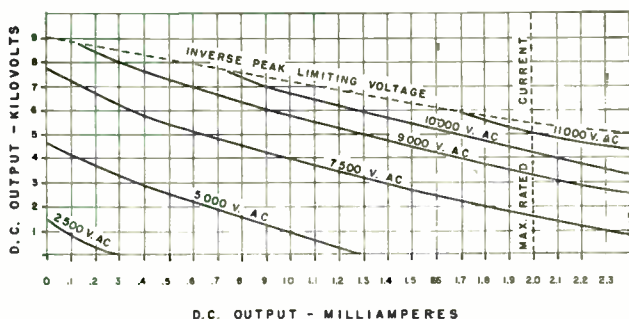
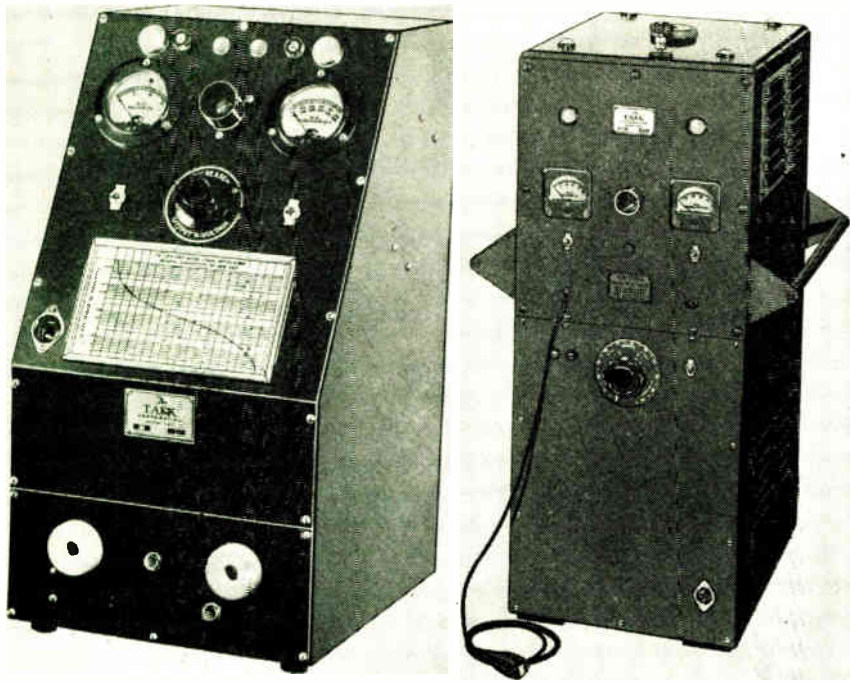

Fig. 6—Voltage-current curves for the 60.8; both types have the same general characteristics and are not harmed by excessive inverse peak voltages



Figs. 7 & 8—Console and cabinet models for fixed station installations, increased output allow testing of high altitude aircraft ignition systems

to supply up to six test stations for rapid production testing of aircraft spark plug leads, etc. It has the same circuit as the Model 55 tester shown in Fig. 2, except that two Type 60.8 tubes are used in parallel at each tube position. This permits a maximum dc output of 18 kv, and 13 kv at 2 ma or 10 kv at 4 ma. This unit is manufactured in a metal case of laboratory bench style.

Fig. 8 shows the Model 58 dc power supply. It produces a peak output voltage of 25 kv at 100 ma and an output of 20 kv at 2 ma. By modifications of the tube used the output current can be increased up to 10 ma. This unit weighs 171 lb. and is 15 x 21 x 37½ in. overall. It has been extensively used in production testing of high altitudes aircraft ignition harnesses.

Figs. 9 and 10 show views of the

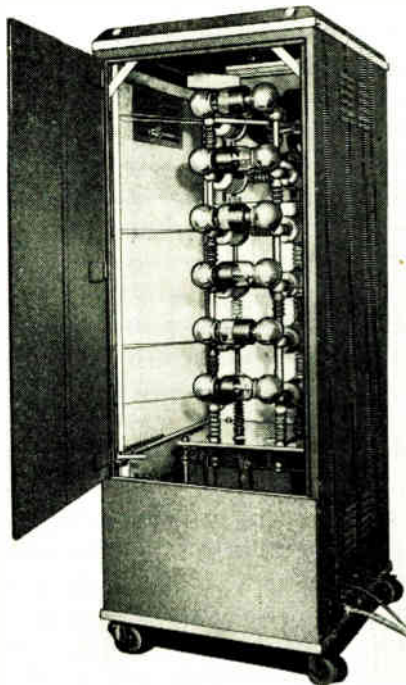

Fig. 9—Power supply unit of Model 48; six tubes provide output ranges sufficient for many varied industrial and laboratory research applications

Model 48 high voltage dc source and its control box. The latter is connected to the power unit by a long rubber covered control cable and permits complete remote control of the output voltage. This unit has a maximum output voltage of 125 kv and an output of 100 kv at 2 ma. It has found many

diversified applications such as electrostatic paint spraying, insulation testing, high voltage research, corona studies, etc. Its usefulness has been largely due to its compactness, light weight and consequent portability. It weighs only 375 lb. and measures 30 x 30 x 72 in. It is mounted on rubber-tired casters and is easily movable in the laboratory or shop. This unit is free of internal corona and no oil insulation is employed in the high voltage portions of the circuit.

### Special features

The power units described have been developed for specific end uses because of critical war needs for such equipment. However, other types and ranges can be built to meet the user's individual needs. Output voltages up to 200 kv can be supplied in units similar to that shown in Fig. 9.

It is believed that as more experience is gained by industry and research laboratories with high voltage dc testing, there will be an increasing need for this type of equipment. Original tests on new equipment, and periodic re-testing at intervals will enable possible breakdowns to be predicted with increasing accuracy. This will enable maintenance men to keep equipment in repair and prevent unexpected shutdowns.

### Electrostatic Precipitation Of Phosphor

Based on his experience in removing airborne pollen from his home by installing a Precipitron to give himself hay fever relief, Mr. Daniel S. Gustin, Manager of Lamp Engineering for the Westinghouse Lamp Division developed a new means of applying phosphorescent coatings on the inner glass walls of fluorescent lamp tubing.

By grinding phosphors into microscopic particles finer than talcum powder and inserting this phosphorized mixture in a reservoir, Mr. Gustin generated a phosphor smoke by injecting a stream of air. This smoke was introduced into the glass tube to be coated while a rounded pencil-thick steel rod with a sharpened tip was drawn through the tube. This rod served as an electrode, introducing into the tube the high voltage necessary to precipitate the phosphor. In order to make the glass walls conductive, the tube was heated to 660° F. The phosphor particles adhered to the glass, insulating it and leaving only clear glass areas to attract more powder. This procedure has resulted in an even distribution of phosphors, giving top light emission efficiency.



Fig. 10—Control console for Model 48 allowing complete remote control of high voltage output

# GROUND WAVE RANGE CALCULATOR FOR FM

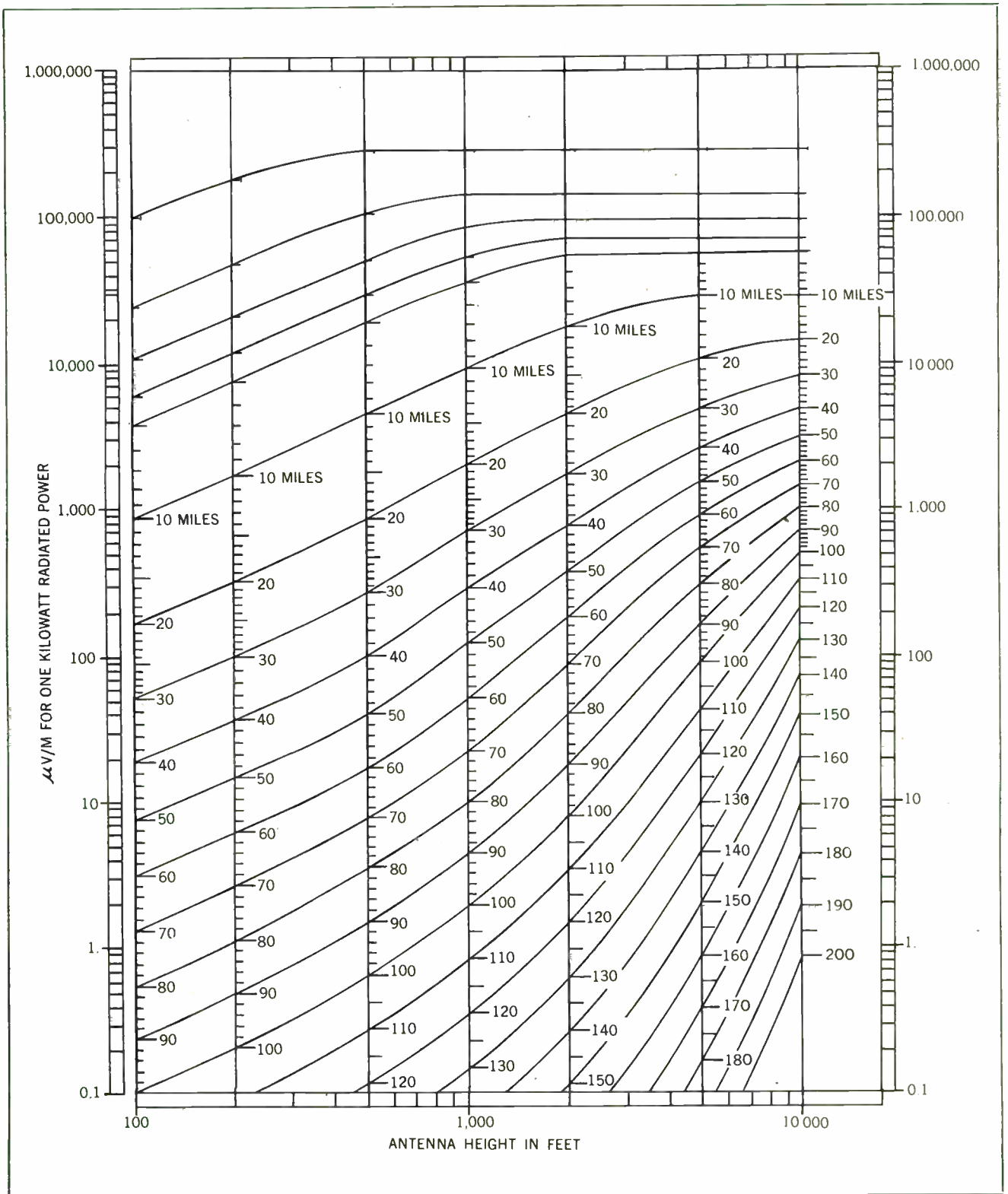

The above chart prepared by the FCC, gives field strength values vs. transmitter antenna height for 1 kw radiated power. Curved lines are

constant distance lines for values of 1 mile to 200 miles from transmitter antenna to receiving antenna. Chart is based on 98 mc frequency,

30 ft. height at receiving antenna,  $\delta = 5 \times 10^{-14}$  e.m.u.,  $\epsilon = 15$ , horizontal polarization. Curves approximately correct for vertical plane.

# TUBES ON THE JOB

## Electronic Blanching of Vegetables

James C. Moyer and Elmer Stotz of the N. Y. State Agricultural Experiment Station, Cornell University, Geneva, N. Y., report the following investigations in the July 20, 1945, issue of Science.

"For their successful preservation by freezing or dehydration, vegetables are briefly exposed to flowing steam or boiling water. This treatment results in the inactivation of enzymes. The use of these heating agencies, however, often damages the texture of the vegetable, leaches out vitamin C and members of the vitamin B complex from these foodstuffs.

"If electronic heat could be used in lieu of steam or boiling water, the texture might be improved and losses in vitamin content due to leaching greatly reduced, if not eliminated. Further, it was thought possible to place the washed fresh vegetables in the final retail cartons, pass them through a high frequency field for enzyme inactivation and thence into the freezer. Such a procedure should eliminate much handling and possible attendant contamination of the vegetable before it reached the consumer in the frozen state.

"Experiments conducted on the heating of cabbage with an oscillator having an output of 750 watts at 150 megacycles have shown that there is little tendency to arc if the vegetable is tightly packed into the container. In testing the effectiveness of dielectric-heating, heads of cabbage were cut into slices an eighth of an inch thick and the shredded material packed into Peters-type cartons commonly used in the freezing of vegetables. An oven temperature of 100° C. was used to prevent the condensation of moisture on the electrodes and counteract heat losses from the carton by radiation. A heating period of two to three minutes was sufficient to raise the temperature of 180 grams of cabbage to 99° C.

"As an indication of the small nutrient losses that may be expected in blanching with r.f. power, the ascorbic acid contents of raw and of water, steam and electronically blanched cabbage samples were determined. The 3 per cent loss of ascorbic acid during electronic blanching in contrast to the 30 to 40 per cent losses occurring in the steam and water processes points the way to production of processed vegetables of higher nutritive value. Other vegetables have been successfully blanched by electronics and

more extensive studies of the value of dielectric heating for the inactivation of enzymes in fruit and vegetables are in progress and will include storage trials."

## Radiotelephone Trucking Control

A forerunner of general two-way radiotelephone, traffic control, dispatching and routing of some five million highway motor freighters has been successfully demonstrated by the Galvin Mfg. Corp. and Standard Freight Lines, Inc., Chicago, in tests conducted with standard FM, 30-40 mc equipment. The tests have shown that two-way truck to fixed station radiotelephone communications can be maintained over a distance of approximately 50 miles, while signals from the fixed station to the truck can be heard up to 80 miles.

At the present time, the FCC has not finally assigned any specific frequencies for highway truck radio, but the proposed allocations include four mobile highway truck channels in the 30-40 mc region, and four channels for fixed station operation in the 42-44 mc region. Urban trucking will probably be in 152-162 mc section of the bands.

The Motorola-Galvin FM, two-way radiotelephone is simple to install. The controls are on a control panel located on the dashboard, and consist solely of a squelch and volume control. The microphone is plugged into the control panel and red and green pilot lights indicate

whether the unit is in transmitting or receiving position.

The entire mobile unit is housed in two cabinets which can be bolted to the floor. The truck's storage battery furnishes the power to run both transmitter and receiver; while operation of the unit is comparatively easy and can be mastered by inexperienced personnel. The antenna is base-hinged to permit its passing under bridges.

## Glass Suntan

A considerable increase in the efficiency and life of germicidal lamps has been made by eliminating the "suntan" which in the past developed in the lamp's glass tubular container. This solarization is similar to the suntanning of the skin. It is caused by ultraviolet radiations of the bactericidal lamp changing the form of metallic oxides in the inner layers of the glass tube. Long research by Westinghouse, with the cooperation of the Corning Glass Works, has developed an alkali-free glass that shows no tendency to "suntan" and transmits the bacteria killing ultraviolet radiations almost perfectly. This new glass has a poor transmission factor for radiations below 2,000 Angstrom units, eliminating the production of an excessive concentration of ozone. Tests showed that in the glass tubes formerly used for these lamps, solarization built up a thin, opaque screen during the first 100 hours of tube life that cut down effective radiation as much as 10 to 20%.

Equipment for FM communications system as mounted on one of the trucks of the Standard Freight Lines in Chicago which will direct and control its vehicles by radio

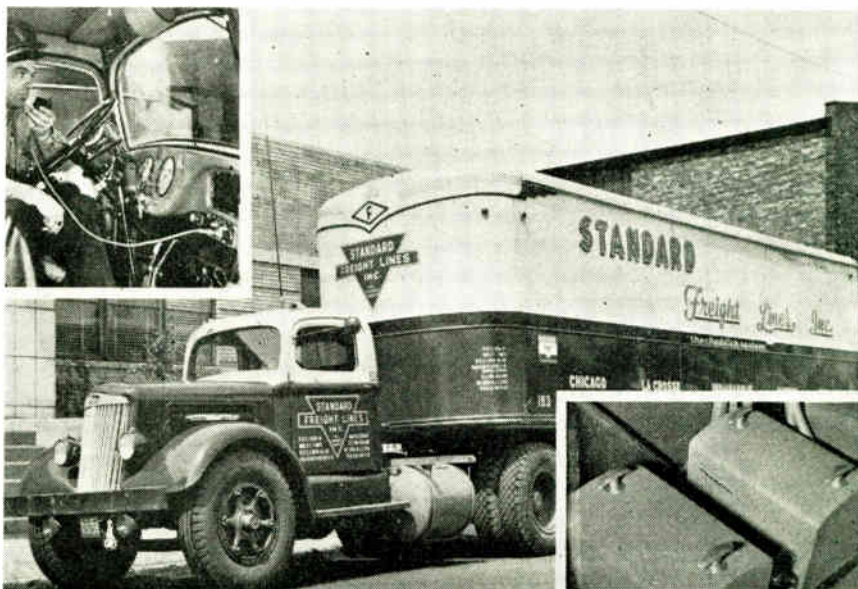



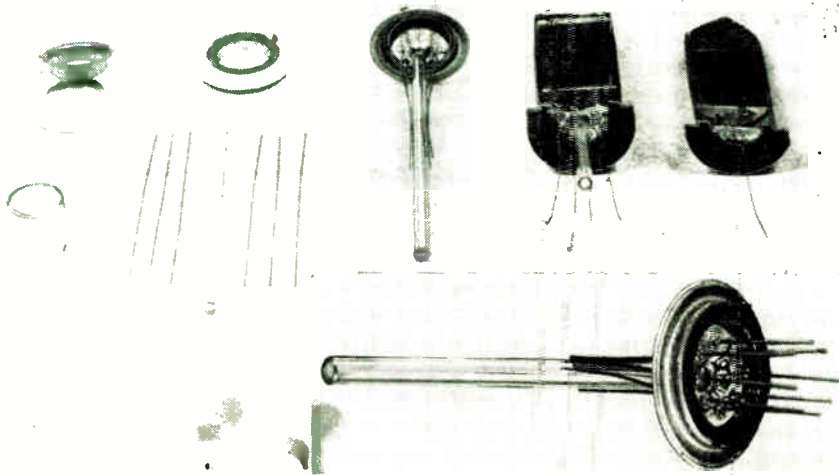

This exploded view of an RCA metal tube illustrates the use of a new technic developed by RCA engineers to form an air-tight seal between steel and glass for the stem of the tube. The small glass collar (lower left) is dropped over the end of the wire leads and heat is applied to melt the glass down to a flat button around the wires, with an opening in the center. The glass straw shown with the wires is then fused to the opening and the "header insert" (dark inner band in the assembly shown above the wires) is raised into position surrounding the button. Gas flames applied to the steel insert cause oxides on its inner surface to be dissolved into the glass. The finished tube stem is shown at center and below with a sectionalized tube at right. Before the new procedure was developed, it was necessary to make the insert from special alloys which are more costly and sometimes scarce.

### Stroboscopic Light in Bombsight Test

Stroboscopic light played an important part in the balancing of rotating parts in the Norden bombsight where tolerances were kept within 20 millionths of an inch. Timed light flashes permitted precise determination of rotating speeds and visual study of unbalance during laboratory tests. In

the photo light flashes were produced by a strobotron tube manufactured by Sylvania Electric. Norden bombsights have two basic parts: a stabilizer that pilots the plane automatically during the bombing run; and a sight which includes a telescope, gyro and computer or "brain." Also shown in the photograph is a technician in the laboratory of the Victor Adding Machine Co. using a General Radio

Testing parts of a Norden bombsight; the dynetric balancer is lighted by a Sylvania strobotron in square box at the left. Timing is done by the General Radio stroboscac

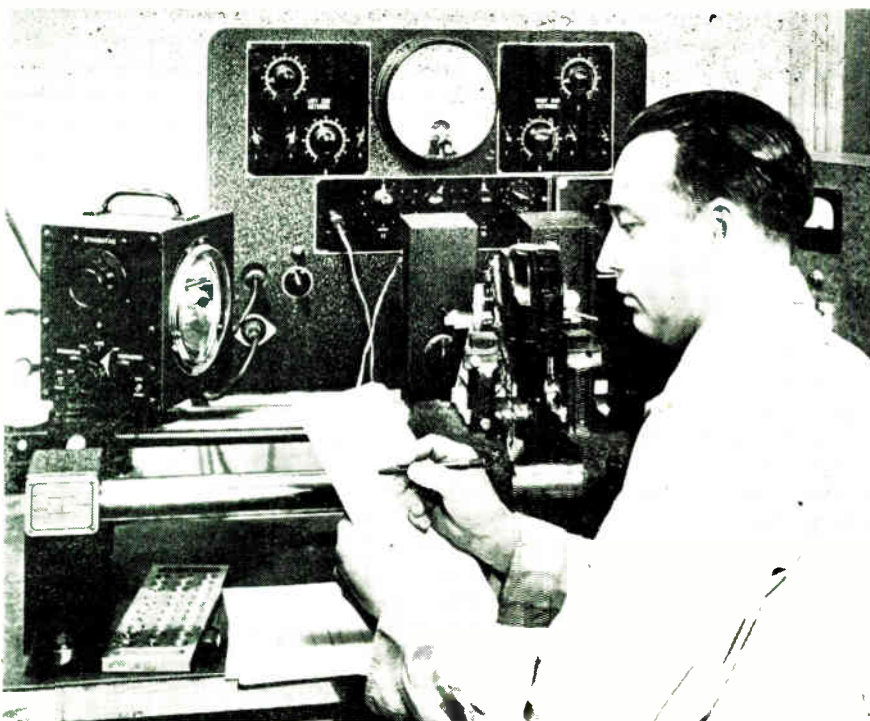

stroboscac and a Gisholt dynetric balancer.

### Dust Identification

Two electronic applications have been teamed up for a more intensive study of the dust, smoke and pollen infestation of the atmosphere. Until recently research has been restricted to working with particles above 5 microns in size, because of the limited magnifying power of the light microscope. But now Westinghouse is using the electron microscope with its magnification of up to 50,000 diameters to identify particles as small as 0.005 microns and to determine the form of 0.02 microns or larger.

The collection of specimens can be done electrostatically by making the particles negative and using a fine point as the positive electrode. After collection the specimens must be transferred to an extremely thin film of collodin or other plastic material because the electron microscope only penetrates to a depth of 0.01 to 0.05 micron.

### Radiation Detector

The collection of specimens can in exploring for possible dangerous after-effects in the recent atomic bomb tests in New Mexico is the Geiger-Muller tube as most everyone knows. In its simplest form this tube consists of two electrodes in a sealed container—a central wire and an outside metallic cylinder. A gas such as argon and often an organic quenching agent is used as an atmosphere between these electrodes. Extremely minute traces of "X" and similar radiations set up a flow of current in the tube and this can be amplified for a visual indication. This photograph is a type of tube manufactured by North American Phillips Co. at Mount Vernon, N. Y., and used in the Geiger-Muller X-ray spectrometer.

Industrial type of Geiger-Muller tube used for checking atomic bomb radiations in New Mexico



# SURVEY of WIDE READING

Electronic news in the world's press. Review of engineering, scientific and industrial journals, here and abroad

## Measuring Emission Characteristics with Pulse Technic

R. L. Sproul (Physical Review, March, 1945)

An apparatus was developed to investigate short-time thermionic emission from oxide-coated cathodes as a function of time, for times ranging from 0.2 to 300  $\mu$ sec. The decay with time of the temperature-saturated electron emission from oxide-coated cathodes was studied. It was observed that simultaneously with the application of anode voltage to an experimental diode the thermionic current density rose to an initial value and subsequently decayed to a steady value 1/5 to 1/15 of the initial value.

### Pulse generating circuit

Tubes  $T_1$ ,  $T_2$ ,  $T_3$  and their associated circuits constitute a square wave generator which delivers positive pulses to  $T_4$ . The width of these pulses can be selected by switch  $S_1$  (about 100,300,600 or 2000  $\mu$ sec.) and the pulse repetition frequency can be selected by switch  $S_2$  (about 20, 30,60,120,600, or 1500 pulses per second). Capacitor  $C_1$  synchronizes the pulses with the 60-cycle power line in order to minimize the effects of ripple and pick-up in the subsequent circuits.

The control grid of  $T_1$ , which is

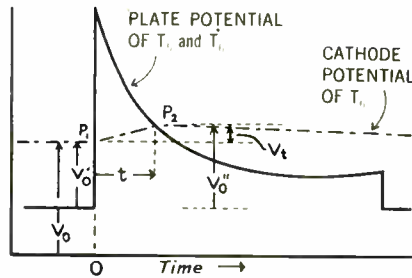

Fig. 2. Diagram explaining operation of tubes  $T_5$  and  $T_6$  and associated circuit elements

about 70 volts negative with respect to  $T_4$  cathode during most of a cycle, is driven positive for the duration of the pulse, applying the voltage  $E_b$  (-100 to -1000 volts) less the small drop across  $T_4$  suddenly to the experimental tube, provided "A" is connected to "a". The entire capacitance charged through  $T_4$  is less than 30  $\mu$ mf, which permits applying a potential difference of 500 volts to the experimental tube in about 0.05  $\mu$ sec.

Switch  $S_3$  selects an appropriate resistance so that the potential drop between ground and the point "B" will be about 15 or 20 volts at the maximum of the current pulse. With "B" connected to "b" and  $S_4$  in the upper position, a negative pulse is applied to the grid of  $T_5$ . This pulse is mirrored in the plate circuit of  $T_5$  and subsequently measured. For cal-

ibration "A" is connected to "a", "B" to "b", and  $S_4$  is in the lower position. The resistance-capacitance combination of  $R_{20}$  and one of the capacitors  $C_{12}$  to  $C_{19}$  serves then to apply a known negative exponential pulse to the  $T_5$  control grid.

### Pulse measuring circuit

Fig. 2 shows the principle of operation of tube  $T_6$ . This tube either carries no current, or a definite amount of current. The plate potential of  $T_5$  rises abruptly from its quiescent value when the pulse arrives, then decreases with the pulse. When it exceeds the value  $V_0$ , tube  $T_6$  begins to conduct, charging capacitor  $C_{22}$ . The cathode potential of  $T_6$  rises slowly and linearly with time until its plate potential falls to  $P_2$ , at which point  $T_6$  ceases to conduct. The cathode potential then slowly decreases (Time constant of  $R_{23}$  and  $C_{22}$  is 0.0025 sec.) to  $V_0$  again in preparation for the arrival of another pulse.

The amplitude  $V_t$  of the cathode potential's excursion from  $V_0$  is a measure of the time  $t$  elapsed between  $P_1$  and  $P_2$ . By setting  $V_0$  at successively different values and determining the time  $t$  corresponding to each, a plot of  $V_0'$  vs.  $t$  is found; it reconstructs the shape and size of the experimental tube current pulse. The value of  $V_0'$  was

Fig. 1. Circuit for the investigation of the thermionic emission of oxide-coated cathodes. Short square wave pulses are generated and applied to the experimental tube; the shape of the resulting current pulse is determined in the subsequent circuit

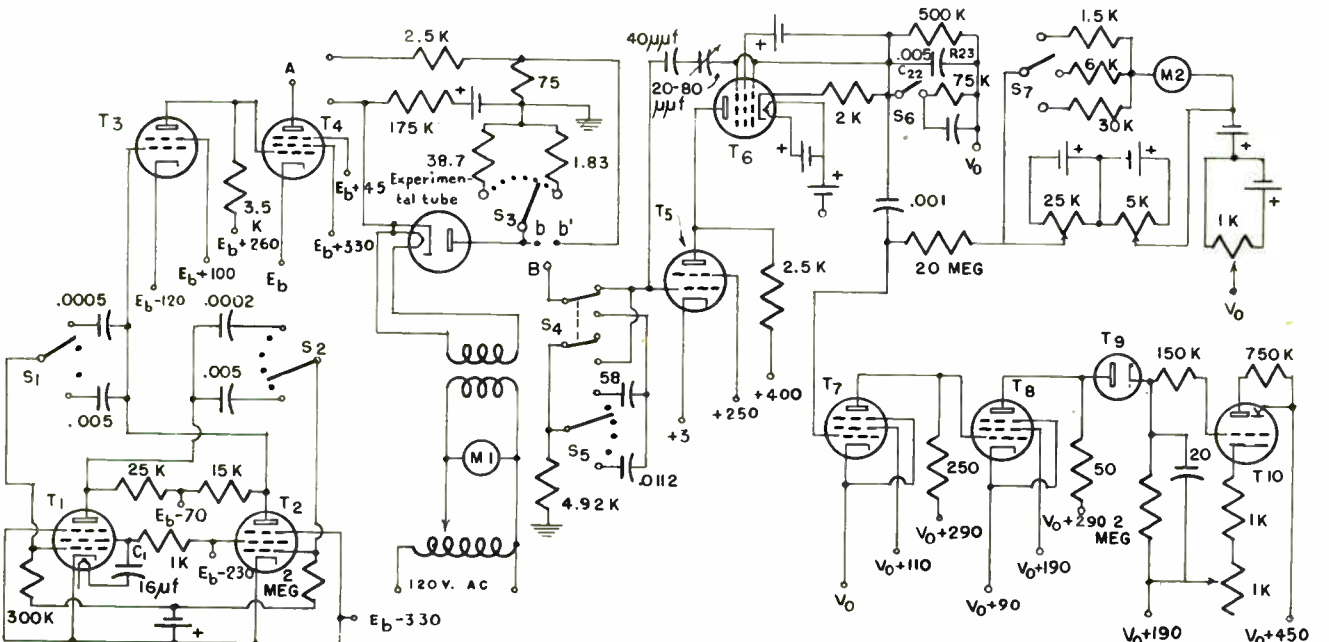

secured by separate measurements; the voltage gain of the stage including tube T<sub>5</sub> was also established. Closing switch S<sub>6</sub> introduces a larger capacitor to be charged while the time constant remains unchanged and hence decreases the time sensitivity of the instrument.

The circuit beyond T<sub>6</sub> is a very sensitive vacuum tube voltmeter of the peak, slideback type; its function is to measure V<sub>t</sub>. T<sub>7</sub> and T<sub>8</sub> are amplifiers, T<sub>9</sub> increases the time constant of the pulse being measured from 0.0025 sec. to 0.1 sec. T<sub>10</sub>, an eye type indicator tube, gives a visual indication when the balance point of the voltmeter has been reached. The maximum sensitivity of meter M<sub>2</sub> is 0.3 volt full scale, which allows measurement to 0.001 volt. Pulse amplitudes of less than 0.2 volt can be measured to within 0.002 volt with this circuit.

Calibrations were within 2% of t = 60 V<sub>t</sub> μsec. for the low sensitivity (switch S<sub>6</sub> closed), and within 4% of t = 9.5 V<sub>t</sub> μsec. for the high sensitivity (switch S<sub>6</sub> open).

### Thermionic emission

A quantitative theory is proposed explaining the decay of thermionic emission during a short time interval (about a millisecond) after drawing of current is initiated. The theory is based on the assumption that the enhanced emission of oxide-coated cathodes is caused by a layer of barium, strontium or calcium atoms on the emitting surface. Current as function of time, dependence of decay on cathode thickness, plate voltage effect and recovery time, work functions, and rate of decay were investigated and discussed in connection with the theory.

### Controlled Mercury Arc Lamp

L. F. Bird (Journal of the Society of Motion Picture Engineers, July, 1945)

The light intensity of high-pressure mercury arc lamp varies considerably with ambient temperature, drafts of air against the arc tube, deterioration of the tube, variations in power supply, varying mercury pressure, etc.

A description is presented of a new high-pressure arc lamp with associated control circuits in which optical inverse feedback is employed to produce a lamp capable of high stability and uniformity of output. Modulation of the light intensity is possible. Suggested applications are variable-density recording and use in printers.

### Tube and circuit

A dc high-pressure mercury vapor arc lamp having solid activated electrodes is employed. Additional heater coils operating at 50 volts

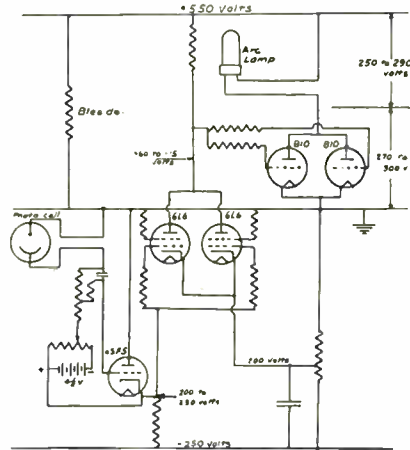

Inverse optical feedback to stabilize light output of dc high-pressure mercury arc lamp

and consuming about one ampere are provided to maintain the enclosed mercury vaporized.

The stabilizing circuit (see figure) incorporates a photocell exposed to the arc light and responsive to its variations. The photocell output is amplified and controls the arc lamp voltage. Two sources of voltage are used for stability reasons and both are obtained from rectifiers. The arc lamp is connected next to the positive voltage terminal of the supply with the control tubes connected to ground in such a manner that the cathodes of these tubes are at ground potential. This arrangement permits close regulation of the grid potentials at all times. The power tube grids are operated by a pair of 6L6 beam power tubes, whose grids are controlled by a single 6SF5 high mu triode.

### Performance

Tests revealed that the light output of the arc lamp varies inversely with the distance of the controlling photocell as the latter is moved away from the lamp over a range from 1 to 100 cms. Such performance proves regulating action of the photocell and associated circuit to stabilize the light intensity at widely varying levels. Other tests also established the stabilizing effect of the optical inverse feedback circuit.

Modulation of the light from the arc for sound track printing is ac-

Graph illustrating output of mercury lamp with and without inverse optical feedback

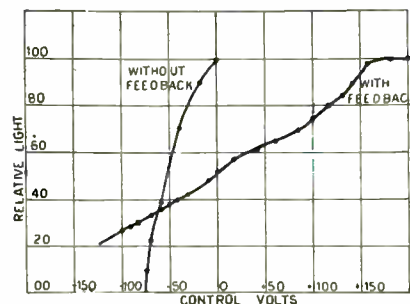

complished by introducing the modulating voltage into the circuit so that it will have the same effect upon the light as if it originated in the photocell. The photocell is then free to act as usual and can require the light output to follow quite closely the pattern of the modulating voltage. The curves in the diagram illustrate the modulating characteristics with and without the optical negative feedback.

### The Cyclotron at Bonn

W. Schmitz and W. Wiebe (Zeitschrift fuer technische Physik, Leipzig, Germany, Vol. 24, No. 9, 1943)

The cyclotron built at the X-ray institute at the University of Bonn, Germany, is described. First the principle of cyclotron operation is explained.

A high-frequency voltage is applied to the dees by the generator S. Positive ions emerging from the ion source in the center are accelerated towards one of the dees (the D-shaped electrodes), depending on their instantaneous potential. As soon as the ions have acquired a velocity, the homogeneous magnetic field will force them to move in a small half-circle inside the dee where they are not exposed to any electric field. Having completed the first half-circle of its path, the ion is again exposed to the high frequency electric field, which in the meantime has reversed its direction, accelerating the ion towards the

(Continued on page 156)

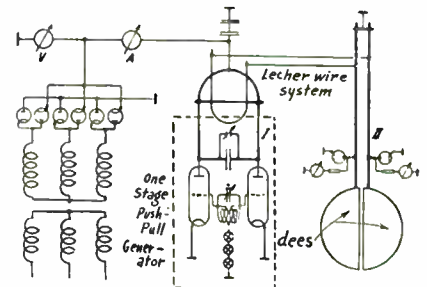

Above: Cyclotron circuit including power supply and dees. Below: detailed view of dees

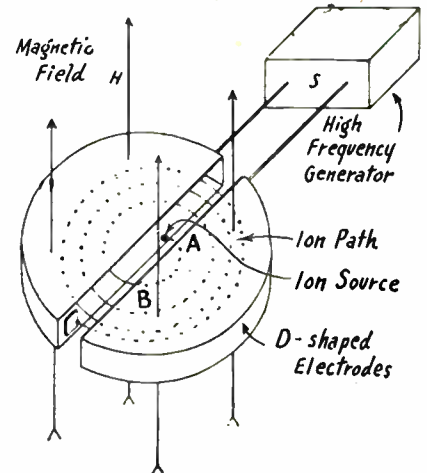

# NEWS OF THE INDUSTRY

## **Radiation Labs Quits**

The Radiation Laboratories established during the war by the government's Office of Scientific Research and Development at Massachusetts Institute of Technology in Cambridge is in process of dissolution. The large number of projects upon which between 2,500 and 3,000 engineers, physicists and technicians have been laboring are being wound up and as of January 1, 1946 the Laboratories will no longer exist as a government operation. For a few months after the first of the year a small group of engineers and physicists will remain to wind up projects upon which they are working. For the most part personnel of the Laboratories will return to industry and to the various colleges from which they were drafted to carry on government work.

## **Sentinel Erects Plant**

Construction of a new manufacturing plant has been started by the Sentinel Radio Corp. to be located at Evanston, Ill. The new plant has been designed to occupy an area covering nine acres with over 125,000 feet of floor space. The production area has been laid out for straight-line assembly, 300 ft. in length, and offering an expected output of more than 3,000 sets per shift. The new structure will also have facilities for a large research laboratory and several auditoriums for display purposes and sales meetings.

## **West Coast Lab**

The newest firm of radio engineering consultants to open offices in San Francisco, Calif., is Universal Laboratories. The Laboratories will be under the direction of Royal V. Howard, vice president in charge of engineering for both Radio Broadcasters Inc. and the Universal Broadcasting Co. Offices are located at No. 1 Nob Hill Circle.

## **Finch Telecommunications Adds Three Directors**

Several important changes have been made in the board of directors of Finch Telecommunications, Inc., Passaic, N. J. Capt. W. G. H. Finch, USNR, has returned to the board after an absence which began before Pearl Harbor, when he resigned his post as president to en-

ter active service with the Navy. He was the original founder of the company, and had been awarded approximately 100 patents relating to facsimile communication, which will be the basis of the company's postwar manufacture.

Vincent Stanley of Boston, Mass., was elected a director. He has been, for more than 40 years, president of the Gamewell Co., Newton Falls, Mass., manufacturer of signal equipment. He is Chairman of the Contract Adjustment Board, Chairman of the Army and Navy E Awards Board, Chairman of the Military and Civilian Suggestions Committee; and a member of the Army Contract Awards Board—all of the Boston Ordnance District of the Army Senior Forces.

A third director elected is Herbert L. Petty of New York, former Secretary of the Federal Communications Commission in Washington. He is executive director of Radio Station WHN of New York, and all stations affiliated with Loews Inc. and Metro-Goldwyn-Mayer and has other radio interests in Milwaukee, San Francisco and Mexico. Three members of the Board reelected are Frank Bottenus of New Rochelle, vice-president of One Eleven John Street Corp., New York; Raymond B. Littlefield, president, Littlefield and Co., Providence, R. I., and Major Frank R. Brick of Finch Telecommunications, Inc.

## **FCC Denies 14**

The Federal Communications Commission clearly underlined its rule, that experimental television and FM station permits would be granted for research only, when it denied applications for construction permits to build six television experimental stations, and eight FM developmental stations. The applications for experimental video stations were for positions in the spectrum that are now assigned for commercial television, and FM developmental station applications asked for positions in both the old 42-50 mc and new 88-108 mc bands.

The Commission explained that the permits were denied because the applicants failed to show a program of meritorious research, and an accurate outline of planned experimentation.

Hallicrafters Co. and Zenith Radio Corp., both of Chicago, were granted construction permits for developmental FM stations to operate in the 92-108 mc band.

## **FM for Vets**

"Conditional Grants" of FM applications, affording servicemen applicants a period of 90 days in which to file engineering data on proposed operation, will be made by the Federal Communications Commission. The Commission set up the "conditional grant" policy to help servicemen who want to get into FM broadcasting. The action was taken by FCC on September 4 following many inquiries by servicemen who are intending to set up frequency modulation operations. The FCC encourages servicemen to file FM applications immediately, since spectrum positions cannot be reserved for future assignment.

## **118 mc FM Police Service**

The use of 118 mc FM operation for direct two-way mobile police service has been pioneered by the city of Miami, with the use of Galvin Mfg. Corp. equipment. The main station was installed in Miami's tallest building, the courthouse, on whose roof was rigged a dual coaxial antenna, serving a Motorola 250-watt 118 mc transmitter-receiver.

The car installations are of conventional 118 mc types, except for the antenna, which is only 23 in. high. A 300 ampere-hour storage battery operates the equipment, and a 40-ampere generator is installed in the car with the fan belt driving both the regular and the added charger.

## **Make Test Equipment**

Baker Instrument Co., has been formed by Frank C. Baker, Jr., and will specialize in production, sales and service of electronic technical equipment for laboratories and pilot plants. Baker was formerly service and sales manager of the Scientific Glass Apparatus Co. The company will do business from 310 Main St., Orange, N. J.

## **Press Wireless Expands**

Press Wireless, Inc., has started construction of a new laboratory and production plant in Long Island City, N. Y. It will be styled Engineering and Assembly building and will be devoted to research and production. Eventually it will become engineering headquarters of the company's manufacturing division.



# ASSOCIATION NEWS

## Happenings of the month concerning industry organizations

### Engineers Plan Show at IRE Winter Meet

Four major features are scheduled to mark the 33rd annual Winter Technical Meeting of the Institute of Radio Engineers at the Astor Hotel, January 23 to 26, 1946. Edward J. Content is chairman in charge of all arrangements for the meeting.

First of the major features will be the annual banquet held Thursday, January 24, at which a speaker of national prominence will address the members and their visitors. In addition, there will be entertainment highlights. At this function also, two major annual awards are scheduled to be made; the Institute Medal of Honor awarded in recognition of distinguished service in radio communications, and the Morris Liebmann Memorial Prize made "to a member of the Institute who has made public during the recent past an important contribution to radio communications." Announcement will then be made of the appointment of new fellows to the Institute, and the president of the Institute, Dr. William L. Everitt, will address the convention and hand the gavel to the Institute's newly elected incoming president.

Next major feature, according to Donald H. Miller, chairman in charge of special features, will be the annual President's luncheon held Friday, January 25, honoring the incoming presidents.

One of the big events of the Meeting will be the greatly expanded main commercial exhibits. For this purpose all of one floor and part of another in the Astor Hotel have been reserved. It is expected that 150 firms or more will take part in this show. Henry F. Scarr is chairman in charge of exhibits. This will constitute for the industry the first trade showing of postwar radio equipment and parts.

Finally, the major features of every annual meeting—the reading of scientific papers and the sessions and symposiums on the latest electronic developments—are expected to take on particular significance this year with papers on many vital subjects hitherto restricted by military security. Tentative subjects scheduled for the meeting, Dr. A. E. Harrison, chairman in charge of papers, announced, will include: Broadcasting, Frequency Modulation and

Television; Navigational Aids; Communications and Relay Links; Radar; Industrial Electronics; Testing Equipment; new developments in Panoramic Reception; Microwave Measuring Devices; Broadcast Receivers; Vacuum Tubes; Antennas and Radio Wave Propagation.

It is contemplated that the Institute will run organized inspection trips to points of interest throughout the city for out-of-town members.

### IRE Section Studies Gun Director

Dr. C. A. Lovell, Bell Telephone Laboratories, told the New York Section of the Institute of Radio Engineers meeting in Red Bank, N. J., middle of September about the development and operation of the M-9 electronic gun directors that were responsible for bringing down 74% of the buzz bombs directed at London during the summer of 1944. Later, he pointed out in his talk, the director had been responsible for the elimination of 97% of the bombs directed at this port.

### Conventions and Meetings Ahead

**Institute of Radio Engineers, New York Section.** 1945 Radio Pioneers Party. Dinner meeting 6 pm Nov. 8, 1945. Hotel Commodore, New York City. (E. J. Content, c/o WOR, N. Y. C.)

**Rochester Fall Meeting** (O. L. Angevine, Hotel Sheraton, Rochester, N. Y.), RMA Engineering Dept. and IRE. November 12-13.

**Institute of Radio Engineers, Cedar Rapids Section** (J. A. Green, Collins Radio Co., Cedar Rapids), Nov. 27.

**Electron Microscope Society of America, Third Annual Meeting,** November 30 and January 1, Frick Chemical Laboratory, Princeton University, Princeton.

**American Institute of Electrical Engineers** (H. H. Henline, 29 West 39th Street, New York City), Winter Technical Meeting, January 21 to 25, Engineering Societies Building, New York City.

**Institute of Radio Engineers, 330 W. 42nd St., N. Y. C.** Annual winter Technical Society, Jan. 23-26, 1946, Hotel Astor, New York City.

### Rochester Program

The Rochester Fall Meeting, sponsored jointly by the Radio Manufacturers Association Engineering Department and the Institute of Radio Engineers, has assembled a program for its two-day meeting, November 12 and 13, which is a fair indication of the importance of the gathering which, over a period of many years, always has drawn a very large audience of topflight engineers. As usual, the meeting will be held at the Sheraton Hotel. The preliminary program follows:

#### Monday, November 12

**Technical Session** (W. L. Everitt presiding): "A Coaxial Modification of the Butterfly Circuit," E. E. Gross, General Radio Co. "Germanium Crystals," Edward Cornelius, Sylvania Electric Products Inc.

**Technical Session** (J. E. Brown presiding): "Microwave Radar," Donald G. Fink. "High Quality Sound Recording on Magnetic Wire," L. C. Holmes, Stromberg-Carlson Co.

**General Session** (George Town presiding): "The Aurora and Geomagnetism," C. W. Gartlein, Dept. of Physics, Cornell University.

#### Tuesday, November 13

**Technical Session** (R. A. Hackbusch presiding): "Report of RMA Engineering Department," L. C. F. Horle, RMA Data Bureau. "Industry Standardization Work in Television," D. B. Smith, Philco Corp.

**Technical Session** (L. M. Clement presiding): "Television—A Review of Technical Status," E. W. Engstrom, RCA Laboratories. "War Influence on Acoustic Trends," Hugh S. Knowles, Jensen Radio Mfg. Co.

**Stag Banquet** (R. M. Brophy—Toastmaster): "The Future of Radar," L. A. DuBridge, Radiation Laboratory, M.I.T.

### Old Timers Night

The Radio Pioneers Party for all radio men, newcomers and pioneers, will be held at a dinner this year at the Hotel Commodore in New York City, November 8. The event is expected to attract more than 1000 old timers and will be highlighted by a display of early radio equipment. The affair will be sponsored by the New York Section of the Institute of Radio Engineers.

DO YOU HAVE A "Borderline" PLASTICS PROBLEM?

Look into

# LUMARITH\* XF

FORM RETENTIVE,  
FLAME RESISTANT  
high acetyl cellulose acetate

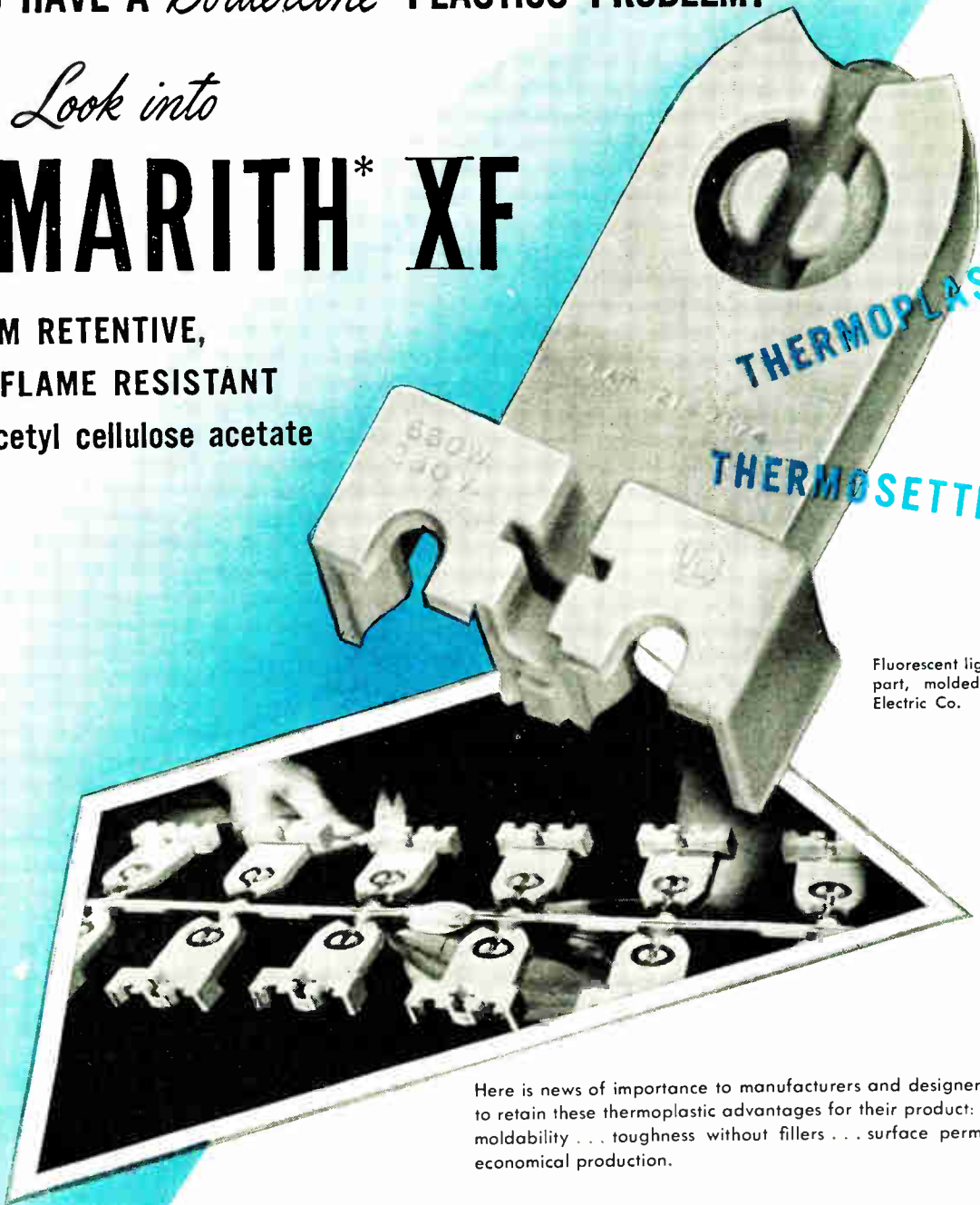

Fluorescent lighting fixture part, molded by Bryant Electric Co.

Here is news of importance to manufacturers and designers who want to retain these thermoplastic advantages for their product: high-speed-moldability . . . toughness without fillers . . . surface permanence . . . economical production.

LUMARITH XF SERIES OF THERMOPLASTIC MOLDING MATERIALS, a new Celanese development, is providing the answer to many "borderline" plastics molding problems. These formulations are rated self-extinguishing when tested according to ASTM method D 635-41T, and show excellent form retention when subjected to heat and humidity. Giving high values for flexural and tensile strength, they offer  $\frac{1}{3}$  greater resistance to cold flow than standard formulations of cellulose acetate.

In the short time since its introduction, Lumarith XF has broadened the field of useful-

ness of the cellulose tremendously—particularly in the electrical and allied fields where flame resistance and stability under load and heat are of prime importance.

If you are planning a product that you feel could be improved or more economically produced by thermoplastics, get in touch with the Celanese technical service staff for complete data on this new Lumarith plastic. Celanese Plastics Corporation, a division of Celanese Corporation of America, 180 Madison Avenue, New York 16, N. Y.

*A Celanese\* Plastic*

\*Reg. U. S. Pat. Off.

# WASHINGTON

Latest Electronic News Developments Summarized  
by Electronic Industries' Washington Bureau

**OBSTACLES IN PATHWAY**—The radio manufacturing industry—and its largest “operating family relative,” the broadcasting industry—has been facing a difficult pathway towards reconversion in sales of sets to the public and transmitters to the broadcasting stations. The blocking of promulgation of the price regulations by OPA had delayed the manufacturing industry during the early fall from launching into reconversion at full speed. However, a number of end-equipment companies commenced their production of home receivers before the final price determinations were fixed by OPA.

**PUSH TELE UPSTAIRS?**—On the broadcasting side, television seemed to have the biggest “gripe” because of the proposed allocations assignments and rules of the FCC with the latter’s plan for use of common antenna sites, community stations and assignments to the smaller cities for the purpose of competition without regard to the fact that these communities would get more facilities than they ever would seek. There seemed a definite implication in the FCC proposed rules to push television “upstairs” as far as possible and throw into the discard the use of the 13 “lower” channels.

**FM MAY GET JUMP**—FCC and radio industry observers feel that FM broadcasting will get into full swing next spring, probably around April, with the wave of interest in this new service, both from the standpoint of set sales and broadcasting at its peak. FM receivers are to be on the market around the first of the year, but most transmitters won’t be operating before early spring; transmitter power converters will be utilized until the higher power transmitters are available.

**FM TUSSELE FOR SPACE**—FM broadcasters and large and new independent stations are slated to put on promotion campaigns to attract public interest in buying FM receivers while they are in the process of building their stations. The attacks of the CIO PAC and American Veterans Committee about the FCC giving a monopoly to existing broadcasters in FM will furnish fuel for the present FM broadcasters to seek an expansion of frequency space. Look for the FM broadcasting proponents to tussle with television to get it out of the 13 lower channels.

**WAR JOB WELL DONE**—The radio manufacturing industry delivered for war purposes \$7,680,000,000 worth of radio and radar end equipment from July, 1940, through July, 1945. These statistics, issued by the WPB Radio and Radar Division which ended its existence October 31, have been compiled in detailed data form by dollar value for types of components and end equipment and facilities broken down by geographical areas and by states; it has been published by the U. S. Bureau of Census. This greatest output in the history of the radio manufacturing industry compares with the 1939 production of \$231,000,000 worth of equipment. Of the output more than 98% was delivered directly to the Army and Navy with less than 2% going to war supporting activities and of the

equipment to the armed services 60.5% went to the Army. This was divided between radio and radar as follows:

	1942	1943	1944	6 months 1945
Radio Equipment..	90.7%	68.5%	50%	37%
Radar Equipment..	9.3%	31.5%	50%	63%

**GROWTH OF INDUSTRY DURING WAR**—How the war production program mushroomed the number of companies in the radio-electronics manufacturing industry was graphically illustrated by the WPB Radio-Radar Division tabulation which excluded 500 other companies that manufactured miscellaneous radio and electronic items during the war and were not required to report their production to the WPB. Following is the WPB table:

Product	Reporting to Bureau of Census—1939 Companies	Reporting to WPB—1944 Companies
Radio and Radar Equipment....	182	202
Test Equipment .....	34	60
Resistors .....	19	46
Capacitors .....	38	48
Transformers .....	42	100
Tubes .....	23	40
Meters .....	35	43

**SURPLUS PROPERTY DISPOSAL ON GOOD BASIS**—Appointment of David H. O’Brein, former Graybar Electric Co. vice president and during the war Director of Distribution for the U. S. Army Signal Corps Procurement and Distribution Service, as Assistant Administrator of the Surplus Property Administration for capital producers’ goods and plants means this government agency will have someone fully familiar with the radio-electronics industry. Previously, the SPA officialdom and planning of surplus disposal in this field has been faulty and slipshod. The SPA authorities now in charge of the program want publicized—unlike some of their predecessors—that the press figures of 3-5 billion dollars’ worth of radio and electronic surplus equipment and parts are greatly exaggerated and that in terms of the price paid by the military services this can be more than cut in half.

**SELL MUCH OVERSEAS**—A large segment of the surplus will be retained by the Army and Navy or, when overseas, will be sold to foreign governments or companies. An overall evaluation panel has been planned by the RFC to eliminate transportation from contract disposal points to agent companies of equipment and materials due for scrapping. In the case of radar, SPA officials admit that manufacturing companies will produce, in the main, lighter, more efficient and more practical apparatus than that used by the armed forces. Walkie-talkies will have to be rebuilt for the new frequencies; communications receivers and test equipment are regarded among the most saleable items by SPA.

National Press Building  
Washington, D. C.

ROLAND C. DAVIES  
Washington Editor



# how **relays** help to make coffee *Automatically*

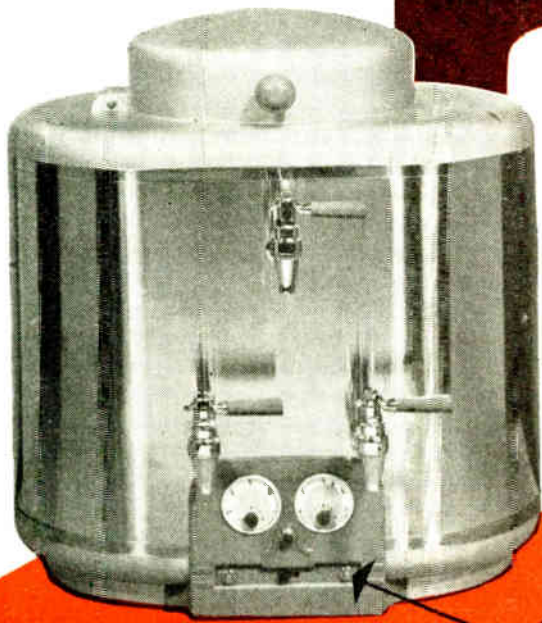

The brewing of fine coffee is an art that has been reduced to a science by All-Lite Mfg. Co., of Chicago, manufacturers of the Urn-O-Matic which automatically controls the brewing process.

## *Relays* BY GUARDIAN Control the Brewing Cycle

To make coffee by this method, the chef determines the amount of coffee desired and adjusts the dial accordingly then presses a push-button. This closes a snap-switch connected across the main circuit. When the predetermined amount of coffee is made a volume regulator actuates a Guardian relay mounted in combination with the snap-switch. An arm on the relay's armature returns the snap-switch to the "off" position and stops the brewing operation.

A simple application, yet one that calls for an accurate, dependable, sensitive relay. Operating on low voltage the relay must withstand jarring and heat, and possess high moisture resistance—specifications that you might ordinarily believe call for a specially built relay.

Actually the relay is Guardian's standard Series 120 with all the standard advantages of quick delivery, lower cost, available replacements.

Whether your application calls for a standard or a special relay, write us. Guardian engineers will recommend a unit most suitable to your needs.

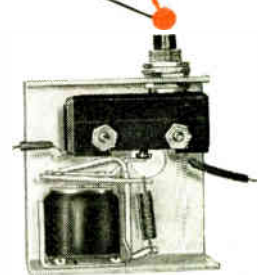

Relay and Snap Switch



Series 120 A.C. Relay

# GUARDIAN ELECTRIC

1622-M W. WALNUT STREET

CHICAGO 12, ILLINOIS

A COMPLETE LINE OF RELAYS SERVING AMERICAN INDUSTRY

# WHAT'S NEW

Devices, products and materials the manufacturers offer

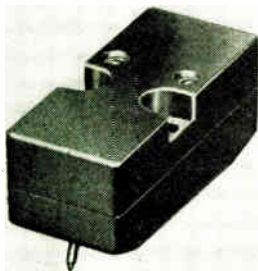

## Magnetic Pickup

A high fidelity magnetic phonograph pickup is being manufactured by the Caltron Co., 11746 West Pico Blvd., Los Angeles 34, Calif. Response curve to 6,000 cps is smooth; sharp cutoff beyond top frequency occurs. The unit has no bearings, pivots or needle chuck. It will track fully modulated pressings with 15 grams needle pressure. No scratch filter is needed in the amplifier connected to this unit.

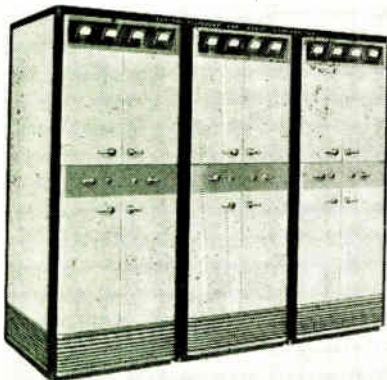

## FM Broadcast Equipment

A new line of FM broadcast transmitters and antennas, with outputs ranging from 250 w to 50 kw, is being manufactured by Federal Telephone & Radio Corp., Newark, N. J. The transmitters are of multi-unit design, permitting the broadcasting station to increase its output when desired, by adding the necessary power amplifier units. The 250 w output of the exciter unit is stepped up to 1, 3, 10, or 50 kw by a power amplifier unit or series of such units. The FM broadcast antenna arrays are fed by standard coaxial lines, combining high power gains with non-critical tuning, and consist of from 1 to 12 or more loops, each embodying two or more half-wave elements. The arrays are factory-tuned for easy installation. A high degree of center frequency stability, is obtained in the FM transmitters by a phase discriminator in the basic unit which locks the center frequency accurately to the crystal oscillator frequency, making the frequency stability of the transmitter equal to the stability of the crystal employed. High fidelity audio frequency response, low harmonic distortion and low hum level are obtained by the application of negative feedback from the last power stage of the exciter to the audio amplifier.

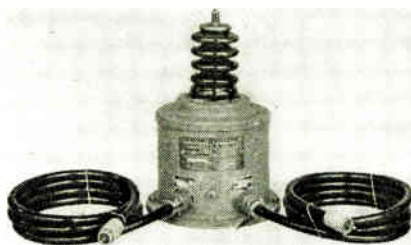

## Capacitance Voltage Dividers

A new line of capacitance voltage dividers for voltage measurement and wave form observation of high frequency voltages, in the range from 15,000 to 50,000 v. peak, is being manufactured by General Electric's Transformer Division, Pittsfield, Mass. Available in ratings for 15,000, 35,000 or 50,000 v. peak pulse levels, each divider may be obtained with two independent voltage ratios of any desired value, for simultaneous pulse measurement and wave form observation. Connected to a high potential, high frequency circuit, the capacitance voltage dividers provide one or two step down ratios, reducing the voltage to a suitably low value for connection to a voltage measuring device, an oscilloscope, or both. For oscilloscopic observation, the new dividers give a faithful reproduction at low voltage levels, of any high voltage, high frequency wave form. These small compact units consist essentially of a high voltage, ceramic bushing, which constitutes a low value of capacitance, in series with one or more standard, molded type Electro-film capacitors, assembled in a hermetically sealed tank. The units can be supplied with either microphone type cable leads, having suitable screw-in terminals, or with connectors for the attachment of coaxial cable.



## Cable Connector Tool

A new foot-operated "Hlytool" has been developed by Burndy Engineering Co., Inc., 107 Eastern Blvd., N. Y. 54, N. Y., for installing indent-type connectors on electrical wire and cable, sizes No. 22 to No. 10 inclusive. A wide jaw opening and front feed make it easy for the operator to insert the cable and connector, as well as to see that they are properly placed in the die. A terminal is completely attached to the cable in a single stroke of the machine, during which the insulation grips are closed and the terminal barrel is indented onto the cable. Each set of dies takes three connector sizes.



## Induction Motor

A capacitor-start induction motor is being manufactured by Small Motors, Inc., 1308 Elston Ave., Chicago 22, Ill., wound for speeds of 3350, 1725, and 1150 rpm, in capacitor and split phase or 3100 and 1550 rpm, as a shaded pole motor. Unit is furnished with precision ball bearings or oilless sleeve bearings. It will operate vertically, or in any mounting position when provided with proper thrust-bearings, on power supply voltages to 460 v., 1/25 to 1/70 hp.

## Heterodyne Frequency Meter

General Radio Co., 275 Massachusetts Ave., Cambridge 39, Mass., is manufacturing a portable, battery-operated heterodyne frequency meter for frequency measurements between 10 and 3,000 mc. The in-

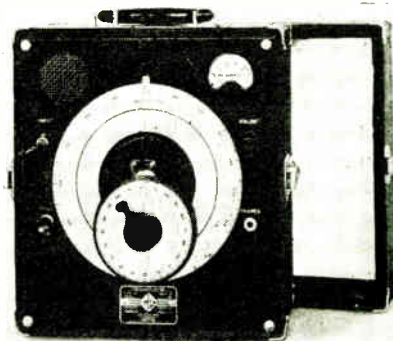

ternal oscillator covers a frequency range of 100-200 mc. For frequencies below 100 mc, harmonics of the unknown frequency are made to produce beats with the internal oscillator. For frequencies above 200 mc, harmonics of the internal oscillator produce beats with the unknown frequency. The internal oscillator uses the new butterfly circuit in which capacitance and inductance are varied simultaneously. No sliding contacts are used in this circuit and no current is carried by the bearings; consequently, smooth and stable adjustment of the frequency can be made over the frequency range of the instrument. The detector is a silicon crystal so mounted that it is easily accessible for replacement. A three-stage audio amplifier is included, having an effective band width of 50 kc. The output of the amplifier operates a panel meter and a built-in loudspeaker. A jack is provided for head telephones. Dimensions are 12 1/2 x 13 1/2 x 10 1/2 in., overall. Net weight with battery is 27 3/4 lbs.

*you can get to work with* plastics

NOW

---

here's

HOW

Here's a new Dow plastic that gives you the rare opportunity to put your plastic plans to work—*RIGHT NOW!* Most plastics are still short. But this new Dow development—its durability and effectiveness proved in war—is now freely available for the many peacetime jobs that call for its unique qualities. It may be just the thing you need. Suggested applications include tools, electrical insulation, home appliances, sporting goods. Field experience and Dow research point unmistakably to a world of opportunities for new and profitable civilian applications. Full data is waiting for you. Push your plastic program—*NOW*—ask Dow about Styraloy at once!

## STYRALOY

### **SOMETHING REALLY DIFFERENT IN PLASTICS**

For better insulation, tool handles, and products as varied as scuff plates, floor mats and fittings or gaskets, Styraloy is the answer to tough service demands.

### **CHECK THESE PROPERTIES**

High dielectric strength, low power loss; flexible and shock resistant from  $-90^{\circ}$  to  $212^{\circ}$  F.; light weight; negligible water absorption; resists heat, many chemicals, permanent indentation and abrasion; easily machined.

### **THE DOW CHEMICAL COMPANY, MIDLAND, MICHIGAN**

New York • Boston • Philadelphia • Washington • Cleveland • Detroit • Chicago  
St. Louis • Houston • San Francisco • Los Angeles • Seattle



STYRON • STYRALOY • ETHOCEL  
ETHOCEL SHEETING • SARAN • SARAN FILM



### Duplicating Bender

Three new benders, for use in die-less duplicating processes, are being manufactured by the O'Neil-Irwin Mfg. Co., Minneapolis 15, Minn. The installation of roller bearings has greatly reduced operating friction, and has also added approximately 35% forming capacity. A forming control lever on the two larger sizes instantly reverses the forming direction of the bender nose, eliminating possible interference when forming materials to complicated shapes.

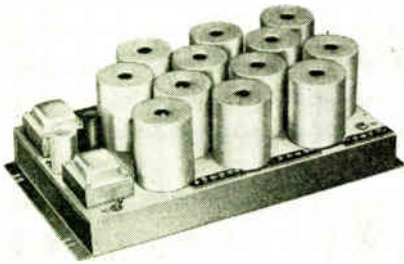

### Antenna Tuning Unit

This unit is used for coupling a single antenna into a number of receivers, or a number of antennas into a single receiver. Each amplifier stage in this unit has low impedance input and output circuits, and contains six rf amplifiers with an associated power supply. Circuits may be series connected for use with a single antenna or receiver. Maker is Andrew Co., Chicago 19, Ill.

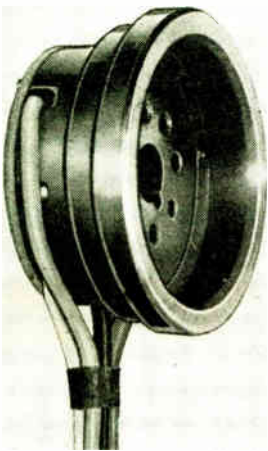

### Television Connector

The Alden Products Co., 117 No. Main St., Brockton 64, Mass., has developed a connector for use in television receivers, that adds only 1/16 in. to the length of the cathode ray tube. Safety features include long leakage paths, bakelite insulation, and protective skirt around prongs of the tube. The leads can be brought out from any side of the connector, to make them as short as possible.



### Impedance Bridge

The Brown Engineering Co., 4635 S.E. Hawthorne Blvd., Portland 15, Oregon, is manufacturing a portable, self-contained impedance bridge, designed for the measurement of capacitance, resistance, and inductance, over wide ranges. The unit is also capable of measuring the storage factor (Q) of coils and the dissipation factor of capacitors. The range of measurement for capacitance is 1 micro microfarad to 100 microfarads; for resistance, 1 milliohm to 1 megohm; for inductance, 1 microhenry to 100 henrys. The accuracy on the main decade is 2 per cent for inductance and 1 per cent for capacitance or resistance measurements.

### Isolation Type Vari-Former

The new type W Vari-Formers that have been developed by the Gulow Corp., 26 Waverly Pl., New York 3, N. Y., are double or isolation wound, for laboratory and industrial use. Units have a primary wound for 115 v. input and a variable secondary wound for an output of 0-130 v. Separate terminals are provided for both

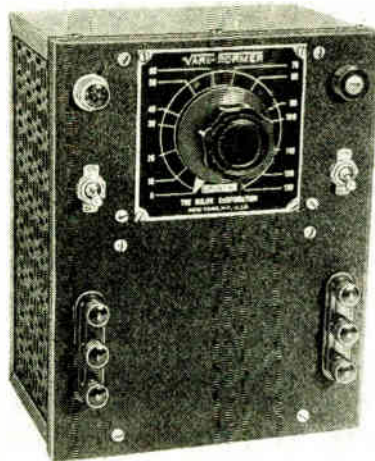

primary and secondary windings. It is therefore possible to connect these units as auto transformers making several different voltage combinations possible. Inputs of 115 or 220 v. can be applied and output ranges of 0-65 or 65-130 are obtainable with increments of 0.3 v. Likewise output ranges of 0-130 or 115-245 with increments of 0.6 are possible. The separate primary and variable secondary windings are wound on the same core which results in good regulation and obviates the necessity of using two transformers to obtain an isolated variable voltage supply. For critical electronic testing and special applications an electro-static shield has been imposed between the primary and secondary, grounded to the core, and brought out to a separate terminal. Units with capacities of 500 VA to 2000 VA are available. The 500 VA measures 7 x 9 x 4 1/2 in. deep; weight 20 lbs. The 2000 VA measures 10 x 10 x 8 in. deep; weight 50 lbs.

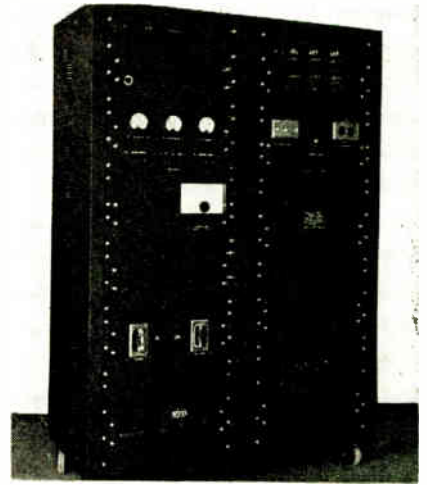

### Electronic Generator

Radio-Television Institute, Inc., 480 Lexington Ave., New York 17, N. Y., has developed an electronic generator which maintains essentially constant rms output voltage while permitting variation of waveform and frequency. The waveform of the output voltage can be carried from nearly square wave through sine wave to peaked

(peak volts)  
wave covering amplitude factors  
(rms volts)  
of from 1.16 to 1.65. The frequency is variable over a range from 50 to 2400 cps. Output voltage is 115 v rms nominally, adjustable between 110 and 120 v. Regulation of output voltage is better than 3 per cent from no load to 300 w and for line voltage changes from 110-120 v ac. The output voltage stays within the same limits for frequency changes over the whole range as well as for changes in amplitude factor from 1.16 to 1.65.

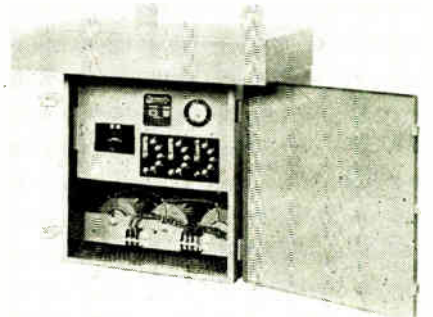

### Cathodic Rectifiers

Cathodic protection rectifiers, designed to reduce to a minimum the galvanic corrosion of underground metal structures, have been developed by Federal Telephone & Radio Corp., of Newark, N. J. By introducing a potential difference between the varied structure and the soil in a direction opposing the galvanic current flow, corrosion is prevented. To accomplish this, the selenium rectifier contained in the unit converts standard ac power to dc. The cathodic protection rectifier is contained in a weather-proof sheet metal cabinet with drip-proof hood and hinged cover affording easy access to the control panel, and is suitable for installation indoors or out, either on a wall or pole. Taps and links permit ready adjustment of the dc output which is indicated by an ammeter mounted on the control panel. The complete unit weighs 150 lbs., is 23 in. high x 25 1/2 in. wide x 19 1/4 in. deep, and is designed for operation on 230 v. 60 cycle, 3 phase power lines, to provide dc outputs up to 20 amperes, from 10 to 40 v. continuous duty.

# Does Your Product Require Electrical Wiring?

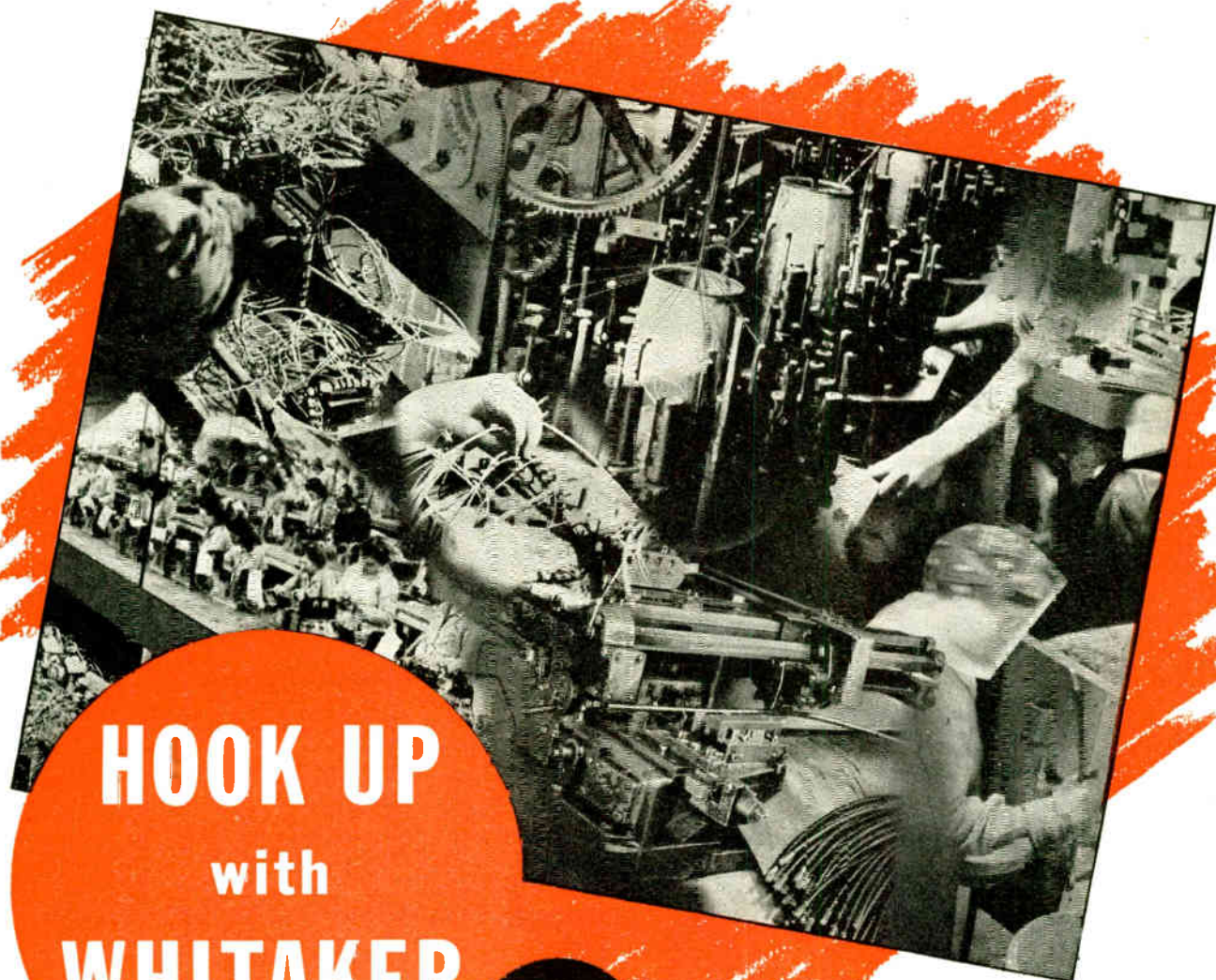

**HOOK UP**  
with  
**WHITAKER**

*Whitaker  
Can  
Wire It*

If your product requires electrical wiring—you'll find Whitaker to be a dependable source for **WIRING HARNESSES . . . BONDING JUMPERS . . . CABLE ASSEMBLIES . . . CABLES or TERMINALS.**

We are wiring *specialists* — and you have everything to gain by utilizing the full benefits of our 25 years of experience,

our ample engineering and production facilities, trained manpower, exacting inspection, and the economies resulting from our use of modern methods, and special equipment... In addition to an engineered wiring service, Whitaker also offers a quality line of standard cable products. We cordially invite you to write us.

## **WHITAKER CABLE CORPORATION**

General Offices: 1311 Burlington Avenue, Kansas City 16, Missouri  
Factories: Kansas City, Mo. • St. Joseph, Mo. • Philadelphia • Oakland

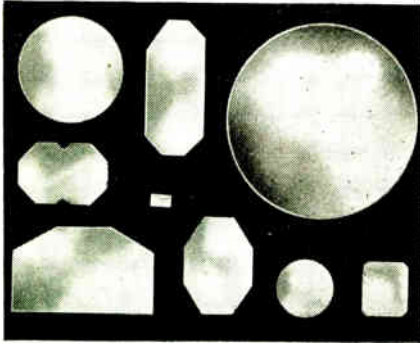

### Precision Mirrors

The Zenith Optical Laboratory, 123 West 64th St., New York 23, N. Y., is manufacturing to specifications, front or rear surface mirrors for precision instruments and electronic equipment. These mirrors can be supplied in gold, silver and various other metals, have permanent reflectivity characteristics, will not tarnish, are free of pinholes, and can be cleaned without damaging the surface. The aluminum alloy mirrors may be particularly useful because their reflectivity curve is virtually a straight line from the infra-red to the ultra-violet.

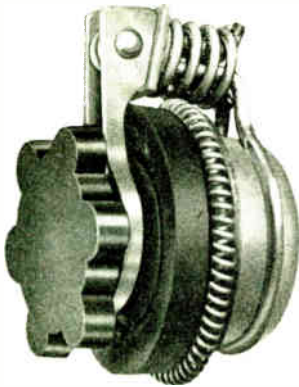

### Waterproof Jack Cover

The Waterproof Electric Co., 72 East Verdugo Ave., Burbank, Calif., has developed a waterproof jack cover that seals electrical jacks used in radio and electrical equipment. The hinged seal-plug is shown closed; when open, a telephone-type plug may be inserted through the jack cover into the jack in the normal manner. No special holes or tools are required for installation.

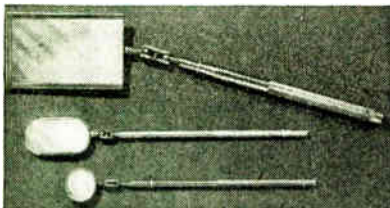

### Inspection Mirrors

The Ullman Products Co., 857-861 4th Ave., Bklyn, N. Y., is manufacturing a complete line of mirrors for industrial use. These mirrors are intended as an extra eye, to give vision in the many blind spots which every mechanic meets. Three models are available: Model A-2: round, 7/8 in. diameter, all angle swivel joint, knurled handle; Model B-2: oval, 1 in. x 2 in., all angle swivel joint, knurled handle; Model K-2: rectangular, 2 1/4 in. x 3 1/2 in., telescoping handle, 15 3/8 in. overall length open, 6 5/8 in. overall length folded.

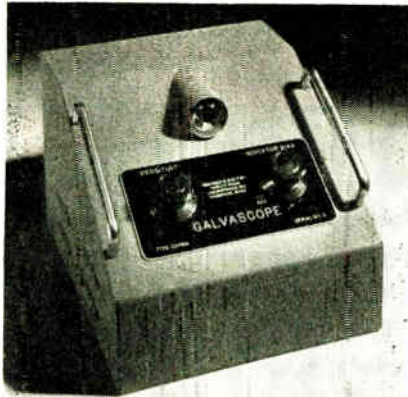

### Electronic Galvanometer

Harvey Radio Laboratories, Inc., 447 Concord Ave., Cambridge 38, Mass., has developed an electronic ac galvanometer, designed to replace auditory methods in bridge testing, with more accurate visual ones. A 6E5 tube is used as an indicator. Two permanently attached cords provide connections to the 115 v., 50-60 cycle ac line, and to the detector terminals of any 1000 cycle ac bridge. The circuit consists of an ac amplifier, a signal rectifier, an indicator, and a self-contained power supply. The operation of the device involves amplification of the 1000 cycle bridge signal, followed by a rectification of the amplified signal, and its application to the indicator tube.

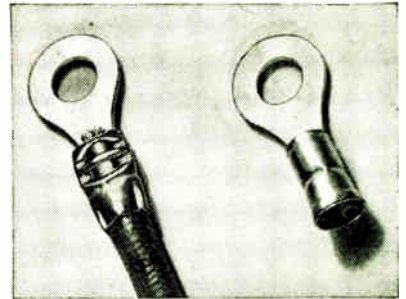

### Solderless Terminals

Aircraft-Marine Products Inc., 1591 D No. 4th St., Harrisburg, Pa., is manufacturing solderless terminals for use on No. 16 to No. 14 wire sizes inclusive, having insulation diameters as large as .250 in. and extra thick tongues. The insulation support sleeve is notched and folded in at the end to form a strong lip and a toothed grip, to prevent sliding. Heavy duty terminals are also manufactured with integral insulation—the insulation bonded to the terminal barrel. Both types are copper, hot electro-tinned for maximum corrosion resistance. AMP pressure-type hand installation tools, or foot or power press dies (for AMP or standard presses) make three crimps on heavy duty terminals in a single crimping operation.

### Insulating Board

The Rogers Corp., 21 Mill St., Manchester, Conn., is manufacturing a 100 per cent non-cotton cellulose electrical insulating board called Durok. Dielectric strength ranges from 400 to 600 v per mil. Stock sheet sizes are 36 x 48 in., and 36 x 24 in. Thicknesses now available are .015 in., .020 in., .025 in. and .030 in.

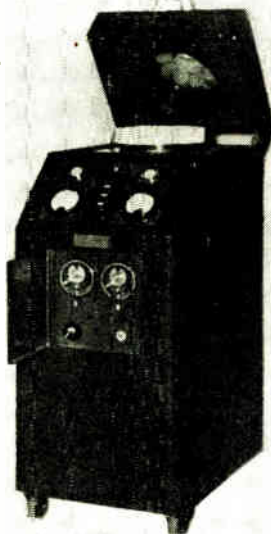

### H-F Pre-Heater

A portable high frequency pre-heater is being manufactured by W. T. LaRose & Assoc., 635 2nd Ave., Troy, N. Y., having an output of 3/4 kw, and measuring 12 x 17 x 22 in. Unit weighs 30 lbs., operates on 110 or 220 v. ac, and can be used for pre-heating either pre-formed or loose compounds. It will heat 1/2 lb. of molding material ready for molding in one minute. The maximum size pre-form it will accommodate is 6 in. in diameter by 3 in. thick. A double interlock safety switch system is incorporated in the design which turns the power off automatically when the lid is raised. Tube life is approximately 1,000 hours. A larger unit (2 kw output) is also available, 14 in. wide, 22 in. deep and 34 in. high, weighing 190 lbs., and having a mobility enabling it to be rolled from press to press. This unit will heat one pound of compound ready for molding in 45 seconds or less.

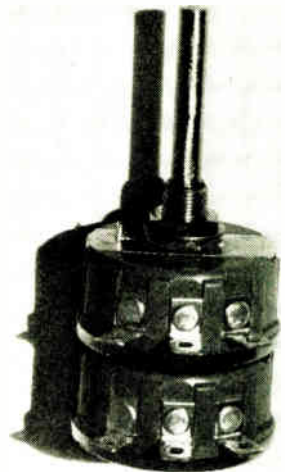

### Wire-wound Potentiometers

The Trefz Mfg. Co., 38-11 Main St., Flushing, N. Y., is manufacturing a new series of wire-wound potentiometers. Linearity of both single and dual units makes them readily adaptable to applications using calibrated dials or in circuit arrangements where close series or parallel tracking is required. Electronically welded instrument spring maintains positive continuity between center terminal and wiping contact. Phenolic case is dustproof. A sealing washer can be furnished between case and the heavy cover, making a hermetically sealed potentiometer for use in conjunction with a water tight panel bushing. Resistance range: 1 ohm to 150,000 ohms. Switches, off position and tapered units can be supplied.

# Three ways to get the *jump* on peacetime tube-production problems

★ ESPECIALLY RECOMMENDED TO COST AND PROFIT-MINDED MANAGEMENT EXECUTIVES



① From design research to quantity production of your transmitting and industrial power tubes, the all-inclusive services of Lewis Electronics can be your complete manufacturing source . . . a distinct and important competitive advantage!

YOUR TUBES - PRODUCED UNDER YOUR BRAND!



② Your production requirements are all-important when entrusted to the Lewis organization. Every employee is a seasoned craftsman . . . steadfast in his willingness and ability to meet the most exacting technical requirements—efficiently!

QUALITY TUBE PRODUCTION . . . IN QUANTITY!

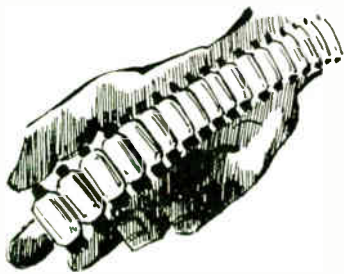

③ At Lewis Electronics there is no delay in getting down to brass tacks on any assignment. Tube production, at low-cost, is assured. You can depend on the efficient service and intelligent cooperation needed to get the jump on competition.

COOPERATION . . . SERVICE . . . LOW COST!

## *Lewis at Los Gatos*

A contract manufacturing organization, whose business is to act as YOUR factory in the design, re-design and manufacture of your transmitting and industrial power tubes ☆ ☆ ☆ A unique organization—the pride of an entire community—with a background of 20 years electronic engineering experience plus a proven record of meeting huge production demands on time, and economically!

EQUIPPED and READY  
to produce YOUR TUBES  
under YOUR BRAND name!

Write, wire or phone to have our representative personally call . .

**Lewis** ★ **ELECTRONICS**  
LOS GATOS · CALIFORNIA

# ★ TELEVISION TODAY\* ★

## New Developments in the Video Field

### **Metallic Backgrounds Give Contrasting Video Results**

Experiments with reflective metallic backgrounds in television studios have resulted in producing pictures having a wider degree of contrast than formerly obtained with ordinary backgrounds. The experiments were conducted by Ted B. Grenier, chief engineer of Metropolitan Television, Inc., and Chet Kulesza, technical supervisor of art and production at Batten, Barton, Durstine & Osborne, Inc.

The experiments indicated that metallic backgrounds using gold, silver, copper or bronze paint produce results that are better than any other color previously used in television. The shaded silver background has been found best since it produces good results for all colors. The silver background also gives better results under incandescent lighting than under mercury vapor illumination.

### **Tele for Teaching**

Television as an educational medium will have its first tryout this fall according to plans of the New York Board of Education and the National Broadcasting Co. Experiments will begin as soon as the schools re-open. The plan is to broadcast a weekly program from WNBT to determine the type of material most suited for classroom use in teaching junior high school pupils between the ages of 13 and 15 years. Pupils and teachers will evaluate such experimental broadcasts at NBC receiving studios. Initial programs will deal with science, the first one being devoted to television itself.

### **Stratovision—Pro and Con**

"Stratovision" plans for broadcasting television and FM programs from planes circling 30,000 ft. aloft, have been carefully worked out by Westinghouse's Walter Evans and C. E. Nobles, as reported in September Electronic Industries, page 94. Numerous merits of the system have already been explained to radio engineers.

But still other advantages not yet mentioned, would seem to have to do with elimination of two minor nuisances which teleset owners now suffer with present low-angle telecasting: 1. Intense swings in screen

illumination intensity when commercial planes fly overhead, reflecting signal strength that is first additive, then subtractive, as it combines with the direct wave. 2. Tree foliage blocking of low-angle waves, making summer reception difficult in leafy suburbs.

### **"Show-me" attitude**

Concerning No. 1, however, a television engineer adopts a "show-me" attitude, commenting "I see no reason for any improvement here, except that since the whole Stratovision system would produce so much off-on fading due to the movements of the transmitting plane, small additional fading would scarcely be noticeable." ..

On No. 2, he continues, "A plane 5 miles high and 5 miles away would have a cleared angle of 45 deg. around the set-owner dipole. This would help out with respect to trees within 100 ft. of his antenna but would show no improvement against foliage at greater distances."

With due regard to the ability of flying television relay stations to speed the network facilities for this new radio art, there are several problems which must be solved. While the overhead position of the transmitting antenna will reduce the problem of "aiming" the receiving antenna for most television viewers, it will not eliminate the

problem of ground reflections and fading due to the movements of the flying transmitting antenna.

A simple dipole antenna probably will not be sufficient for use with flying television transmitters because of the multi-path reflections which will occur due to the ground and other nearby reflecting objects.

(Continued on page 184)

### **Railroad Eye**

"One of the principal railroad lines is seriously considering placing television cameras at front end of locomotives of crack trains, and piping results to lounge and dining cars so that passengers may see country ahead of trains on which they are traveling," says Martin Codel, Washington, always a careful reporter. "It is believed," he adds "that television may thus fulfill boyhood ambition of many to ride in an engine cab, and can thus attract travel business when competition resumes normal proportions."

### **School Tele System**

Syracuse University has reserved an "Intra-Tel" system—wired television—from the General Electric Company for postwar delivery. The television equipment will be used to conduct various classroom teaching experiments, as well as for teaching television programming and other technics to students.

## TELEVISION BRINGS LIVINGROOM FOOTBALL

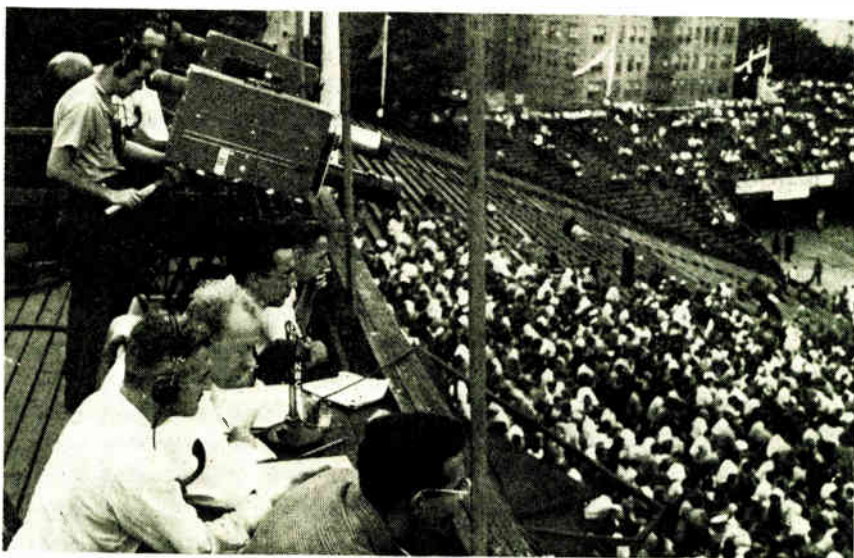

This is the scene as NBC's cameras picked up the Columbia-Lafayette game for the benefit of the New York audience tuned to WNBT. Monitoring and control facilities are housed in a truck remote

\*Title registered U. S. Patent Office.



# This HARVEY Regulated Power Supply 106 PA Is Doing a Dependable Job for DOUGLAS

The HARVEY 106 PA pictured is in the El Segundo Division of Douglas Aircraft Research and Testing Division of the Engineering Department. Here, hooked up with an amplifier, it is helping to perform one of the many vital tests so important to the manufacture of airplanes.

If, like Douglas, you need a constant dependable source of laboratory D. C. power between the range of 200-300 volts, select the HARVEY 106 PA. If you need laboratory D. C. power in a higher range, specify its big brother, the HARVEY 206 PA, 500 to 1000 volts.

Teamed with amplifiers, measurement equipment, constant frequency oscillators, pulse generators or any other apparatus requiring a constant source of D. C. power, HARVEY Regulated Power Supplies are proving the last word in efficiency and dependability. We'd like nothing better than the opportunity to show you why. May we send you illustrated bulletins containing the complete story?

## HARVEY RADIO LABORATORIES INCORPORATED

441 CONCORD AVENUE, CAMBRIDGE 38, MASSACHUSETTS



# NEW PATENTS ISSUED

## Beam-Induction Tube

The electron beam in the tube is made to travel a path which causes induction currents to flow in the coils of armature 5. The deflection system B not only deflects the beam radially but also causes successive electrons to differ slightly in azimuth so that the beam consists of a widening spiral.

The deflection system includes four plates to which a voltage (at a frequency of 100 megacycles or more) is so applied that a revolving uniform electrostatic field exists between the plates. A uniform radial force will be exerted on the electron beam which changes in azimuth as the field rotates; a spiral electron beam is the result. The axial magnetic field provided by magnet 29 exerts a transverse force on the electrons at right angles to their transverse velocity. This tends to rotate the direction of the transverse velocity at a frequency which can be adjusted to be the same as that of the rotating electrostatic field. Each electron will then follow a widening spiral path as it passes between the deflection plates 23, 24, 25. Beyond the influence of the deflecting forces, it will continue along a tangent to the spiral. Successive electrons will leave zone B at different azimuths, depending on the azimuth of the electric field.

The conventional system of deflection without the magnetic field would act in a somewhat similar manner, except that the spiral would return to the axis at intervals if allowed to continue; at some frequencies, no deflection would be produced. In the presence of the magnetic field, only one pair of deflection plates will also produce an approximately circular swing of the beam, permitting a considerably simpler construction of the apparatus.

Deflection booster C temporarily reduces the axial velocity component of the electrons so that they travel a comparatively large radial distance in a short axial length. Further, the radial velocity is considerably reduced shortly before the electrons leave region C.

Individual electrons in zone D travel substantially parallel to the axis of the discharge chamber 1. Successive electrons differ slightly in azimuth, due to the action of the deflection system. As a result, the electrons in various parts of zone D at any instant are disposed along an arc of a helix. The device is so designed that the beam will be in parallel to the armature helix. As time goes on, the electrons advance, and the helix rotates one revolution for each cycle of deflection in zone B. The electron stream behaves as a current flowing in a helical conductor which advances rapidly in the direction of the axis of the discharge chamber. It produces a varying magnetic field which induces voltages of the deflection frequency and its harmonics in the armature conductors. By suitably connecting the armature conductors 5, a desired harmonic may be selected.

The potential of the collecting electrodes is so adjusted as to maintain constant velocity of the electrons in space D. Alternating currents in the armature will set up electromagnetic fields within space D which the beam, by its changes in position, converts into the equivalent of a direct current voltage in series with the beam. In other words, the direct beam current by its rotation relative to the armature 5, generates alternating voltages in the armature. Power may be transferred in either direction—from beam (dc) to ar-

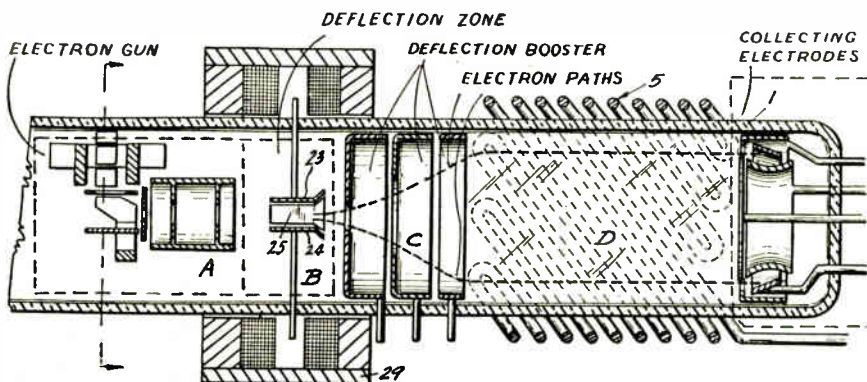

Electron beam tube where the passage of electrons induces a current in output coils 5

mature (ac) or from armature to beam—depending on the phase relationships in the ac circuits.

The device can operate as amplifier, frequency converter, oscillator, amplitude or frequency modulator.

R. E. McCoy, (F) April 5, 1941, (I) May 22, 1945, No. 2,376,707.

## Multiplier-Modulator

The circuit is designed to permit simultaneous multiplication and modulation of high-frequency waves. A radio frequency carrier wave is amplified by tubes 3 and 4 and applied to points A, A. If the transmission line 12 were terminated at points B, B with the proper resistance, the radio frequency wave would be applied to the control grids of tube 8 with a phase difference of 180 deg. The same wave would be applied to the control grids of tube 9 also with a phase difference of 180 deg.; however, the signals applied to corresponding grids of the two tubes would have a relative phase difference of 90 deg., due to the presence of the quarter-wave length transmission line 12. These voltages are shown in the diagram. Due to the bias voltage supplied by the source 13 to the control grids, these tubes are permitted to draw current only during a portion of the applied signal, so that individual output currents as shown in the second row of the diagram are delivered by tubes 8 and 9 to the output circuit. The resulting combined output current is shown in the third row of the diagram.

The resistance connected to points B, B can be controlled by the impedances of tubes 15 and 16 which is a function of the modulating signal. These impedance variations will cause the relative phase of the voltages at A, A and B, B to vary causing a corresponding change in the amplitude of the resultant output current of tubes 8 and 9, as indicated in the last diagram of the figure. A modulated radio frequency output of twice the applied radio frequency is obtained.

A. L. Nelson, Farnsworth Television and Radio Corporation, (F) September 4, 1941, (I) July 10, 1945, No. 2,380,366.

(Continued on page 166)

Frequency multiplier and modulator circuit

Graphs illustrating operating principle of high-frequency circuit which effects simultaneous multiplication and modulation

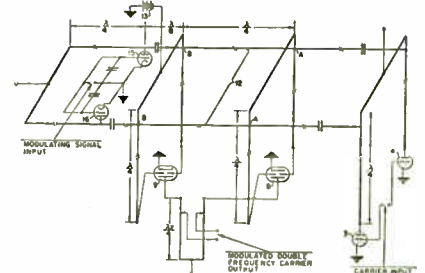
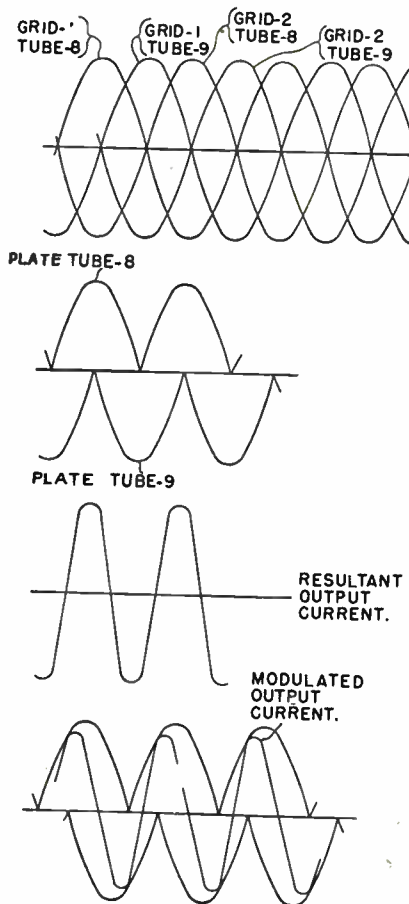

# C-D's Skilled Craftsmen, Backed by Expert Engineers, Build High Voltage Capacitors for the Nation's key installations . . .

From the smallest to the largest . . . no requirement is overlooked in C-D's complete range of capacitors. Outstanding examples of C-D's advanced engineering are high voltage capacitors for plate circuit filter and power-factor improvement.

Recognized by the country's leading public utilities, C-D has given them invaluable aid in meeting ever-mounting demands for more power without adding new equipment. Notable among C-D's many contributions to the power field are such installations as those

at Bonneville Dam. Industry knows C-D's helping hand in keeping production up and costs down.

Cornell-Dubilier engineering is available whenever capacitor problems confront you. Write to Cornell-Dubilier Electric Corporation, South Plainfield, New Jersey.

★ ★ ★ Other plants at New Bedford, Brookline, Worcester, Mass. and Providence, R. I.



**TYPE TK DYKANOL FILTER CAPACITORS** — High-grade multi-layered metal plates, high purity electrolyte, full-specimen material, protected in welded steel cases for long service and high voltage. St. Louis service—prompt, steady, accurate.



## CORNELL-DUBILIER CAPACITORS

MICA · DYKANOL  
PAPER · ELECTROLYTICS



FIRST IN QUALITY — FIRST IN CAPACITOR DEVELOPMENT

# Another Conant first!

**A New Rectifier Assembly  
that Eliminates  
Temperature Variations**

Here's important news for users of rectifier type instruments. Conant has done it again! This new instrument rectifier application makes possible for the first time complete freedom from temperature errors. AC values are read on the same linear scale as DC values.

You'll be amazed at it!

**HOT OFF THE PRESS!!**  
"Instrument Rectifiers"  
By H. B. Conant  
Here's 39 pages of must  
reading for every user of  
rectifier type instruments.  
Send 25¢ to cover handling  
and mailing today.

**CONANT**

*Instrument Rectifiers*

**ELECTRICAL LABORATORIES**

6500 O STREET, LINCOLN 5, NEBRASKA, U. S. A.

20 Vesey St., New York 7, New York  
85 E. Gay St., Columbus, Ohio  
600 S. Michigan Ave., Chicago 5, Ill.  
1215 Harmon Pl., Minneapolis 3, Minn.

2017 Grand Ave., Kansas City 8, Mo.  
1212 Camp St., Dallas 2, Texas  
378 Boulevard N. E., Atlanta, Ga.  
4018 Greer Ave., St. Louis, Mo.

1526 Ivy St., Denver, Colo.  
4214 Country Club Dr., Long Beach 7, Cal.  
Export Div., 89 Broad St., N. Y. 4, N. Y.  
50 Yarmouth Rd., Toronto, Canada

## SURFACE SEARCH RADAR

(Continued from page 100)

imum range of the indicator. On the commercial adaptations of this equipment at least two ranges would be available. The long-range scanning would be suited for land-falls or cruising. The short-range scanning would be for navigation through marked waterways, etc.

In the absence of actual targets, the receiver is tuned by the use of the resonance chamber (echo box). This unit provides a high-Q tuned circuit in which oscillations persist for some time after the transmitted pulse stops. These oscillations are returned as damped waves via the waveguide to the receiver, thus simulating echoes received from an actual target.

Radar equipment requires a closely supervised routine service program. Even in this phase of the work, Raytheon has developed technics that remain restricted. However, when war was declared, the Navy Department anticipated the need to install and service a great variety of relatively complicated radar equipments. Field engineering contracts were let and factory trained field engineering organizations were established at Raytheon to assist Navy technicians. Today Raytheon field engineers are stationed in all major Navy yards and Navy bases. These men are on call at all times and in addition to cooperating with installations, make it a practice to visit the ships as they arrive in port and to check the operation of the equipment. This service will be continued for civilian users of Raytheon radar.

It is an important function of Raytheon's field engineers to install the many improvements and modifications of the equipment which result from lessons learned under battle conditions. These modifications are called Field Changes and are accomplished by means of Field Change Kits which are designed and produced by Raytheon and sent out to the Fleet. While it is questionable whether or not peace time changes will come as rapidly as during the war, it is a service that protects every radar user against obsolescence of his equipment.

Today the SG radar on the USS AUGUSTA, the first installation Raytheon made, is as modern and reliable after 10,000 hours of operation as that coming off the production lines. This modernization program is carried still further by periodically returning all field engineers to the Raytheon plant where they undergo refresher courses and become thoroughly familiar with improvements.



## ERIE STYLE TS1F CERAMIC TRIMMER

**H**ERE is a new ceramic trimmer that's unique in design, extremely compact, with desirable capacity ratios and is priced for a wide range of applications in broadcasting and high frequency bands.

The Erie TS1F trimmer employs a ceramic dielectric and is available in nominal temperature coefficients, zero, -300, and -750 parts/million/°C. In the N750 coefficient, capacity range of 8-50 MMF is available. Corresponding ratios in lower capacities are furnished with zero and N300 coefficient.

Capacity change is essentially constant per degree of rotation, and full range is covered in 180° rotation.

The metal rotor completely covers the stator track. Contact surfaces of both rotor and stator are lapped, providing a high degree of stability, preventing dust or other foreign matter from affecting the performance characteristics of the unit, and keeping noise level to a minimum at high frequencies. Electrical characteristics are given at the right.

These trimmers are firmly held in place in a D hole in the chassis by means of a multiple-tooth spring clip, furnished with the trimmer.

*For complete information contact our nearest representative or write us direct.*

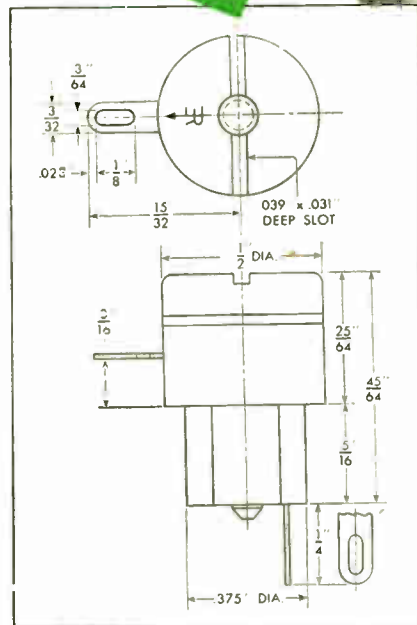

**ERIE TS1F CERAMICON TRIMMER**

- Voltage Rating: 350 volts D.C.
- Flash Test: 700 volts D.C. for 15 seconds
- Initial Q Factor at 1MC: 500 minimum
- Initial Leakage Resistance: 10,000 meg.min.



*Electronics Division*  
**ERIE RESISTOR CORP., ERIE, PA.**  
 LONDON, ENGLAND      TORONTO, CANADA.

# it is folly to put the plow in front of the oxen . . .



. . . and it is equally bungling to use a cheap substitute for Macallen Mica. Not many do, but every once in a while somebody has to learn from experience that trifling with insulation can be a disastrous experiment. The fact of dependability in Macallen Mica has been known to experts for more than 50 years.



*When you think of MICA think of MACALLEN*

## the Macallen Company

16 MACALLEN STREET - BOSTON 27

CHICAGO: 565 W. Washington Blvd.

CLEVELAND: 1065 Leader Bldg.

## PROXIMITY FUSE

(Continued from page 105)

plete structural analysis of all elements mounted in the tube. These were designed by the application of advanced engineering practices used in the construction of bridges, skyscrapers and other large metal structures. In this design it was not only necessary to insure that the tube structure would not fall apart or collapse under the high acceleration involved, but it was also necessary for it to be sufficiently rigid to prevent undue microphonics during actual use. Casual examination of the resulting rugged tubes however will not reveal many startling differences from conventional tubes.

Rigid standards of inspection and quality control, both at the tube factory and in the field were necessary, in order to insure that satisfactory rugged tubes would be produced in quantities large enough to meet production requirements. Every tube manufactured was spun in a centrifuge to an acceleration of 20,000 G before final test at the tube factory.

### 400,000 daily

Sylvania Electric Products Co. was the major production source making over 95 per cent of the tubes subsequently used for fuses. Some idea of the tremendous volume required can be understood from the fact that production as of June 1945 was approximately 400,000 tubes per day and with new facilities being established there is little doubt but that the goal of 525,000 per day would have been reached.

To accomplish this gigantic production job Sylvania established two finishing plants in Mill Hill, Pennsylvania and in Huntington, West Virginia. It then set up fifteen mount plants in small towns in western Pennsylvania, Ohio, Kentucky and West Virginia. Mounts were produced in these feeder plants and then shipped by truck to the finishing plants. In addition to these mount feeder plants, other plants were established to do sub assembly work such as handling small wires and filament padding. In June 1945 Sylvania was operating 23 plants making tubes or parts thereof.

At first dry batteries were used to power the VT fuse but due to their loss of efficiency from aging and the consequent requirement of an extensive program of battery replacements in the fleet, they were abandoned in favor of a reserve or wet type of battery having a life possibly reckoned in terms of years.

The design finally adopted contained a suitable electrolite stored

# Federal... **KNOWS** H-F Cable



## Inside and Out

From inner conductor to outer covering . . . Federal really knows high-frequency (transmission lines).

And this knowledge was not easily won. As the pioneer in the field Federal not only developed over 80% of all h-f cable types in use today . . . but developed most of the equipment needed to test them.

Attenuation, high-voltage, dielectric and balance testing equipment, velocity of propagation, braid-resistance and electric

length meters . . . were all Federal-engineered to fit specific requirements.

That's why it's logical to turn to the acknowledged leader in the field for the finest in h-f cables, specialty-engineered harnesses and cable assemblies.

Where requirements are critical . . . for transmission lines with special characteristics . . . for custom-built and engineered harnesses and cable assemblies . . . take your high-frequency transmission problems to Federal.



## Federal Telephone and Radio Corporation

Newark 1, N. J.



## CUSTOM-BUILT ELECTRONIC ASSEMBLIES

Need electronic assemblies engineered, designed and produced to match your requirements *exactly*? B & W offers unsurpassed facilities in this respect—for anything from a special transmitter or high-voltage equipment to test equipment, tuning units, high—and ultra-high frequency assemblies and dozens of others.

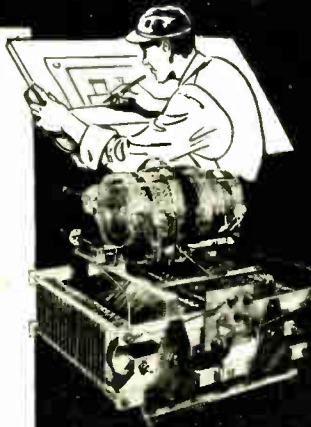

- ✓ Built-in Neutralization
- ✓ Perfect Design Symmetry
- ✓ Heavy-Duty Construction

Half the length of conventional dual units, designed for built-in neutralization, and thus having perfect design symmetry, B & W Heavy-Duty Variable Condensers assure a remarkable improvement in the performance of any equipment from a transmitter to a dielectric heating assembly. Write for Bulletin 75-C.

## CYCLOMETER COUNTERS

Count shaft rotations—facilitate making pre-determined settings

B & W Cyclometer Counter assemblies are useful wherever a shaft must be turned a pre-determined number of times, or set at any exact pre-determined position. Exact settings to tenths of a turn are automatically recorded. Write for Cyclometer Bulletin.



# B & W



## BARKER & WILLIAMSON

Dept. EL-115 235 FAIRFIELD AVE., UPPER DARBY, PA.

Export: LINDETEVES, INC., 10 Rockefeller Plaza, New York, N.Y., U.S.A.

in a glass container or ampule as an integral part of the battery. The shock of firing and high speed of rotation of the shell shattered the ampule and the electrolyte was centrifugally forced to the inner circumference of the battery case where the battery plates were located. As soon as the electrolyte reached the plates, current started to flow.

The problem of safety devices for the fuse was one demanding a great deal of research. As finally designed, the shell fuse contained two safety devices which would both have to be actuated before the fuse could become operative. As a result the safety record with this type of ammunition was as good or better than that obtained with any other type.

### Raytheon VT Radio Proximity Fuse Tubes

Raytheon Mfg. Co. is letting it be known that this company played a major engineering and production part in supplying hearing aid size filament type tubes for the Army and Navy in the proximity fuse project. Raytheon, on October 1st of 1940, was the first radio receiving tube manufacturer to receive an NDRC contract to develop tubes for this project. By March 1st, 1941, tubes made by Raytheon were being successfully shot from laboratory guns by the NDRC. Raytheon's major contribution during the initial stages of development was to establish the project as being practical from the tube manufacturing standpoint. By October of 1940 Raytheon claims to be the only company manufacturing tubes on automatic machinery with a glass bulb less than 4/10 in. in diameter, straight filament less than half inch long, filament secured to bottom mica by bracket beneath bottom mica.

(Continued on page 136)

Sectioned view of the Raytheon CK505AX tube used by NDRC in VT fuse development work

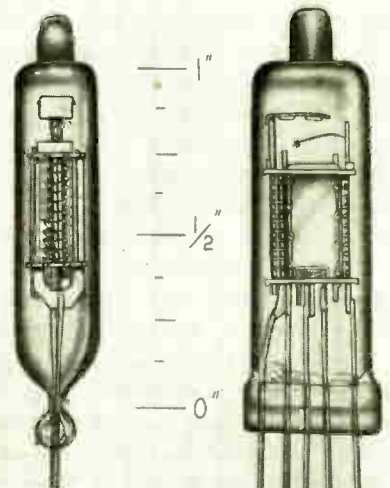



# RADIART VIBRATOR GUIDE (Most Complete Published)

*Makes  
Vibrator Servicing  
Easy!*

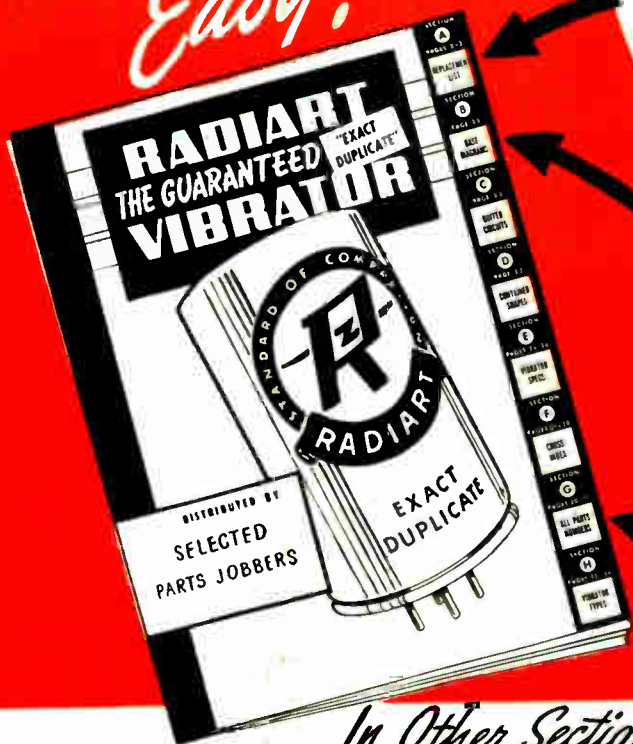

**MFRS. PART NO.**

**SERIES NO. SET MFR. YEAR MADE**

**RADIART NO.**

**BASE DIA.**

**LIST PRICE**

**BUFFER COND.**

**CAR MAKER**

**Section A...Vibrator**

Name, Model No.	Mfrs. Part Number	Radiart Number	List Price	Base Dia.	Buffer Condenser
<b>CHRYSLER</b>					
C1808 (Elec. P. B.) (Philco—1941)....	83-0027	5326P	3.00	A	.005
25C6 (Wells-Gardner—1938)....	19A32	5437	5.95	AB	.018
600 (Mech. P.B.) (Colonial—1941)....	43697	5301	3.55	A	.004
601 (Colonial—1942)....	911545	5301	3.55	A	.004
800 (Philco—1941)....	83-0027	5326P	3.00	A	.005

Every model listed includes all available data. The correct Radiart Replacement number and other essential information is determined instantly.

## SECTION "B"—Cross

Diagram Number	Shape	Voltage	Diam.	Ht.	Freq.	Identifying Characteristics	Max. Load Amps
B 3417	2 6	1 1/2	4 1/2	105	.....	6	
3815	9 6	1 1/2	4 1/2	105 Spec. Cup	.....	6	
C 6309	1 6	1 1/2	2 3/4	105	.....	6	
5331	1 6	1 1/2	3 3/4	105	.....	6	
D 4266	1 6	1 1/2	3 3/4	105	.....	10	
4256-12	1 12	1 1/2	3 3/4	105	.....	6	

In addition to conventional base diagram drawings this section is unique in that it groups all similar base types together indicating readily the differences between vibrators with the same base wiring. All characteristics are shown, including frequency and maximum load limit of each type.

## In Other Sections..

**Section "C"**—Buffer Condenser Values and Circuits.

**Section "D"**—Container Shapes permitting an easy method of "visual" identification.

**Section "E"**—Complete Vibrator Specifications arranged numerically by number. Contains necessary data not published in any other replacement guide.

**Section "F"**—Long a favorite with users of this guide. The only cross-index of all other manufacturers or merchandisers of vibrators, converting their type numbers to the Correct Radiart Replacement.

**Section "H"**—Numerical Listing of Radiart Vibrators. Furnishes complete information as to all models serviced by each unit. Also advises year each type was originated.

### Auto Radio Service Dealers:

Obtain this Guide free of charge from your Radiart Distributor. Ask him to furnish you with a stock of the popular 12 types of Radiart Vibrators each of which is guaranteed to CORRECTLY service the applications listed for it in this guide. With these 12 types you can satisfy nearly all of the "Demand" types. But — RADIART is a complete line and your Radiart Distributor renders a complete service and can quickly furnish all of the necessary slower moving correct Radiart Replacement Vibrators as well.

Manufactured by the makers of RADIART Rust Proof Aerials.

## SECTION "G"—Radiart and Original Equ.

Original Equipment Part No.	Radiart No.	Original Equipment Part No.	Radiart No.	Original Equipment Part No.	Radiart No.
75	3283	1974	5301	8539	
80-161	5421	2080	3417	8540	
82B	5341M	2110	3417	8541	
83-0017	5326P	2269	5413	8542	
83-0025	5326P	2404	5340M	8601	
83-0026	5326P	2501	5411	8602	

Another Radiart Vibrator Guide EXCLUSIVE feature. When called upon to duplicate a vibrator and no information is available except the number on the old one, use this cross-index which shows the original manufacturer's number (as stamped on vibrator) and the CORRECT Radiart Replacement.

# Radiart Corporation

3571 W. 62nd STREET • CLEVELAND 2, OHIO

Export Division  
25 Warren St., New York 7, N.Y.

Canadian Office  
455 Craig St., W., Montreal, Canada

# VIBRATOR TRANSFORMERS

*Efficiently Shielded  
by  
Drawn Steel Cases*

To users of vibrator power transformers, Chicago Transformer recommends its Compound Sealed, Drawn Steel Case construction to achieve maximum shielding, long and dependable operating life, and simplicity of mounting.

## C.T. also makes...

Power transformers for radio and other electronic circuits, audio and filter reactors, instrument transformers, auto and control transformers, wave filters, fluorescent ballasts and ignition coils.

# CHICAGO TRANSFORMER

DIVISION OF ESSEX WIRE CORPORATION

3501 WEST ADDISON STREET

CHICAGO, ILL.



(Continued from page 134)

These features, found in Raytheon's 1940 CK505AX hearing aid tube, were adopted and used successfully in all of the high vacuum tubes later made by Raytheon and other tube companies for the VT fuse.

During 1940 and 1941 Raytheon was the leading source of tubes and of engineering tests on tubes for the radio proximity fuse program, with shipments running 750 tubes per day from its pilot line by the time the Japs attacked Pearl Harbor. Early in 1941 Raytheon contributed a basically improved design of filament suspension which has since been used in all high vacuum tubes for the VT fuse. The success of the proximity fuses using these early tubes was great enough to justify a large scale production program which later followed.

Raytheon not only did the early development work on the proximity fuse tubes, but it also was the second largest producer of the tubes, its output being in excess of 10,000,000. Raytheon was the sole manufacturer to make flat tubes, and in certain weapons such as rockets and bombs, it was necessary to use one flat tube in each weapon.

As the war ended, Raytheon was manufacturing these tubes in Newton, Worcester, Greenfield, and Lincoln, Massachusetts, with sub-contractors making partially completed assemblies in Gardiner, Winchester, and Newton Highlands, Mass.

## SILICON CRYSTALS

(Continued from page 76)

roughly inversely proportional to the dc load into which the crystal works. The average dc voltage can of course be made to approach the peak applied voltage by putting a capacitance in parallel with the load.

For high frequency application, the crystal can be represented by the equivalent circuit shown in Fig. 9.

- $R_s$  = the spreading resistance (approximately 10 ohms)
- $R_b$  = the resistance across the blocking or barrier layer
- $C$  = the cartridge capacitance (0.4 uuf)
- $C_s$  = the storage or barrier capacitance
- $L$  = the series inductance of the whisker (approximately .01 uh)

$R_s$  and  $C_s$  are functions of voltage and frequency. The relative magnitude of  $C_s$  is approximately 1.75 uuf.

Since the blocking layer is but a few microns in thickness, the electron transit time is well below the reciprocal of any frequency obtained in the microwave region. Therefore, the only frequency lim-

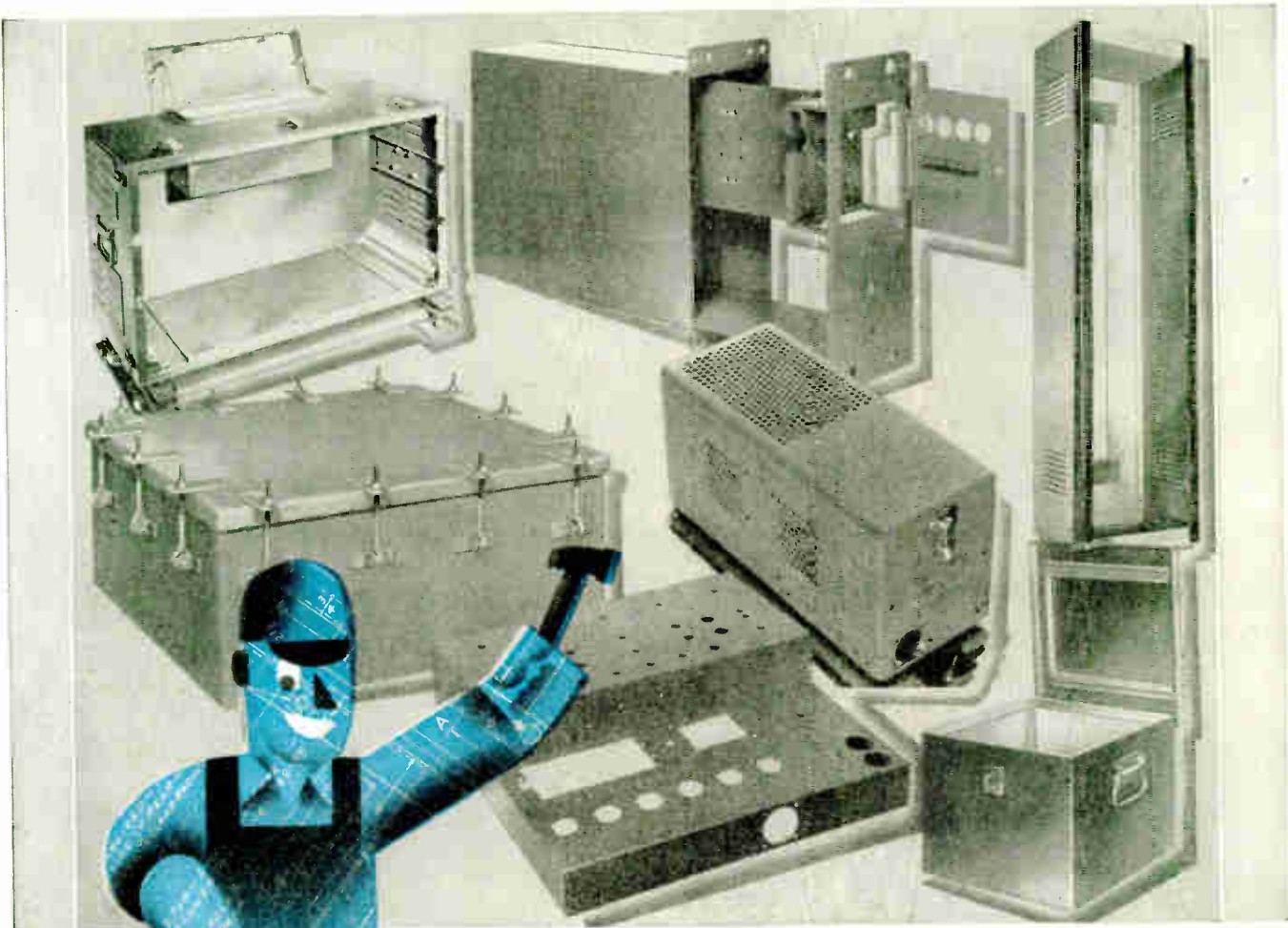

## **KARP solves peacetime housing problems**

All our extensive sheet metal fabricating facilities are now ready to help you speed production of your peacetime products.

Because our specialty in both peace and war years has been a custom-built service at ready-made economy, we have no reconversion worries or delays. We can serve you immediately—whatever your needs may be in sheet metal cabinets, boxes, enclosures or housings . . .

racks, panels, chassis for electrical or mechanical apparatus.

Our vast variety of stock dies is at your service to save your time and money . . . thanks to the fact that our production has never been standardized or restricted to any particular items.

Tell us your needs. Get quotations.

**ANY SIZE • ANY FINISH  
ANY GAUGE • ANY METAL**



# **KARP METAL PRODUCTS CO., INC.**

126-30th Street, Brooklyn 32, N. Y.

*Custom Craftsmen in Sheet Metal*

**AN AMPLIFIED  
ANSWER  
TO AN ENGINEER'S**

**DREAM**



**PARTICULARLY PERFECTED  
FOR PRE-EMPHASIZED  
DISC RECORDING**

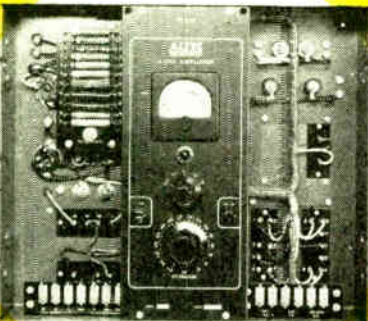

A new Altec Lansing 35 watt, 65 db gain, premium quality A255 amplifier, with plenty of reserve power and flat over the entire frequency range, has been particularly perfected for the requirements of high power at high frequencies as required for pre-emphasized disc recording. Curves, specifications and performance data will be sent immediately upon request. Refer to Altec Lansing's new A255, 35 watt, amplifier.

**ALTEC**  
LANSING CORPORATION

1210 TAFT BLDG., HOLLYWOOD 28, CALIF.  
250 WEST 57 STREET, NEW YORK 19, N. Y.  
IN CANADA: NORTHERN ELECTRIC CO.

itation is the internal capacitance of the unit itself, and this is not troublesome in any microwave region which has been explored to date.

In silicon "diodes" of the 1N21 type it is recommended that not more than 1.0 volt dc be delivered into a resistive load, although rather large overloads may be tolerated for short periods of time without changing the characteristics. An overload in excess of 5 volts blocking or 3 volts passing will ordinarily cause a change in the internal resistance of the crystal, but will seldom render it useless as a rectifier.

**UHF Applications**

The modern silicon crystal "diode" has no competition in the ultra and super high frequency ranges. Due to its excellent frequency response (hundreds or even thousands of times greater than that of vacuum tubes or other dry rectifiers), this unit is at present used chiefly as first detectors in microwave receivers. Its compact and light package, coupled with the fact that no heater or plate supply is required, renders it most valuable in portable and airborne equipment. Indeed, its inherent simplicity and lower cost suggests its replacing vacuum tube detectors in the lower microwave regions.

The asymmetrical characteristics of crystal "diodes" make them useful as low voltage valves. In this application their action is instantaneous. For example, if a current has been flowing in the forward direction and the polarity is suddenly reversed, a virtually immediate high blocking action occurs. This is a distinct advantage over the selenium type which requires an appreciable period of time to establish blocking action.

In a circuit such as Fig. 8 advantage may be taken of the nature of the non-linear characteristics of the crystal to provide regulator action. If the circuit constants and the operating point are chosen properly, the increase in crystal current due to an increase in applied voltage will lower the crystal resistance to such a degree that the crystal voltage drop—and hence the output voltage—are kept essentially constant.

Useful operating range may be determined from curves such as those of Fig. 5. In this connection it should be noted that the ordinates of these curves are plotted on a logarithmic scale. The value of R in the circuit above must be determined from a consideration of both the surrounding circuits and the crystal itself.

New materials and methods of manufacture have recently made possible the development of a line

**Engineered and built by**

*Doolittle*

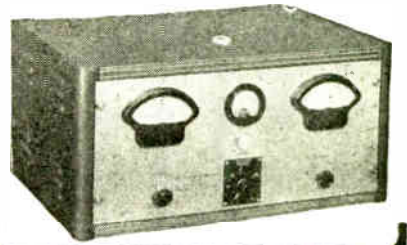

**FM and AM  
FREQUENCY  
MONITORS**

*Direct reading. No charts or complicated calculations necessary. Models available for 110 volt A.C. or battery operated portable use. Meet FCC requirements.*



**DISTORTION  
METER**

*Direct reading device which indicates as a percentage of the fundamental frequency, the square root of the sum of the squares of the harmonic components. It is used for audio frequency measurements in any audio device in the usual range of voice or musical notes from 150 to 15,000 cycles.*

• Utilize the many advantages of these units now. They are sturdily built, self-contained, moderately priced. Remember . . . equipment pioneered by DOOLITTLE years ago, still serves efficiently today!

SEND FOR FULL DETAILS

*Doolittle*  
**RADIO, INC.**

7421 SOUTH LOOMIS BOULEVARD  
CHICAGO 36, ILLINOIS

**BUILDERS OF PRECISION  
RADIO EQUIPMENT**

The Sherron Cathode Ray Null Detector is available in standard 19" rack mount panel. All electrical characteristics are the same as those of the standard model.

Model SE 1

## SHERRON CATHODE RAY NULL DETECTOR

*A Laboratory Precision Instrument Built for Production Application*

THE SHERRON CATHODE RAY TUBE NULL DETECTOR is a precision laboratory instrument designed for all A.C. Bridge measurements.

- It is both a high impedance detector and an undistorted, filtered and shielded source of 1000 cycles per second.
- It has a gain of 80 db at an input voltage of 100 micro volts.
- Bridge detector impedance is 1 megohm.
- Use of the Cathode Ray Tube permits the separate positive adjustment of both reactance and resistance with their individual indication on the same Cathode Ray Tube.
- Comparison of frequencies can be obtained by means of Lissajous figures.
- Self protection from overloading is included in this unit. Under any input conditions, the circuit cannot be overloaded or damaged.
- Since headphones are eliminated, this unit can be used in noisy locations by employing the Cathode Ray Tube for visual indication.
- Automatic control of the gain precludes the necessity of resetting while adjusting bridge for balance.

*Every precision type Bridge requires  
a Sherron Precision Null Detector*

**Sherron  
Electronics**

# SHERRON ELECTRONICS COMPANY

*Division of Sherron Metallic Corporation*

1201 FLUSHING AVENUE, BROOKLYN 6, N. Y.

**"Where the Ideal is the Standard, Sherron Units are Standard Equipment"**



No. 5 of a Series

# MODERN COIL WINDINGS

## Partial View of Assembly Department

For many months, COTO-COIL facilities have been employed in producing wartime essentials. Now, as we have so long hoped, our entire plant can be devoted to peacetime industry.

Our 28 years of experience are at your service to help you with modern coil design and construction.

# COTO-COIL CO., INC.

COIL SPECIALISTS SINCE 1917

65 PAVILION AVE.

PROVIDENCE 5, R. I.

of crystal "diodes" which will withstand voltages in the blocking direction of the order of 50 to 100 volts. These units, for use at frequencies up to 100 mc, have a current carrying capacity from two to three times greater than that of the familiar type 6H6. Such crystals have excellent potentialities as second detectors, diode modulators, clippers, pick-offs, etc. Eventually they may replace vacuum tube diodes in most applications where current drain is small and low capacitances is of prime importance.

Like the silicon "diode," the new types may be used as voltage regulators, and since they withstand much higher voltages, will find many more applications of this principle. Another unusual characteristic of these crystal rectifiers is that they exhibit negative resistance properties which suggest their use as very light and compact oscillators. As we look into the future, it would appear that we have only just begun to realize the potentialities of crystal "diodes."

## HIGH VACUUM PUMPING

(Continued from page 77)

requires a stable oil of very low vapor pressure, without contaminants. Such an oil is produced by Eitel-McCullough for use in the HV-1 (Eimac Type A pump oil) under a carefully-controlled vacuum distillation process which utilizes a battery of HV-1's.

An ultimate vacuum of  $4 \times 10^{-7}$  mm. of mercury is attainable by the HV-1 in industrial applications, but this extremely low pressure requires the removal of every possible source of contamination from the high-vacuum system.

Neoprene is recommended in place of rubber for gasket material, as rubber is particularly objection-

Schematic showing the relation between the diffusion pump and the fore pump

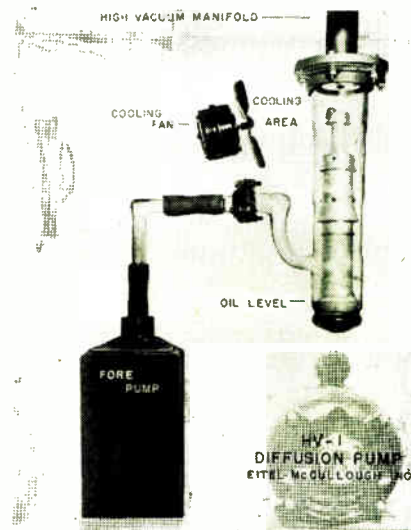

# THE *Quiet* BALLENTINE RECORD CHANGER MOTOR

Has these four characteristics achieved by advanced design, skilled engineering and precision manufacturing.

- Lowest Rumble • Highest Efficiency
- Most Compact Design • Longest Life

The *Quiet Ballentine* Changer Motor is recommended to record changer manufacturers seeking to provide the ultimate in performance.

RUSSELL  
ELECTRIC CO.  
366 West Huron Street  
Chicago 10, Illinois  
*Manufacturers of*  
BALLENTINE  
RECORD  
CHANGER  
MOTOR

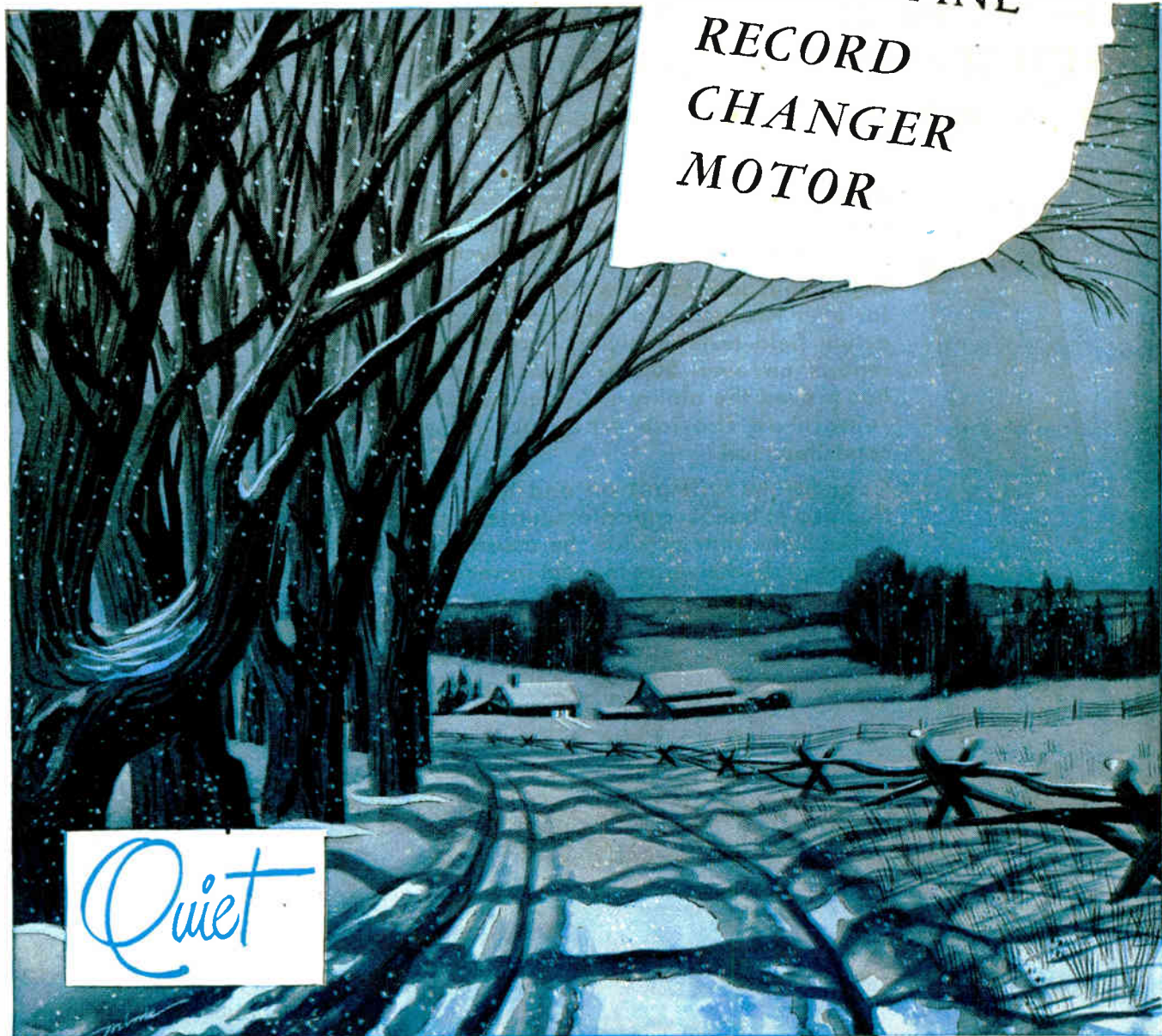

*Quiet*

IF ONLY I HAD USED **CAPACITRONS**  
IN MY FLUORESCENT  
BALLASTS!



## You Too Will Want the Dependability of CAPACITRONS to Keep Your Ballasts on the Job at Extreme Temperatures



Capacitron fluorescent ballast capacitors are the result of one of the most extensive research projects ever conducted.

Continuous laboratory work, carried on for over two years in conjunction with actual field tests involving operational reports on over 20,000 service units, has proved the ability of Capacitrons to remain on the job when ordinary capacitors fail.

Capacitrons will put an end to your fluorescent ballast capacitor worries and at the same time provide the assurance of adequate deliveries to meet increased production requirements. Why not let us work with you now?



**IMMEDIATE  
DELIVERY!**

Telephone VAN Buren 3322



**The CAPACITRON Company**

849 North Kedzie Ave., Chicago 51, Illinois

able in this use. It is also important that the lubricating material used in all stop-cock, valve gasket connections have the lowest possible vapor pressure.

By using more than one HV-1 unit in multiple, a considerable increase in pumping speed (though not in the ultimate vacuum obtained) is attained. However, three HV-1 units in multiple is the maximum number necessary, as they will remove more gas than the largest mechanical forepumps are capable of handling.

### RECEIVER DESIGN

(Continued from page 81)

tion for high stability and coined silver elements for good conduction.

5. Flexible coaxial cables have been developed which are useful for television antenna purposes and in production tests of radio receivers. That is, they serve to deliver high frequency energy from a central signal generator to remote testing positions.

6. For radio sets intended for use in the tropics, there have been developed means for applying chemical protection enabling the sets to function for long intervals of time.

7. Silicone varnishes are now available allowing reliable power transformers to be built in compact form for operation at high temperatures.

8. Progress on wire recording mechanisms for the armed forces will hasten the application of this device to home receivers.

### Lumped Constants

By R. M. Jones,  
Admiral Corp., Chicago

One of the most important advances in the radio art resulting from military experience in the design of communication equipment has been the bridging of that frequency gap in the VHF region where previous lumped circuit constants were too small to be practical and linear circuits were too bulky for the ordinary equipment. The development of new tubes and the improvement of design technique resulting from greater familiarity with the problem has made it possible to use lumped circuit constants throughout the VHF band. Improved iron cores for these frequencies and the development of "Butterfly" tuning circuits have also increased the frequency range at which ganged tuning of receivers is practical.

Other distinct advances may be seen in the development of efficient antenna systems for reception on a broad band of frequencies; the development of improved antenna



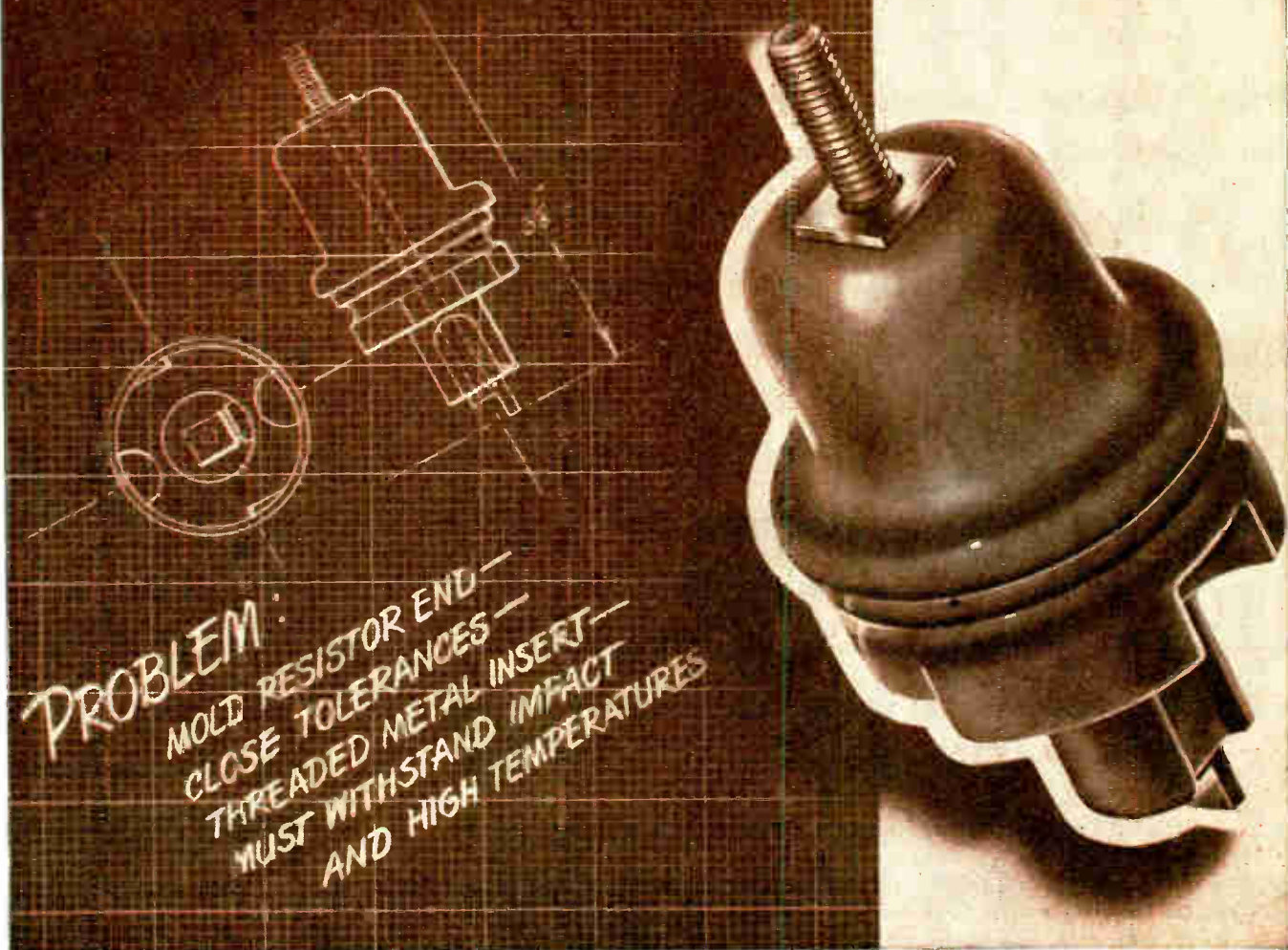

**G-E MYCALEX — FOR SAFE-CONDUCT THROUGH SHOCK AND HEAT**

● Here is the end of a sealed tubular resistor unit that operates at extremely high temperatures. It forms the outside electrical connection of the unit.

Heat-resistant material designed to withstand impact had to be molded over a long threaded metal insert . . . to intricate, grooved dimensions so that a metal shell could be spun over it and held tightly in place.

These exacting specifications were met by injection-molding G-E mycalex—compound of glass and powdered mica with a unique combination of properties.

Why not investigate the possibility of specifying G-E mycalex for your own electrical components? This material is available to you in standard rods and sheets or molded to your design. For information, write to Section T-4, Plastics Divisions, General Electric Company, 1 Plastics Avenue, Pittsfield, Mass.



**G-E MYCALEX**

*A Unique Combination of Properties*

1. High dielectric strength
2. Low power factor
3. Prolonged resistance to electrical arcs
4. Chemical stability—no deterioration with age
5. Dimensional stability—freedom from warpage and shrinkage
6. Imperviousness to water, oil, and gas
7. Resistance to sudden temperature changes
8. Low coefficient of thermal expansion
9. High heat resistance

*Samples Supplied on Request*

**GENERAL  ELECTRIC**

GD46-M4

# Service Approved DYNAMOTORS

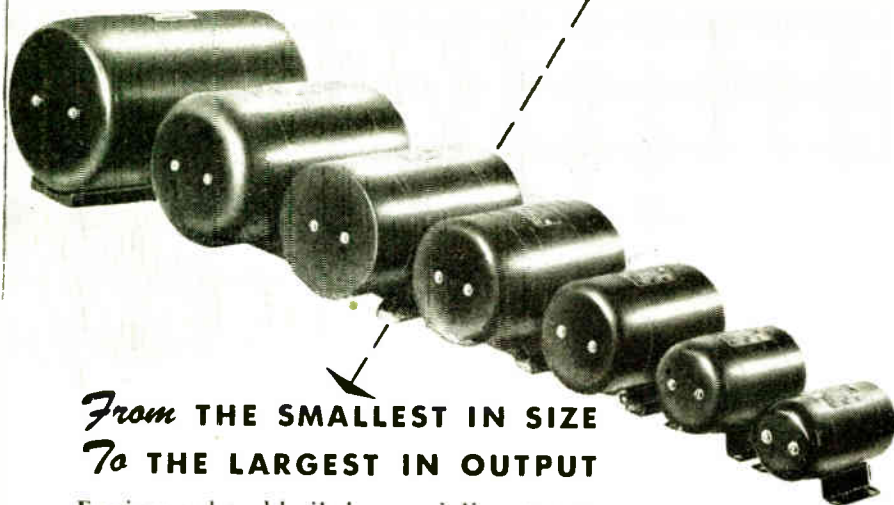

From THE SMALLEST IN SIZE  
To THE LARGEST IN OUTPUT

Engineered and built by specialists, EICOR DYNAMOTORS have earned their fine reputation through years of exacting service. These dependable units furnish the necessary high voltage power for communications, direction finding, radio compass and other controls.

Our complete line of frame sizes makes possible the widest available range of dynamotor output ratings in the most compact sizes and weights. This assures the most economical size and weight for every need!

The experience and skill of Eicor Engineers are instantly available to help you on any problem involving Dynamotors, Motors, or Inverters.



Send for Helpful  
**DATA FOLDER**

*This handy folder gives useful data and information on EICOR Dynamotors, D. C. Motors, and other Rotary Electrical Equipment. Write for it!*

SERIES NO.	MAX. OUTPUT WATTS	DIAMETER	LENGTH	WEIGHT
2300	10	2 $\frac{5}{16}$ in.	4 $\frac{7}{8}$ in.	2 $\frac{1}{8}$ lbs.
2700	15	2 $\frac{3}{4}$ in.	4 $\frac{3}{4}$ in.	2 $\frac{3}{4}$ lbs.
3400	125	3 $\frac{7}{16}$ in.	5 $\frac{5}{8}$ to 8 $\frac{1}{2}$ in.	4 $\frac{1}{2}$ to 7 $\frac{1}{2}$ lbs.
4100	200	4 $\frac{1}{16}$ in.	6 $\frac{1}{2}$ to 7 $\frac{3}{8}$ in.	6 $\frac{3}{4}$ to 9 lbs.
4500	250	4 $\frac{1}{2}$ in.	6 $\frac{1}{2}$ to 8 in.	11 $\frac{1}{2}$ to 13 $\frac{1}{4}$ lbs.
5100	350	5 $\frac{1}{8}$ in.	8 $\frac{1}{2}$ to 10 in.	17 to 21 $\frac{1}{2}$ lbs.
6100	500	6 $\frac{1}{16}$ in.	9 $\frac{5}{8}$ to 12 in.	28 to 36 lbs.

**EICOR, INC.** 1501 W. Congress St., Chicago, U. S. A.  
DYNAMOTORS • D. C. MOTORS • POWER PLANTS • CONVERTERS  
Export: Ad Auriema, 89 Eroad St., New York, U. S. A. Cable: Auriema, New York

feeders; the design of grounded grid amplifiers for rf stages and the improvement of tubes and design technic for high frequency if channels. The design of new tubes having a lower signal to noise ratio and higher input impedance at VHF improves the usable sensitivity of receivers.

## Mechanical Design

By J. E. Brown

Zenith Radio Corp., Chicago

Experience gained in design and production of military radio equipment has resulted in improved FM



circuits and components resulting in a simpler and better product; this includes improved vacuum tubes. The effect of war design and production experience on straight

broadcast receivers has resulted in better mechanical design and construction together with performance improvements through the use of new vacuum tubes and improvements in components. Components and chassis design show mechanical improvements and refinements as result of high requirements of the military agencies.

## Radar Technics

By W. L. Dunn,

Director of Engineering and Research,  
Belmont Radio Corp.

It is our opinion that while technics developed during the war may revolutionize communications and industrial electronics, they are not for the most part usable in broadcast receivers, whether the receivers be FM or AM. It is our feeling that war time electronic developments have been greatly overplayed.

The only developments immediately usable have to do with protection against climatic conditions, improved plastics and better processing of components. Radar technic has probably contributed much to the long range future of television and to a slight degree to the development of television receivers in present commercially assigned bands. We in the Belmont Engineering Department find ourselves in the position of having to forget a temporary orgy of freedom from design limitations and to reestablish our engineering designs around good sound economic principles characteristic of the radio industry prior to the war.

# A Helping Hand TO THE ELECTRONICS ENGINEER!

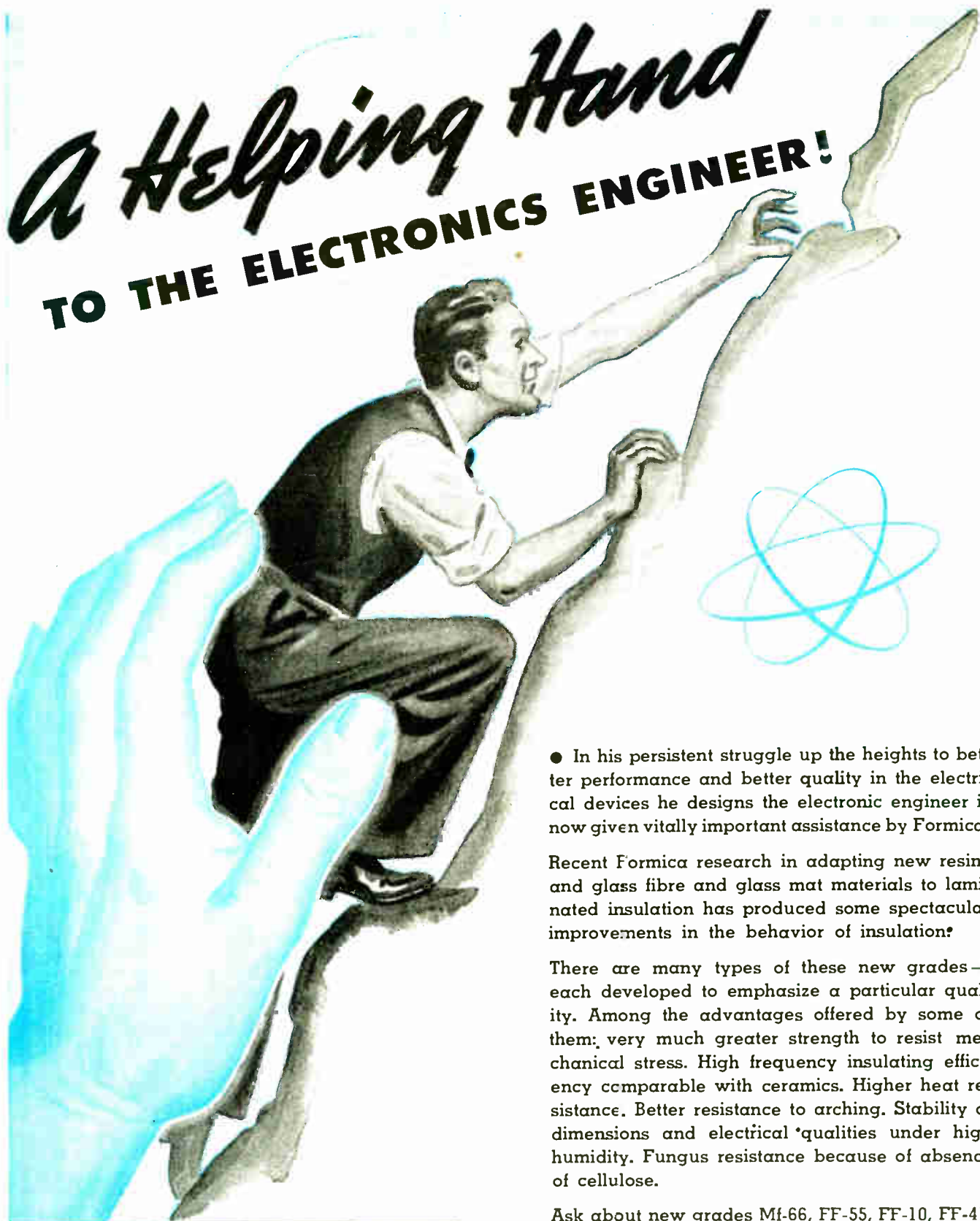

● In his persistent struggle up the heights to better performance and better quality in the electrical devices he designs the electronic engineer is now given vitally important assistance by Formica.

Recent Formica research in adapting new resins and glass fibre and glass mat materials to laminated insulation has produced some spectacular improvements in the behavior of insulation.

There are many types of these new grades—each developed to emphasize a particular quality. Among the advantages offered by some of them; very much greater strength to resist mechanical stress. High frequency insulating efficiency comparable with ceramics. Higher heat resistance. Better resistance to arcing. Stability of dimensions and electrical qualities under high humidity. Fungus resistance because of absence of cellulose.

Ask about new grades Mf-66, FF-55, FF-10, FF-41.

## FORMICA

THE FORMICA INSULATION CO.

4647 SPRING GROVE AVENUE

CINCINNATI 32, OHIO

**Build the competitive advantages of longer life better performance into your products...with**

# SPERTI HERMETIC SEALS

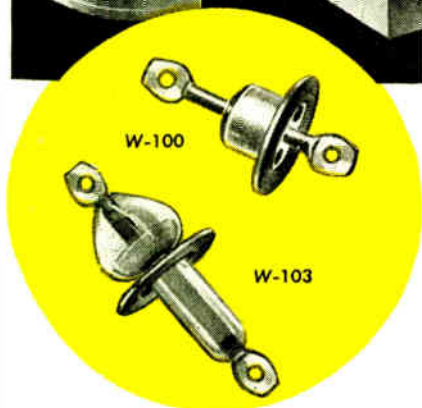
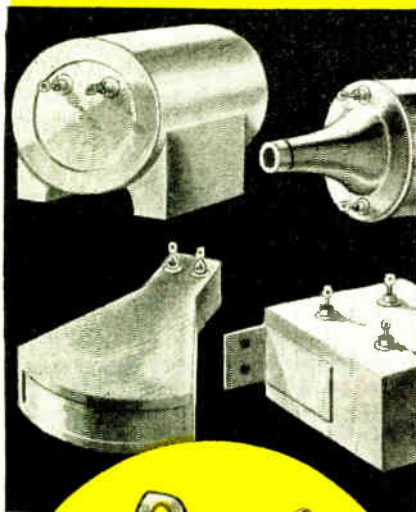

**BUYERS** who have waited through the war years will be looking for big improvements in your products. You'll have to meet civilians' expectations... just as you have met military specifications.

You can do it by building longer life, better performance, more trouble-free operation into your products. That calls for Sperti Hermetic Seals, the rugged, dependable, war-proved seals that effectively shut out dust, moisture and deteriorating agents.

Sperti Hermetic Seals are durable, one-piece units, easily soldered-in at less expense. Because of Sperti's advanced manufacturing methods, plus exhaustive tests and inspections, you'll get "true" seals that cut down production delays and costly rejects in the inspection line.

**WRITE, TODAY.** Get the facts. Find out about the many product applications of Sperti Hermetic Seals and their performance advantages.



## Sperti

Incorporated, Dept. EI-115  
Cincinnati 12, Ohio

RESEARCH • DEVELOPMENT • MANUFACTURING

## PAYING THE ENGINEER

(Continued from page 85)

should not expect direct or immediate compensation for these, because he is expected, if he is in a research department, to have new ideas. On the part of management it is only wise both to commend and, if possible, reward indirectly the younger engineer who is inventive.

Sharing profits with employees is fundamentally sound and desirable. Employees who are shareholders in a company make much better workers and managers.

### Complex problem

Another experienced engineering executive has the following comments on the five bonus proposals already set forth:

There is no doubt that a workable plan for incentive compensation to engineers can be worked out for the radio electronic industry. However, such a plan, if it is to be equitable will have to be rather complex. For example: Take the suggested bases already proposed. (1) Capital, or earning value, of innovations introduced. How is such value to be determined, and for what period of time? There comes a much more important factor. Having determined the value of the innovation, how shall we scale the bonus—for the reward should be much less to the engineer who has been assigned specifically to the problem, than to one who discovers it as a by-product of this work.

### Value of patents

(2) Same problem as (1) but magnified, since the value of a patent cannot be fairly determined until adjudicated and after a rather substantial lapse of time.

The 3rd and 4th bases for bonuses are even more delicate, since in the production of company or department volume, or company net profit, there are so many other factors of far greater importance.

Certainly, a plan can be worked out—probably should be—and no doubt one day will be, though one cannot be at all sure that the true scientist, the researcher, will respond as much to direct financial incentives as to some other forms.

It is a question which has many facets, not all of which have been very thoroughly explored, and on several of which most engineers and employers probably have no opinion, much less conviction.

In conclusion, observes this engineering executive who views the problem from both sides of the fence, "I'd welcome the opportunity of reading the views of others, and



## CAPACITY... for the hard-to-do

When the assembly of your product requires a special fastener or cold-forged product, call on our consultant service to help you at no obligation to you. We are equipped to manufacture cold-forged specialties in a wide range of metals, sizes and designs, in large or small quantities. In most instances, too, you'll find that cold-forging your special part represents a saving.



This Decimal Equivalents wall chart is accurate to four places and signalled in three colors. Yours at no cost or obligation. Just send us your name, title and address.

See our Catalog in Sweet's File for Product Designers

## JOHN HASSALL INC.

Specialists in Cold-Forging Since 1850

412 Oakland St.  
Brooklyn 22, N.Y.



# Tops in the Field

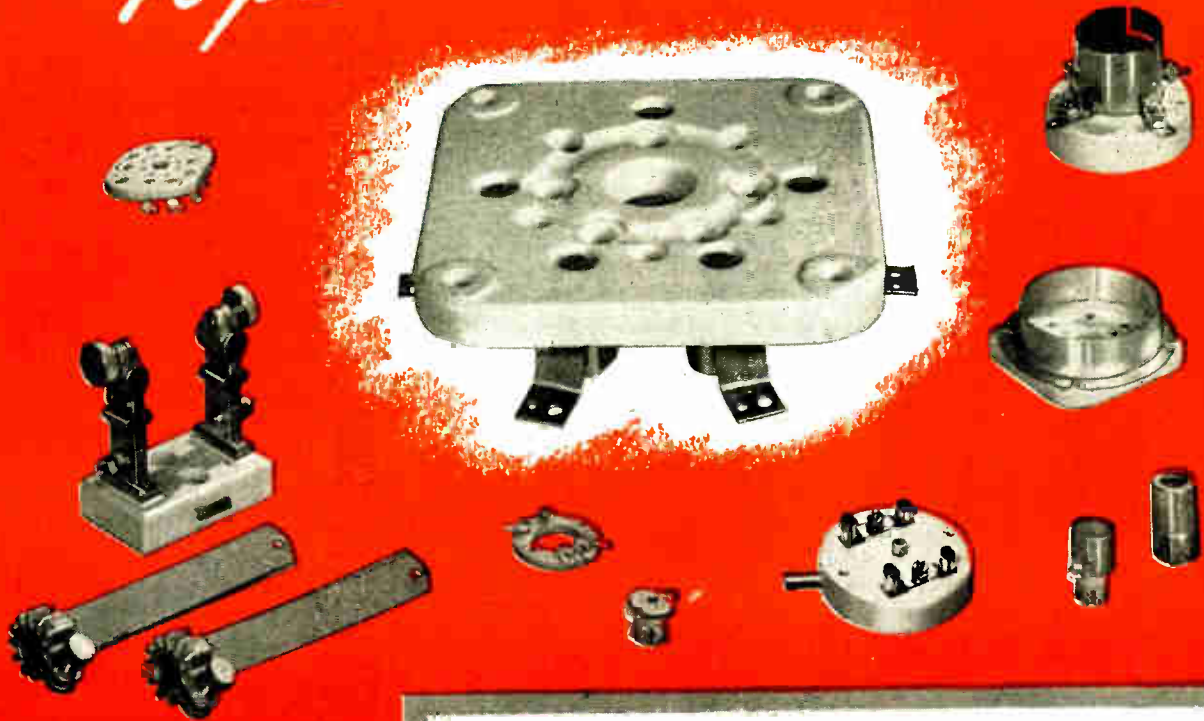

Write for  
**TUBE SOCKET  
GUIDE**

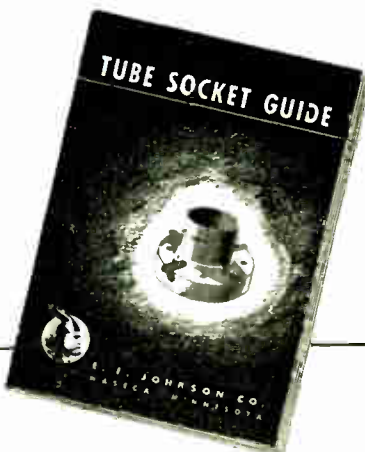

Johnson sockets are stocked by leading radio-electronic parts jobbers.

The latest addition to the famous line of Johnson tube sockets is the 275, Giant Five Pin socket with all the outstanding features which have made other Johnson sockets superior. A special feature of the 275 is the provision that has been made to allow forced ventilation from below the chassis, as required for the recently announced Eimac 4-125A and 4-250A. This socket may also be used for other Giant Five Base tubes when a wafer type socket is desired.

Johnson sockets are engineered to meet the most exacting requirements of industrial, commercial broadcast and "ham" applications. For more than 20 years Johnson engineers have designed, and Johnson production lines have produced, transmitting components known throughout the industry as tops in the field. With this background and the close association with tube manufacturers, Johnson is continually leading the way with tube sockets designed to meet the rigid requirements of present day electronic circuits and equipment.

If you have a special tube socket problem, write Johnson, today.

## JOHNSON

*a famous name in Radio*



An  
*Outstanding New Line*  
 of  
**A·C and D·C RELAYS**

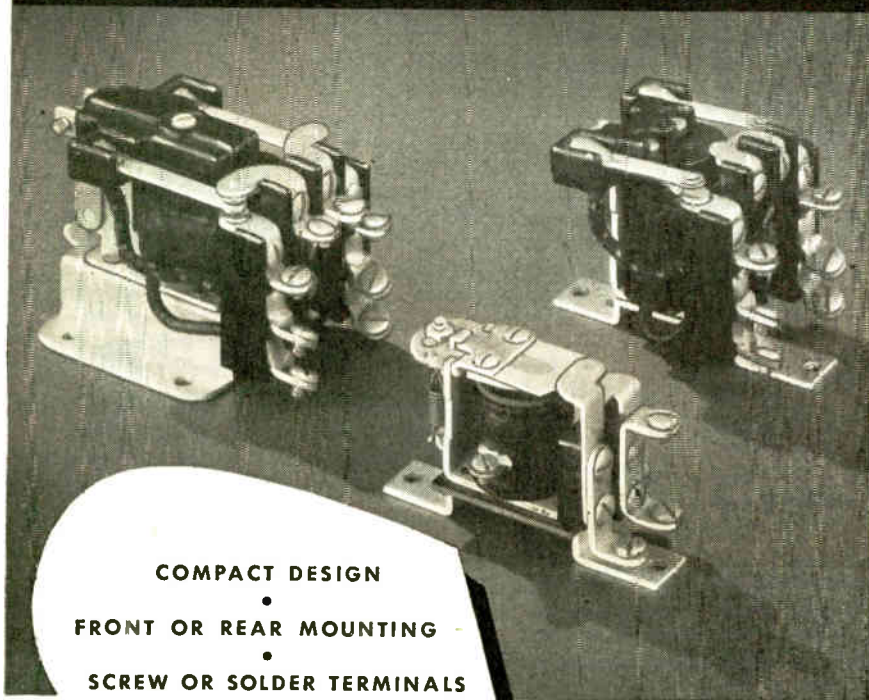

COMPACT DESIGN  
 •  
 FRONT OR REAR MOUNTING  
 •  
 SCREW OR SOLDER TERMINALS

● R-B-M announces a new and improved design of magnetic relays rated 10 amperes at 24 volts D. C. and 110 volts A. C. and 5 amperes at 220 A. C. Relays rated at one horse power single phase 110 and 220 volts A. C. Silver to silver contacts. Self-aligning armature. All wiring terminals accessible from front. Contact arrangement—single and double pole; normally open, normally closed and double throw. Steel mounting with A. C. and D. C. relay mounting dimensions interchangeable. Available in open type or with sheet steel general purpose enclosure. Bulletin 510 on D. C. relays and Bulletin 560 on A. C. relays available upon request. Write Department B-11...

**R-B-M MANUFACTURING COMPANY**  
*Division of*  
**ESSEX WIRE CORPORATION**  
**LOGANSPORT, INDIANA**



MANUAL AND MAGNETIC ELECTRIC CONTROLS—FOR  
 AUTOMOTIVE, INDUSTRIAL, COMMUNICATION AND ELECTRONIC USE

suggest that Electronic Industries might render a genuine service by conducting a survey tabulating opinions, and publishing the results."

**In broadcasting field**

Most of the interest in incentive compensation has come from the industrial field. An experienced broadcast engineer with whom this subject has been discussed comments as follows:

"I personally believe that an incentive pay system is a distinct advantage in any industry where its application is practical. However, the problem is so vastly different in radio manufacturing in comparison to broadcast-station operations that it does not seem to me advisable to cover both subjects within the scope of one set of compensation standards.

"In manufacturing industries the incentive can be directly tied to the production of goods, and an individual's own efforts may determine his incentive compensation. In broadcasting it is only teamwork that counts. The efforts of the individual, except in the case of the salesman, usually cannot be measured in terms of productive capacity. Many broadcast stations have bonus arrangements, shared by all employees, based on the net earnings of the enterprise. This type of incentive should be productive of the teamwork necessary in broadcast operations."

**Paying Engineers for Inventions and Patents**

*Editor's Note—The secretary of the Chicago Section IRE, Alois W. Graf, has long been interested in matters relating to the compensation of engineers and technical men. As a practicing attorney, he has also been concerned with payments for inventions and patents. Accordingly an advance copy of the foregoing article was shown to Mr. Graf, and he comments on it in the following letter:*

*Editors, Electronic Industries—*

I am very familiar with Alpha Co. but am not able to agree with the final conclusion that there was not very much incentive. I would state rather that there was insufficient incentive, which, however, was primarily due to a lack of early education of the younger engineers of the employing company as regards the place patents played in that company's business and the value placed upon patents when considering advancement, returns in times of depression, or hiring of engineers. I have had occasion several times to make recommendations relative to the employment of engineers based upon their contribution in inventions.

I believe that between Beta and Gamma attention might be direct-

# NOW AVAILABLE

## FOR ALL CIVILIAN USE...

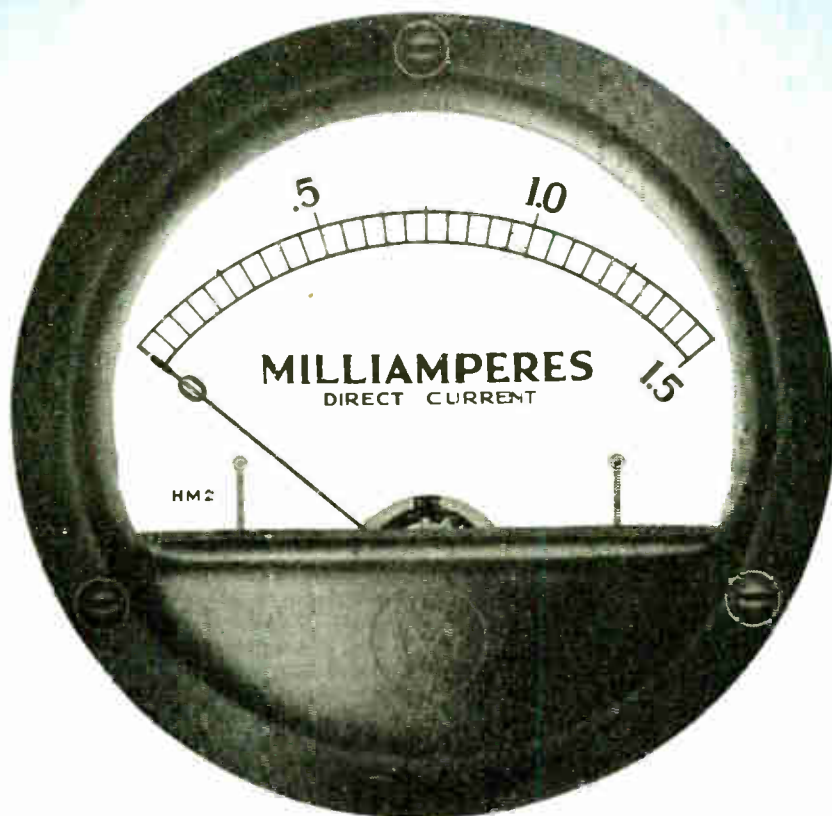

..... AT NO MORE COST THAN  
STANDARD UNSEALED INSTRUMENTS

*Marion Glass-to-Metal Truly Hermetically Sealed  
2 1/2" and 3 1/2" Electrical Indicating Instruments*

IMPROVED PRODUCT • APPEARANCE • PERFORMANCE • RELIABILITY

Write for our 12-page brochure



MARION ELECTRICAL INSTRUMENT CO.

MANCHESTER, NEW HAMPSHIRE

EXPORT DIVISION • 458 BROADWAY • NEW YORK 13, N. Y., U. S. A. • CABLES: MORMANEX

# NEW!

A complete,  
24 page  
Illustrated  
Manual

on *Permanent Magnets*

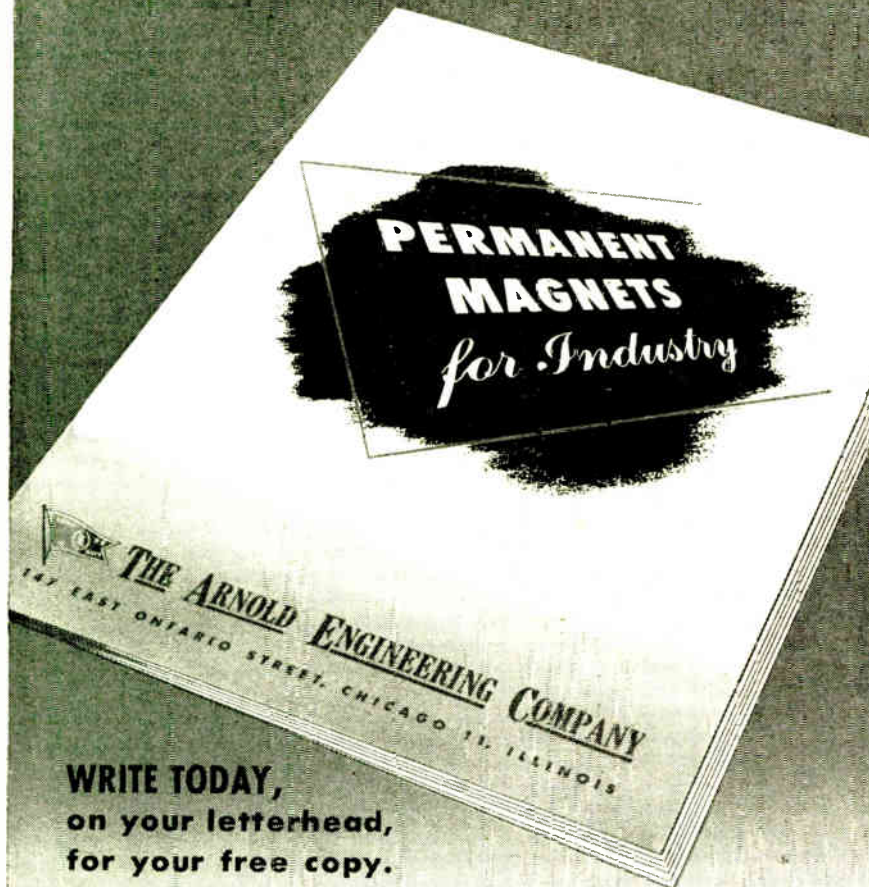

**WRITE TODAY,  
on your letterhead,  
for your free copy.**

This unusual Arnold manual on permanent magnets is the product of many months of careful research and planning.

It is devoted entirely to the consideration of the factors affecting the design, fabrication and application of Alnico permanent magnets. Written entirely by Arnold engineers, its purpose is to help engineers in industry to better utilize the magnetic and physical characteristics of the Alnico alloys in arriving at efficient design.

Write today, on your letterhead, for your free copy.



## THE ARNOLD ENGINEERING COMPANY

147 EAST ONTARIO STREET, CHICAGO 11, ILLINOIS

Specialists in the Manufacture of ALNICO PERMANENT MAGNETS

ed to the method of another company (Western Electric Company) which pays a flat sum of two hundred dollars (\$200) to the employe when the patent is granted regardless of whether the employe is still with the company.

I have come across another plan which in an arbitrary way predicates the compensation upon some measure of the value of the patent. This company pays each inventor fifty dollars (\$50) upon the filing of each patent application. When a patent is issued compensation is offered under the following schedule: If the engineer is still with the company, a patent having less than ten claims gives the engineer payment of eight dollars (\$8) per year over a ten-year period. A patent having from ten to twenty claims pays ten dollars (\$10) a year for ten years, and a patent having twenty to one hundred claims pays twelve dollars (\$12) per year for ten years. Since the patents covering the greatest advances generally contain the greater number of claims, this scheme after some fashion varies the compensation in accordance with some measure of value of the invention. I thought perhap you might want to tell your readers about these plans in this article.—Alois W. Graf.

Moore, Olson & Trexler,  
135 S. La Salle St.,  
Chicago 3, Ill.

## NAVY'S ORGANIZATION

(Continued from page 93)

named head of the Special Electronics Research and Development Division. He is well known for discovery of Miller effect and development of the vacuum tube bridge. Dr. Miller is a Fellow of the Institute of Radio Engineers, Ph.D. (Yale), and holder of more than 20 electronic patents. After previous service at the Naval Research Laboratory, he became associated with Atwater Kent and later served as assistant head of RCA Mfg Co.'s research laboratory, working in the ultra-high frequency and television fields. With the first signs of World War II, Dr. Miller returned to the Naval Research Laboratory as associate superintendent of the radio division.

L. A. Gebhard whose radio career started in 1917, since which time he has rendered distinguished service to the Navy in radio research, heads the Ship-Shore Radio Division. Mr. Gebhard is an electrical engineering graduate of George Washington University and holds an LL.B. degree from Georgetown University.

Still in the formative stage in the Naval Research Laboratory Electronics organization is a new



## Here's How Resistance Welding Pays:



Weld-O-Trol and weld-and-sequence timer added to this welder brought a net saving of \$23,960.05 in production of blower units.

This large electrical manufacturer reaped a \$23,960.05 dividend from two electronic units that put resistance welding to work on his production line.

To begin with, he invested \$493 in this electronic equipment... a Westinghouse Weld-O-Trol and an automatic weld-and-sequence timer. These controls were added to a welder whose original cost was \$2,020, making a total outlay of \$2,513.

The unit was then used to resistance-weld two types of double-sided blowers, which included welding 24 vanes on each side of the main circular sheet and a reinforcing ring welded to the vanes on the outside. The blowers, made of 1/8" mild steel, were formerly welded by a slower process.

How well resistance welding speeded the operation is shown by the savings in labor costs over a period of one year in producing 4,155 units... a total saving of \$26,473.05! Subtract the investment and the manufacturer still pocketed \$23,960.05... a gift of resistance welding to his

recognition of the high ability of this electronic welding process.

The results of this remarkable history are nothing new to users of resistance welding familiar with the wide flexibility of this modern production tool. Ask your nearest Westinghouse office to show you how resistance welding control can work in your plant. Westinghouse Electric Corporation, P. O. Box 868, Pittsburgh 30, Pa. J-21345



**Westinghouse**  
PLANTS IN 25 CITIES . . . OFFICES EVERYWHERE

*Electronics at Work*

**WRITE FOR YOUR  
COPY TODAY!**



**Akra-Ohm  
Resistors**

Accurate Fixed  
Wire Wound  
Types

*This New Bulletin  
tells you what you  
want to know about*  
**ACCURATE FIXED  
WIRE WOUND  
RESISTORS**

**DIMENSIONAL SPECIFICATIONS • MOUNT-  
ING AND TERMINAL DESIGNS • POWER  
DISSIPATION • TEMPERATURE COEFFI-  
CIENT OF RESISTANCE • MAXIMUM  
RESISTANCE CHARTS • RESISTANCE  
ALLOYS • MOISTURE AND FUNGUS  
PROOFING • HERMETIC SEALING**

*Shallcross Types Designed to  
Meet JAN-R 93 Specifications*

**SHALLCROSS MFG. CO.**

**DEPT. EI-115 COLLINGDALE, PA.**

**ENGINEERING • DESIGNING • MANUFACTURING**

airborne electronics division. R. A. Gordon, a veteran of World War I, and well known to radio engineers throughout the country, has been appointed Assistant Superintendent of this division. Mr. Gordon was formerly Chief of the Aircraft Section of the radio division.

The new Division Superintendents find themselves as Naval Research Laboratory Superintendents in company with such distinguished scientists as Dr. Harvey C. Hayes (acoustics), Dr. E. D. Hulburt (physical optics), Dr. Ross Gunn (general physics, and director of a successful joint Army-Navy precipitation static reduction project), Dr. Parry Borgstrom (chemistry) and Dr. F. M. Walters, Jr. (metallurgy).

**RADIO FREQUENCY CORE**

*(Continued from page 89)*

the conductivity decrease with temperature would decrease eddy current losses:

It is often of importance to know the effect of current intensity on permeability. Fig. 8 shows the permeability, expressed in per cent of initial permeability, as a function of alternating magnetizing force  $H = 0.4 NI/d$  oersted (or gilbert/cm) where  $N$  = the number of turns of wire,  $I$  = peak current (Amp) and  $d$  = effective magnetic diameter (cm). It can be seen that the increase in permeability with higher magnetizing force is proportional to initial permeability.

In Fig. 9 are shown the magnetization curves of the three rings, as determined by the ballistic method. Again, as one would expect, the magnetic variables, such as flux density, saturation magnetization, overall permeability and incremental permeability show a striking correlation to the three initial permeabilities, 40, 55 and 70.

Fig. 10 gives the hysteresis "loops," computed from the hysteresis loss coefficients on the assumption of ellipsoidal shape:

$$a_1 = 0.5 a B^2 \text{ from Legg (19)}$$

$$\text{and } a_1 = \pi \frac{H}{\cos \alpha} B_r \cos \alpha = HB_r \pi$$

$$\text{hence } B_r = \frac{a \mu B^2}{2\pi}$$

where  $a_1$  = area of hysteresis loop,  $a$  = hysteresis loss coefficient,  $B$  = peak flux density,  $H$  = magnetizing force,  $\alpha$  = the arc tan of the slope of the B-H curve,  $B_r$  = retentivity.

It should be noted that the thickness of the "loops" is only about 1/10,000 of their length and thus is less than the thickness of the lines in the drawing.

These "loops" apply to  $L = 1$  mh and  $I = 1$  ma (r.m.s.).

*(Continued on page 154)*

# Enclosed CLARE "Custom-Built" RELAYS

Assure Long Life, Trouble-Free Operation  
for WELTRONIC WELDING TIMERS

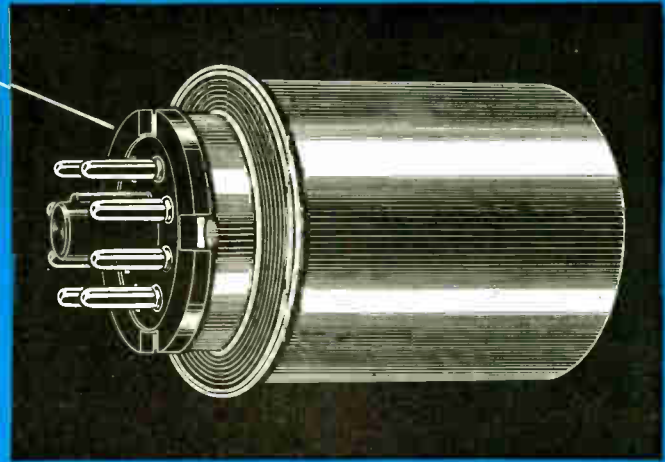
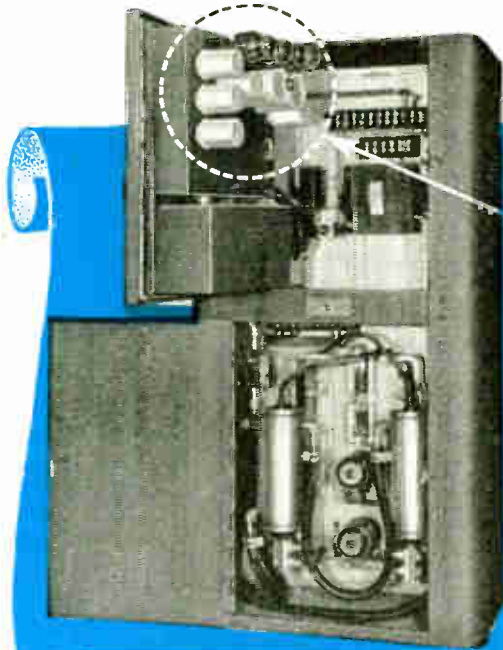

## TYPE "K" SEALED-IN RELAY

Clare Type "K" Sealed-in Relay  
(2 11/32" long x 1 21/32" wide)



Strong, hard, long wearing Bakelite bushing insulators resist vibration and heavy contact pressures.

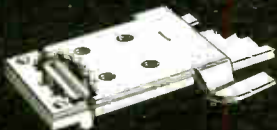

Hinge of "fatigueless" beryllium copper insures long life under vibration.



Contacts are welded to nickel silver springs by special process.



Spring assemblies may include any combination of these basic forms.

● Welding timers have to stand the gaff. They are an important part of the production line which cannot lag from failure of individual units.

That's why the Weltronic Company of Detroit, Michigan, chose Clare Enclosed "Custom-Built" Relays as important components of their automatic weld and sequence timers. These trouble-free units are sealed against dirt and dust. The plug-in feature makes them as easy to service and replace as an electronic tube.

Five Clare Type "K" Sealed Relays, in individual protective housings, are located on the hinged control panel of the Weltronic Weld Timer illustrated above. These small, compact, fast-operating relays provide accurate timing for each operation in the welding cycle.

Clare "Custom-Built" Relays give maximum reliability in such special functions because of the flexibility of Clare design which offers a relay that will give exceptional service, long life, and absolute dependability for the specific requirement.

Exceptional performance is being provided by Clare "Custom-Built" Relays for sequence control of machine tools, counting equipment, electric eye controls, in radio, radar, and many other electronic devices. Designers and engineers should know about Clare Relays. Send for the Clare catalog and data book. Address: C. P. Clare & Co., 4719 West Sunnyside Avenue, Chicago 11, Illinois. Sales engineers in all principal cities. Cable address: CLARELAY.



# CLARE RELAYS

"Custom-Built" Multiple Contact Relays for Electrical, Electronic and Industrial Use

# PLUGS and JACKS

...for every known application!

Built in accordance with latest Signal Corps and Navy specifications, Amalgamated Plugs and Jacks are tropicalized to make them fungus resistant, waterproof and moistureproof when called for. Insulators of these components are designed to withstand extremes of temperatures for -67°F to +167°F, at humidities up to 100%. We also specialize in producing Plugs which will bear up under the high heat met in rubber molding cord sets.



**NOTE:** Amalgamated Engineers will gladly consult with you on the design and development of Plugs and Jacks for special applications — present or postwar.



**PLUG PL-55 and N.A.F. 1136-1**

Long sleeve, two-conductor plug, mate to Jack JK-34-A. Withstands minimum of 60 cycles AC, potential of 500 volts effective, applied between any two terminals for not less than two seconds. Meets minimum insulation value of 2000 megohms between conductors at 68°F, at humidities up to 100%.

**JACK JK-26, N.A.F. 215284-2**

Two-conductor Jack, mate to PL-54, Tropicalized. Withstands 60 cycle AC potential of 500 volts effective, applied between any two terminals for not less than two seconds. Meets minimum insulation value of 2000 megohms between conductors at 68°F, at humidities up to 100%.



**PLUG, STYLE "A"**

Two-conductor, special type plug for use with Neoprene or Buna S molded cords. Same specifications as PL-55.

**JACK JK-48**

Light duty, two-conductor Jack, mate to Plug PL-291 and Plug 291-A.



**PLUG PL-204**

Hand set. A special plug wherein both a modified plug, PL-55 and PL-68, are held in place by a phenolic case. Same specifications as PL-55 and PL-68.

**PLUG PL-54, PL-540, PL-354, N.A.F. 215285-2**

Short sleeve, two-conductor plug, mate to Jack JK-26. Same specifications as PL-55.



**PLUG, STYLE "D"**

Two-conductor, special type plug for use with Neoprene or Buna S molded cords. Same specifications as PL-55.

References

- (1) Tuning by Permeability Variation; R. Langley: Electronics, July 1931
- (2) Iron Powder Compound Cores for Coils; G. Howe: Wireless Eng. 10, 1, (1933)
- (3) Iron Core Intermediate Frequency Transformer; A. Crossley: Electronics, Nov. 1933
- (4) Ferro-Inductors and Permeability Tuning; W. Polydoroff: Proc. I.R.E. 21, No. 5, (1933)
- (5) Further Notes on Iron Core Coils; W. Polydoroff: Electronics, Jan. 1934
- (6) Iron Cored Tuning Coils; K. Kaschke: Wireless Eng., 13, 14 (1936)
- (7) Iron in HF Circuits; J. Britton: Proc. I.R.E. Australia, 1, No. 2, Sept. 1937
- (8) Iron Powder Cores; E. Friedlaender: Wireless Eng. 15, 473 (1938)
- (9) Die optimale Dämpfung von Massekernspulen (Optimum Q of Dust-Cored Coils); J. Labus: Hochfrequenztechnik und Elektroakustik 57, 112 (1941)
- (10) Measurement of Iron Cores at Radio Frequencies; D. Foster & A. Newlon: Proc. I.R.E. 29, 266 (1941)
- (11) Radio Uses of Powdered Iron Cores; Editorial, Electronics p. 35, Feb. 1942
- (12) Neuere Erkenntnisse aus der Massekern technik (Recent Developments in Dust Core Technology); G. Kiessling & O. Ludl: Elektrotech. Zs. 63, 413 (1942)
- (13) A Study of Iron; S. White: Communications, June 1943
- (14) Powdered Iron Cores; A. Crossley: J. Applied Physics 14, 451 (1943)
- (15) Dust Cored Coils; V. Welsby: Electronic Eng.—London, various parts throughout 1943
- (16) Magnetic Measurements on Iron Powders; T. Oddie: J. Scientific Instruments —London, p. 154, Sept. 1944
- (17) Compressed Powdered Molybdenum Permalloy for High Quality Inductance Coils; V. Legg & F. Given: Bell Syst. Tech. J. 19, 385 (1940)
- (18) Magnetic Moments at High Frequencies; L. Page: Phys. Rev. 60, 675 (1941)
- (19) Magnetic Measurements at Low Flux Densities Using the AC Bridge; V. Legg: Bell Syst. Tech. J. 15, 39 (1936)
- (20) Spulen mit Massekernen (Coils with Dust Cores); M. Kersten: Elektrotechnische Zs. 58, 1335 (1937)
- (21) L'Uso dei Materiali Ferromagnetici Nelle Bobine per Radiofrequenza (Use of Ferromagnetic Materials in RF Coils); R. Koch; Alta Frequenza 8, 251 (1939)
- (22) Magnetic Materials at Radio Frequencies; F. Colebrook: Dept. Sci. & Indust. Res. (Radio) Special Report No. 14 (London) 1934
- (23) Incremental Permeability Tuning; W. Polydoroff: Radio, p. 31, Oct. 1944

Note: Since preparing the manuscript 2 new papers have appeared:  
Powdered Iron Cores; C. T. Martowicz: Electronic Industries, June 1945  
Magnetic Powders; H. G. Shea: Electronic Industries, August 1945

**Errata!** The authors, Dr. Hans Bel-ler and Mr. G. O. Altmann are re-spectively Manager and Physicist of the Carbonyl Iron Plant, General Aniline and Film Corp., Crosselli, N. J.

The caption of Fig. 1 page 86 should have added the following: Dots represent points obtained with molding pressures of 55 tons per square inch, circles: 85 tsi, squares: 110 tsi.

The caption of Fig. 2 should read as follows: Photomicrograph of section of a core with  $\mu = 55$  and a density of 7.3. The molding pressure needed is not excessive.

In the 4th column of table I, page 87, "Dilution" is expressed in per cent.

The caption of Fig. 4 should be as follows: Values from the same cores but with a toroidal winding of as many turns of 20/38 litz as needed to make .10 millihenry.

**AMALGAMATED RADIO TELEVISION CORP.**

476 BROADWAY • NEW YORK 13, N. Y.

# Coming

## THIS NEW IMPORTANT REFERENCE BOOK

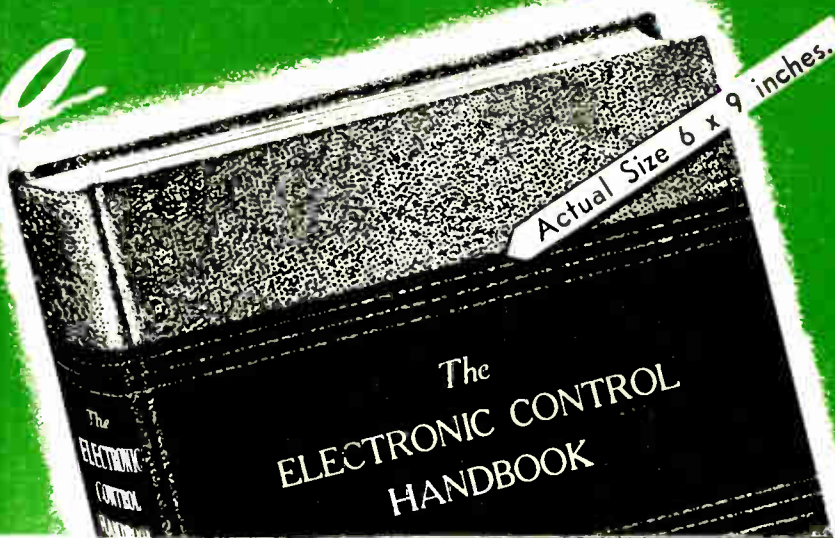

# ELECTRONIC CONTROL HANDBOOK

**FIRST AND ONLY** volume to give you the *fundamentals* of electronic control principles used in industry. Here is all the essential data you must have to accurately estimate the worth of an electronic control device. With the fundamental facts about circuits, which this Handbook will give you, you can correctly specify the type of electronic control best adapted to your needs.

All known electronic control devices are broken down to show you the basic components of these devices and the circuits used to effect the control desired. Correctly applied, electronic control of industrial processes can cut costs, speed production, improve quality, make previously difficult and costly tasks simple, routine processes. To know *when, how and where* to apply electronic controls you must have the basic data in the **ELECTRONIC CONTROL HANDBOOK**.

### RESERVE YOUR COPY NOW!

**Edition will be limited.**

If you are already a subscriber to **ELECTRONIC INDUSTRIES**, enter a renewal subscription to include the Electronic Control Handbook. If you do not now subscribe to the magazine enter a **NEW** subscription to begin with the big Directory issue scheduled for December.

The Electronic Control Handbook is not for sale.

It may be had only with paid subscriptions to **ELECTRONIC INDUSTRIES** at the following rates:

Two Years (24 issues) of the magazine plus Handbook..... \$6.00  
Three Years ..... \$7.50

*Not available with one year subscriptions.*

More than 350 pages.  
Hundreds of Charts, Dia-  
grams, Tables, Drawings,  
Photographs, Completely  
Indexed for Reference  
Purposes.

### ELECTRONIC CONTROL HANDBOOK Contents

#### Section I—Basic Elements of Control

- Chapter 1—Theory of Control Systems
- Chapter 2—Signal Transmission Systems

#### Section II—Conversion Elements

- Chapter 1—Displacement and Pressure Conversion Elements
- Chapter 2—Temperature Conversion Elements
- Chapter 3—Miscellaneous Conversion Elements

#### Section III—Electronic Modification Circuits

- Chapter 1—Control Amplifiers
- Chapter 2—Control Oscillators
- Chapter 3—Counting and Timing Circuits
- Chapter 4—Rectifiers and Miscellaneous Circuits
- Chapter 5—Passive Networks
- Chapter 6—Error Detectors

#### Section IV—Activation Elements

- Chapter 1—Synchros
- Chapter 2—Solenoids and Relays
- Chapter 3—Saturable Reactors
- Chapter 4—Amplidynes
- Chapter 5—Control Motors

#### Section V—Control Applications

- Chapter 1—Welding Control
- Chapter 2—Motor Speed Control
- Chapter 3—Temperature Control
- Chapter 4—Miscellaneous Applications

# ELECTRONIC INDUSTRIES

Published by CALDWELL-CLEMENTS, Inc.

480 LEXINGTON AVENUE

NEW YORK 17, N. Y.

Draw a picture here...rough or detailed...of  
the type of rectifier you have in mind...\*

*\* We'll build it . . . Rectifier engineering  
is our business*



**W. GREEN ELECTRIC COMPANY, INC.**

GREEN EXCHANGE BUILDING • 130 CEDAR ST., NEW YORK 6, N. Y.

## WIDE READING

(Continued from page 113)

other dee. It will describe a half-circle of slightly greater radius due to the acceleration suffered in the slit between the dees. This process is repeated and the positive ion is accelerated each time it passes the slit between the two electrodes eventually reaching a high velocity. Obviously it is essential that the electric field have the correct polarity every time the ion is exposed to it.

Particle velocities corresponding to energies of 0.76 to 3.03 MeV for protons and to 0.67 to 1.52 MeV for deuterons were obtained with this cyclotron.

The magnet used which weighs 5700 kgm is described in detail. The high frequency generator is required to be constant to 8000 cycles when operating at 8,000,000 cycles. A one-stage, push-pull circuit has been chosen. The two dees representing a capacitance are combined with a Lecher wire system to form a resonant circuit.

The voltage at the dees is continuously indicated by a tube voltmeter; the current through a capacitor is measured by means of a rectifier tube. The wavelength can be read on a cathode ray tube indicator.

## Radio Control of Rocket Velocity

A. G. Pither (Electronic Engineering, London, September, 1945)

Some of the rockets which arrived in England contained electronic equipment to measure the velocity of the projectile and to cut off the fuel when a predetermined velocity had been reached. Continuous waves were transmitted from a ground station at a frequency of approximately 30 megacycles. The frequency received at the projectile was less than 30 megacycles owing to the fact that the receiver was moving away from the transmitter at very high speed.

A loss in frequency of one cycle indicates that the rocket covers the distance of one wavelength (or 0.00666 miles at a frequency of 30 megacycles) within one second. A decrease in frequency of 300 cycles, then, represents a speed of 2.0 miles per second or 7,200 miles per hour. In practice the signals received by the projectile were doubled in frequency and retransmitted to the ground at about 60 megacycles.

The controller had a suitable frequency meter and when the desired speed was reached, a second ground transmitter radiated control signals received by a second receiver on the projectile, cutting off the fuel supply. This system, however, was open to the very grave risk of jamming by the enemy.

(Continued on page 158)

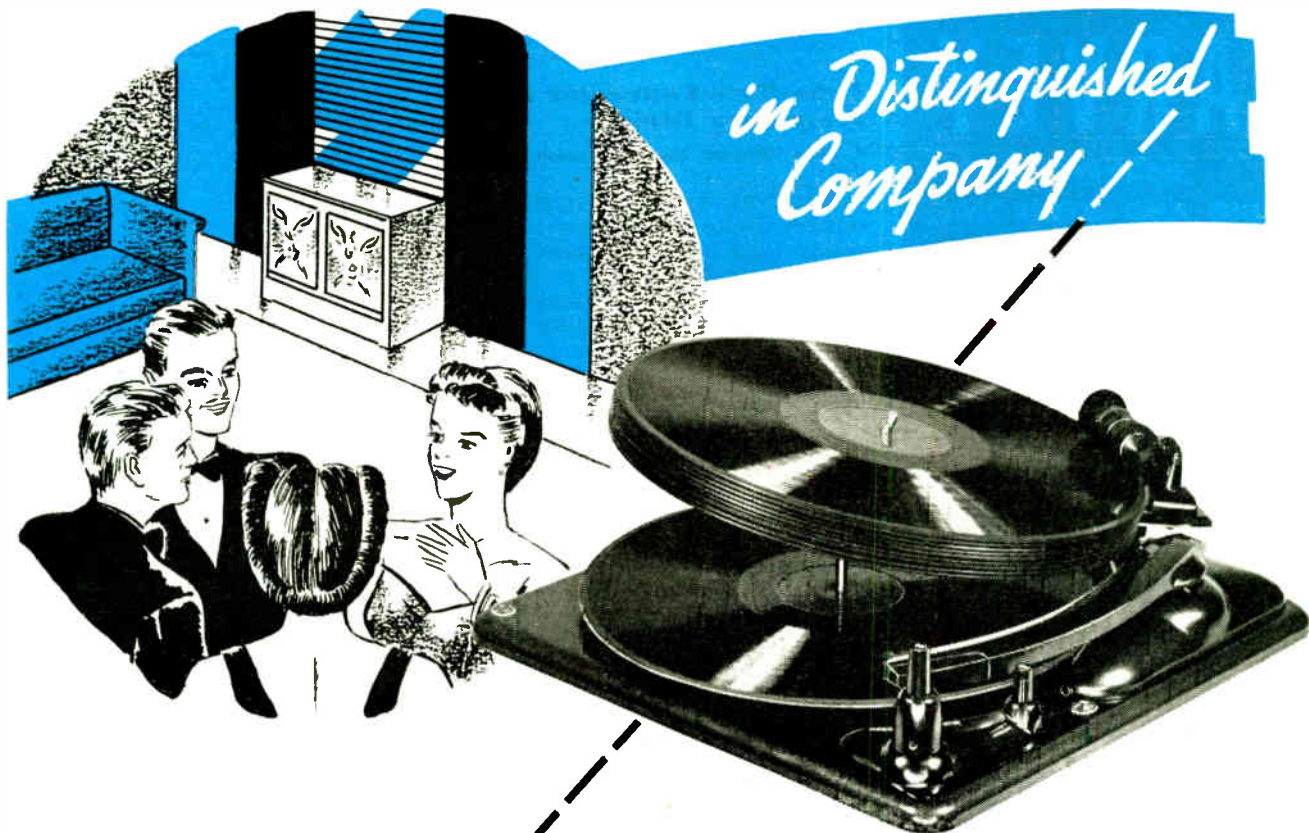

## MODEL 56 WEBSTER RECORD CHANGER

*... as new as the Post-War Era*

In related industries—names with integrity and reputation go hand in hand. Thus—in radio-phonograph combinations—Webster Record Changer, Model No. 56, will continue in distinguished company—just as its predecessors have in the past. New brilliance of performance has been achieved—new mechanical perfection that will prove most pleasing to dealers and consumers alike. Read the following advantages—then contact us for full details and engineering council.

- ✓ Dependable heavy duty Webster 4 Pole motor—cushion mounted for silent operation. No audible rumble or "wow."
- ✓ Records drop quietly—velvet soft heavy-pile turntable covering.
- ✓ Installation done from top—quick, easy mounting.
- ✓ 14-inch square mounting base. Over-all depth—above and below mounting board—9 inches.
- ✓ Built for lasting performance. Practically no service calls are required.
- ✓ Perfectly crafted—highly styled—beautiful lines.
- ✓ Changes all standard records. Plays ten 12" or twelve 10" records in one loading.
- ✓ Fast change cycle—approximately 4 seconds.
- ✓ Simple, fool-proof operation. Can not be "jammed."
- ✓ Automatic shut-off after last record has played.
- ✓ Feather light needle pressure.
- ✓ Longer life for records—no cracks—no chipped edges.



**WRITE  
FOR  
INFORMATION**

**KEEP UP A GOOD HABIT—BUY VICTORY BONDS**

**WEBSTER**



**CHICAGO**

5610 BLOOMINGDALE AVENUE  
CHICAGO 39, ILLINOIS

**31 YEARS OF CONTINUOUS SUCCESSFUL MANUFACTURE**







## MARK OF QUALITY

THE new ALSiMAG labels represent a new convenience in parts identification for our customers. But more than that, they are the mark of insulators made to the highest known standards of quality.

Rely on ALSiMAG—the foun-

ation of *quality* equipment in the electronic and electrical field.

ALSiMAG Steatite Ceramic Insulators are custom-made to your specifications. High speed production is usually possible with pressed and extruded parts. Inquiries are invited.

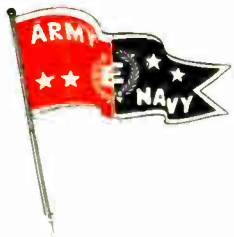

ALCO has been awarded for the fifth time the Army-Navy "E" Award for continued excellence in quantity and quality of essential war production.

**AMERICAN LAVA CORPORATION**  
**CHATTANOOGA 5, TENNESSEE**

43RD YEAR OF CERAMIC LEADERSHIP

World Radio History

## WIDE READING

(Continued from page 158)

waveforms at different points in the circuit. The component values in the circuit diagram relate to operation at 50 cycles; suitable changes for other frequencies should be made.

### Measurement of Effective Search Coil Area

H. Mikhail and Y. L. Yousef, Fouad I University, Cairo (Proceedings of the Physical Society, London, May, 1945)

An experimental method involving only the knowledge of two resistances for the comparison of the effective areas of small search coils is described. An accuracy to four significant figures is possible.

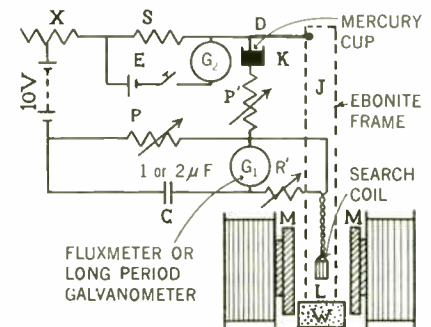

In the figure E is a standard cadmium cell connected with a sensitive galvanometer  $G_2$  across a fixed resistor  $S$ ; it serves to check the constancy of the potentiometer current. The variable resistance  $X$  enables a fixed potential difference to be maintained across  $S$ .

When the ebonite frame is lifted, the search coil is suddenly removed from the field and the battery circuit simultaneously interrupted at  $K$ . The capacitor  $C$  will then discharge through galvanometer  $G_1$  and its shunt circuit; the quantity of charge passing through  $G_1$  being  $CVR/(R+F)$  microcoulombs, where  $V$  is the voltage across  $P$ ,  $R$  the combined resistance of resistor  $R'$  and the search coil, and  $F$  the resistance of the galvanometer  $G_1$ . Meanwhile, the galvanometer  $G_1$  will receive an opposite impulse  $HA/100(R+F)$  microcoulombs due to cutting the field  $H$  by the search coil,  $A$  is the effective search coil area to be found.

If the circuit is adjusted for exact compensation of these two quantities  $A=100CVR/H$ . For comparative measurements, two search coils were successively tested and balance obtained by adjustment of resistor  $R'$  only. The effective areas of the search coils are then proportional to the shunt resistances  $R$ ; or  $A_2:A_1=R_2:R_1$ .

The calculated time for discharge of capacitor  $C$  to  $10^{-4}$  of its initial charge and the time required to remove the search coil to about 20

(Continued on page 162)

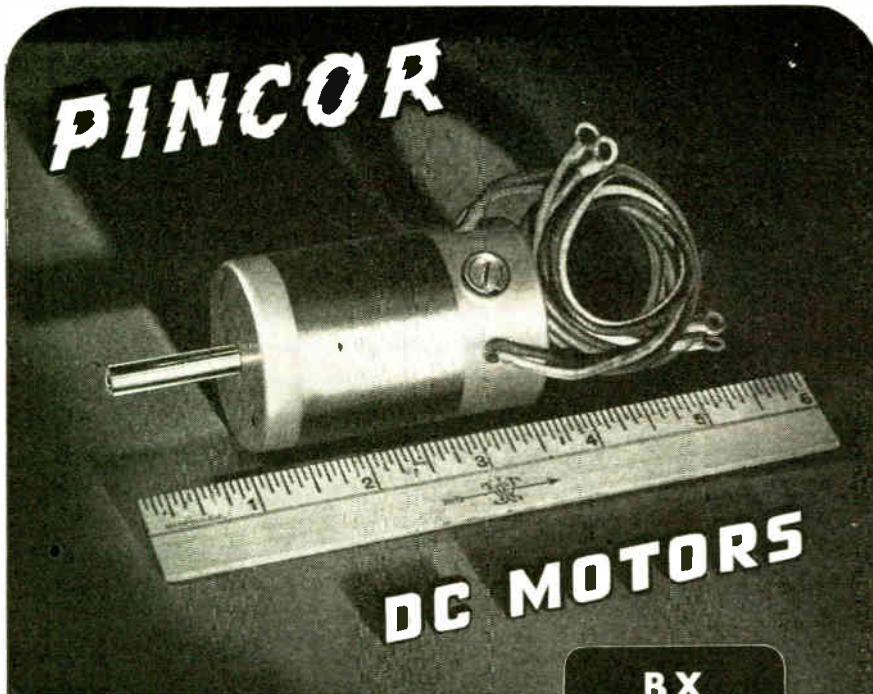

The urgent demand, in peacetime days, by the aircraft and radio industries for a compact, efficient D.C. motor was the challenge that led Pioneer to develop the Pincor BX series. Today Pincor BX motors flow from our plant in a steady stream to the producers of aircraft and radio equipment for the armed services.

Pincor BX motors, in their classification, meet the varied requirements of aircraft and radio manufacturers that demand light weight, compact motors for efficient and dependable application. Pincor BX motors are direct drive, ball bearing, high speed units wound for continuous or intermittent duty. Shunt, series or split series windings are for operation on 12 to 24 volt battery systems currently used and may be easily modified to meet your product demand.

Depend on these rugged Pincor quality-proven motors in the BX series. Send your problem to Pioneer engineers and let them put their years of experience to work for you. Consultation with these men will not obligate you in the least.

DYNAMOTORS • CONVERTERS  
GENERATORS  
POWER PLANTS • GEN-E-MOTORS

**PINCOR**  
Products

**PIONEER GEN-E-MOTOR**  
CORPORATION

5841-49 DICKENS AVENUE CHICAGO 39, ILLINOIS

BUY MORE BONDS!

Export Office, 25 Warren Street, New York 7, U.S.A.  
Cable Address: Simonrice, N.Y.

# FOCUSED HEAT



with **AJAX-NORTHRUP**

A little Ajax-Northrup inductor like the one pictured above focuses high-frequency heat into a small, odd-shaped area and produces white heat in a matter of seconds!

Heat that's concentrated. No need to heat the whole piece when you're just going to braze one small joint, or harden part of the surface, or forge only one end of a bar.

That is why Ajax-Northrup heat cuts unit costs, speeds production, reduces rejects, and eliminates warping and scale in jobs ranging all the way from drying coatings on welding rod, or bonding plastics, to heating big tubes for spinning, or hardening razor blades "on the fly."

Ajax-Northrup engineers have pioneered new induction heating applications for more than 27 years. Our experience-designed equipment includes both motor-generators and converters, with capacities from 3 to 1200 kw. and up, and frequencies from 60 to several million cycles.

Send for Bulletin 25. It shows hundreds of ways you can use induction heating and melting to save time, produce more accurate results, reduce spoilage, and do heat-ing jobs that couldn't be done before.

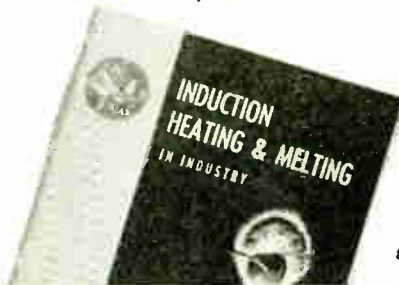

**HARDENING**



**BRAZING**

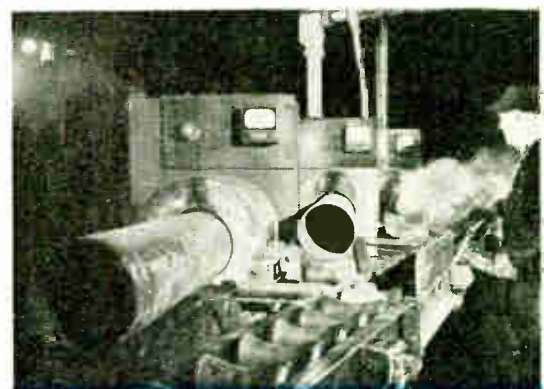

**FORGING, SPINNING**

**AJAX**  
**NORTHRUP**  
Since 1916

AJAX ELECTROTHERMIC CORP., AJAX PARK, TRENTON 5, N. J.

**HIGH-FREQUENCY HEATING • MELTING**

AJAX METAL COMPANY, Non-Ferrous Ingot Metals and Alloys for Foundry Use  
AJAX ELECTRIC FURNACE CORP., Ajax-Wyatt Induction Furnaces for Melting  
AJAX ELECTRIC CO., INC. The Ajax-Hultgren Electric Salt Bath Furnace  
AJAX ENGINEERING CORP., Ajax-Tama-Wyatt Aluminum Melting Induction Furnaces

A S S O C I A T E  
C O M P A N I E S



# Today's New Trend is toward Webster Electric Pickups

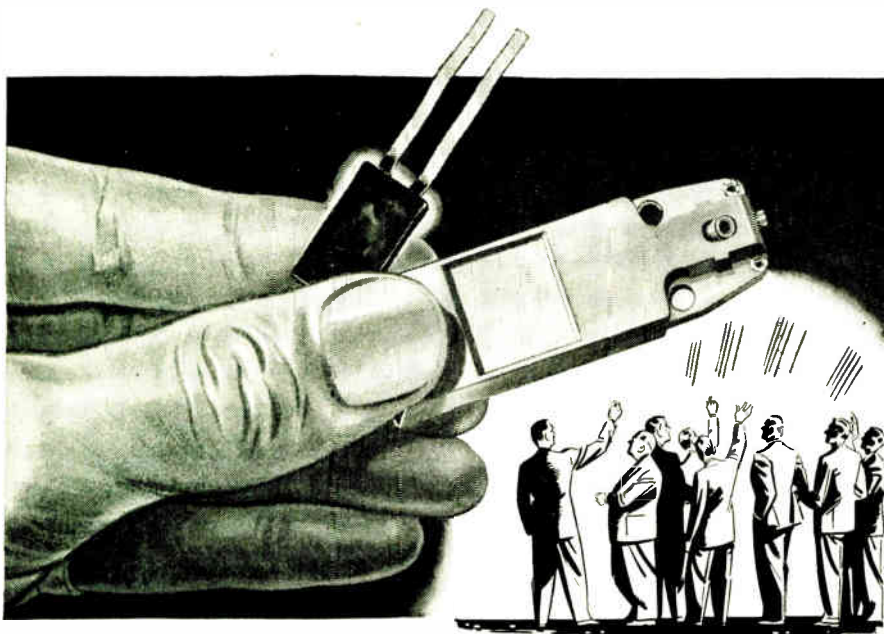

**W**EBSTER Electric Pickups have won their present position of pronounced preference among those who make, sell and own radio-phonograph combinations because of their superb performance.

These fine quality pickups are precision-built to meet the highest standards of tonal beauty in record reproduction. Sensitive, delicate, responsive . . . they cover the entire range of vocal and orchestral tone with unsurpassed clarity and fidelity. Despite a constantly increasing demand for Webster Electric Pickups and Cartridges, each one must meet the most rigorous inspection tests before it leaves the factory.

If you have not already standardized on Webster Electric Pickups for your present or planned line of fine radio-phonograph combinations, we urge you to consult with us on your needs without delay. Write us direct.

Keep Buying Bonds



(Licensed under patents of the Brush Development Company)

## WEBSTER ELECTRIC

Racine, Wisconsin, U.S.A. • Established 1909 • Export Dept.: 13 E. 40th Street, New York (16), N. Y. Cable Address "ARLAB" New York City

"Where Quality is a Responsibility and Fair Dealing an Obligation"

## WIDE READING

(Continued from page 160)

cm from the gap are both of the order of 1 sec. Consequently a sharp balance is possible even with a galvanometer whose period is not too long. With the aid of the standard cell,  $V$  can be maintained constant to 1 in  $10^4$ . It is possible to keep  $H$  constant to at least 1 in  $10^3$ .

### Technics for Evaporation of Metals

L. O. Olsen, C. S. Smith, and E. C. Crittenden, Jr. (Journal of Applied Physics, July, 1945)

Thirty-four elements have been observed for evaporation behavior and the results are reported; the best technics are listed in a table. The text also describes in detail the procedures and equipment used in the studies.

### European Wavelength Scheme Proposed

A new wavelength scheme which would enable every European nation's broadcasting service to be appreciably improved is proposed by the Technical Committee of the British Radio Equipment Manufacturers' Association. It is based on the fact that the longer the wavelength of a broadcasting station, the greater the area over which it can give a reliable service.

Shifting the "local" services of all countries to the lower end of the medium waveband, and slightly extending downwards the present long waveband, would provide enough channels to give every country in Europe (and every large language group in the case of dual-language countries) two reliable national programmes. At the same time, it would allow the present 9-kilocycle separation between stations to be increased to 11 kilocycles.

Under the plan, the former conception of "long" and "medium" wavebands would be replaced by a "national" waveband extending from 2,000 to 259 metres (150 to 1,157 kilocycles) and a "regional" waveband from 259 to 192 metres (1,157 to 1,560 kilocycles). Within these wavelengths it is claimed that every nation in Europe can be given an adequate (and in most cases an improved) broadcasting service.

### Scott Adds Recorders

Scott Radio Laboratories Inc. of Chicago will be ready to market in the next three months a new line of improved home magnetic sound wire recorders. The recorders will be distributed through dealers who handle Scott radio sets.

# ELECTRONIC BRAZING

## UNIT

### with 24 Station INDEXING Work Carrier



### Delivers 5 Complete Assemblies Per Minute



HERE'S a striking example of how Scientific Electric Engineers increased brazing production output by designing a special automatic machine to operate in conjunction with Electronic heating.

A manufacturer of weather-proof control box covers was already using electronic heat to speed up production in the brazing operation involved. But greater production was urgently needed. Each assembly was being inserted and removed from a single heater coil . . . one at a time.

To increase output Scientific Electric engineers designed this compact circular, 24 station indexing work carrier which operates from the 18 KW electronic generator at the left.

The operator merely loads the stations as they come around empty. Heat is applied by three water-cooled induction coils under three of the work positions. The coils are followed by the vertically operating ejecting mechanism and a complete assembly is ejected from the carrier each 12 seconds.

The carrier, which is operated by a small motor can be applied to any of our electronic generators depending upon the heat input requirements of the work to be handled. Normal output of the unit illustrated is at 200 to 600 kc.

Workpiece output up to 20 per minute can be obtained and carriers, custom tailored to your requirements, can be delivered within 30 days. Send us your requirements today.

Scientific Electric Electronic Heaters are made in these power sizes... and a range of frequencies up to 300 Megacycles depending upon power requirements.

3 KW	18 KW
5 KW	25 KW
7½ KW	40 KW
8 KW	60 KW
10 KW	80 KW
12½ KW	100 KW
15 KW	250 KW

## Scientific Electric

Division of

"S" CORRUGATED QUENCHED GAP COMPANY

119 MONROE ST.  GARFIELD, N. J.

Manufacturers of

Vacuum Tube and Spark Gap Converters Since 1921

*Depend on  
Permoflux for  
Better Acoustical  
Reproduction*

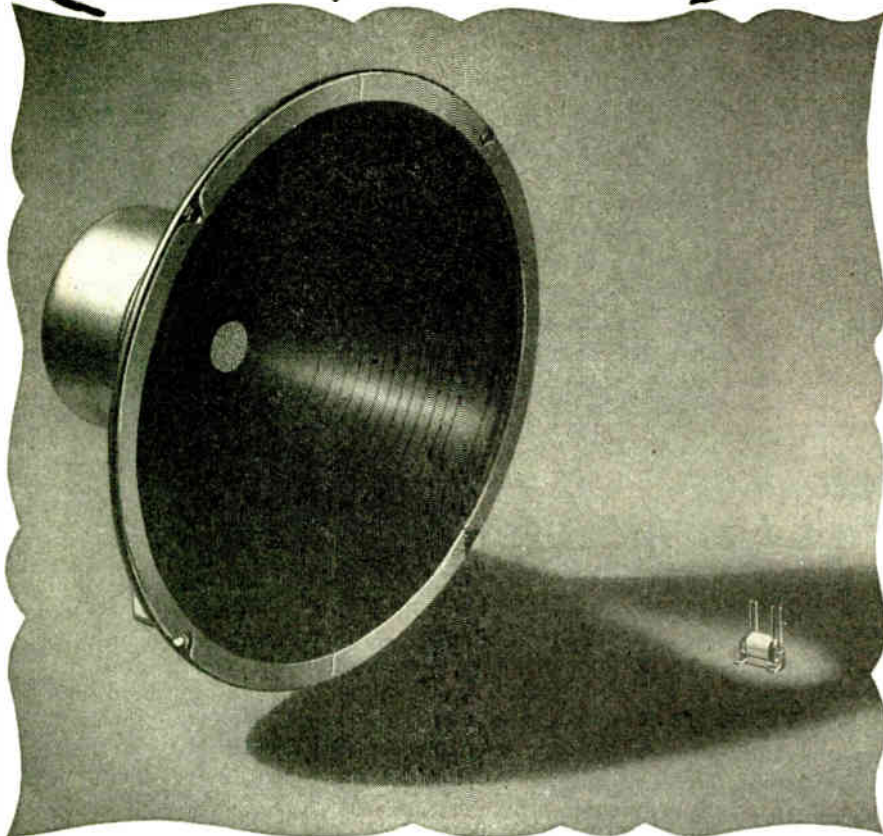

The many specialized Permoflux designs and engineering developments that have so notably demonstrated their superiority in wartime applications are available to improve the performance of your peacetime products. Why not consult specifically with our representative on your own problem?

TRADE MARK  
**PERMOFLUX**

**PERMOFLUX CORPORATION**  
4900 WEST GRAND AVE., CHICAGO 39, ILL.



**PIONEER MANUFACTURERS OF PERMANENT MAGNET DYNAMIC TRANSDUCERS**

## **RATIO DISCRIMINATOR**

*(Continued from page 83)*

In general a high intermediate frequency is not needed with this ratio detector. Also, the ordinary method of rating circuits for 20 db of quieting is meaningless. The AVC should be carefully designed to prevent variations in input capacity due to amplitude changes from causing detuning.

In laboratory models, only one if stage was used before the discriminator driving tube but a stage of amplification before the frequency converter was included. Results were excellent on low signals.

Another advantage was that the set tunes across signals better than usual circuits, having less distortion as the center frequency is approached. As a result it appears as though it had higher selectivity.

An interesting note is that to facilitate study of this circuit a scale model was built to operate at 1/25 normal frequency. Instead of using 8.25 mc it was scaled to use 330 kc. This facilitated insertion of probes, oscilloscope leads and VTVM leads.

## **FCC to Test Diathermy for Frequency Tolerance**

Tests on non-communication radio equipment are being planned by FCC to determine whether newly designed medical diathermy and industrial X-ray equipment, manufactured since last May, operates within the three bands allocated by the Commission last Spring. The FCC is looking to the possible promulgation of rules and regulations governing this equipment in order to clean out any interference on commercial channels from harmonics caused by this equipment.

Several new models of the equipment have been sent to the FCC for testing. In the event that FCC finds the equipment can follow the newly assigned channels, the name of the manufacturer will be listed and approval sent to the medical profession and industrial buyers.

The new equipment must follow the following allocation pattern:

Center Frequency of Channel	Band Width of Channel (PC of Center Frequency)	Band Width of Channel (Kilocycles)
13.66 mc	X.05	15
27.32 mc	X.5	270
40.98 mc	X.05	40

## **White Buys Rola**

The White Company of Chicago has acquired all the capital stock of the Rola Company Inc., Cleveland manufacturer of loud speakers. Officials of the purchasing firm assert that Rola will continue manufacturing under the original name but be listed as a division of the White Company.

# HEINEMANN

## MAGNETIC CIRCUIT BREAKERS

were the choice of the W. GREEN ELECTRIC CO., Inc. of New York, for protection of their high voltage rectifier and life test cabinet shown here. This equipment, intended for life test of high frequency transmitting triodes under static conditions, required the most flexible but unfailing protection available—hence the HEINEMANN *fully magnetic* Circuit Breakers shown here.

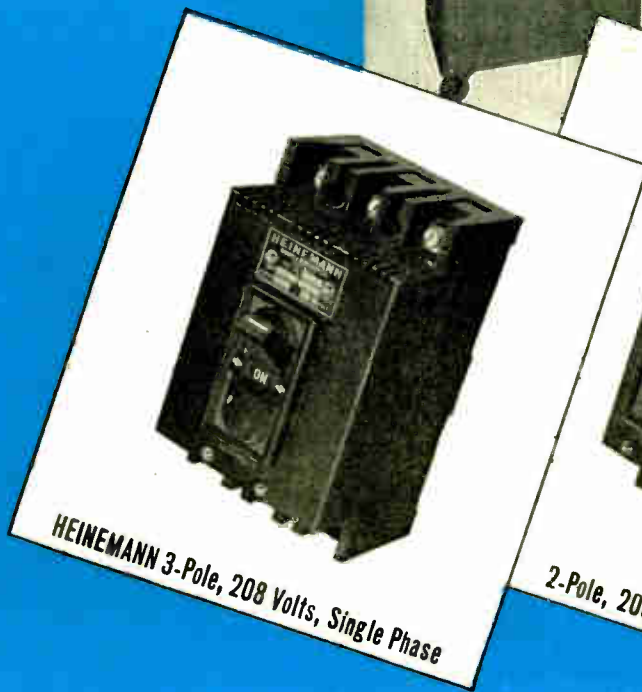
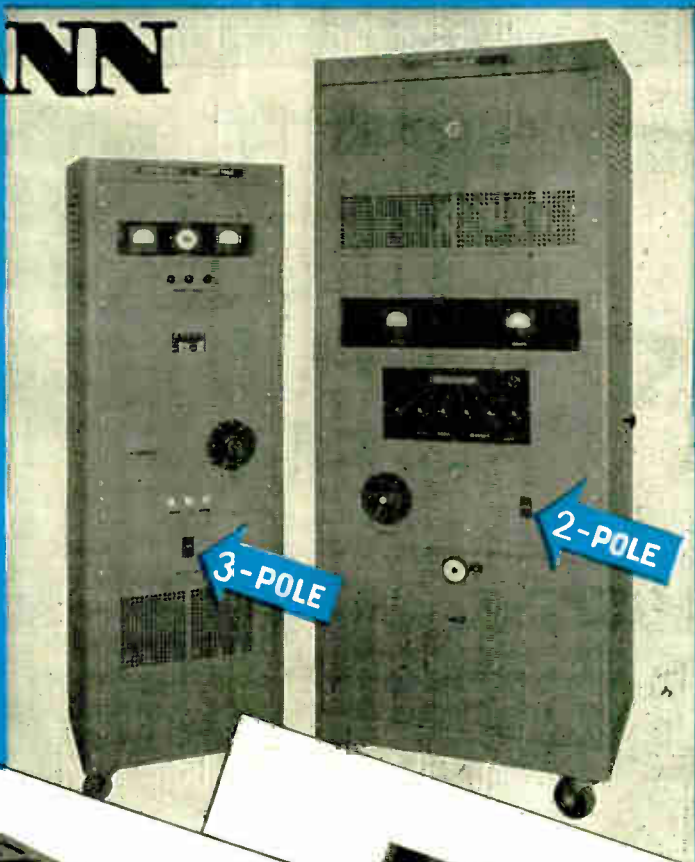

HEINEMANN 3-Pole, 208 Volts, Single Phase



2-Pole, 208 Volts, Single Phase



HEINEMANN furnishes a complete line of Circuit Breakers in both Instantaneous Trip and Time Delay Type. The former trips *instantly* on the smallest overload. The latter also trips *instantly*, but on short circuit *only*, while on harmless overloads or inrush currents it has sufficient time delay to avoid nuisance trips. The time delay may be matched to circuit characteristics.

SEND FOR NEW CATALOG WITH COMPLETE LINE AND ENGINEERING DATA

## HEINEMANN CIRCUIT BREAKER CO.

Subsidiary of Heinemann Electric Co., Est. 1888

137 PLUM STREET

TRENTON, N. J.



FIRST AWARD . . . JUNE 23, 1944

FIRST RENEWAL WITH STAR . . . DEC. 16, 1944

SECOND RENEWAL WITH STAR . . . MAY 26, 1945

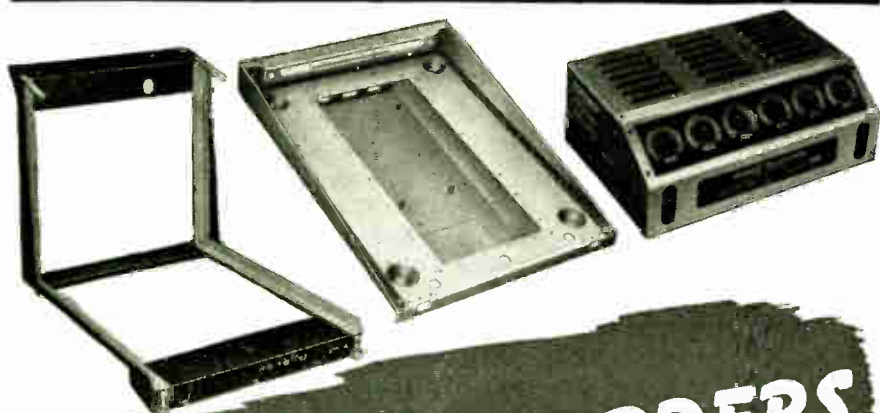

# UNLIMITED ORDERS ACCEPTED NOW

## FOR METAL CHASSIS, CABINETS, TERMINAL BOARDS, AND STAMPINGS

### TO YOUR SPECIFICATION

Insuline is equipped to make anything from a lug to a huge transmitting cabinet according to your specifications. All materials—steel, aluminum, brass, copper, etc.—are on hand; and the following facilities for producing the complete job, from beginning to end, are available:

A complete tool and die shop; automatic and hand-screw machines; engraving, coil-winding, milling, and grinding machines; power shears; power brakes; punch presses; automatic welding machines; spray booths; baking ovens; plating tanks, etc., plus an entire floor devoted to machine and hand assembly.

In addition, our competent engineering staff and a modern experimental laboratory are always available to help you with your production problems.

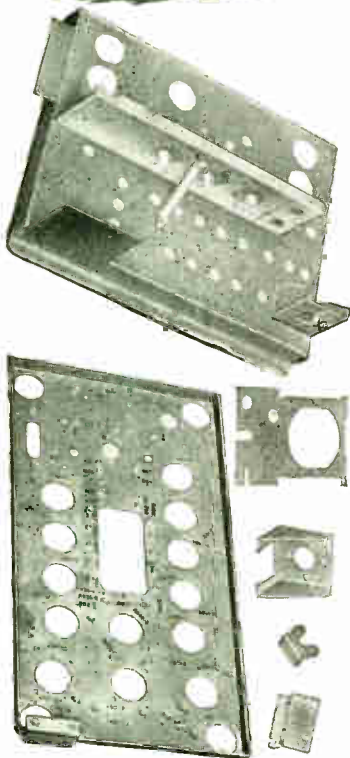

## NEW PATENTS

(Continued from page 128)

### Selecting Mechanism

The multianode electron beam tube 114 is made to control the start-stop distributor in a telegraph or teletypewriter system. A teletypewriter receiver is represented in the drawing; all relays are shown in no-signal position; no electron beam is established in tube 114.

The magnetic field of coil 111 invades the envelope of the tube and tends to deflect the electron beam. In the no-signal position, the magnetic field of the coil is of such magnitude as to direct the electron beam, if emitted, towards the first anode 119.

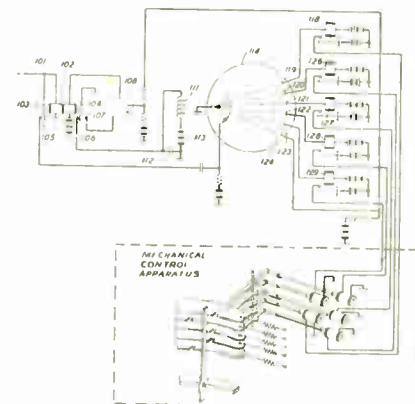

The communication signal to be received consists of a start signal impulse, a permutation code combination of five character-determining signal impulses and a stop signal impulse. The start signal impulse is a no-current impulse, each of the five following impulses is either a current or a no-current impulse depending on the particular code combination, and the last impulse is always a current impulse.

The starting no-current impulse of each signal train deenergizes the left-hand winding of relay 102, releasing armatures 103 and 104; contacts 105 and 107 will be closed. This will initiate current through trigger tube 108 and the right-hand winding of relay 102. The effect of the current in the right-hand winding of relay 102 opposes the effect of current in its left-hand winding and is dominant over the effect of the current in the left-hand winding so that contacts 105 and 107 will remain closed as long as tube 108 carries current.

Opening of contact 106 initiates oscillation in circuit 111, 112, 113 which tends to deflect the beam towards anodes 120, 121, 122, 123 and 124 in succession. With contact 105 closed, any current signal impulse on line 101 will cause the formation of an electron beam in tube 114; no beam will traverse the tube during no-current pulses.

It will be seen that all current signal pulses will permit the electron beam in tube 114 to be directed at the particular anode corresponding in position to the position of the particular current signal pulse. Each of relays 118, 126, 127, 128, and 129 which operates produces a certain movement in the mechanical control apparatus selecting a combination indicated by the code.

Tube 108 is either a gaseous discharge tube or a secondary emission tube; in either case it is a trigger tube where the grid also controls the current interruption.

The last signal pulse, which is a current pulse, will cause the beam to impinge against anode 124 cutting off current through tube 108 and the right-hand wind-

(Continued on page 168)



# insuline

CORPORATION OF AMERICA

QUALITY PRODUCTS SINCE 1921

INSULINE BUILDING • LONG ISLAND CITY, N. Y.



# WHAT WILL YOU NEED TO PRODUCE BETTER POST-WAR PRODUCTS ?

**CORNING  
GLASS  
GIVES YOU**

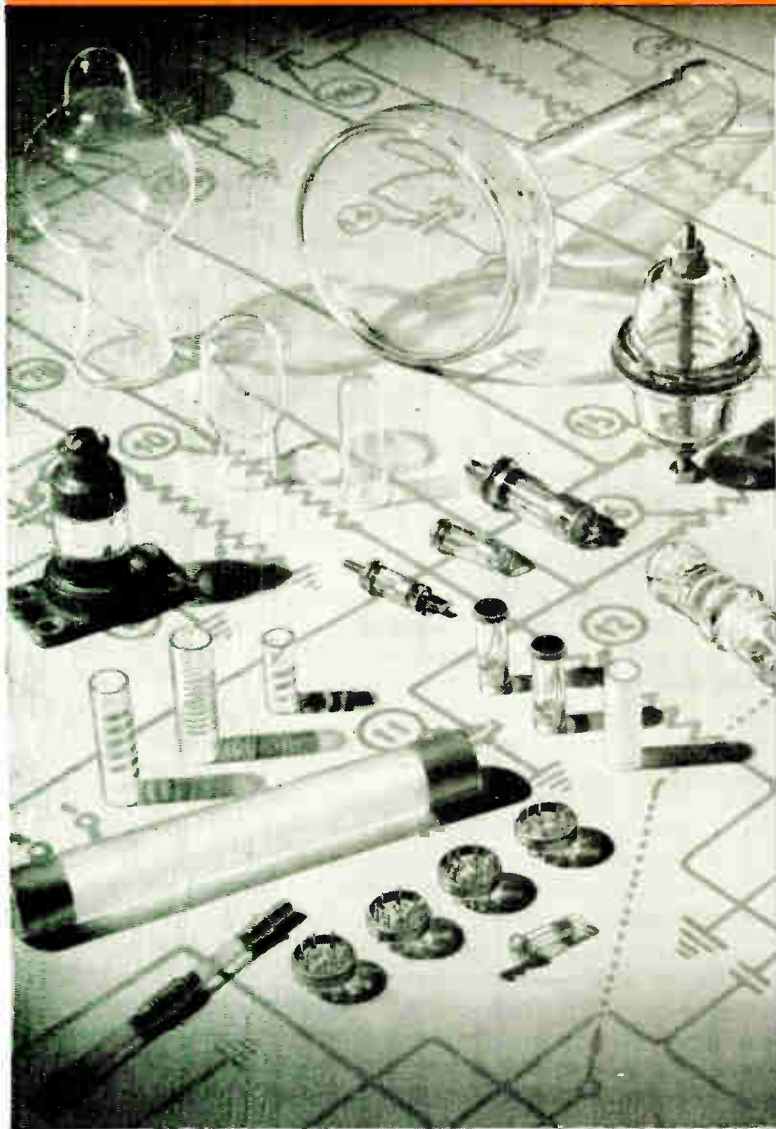

## Special Electrical Qualities

**Thermal Endurance**

**Hermetic Sealing**

**Mechanical Strength**

**Corrosion Resistance**

**Precision**

**Permanence**

**Metallizing**

**Dimensional Stability**

High dielectric strength—high resistivity—low power factor—wide range of dielectric constants—low losses at all frequencies.

Permanent hermetic seals against gas, oil and water readily made between glass and metal or glass and glass.

Commercial fabrication to the fine tolerances of precision metal working.

Corning's metallizing process produces metal areas of fixed and exact specification, permanently bonded to glass.

**A**S YOU plan post-war electronic products, give a thought to versatile glass. We really mean glasses, for Corning has, at its fingertips, 25,000 different glass formulae from which to select those especially suited to your electronic applications. Let us show what glass can do for you. We may already have a solution — or Corning Research can find the answer for you. Phone Corning 2852 or wire Electronic Sales Dept., I-11, Bulb and Tubing Division, Corning Glass Works, Corning, New York. We'll have a man on the job promptly.

**CORNING**  
— means —  
Research in Glass

## Electronic Glassware



“PYREX”, “VYCOR” and “CORNING” are registered trade-marks and indicate manufacture by Corning Glass Works, Corning, N. Y.

# Specialists in Special Crystals

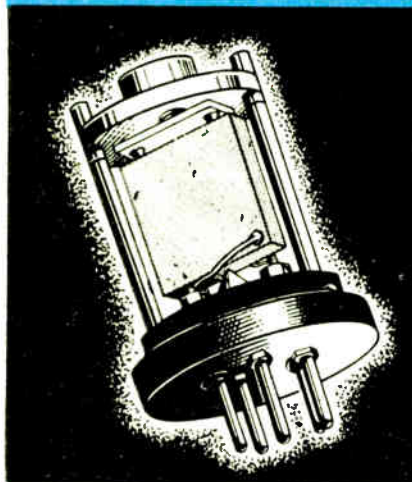

## 200 - 500 K. C. EXTREMELY STABLE CRYSTALS FOR HIGH OUTPUT AND KEYING

Clamped low frequency plated crystal units with permanent frequency precision,  $\pm 0.1\%$  from  $-30^\circ\text{C}$  to  $+60^\circ\text{C}$ ! None of the instability typical of old-style spaced units. A crystal that can take it, designed for use in such places as the 30-ton Coast Guard buoy transmitter, lighthouse transmitters, aircraft landing, etc. Each unit subjected to rigid Government specification keying tests. Mounted in aluminum hermetically-sealed holder.

- \* 3 point edge suspension. Top 2 points are spring adjusted, tamper-proof sealed for permanent frequency stability
- \* Electrical contacts soldered to silver plate at nodal points — no mechanical strain.
- \* Hermetically sealed holder accomplished by spinning aluminum can over gasket under high pressure
- \* Another Crystalab-engineered development.

Write Dept. E.I. for comprehensive catalogue "Selectronic Crystals" and facilities booklet "Crystalab Solves a Problem".



Manke Ingenuity makes us

SPECIALISTS IN SPECIAL CRYSTALS



## CRYSTAL RESEARCH LABORATORIES

INCORPORATED  
LABORATORIES AND MAIN OFFICE: 25 ALLYN STREET, HARTFORD 3, CONN.  
New York Office: 15 E. 26th Street, New York 10, N. Y. Phone M.H. 5-2352

# ALWAYS GETS A HAND!

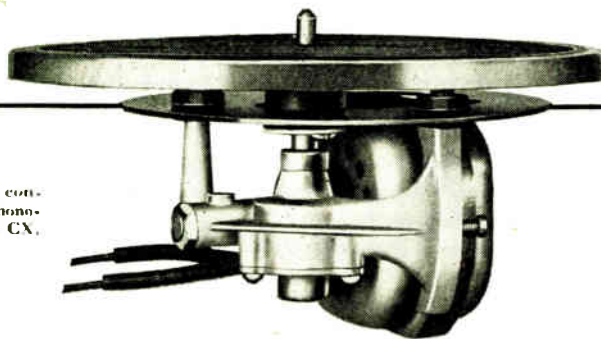

General Industries constant-speed electric phonograph motor—Model CX.

Users and the trade have always given hearty applause to General Industries phonograph mechanisms. Owners like the fine fidelity of every note or syllable—and sales and service departments are strong for their reliability and freedom from maintenance troubles.

You get this same old-time satisfaction from our Smooth Power turntable motors, recording assemblies and record-changer recorder com-

binations as we return to civilian production. As always, General Industries equipment will earn your approval.



THE  
**GI** GENERAL INDUSTRIES COMPANY  
DEPT. M ELYRIA, O.

## NEW PATENTS

(Continued from page 166)

ing of relay 102. Simultaneously, the left-hand winding of relay 102 is energized positioning armatures 103 and 104 as indicated in the drawing. The apparatus is ready for the next signal train.

A. M. Skellett, Bell Telephone Laboratories, (F) September 16, 1944, (I) May 1, 1945, No. 2,375,044.

## High-Level Modulator

The circuit is intended for the linear amplification of an amplitude-modulated carrier and is designed for high efficiency of operation. The two tube input circuits are excited an equal amount but in phase quadrature. Tube 10 is biased about to cutoff at carrier amplitude so that only tube 26 carries current at levels lower than carrier amplitude. Under these conditions, the output circuit of tube 26 is loaded with the reflected resistance of R into circuit 36. This reflected impedance is made to be

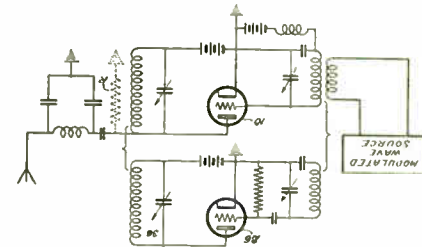

equal to  $4R$ , where  $R$  is the load impedance. It is high enough to make tube 26 operate efficiently for all voltages of amplitude less than the carrier amplitude. Tube 26 works into a constant impedance.

For modulating voltages exceeding the carrier level, tube 10 becomes conductive. This tube also supplies power to the load increasing the total effective load impedance  $R$ . A decrease in the reflected load resistance across tank circuit 36 results so that tube 26 now feeds more power into circuit 36 and thence to load  $R$ . When peak modulation is reached, the impedance into which tube 26 works is reduced by about  $\frac{1}{2}$  and is  $2R$ , and tube 26 supplies to the load  $R$  twice as much power as at carrier excitation. The arrangement is such that tube 10 is then supplying about half the total power to the load.

It can be shown that the effective load conductance across circuit 36 is inversely proportional to the load conductance across 18 when the  $Q$ 's of the circuits are sufficiently large. Other modifications of the system are illustrated and explained.

W. van B. Roberts, RCA, (F) January 27, 1943, (I) May 15, 1945, No. 2,375,821.

## Oscillator-Reactance Tube

Tube 10 is connected to simultaneously function as an oscillator and as a reactance tube generating variable frequency waves. The feedback path taken from the screen grid 13 and including coil 21 which is coupled to coil 16 provides positive feed-

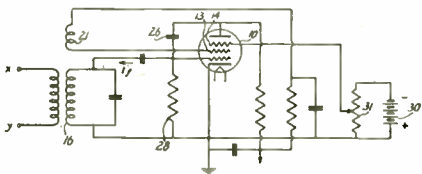

back to maintain oscillations. Quadrature voltage developed across resistor 28, which is inserted in series with capacitor 26 between the plate and the cathode of tube 10, is applied across the tank circuit. The

(Continued on page 170)

# The "chance" factor...

**eliminated in  
transformer production  
by N.Y.T. engineers**

NYT Engineering, through long experience and specialization in problems of transformer design, assures units of dependability.

All required characteristics are incorporated to an exacting degree, with mechanical and electrical problems effectively surmounted at the blueprint stage.

Equally important is the fact that every NYT design is checked for mass production.

*Address inquiries to Dept. N*

**NEW YORK  
TRANSFORMER  
COMPANY**

26 WAVERLY PL NEW YORK 3, N. Y.

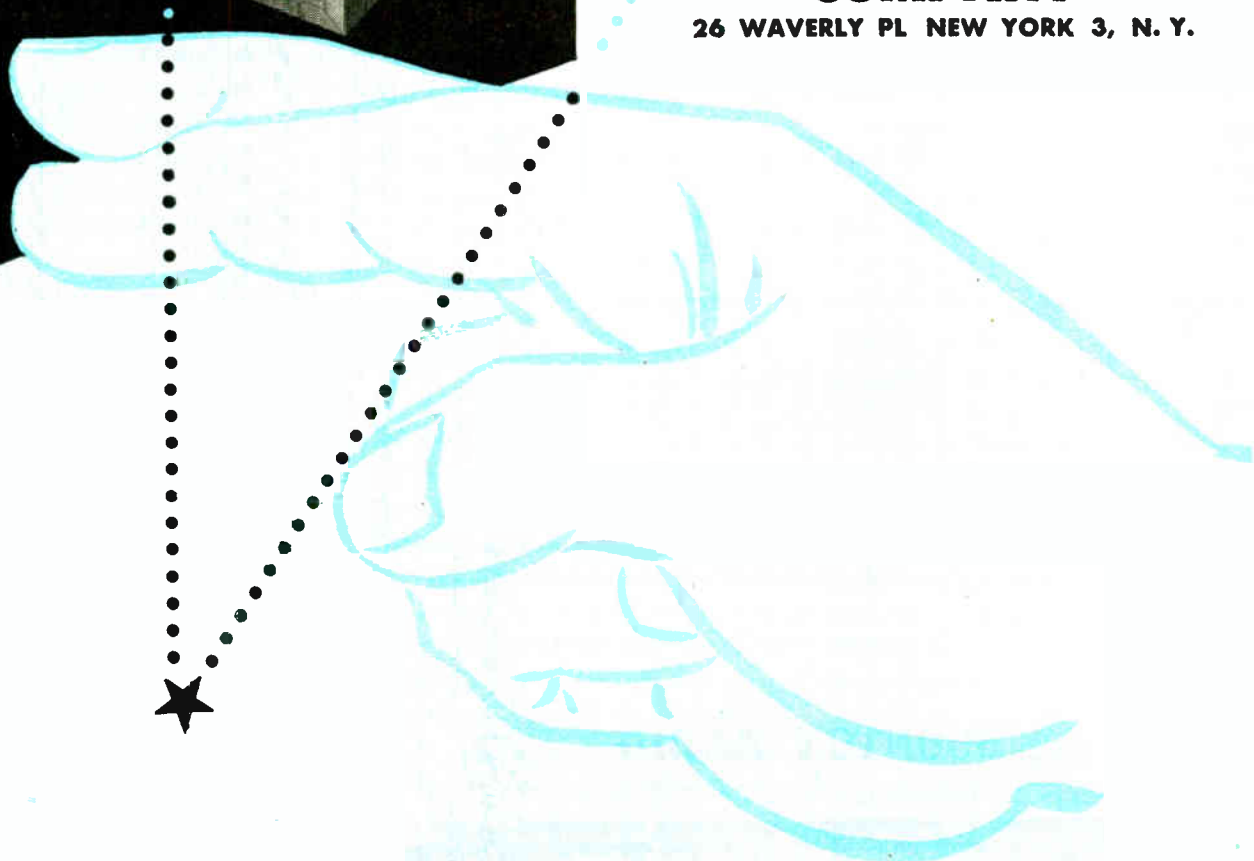
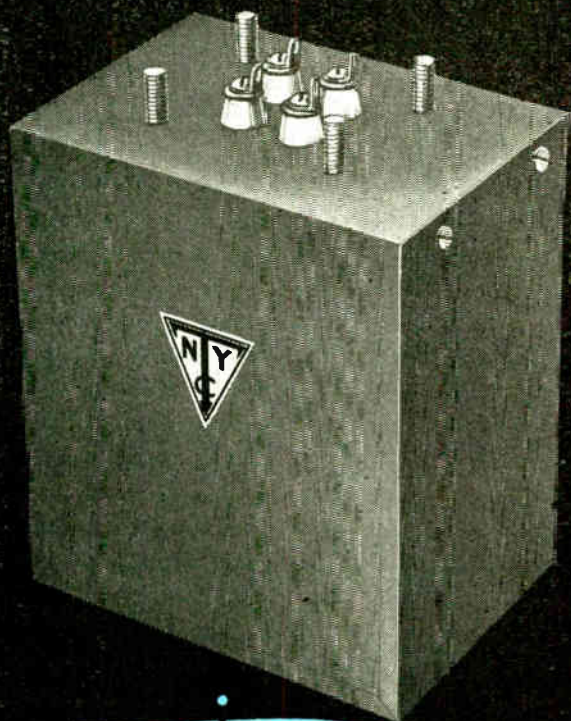

# Now! Q SERVICE

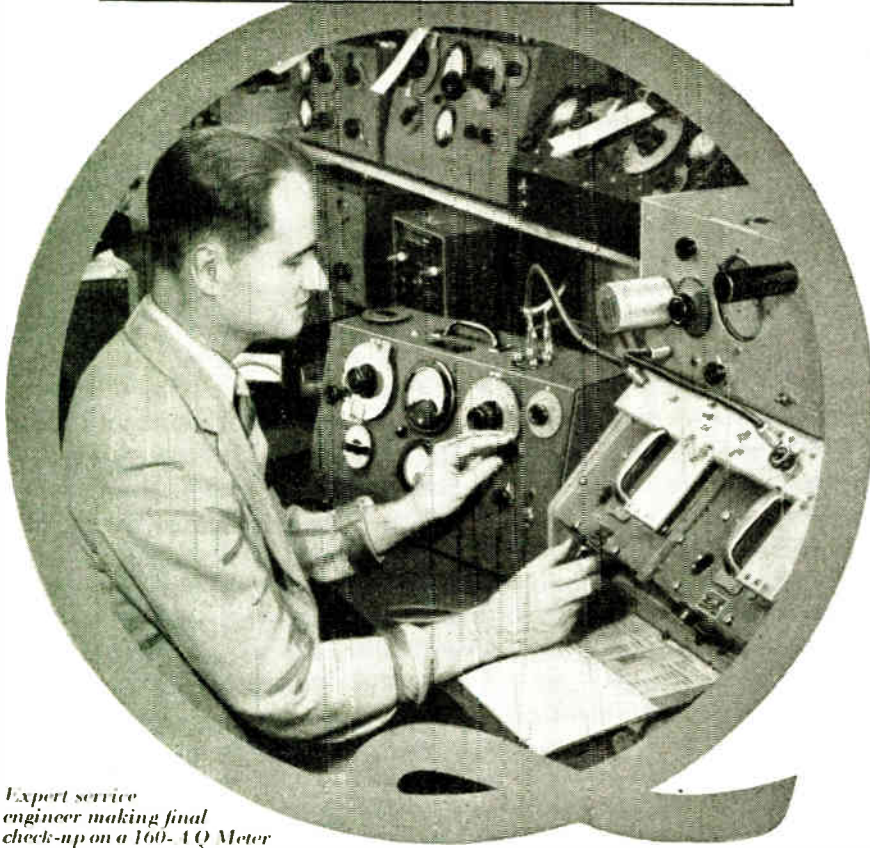

Expert service engineer making final check-up on a 160-A Q Meter

**A complete Laboratory Overhaul  
for your Q Meters and Q-X Checkers  
after strenuous wartime use.**

### "Q SERVICE" includes

1. General Check and Clean-up of the instrument.
2. Complete Re-calibration in our Standards Department.
3. Loan of a replacement while your instrument is in our Laboratory.

In answer to many requests and in recognition of the unusual demands made on your instruments during the Wartime years, this "Q SERVICE" has been developed.

For complete information write to Department 1



**BOONTON RADIO**

BOONTON, N. J.

*Corporation*



DESIGNERS AND MANUFACTURERS OF THE "Q" METER . . . QX-CHECKER . . . FREQUENCY MODULATED SIGNAL GENERATOR . . . BEAT FREQUENCY GENERATOR . . . AND OTHER DIRECT READING TEST INSTRUMENTS

## NEW PATENTS

(Continued from page 168)

amount of voltage fed back by either path is controlled by the potential of the suppressor grid 13 so that the potentiometer voltage at resistor 31 determines the frequency of the generated oscillation. A modulating potential may be substituted for the resistance-battery combination 30, 31 and a frequency-modulated signal taken off terminals x, y.

K. Rath, Radio Patents Corporation, (F) March 17, 1942, (I) June 12, 1945, No. 2,378,245.

### Piezoelectric Filter Discriminator

A single piezoelectric crystal tuned to the carrier frequency is so connected as to provide at its output terminals a pair of complementary sloping filter characteristics to be employed in an automatic frequency control circuit. The crystal filter also supplies

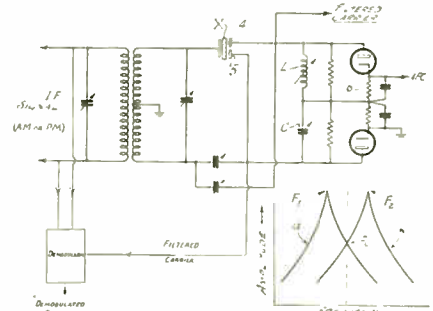

carrier energy of the phase or amplitude modulated wave which is fed to a carrier-excited demodulator.

Adjustable coil L is arranged in series with crystal X to provide the off-center peak frequency  $F_1$ . The adjustable capacitor C is arranged in series with the crystal to provide the off-center frequency  $F_2$ . The frequencies  $F_1$  and  $F_2$  are equally spaced from the center frequency F. Consequently the circuit will operate as a frequency discriminator. Automatic frequency control bias is derived from the cathode end of load resistor 6, filter carrier energy may be tapped from crystal output electrode 4 or from crystal output electrode 5.

M. G. Crosby, RCA, (F) April 27, 1943, (I) May 15, 1945, No. 2,376,127.

### AC-DC Amplifier

By modulating an ac wave with the ac or dc voltages to be amplified, it is possible to use the identical circuit for either dc or ac amplification. In the particular modulation system described, an ac generator provides oscillations at a frequency

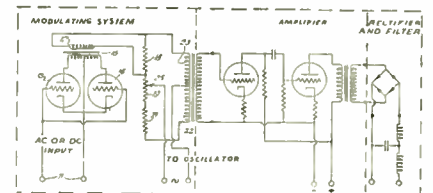

higher than any of the frequencies to be amplified across one diagonal of a bridge 22, 23, 18, 17, 19, 21. To modulate these oscillations, tubes 13 and 14 are provided. Their plate voltage is supplied by the oscillations through transformer 17 and they operate as half wave rectifiers, loading transformer winding 17 and thereby changing the equivalent impedance of the bridge arm including resistor 18 and winding 17 of the transformer. The amount of loading of the transformer winding depends on the plate resistance of tubes 13

(Continued on page 172)

# ELECTRICAL CONNECTIONS

*At Low Cost...*

FOR SMALL OR LARGE QUANTITIES!



## NEW BURNDY HYTOOL

Simple, compact, and relatively inexpensive, the Burndy HYTOOL (Cat. No. Y10R) provides new economies in making small wire connections . . . *regardless of quantities.*

In addition, each connection made is uniformly high in *mechanical strength* and *electrical efficiency* . . . because of the Burndy indent method, and Burndy's one-piece, pure-copper connector design. Here are the outstanding features of this HYTOOL:

1. Large jaw opening simplifies operation and speeds up work.
2. Foot-pedal leaves both hands free for fast, uninterrupted production.
3. Multiple die accommodates connector sizes 18, 14 and 10, with or without insulation grips, for wire sizes 22 to 10 inclusive . . . no 'setting-up' required when changing.
4. Economical for short runs . . . high production and low-cost on long runs.
5. Provides *uniform* indent, assuring uniformly strong, efficient connections.
6. Price: \$50.00 complete with die set. F.O.B. factory.

Also available for pneumatic operation. For full details, get in touch with the Burndy representative near you, or write, Burndy Engineering Co., Inc., 107-K Bruckner Blvd., New York 54, N. Y.

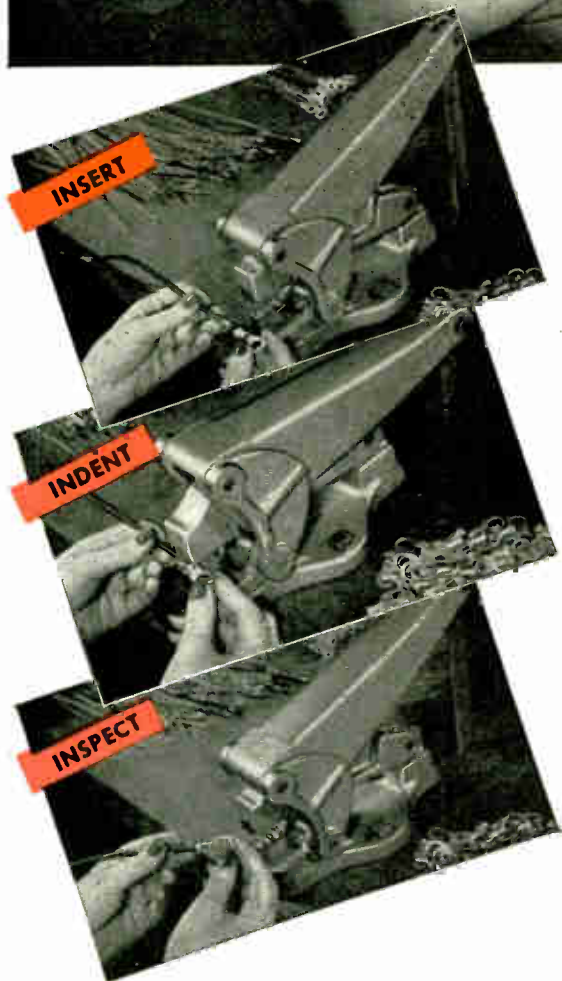

Headquarters for  
CONNECTORS

# Burndy

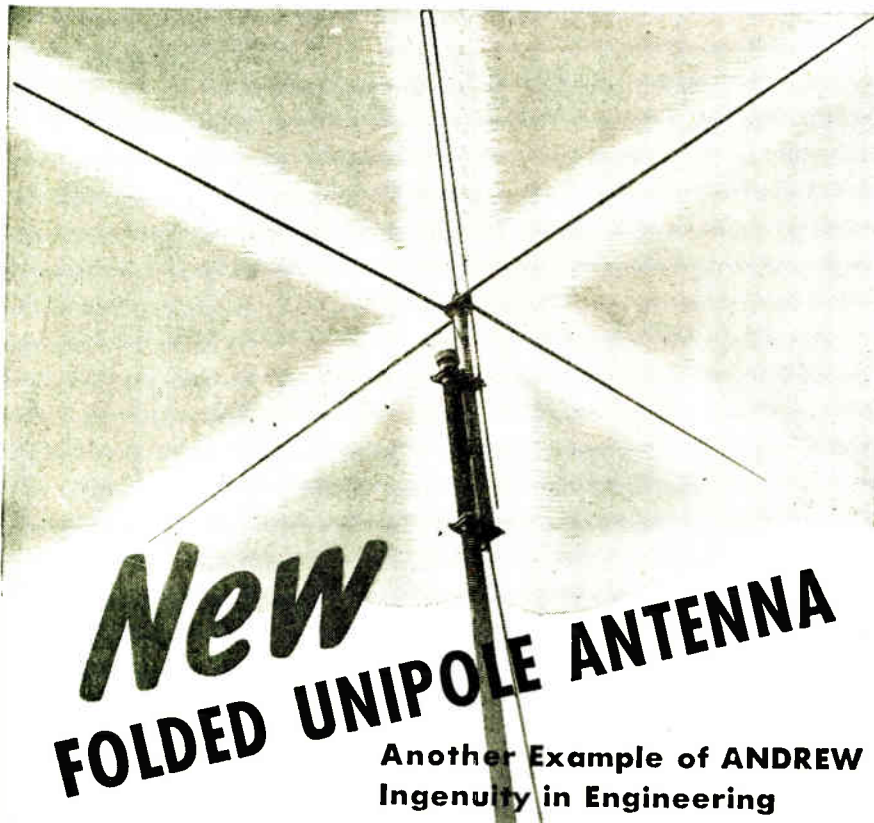

# New FOLDED UNIPOLE ANTENNA

Another Example of ANDREW Ingenuity in Engineering

Concentrating on electrical performance, Andrew engineers have designed a unique Folded Unipole Antenna which—according to comparative tests—easily outperforms other antennas at several times the price.

Used for transmitting and receiving at frequencies from 30 to 40 MC and for powers up to 5,000 watts, this antenna has proved so successful that similar models for higher frequencies are now being designed.

## FEATURES:

- Light weight — only 15 pounds — simplifies installation.
- Lightning hazard minimized by grounded vertical element.
- "Slide trombone" calibration permits exact adjustment for any frequency between 30 and 40 MC, using only a wrench. Optimum performance for that frequency is guaranteed without "cut and try" methods.
- Proper termination of coaxial transmission line. Unlike other "70-ohm" antennas, the Folded Unipole actually provides a non-reactive impedance with a resistive component varying between 62 and 75 ohms (see lower curve).
- Excellent band width, ideal for FM (see upper curve).

Andrew Co. specializes in the solution of antenna problems. For designing, engineering and building of antenna equipment, consult Andrew Co.

**ANDREW CO.**  
363 EAST 75th ST., CHICAGO 19, ILL.

WRITE FOR FULL INFORMATION

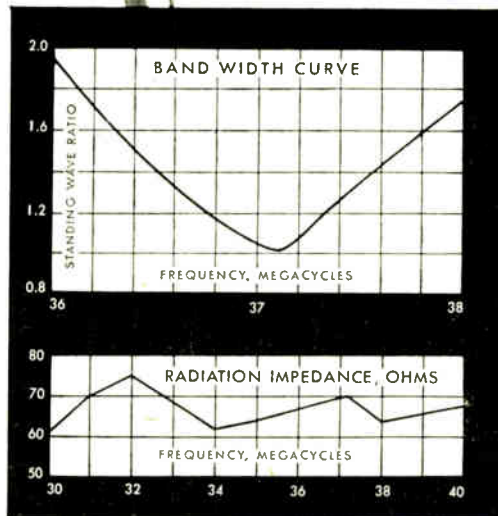

## NEW PATENTS

(Continued from page 170)

and 14 and consequently on the voltage across terminals 11 which it is intended to amplify. The modulated voltage is then amplified and rectified.

F. K. Floyd, Hathaway Instrument Company, (F) June 3, 1943, (I) July 10, 1945, No. 2,379,897.

### Thermistor AVC Circuit

Signals rectified by the left-hand section of diode D are obtained across resistor  $R_2$ , a smoothing circuit  $R_1, C_2, C_3$  being provided to remove the high frequency components. These rectified audio frequency signals are applied to the control grid of tube  $T_1$  through blocking capacitor  $C_5$  and the resistor combination including resistors  $R_3, R_4$  and potentiometer P. The incoming

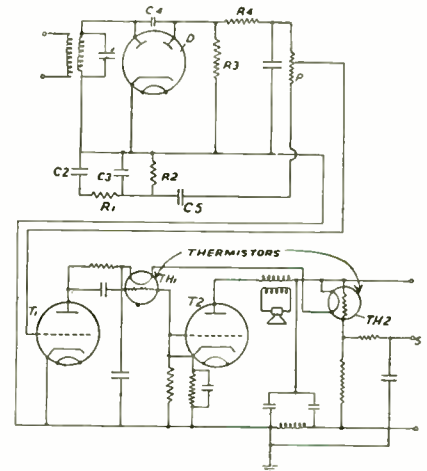

signals to the right-hand section of diode D pass through capacitor  $C_4$  and produce an AVC voltage across resistor  $R_3$ , providing a negative bias for the grid of tube  $T_1$  which increases as the signal level increases.

Tube  $T_1$  operates as amplifier. When there are no signals arriving in the receiving circuit, the negative grid bias voltage of tube  $T_1$  obtained from resistor  $R_3$  will be comparatively small and the plate current through  $T_1$  will be a maximum. Accordingly both thermistors  $Th_1$  and  $Th_2$  will be hot; as both have a negative temperature coefficient of resistance, their resistance will be low. When signals at a high level are received, both thermistor resistances will be high. Due to the presence of thermistor  $Th_1$ , the potential at terminal 5 will become more negative with an increase in signal level. Thermistor  $Th_2$  varies the coupling between tubes  $T_1$  and  $T_2$  in such a sense as is desired for automatic volume control action.

P. K. Chatterjea and C. T. Scully, Standard Telephones and Cables Limited, (F) May 20, 1943, (I) June 19, 1945, No. 2,378,620.

### AVAILABLE PATENTS

The following five U. S. patents are listed in the Register of Patents Available for Licensing or Sale, September 4, 1945, published by the United States Patent Office as an addition to the Official Gazette:

Pat. 2,092,951. Finding Apparatus. Patented Sept. 14, 1937. Device for locating buried pipe, particularly non-metallic, including a tubular transformer with conical shaped ends and weighted and pivoted coil therein; coil remains perpendicular while transformer is horizontal. It is not necessary that pipe to be located function as part of device. (Owner) Frank N. Blake, 15 Highland Avenue, North Adams, Mass.

Pat. Re. 21,711. Pipe Finder. Reissued Feb. 11, 1941. Orig. No. 2,192,765 dated

(Continued on page 174)

New Westinghouse 6-volt input, 250-volt output dynamotor delivers 50 milliamperes. Adaptable for other ratings. Size 3.45 inch frame.

**power  
on call**



**where it's needed • • when it's needed**

**OTHER WESTINGHOUSE EQUIPMENT  
FOR COMMUNICATIONS**

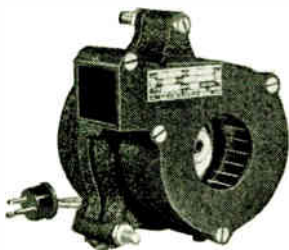

**LIGHTWEIGHT  
MOTOR BLOWERS**

cool electronic equipment or keep temperature constant. Deliver 8 cfm free air at 60 cycles, single-phase and 25 cfm at 400 or 800 cycles, single-phase.

**MOTORS**

in a wide range of ratings—light in weight, compact, efficient for driving blowers or actuating controls.

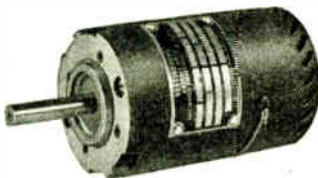

This compact dynamotor for police communications equipment rates high on every count . . . for efficiency . . . light weight . . . dependable, long life . . . quiet operation . . . low ripple . . . excellent commutation. It provides the right power output where it's needed—in the way it's needed.

It's efficient as well, in conserving input power—important for low-voltage supply systems—operating, in effect, as a rotating direct-current transformer. Furthermore, its smooth functional design economizes on the small space allotted in a radio transmitter or receiver. Its ruggedness withstands the shock in moving vehicles as well as extreme climatic conditions. It is built to operate 2000 hours without servicing.

For further details on Westinghouse Dynamotors, see your nearest Westinghouse representative, or write Westinghouse Electric Corporation, P. O. Box 868, Pittsburgh 30, Pa.

J-03240

**Westinghouse**  
PLANTS IN 25 CITIES... OFFICES EVERYWHERE

*Communications Equipment*



# Willor

For *Precision Accuracy*



## WILLOR STAMPINGS

A modern plant, including designing, Tool and Die making — automatic stamping — machining — welding — assembling — spraying — large or small production runs — special custom built products, at low cost.

**A Service . . .  
Complete from  
Design to  
Finished Product**

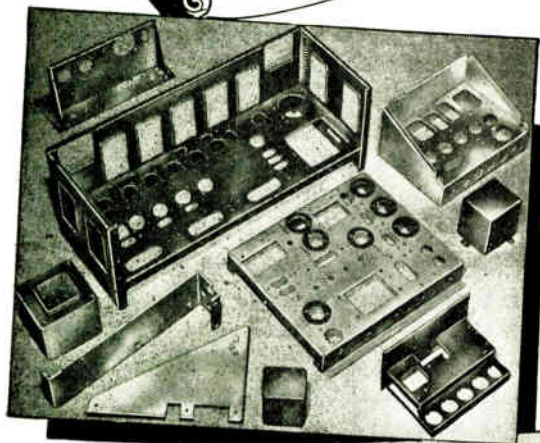

## WILLOR

is your definite assurance of **SKILL** and **ACCURACY** for **PERFORMANCE**.

If your product is in the development stage or finished blueprint, write WILLOR for quotations.

You will find our plant is prepared to produce to meet your needs.

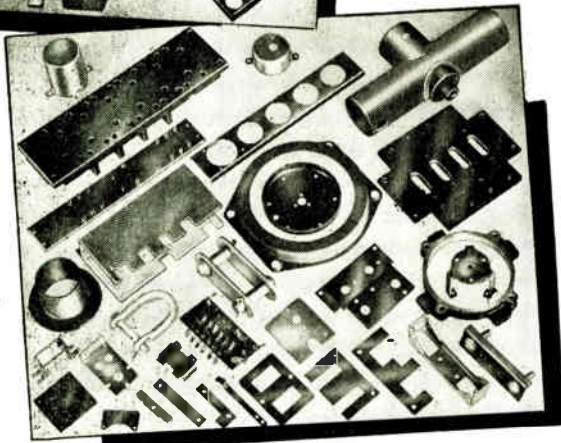

Our large assortment of stock dies may fit your requirements and result in real savings for you.



# WILLOR

manufacturing Corp.

794 A EAST 140th STREET, NEW YORK 54, N. Y.

MELROSE 5-6085

OVER 40 YEARS OF EXPERIENCE

## AVAILABLE PATENTS

(Continued from page 172)

Mar. 5, 1940. Device for locating buried pipes in which transformers, coil means, batteries, amplifier, phone tip sockets, etc., are combined in a container having multiple compartments. Can be carried around by one person wearing ear phones and turned on and off at will. (Owner) Frank N. Blake, 15 Highland Avenue, North Adams, Mass.

Pat. 1,978,434. Optical Apparatus for Measuring the Thickness of Piezo Electric Crystals. Patented Oct. 30, 1934. (Granted under the act of March 3, 1883; as amended April 30, 1928; 370 O. G. 757.) The thickness of a doubly refracting slate is measured over the entire viewing field by the color produced by its double refraction. (Owner) Harry B. Maris, 4711 Riverdale Road, Riverdale, Md.

Pat. 2,206,827. Device for Differentiating and Indicating the Relative Occurrences of a Sequence of Events. Patented July 2, 1940. A four lane course is illustrated and the arrangement of electrically operated lights and circuits, theory of operation and type of lamps used are set forth in detail. (Owner) Leon M. Prince, Jr., 424 W. 116th St., New York 27, N. Y.

Pat. 2,308,778. Automatic Telephone System. Patented Jan. 19, 1943. An "all-electronic" control which comprises a "counting" circuit A, a "differentiating" circuit B and a "register" circuit C. Circuit A counts the dial impulses and transmits the results to circuit B which codifies them and actuates circuit C. The last named circuit records the number and initiates the connection. (Owner) Leon M. Prince, Jr., 424 West 116th St., New York 27, N. Y.

Printed copies of these U. S. patents can be obtained from the Commissioner of Patents, Washington, D. C., at the cost of 10c per copy.

## Postage Stamp Issue to Mark Radio Anniversary

A petition, asking the government to issue a postage stamp commemorating the twenty-fifth year of broadcasting in the U. S., has been presented to President Truman by the National Broadcasters Association. The request is in line with National Radio Week which has been proclaimed for Nov. 4-11.

To give National Radio Week nationwide significance, a series of programs has been planned. Several of the scheduled programs will go out over network hook ups with small local stations piping the programs from the network affiliates.

## Subscription Radio Quits

There won't be any "pig squeal" radio after all. Subscription Radio Inc., which maintained headquarters at 342 Madison Ave., New York, has passed out of the picture. William Benton, who was a prime mover in the venture, has withdrawn to devote all his time and talents as Assistant Secretary of State, to which post he was recently appointed. The company points out that without his active participation it appeared unwise and unsound to launch the venture.



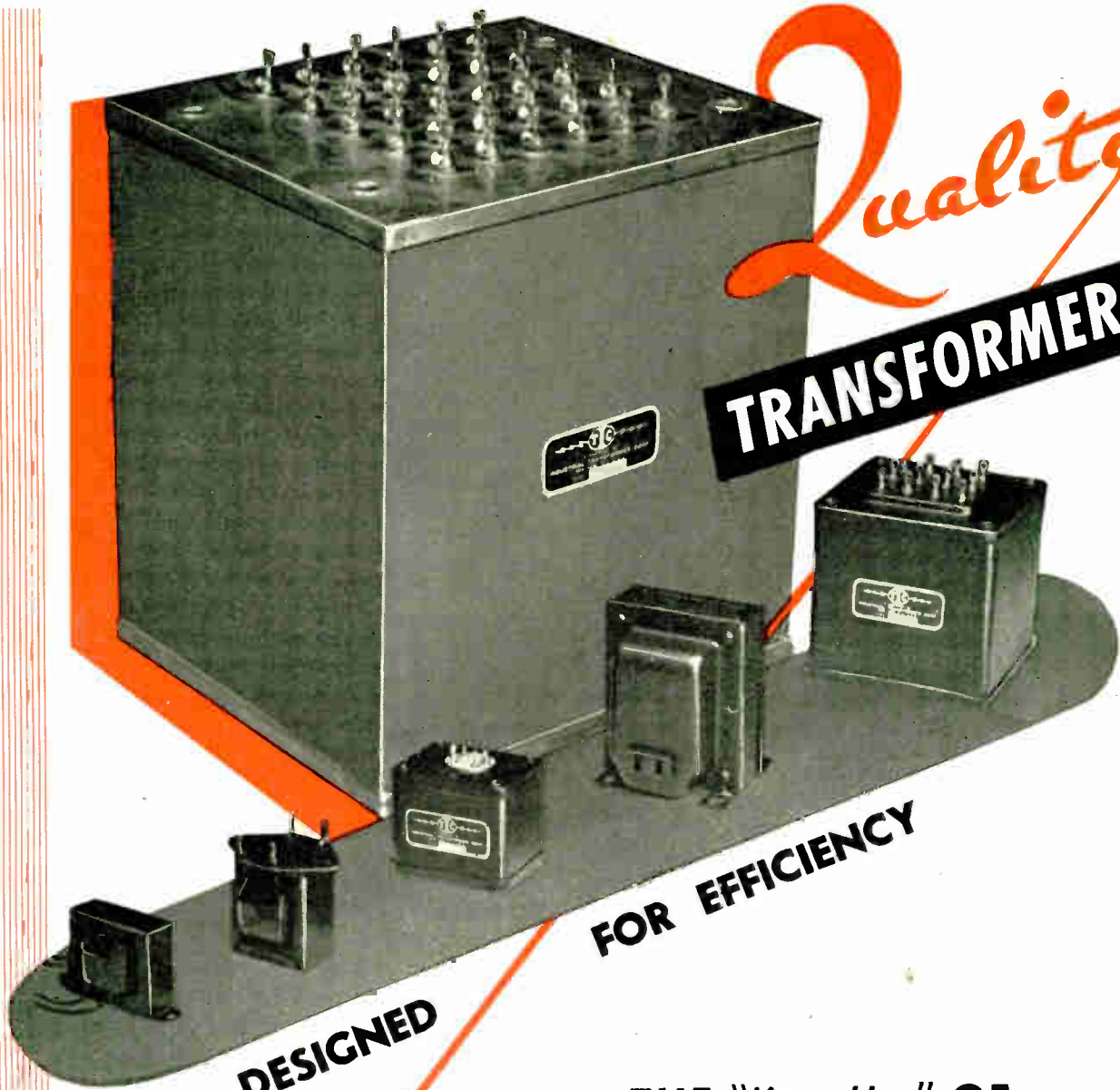

*Quality*

**TRANSFORMERS**

**DESIGNED FOR EFFICIENCY**

### THE "Know-How" OF TRANSFORMERS

... ITC combines years of experience in the field, with leadership in the scientific design of every type of transformer for every application ... to bring you better transformers.

... The trained, skilled engineers who design ITC TRANSFORMERS are ready to aid you with your individual transformer problems.

... For dependable service now ... and in the future, be sure to use and specify ITC TRANSFORMERS.

... Your inquiries are invited.



**INDUSTRIAL TRANSFORMER CORP.**  
**2540 BELMONT AVENUE, NEW YORK, N. Y.**

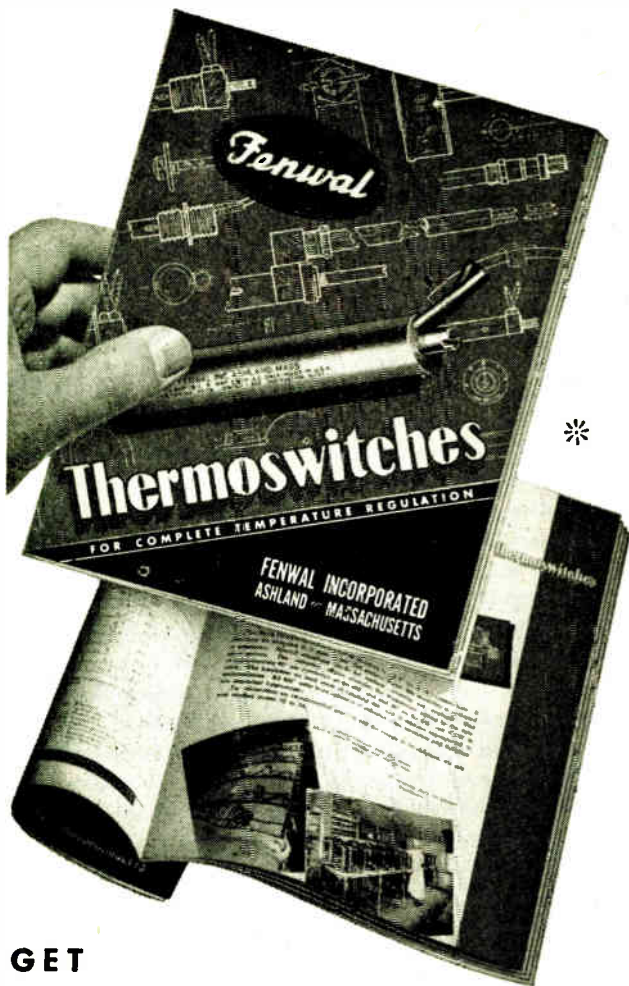

**GET  
THIS VALUABLE BOOK  
On Temperature Control**

**Mailed to you  
without obligation  
immediately**

**TO ELECTRICAL EQUIPMENT  
MANUFACTURERS**

Before deciding on temperature regulating devices for your products, be sure to investigate Fenwal Thermoswitches. They operate on an unusual principle, and offer many advantages not found in other types of switches. The Fenwal Engineering Data Book contains detailed drawings of construction of various models and typical installations.

- Compact construction permits installation in tight places.
- Make and break unaffected by external vibration.
- Readily adjustable for wide range of temperature control.
- Minutely accurate.
- Adaptable for all types of media.
- Inexpensive.
- A 44-page treatise on Thermal Control including installation, drawings, photographs, blueprints and descriptive suggestions for future planning with basic principles involved in temperature regulation and control. . . . Just write for your free copy on your business letterhead.

"IF IT'S A FENWAL — IT'S THE BEST OF ALL"

**Fenwal, Inc.**  
THERMOSWITCHES  
FOR COMPLETE TEMPERATURE CONTROL  
67 Pleasant Street, Ashland, Massachusetts

**PERSONNEL**

**J. B. Coleman** has been appointed assistant director of engineering for the RCA Victor Division RCA



**J. B. Coleman**

and **M. C. Batsel** is the new chief engineer for engineering products. Mr. Coleman, who will make his headquarters at the company's home office in Camden, N. J., joined RCA in

1930. In 1939 when he was appointed chief engineer of the engineering products department, a position he held until his new assignment Mr. Batsel became associated with RCA in 1929. Previous to his new assignment, he was chief engineer at the RCA Victor plant in Indianapolis.

**William D. Macegeorge**, formerly chief of electronic laboratory, Baldwin-Southwark, has joined the staff of Automatic Temperature Control Co., Philadelphia, in the capacity of technical consultant. He has done much work in the development of electronic equipment, notably in the field of strain gauges.

**W. H. Wells** has been appointed quality control engineer of the heating device division of the General Electric Company's appliance and merchandise department, Bridgeport, Conn.

**Paul H. Thomsen** has been appointed chief engineer in charge of special electronics at the Los Angeles plants of the Hoffman Radio Corp. Previously he had been a consultant for seven years with the National Radio Institute, Washington. He was vice president in charge of engineering for four years at College Park, Md., with the Air Track Mfg. Corp. and with the Jenkins Television Corp. in New York and Washington for six years.

**C. A. Lindemann** has been appointed quality control engineer for the wiring device and accessory equipment divisions of the General Electric Co.'s appliance and merchandise department, Bridgeport, Conn.

**Freeman A. Spindell** had been appointed chief engineer of Browning Laboratories, Inc., Winchester, Mass. He became associated with the Browning Laboratories in the Spring of 1941, where he has devoted his time to the design of radar and radar test equipment.

(Continued on page 178)

# Mathematical Dimensioning

MAKES C.T.C. CRYSTALS—CRYSTALS YOU CAN COUNT ON



**A** new C.T.C. development . . . a precise mathematical method of predetermining exact crystal dimensions . . . the most important new contribution to the manufacture of quality crystals . . . Mathematical dimensioning achieves greater accuracy. It provides the utmost assurance of consistent performance . . . guarantees frequency stability, high activity, long life in every C.T.C. Crystal . . . Learn the facts about "mathematical dimensioning" and why it assures better, lasting performance. Write for C.T.C. Crystal Bulletin No. 015. It contains the complete story.

**CAMBRIDGE THERMIONIC CORPORATION**  
441 CONCORD AVENUE, CAMBRIDGE 38, MASS.

*A representative selection of C. T. C. "mathematically dimensioned" Crystals*





ONCE AGAIN you can get sturdy, dependable STANCOR Transformers in a wide variety of sizes and types—or get them built to your exact specifications—in any reasonable quantity, within reasonable time.

STANCOR Transformers, Reactors and Electronic Equipment made outstanding performance records all over the world—often under most adverse operating and climatic conditions. They are the best that science, skill and modern precision equipment are producing today. So get "quotes" from STANCOR first and specify STANCOR where performance counts.

# STANCOR

STANDARD TRANSFORMER CORPORATION  
1500 NORTH HALSTED STREET, CHICAGO 22, ILLINOIS

## PERSONNEL.

(Continued from page 176)

**P. D. DeLeo** has been appointed development engineer; **I. A. Crawford**, research engineer and **E. Y. Bunting**, machine design engineer for the Progressive Welder Co., 3050 E. Outer Drive, Detroit 12, Mich. DeLeo was formerly connected with the Carnegie-Illinois Steel Co., and Federal Machine & Welder Co.; Crawford goes to Progressive from Westinghouse Electric Corp., and Bunting was formerly connected with the Federal Machine & Welder Co.



**J. Kelly Johnson** has established his own office at 55 West 42nd St., New York, N. Y., and will do business as a consulting engineer—specializing in home

radio receivers. He has had many years experience having at various times been connected with Hazeltine, Wells-Gardner and Hammarlund. For a year he was chief of the production section in the electronics division of the Navy.

**Raymond K. McClintock**, a Sylvania Electric engineer since 1936, has been appointed engineering consultant for the company's International Division with headquarters in New York. He will represent the Radio and Lighting Divisions and work directly with sales managers in Mexico and South America, as well as those in Europe and Asia when normal trade is resumed.

**William J. Larkin** has been appointed engineering manager of the National Radio Co., Malden, Mass. Larkin joined National in 1934 after receiving his master of science degree from the Massachusetts Institute of Technology. He rose in the ranks of the engineering department and several years ago was made chief mechanical engineer, a post he held until his promotion to the top engineering berth in the company.

**Commander Herbert C. Guterma**n has been appointed executive assistant to the president of the Emerson Radio & Phonograph Corp., New York, N. Y. He has been head of the Electronic Components Group of the Production Division of the Bureau of Aeronautics where he was in charge of production of electronic and electrical equipment used by the Naval Air Arm during the war.

(Continued on page 180)

And now . . .

# MYCALEX

## 410

### PRECISION-MOLDED

**Newest and Greatest Advancement  
in Low Loss Insulation**

Just as sound advanced motion pictures and as television is advancing radio, so the new improved MOLDED MYCALEX will advance the cause of electronic engineers who seek ever-higher standards in insulating materials.

New and exclusive methods of MYCALEX CORPORATION now enable us to mold MYCALEX to far more exacting specifications . . . closer tolerances, with metal inserts molded in and other refinements.

Our technique affords a virtually endless variety of irregular shapes that compare with molded plastics for smoothness and precision. Yet MYCALEX offers so much more in electrical and physical advantages.

For example: greater strength and dimensional stability, freedom from cold flow, freedom from carbonization, imperviousness to moisture and gases . . . ability to withstand temperatures beyond 400 C.

Investigate the new uses and applications of this remarkable new advancement in MYCALEX. Get the facts about MYCALEX 410.



## MYCALEX CORPORATION OF AMERICA

*"Owners of 'MYCALEX' Patents"*

Plant and General Offices, CLIFTON, N. J.

Executive Offices, 30 ROCKEFELLER PLAZA, NEW YORK 20, N. Y.

# Communications WELL IN HAND



• Transmitting equipment designed and manufactured by Wilcox Electric Company of Kansas City, Missouri.

**T**HE inclusion of Astatic's GDN Series Dynamic Microphone in this modern airline dispatching office installation speaks for itself. Present-day communications systems demand the finest possible equipment. Astatic products measure up to these high standards of operating efficiency.



**S**HOWN in the installation pictured above is a Dynamic, semi-directional, all-purpose Microphone of the Astatic DN Series, mounted on Grip-to-Talk Desk Stand. This stand embodies a relay-operating ON-OFF Switch for remote control of transmitters and amplifiers, the switch itself being operated by a slight pressure of the fingers upon a convenient grip bar.

*Astatic* Microphones, Phonograph Pickups and Cartridges are going forward daily in an ever-increasing volume to manufacturers of radio, phonograph, communications and public address equipment, and to authorized Astatic jobber outlets.

You'll HEAR MORE  
from Astatic

**THE**  
*Astatic*  
**ASTATIC CORPORATION**  
CONNEAUT, OHIO  
IN CANADA CANADIAN ASTATIC LTD, TORONTO, ONTARIO

## PERSONNEL

(Continued from page 178)

Henry Grossman, at present director of technical operations, and James Seward, director of operations for Columbia Broadcasting System, have been given added duties involving responsibility for television technical operating routines, personnel



Henry Grossman

and routine maintenance of equipment. The change will not affect the responsibility of Dr. Peter C. Goldmark for equipment design and installation, engineering standards and developmental tests.

Norman H. Saunders has been appointed engineering manager of the Kellogg Switchboard & Supply Co., 6830 So. Cicero Ave., Chicago. He will be in full charge of research, development, design and general engineering of Kellogg products. Has lately been released from the United States Signal Corps, Chicago Procurement District where he was executive officer.

Jules G. Simmonds and John J. Guarrera, formerly staff members of Radiation Laboratory, Massachusetts Institute of Technology, are now affiliated with the Engineering Staff of Bernard Rice's Sons, Inc. of 325 Fifth Avenue, New York, N. Y. The company will continue to develop, engineer and manufacture in the micro-wave, UHF and RF fields.

Norman Wunderlich, formerly manager of communications of the electronic division of the Galvin Corp., Chicago, has been appointed executive sales director for radio equipment and allied products by the Federal Telephone & Radio Corp. As sales director, he heads six sales sections embracing broadcast equipment, industrial electronics, rectifier equipment, aerial navigation, components, and two-way emergency service equipment.

### Hoffman Adds Air Communication Units

Hoffman Radio Corp., Los Angeles, has formed a new department, to be known as the CAA division and will develop material to CAA specifications. In charge will be Elmer P. Gertsch, who was a section engineer for RCA in Camden for 13 years and, more recently was for four years radio department manager for Air Associates Inc.

# Navy Reveals "Top Secret"

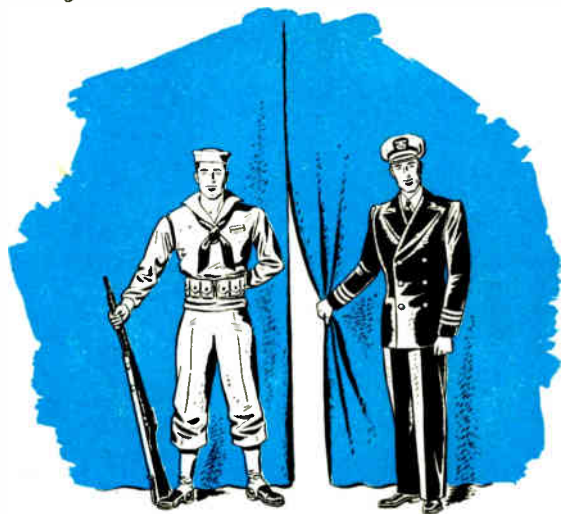

AWARDS SPECIAL NAVAL ORDNANCE  
"E" WITH 3 STARS TO IRC FOR "A  
WAR TIME TASK OF FIRST MAGNITUDE."

And IRC, with pride tempered by  
humility, records its gratitude for  
the privilege of making a modest  
contribution to Victory..and Peace.

The story of the Navy's "Project A" . . . the VT-Fuze, rates a close second in ordnance drama to the mighty Atomic Bomb. This tiny radio sending and receiving set hardly larger than a fist, fitted into the nose of a projectile or bomb, emits impulses at the speed of light itself. As the missile nears its objective the proximity device automatically detonates the charge and showers the target. . . . "Top secret" during its many months of development and use, the VT made possible an effective defense against Nazi Buzz Bombs and the Jap Kamikazes and greatly increased the accuracy of artillery fire. . . . IRC is honored to have been designated as the sole design and production source for the accurate and rugged BTR Resistors required—a total of 306,359,511! . . . Our sincere thanks are due to the Navy Department Bureau of Ordnance, Eastman Kodak Company, McQuay-Norris Manufacturing Co., Sylvania Electric Products, Inc., the Crosley Corporation and the Radio Corporation of America for the splendid cooperation which they extended to us throughout the entire period of design, development and production of the joint project. . . . United toward a common goal, their efforts and those of the eighty thousand men and women workers who participated, symbolize the strength that is America!

## International Resistance Co.

401 N. Broad Street

Philadelphia 8, Pa.

In Canada: International Resistance Co., Ltd., 11 King St., W., Toronto



IRC Makes More Types of Resistance Units, in More Shapes, for More Applications Than Any Other Manufacturer in the World.





# W

*With this instrument a new era in tube testing begins*

*... Remember ...*

As you read below the many other features of this pioneering instrument, remember this: It is a Simpson instrument, with all that implies in creative engineering research, in controlled testing and manufacture. Simpson products are not "assembled", they are engineered and built in the Simpson plant. Practically every component part, from the dial movement to the beautifully designed panels and the bakelite cases and panels, is made by Simpson. It is this that makes Simpson's the "instruments that *stay* accurate" with ideas that *stay* ahead.

#### SIMPSON MODEL 330 MUTUAL CONDUCTANCE TUBE TESTER

1. Size—15½" x 9½" x 6½".
2. Case—Sturdy plywood construction, with heavy fabricoid covering, corners trimmed in leather, rustproof hardware—removable cover with slip type hinges.
3. Panel—Heavy molded bakelite, beautiful satin grained finish. All characters, numerals, and dial divisions are engraved and filled in white, insuring long wearing qualities.
4. Meter—4½" rectangular of modern design with artistic four-colored dial indicating good, fair, doubtful, and bad—also "Percentage of Mutual Conductance" scale.
5. Sockets provided for all types of tubes with two spare socket positions.
6. Neon glow tube incorporated to indicate shorted tubes.
7. New simplified revolutionary switching arrangement (see description above).
8. The tube chart provided is arranged for quickly identifying the tube and setting the controls.
9. Tests tubes with voltage applied automatically over the entire operating range and under conditions approximating actual operation in a radio set.

Ask Your Jobber



### The New Simpson Mutual Conductance Tube Tester Brings To Radio Servicemen and Dealers An Entirely New Method of Testing Tubes And A Revolutionary New Switching Arrangement!

Tube manufacturers consider that a radio tube has reached the end of its usable life when it falls to 70% of its rated value. Until now there has never been an instrument to test tubes in percentage terms.

But now here *is* such an instrument. The new Simpson Model 330 tests tubes in terms of percentage of rated dynamic mutual conductance—a comparison of the tube under test against the standard rated micromho value of that tube. The colored zones on the dial coincide with the micromho rating or the percent of mutual conductance, indicating that the tube is good, fair, doubtful or definitely bad. Thus, at a glance, you can check the tube against manufacturers' ratings. If, for any reason, it becomes desirable to know the actual value in micromhos, the percentage reading may be easily converted.

This is the way tubes should be tested—the way testers always should have worked—but Simpson is first again in bringing this needed development. It tests tubes with voltage applied automatically over the entire operating range, reproducing more completely than ever before the actual conditions under which a tube functions in a radio set. No instrument, not even delicately adjusted laboratory devices, can do this 100%. But this new Simpson Mutual Conductance Tester approaches perfection as never before.

Besides this revolutionary new method, Simpson offers you an equally revolutionary switching arrangement. The circuit is so arranged that, even though there are numerous combinations possible, very few switches require moving to test any one tube. Many of the popular tubes are tested in the "normal" position without moving any of the nine tube circuit switches.

Ten push button switches and nine rotating switches of six positions each provide infinite combinations in tube element and circuit selection. Only a few settings are necessary for the most complicated tube. The tube chart provided is arranged for quickly identifying the tube and setting the controls.

When you have finished a tube test, the Automatic Reset takes over to speed and simplify the next test. Just press the reset button and instantly all switches, both push button and rotary, return to normal automatically!

Here is the test instrument you have had a right to expect from Simpson. With greater flexibility in its circuit and switching arrangement than any other tester can provide, it gives maximum provision against obsolescence. It's the tester of a new era.

SIMPSON ELECTRIC COMPANY  
5216 W. KINZIE ST., CHICAGO 44, ILLINOIS

# Simpson

INSTRUMENTS THAT STAY ACCURATE

WATCH FOR OTHER SIMPSON DEVELOPMENTS . . . THEY ARE EQUALLY WORTH WAITING FOR

## STRATOVISION

(Continued from page 126)

These ground reflections are produced by the transmitted signals being reflected from surfaces below the level of the receiving antenna and returned to it over a path which is somewhat longer than the direct transmission path from plane to receiving antenna. This is the common ghost problem and will either produce a definitely visible ghost or, if the distance is small, a resulting smear of the details of the picture.

These ground reflections and other reflections which approach the receiving antenna from below or a nearly horizontal angle can be eliminated through the use of a suitable reflector arrangement similar to that employed on so-called corner antennas. Where these ghost reflections are not eliminated through the use of reflectors, they will tend to wander across the picture as the plane travels in its circular path.

A second problem with the flying plane transmitter is the one of securing perfectly uniform field strength in all directions from the plane transmitter antenna. As the plane flies on its circular path, the antenna will present different sides to a given receiver antenna and may produce fluctuating field strength at a frequency dependent upon the time required for the plane to make its circuit. This latter problem can undoubtedly be handled by putting automatic volume control systems into television receivers and by design of the transmitting antenna.

### **Electronic Aids at Grand Coulee**

Plans are underway to erect a Washington State Building at the site of the great Grand Coulee Dam, to entertain and interest tourist travel. A large aluminum-covered building will have a high tower overlooking Roosevelt Lake above the dam. In this building it is proposed to have electronic devices, television, and other novelties to interest visitors. Arrangements are being made by former Senator C. C. Dill (who will be remembered as author of the Dill-White radio legislation)—now a member of the Columbia Basin Commission, who has recently been in the East contacting electronic organizations.

### **Now Its Vokar**

The name of the Electric Products Mfg. Corp. of Dexter, Mich., has been changed to the Vokar Corporation. The change is in name only.

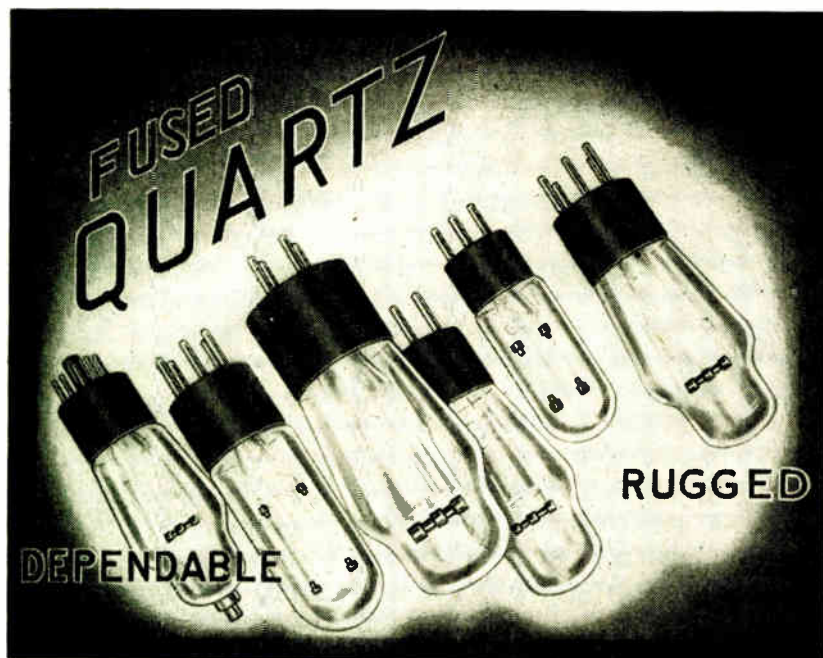

## INSULATORS

are a "main factor" of the high power electronic tube. Quartz is the best electrical insulator known to science. Many other qualities make it ideal for the job. . . . Not subject to thermal shock. Non hygroscopic. High surface resistance. Shaped to specification.

**ULTRA VIOLET LAMPS (quartz mercury arcs)**

**HYDROGEN ARCS IN QUARTZ**

**FUSED QUARTZ ROD,**

**TUBING, PLATES and SPECIAL SHAPES**

**HANOVIA**

**CHEMICAL & MANUFACTURING CO.**

Dept. EI-18

NEWARK 5, N. J.

# Synthetic Tubing

THE MODERN ELECTRICAL CONDUIT  
FOR INDUSTRY

TRANSPARENT...

ABRASION PROOF...

ACID PROOF...

Amphenol "9746"  
Flexible Synthetic Tubing

Size No.	Nominal I.D.	Wall Thickness	Number
20	.034"	.016"	9746-034
19	.038"	.016"	9746-038
18	.042"	.016"	9746-042
17	.047"	.016"	9746-047
16	.053"	.016"	9746-053
15	.059"	.016"	9746-059
14	.066"	.016"	9746-066
13	.076"	.016"	9746-076
12	.085"	.016"	9746-085
11	.095"	.016"	9746-095
10	.106"	.016"	9746-106
9	.118"	.016"	9746-118
8	.133"	.016"	9746-133
7	.148"	.016"	9746-148
6	.166"	.016"	9746-166
*3/16	.186"	.040"	9746- 3
*1/4	.250"	.040"	9746- 4
*3/8	.375"	.060"	9746- 6
*1/2	.500"	.083"	9746- 8
*5/8	.625"	.083"	9746-10
*3/4	.750"	.083"	9746-12
*7/8	.875"	.083"	9746-14
*1	1.00"	.083"	9746-16

\*Ferrules available for attaching end couplings or connectors.

Amphenol's Synthetic Tubing resists oil . . . resists grease . . . resists acids and alkalis . . . extremely flexible . . . provides easy identification of wires because it is transparent . . . can be cut at any point . . . not subject to tearing or abrasion.

Amphenol's Synthetic Tubing is widely used by manufacturers of electronic devices, aircraft, instruments and appliances to lower manufacturing costs and insure lasting efficiency for their products . . . characteristics permit wide range of uses. Write for full details.

**AMERICAN PHENOLIC CORPORATION**

Chicago 50, Illinois

In Canada • Amphenol Limited • Toronto



U.H.F. Cables and Connectors  
Conduit • Fittings • Connectors  
(A-N., U.H.F., British) • Cable  
Assemblies • Radio Parts  
Plastics for Industry

ONE QUICK CENTRAL SOURCE  
for all Leading Makes of  
**TRANSFORMERS**

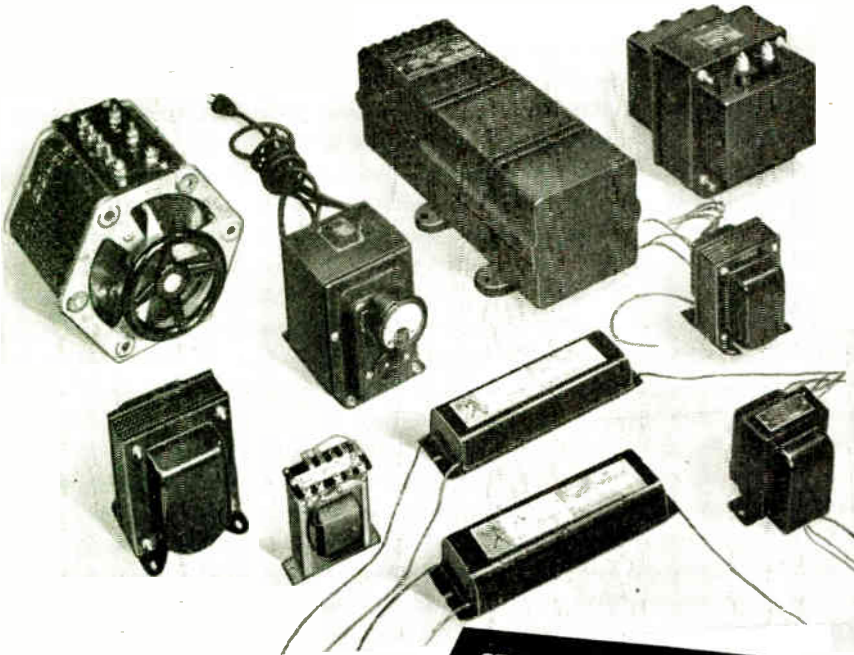

**STOCK ON HAND FOR  
IMMEDIATE DELIVERY**

Thordarson  
Stancor  
Sola  
General Radio  
UTC  
Superior  
Merit Coil  
Knight  
General  
Transformer  
Acme  
Pioneer Electric  
Crest

It's simpler, faster to get your transformer needs from this one central source. Here, under one roof, are *all the leading makes, in all the wanted types:*

Power • Adjustable • Voltage Regulating  
Step-up and Step-down • Plate and Filament  
Audio Input • Interstage and Output • Modulation  
Driver • Microphone, Line and Mixing Transformers  
Filter and Swinging Chokes • Audio Reactors  
Fluorescent Lighting Ballasts

Large and varied stocks are maintained for *rush service*. Close contact with manufacturers expedites procurement. This complete service saves time and work. That's why thousands call ALLIED First!

WRITE, WIRE, OR PHONE HAYMARKET 6800  
for Everything in Radio and Electronics

**ALLIED RADIO**  
CORPORATION

833 W. Jackson Blvd. • Dept. 32-L-5 • Chicago 7, Illinois

SUPPLIERS OF ELECTRONIC PARTS AND EQUIPMENT TO INDUSTRIAL AMERICA  
Electronic Tubes, Rectifiers, Power Supplies, Intercommunicating Systems, Sound Systems, Photo-Cell Equipment, Batteries, Chargers, Converters, Generators, Supplies for Resistance Welders, Fuses, Test Instruments, Meters, Broadcast Station Equipment, Relays, Condensers, Capacitors, Resistors, Rheostats, Transformers, Switches, Coaxial Cable, Wire, Soldering Irons, Microphones, Speakers, Technical Books, etc.

**TBA Proposes Big  
Tele Allocation Boost**

Quite a bit of the fussing was over programming, but the principal bone of contention thrown on the table at the hearing called by FCC to consider that organization's proposed television rules, regulations and standards was the matter of channel allocations. The hearing, postponed from October 4 to October 11, drew quite a crowd.

The video people are almost solidly against FCC's proposal to provide for only 342 metropolitan stations throughout the United States. In support of its arguments that this number of stations is not only inadequate but not in accordance with good engineering practice, Television Broadcasters Association presented a carefully worked out plan under which that number of allocations could be increased to 401. The additional 59 stations could be provided for without causing interference through the adaption of simple types of directive antennas.

**Metropolitan Increases**

If some such plan were adopted, and TBA asserts that it is thoroughly feasible from an engineering point of view, FCC could then increase the number of metropolitan stations in New York from 4 to 7, in Chicago from 5 to 7, in Los Angeles from 6 to 7, in Philadelphia from 3 to 4, in Boston from 3 to 5, in Detroit from 3 to 5, and in Cleveland from 3 to 5, these being considered the principal markets from a population point of view.

Under the original FCC plan issued in September and later revised, no provision had been made for metropolitan power stations in quite a few of the 140 principal market districts. Under the TBA plan, such power stations would be possible in substantially all such areas. TBA points out that a minor amount of directivity would improve assignments in many cases, a simple dipole would help in other cases, and a dipole with ground sheet would be effective in the remainder of those locations where interference would result if channel assignments were increased without such treatment.

On the programming side of the picture the principal argument centered around the Commission's proposed rule requiring six hours of transmission daily. Engineers who appeared before the hearing were about evenly divided regarding the possibility, desirability and necessity of the proposed rule. Some pointed out that six hours appears to be an excessive require-

(Continued on page 188)

**NEW!**

# *Sweep-Balance Recorder*

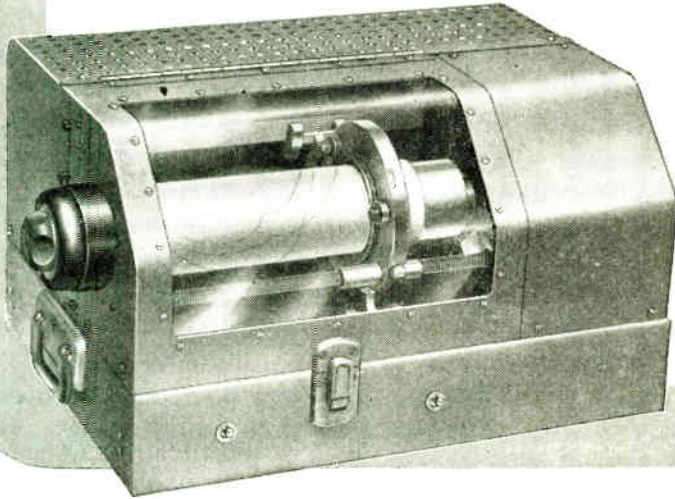

✓ PLOTS CURVES OR SETS OF CURVES OF TWO FUNCTIONAL VARIABLES.

✓ PRODUCES A PERMANENT RECORD.

Now you can record many types of relationship with new speed and accuracy. Obtain permanent inkless records of such functions as *viscosity vs. temperature . . . speed vs. torque . . . angle vs. light emission . . . volts vs. amperes.*

A complete picture of the required information is automatically and quickly produced without chance of error due to human element. As many as 1000 related points visually recorded in three minutes' time. Up to six variables can be traced simultaneously as a function of a common seventh, making multiple testing simple.

For example, three samples of oil can be tested at one time, for *viscosity vs. temperature.* with each test permanently recorded.

The Sweep-Balance X-Y Recorder is readily adapted for recording any magnitude which can be transformed into an electrical signal. Adaptation to a multitude of recording problems is simple. Often, only the pick-ups (for temperature, pressure, humidity, etc.) may have to be changed to meet specific applications.

Outline your production or laboratory testing requirements by letter. They will have the prompt attention of our engineers. Great American Industries, Inc., Connecticut Telephone & Electric Division, 405 Britannia Street, Meriden, Connecticut.

# **Connecticut**

ELECTRICAL EQUIPMENT



# CARDWELL skill and facilities responsible for this "Special Order" Equipment are available for design and production problems...

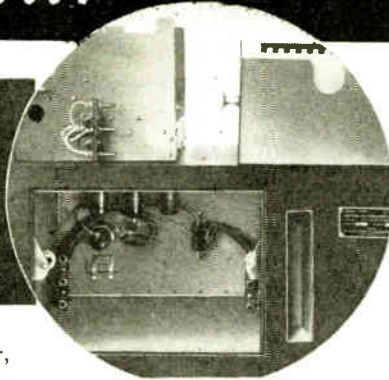
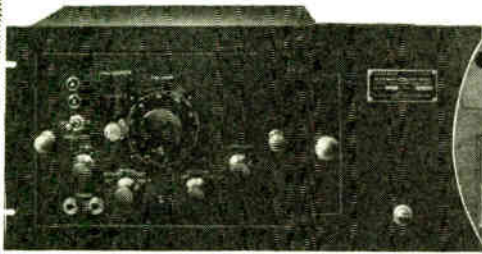

Rack Mounted Heterodyne Frequency Meter, Type 221 — Complete with A.C. power supply; ranges: 125 kc. to 20,000 kc.

Similar Frequency Meter in Portable Case — Battery operated (or A.C. power supply can be substituted); ranges of various Army or Navy Frequency Meters:

- Type 221 ..... 125 kc. to 20 Mc.
- Type 173 ..... 90 Mc. to 450 Mc.
- Type 174 ..... 20 Mc. to 250 Mc.
- Type 175 ..... 85 Mc. to 1000 Mc.

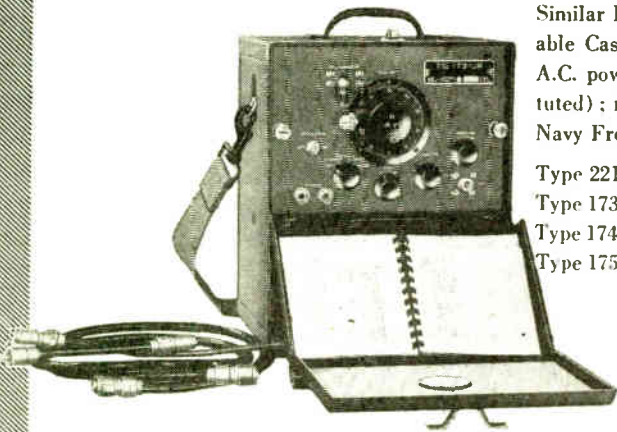

These are instruments of accuracy and precision as manufactured for government service by the makers of Cardwell variable and fixed air capacitors, which have long been a "Standard of Comparison".

The Cardwell engineering and manufacturing personnel and facilities, so skillfully employed on this equipment, are available for any production or design problem in the field of electronics.



Address inquiries to:

**DEP'T. M, CONTRACT MANUFACTURING DIVISION**

**THE ALLEN D. CARDWELL MANUFACTURING CORP.**

**MAIN OFFICE: 81 PROSPECT STREET, BROOKLYN 1, N. Y.**

**FACTORIES: PLAINVILLE, CONN. — BROOKLYN, N. Y.**

ment in view of the relatively high cost of television programs and the limited viewing audience. Others felt that six hours a day was none too little to help in quickly building an audience. Commander Eddy made the point that currently operating television equipment just would not stand the gaff of such an extensive schedule, that replacements are difficult if not impossible and will remain so for some time.

The feeling at the hearing appeared to be that no matter what is done, the present use of 13 channels below 300 megacycles is only a temporary expedient and that eventually and in the not too far distant future television will be forced to go to the higher frequencies between 480 and 920 megacycles, for which FCC has made provision. In the meantime, the opinion is unanimous that everything should be done to insure the quickest possible start of television for the public on a practical commercial basis. Following are FCC's proposed allocations.

Following is the latest revised list of Metropolitan and Community station allocations made by FCC:

District	Total Stations	
	Metro-politan	Community
Akron .....	1	1
Albany .....	1	—
Schenectady } .....	5	—
Troy .....	—	—
Allentown .....	—	—
Bethlehem } .....	0	1
Easton .....	—	—
Altoona .....	1	1
Amarillo .....	4	—
Asheville .....	2	—
Atlanta .....	4	—
Atlantic City .....	0	1
Augusta, Ga. ....	1	1
Austin .....	2	—
Baltimore .....	3	0
Beaumont } .....	4	—
Port Arthur .....	—	—
Binghamton .....	1	1
Birmingham .....	2	—
Boston .....	3	0
Bridgeport, Conn. ....	0	1
Buffalo } .....	3	—
Niagara .....	—	—
Canton, Ohio .....	0	1
Cedar Rapids .....	2	—
Charleston, S. C. ....	2	—
Charleston, W. Va. ....	3	—
Charlotte .....	3	—
Chattanooga .....	3	—
Chicago .....	5	0
Cincinnati .....	3	—
Cleveland .....	3	—
Columbia .....	3	—
Columbus, Ga. ....	1	1
Columbus, Ohio .....	3	—
Corpus Christi .....	4	—
Dallas .....	2	—
Davenport .....	—	—
Rock Island } .....	4	—
Moline .....	—	—
Dayton .....	2	—

(Continued on page 193)



# BECKMAN Helipot

Now available for  
civilian electronic applications!

## Can you use this important development to improve your product?

**THE HELIPOT**—a Beckman development widely used during the war on such precision instruments as radar, flight control units, depth sounding devices, and other critical electronic equipment—is now available to manufacturers and users of civilian electronic instruments!

The Beckman Helipot is a unique *new type* of potentiometer-rheostat which combines in *one compact unit* both the wide resistance range and extreme fineness of adjustment heretofore usually obtainable only through use of *two* separate rheostats, *two* control knobs, *two* adjusting operations. It is outstanding for all types of precision electronic equipment requiring high linearity, wide range and precise resistance control.

► **WHAT IT IS:** The Beckman Helipot consists of a long, precision slide wire coiled helically into a small case and equipped with a slider contact assembly that is moved in the usual manner—by rotation of a shaft. A simple device automatically guides the slider contact over the helical path of the resistance winding so that the entire length of the wire can be contacted by rotation of *one* knob.

This unique design enables the Helipot to occupy no more panel space than a conventional single-turn rheostat. Yet the greatly increased length of the resistance winding provides a new standard of high accuracy *and* wide resistance range *in one unit*. It means, for example, that a ten-turn Helipot has *ten times the fineness of adjustment* possible with a single-turn rheostat of the same range. Or conversely, for the same fineness of adjustment a ten-turn Helipot has *ten times the range*.

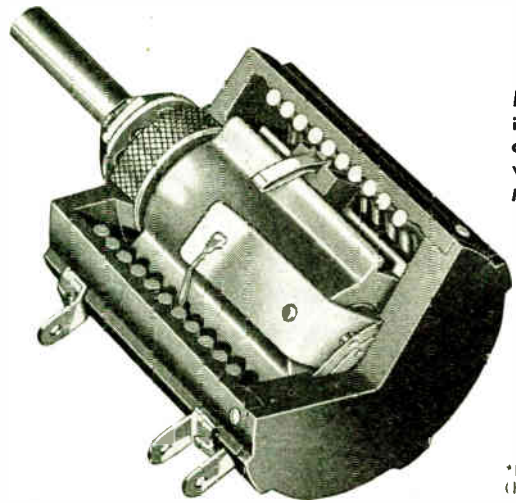

**High Linearity**—As a result of fulfilling wartime requirements for ultra-precision circuit controls, Helipot's are mass-produced with linearity tolerances of *one tenth of one per cent*—and even less!

**Precise Settings**—Because of the many-times longer slide wire, settings can be made with an accuracy impossible with single turn units.

**Wide Range**—By coiling a long potentiometer slide wire into a helix, the Helipot provides *many times* the range possible with a single turn unit of comparable diameter and panel space requirements.

**Low Torque**—Of special interest for power-driven applications—the Helipot has unusually low torque characteristics. The 1½" Helipot, for example, has a torque of only one inch-ounce.

### IMPORTANT HELIPOT FEATURES

Write for further details!

\*HELIPOT—T. M. Reg.  
(HELical POTentiometer)

The Beckman Helipot is precision-built of the finest materials and is designed for use in all types of high quality electronic instruments where accuracy, sensitivity, wide range and positive operation are required. Why not investigate its use to increase the accuracy, the convenience, the efficiency of your quality electronic products? Our engineers will be glad to explain how the Helipot can fit your application. Write, briefly outlining your needs and ask for Helipot Bulletin!

**VARIOUS SIZES AND TYPES**  
Current Helipot production is in several types and sizes, including . . .

Diameter	No. of Turns	Total Length Slide Wire
1½"	Up to 10	Up to 44"
3"	Up to 40	Up to 378"
Other sizes available on special order.		

**THE Helipot CORPORATION**, South Pasadena 3 Calif.

# Out of Two Laboratories

comes a **NEW** railroad communications

Rock  
Island

SPERRY



● Sperry's Research Laboratory where Railroad Communications System was designed and developed



● Rock Island's Mobile Electronic Laboratory where equipment was put to rugged test

THE ENGINEERING STAFF of the Sperry Gyroscope Company, in collaboration with engineers of Rock Island Lines, has perfected a new *system* of railroad communications.

Designed especially for railroads by Sperry and tested extensively by Rock Island, this system offers to the railroad industry microwave applications, secret until now, which Sperry's vast engineering group developed during the war years in co-operation with the U. S. Navy. With the aid of Rock Island engineers working in their specially equipped Electronic Car, the Sperry system has been completely tested and proved.

Sperry's Railroad Communications System makes possible *for the first time* clear, audible signals through tunnels, deep gorges, and the usual terrain and atmospheric conditions encountered in railroad service. No man-made

SPERRY GYROSCOPE COMPANY, INC.

*Division of the Sperry Corporation*

*Leaders in the fields of* . . . GYROSCOPICS . ELECTRONICS



system!



or atmospheric disturbance interferes with vital business!

Automatic relay stations, employing heretofore-restricted radar components that can be substituted for overhead land lines in treacherous storm areas, will link way stations and headquarters, and provide a continuous en route connection between trains and wayside points. A specially designed antenna provides any required degree of directional control.

Rock Island Lines, whose "sole purpose is to provide the finest in transportation," is being equipped with a Sperry Railroad Communications System.

If you would like our help in planning a complete radio communications system to expedite the handling of your freight and passenger traffic, write our Industrial Department for further information.

### SPERRY RAILROAD COMMUNICATIONS SYSTEM

- **Microwave applications for the first time**
- **Designed especially for railroads**
- **Greater Range**
- **Increased Signal Strength**
- **FM Signal Audibility through any kind of interference**
- **Any degree of Directional Control**
- **Suitable for indoor and outdoor installations**
- **Available in both VHF and UHF**

**GREAT NECK, N. Y.** ★ LOS ANGELES • SAN FRANCISCO • SEATTLE • NEW ORLEANS • CLEVELAND • BROOKLYN • HONOLULU ★

**RADAR • AUTOMATIC COMPUTATION • SERVO-MECHANISMS**

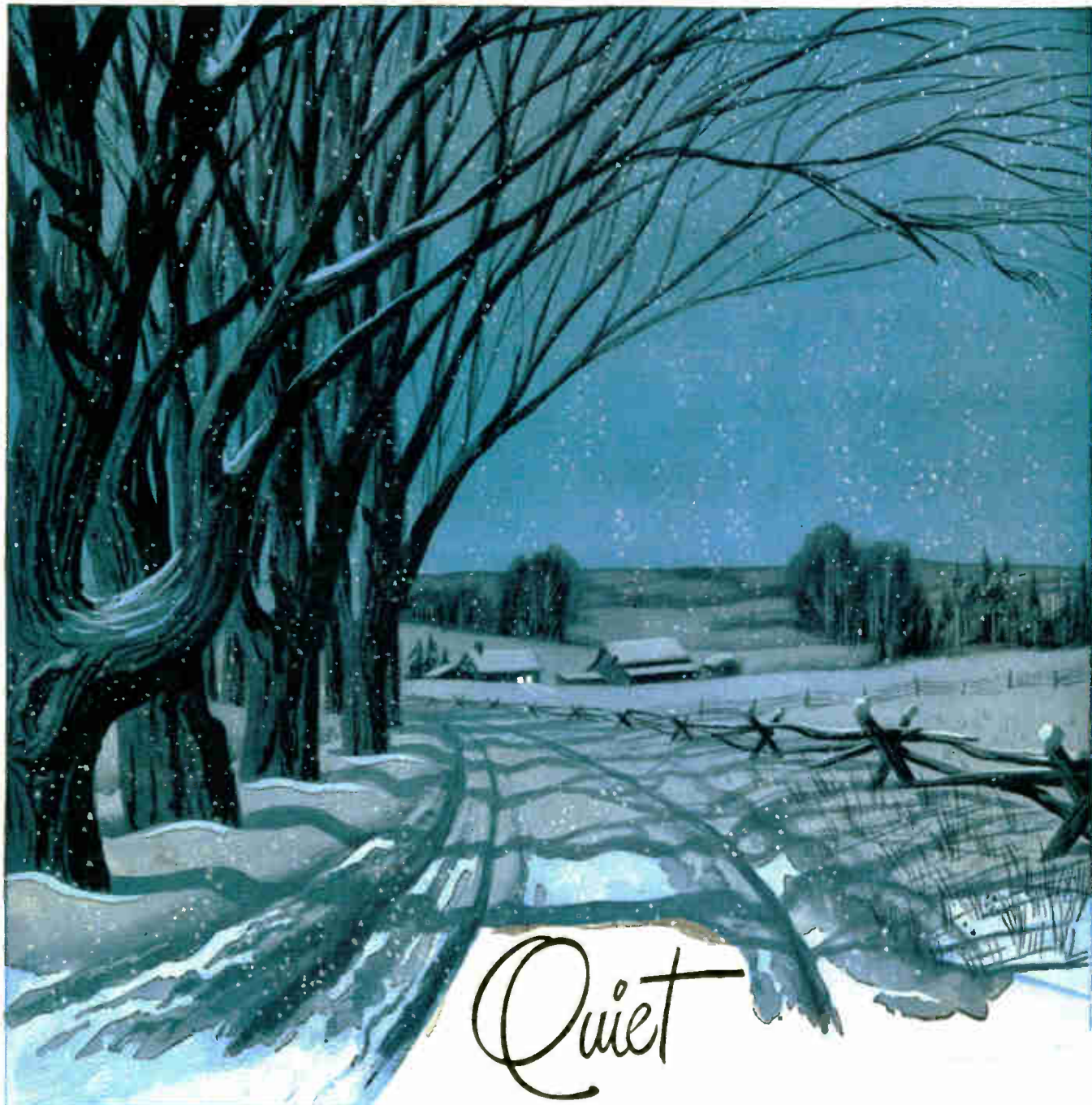

Quiet



BALLENTINE

PHONOGRAPH DRIVE

The Ballentine Phonograph Drive is designed for just one purpose—to provide a reliable mechanism with the least possible background noise or rumble.

The high degree of perfection achieved by the Ballentine Phonograph Drive is the result of *precision dynamic balance*, excellence of design, rigid adherence to close tolerances plus modern manufacturing methods and equipment.

Send today for descriptive folder on the Quiet BALLENTINE Phonograph Drive.

**RUSSELL ELECTRIC COMPANY**

366 W. HURON STREET, CHICAGO 10, ILL.

Manufacturers of

**BALLENTINE PHONOGRAPH DRIVE**

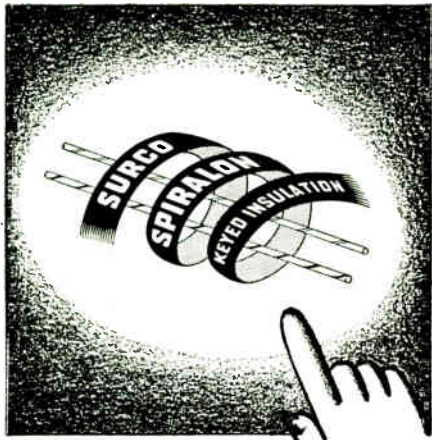

**EASILY, QUICKLY IDENTIFIED!**

## Unlimited coding plus maximum insulation resistance

Spiralon, a new Surco plastic insulated wire, spiral striped, offers the widest range of tracer code identification in small as well as large sizes of wire, in short as well as long lengths. By avoiding use of color pigments, the primary covering retains full insulation resistance.

### With Nylon Jacket

Spiralon reduces weight, permits a smaller OD., increases fungi and abrasion resistance, allows increased voltage, improves all electrical properties, eliminates all voids in the covering which ordinarily weaken such properties, resists creepage when terminals are being soldered or injury to wire insulation when accidentally touched by a hot soldering iron in production and overcomes deterioration from age. This high heat, low temperature non inflammable nylon jacket has already proved to be ideal for many applications.

A complete presentation on Spiralon is on the press. Please ask for your copy.

Address Dept. O



(Continued from page 188)

District	Total Stations Metro- polltan	Community
Decatur	1	1
Denver	5	—
Des Moines	4	—
Detroit	3	—
Duluth } Superior }	4	—
Durham	2	—
El Paso	4	—
Erie	1	1
Evansville, Ind.	2	—
Fall River } New Bedford }	0	1
Flint	0	1
Fort Wayne	4	—
Fort Worth	3	—
Fresno	4	—
Galveston	2	—
Grand Rapids	2	—
Greenboro	2	—
Hamilton } Middletown }	0	—
Harrisburg	1	0
Hartford } New Britain }	2	0
Houston	4	—
Huntington, W. Va. } Ashland, Ky. }	1	1
Indianapolis	3	—
Jackson	4	—
Jacksonville	4	—
Johnstown, Pa.	0	1
Kalamazoo	1	1
Kansas City, Mo. } Kansas City, Kans. }	4	—
Knoxville	4	—
Lancaster	0	0
Lansing	1	1
Lincoln	1	—
Little Rock	4	—
Los Angeles	6	—
Louisville	2	—
Lowell } Lawrence }	0	1
Haverhill }	—	—
Macon	3	—
Madison	1	1
Manchester	0	1
Memphis	5	—
Miami	4	—
Milwaukee	3	—
Minneapolis } St. Paul }	5	—
Mobile	4	—
Montgomery	2	—
Nashville	4	—
New Haven	1	0
New Orleans	5	—
New York } Northeastern New Jersey }	4	0
Norfolk } Portsmouth }	3	—
Newport News }	—	—
Oklahoma City	4	—
Omaha } Council Bluffs }	3	—
Peoria	2	—
Philadelphia	3	0
Phoenix	4	—
Pittsburgh	3	—
Portland, Maine	3	—
Portland, Oreg.	4	—
Providence, R. I.	1	1
Pueblo	4	—
Racine } Kenosha }	0	1
Reading	0	1
Richmond	3	—
Roanoke	2	—
Rochester	3	—

**PARTS?**  
ORDER TODAY FROM...

**R. W. T.**  
**WORLD'S LARGEST**  
Radio Supply House • Founded 1922

For Industrial Organizations  
Laboratories • Purchasing Agents  
Radio Dealers & Service Men  
Training Schools • Expeditors  
Amateur Operators and Experimenters

**10,000 PARTS**  
immediately available. (Some no longer  
need priorities.) Selected and shipped  
same day your order is received.

**Radio Wire  
Television Inc.**  
100 SIXTH AVE. (Dept. N-11) NEW YORK 13  
BOSTON, MASS. NEWARK, N. J.

Originators of the  
*Lafayette Radio*  
soon in production again



# POWER Rheostats



Insulated metal core supports resistance winding. Winding imbedded in "Greenohm" cold-setting inorganic cement.



Normal current rating may be exceeded by 50% at any setting up to 1/3 total rotation, without damage.



Rotor design provides smoothest rotation and positive conduction at all settings.



1 to 5000 ohms in 25-watt; 1/2 to 10,000 ohms for 50-watt.



Detent action, hop-offs, special shafts, different terminals, etc., available on special order.

★ Hundreds of thousands of these Clarostat power rheostats are now in daily use. They are standard equipment in radio, electronic, aircraft and electrical assemblies. Likewise in more and still more industrial equipment. They are proving that they "can take it"—and then some. No tougher controls are made.

The 25- and 50-watt units here shown are of the enclosed or protected type. Uncased units are also available, where the casing is not required. Wide choice of resistance values.

★ Write for details . . .



## Controls and Resistors

CLAROSTAT MFG. CO., Inc. · 285-7 N. 6th St., Brooklyn, N. Y.

District	Total Stations	
	Metro-politan	Community
Rockford .....	1	1
Sacramento .....	4	—
Saginaw } .....	2	—
Bay City .....		
St. Joseph .....	1	1
St. Louis .....	4	—
Salt Lake City .....	5	—
San Antonio .....	5	—
San Diego .....	4	—
San Francisco } .....	6	—
Oakland .....		
San Jose .....	0	1
Savannah .....	4	—
Scranton } .....	1	1
Wilkes-Barre .....		
Seattle .....	4	—
Shreveport .....	4	—
Sioux City .....	3	—
South Bend .....	1	1
Spokane .....	5	—
Springfield, Ill. ....	2	—
Springfield, Mass. } .....	1	0
Holyoke .....		
Springfield, Mo. ....	4	—
Springfield, Ohio ....	0	1
Stockton .....	0	1
Syracuse .....	2	—
Tacoma .....	2	—
Tampa } .....	4	—
St. Petersburg .....		
Terre Haute .....	1	1
Toledo .....	1	1
Topeka .....	1	1
Trenton .....	1	0
Tulsa .....	4	—
Utica } .....	1	1
Rome .....		
Waco .....	4	—
Washington .....	3	—
Waterbury .....	0	1
Waterloo .....	2	—
Wheeling .....	0	1
Wichita .....	4	—
Wilmington .....	0	1
Winston-Salem .....	2	—
Worcester .....	1	0
York .....	0	1
Youngstown .....	1	1

### New Wire Recorder Licensee

The Hallicrafters Co., Chicago, is the newest addition to the growing list of more than 20 companies to be licensed under the Armour magnetic sound wire recorder patents. Hallicrafters plans to manufacture wire recorders in conjunction with their receiving sets and experiments are being planned to incorporate the recorder for use in marine and aircraft communications.

### Wave Guide Specialists

Waveguide Electronics, 30 Church Street, New York City, has been organized to specialize on the installation details relating to radar and wave guide equipment for marine and commercial applications of ultra high frequency communications. M. M. Genodman is president.

POWER OUTPUT-WATTS

DRIVING POWER-WATTS

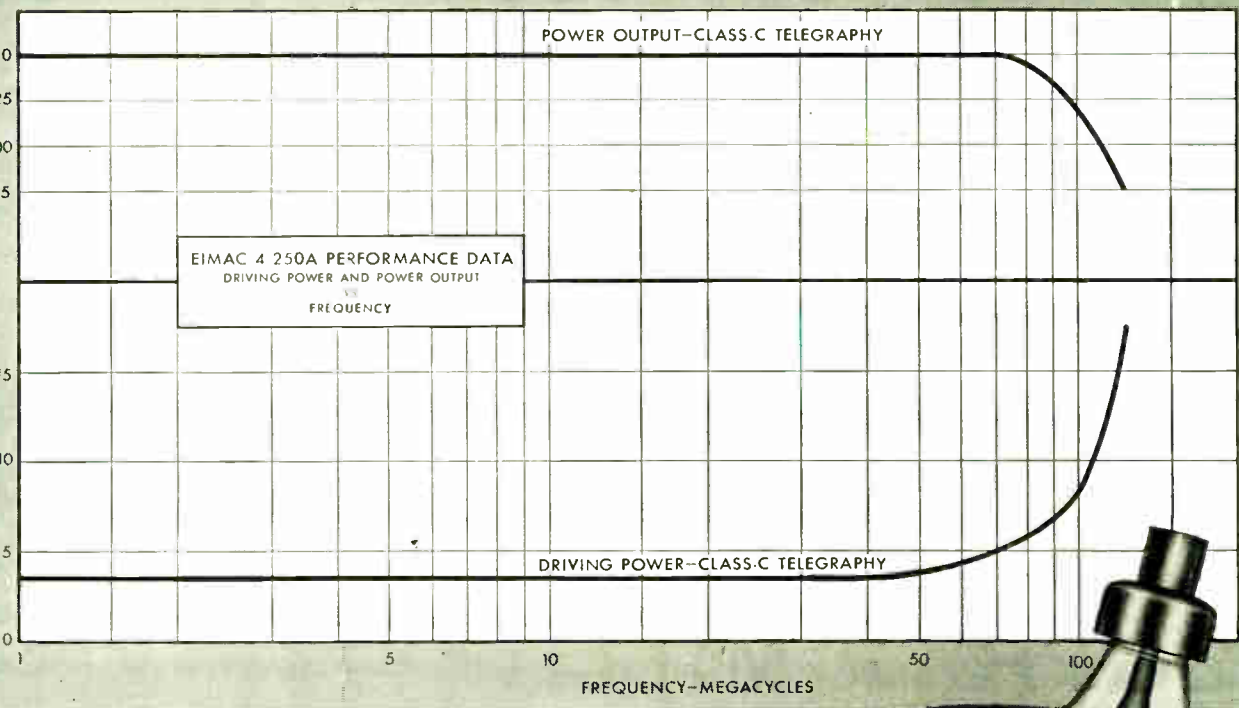

## NEW EIMAC 4-250A TETRODE

Heading a parade of sensational new tubes now in production, the Eimac 4-250A Tetrode—introduced several months ago—is already in great demand. It may pay to check these performance characteristics against your own requirements.

As can be seen by the chart above, the new Eimac 4-250A Tetrode will deliver 750 watts output at frequencies up to 70 Mc. with a driving power of only 5 watts. At frequencies up to 40 Mc. an output of 750 watts may be obtained with a driving power of 3.5 watts.

The grid-plate capacitance of 0.12 *μfd.* is extremely low, allowing operation at high frequencies without neutralization. Use of Eimac "X" process control grid reduces both primary and secondary emission which provides utmost stability.

You are invited to supplement the information given here with a technical bulletin on Eimac 4-250A Power Tetrode. It contains an elaboration of the tube's characteristics and constant current curves. Send your name and address and a copy will go to you by return mail.

**The Lid's Coming Off...**  
Watch your favorite trade journals for announcements of other new Eimac tubes to be released this year.

**CAUTION!** Check serial numbers on Eimac tubes before you buy. Be sure you're getting newest types. Look for latest serial numbers.

FOLLOW THE LEADERS TO



EITEL-McCULLOUGH, INC., 1086 San Mateo Avenue, San Bruno, Calif.  
Plants located at: San Bruno, California and Salt Lake City, Utah  
Export Agents: Frazar & Hansen, 301 Clay St., San Francisco 11, Calif., U. S. A.

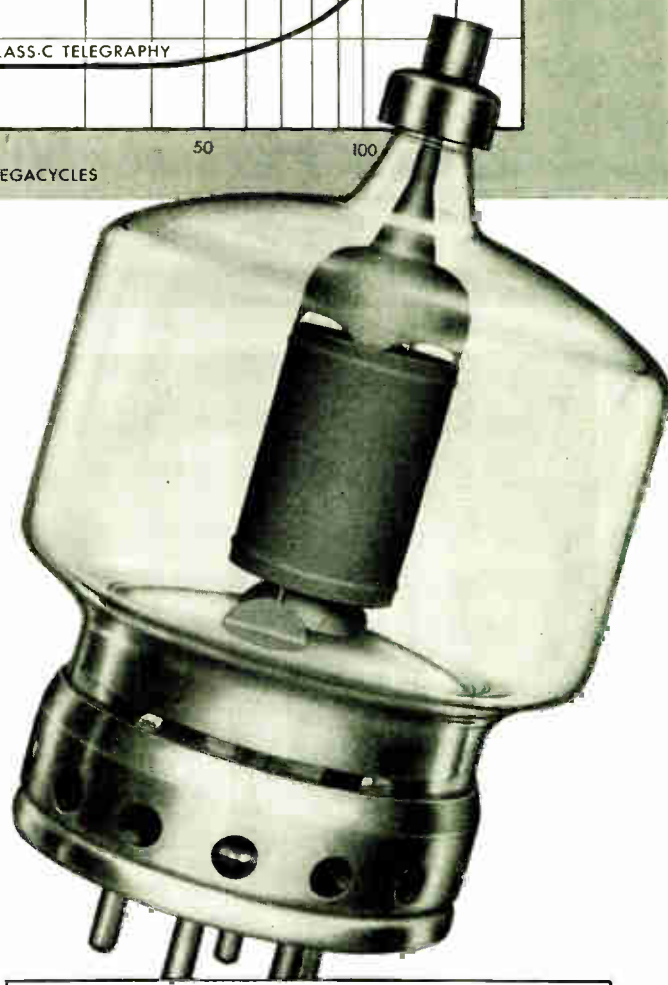

**TYPE 4-250A—POWER TETRODE**  
**ELECTRICAL CHARACTERISTICS**

Filament: Thoriated Tungsten	
Voltage . . . . .	5.0 volts
Current . . . . .	14.5 amperes
Plate Dissipation (Maximum) . . . . .	250 watts
Direct Interelectrode Capacitances (Average)	
Grid-Plate . . . . .	0.12 <i>μfd.</i>
Input . . . . .	12.7 <i>μfd.</i>
Output . . . . .	4.5 <i>μfd.</i>
Transconductance ( <i>i</i> <sub>B</sub> = 80 ma., <i>E</i> <sub>B</sub> = 3000 v., <i>E</i> <sub>c2</sub> = 500 v.)	4000 <i>μmhos</i>



## Fungus-Proofed Waxes

As a vital service to the Armed Forces we now offer Fungus Resistant Materials. These recently developed products are the answer to Communications requirements where the impregnation or coating of radio parts and equipment are concerned.

ZOPHAR waxes and compounds meet every specification of both the Army and Navy for waterproofing and insulating all electrical and radio components. They also have wide application in packaging of every description.

# ZOPHAR MILLS I N C

112-130—26th STREET  
BROOKLYN, N.Y.

ESTABLISHED 1846

# WOMAR

*Manufacturers of*  
RADIO, ELECTRICAL AND  
ELECTRONIC COMPONENTS

**ELECTRONIC PRODUCTS MFG. CORP.**  
DEXTER, MICHIGAN

## National Conference To Be Perpetuated

The National Electronics Conference staged last year in Chicago by the Illinois Institute of Technology and other organizations of learning is to be perpetuated. The Conference has been incorporated in the State of Illinois and present plans are to hold gatherings in Chicago in the month of October during each year starting in 1946. Thus, there will be no Conference this year.

## New Hallicrafters Plant

Plans for the construction of a modern single story building in which it will center its activities have been completed by the Hallicrafters Co., Chicago. Cost of the building, which will be erected at Kostner and 5th avenues, will be \$600,000. The site comprises 175,000 sq. ft. Hallicrafters now operates six manufacturing plants and several warehouses on leased premises. The new plant will permit the grouping of most of the firm's activities under one roof, cutting the need for leased space to a minimum.

## Electronic Pianos

Production of electronic pianos, AM-FM combination home receivers, and "Paneltone" wall radios, has been started by the Ansley Radio Corporation, Long Island City, N. Y. Radio units are expected to reach the market within 90 days. First pianos are due for marketing by the first of the year.

## Drive-in Movies to Triple

A new demand for acoustically perfected equipment, that has been developed since the war, can be expected in the drive-in theater business. The War Production Board recently forecast that the number of drive-in theaters would triple as soon as equipment becomes available. This would boost the existing number of theaters from 100 to 300 or more. New equipment developed by RCA includes an acoustically improved, weather-proof speaker that can be installed in a car at each parking space on the theater's ramp. A volume control, within easy reach of the patron, will insure synchronization between sight and sound.

## Metal Parts

Dover Industries, Inc., 2929 No. Campbell Ave., Chicago, has been organized for the manufacture of metal parts requiring special plated finishes. L. D. Jensen, formerly vice-president of the Chromium Corp. of America, heads the company.

# HERE'S THE FULL STORY

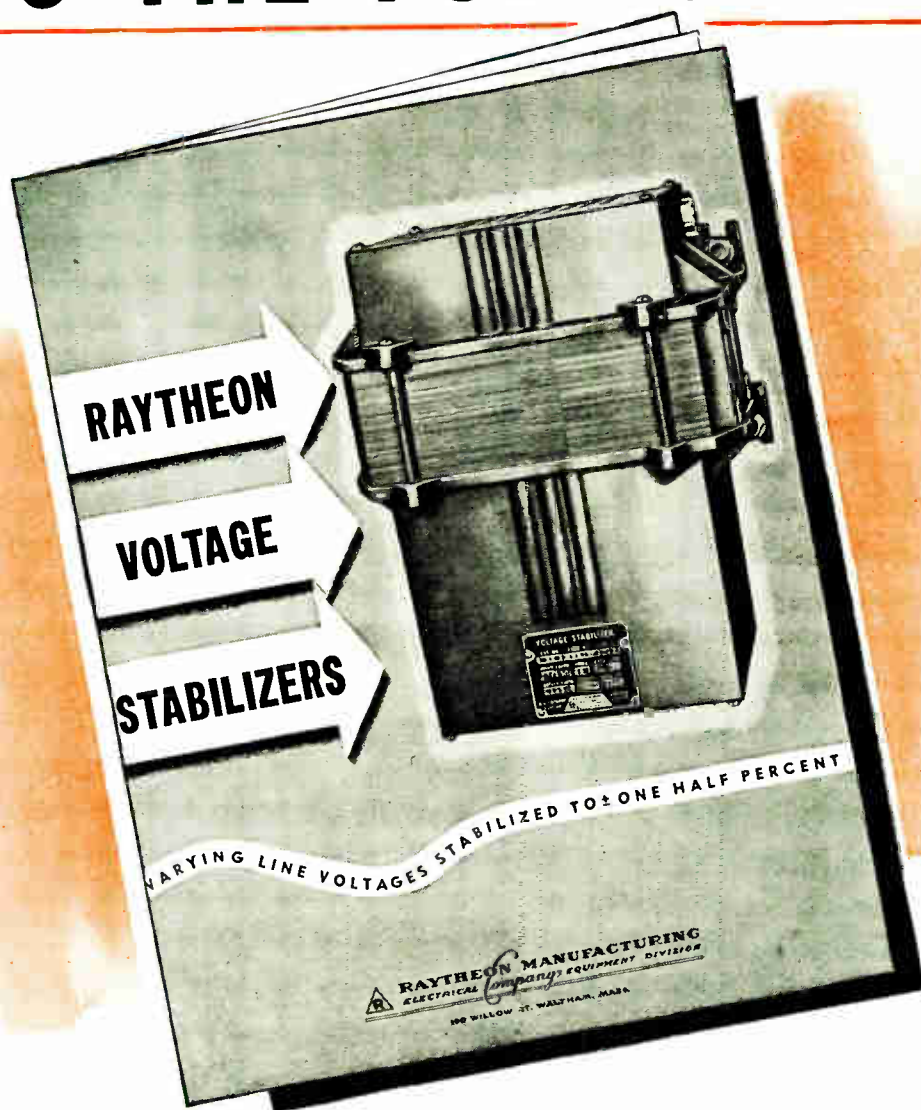

## SEND FOR IT TODAY...

IN A DETAILED, 8-page bulletin now available, Raytheon Manufacturing Company tells the complete story about the dependable Raytheon Voltage Stabilizers. These trouble-free magnetic-type units... with no moving parts to get out of order... stabilize AC from ordinary voltage sources to within plus or minus a half percent, throughout their full rating.

The bulletin includes such useful information as electronic applications, performance features, principles of operation, operating characteristics, graphs, specifications of the three immediately available designs, cased, uncased, and endbell, and a price list.

We urge you to send for your copy promptly. Ask for Bulletin DL48-537, and address your request to Raytheon Manufacturing Company, Electrical Equipment Division, Waltham 54, Mass.



## Ingenious New Technical Methods

To Help You with Your Reconversion  
Problems

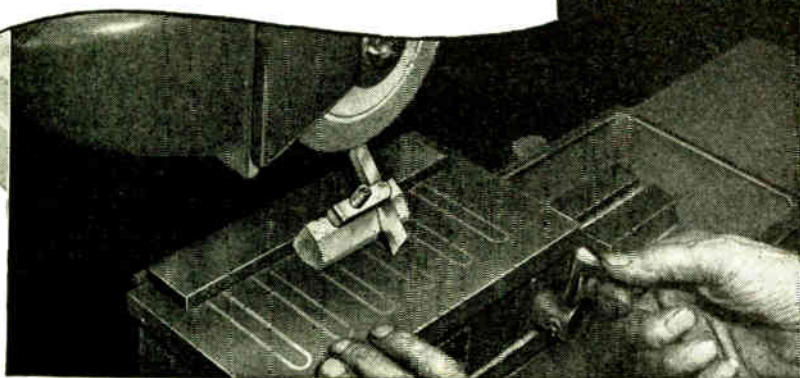

### NOW ANYONE CAN GRIND THREADING TOOLS! — WITH MASTER GRINDING GAUGE!

Until the advent of the Acro Master Grinding Gauge, only a skilled mechanic could grind thread-cutting tools to the required degree of accuracy. Now anyone can do it—in less time, with less waste, with even greater precision!

The cutting tool is simply placed in slot of the Master Grinding Gauge, and thumb screws hold it tightly in place, at the proper angle, while being ground on any type of surface grinder! The Gauge is made of hardened tool steel. There are no delicate or moving parts to get out of order. Milled slots at top and bottom provide correct grinding angles. A small set screw at end, eliminates any lateral motion. There is nothing special to learn—anyone can use it!

Anyone can be "helped on the job" by Wrigley's Spearmint Gum, too, once this quality product again becomes available. Just now, no Wrigley's Spearmint Gum is being made, and until conditions permit its manufacture in quality and quantity for everyone, we again urge you, please, to "Remember the Wrigley's Spearmint wrapper." It is our pledge to you, of the finest quality and flavor in chewing gum—that will be back!

You can get complete information from:  
Acro Tool and Die Works, 4554 Broadway, Chicago 40, Ill.

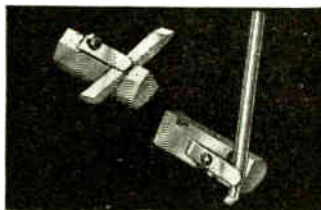

Acro Master Grinding Gauge



Remember this wrapper Z-90

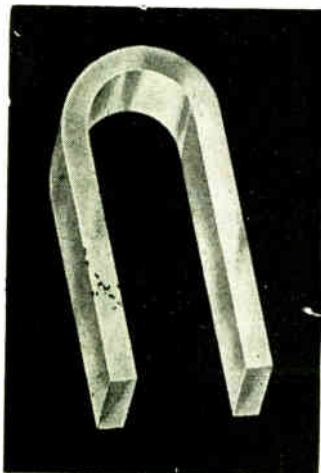

## Permanent Magnets

All Shapes, Sizes and Alloys. Alnico magnets cast or sintered under G. E. license. Chrome, Tungsten and Cobalt magnets stamped, formed or cast.

### THOMAS & SKINNER

STEEL PRODUCTS CO. • INDIANAPOLIS, IND.  
42 YEARS' EXPERIENCE

### Electronic Consultants

A new firm of radio-electronic consultants will do business in Washington at 1108 16th St. N. W., under the style McKey and Shaw. Dixie B. McKey until lately has been chief engineer of Radio Station WKY in Oklahoma City, prior to that was for 17 years on the technical staffs of AT&T, Bell Telephone Labs. and Graybar Electric. Robert C. Shaw has been connected with the Bell Telephone Labs. where he was staff technician for more than 18 years and latterly has been chairman of the Antenna Coordination Committee of NDRC. The firm will function as consultant in all branches of broadcast and television field.

### Belmont Pocket Radio

The first pocket radio set shortly is to appear on the market — by Christmas, according to Belmont Radio Corp., Chicago, which is starting production. The set is truly a pocket model, measuring  $3\frac{3}{4} \times 6\frac{1}{2}$  inches, the latter being the height. It depends for operation on five tubes of the hearing aid type and the manufacturers hope to sell it in its cheapest form for about \$40. Models will also be produced in silver and gold at higher prices. The complete set, including the batteries, weighs but 10 oz. Batteries are two pencil type flashlight cells for filaments and a tiny, compact B battery that is expected to give 60 hours' service. The A batteries are rated at two hours, continuous. The twisted pair lead for the single hearing aid type crystal fone serves also as the antenna. The set tunes all stations in the AM band.

Belmont's pocket radio has fone cord antenna, weighs only 10 oz.





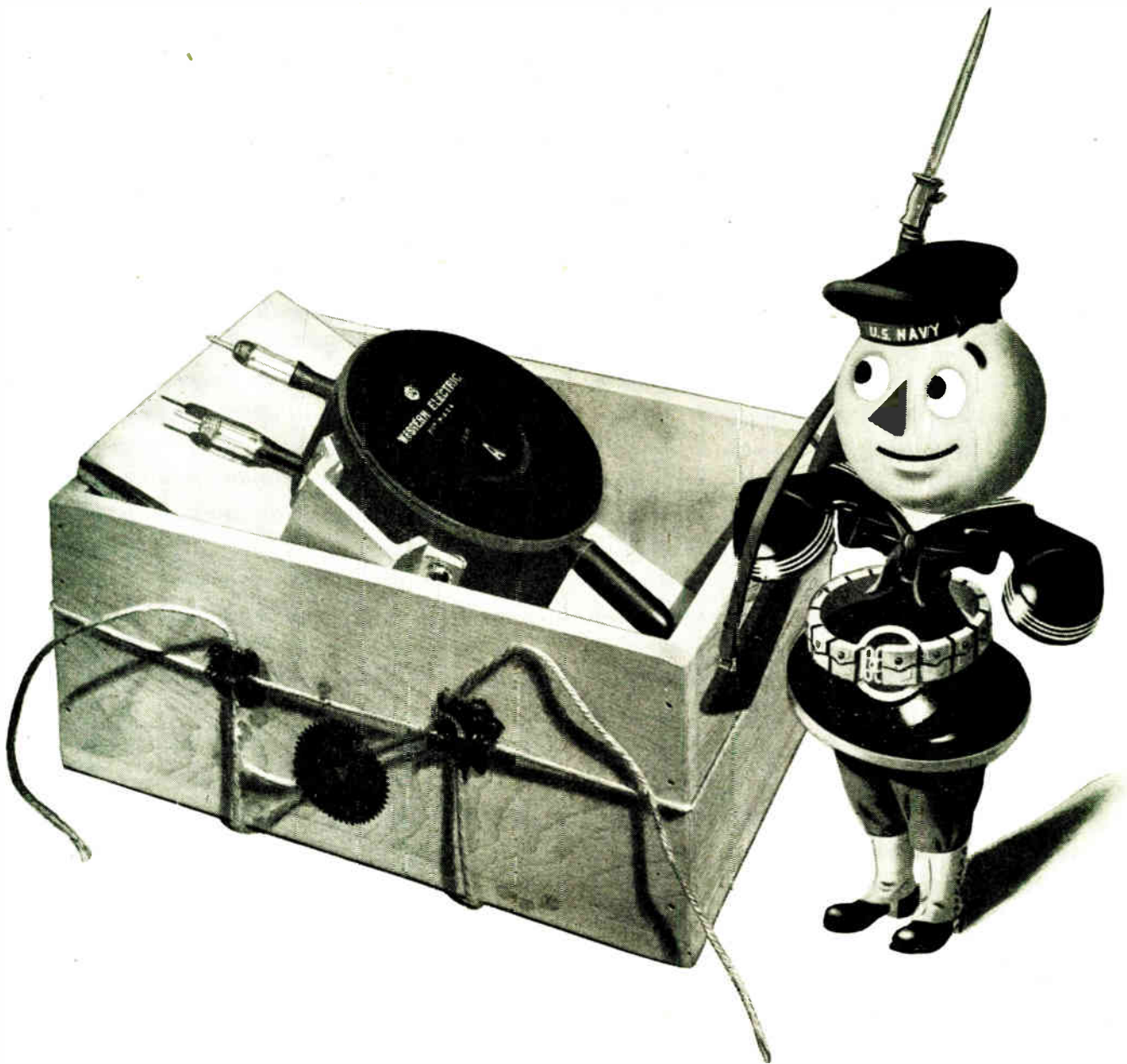

## VICTORY REVEALS A MYSTERY

More than two years ago, an engineer of the Laboratories visited *U.S.S. Boise*, returned with a mysterious box which went into the Laboratories' vault. Now, victory opens the box and discloses a special kind of electron tube called a magnetron. It was part of a Radar which furnished data to aim *U.S.S. Boise's* guns during the night action off Savo Island on October 11-12, 1942. Because of the high frequency generated by this magnetron, the Radar was not detected by the enemy and the action was a complete surprise. Six Japanese warships were sent to the bottom of the sea.

This magnetron is a symbol of the Laboratories' enormous war program. Half of it was devoted

to Radar, the other half gave birth to radio transmitters and receivers, sonar apparatus for the Navy, loudspeaker systems for ships and beach-heads, fire-control apparatus for anti-aircraft artillery. Coming months will unfold the story of these and many other contributions of the Laboratories to the victory of our arms.

Bell Telephone Laboratories' war work began before the war; until now, it claimed practically all our attention. With victory, we will go back to our regular job—helping to bring you the world's finest telephone service.

**BELL TELEPHONE LABORATORIES**



Exploring and inventing, devising and perfecting, for continued improvements and economies in telephone service.

**THE  
VIBRATION-PROOF  
SHOCK-PROOF  
EBY  
MINIATURE  
TUBE  
SOCKET**

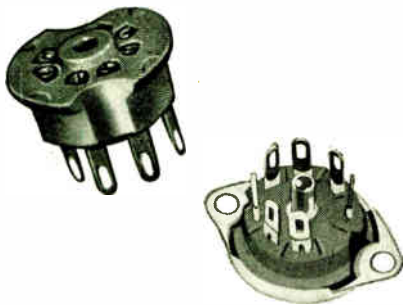

**The ideal miniature socket for  
RAILWAY • AIRCRAFT  
AUTOMOTIVE  
and other commercial radio  
and electronics equipment**

Now available for commercial use — the famous Eby miniature tube socket, the only socket meeting specification JAN-5-28 for military aircraft use.

Developed to meet the most rigorous service conditions of constant vibration and shock, the peace-time applications of this socket are readily apparent.

The use of the Eby miniature tube socket with special beryllium copper contacts assures minimum tube breakage and maximum uninterrupted operation of equipment.

Can be supplied with shock shield and protective cover or saddle type.

(Also available with phosphor bronze contacts for home radio receivers.)

Write today for  
Samples and Prices  
of the Eby Vibration-  
proof, shock - proof  
miniature tube  
socket.

**HUGH H.  
EBY**  
INCORPORATED  
18 W. CHELTEN AVE.  
PHILA. 44, PENNA.



**Giant Tank Capacitor**

This giant tank capacitor was specially designed for a trans-oceanic transmitter. Cornell-Dubilier engineers were asked to build a capacitor that would require only a fraction of the space usually needed for such units but to be able to operate under unusual and exacting conditions with the capacitance of much larger capacitors.

**Lectures on Induction  
Heating Underway**

A series of seven lectures on induction and dielectric heating has been started by the New Jersey Activities Committee of the New York Section AIEE. The series outlines the development of induction and dielectric heating and places emphasis on industrial heating problem. Three lectures have been held.

**Program subjects**

On Oct. 15, Dr. G. H. Brown of RCA lectured on Induction Theory and History. Oct 22, T. R. Kennedy, Ajax, Alternation and Spark Gap Converters, General Design and Application, and Comparison with Other Generators. Oct 29, T. L. Wilson, F.T.R.C., Vacuum Tube Oscillators as Generators, Frequencies, Control Circuits, Output Circuits and Comparison with Other Types of Generators. Nov. 5, W. M. Roberts, RCA, Applicator Coils and Electrodes, Impedance Matching and Output Circuits for Vacuum Tube Generators. Nov. 12, R. M. Baker, Westinghouse, Induction Heating Applications for Surface Hardening, Welding, Soldering, Annealing, and Metal to Glass Seals. Nov. 19, R. J. Jacobson, F.T.R.H., Dielectric Heating Applications Cutting, Bending, Welding, Glueing, etc. Nov. 26, V. W. Sherman, F.T.R.H., Demonstrations. The lectures are being conducted at the Bell Telephone Company in Newark, N. J.

**Railroad Communications**

Eleven manufacturers and eight railroads have applied to FCC for experimental installations of railroad radio communications. More railroads and manufacturers are expected to file applications as soon as FCC sets up rules and regulations and engineering standards for the new services. At a meeting held in Chicago by the communications committee of the Association of American Railroads, FCC engineers in charge of safety and special services presented proposed rules recently drawn up by the Commission. Railroad representatives revealed that as soon as the rules were adopted, the new service would become more active.

Railroads that have made application to FCC are: Atchison, Topeka & Sante Fe Railway, (20 stations) using Bendix SCR-522, MF-106-A, and experimental composite equipment; Baltimore & Ohio Railroad, (4 stations) using Bendix FMTR-1-A; Chicago, Rock Island & Pacific Railroad, (7 stations) using Bendix experimental equipment; Denver & Rio Grande Western Railroad, (6 stations) using Bendix and McGuire FMST-15-B and General Electric 46F5A-4Y24A; Jacksonville, Fla. Terminal Co. (3 stations) using FRST-1-A Bendix equipment; New York Central Railroad (40 stations) Central Railway type D and Communications Co. experimental equipment; Seaboard Air-Line Railway (4 stations) using Communications Company Inc. experimental composite equipment; and Union Pacific Railroad (9 stations) using Galvin Motorola, FMTR-50-BM.

Manufacturers who have applied to FCC for experimental installations are: Aireon Mfg. Co. (3 stations) on Kansas City Southern Railroad; Bendix Division, (42 stations) using composite and experimental equipment; Joseph P. Bruno & Russell C. Sorenson (3 stations); Robert S. Clark Jr. (2 stations) using Communications Co. Inc. type 145 equipment; Communications Co. Inc. (4 stations) using composite and experimental type equipment; Farnsworth Radio & Television Corp. (8 stations) in New York Central Railroads's yards using composite and experimental type equipment; McGuire Industries Inc. (3 stations) Reading Railroad, using composite and experimental equipment; Pacific Telephone and Telegraph Co. (2 test stations) using Galvin experimental equipment; Raytheon Mfg. Co. (6 stations) using composite and experimental equipment; and Westinghouse Radio Stations Inc. (9 stations) using both composite and experimental equipment type FSTR-50-BR and FMTR-30-DN.

# PRIORITIES NO LONGER NECESSARY

## You Can Now Purchase SECO Products on Unrated Orders

To obtain any SECO product is now an easy task. By merely calling or mailing your order to the factory results in prompt shipment of the correct voltage control apparatus for your particular application. Your order does not have to wait its turn because a higher priority job has pushed it aside.

The majority of the standard POWER-STAT variable transformers are carried in stock for immediate shipment. For instance; if a smooth continuously adjustable output voltage is required from a 115 volt line, POWERSTAT type 116 is available with an output range of 0 to 135 volts. Its current rating is 7.5 amperes.

For control of POWERSTATS from push-button stations or automatic controllers, motor-driven POWERSTATS are offered in the same capacities as manually-operated units. Only a few days is necessary to make delivery of any standard model.

SECO'S increased production of SECO Automatic Voltage Regulators means that the unequalled performance of the SECO Regulator in maintaining a constant output voltage regardless of variations in input voltage or output load current is available for all requirements in the range of 1 to 100 KVA.

When space is limited or the atmosphere is hazardous, Oil-cooled POWERSTATS can be run at increased ratings with no danger involved.

Whether production testing or laboratory use is the demand, the VOLTBOX a-c power supply provides an ideal portable source of variable voltage. Regulated and unregulated models are obtainable from stock.

Send for Bulletin 1E

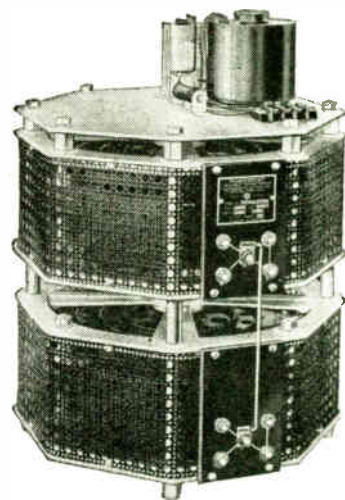
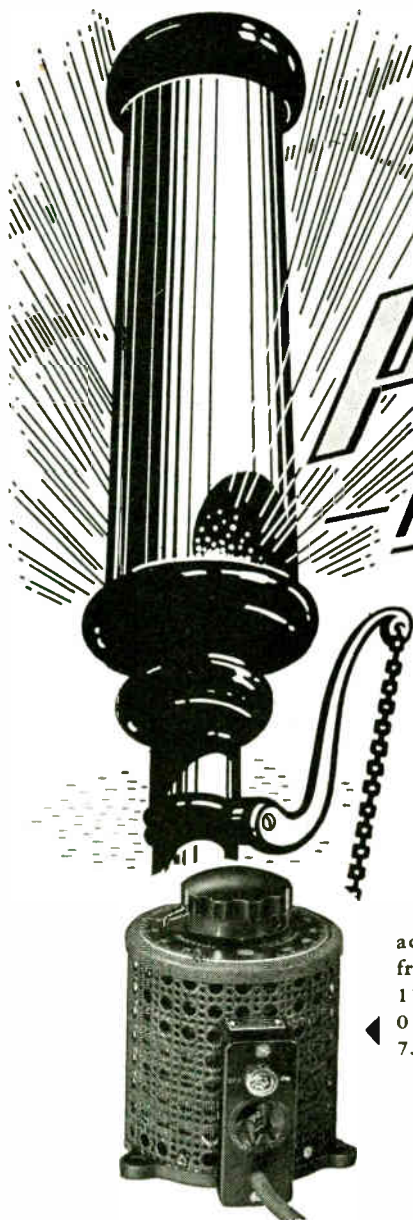

# SUPERIOR ELECTRIC COMPANY

470 LAUREL STREET,

BRISTOL, CONNECTICUT

## Check the Quality Features of the Drake No. 500 Series

- ✓ Time tested — *Millions have been used Since March 1940!*
- ✓ Available in *any* quantity with *any* type of bracket.
- ✓ Sturdy Bakelite Molded insulating casting shields socket from outside contact.
- ✓ Center contact lead wire mechanically secured before soldering.
- ✓ Both lead wires withstand over 25 lbs. tension.
- ✓ Rounded eyelet edges prevent cut or frayed lead wire insulation.
- ✓ 1000 volts minimum breakdown voltage between contacts and to ground.
- ✓ Casting mechanically secured to bracket — can't turn.
- ✓ Socket mechanically secured within casting — can't turn or be pulled out.
- ✓ Center contact secured within socket — contact won't protrude when lamp is removed.

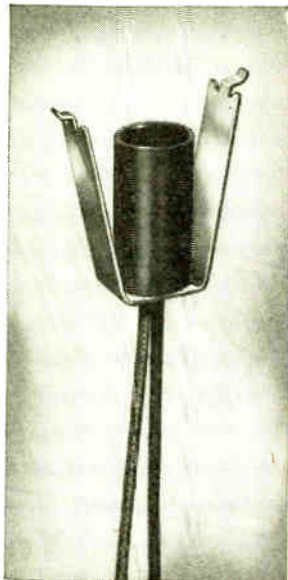

The NO. 527F TYPE



Consider this better underwriters' approved DRAKE dial light assembly for your production requirements. Lead wire 2 3/4 in. to 4 ft. Prompt shipment in any quantity assured. May we send samples or our newest catalog?

### SOCKET AND JEWEL LIGHT ASSEMBLIES

# DRAKE MANUFACTURING CO.

1713 WEST HUBBARD ST., CHICAGO 22, U.S.A.



## METAL-TO-GLASS SEALS

### Intricate glass work and tubes made to your specification

The Universal X-Ray plant specializes in the production of metal-to-glass seals. Intricate glass seals are made to customers' specifications for electronic tubes, transformers, resistors, capacitors, condensers, vibrators, switches, relays, instruments, gauges, meters, receivers, transmitters, and other scientific apparatus.

A strong metal-to-glass bond assures unflinching protection against rust, corrosion, and extreme climatic conditions in a vacuum-tight seal. Good deliveries can be made on volume orders. Submit your metal-to-glass seal problems to the Universal engineers for recommendations and estimates.

**UNIVERSAL X-RAY PRODUCTS INC.**

1800-B N. FRANCISCO AVENUE • CHICAGO 47, ILLINOIS

## NEW BULLETINS

### Vacuum Switches

A new catalog-folder on vacuum switches and one on vacuum capacitors have been issued by General Electric Co., Schenectady, N. Y. Switches will carry 10 to 20 amps with hold-off voltages up to 7,500. Capacitors from 6 to 100 mmfd are listed.

### Motor Controls

A line of electronic motor controls for operating dc motors from ac lines under controlled speed and torque conditions is featured in a folder newly issued by Electron Equipment Corp., 917 Meridian Ave., So. Pasadena, Calif. Sizes from 1/2 hp up are available. Applications of this type of device to industrial processes are nearly endless.

### Infrad-red Lamps

Carbomatic Portable Infra-Red electric units for 6 lamps and 12 lamps are featured in a leaflet issued by Carbomatic Corp., 1775 Broadway, New York 19. The units are flexible and lend themselves ideally to operation in smaller industrial plants.

### Induction Heating

Ajax-Electrothermic Corp., Ajax Park, Trenton 5, N. J., has issued a new booklet on induction heating and melting of the larger type of parts. This is a descriptive work indicating the various ways in which this equipment has been used.

### Small Resistors

International Resistance Corp., 401 No. Broad St., Philadelphia 8, Pa., has issued a new catalog of small resistors in sizes from 1/3 w to 2 w. Much useful information about sizes and temperatures and other characteristics is included for the engineer.

### Die Strippers

The second issue of catalog S, covering the availability and applications of "Strippits" spring units for automatically removing punched metal parts from dies, has just been issued by the Wales-Strippit Co., No. Tonawanda, N. Y. These Strippits are self-contained and eliminate the necessity of removing dies from presses or disassembling to repair or replace broken or defective parts.

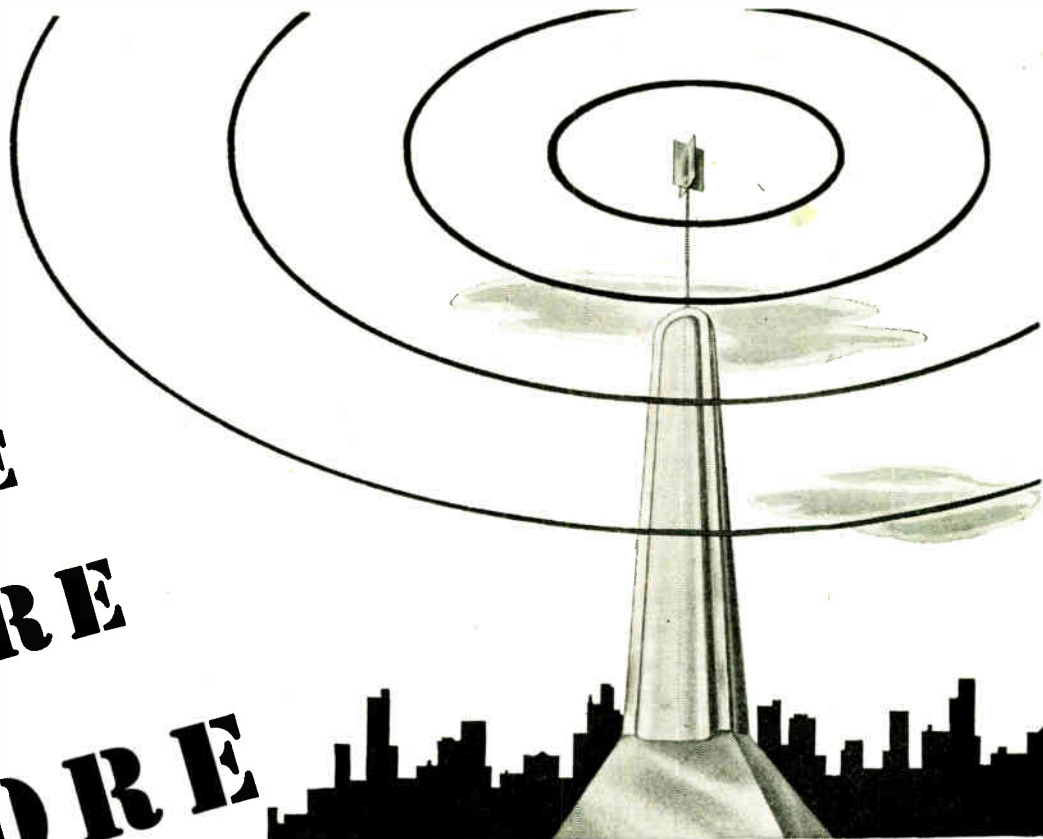

**MORE  
MORE  
MORE**

**TELEVISION "Know-How" THAN ANY OTHER COMPANY!**



DuMont engineers have designed and built more television stations than any other organization...are now completing the world's first "Television City" in New York.

During more than four years of operational trail-blazing, DuMont equipment design has been steadily improved to keep pace with increasingly elaborate programming experimentation. Today,

DuMont design boasts incomparably simplified precision controls...provides high efficiency, extreme flexibility and rugged dependability at *low operating cost*.

DuMont experience assures the finest craftsmanship for the least outlay...offers a pattern of station operation for your study and a plan for training your personnel...starts you off in television on the right foot!

Copyright 1945, Allen B. DuMont Laboratories, Inc.

**DUMONT**



*Precision Electronics and Television*

ALLEN B. DUMONT LABORATORIES, INC., GENERAL OFFICES AND PLANT, 2 MAIN AVENUE, PASSAIC, N. J.  
TELEVISION STUDIOS AND STATION WABD, 515 MADISON AVENUE, NEW YORK 22, NEW YORK

*Immediate Delivery! No Priority!*

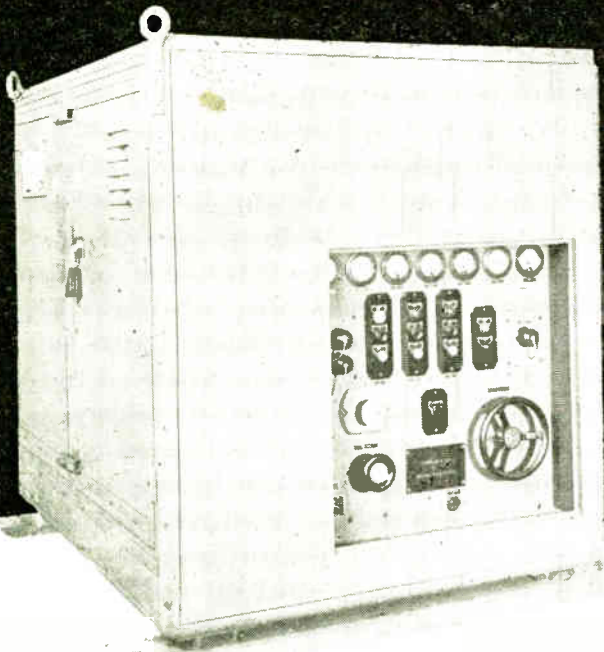

## RA-38 POWER SUPPLY

Extraordinary  
value at  
**\$400.00**

FOB Baltimore

Original cost to government \$3,000.00

Designed to meet rigid Signal Corps specifications for mobile operation, RA-38 combines all the usual features found in commercial practice. Rugged mechanical construction to meet field condition needs. All component parts conservatively rated to provide continuous duty operation, insuring trouble-free service over long periods.

Useful in a wide variety of industrial applications. RA-38 is now available through Reconstruction Finance Corporation's plan of selling excess stocks of government-owned electronic apparatus through recognized manufacturers of electrical equipment acting as D.S. agents.

*All units, completely inspected and tested by us, carry manufacturer's 90-day guarantee. Immediate delivery without priority. Technical bulletins on RA-38 and other units of interest to electronic engineers will be forwarded on request.*

### SPECIFICATIONS

1. Power Output continuously variable 0—15000 volts at 500 ma. 7.5 kw.
2. Ripple  $\frac{1}{2}\%$  at 100 ma.— $3\%$  at 500 ma.
3. Regulation 15800 V at 100 ma.—15000 V at 500 ma.  
6800 V at 100 ma.—5000 V at 500 ma.
4. Power Input 115 V 60 cycles 125 amperes at maximum output.
5. The equipment is assembled in a steel cabinet which is mounted on skids by means of rubber shock mountings.
6. The unit is  $63\frac{1}{2}$ " long,  $53\frac{3}{4}$ " wide and  $56\frac{7}{8}$ " high. Net weight complete is 2040 pounds.

## COMMUNICATION MEASUREMENTS LABORATORY

Agent of Defense Supplies Corporation  
Handling All Types of Electronic Equipment

120 GREENWICH STREET

NEW YORK 6, N. Y.

## NEW BULLETINS

(Continued from page 202)

### Tungsten Properties

Cleveland Tungsten, Inc., Cleveland, has issued a descriptive booklet on tungsten, its minerology, manufacture, and uses. This work is profusely illustrated and shows grain structure photographs for the various grades of tungsten available. The interesting properties of tungsten, particularly its high melting point of 6100 deg. and its enormous tensile strength of 500,000 lbs. per sq. in. are fully discussed.

### Ignitrons

A new booklet, entitled "The Ignitron and How It Is Used," has been issued by General Electric Co., Schenectady, N. Y. Featured are simplified drawings showing the functions of various parts. Explanations of circuits and use are included. Characteristics of the various models with their prices also are given.

### Air Motors

A new 8-page folder on air motors has been issued by The Bellows Co., 861 East Tallmadge Ave., Akron 10, Ohio. Specifications of two standard models, developing respectively 5 and 10 times air line pressure, are listed and numerous suggestions for manufacturing applications are given.

### Radial Power Switches

Medium and high power multi-contact radial switches are offered for miscellaneous applications in Technical Bulletin No. 730 from Communication Products Co. Inc., 744 Broad St., Newark, N. J. Solid silver contacts, improved soldering lugs, balanced high voltage spacing and low inductance and capacity values are featured.

### Silicones

All of the main classes of silicone products and many special formulations among each of them are described in a new booklet from the Dow Corning Corp., Midland, Mich. In this booklet, entitled "Dow Corning Silicones," many industrial uses for these heat stable, waterproof materials are presented and many more will be suggested by their quite unique properties. Available variations include sealing compounds, greases, fluids for damping, hydraulics, heat transfer, diffusion pumps, high temperature lubricants and waterproofing insulators; also varnishes and resins and silicone rubber. Extensive tables of physical properties as well as charts are included.

One  
call  
to  
one  
local  
source



**WILL BRING YOU ANY  
ELECTRONIC TUBE YOU NEED...**

**HERE'S HOW THE WESTINGHOUSE SURVEY AND SUPPLY PLAN WORKS!** A Westinghouse tube distributor or representative will survey your electronic equipment to determine the number and type of each tube, regardless of make.

A Westinghouse tube distributor or representative also will make tube surveys of the other plants in your area to determine the quantity, number and type of tubes required.

Your Westinghouse tube distributor then has an accurate picture of tube requirements of your entire area on which he may base his tube stock. This stock will include all the tubes which your equipment requires, regardless of make.

**HERE'S WHAT YOU GET!** A copy of the survey of your equipment. A report on the tubes used in your plant. Prompt delivery on the tubes you need from your local Westinghouse tube distributor, where your order is placed.

**FOR A SURVEY OF YOUR PLANT . . .** call your local Westinghouse tube distributor or representative or write Westinghouse Electric Corporation, Lamp Division, Bloomfield, N. J.

TUNE IN: John Charles Thomas—Sunday, 2:30 pm., EST—NBC.  
Ted Malone—Monday through Friday, 11:45 am., EST—ABC.

**Westinghouse**

*Electronic Tubes at Work*

(Continued from page 204)

**Fluxmeters and Spectrophotometers**

The General Electric Co. has issued new sheets for its Special Products handbook describing indicating fluxmeters and spectrophotometers. The fluxmeters are adapted to the measurement of dc magnetic fields which occur in research testing and production work. The spectrophotometer is an instrument for charting the emission curves of colors. By eliminating guesswork in color composition it allows technicians to measure the effects of various components and thereby exercise fine control over mixing and blending processes.

**Precision Dials**

A new type of precision dial is described in a four-page pamphlet issued by the American Dial Co., Inc., 450 West 45th street, New York. Dials requiring any number of divisions (absolutely accurate dials have been made containing as many as 2,160 graduations on a four-inch circle), equal or logarithmical, are produced on a wide variety of plastic materials and on metal. Various combinations of color may be used on the graduation marks or legends and the dials may be finished in matte, semi-matte or glossy. Divisions are electro-mechanically produced and dials are reproduced from a master by a photographic printing process, all machining operations being carried on from the center hole, thus preserving accuracy.

**Class 1 Resistors**

A supplemental catalog data bulletin has been issued for grade 1 class 1 power resistors by International Resistance Co., 401 N. Broad St., Philadelphia, Pa. This folder gives physical dimensions and electrical ratings with applicable ambient conditions.

**Movies in Industry**

"Movies Go to Work," a booklet giving industry the reasons for adopting motion pictures as a management tool and telling what steps to take to "get going—and keep going—right," has just been issued by Bell & Howell Co., 7100 McCormick Rd., Chicago 45, Ill. The booklet is divided into five chapter headings: "Training Salesmen"; "Selling Your Product"; "Increasing Production"; "Improving Personnel Relations"; and, "Interpreting Your Material."



**Our Hat Is Off...**

Our hat is off to those radio men, both military and civilian, who contributed so much to the successful completion of the war. Too, our hat is off to those radio servicemen and jobbers who were patient and understanding of the shortage of Rider Books caused by wartime restrictions, now removed.

Our hat is off (and our coat too), ready to tackle the peacetime radio problems in the civilian field. In the light of our wartime experiences we have planned a five year program which is right now developing in our own laboratories. From this research will result many innovations—and one of the most ambitious publishing programs we ever scheduled. It will bring to the student, the amateur, the serviceman, yes even the radio engineer the very information each must have if he is to understand, and work in radio and the new fields of television and microwaves that will be commonplace in

coming years. This is not a program of the future, it is functioning today. Next month will witness the publishing of the first of these new Rider Books. Announcements will carry complete details. Yes, our hat is off—and it's great to be back!



*John F. Rider*

JOHN F. RIDER PUBLISHER, INC., 404 FOURTH AVE., NEW YORK 16, N. Y.  
 "Publishers of Radio Technical Books Exclusively"

**WANTED—CONTRACT WORK**

Complete service offered for Engineering, Development and Manufacture of mechanical and electrical units, assemblies and production work. Large production capacity now open on modern equipment consisting of:

- |                     |              |                          |
|---------------------|--------------|--------------------------|
| 14 Milling machines | 42 Lathes    | 11 Grinder, cylindrical, |
| 2 Jig borers        | 2 Bevel gear | internal and surface     |
| 1 Broach machine    | cutters      | 39 Drill presses, radial |
| 3 Tapping machines  | 1 Hobber     | fl. type and bench       |
| 5 Power presses     | 3 Band saws  | 1 Engraving machine      |
| 2 Shapers           | 1 DuAll      | 2 Profilors              |

Complete Mechanical-Electrical Testing Laboratories.  
 Mechanical and Electrical Engineering Departments.

Send Blueprint or Samples for Prompt Quotation and Delivery

**BENNEL MACHINE COMPANY, INC.**

20 GRAND AVENUE EV 8-1040-1-2 BROOKLYN 5, NEW YORK



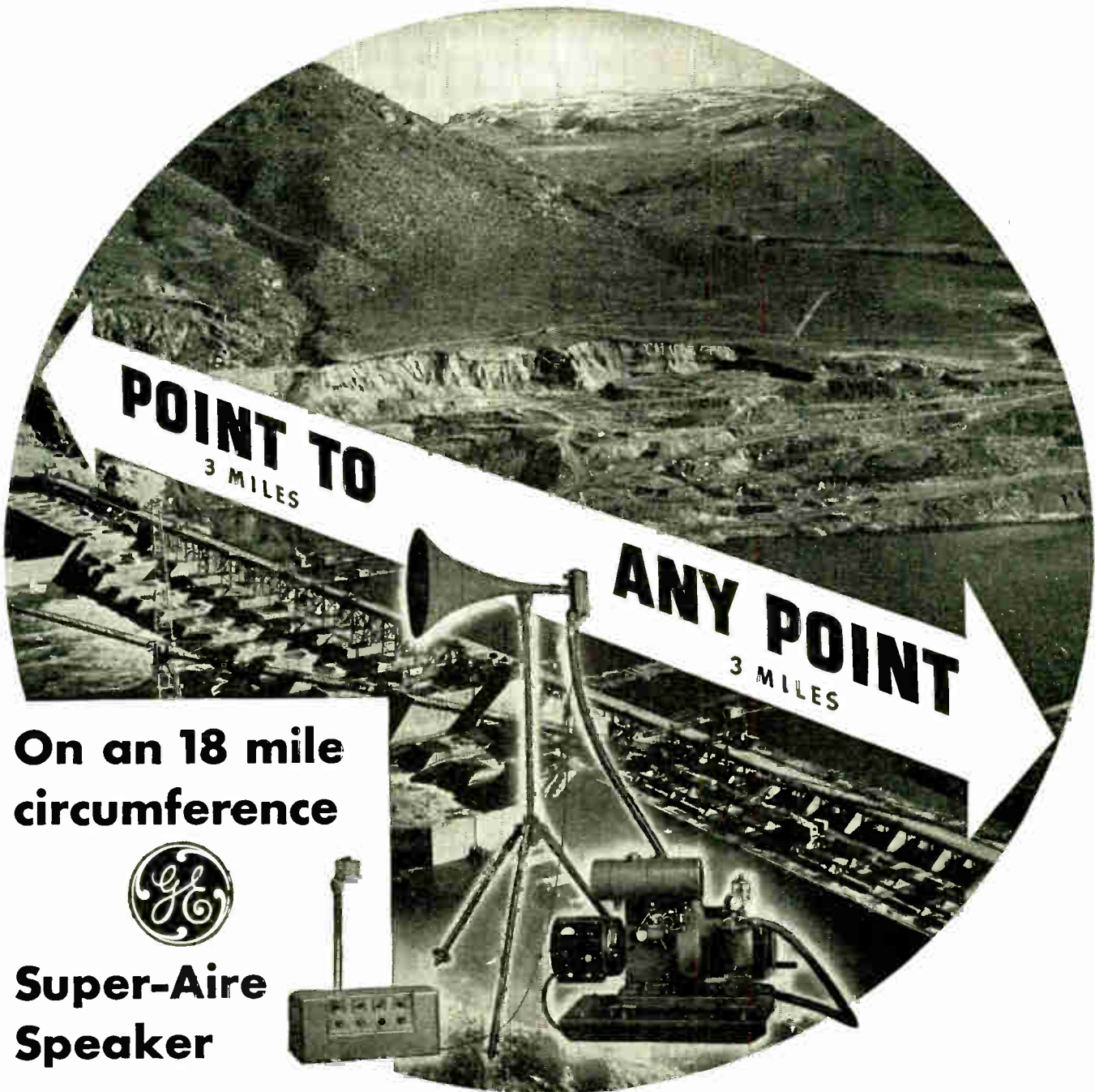

**On an 18 mile  
circumference**



## **Super-Aire Speaker**

**D**IRECT as an arrow to the target—that's the way your voice can reach any point in a vast area with the G-E Super-Aire Speaker. The G-E Super-Aire Speaker is a complete public address system in compact and economical form.

Ruggedly designed for hard field usage, in any climate or weather, it can be employed in the tough day-by-day jobs of freight yard traffic control, harbor control, giant dam construction projects and a host of similar widespread operations. Even the pre-

cision voice element can "take it" without fracturing under the assault of terrific shock or vibration.

Where no power supply is available, a small gas engine can take over the work of operating the compressor and furnishing power for the amplifier. Mobility is just one among the many advantages of the Super-Aire Speaker that makes it the perfect unit for the job.

The G-E Super-Aire Speaker is modern—and today it is available

"must" equipment on large projects.

Write for complete information to:  
*Electronics Department, Specialty Division, General Electric, Syracuse, N. Y.*

See your G-E distributor for *Universal Radio Parts, P. A. Systems, Crystals, Receiving, Industrial and Transmitting Tubes, Laboratory and Service Test Equipment.*

**GENERAL  ELECTRIC**

186-D2

Electronics Department EI-11  
General Electric, Syracuse, N. Y.  
We are interested in further information concerning  
the G-E Super-Aire Speaker for  
Our own use  
Resale Distribution

Name.....  
Company.....  
Address.....

# AN 3155 POWER RHEOSTAT

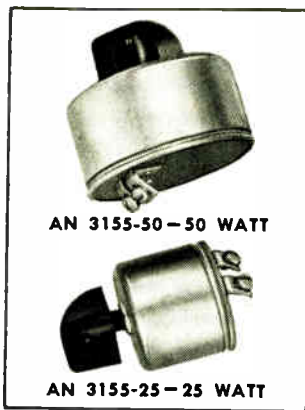

Totally enclosed in accordance with Army-Navy specifications (AN-R-14A). Permanently sealed in dust-proof, corrosion-proof metal cases. Smooth control, rugged and thoroughly dependable under the most severe service conditions—shock, vibration, humidity, heat, cold, and altitude.

Hardwick, Hindle is proud of the excellent performance of these power rheostats on thousands of planes flying in every theatre of war under all climatic conditions. And they will prove to be invaluable in innumerable post-war applications.

Let us send you technical data and detailed information on these and many other rheostats and resistors with H-H exclusive features.

*Write today for our new catalogue.*



**HARDWICK, HINDLE, INC.**

RHEOSTATS and RESISTORS

SUBSIDIARY OF

**THE NATIONAL LOCK WASHER COMPANY**

ESTABLISHED 1886

Newark 5, N. J., U. S. A.



## RADELL-BUILT PRODUCTS

• It is easy to recognize the marks of superior craftsmanship in Radell-built electronic products. With a broad basic knowledge and advanced production skill, Radell Corporation is a versatile organization specializing in the assembly and sub-assembly of highest quality electronic products.

**COMPLETE FACILITIES FOR AUDIO WORK**

**RADELL** CORPORATION

6323-37 Guilford Avenue, Indianapolis 5, Indiana

## NEW BULLETINS

(Continued from page 206)

### X-Ray Diffraction

A series of articles by F. G. Firth, Research Engineer of the North American Philips Co., Inc., Dobbs Ferry, N. Y., is available in reprint pamphlet form. Basic principles and theory of diffraction and its use in identifying the basic structure of matter are treated in Article No. 1, and the constitution of matter is discussed in Article No. 2; the applications of X-ray diffraction to the study of catalysts, mineral substances, high polymers, petroleum products and heat exchanger problems is taken up in Article No. 3. In a separate pamphlet, Mr. Firth discusses use of low angle X-ray scattering in the study of catalysts, viruses and other materials. These articles are all informative and of value to prospective users or workers already in the field.

### Relays

"The Application of Relays to Electronic Circuits" is the title of a new booklet issued by the Automatic Electric Co., 1033 West Van Buren St., Chicago 7, Ill. This is a technical work suggesting circuits incorporating either ac or dc relays. Their uses in connection with gas tubes, both cold and hot cathode with various types of anode supply are completely discussed and examples are given of circuit calculations required to choose a proper relay.

### Engineers' Glass

A new bulletin has been issued by Engineers' Specialties Division of the Universal Engraving & Colorplate Co., Inc., 980 Ellicott St., Buffalo 8, N. Y., describing a detail engineers' glass and a universal layout scale for form grinders, operating at 50 to 1 magnification. The detail engineers' glass is on a very hard sheet thin metal which takes erasures well while the layout scale is all glass.

### Pressure Switches

A fairly complete line of immersion, room type, air and liquid thermostats as well as pressure and vacuum switches is described in a condensed catalog and price sheet issued by United Electric Controls Co., 69-71 A St., Boston 27, Mass. Thermostatic ranges from  $-120^{\circ}$  to  $+600^{\circ}$  F are available, while pressure switches are made in vacuums down to 30 inches of mercury and pressures up to 350 psi.

# 1945 ELECTRONIC ENGINEERING DIRECTORY

INDEX TO PRODUCTS, EQUIPMENT, INSTRUMENTS AND MATERIALS

Product	Page	Product	Page
Diagrams	143	Dial Lamps	135
	143	Dial Light Assem.	135
	163	Dial Locks	135
		Dial Parts	138
			148

## ALPHABETICAL FINDING LIST of Electronic Manufacturers

Use this list if you know the name of a company and want to learn one of its products. Most of the following companies manufacture more than one product

### A

- Aarons Radio Corp., New York, N. Y.
- Control Equipment
- ABC Radio Labs., Indianapolis, Ind.—Antennas
- Abbott Instrument, Inc., New York, N. Y.—Transmitters
- Acadia Synthetic Products Div., Western Felt Works, Chicago, Ill.—Plastic Material
- Accurate Spring Mfg. Co.—Springs
- Ace
- Airplane & Marine Instruments, Inc., Clearfield, Pa.—Transmitters\*
- Air Reduction Sales Co., New York, N. Y.—Inert Gases
- Air-Way Electric Appliance Corp., Toledo, Ohio—Motors
- Ajax Electrothermic Corp., Ajax, Pa.—Trenton, N. J.—Industrial
- Akron Porcelain
- American Instrument Co., Silver Spring, Md.—Relays\*
- American Insulated Wire Co., Providence, R. I.—Wire
- American
- Arens Cording

### Antennas & Accessories



- Airplane antenna ..... AA
- All-wave (home) ..... AW
- Antenna reeling equipment ..... AR
- Auto ..... DA
- Dummy antenna ..... FS
- Feeder spreaders ..... G
- Grounding clamps ..... GS
- Grounding springs ..... HF
- HF assemblies ..... I
- Insulators ..... K
- Kits ..... L
- Lightning arresters ..... LA
- Loop antennas ..... MS
- Master systems ..... O
- Outlets ..... RB
- Rotary boom ..... TL
- Television & FM ..... T
- Towers & Supports (home) ..... T

- ABC Radio Laboratories, 3334 N. New Jersey St., Indianapolis, Indiana—AW
- Acme Welding Co., Louisville, Ohio—AW, F, LA, T
- Aeronautical Radio Mfg. Co., Roosevelt Field, Mineola, L. I., N. Y.—AA, L, LA, AR
- Aircraft Accessories Corp., Fairfax & Funston Bld., Kansas City 15, Kan.—AA, LA
- Airplane & Marine Instruments, Inc., Box 92, Clearfield, Pa.—TL, LA
- The Akron Porcelain Co., Corey Ave., Akron 14, Ohio
- Alpha Wire Corp., 50 Howard St., New York 13, N. Y.—G, I, K, L, MS, TL
- American Lava Corp., Cherokee Blvd. & Manufacturers Rd., Chattanooga 5, Tenn.—FS, I
- American Radio Hardware Co., Inc., 478 Broadway, New York, N. Y.—G, O
- Amplex Engineering, Inc., 1620 Grand Ave., New Castle, Ind.—RR, T
- Amy, Aceves & King, Inc., 11 W. 42nd St., New York 18, N. Y.—MS, O
- Andrew Co., 363 E. 73rd St., Chicago, Ill.—AA, AW
- A. H. F., K. I. A., MS, RB, TL
- Astatic Corp., 830 Market St., Youngstown 1, Ohio—AA
- Atlas Products Corp., 30 Rockefeller Plaza, New York
- Atsiddletown, Conn.—

- Centralab, D Keefe Ave. Clamport—M Collins—Radi Iowa—T Colonial Rat
- Communicat Coral Gal Communicat Blvd. P Consolidate Chicago. Cook Cera N. J.—Cook Elec I. Corning I. Cornish T, N. TL. Corvico-Coto-Co R. I. Creativi N. Y. Doolitt 36, DX Cr RB Eagle Low Elect N. Elect N. Elec Esp N Ess J Fa Fe Fi F

**LAST CALL**  
for  
**ADVERTISING**  
in the  
**DIRECTORY NUMBER**

**ELECTRONIC INDUSTRIES**

December 1945

FINAL CLOSING DATE NOVEMBER 10

**CALDWELL-CLEMENTS, INC.**

480 Lexington Avenue, New York 17, N. Y.

**WIRE SO FINE  
IT MUST BE  
Magnified  
TO BE SEEN**



**WOLLASTON PROCESS  
Wire as small as**

**1 { OF AN INCH  
100,000 { IN DIAMETER**

**... available in Platinum  
and some other Metals**

**.00001" is less than 1/30 the  
diameter of the smallest wire  
die commercially available.  
Yet our Wollaston Process  
wire (drawn in a silver jacket)  
closely meets your specifica-  
tions for diameter, resistance  
and other characteristics.**

**This organization specializes  
in wire and ribbon of smaller  
than commercial sizes and  
closer than commercial toler-  
ances. Write for List of Products.**

**SIGMUND COHN & CO.**



**44 GOLD STREET NEW YORK 7**

## NEW BULLETINS

(Continued from page 208)

### Pipe Joints

The Silbraz joint—a modern threadless connection that bonds I.P.S. copper tubing and brass pipe into a single one-piece pipe line—is thoroughly described in the new 16-page, 2-color booklet: "How to Cash In on the Silver Ring," issued by Air Reduction Sales Co., 60 East 42nd St., New York 17, N. Y. Profusely illustrated, the booklet shows how Silbraz joints are made from patented bronze pipe fittings, valves and flanges—containing a factory inserted ring of silver brazing alloy in each port opening. The literature shows that when brass pipe or I.P.S. copper tubing is properly inserted in these fittings and the assembly is brazed, the resulting joint is stronger than the pipe itself.

### War Time Research

An interesting 32-page booklet has been brought out by Western Electric Co., 195 Broadway, New York 7, N. Y., entitled "We Did It This Way". A series of two or three page articles describe new products and methods developed by the company during the war, such as a tiny induction coil no larger than an aspirin tablet, a capacitance bridge to measure values as small as .0001 micromicrofarad, a method of heat conditioning paper condensers, and several other interesting technics.

### Motor Controls

A 4-page folder describing package motor control units for application to all kinds of industrial uses has been issued by Electron Equipment Corp., 917 Meridian Ave., South Pasadena, Calif. Pictured are the various units available in sizes from one-half horsepower upward, for providing flexible control of dc motors on industrial units.

### Patents

The National Association of Manufacturers, 14 West 49th St., New York 20, N. Y., has issued a 22-page booklet pointing out the usefulness of patents in the American economy and some of the characteristics of the patent licensing system.

### Precision Optics

A new pamphlet, entitled "Precision Optics by American Methods," describes the services and facilities of the American Lens Co., Inc., 45 Lispenard St., New York 13, N. Y. Many illustrations are included.

## EASTERN HEAT DISSIPATING UNIT

The Eastern Heat Dissipating Unit is used in connection with television, radar, short wave radio communications, high pressure mercury lamps, X-Ray tubes, induction heating units, and many other applications. It was developed for military requirements in conjunction with radar and electronic tube cooling problems. Units were designed in various sizes and capacities, some with the close heat control range of 2 degrees C. Used successfully for ground, water and airborne service, they combine rugged construction, compactness and light weight.

The model illustrated will dissipate up to 1200 watts with a constant controlled temperature, irrespective of surrounding temperatures, within 2 degrees C. It is complete with Thermostat control, Thermostatic valves and flow switch. Eastern has built airborne units of much smaller sizes and industrial units of much larger sizes and capacities. The specifications for the unit shown are: SIZE: 16" x 7 1/2" x 7 1/2"; METALS: Steel, Bronze, or Aluminum. Other models can be designed to dissipate up to 5000 watts.



Closed View

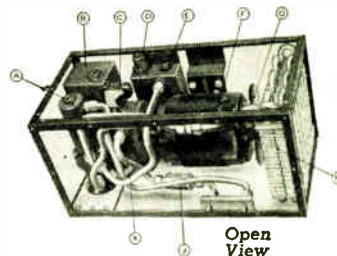

Open View

- |                          |             |
|--------------------------|-------------|
| A. Thermo flow-regulator | F. Motor    |
| B. Reservoir             | G. Fan      |
| C. Flow Switch           | H. Radiator |
| D. Thermostat            | I. Filter   |
| E. Auxiliary Heater      | J. Pump     |

Eastern's experience in solving heat control problems, especially where compactness and light weight are necessary, makes them the logical people with whom to discuss heat control applications. If you are designing or planning to build equipment that calls for heat dissipation or the close control of operating temperatures, Eastern will design and build the entire unit for you to meet your specific requirements.

An inquiry about your heat dissipating needs will not obligate you in the slightest.

A large part of Eastern's business is the designing and building of special pumps, in quantities ranging from 25 to several thousand for the aviation, electronic, chemical, machine and other special fields. Eastern builds over 600 models, both centrifugal and positive pressure, ranging in size from 1/100 H.P. to 1/4 H.P. as standard units.

*Eastern Engineering Co.*

94 FOX STREET, NEW HAVEN 6, CONN.

# WHAT DO YOU WANT IN A CABLE?



**ANSONIA**  
and  
**ANKOSEAL**  
can supply the  
combination of  
Qualities You Need!

To do your job and do it right, you need cable with certain characteristics. Three or four or more factors—heat resistance, dielectric strength, flexibility and durability, for instance—must be satisfied in the *one* cable. You *can* settle for less—but when a cable fails, it's *your* reputation that suffers.

At Ansonia, electrical cable is engineered to meet *all* necessary requirements as far as that is possible. And,

thanks to ANKOSEAL, a remarkable thermoplastic insulation, our engineers are usually able to combine in one cable all the qualities you need.

Simply tell us what you *want* in a cable—we'll design and produce it. It won't be the cheapest cable—but *it will be right!* The difference will result in longer life and better performance.

We'll be glad to describe in detail what Ansonia can offer you in the form of *job-engineered* cable. Write now for fuller information.

## Why ANKOSEAL solves cable problems

Ankoseal, a thermoplastic insulation, can help solve many electrical engineering problems, now and in the future. *Polyvinyl* Ankoseal possesses notable flame-retarding and oil resisting characteristics; is highly resistant to acids, alkalis, sunlight, moisture, and most solvents. Polyethylene Ankoseal is outstanding for its low dielectric loss in high-frequency transmission. Both have many uses, particularly in the radio and audio fields. Ankoseal cables are the result of extensive laboratory research at Ansonia—the same laboratories apply engineering technique in the solution of cable problems of all types.

## THE ANSONIA ELECTRICAL COMPANY

Specializing in "Ankoseal" a Thermoplastic Insulation

ANSONIA • CONNECTICUT

A Wholly-Owned Subsidiary of

## NOMA ELECTRIC CORPORATION

GENERAL OFFICES • NEW YORK, N. Y.

Makers of the famous Noma Lights—the greatest name in decorative lighting. Manufacturers of fixed mica dielectric capacitors and other radio, radar and electronic equipment.

# Specialized SWITCHING APPARATUS FOR ELECTRONIC EQUIPMENT

Shown below are just a few of many specialized types of switching apparatus which we design and manufacture specifically for electronic application. If you are confronted with an unusually difficult switching problem, write, and we'll be glad to consult with you regarding your requirements.

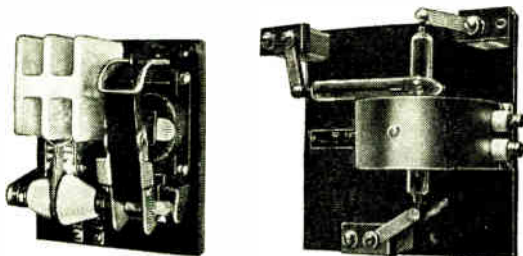

**HIGH VOLTAGE D. C. HOT BREAK CONTACTORS** for energizing high voltage vacuum tube circuits. Contactor, *above left*, breaks circuit carrying 1 ampere at 3,000 volts D. C. Contactor, *above right*, successfully breaks circuit carrying 2 amperes at 5,000 volts because contacts operate in a vacuum. This contactor incorporates principles of Eimac VS2 vacuum switch which eliminates external moving parts. Operating coil completely shielded. Can be completely tropicalized.

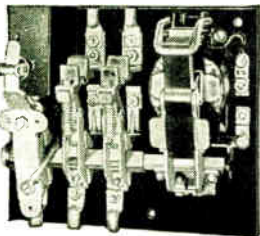

**CONTACTOR-TIMERS** used as main power or filament contactors with auxiliary delayed time circuit or circuits. Contactor and timer joined together physically, as well as electrically, saving space, assuring certain operation.

### HIGH VOLTAGE-HIGH FREQUENCY CONTACTORS

designed primarily for high frequency switching from a remote control point. Can be used with any high voltage cold break application—A. C. or D. C. All insulation of low loss type, either steatite or glass bonded mica. Held either mechanically or magnetically. Furnished either normally open, normally closed or both. Our complete line of contactors range from 15 amps at 3,000 volt minimum to 35 amps at 25,000 volt maximum.

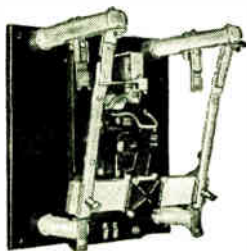

### HIGH FREQUENCY-HIGH VOLTAGE TRANSFER SWITCHES

for either radio or industrial load transfer. Magnetically operated from remote point but mechanically held in either position. Can accommodate currents up to 75 amps high frequency. Insulation of low loss type, either steatite or glass bonded mica. Cold break only.

**COMBINATION POWER AND SIMULTANEOUS CONDENSER DISCHARGE CONTACTOR**, right, is a striking example of Monitor's ability to create highly specialized switching apparatus designed in accordance with unusual customer specifications.

Consult us on all of your switching requirements. Remember, we specialize in doing the unusual.

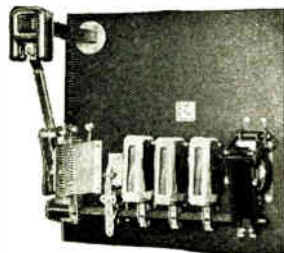

## NEW BULLETINS

(Continued from page 210)

### Permanent Magnets

The Arnold Engineering Co., 147 E. Ontario St., Chicago (11), has issued a 24-page design manual with particular reference to the use of Alnico. Exact demagnetization and energy curves are given for the various grades of Alnico. In addition, resistance of finished magnets to the effects of stray fields, vibration, and heating are charted. Physical specifications of the material are included and discussion of methods of casting, heat treating, finishing and assembly are given.

### Plastic Casting Resin

A technical discussion of Durez casting resin has been issued in pamphlet form by the Durez Plastics and Chemicals, Inc., North Tonawanda, N. Y. Full instructions are included for the use of this material. Its adaptability in quickly making models, molds, fixtures and dyes for soft materials is discussed. The booklet is well illustrated and is completely up to the minute.

### Phenol Plastics

A folder giving a general comparison of properties of electric insulating materials has been issued by Continental Diamond Fibre Co., Newark 12, Delaware. The company's various forms of plastic insulating materials are described and their properties are given. Also included is a table of standard sizes and available colors.

### Unichrome Dipping

Unichrome dipping is described in a folder from United Chromium, Inc., 51 East 42nd St., New York 17, N. Y. The process is a means of obtaining corrosion protection, developed for zinc and cadmium servicing. It produces black or olive drab finishes and also provides a superior base for paint or lacquer. Only a single two to five minute immersion is required.

### Precision Resistors

A new catalog and price list of precision electrical resistors from under 1 ohm to over 2.5 megohm has been issued by the Madison Electrical Products Corp., Madison, N. J. The catalog is made in wall chart form and shows specifications for each type of resistor together with an illustration and discussion of the application field.



**The Monitor  
Controller Company**  
BALTIMORE 2, MARYLAND

CANADIAN AFFILIATE • CANADIAN CONTROLLERS LTD • TORONTO, ONTARIO, CANADA



They wanted wire, tube  
and strip in

# Split-Hair Sizes

...and found the strong, corrosion-resistant metals they sought among the INCO Nickel Alloys

Are you looking for metals in ultra-fine sizes for essential applications today...or for your new products after the war?

Do you want...in addition to the split-hair size...metals with strength, toughness and high resistance to corrosion?

Then take a look at these examples of how INCO Nickel Alloys can be produced in practically any form or size you may want for applications that need a rustless corrosion-resisting material with high mechanical properties...

**THE WIRE** shown in the magnified photo above knotted around two strands of human hair is 0.0009" thick. A pound would stretch 80 miles. It is a regular commercial product of the Driver-Harris Co.

**THE TUBING**, one of the smallest ever drawn, is compared with a mosquito's stinger. Outside diameter of this nickel tube is 0.0019"; inside diameter, 0.0004". (World's smallest metal tube, 0.0014" outside diameter, is also Nickel.) Superior Tube Company produces commercial tubing in INCO Nickel Alloys as small as 0.010", outside diameter.

**THE STRIP** is .00075" thick...one-third the thickness of this page. It would take more than 1300 strips to equal an inch. This nickel strip is made by Somers Brass Company for regular commercial use.

In addition to their group properties of high strength, toughness and corrosion resistance, individual INCO Nickel Alloys have *specialized* properties for applications requiring high-temperature strength, special hardness, resilience, etc.

"Tremendous Trifles" a booklet which discusses the properties, sizes and forms of 8 INCO Nickel Alloys will be sent to you on request. Please give Company, Name and Title. Address:

THE INTERNATIONAL NICKEL COMPANY, INC.  
67 Wall Street, New York 5, N. Y.

## INCO NICKEL ALLOYS

MONEL • "K" MONEL • "S" MONEL • "R" MONEL  
"KR" MONEL • INCONEL • "Z" NICKEL • NICKEL  
Sheet...Strip...Rod...Tubing...Wire...Castings...Welding Rods

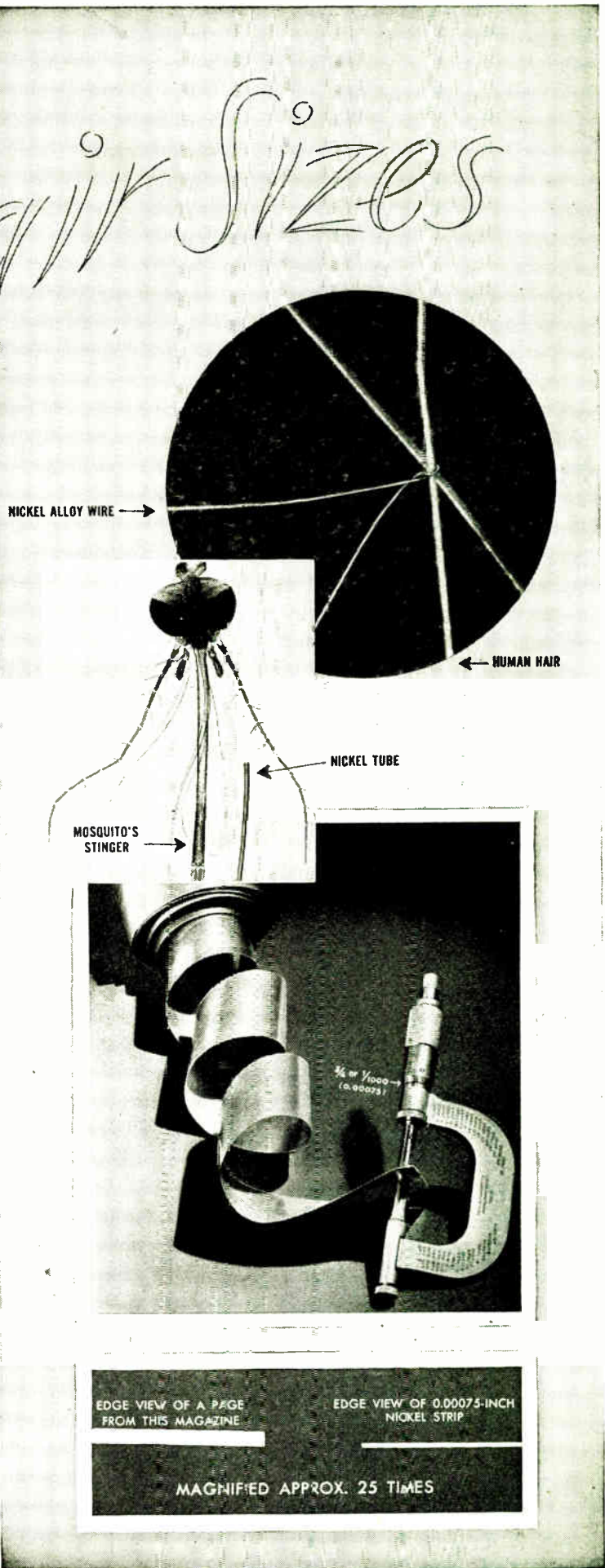

**PERFECT YOUR  
POST-WAR  
PRODUCTS  
WITH DIALCO**

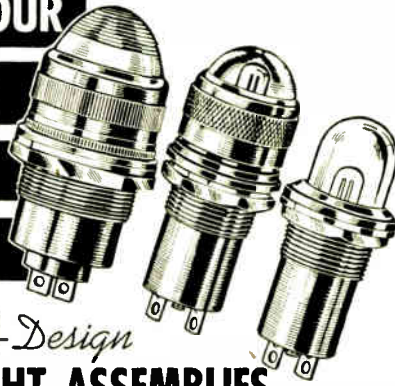

*Functional-Design*  
**PILOT LIGHT ASSEMBLIES**

HOUSING NEON OR MAZDA LAMPS

**G**REATER emphasis on functional design is the trend in post-war engineering of Electrical-Electronic Products. Mindful of this fact, Dialco has produced a line of Pilot Lights calculated to meet readily all post-war requirements. Comprising Warning-and-Signal Pilot Lights, Panel Lights, Jewel Assemblies, and Socket Assemblies, the Dialco line offers unlimited variations in functional design, size, shape, electrical characteristics, color, finish, etc. Special emphasis on applications of NEON Glow Lamps.

Let our Engineering Dept. help you select the *Pilot Light* best suited to the functional design of your post-war product.

**PLUS LAMPS:** To help speed production, we offer Pilot Lights completely assembled with the required General Electric or Westinghouse Lamps.



**DIAL LIGHT CO.** of America, Inc.

900 BROADWAY • NEW YORK 3, N. Y.

Telephone: ALgonquin 4-5180-1-2-3

WRITE FOR NEW  
ILLUSTRATED  
BROCHURE

## NEW BULLETINS

(Continued from page 212)

### Crystals

Just off the press is a new eight page catalog issued by Crystal Research Laboratories, Inc., 29 Allyn St., Hartford 3, Conn. In addition to illustrations and descriptions of different types of crystals manufactured, numerous photographs of plant facilities are shown.

### Vibration Testing

Specifications and illustrations of vibration testing machines are included in a folder from All American Tool & Mfg. Co., 1014 Fullerton Ave., Chicago 14, Ill. Six models are listed from 10 to 100 lbs. capacity and up to 37 g. acceleration.

### Transmitting Tubes

A new special purpose transmitting tube catalog issue by Hytron Radio & Electronics Corp., 76 Lafayette St., Salem, Mass., gives the characteristics of a number of tubes in pictorial and chart form for convenient reference. Basic diagrams are included on the last page.

### RF Coils

A one-page flyer has been issued by Stanwyck Winding Co., Newburgh, N. Y., describing a line of standard coils for the broadcast band. Oscillator, rf and antenna coils are described and illustrated. Also included are 455 kc transformers and a broadcast loop.

### Rectifiers

A folder on design of rectifiers has been issued by Green Electric Co., 130 Cedar St., New York 6, N. Y. Advantages of selenium and tube rectifiers are compared and sample designs are given in detail.

### 7½ Billion Dollars War Radio Production

With a total war output of approximately 7½ billion dollars, the radio industry produced nearly twice as much radio-radar communications equipment during the war than it produced radio equipment alone for civilian use in all the years since commercial radio began about 1922.

This has been made public by the Radio Manufacturers Association based on new production records of the War Production Board Radio and Radar Division. From January, 1942, until the war ended this summer, the industry's war production mounted to the huge total of \$7,220,000,000, the records show. In

(Continued on page 216)

## New INLAY PROCESS

### ELIMINATES NAME PLATES ON FRONT PANELS

A proven method for placing durable characters on metal panels, chassis, etc.

- ★ Inlaid baked enamel characters, protected by background finish; resistant to abrasion and salt spray; guaranteed to pass 50 hour salt spray test. NOW available in luminous characters, if desired, either phosphorescent or fluorescent.
- ★ Front panel will match finish of cabinets.
- ★ Recommended and endorsed by scores of manufacturers of electronic, sound and communication equipment.

PROMPT DELIVERIES—Send us your bare fabricated steel and within two weeks we will return it finished and marked to your complete satisfaction

**S**CREENMAKERS

64 FULTON STREET • NEW YORK 7, N. Y.

Tel.: REctor 2-9867

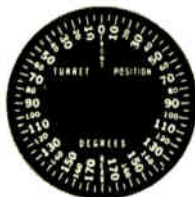

ALSO...  
SILK SCREENING on front panels and chassis, either metal or plastic. Sharp clear characters durably printed on finished or unfinished surfaces.



# Sterling

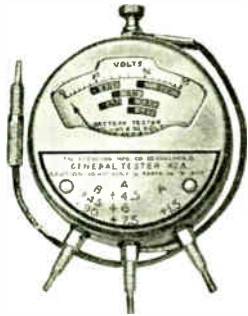

No. 42A General Tester

## Sterling Went to War, Too!

That's why you haven't heard from us recently but it won't be long until you can get plenty of Sterling Meters again.

Yes, Sterling's well known line—Pocket Meters for all kinds of Battery testing and Panel Meters for the common ranges of A.C. and D.C. civilian equipment requirements will soon be available. Substantial quantities have been scheduled for peacetime production and you can be assured of obtaining your Sterling products as in the past.



Type 68

THE *Sterling* MANUFACTURING COMPANY

9205 DETROIT AVENUE

CLEVELAND 2, OHIO

## B-L METALLIC ELECTRICAL RECTIFIERS

*offer you these advantages:*

They are **COMPACT . . . SILENT . . .**  
**DEPENDABLE . . . TROUBLE-FREE . . . RUGGED . . .** and

They are **ADAPTABLE** for power outputs from Milliwatts to Kilowatts.

Many rectifier applications, heretofore considered impractical, have been devised by B-L Engineers. It is more than likely that they can be of assistance in solving your problems of converting AC current to DC... Write for Bulletin R38-b.



**SELENIUM** **COPPER SULPHIDE**  
**THE BENWOOD-LINZE COMPANY**  
1815 LOCUST STREET • ST. LOUIS 3, MO.  
Long distance telephone CEntral 5830



**First Choice**  
**OF AMERICA'S MOTORISTS**

Vital wartime developments have simply added to the already great efficiency, top quality and precision workmanship that made Ward Antennas first choice of America's motorists before the war. To give your customers the best performance and complete dependability... and yourself maximum profits... look to Ward. Order the world's finest antennas for car and home now!

**THE WARD PRODUCTS CORPORATION**  
1523 EAST 45TH STREET • CLEVELAND 3, OHIO  
IN CANADA: ATLAS RADIO CORP. • 560 KING ST. W., TORONTO  
Export Dept. 4900 Euclid, Cleveland, O.

**WARD Antennas**

# Full Range

HIGH AND LOW FREQUENCY  
REPRODUCTION IN ONE ASSEMBLY!



HORIZONTAL SOUND DISTRIBUTION 80°

## TRU-SONIC CO-AXIAL SPEAKER

The Tru-Sonic Co-Axial Speaker combines a high frequency metal diaphragm reproducer and a low frequency paper cone reproducer, mounted together with the dividing network in a single, compact assembly, 15" in diameter and 9" in depth giving a horizontal sound distribution of 80 degrees. Outstanding for custom quality, and excellence before the war, the Tru-Sonic Speaker is finer than ever, but is available at a lower price, because of quantity production. Available now! Write for illustrated brochure.

Licensed under Western Electric Patents

### STEPHENS MANUFACTURING CO.

10416 NATIONAL BLVD.  
LOS ANGELES 34, CALIF.

(Continued from page 214)

addition, the industry produced about \$250,000,000 in military equipment from September, 1941, until the end of that year, according to RMA, bringing the aggregate contribution to the war effort to close to the 7½ billion mark.

Best industry and trade statistics show that in the entire period of civilian radio beginning in 1922, the total volume of radio equipment manufactured was about \$4,225,000,000, not including transmitting and communications equipment, the association announced. This is some 3¼ billion dollars less than the production total for war.

During the war, the radio industry hit its peak volume in the year 1944 when production averaged \$223,000,000 a month for a year's total of \$2,676,000,000. In the seven months of 1945, ending in August, production was at the rate of \$200,000,000 a month, the same as in the last six months of 1943. These figures compare with \$55,000,000 monthly in the first six months of 1942; \$109,000,000 monthly in the last six months of 1942, and \$160,000,000 per month in the first six months of 1943.

Totals for the war years, RMA discloses, are approximately as follows: 1941 (four months), \$225,000,000; 1942, \$984,000,000; 1943, \$2,160,000,000; 1944, \$2,676,000,000, and 1945 (seven months), \$1,400,000,000.

### OPA Permits Radio Set Prices to Rise

Supplementing its adoption of revised prices for radio components, the Office of Price Administration has ruled that home receiving sets may be increased in price by a factor varying from 10½ to 15%. It is pointed out, however, that retail prices are expected to remain at approximately the 1942 level with the wholesalers and retailers absorbing nearly if not all of the increase.

Under the terms of the rule, sets which sold under \$11 can be increased 15%. Those whose price ranged from \$11 to \$30 may go up 12%. Higher priced models selling for \$30 and over may be increased 10½%.

### OPA Authorizes Parts Price Boost

The radio parts industry battle for increased ceiling prices has resulted in revisions in the price factor which about double the interim boosts issued September 1 by the Office of Price Administration. With this bottleneck removed, the radio industry is expected to swing into full production.

The price increase factor is arrived at by adding "legitimate"

(Continued on page 218)

## Progressive midwestern capacitor manufacturer has permanent key positions for top notch executive calibre men as follows:

### ELECTROLYTIC DEVELOPMENT ENGINEER

Capable of designing and supervising installation of equipment. To take complete charge of laboratory and supervise production quality control. Must have previous experience with etching and formation processes.

### ELECTRICAL ENGINEER

Should have broad background of theory and practice in small electrical parts or equipment manufacturing. Position at present that of coordinating engineering problems of field sales with laboratory, engineering and manufacturing departments. Will have wide latitude of authority and report directly to management. To the right man, position will lead to that of Chief Electrical Engineer. Experience in capacitor field is advisable.

### ELECTRICAL ENGINEER POWER FACTOR IMPROVEMENT

This key position for a new department requires an electrical engineer with specific experience in power factor improvement problems. Technical writing ability is important. The right man probably would have gained his experience with a public utility or manufacturer of heavy power equipment. He must be qualified to create and supervise an entire department for sales of capacitors used in power factor improvement. He will be given assistance of a competent staff of capacitor engineers but will be required to design and arrange for manufacture of associated power factor equipment. Sales experience will be helpful but not essential.

Applicants are requested to outline experience, education, present and previous earnings and salary requirements. All replies will be held in strictest confidence. Our own engineers know of this advertisement.

Address Box 3

**ELECTRONIC INDUSTRIES**  
201 NORTH WELLS STREET  
CHICAGO 6, ILLINOIS

# Revolutionary!

## 1000 uufds. HIGH VOLTAGE VACUUM CAPACITORS

ANOTHER FIRST BY

**Jennings**  
-RADIO-

VACUUM ELECTRONIC COMPONENTS

### TENTATIVE CHARACTERISTICS

Peak Voltage, 10 KV (increased voltage ratings may be obtained upon request.)

Peak Current, 100 amps. Capacity, .001 uufds.  
Overall Length approximately 7½"  
Maximum Diameter at center 4½"

This new Jennings unit is required for heavy industrial needs where induction heating and other electronic uses call for the unusual in capacities, size and performance. Also for Broadcast Studios and Experimental Laboratories where rugged mechanical construction in a vacuum capacitor of this capacity is essential.

We welcome your inquiry and the opportunity to serve you.

WATCH JENNINGS FOR NEW DEVELOPMENTS IN THE FIELD  
OF SPECIALIZED VACUUM ELECTRONIC COMPONENTS.

WRITE FOR  
CATALOG E!

Patent  
applied for

JENNINGS RADIO MANUFACTURING COMPANY • 1098 E. WILLIAM ST. • SAN JOSE 12, CALIFORNIA

Transformer  
Engineers  
Devoted to



## RESEARCH·DEVELOPMENT

● As leaders in the field of design and development of specialized transformers, Electronic Engineering Co. has established an enviable reputation for solving the most difficult transformer applications. With complete electronic laboratories and the finest engineering talent available, Electronic Engineering Co. is devoted exclusively to the production of specialized transformers.

**ELECTRONIC ENGINEERING CO.**  
3223-9 WEST ARMITAGE AVE., CHICAGO 47, ILLINOIS  
"SPECIALIZED TRANSFORMER ENGINEERS"

(Continued from page 216)  
material and wage increases and a profit margin average for the years 1936-39 to prices of October 1, 1941. Any firm can take its own 1941 prices and increase them by the amount of the OPA price factor.

On the basis of cost data assembled by its accountants, OPA has authorized the following increases in price factors.

Coils from 11% authorized in September to a new figure of 26.3%; transformers and chokes, from the previous 11% to a new figure of 16.1%; vibrators, 16.1% (no interim price was given); speakers and speaker parts and variable condensers (except mica), from 9 to 13.5%; fixed capacitors, from 7 to 16.4%; parts for electric phonographs and combinations, 7 to 11.5%; fixed and variable capacitors, 5 to 9.5%; all others, 5 to 9.5%.

These increases are applicable to all uses of these parts, whether in radios or in other electric equipment.

Most radio parts manufacturers are reported to be "well satisfied" with the revisions. The variable capacitor manufacturers have expressed dissatisfaction, and the speakers and resistors prices are not considered wholly adequate.

### Fundamentals of Nuclear Physics

The New York Section of the Instrument Society of America and the New York Chapter of the American Society of Heating and Ventilating Engineers met jointly and heard an address by Dr. John R. Dunning, Director of Research, Special Section of Columbia University Division of War Research. The meeting was held on October 15, at the Pupin Physics Building of Columbia University. The topic was fundamentals of nuclear physics and included a discussion of basic principles of atomic disintegration, accompanied by some laboratory demonstrations.

### Gamma, Gamma, Gone!

Workers in X-ray laboratories are familiar with the sterilizing dangers to both the male and female reproductive organs resulting from exposure to strong X-radiation. Remembering that when U-235 breaks down into krypton and barium, tremendous outbursts of gamma rays and high-voltage X-rays occur, effects on future Jap population, not heretofore reported, may be surmised. To wit: besides wiping out the Japs in downtown Nagasaki, the attendant X-rays may have blotted out all future Jap generations in the surrounding territory—which is all right with us, too!

## "TAB"

AMATEURS—EXPERIMENTERS  
BROADCAST STATIONS  
LABORATORIES—MANUFACTURERS

"TAB" DEALS MEAN SAVINGS TO YOU

All Items Originate from Gov't. and Mfrs.' Disposal Centers. Include products from U.T.C., Daven, W.E., G.E., Westinghouse, Ohmits, Hardwick-Hiadle.

ALL NEW AND GUARANTEED—NO REJECTS

Aircraft midget type audio P to G 10-1 ratio—S.C. ....	\$ .35
Aircraft midget phasing type audio 2 C.T. sec's—S.C. ....	.35
Bridge or Decade attenuator resistance box (contains nine)—S.C.	
Attenuator type precision 20-step linear silver contact variable	
Resistor units—two 2 OHM units steps 0.1 OHM—three 40 OHM	} 12.00
units steps 20 OHMS—three 800 OHM units steps 40 OHMS	
One 16,000 OHM unit steps 800 OHMS—(Unit cost Navy \$250.00)	
Oil filled paper condensers guaranteed new perfect condition	
2 MFD 600 V.D.C. working can type L1½" W1" H4¾" .....	.99
4 MFD 600 V.D.C. working can type L2½" W1½" H4¾" .....	1.24
4 MFD 500 V.D.C. working can type L1½" W1" H4½" .....	.88
2 MFD 580 V.D.C. 440 V.A.C. working can type L4¼" W7½" H4¾" .....	.83
0.5 MFD 600 V.D.C. working bathtub MTG L1½" W1½" H2" .....	.57
2 MFD 900 V.D.C. 660 V.A.C. working can type L3¾" W1½" H3½" .....	1.31
2 MFD 1000 V.D.C. working can type L1½" W1" H3¾" .....	1.60
3.5 MFD and 0.5 MFD (4MFD) 1000 V.D.C. working can type L2½" W1½" H4½" .....	2.19
0.5 MFD 1500 V.D.C. working cap type L1½" W1" H2½" .....	1.44
1 MFD Tubular paper wax impregnated 600 V.D.C. working	.21
1 MFD oil type condenser 1000 V.D.C. working cylindrical can MTG bracket D2" H2¾" .....	1.10
4 MFD oil type condenser 2000 V.D.C. working rect. can L3¾" W2½" H4" .....	3.90
1 MFD oil type condenser 5000 V.D.C. working type 25F695 H6¼" W3½" D4¾" .....	7.95
1 MFD oil type condenser FF metal case 10,000 V.D.C. working H8¾" W7½" D4¾" .....	26.40
0.5 MFD oil type condenser 25,000 V.D.C. working FL-Inerteen metal case H16" W14" D4½" .....	36.90
1 MFD oil type condenser 25,000 V.D.C. working 1212864 Inerteen metal case H12" W13" D8" .....	49.97
Special type G 75 watt variable rheostat with C.T. 50 ohms 1.23 amps or 25 ohms 2.46 amps (150 watt) .....	1.10
150 Watt variable rheostat 10 ohms .....	2.75
G.E. Selsyn-Synchro Generator Model 2A size 6G 90-115V-60 cycles. .... Per Pair	29.50

Send Orders TAB, DEPT. EI-10, 75 Vesey Street, New York City



## Long Scale, Wide Range Volt-Ohm-Milliammeter

### DOUBLE SENSITIVITY D.C. VOLT RANGES

0-1.25-5-25-125-500-2500 Volts, at 20,000 ohms per volt for greater accuracy on Television and other high resistance D.C. circuits.

0-2.5-10-50-250-1000-5000 Volts, at 10,000 ohms per volt.

### A.C. VOLT RANGES

0-2.5-10-50-250-1000-5000 Volts, at 10,000 ohms per volt.

### OHM—MEGOHMS

0-400 ohms (60 ohms center scale)  
0-50,000 ohms (300 ohms center scale)  
0-10 megohms (60,000 ohms center scale)

### DIRECT READING OUTPUT LEVEL DECIBEL RANGES

—30 to +3, +15, +29, +43, +55, +69 DB

### TEMPERATURE COMPENSATED CIRCUIT FOR ALL CURRENT RANGES D.C. MICRO-AMPERES

0-50 Microamperes, at 250 M.V.

### D.C. MILLIAMPERES

0-1-10-100-1000 Milliamperes, at 250 M.V.

### D.C. AMPERES

0-10 Amperes, at 250 M.V.

### OUTPUT READINGS

Condenser in series with A.C. Volts for output readings.

### ATTRACTIVE COMPACT CASE

Size: 2½" x 5½". A readily portable, completely insulated, black, molded case, with strap handle. A suitable black, leather carrying case (No. 629) also available, with strap handle.

### LONG 5" SCALE ARC

For greater reading accuracy on the Triplet RED DOT Lifetime Guaranteed meter.

### SIMPLIFIED SWITCHING CIRCUIT

Greater Ease in changing ranges.

Write for descriptive folder giving full technical details.



HERE'S THAT NEW  
**TRIPLET**  
**625-N**

# Triplet

**ELECTRICAL INSTRUMENT CO.** BLUFFTON, OHIO

# W

Let us tell you how you may use our organization just as if it were yours.



A MOST  
UNUSUAL SERVICE  
TO A  
MANUFACTURER

SEND FOR NEW CATALOG

# WATERBURY

MOLDINGS OF MERIT

*Compression  
Transfer  
Injection*

**WATERBURY COMPANIES, INC.**  
FORMERLY WATERBURY BUTTON CO., EST. 1812  
WAY BLVD., WATERBURY, CONN.

# EISLER

IS WELL EQUIPPED TO MAKE YOUR  
**TRANSFORMERS**

### EISLER OFFERS

- COMPETENT ENGINEERING
- PROPER SUPERVISION
- QUALITY MATERIAL
- RIGID TEST & INSPECTION
- GOOD DELIVERY
- SATISFIED CUSTOMERS

Capacities ¼ to 300 KVA. Lighting — Distribution — Furnace — Auto — Phase Changer — Air or Oil Cooled — Power — Special Transformers.

WRITE FOR CATALOG

**CHAS. EISLER**  
**EISLER ENGINEERING CO.**  
778 SO. 13TH ST. (NEAR AVON), NEWARK 3, N. J.

## With reconver- sion in full swing

You will want to use and know more about these new sub-miniature vacuum tubes

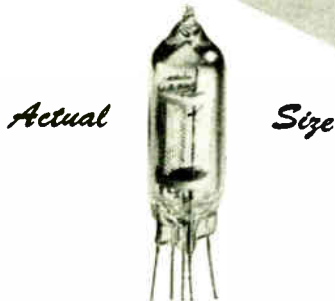

### -Series VW- 15 ma., 1.5 volts

Grid current less than  $10^{-14}$  amperes—grid resistance approximately  $10^{16}$  ohms.

Individually checked for uniformity within the range of the best operating characteristics—each tube is built for exacting circuit requirements.

Available as . . .  
Electrometers  
Pentodes  
Tetrodes  
Triodes  
Diodes

And now in production—new hi-meg vacuum sealed resistors in a range never adequately covered before—values from 1 megohm to 1,000,000 megohms. Write for literature on tubes and resistors or consult us on your tube problems.

1,000,000 Megohms



Actual size



THE VICTOREEN INSTRUMENT CO.  
5806 HOUGH AVENUE  
CLEVELAND 3, OHIO

## NEW BOOKS

### Applied Mathematics for Radio and Communication Engineers

By Carl E. Smith, Assistant Chief, Operational Research Branch, Office of the Chief Signal Officer, War Department; published by McGraw-Hill Book Company, Inc., New York, 1945, 336 pages, \$3.50

The text written in connection with a general plan for a practical home study course offered by the Smith Practical Radio Institute of Cleveland, Ohio, for students with high-school education who desire to acquire elementary knowledge of several branches of mathematics used in communication engineering.

Starting with arithmetic, logarithms, algebra, geometry, trigonometry, the text explains only the basic aspects of each subject with a view to radio engineering applications, and advances rapidly to include vector addition, solution of simple systems of simultaneous equations, hyperbolic functions and their different interpretations. The last chapters give a brief survey of differential and integral calculus, mentioning Bessel functions because of their interest in high frequency problems, and review some mathematical series and their properties as well as wave form analysis.

The appendix comprises a number of useful tables and formulas such as logarithms, hyperbolic functions, Bessel functions, and trigonometric and calculus formulas.

### Electrical Measurements of Mechanical Quantities

By Paul M. Pflieger. Second edition 1943 (Springer-Berlin) reprinted and published in original German by J. W. Edwards, Ann Arbor, Mich. 259 pages with 326 illustrations, price \$6.50. (Published in public interest by authority of Allen Property Custodian.)

This book gives a comprehensive survey of industrial measuring principles covering most of the usual mechanical problems. It describes hundreds of converters useful in changing physical and mechanical effects into electrical quantities, together with utilization circuits whereby those effects can be measured. The instruments described are those that were available on the German market. Detailed sketches or photographs are generally included.

The subjects include a listing of advantages of electrical instruments and calibration methods; methods of transforming mechanical into electrical quantities; measuring procedures for displacements, forces, velocity, accelera-

(Continued on page 222)

# SUN RADIO

in  
*New and larger  
quarters!*

## AMERICA'S

most

## COMPLETE

## SOURCE of SUPPLY

Where the impossible becomes the usual. 6,000 square feet of space and a considerably enlarged staff, enable us to improve a service that has always been TOP FLIGHT.

With over 10,000 items in stock, of Standard Nationally advertised products, you have a wide selection to fill your every requirement.

Note our New Address

**SUN RADIO**  
& ELECTRONICS CO., Inc.  
122 Duane St., New York 7

Tel. BRa clay 7-1840



# WE SPECIALIZE IN "Specials"

**FOR NEARLY 20 YEARS**, the Kenyon Transformer Company has done an outstanding job of satisfying the demand of large manufacturers for "special units" to fit exactly their most critical needs, with the same care that other manufacturers could provide items of their standard catalog lines.

**THIS ACHIEVEMENT** is a tribute to the skillful engineering ability of the Kenyon Pioneers who have maintained a leading place in the development of outstanding transformer equipment.

**WE INVITE INQUIRIES** from manufacturers of electronic and other types of equipment, and from industrial and commercial users of transformers.

**KENYON PREDICTS** that the small additional cost of "specials" will be more than offset by the superior product—streamlined to fit each manufacturer's requirement.

*Inquiries invited — write for our new 1945 ILLUSTRATED CATALOG.*

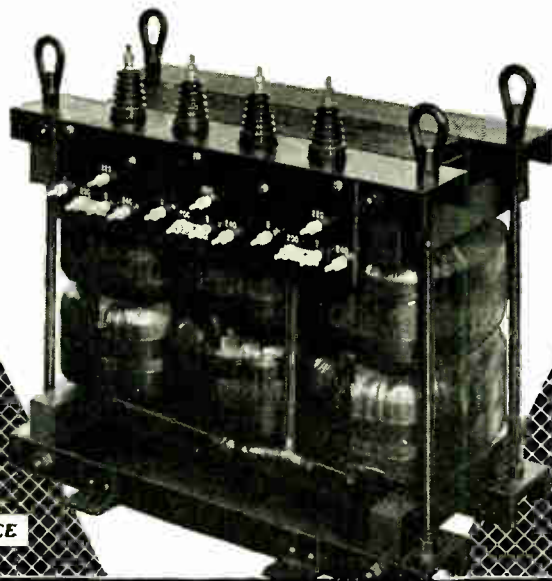

THE MARK OF

EXCELLENCE

**KENYON TRANSFORMER CO., Inc.** 840 BARRY STREET  
NEW YORK, U. S. A.



## THERMOSTATIC METAL TYPE DELAY RELAYS PROVIDE DELAYS RANGING FROM 1 TO 120 SECONDS

### Other important features include:—

1. Compensated for ambient temperature changes from  $-40^{\circ}$  to  $110^{\circ}$ F.
2. Contact ratings up to 115V-10a AC.
3. Hermetically sealed — not affected by altitude, moisture or other climate changes . . . Explosion-proof.
4. Octal radio base for easy replacement.
5. Compact, light, rugged, inexpensive.
6. Circuits available: SPST Normally Open; SPST Normally Closed.

**WHAT'S YOUR PROBLEM? Send for "Special Problem Sheet" and Descriptive Bulletin.**

**AMPERITE CO.** 561 BROADWAY  
NEW YORK 12, N. Y.  
In Canada: Atlas Radio Corp., Ltd.  
560 King St. W., Toronto

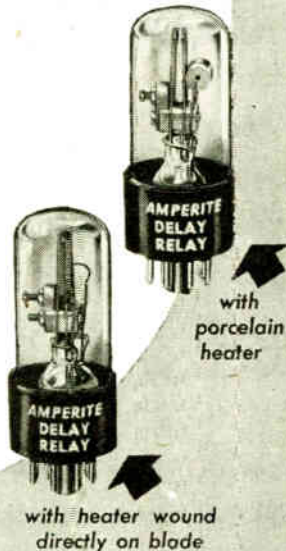

## NEW BOOKS

(Continued from page 220)

tion, oscillations, vibrations, time and time intervals.

A sixteen page bibliography is included containing some six hundred references on these matters, based on German, English and American publications.

The book will provide an excellent reference (to those who can handle German text) in helping choose a solution to an engineering problem that involves mechanical quantities.

### Optical Instruments

By Earle B. Brown. Published 1945, Chemical Publishing Co., 26 Court St., Brooklyn, N. Y., 432 pages, fully illustrated, 1945. Price \$10.00.

This book is written in the descriptive style, and covers the general field of optical instruments. It describes the nature and uses of most of the military and industrial optical instruments and discloses the basic principles of design, their functions and their adjustment and repair.

Emphasis has been given to the telescope, spectroscope and the range finder. The book contains but little on the engineering aspects of optical problems, but much data has been included on care and maintenance. For example methods of collimation, adjustments for parallax, tilt, double vision, etc., are covered. A glossary of engineering terms is included.

### Pulsed Linear Networks

By Ernest Frank, Garden City Research Laboratories, Sperry Gyroscope Co., Inc. Published by McGraw-Hill Book Co., 330 W. 42nd St., New York City. 267 pages, 9 chapters, 179 illustrations.

Mr. Frank has written a readable introduction to transient analysis "for undergraduates in their junior or senior year." Lumped linear parameters, classical differential equations, square pulses, and single- or double-mesh circuits are treated. The book is concerned with setting up the differential circuit equations subject to the stated restrictions, solving the equations and introducing the boundary conditions. Academic problems are posed at the end of each chapter.

The author discusses a special network on page 225 (series-parallel RLC circuit) with constant impedance for the condition  $R = R = (L/C)^{1/2}$ . He is off to a good start at this point, and it appears odd that other members of the family, of great importance to modern practitioners of the circuit art, have been neglected.

This book can be recommended

(Continued on page 224)

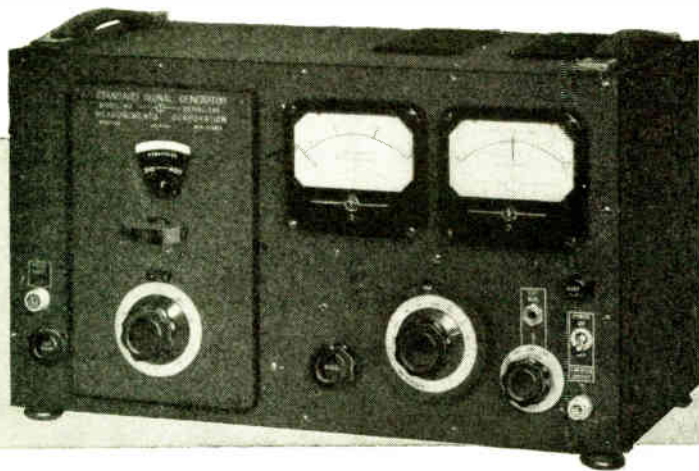

## STANDARD SIGNAL GENERATOR Model 80

### SPECIFICATIONS:

- CARRIER FREQUENCY RANGE:** 2 to 400 megacycles.  
**OUTPUT:** 0.1 to 100,000 microvolts. 50 ohms output impedance.  
**MODULATION:** A M 0 to 30% at 400 or 1000 cycles internal.  
 Jack for external audio modulation.  
 Video modulation jack for connection of external pulse generator.  
**POWER SUPPLY:** 117 volts, 50-60 cycles.  
**DIMENSIONS:** Width 19", Height 10 3/4", Depth 9 1/2".  
**WEIGHT:** Approximately 35 lbs. **PRICE—\$465.00 f.o.b. Boonton.**  
 Suitable connection cables and matching pads can be supplied on order.

MEASUREMENTS CORPORATION  
BOONTON NEW JERSEY





# A NEW SOCKET

*for very high frequencies*

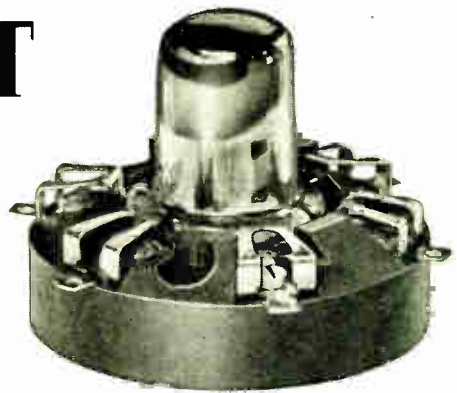

Born of war-time necessity, this new socket, Type XLA, for the 6F4 and the 950 series acorn tubes, has been designed for working frequencies as high as 600 MC. The acorn tube is inserted in position, and rotated to engage the contacts. The tube terminals are held in a vise-like grip which insures permanently low contact resistance. Inductance is low and constant, and leads are short and direct. An internal shield, Type XLA-S, is available for tubes such as the 956. By-pass condensers may be conveniently mounted between the contact terminals and the chassis, but for minimum radiation a special ceramic condenser, Type XLA-C, may be mounted inside the socket in place of the contact screw. The socket is 1 17/32" diameter. Insulation is low loss R-39. Prompt delivery can be made without priority.



NATIONAL COMPANY, Inc.  
MALDEN, MASS.



Designed for



Application

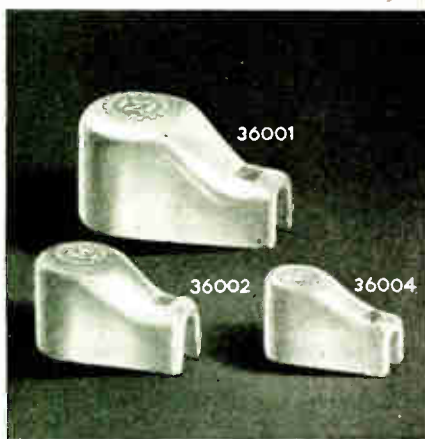

### 36000 SERIES

Ceramic Plate or Grid Caps

A new addition to this series of exclusive Millen "Designed for Application" products is the 36004 for use on tubes with  $\frac{1}{4}$ " diameter contacts. Efficient, compact, easy to use and neat appearing. Soldering lug and contact one-piece. Lug ears annealed and solder dipped to facilitate easy combination "mechanical plus soldered" connection of cable. No. 36001 for 9, 16" tube terminals. No. 36002 for  $\frac{3}{8}$ ". No. 36004 for  $\frac{1}{4}$ ".

**JAMES MILLEN  
MFG. CO., INC.**

MAIN OFFICE AND FACTORY  
MALDEN  
MASSACHUSETTS



## NEW BOOKS

(Continued from page 222)

to students who have found difficulty in correlating derivatives and differentials with linear circuit parameters. Exposition is effective and derivations are painstakingly thorough. It would be impossible to escape assimilation of the writer's points upon systematic reading of the book.

### Electronic Equipment and Accessories

By R. C. Walker. Published 1945 by Chemical Publishing Co., Inc., Brooklyn. 393 pages, 343 illustrations. Price \$6.00.

This book, apparently of British authorship, offers specific information on the various applications of industrial electronic devices. It describes and illustrates many examples of electronic application outside the field of telecommunication. It takes up the fundamental characteristics and applications of evacuated tubes, gas filled thyratrons, phototubes and cathode ray tubes. It also describes many miscellaneous auxiliary components that are used in conjunction with electronic circuits such as relays of all types, delayed action devices, impulse counters, motors, etc. The book should prove of interest to industrial engineers.

### Color Scanner

A hand-viewing device for use by owners of black and white receivers which gives color images when color is being broadcast has been developed by Dr. Alfred N. Goldsmith, New York radio and television consulting engineer. The device is a rotating disc about four inches in diameter, actuated by a miniature motor which operates from the 110 v lines.

### TBA Lists New Members

The Westinghouse Electric Corp. of Baltimore, Md., has been admitted as an affiliate member of Television Broadcasters Association Inc., New York. Syracuse University and Western Reserve University also were given membership status in the association.

### Tele Show Scheduled

A wide variety of television equipment, including home receivers, station equipment and television components, will highlight the second convention of the television industry scheduled to be held in New York City next Spring. The convention will be held under the auspices of Television Broadcasters Association Inc. and will be the first industry-wide meeting held since the start of the war.

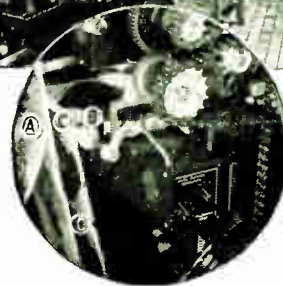
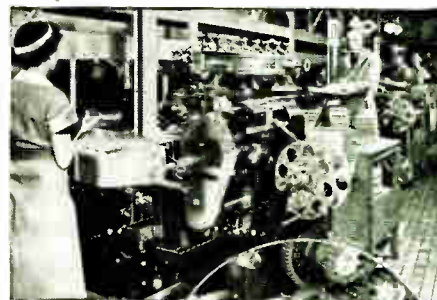

### Wrapping Candy Accurately and Quickly with WRAP-O-MATICS Equipped with United Cinephone Electronic Controls

The quantity production of candy bars requires quick secure wrapping with the label design perfectly centered. The Lynch Manufacturing Corporation of Defiance, Ohio has achieved these desirable results on the Wrap-O-Matic machine, pictured above. The wrappers are web-fed from a roll (A) into the machine at (B). The electric eye markings (C) register under the photo electric cell of the United Cinephone Dual Scanner registration control and actuate the cutting and wrapping mechanism with split-hair accuracy.

This is one of the many practical applications of these United Cinephone Electronic Controls to modern production needs . . .

OTHER APPLICATIONS of United Cinephone Electronic Controls are almost without limit. If you have a problem of measuring, gauging, counting, sorting, heating, or some other operation in your plant, which is costly and unreliable, you will want to investigate the possibility of solving the problem ELECTRONICALLY. That's where our extensive experience and facilities in Electronic design, engineering, and manufacturing can be of invaluable help. Your inquiry will be welcome.

Electronic fields we cover include:

1. Industrial Controls
2. Aircraft Communications
3. Laboratory Test Equipment
4. Radio and Audio Equipment

**UNITED CINEPHONE  
CORPORATION**

28 NEW LITCHFIELD STREET  
TORRINGTON, CONNECTICUT



# Now - MATCH THEIR BEST WITH YOUR MOST IN THE VICTORY LOAN!

Top off your good work on your Payroll Savings Plan with an outstanding showing in the Victory Loan—our last all-out effort!

Help bring our boys back to the homes for which they

fought—and give our wounded heroes the best of medical care—by backing the Victory Loan! You know your quota! You also know by past war-loan experience that your personal effort and plant solicitation are required to make your quota.

## Sell the New F.D. Roosevelt Memorial \$200 Bond through your PAYROLL SAVINGS PLAN!

In rallies, interdepartmental contests, and solicitations, promote the new Franklin Delano Roosevelt Memorial \$200 Bond! Better than "cash in hand," Victory Bonds enable the buyers to build for the future—assure a needed nest egg for old age.

Keep on giving YOUR MOST to the Victory Loan! All Bond payroll deductions during November and De-

cember will be credited to your quota. Every Victory Bond is a "Thank You" to our battle-weary men overseas—also a definite aid in making their dreams of home come true! Get behind the Victory Loan to promote peacetime prosperity for our returning veterans, your nation, your employees—and your own industry!

*The Treasury Department acknowledges with appreciation the publication of this message by*

# ELECTRONIC INDUSTRIES



*This is an official U. S. Treasury advertisement prepared under auspices of Treasury Department and War Advertising Council*

## Integrity of Design



For nearly a quarter of a century Carter has been a well known name in radio and has led the industry in designing and manufacturing the finest Rotary Electrical Power Supplies.

The preference and specification of Carter Products is an attribute to their precision performance and integrity of design. Write for latest catalog today.

**Carter Motor Co.**  
Chicago, Illinois

# Toroids..

by

# DX

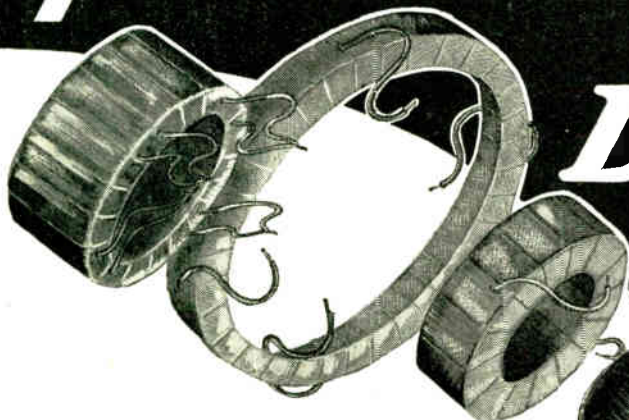

Doughnut Coils for electronic and telephone purposes. High Permeability Cores are hydrogen annealed and heat treated by a special process developed by DX engineers. Send us your "specs" today—ample production facilities for immediate delivery.

**DX RADIO PRODUCTS CO.**

GENERAL OFFICES 1200 N. CLAREMONT AVE., CHICAGO 22, ILL., U.S.A.



## Plan FMBI-NAB Merger

The National Association of Broadcasters and the Frequency Modulation Broadcasters Inc., may be drawn together. The possibility of consolidating the two organizations was discussed at length during a meeting of a joint committee representing both organizations. A plan for merging the two groups was drawn up and will be presented at the board meeting of FMBI scheduled for this month. NAB members of the joint committee were Paul W. Morency, Leslie Johnson, and Frank Stanton, while FMBI was represented by Wayne Coy, Gordon Gray and Cecil Mastin.

## Radar Lectures Start

The Communications Group of the New York Section of AIEE jointly with the New York Section of IRE has started a series of lectures relating to the fundamental theory and concepts of radar. Three of the six listed lectures have been conducted.

The schedule: Oct. 19, Introduction of Radar Concepts, D. G. Fink; Oct. 26, Transmission, Radiation, and Propagation, S. Silver, M.I.T. Radiation Laboratories; No. 2, Generation, J. B. Fisk, Bell Telephone Laboratories; Nov. 9, Reception, S. E. Miller, Bell Telephone Laboratories; Nov. 16, Indication, L. J. Harworth, M.I.T. Radiation Laboratories; Nov. 23 or 30, Testing Equipment, F. J. Gaffney, M.I.T. Radiation Laboratories. The lectures are being conducted in the engineering auditorium, Engineering Societies Bldg., New York City.

## Technical Societies Council

Seventeen professional and technical societies of the Kansas City area have joined forces to establish the Technical Societies Council for unified action in matters pertaining to the development of scientific endeavors. A monthly bulletin will be published programming activities of all organizations. Some of the principal objectives include support for establishing better technical and scientific libraries in the Kansas City region, encouragement of technical training courses, and cooperation with civic, educational, and government agencies in matters requiring professional assistance. Each of the seventeen participating organizations elected two delegates to a council which will have headquarters in the offices of the Midwest Research Institute.

The American Institute of Electrical Engineers, the American Society for Metals, and the Institute of Radio Engineers are cooperating organizations.

*Start* **RIGHT**  
**AND YOU** *End*  
**RIGHT!**



**with WESTONS ON ALL PRODUCTION TEST-STANDS AND INSPECTION EQUIPMENT!**

With the race for markets in full swing, electrical manufacturers are eliminating costly production bottlenecks by providing *uniform dependability* in testing procedure all along the line. From the inspection of purchased components right through to final product inspection, they insure accurate testing by using instruments they can trust.

And it's easy to insure *measurement dependability* at every step, because there are WESTONS for every testing need . . . including types for all special test-stand requirements, as well as a broad line of multi-range, multi-purpose test instruments. These compact, multi-purpose testers often afford new simplicity and economies in testing procedure, while assuring the dependability for which WESTONS are renowned.

Literature describing the complete line of WESTON panel and test instruments is freely offered . . . Weston Electrical Instrument Corporation, 666 Frelinghuysen Avenue, Newark 5, New Jersey.



**Weston** *Instruments*

ALBANY • ATLANTA • BOSTON • BUFFALO • CHICAGO • CINCINNATI • CLEVELAND • DALLAS • DENVER • DETROIT • JACKSONVILLE • KNOXVILLE • LOS ANGELES • MERIDEN  
 MINNEAPOLIS • NEWARK • NEW ORLEANS • NEW YORK • PHILADELPHIA • PHOENIX • PITTSBURGH • ROCHESTER • SAN FRANCISCO • SEATTLE • ST. LOUIS • SYRACUSE  
 In Canada, Northern Electric Co., Ltd., Powerlite Devices, Ltd.

# DEPENDABLE!

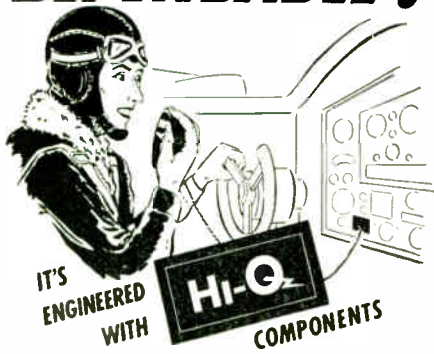

Made right . . . to work right . . . and stay right. Whether in stock ratings or to your own specifications you will find Hi-Q components precise, dependable and long lived. Send for samples and complete information.

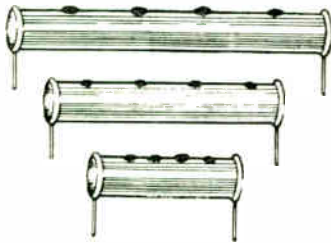

Hi-Q Ceramic Capacitors are of titanium dioxide (for temperature compensating types) and are tested for physical dimensions, temperature co-efficient, power factor and dielectric strength. CI type with axial leads; CN type with parallel leads.

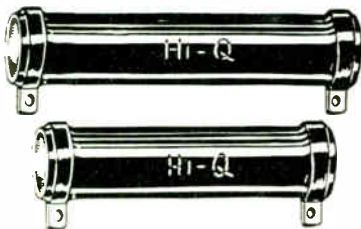

Hi-Q Wire Wound Resistors can be produced promptly and in quantity — with quality physical specifications and high performance electric specifications.

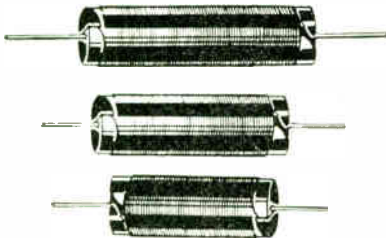

Hi-Q Choke Coils are uniform in their high quality performance. Ruggedly constructed for long service.

**ELECTRICAL REACTANCE CORPORATION**  
FRANKLINVILLE, N. Y.

## Choice of Frequency in Dielectric Heating

G. W. Scott, Jr., Armstrong Cork Company.

It is pointed out that a careful choice of the frequency used in dielectric heating is a very important factor in the efficient operation of the set up; increase in frequency does not necessarily lead to an increase in the rate of heating as seems to be indicated by the formula for the amount of heat  $H$  generated as a function of frequency.  $H = \omega CE^2 \cos \theta$ , where  $\cos \theta$  is the power factor of the material heated.

Attention is drawn to the facts that (1) none of the variables in the above equation are completely independent of frequency or its effects, (2) as the frequency is increased, the load capacitance must be decreased to allow tuning and to avoid short circuiting the generator, (3) at higher frequencies load length must be kept at a minimum to eliminate the possibility of standing waves, and (4) increased frequency accentuates the load shunting effect of stray capacitance and seriously reduces the overall efficiency of the process. The frequency band from 10 to 30 megacycles is recommended for large scale industrial dielectric heating, that is for load capacitances up to 500  $\mu\text{f}$  and for output power as high as 100 kw. Conditions obtaining in actual equipment are discussed and factors to be considered in the design are pointed out.

## Germanic-Electronic Diplomacy

The sales engineer of a large glass company was journeying to an eastern radio manufacturer to arrange for a large order of television glass blanks. It was important, he thought, so that he took with him his German glass expert.

Around the conference table the television researchers conferring with the two glass men had all but reached their final conclusions and specifications when in walked the chief engineer, unannounced and not introduced to the visitors. This older man, who was noted more for dominance in his department than for his knowledge of television tubes, reached for the sketches and specifications. Within a few minutes the newly formulated plans were being rapidly upset.

The German glass expert was saying, "But that is impossible!" and later, ". . . but you can't seal heavy glass to thin glass!" The men who seldom heard their chief contradicted rather enjoyed this part of the conference in which the

(Continued on page 230)



Radio - Electronic Parts and Materials — as per above — and many other lines . . .

Dalis carries an outstanding stock—most items right off the shelf—or Dalis go-gets them in a hurry, for you.



Try DALIS — just wire, 'phone or write . . .

**H. L. DALIS**

Wholesale Distributors  
RADIO-ELECTRONIC SUPPLIES & PARTS

17 Union Square

NEW YORK 3, N. Y.

Phones: ALgonquin 4-8112-3-4-5-6-7

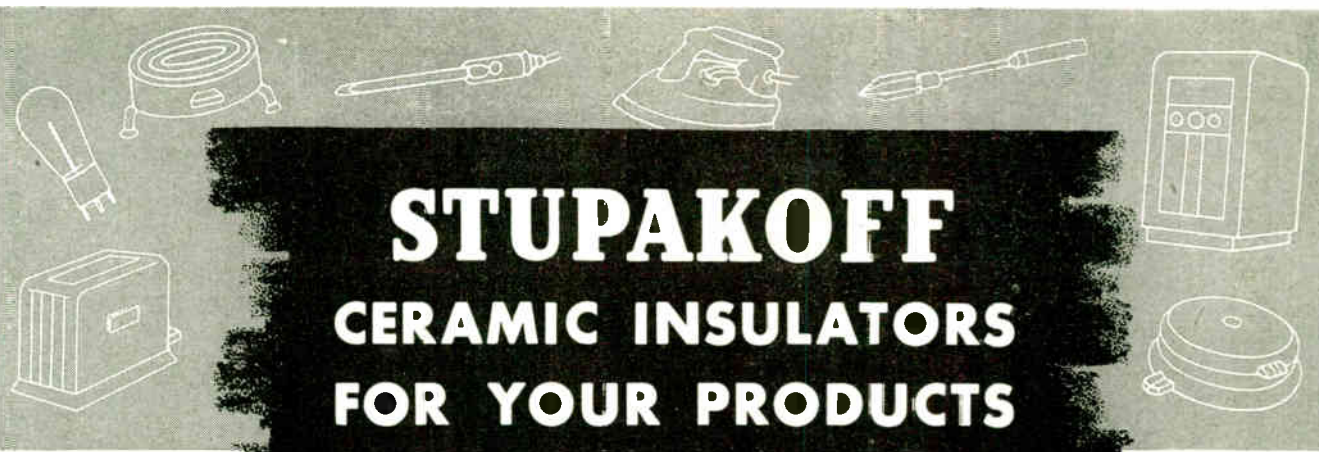

# STUPAKOFF CERAMIC INSULATORS FOR YOUR PRODUCTS

## PADDER AND TRIMMER BASES

Padder and trimmer bases that are mechanically strong, dimensionally accurate, and electrically stable, keep assembly lines flowing, minimize breakage in production and in use, insure consumer satisfaction. STUPAKOFF combines mass production with laboratory precision. Exact control extends from scientific testing of raw material through final packing. STUPAKOFF engineers are at your service.

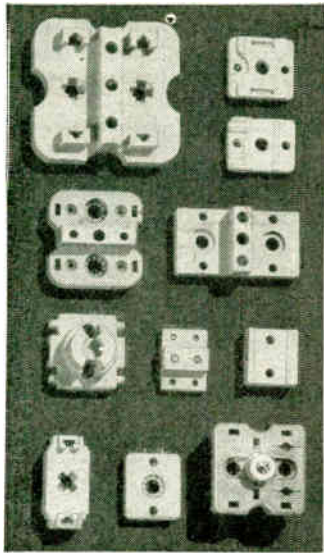

## TUBE PARTS

From the day when the first STUPAKOFF ceramic heater insulator was produced for the first A.C. radio tube, the name STUPAKOFF has been a synonym for quality in the field of radio ceramics. Adherence to specification tolerances, both mechanical and electrical, and to the proper material for the specific application are integrated in every STUPAKOFF product.

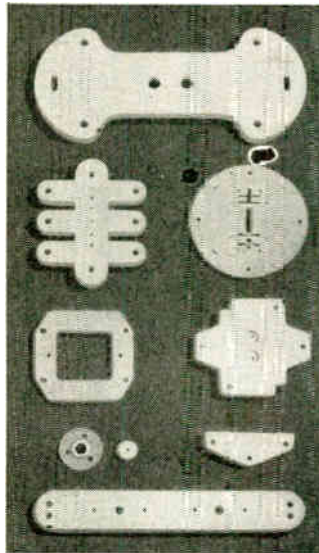

## RESISTOR PARTS

STUPAKOFF produces precision-made ceramic resistor parts as rods, plain or threaded; as tubes, plain or threaded; as winding forms for all types of resistors; and metallized for solder-sealed resistors. STUPAKOFF ceramics are dense and sturdy, vitrified to withstand moisture, resistant to vibration and thermal shocks.

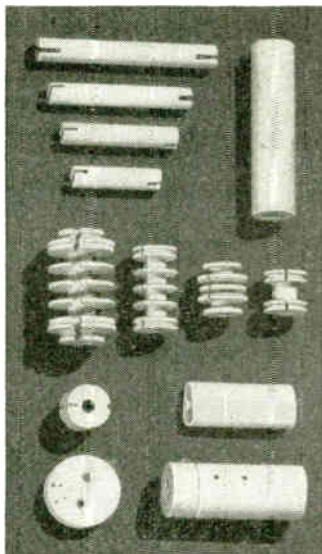

## ELECTRIC APPLIANCE CERAMICS

STUPAKOFF insulators are planned to meet the demands of assembly line production and to endure the rigorous usage requirements, thus minimizing field failures and service calls. Made vitrified, dense, non-hygrosopic or porous as required. Made to withstand sudden temperature changes without fracturing. Engineered to suit the job.

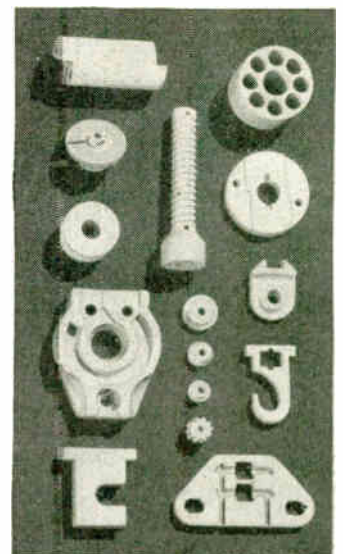

★ BUY VICTORY BONDS ★



STUPAKOFF CERAMIC AND MANUFACTURING CO., LATROBE, PA.

*Products for the World of Electronics*



# Instantaneous Recycling



FLEXIBLE  
 .  
 RELIABLE  
 .  
 REASONABLY PRICED  
 .  
 COMPACT

## AGASTAT

ELECTRO-PNEUMATIC TIME DELAY RELAY

ELIZABETH A'GA NEW JERSEY  
 AMERICAN GAS ACCUMULATOR COMPANY

(Continued from page 228)

visitor did not hesitate to criticize proposed ideas.

The sales engineer, squirming in silent agony, finally was able to slip a note to his expert which read, "THIS is the big shot!!"

The German's demeanor changed at once. He said, "Oh yes, sir. You are quite right! That is the way it should be done."

The conference ended soon afterwards, and the representatives of the glass company returned with the order which they had secured by a very narrow margin.

### Why Not Electronic Dollars?

Transmutation of metals seems a foregone conclusion with atomic power. And remembering that the total monetary gold in the world amounts only to a cube 40 ft. on a side, it may be possible eventually to duplicate such a cube out of mercury, by reducing the nuclear positive charge from 80 to 79. If this could be done at low cost, then where would be our international gold standard?

The electron may be the only unshakeable international unit left!

FOR ENTERPRISING  
 INDUSTRY... THIS NEW  
 SIGNALLING TIMER!

Designed to give precision where seconds count, and accuracy is imperative. The New Signalling Timer, Model Series S does just that; set it to any specific time cycle, and when that desired interval has elapsed, visual and audible attention is registered to the operator as the circuit is stopped. It eliminates guess-work, mistakes, and spoilage in industry, and gives the highest degree of precision timing. Write for details.

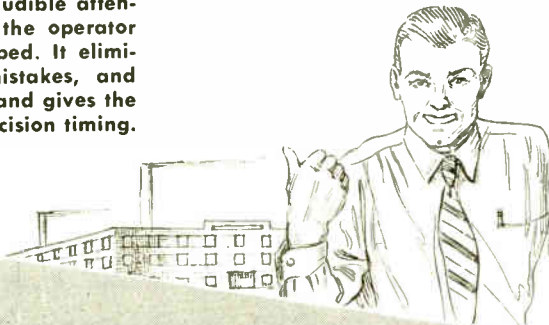
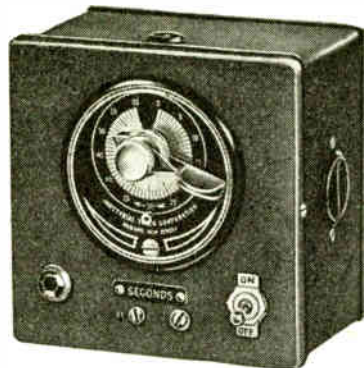

## INDUSTRIAL TIMER CORPORATION

110 EDISON PLACE

NEWARK, NEW JERSEY

RADEX

CHICAGO

# RADEX

**I**n future peace-time production, Radex will uphold its war-won reputation by the scope and caliber of its service to the radio and electrical industries.

**Radex Corporation**

53 W. Jackson Blvd., Chicago 4, Ill.



# THIS IS THE "PULSE" OF RANGE FINDING AND DETECTION

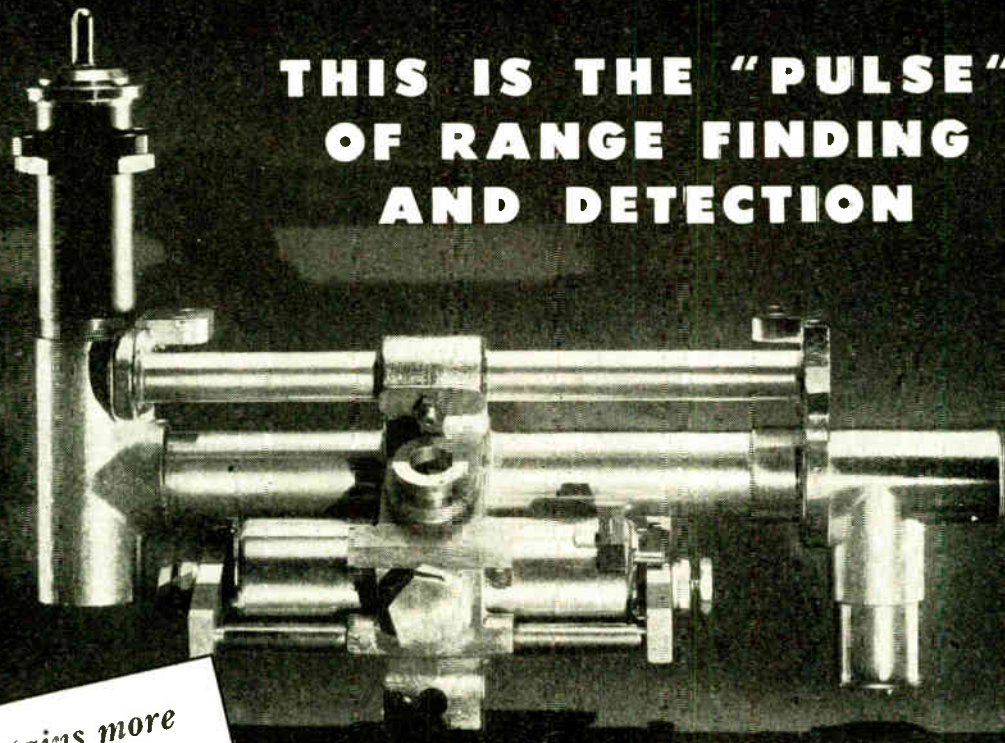

It contains more  
than  
50 Electronents\*  
made  
and assembled  
by Scovill

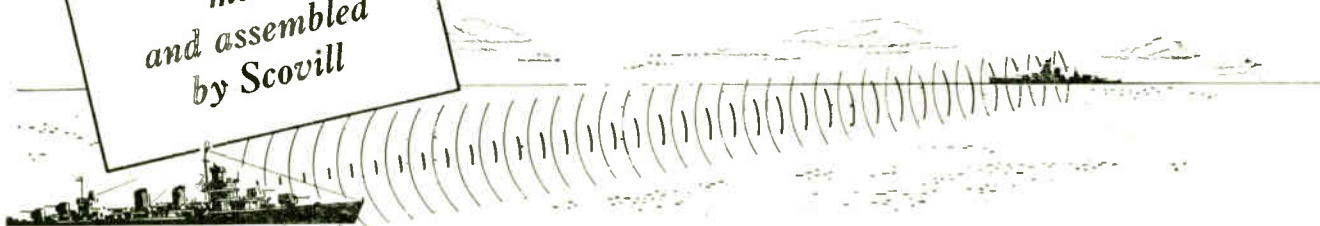

Illustrating the wide scope of Scovill's metal-working ability in the electronics field

This "pulse" valve for range finding and detection apparatus was made by Scovill to more exacting specifications than you would perhaps ever demand. Let's look at some of the requirements.

Its 50-odd metal parts . . . made of sheet, rod, wire and tube stock by forging, stamping, drawing, cold-heading, machining and wire-forming . . . required working to tolerances of the highest order since each must fit its neighbor exactly during assembly. Most of the joints were soldered . . . yet no solder

could go through to the inside . . . under penalty of rejection.

Plating of internal walls to a specification plate thickness required precise control. A single scratch or nick on internal surfaces or edge of flanged connecting tube meant rejection of the entire assembly. Yet rejections were few.

### CONSIDER SCOVILL'S VERSATILITY

To improve the quality or lower the cost of your small electronics components or complete assemblies, investigate the production versatility as outlined for the "pulse" valve. You'll find that Scovill's designing, metal-working

and assembling skill is your best bet for the *right* metal parts. For proof, write for literature, using coupon below.

\*Electronents = Electronic Components.



Please send me a free copy of "Masters of Metal" booklet describing your facilities. I am interested in the ELECTRONENT\* applications checked.

- |  |                                      |  |
|--|--------------------------------------|--|
| <input type="checkbox"/> Batteries       | <input type="checkbox"/> Dials       | <input type="checkbox"/> Panels            |
| <input type="checkbox"/> Record Changers | <input type="checkbox"/> Escutcheons | <input type="checkbox"/> Sockets           |
| <input type="checkbox"/> Clips           | <input type="checkbox"/> Jacks       | <input type="checkbox"/> Stampings (misc.) |
| <input type="checkbox"/> Condensers      | <input type="checkbox"/> Lugs        | <input type="checkbox"/> Tubes             |

Other applications.....

### SCOVILL MANUFACTURING COMPANY

Electronic Division  
23 Mill Street  
Waterbury 91, Connecticut

Name .....

Company .....

Address .....

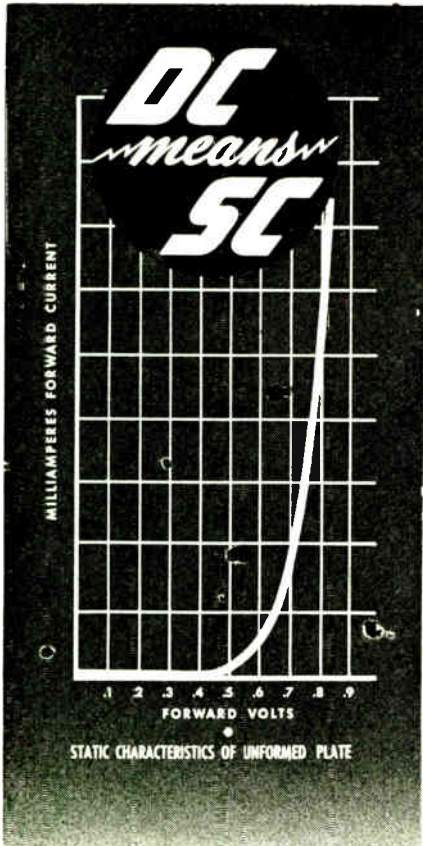

STATIC CHARACTERISTICS OF UNFORMED PLATE

**DC means SC . . .**  
**Selenium Control.** The forward threshold of Selenium plates falls naturally at .6 volts per plate. Use this characteristic as a Control Element. A DC circuit...fed by fluctuating battery voltage . . . can be controlled at 1.2 maximum voltage by connecting 2 Selenium plates in series. Selenium rectifier plates can be manufactured to close electrical tolerances. One of the many reasons why DC means SC . . . Selenium Control. If you use DC, get the facts on SC!

**SEND FOR BULLETIN**

**SELENIUM CORPORATION of AMERICA**



1719 WEST PICO BOULEVARD  
 LOS ANGELES 15, CALIFORNIA

EXPORT DIVISION: FRAZER & HANSEN  
 301 CLAY STREET, SAN FRANCISCO, CALIFORNIA

IN CANADA: BURELCO LTD., TORONTO 13, ONTARIO, CANADA



**Non-Electronic Control**

Bill Halligan, who as most everyone knows is head of Hallicrafters, probably knows more about electronics than he does about steam shovels. Nevertheless, here he is, with his company's secretary J. J. Frendreis, starting excavation for his new, big plant

**Electronic Control At Clarksburg, W. Va.**

Editors, Electric Industries:— Thank you for your prompt reply furnishing us with reprints of the article "DC Motor Control with AC" by B. J. Dalton from your October, 1943, issue, and the chart "Electron Tubes as Elements of Control" by Ralph R. Batcher, August, 1943.

Interest in this subject here in Clarksburg grew out of the fact that the Barnes & Brass Electric Company, local electrical distributors, recently held an "open house" at their newly acquired building, and one feature of the program was a demonstration of a Clark Controller Company electronic motor control. Many spectators became interested in how it operates and why. Mr. Van Voorhis of Barnes & Brass told me he was interested in finding articles on electronic control to acquaint his customers with its advantages and possibilities and how it operates.

I remembered that your Electronic Industries had carried the best articles I had seen and told Mr. Van Voorhis about them.

My own request was made in order to give several members of our own organization copies to study, as we contemplate using electronic controls for a part of our manufacturing process.—J. S. Ritter, Chief Engineer, Adamston Flat Glass Company, Clarksburg, W. Va.

**Popcorn Popper**

An electronic popcorn popper has been developed by the Design and Management Corp. of New York City. Designing engineers say that the unit, operating with tube gen-

erated heat instead of ordinary heating coils, gives better control than ordinary poppers.

**What's Ahead for Television in 1946?**

By Dr. Ray H. Manson

President, Stromberg-Carlson Co., Rochester

We believe in the future of television and, in fact, have applied for a license to install and operate a television station here in Rochester. However, there are many technical as well as commercial factors which have not been worked out completely and, until satisfactory answers are provided, they will prevent rapid growth of a television audience.

From the technical standpoint, there is the subject of screen detail and color. Also the uncertainty as to whether television will continue to operate in the present low frequency allocations for any great length of time. The matter of providing sufficient variety of really interesting programs is a major problem which will probably be helped greatly when network operation is provided.

From the standpoint of actually producing receivers in mass production, there is the matter of picture tubes. It is my understanding that 7 in. and 10 in. diameter direct viewing tubes have been standardized, with a view of getting machine production of the glass blanks or envelopes from the supplier of this product. Until this is done, no large production at reasonable cost can be expected for the picture tubes. Also I understand that a 5 in. diameter projection type of tube in two designs of envelopes is to be provided—one with a curved screen for the so-called Schmidt system and a flat screen for straight optical projection.

**Tube sizes**

I have no way of determining how many picture tubes of all sizes can be produced, but this factor alone will limit the number of television receivers which can be produced in any one year. It is one thing to obtain orders from dealers for large quantities of television receivers and still another to manufacture these receivers, including the tubes. My guess is that the total television receivers which can be made in 1946 will not reach 1,000,000 and may be nearer 500,000.

Now as to size of image, in the direct viewing designs of receivers, the majority probably will be built up around the 7 in. and 10 in. tubes and, no doubt, a few hand made tubes of small or larger size may be provided by some television manufacturers, but mass production will center around the tubes which are standardized and which can be made by mass production

ANOTHER WILCO DEVELOPMENT

# SILVER JACKETED WIRE

**WILCO Silver Jacketed Copper Wire** now widely used for coils in **Short Wave Radio Communications Systems**.

**PROPERTIES AND CHARACTERISTICS**—WILCO Silver Jacketed Copper Wire—an economical non-corrosive wire with solid-silver characteristics—is used successfully in many *electronic* applications, where high frequency currents are a problem. Another WILCO jacketed type combines great physical strength with high conductivity. A third unites stamina with highly desirable electrical characteristics. In fact there is almost no limit to WILCO facilities for combining metals of widely differing physical and electrical properties to meet individual engineering needs.

Gold, silver, copper, brass, bronze, iron, steel, nickel, monel and invar, are all utilized in producing WILCO'S uniform, non-porous, securely bonded jacketed wire and rolled strip.

**CONSULT OUR ENGINEERING DEPARTMENT**—Write our Engineering Department for help in developing the proper application of WILCO materials to your products.

**SEND FOR WILCO BLUE BOOK**—The Blue Book contains charts, formulae and full descriptions of *all* Jacketed Materials and other WILCO products. Send for FREE copy today.

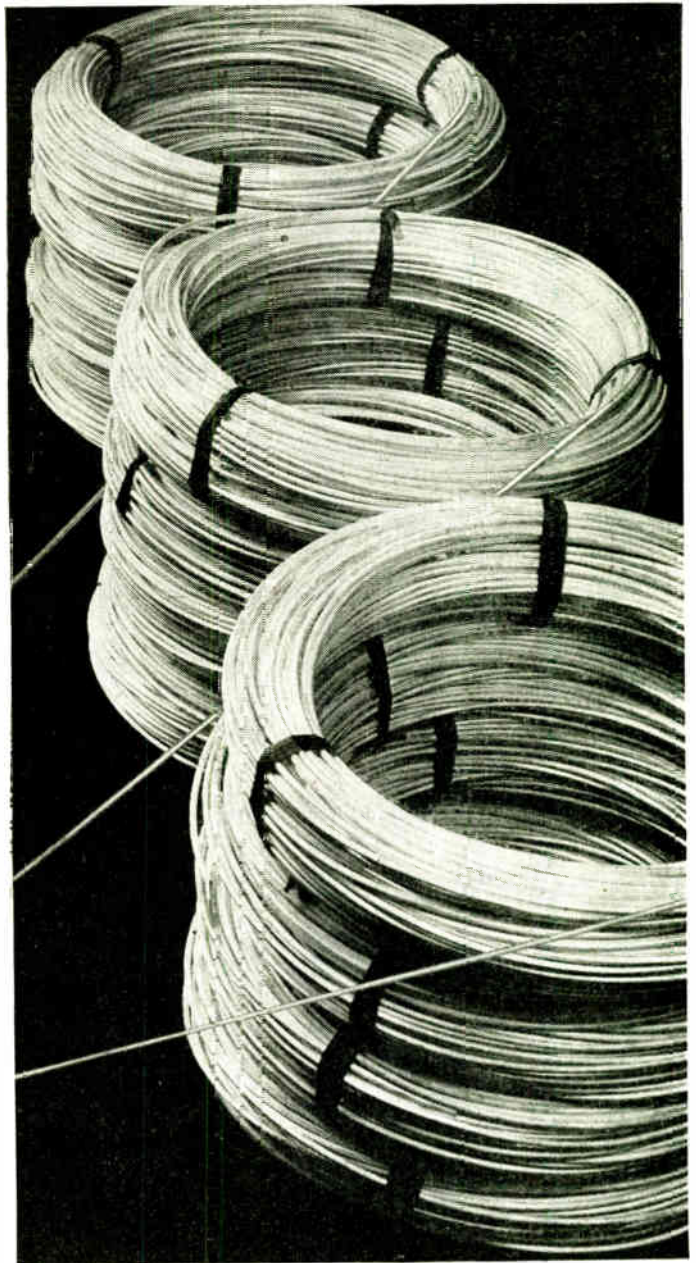

## WILCO PRODUCTS INCLUDE:

### Contacts—

Silver  
Platinum  
Tungsten  
Alloys  
Sintered Powder Metal

### Thermostatic Bimetal—

High and Low Temperature with new high temperature deflection rates

### Precious Metal Collector Rings—

For rotating controls

### Silver Clad Steel Jacketed Wire—

Silver on Steel, Copper, Invar or other combinations requested

### Rolled Gold Plate

### Special Materials



## THE H. A. WILSON COMPANY

105 Chestnut Street, Newark 5, N. J.

Branch Offices: Chicago • Detroit • Los Angeles

**SPECIALISTS FOR 30 YEARS IN THE MANUFACTURE OF • THERMOMETALS  
ELECTRICAL CONTACTS • PRECIOUS METAL BIMETALLIC PRODUCTS**

# NORTON

## Electrical Instruments



SWITCHBOARD  
& PORTABLE



AMMETERS  
VOLTMETERS

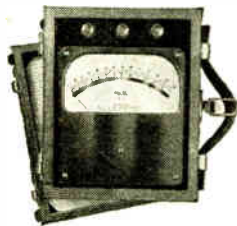

Norton Instruments are precision built to maintain accuracy under exacting conditions. Hand calibrated to meet your exact needs. Widely used in the Electronic Industry for testing and production equipment. Send for catalog.

**NORTON Electrical Instrument Co.**  
85 HILLIARD ST., MANCHESTER, CONNECTICUT

## DUMONT TYPE P-6 CAPACITORS

- ▶ SMALL SPACE
- ▶ LONG LIFE
- ▶ MOISTURE PROOF
- ▶ HEAT PROOF

Dumont Resinoid sealed • Will not melt at 300° F

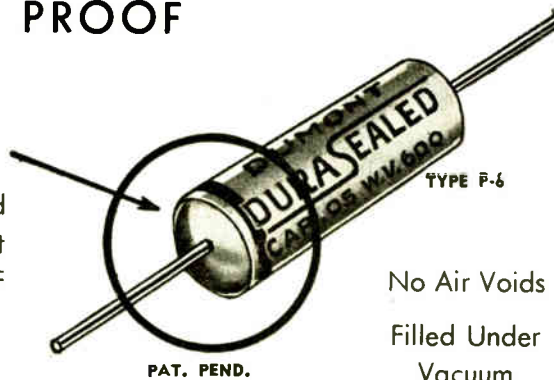

PAT. PEND.

No Air Voids  
Filled Under  
Vacuum

Write for complete list of sizes and prices

M'FG  
BY

**DUMONT ELECTRIC CO.**

34-54 HUBERT ST.  
NEW YORK, N. Y.

methods. The projection type of set is more difficult to produce. It requires very careful workmanship in adjustment but the large size picture certainly will have an appeal which cannot be overlooked.

Now as to prices, it is too early to say just what costs on components will be but, on the basis of prewar prices, it would appear that a good reliable television receiver, handled through standard distribution channels and with 7 in. or 10 in. tube, but without radio or phonograph provisions, would have to sell for \$175 and up and that the projection type set with AM-FM receiver and some other special equipment, such as phonograph, would run up well above \$500.

In order to interest the public in purchasing and using television receivers, it is necessary that the picture be technically OK in every respect and that it be on a screen sufficiently large to provide entertainment value on various types of programs.

The installation and maintenance of television receivers can be done by dealer service men but these men should have special training. No doubt, there will be a large number of returned service men who have had training in the handling of radar and similar equipment who can, with very little additional training, handle the installation and servicing of television sets, without further help from the factory.

I have faith in the ability of radio manufacturers to produce successful television sets and build up a large audience but, due to the complications involved, it will take much longer than the enthusiasts would lead the public to believe.

### Magnetophon Tape Recording Equipment

A new transcription development encountered by the U. S. broadcasting mission in Europe, reports Sol Taishoff, who was a member of that mission and is editor and publisher of "Broadcasting," in which the report appeared, is the German-invented Magnetophon, an all-purpose recording and playback apparatus using the tape principle and excelling in quality anything heard in Europe or in the U. S.

"Manufactured by a company known as E. E. G. Magnetophon, the machine uses tissue-thin tape of a plastic base, impregnated with iron oxide. The tape is manufactured by I. G. Farben, giant chemical cartel taken over by the U. S. Army. Factories are scattered throughout Reich former holdings.

"The recordings, which are instantaneous, have a frequency response from 50 to 8,000 cycles. Above that, the range up to 12,000

# CONTACT DATA

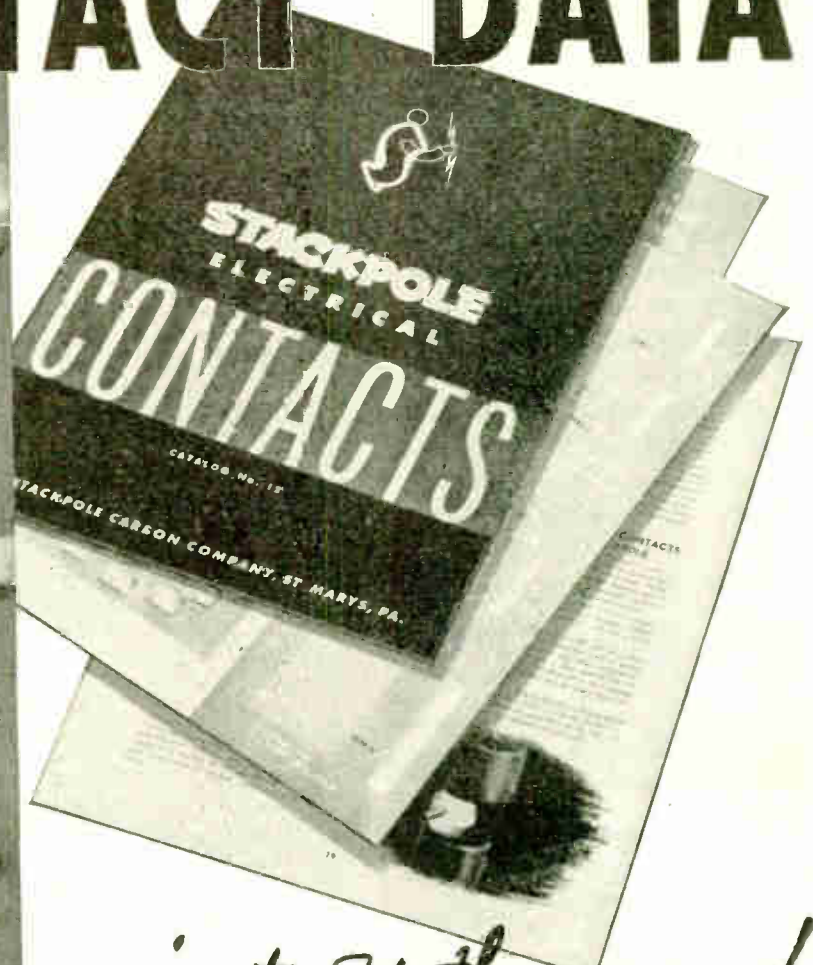

*... just off the press!*

If your product uses contacts you'll find in this new Stackpole Contact Catalog a wealth of information designed to help you select units for maximum service under all conditions of use. New contact developments described will prove highly important in the design of smaller, better post-war electrical equipment. Write today!

**STACKPOLE CARBON COMPANY, ST. MARYS, PA.**

**WRITE  
FOR YOUR  
COPY TODAY!**

# STACKPOLE

BRUSHES and CONTACTS (All carbon, graphite, metal and composition types)  
RARE METAL CONTACTS • IRON CORES • WELDING CARBON PRODUCTS  
PACKING, PISTON AND SEAL RINGS • RHEOSTAT PLATES AND DISCS  
BATTERY CARBONS • POWER TUBE ANODES • CARBON PIPE, ETC.



# RARE GASES AND MIXTURES

OF TESTED PURITY

STANDARD OF THE INDUSTRY

● Airco Rare Gases of highest purity, and Airco Rare Gas Mixtures, blended accurately, meet the most exacting requirements of laboratory and production applications. Their uniformity and purity are definite factors contributing to increased tube operating efficiency...and longer life. Airco Rare Gases are supplied in lead glass or PYREX containers from which they are easily removed with no change in quality. Your nearby Airco Office can supply your needs quickly.

## AIR REDUCTION

60 EAST 42nd STREET • NEW YORK 17, N. Y.

Offices in Principal Cities

ARGON • NEON • HELIUM • KRYPTON • XENON  
STANDARD AND SPECIAL MIXTURES

# MAGNETIC WIRE RECORDING

RESEARCH  
DEVELOPMENT  
MANUFACTURE

## WiRecorder Corporation

STROH BLDG.

DETROIT

MICHIGAN

cycles falls off slightly. The tape costs about \$3 for a roll which runs 20 minutes. Equipment, costing about \$2,000 prewar, includes twin turntables (actually tape recording and reproducing units) plus three heads on each turntable. One head demagnetizes, the second records, the third plays back.

"The mission first learned of the Magnetophon in London Aug. 13. Engineering executives of the BBC told about it. In France, also, comments were heard. In Luxembourg the apparatus was demonstrated by engineers at Radio Luxembourg, taken over by Allied forces after the Germans fled the tiny Duchy. The chief engineer of Radio Luxembourg was there both before and after the Germans and was familiar with the apparatus.

"The American broadcasters were amazed by a recording of a musical program being transmitted. It was played back immediately and the quality was better than good. There was no surface noise. The tape was purposely broken and spliced immediately with a dab of chemical. Recordings can be edited to the syllable by splicing. Tape seldom breaks, however.

### Dry processed film

"Luxembourg engineers said the tape apparently can be played back indefinitely. Since 1941, when the machines were installed, no recording has shown deterioration. Engineers said the quality was head and shoulders above conventional recordings in frequency range, dynamic range, absence of surface noise and ease of editing."

Later information revealed by the Enemy Technical Reports Committee states that the film used in the Magnetophon is called Luvi-therm and is a dry-processed unplasticized polyvinyl chloride.

It is 0.035 mm thick on which is cast, by means of a doctor blade, a coating 0.008-0.010 mm thick from a mixture consisting of equal parts of Igelit MP-400 and magnetic iron oxide in tetrahydrofurane and vinyl isobutyl ether, the solution having a viscosity of about 50 poises. The iron oxide is produced by reacting ferro sulfate, ammonia and ammonium nitrate in aqueous medium to crystallize out black magnetic iron oxide. This is then oxidized at 230° C. for six hours in an agitated drier with air blowing through to give 1- $\mu$  crystals of ferric oxide possessing magnetic properties.

In operation, the tape passes from a roll across the gap of a small magnetic armature with the surface bearing the magnetite running against the armatures. For transcribing, sounds are electrically amplified, inducing strong magnetic

# BIRD & CO. GLASS INSTRUMENT BEARINGS

GLASS "V" BEARINGS  
made and set to your  
specification



We specialize in the setting of  
all types of Jewel Bearings

We welcome your inquiries

## RICHARD H. BIRD

Manufacturers of Jewel Bearings  
for thirty years

23 MOODY STREET  
WALTHAM, MASS.



## Waterproof Switch Covers

are designed to cover certain toggle switches so as to make them completely waterproof without impairing freedom of movement. The Neoprene boot is replaceable without removing nuts, screws, etc., and without special tools.

Specified on many Navy items. Installation is simple, and cost moderate.

Send for catalog describing this and other waterproofing items.

# WATERPROOF

ELECTRIC COMPANY

70 E. VERDUGO AVE., BURBANK, CALIF.

HIGH SPEED  
MACHINES  
INSURE PROMPT  
ACTION ON  
YOUR  
ORDERS

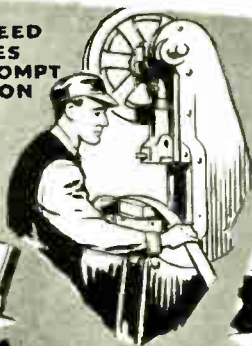

EXPERIENCED  
ENGINEERS  
HELP YOU TO  
SOLVE YOUR  
PROBLEMS



DIES FOR YOUR  
SPECIAL NEEDS



# A Many-Sided Service

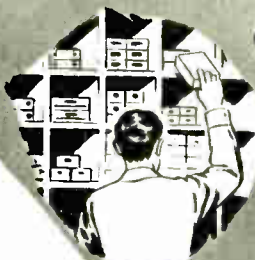

HUNDREDS  
OF ITEMS  
TO MEET  
YOUR  
REQUIRE-  
MENTS



AN EFFICIENT  
HOT TINNING  
SERVICE



YOUR BLUE PRINTS  
ARE READ BY  
HIGHLY TRAINED  
DRAFTSMEN



BIG SCALE  
ELECTRO PLATING  
FACILITIES

## STEWART METAL STAMPINGS TERMINALS LUGS BRACKETS CLIPS

We carry hundreds of items in stock, to meet practically every installation requirement. All pieces can be furnished in any desired finish.

HOT TINNING.  
NICKEL, CADMIUM, SILVER  
AND ZINC PLATING

#### REPRESENTATIVES

LLOYD C. NYMAN  
706-2 Boulevard Bldg.  
Detroit, Mich.

F. E. HARTWEG  
800 North Delaware Ave.  
Philadelphia, Pa.

M. L. COHN  
9476 Readcrest Drive  
Beverly Hills, Calif.

J. L. ROWE  
20 North Wacker Drive  
Room 866, Chicago 6, Ill.

**M**ANY of our customers, whose relations with us were originally limited to stamped metal parts, have since learned that we can serve them efficiently in other directions.

On work involving the making of dies, or in cases where special finishes are required, they find it an advantage to deal with a house of established reputation for quality and dependability. They realize that, by consolidating their orders with us, they can get quick action, resulting in the saving of valuable time on the production line.

Stewart "Many-sided Service" brings to you engineering talent of a high order that offers you practical aid in the solution of knotty problems and, not infrequently, welcome suggestions for cutting costs.

*Let us have your blue prints and specifications. Quick response to inquiries.*

**STEWART STAMPING COMPANY**  
630 CENTRAL PARK AVENUE, YONKERS, N. Y.



AN AMERICAN SOLUTION TO  
YOUR CAPACITOR PROBLEMS

ALL TYPES • BY PASS  
AND ELECTROLYTIC

DATA SHEETS  
ON REQUEST

**AMERICAN CONDENSER CO.**

4410 No. Ravenswood Ave.

Chicago 40, Ill.

**ATTENTION:**

- Commercial Broadcasters
- Schools
- Hospitals
- Utility Companies
- Geophysicals
- Transportation Companies
- Marine Operators
- Industrial Plants
- Municipalities
- Radio Dealers
- Radio Servicemen

**AT EASE!**

Everything in radio and electronics from a 1/4 watt resistor to 50,000 watt transmitter.

Engineering Assistance, too.

Call—Wire—Write.

**Houston Radio Supply Co., Inc.**  
910 CALHOUN STREET  
HOUSTON, TEXAS

'Ole Miss Supply  
New Orleans, La.    Baton Rouge, La.

**PREMAX**

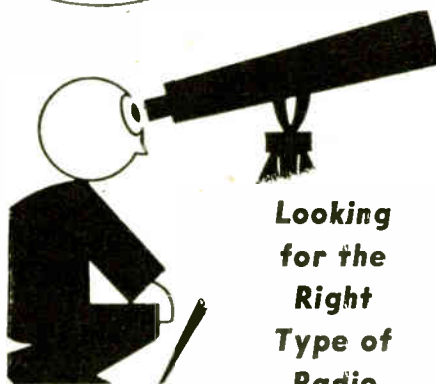

Looking  
for the  
Right  
Type of  
Radio

**Antenna**

If it is of a tubular type, up to 35 feet long, Premax can supply it in steel, monel, aluminum or stainless steel. Mountings are heavy duty type, give perfect insulation and support. Write for details of the many standard and special styles now available.

**Premax Products**

**Division Chisholm-Ryder, Co., Inc.**  
4612 Highland Ave., Niagara Falls, N. Y.

fields across the gap of the armature, thus establishing many small permanent magnets in the iron oxide of the tape.

In playing back, the machine operates in reverse fashion, the magnetic variation in the tape inducing small magnetic fluxes in the armature which are amplified and reproduced as sound. The tape can be cleared of recording by passing it over another properly magnetized armature. New recordings can then be made on the tape, if desired, the clearing and recording can be done on one pass. The system was in general use on the German radio networks, and was used extensively by the Army and Navy for fixed station recording, for mobile communication, and in haversack size units for front-line listening posts.

At the regular tape speed of 80 cm/sec., it is said that the instrument will record and reproduce frequencies as high as 10,000 cps. The tape is 0.05± .01 mm thick, approximately 5 mm wide and 1 kilometer long, weighing 500 grams. One tape will thus last over 20 minutes. Through 1943-44 6,000 tapes were made per month. For the future, they visualize recordings transmitted by phone or radio communication. A significant A.E.G. improvement appears to be a unit based on the same principle, which will scan 8 hours recording on an 8½x 11 plastic sheet (not tape).

**Farnsworth Exhibits**

Dealers have been shown 16 models of home radio receivers and radio-phonographs comprising the new line of the Farnsworth Television & Radio Corp. of Fort Wayne, Ind. The sets are expected to be ready for the market by the first quarter of next year. Television receivers, expected to be ready for marketing by June of 1946, will be equipped to handle both AM and FM reception.

**Properties of Dielectrics**

Robert F. Field of the General Radio Co. reported on the behavior of dielectrics over wide ranges of frequency, temperature and humidity at a meeting of the Cedar Rapids Section of the Institute of Radio Engineers, held on September 19, 1945.

Curves for dielectric constants and dissipation factors as function of frequency are shown from which it may be inferred that the dielectric constant increases as the frequency is lowered. Other curves demonstrated that with increasing temperature the dissipation-frequency and dielectric frequency curves are moved along the frequency scale toward higher fre-



*Compression Molded*

## **PLASTIC PRODUCTS**

★ Here at Rogan, you are invited to avail yourselves of our complete knowledge and long experience in all phases of plastic molding. Our staff of trained experts will be glad to assist you with your plastic problems, no matter how involved or comprehensive.

In addition to compression molding, we also offer an exclusive "deep relief" branding process that goes a long way toward reducing the cost of plastics that must bear markings, lettering or other descriptive matter.

Write for facts on this lower cost, combination service today.

## **ROGAN BROS.**

Compression Molders and Branders of Plastics  
2007 S. MICHIGAN AVENUE • CHICAGO 16, ILLINOIS

GRAYHILL ROTO-SWITCHES ARE AVAILABLE WITH AMPLE CLEARANCE FOR HIGH VOLTAGE AND OFFER UNLIMITED MULTIPLICITY OF CIRCUITS THRU THE BUILD-UP FEATURE. ASK GRAYHILL ENGINEERS HOW THE ROTO-SWITCH SATISFIES YOUR REQUIREMENTS.

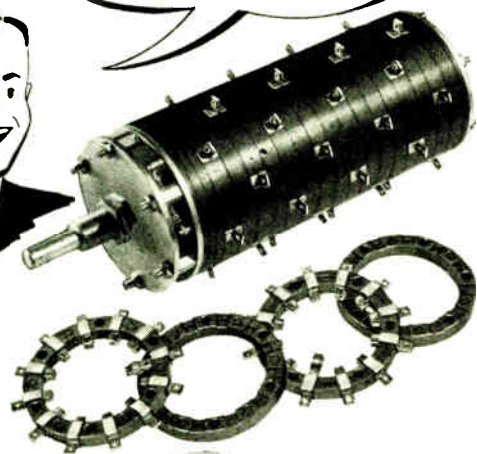

*Grayhill*

9 N. PULASKI RD., CHICAGO 24, ILL.

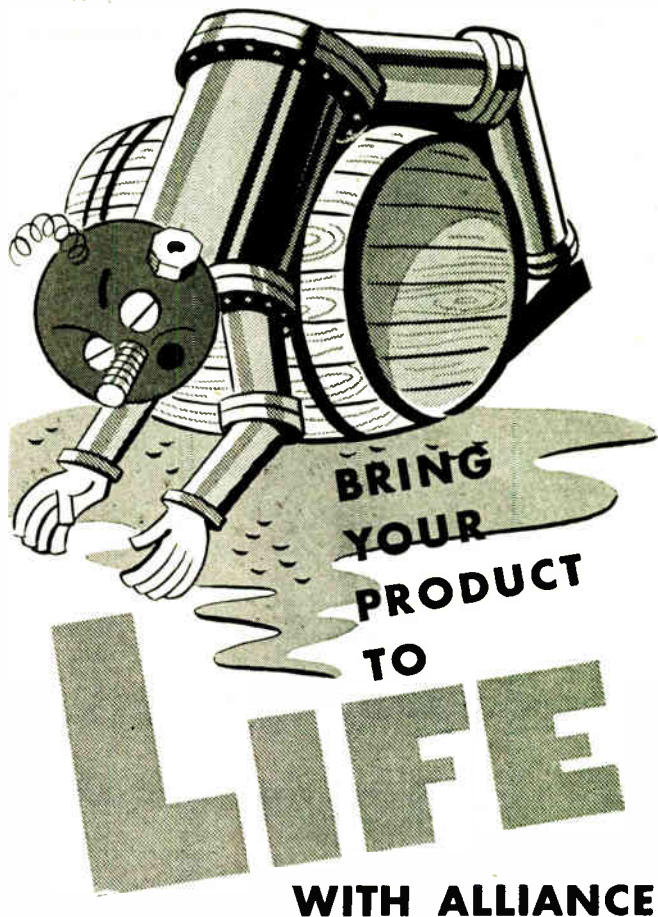

When you want action—remote control, automatic or non-automatic, it will pay you to use Alliance Power Pact MOTORS. Not only in finished products, but as a flexible power source in your own industrial processes, these miniature power units really bring your product to life.

Here are just a few of the ways that Alliance motors can add to the usefulness of any machine, device or control. Of course there are many more!

Electronic and electric controls, time, temperature, pressure and humidity controls, coin operated phonographs, drink and merchandise dispensers, fans, valves and blowers, door openers, signals, motion displays, movie projectors and scores of industrial applications.

WHEN YOU DESIGN—KEEP

# **alliance**

IN MIND

ALLIANCE MANUFACTURING CO. • ALLIANCE, OHIO

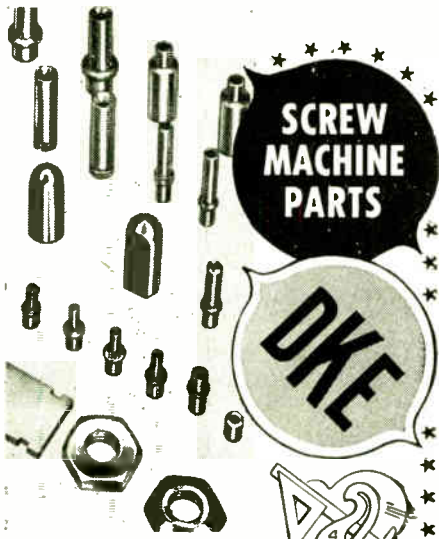

SCREW MACHINE PARTS

DKE

...for exacting needs!

Facilities for the rapid production of all types of screw machine metal parts—to close tolerance specifications—are available for industry. DKE equipment includes a battery of Brown & Sharpe automatic screw machines, power presses, drill presses, hand turret lathes, and modern machine tools for all other phases of finishing. Quality of work is uniformly high, with particular emphasis on low unit cost.

INQUIRIES INVITED

THE ENGINEERING CO.

DANIEL KONDAKJIAN  
27 WRIGHT ST., NEWARK, N. J.

**JONES 500 SERIES PLUGS and SOCKETS**

(Heavy Duty)

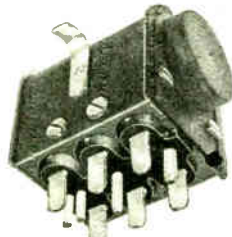

P-506-CE



S-506-DB

Designed for 5000 Volts and 25 amperes per contact. Socket Contacts of phosphor bronze, knife-switch type, silver plated. Plug Contacts are of hard brass, silver plated. Made in 2, 4, 6, 8, 10 and 12 Contacts.

All Plugs and Sockets are Polarized. Long leakage path from Terminal to Terminal and Terminal to ground. Caps and Brackets

are of steel, parkerized. Plug and Socket blocks interchangeable in Caps and Brackets. This series is designed for heavy duty electrical work and will withstand severest type of service.

Write for Bulletin No. 500 describing this line of Heavy Duty Plugs and Sockets.

**HOWARD B. JONES COMPANY**  
2460 W. GEORGE ST. CHICAGO 18

quencies. Inflection points of the dielectric constant-frequency curve occur at the same frequency as the maxima of the dielectric loss-frequency curves.

Debye's theory of solarization and polarization caused by interfaces were reviewed. Changes with frequency are the same for both types of polarization, theoretical curve shapes were discussed and the Argand diagram mentioned. The discrepancies of actual data obtained for solids were considered and two equivalent circuits for the theoretical and the actual behavior shown. Effect of humidity was discussed.

STATEMENT OF THE OWNERSHIP, MANAGEMENT, CIRCULATION, ETC., REQUIRED BY THE ACTS OF CONGRESS OF AUGUST 24, 1912, AND MARCH 3, 1933

OF ELECTRONIC INDUSTRIES, published monthly at New York 17, N. Y., for Oct. 1, 1945, State of New York, N. Y., County of New York, N. Y.

Before me, a Notary Public in and for the State and county aforesaid, personally appeared Orestes H. Caldwell, who, having been duly sworn according to law, deposes and says that he is the Editor of ELECTRONIC INDUSTRIES and that the following is, to the best of his knowledge and belief, a true statement of the ownership, management (and if a daily paper, the circulation), etc., of the aforesaid publication for the date shown in the above caption, required by the Act of August 24, 1912, as amended by the Act of March 3, 1933, embodied in section 537, Postal Laws and Regulations, printed on the reverse of this form, to wit:

1. That the names and addresses of the publisher, editor, managing editor, and business managers are: Publisher, M. Clements, Rumson, N. J., Editor, Orestes H. Caldwell, Catroek Road and Bible St., Cos Cob, Conn. Managing Editor, Stanley P. McMin, 92 Adams St., Garden City, L. I., N. Y. Business Manager, M. H. Newton, 583 W. 215th St., New York, N. Y.

2. That the owner is (If owned by a corporation, its name and address must be stated and also immediately thereunder the names and addresses of stockholders owning or holding one per cent or more of total amount of stock. If not owned by a corporation, the names and addresses of the individual owners must be given. If owned by a firm, company, or other unincorporated concern, its name and address, as well as those of each individual member, must be given.) Caldwell-Clements, Inc., 480 Lexington Avenue, New York 17, N. Y. M. Clements, O. H. Caldwell, Charles Schatvet, Trustees, 480 Lexington Ave., N. Y. C. M. Clements, Trustee, Rumson, N. J. O. H. Caldwell, Trustee, Catroek Rd. and Bible St., Cos Cob, Conn. Charles Schatvet, Trustee, Darien, Conn. Peter Kes, 111 Hamilton Road, Ridgewood, N. J. McGraw-Hill Publ. Co., \* 330 W. Forty-second St., New York, N. Y.

3. That the known bondholders, mortgages, and other security holders owning or holding 1 per cent or more of total amount of bonds, mortgages, or other securities are: (If there are none, so state.) None.

4. That the two paragraphs next above, giving the names of the owners, stockholders and security holders, if any, contain not only the list of stockholders and security holders as they appear upon the books of the company but also, in cases where the stockholder or security holder appears upon the books of the company as trustee or in any other fiduciary relation, the name of the person or corporation for whom such trustee is acting, is given; also that the said two paragraphs contain statements embracing affiant's full knowledge and belief as to the circumstances and conditions under which stockholders and security holders who do not appear upon the books of the company as trustees, hold stock and securities in a capacity other than that of a bona fide owner; and this affiant has no reason to believe that any other person, association, or corporation has any interest direct or indirect in the said stock, bonds or other securities than as so stated by him.

(Signed) Orestes H. Caldwell

Sworn to and subscribed before me this 21st day of September, 1945.  
W. Kenneth Reynolds  
Notary Public New York County.  
Notary Public N. Y. County Clerk's No. 95.  
Notary Public N. Y. County Register's No. 538-R-7.  
(My commission expires March 30, 1947.)

\*Represents minority stock interest which was purchase price for Radio & Television Retailing. Majority stock and control continue in hands of O. H. Caldwell and M. Clements.

**THERE'S A DRAKE SOLDERING IRON FOR EVERY TYPE OF ELECTRONIC WORK**

From that mighty mite



the Drake No. 400 to the high speed production "honey"



the Drake No. 600-10 there is a high quality Drake Soldering Iron "just right" for the job.

Drake Heat Controls and the Drake "Magic Cup" Stand are important soldering aids.



SEE YOUR RADIO PARTS JOBBER

**DRAKE ELECTRIC WORKS, INC.**  
3656 LINCOLN AVE. CHICAGO, ILL.



**WE TAKE THE WORRIES OUT OF YOUR HANDS!**

OUR SPECIALTY



**FABRICATING GLASS-BONDED MICA**

IN ALL FORMS, to Specifications



**COLONIAL KOLONITE COMPANY**  
2212 W. ARMITAGE AVE., CHICAGO, ILL.

**How STAMPING  
DRAWING and  
BRAZING  
Can Reduce  
Costs!**

**You, too, can save by  
GOAT PRECISE-FORMED  
METAL STAMPINGS**

Induction brazing and machining operations can save you money by replacing many types of machine parts, castings and assemblies. New techniques in deep drawing eliminate the necessity of in-between annealing. As a result, we can produce stampings, as well as assemblies of stampings, that would have been regarded as impossible prior to the war.

Compare the costs! Formerly the part shown below was machined from tubing, an expensive operation involving the time-taking removal and waste of a large amount of stock.

1.  This deep-drawn shell, 1 13/16" d x 4 3/8" is drawn without expensive annealing, by the Goat Precise-Formed Process.
2.  Stamped thread rings shown above is induction brazed to the shell.
3.  A thread is cut on the ring, completing the product.



*Samples or Prints  
analyzed without obligation*



**GOAT METAL STAMPINGS, INC.**  
Affiliate of The Fred Goat Co., Inc.  
314 DEAN STREET BROOKLYN, N. Y.

**CONSULTANT for INDUSTRY  
on  
Moisture & Fungus Problems**

SEYMOUR C. HYMAN, Chem. Eng.

For the duration of the war, Chief of Moisture and Fungus Proofing Section developing and applying tropic-proof materials for U. S. Army communications equipment. Now available to manufacturers and materials suppliers for consultation on protective coatings, insulation and choice of engineering materials.

P. O. BOX 111 LONG BRANCH, N. J.

**SALES ENGINEERING REPRESENTATION**

A graduate engineer, age 36, B.S. and M.S., thoroughly schooled in the Electronic Industry and now employed as a Product Engineer with a large electrical manufacturing company wishes to open a New York Office to act as Sales Representative, Applications Engineer, Distributor, etc., for several non-competitive electrical product lines. Inquiries are solicited from Pacific and Midwest Manufacturers who have inadequate East Coast representation as well as from Eastern Concerns who cannot justify a full time Sales Engineer.

Box 1157  
ELECTRONIC INDUSTRIES  
480 Lexington Avenue New York 17, N. Y.

*the part he needed...*



**WALTHAM  
SCREW COMPANY  
Produced!**



Tiny but essential are screws and other threaded members of modern industrial assemblies. Thousands of sizes and types of screw machine products are on the market for ready sale. Yet today sees some new design of instrument or machine in which mechanical function must derive from a screw machine product heretofore never known.

At this point Waltham Screw Company, its designers, its engineers and its precision machines come forward with the ability to produce the vital unit, to engineer it to exact specifications in whatever volume required.



The wasp, whose hexagonal cell-measurement never varies, is Waltham Screw Company's hall-mark. It denotes *utter precision*.

Telephone Today Collect  
Waltham 5830

**WALTHAM SCREW  
COMPANY**  
77 Rumford Ave.  
Waltham, Mass.

You get a good deal  
when you deal with us!



Ever Ready is every manufacturer's ace-in-the-hole. Package labels, shipping labels, stock labels —gummed labels, ungummed labels or pressure sensitive labels for plastics, whatever you need you'll get the most for the least from Ever Ready.

Sample label assortment on request. Write Department E.

**EVER READY Label CORP.**  
141-155 EAST 25TH ST. NEW YORK 10, N.Y.



**DEPENDABLE**



**DURABLE  
EFFICIENT**

# American Beauty

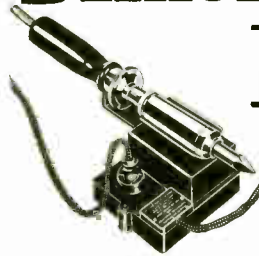

**ELECTRIC  
SOLDERING IRON**

**TEMPERATURE  
REGULATING STAND**

A thermostatically controlled stand for regulating the temperature of an electric soldering iron when at rest. The thermostat is adjustable for various heats.

Preferred by those who measure the value of a tool by the service it renders. Soldering irons are made in 5 sizes and for low as well as standard voltage.

Write for Catalog Sheets.

108-1

**AMERICAN ELECTRICAL HEATER COMPANY**  
DETROIT 2, MICHIGAN, U. S. A.

## STAINLESS STEEL FASTENING DEVICES

**IN STOCK!**

**Prompt Delivery  
of both Specials  
and Standard Items**

**We Stock:**

- Cop Screws
- Machine Screws
- Bolts
- Washers
- Nuts
- Wood Screws
- Taper Pins
- Pipe Fittings
- Rivets
- Cotter Pins
- Wing Nuts
- Etc.

When you need non-corrosive fastening devices, write or phone Allmetal first. Chances are we have them **IN STOCK** ready for shipment. We can take care of your special work, too, as we have equipment for tapping, drilling, reaming, turning, slotting, etc. We also have complete centerless grinding facilities. Let us estimate on your requirements. Write us today.

**Send for FREE CATALOG**



This new, 83-page catalog helps you pick the correct size and type of non-corrosive fastening device for any particular job. Includes stock sizes, typical specials, engineering data, etc. Make request on company letterhead, please.

Write to  
**DEPARTMENT D**

**ALLMETAL SCREW PRODUCTS CO.**  
80 Grand Street New York 13, N. Y.

Let us tell you how you may  
use our organization just as  
if it were yours.

**A MOST  
UNUSUAL SERVICE  
TO A  
MANUFACTURER**

**SEND FOR NEW CATALOG**

# WATERBURY

**METAL PARTS**

*Eyelets  
Ferrules  
Terminals*

**WATERBURY COMPANIES, INC.**  
FORMERLY WATERBURY BUTTON CO., EST. 1812  
WAY BLVD., WATERBURY, CONN.

# ELECTRONIC INDUSTRIES

Advertisers—November, 1945

	Page		Page		Page
Aerovox Corp.	30	Eisler Engineering Co.,		Premax Products, Div. Chisholm-	
Aireon Mfg. Corp.	6	Chas.	219	Ryder Co., Inc.	238
Air Reduction	236	Eitel-McCullough, Inc.	195	Printloid, Inc.	42
Ajax Electrothermic Corp.	161	Electrical Reactance Corp.	228	Process & Instruments	244
Alliance Mfg. Co.	239	Electric Specialty Co.	244		
Allied Control Co., Inc.	33	Electronic Engineering Co.	218	Radell Corp.	208
Allied Radio Corp.	186	Electronic Mechanics, Inc.	19	Radex Corp.	230
Allmetal Screw Products Co.	242	Electronic Products Mfg.		Radiart Corp.	135
Altec Lansing Corp.	138	Corp.	196	Radio Corp. of America:	
Amalgamated Radio Television		Engineering Co.	240	RCA Tube Division	Cover 4
Corp.	154	Ever Resistor Corp.	131	RCA Victor Division	69
American Condenser Co.	238	Ever Ready Label Corp.	242	Radio Receptor Co., Inc.	55
American Electrical Heater				Radio Wire Television, Inc.	193
Co.	242	Federal Telephone & Radio		Rauland Corp.	32
American Gas Accumulator		Corp.	39, 133	Raytheon Mfg. Co.	70, 197
Co.	230	Fenwal, Inc.	176	R-B-M Mfg. Co.	148
American Lava Corp.	159	Formica Insulation Co.	145	Revere Copper & Brass,	
American Phenolic Corp.	185	Franklin Airloop Corp.	56, 57	Inc.	7
American Time Products,		General Electric Co.	5, 26, 27	Rice's Sons, Inc., Bernard	28
Inc.	68	52, 143, 207		Rider Publisher, Inc., John	206
American Transformer Co.	29	General Industries Co.	168	F.	239
Amperex Electronic Corp.	2	Goat Metal Stampings, Inc.	241	Rogan Bros.	239
Amperite Co.	222	Grayhill	239	Runzel Cord & Wire Co.	43
Anaconda Wire & Cable Co.	37	Green Electric Co.,		Russell Electric Co.	141, 192
Andrew Co.	172	Inc., W.	156		
Ansonia Electrical Co.	211	Guardian Electric Co.	119	Sangamo Electric Co.	40, 41
Arnold Engineering Co.	150	Hallcrafters Co.	14, 25	Schweitzer Paper Co.	67
Astac Corp.	180	Hammarlund Mfg Co., Inc.	58	Scientific Electric Div. of "S"	
Automatic Electric Sales		Hanovia Chemical & Mfg.		Corrugated Quenched Gap	
Corp.	45	Co.	184	Co.	163
		Hardwick, Hindle, Inc.	208	Scovill Mfg. Co.	231
Barker & Williamson	134	Harvey Radio Co.	158	Screenmakers	214
Bell Telephone Laboratories	199	Harvey Radio Laboratories,		Seeburg Corp., J. P.	54
Bennel Machine Co., Inc.	206	Inc.	127	Selenium Corp. of America	232
Bentley, Harris Mfg. Co.	31	Hassall, Inc., John	146	Shallcross Mfg. Co.	152
Benwood-Linze Co.	215	Heinemann Circuit Breaker		Sherron Electronics Co.	139
Bird & Co., Richard H.	236	Co.	165	Simpson Electric Co.	182, 183
Boonton Radio Corp.	170	Helipot Corp.	189	Spencer Wire Co.	63
Bradley Laboratories, Inc.	38	Houston Radio Supply Co.,		Sperry Gyroscope Co.,	
Burdny Engineering Co.,		Inc.	238	Inc.	190, 191
Inc.	171	Hytron Radio & Electronics		Sperti, Inc.	146
Burstein-Applebee Co.	244	Corp.	115	Sprague Electric Co.	23
Byington & Co.	244	Indiana Steel Products Co.	22	Stackpole Carbon Co.	235
		Industrial Timer Corp.	230	Standard Transformer Corp.	178
Caldwell-Clements, Inc.	155, 209	Industrial Transformer Corp.	175	Stephens Mfg. Co.	216
Callite Tungsten Corp.	51	Insuline Corp. of America	166	Sterling Mfg. Co.	215
Cambridge Thermionic Corp.	177	International Nickel Co.,		Stewart Stamping Co.	237
Capacitron Co.	142	Inc.	213	Struthers-Dunn, Inc.	16
Capitol Export-Import Co.	244	International Resistance Co.	181	Stupakoff Ceramic & Mfg.	
Cardwell Mfg. Corp.,		Jefferson Electric Co.	15	Co.	229
Allen D.	188	Jennings Radio Mfg. Co.	217	Sun Radio & Electronics Co.,	
Carter Motor Co.	226	Jensen Radio Mfg. Co.	44	Inc.	220
Celanese Corp. of America	117	Johnson Co., E. F.	147	Superior Electric Co.	201
Centralab	62	Joliet Chemicals, Ltd.	64	Surprenant Electrical	
Chicago Telephone Supply		Jones Co., Howard B.	240	Insulation Co.	193
Co.	21	Kahl Engineering Co.	244	Sylvania Electric Products,	
Chicago Transformer Div. of		Karp Metal Products Co.,		Inc.	66
Essex Wire Corp.	136	Inc.	137	Tab	218
Clare & Co., C. P.	153	Ken-Rad, Div. of General		Thomas & Skinner Steel	
Clarostat Mfg. Co., Inc.	194	Electric Co.	13	Products Co.	198
Cohn & Co., Sigmund	210	Kenyon Transformer Co.,		Times Telephoto Equipment,	
Collins Radio Co.	17	Inc.	221	Inc.	12
Colonial Kolonite Co.	240	Keuffel & Esser Co.	59	Transmitter Equipment Mfg.	
Communication Measurements		Lapp Insulator Co., Inc.	48	Co., Inc.	11
Laboratory	4, 204	Langevin Co.	60	Triplet Electrical Instrument	
Conant Electrical		Leland Electric Co.	47	Co.	219
Laboratories	130	Lewis Electronics	125	Tung-Sol Lamp Works, Inc.	10
Concord Radio Corp.	243	Lord Mfg. Co.	9		
Connecticut Telephone &		Macallen Co.	132	United Cinephone Corp.	224
Electric	187	Magnavox Co., Inc.	36	United Screw & Bolt Corp.	46
Cook Electric Co.	20	Mallory & Co., Inc.,		United Transformer Corp.	72
Cornell-Dubilier Electric		P. R.	Cover 2, 8, 61	Universal X-Ray Products,	
Corp.	129	Marion Electrical Instrument		Inc.	202
Corning Glass Works	167	Co.	149	U. S. Treasury	225
Coto-Coil Co., Inc.	140	Measurements Corp.	222	Utah Radio Products Co.	65
Crystal Research		Millen Mfg. Co., Inc.,		Victoreen Instrument Co.	220
Laboratories	168	James	224		
Dalis, Inc., H. L.	228	Monitor Controller Co.	212	Waltham Screw Co.	241
Daven Co.	Cover 3	Mycalex Corp. of America	179	Ward Leonard Electric Co.	50
De Mornay-Budd, Inc.	53	National Co., Inc.	223	Ward Products Corp.	215
Deutschmann Corp., Tobe	3	National Vulcanized Fibre		Waterbury Companies,	
Dial Light Co. of America,		Co.	71	Inc.	219, 242
Inc.	214	New York Transformer Co.	169	Waterproof Electric Co.	236
Doolittle Radio, Inc.	138	Norton Electrical Instrument		Webster Chicago	157
Dow Chemical Co.	121	Co.	234	Webster Electric Co.	162
Drake Electric Works,		Ohmite Mfg. Co.	24	Western Electric Co.	34, 35
Inc.	240	Patton-MacGuyer Co.	244	Westinghouse Electric	
Drake Mfg. Co.	202	Permotux Corp.	164	Corp.	151, 173, 205
Dumont Electric Co.	234	Pioneer Gen-E-Motor Corp.	160	Weston Electrical Instrument	
Du Mont Laboratories, Inc.,				Corp.	227
Allen B.	18, 203			Whitaker Cable Corp.	123
DX Radio Products Co.	226			Willor Mfg. Corp.	174
				Wilson Co., H. A.	233
Eastern Air Devices, Inc.	49			WiRecorder Corp.	236
Eastern Engineering Co.	210			Wrigley Co., Wm.	198
Eby, Inc., Hugh H.	200			Zophar Mills, Inc.	196
Eicor, Inc.	144				

**Now—  
Immediate  
Delivery!**

Priorities on all radio parts and electronic equipment have been removed! You can again order long-scarce items, until now available only to producers for war. Concord is ready to fill your needs from vast stocks.

## RADIO PARTS ELECTRONIC EQUIPMENT

Order Today for Shipment Tomorrow

Our shelves are loaded with Condensers, Transformers, Tubes, Resistors, Test Equipment, Amplifiers, Repair and Replacement Parts of every description, and hundreds of other essential items. Our warehouses can ship most orders in 24 hours. Order from CONCORD for dependable quality, excellent values, and immediate service.

**COMPLETE STOCKS AT  
CHICAGO AND ATLANTA**

Aerovox • Amphenol • Amperite • Centrolob  
Cornell-Dubilier • General Electric • Hollifrofters • IRC • Jensen • Mollory • Meissner  
Ohmite • RCA • Reodrite • Shure • Sprague  
Stonor • Supreme • Thordorson • Triplett  
UTC • Weston

Use our previous Catalogs No. 345 and No. 94. They offer thousands of parts and many types of equipment AVAILABLE NOW for immediate shipment.

**Mail Coupon for  
FREE Victory Clearance Flyer**

Just published—exciting new Flyer offering thousands of standard-line, standard-quality parts and equipment at Victory Clearance prices. Consult this Flyer before you buy, and save money. Mail coupon below for your copy—it's FREE.

**CONCORD RADIO CORPORATION**  
*Lafayette Radio Corporation*  
CHICAGO 7, ILL. ATLANTA 3, GA.  
901 W. Jackson Blvd. 265 Peachtree Street

CONCORD RADIO CORP.  
901 W. Jackson Blvd. Dept. J-115  
Chicago 7, Ill.

Send me at once copy of VICTORY CLEARANCE FLYER—free.

Name.....  
Address.....  
City..... State.....

**WANTED**  
**RADIOS FOR EXPORT**

Our world wide Organization needs large quantity of RADIOS, RADIO PARTS and RADIO TUBES for immediate orders. We are also interested in securing Exclusive Agency for Foreign Markets for Radio and Electric Material. Manufacturers please communicate with:

**CAPITOL EXPORT-IMPORT CO.**

601 N. Rexford Dr.

Beverly Hills, Cal.

**YOUR SOURCE OF SUPPLY FOR MICA AND SEMI-PRECIOUS STONES**

Byington and Company of Brazil control deposits of high grade Brazilian mica and semi-precious stones for interested buyers. For further information and particulars contact

**BYINGTON AND COMPANY**

(Rio de Janeiro, Sao Paulo, Brazil)

**W. P. BROWN, AGENT**

165 BROADWAY

NEW YORK 6, N. Y.

**Kahle**

**ENGINEERING COMPANY**  
**ELECTRON TUBE MACHINERY**

All types, standard and special design.

Specialists in equipment and methods for the manufacture of:

<b>RADIO TUBES</b>	<b>NEON TUBES</b>
<b>CATHODE RAY TUBES</b>	<b>PHOTO CELLS</b>
<b>FLUORESCENT LAMPS</b>	<b>X-RAY TUBES</b>
<b>INCANDESCENT LAMPS</b>	<b>GLASS PRODUCTS</b>

On Production or Laboratory basis

1307-1315 SEVENTH ST., NORTH BERGEN, N. J., U. S. A.

**TECHNICAL MAN**

Who knows core manufacturing in the radio and electronics industry to develop and sell a new chemical product used in this and related fields. Salary \$7,000 to \$9,000.

BOX 1194

**ELECTRONIC INDUSTRIES**

480 LEXINGTON AVE., NEW YORK 17, N. Y.

**CHEMICAL CONSULTANTS TO THE ELECTRONICS INDUSTRY**

AUTOMATIC ANALYSIS INSTRUMENTS  
PROCESS DEVELOPMENT  
METAL EVAPORATION  
PLASTICS

**PROCESS & INSTRUMENTS**

60 Greenpoint Ave.

Brooklyn 22, N. Y.

**ESCO**



**SPECIALLY DESIGNED**

**MOTORS, GENERATORS AND OTHER ELECTRICAL POWER UNITS**

Designed and produced to meet your specific requirements . . . not ordinary stock units. From blueprint to finished product . . . our years of engineering skill plus initiative and expert craftsmanship are your assurance of complete satisfaction.

**ELECTRIC SPECIALTY CO.**

214 SOUTH STREET

STAMFORD, CONN.

**FREE TO YOU**  
**COLOR CODE AND OHMS LAW CALCULATOR**

A great convenience. Easy to work. Solves many problems. Attach coupon to your letterhead. Free to radio men, engineers, etc.

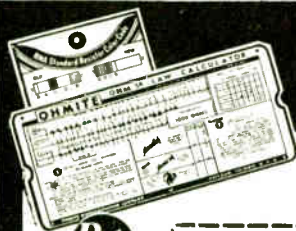

**BURSTEIN-APPLEBEE COMPANY**  
1012 McGee St.  
Kansas City 6, Mo.

Mail Coupon Now

BURSTEIN-APPLEBEE COMPANY  
1012 McGee, Kansas City 6, Mo.

Send me FREE Color Code and Ohms Law Calculator along with latest catalog.

I am \_\_\_\_\_  
STATE CONNECTION IN INDUSTRY

NAME \_\_\_\_\_

ADDRESS \_\_\_\_\_

TOWN \_\_\_\_\_ STATE \_\_\_\_\_

**TERMINALS**

for  
ELECTRIC WIRES

**SMALL METAL STAMPINGS**

in accordance with your blueprints

**PRECISION PARTS**

from Modern Equipment

**PATTON-MacGUYER CO.**

17 VIRGINIA AVENUE

PROVIDENCE 5, R. I.

# 4 Precision Switches

## ATTENUATOR COMBINED with SWITCHING DEVICE:

Application of rigid rotor with two pairs of spring-button type contacts.\* Supplied as shown with terminals wired.

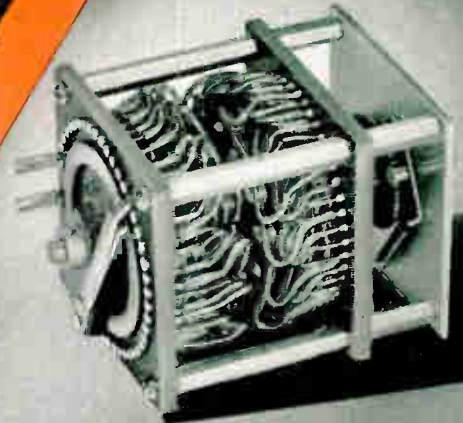
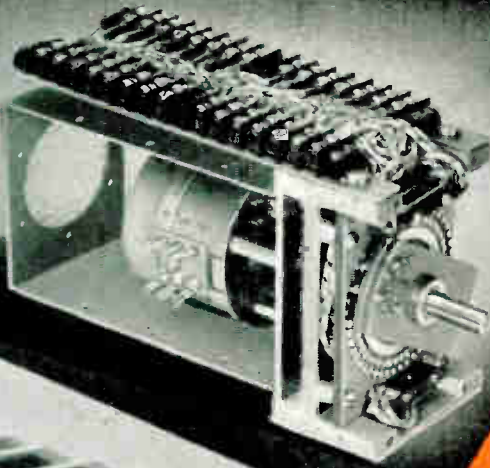

## DUAL-POTENTIOMETER:

40 steps per deck; compact back-to-back type assembly. 40 precision wire-wound resistors, mounted on each deck.



## SWITCH:

3 pole, 3 deck, 100 position, break-before-make. 200 contacts, 101 solder lugs per deck. This unit employs a newly designed switch rotor with spring-button type contacts.\*



## SWITCH:

10 pole, 3 deck, 4 position, break-before-make. Total of 52 lines wired to adaptor base. Illustrated is a stripped, wired and enclosed view.

PATENT APPLIED FOR

## Engineered by **DAVEN** FEATURING LOW AND UNIFORM CONTACT RESISTANCE

The four precision controls illustrated are but a few of the DAVEN-engineered switches now filling important war assignments. Each unit represents the skilled adaptation of basic DAVEN techniques to the problems of the specific application. The distinct advantage of this method of engineering switches is the assurance of a result ideally suited for the

job, plus important savings in time and cost of development. DAVEN-engineered switches are built in a wide range of sizes, of many types of materials, with varied numbers and arrangements of poles, positions, decks and terminals, in shorting and non-shorting types. A DAVEN engineer will gladly work with you on your switch problems.

KEEP BUYING WAR BONDS

THE **DAVEN** COMPANY

DON'T LET UP NOW

191 CENTRAL AVENUE  
NEWARK 4, NEW JERSEY

World Radio History

RCA Tube Plant, Lancaster, Penna.  
RCA manufactures cathode-ray tubes, as well  
as power tubes, in this modern plant.

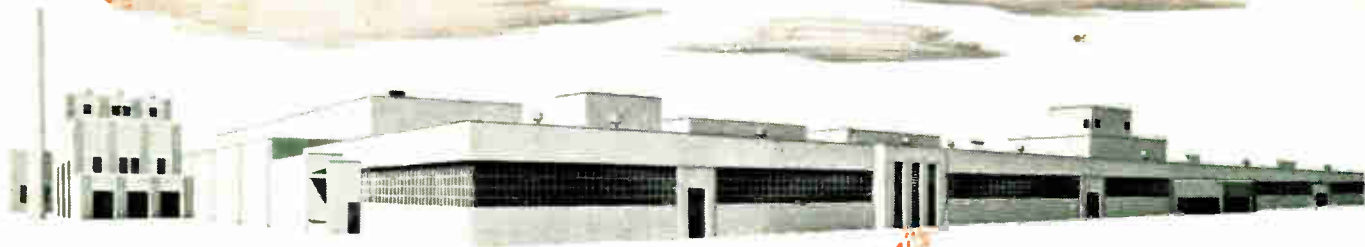

Last year the production of  
***POWER TUBES***  
by the Tube Division of RCA  
was greater than that of  
any other manufacturer in the world

THE FOUNTAINHEAD OF MODERN  
TUBE DEVELOPMENT IS RCA



62-8136-37

**RADIO CORPORATION OF AMERICA**

TUBE DIVISION • HARRISON, N. J.