

# ELECTRONIC INDUSTRIES

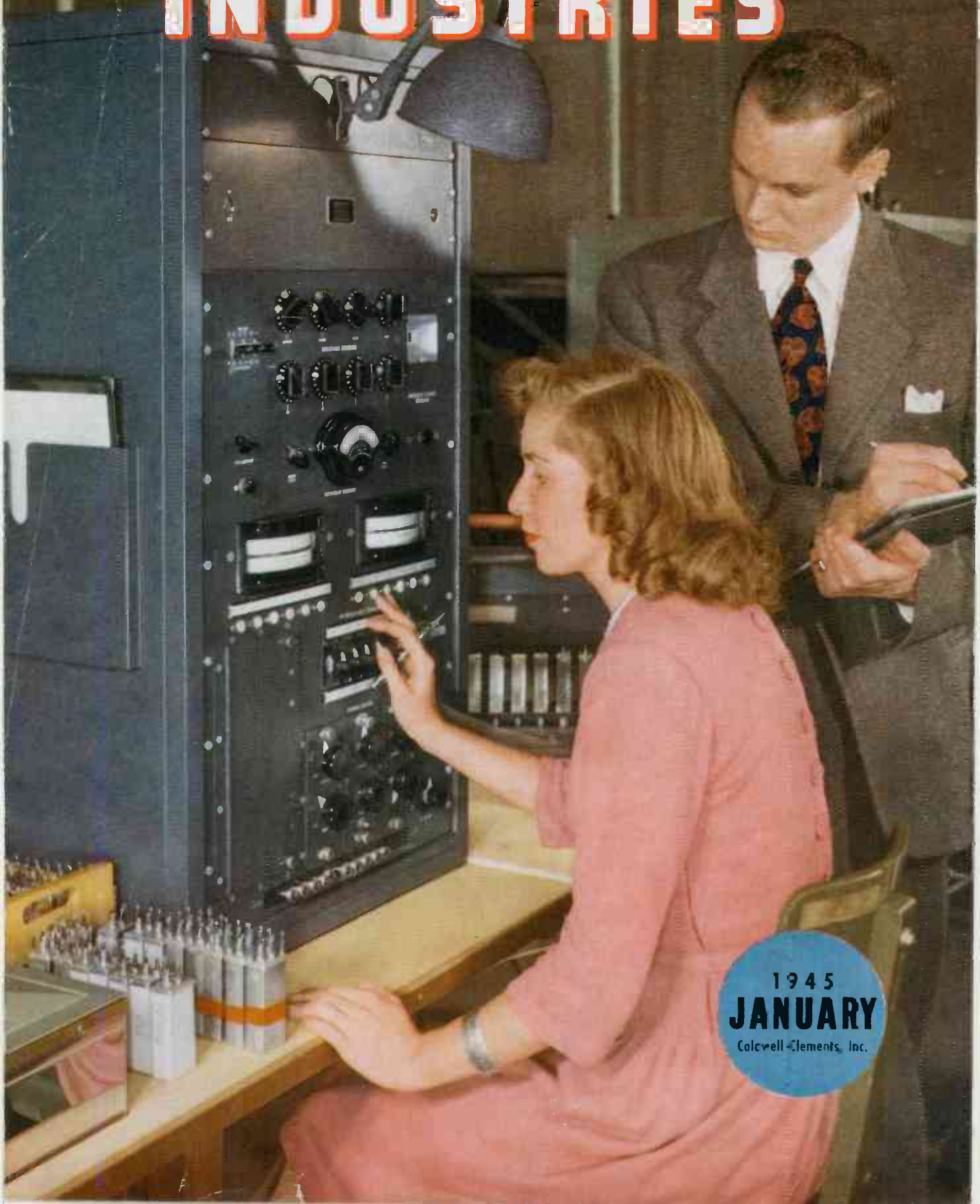

1945  
**JANUARY**  
Calwell-Clements, Inc.



# When a Flier's Best Friend is His "Gibson Girl"

*This emergency radio transmitter, as built by Kingston Products Corporation, Kokomo, Ind., has a Mallory Circuit Selector Switch for sure-fire signal selection.*

WHEN a plane is forced down, rescue of the crew often depends on their "Gibson Girl"—the curvilinear emergency transmitter that can send out three kinds of radio distress signals, or flash a light, continuously or intermittently.

Nerve center of the "Gibson Girl" is a precision switch by which the operator turns the transmitter on or off and selects the desired radio or light signal. In this application, where dependability is literally vital, a Mallory Circuit Selector Switch is used. Sturdily built, with essential parts made of cadmium-plated steel and silver-plated brass, this switch is designed to resist salt water and atmospheric corrosion in any climate.

When you're designing new radio, electronic or electrical devices, be sure to check over the line of *standard* Mallory products, built with *special* precision features—single and multi-gang circuit selector switches, push button and jack switches, resistors, volume controls, condensers, plugs and jacks. To simplify your assembly problems, speed production and cut costs, write Mallory parts into your circuit diagrams or blueprints.

Ask your nearest Mallory Distributor for a free copy of the latest catalog on Mallory Approved Precision Products. If you have a specific design problem, consult our engineers.

**P. R. MALLORY & CO., Inc.**  
**INDIANAPOLIS 6, INDIANA**



P. R. MALLORY & CO. Inc.  
**MALLORY**

**Industrial and Electronic Switches**

# ELECTRONIC INDUSTRIES

Including INDUSTRIAL ELECTRONICS

★ IN THIS ISSUE JANUARY, 1945 ★

FRONT COVER—Thermistor Processes .....	See Page 4
EDITORIAL .....	75
THERMISTORS in ELECTRONIC CIRCUITS—Ralph R. Batcher .....	76
1945 STATISTICAL PICTURE .....	81
LOCATING LAND MINES—Paul P. Horni .....	82
APPLYING POWER LINE CARRIER PRINCIPLES—F. S. Beale .....	84
KLYSTRON EQUIPMENT—Jesse B. Sherman .....	88
CROSLY-OWI 200 KW "VOICE OF AMERICA"—R. J. Rockwell .....	90
IRE TECHNICAL MEETING .....	95
PE TUBE X-RAY TIMER—H. D. Moreland .....	96
FACTORY SHORT CUTS .....	98
LATEST TYPE AAF BLIND LANDING EQUIPMENT—M. E. Montgomery .....	100
HEARING AID TECHNIC—C. J. LeBel .....	104
CR TUBE LIFE TESTS—Leonard Chioma .....	107
TUBES on the JOB .....	108
TELEVISION IS READY .....	122
What's New .....	109
Survey of Wide Reading .....	112
Washington News .....	116
Association News .....	118
New Patents Issued .....	124
Television Today .....	120
New Books .....	207
New Bulletins .....	210

ORESTES H. CALDWELL, Editor M. CLEMENTS, Publisher

**EDITORIAL STAFF**—Ralph R. Batcher, consulting editor; Stanley P. McMinn, managing editor; William Moullic, electronic theory and design; Gilbert Sonbergh, industrial applications; Josepha Zentner, Ph.D., patents and foreign reviews; H. L. M. Capron, engineering management relations; E. T. Bennett, editorial records; Charles Dreyer, art director; Carl Buhner, circuit diagrams; Barbara Chasen, layout and production; Roland C. Davies, Washington editor.

**READER SERVICE**—L. D. Chesson, H. Mirtel; data research, H. Kulik.

**CIRCULATION**—B. V. Spinetta, circulation director; Subscriptions; list compilation: B. Gollub, M. Groening, B. Ruchaisky, A. Warshaw.

**BUSINESS**—M. H. Newton, business manager; John Samborn, eastern manager; Richard Fitzpatrick, western manager; O. H. Sutter, New England Manager; Lee Robinson, district manager; N. McAllister, production manager; J. E. Cochran, make-up; E. P. Butler, E. Hekking; W. W. Swigert, credit manager; W. Kenneth Reynolds, M. Feldman, D. Williams, E. Callahan.

**CHICAGO MANAGER**—R. Y. Fitzpatrick, 201 N. Wells Street. Tel. RAN 9225.

Electronic Industries, January, 1945. Vol. IV, No. 1. Regular price per copy 35 cents. Published monthly by Caldwell-Clements, Inc., 480 Lexington Avenue, New York, N. Y. M. Clements, President; Orestes H. Caldwell, Treasurer; M. B. Clements, Assistant Secretary. Subscriptions: United States and possessions, Mexico, Central and South American countries, \$3.00 for one year; \$5.00 for two years; \$6.50 for three years. Canada, \$3.30 per year; \$5.50 for two years; \$7.15 for three years. All other countries \$5.00 a year. Entered as Second Class Matter, September 20, 1943, at the Post Office at New York, N. Y., under the act of March 2, 1879. Copyright by Caldwell-Clements, Inc., 1945. Printed in U. S. A.

CALDWELL-CLEMENTS, INC.—TEL. PLAZA 3-1340—480 LEXINGTON AVENUE, NEW YORK 17, N. Y.

*Why*

# AMPEREX

WATER AND AIR COOLED TRANSMITTING AND RECTIFYING TUBES



**AMPEREX**

*... the high performance tube*

The ILLINOIS TOOL WORKS has made tremendous strides in the design and development of dielectric heating equipment for such applications as moulding bakelite, heating pre-forms, joining thermoplastics, etc. AMPEREX tubes are used in all such equipment produced by this well-known concern.

With the ILLINOIS TOOL WORKS, as with many other leading concerns working with electronic tubes, it's the "Amperextra" of longer life and low-cost efficiency that has made our products a first and exclusive choice. AMPEREX pioneered in the field of tubes for industrial applications. We are familiar with the needs of industry, and we have the tubes to meet all requirements. Consult AMPEREX for assistance with your present or postwar problems.

**IMPORTANT!** AMPEREX tubes are now available through leading radio equipment distributors. This new arrangement may save valuable time for busy engineers by enabling them to obtain many of our standard tube types from their local supply sources.

## AMPEREX ELECTRONIC CORPORATION

79 WASHINGTON STREET . . . . . BROOKLYN 1, N. Y.  
Export Division: 13 E. 40th St., New York 16, N. Y., Cables: "Arlab"



THE WAR ISN'T OVER YET... BUY AND HOLD MORE WAR BONDS

# LONG LIFE

is built into every

# Tobe Capacitor



In War, Long Life Saves Lives  
 In Peace, Long Life Saves Customers



SPECIFICATIONS OF JUST ONE TYPE OF THE MANY TOBE OIL-IMPREGNATED AND OIL-FILLED PAPER CAPACITORS . . .

### OM-CAPACITORS

TYPE	OM-*
RATINGS . . . . .	.05 to 2.0 mfd. 600 V.D.C. .05 mfd. to 1.0 mfd. 1,000 V.D.C.
STANDARD CAPACITY TOLERANCE . . . . .	20%**
TEST VOLTAGE . . . . .	Twice D. C. rating
GROUND TEST . . . . .	2,500 Volts D. C.
OPERATING TEMPERATURE . . . . .	-55° F to 185° F
SHUNT RESISTANCE . . . . .	.05 to 0.1 mfd. 20,000 megohms .25 to 0.5 mfd. 12,000 megohms 1.0 to 2.0 mfd. 12,000 megohms
POWER FACTOR . . . . .	At 1,000 cycles—.002 to .005
CONTAINER SIZE . . . . .	Width 5/8", length 1-5/16", height 2 1/4"
MOUNTING HOLE CENTERS . . . . .	1 1/2"

\*Data sheets showing complete code number for units having a specific capacitance value and voltage rating available on request. \*\*Other tolerances available.

### MIDGET OM-CAPACITORS

TYPE	OMM-*
RATINGS . . . . .	.05, .1 and 2 x .05 600 V.D.C. .05 x .1 1,000 V.D.C.
STANDARD CAPACITY TOLERANCE . . . . .	20%**
GROUND TEST . . . . .	2,500 V.D.C.
OPERATING TEMPERATURES . . . . .	-55° F to 185° F
SHUNT RESISTANCE . . . . .	20,000 megohms
POWER FACTOR . . . . .	At 1,000 cycles—.0075
CONTAINER SIZE . . . . .	Width 3/8", length 1-5/16", height 1-11/64"
MOUNTING HOLE CENTERS . . . . .	1 1/2"

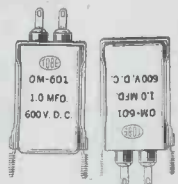

*This new separate mounting is stronger and helps prevent leaks caused by breaks in can. This outstanding Tobe design takes the minimum amount of space.*

A SMALL PART IN VICTORY TODAY... A BIG PART IN INDUSTRY TOMORROW

# Greetings

To the many friends of  
Stancor, our sincere thanks for your generous  
cooperation throughout the past year . . . It is a  
genuine pleasure to assure you that the future  
not only will bring greater fulfillment of your  
needs, but electronic refinements of which you  
and we both shall be proud . . . Won't you  
kindly accept our wishes for your good health  
and prosperity.

STANCOR TRANSFORMER CORPORATION, 1500 NORTH HALSTED ST., CHICAGO 22, ILLINOIS



Transformers

## THE COVER

The original Kodachrome photograph, made especially for "Electronic Industries" in the Western Electric Laboratories by Lazarnick, illustrates one phase of thermistor testing. Sometimes these tiny components are built into networks and housed in metal containers. Such box-type thermistor units are shown here under final test. The recent development of precision test procedures has advanced the knowledge of thermistor characteristics and provided industry with a new circuit element of considerable importance.

### Help for Filers

You may notice that beginning with this issue of "Electronic Industries" there is a somewhat conspicuous figure 1 on what printers call the backstrap of the magazine. The idea originated in the editorial department where the orderly nature of one of the editors indicated a need for revealing at a glance whether his file of issues was complete. If issues are missing, or if they become misplaced in order, the numbers, he says, stick up like lights in a blackout. So henceforth each issue will carry a number arranged so that as the file grows the line of numbers will slant as shown in the illustration.



### Correction

An unfortunate typographical error in the article, "Television Service Hinges on Frequency," appearing in the December issue of "Electronic Industries," made Dr. E. W. Engstrom observe that, "All factors considered, television broadcasting channels should start as near 145 mc as possible." What Dr. Engstrom said, as properly quoted from his testimony before the FCC public hearing in Washington, was "45 mc," not 145.

The National Assembly of Turkey has authorized the construction of four new radio broadcasting stations and enlargement of the existing station at a cost of \$4,230,800. There have been many complaints that the existing station at Ankara cannot be heard clearly in other parts of the country.

**106 tests  
assure you of top  
performance from  
this G-E electronic  
tube**

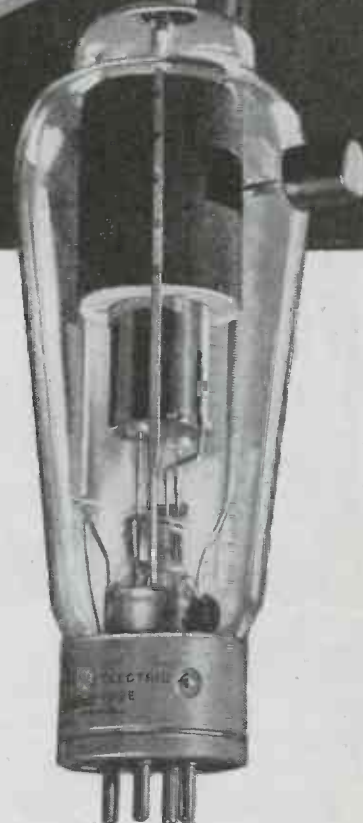
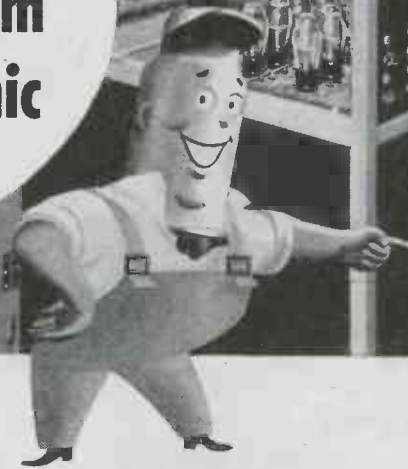

**THYRATRON FG-105.  
PRICE \$37.**

**I**NCLUDED in the many test and inspection operations which guard the quality of the FG-105 thyatron—a widely used G-E industrial tube—are 50 that cover materials (in the course of which 237 dimensions are checked for accuracy); 28 inspections of successive processes of manufacture; also 28 different tests of electrical characteristics and mechanical construction which are made after the tube is completed. *Every tube undergoes this exhaustive series of checks and inspections*—comes to your plant fully pre-tested for the kind of work it is to do.

Over and above these tests are others for which tubes are selected at random in order to prove by extensive use—and abuse—that they will perform their design functions with margin to spare, will withstand vibration in transit and in use, and—of prime importance—will do their jobs properly for the full life period. Such tubes are given accelerated life tests by being subjected relentlessly to conditions much more severe than actual operation, to an extent where

THERE ARE 265 MAIN SUPPLY OUTLETS FOR G-E ELECTRONIC TUBES, BACKED UP BY CENTRALLY LOCATED STOCKS IN 26 LARGE CITIES FROM COAST TO COAST

500 hours on test equals 10,000 hours' normal use. Nothing less than successful completion of the required period *plus* is taken as evidence that tube production is holding to General Electric's high standards of quality.

The life test sets the seal on a thoroughgoing inspection program which places G-E tubes in your hands for service that is better and more dependable. You can count on the G-E electronic tubes you buy! And you can rely on securing them in the minimum time from a convenient and reliable local source. G-E offices and distributors are everywhere, their service backed by an extensive system of warehouse stocks. For information and prices on any industrial tube in G-E's *complete* line, consult your nearest G-E supply source, or write direct to *Electronics Department, General Electric, Schenectady 5, N. Y.*

*TUNE IN General Electric's "The World Today" and hear the news from the men who see it happen, every evening except Sunday at 6:45 E.W.T. over CBS network. On Sunday evening listen to the G-E "All Girl Orchestra" at 10 E.W.T. over NBC.*

This mercury-vapor 4-electrode tube—with both control and shield grids—is adapted to many industrial sockets where sensitive grid response is essential. Motor control is one such type of service: ratings for this are cathode 5.0 v and 10.0 amp; anode 2,500 v peak, 40.0 amp peak and 6.4 amp average. For resistance welders, where FG-105 controls the transformer primary current, the tube is rated at cathode 5.5 v and 11.0 amp; anode 750 v peak, 77.0 amp peak and 2.5 amp average. For special high wave or "energy storage" welders, the ratings are cathode 5.0 v and 10.0 amp; anode 10,000 v peak, 16.0 amp peak and 4.0 amp average. Complete data and performance chart will gladly be supplied to you upon request.

**GENERAL  ELECTRIC**

162-D1-8850

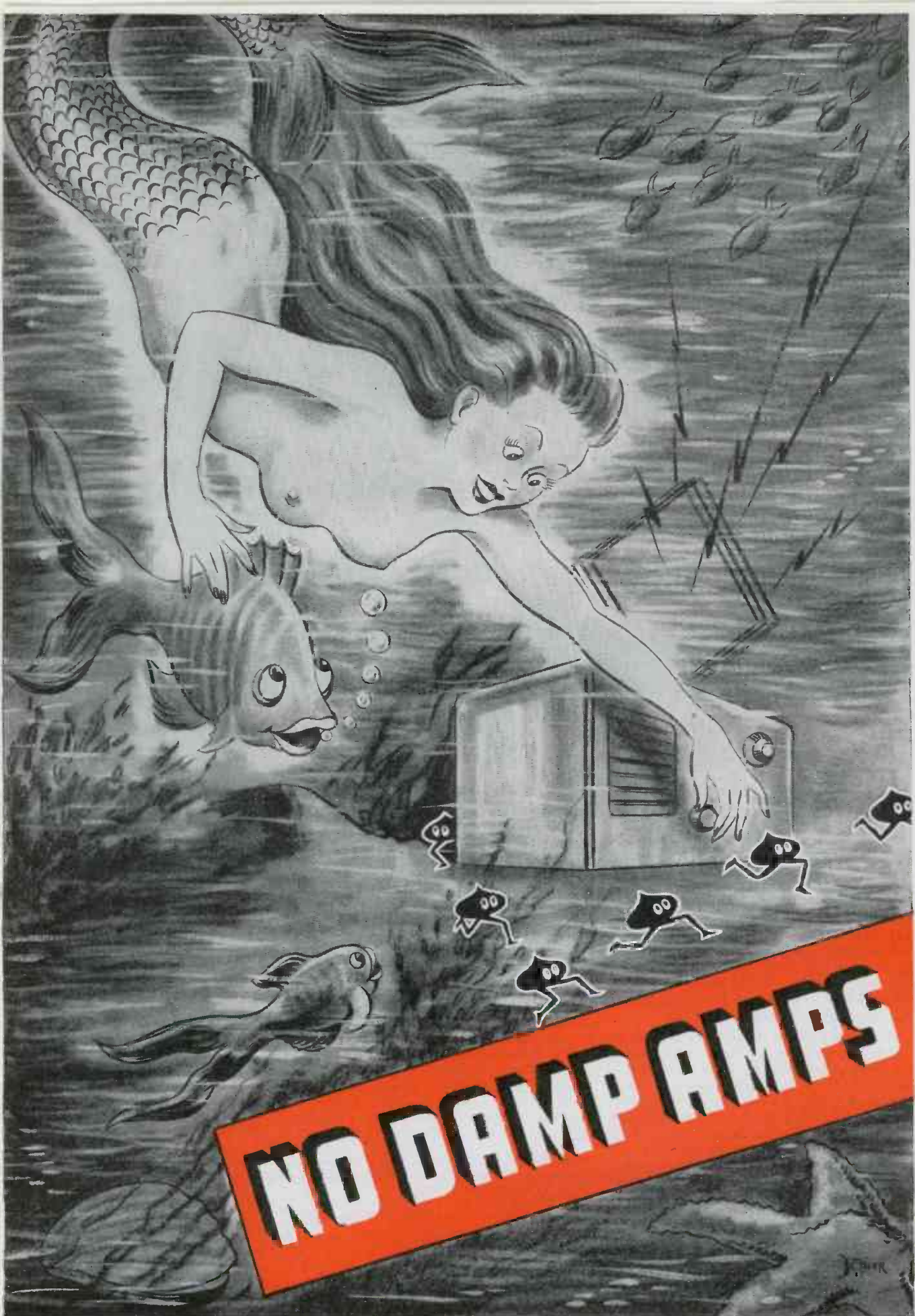

**NO DAMP AMPS**



700  
SERIES

900  
SERIES

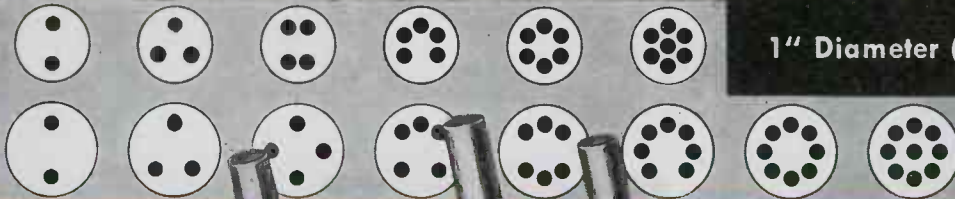

1" Diameter (.952)

1 1/4" Diameter  
(1.235)

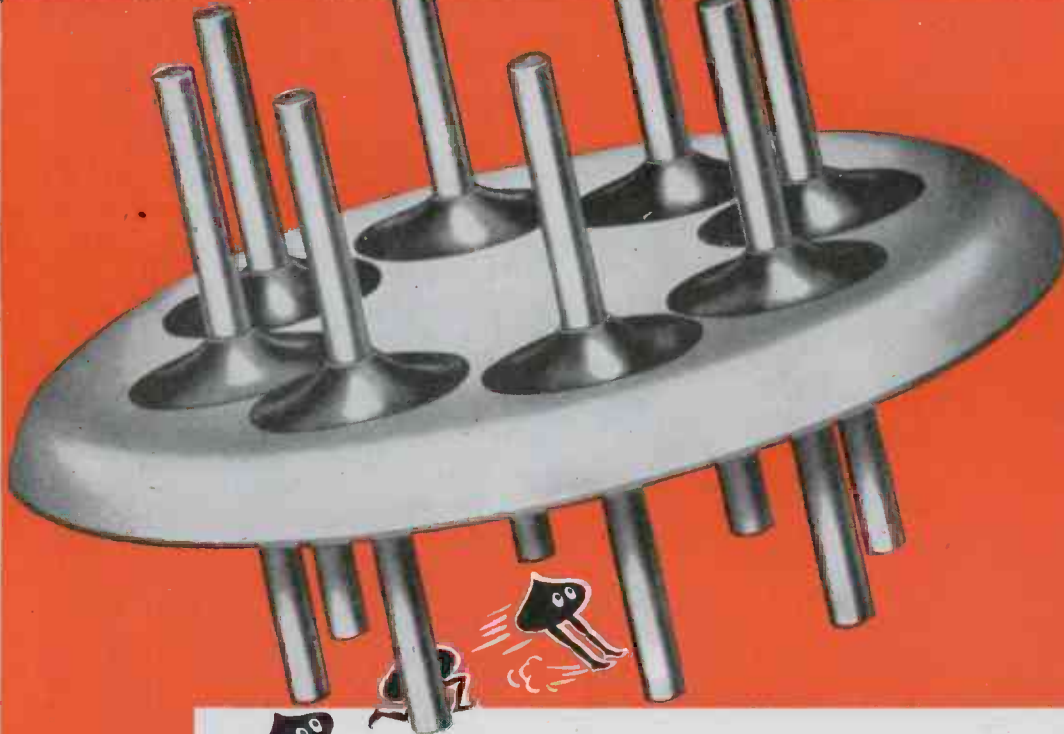

Fusite terminal panel used as cover for container. A single sealing operation.



Hole punched and adapter socket formed to receive Fusite terminal panel.



**WARNING:** . . . the illustration to the left is not drawn from real life. But getting down to the real facts of life, Fusite multi-terminal panels make your fondest dreams come true regarding hermetic sealing. Fusites can and do stand production handling. They pass the tough thermal shock test of dry ice to boiling water. They are made of cold-rolled steel, tin plated. But this is only part of the story. The glass insulation is joined by interfusion with metal. And it works! Fusite is the only (so far as we know) multi-terminal panel interfused within a reinforced metal shape, all in one piece. One and only one sealing operation is required to hermetically seal electronic component parts—such as transformers, relays, coils and the like. Write on your business letterhead for samples and descriptive literature (we may have it ready). And don't send us an order now . . . but please remember to do so when Uncle Sam says, "Okay, boys, you can produce for others." We want your business, but we no-can-do, now! We'll need it then. So let's be friends now and customer-friends then. Thanks for readin' and writin' and rememberin'.

**WITH  
FUSITE  
SEALS**



I'M JUST AN AMP,  
A' CIRCUIT SCAMP,  
AND DAMPNESS SETS ME REELING;  
SO KEEP ME DRY,  
INTENSELY SPRY,  
WITH **FUSITE ATMO-SEALING.**



**CINCINNATI ELECTRIC  
PRODUCTS COMPANY**

**CARTHAGE AT HANNAFORD, NORWOOD,  
CINCINNATI 12, OHIO**

**NO DAMP AMPS**



*History of Communications. Number Twelve of a Series*

## COMMUNICATION BY THE BLINKER



The Blinker, an adaptation of the Heliograph with its own source of light, has been found invaluable for night and day Naval Communications. While limited by "line-of-sight" transmission and the elements of weather, it has been an aid to our cautious convoys during "radio silence."

When Victory is ours and the days of "radio silences" are gone forever, private citizens again will have electronic voice communication equipment for their yachts and other pleasure craft. With the release of civilian radio bands Universal will again offer the many electronic voice components for use in marine craft.

*< FREE--History of Communications Picture Portfolio. Contains over a dozen pictures suitable for office, den, or hobby room. Write for your "Portfolio" today.*



**UNIVERSAL MICROPHONE COMPANY**  
INGLEWOOD, CALIFORNIA



# A Dependable Source For U.S. Army-Navy Coaxial Connectors

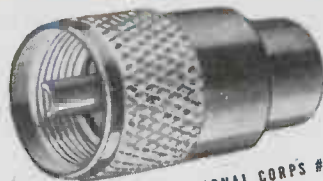

CONNECTOR #50.399-1 SIGNAL CORPS #PL-259



CONNECTOR #50.393 SIGNAL CORPS #PL-259A NAVY #CI-49195

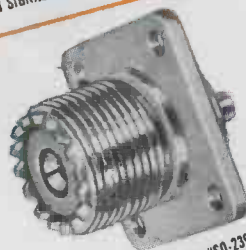

CONNECTOR #50.392-1 SIGNAL CORPS #S0-239 NAVY #CI-49194



OUR present production rate permits us to offer sizeable quantities of these precision-machined units on a favorable schedule. Why not anticipate your needs for connectors of this type now and allow us to schedule your requirements to assure delivery when wanted? Built to conform in every respect to U. S. Army-Navy designs and specifications, these parts interlock firmly, when coupled, to assure positive, vibration-proof contact. The die-cast zinc housings and other metal parts are heavily silver plated. Contact parts (both pins and sockets) are made of specially tempered spring-brass. Cable plugs and receptacles alike are insulated with low-loss mica-filled bakelite. Plugs may be had in either Connector #50.399-1 (Signal Co-rps #PL-259), or Connector #50.393 (Navy #CI-49195) models. Connector receptacle #50.392-1 (Signal Corps #S0-239, Navy #CI-49194) is standard for each of these designs.

For more detailed information we suggest you write today for Connector Division Bulletin No. 4.



CONNECTOR DIVISION OF  
**INTERNATIONAL RESISTANCE CO.**

401 N. BROAD STREET, PHILADELPHIA 8, PA.

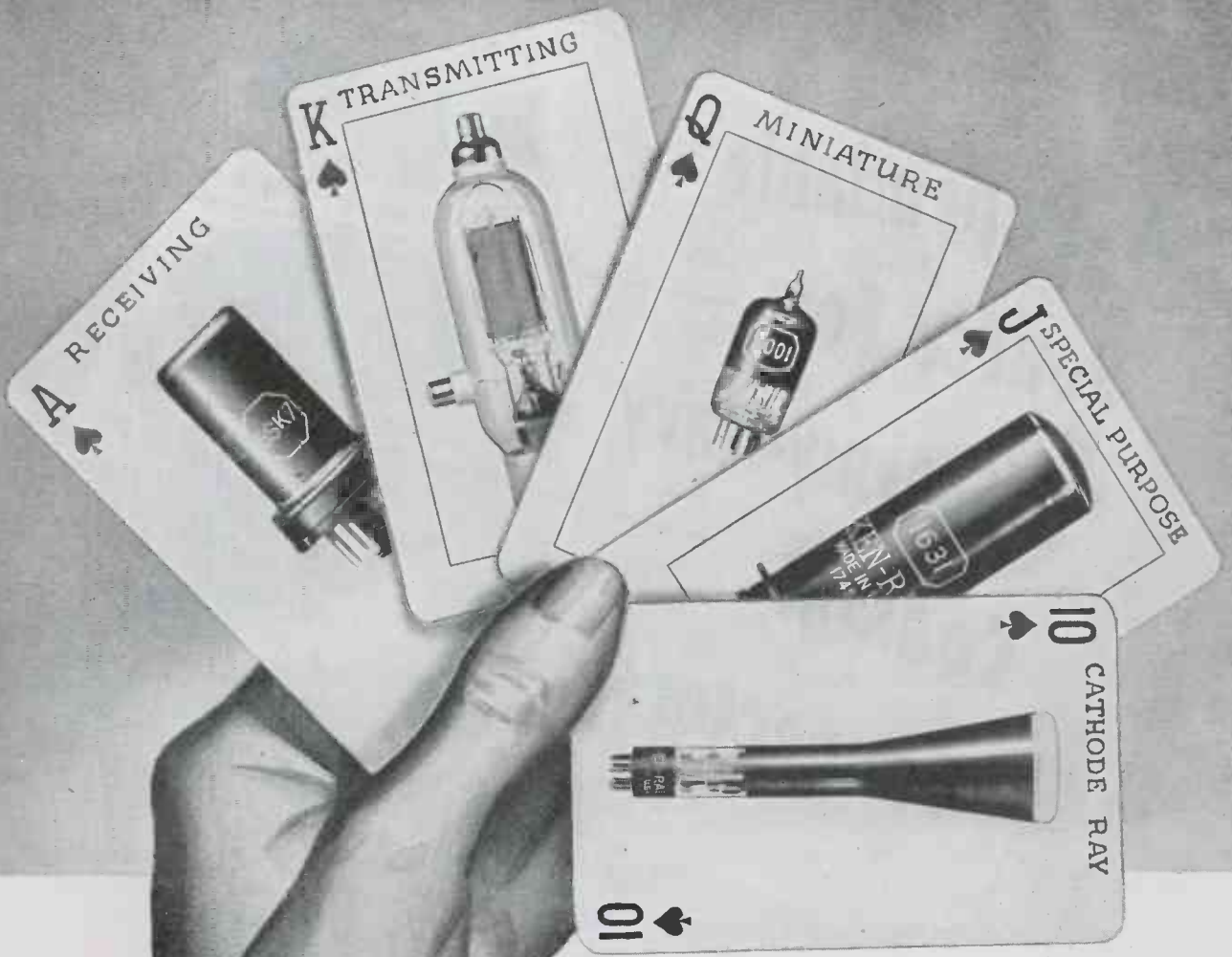

# KEN-RAD

## ELECTRON TUBES

*All Naturals!*

Write for your copy of "Essential Characteristics" the most complete digest of tube information available

- TRANSMITTING TUBES
- CATHODE RAY TUBES
- SPECIAL PURPOSE TUBES
- RECEIVING TUBES
- INCANDESCENT LAMPS
- FLUORESCENT LAMPS

# KEN-RAD

EXECUTIVE OFFICES  
OWENSBORO · KENTUCKY  
EXPORTS 15 MOORE STREET NEW YORK

GRANT



**UTAH SPEAKERS:**  
 More than 20 million Utah speakers have been made for radio, and public address systems.

## THE UNBROKEN CIRCUIT

A machine like that shown above may look like a complicated and perplexing mass of metal to you, but not to Utalins\*.

They visualize the precision of the resulting tools . . . made in Utah's own factory to Utah's undeviating standards. They know these tools will play a major part in creating the quality products that make possible the modern electronic circuit.

And Utalins\* *know* the performance of these products! For Utah's process is absolutely comprehensive

\*Utalins—Utah's helpers.

. . . the making of tools is only the first step. It is followed by the close supervision and painstaking testing of all steps of manufacture, from raw material to finished product . . . *the unbroken circuit.*

When finally these products become an integral part of an electronic device, those listening—as well as those working in the many phases of electronic development—can recognize the superior quality of the

products that emanate from Utah's self-contained plant.



# A Quarter

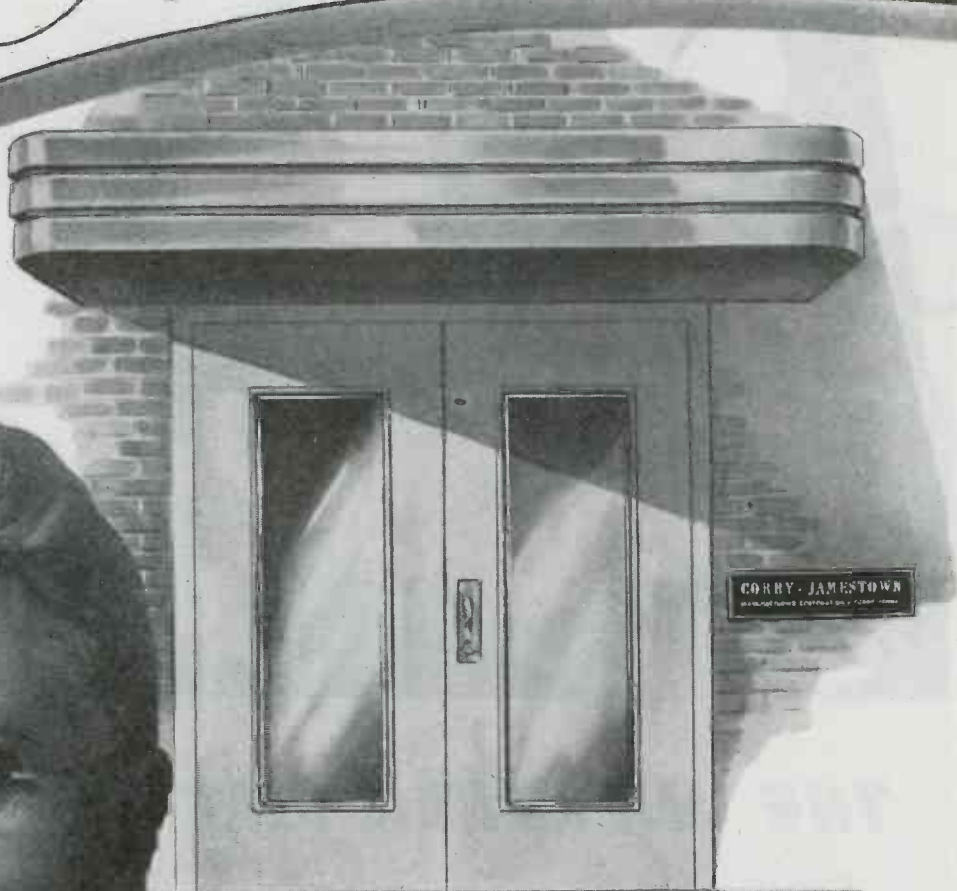

☆ Largely responsible for Corry-Jamestown's success is the founder, Mr. D. A. Hillstrom. Relentless in his quest for ways to improve "Steel Age" products, he has built an organization constantly dedicated to producing improved products and services.



Century

## of ACHIEVEMENT...

☆ Corry-Jamestown celebrates its 25th birthday this month. Over those years we have multiplied our manpower from 10 to 350 . . . our floor space from 20,000 to 185,000 square feet. But, more important, we have established a record of integrity and a reputation for quality that transcends physical measurements.

☆ Originally devoted exclusively to the manufacture of "Steel Age" Office Furniture, with the war we turned our facilities to the production of electronic equipment. Our success has brought us to a determined decision. Postwar we shall continue in this field with a fully manned electronics division.

☆ With our full energies devoted to war work, we have little time to celebrate our QUARTER CENTURY OF ACHIEVEMENT. Yet, briefly, we mark it in passing with wholehearted thanks to those leaders in the electronic industry who have selected us to serve them today. In a peacetime tomorrow, we pledge a continuance of the quality of workmanship that has marked our small contribution to your great wartime work.

**CORRY - JAMESTOWN**

**MANUFACTURING CORPORATION ★ CORRY, PENNA.**



## Manufacturers

are invited to take advantage of Centralab's unchanging quality and splendid engineering co-operation on Selector Switches.

These switches are available in both steatite and bakelite insulation, the former being indicated where low loss and low moisture absorption for high frequency circuits are required. Built by Centralab to withstand the heavy service specifications required by the Army and Navy. May be had with fungicidal treatment for tropical climate.

All switches have double-wipe contact terminals for long life. Low contact resistance of less than  $2\frac{1}{2}$  milliohms and are completely self cleaning.

# Centralab

Division of GLOBE-UNION INC., Milwaukee  
Producers of Variable Resistors—Selector Switches —  
Ceramic Capacitors, Fixed and Variable—  
Steatite Insulators.





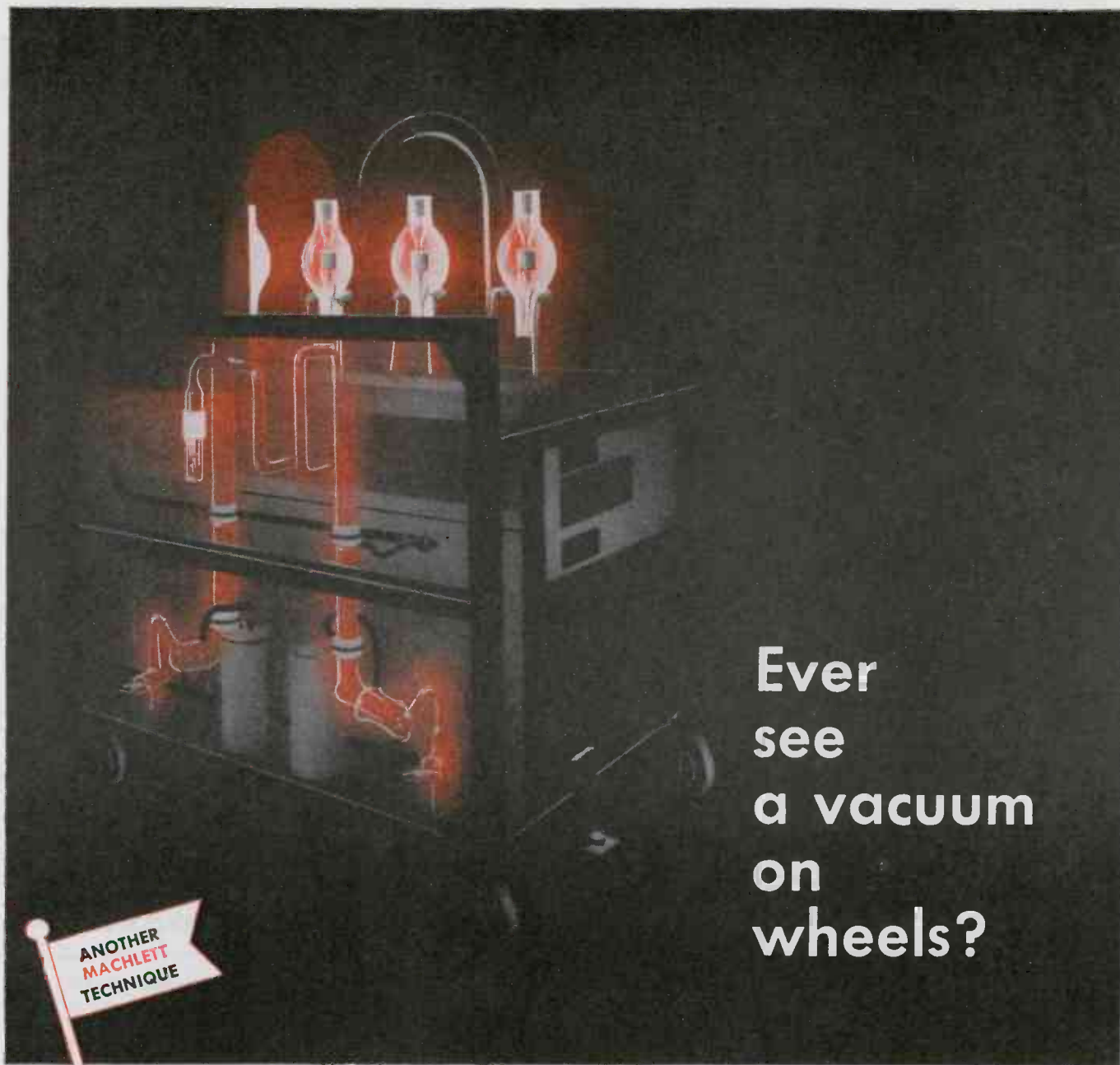

Ever  
see  
a vacuum  
on  
wheels?

The final stages of manufacture of large oscillator and rectifier tubes must include thorough outgassing. This has customarily been done in three separate operations, and it was considered inevitable for two-thirds of the equipment to be idle while one-third was in operation. Machlett felt that this produced highly undesirable effects on output, costs, and on tube quality. So we developed a unique production line.

Here is the Machlett method: the tubes are sealed on a high-vacuum pump which is mounted on a dolly, and thus can be wheeled through each station in turn while pumping continues steadily. The dolly goes first into the baking oven (shown above); then to the second station, where the tube elements

are brought to red heat by induction; then to the third, in which they are bombarded repeatedly at 70,000 volts. This is about 10 times the usual voltage, and not only reduces the time required in a later seasoning process, but assures much better tubes.

This system, devised at a time when war demands were tremendous, approximately triples the output of the equipment. More than that, we believe it produces tubes with less residual gas and hence more stable operation and longer life. When buying radio tubes for communications or industry remember this Machlett production technique which makes possible the tube illustrated above . . . Machlett Laboratories, Inc., Springdale, Connecticut.

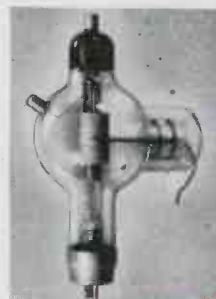

ML-861, screen-grid r-f oscillator and amplifier tube.

**MACHLETT**  
APPLIED TO RADIO ITS 46 YEARS  
OF X-RAY TUBE EXPERIENCE

# A GLASS BONDED MICA INSULATING MATERIAL



## INTERNATIONAL "PEMQUE" Machined to tolerances of a frog's hair

### CHARACTERISTICS

High Dielectric Strength  
Low Power Factor  
High Resistance to Electric Arcs  
Dimensional Stability  
Practically impervious to moisture absorption  
No Deterioration with Age  
Resistance to Heat  
Impervious to oil and gas  
Low Coefficient of thermal expansion  
Resistant to Fungi Growth

### PROPERTIES

#### ELECTRICAL

Dielectric Constant . . . . . 7.21  
Power Factor . . . . . .002-.003

(At one Megacycle)

(After 48 hours in distilled water at room temperature)

Arc Resistance (Current and time to form conducting path)

Milliamperes Average . . . . . 45  
Seconds Average . . . . . 427

#### PHYSICAL

Water Absorption . . . . . .009

Coefficient of Linear Expansion

Per Degree C . . . . . 10 x 10-6

Density—lbs. per cubic inch . . . . . 1.100

Specific Gravity . . . . . 2.83

Color . . . . . Gray

Surface . . . . . (Hard - Smooth)

Porosity—After 6 hours in dye at 10,000 psi there was no visible penetration into the sample.

#### MECHANICAL

Tensile Strength—

lbs. per sq. in. . . . . 8,500-10,000

Compressive Strength—

lbs. per sq. in. . . . . 35,000-45,000

Flexure . . . . . 17,000-18,500

Impact Strength (IZod)

Energy absorbed ft. lbs.

Per inch—Width (Aver.) 0.437

Per inch—Square (Aver.) 2.25

Pemque will not soften until it reaches a temperature of 800° to 900° F. It has, however, a permanent expansion as shown on the following table:

Permanent Expansion	15-Min. Cycle
750 F.	.05%
850 F.	.29%
950 F.	1.75%

**H**ERE is a high-frequency, glass-bonded mica, insulating material that can be machined to tolerances, the thickness of a "frog's hair"—or at least .005 of an inch.

The density that makes this kind of fabricating possible is obtained through a Pyro-Welding process exclusive to INTERNATIONAL "PEMQUE." It is a practical guarantee against insulation failures; of high resistance to moisture—to heat—to fungi growth and assures almost unlimited years of low-loss service.

INTERNATIONAL "PEMQUE" is available in three sizes: (1) 10¼" x 12⅛" (2) 8½" x 14½" (3) 6½" x 18½". We are equipped, however, to supply in any quantity, in any size, intricate forms that must be machined to the most rigid requirements.

Ask us to tell you more about INTERNATIONAL "PEMQUE"

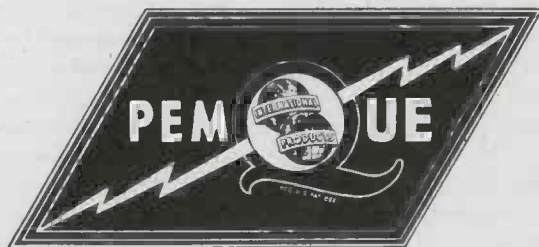

INTERNATIONAL PRODUCTS CORPORATION

2554 GREENMOUNT AVENUE

BALTIMORE 18, MARYLAND

QUOTATIONS CHEERFULLY SUBMITTED ON REQUEST

# HIGH-ALTITUDE BRUSHES...

*First aid for difficult  
ground-level applications*

Many months have now passed since Stackpole brushes treated with a Westinghouse process first made aircraft generator brush life at high altitudes a matter of weeks and months instead of simply hours. During this time, much has been accomplished in adapting these same outstanding high-altitude brush principles to difficult and unusual ground-level applications.

The basic feature of these brushes is of course their amazing ability to maintain the essential protective film on commutators in order to minimize wear under a wide variety of commutating conditions. Although Stackpole research in applying this feature to brushes for earth-surface equipment is still continuing, it has now reached a point where Stackpole engineers will welcome inquiries from brush users having unusually difficult conditions to meet. You can count on a frank and honest opinion as to whether or not we believe Stackpole High-Altitude Brushes can help you.

**STACKPOLE CARBON CO., St. Marys, Pa.**

# STACKPOLE

**THE NATION'S LARGEST PRODUCER OF  
FRACTIONAL HORSEPOWER MOTOR BRUSHES**

*Brushes and Contacts (All carbon, graphite, metal and composition types.)  
Rare Metal Contacts • Graphite Bearings • Welding Carbon Products  
Packing, Piston and Seal Rings • Continuously Adjustable Carbon Rheostats  
Sintered Iron Components*

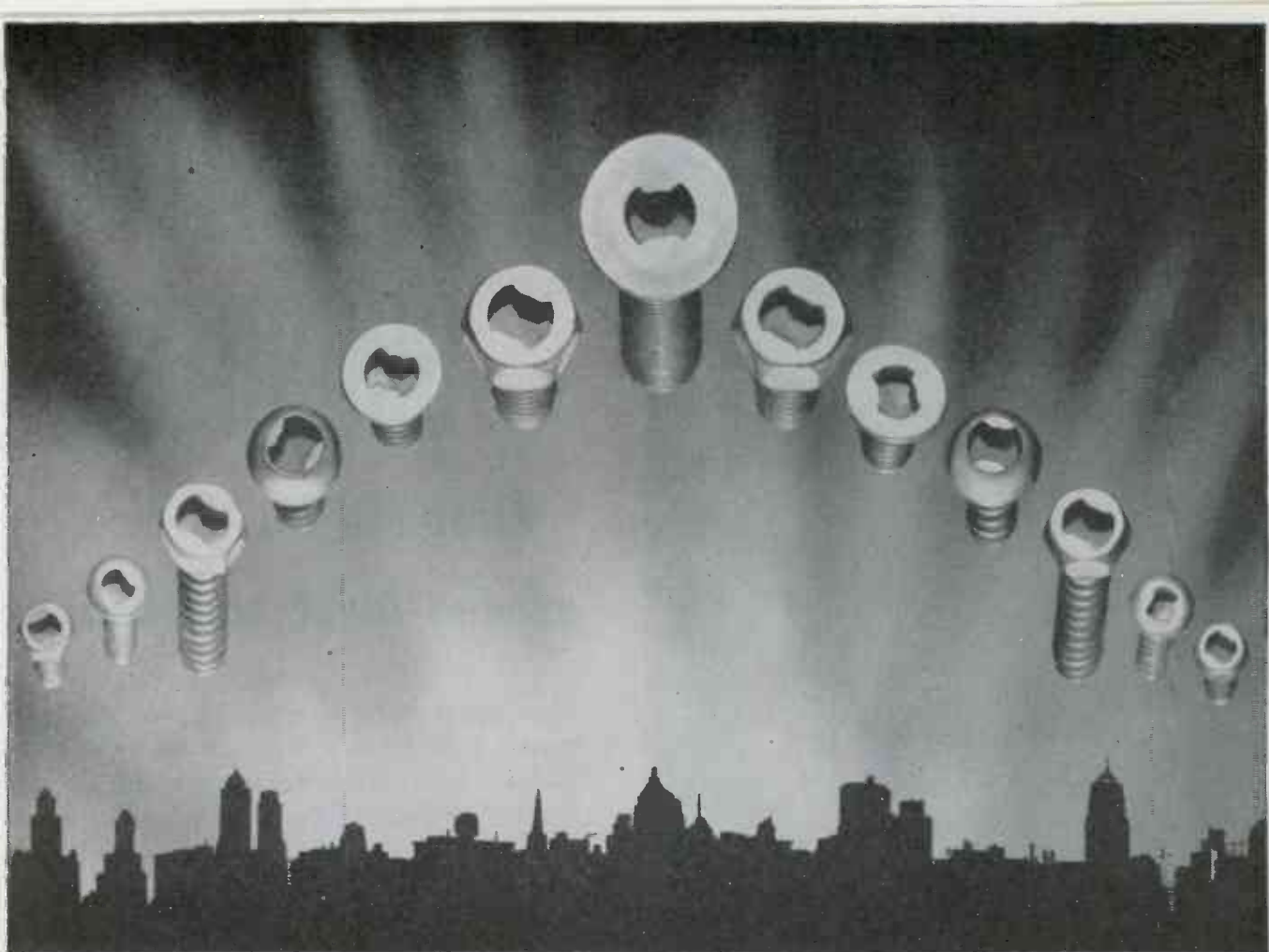

*New Methods* in industry impose new demands on assembly lines . . . for a new measure of economy through *faster, safer, easier, and better* production. Wherever power driving is used, the records show that **CLUTCH HEAD** Screws scale down the final costs with modern features and advantages which are *not matched by any other screw on the market today.*

**VISIBILITY . . .** The wide Clutch recess offers a clear, definite target, inviting confidence and unwavering action by the "greenest" operator. No "breaking-in" required.

**SAFETY . . .** The Center Pivot on the driver makes deep dead-center entry automatic. No canting, no slippage to injure manpower or damage materials.

**EFFORTLESS DRIVING . . .** The straight-sided driver squarely contacts the full area of the straight-walled Clutch to eliminate end pressure as a hazard and as a fatigue factor. With **CLUTCH HEAD**, there is no ride-out tendency as set up by "tapered" driving.

**CLUTCH HEAD LOCK-ON . . .** A slight reverse turn creates a friction-hold which unites screw and driver as a unit for easy one-handed reaching to hard-to-get-at spots. No slow-down fumbling. With field service Type "A" Bits, this feature functions automatically for easy withdrawal of screws, undamaged and saved for re-use.

**SCREWDRIVER CONTROL . . .**

This is the only modern screw engineered for operation with ordinary type screw drivers or any flat blade of reasonably accurate width. Thickness of the blade is secondary because the roomy Clutch permits a wide tolerance.

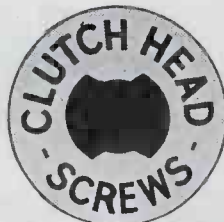

**NEW TOOL ECONOMY . . . .**

Ruggedness of structure explains why this tool stands up through a longer continuous "spell" on the line. Repeated reconditioning to original efficiency requires only a 60-second application of the end surface to a grinding wheel.

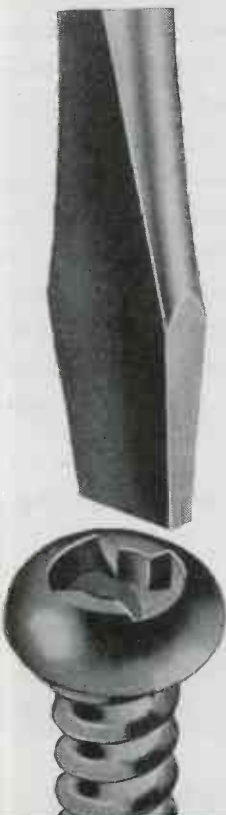

**UNITED SCREW AND BOLT CORPORATION**  
**CHICAGO 8                      CLEVELAND 2                      NEW YORK 7**

# CHECKING RELAY REBOUNCE BY MEANS OF

# DuMONT

# Oscillography

Parasitic oscillations caused by rebounding relay contacts can prove mighty troublesome. However, *DuMont Oscillography* (oscillographic equipment plus the know-how) can be invaluable in determining the source of such difficulty as well as providing conclusive evidence that remedial measures have proved effective. For instance:

A standard DuMont oscillograph with single-sweep feature is used. No additional accessories required. Relay is actuated by closing a switch. Relay contact applies 60-cycle wave to vertical deflection plates of cathode-ray tube. With sweep frequency set at 60 cycles, one complete sine wave period appears on screen.

If relay contact closes without rebound, the transition from horizontal line to sine wave is a simple straight line and generally occurs so quickly that it is difficult to observe visually. However, if rebound is present, the interruptions are indicated by a series of parallel vertical lines readily observed, as in Fig. 1.

If it is desired to determine the

number of interruptions and duration of rebound periods, photographic records are made. Since the frequency of the sine wave is known, the evaluation of results is simple. In this oscillogram there were over 20 rebounds before establishing definite contact. Total duration of series of rebounds is  $1/250$ th second. Time between opening and closing of contact is about 50 microseconds. Greater accuracy may be had by using higher frequency wave generated by an external oscillator.

Fig. 2 oscillogram demonstrates that rebound has been eliminated by cadmium plating the contacts, amalgamating with mercury, and finally dropping liquid mercury on them.

An illustration from hundreds of useful applications of DuMont Cathode-Ray Oscillographs. Perhaps your measurement technique can be simplified or improved upon by DuMont.

© ALLEN B. DUMONT LABORATORIES, INC.

# DUMONT

# Precision Electronics & Television

ALLEN B. DUMONT LABORATORIES, INC., PASSAIC, NEW JERSEY • CABLE ADDRESS: WESPXLIN, NEW YORK

# Basic Design

## *makes the difference!*

### *Smudge-voice*

While these two columns read identically, word for word, the smudged column is a visual representation of an acoustical condition when background noise interferes with transmitted speech.

The words may be readable, but effort and concentration are required for accuracy. And so with reproduced sound: with general purpose microphones, articulation is lowered even though ambient noises do not completely override speech. The Electro-Voice Differential is specifically designed to erase interfering background noise. Speech is clean, clear, crisp . . . unadulterated by stray pickup or distracting background.

### *Electro-Voice*

While these two columns read identically, word for word, the smudged column is a visual representation of an acoustical condition when background noise interferes with transmitted speech.

The words may be readable, but effort and concentration are required for accuracy. And so with reproduced sound: with general purpose microphones, articulation is lowered even though ambient noises do not completely override speech. The Electro-Voice Differential is specifically designed to erase interfering background noise. Speech is clean, clear, crisp . . . unadulterated by stray pickup or distracting background.

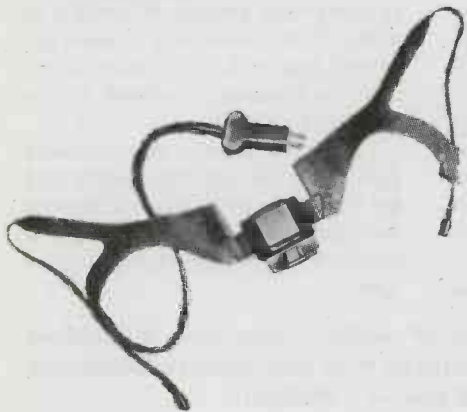

## *Electro-Voice* DIFFERENTIAL MICROPHONES

Electro-Voice engineers have years of experience in the elimination of ambient noise. We designed and developed the now-famous "Lip-Mike," the first successful Differential microphone. Our new Model 205-S for aircraft, railroad, industrial and police applications is another Differential achievement. Soon there will be Electro-Voice Differential microphones for all communication services. Watch for them.

If any of your limited quantity needs can be met by standard model Electro-Voice microphones, with or without minor modifications, contact your local radio parts distributor.



BLOOD DONORS ARE URGENTLY NEEDED . . . SEE YOUR LOCAL RED CROSS

# *Electro-Voice* MICROPHONES



ELECTRO-VOICE CORPORATION • 1239 SOUTH BEND AVENUE • SOUTH BEND 24, INDIANA  
Export Division: 13 East 40th Street, New York 16, N. Y., U. S. A. Cables: Arlab



## The Greeks gave us a word for it . . . now we give it to you

WHEN Sperry first developed its velocity-modulated, ultra-high-frequency tube, the word "KLYSTRON" was registered as the name of the new device.

This name — from the Greek, as coined by scientists of Stanford University — is an apt description of the bunching of electrons between spaced grids within the tube.

"Klystron" is a good name. So good, that it has come into widespread use as the handy way to designate any tube of its general type,

whether a Sperry product or not.

This is perfectly understandable. For the technical description of a Klystron-type tube is unwieldy, whether in written specifications, in conversation, or in instructing members of the Armed Forces in the operation of devices employing such tubes.

These conditions have prompted many requests from standardization agencies—including those of the Army and Navy—for unrestricted use of the name Klystron. In the public interest, Sperry has been glad to

comply with these requests . . .

*From now on, the name KLYSTRON belongs to the public, and may be used by anyone as the designation for velocity-modulated tubes of any manufacture.*

Sperry will, of course, continue to make the many types of Klystrons it now produces, and to develop new ones.

On request, information about Klystrons will be sent, subject to military restrictions.

**SPERRY GYROSCOPE COMPANY, INC. GREAT NECK, N. Y.**

*Division of the Sperry Corporation*



LOS ANGELES • SAN FRANCISCO • NEW ORLEANS  
HONOLULU • CLEVELAND • SEATTLE

GYROSCOPICS • ELECTRONICS • RADAR • AUTOMATIC COMPUTATION • SERVO-MECHANISMS

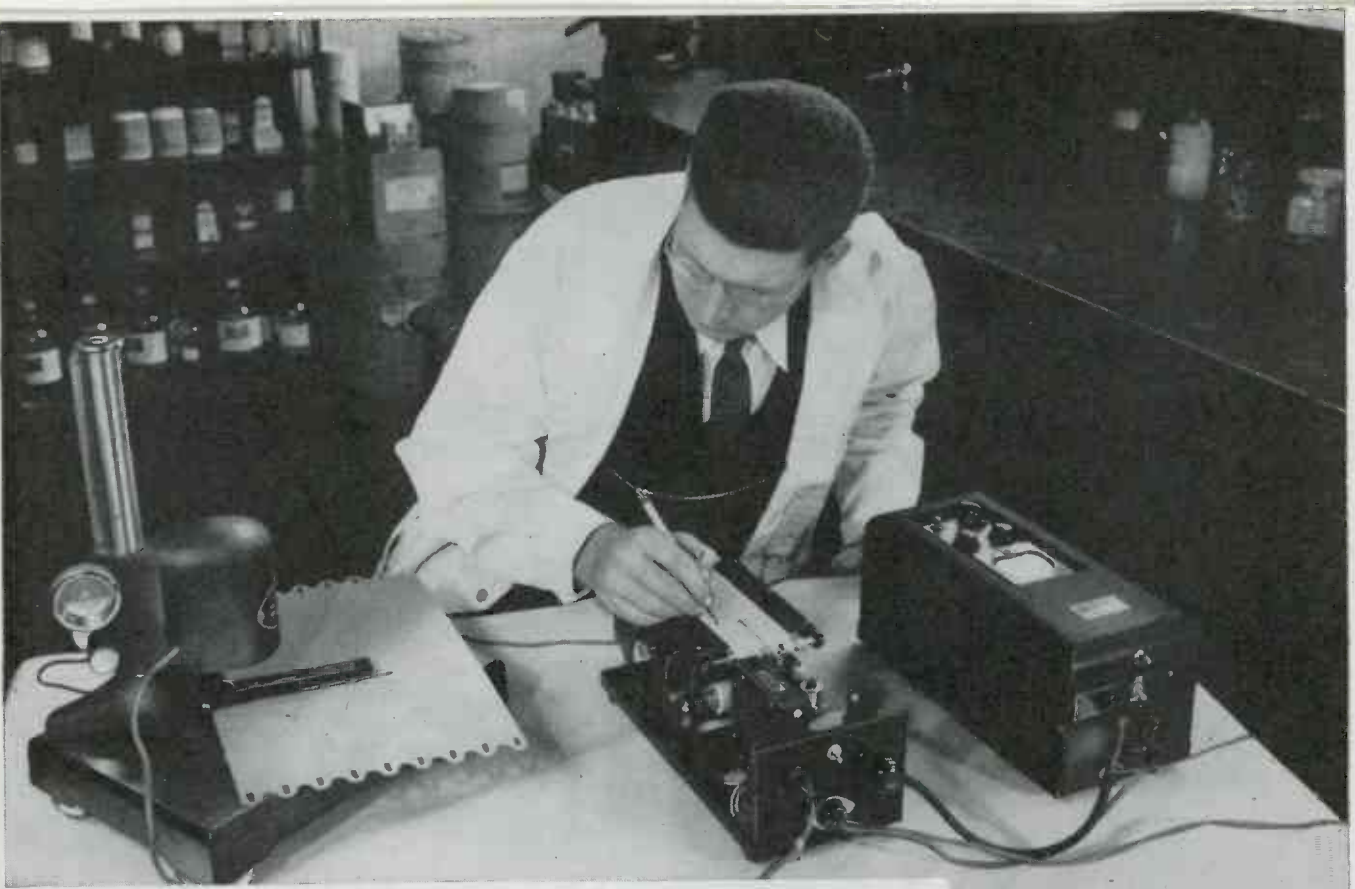

Photo courtesy of  
Addressograph-Multigraph  
Corporation

## High Priorities...

### BOUGHT THIS BRUSH SURFACE ANALYZER

When the Addressograph-Multigraph Corporation in Cleveland, found it necessary to accurately measure the surface finish on grained zinc plates, they bought a Brush Surface Analyzer to do the job. Now, they are able to control these surfaces to micro-inch roughness by studying graphic readings of the irregularities measured to one millionth of an inch (.000001").

This instrument was purchased with a high priority rating. No longer is this necessary. Greatly expanded production facilities are now enabling us to make *prompt delivery with no priorities.*

The Brush Surface Analyzer is an indispensable tool in modern production where closer control of surface finish is greatly emphasized.

See how this instrument can best serve your production needs by a demonstration at your plant.

Also write for a free brochure—"Surface Finish—.000001 inch."



**THE BRUSH DEVELOPMENT COMPANY**

3433 PERKINS AVENUE

CLEVELAND, 14, OHIO



# ... How MYCALEX Solved a Tough Insulating Problem for HAZELTINE ELECTRONICS and the NAVY ...



PLANT  
58-25 LITTLE NECK PARKWAY  
LITTLE NECK, LONG ISLAND  
FLUSHING 7-0300

HAZELTINE ELECTRONICS CORPORATION  
EXECUTIVE OFFICES  
1775 BROADWAY  
NEW YORK 19, N. Y.

ARMY  
NAVY

TELEPHONE  
COLUMBUS 5-0781  
TELETYPE - NY 11-2880

September 15, 1944

Mycalex Corporation of America  
30 Rockefeller Plaza  
New York, N. Y.

Attention: Mr. Jerome Taishoff, President

Gentlemen:

In the development of special apparatus, to be supplied on a Navy contract by Hazeltine Electronics Corporation, it was found necessary to utilize a material with a dielectric constant of 12-15.

We put our problem in the hands of your company.

The cooperation which we received from your organization is to be very highly commended. The special material, which was developed after much experimentation and research on your part, has maintained a constant dielectric all through production.

We have delivered a quantity of these units to the Navy, and we wish to again thank you for the large part you played in making the delivery of these vital equipments possible.

Very truly yours,

*J. E. Gray*  
J. E. GRAY  
Co-ordinating Engineer



Note one more success story concerning MYCALEX and an outstanding builder of electronic apparatus. MYCALEX—the "last word" in low-loss insulation—may be the right answer to your problem, too. Write for detailed specifications and samples.

## MYCALEX CORPORATION OF AMERICA

"OWNERS OF 'MYCALEX' PATENTS"

CLIFTON,  
NEW JERSEY

Executive Offices: 30 ROCKEFELLER PLAZA  
NEW YORK 20, N. Y.

**77  
WATTS  
OUTPUT  
FROM A PAIR  
AT 200  
MEGACYCLES**

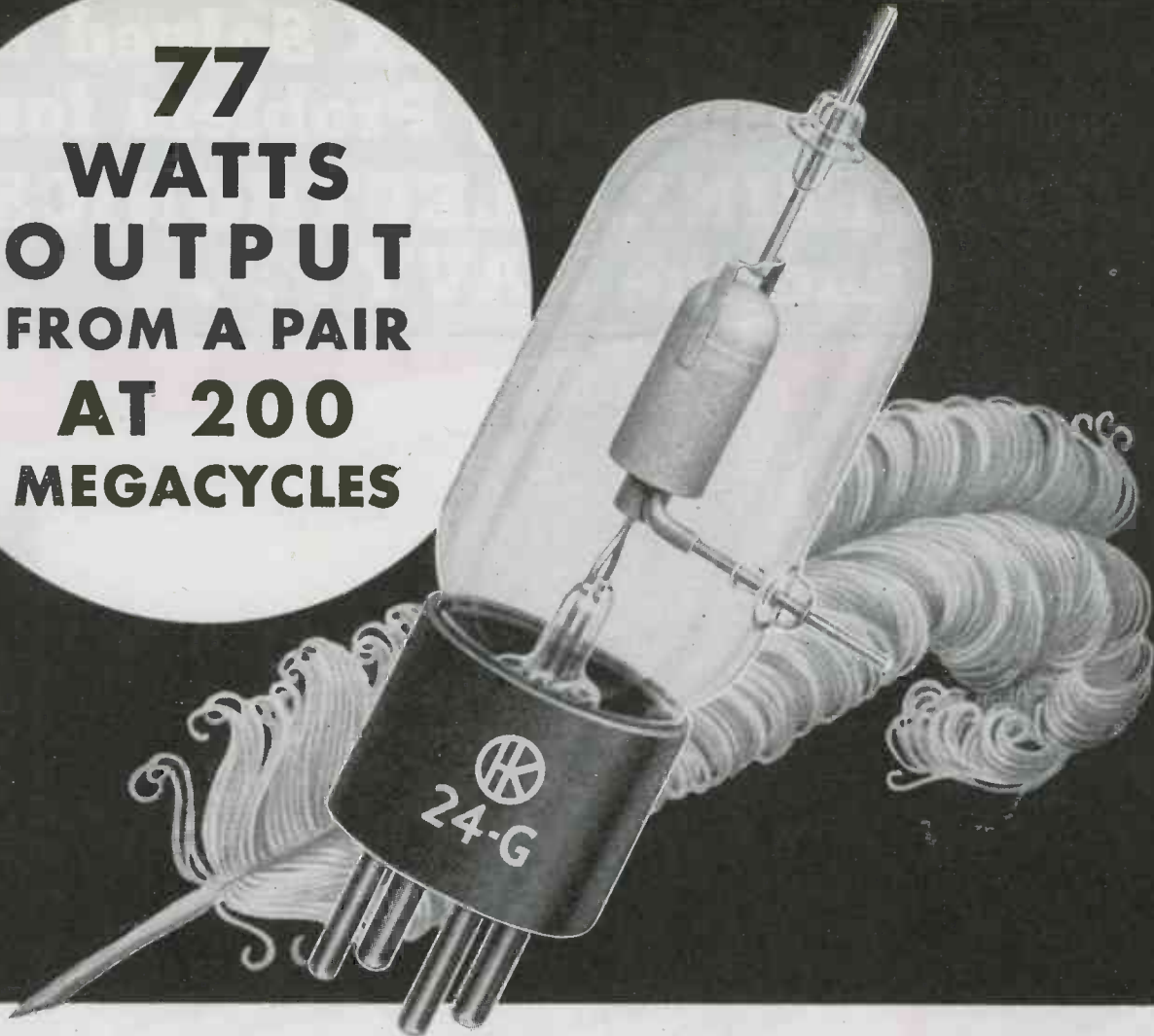

**H & K developed this *featherweight* to pack a wallop in the VHF region**

The only thing that's small about this 4½-inch, 1½-ounce Gammatron is its size. Heintz and Kaufman engineers originated and perfected this powerful little tube to put out a 77 watt signal from a pair at 200 Mc. as a Class C unmodulated amplifier... 116 watts at 100 Mc. Even at peak frequency, 300 Mc., a pair of HK-24G Gammatrons develop a remarkable 44 watts.

The high efficiency of the HK-24G in the VHF region results from (1) the long, capped tantalum plate, typical of Gammatrons, which confines the entire electron stream for useful output, and (2) the fact that this grid is closely spaced to the filament for short electron time-flight.

The HK-24G triode is easy to neutralize, and parasitic oscillation is avoided, because the inter-electrode capacities are very low, and the grid and plate leads are short. For typical operating ratings of the HK-24G as an r. f. power amplifier, audio amplifier, crystal oscillator, doubler, or tripler, write today for data.

**HK-24G MAXIMUM RATINGS**

Power Output  
Class "C" R. F. . . . 90 Watts  
Plate Dissipation . . . 25 Watts  
Amplification Factor . . . . 25  
Plate Voltage . . . . 2000 Volts  
Plate Current . . . . . 75 MA  
Grid Current . . . . . 25 MA  
Frequency . . . . . 300 MC

INTER-ELECTRODE CAPACITIES  
C Grid-Plate . . . . . 1.6 UUF  
C Grid-Filament . . . . 1.8 UUF  
C Plate-Filament . . . 0.2 UUF

FILAMENT  
Volts, 6.3 Amperes, 3

**LOAN YOUR DOLLARS  
DONATE YOUR BLOOD  
FOR EARLY VICTORY**

**HEINTZ AND KAUFMAN LTD.**  
SOUTH SAN FRANCISCO • CALIFORNIA

*Gammatron Tubes*





# Extra hands

KARP facilities and men, skillful in engineering and fabricating metal parts and products of simple or complex design, are your *extra hands*. In design, our engineering department has helped solve the knottiest of problems. In production and deliveries, our facilities have been praised for maintaining and beating standards and schedules. In cost, KARP extensive stocks of dies have saved thousands of dollars for customers.

ANY QUANTITIES—ANY METAL—ANY SIZE—ANY FINISH

ARTISANS  
IN  
SHEET  
METAL

**KARP METAL PRODUCTS CO. INC.**

126 30th STREET • BROOKLYN 32, N. Y.

CABINETS  
CHASSIS  
RACKS  
PANELS

**KEEP BACKING THE ATTACK . . . BUY MORE WAR BONDS**

In ratings from 1000 volts to 10,000 volts test . . .

*Molded-in-Bakelite*

# MICA CAPACITORS

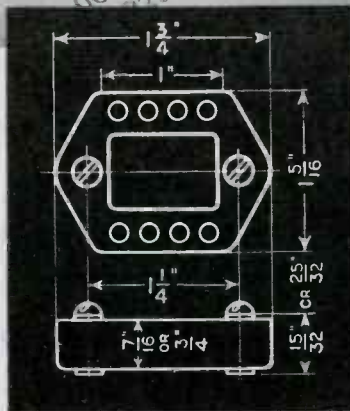

● The 1650 Series is the most rugged of the heavy-duty molded-in-bakelite mica capacitors of the extensive Aerovox line. These high-voltage units are intended for the most critical service of low-powered transmitting circuits, buffer stages, power amplifiers, laboratory equipment, etc. Also recommended for use in ultra-high-frequency circuits, and accordingly their r.f. current ratings are given in the Aerovox Capacitor Catalog.

The extra-generous use of high-grade dielectric material provides that greater factor of safety for longer service under severest operating conditions.

Standard units with tapped holes take 6/32 screws which serve for terminals. Also available with clearance holes through which screws or rods may be slipped, so that two or more units can be stack-mounted. Low-loss ceramic mounting insulators are available for mounting on metal surfaces. Standard units molded in brown bakelite. Also available in low-loss (yellow) XM bakelite.

In 1000, 2500, 5000, 7500 and 10,000 volts D.C. test. Capacitance ratings from .00005 mfd. to .06 mfd. in Type 1650 at 1000 v. D.C. test; .00005 mfd. to .001 mfd. in Type 1654L at 10,000 v. D.C. test.

● Literature on request . . .



*Capacitors*

INDIVIDUALLY TESTED

AEROVOX CORPORATION, NEW BEDFORD, MASS., U. S. A.

SALES OFFICES IN ALL PRINCIPAL CITIES

Export: 13 E. 40 St., New York 16, N. Y. • Cable: 'ARLAB' • In Canada: AEROVOX CANADA LTD., HAMILTON, ONT.

# A MODERN TOOL FOR MODERN INDUSTRY

## **-MEGATHERM\*** - ELECTRONIC HEAT

Here is high-speed uniform heat—precision controlled and directed—offering tremendous possibilities for new products and new processes . . . for faster, more efficient production . . .

That's Megatherm—high-frequency electronic heating at its best—a modern tool with uses as broad as industry itself.

In the processing of plastics, foods, drugs, candy, paper, textiles, wood products, and in printing, book-binding . . . in the surface hardening of metals, brazing, soldering, and annealing . . . to mention only a few of an endless number of possible applications.

Megatherm is available in a range of compact, efficient models—powers from 3 kilowatts to 100 kilowatts. One of these models is right for your work.

Now, while you are planning for the future, is the time to get the story on Megatherm—learn how it will speed your production—cut your costs—make new designs—new products and new materials possible. Write for data.



# Federal Telephone and Radio Corporation

\*Reg. U. S. Pat. Office

INDUSTRIAL ELECTRONICS DIVISION



Newark 1, N. J.

# electronics.. problem child or benefactor?

**THE N-Y-T SAMPLE DEPARTMENT CAN TAKE  
THE GUESSWORK OUT OF TRANSFORMER  
SPECIFYING FOR YOUR POST-WAR NEEDS**

Placing the cart before the horse is to publicise in glowing terms, electronics of the future. Constructively, it's a job for engineers and designers with 'both feet on the ground'.

The N-Y-T Sample Department is helping to set the pace with research, engineering and development in the electronic field. Specially-built transformers, filters and

solenoids—for every industrial and electronic requirement—are being produced to the highest degree of perfection ever attained.

Immediately that military needs taper, collaboration in the solution of transformer problems will be available to aid in the advancement of electronics . . . through product prestige and integrity.

## **NEW YORK TRANSFORMER CO.**

22-26 WAVERLY PLACE, NEW YORK 3, N. Y.

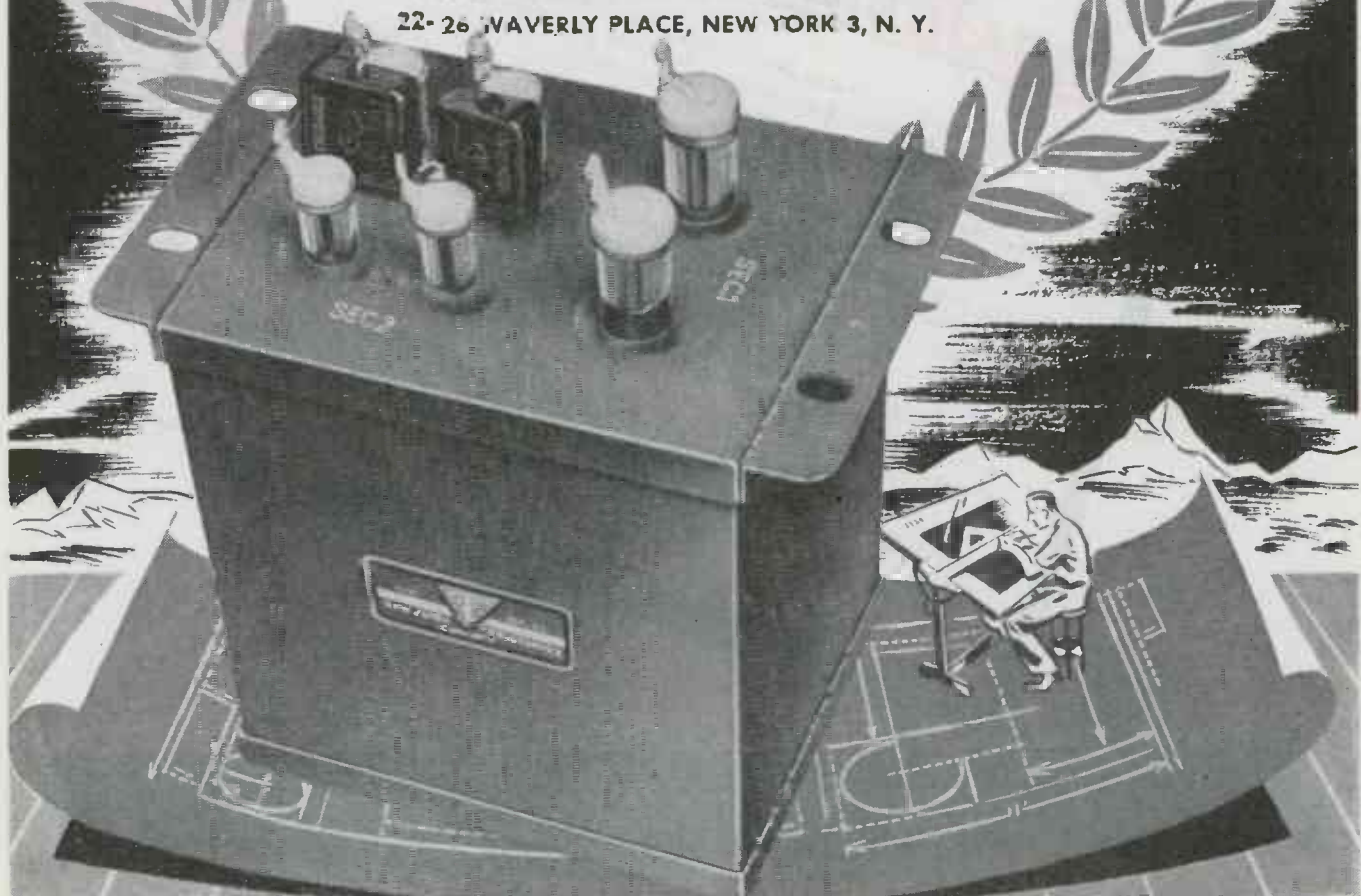

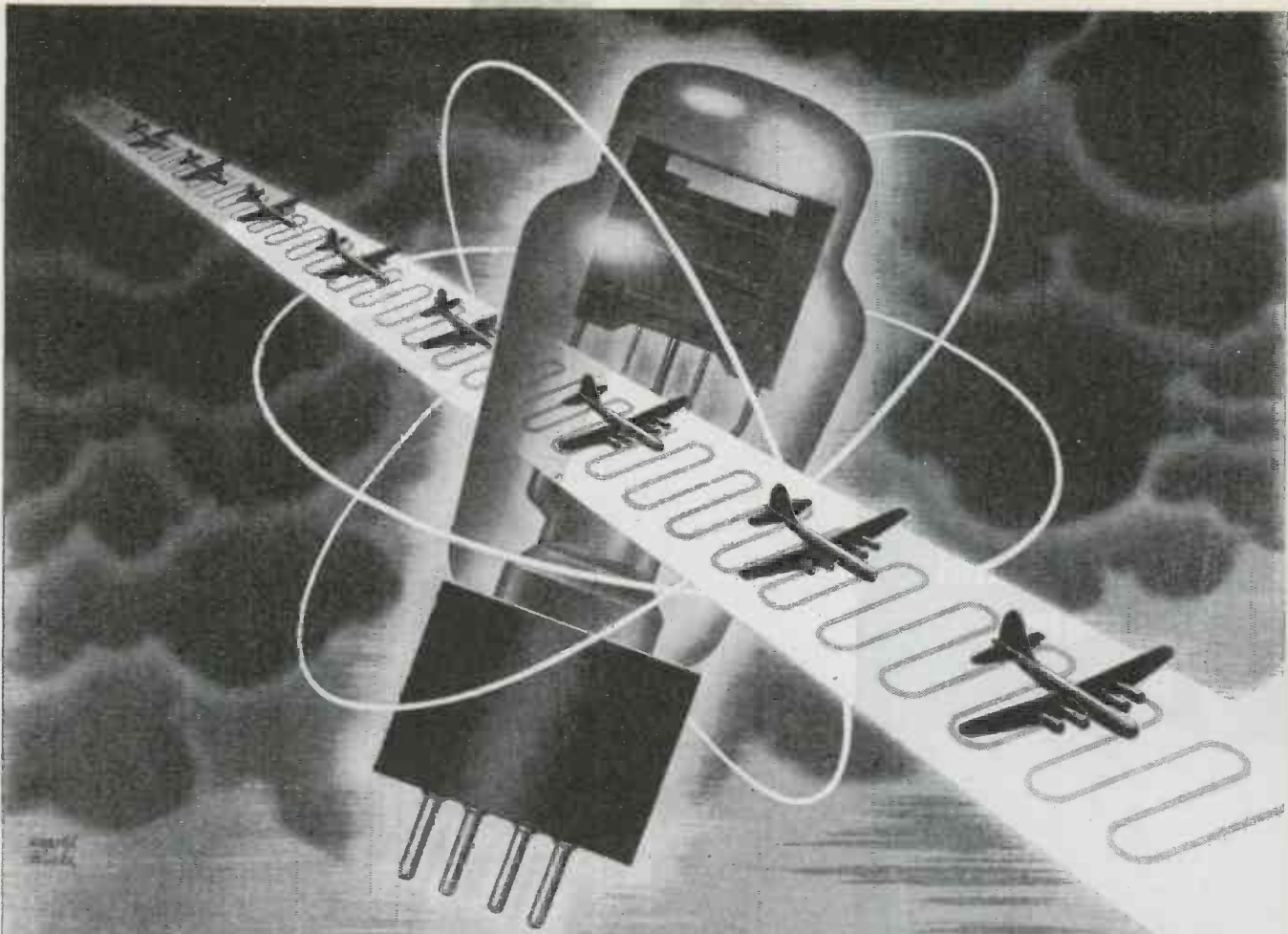

# **D**elco Radio Products Mean Fine Performance

From compact auto radio sets to highly intricate radio and electronic equipment for the armed forces, Delco Radio products are distinguished by fine performance. Each unit reflects care and competence in engineering; each part represents advanced techniques in production accuracy.

Tomorrow's civilian needs, like today's military demands, will benefit from Delco Radio's engineering vision, manufacturing precision.

Delco Radio Division, General Motors Corporation, Kokomo, Indiana.

**Put Your Dollars in Action—BUY MORE WAR BONDS**

**Delco Radio**  
DIVISION OF  
**GENERAL MOTORS**

...Hardly had man learned to fly than he began to feel the urgency of the need to communicate between ground and plane.



Radio headsets are one of C. T. & E. Division's contributions to aviation communications in World War II.



One of the first successful attempts in such two-way contact was accomplished with equipment designed and manufactured by *Connecticut Telephone & Electric*. Since the early days of the telephone, our people have been identified with progress in communications. Today the principles of communications have applications of the greatest importance to industry, in connection with product development and production control. Our developmental engineers also have much to offer to industrial executives seeking to produce a better product at lower cost. If our engineering and production facilities might tie in with your plans, we shall be happy indeed to talk with you.

## CONNECTICUT TELEPHONE & ELECTRIC DIVISION

GREAT AMERICAN INDUSTRIES, INC.  
MERIDEN, CONNECTICUT

TELEPHONIC SYSTEMS • SIGNALLING EQUIPMENT • ELECTRONIC DEVICES • ELECTRICAL EQUIPMENT • HOSPITAL AND SCHOOL COMMUNICATIONS AND SIGNALLING SYSTEMS • IGNITION SYSTEMS

ELECTRONIC INDUSTRIES • January, 1945





# QUADRUPLED *Capacity* ... AND THE LAST WORD IN EQUIPMENT...

War expansion quadrupled Formica's capacity both for production and machining of laminated plastics. It brought about the installation of the latest modern equipment, and the revision of procedure throughout the plant.

Now this giant capacity—by far the largest in the industry—this up-to-date equipment, and the trained man power to operate it, is ready for the service of industry in general.

It will make possible prompt delivery in quantity—flexible service, a high level of uniformity and accuracy in the material produced.

Among the new features of equipment: vertical treating machines with heat applied by infra-red lights; even cure of thick material by application of high frequency electronic heat; new types of tube rolling machines and many others.

**THE FORMICA INSULATION COMPANY**  
4647 SPRING GROVE AVENUE  
CINCINNATI 32, OHIO

**FORMICA**

A "Must"  
for Welding  
Engineers . . .

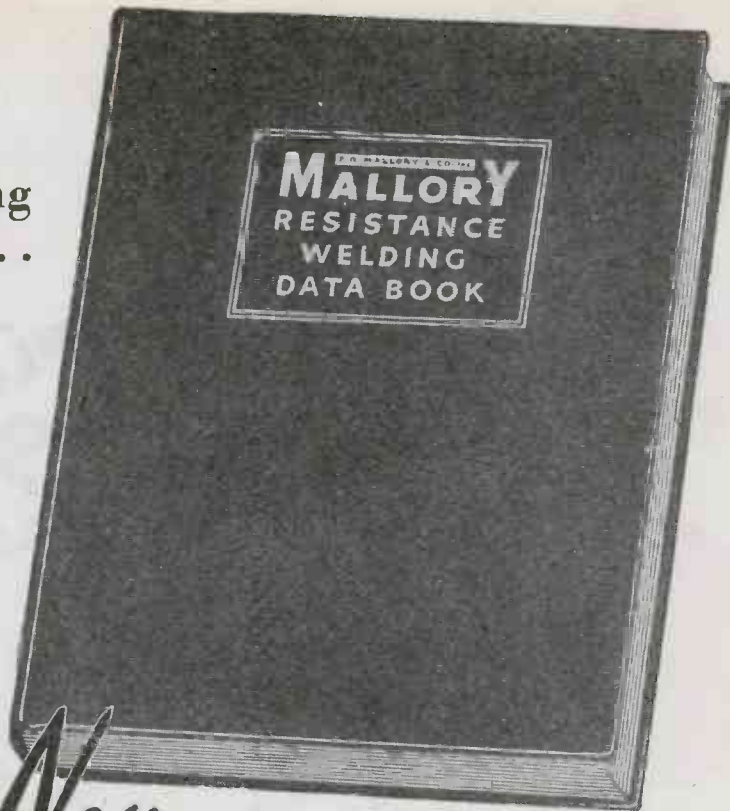

*The New*

# MALLORY RESISTANCE WELDING DATA BOOK

WRITTEN by experienced welding engineers and metallurgists, this new edition of the practical Mallory manual covers every phase of resistance welding . . . provides factual answers for hundreds of questions.

Included in the Third Edition Mallory Resistance Welding Data Book is material on

Welding Principles	Controls and Timing Devices	Cooling Methods
Heat Generation	Electrodes	Applications
Resistance Welders	Timing	Special Processes
Resistance Factors	Pressure	Electrode Alloys
Current Requirements		Definitions

Materials to be Welded: Ferrous and Non-Ferrous, Plated and Coated  
Do's and Don'ts of Resistance Welding

This new Data Book is replete with tables, charts, diagrams and photographs of operations illustrating correct methods of welding. It will be sent gratis to resistance welding engineers when requested on company letterhead. Price to students, libraries and schools is \$2.50 per copy, postpaid.

P. R. MALLORY & CO., Inc., INDIANAPOLIS 6, INDIANA



## P. R. MALLORY & CO. Inc. Standard MALLORY Resistance Welding Electrodes

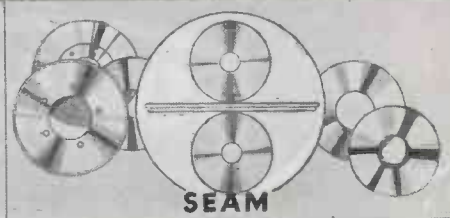
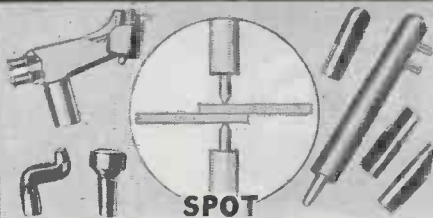
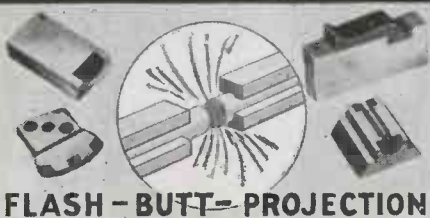



*The Extra Quality*

THAT GIVES CHAMPIONSHIP

PERFORMANCE

ANY horse can run a race, but only a thoroughbred wins consistently.

Where performance counts, Turner Microphones win top recognition in every field of electronic communications. On land, on sea and in the air — in education, business, entertainment and science, Turner applications deliver that EXTRA quality that is the measure of a thoroughbred.

Turner pioneers the communications

field with scientific engineering that reproduces only those vibrations received by the diaphragm without adding any of the harmonics. The full meanings of sound are delivered with their delicate gradations of tone and volume. A soft whisper or a shrill fortissimo come clear and crisp in the full focus of intelligibility.

Let Turner Microphones "spark" your electronic communications with life-like performance.

Crystals Licensed Under Patents of the Brush Development Company



The **TURNER**  
Company

CEDAR RAPIDS, IOWA



Write for  
*Free*  
CATALOG

**TURNER**—Pioneers in the Communications Field



TURNER 22



TURNER 211



TURNER HAN-D



TURNER 99

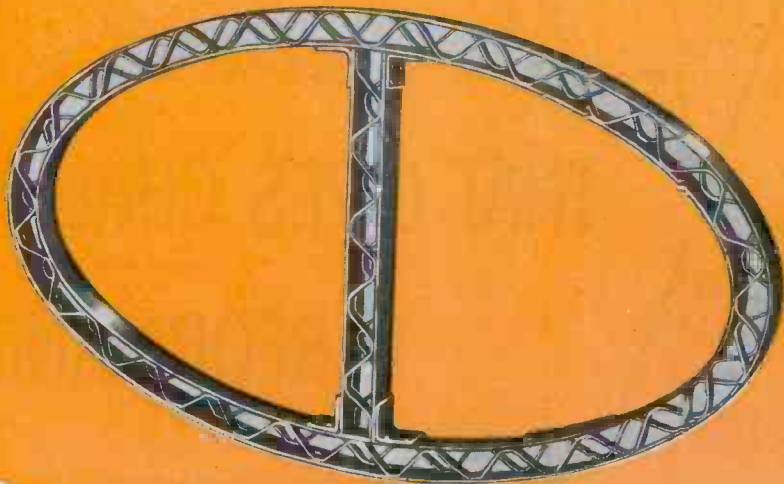

★ Structural member of Bullet-Sealing Fuel Tank used on the B-29 Super-Fortress. It is made entirely of National Vulcanized Fibre.

## Is there an Idea for your New Products in this War-time Use of National Vulcanized Fibre?

National Vulcanized Fibre, because of its remarkable combination of properties—resilience, formability, lightness in weight and exceptional strength—was found to be exactly the right material for this structural member of the bullet-sealing fuel tank of the B-29 Super-Fortress. Its superior resiliency and shock-absorbing qualities protect the tanks from the sudden and great impacts of landing. The same properties that make National Vulcanized Fibre the

best material for this and thousands of other war-time applications make it equally practical for countless peace-time uses. National Vulcanized Fibre may be the means of developing new, profitable products for you—of enabling you to get the lead on your post-war competition.

National engineers are available today to assist you in your current design and research work. Write, phone or wire us.

**Electrical Applications**—National Vulcanized Fibre, in combination with its exceptional physical and mechanical properties, has high dielectric strength which makes it the one best material for numberless electrical and electronic uses.

# NATIONAL VULCANIZED FIBRE CO.

Wilmington, Delaware

Offices in Principal Cities



ELECTRONIC INDUSTRIES • January, 1945

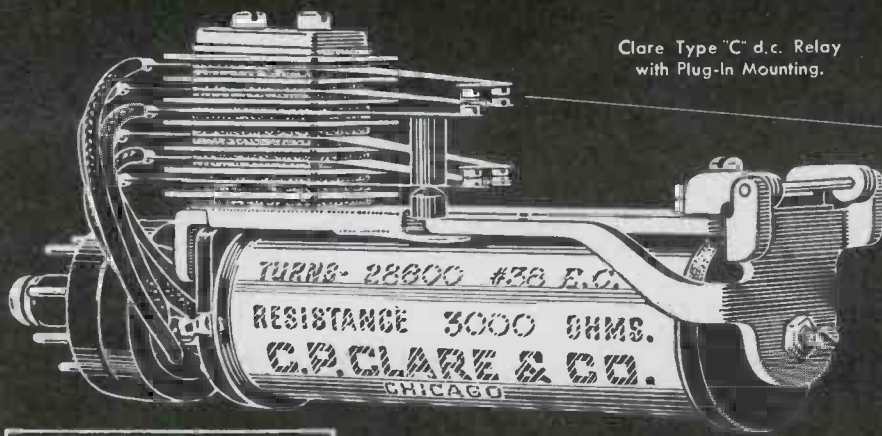

Clare Type "C" d.c. Relay  
with Plug-In Mounting.

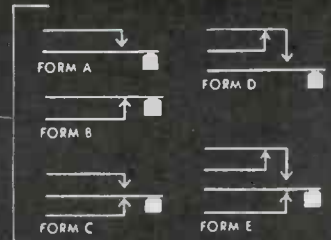

Contact springs employing any  
of these basic forms can be fur-  
nished.

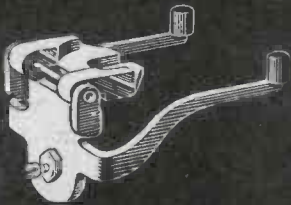

Double arm armature assem-  
bly of stainless steel shaft,  
operating in a marine brass  
yoke. Heelpiece, core and  
armature assembly are of  
magnetic metal.



High voltage spring pile-up  
insulators of special heat-  
treated Bakelite. Has mini-  
mum cold flow properties, low  
moisture absorption content  
and permits punching without  
cracks or checks.



Contacts are welded to nickel  
silver springs by special proc-  
ess. May be of precious  
metals or alloys in 12 differ-  
ent standard or special types  
and sizes.

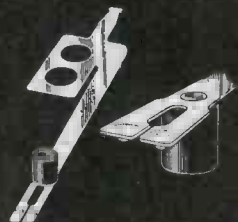

Spring bushing insulators are  
made of Bakelite rod under  
patented process. Resist vi-  
bration and withstand heavy  
duty service.

## CLARE "CUSTOM-BUILT" RELAYS

Can be depended on under most severe conditions of Temperature  
... Humidity ... Atmospheric Pressure ... Voltage ... or Vibration

**T**HE Clare Type "C" d.c. Relay, like all Clare "Custom-Built" Re-  
lays, has that unusual flexibility of design that permits the design  
engineer to have just the relay for the specific function required.

By "custom-building" the Clare Type "C" Relay in this way, Clare  
assures exceptional service in spots where hard usage, long life and  
absolute dependability are of prime consideration. Severe conditions  
of temperature, humidity, atmospheric pressure, voltage and vibra-  
tion are met by including in the relay construction the particular  
Clare feature or features to meet them.

The Clare Type "C" Relay can be "custom-built" to work perfectly  
under conditions that call for definite times for operation and release  
of the relay, high speed keying without contact chatter, marginal  
operation which may include close pick-up and drop-out values, the  
transfer and switching of high frequency circuits ... and many others.

Design engineers have found the innumerable contact arrangements  
possible with the Clare Type "C" to be valuable. Some of the impor-  
tant uses to which these relays have been put include:

- Sequence control of machine tools
- Radio, radar or other electronic controls
- Electric eye controls
- Counting equipment
- Alarm systems

Pictured and described here are some of the special Clare construc-  
tion features that make it possible for Clare Relays to so effectively  
reduce overall relay cost, simplify installation and insure better and  
more dependable performance.

Clare engineers are ready at all times to assist in developing a relay  
"custom-built" to your exact requirements. Send for the Clare catalog  
and data book. C. P. Clare & Co., 4719 West Sunnyside Avenue,  
Chicago (30), Illinois. Sales engineers in all principal cities. Cable  
address: CLARELAY.

# CLARE RELAYS

"Custom-Built" Multiple Contact Relays for Electrical, Electronic and Industrial Use

# 2 power sources



## THE G-E DYNAMOTOR

Designed to deliver high output from small frame size, G-E dynamotors have earned a reputation for thoroughly dependable service under adverse conditions. Compactly constructed and light in weight, these units are available in outputs of 15 to 350 watts intermittent (15 to 200 continuous) and with output voltages ranging up to 1500 volts d-c when operated on a 12- or 24-volt battery source. Weights range from 3 to 31 lb. These dynamotors are specially designed to minimize objectionable a-c ripple and consequent need for radio filtering.

## THE G-E INVERTER TRANSFORMER

Custom-designed for individual applications, G-E inverter transformers are compact and light in weight. They are specially designed for low internal heating, are quiet and efficient in operation, and readily interchangeable with correspondingly rated dynamotors. They can be designed for operation on a 6-, 12-, or 24-volt battery source, to supply wide range of output voltages—either a-c or d-c. Where conditions require, these units can be made dust-tight and can be shockmounted on rubber cushions.



# to choose from...

**Another example of how the variety of G-E components enables you to choose your own method of accomplishing a desired result.**

● If you have a problem involving a portable power supply for radio or allied electronic equipment, it will pay you to look into the merits of the dynamotor and inverter shown at the left. Similarly, if you have need for any of the many other components in the diversified G-E line, you can profit by discussing those needs with our engineers.

For every one of these G-E products has been worked out in close co-operation with designers in the electronic industries. All have been thoroughly tested—in our laboratories, in our customers' laboratories, and in labora-

tories operated by the Armed Services. More impressive still, many have been tested on the field of combat, where their dependability has proved a contributing factor in the success of a variety of radio and allied equipment.

Whether you are designing new electronic equipment or improving old designs, take advantage of the extensive line of G-E components and G-E electronic "know-how." Whatever your objectives, find out how G.E. can help you achieve them more simply or more economically. The G-E office near you will gladly furnish details. *General Electric, Schenectady 5, N. Y.*

**Buy all the Bonds you can—and KEEP ALL YOU BUY**



**GENERAL  ELECTRIC**  
642-3

  
**COMPONENTS  
for  
ELECTRONIC  
EQUIPMENT**



## Basic Types of Permanent Magnets

The thirty-six representative forms of permanent magnets shown above are adaptable to an infinite number of variations and uses. We have already made over 23,000 applications. Most of such applications are required to do some job which can be done better by magnetism than by other force, and are designed and engineered for this specific purpose. Permanent magnets are today making possible many mechanical and physical operations on implements of war which no other form of energy could actuate.

To determine the type of magnet for any industrial need calls for exceptional experience and research training in magnetics. As exclusive manufacturers of permanent magnets for over thirty-four

years, this company has pioneered many advances in magnetic technology. Our technical and engineering staff can help you to solve your problems in magnetization. Write for consultation . . . and ask for a copy of our informative article, "Permanent Magnets Have Four Major Jobs," from which the above illustration is taken.

## ★ THE INDIANA STEEL PRODUCTS COMPANY ★

6 NORTH MICHIGAN AVENUE • CHICAGO 2, ILLINOIS

Specialists in Permanent Magnets Since 1910

COPYRIGHT 1945, THE INDIANA STEEL PRODUCTS COMPANY

ELECTRONIC INDUSTRIES • January, 1945



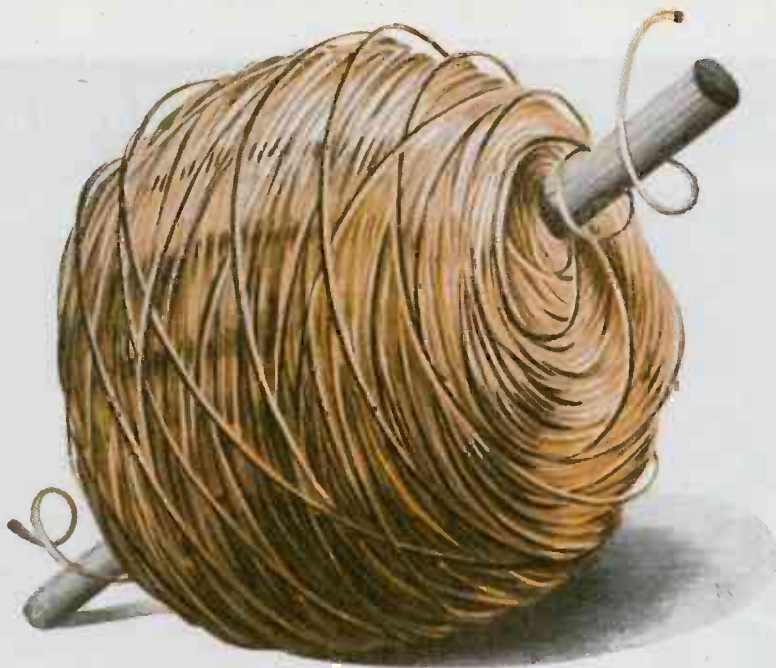

## *A Coil is more than just a bundle of wire*

ANACONDA COIL ENGINEERS have designed over 15,000 individual types of coils during their many years of experience. Some have weighed as little as 1/100th of a pound; others as much as a quarter of a ton.

But each coil began with a blueprint. Type, shape, size, winding, insulation, treatment, cost—every factor entering into designing the best coil for the use intended was pre-determined by Anaconda engineers.

Anaconda Coils derive dependability from still another advantage. The magnet wire used for winding them is also a product of Anaconda engineering—with quality carefully controlled from ore to finished wire.

It is a highly effective combination: Coil producers who can command the complete experience of magnet wire specialists! Magnet wire producers who

enjoy the close cooperation of coil experts!

And back of each are exceptional manufacturing facilities. Modern plants . . . efficient equipment likewise engineered . . . experienced, skilled personnel.

Any Anaconda sales office will be glad to refer inquiries on coils or magnet wire to our engineering staff. 44239



View of a modern coil winding department at one of the Anaconda plants.



*Magnet wire and coils*



## ANACONDA WIRE & CABLE COMPANY

GENERAL OFFICES: 25 Broadway, New York 4

CHICAGO OFFICE: 20 North Wacker Drive 6 • Sales Offices in Principal Cities

*Subsidiary of Anaconda Copper Mining Company*

NATIONAL RECEIVERS ARE THE EARS OF THE FLEET



OFFICIAL U. S. NAVY PHOTOGRAPH  
FROM FREDERICK LEWIS

EACH LST  
HAS TWO  
NATIONAL  
RECEIVERS



**NATIONAL COMPANY**

MALDEN  MASS, U. S. A.

NATIONAL RECEIVERS ARE IN SERVICE THROUGHOUT THE WORLD

# Whitaker Can Wire It

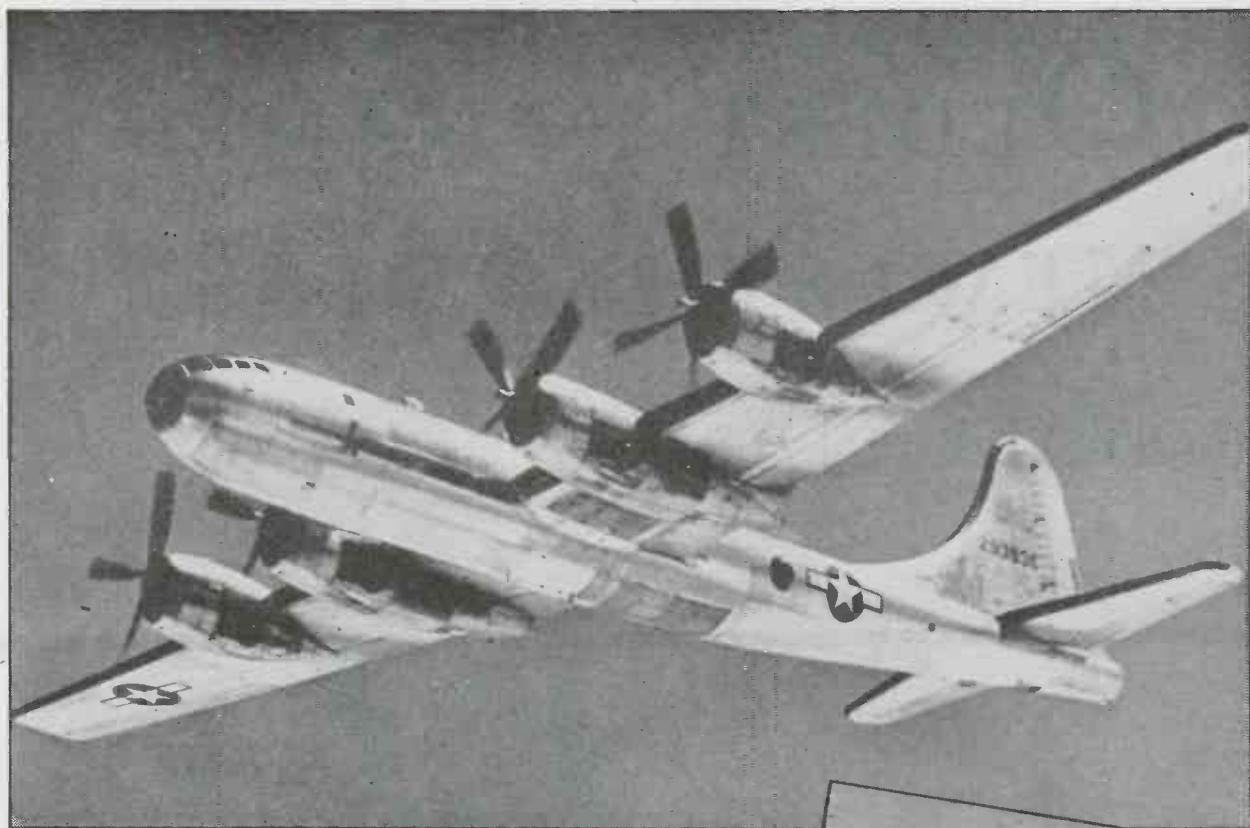

**IF YOUR  
PRODUCTION NEEDS  
include:**

- ★ **WIRING HARNESSSES**
- ★ **BONDING JUMPERS**
- ★ **CABLE ASSEMBLIES**
- ★ **CABLE or TERMINALS**

**--you'll find WHITAKER  
is a dependable source**

Whitaker has complete facilities for engineering and producing cable and wiring assemblies, harnesses, or any type of flexible leads for power and lighting.

In addition to an engineered wiring service, Whitaker also offers a quality line of standard cable products . . . Catalog on request . . . Your inquiries are solicited.

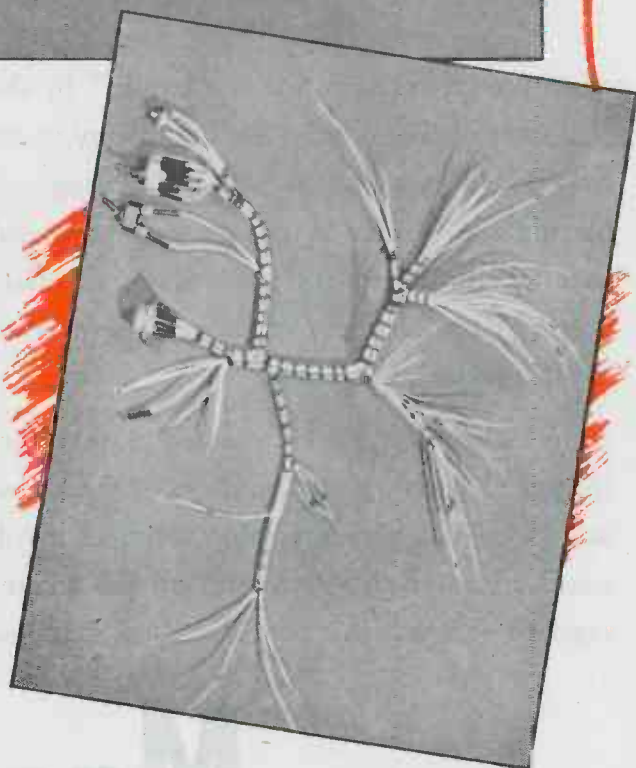

Wiring Harness Assemblies made by Whitaker vary from the simplest type of sub-assembly to others that are a major portion of the complete product.

## **WHITAKER CABLE CORPORATION**

General Offices: 1311 Burlington Avenue, Kansas City 16, Missouri  
Factories: Kansas City, Mo. • St. Joseph, Mo. • Philadelphia • Oakland

# OLDEST IN NAME— NEWEST IN IDEAS MAGNAVOX



**TYPE FP**

Improved processing technique insures fine performance, long life, economy, speedy delivery.

“LOOK TO THE PAST for the future” in the case of Magnavox. This company, with radio’s oldest name, is still pioneering . . . blazing new trails in design and advanced engineering. And its pioneering is made practical by 33 years of doing. *There is no substitute for experience!*

Specializing in FP (fabricated plate) Electrolytic Capacitors, with millions of them now in service, Magnavox is able to effect a full standardization program with all the advantages to you that this provides. Our technical

department is available for consultation regarding capacitors for special applications.

After Victory, we shall again serve the radio industry in the traditional Magnavox manner, with the added advantages of our new developments and the superb equipment of our new modern six-acre plant.



The Magnavox Company, Components Division, Fort Wayne 4, Ind.

**Magnavox**  
has served the radio industry 33 years

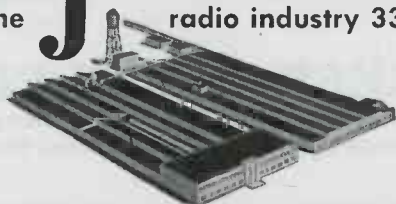

**SPEAKERS • CAPACITORS • SOLENOIDS • ELECTRONIC EQUIPMENT**

# Equipped to Surmount NEW PEACETIME PEAKS



AMPHENOL

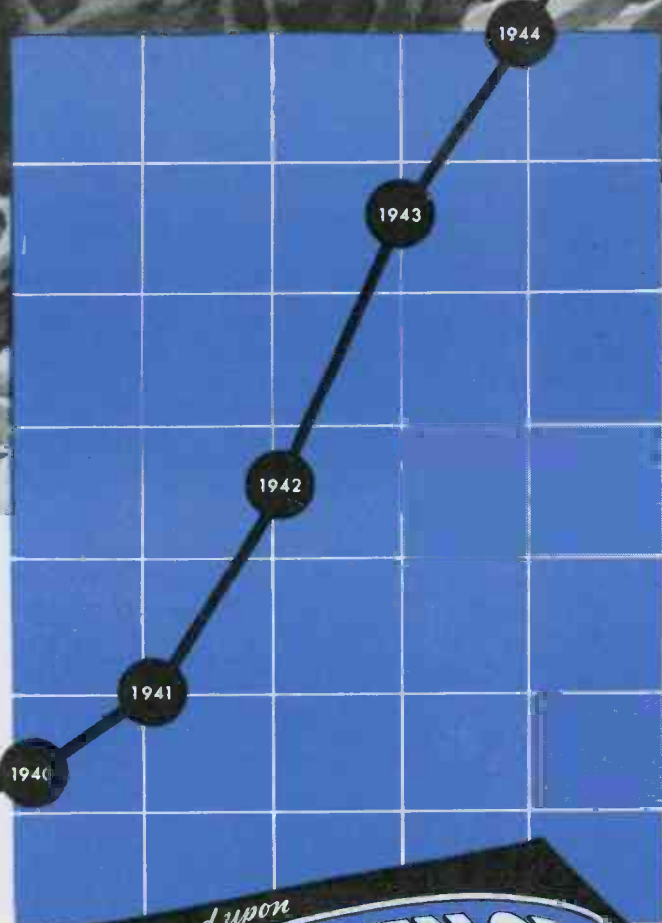

Depend upon

AMPHENOL

Quality

● Up to 1940 when war construction began, Amphenol had a long, proud record of achievement in the production of electrical transmission equipment of the better—more critical—kind. Among other "firsts" Amphenol had developed, and built, the first ultra-high frequency cable.

When production for the Air Corps, Army and Navy demanded precision far beyond that of civilian manufacture, Amphenol went to work exclusively for the Armed Forces . . . will continue working for Uncle Sam until the last bomb burst. When that time comes, the years of experience "under fire", the broadened perspective and knowledge will mean new and improved products, a source of supply of unlimited capacity. This is a rich background of experience in the production of parts for the users of electrical transmission equipment in the electronic, radio and electrical fields.

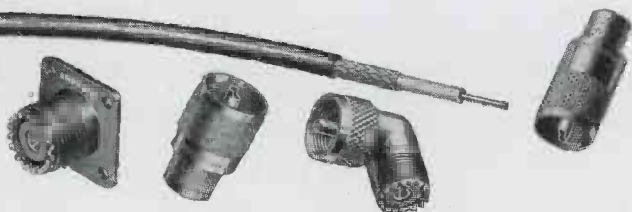

AMERICAN PHENOLIC CORPORATION, Chicago 50, Illinois • In Canada: Amphenol Limited, Toronto

Connectors (AN, British, U. H. F.) • Conduits • Fittings • Cable Assemblies • U. H. F. Cables • Radio Parts • Plastics for Industry

[www.americanradiohistory.com](http://www.americanradiohistory.com)

# BELL TELEPHONE LABORATORIES

*Exploring and inventing, devising and perfecting for our Armed Forces  
at war and for continued improvements and economies in your telephone service*

**R**ESearch, in the Bell Telephone System, has always been an expanding activity, growing with the scientific knowledge of the times and contributing to that knowledge. Upon it have been based important inventions and developments.

The telephone, itself, was invented in the laboratory where Alexander Graham Bell was carrying on researches in speech and hearing and laying the foundation for the electrical transmission of speech. As time went on the telephone research program expanded to cover every science which gives any promise of improved telephony and every engineering art which applies to the development, construction, installation and operation of telephone facilities.

These researches and development studies now cover electrical communication of speech—both by wire and by radio—the transmission of pictures (television)—and many important projects for war.

## *There Is No End to Progress*

Every new research gives rise to new inventions and to new lines for development and design. New inventions indicate new lines for more research. Research and development work, invention and design go hand in hand. In the early years, this work was carried in part by the American Telephone and Telegraph Company and in part by the Western Electric Company, the manufacturing unit of the Bell System.

For many years, however, this work has been assigned to a specialized unit, Bell Telephone Laboratories, Incorporated. Theirs is the responsibility for the technical future of the industry. They carry their developments from the first faint glimmerings which basic researches disclose to the final design of equipment and the preparation of specifications for its manufacture. And after manufacture and installation, they follow their products in operation; and continue development work to devise still more perfect

equipment, less expensive, more convenient and of longer useful life.

These policies and procedures of Bell Telephone Laboratories are distinguished by two characteristics. In the first place the Laboratories design for service. The consideration is not the profit of a manufacturer through first sales and replacement models but the production of equipment which will give the best service at the lowest annual cost when all factors are considered, such as first cost, maintenance, operation, and obsolescence. The Laboratories make no profit and the equipment they design is owned and used by the telephone companies; and the emphasis is upon that use.

## *Organized Co-ordinated Research*

In the second place the Laboratories design always with reference to the complete communication system in which the particular equipment is to play a part.

Reliable, economical telephone service, which is the product of its efforts, is not so much an assemblage of excellent apparatus as it is an excellent assembly of co-ordinated equipment—all designed to work together reliably and economically for a larger purpose.

It is not enough that Bell Laboratories shall design a new piece of electronic equipment which has merit or a new cable or telephone receiver. They must design with reference to all the other parts of the communication system so that the co-ordinated whole will give the best possible service.

## *4600 People in Bell Laboratories*

Bell Laboratories contributions to the Armed Forces derived in large part from the technical background that the Laboratories had acquired through their steadily maintained program of research. The Laboratories had special knowledge, skill and techniques which could instantly be diverted to war problems.

At the time of Pearl Harbor, over a quarter of the 4600 people in the

Laboratories had twenty or more years of service. This breadth of background made possible many engineering developments outside the strict field of communication and these have been of value to the Armed Forces. So far the Armed Forces and the O.S.R.D. have engaged the Laboratories on over a thousand major projects. The majority of these assignments have been completed; and have contributed to our victories on many fronts.

Most of the Laboratories developments, of course, have been in the field of electrical communication. Communication, not simply between individuals as in ordinary telephony, but between mechanisms—as in the electrical gun director. The Laboratories techniques and electronic researches have produced many secret weapons for our country's Armed Forces.

## *Leader in Electronic Development*

For those problems the Laboratories had a remarkable background of experiences in research and development. In World War I, they pioneered by developing radio telephone systems for talking between planes and between planes and ground stations. They also contributed methods and devices for locating enemy planes, submarines, and artillery.

In this war, Bell Laboratories have pioneered in the field of electronics. The Western Electric Company, which manufactures the designs of the Laboratories, is the largest producer of electronic and other war communication equipment in the United States and is now engaged almost exclusively in the manufacture of this equipment.

In war, Bell Telephone Laboratories devote their work to the needs of our Armed Forces. In peace, they are constantly exploring and inventing, devising and perfecting for continued improvements and economies in telephone service. Centralized research is one of the reasons this country has always had "the most telephone service and the best at the least cost to the public."

BELL TELEPHONE LABORATORIES



ELECTRONIC INDUSTRIES • January, 1945



# After ADOLPH and TOJO are **Q·R·T**

The rig he left behind is due for a big change when GI Joe comes home. War experience has been an "eye opener" for him. From chassis to sky wire many pre-war Ham outfits will undergo a major alteration and amazing technical advances will be put into practice. Stimulated by training and experience gained in the armed services thousands of new enthusiasts will swell the ranks of amateur radio.

When the gang goes back on the air again,

CQ'ing, SS or DX; UNITED will be ready to serve the Amateur with war-perfected Transmitting Tubes.

Since 1934 UNITED has specialized in engineering, designing and building Transmitting Tubes that set the Quality Standard for the entire Radio Industry. When performance counts UNITED Tubes provide a maximum of electronic efficiency—plus a long and dependable life. Accept nothing less than UNITED quality for your own tube requirements.

Order direct or from your electronic parts jobber.

## MASTERPIECE OF SKILLED HANDS

# UNITED

ELECTRONICS COMPANY

NEWARK, 2



NEW JERSEY

Transmitting Tubes EXCLUSIVELY Since 1934



813



DEPENDABLE

TROUBLE-FREE

SMOOTH ACTING

FAST CHANGING

FOOL PROOF

LIGHT NEEDLE PRESSURE



GET THESE QUALITIES IN YOUR RADIO-PHONO WITH  
**WEBSTER RECORD CHANGERS**

The soldier at the front is not easing off—he knows there is still a big job to be done. Do *your* full share, too.

**BUY AN  
EXTRA  
WAR BOND  
NOW!**

Yes, Webster is ready! With Webster Record Changers, your postwar combination will have faster change cycle than ever before . . . featherlight needle pressure, long record life, less needle scratch . . . smooth and fool-proof operation. The trade will be quick to endorse these improvements which mean satisfied customers and fewer profit-killing service calls . . . And, all this with remarkable economy of space.

**WEBSTER**



**PRODUCTS**

3825 W. ARMITAGE AVE.

CHICAGO 47, ILLINOIS

ELECTRONIC INDUSTRIES • January, 1945





more efficient  
... in miniature

The dainty watch that graces a lady's wrist is just as efficient a time piece as the huge chronometer of the century past. Modern engineering has made it so. Likewise, the modern miniature electronic tubes will do everything the large, old style tubes will do. The minute dimensions of miniature tubes themselves and their sockets open up entirely new possibilities in the compactness of electronic equipment.

Manufacturers of radio sets are invited to consult with TUNG-SOL engineers prefer-

ably while their equipment is in the blueprint stage. While continuing to make the old style tubes, for replacement, TUNG-SOL is now producing many of the same types in miniature and is preparing to produce others when set manufacturers require them. Of course, your future plans will be held in strictest confidence.

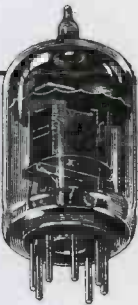

**TUNG-SOL**  
*vibration-tested*  
**ELECTRONIC TUBES**



**TUNG-SOL LAMP WORKS INC., NEWARK 4, NEW JERSEY**  
*Also Manufacturers of Miniature Incandescent Lamps, All-Glass Sealed Beam Headlight Lamps and Current Intermittors*

# Hours to Plot it... a Second to See it

## on a CATHODE-RAY TUBE

Curve tracing by means of cathode-ray tubes is faster, more accurate, more economical, and permits simultaneous comparison of several curves

Electrical measurement with RCA cathode-ray oscillograph tubes has saved countless hours for radio-set manufacturers. They use this method to trace the resonance curves of the r-f stages of receivers—and for many other purposes, too.

This use of RCA cathode-ray tubes has already been extended to fields other than radio—to applications such as determining pressure curves for internal-combustion engines, studying rapid variations in strain, measuring extremely short time-intervals, and for plotting other data which can be expressed graphically.

And these are but a few of hundreds of uses for cathode-ray tubes. Any physical or chemical phenomenon which can be translated into electrical impulses—and there are few which cannot—can be studied visually on the screen of an RCA cathode-ray tube, whether depicting a single, static condition, or a number of simultaneous, fluctuating conditions.

Perhaps you are building equipment in which cathode-ray tubes could be used to advantage for visual indication of proper adjustment, or measurement of performance, or the correlation of several variables of operation.

If so, why not take advantage of the expert knowledge of RCA tube-application engineers? RCA has the tubes, the engineering "know-how," and the willingness to help you utilize cathode-ray tubes in your products.

Address inquiries to RCA, Commercial Engineering Section, Dept. 62-38J, Harrison, New Jersey.

*The Magic Brain of all electronic equipment is a Tube...and the fountain-head of modern Tube development is RCA.*



62-6236-38

### RADIO CORPORATION OF AMERICA

RCA VICTOR DIVISION • CAMDEN, NEW JERSEY

V. R. S. — Buy More War Bonds V. R. S. —



Here's information you can use, **NOW!**

New FIBERGLAS\* ELECTRICAL INSULATION MATERIAL BOOKLET . . . TELLS WHAT TYPE TO USE, WHERE AND HOW . . .



This free, new booklet will be helpful to anyone concerned with the specification or application of electrical insulation.

It will help you determine which of the many types of Fiberglas electrical insulation materials should be used for a specific job.

The booklet will show you where this better insulation material can be used advantageously for electronic, radio and electrical applications.

It will indicate the ways to use Fiberglas electrical insulation material to obtain all of the benefits which it affords.

Containing complete information about Fiberglas, the new booklet illustrates Fiberglas fibers and filaments twisted into yarns, served on wires, woven into tapes and cloths, braided into sleeveings and formed into tying cords.

It describes the unique combination of elec-

trically and mechanically important characteristics of Fiberglas such as: high temperature, moisture and acid resistance, favorable space factor and high tensile strength. It shows how the insulating impregnants increase the effectiveness of Fiberglas' inherent characteristics and add others such as high dielectric strength, insulation resistance and resistance to abrasion.

You will see why the use of this basic, inorganic, insulating material is increasing so rapidly—why so many designers, manufacturers and repair shop operators prefer it.

Be sure to have a copy of this new booklet in your file for ready reference. Write for your copy today—there is no obligation. Address: *Owens-Corning Fiberglas Corporation, 1867 Nicholas Building, Toledo 1, Ohio. In Canada, Fiberglas Canada Ltd., Oshawa, Ontario.*

Fiberglas varnished cloth and tape



Fiberglas insulated wire



Fiberglas tying cord



Fiberglas saturated sleeveing and varnished tubing



Fiberglas laminated plastics



Fiberglas-mica combinations



# FIBERGLAS

\*T. M. Reg. U. S. Pat. Off.

ELECTRICAL INSULATION MATERIAL

**Your Product Designers May Need**

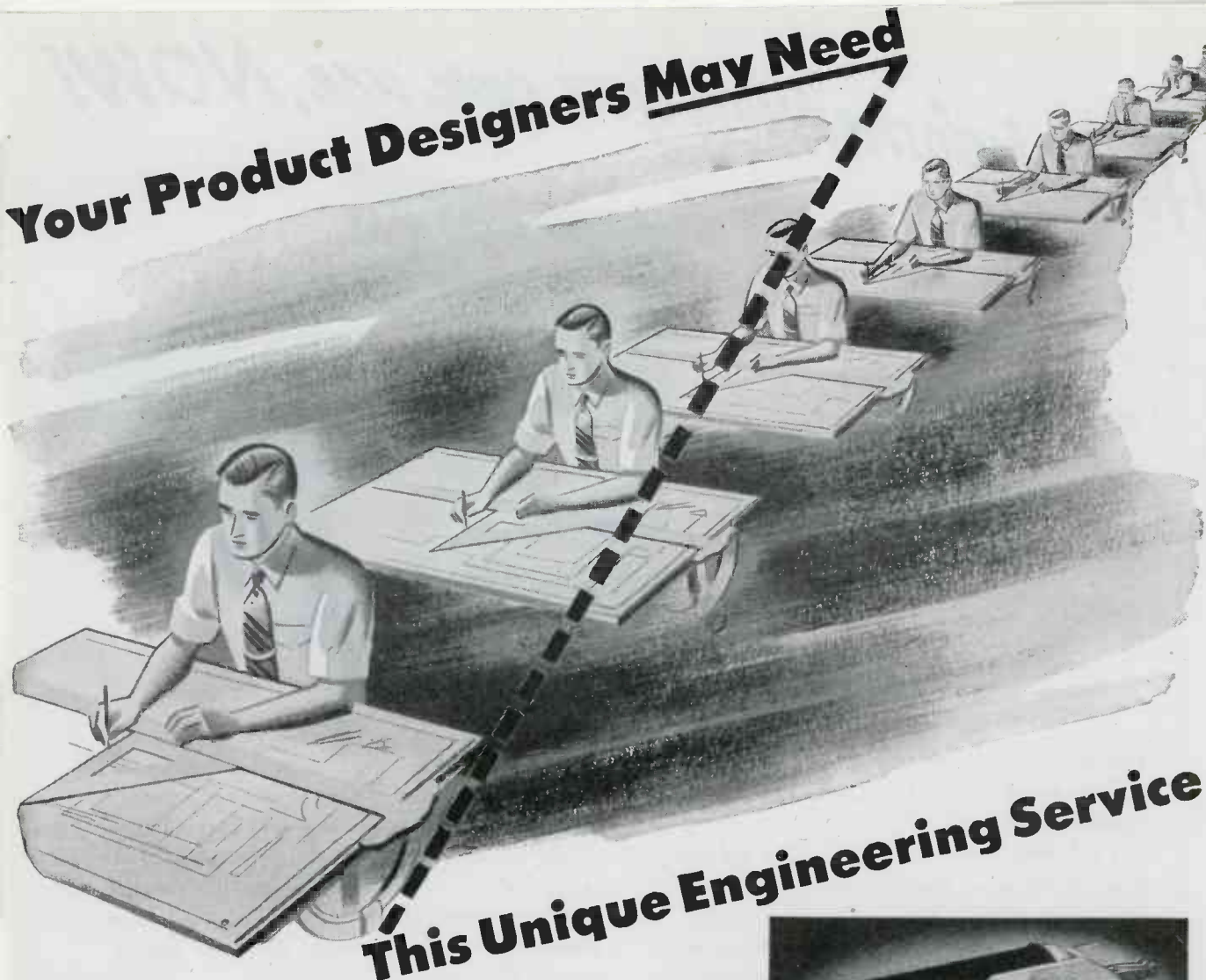

**This Unique Engineering Service**

There are hundreds of products on drawing boards today that will do a better job at lower cost with the *right* electrical control apparatus. The problem is: precisely what apparatus?

That is where the Automatic Electric field engineer can help. He is a specialist in electrical control, backed by an organization that offers this three-point service:

1. Technical advice by experienced field engineers, who know the "how" and "why" of control technique.
2. A complete range of relays, stepping switches and other control units—time-proved products readily adapted to your needs.
3. A design and manufacturing service for complete engineered assemblies.

Ask our field engineer for a copy of our catalog of control devices. He will be glad to show you how they can serve you.

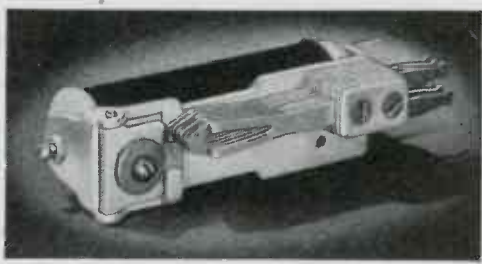

Here are jobs that can be done easier and better with Automatic Electric control devices:

- Automatic Selection and Switching of Circuits
- Time, Temperature and Sequence Control
- Counting and Totalizing
- Inspection and Sorting Operations
- All Types of Electrical and Electronic Control.

*Relays*  
AND OTHER CONTROL DEVICES  
*by* **AUTOMATIC ELECTRIC**



**AUTOMATIC ELECTRIC SALES CORPORATION**  
1033 West Van Buren Street • Chicago 7, Illinois

In Canada: Automatic Electric (Canada) Limited, Toronto

**PARTS AND ASSEMBLIES FOR EVERY ELECTRICAL CONTROL NEED**



***"I'LL BE BACK. I FORGOT TO TELL THE BOSS THAT  
ALBION CAN SHIP ALL THE COILS HE NEEDS"***

**SUPER-QUALITY COILS AT REASONABLE PRICES**

More and more every day, the industry is turning to Albion for fast, quality and quantity production of coils, chokes, and transformers. That's because here you benefit from the unbeatable combination of management "know how," skilled workmanship, streamlined facilities, and central location. Your requirements will be given prompt and thoughtful attention.

ELECTRONIC INDUSTRIES • January, 1945

**ALBION  
COIL COMPANY**

ALBION, ILLINOIS

R. F. AND TRANSMITTING COILS AND CHOKES;  
I. F. TRANSFORMERS

**HEAT COMES UP  
200 DEGREES IN  
90 SECONDS...**

IN A 5 LB. PREFORM IN THE NEW

**Thermatron**  
**"HEATMASTER"**  
5 kilowatt plus output  
**MORE BTU'S PER DOLLAR**

NEW HIGH POWER • NEW LOW PRICE  
NEW LONG-LIFE TUBES • NEW SIMPLE CONTROLS

Send for Circular on the new "HEATMASTER"  
and other Thermatrons from 500 W to 30 KW output.



# Thermatron

## ELECTRONIC HIGH FREQUENCY HEATING

This powerful new force is now available to industry in the **Thermatron** offering—

- simplified controls
- economy in cost and operation
- safety for unskilled personnel
- guaranteed results

The **Thermatron** heats, sterilizes, dehydrates, roasts, evaporates, melts and bonds. New applications discovered daily.

Investigate the great potentialities of **Thermatron** internal heat generation—heat without flame—by electronic high frequency currents. It is revolutionizing

many manufacturing processes, lowering costs and making possible many new products. Its usefulness has been proved in the following general fields among others—

<b>Plastics</b>	<b>Ceramics</b>
<b>Drugs and Chemicals</b>	<b>Food Products</b>
<b>Wood Products</b>	<b>Textiles</b>
<b>Paper</b>	<b>Rubber</b>

Let us fit a **Thermatron**  
to your factory—sizes 500w to 30 kw.

To learn how **Thermatron** Dielectric High Frequency Heaters can work for you, write or phone, stating nature of your application to —The Manager...

## Thermatron Division

**RADIO RECEPTOR COMPANY, INC.**  
251 WEST 19th STREET  
NEW YORK 11, N. Y.

SINCE 1922 IN RADIO AND ELECTRONICS



# QUICKER THAN YOU CAN READ THIS HEADING

The Operator  
has sealed  
another  
TIME-DELAY TUBE  
for a

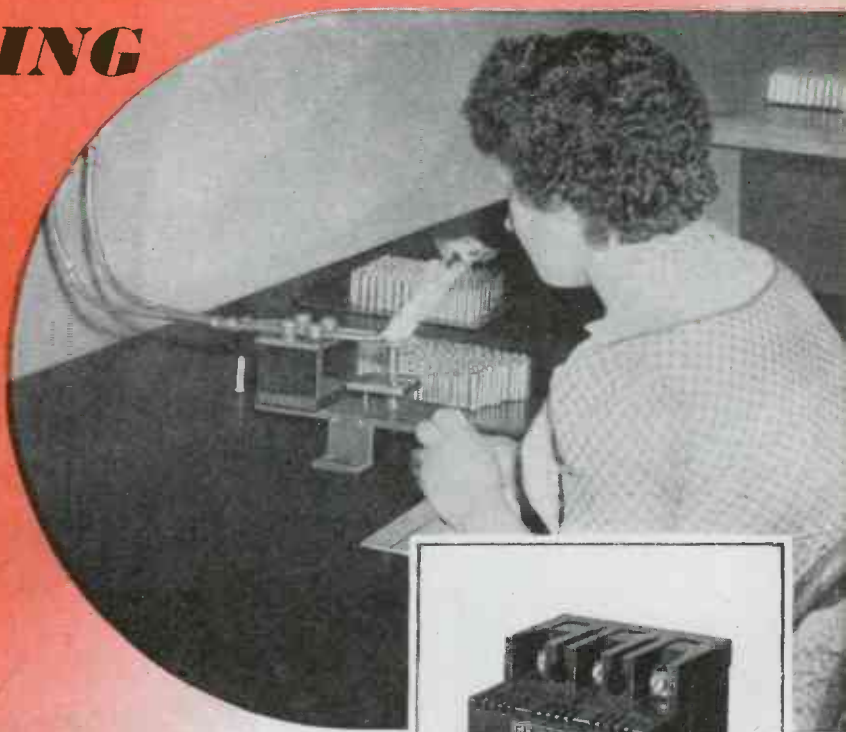

## HEINEMANN MAGNETIC CIRCUIT BREAKER

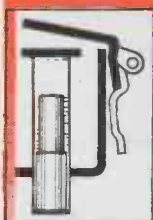

Plunger in normal position at bottom of cylinder.



Plunger after overload with armature attracted to pole piece, opening contacts.

Every time-delay type HEINEMANN Circuit Breaker is equipped with a time-delay tube. This operates so that the contacts open with a speed in inverse ratio to the amount of overload current passing through the breaker coil which surrounds the tube. The time-delay prevents the breaker from opening on sudden inrush currents, but allows it to open on sustained overloads. The plunger action in the liquid-filled tube shown at the left is the secret of how this is accomplished. The speed with which the plunger is drawn toward the pole piece depends on the viscosity of the liquid.

*By means of a special apparatus developed by this company, the operator hermetically seals the time-delay tube in ONE SECOND by melting and spreading a drop of solder over the end cap of the tube. This is done by thrusting it into the field of a high-frequency induced current.*

*Speed is necessary, since the tube is entirely filled with a liquid which would boil and explode the tube if the heat lasted too long.*

Send For Catalog Showing Complete Line and Engineering Data  
**HEINEMANN CIRCUIT BREAKER CO.**

Subsidiary of Heinemann Electric Co., Est. 1888

137 PLUM STREET

TRENTON, N. J.

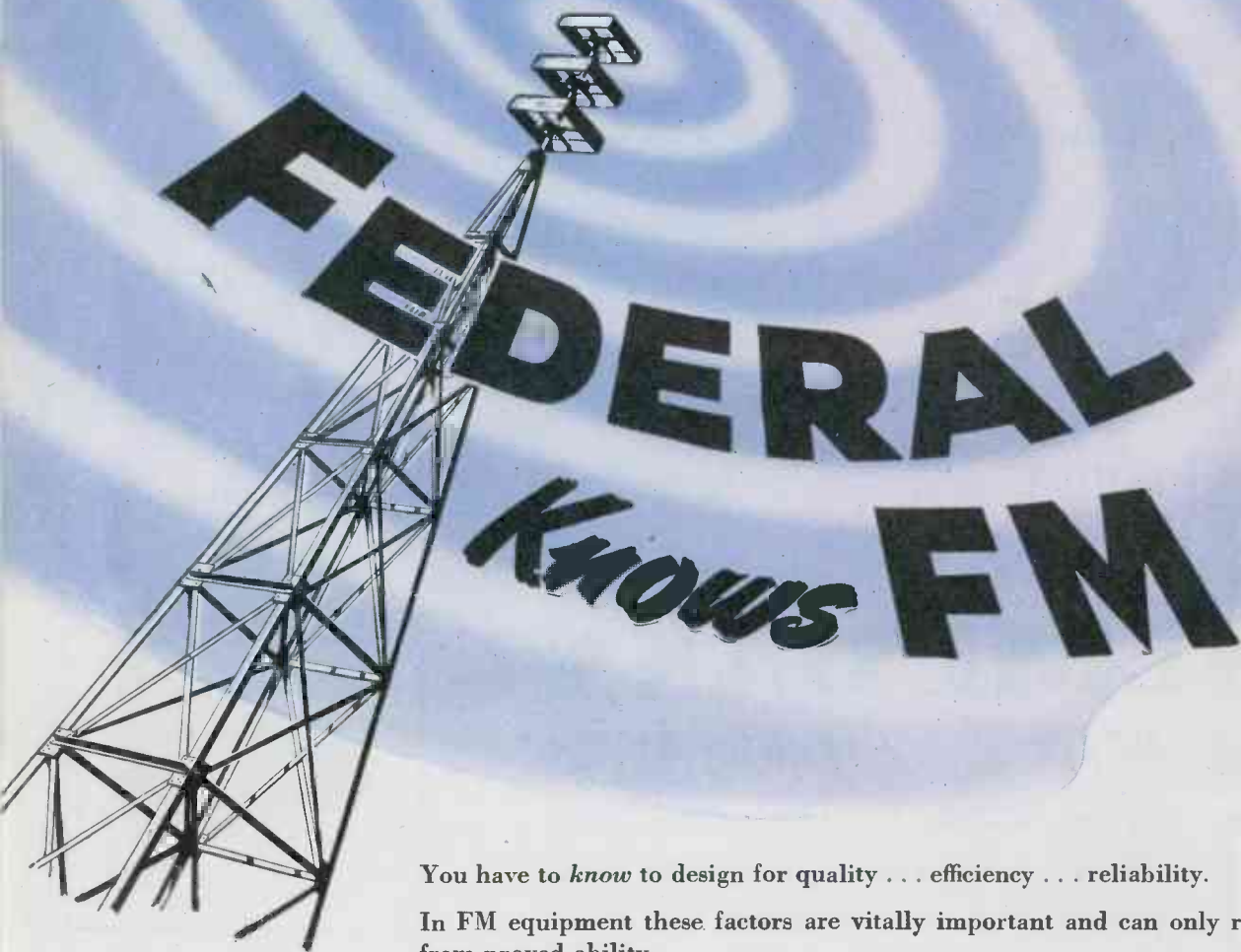

You have to *know* to design for quality . . . efficiency . . . reliability.

In FM equipment these factors are vitally important and can only result from proved ability.

You will find this ability at Federal — whose engineer-specialists *know* FM.

Federal's broadcast equipment has earned an enviable reputation . . . the end result of a long list of impressive achievements. It was Federal's engineers who contributed their knowledge to the development of the "Micro-ray", the forerunner of modern high-frequency technique.

This pool of research and development experience, working in the same tradition of perfection, is now responsible for Federal's FM equipment — the ultimate in modern engineering design.

Look to Federal for complete FM installations . . . antennas, cables, transmitters, transformers, vacuum tubes . . . all backed by Federal's name . . . the name that stands for the best in broadcast equipment.



*Federal Telephone and Radio Corporation*



Newark 1, N. J.



# NO LOST TIME FOR *Reconversion*



## These Controls Are Ready

Practically every Ward Leonard Product used for war purposes required little or no equipment change. The controls of the machines of peace are essentially the same controls of machines of war. Hence, when the entire facilities of Ward Leonard were needed for the war emergency, production went on as usual, only in greater magnitude. Those same facilities are available for postwar production as and when they are released from war service. Again the change-over will be made without delay as there is no need for reconversion. The products are the same except for specifications and will be made by the same workers and same machines. When planning the controls for your postwar products, you will save time and money and be assured of war-tested units, controls and assemblies by making your selection from the Ward Leonard line. Send for bulletins describing controls of interest to you.

# WARD LEONARD

**RELAYS • RESISTORS • RHEOSTATS**

Electric control  devices since 1892.



**RELAYS**

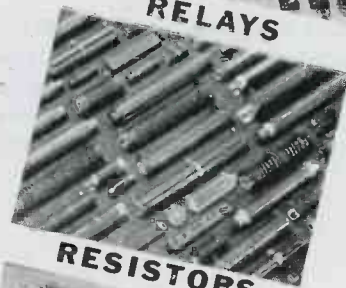

**RESISTORS**



**RHEOSTATS**

WARD LEONARD ELECTRIC COMPANY • 61 SOUTH ST. • MOUNT VERNON, N. Y.

# ANNULAR SOUND DISTRIBUTOR

*Absolutely uniform over 360 degrees*

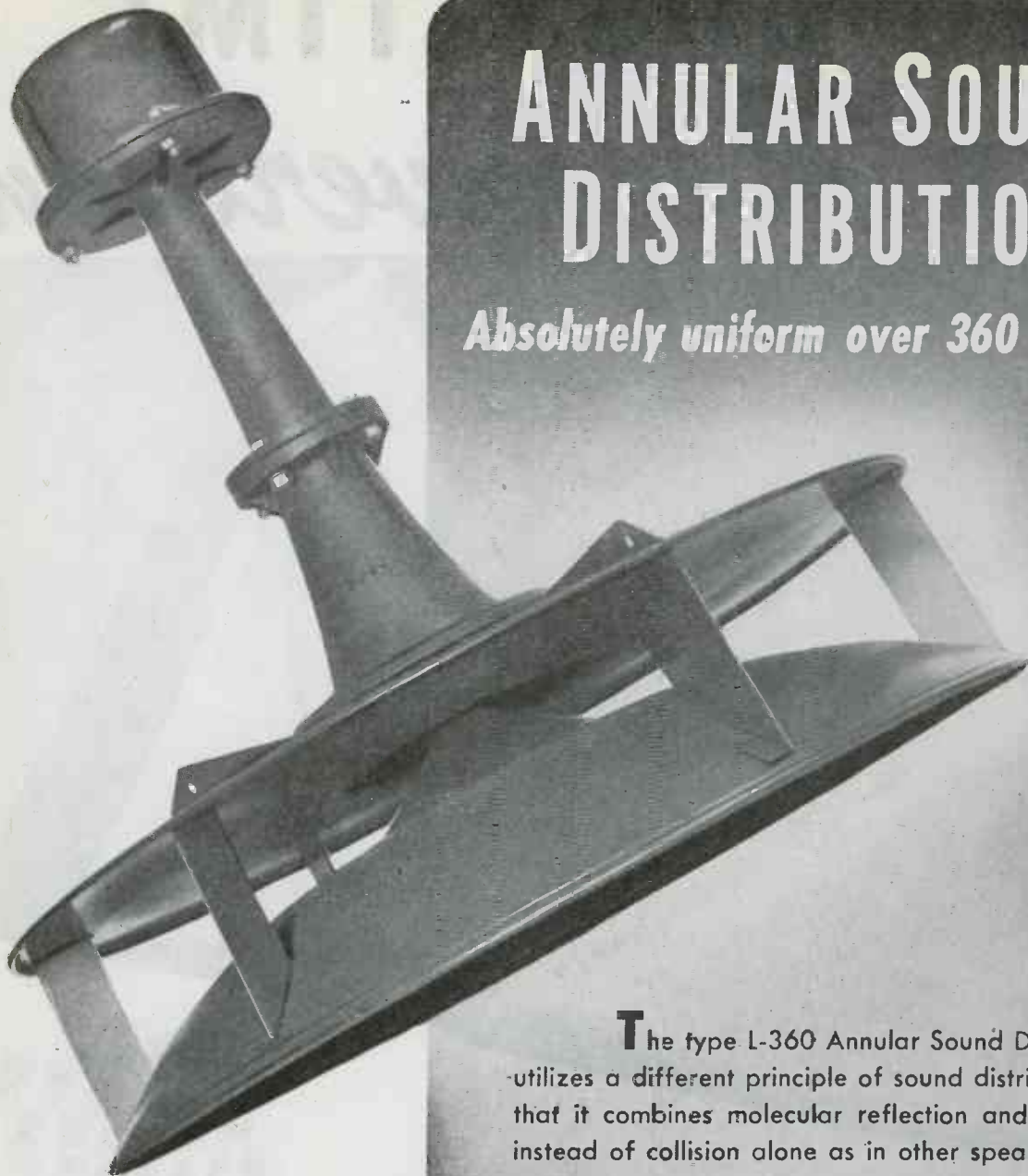

Above illustrated Langevin Type L-360 Distributor equipped with Jensen U-20 Drive Unit. When so equipped will safely handle power input of 20 watts. Design patent pending.

*Bulletin Upon Request*

The type L-360 Annular Sound Distributor utilizes a different principle of sound distribution in that it combines molecular reflection and collision instead of collision alone as in other speakers. The use of this principle results in a uniformity of sound distribution both as to frequency and power over a horizontal plane of 360 degrees and a vertical plane of approximately 40 degrees. Acoustical output characteristics available on request. Type L-360 Distributor is 23" in diameter with an over-all height of 25".

## *The Langevin Company*

INCORPORATED

SOUND REINFORCEMENT AND REPRODUCTION ENGINEERING

NEW YORK  
37 W. 65 St., 23

SAN FRANCISCO  
1050 Howard St., 3

LOS ANGELES  
1000 N. Seward St., 31

# MAILED FREE on request!



At last! Industries' new and revolutionary heating process explained in a language understandable to everyone. In fifteen minutes reading time, you will gain a complete basic knowledge of Electronic Heating. This important handbook discusses all the essential facts you have to know in considering the application of Electronic Heating to your own manufacturing methods.

It contains a brief record of the historical background and development of the process — explains the principle of its operation — describes the two chief methods and fields of application and lists many proved present-day uses.

Let us send you a complimentary copy at once. Fill in the coupon or write on your company letterhead.



Manufacturers of Vacuum Tube and Spark Gap Converters since 1921

## Scientific Electric

DIVISION OF "S" CORRUGATED QUENCHED GAP COMPANY

119 Monroe Street

Garfield, New Jersey

### USE THIS COUPON FOR CONVENIENCE

SCIENTIFIC ELECTRIC  
119 Monroe Street, Garfield, N. J.

Please rush my complimentary copy of *The ABC of Electronic Heating* today to:

Name..... Title.....

Company Address.....

City..... State.....

# Design value

goes beyond

price

What does one designer build into his product that makes it sell at a profitable price, while a competing article loses money for its producer?

Little things, often hidden things. Little things that make a big difference, like Lord Shear Type Mountings of Bonded Rubber.

Where there is machinery in motion, there is vibration, and vibration means strain to machine and to man. Lord Shear Type Mountings and other bonded rubber products control and isolate vibration.

Factories that are quieter, pleasanter, more efficient; automobiles, trucks, buses, locomotives, airplanes that are smoother and safer in operation; delicate laboratory equipment that is made more accurate and trust-worthy; these are the results that Lord is helping designers and manufacturers to accomplish.

The science of vibration control and isolation has been developed by Lord for more than twenty years. This accumulated experience is available to you, without cost, whenever you are faced with a vibration problem.

Write for free literature which will bring you up to date in factual information on vibration control. Lord Vibration Engineers will work with you to bring your product to a new standard of perfection.

Buy More War Bonds

IT TAKES RUBBER *In Shear* TO ABSORB VIBRATION

**LORD MANUFACTURING COMPANY**  
ERIE, PENNSYLVANIA

SALES REPRESENTATIVES  
NEW YORK - 280 MADISON AVE.  
CHICAGO - 520 N. MICHIGAN AVE.  
DETROIT - 7310 WOODWARD AVE.  
BURBANK, CAL. - 245 E. OLIVE AVE.  
CANADIAN REPRESENTATIVES  
RAILWAY & POWER ENGINEERING CORP., LTD.  
TORONTO, CANADA

Originators of Shear Type Bonded Rubber Mountings



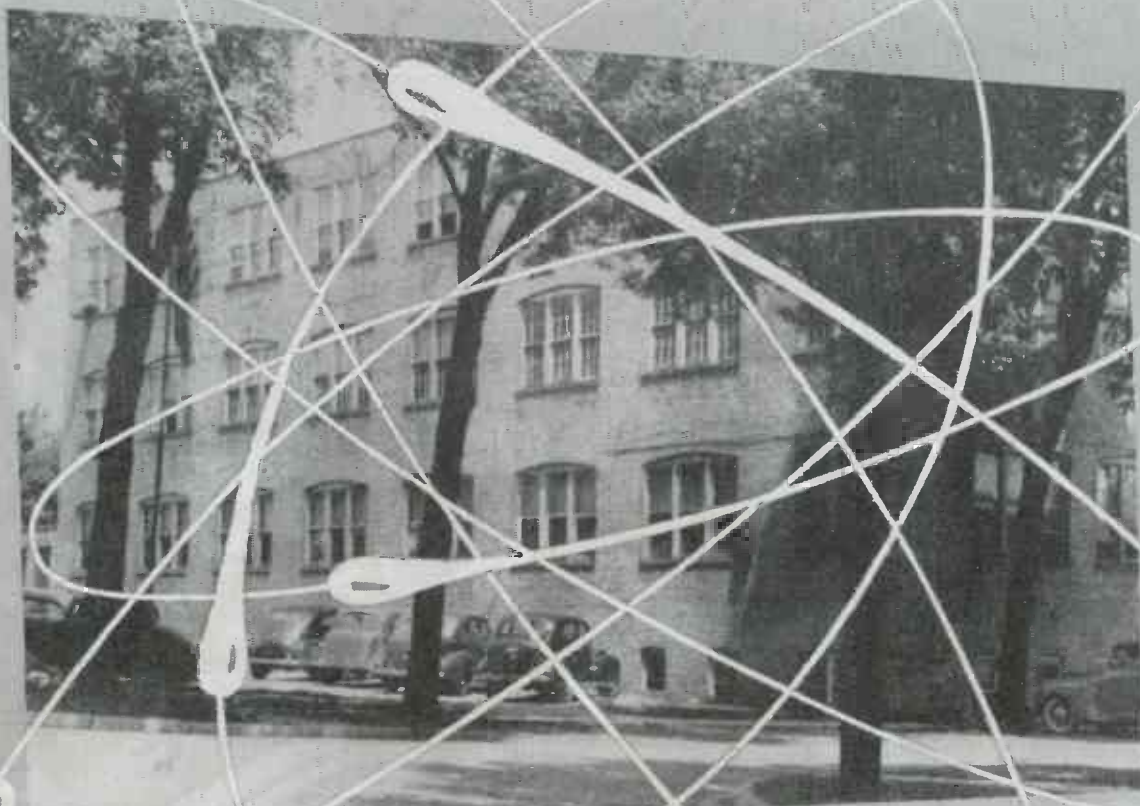

THE HOME OF **CETRON**  
*is a Hub of Activity*

Long before war started, Cetron tubes were firmly established as being well-nigh indispensable to many industrial operations. Countless industrial engineers, who themselves "know their stuff" consistently look to, and consult with Cetron engineers when any important tube problem must be solved.

For the duration we, like other manufacturers, have devoted a large share of our efforts to supplying important needs of the Armed Forces. But during this period we still have been able to take care of most urgent civilian industrial needs. We have increased our capacity as well as the scope of our technical knowledge . . . turning out more serviceable tubes even than formerly, for a more broader usage. In the field of phototubes, especially, Cetron now occupies the premier position in producing these tubes for all sorts of purposes. Our Rectifiers and Electronic Tubes of many types are improving efficiency and increasing productivity in a host of industries.

In your own operations there may be places where Cetron tubes could radically and favorably affect operating costs. We invite you to outline your problem, whatever it may be, for consideration by our engineers without obligation.



**CONTINENTAL**  
**ELECTRIC COMPANY** GENEVA, ILL.

★ CHICAGO OFFICE, 903 Merchandise Mart  
NEW YORK OFFICE, 265 West 14th Street

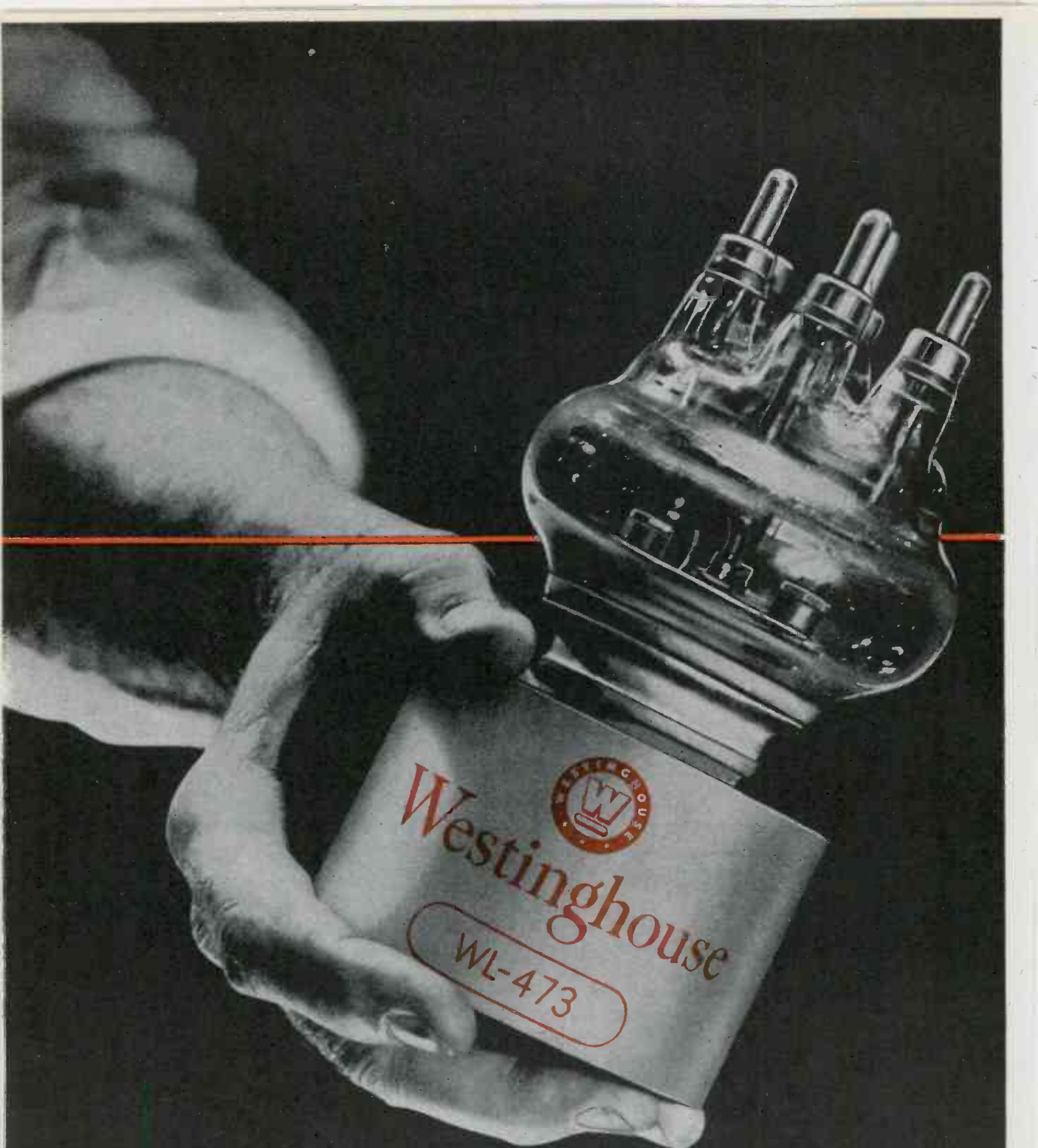

  
Westinghouse

WL-473

# Westinghouse

PLANTS IN 25 CITIES . . . OFFICES EVERYWHERE

# Concentrated POWER

... in this new

## Westinghouse Tube!

Westinghouse announces the production of a new electronic tube—a Pliotron no larger than a man's hand but delivers two and one-half kilowatts of plate power. It is low in cost but high in quality, and is designed for applications in dielectric and induction heating, and in AM and FM radio transmission.

It is small and compact even though air cooled, and designed to deliver full plate output at frequencies up to and including the present FM band.

Designers of electronic devices will find in

the small size and large output of this tube the answers to many of their problems. In addition, it has the same rugged dependability that characterizes all Westinghouse Electronic Tubes.

The outstanding features of the WL-473—which are exclusively Westinghouse—will appeal to you. Ask your nearest Westinghouse Electronic Tube Distributor or write to the Westinghouse Electric and Manufacturing Co., Lamp Division, Bloomfield, N. J. for complete information.

*Quality Controlled Electronic Tubes*





## Entirely Collins equipped...

BRANIFF AIRWAYS, INC. has been using Collins ground transmitters since 1935 and Collins aircraft transmitters since 1937.

It was the first great airline to recognize the superiorities of Collins design, workmanship, and performance, the first to avail itself of the precise, sturdy, reliable Collins Autotune.\*

Today Braniff uses Collins multi-channel or Autotune equipment at every point at which it has a radio station, and every ship in its *Super B Liner* fleet carries a Collins 17F Autotune aircraft transmitter.

There is a deep satisfaction in having supplied the nerve-system on which Braniff relies in maintaining its magnificent record of safety and operating efficiency.

When Collins turned to war production, it could apply the know-how that came from furnishing communication equipment which met the exacting needs of Braniff and other major airlines. When it returns to civilian design and production, it will add to that know-how the tremendously increased, intensified experience acquired in its services to the Armed Forces. Collins Radio Company, Cedar Rapids, Iowa.



\*The Collins Autotune is a repositioning mechanism which quick-shifts all transmitter or receiver tuning controls simultaneously and with extreme precision to any one of a number of pre-determined frequencies. Patents issued and pending in the USA and other countries.





**IT ALL DEPENDS ON**

**WHERE YOU PUT THE BRUSH**

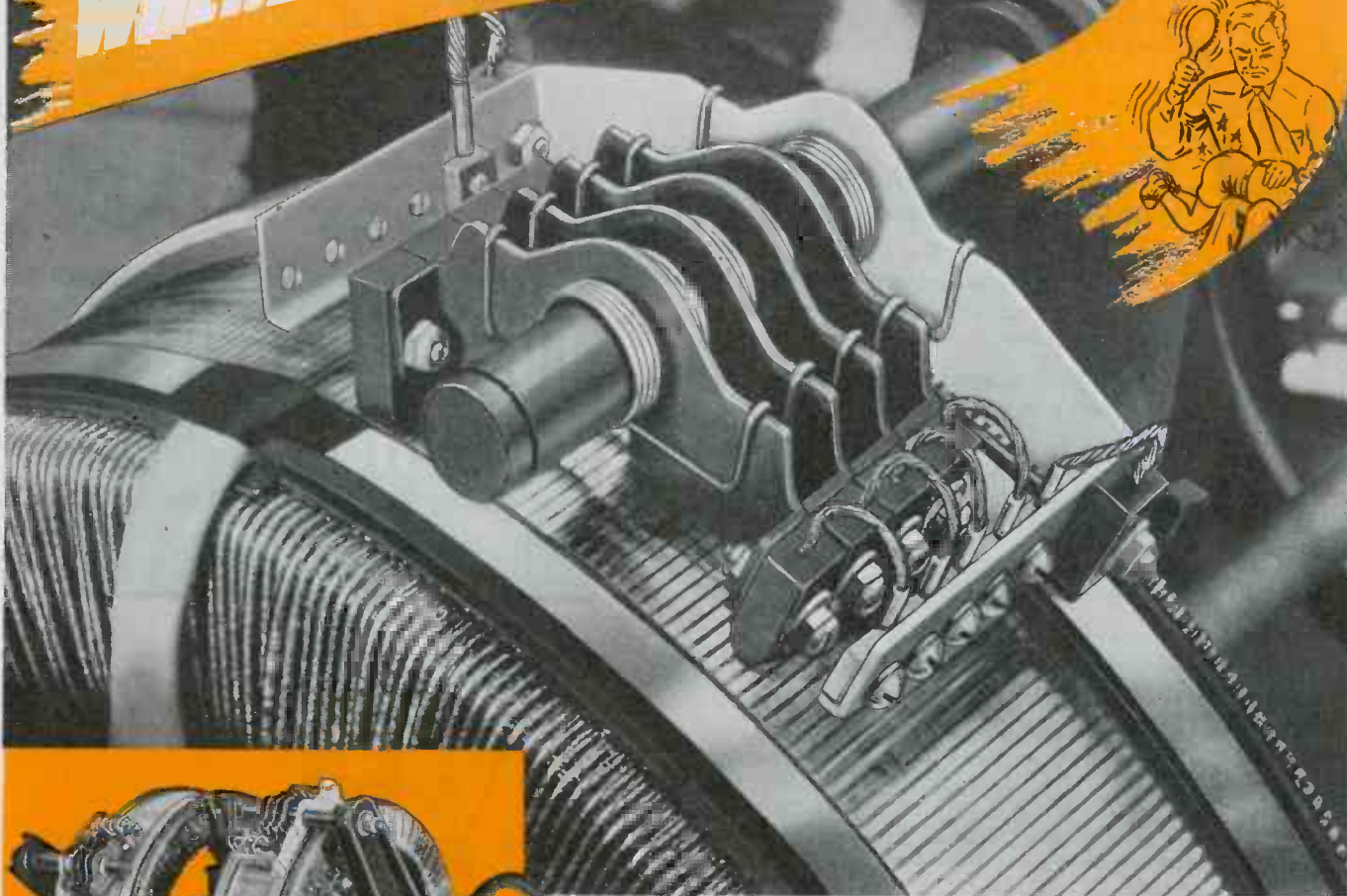

11.5 KVA, single phase,  
50/60 cycles, input  
115 Volts, output 0-115  
Volts, 100 Amps.

**T**opside or bottom—a hair brush can be applied effectively at either place according to the result desired. But the commutator brush on an a.c. voltage regulator is different. Only **one** place will do for best results and that is where the Transtat's brush track is.

Instead of on the commonly used flat annular section, where brush area is limited, the Transtat brush rides on the curved outside surface of the coil. There, the uniformly laid wires permit grinding smooth, perfectly parallel, evenly spaced commutator segments. That means arc-less, prac-

tically stepless control without circuit interruption. This position allows room for the long, sturdy Transtat brushes with their larger heat dissipating surfaces and lower current density per contact area . . . cooler running, longer lasting brushes.

Being transformer type regulators, Transtats will not distort wave form or alter power factor. Their varnish-impregnated cores and coils cannot loosen in service. The balanced collector arms maintain brush setting in any position. For continuous a.c. voltage regulation in testing, heating, plating, light control, speed control and in radio transmitters and other electronic apparatus they are unexcelled. Write for bulletin 51-2.

AMERICAN TRANSFORMER COMPANY • 178 Emmet Street, Newark 5, N. J.



Pioneer Manufacturers of Transformers, Reactors and Rectifiers for Electronics and Power Transmission



# SKILL OF THE SPECIALIST

Twenty seven years ago she started work at C-D.  
That was in our first plant.

She is still with us. But the scene has changed.  
Equipment undreamed of in 1917, now speeds  
millions of capacitors to the great names in  
American industry.

*Here at C-D long service is not unusual.* In our  
six plants we have many old-timers.

Their love for the job, their fierce pride in  
perfection, their insistence on maintaining qual-  
ity standards is an "extra" you get from C-D.  
An "extra" that means long, stable capacitor life.

Engineers know this. That's why there are more  
C-D's in use than any other make.

*If you have a capacitor problem, one of our  
basic innovations in design, engineering or  
manufacture may be the answer.*

Write to Cornell-Dubilier Electric Corporation,  
South Plainfield, New Jersey.

*other plants: New Bedford, Brookline,  
Worcester, Mass., and Providence, R. I.*

These tiny featherweight  
1R Silvered Mica Capacitors  
withstand extremes of  
temperature and humidity.  
Extra heavy silver coating  
thoroughly bonded to mica,  
practically no drift with  
time. Tinned brass leads bend  
easily without breaking.

## CORNELL - DUBILIER CAPACITORS



WET AND DRY ELECTROLYTICS MICA • DYKANOL • PAPER •



# SYNCHRONIZATION OF VIBRATORS FOR PARALLEL OPERATION

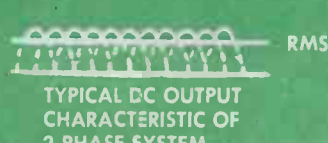
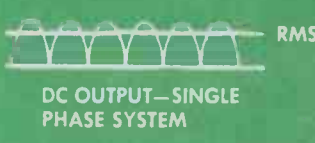
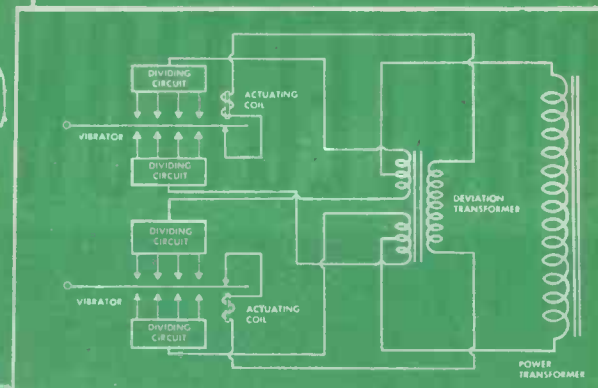
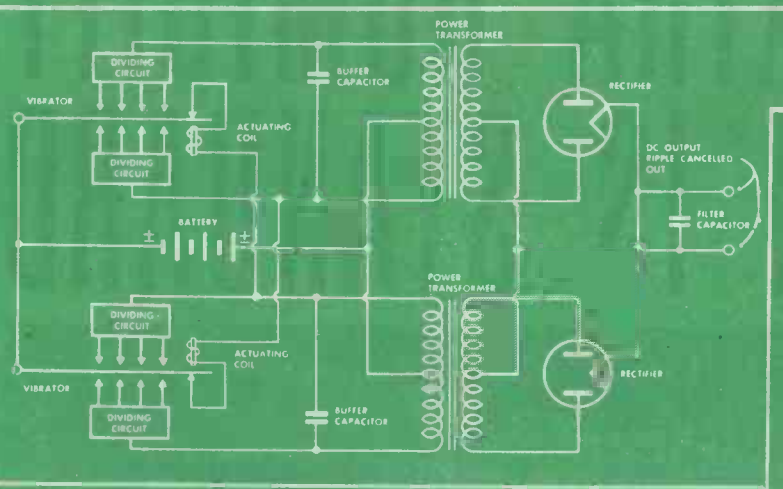

Typical E-L single-phase and two-phase circuits of dual vibrators which permit power outputs in excess of 1,000 watts.

While improvements in circuit technique developed by Electronic Laboratories have allowed commutation of currents up to 25 to 30 amperes, recent requirements for increased power have necessitated introduction of dual vibrator circuits thereby doubling the output of E-L Power Supplies. Both in-phase and two-phase systems are available permitting output powers in excess of 1000 watts.

## Parallel Operation — Single-Phase — A.C. Output

In units furnishing A.C. power as output, the vibrators must operate in phase. This operation is secured by means of modulating voltage obtained from a secondary placed on a current dividing reactor, which insures the division of the current between the two vibrators. The primary is center-tapped with the center tap feeding the power transformer, while the ends connect to power contacts on the same side of the respective vibrators. If one vibrator makes contact before the other there will be a voltage induced in the secondary of the transformer. This induced voltage is applied to the actuating coil of the other vibrator in such a way as to be in phase and thereby cause it to increase its frequency and decrease that of the higher frequency vibrator. When the vibrators reach the same frequency it is obvious there will be no modulating voltage. The time constant of the current division network is such as to take care of small time differentials. The circuit has the further advantage of allowing the use of one large power transformer which gives higher efficiency than can be secured by using two smaller ones.

## Parallel Operation — Two-Phase — D.C. Output

In vibrator power units which have a filtered D.C. output, the advantages of a two-phase system are obvious in the reduction of the filter network required to secure a given A.C. ripple on the output.

To correct any possible frequency deviations, Electronic Laboratories' engineers have cross-modulated the D.C. voltage applied to the respective actuating coils with an A.C. voltage secured from the opposite transformer primary. The A.C. voltage is of such a value that the alternate in- and out-of-phase relationship effectively forces the vibrators to assume the same frequency. The 90° phase relationship essential to insure low ripple outputs from associated rectifiers is secured by the action of the modulating voltage, inasmuch as the vibrator having the higher natural frequency will make contact first upon the application of the input voltages. This causes the effective voltage on the actuating coil of the lower frequency vibrator to be  $E_{dc} + E_{ac}$  ( $E_{ac}$  is the modulating voltage received from the transformer winding associated with the higher frequency vibrator). When the lower frequency vibrator actually makes contact, the phase of the A.C. modulation is such that the effective voltage applied to the higher frequency vibrator is  $E_{dc} - E_{ac}$ , thus causing a reduction in its frequency until synchronism is obtained with the lower frequency vibrator and contact is broken. It then functions in the normal manner. The cycle then repeats itself and maintains the 90° phase shift.

The E-L unit, shown below is a typical Vibrator Power Supply used in the operation of communication equipment. With a 12 volt DC input, it develops 500 watts power output. Dimensions: 20 x 20 x 8½ inches.



# Now! EXTRA HUMIDITY PROTECTION IS STANDARD

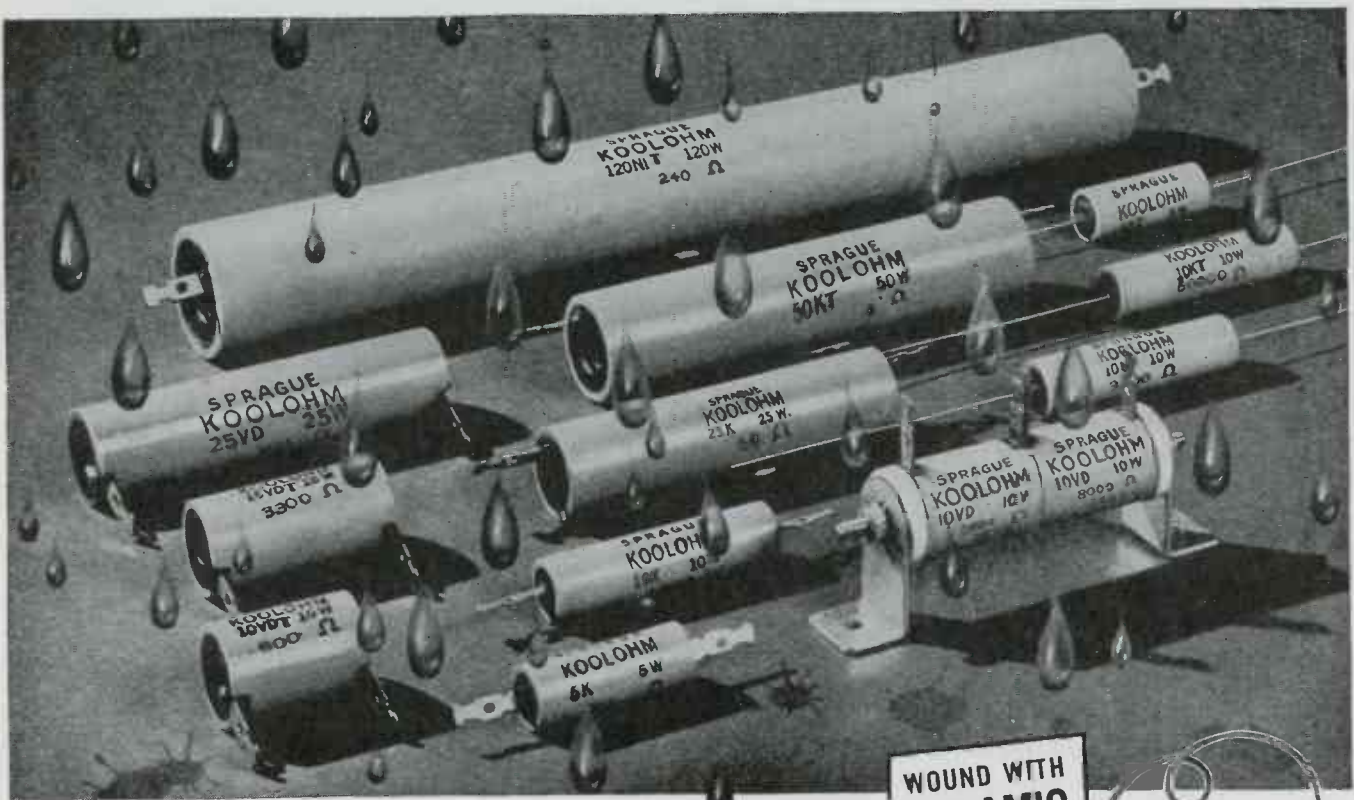

... designed for tropical conditions  
 ... unbeatable on ANY job

Standard Sprague Koolohm Wire Wound Resistors now offer the same high degree of humidity protection formerly obtainable only on special order to match exacting military specifications. This construction, newly adopted as standard, includes a glazed ceramic outer shell and a new type of end seal. These features give maximum protection against even the most severe tropical humidity conditions. Type numbers remain the same ex-

cept for the fact that the letter "T" has been added to designate the new standard construction.

Thus, again, Sprague leads the way in practical, truly modern wire wound resistor construction. Your job of resistor selection is greatly simplified. No need to study and choose between types or coatings. One type of Koolohms, the *standard* type, does the job — under any climatic condition, anywhere in the world!

**SPRAGUE ELECTRIC COMPANY, North Adams, Mass.**  
 (formerly Sprague Specialties Co.)



# SPRAGUE KOOLOHM RESISTORS

TRADEMARK REGISTERED U.S. PAT. OFF.

The Greatest Wire-Wound Resistor Development in 20 Years

# CREATIVE ELECTRICAL ENGINEERING



Industry is entering an era of electricians, marked by the keenest competition in business history. The rich rewards will surely go to those who employ *Creative Electrical Engineering* to best advantage.

In this highly technical field, LELAND Electric has solved many difficult electrical problems with skill and ingenuity. This valuable experience may be the key to your post-war plan. We invite your inquiry.



**THE Leland ELECTRIC COMPANY**  
Dayton 1, Ohio. In Canada—Leland Electric Canada Ltd., Guelph, Ontario.

MOTOR GENERATOR SET NAVY TYPE 3 LMG—A.C. or D.C. drive, and up to 2½ KW, A.C. or D.C. output—special frequencies governor speed controlled.

# how high is very high?

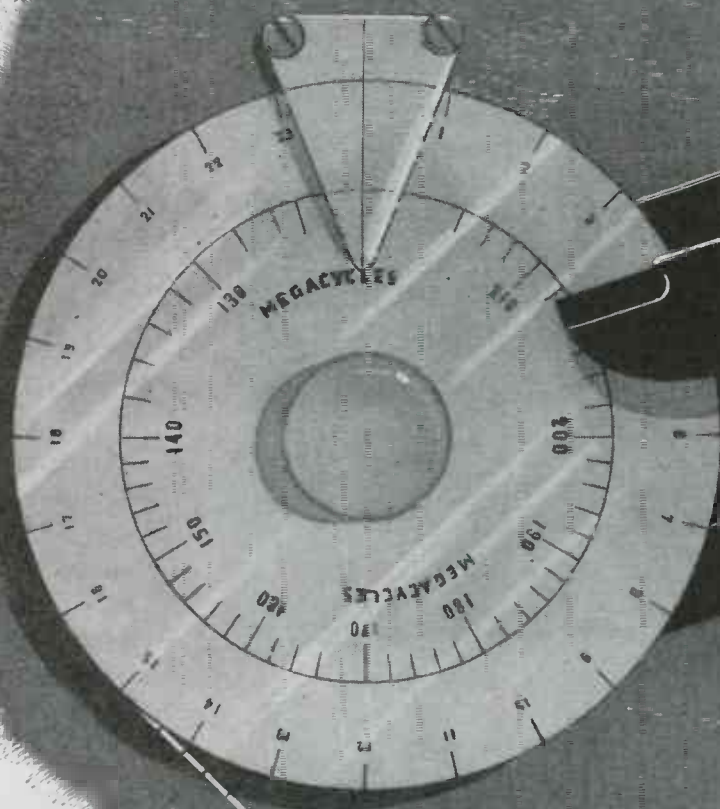

★ Engineers at Hallicrafters are continually striving for new heights of perfection in high frequency development work. The Model S-37 is one example of the progress they have made. This is the first and only set of its kind — covering both AM and FM and operating in the range of 130 to 210 Mc. Two r.f. stages are used and in conjunction with an intermediate frequency of 18 Mc., assure an amazingly high ratio of image rejection. It is becoming a valuable instrument in the hands of all exploring the upper reaches of the high frequency ranges.



*Model S-37. The highest frequency range of any continuous tuning commercial type receiver.*

## hallicrafters RADIO



Buy a War Bond Today.



THE HALLICTRAFTERS CO., MANUFACTURERS OF RADIO AND ELECTRONIC EQUIPMENT, CHICAGO 16, U. S. A.

ELECTRONIC INDUSTRIES • January, 1945

**IRC** is ready with...



THE NEW **BTA**  
RESISTOR

**Lowest Temperature Rise** ▶

Like all BT Resistors, the operating temperature of the new BTA is *lower* than other resistors of comparative size!

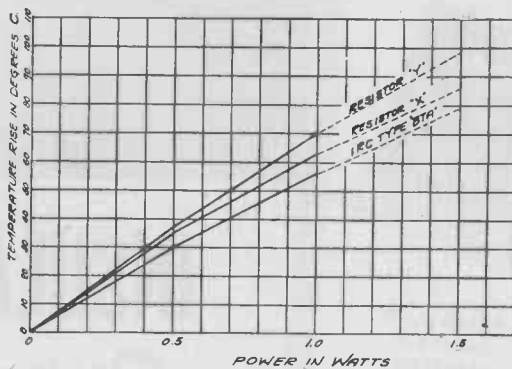

Only the extreme pressure of essential war production has delayed our release of this small one-watt AWS RC 30 type *insulated* resistor. You'll find the BTA insulated resistor a worthy and important addition to the BT family. Built to meet American War Standards specifications, the BTA is only 0.718 inches long and 0.250 inches in diameter. Wattage rating, 1 Watt at 40° C ambient. Voltage rating, 500 volts. Minimum range, 330 ohms. Maximum range, Standard: 20 megohms.

Write today for comprehensive bulletin containing engineering data and charts.



**INTERNATIONAL RESISTANCE CO.**

401 NORTH BROAD STREET PHILADELPHIA 3, PA.

IRC makes more types of resistors than any other manufacturer in the world.

COMING... COMING... COMING... COMING...



AN 31-20 Rheostat

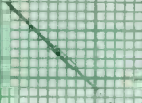

BTR - 1/4 watt Insulated Resistor



BTA - 1 watt Insulated Resistor

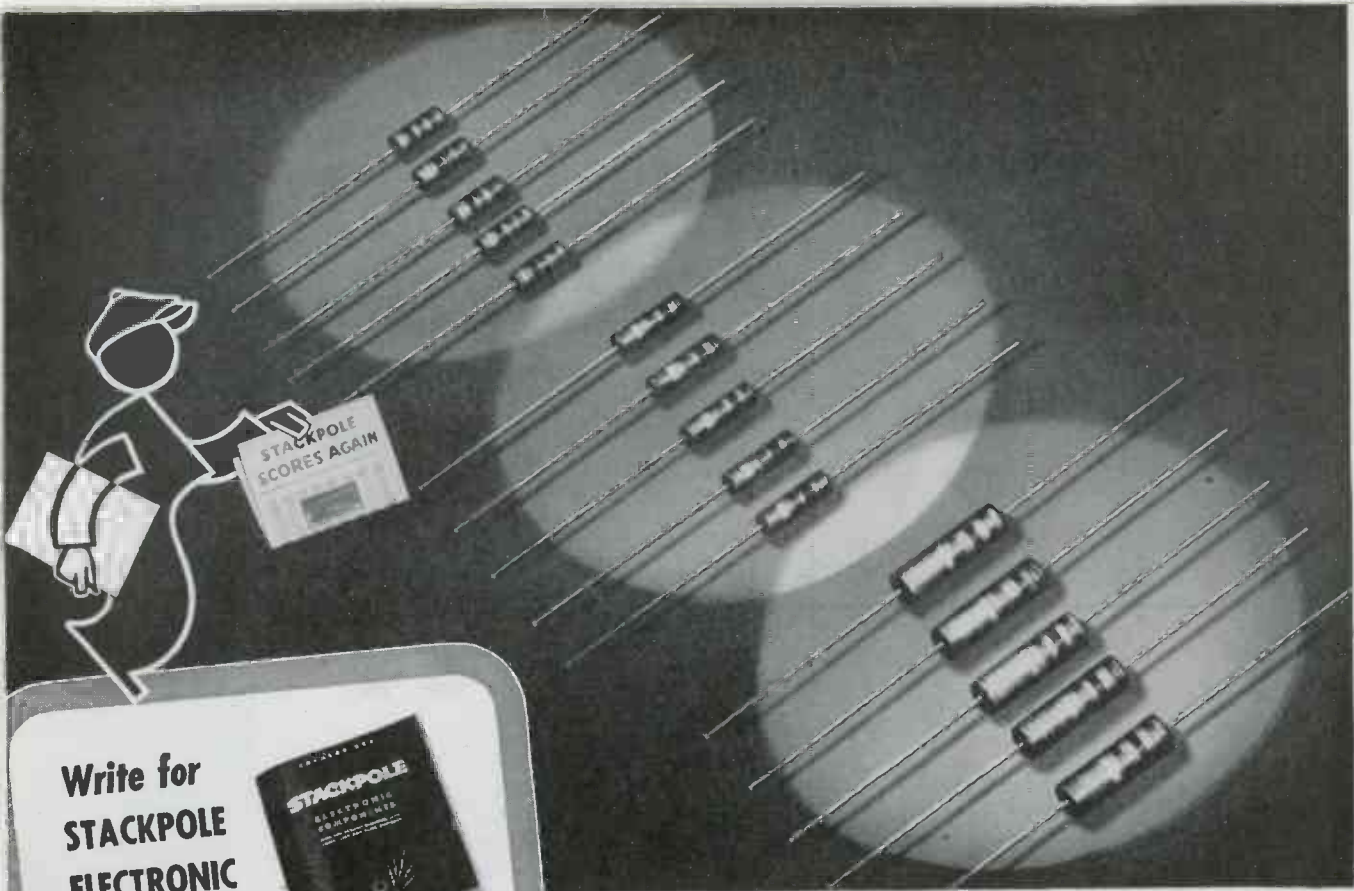

**Write for  
STACKPOLE  
ELECTRONIC  
COMPONENTS  
Catalog**



Whether for today's needs or post-war engineering, write today for your copy of this 36-page Catalog RC 6 replete with helpful engineering data.

**FIXED AND  
VARIABLE  
RESISTORS  
IRON CORES  
LINE, SLIDE,  
ROTARY  
ACTION  
SWITCHES**

**OTHER STACKPOLE PRODUCTS**

- BRUSHES and CONTACTS  
*(All carbon, graphite, metal and composition types)*
- RARE METAL CONTACTS
- WELDING CARBON PRODUCTS • BEARINGS
- BRAZING BLOCKS • ANODES
- ELECTRODES • CARBON PILES
- PACKING, PISTON, and SEAL RINGS
- RHEOSTAT PLATES and DISCS
- SPECTROGRAPHITE NO. 1
- CARBON and MOLDED METAL POWDER SPECIALTIES

# INSULATED RESISTORS

*Designed to Match War  
Standards Specifications*

Integrally molded in one operation under laboratory controlled production standards, Stackpole Type CM Resistors in  $\frac{1}{3}$ -(RC-10):  $\frac{1}{2}$ -(RC-21): and 1-watt (RC-30) sizes have been specifically designed to meet the newly issued Army-Navy specifications. The construction of these new resistors is such that they offer an exceptional degree of stability under load—the average change being less than 5% after 1000 hours under test at full load. In addition to having highly satisfactory humidity characteristics well within today's exacting requirements, Stackpole Type CM Insulated Resistors meet up-to-the-minute salt water immersion specifications.

*Samples to any required tolerance on request.*

# STACKPOLE

STACKPOLE CARBON COMPANY, ST. MARYS, PA.



# HOW G-E CAPACITORS are being used on new jobs

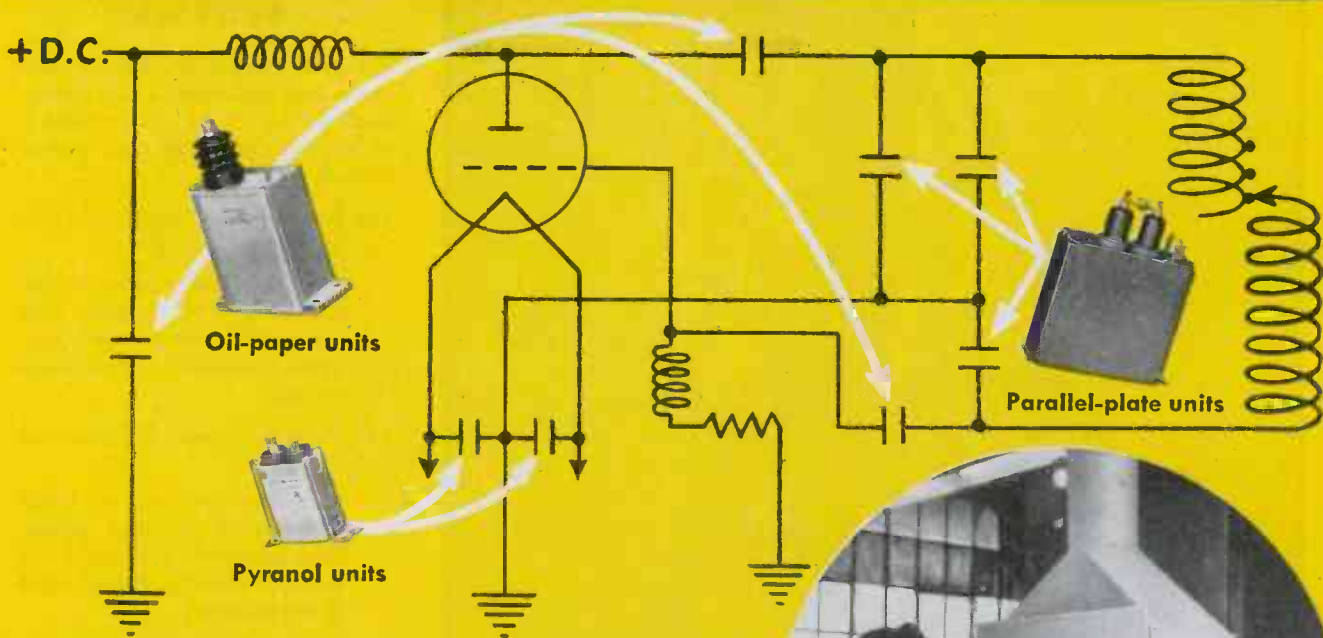

**8 CAPACITORS NOW DO THE WORK OF 31** in this h-f oscillator circuit, and save space, weight, money

THE great number and wide diversity of capacitors required by today's electronic circuits make their selection an important factor in the design of the completed electronic device. Capacitors *designed for the job* can often appreciably reduce the over-all weight, size, and cost.

Take the simplified electronic-heater circuit shown above: The *original* circuit called for 31 capacitors. By selecting G-E high-frequency capacitors *designed for electronic-heater applications*, this number was reduced to eight.

Four mica capacitors were replaced with three G-E oil-paper blocking capacitors. This change alone saved more than \$50.

In the resonant circuit, it originally took 25 mica units to do the job that three G-E high-frequency parallel-plate capacitors are now doing. These compact water-cooled units permitted an additional sav-



ing of more than \$200, as well as a appreciable reduction in the over-all dimensions of the electronic heater.

As a manufacturer of a wide variety of capacitors—including Pyranol\*, oil-paper, high-frequency parallel-plate, and Lectro-



Electronic heater being used to solder on the covers of G-E capacitors. Four units are soldered simultaneously.

G-E capacitors designed for h-f oscillator circuits. Large unit: high-frequency, parallel-plate capacitor for the resonant circuit. The others: an oil-paper, high-frequency blocking capacitor, and (smallest) a Pyranol by-pass capacitor.

film units—G.E. is in a position to help you make savings like these in *your* electronic devices. Bulletins on our various lines are yours for the asking. See your nearest G-E representative, or write to General Electric Company, Schenectady 5, N. Y.

\*Reg. U.S. Pat. Off.

Buy all the BONDS you can—and keep all you buy

# GENERAL ELECTRIC

407-82-5700

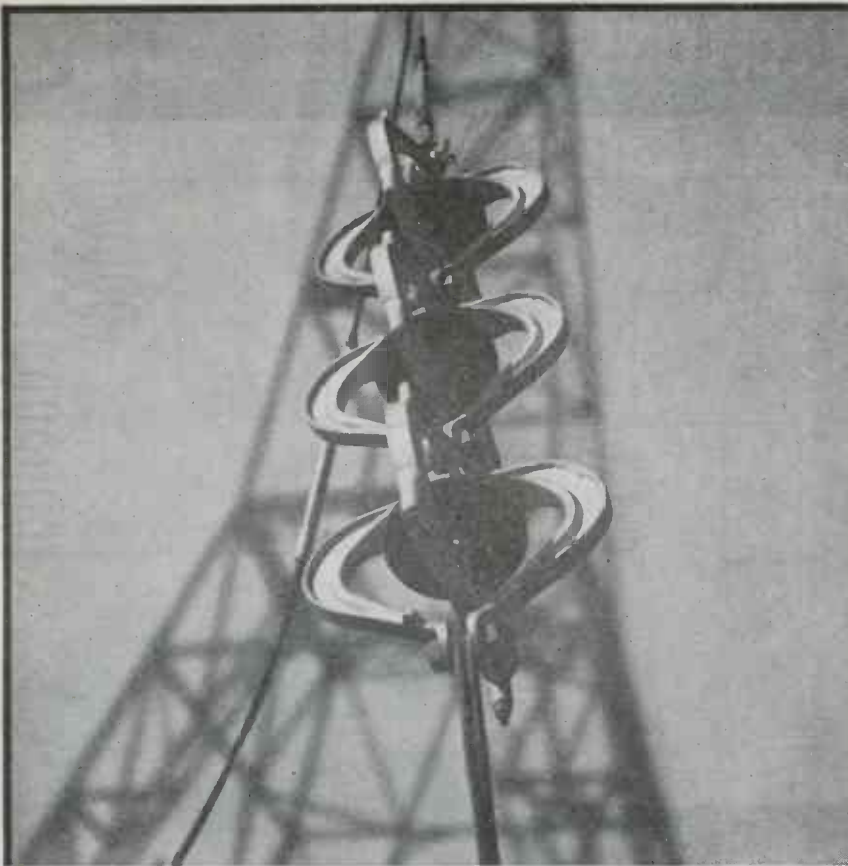

## Do you recognize these insulators?

They are the first radio tower insulators made in this country. They were designed and built by Locke for the original wireless telegraph stations.

That was a long time ago and every day since has added to our skill and experience. Research facilities available nowhere else in the industry have been in constant use finding better, simpler, lower cost methods of producing the finest in radio insulators.

Whether your requirements are standard or special, we think you will find them better filled by Locke.

# Locke

## INSULATOR CORPORATION

BALTIMORE, MARYLAND

*"Leaders in Clayramics"*

### A COMPLETE "CLAY"RAMIC SERVICE

For every electrical, chemical and mechanical application, Locke has unrivalled facilities for the production of fired clay pieces by every known method.

(1) Dry Process — Porcelain and Steatite

A process ideally suited to the production of certain pieces with reasonable tolerances and adequate mechanical and electrical strength.

(2) Vacutite Process—Porcelain and Steatite

A process developed by Locke for forming intricate pieces. Close tolerances. Mechanical and electrical strength almost equal to wet process.

(3) Wet Process — Porcelain and Steatite

The standard process for the production of high voltage insulators, and porcelain for mechanical and chemical applications. Exceptionally strong mechanically and electrically.

Locke Wet Process porcelain and Locketite is produced by the following methods, the selection of method depending upon the piece.

- |                   |                   |
|-------------------|-------------------|
| (1) Pugging       | (5) Jigging       |
| (2) Ram Extrusion | (6) Plastic Press |
| (3) Wet and Dry   | (7) Core Casting  |
| Turning           | (8) Drain Casting |
| (4) Plunging      | (9) Throwing      |

and certain other methods which at the present have only limited application.

Other clayramic products will be available in the future to meet special conditions. Whatever your problem, our experienced electrical, mechanical and ceramic engineers will be glad to help. Their services have resulted in material savings in money, time and critical materials to other manufacturers. Perhaps they can help you.

# HIGH VOLTAGE Ceramic Condensers



## ERIE DOUBLE CUP CERAMICONS

REG. U. S. PAT. OFF.

These compact, high voltage condensers are designed to carry appreciable amounts of current at high voltage without danger of corona or excessive internal heat. The silvered ceramic construction provides choice of temperature coefficient, excellent stability and retrace characteristics. Two sizes are illustrated above.

Type SP-106 is rated at 5 KVA. Peak working voltages at sea level for types SP-106 and SP-172 are as follows:

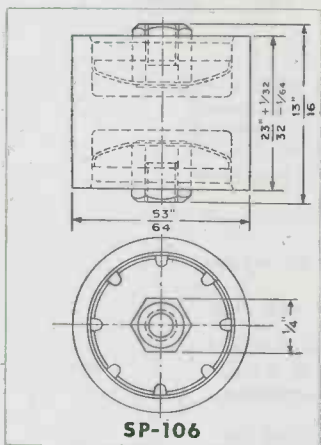

SP-106		
Capacity	Temperature Coefficient	Peak Working Volts at Sea Level
20 MMF	NPO	10,000
30 MMF	NPO	6,500
39 MMF	NPO	5,000
51 MMF	N-750	10,000
75 MMF	N-750	7,500
100 MMF	N-750	5,500

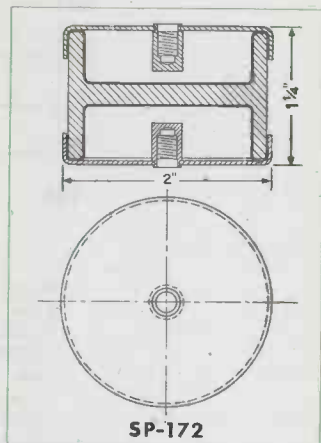

SP-172		
Capacity	Temperature Coefficient	Peak Working Volts at Sea Level
51 MMF	NPO	10,000
75 MMF	NPO	10,000
100 MMF	NPO	10,000
200 MMF	N-750	10,000
300 MMF	N-750	10,000
390 MMF	N-750	8,000

If you have applications for condensers of this style for either military or peacetime equipment, our engineers will be glad to discuss them with you.

Note: Test voltage, SP-106 and SP-172—60 cycle RMS equal to peak working voltage.



Electronics Division  
**ERIE RESISTOR CORP., ERIE, PA.**  
 LONDON, ENGLAND • • TORONTO, CANADA

★ ★ ★ Do More Than Before—Buy EXTRA War Bonds ★ ★ ★

# HIGH Q COILS *by*

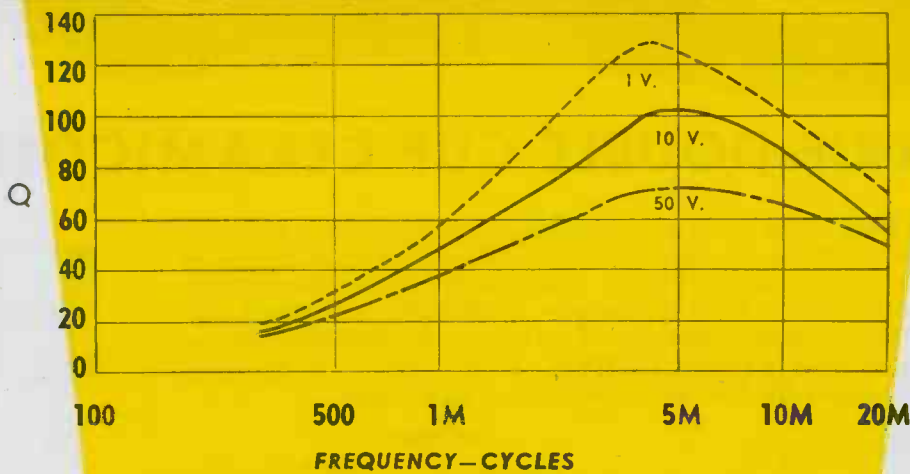
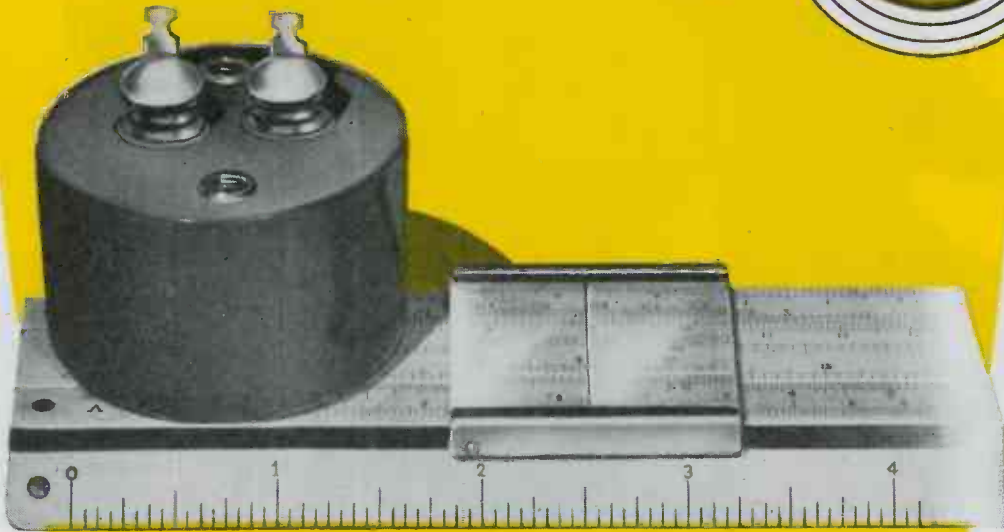

There are many applications in the audio field requiring coils of high Q and good stability. UTC coils of the type HQA series are ideal in this respect. Q CHARACTERISTICS of a typical .14 Hy. coil at three voltages are illustrated. VOLTAGE STABILITY is high. At 1,000 cycles, for applied voltages from .1 to 25 volts, the change in inductance is less than 1%. DC current change in inductance is approximately 1% per 10 Ma. linearly.

HUM PICKUP is low due to a self shielding structure: . . . 70 microvolts per gauss at 60 cycles.

TEMPERATURE effects are negligible. From -60 degrees C. to plus 85 degrees C., inductance variation is less than 1/3%.

MECHANICALLY, these units are hermetically sealed in a drawn steel case 1-13/16" diameter by 1-3/16" high. Weight . . . 5 ounces.

VIBRATION effects are not evident over entire range of normal aircraft tests.

HQA UNITS are available in any inductance value from 5 Mhy. to 2 Hy., and are ordered as: HQA followed by value in Mhy. Typical semi-standard values are:

HQA-12.5 . . . . .	\$5.00 net	HQA-200 . . . . .	\$8.00 net
HQA-30 . . . . .	\$6.00 net	HQA-500 . . . . .	\$9.00 net
HQA-80 . . . . .	\$7.00 net	HQA-1250 . . . . .	\$10.00 net

*United Transformer Co.*  
 150 VARICK STREET NEW YORK 13, N. Y.

EXPORT DIVISION: 13 EAST 40th STREET, NEW YORK 16, N. Y., CABLES: "ARLAB"



# ELECTRONIC INDUSTRIES

Including INDUSTRIAL ELECTRONICS

O. H. CALDWELL, EDITOR ★ M. CLEMENTS, PUBLISHER ★ 480 LEXINGTON AVE., NEW YORK (17), N. Y.

## **Engineer in the Saddle**

Both the American public and the radio industry are to be congratulated that at this critical culmination of FCC allocation activities, the acting chairmanship of the Commission is in the capable engineering hands of quiet, earnest Comdr. E. K. Jett. All sides recognize that his impartial conclusions will be based on sound technical consideration of the welter of evidence and conflicting pressures.

## **100-fold Television Pickup**

Greater sensitivity of new television pickups—perhaps to the extent of 100-to-one, as compared with present video cameras—presents one of the greatest possibilities for postwar television advance. When subjects under ordinary room lighting can be satisfactorily televised, the field for the new art will be immeasurably broadened.

## **Let's Not Overlook Facsimile**

Facsimile will bear watching. Smoke-screened into virtual obscurity by the welter of words about FM and television, little has been said and less printed about the "radio printing press." Yet much thought, careful research and just plain hard work have gone into the solution of problems that have been so well licked that facsimile has become a valuable adjunct to military communications. Facsimile has distinct commercial possibilities.

## **War Secrets and Super-Television**

Much comment on how the great advances in wartime electronic developments will radically change television is being quoted and printed for the public consumption. Some claim that "super-television" can be had if we only apply these wartime improvements. When it comes to "pinning down" just how certain

things are to be accomplished, the answer is, "That's a war secret." The flourish of megacycles, megawatts and microseconds does not answer all problems of modern-day television. War developments will most certainly play a part in extending the efficiency of television. However, it is doubtful whether most of these developments have reached a stage where they can produce the results attributed to super-television.

## **Electronic Automobile Ignition**

Mechanical improvements in machinery usually involve closer tolerances, greater precision in operation. The automobile industry, generally expected to be among the first to reconvert to civilian production status, is an excellent example. Improved engine efficiency will mean higher compression ratios in order to take advantage of modern fuels. This in turn will require ignition devices of considerably higher precision than the currently used—and quite sloppy—distributor systems. Progress, resulting from presently-conducted experiments, makes it appear possible that vacuum tubes may ultimately render obsolete most present systems for firing the mixtures in automobile cylinders.

## **Wanted: Better Salesmen for Better Mousetraps**

The world can be very blase indeed about a new invention. The way postwar industrial electronic devices will become a big business is through forceful creative salesmanship. It must be forceful to overcome the demoralizing human trait of resisting changes, new ideas, new methods. It must be creative in its sympathetic analysis of thousands of industrial problems and the intelligent invention of electronic solutions to them. The man best fitted for the creative part of this process is the electronic engineer. If he can learn also to be a forceful salesman, he'll be able to name his own figure.

## **IRE WINTER TECHNICAL MEETING**

**Hotel Commodore, New York City, January 24, 25, 26, 27**

*For details of technical program, see page 95 of this issue*

(Joint Electronic Panel of AIEE-IRE War Production and Reconversion Conference,  
West Ballroom, Hotel Commodore, New York, 8:30 p.m. Tuesday, January 30.)

# THERMISTORS IN



by RALPH R. BATCHER  
Consulting Editor

*A variety of electronic circuit applications are aided by use of thermal-sensitive elements having negative characteristics*

• Three years of intensive development under the impetus of the war, yielding scientific results which in normal times would have required a decade, have offered electronic designers many new circuit components that will enhance electronic circuits and direct them into new paths. One group of devices, known as Thermistors, utilized to some extent before the war, has already proven of primary importance in the fields of regulation, measurement and control. Accordingly a discussion of the basic characteristics should prove of interest to both industrial electronic designers and communication engineers.

Thermistor is a contraction of the expression "thermally sensitive resistor," and is one class of the group of non-ohmic solid conductors known as Varistors. The word Varistor, in turn, means variable resistor, that is, a semi-conductor whose resistance value varies in response to the conditions to which it is subjected in accordance with definite laws. Three classes of Varistors are commonly distinguished: The rectifiers, such as copper oxide on copper, exhibit unilateral or asymmetrical conductivity of electric current. Then there are two varieties of symmetrical Varistors: first, the type whose con-

ductivity is a function of voltage, such as bonded silicon carbide and second, the type whose conductivity is a decided function of temperature, known as Thermistors. The Thermistor is the most novel and least well known of the three major classes of Varistors.

Materials with some of these peculiarities have long been known. However, only in recent years have methods been devised for producing in quantities such components having stable and reproducible characteristics. While some classes of Varistors are the product of several concerns, this article will be confined to a discussion of Thermistor types developed by the Bell Telephone Labs. and manufactured by the Western Electric Co., and utilized in numerous military devices. These are becoming available to equipment designers for postwar use. Because Thermistors undergo large resistance changes in response to changes in temperature or impressed power, they are demonstrating their usefulness in many ways in putting electronic circuits to work at new tasks or in making these circuits function more effectively at old tasks.

Thermistors are made in a variety of forms from mixtures of cer-

tain metallic oxides pressed into discs, extruded into rods, or formed into beads. These forms after heating are hard and durable. Suitable electrical contacts are attached or built in. The metal oxides used are semi-conductors characterized by a high negative temperature coefficient of resistance as great in some types as 5 per cent per degree C. at room temperature. Fig. 1 shows the resistance temperature characteristics for typical units. Intensive study was necessary for success in developing processes of manufacture that will result in specified characteristics and in stabilizing those characteristics so as to assure indefinitely long service life. Several forms of Thermistors are shown in Fig. 2.

## *Many varieties possible*

Thermistors are produced with resistance values ranging from a few ohms to several megohms. The higher resistance range has particular importance in electronic circuits which work best with relatively high impedance components. For this reason many types of Thermistors are "natural" electronic circuit components.

Thermistors can be constructed for use wherever temperature varia-

# ELECTRONIC CIRCUITS

tions exist or can be produced. These variations in temperature may result in three ways: externally, by changes in the ambient temperature; directly, as when current is passed through the Thermistor thereby heating it; or indirectly, as when current, controlled as desired, is passed through a small heater associated closely with the Thermistor.

Specific applications may be divided into two broad fields depending on whether the Thermistor is kept at the same temperature as its surroundings, or whether it is heated by the circuit associated with it. The first field includes uses like temperature measurement, temperature control and temperature compensation or the neutralization of undesired temperature effects in other circuit components, meters, or electrical conductors.

When used as resistance thermometers, precision greater than that obtainable with thermocouples is possible. As temperature compensators, Thermistors are frequently used to neutralize the temperature error of instrument readings when wide temperature variations are encountered as in aircraft instruments.

## **Finds many uses**

The second field involves a very great number of applications. These uses depend upon one or more fundamental characteristics which include the non-linear voltage-current relationship, the corresponding resistance-power relationship and the heating and cooling time effects. One group of these uses includes flow meters, anemometers and vacuum gages where the Thermistor measures heat loss due to gas or fluid conduction. Another set of applications utilizes Thermistors as slow actuators for relays or circuits, overload protective devices and timing mechanisms.

As power responsive variable resistance devices, Thermistors have important uses in the measurement of small amounts of power, in automatic transmission regulating networks for long line communications circuits, and in signal and characteristic shaping networks such as speech volume limiters, compressors or expanders. In a related type of use they are valuable as oscillation amplitude stabilizers and as voltage regulators.

A few typical Thermistors will now be described. The 1A Thermis-

## WITH THERMISTORS

- 1—Ohm's law is obeyed if the temperature of the element is held constant.
- 2—The unique properties are due basically to the high negative temperature coefficient of resistance.
- 3—No rectification occurs in Thermistors.
- 4—While a thermoelectric effect can be obtained, Thermistors are so designed as to eliminate it.
- 5—The unheated or cold resistance of a Thermistor is proportional to the length and inversely proportional to the cross-section of the element.
- 6—Resistance changes do not instantaneously follow changes of applied power, but depend on the resulting temperature change.
- 7—When the power is suddenly increased from one value to a higher value the resistance begins to decrease rapidly at first and then more and more slowly until it approaches its new steady value.
- 8—When a voltage is impressed across a Thermistor in series with an ordinary resistance of relatively low value, the current initially is small, builds up gradually at first, then more rapidly and finally slowly approaches and reaches a steady value. At low currents the voltage across the Thermistor is proportional to the current; at somewhat higher currents the voltage does not increase as rapidly as the current.
- 9—At a still greater current the voltage across the Thermistor attains a maximum value. The resistance at this point is roughly one-third of the unheated resistance at the same ambient temperature.
- 10—At currents beyond the maximum voltage point, a Thermistor acts like a negative resistance, i.e., as the current through the Thermistor increases the voltage across it decreases.
- 11—Thermistors in general are small, relatively inexpensive, have no standby filament power losses, have no moving parts, produce no noise, require little or no servicing, have comparatively long life.
- 12—A wide range of circuit applications has already been found for Thermistors. Among some of the more important are: precision thermometers, temperature controllers, compensators, time delays, stabilizers, compressors, limiters, expanders, voltage regulators, oscillators, power sensitive rheostats and negative resistances.

tor will serve as an example of the directly heated type. It consists of a small bead of sintered uranium oxide on fine terminal wires (Fig. 4) enclosed in an evacuated glass bulb with two wire terminals. This assembly is further encased in an insulating tube with metal con-

tacts on the ends, much like a fuse housing.

The nominal characteristics of several typical Thermistors of the directly heated type illustrated in Fig. 4 are listed in Table I. In this table the "cold resistance" is the resistance of the Thermistor meas-

TABLE I

Type	Cold Resistance in Ohms			Temp. Coeff. per degree C at 25° C	Max. Continuous Ma		Power Sensitivity, Milliwatts at 25° C	
	0° C	25° C	40° C		ac	dc	to reach R <sub>0</sub> /3	to reach R <sub>0</sub> /100
1A	140,000	60,000	38,000	0.030	15	1	15	75
1B	850,000	380,000	230,000	0.031	3	0.2	10	65
1C	155,000	50,000	26,000	0.044	25	25	18	100
1D	310,000	100,000	52,000	0.044	20	20	14	90

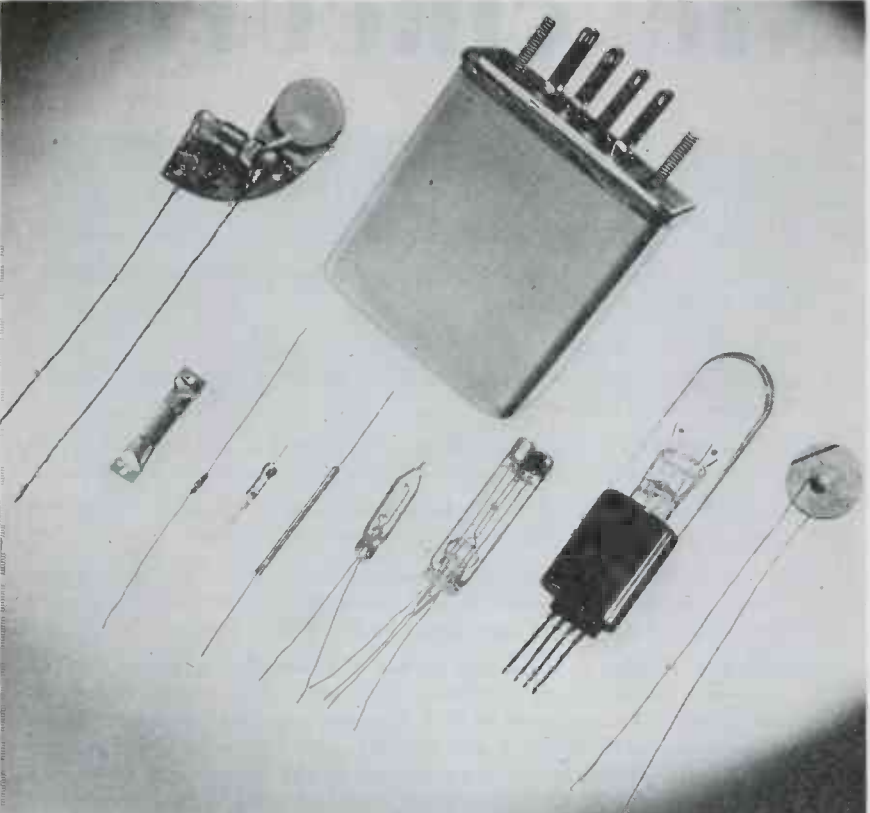

Fig. 2—A wide variety of sizes and shapes have been developed for numerous military equipment applications. Fig. 3—(Below) shows the resistance-current relation of one style at two levels of operating temperature representing the static characteristic curve

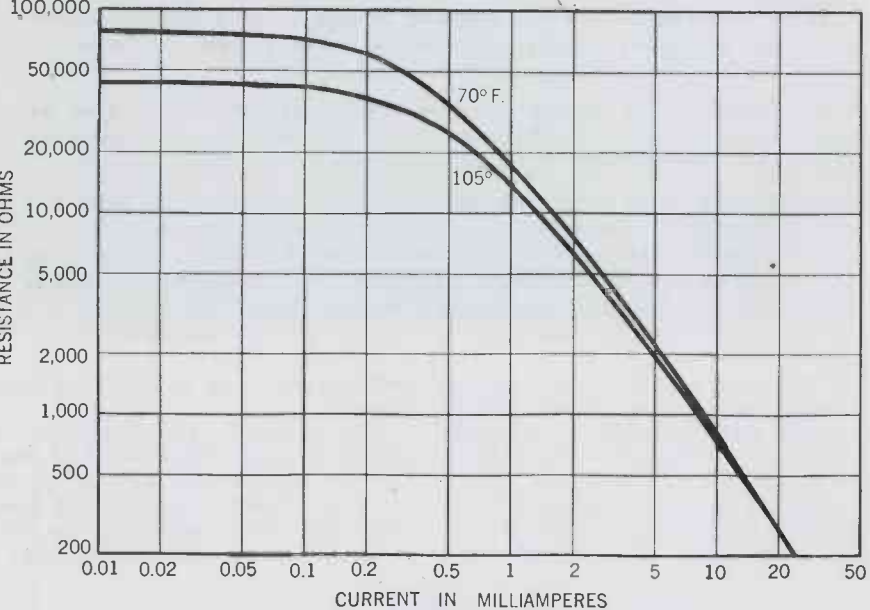

Fig. 4—A common form of Thermistor is mounted as is a fuse. Evacuated element and its mounting case shown below. Dimensions of this case are shown in Fig. 1

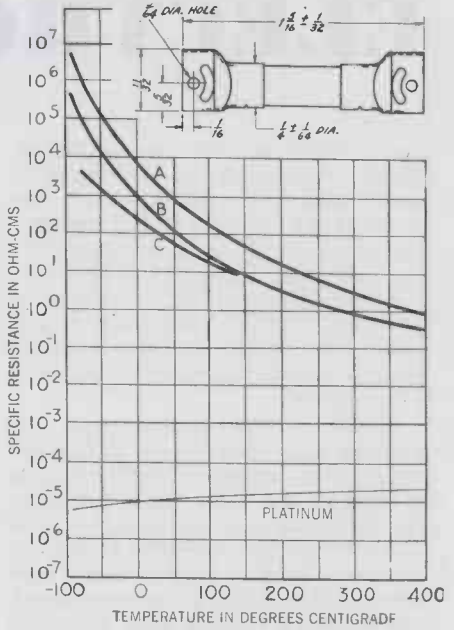
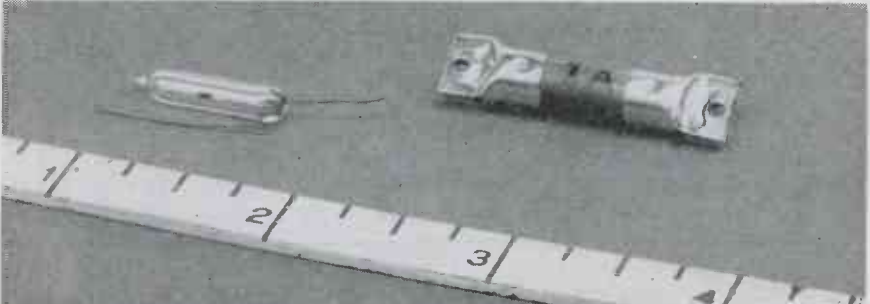

Fig. 1 shows highly negative resistance-temperature coefficient, typical of three types, with a sketch above of the 1A mounting

ured with a current small enough so as not to heat it appreciably. The ambient temperature at which the cold resistance is measured must be specified. The "power sensitivity" as used in Table I is the steady state power which must be dissipated in the Thermistor at the stated ambient temperature to produce a reduction of the cold resistance by the ratio indicated. This figure of merit is included to indicate the order of magnitude of power required to produce useful changes in the Thermistor resistance.

**Static characteristics**

Fig. 3 gives the static characteristics of the 1A Thermistor, showing the resistance versus current curves at two temperatures. An examination of the 70 deg. F. curve shows that if sufficient current is passed through the oxide bead to result in the dissipation of 15 milliwatts in it, the unit becomes heated and its resistance decreases about 44,000 ohms to a new-value of 22,000 ohms. When 75 milliwatts is applied, the resistance becomes approximately 650 ohms. The Thermistor will retrace the characteristics here indicated without appreciable deviation over an indefinitely long life.

The indirectly heated type of Thermistor is most useful where electrical separation of the controlling and controlled circuit is necessary. The heater is also useful in thermostating the Thermistor so that the latter can be used as a directly heated device without undesirable effects due to ambient



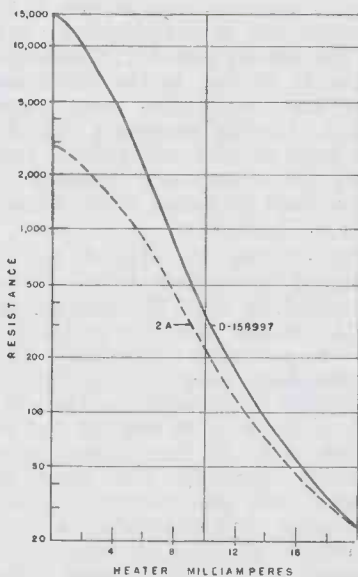

Fig. 5—The use of an independent heater provides for control by an effect in an associated circuit. A 500-fold resistance variation is obtainable with a few milliwatts to the heater

temperature changes. Table II lists the nominal characteristics of two Western Electric heater type Thermistors.

The interdependence of the Thermistor resistance and the heater current can be visualized best in graphical form as in Fig. 5, which gives this characteristic for

Type	Heater Characteristics		Thermistor Characteristics				
	Resistance in Ohms	Max. Continuous Current, MA ac or dc	Resistance, Ohms (No heater power)			Min. Continuous Res. Ohms	Max. Continuous MA, ac or dc
			0° C	25° C	50° C		
2A	100	25	7,200	2,800	1,250	10	75
D-158997	200	20	45,000	15,000	6,000	19	50

the 2A Thermistor at 25 deg. C. The mutual characteristics resulting from the dissipation of power simultaneously in both heater and Thermistor are given for the 2A Thermistor in Fig. 6. These characteristics, will prove valuable in numerous circuits as experience is gained in adapting them to specific jobs.

The large negative temperature coefficient of resistance which is the basic property of Thermistors is about ten times as great as the corresponding positive coefficient of metals. An idea of the great change in Thermistor resistance value resulting from a moderate temperature change was shown in Fig. 1, which is a plot of resistance on a logarithmic scale against temperature on a linear scale for three different types of Thermistor material and for a typical metal. A more nearly linear curve will be

obtained for the Thermistor materials if the logarithm of the resistance is plotted against the reciprocal of the temperature in absolute degrees. This property of resistance change with temperature is utilized directly in non-heated or externally heated applications such as Thermistor thermometers and temperature compensators.

Another fundamental property of Thermistors is that of time lag, or thermal inertia. It is a common observation that bodies cannot be heated or cooled instantly. Since the resistance of a Thermistor varies with its temperature, and its temperature cannot be changed instantaneously, obviously the resistance of the Thermistor will not change instantly in response to a change of power applied to it. This effect can be utilized and controlled as it has been in time delay applications. On the other hand it can

It is generally convenient to plot mutual characteristics of indirectly heated units with log-log scales as shown in Fig. 6. All relations between resistance, power, current and volts are shown here. The resistance scale slopes with increasing current. The wattage scale has an upward slope

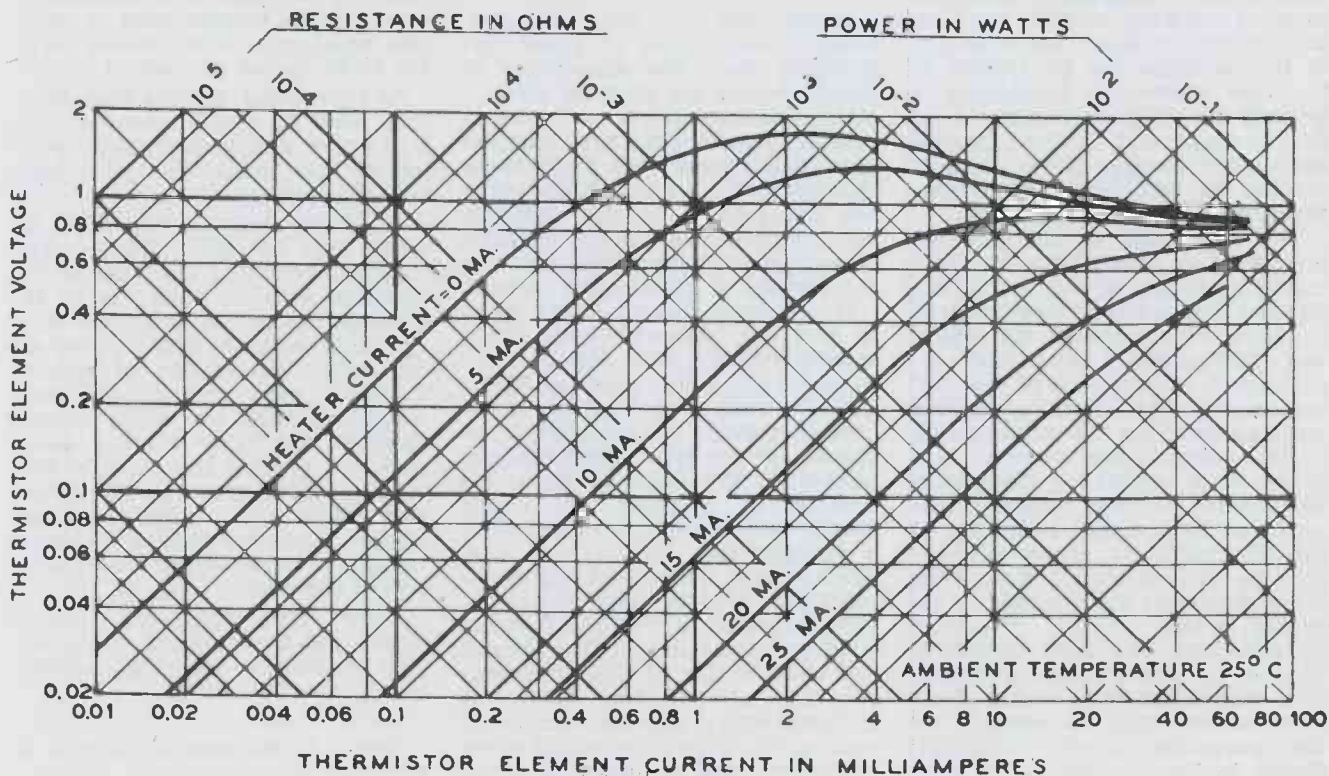

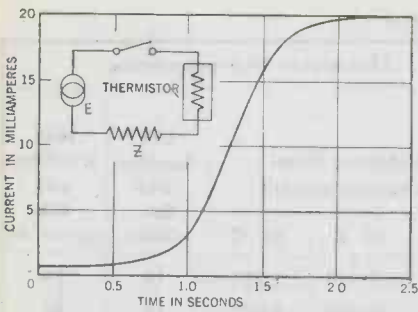

Fig. 7 shows circuit and characteristic wherein a time delay of the order of 1.5 seconds is introduced by Thermistor's operation

be minimized by proper design.

A Thermistor element in which no electric power is being dissipated and which is at a higher temperature than that of the medium in which it is situated, will cool at a rate proportional to the currently existent temperature difference until the temperature difference ceases to exist. The rate will also depend upon two factors peculiar to the Thermistor element and its intimacy of connection to its surroundings, i.e., its thermal capacity or mass times specific heat, and the dissipation constant. The latter is defined as the power in watts necessary to accomplish a temperature change of one degree centigrade.

**Time constant**

The quotient of thermal capacity by dissipation constant is the "time constant," which is the time in seconds taken by the Thermistor to change its temperature by 63 per cent of the temperature difference existent originally between the body and its surroundings. An extension of this analysis can be applied in the case where the Thermistor is initially at the temperature of its surroundings and is then heated by applied electric power until it reaches an equilibrium at a temperature higher than ambient.

The utilization of the thermal inertia of a Thermistor is illustrated by means of Fig. 7, where a directly heated Thermistor is placed in series with a source of voltage, key, milliammeter and load resistance Z. On closure of the key, the meter will show a delayed building up of the current as shown in the current-time curve of this figure for a typical 1A Thermistor. The initial current, which is determined by the cold resistance of the Thermistor, is small and begins to rise slowly at first, then more rapidly as the Thermistor becomes heated and its resistance becomes less. The final current is limited by the circuit resistance. The magnitude of the time delay amounts to about 1.5 seconds for the particular circuit conditions shown in Fig. 7. This value, how-

ever, increases with decrease of supply voltage.

The action described here may be further studied by means of Fig. 8, which gives the static (steady state) voltage-current characteristic of the Thermistor of Fig. 7. Suppose that the Thermistor and circuit are stabilized at the operating point A' of Fig. 8, and the conditions are then suddenly altered so that a new steady operating point C' is called for. The incremental resistance will therefore begin to change, going through values represented by lines having all slopes between those shown as AA' and CC' in Fig. 8 including zero at point B. This change occurs at a rate depending entirely upon the accumulation of heat in the Thermistor, so that, of course, there is a delay in the current rise.

The basic relationships of resistance-temperature and of tem-

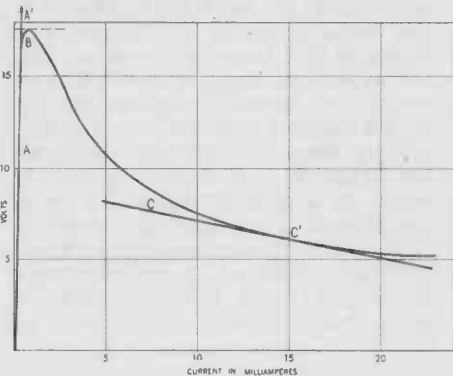

Fig. 8 illustrates "negative" resistance region when dynamic characteristic curve is evaluated

perature-time have been discussed. Other relationships of great importance from the standpoint of circuit design are those of steady-state resistance-power and current voltage. Figs. 3 and 8 are examples of these characteristics. While these characteristics are non-linear, they are interrelated in the ordinary way, i.e., resistance is the quotient of voltage by current, and power is the product of voltage and current.

It is convenient in many cases to plot the current-voltage characteristic as  $\log_{10}e$  vs.  $\log_{10}i$  on account of the wide ranges of values to be covered. Fig. 6, which is the current-voltage characteristics for the 2A (heater type) Thermistor, is plotted in this fashion. With this method of plotting, an ohmic (fixed) resistance is represented by a straight line having a 45 deg. angle sloping from lower left to upper right. Resistors having a negative temperature coefficient of resistance have curves with slopes of less than 45 deg. If their temperature is permitted to vary. Conversely those with a positive coefficient, such as ordinary wire-wound types, are represented by lines with slopes

slightly greater than 45 deg. if the temperature is permitted to vary. On the log-log plot Fig. 6, auxiliary scales at 45 deg. to the main axes give the resistance and power values. Circuit designers will find this type of plot convenient, especially when ordinary resistors are to be used in series or in parallel with a Thermistor.

The curves of Fig. 6 can be analyzed in further detail. It will be noted at low Thermistor currents (where the temperature is not appreciably affected) that Thermistors obey Ohm's law, as evidenced by linearity of the curve with a slope of 45 deg. at the left of the plot. As the current is increased, however, the slope decreases until the voltage reaches a maximum and thereafter actually decreases as the current is increased further, the device taking on the characteristics of a negative resistance. The voltage maximum point comes at a resistance value about one-third of the cold resistance. At large currents the voltage across the Thermistor becomes quite small.

Whenever sufficient power is dissipated in a Thermistor to carry it to current values beyond that associated with the voltage maximum point, it is necessary to provide a current limiting resistor in the circuit. This is a consequence of the negative resistance characteristic which prevails to the right of the voltage maximum. Incidentally it should be observed that if sufficiently low temperature coefficient material were used in a Thermistor, no maximum voltage point or negative resistance region would occur for finite values of current.

As time delay devices they have been used to protect standard relays which would otherwise be subject to false operation due to high voltage surges.

A Thermistor is connected in series with the relay winding. The thermal inertia of the Thermistor, together with its high "cold" resistance, discriminates against voltage surges of short duration, but an application of voltage of greater duration, even though of lesser magnitude than the surge voltage, operates the relay after a delay sufficient to heat the sensitive element of the Thermistor. The surges may attain peak values of voltage several times the normal operating voltage without causing false operation of the relay.

Many other ingenious arrangements will be developed as experience is gained in applying Thermistors to specific jobs.

(Part II of this subject will appear in an early issue—Ed.)

# 1945 STATISTICS

## Radio-electronic output, civilian and military totals. How production and use compare during past 23 years

From the very beginning of broadcasting the present publishers of "Electronic Industries" have been compiling the annual statistics of civilian radio. Continuing the practice of many years in past January issues of "Radio Retailing" and "Radio Today," there are summarized on this page past radio figures. And new statistics for the current situation are also presented.

With civilian radio production almost completely shut down, except for a limited number of tubes and repair parts, it has proven impracticable to give detailed figures on 1944 wartime output of components, transformers, condensers, volume controls, etc., since such data might reveal military radio production secrets.

### THE RADIO INDUSTRY, JANUARY 1, 1945

	Total Investment	Annual Gross Revenue	Number of Employees	Annual Payroll
Radio manufacturers (1200) .....	\$350,000,000	\$4,733,000,000	530,000	\$1,200,000,000
Radio distributors, dealers, etc. ....	280,000,000	200,000,000	100,000	150,000,000
Broadcasting stations (1960) incl. talent costs	90,000,000	300,000,000	*20,000	55,000,000
Commercial communication stations .....	60,000,000	—	15,000	7,000,000
Listeners' sets in use (55,000,000) .....	3,500,000,000	—	—	†330,000,000

Note: Manufacturers' gross revenue was almost entirely for Army-Navy radio-electronic production, totalling in 1944 \$4,623,000,000.

\*Regular staff—not including part-time employes, artists, etc., who number at least 25,000 more.  
†Annual operating expense for listeners' sets, for tube replacements, electricity, servicing, etc.

### Civilian Sets in Use

	Jan. 1, '44	Jan. 1, '45
U. S. homes with radios** ...	31,000,000	31,000,000
Secondary sets in above homes	16,000,000	16,000,000
Battery portables .....	2,000,000	1,000,000
Auto radios...	8,000,000	7,000,000
<b>Total sets in U. S. ....</b>	<b>57,000,000</b>	<b>55,000,000</b>

\*\*Means "homes with radios in working order." The figure shown is thus comparable with the broadcasters' new figure of 33,100,000 radio homes," which they take to mean "homes possessing a usable radio set in any condition, either working, or temporarily-not-working because of missing tube or other part."

### Annual Bill for U. S. Civilian Radio

Sales of time by broadcasters, 1944.....	\$250,000,000
Talent costs .....	50,000,000
Electricity, batteries, etc., to operate 55,000,000 receivers.....	200,000,000
22,000,000 replacement tubes.....	25,000,000
Radio parts, supplies, etc. ....	60,000,000
Phonograph records, 100,000,000.....	50,000,000
Radio-set repairs, servicing.....	50,000,000
<b>Total .....</b>	<b>\$685,000,000</b>

Note: WPB ordered (April, 1942) all civilian radio-set production stopped and factories converted to war production.

### PRODUCTION OF CIVILIAN RADIO EQUIPMENT — 1922 TO 1944

	Total Civilian Sets Manufactured		Total Civilian Tubes Manufactured		Automobile Sets Manufactured		Total Reception Equipment	Auto Sets in Use	Homes with Radio Sets	Total Radio Sets in Use in U.S.	At Close of
	Number	Value	Number	Value	Number	Value	Value	Number	Number	Number	
1922	100,000	\$ 5,000,000	1,000,000	\$ 6,000,000	.....	.....	\$ 60,000,000	.....	260,000	400,000	1922
1923	550,000	15,000,000	4,500,000	12,000,000	.....	.....	136,000,000	.....	1,000,000	1,100,000	1923
1924	1,500,000	100,000,000	12,000,000	36,000,000	.....	.....	358,000,000	.....	2,500,000	3,000,000	1924
1925	2,000,000	165,000,000	20,000,000	48,000,000	.....	.....	430,000,000	.....	3,500,000	4,000,000	1925
1926	1,750,000	200,000,000	30,000,000	58,000,000	.....	.....	506,000,000	.....	5,000,000	5,000,000	1926
1927	1,350,000	168,000,000	41,200,000	67,300,000	.....	.....	425,600,000	.....	6,500,000	6,500,000	1927
1928	3,281,000	400,000,000	50,200,000	110,250,000	.....	.....	690,550,000	.....	7,500,000	8,500,000	1928
1929	4,428,000	600,000,000	69,000,000	172,500,000	.....	.....	842,548,000	.....	9,000,000	10,500,000	1929
1930	3,827,800	300,000,000	52,000,000	119,600,000	34,000	\$ 3,000,000	496,432,000	.....	12,048,762	13,000,000	1930
1931	3,420,000	225,000,000	53,000,000	69,550,000	108,000	5,940,000	300,000,000	100,000	14,000,000	15,000,000	1931
1932	3,000,000	140,000,000	44,300,000	48,730,000	143,000	7,150,000	200,000,000	250,000	16,809,562	18,000,000	1932
1933	3,806,000	180,500,000	59,000,000	49,000,000	724,000	28,598,000	300,000,000	500,000	20,402,369	22,000,000	1933
1934	4,084,000	214,500,000	58,000,000	36,600,000	780,000	28,000,000	350,000,000	1,250,000	21,456,000	26,000,000	1934
1935	6,026,800	330,192,480	71,000,000	50,000,000	1,125,000	54,562,500	370,000,000	2,000,000	22,869,000	30,500,000	1935
1936	8,248,000	450,000,000	98,000,000	69,000,000	1,412,000	69,188,000	500,000,000	3,500,000	24,600,000	33,000,000	1936
1937	8,064,780	450,000,000	91,000,000	85,000,000	1,750,000	87,500,000	537,000,000	5,000,000	26,666,500	37,600,000	1937
1938	6,000,000	210,000,000	75,000,000	93,000,000	800,000	32,000,000	350,000,000	6,000,000	28,000,000	40,800,000	1938
1939	10,500,000	354,000,000	91,000,000	114,000,000	1,200,000	48,000,000	375,000,000	6,500,000	28,700,000	45,300,000	1939
1940	11,800,000	450,000,000	115,000,000	115,000,000	1,700,000	60,000,000	584,000,000	7,500,000	29,200,000	51,000,000	1940
1941	13,000,000	460,000,000	130,000,000	143,000,000	2,000,000	70,000,000	610,000,000	8,500,000	29,700,000	56,000,000	1941
1942	4,400,000	154,000,000	87,700,000	94,000,000	350,000	12,250,000	360,000,000	8,750,000	30,800,000	59,340,000	1942
1943	.....	.....	17,000,000	19,000,000	.....	.....	60,000,000	8,000,000	31,000,000	57,000,000	1943
1944	.....	.....	22,000,000	25,000,000	.....	.....	70,000,000	7,000,000	31,000,000	55,000,000	1944

Figures for sets include value of tubes in receivers. In normal years replacement tubes have run 25% to 40% of total tube production. All figures are at retail values. (Statistics Copyrighted by Caldwell-Clements, Inc.)

# LOCATING LAND MINES

by PAUL P. HORNI

President, Horni Signal Mfg. Corp., New York

**Induction balance circuit provides both audible and visible signals for detection of enemy explosives**

● At the outset of the war, little was known of a mine detector for checking the German mines. A new type of metallic detector was designed and immediately roughed out by officers of the Engineer Board at Fort Belvoir, Va. Then with the cooperation of Major George A. Rote of the Board it was further studied at the Hazeltine Laboratories on Long Island.

The Horni Signal Mfg. Corp. of New York made the first production models, and became the first company to manufacture these newly designed mine locators for detecting buried metallic masses. Within a short time they were on a full scale production basis. This detector has proved its value as a life saver and a prime necessity of war equipment.

This mine detector as made by

Horni is a portable battery operated device capable of detecting all types of metals. Its use is confined to the location of buried masses of metals such as anti-tank mines, which are indicated by both audible and visual means. An increase in the volume of the 1,000-cycle tone in receiver denotes the presence of a metal object which is also indicated on a meter in the control box. This particular type of unit will detect the standard American anti-tank mine at a distance of 24 in., with a reading of 6 on the meter. Detection of the mine is possible at greater distances but the needle deflections are correspondingly reduced. When operating this detector over certain types of soil, it is important that the same operating distance above ground be maintained. However,

in dry, sandy soil, it will be found that there is little or no ground effect, and the distance between the search-coil disk and the ground is not so important. The detector set also may be used to locate mines that are planted in either fresh or salt water. Then the search-coil disk is floated on the surface of the water or slightly submerged.

When more than one detector is operated in the same area, a minimum distance of from 25 to 40 ft. must be maintained between the detectors. The minimum distance from each other at which detectors may be operated depends, to a great extent, upon the skill of the operator, and can be determined only by experience.

The power source consists of three batteries contained in the battery compartment.

Circuit wiring diagram of the SCR 625-F land mine locating equipment which is battery operated and all except the search coil assembly contained in a back pack. For use over any type of soil, equipment is also effective in locating mines submerged in fresh or salt water

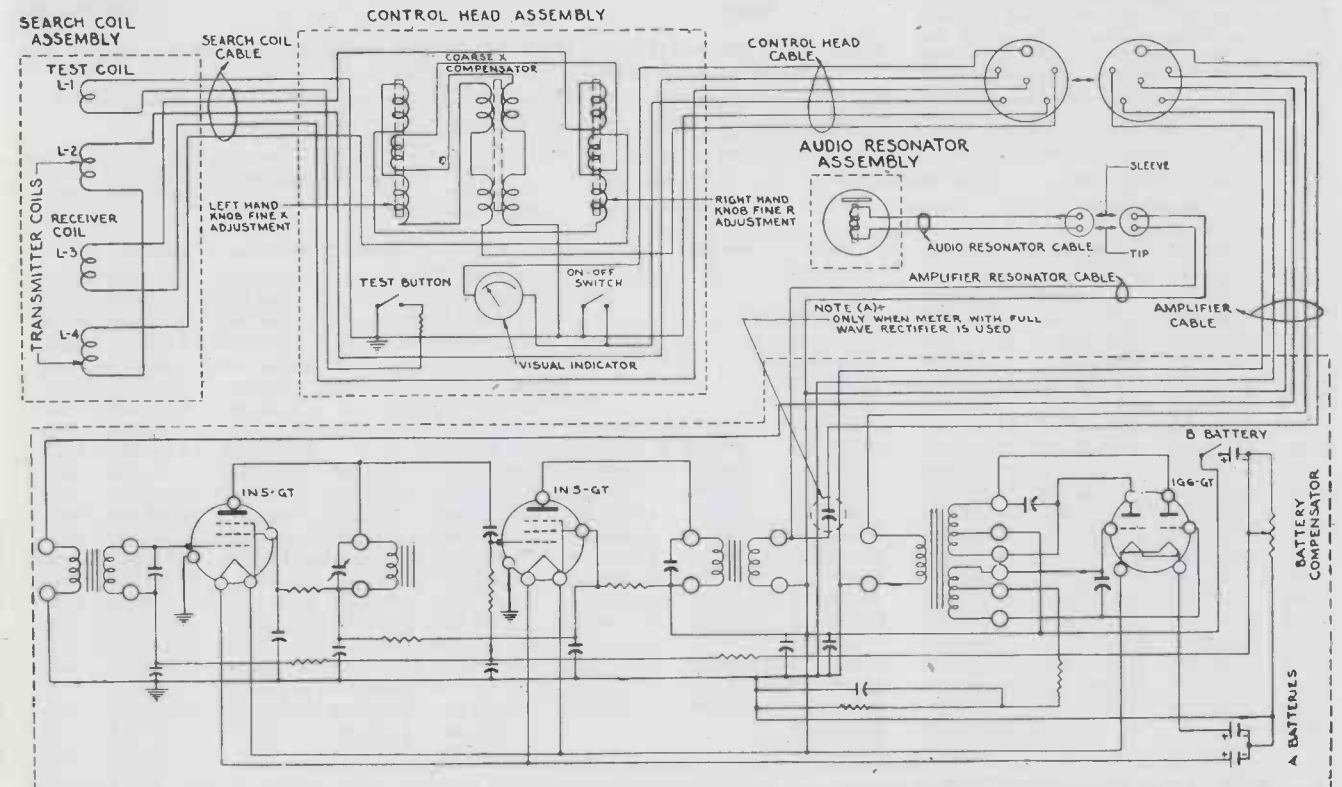

The unit is comprised of the exploring-rod assembly consisting of the search coil, control box, and handle. The control box contains the visual indicating meter, test button, two compensator knobs, coarse compensator, and an ON-OFF switch. The amplifier contains the battery compartment and amplifier chassis.

The chassis is mounted on a hinge, and is held in the housing by means of a locking screw. This provides a convenient method for the removal of the unit for the replacement of tubes. The housing is weather-proof and sealed by a gasket lining the inside top surface. All cables from the amplifier are waterproofed. The receiver or resonator is mounted in a metal bag and equipped with a strap having a dpt fastener which is used to fasten the resonator to the strap of the amplifier bag or the haversack.

A wood carrying case is provided. It is used to transport and store the equipment when not in use.

The detector set operates on the principle of a balanced mutual inductance bridge. Three of the inductances contained in the search-coil constitute the main component of the bridge. Two inductances are connected to a source of sine-wave voltage. This voltage at a frequency of 1,000 cycles per second is generated by a push-pull oscillator circuit. The third inductance is connected to a tuned two-stage audio amplifier, the output voltage of which is applied to a resonator and an 0-1 milliamper rectifier-type meter.

Inductances L2 and L4 are connected in series so that their fields oppose and the combined mutual inductance with respect to coil L3 is approximately zero. A complete balance is accomplished by the use of tuned compensator coils contained in the control box. When the mutual inductance between two transmitting coils (L2 and L4) and the receiving coil (L3) is zero, there will be no signal voltage at the input of the amplifier. The presence of metal in the field of these coils changes their mutual inductance, and the signal voltage is induced in the receiving coil (L3). The receiving coil (L3) is coupled to the input of the amplifier and all increased signal voltage is supplied to the resonator and to the indicating meter.

The balancing of the mutual inductance is accomplished by the adjustment of two controls. One of these controls provides coarse compensation. The other is used as a fine control after the coarse compensation has been approximated. The balance is accomplished by the adjustment of the coupling between the primary and the properly phased

secondary of the coils, respectively, by means of iron cores. The resistive balance of the circuit is accomplished by the adjustment of the coupling between the primary and the properly phased secondary of coil by means of a brass core.

The voltage produced in the receiving coil (L3) is applied to the grid of the tube, through a transformer, the secondary of which is tuned to 1,000 cycles by a capacitor.

The plate circuit of the tube is

(Continued on page 174)

Top—Signal Corps photo showing SCR 625-F mine detector in use under battle conditions as engineers check the ruins of St. Lo for buried explosives. Center—Exploded view of the equipment showing its various components. Bottom—Photographed in North Africa, these three types of German Tellur mines are charged with 11 pounds of explosives

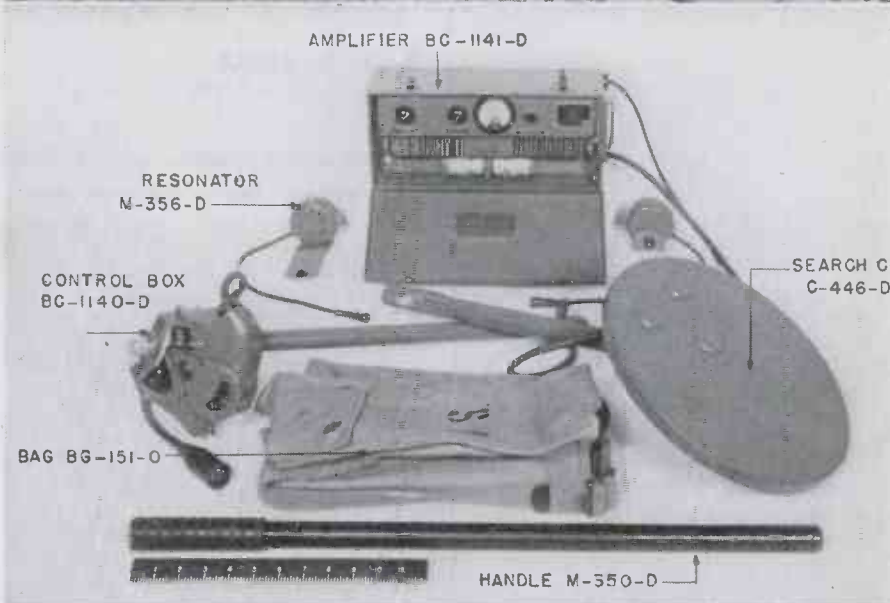

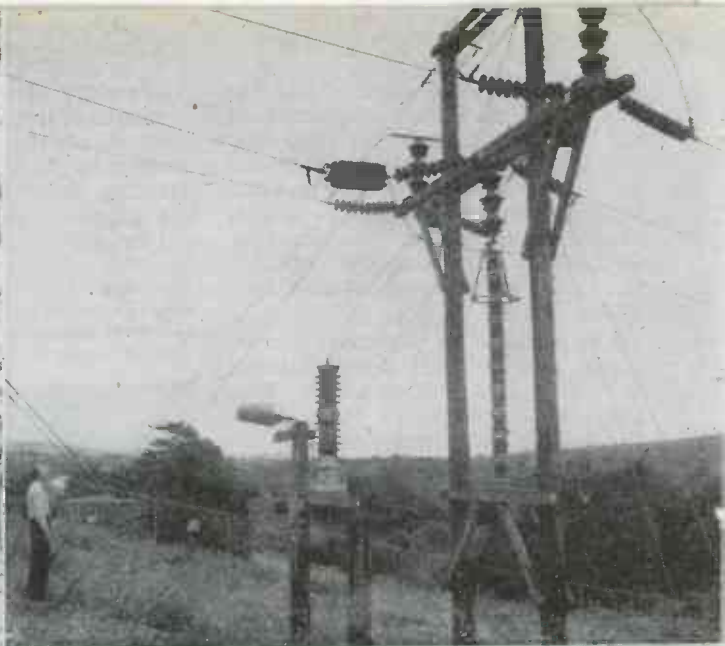
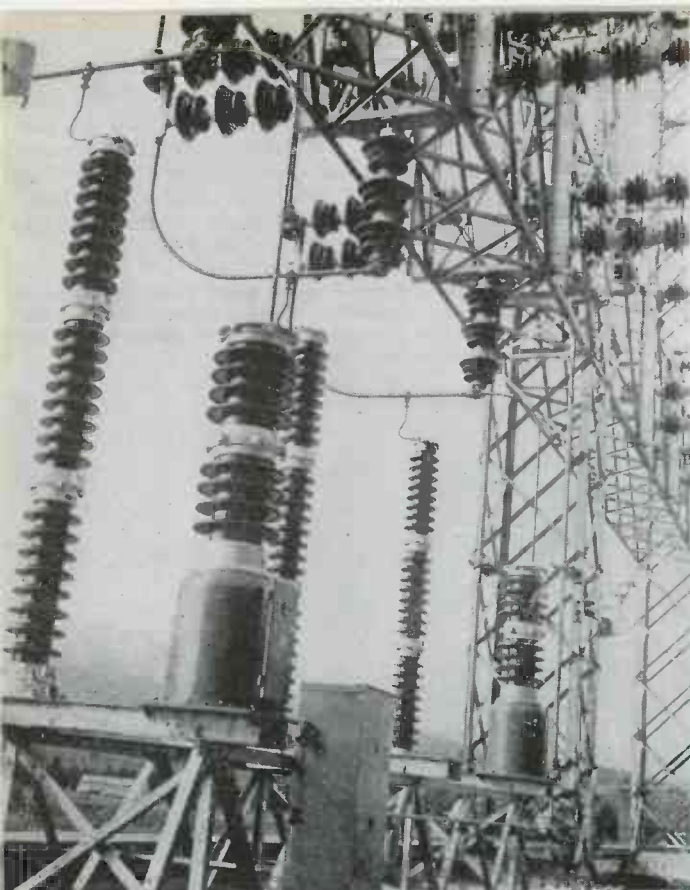

Left—Typical phase-to-phase coupling with two capacitors supplied from one line tuning unit. Tall, thin stacks are lightning arrestors

Above—Another method of installing line traps and coupling capacitors, the latter mounted on stub poles, are connected to the line before it enters the line trap. The line connects through the line trap to another section on the left

# APPLYING POWER LINE

by F. S. BEALE

Westinghouse Elec. & Mfg. Co., Baltimore

**Communication, supervisory system control and telemetering are representative of engineering worth**

● Power line carrier, a means of transferring information from one point to another over an electrical power transmission line, is a significant factor in maintaining and controlling power transmission. Continuity of service, either from the standpoint of the utility operator or the consumer, is self-evidently vital: interruption of service is costly to both.

Power line carrier provides a practical and reliable method of communication, control, relaying, and telemetering. It performs these functions electronically, for two of the three necessary components of this system are (1) the high frequency alternating current forming the base or carrier, and (2) the modulation or control applied to the carrier. The third system element is the path over which the modulated or controlled carrier energy flows—the ordinary power transmission line.

In power line carrier the energy

is produced by a carrier frequency generator or transmitter. This energy is transferred to a power line by suitable coupling devices; it flows over the power line linking the stations between which communication is desired; and it appears at the receiving equipment because the latter also is coupled to the power line by coupling devices.

As it is commonly found today, power line carrier equipment consists of units similar to those used in radio. It is distinguished from radio in that the energy produced by the transmitter is not intentionally radiated into space. All design, construction, and adjustment features are aimed at preventing any radiation of energy.

The object of the equipment is to put the energy into the power transmission line. Thus, with the power transmission line linking the two stations, communication is established over a rugged metallic

circuit. Atmospheric disturbances have no effect upon such communication. Actual strokes of lightning contacting the transmission line over which one may be talking by means of power line carrier, will produce popping sounds similar to but not as loud as those heard on ordinary open wire telephone circuits.

## Advantages of carrier

Continuity of service is a critical feature of electrical utility operation. Adequate and reliable communication and control throughout a system is thus extremely desirable. In spite of the fact that many utilities string their own telephone wires on the poles of their transmission lines, there are three excellent reasons underlying the installations of power line carrier equipment by utility system operators: (1) reliability, (2) safety, and (3) economy.

Strength of construction is one

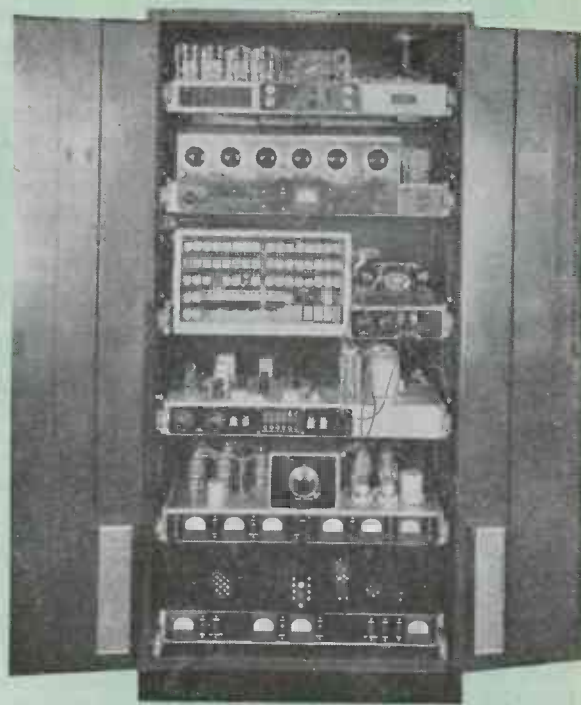

Above—A more compact panel mounted assembly that handles all of usual carrier functions. A typical power line carrier assembly housed in a steel cabinet, containing from top down, a power distributing unit, with the telephone line test jacks, receiver, telephone unit, electronic transfer control chassis, transmitter chassis and, at the bottom behind the screen, the power amplifier chassis

# CARRIER PRINCIPLES

of the elements contributing to the reliability of power line carrier. Power circuits are ruggedly built, with large factors of safety. Underground telephone cable construction is not much more reliable. Moreover, carrier does not suffer from the well known inductive disturbances of wire telephone circuits. Many old power transmission lines do not have transpositions. Telephone lines strung on these power transmission line structures require wide conductor spacings because of the long spans used. Such construction requires special treatment to reduce noise levels, including such things as drain coils which increase the loading of the line. Transpositions in the telephone lines must be coordinated with transpositions in the power line in order to secure the best results.

Furthermore, actual physical breaks in the power line conductors do not always stop power line carrier. Transmission line wires may sometimes actually be lying on the ground with communication still maintained through damaged circuits.

Safety is assured since the power line carrier telephone is very well insulated from the transmission line voltage. Telephone lines connected to power line carrier equip-

ment may be connected to conventional telephone equipment, including PBX boards. While broken power line conductors offer a hazard to the physical telephone lines strung under them, this hazard is not present with power line carrier, providing physical arrangement of the carrier equipment and its telephone extension lines is such that the broken power conductors cannot possibly contact the low voltage circuits.

## Maintenance cost

Lower maintenance cost is another advantage of power line carrier. Since the transmission line must be maintained for power purposes, line maintenance for the communication circuit is automatically provided. The cost of maintaining the equipment and lines for an equivalent conventional telephone circuit far outweighs the cost of maintaining power line carrier equipment.

When the cost of producing a desired result is considered, even without consideration of safety or reliability, power line carrier will prove cheaper for longer distances. Such distances, of course, will depend upon the completeness and complexity of the communication

service desired and the cost of installing or leasing equivalent wire telephone lines.

## Method of operation

Transmitter-receiver equipment is located at each of the stations between which communication is desired. It is coupled to the power transmission lines connecting these stations. Operation of the transmitter sends carrier frequency energy over the power transmission lines, and this energy goes wherever the lines go. A receiver at one of the stations on the "channel" detects the presence of the carrier energy on the lines because it is coupled to it, just as is the transmitter.

The equipment consists of five units: (1) transmitter, (2) a means of coupling to the power transmission line, (3) the power transmission line, (4) means of coupling to the receiver, and (5) the receiver.

These five units form a channel for communication in one direction only. For communication in both directions, there must be a receiver and transmitter at each station. If the transmitter and receiver located at the same station are tuned to the same frequency, the receiver will be blocked by the

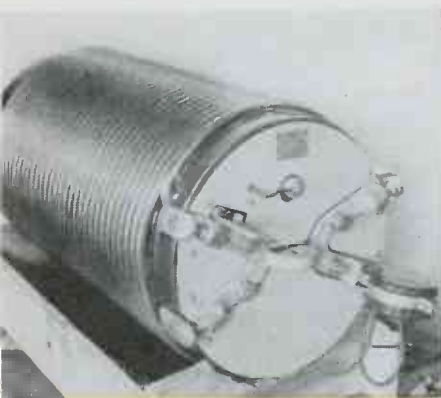

The resonant line trap is wound on a hollow porcelain core holding the tuning capacitor

relatively high signal strength of the local transmitter, and will be prevented from receiving signals from distant stations during the operation of the local transmitter. This means that the transmitter must be energized only while talking and only at the station doing the talking. This single frequency system permits the receiver at the listening station to operate normally. Conversation may proceed only in one direction at a given time.

Under some conditions the number of stations on a single frequency channel is limited by the number of stations which selective ringing equipment can handle. This single frequency system is called "simplex" because communication is possible only in one direction over the channel at any particular instant.

### Two-way circuits

The use of two carrier frequencies per channel permits conversations to proceed in both directions simultaneously because transmitters at opposite stations are on different frequencies. This allows each receiver to be tuned to a frequency not in use by its associated transmitter, so that signals can be received normally even though the local transmitter is operating. But this system requires two frequency assignments per channel, and usually only two stations may be operated conveniently. However, with such system it is possible for any of several stations to communicate with a single station, but they will not be able to communicate among themselves without special arrangements of the equipment.

For telephonic communication by means of power line carrier equipment, a means of modulating the transmitter becomes part of the basic equipment. Other functions than telephone service may be handled simply by using suitable means of controlling the transmit-

ter and of transforming the received signals into the desired means of control or signalling. Control may take the form of starting and stopping the carrier transmitter. It may take the form of momentarily changing the frequency of the transmitter from its normal standby frequency to a higher or lower frequency. Or it may take the form of modulating the carrier with some audio frequency tone which, in turn, may be separately controlled.

Communication by telephone is, of course, an obvious application of power line carrier. The system may take the form of two frequency equipment where only two stations are involved on the channel; if more than two stations are involved it is highly desirable, if not necessary, to use the single frequency method.

Signalling the called station can be done by several means. With a loud speaker at each station, the operator can call the other station by merely lifting the telephone instrument and speaking into it, calling the name of the desired station. This method has an obvious shortcoming: the operator may not be within earshot of his loud speaker. A system of bell signalling, in which operating a crank, key switch or push button at the calling station controls the ringing of a bell at the called station, overcomes this difficulty. Instead of bell signalling, a small dial telephone exchange may be installed in each transmitter-receiver unit, providing a power line carrier telephone service equivalent to that obtained from conventional dial telephone systems.

Several problems generally confront the power system operator in

connection with the application and installation of power line carrier equipment: (1) getting the energy onto the transmission lines; (2) tuning the coupling equipment; (3) connecting terminal equipment, tuner, and coupling; (4) segregation and confinement of energy to path; (5) corona interference; (6) transient arc interference; and (7) surge protection.

Getting the energy onto the transmission line is now done in a more or less standardized fashion. Paper-dielectric capacitors are used. They are assembled in series parallel groups, placed in porcelain weather-guards, and sealed with metal tops and bottoms which also serve as the capacitor terminals. A base unit is arranged somewhat differently for practical reasons. One terminal of the capacitor connects to a special base and ground through a 60 cycle drain coil.

### Line tuning unit

The carrier energy is fed to the same terminal of the base coupling capacitor to which the drain coil is connected. As many coupling capacitor sections as are needed to operate safely on the power transmission line voltage are stacked one above the other on top of the base unit. Bolted together in this fashion they are electrically in series, and the power transmission line conductor selected as the carrier energy path is then connected to the top cap of the coupling capacitor assembly.

The carrier energy may thus divide between the path to ground through the 60 cycle drain coil, which has an impedance of many thousand ohms at the carrier frequency, and the coupling capacitor path to the transmission line conductor. Because the coupling capacitor path will have capacitive reactance series-resonated by means of the tuner inductance at the carrier operating frequency, the net impedance at this frequency approaches zero. For this reason only a very small portion of the carrier energy will be lost via the drain coil.

Tuning the coupling equipment is necessary in order to cancel the net capacitive reactance of the coupling capacitor at the frequency of the carrier energy. It is done by means of adjustable inductors to produce series resonance of the combined circuit.

Connections of the terminal equipment, which includes the transmitter and the tuning and coupling devices, depend upon the relative locations of these three items. Generally speaking, the tuning equipment is located within five to 25 ft. of the coupling capacitor

Fig. 5—Curves showing influence of absorption and reflection of tap lines, transformers and similar equipment in carrier frequency transmission. With a carrier frequency of 70 kc the attenuation is low. For other loading conditions, the losses may double or more, especially at certain frequencies such as 110 kc

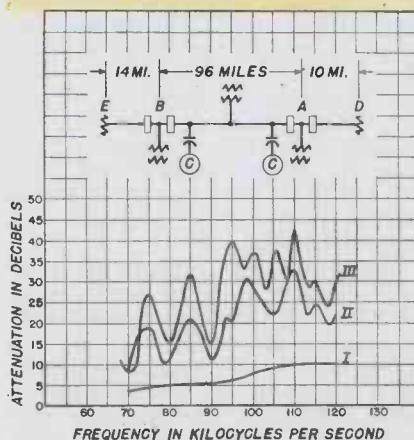



and is connected to it by bare or insulated wire. This wire must be supported on good insulation, because it is very necessary to maintain the highest practical value of resistance for the leakage at carrier frequencies and the relatively high value of impedance at which this connection operates.

With the tuning unit close to the coupling capacitor, the transmitter is usually connected to the tuning unit by means of a low impedance line or coaxial-type cable, the latter being preferred. From 50 to 70 ohms is the usual range of coaxial cable impedance, and the lengths may run to several thousand feet, provided that connection to the tuning unit is made through some sort of impedance matching device and the coupling capacitor reactance is neutralized by the tuning unit inductance.

### Overcoming troubles

Every application of power line carrier raises the question of segregating and confining the carrier energy to the proper path. It may be that the frequency for a power line carrier channel cannot be changed, and it is found that the power transmission line acts like something more or less closely approaching a short circuit at the particular frequency which must be used. The section of the line being used may behave as a resonant trap and cause this trouble.

Another condition frequently encountered is that of the possibility of open power transmission line circuit breakers at some intermediate station along the path of the power line carrier channel. Of course, this may open-circuit the carrier channel. This condition is one which must be considered from the economic standpoint, since it may cost more to by-pass such sectionalizing points than the communication would be worth during the length of time the by-pass might be in use. If continuity of carrier channel is worth more than the cost of by-passing, however, it should be provided.

Segregation and confinement of the power line carrier energy is important in some cases and less important in others. The reasons are economic and operational. If the carrier energy dissipated by certain tap lines must be reduced, a device having a high series impedance at the carrier frequency can be installed in the proper conductors of the tap lines. Such an impedance usually consists of an inductance and capacitance connected for parallel resonance, tuned to the carrier frequency. It is commonly known as a resonant line trap.

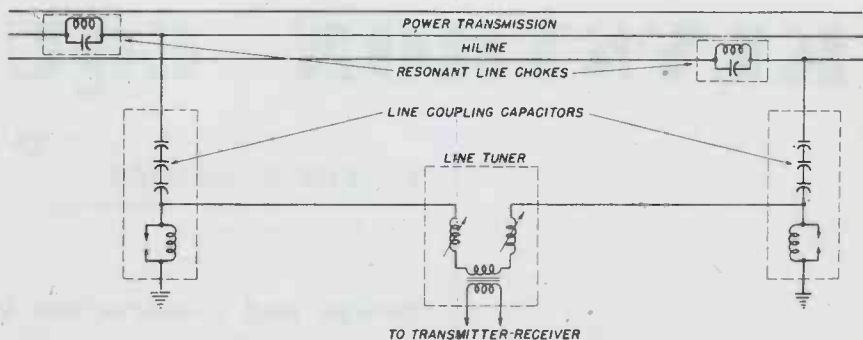

Carrier line coupling scheme wherein traps are installed in transmission line conductors at a point ahead of coupling capacitors to prevent short-circuiting the carrier energy

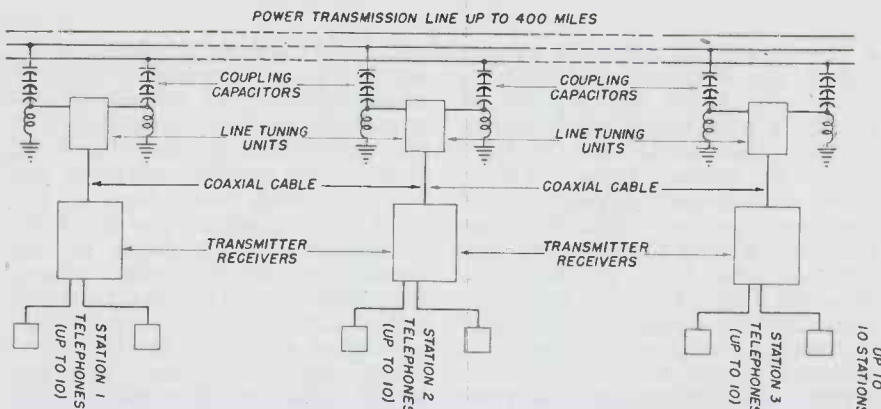

Block diagram showing connection of three such stations to a transmission line. In each case the transmitter-receiver units are capable of serving up to ten telephone circuits. This method, called interphase or phase-to-phase coupling, gives greatest reliability because of grounds

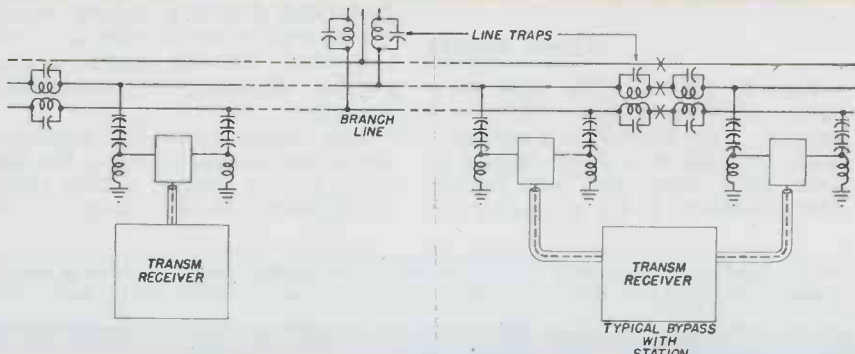

At right, shows method of by-passing circuit breakers so that when line faults open the breaker communication may be maintained; energy flows between couplings by way of line tuning unit

Power lines terminating in circuit breakers are frequently provided with grounding switches which can be used to ground the power lines while the circuit breakers at the terminals are open. These grounds could, of course, short circuit the carrier energy, but the use of resonant line traps will prevent this. Such grounding arrangements often are found at sectionalizing points, and where these are by-passed for the carrier energy resonant line traps are required.

Two other factors bear upon the segregation and confinement of the carrier energy to its path: line attenuation and absorption. The transmission of carrier frequency energy over the power transmission line encounters the same difficulties that all wire transmission lines of-

fer to the flow of radio frequency energy. The attenuation of such lines is a result of their resistance, inductance, capacitance, leakage paths, and reflections due to physical and electrical discontinuities.

The pattern of attenuation over a range of 50 to 150 kc, for example, follows the usual pattern for improperly terminated radio frequency transmission lines, having a cyclic pattern of rising and falling values due to reflection and radiation phenomena. If these troubles render a carrier channel inoperative, a study may reveal that use of resonant line traps will cure the difficulty; the other possibilities are to change to another frequency, or to raise the transmitter power.

Transient-arcs produce noise in  
(Continued on page 174)

# KLYSTRON EQUIPMENT

by **JESSE B. SHERMAN**

Assistant Professor, Electrical Engineering  
The Cooper Union, New York

## *Design and construction of flexible laboratory set-up for convenient generation and study of microwaves*

● The equipment described in this article was designed and built in the Cooper Union Laboratories to provide a high degree of flexibility in the experimental use of Klystrons of various types. Fig. 1 shows the general appearance of the complete set. The Klystron tube and blower comprise the uppermost unit (Fig. 2); which is mounted atop a standard steel cabinet containing filament, bias, and modulation supplies. Below this cabinet is housed the variable anode supply. The arrangement provides great convenience, both with respect to operation and interchange of tube types.

### **Anode supply**

Fig. 3, showing the rear door open, indicates details of the anode supply. This furnishes a continuously variable dc voltage from 0 to over 3,000 volts, and will deliver approximately 1 kw at maximum

voltage. Control is obtained by means of a Powerstat variable transformer (upper portion of compartment) feeding the primary of the power transformer (center of floor). The rectifier employs the two type 866A tubes seen at the right, behind which are the filter condensers. To the left of the transformer are the filter chokes. The high-voltage supply is interlocked through the rear door; the contactors appear at the left. The anode control, together with the anode voltmeter, line switch, and pilot light, are located on the 45-degree panel seen in Fig. 1. The small knob next to the main Powerstat dial is a geared vernier which was added to give an 8-to-1 reduction; this has proved a great help in adjusting the accelerating voltage.

The chassis above the high-voltage compartment contains the Klystron heater supply, a bias supply continuously variable from 0 to 150

volts which can be made either positive or negative with respect to cathode, and the usual 60-cycle anode modulation voltage to facilitate tuning adjustments. The bias voltage is controlled by means of a potentiometer in the transformer primary. Since the Klystron operates with anode at ground potential, the filament and bias transformers must be insulated for full anode voltage.

The front panel of this chassis (Fig. 1) has filament voltmeter and rheostat; bias voltmeter, milliammeter, potentiometer, and reversing switch; anode milliammeter with ranges of 30 and 300 ma, and switch for selecting range; and modulation switch and pilot. All of the meters are mounted on an insulating strip behind a glass window in the panel, as may be seen in Fig. 4. The small tube in the center of the chassis is type 6X5GT/G, mounted with socket below deck; this is the bias rectifier.

Fig. 2—Front panel and general arrangement of Klystron oscillator showing method of changing frequency of the 410-R tube, which with its blower is mounted on top of the steel cabinet

Fig. 1—General view of complete equipment, power supplies in compartment at the bottom

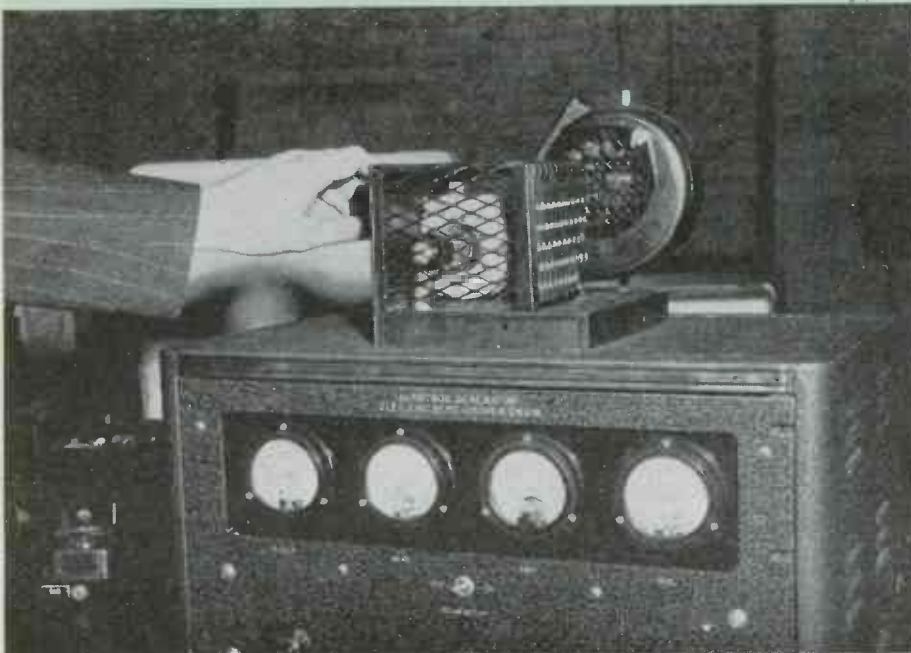

The two housings at right and left of this tube are respectively bias and modulation transformers, while toward the panel are filament transformers for bias rectifier and Klystron, and bias choke. All of the connections from the high-voltage compartment to the chassis are through a plug and socket located on the underside of the chassis at the right rear, a suitable hole being cut in the bottom of the cabinet.

The connections to the Klystron and blower unit are made through the two sockets mounted on tall brackets in the center of the chassis. Fig. 5 shows how this unit plugs in through holes in the top of the cabinet. Two 4-pin plugs are used; one carries the heater, cathode, and bias connections, all of which are at high negative potential to ground; the other plug carries the blower motor connections and an interlock. Thus the cabinet cannot be opened until the Klystron unit is removed, which also disconnects the high voltage.

#### Operator protection

The Klystron itself is provided with a mesh guard for mechanical protection. The guard can be removed with complete electrical safety to the operator as the socket is enclosed in a grounded shell and the connections are in grounded braid. Such a protected socket can be made from a standard Amphenol octal connector by replacing the standard socket with an Amphenol ceramic socket, wrapping with as much varnished cambric as space

within the housing permits, and running the leads out through a length of rubber tubing enclosed in braid. Unused socket springs should be removed. This arrangement was tested with all leads connected together and withstood 7,000 volts rms to ground.

The tube shown in the illustrations is the Sperry type 410-R,

which has a maximum voltage rating of 3,000 volts. Other tubes can be used in this equipment by simply providing suitable units to be plugged in, to replace the one shown. The outfit has proved thus far to be a most convenient source of microwaves, and a valuable addition to the Communication Laboratory at The Cooper Union.

Fig. 4—Rear view of complete oscillator chassis showing method of pillar mounting Klystron tube which is plugged into sockets (Fig. 5, below) mounted flush with the top of the cabinet

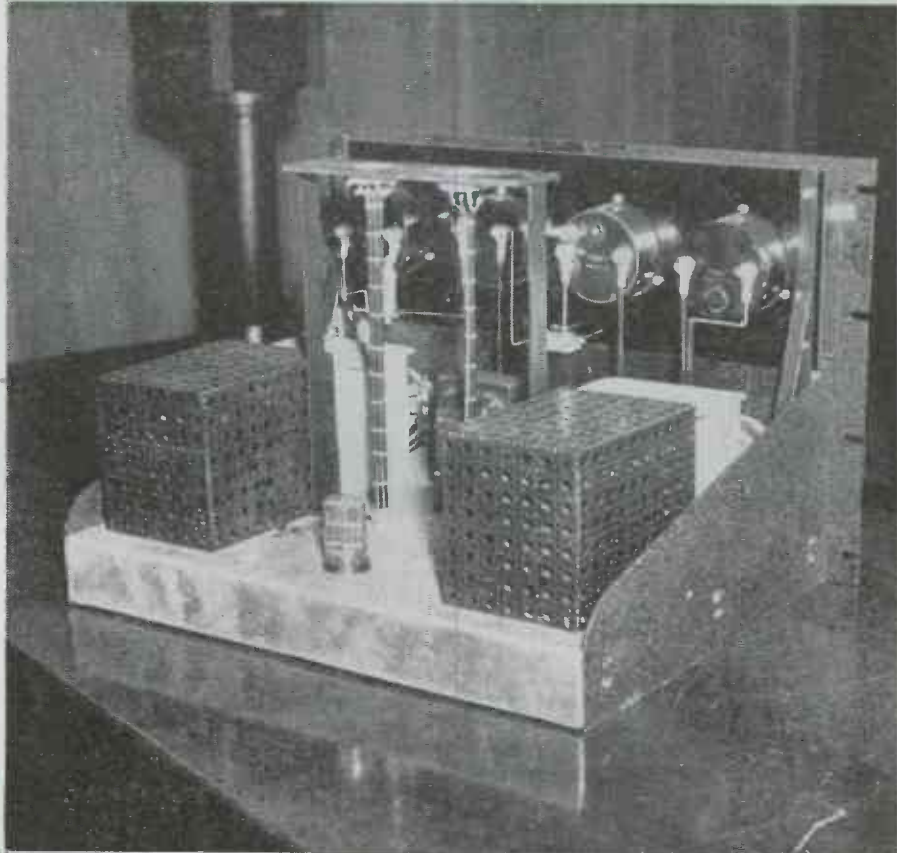
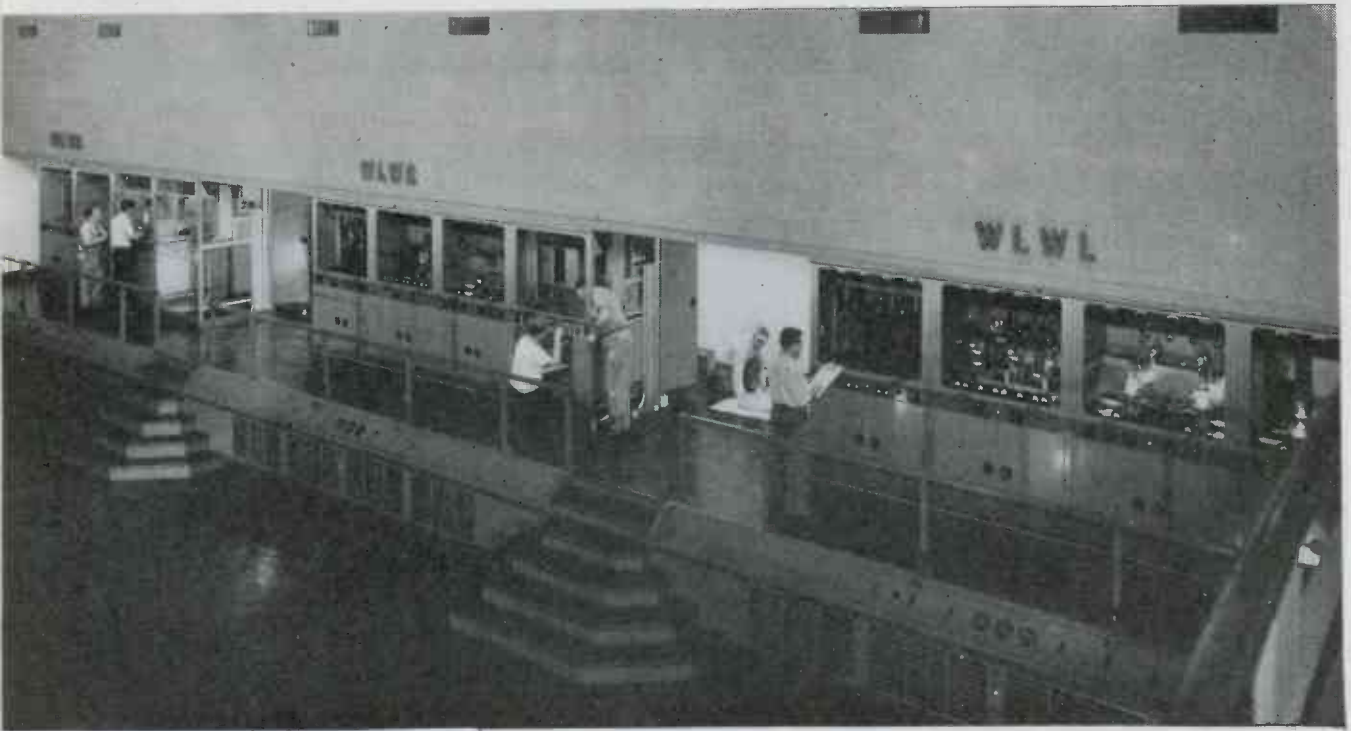

Fig. 3—Rear of power supply with interlocked protecting door open. 866 rectifiers at right



# CROSLY-OWI 200 KW



• Shortly after Pearl Harbor thrust the nation headlong into war, the Board of War Communications called a conference in Washington, at which all international radio licensees, equipment manufacturers, representatives of Federal Communications Commission, Office of the Coordinator of Inter-American Affairs, the Department of State, and others, studied the psychological warfare situation, and found Uncle Sam pitifully inferior to his Axis enemies in international broadcasting facilities.

At this and subsequent meetings, plans were made to remedy the situation—and an important part of those plans was the design and construction of six 200 kw transmitters, three of which were to be installed at Bethany, Ohio, about twenty miles from Cincinnati. The job of designing, manufacturing and installing these three transmitters was given to the Crosley Corp., and its engineering staff went to work.

Of course, there were a few “impossibilities” involved. There were no vacuum tubes, no output circuits, no antennas in existence, capable of such power! The tubes, particularly, were a serious problem. They first had to be designed; then they had to be built, and finally they had to operate from a 750 kva, 14,000-volt power supply, capable of irreparably damaging

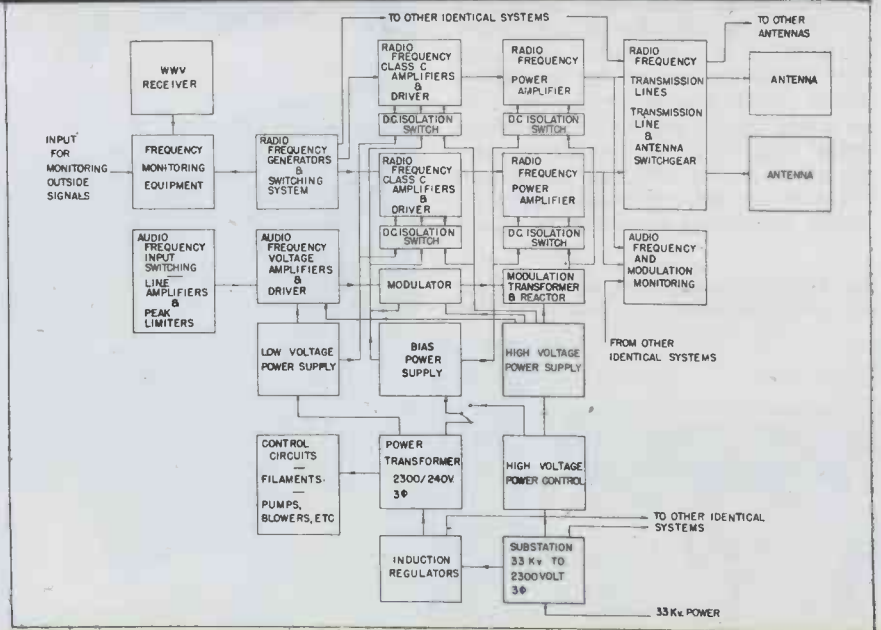

The three transmitter units that go to make up the Bethany installation present an impressive appearance. The block diagram shows one complete transmission system, primary power to antenna

such tubes in the event of an overload or an arc-back. Ordinarily, protection against such damage might be provided by any one of several types of 2,400-volt primary circuit breakers, all of which operate to remove power, in the event of a fault, and thus limit the damage.

Most power type air or oil circuit breakers have what is considered

fast action, when breaking their full rated current. For this installation, however, the normal fault current is about 10 per cent of the necessary maximum rating of a suitable breaker. At such low current values as this, a good high speed circuit breaker requires four or five times its high speed rating to break the current—about 12 to 15 cycles, or .2 to .25 seconds. Spe-

# "VOICE OF AMERICA"

cial air-blast breakers can cut this time to 2 or 3 cycles, or about .05 to .075 seconds.

Such speeds would not have provided a sufficiently safe margin for this installation. One other possibility remained—grid controlled high voltage rectifiers for the high voltage supply itself. Such rectifiers would provide the required interrupting speed, but unfortunately, there were none available which could be adapted to this installation.

So the designing engineers looked in another direction. High speed electronic circuit interrupters had been in use for several years in welding control equipment. Westinghouse and General Electric had developed this electronic device, called the Ignitron, a mercury pool cathode tube, requiring ignition of the cathode at the start of each conduction cycle. Investigation revealed that these lower voltage, higher current tubes could be used in the 2,400-volt primary circuit,

by **R. J. ROCKWELL**

Director of Broadcast Engineering  
The Crosley Corp., Cincinnati, Ohio

## ***How the Bethany short wave transmitter installation was planned and built and details of its operation***

properly phased igniting system is required for each tube, and the contactor conducts only when this system is operating. Ignition is controlled by thyatron tubes with dc bias. In normal operation, the bias supply delivers a small, negative voltage to the grid of all the firing thyratrons. This bias voltage is shorted out by closed contacts on the tube overload relays, door interlock circuits, and the "on" and "off" circuits.

### ***High speed protection***

When a fault occurs, however, these contacts increase the negative bias to a point where the peaking voltage will no longer fire the

it produces a flame at some point in the equipment before interruption is complete. With the Ignitron, there is seldom more than a spark, with no flame at all, which is evidence of its high speed.

Thanks to the Ignitron and a score of other entirely new ideas, applications and inventions in the field of radio engineering, the new "Voice of America" tried out its young lungs late in the summer of 1944 and on September 23, was formally dedicated in a nation-wide broadcast ceremony sponsored jointly by OWI, CIAA, and the Crosley Corp., after almost two years of planning, designing and building.

Once the basic plan was evolved, the first big problem was the selection of a site on which to build the project. The Bethany site was chosen only after thorough studies had been made of U. S. topographical maps covering a radius of about 50 miles around Cincinnati, and after every other possible site had been investigated.

### ***Transmitter building***

The building which houses the "loudest voice in the world" is composed of two separate units, an administrative section and a transmitter section. Although, due to the character of the design, there is an expansion joint between these sections, the two are actually one building. The administrative portion is two stories high, with a four-story central tower that serves as a guard station and revolving searchlight beacon house. Offices and living quarters for resident engineers, a machine shop and a garage occupy the two stories of the building itself, while the first three levels of the guard tower contain radio testing equipment, a storage tank for distilled water used in tube cooling, and two 1,500-gal. water storage tanks for general building purposes.

The transmitter section is a monitor type building 175 ft. wide by 75 ft. long. A tunnel extends under the center of the concourse, connecting with the boiler room under the administrative section, and provides cross-connecting facilities for the transmitters on



A complete system of modulation monitoring by means of oscilloscopes, and of frequency monitoring by secondary standard and WWV comparison is centrally located in the control room

and interruption of power could be accomplished in .015 seconds or less after interruption of the Ignitron system, for the Ignitron breaks the circuit in a fraction of a cycle, continuing to conduct only until it reaches normal current zero.

By using six Ignitron tubes in three pairs, each pair connected in inverse parallel, a three-phase electronic contactor was set up. A

thyratrons, thus preventing firing of the Ignitron tubes. High speed telephone type relays minimize relay operating time. The resulting interruption speed is from 60 deg. to 120-deg. of a cycle, plus .005 seconds, or less, for relay operation, a total of .008 to .015 seconds, at least twelve times as fast as a good high speed oil circuit breaker.

Ordinarily, when an arc occurs,



The building that houses the Bethany installation is two separate units, an administrative section and a transmitter section, the former having a four story tower that serves as a guard station and for a beacon, quarters for resident engineers. The transmitter section is 175 x 75 ft.

each side. To permit flexibility for piping and wiring a cellular steel floor was set between two mats of concrete, the upper layer being the floor of the concourse. This steel "Q-floor" extends from the sides of the tunnel walls to the undersides of the transmitter catwalks.

Another unusual design feature is its cantilever construction. The high bay has a span of 64 ft. between column supports. The monitor width of the high bay is 99 ft. To reduce the depth of the girders, supporting bay beams, 17 ft., 6 in. cantilevers, were designed on the outside of the columns, to support the extension of the monitor beyond the column centers. This cantilever action produced negative

moments in the center of the span, permitting a reduction of the beam depth of the girders bridging the high bay. The roof slab of the side bays is suspended from the bottom level of the cantilevers, producing a design in which only three spans are necessary to bridge a total distance of 175 ft., and which, at the same time, accomplishes the difference in ceiling heights incident to monitor type roof construction.

#### Transmitter arrangement

The transmitter section interior consists of the center concourse, flanked by catwalks, on which are mounted six transmitter units. Directly behind these units is a

continuous wall, in which is mounted, behind each individual unit, a group of cabinets which include 240-volt power distribution panels, magnetic switch panels, automatic air control equipment, etc. Beyond the wall to the rear are individual fan rooms, in which are cooling fans, water pumps, and plenum chambers for distributing inlet and heated air. Directly behind these fan rooms are the transformer vaults, in which the Ignitron units are installed. Under the catwalks are the filament transformers, and plumbing for distributing the water to water-cooled tubes. On the slanted front edge are water-flow meters, temperature gages, and water controls.

General view of one group of rhombic antennas, there being nine such groups arranged as shown in the map which also shows the property lay-out

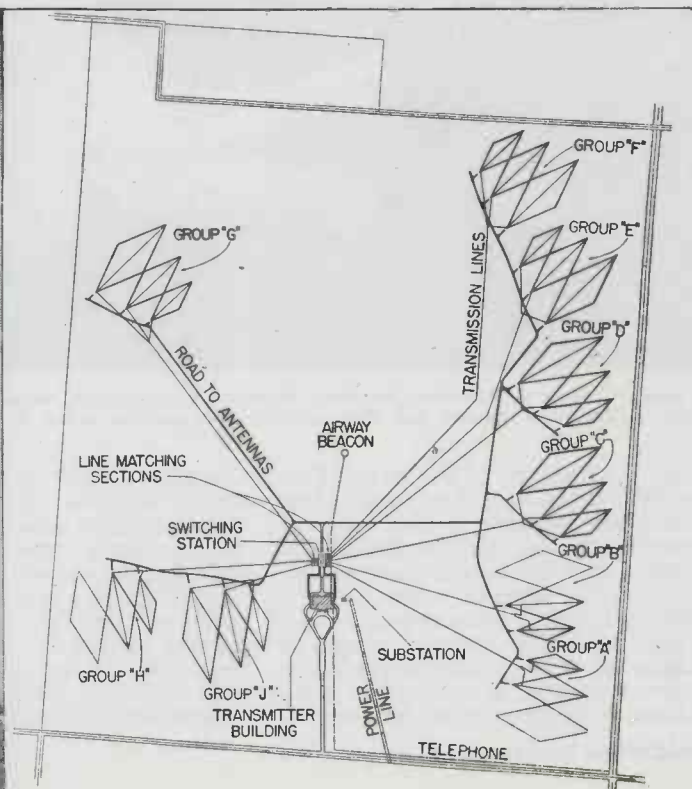
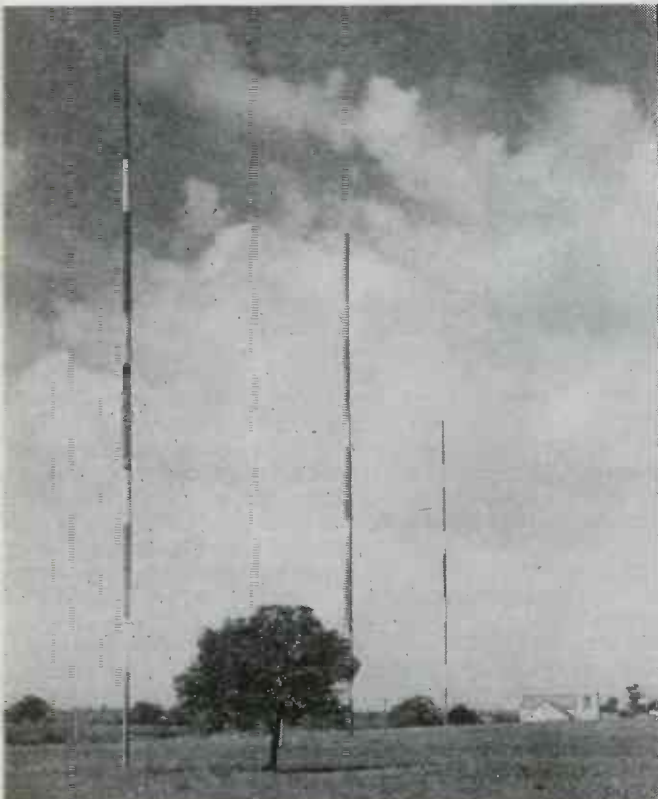



The main antenna switching station provides facilities for connecting the transmitters to the 27 radiators that are used, all being of the rhombic type. All are four wavelengths long. To change frequency two men are needed, one at the transmitters and the other to connect proper antennas

The entire building is thoroughly grounded, a mat of wires radiating on all sides for a distance of 50 ft., and extending to the reinforcing bars which are welded together within the concrete. This was done to eliminate the possibility of cross-modulation, and to provide a good ground matting for the transmitters.

### Transmission system

To give a general over-all picture of the complete transmission system, a block diagram is shown. The diagram shows one complete transmission system with its three essentials—primary power, radio frequency power, and audio frequency power—separately obtained and combined into high power modulated radio frequency energy, which is radiated by the antenna system.

Radio frequency at carrier frequency is generated continuously on all frequencies assigned to this plant. Separate 15-watt exciters for each frequency are mounted, six to a bay, in the control room. Exciter power is fed to the transmitters through a plug and jack panel, using multiple, double conductor coaxial lines and jacks.

The rf driver unit, operates at carrier frequency throughout. Its range is 6 to 22 mc. Input power from the exciters is from 2 to 5 watts. A maximum output power of 10 kw can be obtained from this unit, which is coupled, through an adjustable link, to the power amplifier in the adjacent cabinet to the right.

The modulated class C amplifier employs two tubes, operating push-pull, capable of 200 kw carrier output. Conventional lumped constant circuits are used in the grid, while the plate circuit consists of a lumped variable capacity, and a shorted transmission line section for the inductance. Variable inductive coupling is employed to trans-

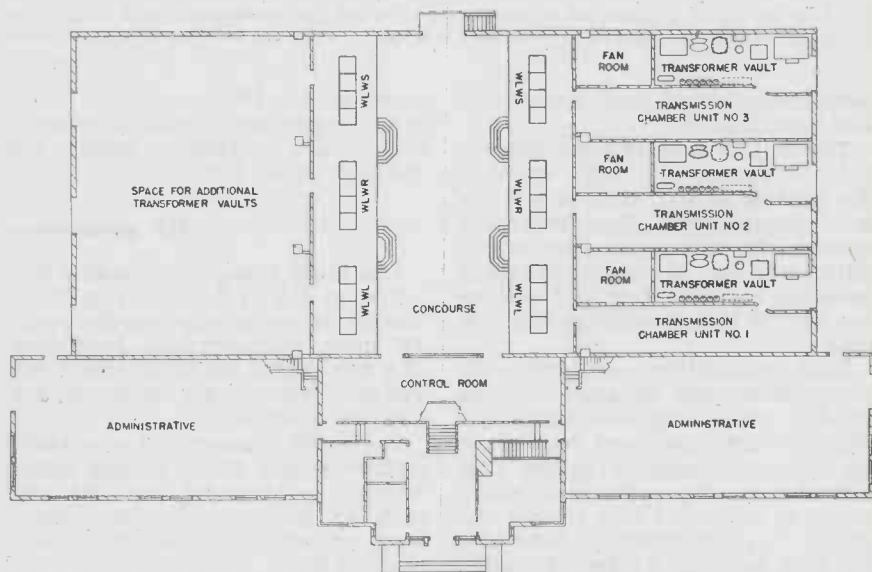

Plan view of the combination administrative-transmitter building showing arrangement of the transmitters, power supplies, transformer vaults and controls in the rear section

fer power to the antenna transmission lines.

The audio frequency circuits originate in the control room, where the modulating signal is taken from incoming telephone lines, or local electrical transcriptions. A transmitter circuit includes a limiting line amplifier, to amplify the audio voltage and compress high level peaks, a peak clipper to chop both positive and negative peaks at a pre-set level, usually equivalent to 100 per cent transmitter modulation, and the usual level controls and volume indicators.

From the control room, the audio frequency voltage is fed at zero level to the modulator unit of the transmitter. The modulator contains three push-pull voltage amplifier stages, and a multiple-tube class B power stage, capable of delivering 180 kw of audio power. The modulation transformer, modulation reactor, and dc blocking condenser are located in the trans-

former vault, and are connected to the modulator through high voltage cables.

Primary power for these transmitters is derived from a substation at the side of the main building, and a stepdown transformer in the transformer vault. All rectifier tubes and their filament transformers are located in the rectifier unit of the transmitter.

### Rectifier unit

The rectifier unit also serves as a control and supervisory unit for the entire transmitter. Momentary contact buttons, pilot relays, and supervisory relays and lights are mounted in the rectifier cabinet. All 240-v power contactors for filaments, low voltage supplies, etc., and a 240-v breaker and distribution panel are located in the wall cabinet behind the transmitter, as previously described. All equipment dangerous to personnel is com-

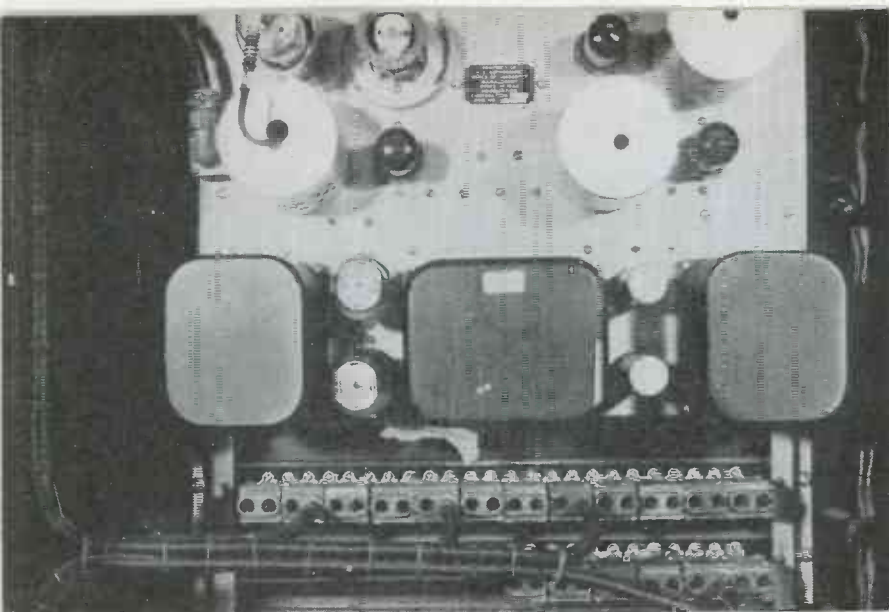

Top view of one of a battery of rf generator units which run continuously, have plug-in inductances and may be tuned to any operating frequency. Shield has been removed from buffer

pletely interlocked, both electrically and mechanically.

The antenna system consists of a transmission line from each of the six transmitter bays to a common transmission line switching system. In this gear, any transmitter line can be connected to any outgoing antenna line. All antennas are of the re-entrant rhombic type.

Each transmitter is equipped with a complete and separate cooling system, which supplies water for water-cooled tubes, and ventilating air for general cabinet cooling. This system is so arranged that all waste power is converted into heated air, which is automatically used for building heat in winter. In summer, heated air is forced through roof ventilators, causing cool air to be drawn into the building. A 50-gal.-per-hour still in the boiler

room and a 400-gal. storage tank in the guard tower, with a common feeder to all systems, supply the distilled water for cooling.

#### RF generator

The radio frequency signal is initiated in the rf generator units, a battery of which runs continuously. All units are identical, consisting of a 6V6 crystal oscillator stage, two 6V6 multiplier-buffer stages, and a final 807 amplifier.

Each unit is assembled on a rack-mounting 12 x 20 in. chassis, all of which are identical, so that any unit can operate on any frequency, when proper coils and crystals are plugged in.

Tuning the crystal oscillator and buffer amplifier stages is accomplished by midget variable condensers mounted inside the coil

forms. The tuning condenser for the plate circuit of the 807 stage is mounted on the chassis, and is adjustable from the front panel. Thus, to set up any unit on a given frequency, it is necessary only to plug in the proper coils and crystal, and peak the tuning of the 807 stage. In the view of one of the rf generator units, the shield has been removed from the second buffer stage coil to show the construction.

Audio monitoring is accomplished by speakers concealed above each transmitter. Each speaker is driven from its own amplifier. The input to this amplifier is normally fed from a diode monitor coupled to the transmitter output. By means of a switch located on the hand rail in front of the transmitter, speakers may be switched to the audio line so that comparison may be made between the signal as it enters the modulator input, and as it leaves the transmitter. Duplicate speakers are similarly located in the control room above the control desk, where monitoring is accomplished in the same manner. In addition, there are monitor level controls on the desk.

Cathode ray oscilloscopes are provided for monitoring the carrier of each transmitter, and are located in the control desk. Immediately below each oscilloscope panel is a small panel bearing the audio level control, the "Carrier on" light, the "emergency off" button for each of the transmitters, and a key which, when thrown, drops the studio line, and picks up the output of a pre-set electrical transcription machine, and simultaneously, through relays, starts the transcription machine motor. To the right of the public address speaker on the center panel is a master key, which operates all

(Continued on page 158)

Left is a view of the modulator unit which has three stages terminating in a pair of 89I tubes in push-pull. At the right is a close-up of the final amplifier designed to deliver 250 kw, 100 per cent plate modulated at frequencies between 6 and 21.65 mc, with plate voltages up to 15000

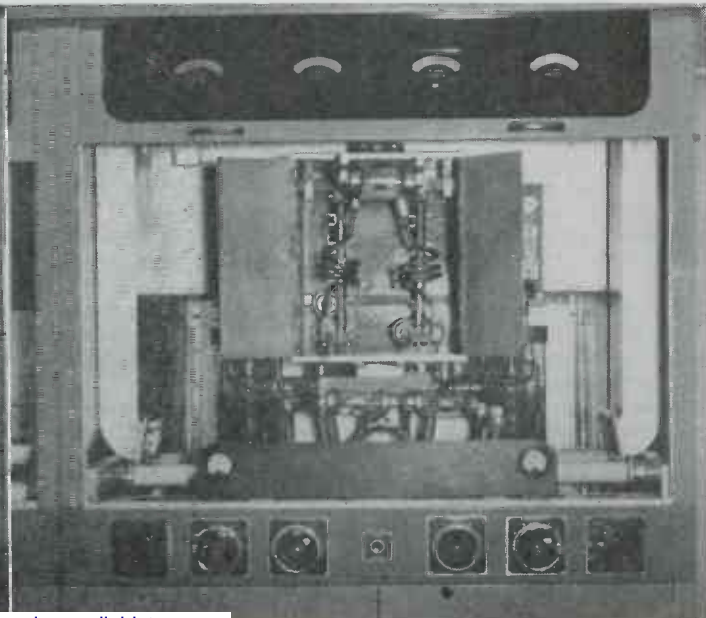
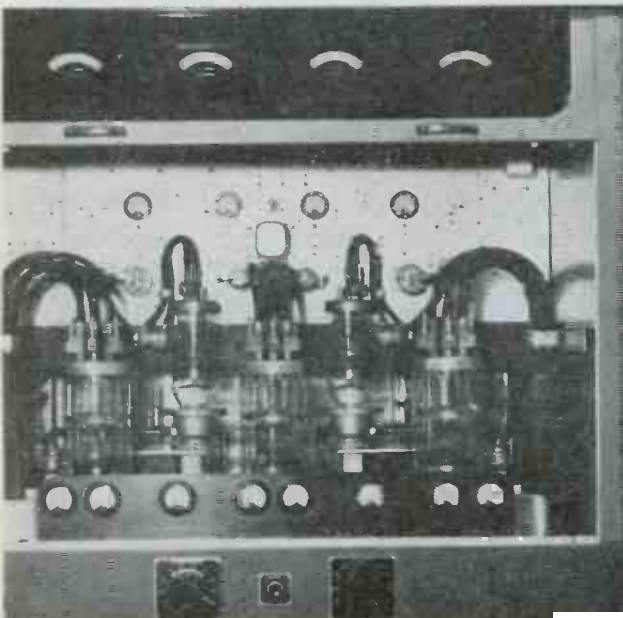



# IRE TECHNICAL MEETING

**Engineers schedule four-day conference to discuss unusually long program — Joint session with AIEE**

The Institute of Radio Engineers has scheduled one of its longest programs for the 1945 Winter Technical Meeting which opens at the Hotel Commodore, New York, on Wednesday, January 24, and will adjourn the following Saturday at

2:00 P.M. During the four days, a total of some 60 technical addresses will be made by engineers prominent in the industry as compared with about half that number that were given during the two days of the 1944 meeting. As was the case

last year, there is to be a joint session between members of the American Institute of Electrical Engineers and the IRE. This gathering will be held in the Engineering Societies building at 8:00 o'clock on  
(Continued on page 206)

**THURSDAY, JANUARY 25—10:30 A.M.—12:30 P.M.**

## **SYMPOSIUM OF THE IRE TECHNICAL COMMITTEES**

**Introduction:** The Committee Structure, F. B. Llewellyn.  
**Electronics Committee:** (a) Scope and Activities, R. S. Burnap; (b) Cathode-Ray-Tube Problems, L. B. Headrick; (c) Measurement of Admittance Coefficients at High Frequencies, J. A. Morton.  
**Piezoelectric Committee:** How Crystal Cuts Are Specified, W. G. Cady.  
**Circuits Committee:** What Should a Circuits Committee Standardize, and Why? E. A. Guillemin.  
**Facsimile Committee:** A Common Language for All Kinds of Picture Transmission, C. J. Young.  
**Radio Wave Propagation Committee:** C. R. Burrows.  
**Frequency-Modulation Committee:** Translating Amplitude-Modulation Concepts to Frequency Modulation, C. C. Chambers.  
**Transmitter Committee:** Functions and Objectives, R. F. Guy.  
**Symbols Committee:** Coordination of Communication and Power Symbols, E. W. Schafer.  
**Television Committee:** Television Standards, I. J. Kaar.  
**Electroacoustics Committee:** Possible Future Activities, G. G. Muller.  
**Receivers Committee:** Rating of Receiver Noise, L. F. Curtis.  
**Antennas Committee:** Andrew Alford.  
**Annual Review Committee:** The Institute Adds a Chapter to Its Survey of Radio Progress, L. E. Whittemore.  
**Standards Committee:** Expansion of Standards Activities, H. A. Wheeler.

**2:00 P.M.**

"Measurement of Receiver Impulse-Noise Susceptibility," Jerry P. Minter, Measurements Corp., Boonton, N. J.  
"Very-High-Frequency and Ultra-High-Frequency Signal Ranges as Limited by Noise and Co-channel Interference," K. A. Norton, formerly FCC, now War Department, Washington, and E. W. Allen, Jr., FCC.  
"Equivalent Networks for the Three Kinds of Triode Circuits," Harold A. Wheeler, Hazeltine Corp.  
"Exalted-Carrier Amplitude- and Phase-Modulation Reception," Murray G. Crosby, Consulting Engineer, formerly RCA Laboratories.  
"The Application of Double-Superheterodyne Receivers for Broadcast Reception," John D. Reid, Crosley Corp.  
"Klystron Characteristics," Coleman Dodd, Sperry Gyroscope Co.

**7:00 P.M.—ANNUAL IRE BANQUET—AWARDS—ADDRESS OF RETIRING PRESIDENT.**

**FRIDAY, JANUARY 26—**

**TECHNICAL SESSION "A"—9:30 A.M.**

## **VACUUM TUBES**

"New Miniature Tubes," R. L. Kelly and N. H. Gleen, RCA Victor Division, RCA, Harrison, N. J.  
"Introducing the Disk-Seal Tube," E. D. McArthur, Research Laboratory, General Electric Co.  
"Two Resonator Klystron Oscillators," D. R. Hamilton, Sperry Gyroscope "Reflex Oscillators," J. R. Pierce, Bell Telephone Laboratories.  
"A New Very-High-Frequency Tetrode for Medium-Power Output," Clayton E. Murdock, Eitel-McCullough, Inc.  
"A Vacuum-Contained Push-Pull Triode Transmitter," Major H. A. Zahl, J. E. Gorham, and G. F. Rouse, Signal Corps Ground Signal Agency, Asbury Park, N. J.

**TECHNICAL SESSION "B"—9:30 A.M.**

## **QUARTZ CRYSTALS**

"Introduction," Karl S. Van Dyke, Signal Corps Ground Signal Agency, Asbury Park, N. J.  
"Quartz-Crystal Supply Program," Major Edward W. Johnson, Signal Corps, Office of the Chief Signal Officer.  
"Crystal Quality," I. E. Fair, Bell Telephone Laboratories.  
"The Performance of X-Ray Meters," C. W. Harrison, Bell Telephone Labs.  
"Frequency Adjustment of Quartz-Oscillator Plates by X-Rays," Clifford Frondel, Reeves Sound Laboratories.  
"Equipment for Frequency Adjustment of Quartz-Oscillator Plates by X-Rays," Charles Roddy, North American Philips Co.  
"Aging of Quartz-Crystal Units," Virgil E. Bottom, Signal Corps Ground Signal Agency, Asbury Park, N. J.

**12:30 P.M.—PRESIDENT'S LUNCHEON, HONORING DR. W. L. EVERITT**

**TECHNICAL SESSION "A"—2:00 P.M.**

## **INDUSTRIAL ELECTRONICS**

"Is Industrial Electronic Technique Different?" W. D. Cockrell, Industrial Engineering Division, General Electric Co.  
"Practical Methods of Shielding Dielectric-Heating Installations," G. W. Klingaman and G. H. Williams, RCA.  
"Heating with High-Frequency Electric Fields," Paul D. Zottu, Girdler Corp., Louisville, Ky.  
"Operating Experiences with Induction-Heating Oscillators," Wallace C. Rudd, Induction Heating Corp., New York.  
"A High-Frequency Wattmeter and Its Uses in Industrial Applications," Eugene Mittelmann, Illinois Tool Works, Chicago.  
"The Radio-Frequency Dehydration of Materials Labile with Heat," George H. Brown, R. A. Bierwirth, and Cyril N. Hoyler, RCA Laboratories.

**TECHNICAL SESSION "B"—2:00 P.M.**

"The Interdepartment Radio Advisory Committee," Captain E. M. Webster, Vice-Chairman, Interdepartment Radio Advisory Committee, Washington.  
"Activities of the Radio Technical Planning Board," Alfred N. Goldsmith, Vice-Chairman, RTPB.  
"Notes on Selectivity-Design Parameters of Superregenerative Receivers," Allen Easton, Emerson Radio and Phonograph Corp., New York.  
"A Portable Two-Channel Recording Oscilloscope for Battery Operation," R. F. Wild and D. C. Culver, Research Section, Brown Instrument Co., Philadelphia.  
"High-Voltage Rectified Power Supply Using Fractional-Mu Triode Radio-Frequency Oscillator," R. L. Freeman and R. E. Hergenrother, Hazeltine Corp.  
"Centimeter-Wave Measurements," R. L. Sproull and E. G. Linder, RCA Laboratories.  
"An Electrometer Tube and Its Use in Minute Measurements," W. A. Hayes, Westinghouse Electric and Mfg. Co., Bloomfield, N. J.

**6:00 P.M.—COCKTAIL PARTY**

**SATURDAY, JANUARY 27—**

**TECHNICAL SESSION "A"—9:30 A.M.**

## **RADIO LINKS AND RELAYS**

"Introduction," Ralph Bown, Bell Telephone Laboratories.  
"Cape Charles-Norfolk Ultra-Short-Wave Multiplex System," N. F. Schlaack and A. C. Dickieson, Bell Telephone Laboratories.  
"Ultra-Short-Wave Multiplex," Charles R. Burrows, Bell Telephone Laboratories, and Alfred Decino, formerly Bell Telephone Laboratories.  
"Ultra-Short-Wave Receiver for the Cape Charles-Norfolk Multiplex System," D. M. Black, G. Rodwin, and W. T. Wintringham, Bell Telephone Laboratories.  
"Ultra-Short-Wave Transmitter for the Cape Charles-Norfolk Multiplex System," R. J. Kircher and R. W. Friis, Bell Telephone Laboratories.  
"Radio-Relay Communications Systems in the United States Army," Lieutenant-Colonel William S. Marks, Jr., Captain O. D. Perkins, and W. R. Clark, Signal Corps Ground Signal Agency, Asbury Park, N. J.

**TECHNICAL SESSION "B"—9:30 A.M.**

"The Servo Problem as a Transmission Problem," E. B. Ferrell, Bell Telephone Laboratories, Inc.  
"Instrument Approach and Landing Systems," Lieutenant-Colonel F. L. Moseley, Air Corps, Air Technical Service Command, Wright Field.  
"The Design of Broad-Band Aircraft Antenna Systems," Captain A. S. Meier, Air Corps, F. D. Bennett, and P. D. Coleman, Aircraft Radio Laboratory.  
"Some New Antenna Types and Their Applications," A. G. Kandoian, Federal Telephone and Radio Laboratories, New York.  
"Applications of High-Frequency Solid-Dielectric Lines to Radio Equipment," H. Busignies, Federal Telephone and Radio Laboratories, New York.

**12:30 P.M.—LUNCHEON IN HONOR OF MEN IN THE ARMED FORCES**

# PE TUBE X-RAY TIMER

by H. D. MORELAND

Manager, X-Ray Engineering  
Westinghouse Elec. & Mfg. Co., Baltimore

## *Electronic control of medical equipment provides uniformity of photofluorography, doubles efficiency*

● The difficulty of obtaining uniform density of negatives made by X-ray exposure for medical purposes has always represented somewhat of a limitation in the use of photo-fluorographic diagnosis. Uniform density is necessary in order that radiologists and technicians may be able to make accurate comparisons between negatives made in a series. For the first time, an electronic method of controlling exposures has been developed. The new process not only insures great uniformity of exposures but practically doubles operating efficiency. The process involves the use of a photoelectric timer which operates on the familiar principle of the exposure meter used by photographers.

X-ray radiation, passing through an object, strikes a fluorescent screen and is converted into visible radiation. The light from the luminous screen is focused on a phototube which in effect measures the light leaving the screen. When enough light has left the screen for the desired film exposure, the timer actuates a relay, opening the X-ray

circuit and terminating the exposure.

### *Industry uses*

Although first used in medical radiography for mass chest surveys on miniature roll films, the development will be generally useful and will include industrial X-ray analysis. Objects such as castings, conducted on conveyors, can be photographed inexpensively, quickly, and uniformly on miniature roll film using the phototube exposure control. Large, irregular objects need only be positioned before the screen. Since the phototube control responds to the actual light on the screen, deviations in the internal structure of the object X-rayed will not deceive the timer, and the result will be films of desired density, analytically satisfactory, attained with minimum cost.

Efficient photofluorography requires the examination of many objects in reasonable intervals of time, and the procedure must be simple enough to require a minimum of operating personnel. There

must be extreme uniformity between films for maximum analytic value, and the number of incorrect exposures requiring repetition must be small. The electronic timer fulfills these conditions so adequately that the operator need only position the object before the fluorescent screen and close the exposure switch. The timer then not only terminates the exposure at the proper moment, but an auxiliary circuit prevents overloading the X-ray tube.

### *Timer principles*

The operation of the timer is simple both in its principle which was first utilized by Dr. Russel E. Morgan under the direction of Dr. Paul C. Hodges, Director of Radiology at the University of Chicago. The timer takes advantage of the nature of the phototube in which output is proportional to the light striking the cathode.

The electronic timer consists primarily of a multiplier phototube and a capacitor-thyratron-relay system. When the exposure switch of the X-ray unit is closed, the X-ray



Method of mounting phototube camera on any standard fluorographic hood. Right—Timer in position on camera as subjects are positioned for making chest X-rays on 16mm. film



tube circuit is energized and X-rays pass through the object positioned before the photofluorographic hood. A grid in the hood filters out undesired, scattered X-ray radiations. The X-ray beam, having passed through the object and the grid, strikes the fluorescent screen. The fluorescent screen converts the invisible electromagnetic radiation into visible radiation, and light emanates from the screen in accordance with the density of the object.

Some of the light is focused by a lens onto the film of the camera at the apex of the hood; at the same time, some of the light is focused by another lens onto the cathode of the phototube in the so-called phototube camera mounted on the lower side of the hood. The light entering this tube initiates a small current proportional to the light intensity of the scanned section of the fluorescent screen. This current charges a capacitor and produces a potential which increases as the collected charge increases. The capacitor voltage is impressed across the grid and cathodes of a thyratron and "fires" this tube when the necessary ionization potential is reached. The circuit elements are chosen so that the ionization potential is attained only when sufficient radiation emanates from the fluorescent screen for correct, uniform film exposure. When the trigger tube ionizes and fires, a relay is energized which opens the X-ray circuit, terminating the operation of the X-ray tube and the exposure of the film.

Five variables, in general, are involved in X-ray photofluorography: (1) thickness of the object, (2) ex-

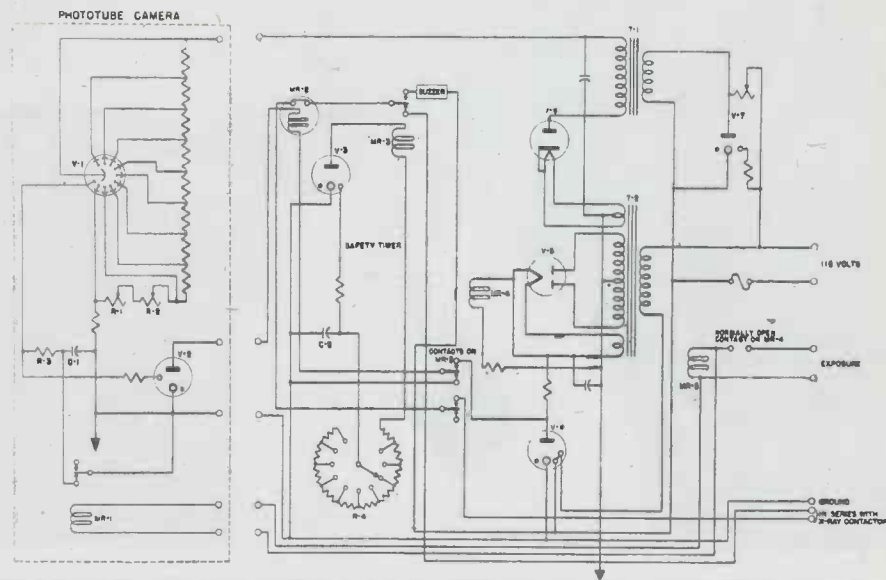

The two sections of the phototube timer circuit, with the camera equipment shown in the dotted box at left and the safety timer and power supply assembly at the right of the diagram

posure time, (3) X-ray tube voltage, (4) X-ray tube current and (5) distance from X-ray tube to fluorescent screen. In medical radiography prior to the development of the phototimer, the tube current and the distance were the only fixed factors—for example, 200 milliamperes and 40 in.

With the electronic control, the current is set at some particular value, but variations of current (or voltage) are of no consequence, and the exposure time is allowed to vary over a range from 1/20 to 1/5 of a second. Only a very rough kilovoltage adjustment is made based on an estimate of subject size, and the thickness of the subject need not be measured.

The essential parts of the phototube camera are the focusing lens, the multiplier phototube, a capacitor, a resistance, and a gas triode trigger tube. The phototube assembly is mounted beneath the photofluorographic hood, and the lens scans a representative, rectangular area of the fluorescent screen. In chest photofluorography this area, 9½ in. in the horizontal direction and 3¾ in. in the vertical, coincides with the portions of the upper lobes of the right and left lungs because they are representative areas of the subject's chest.

The density of the exposed film can be adjusted in accordance with the preference of the radiologist. A density control mounted on the phototube camera assembly varies the voltage between the eighth and ninth dynodes through a resistor and may be locked by means of a lock nut.

Initiation of the exposure occurs on closing the exposure switch. A current flows in the phototube circuit creating a potential across a resistor and capacitor. The resistor is included to compensate for the relay drop-out time—about 1/60 of a second. The trigger tube fires at

(Continued on page 208)

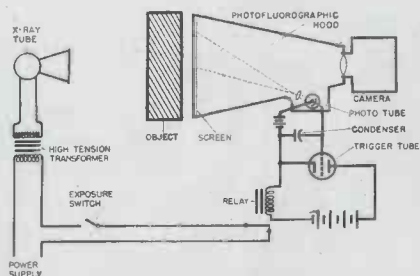

H. D. Moreland examining the phototube camera; above a schematic of the complete equipment

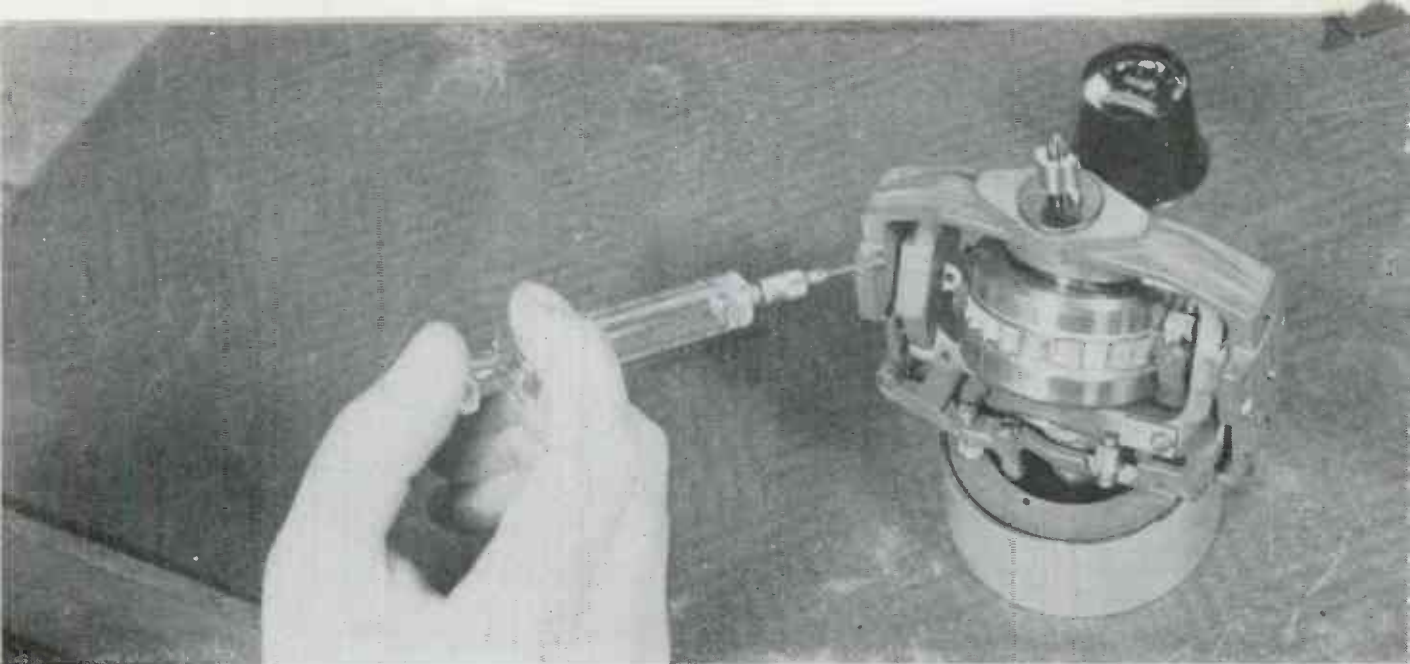

**1**—Hypodermic syringe saves the day when speed and accuracy are needed on delicate oiling jobs. Small amount of lubricant is here being applied to Sperry Co. directional gyro pivots being produced in plant of AC Spark Plug Co., Flint, Michigan.

## FACTORY SHORT CUTS

**2**—Fifteen kilowatt soldering job by induction heating, at Camden, N. J., RCA plant. Eight elements for a test equipment are assembled with a preformed ring of solder in position at the juncture of parts to be sealed. Operator presses push button and the job is done

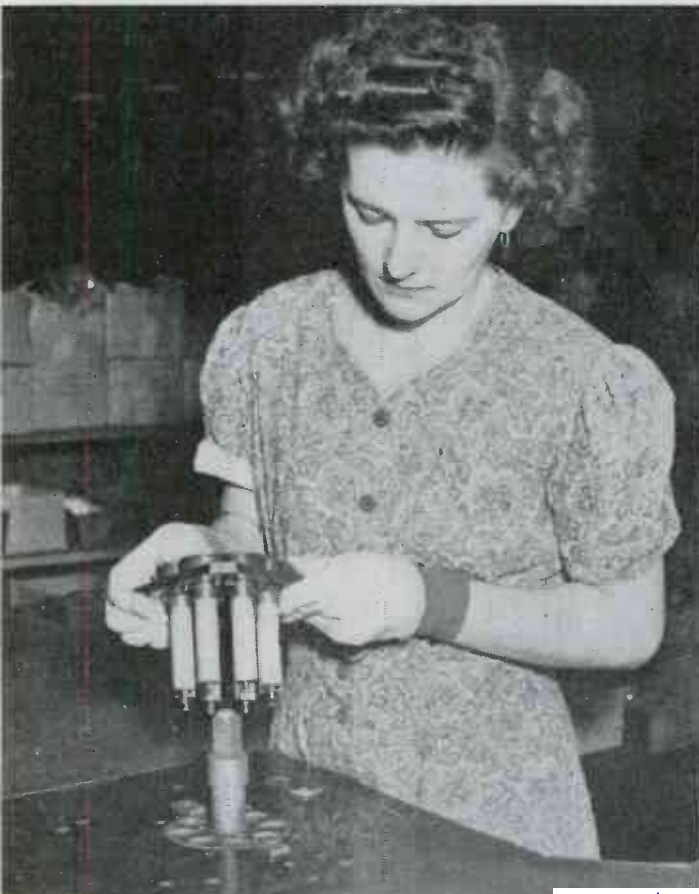

**3**—"Trolley Car Test Set" at Westinghouse Lamp Division, Bloomfield, N. J., so named because of the obviously reminiscent control handle, which advances tube to be tested to point where contact is made. Preheating and storage rack at girl's right



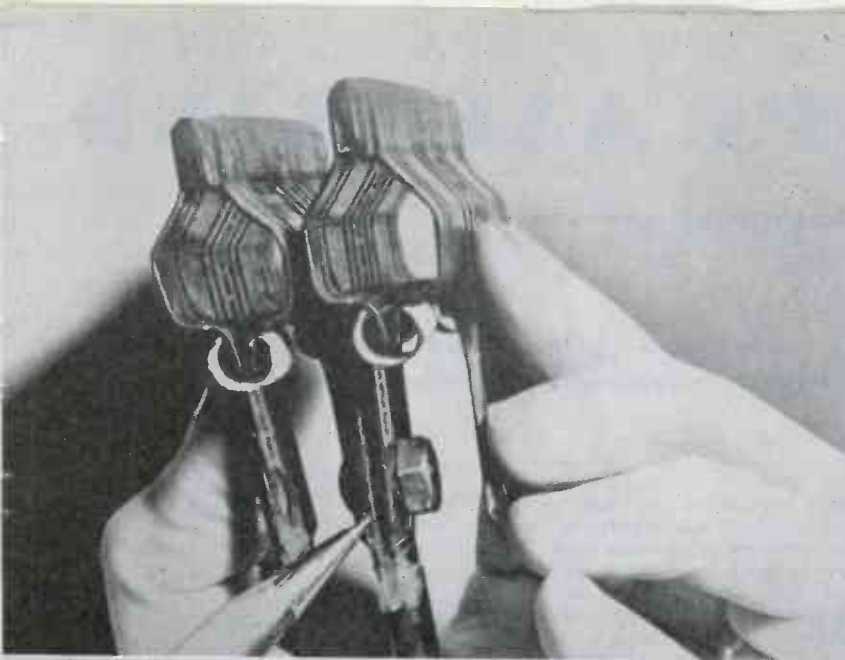

**4**—Brazing and bolting the center of double clip holders used at the RCA plant in Harrison for holding tube filaments while they get a coat of spray has reduced repair time and saved 1000 clips a year. Old way the clips, after cleaning, used to weaken at the center, and break

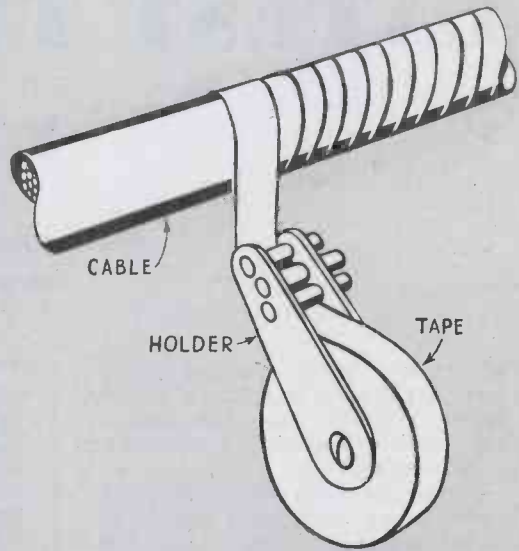

**5**—This holder for cotton tape that is used in serving the ends of cables was devised by a worker in the plant of the Kaiser Co., Portland, Ore. It makes neater job, with even laps, saves much time

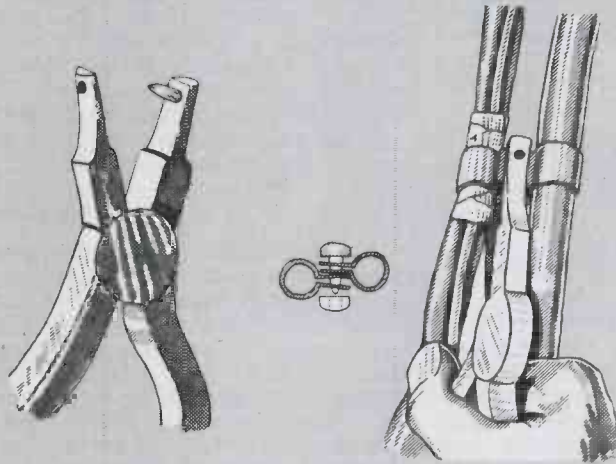

**6**—Instead of lining up clip holes with an awl while holding the clip with long nose pliers, operator at Murray Corp. of America, Detroit, altered a pair of pliers as shown so that one operation lines up holes ready for insertion of the pin

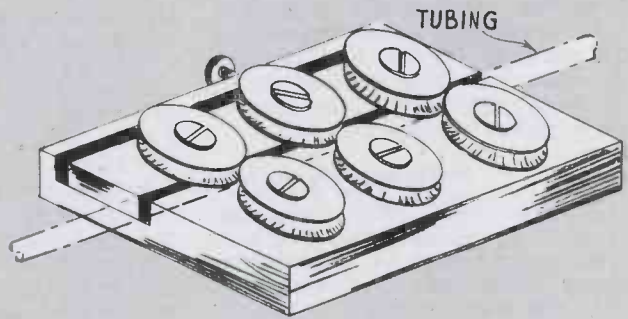

**7**—Another Kaiser worker developed this simple piece of equipment that is used to straighten lengths of soft copper tubing. Tubing is coiled when received. Pulling it through the concave wheels on the fixture straightens it easily, quickly

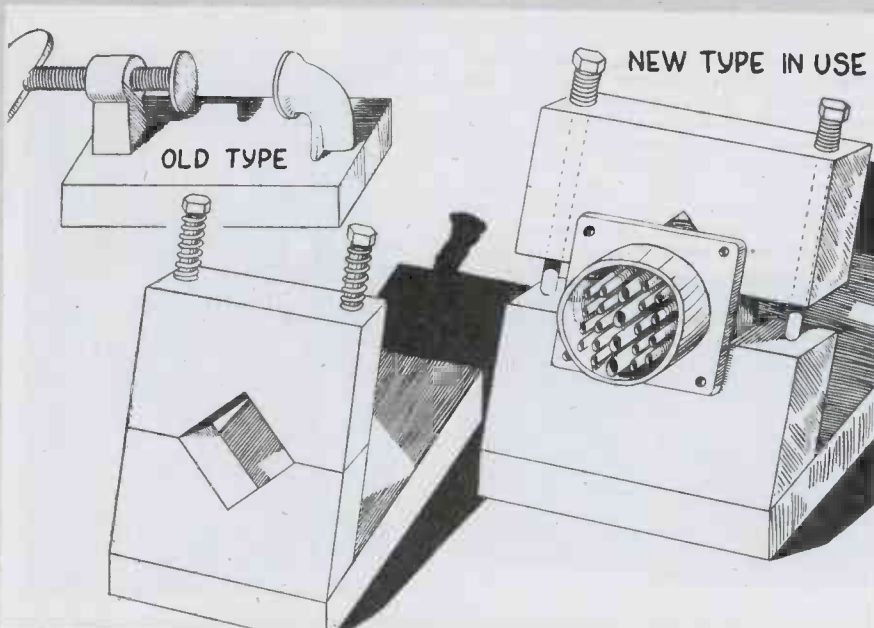

**8**—The old type holder used in soldering leads to a plug was slow to use, did not hold the plug tight enough. So a Murray worker devised this new one consisting of a couple of wood V-blocks, the lower one fastened to the bench and the top block held in position with a couple of bolts

# LATEST TYPE AAF BLIND

by M. E. MONTGOMERY

Federal Telephone and Radio Corp.

**Greatly improved glide path system is further step toward completely automatic aircraft control**

● Airplane traffic control equipment is divided into three general types: 1—Radio range equipment; 2—Position markers; 3—Landing control equipment.

Much has been discussed about radio range equipment which directs planes on their course between airports. Position markers form a functional part of this system in providing fixed points or signals to enable pilots to identify specific locations. However, it is in the third classification, that of airport control of landing, that the greatest advances have been made in the past few years. Particularly revolutionary and important has been the development of instrument landing systems for guiding the plane on its true landing path no matter what the weather conditions or visibility at the airport for a radius of fifteen miles.

## Indianapolis system

In May, 1938, after about ten years of preliminary study, a contract was awarded to the International Telephone Development Co., Inc., for the development, manufacture and installation of an instrument landing system in accordance with CAA specifications to be located at Indianapolis. This system was completed in October,

Present estimates of future airplane traffic in this country indicate commercial, private and military aircraft movements will be approximately five times the amount of airway traffic now being handled.

While it is obvious that more and larger airports will aid greatly in handling this vast increase, the most important factor is the control by radio equipment of the take-off, flight and landing of planes by an overall system of air traffic control.

1939, and included a runway localizer, marker system glide path, with a monitor system for a control of the functional units. After extensive tests the system was immediately accepted and placed in operation.

Following the combined work of the Civil Aeronautics Authority and the International Telephone Development Co., which came to function in the first Instrument Landing System at Indianapolis (see "Electronic Industries," May, 1944), additional test and development work resulted in the modification and redesign of much of the equipment.

At left, localizer transmitter containing radio frequency section, modulator equipment, and power supply. Below, indicators for localizer monitor. Meters show course location, modulation level, and field strength. Alarm rings on any deviations from normal. At right, glide path transmitter. Bottom drawer contains driver and amplifier stages, middle, crystal oscillator and multipliers, top, monitor using path angle meter identical to that in planes

As a consequence, complete instrument landing systems for commercial air traffic were installed at six major airports, in New York (see "Electronic Industries" for Jan., 1943), Chicago, Cleveland, Kansas City, Atlanta and Los Angeles. Under contract with the CAA, this equipment was manufactured and installed by Federal Telephone and Radio Corp., successor to International Telephone Development Co., and consisted of localizers, markers with complete monitoring and remote control equipment installed in the airport control tower. Because of new developments being made by Federal, a glide path was not included in any of the six installations.

## New glide path

At that time, the quickening tempo of the air invasion of German-occupied Europe required the rapid completion of better and more accurate systems of instrument landing. The efforts of the Signal Corps Aircraft signal agency, other agencies, and of Federal were combined to develop a portable instrument landing system suitable for Army Air Force use. The result of this work was the present AAF Instrument Landing System for which extensive manufacturing

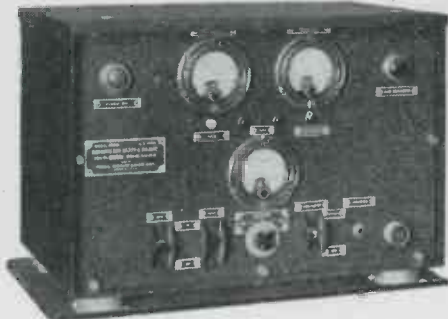

# LANDING EQUIPMENT

contracts were given to Federal. This system was adopted not only by the United States Army but by the Royal Air Force as well.

The two most important functional units of the instrument landing system are the localizer and the glide path. In this system, the localizer radiates two independently modulated signals on the same carrier frequency. A general description of the localizer unit which furnished lateral guidance to the pilots as used at Indianapolis is applicable to the present equipment.

The mechanical modulator incorporated in this equipment produces 90 and 150 cycle modulation on the same carrier frequency, by a system independent of the aging of vacuum tubes and other components in the transmitter—preventing the course from wandering. The localizer or "beam" pattern is produced by two outside radiators excited 180 degrees out of phase with equal amplitudes of 90 and 150 cycle side band energy, and a center radiator excited with equal amounts of fully modulated 90 and 150 cycle energy. The "on course" signal is composed only of the 100 per cent modulated signal of the center radiator and the "off course" signal is the result of the interaction of the signals from the two outer radiators and the center radiator.

## Sharply directional

The complete antenna system makes use of a number of radiators (5, 7 or 9) which act to sharpen the course. A sharp course is characterized by a rapid increase of one modulation frequency over the other when the airplane departs from the prescribed course. The Federal Telephone and Radio localizers which embody this feature of course-sharpness work where others fail because of reflections from hangers and surrounding objects. With a localizer a plane may be guided to within five feet of the center line of the runway.

The loop antennas and mechanical modulator have been designed to operate over a wide band of frequencies so that any one of a number of channels may be used without making any adjustment to the antenna system or the mechanical modulator.

The localizer transmitters, manufactured for the United States Army, have been reduced in size and weight without impairing their reliability. They have been equipped

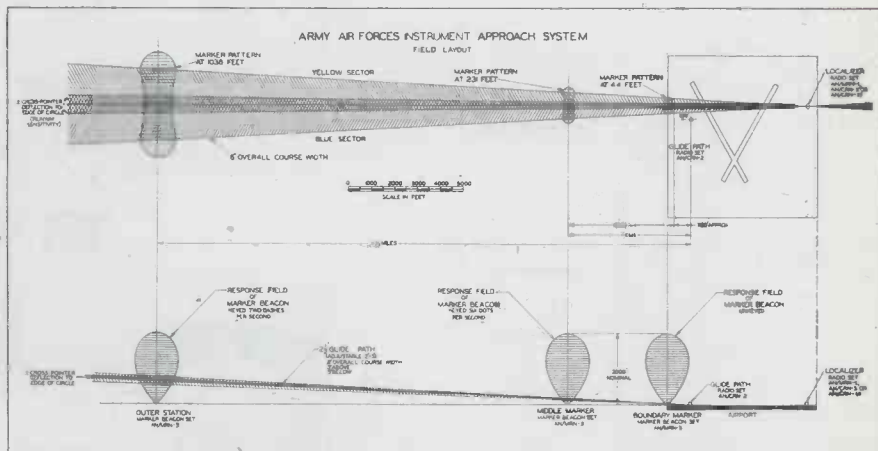

Field strength patterns simplified to show entire layout of new AAF instrument landing system

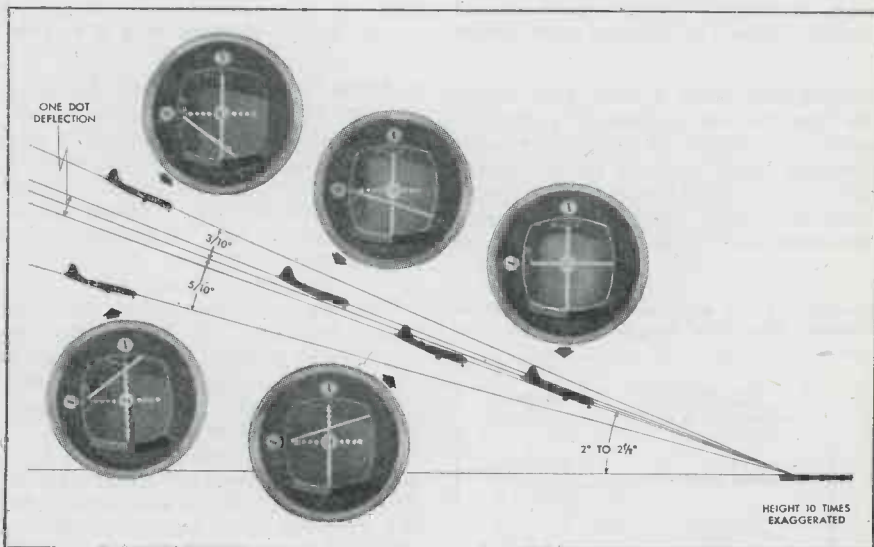

Pilot's glide path indicator, showing action of needle for different attitudes of the plane

Vertical radiation patterns of glide path transmitter, resulting from ground reflections

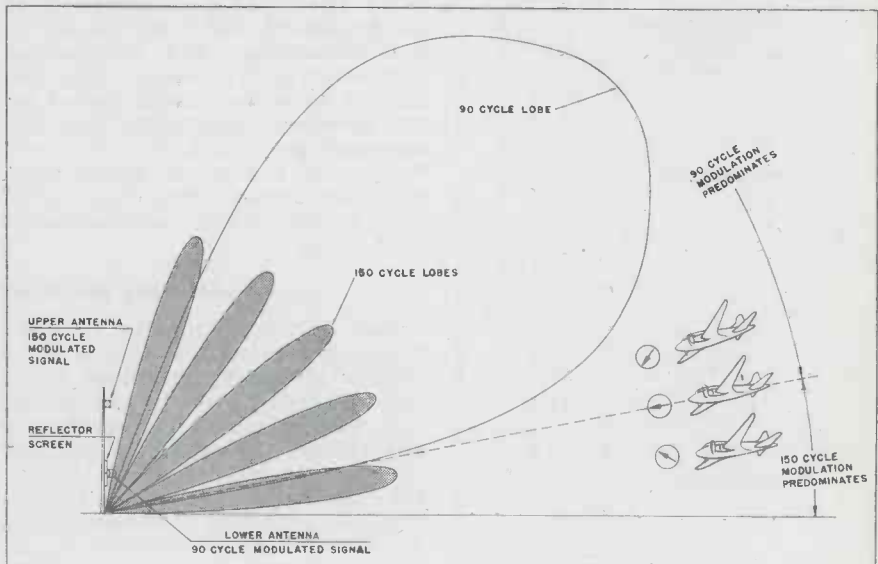

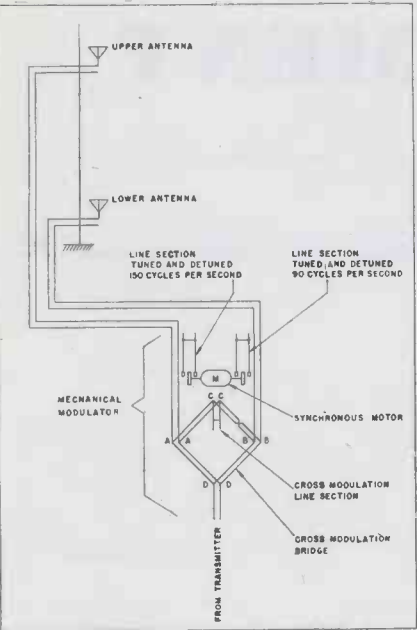

How 90 and 150 cycle modulation of same carrier is obtained. Carrier output is split and feeders detuned by rotating paddle wheels

throughout with screen grid tubes so that no neutralization is necessary. A number of plug-in crystals permits rapid change of the operating frequency. Generally six crystals are used, giving frequencies between 108.3 and 110.3 megacycles

Location of the glide path equipment at an airport. Note field pattern on opposite page

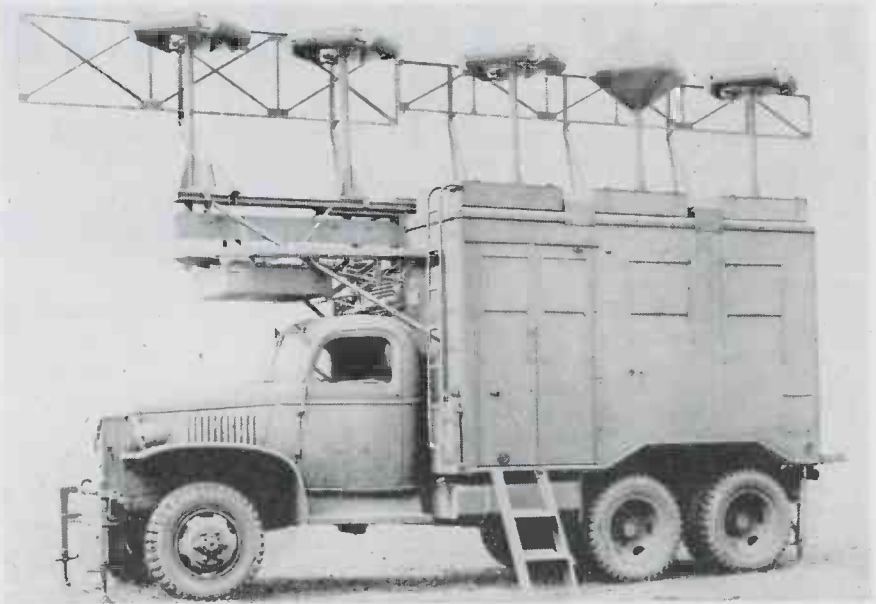
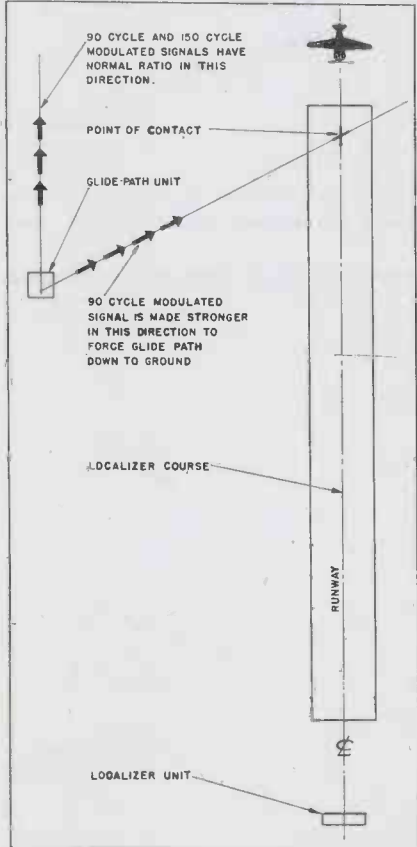

Truck mounted localizer equipment AN/MRN-1 set up for operation. Not all installations make use of antenna reflector MC-528. The localizer truck is positioned at far end of runway, on line of flight, while glide path equipment is 500 ft. to one side at near end

in steps of 0.4 megacycle. In some models, keyed identification modulation and voice modulation are provided so that the airplane pilot can identify the station and receive flight instructions. These voice modulations are simultaneously transmitted with the 90 and 150 cycle "course" modulation.

The transmitters utilize two 807 tubes and one HK 257B tube for the crystal oscillator and frequency multiplication stages. The power amplifier has two HK 257B tubes. The models which provide simultaneous voice modulation and tone identification on the same carrier frequency utilize, in addition, one 6F6 receiver type tube, one 6SN7-GT and two 807 tubes for plate modulation. Carrier output of the transmitter is 100 watts which may be modulated 100 per cent by voice. Since the "course" modulation is all downward, the total output of the transmitter and mechanical modulator is 37½ watts. The reduction in power output caused by this downward modulation does not represent power loss but only a reduction in the power taken from the plate supply. The range provided by this power is approximately 75 miles.

**Indicating monitor**

Each localizer includes a monitoring system which gives a continuous indication of course location and signal strength with visual and audible alarm indications of any failure. A monitor consisting of a simple receiver is set up on the localizer course close to the localizer antenna. Demodulated signal is fed by the monitor to an

indicator housed within the localizer transmitting equipment. This signal is separated into its 90 and 150 cycle components by wave-filters and each is gaged by both indicating meters and by sensitive relays. The meters give immediate indications of course shift or low signal level, but the sensitive relays operate through resistance and capacitance networks to give a time-lag to the sounding of alarms.

In this way a close check can be

Development model of glide path transmitter





maintained during the periods when an airplane is making a landing (by observation of the meters), but repeated and unjustified alarms such as might be caused by a vehicle driving close to the monitor are prevented. Gas-tube circuits are provided automatically to reset the alarm if a temporary disturbance is cleared before the time-lag period has elapsed. Once the alarm has sounded, however, a manual reset operation is required, thus ensuring the attention of the operator.

### CAA recording monitor

Monitoring equipment provided for the CAA provides additional remote indication, alarm and control facilities in the airport control tower. A master control panel and indicator is provided for the localizer, glide-path and markers. In addition, a recorder is provided which makes a permanent monitoring record of localizer, glide-path and marker operation. A commutating circuit is used so that a single recorder shows the performance of all the facilities.

The original glide-path was of the constant intensity type in which the plane followed the locus of constant field intensity. In simple form, without adjustment, the path was a parabola, but by using three antennas, the pattern was shaped in a manner to give a straight line glide-path. This method was abandoned in favor of a new and more positive system now being used by the United States Army and a considerable number (approximately 100) will be installed by the CAA at commercial airports.

In operation, this new glide-path is very much like the present localizer turned on edge, as it is of the equi-signal type. The path is defined by the equality of 90 and 150 cycle modulation on the path. Above the path there is an excess of 90 cycle modulation which deflects the needle downward, indicating that the plane should "fly down." If the plane is below the glide-path, an excess of 150 cycle modulation causes the indicator to rise, indicating that the plane should "fly up."

In this equi-signal glide-path two antennas are mounted on the same mast at the different heights. The signals radiated from the two antennas are not mixed as in a localizer. Instead, the 150 cycle modulated signal is fed to the upper antenna and the 90 cycle signal to the lower antenna. The vertical radiation patterns are obtained as a result of the reflection of the signals from the ground and do not depend upon the radiation pattern of the antennas themselves.

The upper antenna is approximately (Continued on page 190)

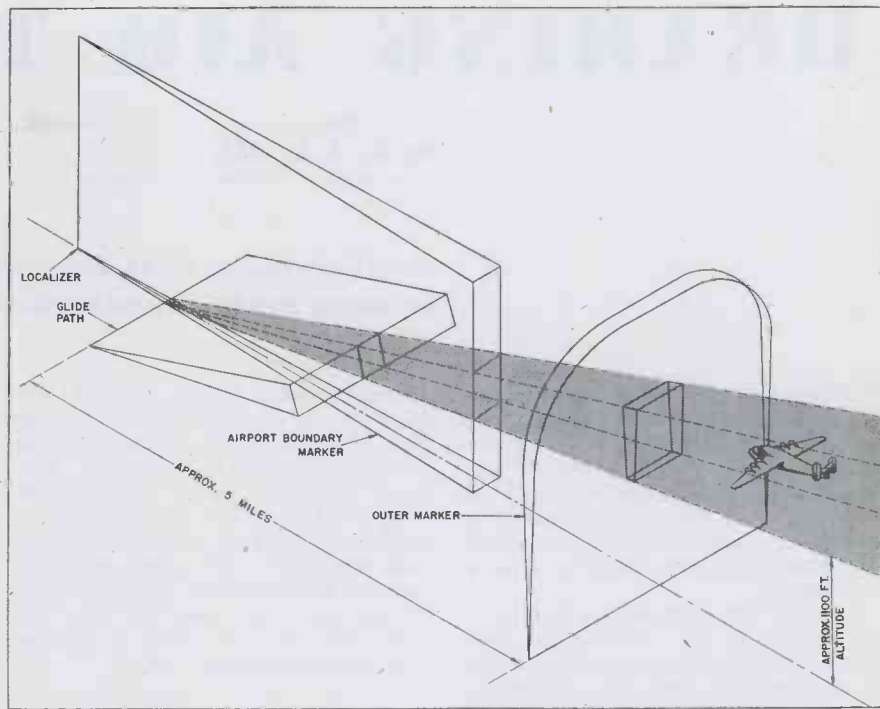

Artist's representation of complete system shows localizer defining vertical plane for aircraft to follow while glide path defines horizontal plane. Intersection of the two planes is true course for aircraft to follow in landing

Horizontal field pattern of glide path transmitter located to one side of near end of runway

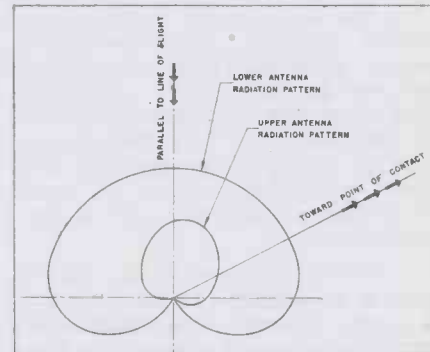

Complete block diagram of new glide path equipment developed for AAF landing system

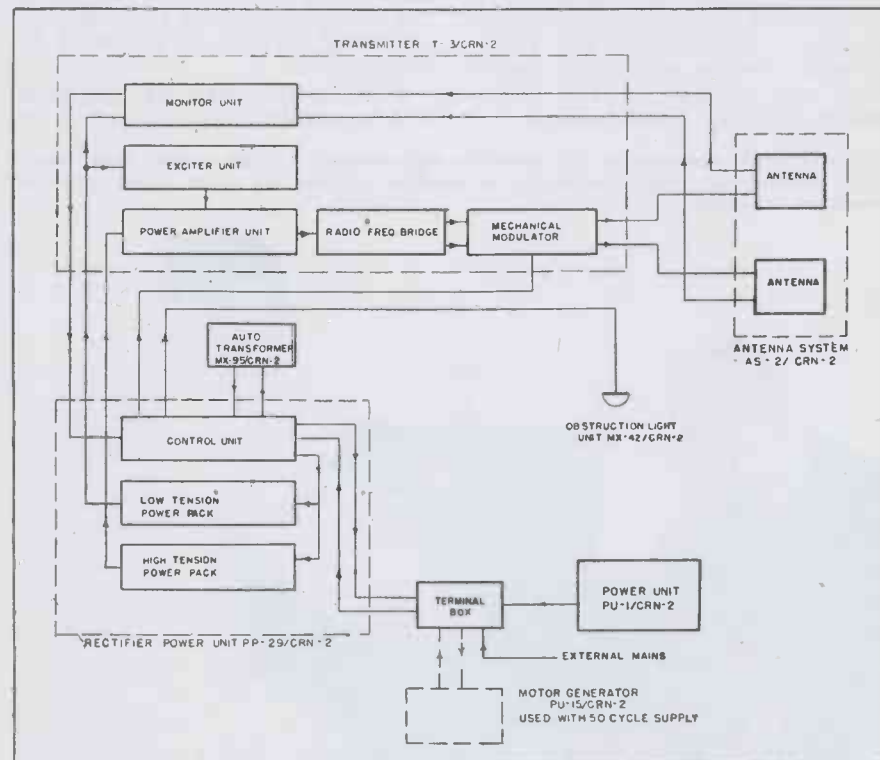

# HEARING AID TECHNIC

by **C. J. Le BEL**,  
Chief Engineer, The Maico Co., Minneapolis

## *Engineering of light weight units involves solution of many problems both electrical and mechanical*

• Much has been told of the many contributions that have been given to certain industries by war developments. The reverse is true in the hearing aid field because much of the technic of developing and using extremely small tubes furnished the basis of many recent military devices.

Hearing aid engineering has been somewhat of an esoteric art because it has involved a combination of engineering fact and subjective opinion. The subjective opinion in turn has been guided by little publicized facts in psycho-acoustics, which have been studied and developed by only a few physicists. Not many engineers have bothered to read the rather formidable books, and to separate the material that deals with the problem at hand from that of interest only to psychologists.

A hearing aid consists of a microphone, an amplifier, a receiver, and a source of power. The combination must be light and so arranged that it may be worn continuously 12 to 16 hours a day without excessive fatigue. In practice, the major problem revolves around the amplifier, and secondarily, the microphone-amplifier combination.

The average good hearing aid amplifier is designed for a voltage gain of 70 to 85 db, depending on the manufacturer's intentions. The same combination of tubes could yield a gain of 100 db in the ultimate, but this has not been considered desirable. The first wearable vacuum tube hearing aids used 100-120 db gain, and year by year the value has dropped until it centers in the present range.

### **Design problems**

Making a commercial amplifier is not as easy as making a sample. One has to design in some stability—uniformity from instrument to instrument, and steadiness as battery voltage varies. The average user keeps an A battery until it is well below .9 volt, and a 45 volt B battery until it is well below 30 volts. All that stability has to be packed into 2 cu. in. A good design means that the factory can get a wire 1/16 in. out of place without introducing uncontrolled oscillation. Yet there is no room for elaborate shielding. Skillful layout must do the job.

This stability can be combined with a gain/volume ratio of 45 db

per cu. in.; broadcast remote equipment of comparable range has been made with a ratio of .03 db per cu. in. From the weight point of view, a hearing aid may average one ounce per milliwatt of output, whereas a broadcast remote amplifier may be three pounds per milliwatt.

The frequency response of a broadcast studio system is easy to define arbitrarily, as for instance, within  $\pm 1$  db from 40 to 10,000 cycles. On the other hand, a hearing aid is not so easy to classify. Overall responses (air to air) of two hearing aids are shown in Fig. 1. The typical ruler-minded engineer might prefer curve A, because it is so uniform. However, what actually happens in practice, is that different users have different types of hearing loss. Two typical curves of loss, plotted on standard audiogram cards are shown in Fig. 2.

Customer A has a loss which is uniform with respect to frequency, so he will find curve A in Fig. 1 very satisfactory. Customer B, on the other hand, will find the uniform amplification system loud but muffled, as his loss is much greater at the higher frequencies. We can compensate for this by using increasing amplification at the higher frequencies just as we equalize the response of a telephone line. At least 50 per cent of the hard of hearing customers will have such a type of loss, which is usually indicative of nerve involvement.

### **Matching hearing loss**

The index to what is the best frequency response, then, depends on how well the customer's loss is matched. A good hearing aid will be well fitted in the vital speech range—from 400 to 500 cycles up to 3,000 to 4,000 cycles. Of course some extreme types of loss, such as in Fig. 3, cannot be matched over all this range.

Matching the loss curve with suitable amplification is known as "corrective amplification," and its advantages were shown, in April, 1940, by Professors Watson and Knudsen. Incidentally, the same study showed that a person cannot,

Fig. 4—Practical application of the audiometer which consists of a high stability audio oscillator, a precision wide range attenuator, a low distortion amplifier and a high quality, calibrated headphone transducer.



unaided, tell which general type of response curve is better for himself. He is most likely to pick a general type of curve which amplifies what he can already hear—represented by a curve peaked around 1,000 cycles. Experience shows that such an instrument is easy to sell because it is loud—but not easy to keep in use, for after several weeks or months of wearing, the user realizes it is not clear, particularly in the important 1,500 to 3,000-cycle consonant range. He very seldom puts his complaint in that form, though, usually merely saying it is too hard to understand or is too tiring to wear.

Actually, the average customer may be able to tell, after several days of wearing, which of two closely similar adjustments is preferable; but he cannot tell in a few minutes which general type is better. The usable frequency range of a user may be extended as much as 50 to 200 per cent by proper use of corrective amplification.

### Picturing acuity

The cornerstone of hearing aid data, the audiogram, is a graph of relative hearing acuity, in db, as a function of frequency. The reference level is the modal value hearing of several thousand normal ears taken at random from the general population by the U. S. Public Health Service. This determination was made in fairly quiet rooms with an ambient noise level of perhaps 30 or 35 db. Since the sensitivity of the ear changes with frequency in a well known fashion, this is a variable reference level.

The ear is so complex that one can easily encounter audiograms which would be not too easy to duplicate in an ordinary laboratory. For example, the audiogram of Fig. 3 shows a comparatively steep cut-off, which could be produced in the laboratory only by a wave filter.

While derangement of the mechanical apparatus of the ear can change its audiometric characteristics, most of the steep cut-offs and other unusual variations are

Fig. 1—Overall response (air-to-air) of two different makes of hearing aids

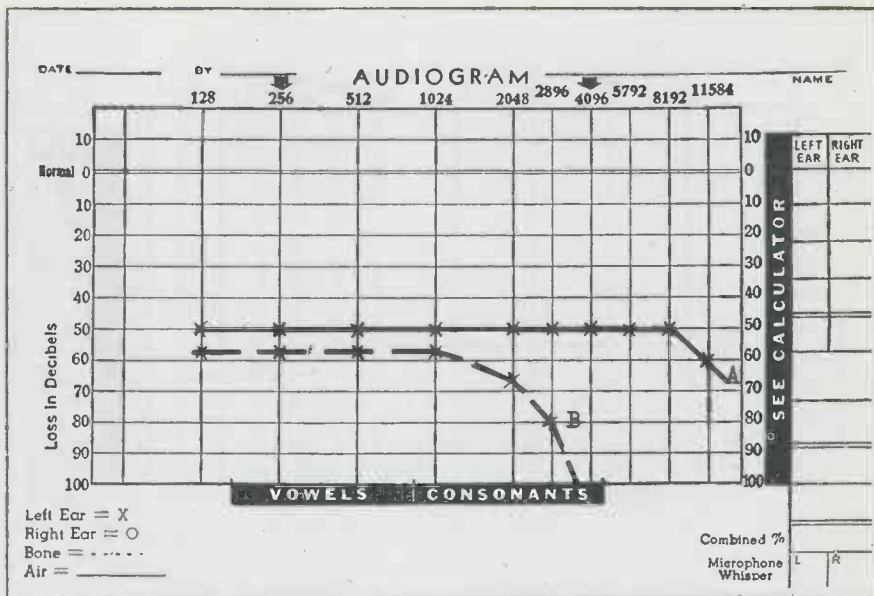
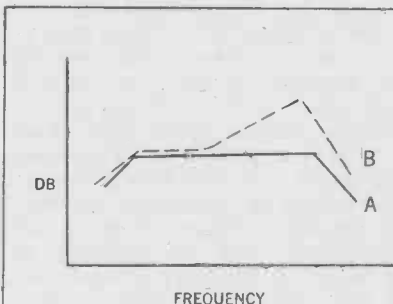

Fig. 2—Different users have different types of hearing loss, as shown by these two typical curves of loss which were plotted on standard audiogram cards with the aid of the audiometer

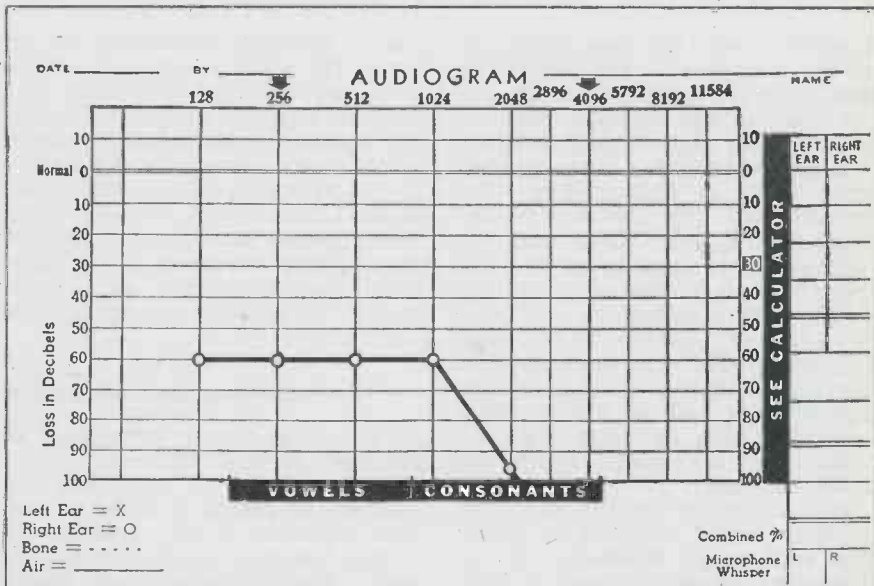

Fig. 3—Where hearing loss shows a sharp cut-off such as this, it is impossible to closely match the patient's loss through corrective amplification over the whole range

due to nerve defects (a physiological effect). The actual detection of a given tone occurs at a specific area of the basilar membrane, with different frequencies. Loss of effi-

ciency by a given area, or by the nerves associated with it, will reduce the hearing sensitivity in the appropriate frequency band.

Since the determining factor is

Fig. 5—Nerve type losses do not follow the same laws governing stimulus and effect

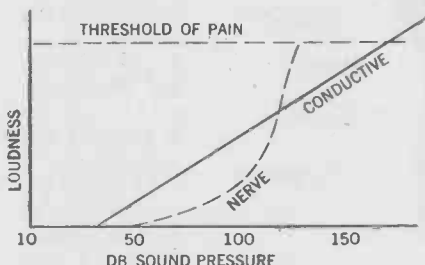
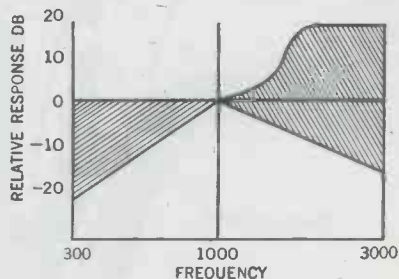
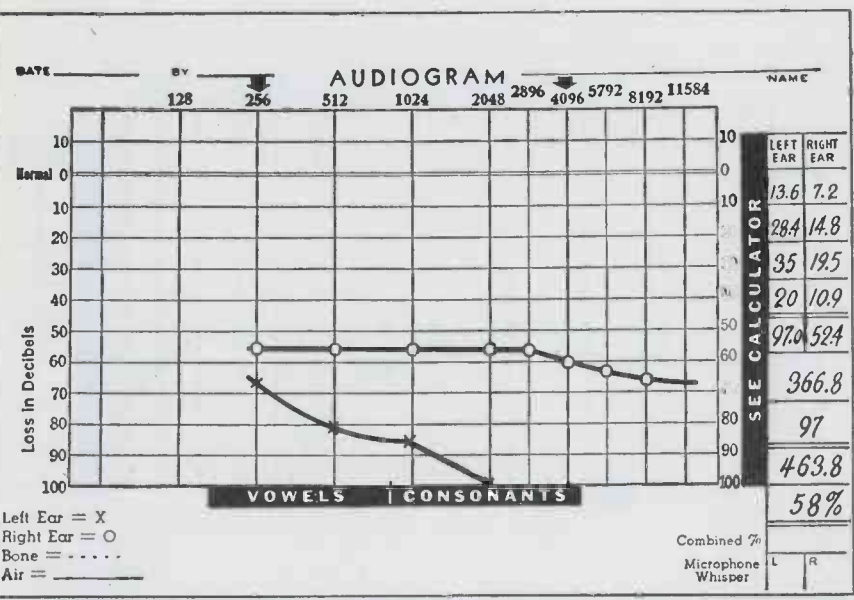

Fig. 7—Range of adjustment necessary to fit the usual loss characteristics





The audiogram is analyzed with the aid of a transparent printed calculator chart, indicating the affect of the loss at various frequencies. The calculator is laid over the audiogram so that the loss may be interpreted. These figures are inserted at the right and give total disability

a specific area, the rate of cut-off at the boundary of the pass band may be gradual or very steep, depending on the relation between position and physiological activity.

It can be seen that there are two main kinds of hearing loss—the “conductive” type, caused by mechanical malfunctioning; and the “nerve” type, caused by physiologic imperfections of the detecting apparatus. A combination of these two—“mixed” loss—can also occur. It is highly desirable to distinguish between conductive and nerve (or mixed) loss before fitting. This separation can be made with an audiometer, accurately enough for fitting purposes.

An audiometer consists of a high stability audio oscillator, a precision wide range attenuator, a low distortion amplifier, and a high

quality dynamic transducer, as in Fig. 4. The sound output varies with frequency, and the attenuator dial is calibrated to indicate directly the acoustical output with respect to the normal threshold of hearing. To be approved by the American Medical Association, a unit must meet rigorous standards of acoustical accuracy—so rigorous that only three manufacturers have succeeded in making an acceptable unit.

**Audiometer principles**

The output of the audiometer is adjusted, at each frequency, until the threshold of audibility is reached. A graph of these values, with reference to the threshold of normal hearing, is called an audiogram. The physician can make

many other tests with an audiometer, of little interest to the hearing aid technician. However, experienced audiometric technicians can make a number of tests which are very helpful in hearing aid fitting, in addition to making an audiogram.

It may be seen that the usual audiogram is run at the thresh-

old of audibility. It has been found that in the frequency range covered by hearing aids, the threshold audiogram and the audiogram at normal listening level are usually parallel, viz. the relative response does not change with level. It is possible to use audiometers to make audiograms at levels above threshold, if desired in the few cases where there is a divergence.

The conductive loss is usually fairly uniform with respect to frequency, and is not too hard to fit. The nerve type of loss is quite another matter. While the shape of the audiogram may be very similar (it is usually much more irregular), the nerve type demands are exacting. Precision of acoustical fit is essential. Extraneous noise (due to clothing rubbing on the case) must be very low. Finally, the nerve type case exhibits recruitment which may be characterized as non-logarithmic hearing. This phenomenon can be best shown in a graph (Fig. 5). The well known Weber-Fechner law states that the effect (loudness) is proportional to the logarithm of the stimulus (sound intensity). The nerve type loss does not follow this law. As can be seen from the graph, the subjective loudness increases rapidly beyond a given point and shortly reaches the threshold of pain, long before the conductive case exhibits any discomfort whatever.

In practice, the output of a hearing aid may be satisfactorily limited by adjustment of B battery voltage, but this adds still another step in the process of fitting. Ordinary radio receiver AVC action is not satisfactory, for it would tend to set itself at full sensitivity during a moment of silence—leaving the ear undefended against a sudden loud noise. In practice, the limiting action of reduced B voltage is so satisfactory that the more elaborate apparatus which could be devised, has never been commercialized.

**Harmonic distortion**

The hard of hearing are surprisingly sensitive to harmonic distortion. To test this, a number of individuals with different kinds of hearing loss were given a group of instruments matched for frequency response, but adjusted for different degrees of distortion. These instruments were ranked after several days wearing of each as regards sound quality, as accurately as the distortion meter. Nerve type cases are more sensitive to distortion than those with conductive losses.

Distortion, by impairing naturalness, seriously reduces ease of understanding. For an analysis of this effect an ordinary articulation test will not tell the story since

(Continued on page 198)

Internal construction of the ear. The cochlea has been shown straight instead of coiled, for the sake of clarity

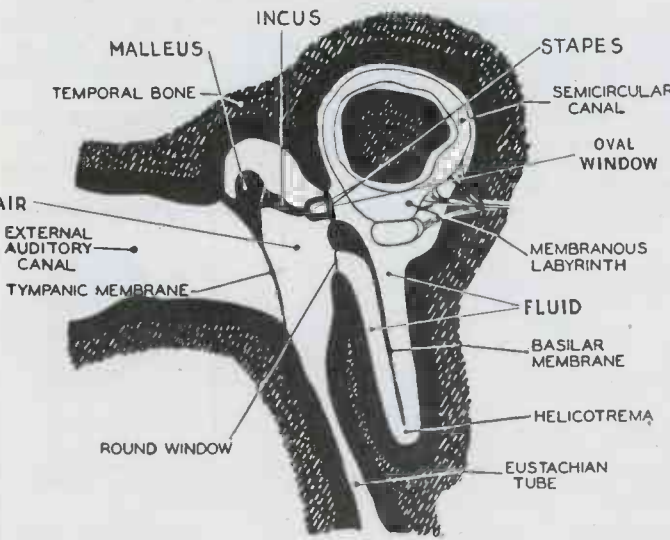



# TUBES ON THE JOB

## Penicillin Drying Plant

Completion of the first all-electronic drying system for producing penicillin was announced by Dr. George H. Brown of RCA Labs. Ready-to-use ampuls of penicillin can be obtained at the rate of 200,000,000 Oxford units an hour.

Since ordinary heat methods destroy the effectiveness of penicillin, bulk-reduction of penicillin solution and the final drying process has been through the use of dry ice and a high vacuum at below freezing temperatures. The RCA engineers discovered that in a moderate vacuum they could boil and evaporate the solution at 50 deg. F., a temperature that does no harm to the drug during its brief period of exposure.

This knowledge was helpful in tackling the final problem but it was found that when the vacuum was applied to the 20 cc. bottles containing 1 cc. of concentrated penicillin solution, the liquid foamed and much of it was lost. This appeared to be an unsurmountable obstacle for a while. Then it occurred to the scientists that revolving the bottles at a speed high enough to cause the liquid to form a thin layer around the walls of the bottle might solve the problem.

## 34 spinners per unit

Dr. Brown and his associates designed such a rotator and were rewarded by the discovery that it not only worked but the thin layer of liquid would evaporate much faster than anticipated. They next built a vacuum chamber out of a reconditioned porthole frame and window—and in it they placed 34 rotators that could spin up to 3,000 revolutions a minute. Three metal belts between the circling rows of the rotators acted as electronic heating plates.

Next they conceived a revolving table with six chambers atop of it in such a manner that three of them could be exposed to the current at one time. The table turns 60 degrees at one-minute intervals, thus giving each of the 34 ampuls of penicillin in the chambers three minutes of current and at the same time allowing for the unloading and loading process as the chambers make the circuit.

The set-up works on a push button arrangement and may be started or stopped at will without endangering the drug under process. But its great advantages are

that it affords a continuous production at a fixed rate of speed, necessitates only a fraction of the floor space required by the conventional freeze-drying systems and operates at cost far below that of the older system.

## Airborne Electronic Gun Director



Under development since 1938, the latest in military electronic devices is the K-8 gunsight manufactured by Fairchild Camera and Instrument Corp., New York. Following the success of the Western Electric gun director, for ground to plane fire control, and the satisfactory performance of a British designed electronic unit for plane to plane firing, the Fairchild equipment represents a distinct improvement, enabling up to fifty to ninety per cent as many hits in the air as are normally obtained from a stationary platform. The K-8 was developed by Erwin Hale and Irving Doyle.

To use the device, the turret gunner, after identifying the type of enemy plane coming up, sets three dials—one to the known wing-span of the target, others to the speed and altitude of his own ship. He sights the target squarely in his finder, it being unnecessary to "lead" the target, and, with a foot pedal, adjusts the size of an orange circle of light visible in the center of his sight to frame the attacking plane from wing tip to wing tip. The electronic unit then automatically computes all essential factors and through servo motors positions the gun barrels properly to hit the attacking plane.

## New Life for Old Machines

The Axelson Manufacturing Co., Los Angeles, recently installed Westinghouse electronic motor drives on three 30-year-old Heald

grinders, resulting in improved quality of precision finishing, vibration-free, stepless, speed control over a 20-to-one speed range, and better working conditions.

Problems in machining hardened pump liners were augmented by specifications which require a finished tolerance of .001 in. The variation in liner sizes and materials used required grinding speeds over a wide, closely regulated stepless range in order to secure the desired tolerance and finish. This stepless quality in speed regulation permits the operator to choose just the right speed for size of hole, material to be finished and grade and grit of the wheel.

## Big Industrial Tube Market

A vast new postwar market for electron tubes, far exceeding the prewar demands of radio and communications, will be found in manufacturing and processing industries as a result of increasing uses of electronic power and electronic controls, according to L. W. Teegarden, general manager of the Tube and Equipment Dept. of the RCA Victor Division, Radio Corp. of America. The rated power represented by a single order recently received by RCA for power oscillator tubes for electronic power heating was equal to the combined rated power of all radio stations in the United States. Industry's postwar demand for power tubes, which constitute the heart of any electronic power generator, may be many times the total prewar demand, which came principally from the broadcasting field.

## Electronic "Housemaid"



Experimental model of postwar Westinghouse Precipitron for the home eliminates dust rag

# WHAT'S NEW

Devices, products and materials the manufacturers offer

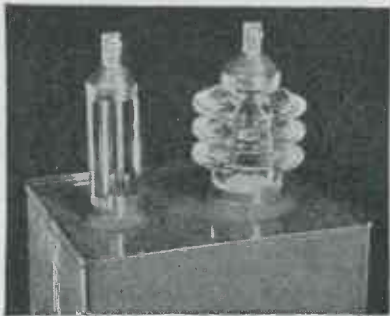

## Glass-to-Metal Seals

The old problem of guarding various capacitor and resistor types adequately against leaks and moisture is solved by a glass-to-metal seal perfected by the Sprague Electric Co., North Adams, Mass. The glass bushings are sealed direct to the metal capacitor container, and do not require adjacent metal rings with "matched" temperature coefficients of expansion. On resistors, the resistance unit is encased in a special glass tube which is sealed directly to the metal ends. The resulting seals make glass and metal a solid integral unit, and are leak-proof, shock-proof, and humidity-proof. In addition, they protect the component without the use of organic bushings or other materials which might be attacked by fungus.

## Automatic Selector

Smaller, lighter electrical equipment is made possible by a compact FTR 800 automatic selector now being manufactured by Federal Telephone and Radio Corp., Newark, N. J., associate of International Telephone and Telegraph Corp. Occupying approximately half the space required by other selectors of a comparable range, this high-speed, multi-contact switch is adaptable for use as an automatic or remote control device for many industrial applications. The rotor assembly is operated by a stepping mechanism which responds to impulses of current. After each impulse, a reed suspended pawl engages a ratchet, moving the wipers one step forward over the bank contacts. By this method, connections are made from circuits (connected to wipers) to other circuits (connected to the bank assembly). The stepping mechanism may be controlled manually by a dial or other means. Automatic control for the stepping magnet may be provided by interrupter springs, elec-

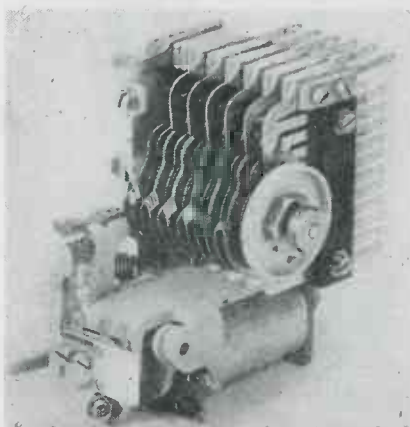

tronic circuits or relay circuits. The wipers on the rotor may be either of two types: double-ended or single-ended. According to the type of wiper used, this selector can be arranged to have a capacity of from one to three 2-row levels of 22 points each or from one to six single-row levels of 11 points each. The wipers can be either bridging or non-bridging. The non-bridging wiper passes from one contact to the next without short circuiting the adjacent contacts. A bridging wiper connects with one contact before disconnecting from the adjacent contact. When the step is completed, the wiper is connected to one contact only.



## Glass Sleeving

Turbo single saturated glass sleeving, a new tubing, has greater flexibility than has heretofore been associated with electrical insulation of this type. It is non-moisture absorbing, non-burning and will not fray, split or crack. Any color can be supplied. Maker is William Brand & Co., 276 Fourth Ave., New York.

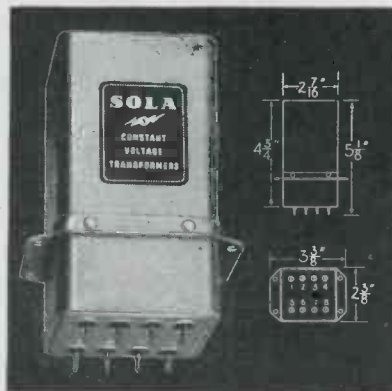

## Regulated Supply

This small, compact, hermetically sealed constant voltage transformer for through-chassis mounting, has been designed for precisely regulated supply voltage. At any reasonable transformation ratio of input to output it will provide a single output voltage constant to within  $\pm 1$  per cent of rated requirements regardless of line voltage variations as great as  $\pm 12$  to 15 per cent. Capacities up to 15 va, 60 cycle operation are available and are supplied with a separate capacitor unit for external mounting. This transformer has no moving parts, requires no manual supervision or adjustments and is self-protecting against short circuit. Sola Electric Co., 2525 Clybourn Ave., Chicago 14, Ill., is the maker.



## Linear Ohmmeter

The Rowe radio type LM21 linear ohmmeter was designed for production use wherein measurements within a restricted range of electrical resistance are required. It has a linear scale calibrated directly in ohms; the length of leads to the resistance under test have negligible effect on the accuracy. Units are available for practically any full scale value of resistance including fractions of an ohm. Standard units are battery operated but can be had with a power supply if required. The instrument is in a black wrinkle baked enamel finished case approximately 11 in. long by 8 in. high and 8 in. deep. Manufacturer is Rowe Radio Research Laboratory Co., 2422 North Pulaski Rd., Chicago.

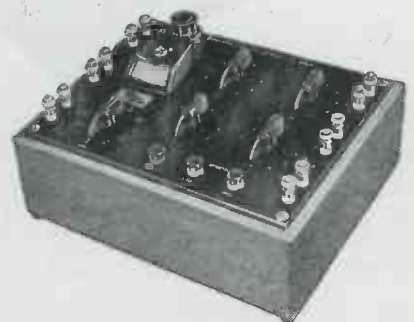

## Wide Range Bridge

Combining both Kelvin and Wheatstone bridges, the Shallcross Type 638-2 bridge provides a resistance measurement instrument having range of from 0.0001 ohms to 11.11 megohms in a single, portable unit. When used as a Wheatstone bridge for measurements between 1 ohm and 1 megohm, normal accuracy is 0.3 per cent or better. Low-resistance measurements using the Kelvin range utilize current and potential terminals to eliminate lead and contact resistance. The accuracy of Kelvin measurements at ranges lower than 0.1 ohm is on the order of 3 per cent. The rheostat is variable in steps of 1 ohm for Wheatstone bridge measurements, and 1 micro-ohm for Kelvin bridge measurements. Separate keys are provided for the battery and galvanometer circuit. The built-in galvanometer has a sensitivity of 0.25 microamperes from millimeter deflection.

Manufacturer is the Shallcross Mfg. Co., Jackson & Pusey Avenues, Collingdale, Pa.



### Sealed Relay

These relays are hermetically sealed in a metal shell. Units corosealed are normally sealed with content of pre-filtered dry air but can be furnished with inert gas or pressurized content when desired. This component incorporates a standard octal plug base, is 1 11/16 in. long 2 7/8 in. including prongs and weighs 4 oz. Coil windings can be supplied for voltage ranges from 1.5 to 70v dc. Inorganic base plastic insulation minimizes high frequency loss. Contacts handle 2 amps. at 100 watts. Maker is Betts and Betts Corp., 551 W. 52nd St., New York.

### Foot Switch

A new type foot switch (Model MF) for handling up to eight circuits has been developed by General Control Co., 1200 Soldiers Field Rd., Boston, Mass. The switch operates on 1/4th in. throw, the foot rest being but 1/2 in. above the floor.



### Plywood Mast

A portable, telescopic, light-weight, tubular plywood antenna mast is being marketed by Plymold Corp. of Lawrence, Mass., in a variety of models. Heights to 90 ft. are available with standards of 50, 55 and 75 ft. carried in stock. Sections are 12 ft. in length and masts are shipped complete with fittings, stays and erection equipment.

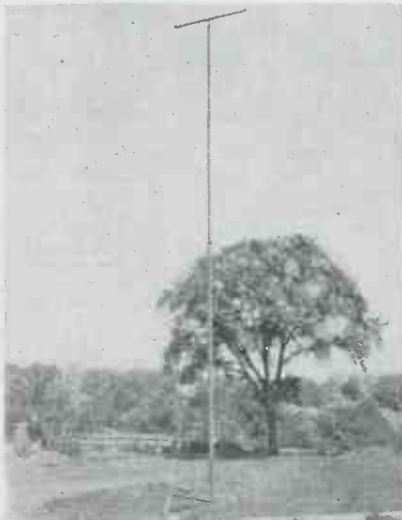

### Single-Button Mikes

Universal Microphone Co., Inglewood, Calif., early in 1945 will re-issue its CU-1 and CU-2 microphones for mobile transmitter installation, including marine and aircraft installation. Button impedance is 200 ohms and output approximately 30 volts RMS across the microphone transformer secondary. A double pole, single throw, press-to-talk switch connects the microphone and relay circuits. The CU-1 has a three-way plug, while the CU-2 has the PL-68



telephone type of plug. Universal will also resume production soon with its KD and 15 mm's, both dynamics; the 200 series, hand-type; the 800 series, velocity; and the X-1 and XX, both carbons, as postwar microphone releases.

### Hermetic Terminals

Two standard types of hermetic terminals in which cold-rolled steel is bonded to glass, are being produced by Cincinnati Electric Products Co., Carthage at Hannaford Ave., Cincinnati. One type approximately 1 1/4 in. in diameter accommodates 2 to 9 terminals

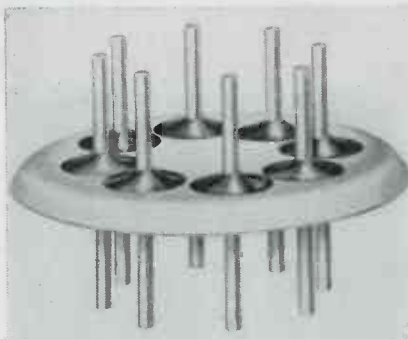

and the other slightly under 1 in. in diameter carries 2 to 7 terminals. Interfusion of the glass and cold-rolled steel produces a thermal shock resistant bond.

### Protected Resistors

Sprague Electric Co., No. Adams, Mass., is now applying humidity protection to wire wound resistors formerly obtainable only on special order. A new construction, adopted for all standard production, includes a glazed ceramic outer shell and a new type end seal.

### Coloring Metals

A process for coloring steel, copper, glass, bronze, zinc, nickel, tin, gold, silver, aluminum, magnesium and other metals and alloys has been developed by Technical Processes Division of Colonial Alloys Co., Philadelphia. The process involves immersion in chemical coloring salts or solutions which are supplied together with instructions for metal preparation and cleaning.



### Carbon Pile Rheostat

A large variety of continuously adjustable carbon pile rheostats is being supplied by Stackpole Carbon Co., St. Marys, Pa. A typical carbon disk pile 1 1/2 in. long with disks .432 in. in diameter, permits a resistance range of from 60 ohms with 1 oz. pressure to 0.3 ohms with 32 lbs. pressure.

### Solderless Kit

Aircraft-Marine Products Inc., 1591-D No. 4th St., Harrisburg, Pa., is marketing a wiring kit consisting of a 6-purpose installation tool which cuts and strips wire, indicates stud sizes, and crimps terminals to the wire. Included is an assortment of 100 solderless terminals of common types.

### Liquid Mixture Check

Photoswitch, Inc., Cambridge, Mass., has an electronic concentrate control for detecting and controlling changes in liquid concentrations. The method provides accurate control for all applications in which changes in concentration are accompanied by a corresponding change in electrical conductivity. Installation requires a probe mounted on the tank, wired to the control. An adjustment on the control housing is set so that the control relay will operate when liquid of a predetermined electrical resistance contacts the probe.

### Soldering Stand

A new type of soldering iron stand which holds the iron and provides a magnifier window is being marketed by Ess Specialty Corp., Bergenfield, N. J. The stand is supplied with a cast bracket for assembly table mounting; the fume stack is 3 x 9 1/4 x 32 in. high.





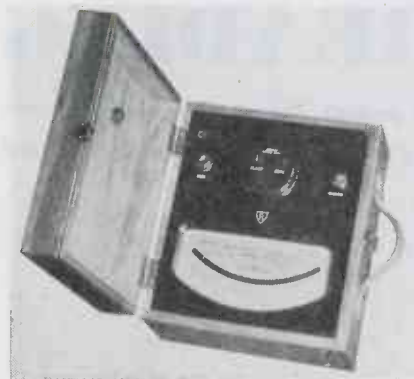

### Electrostatic Voltmeter

The new Rawson type 518 electrostatic voltmeter is intended for the measurement of high voltages and draws extremely low current from the source. They will measure either dc or ac accurately, giving exact rms readings on ac. The frequency response is good, without appreciable errors even at low radio frequencies. For dc measurements there is no appreciable current drain, since the insulation resistance is guaranteed to be higher than one million megohms. This makes it possible to measure high voltage sources which are designed for a load current of only a few microamperes without disturbing the circuit in any way. Since this type of voltmeter does not discharge the source it is possible to use these meters for measurement of voltages of electrostatic nature such as are generated in the process of manufacturing paper, cloth, celluloid, and other dielectric materials. For ac measurements, the input impedance is that of a small capacitance in parallel with a very high leakage resistance. As an example, the 5,000-volt meter has a capacitance of around 8 micromicrofarads and a resistance of several million megohms. These meters are available for much higher voltages than previously without the use of condenser multipliers. They are offered in ranges of 1, 2, 3, 5, 10, and 20 kv full scale, with a scale length of 5½ in. The moving systems are ruggedly constructed and adequately damped to facilitate rapid readings. Maker is Rawson Electrical Instrument Co., 116 Potter St., Cambridge 42, Mass.

### Multi-Output Rectifier

This new multi-rectifier incorporates six selenium rectifier sections which may be interconnected by external links to provide four ranges of dc power:—

- 0-8 v, max. capacity 100 amps.
- 0-16 v, max. capacity 50 amps.
- 0-24 v, max. capacity 35 amps.
- 0-48 v, max. capacity 18 amps.

Thus it is possible for the two panel-mounted voltage control switches to provide a range of control in 49 steps, from zero to maximum, on any range. The built-in voltmeter and ammeter indicate the dc output voltage and current at all times, and



red line calibrations indicate the maximum current limitation on each range. On each side of the cabinet wing nut terminals are duplicated for convenience in connecting loads. The section binding posts for interconnection are externally located on the right hand side only. Additional features include a three phase magnetic contactor in the main power supply circuit with ON-OFF push buttons, pilot lamp, monitor lamp, buzzer (overload warning), and automatic watchman which provides automatic current interruption in case of prolonged overload. The unit is available for operation from 220 to 440 volts. Manufacturer is Green Electric Laboratories, 130 Cedar St., New York.

### Vacuum Recorder

A new type vacuum recording gage has been developed by George E. Fredericks Co., Bethayres, Pa., for indicating and recording vacuum within the range of 1 to 500 microns. Model MR Televac is operated by means of a new type vacuum gage known as the Televac "500" thermal gage which has filaments that have been covered with



a protective coating to make them immune to contaminating vapors such as oil, water, mercury, etc. Thus the calibration of the gage is constant under all normal operating conditions and does not have to be checked. Increased sensitivity is gained by the use of two filaments in both the standard and variable tubes of the gage. All "500" Thermal Gages are interchangeable without recalibration and have an indefinite life. The power supply to the filaments is supplied through carefully calibrated coils in series with the secondaries of a transformer. The instrument operates on 110 volts ac which is supplied through a voltage regulator mounted in the Televac recorder cabinet. Continuous records are obtained on such processes as vacuum tube manufacture, automatic exhaust machines, vacuum dehydration of blood plasma, penicillin, etc., vacuum impregnation, etc. Due to the stability of the gage, the instrument can record vacuum in several systems simultaneously by means of a multiple point recorder or through a selector switch.



### Midget Relay

A new, light-weight, midget relay, product of Guardian Electric Mfg. Co., 1622 W. Walnut St., Chicago, has been engineered for applications where weight and space are at a premium. It weighs 1.2 oz., and measures 1-9/32 x 1-5/32 x 29/32 in., single pole, single throw. It operates on dc only, and has a switch capacity of double pole, double throw with 1.5 amp. contacts. Power requirement—1.75 watts.



### Plug-in Welding Timers

New improved Weltronic universal timers with interchangeable plug-in type control panels make possible the conversion of timing controls to any of the NEMA standard types in a few seconds. The design of the complete range of new weld and sequence timers incorporating a universal cabinet-and-power-supply unit and a series of individual control panels that can be interchanged without the use of tools or rewiring, permits any resistance welder to be immediately available for any type of welding within its capacity. Use of a flexible cable, multi-point plug and receptacle for the interconnection between a control panel and the power supply unit plus a slotted-hinge type panel mount reduces the removal of a control panel to a simple swing-out, pull-plug, lift-off hand operation. Another panel of either the same, or for a different type of welding can be set in just as easily. Provision of a spare control panel to quickly replace any one of a group in service permits the inspection or servicing of all welder controls to be performed without shutting down any of the machines. The Universal power supply unit is adaptable for 115, 230, 575, or 460 volt, 50/60 ac service by shifting one jumper. Entire unit is mounted on a single panel that can be removed, for servicing, by taking out four screws.

A minimum of moving parts, fewer and less expensive tubes and interchangeable component parts, made possible by the use of exclusive Weltronic timing circuits reduces maintenance to a minimum. Precision timing, fully electronic and adjustable by easily read dials accurately calibrated in cycles, is provided for wide ranges of welder electrode movement and pressure sequences. Each time adjustment is independent of all others. Manufacturer is the Weltronic Co., 19500 West Eight Mile Rd., Detroit 19, Mich.

### Secondary Standard

The James Knights Co., Sandwich, Ill. has a new secondary frequency standard. Crystal controlled with a hermetically sealed MD cut dual frequency crystal, the instrument provides useful output up to 40 megacycles at 1,000 kilocycle, 100 kilocycle and 10 kilocycle intervals. Operates from 60 cycle 115 volt line. The unit is housed in a metal cabinet with gray crackle finish.

(Continued on page 114)



# SURVEY of WIDE READING

Electronic news in the world's press. Review of engineering, scientific and industrial journals, here and abroad

## Fluorescent Testing of Food

J. A. Pearce (Canadian Journal of Research, Section F, Ottawa, July, 1944)

Several different foodstuffs have been investigated as to the changes in their fluorescence with changes in quality; the quality was established by a number of tasters.

Development of fluorescent substances during storage was observed in high protein foods (whole milk powder, dehydrated pork), in high carbohydrate foods (dried banana flakes, dried parsnips) and in mixed food (ration biscuits).

The results indicate that fluorescent measurements are not likely to be a satisfactory quality test for dried milk powder or soya flour but may prove useful as a measure of quality for dehydrated pork, dried banana, dried parsnips, ration biscuits, and butter. This test may also detect reversion in hydrogenated linseed oil shortening.

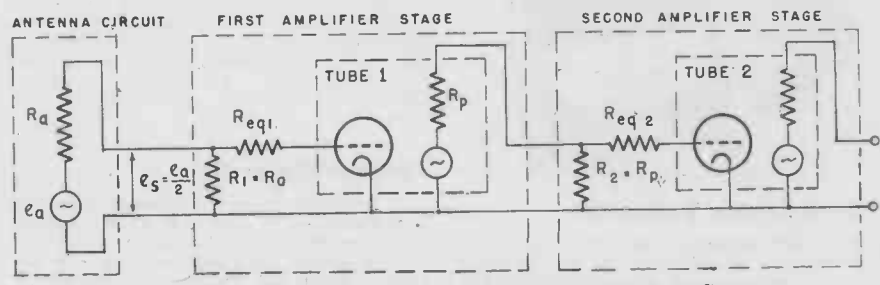

Schematic diagram of two-stage amplifier for computing noise figure

## Computing Noise in Receivers

D. K. C. MacDonald (Philosophical Magazine, London, June, 1944)

Computation of thermal and shot noise in multistage receivers is studied. The noise figure  $F$  is defined by the expression

$$F = S_i S_o / N_i N_o$$

where  $S_i$  is the signal power delivered from the antenna circuit to the matched load,  $S_o$  is the signal power available at the output of the amplifier when coupled to the antenna circuit,  $N_i$  is the noise power delivered from the antenna circuit to the matched load, and  $N_o$  is the noise power available at the output of the amplifier when coupled to the antenna circuit.

For a one-stage amplifier matched to the antenna:

$$F = 2 + 4R_{eq} / R_a$$

where  $R_{eq}$ , the equivalent grid noise resistance, is a fictitious noise resistance in series with the grid circuit which accounts for all subsequently introduced noise,  $R_a$  is the resistance in the antenna circuit.

The noise figure of an  $n$ -stage receiver may be found from the expression:

pression:

$$F_{1+2+3 \dots n} = F_1 + (F_2 - 1) / G_1 + (F_3 - 1) / G_1 G_2 + \dots + (F_n - 1) / G_1 G_2 \dots G_{n-1}$$

where  $G_n$  is the gain of the  $n$ th stage and  $F_n$  the noise figure of the  $n$ th stage.

The correct derivation of noise figures from the basic equations is explained and a possible error pointed out. In particular, the evaluation of  $R_{eq}$  in the general noise formula:

$$F = 2 + 4R_{eq}^2 / R_a^2$$

( $e_i$  is the signal input voltage at the grid) is considered. A two-stage amplifier (see figure) is discussed in more detail and  $F_{1+2}$  is derived:

$$F_{1+2} = 2 + 4R_{eq1} / R_a + R_{eq2}^2 / R_1 + R_2 \mu^2 / 4R_1$$

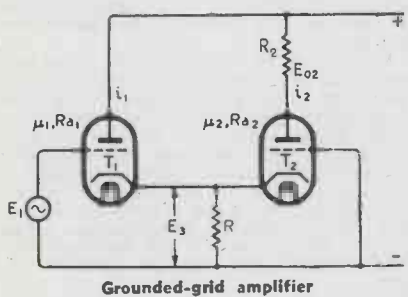

Grounded-grid amplifier

## Grounded-Grid Circuits

F. Butler (Wireless Engineer, London, November, 1944)

Here the grid of the amplifier or oscillator is grounded for radio frequencies and the controlling voltage is applied between ground and cathode; the load impedance is connected in the plate circuit. The input impedance of this circuit is low and its output impedance abnormally high. Undesired feedback from cathode-plate capacitance is very low, so that neutralization is rarely necessary.

A single-tube grounded-grid oscillator is discussed. A tuned resonant circuit is inserted between plate and ground and the cathode is connected to a tap on the inductance coil of the resonant circuit. Grid

(Continued on page 175)

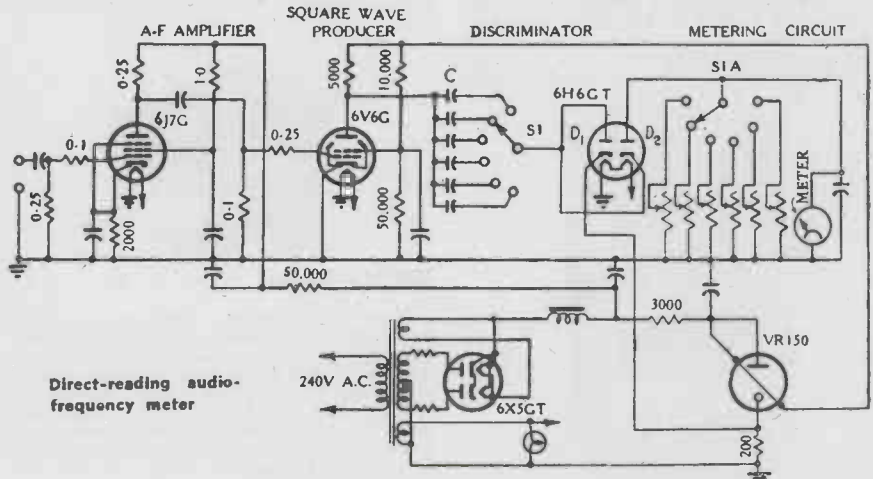

Direct-reading audio-frequency meter



## THEY SAID IT COULDN'T BE DONE!

Back in 1938, Hytron began designing new dies and converting production machinery for the first BANTAM GT tubes. The industry said in effect: "You're crazy; it won't work. You can't telescope standard glass tubes to BANTAM size and get the same results." Beam tetrodes, such as the 50L6GT, particularly were considered impossibilities. The intense heat developed during normal operation would warp the elements and crack the small glass bulb.

But Bruce A. Coffin, originator of the BANTAM GT, stuck to his guns. In a few short years, Hytron developed over fifty GT types. The GT became the most popular receiving tube.\* Short leads, low capaci-

ties, advantages of shorter bombardment at lower temperatures, ruggedness of compact construction plus both top and bottom mica supports, smaller size, standardized envelopes and bases — all contributed to that popularity.

The BANTAM GT permitted new space economies in pre-war receivers. Only its universal acceptance as standard by all manufacturers makes possible fulfillment of the Services' demands for receiving tubes. In increasing numbers, as this war draws to its ultimate conclusion, Hytron will continue to supply you with the popular BANTAM GT tubes which everyone said just couldn't be made.

\*1941 industry production figures: GT—52,000,000; metal—27,000,000; standard glass, G, and local—56,000,000.



OLDEST EXCLUSIVE MANUFACTURER OF RADIO RECEIVING TUBES

**HYTRON**  
CORPORATION

ELECTRONIC AND  
RADIO TUBES

SALEM AND NEWBURYPORT, MASS.



**BUY ANOTHER WAR BOND**

## WHAT'S NEW

(Continued from page 111)



### PM Loud Speaker

A new reflexed, stormproof permanent magnet loud speaker has been developed by Atlas Sound Corp., 1443 39th St., Brooklyn, N. Y. It has a non-corrosive diaphragm, a waterproof housing for the transformer, the horn is die-cast aluminum. The bell diameter is 7 in.; overall length, 7½ in. Voice coil impedance is 15 ohms; power, 15 watts.



### Mercury Plunger Relay

As a further refinement in the H-B mercury plunger relay, a new crown-shaped wire guide has been incorporated as a part of the plunger. This guide keeps the plunger upright and friction-free which results in a faster cleaner break with no chance for mercury splash or a prolonged arc. In addition, the arc is now broken over a new hardened ceramic material which eliminates powdering, thus still further prolonging service life. The new H-B mercury plunger relays are of the normally open series, available for ac up to 440 volts and for dc to 250 volts, with contact capacities as high as 30 amps. All have hermetically sealed mercury-to-mercury contacts which are positive, chatterless, noiseless, with no exposed arc. Manufacturer is H-B Electric Co., 6101 North 21st St., Philadelphia 38, Pa.

### Protected Resistors

A new line of bakelite encased fungus resistant resistors in a wide variety of resist-

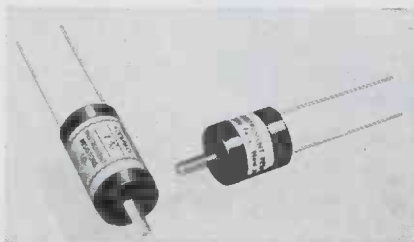

ance values and wattage ratings has been developed by Instrument Resistors Co., 25 Amity St., Little Falls, N. J. After resistors are dehydrated they are sealed in a special compound to make them impervious to atmospheric changes. Leads are bare at point of entrance and are hermetically sealed. After completion a special fungicidal coating is applied.

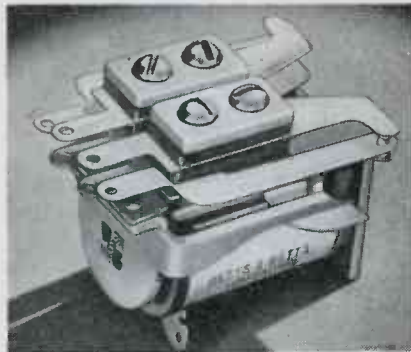

### Telephone Type Relays

These Type RAC midget type relays are especially designed for communication, electronic and aviation applications. These components meet rigid Army Air Force tests for altitude, vibration, shock, humidity and extreme temperatures. Dimensions are 1¼ in. long, 1 in. wide and 1½ in. high including first two pairs of contacts. Each additional two pairs of contacts adds ½ in. more. Weight 1¼ oz. Coils are protected against moisture, corrosion and electrolytic action and have voltage range from 1½ to 70 v dc. A highly efficient magnetic circuit permits operation with plus or minus 25 per cent voltage fluctuation. Insulation is inorganic-base plastic for minimum high frequency loss and extra mechanical strength. Any arrangement of contacts can be supplied for making, breaking or both up to twelve contacts. Contact springs are of resilient fatigueless alloy with over-all welded silver contact surfaces. Sufficient back pressure assures dead beat positive wiping action. Contact capacity 2 amps. at 100 watts. Manufacturer is Betts and Betts Corp., 551 West 52nd St., New York.



### Temperature Control Switch

Utilizing the standard Type M MU switch in a thermostatic control capable of handling loads up to the full 15 ampere 125 volt ac rating of the switch, the Type T-2 Ther-MU-trol is applicable to remote control of temperature in liquids, gases, and solids, through a calibrated, continuously adjustable range of 200 to 600 deg. F. A built-in safety device enables the unit to withstand temperatures up to 50 deg. beyond the maximum calibrated range. The heat-sensitive system of the device is of the hermetically sealed, liquid-filled type employing a bulb, a bellows, and a capillary tube of such length that the control unit can be mounted at some distance from the controlled element. The control housing, which contains the MU-switch and calibrated dial, is brass, 3 in. in diameter by 2-15/16 in. deep. Made by MU-Switch Corp., 38 Pequit St., Canton, Mass.



### Impulse-Initiated Timer

A new impulse-initiated timer introduced by Struthers-Dunn, Inc., 1321 Arch St., Philadelphia 7, Pa., is 71.8 per cent smaller by volume than previous conventional units used for similar applications. Type PSEH-1 timer is made in both ac and dc types. Contact operation occurs at the end of a delay interval after power has been applied, or after receipt of a momentary impulse from a push-button, limit switch, or other source. The adjustable timing range is 20-to-1, and the mechanism is immediately recycling. A built-in double-pole, double-throw auxiliary relay provides a variety of circuit arrangements common to, or isolated from, the control circuit. Timers can be supplied for ac operation on 110 v 60 cycles or 25 cycles; 220 v 60 cycles or 25 cycles; or for dc operation at any specified voltage from 6 to 120 volts. Size of a typical unit is 3½ x 3½ x 3¼ in.

### Fence Controller Tubes

Two fence controller tubes have been developed by Taylor Tubes, Inc., 2312 Wabansia Ave., Chicago. One, the Taylor 208 is a glow discharge tube and the other, the Taylor 207, is a rectifier. Both tubes have glass envelopes and a standard 4-pin base. Electrical characteristics: Taylor 208 discharge at 875 to 950 volts dc at 8 milliamperes. Taylor 207 filament volts: 2.5 v ac, filament current 2.5 amperes, max. rms ac volts 1250, max. dc current 125 milliamperes. Connections are all brought out to the pins in the base.

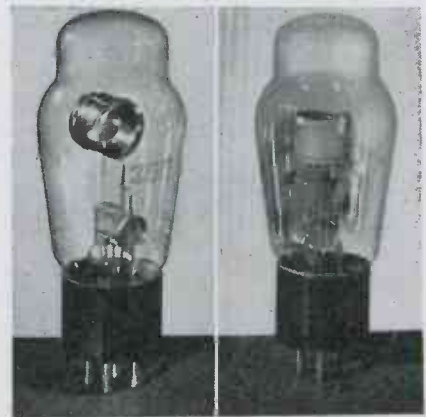

### Plastic Condensers

American Condenser Co., 4410 Ravenswood Ave., Chicago, has a complete new line of Amcon plastic condensers for radio. These advanced types of components are now in production in limited quantities. They come in all standard capacitance values and working voltages. Laboratory and field tests reveal better general electrical as well as unusual shockproof characteristics.

# Larvie

## UHF PRECISION INSTRUMENTS



### HARMONIC FREQUENCY GENERATOR

PROVIDES output voltages in 10 or 40 megacycles with CRYSTAL-CONTROLLED accuracy.

SELECTS 10 or 40 megacycle series by means of front panel switch.

IDENTIFIES any one of these harmonics by means of a Frequency Identifier\* which consists of a filter providing high attenuation of all voltages except that of frequency to be identified.

USED FOR calibration of receivers, wavemeters, or (with Beat Detector built into instrument) for calibration of oscillators and signal generators.

\* Specify frequency.



### PRECISION FREQUENCY METER

Completely portable Accuracy 0.1%  
Battery or AC-Operated

Models available from 100 to 1500 megacycles with 2 to 1 frequency coverage on each model. Available only on high priority while nation is at war.

#### RECOMMENDED FOR:

- Production testing
- Measurement of oscillator drift
- Independent alignment of transmitters and receivers
- Precise measurements of frequencies

FULL DETAILS ON REQUEST



# Larvie Laboratories

RADIO ENGINEERS AND MANUFACTURERS

MORGANVILLE, N. J.

*Specialists in the Development of UHF Equipment*

# WASHINGTON

★ ★ ★ ★ ★  
Latest Electronic News Developments Summarized  
by Electronic Industries' Washington Bureau

**ALLOCATIONS ANNOUNCEMENT LATER THIS YEAR**—Because of the huge problem of proper analysis of the manifold plans of postwar radio in all its branches—FM, television, emergency-safety, aviation, facsimile and communications—the FCC was slated to postpone the issuance of its overall spectrum-wide allocations plan until later in 1945.

**PRELIMINARY PLAN IS SHELVED**—Due to the changed trend of the war with the present prospect of a much longer conflict in Europe, the pressure for a speedy blueprint of the spectrum plan, affecting international frequency assignments, by the State Department for its preparations for the postwar world telecommunications conference had been dissipated, with the original schedule of the FCC to present a preliminary plan in early December being shelved.

**IRON OUT CONFLICTS WITH GOVERNMENT NEEDS**—Major task during December was to reconcile the conflicts between the frequency requests of civilian and industry radio services, as represented by the FCC and RTPB allocation plans, and the wavelength requirements of the government which are handled by the Interdepartment Radio Advisory Committee. The government frequency requirements naturally are huge during the war and even after peace comes will remain much greater than ever before.

**TENTATIVELY APPROVE BELOW 30,000 KC**—The FCC tentatively approved the allocations below 30,000 kc, the major readjustment being the IRAC proposal to eliminate specific bands for international broadcasting. The FCC has recommended restoration of such bands, based on space before Pearl Harbor. Aviation's overseas frequencies also may be shifted higher and the amateur long distance wavelengths also were under scrutiny.

**FM BROADCASTING THE KEY**—FM broadcasting is key to whole picture above 30,000 kc. Once it has been determined, if FM (as now was felt quite likely) is to remain in the lower portion of the spectrum because the propagation disturbances, viewed by some government engineers, are thought not of sufficient interference impact to warrant its shift upwards, the allocations can be framed for many other services—police, bus, truck, mobile highway, railroads, etc.

**TELEVISION LIKELY TO "STAY PUT"**—Television was deemed certain to be assigned a dozen 6-mc channels in the lower spectrum for monochrome video, but will be given adequate space "upstairs" for high-definition, color transmission. Amateurs will be placed in the upper strata of the spectrum; aviation, police and other emergency services will be well fixed for space.

**WAR PRODUCTION STILL NO. 1 JOB**—The new "Victory First" radio-radar-electronics war production program calls for maximum peak production at a rate of \$250,000,000 a month by March 1, 1945, especially in airborne radar so vital to the combat forces. New designs of radar and other imperative radio apparatus to meet battle requirements are being given the industry, as is well known, whenever battle experience necessitates modifications.

**LITTLE TAPERING OFF**—After next March 1, if emergency military procurement orders now indicated are issued, the Army-Navy requirements will probably approximate the March 1 level of around \$250,000,000 for several months and will counter-balance any tapering off of the current orders expected in March through June. The battery manufacturers are being asked to intensify ten critical types of cells production.

**INDUSTRY PRAISED**—WPB Vice-Chairman Hiland G. Batcheller at the recent meeting of the Radio and Radar Industry Advisory Committee termed the achievements of the industry "magnificent" and expressed the view that producers of radio and radar equipment will carry on successfully as in the past, maintaining schedules in the face of changes in design and complicated production and labor problems. Component manufacturers, too, have their task cut out. The Army and Navy with the intensification of combat operations often are receiving immediate urgent calls for repair and spare parts from the units on the fighting fronts.

**BACK IN HARNESS**—Ray C. Ellis took over the reins of his old WPB Radio and Radar Division in mid-December to carry on for a month for Director Louis J. Chatten, while the latter underwent a serious operation. Mr. Chatten had been working tremendously hard despite ill health up to the time an operation became imperative. Mr. Ellis, who had achieved such a notable record as chieftain of the Division ever since its creation, was called back from his post on directing reconversion problems for General Motors to step into the breach.

**MISCELLANY**—Distributors of electronic equipment have decided that they should not engage in the manufacture of equipment or parts; the two businesses of manufacturing and distribution are to be kept separate. Distributors with electronic components and parts for which no sale can be found will have to apply for WPB permission for manufacturing just like any other manufacturer. . . . Rear Admiral Redman, Director of Naval Communications, visualizes multi-channel use of radio circuits in international communications along lines of telephone wire carrier currents which will mean not only telegraph, facsimile and telephone from same transmitting stations using filters for different services, but also will be a most important saving of frequency space. These are the lessons on the use of radio learned by the Army and Navy. . . . A Central Frequency Registration Board is likely to replace the Berne Bureau of Telecommunications after the war if approved at the world telecommunications conference. . . . Army and Navy expected to formulate uniform procedure for surplus disposal, like joint contract termination procedure; all component and tube manufacturers agree to government contract form and end-product manufacturers also sanctioning plan. . . . Army surplus tubes still form virtually all surplus to be sold, nearly 14 million dollars worth.

National Press Building  
Washington, D. C.

ROLAND C. DAVIES  
Washington Editor

# wherever a tube is used ...

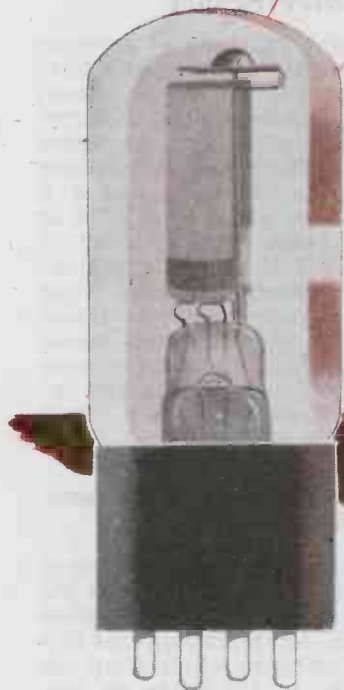

## COMBUSTION CONTROL

An abnormal increase in the density of smoke passing through a boiler breeching means a reduction of heat, loss of efficiency, increase in fuel consumption, and probably violation of smoke control ordinances. The electronically operated Worner Combustion Supervisor detects such conditions, turns in an audible or visible alarm, and sets in motion the mechanism that will bring about efficient combustion.

*for example:*



Control Unit

## THERE'S A JOB FOR *Relays* BY GUARDIAN

The "Combustion Control Supervisor," made by Worner Electronic Devices of Chicago, is a photo-cell system that responds to any predetermined degree of smoke density. To avoid "false alarms" resulting from momentary puffs of smoke, it is equipped with a time delay feature.

Worner's specified that the three relays used in this system must be sensitive but not delicate; that they require no adjustment; and that they meet Underwriter's requirements.

Guardian engineers developed the Series 155 D.C. relay as the answer to these specifications. This is a compact, sturdy, easily mounted unit with constant spring tension on the contacts. It is widely used on remote selection devices and other low voltage applications. Copper slug time delays up to .05 seconds on attract and 0.15 seconds on release are available. Coils for operation on any voltage up to 230 volts D.C. For further information write for Series 155 bulletin.

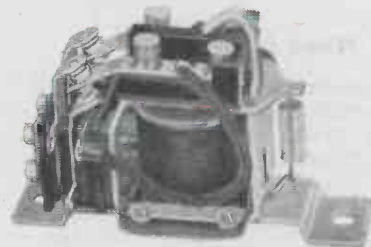

Series 155 D.C. Relay

Consult Guardian whenever a tube is used —however—Relays by Guardian are NOT limited to tube applications, but are used wherever automatic control is desired for making, breaking, or changing the characteristics of electrical circuits.

# GUARDIAN ELECTRIC

1622-A W. WALNUT STREET

CHICAGO 12, ILLINOIS

A COMPLETE LINE OF RELAYS SERVING AMERICAN WAR INDUSTRY

# ASSOCIATION NEWS

## Plan Electronic Panel For War Conference

An Electronics Panel is to be jointly sponsored by the Institute of Radio Engineers and the American Institute of Electrical Engineers as a part of the War Production and Conversion Conference to be held at the Hotel Commodore on Tuesday, January 30. The Panel, which is to convene at 8:30 in the evening, will consider three subjects, one dealing with the future prospects of electronics in general, another on "Electronic Heating" and a third covering "Applications of Electronic Devices in Industry."

C. S. Purnell (Westinghouse Electric & Mfg. Co., New York), is chairman of the Panel and associated with him will be Dr. O. H. Caldwell (Editor of "Electronic Industries"), Dr. B. E. Shackelford (RCA), F. R. Lack (vice-president WE), D. D. Knowles (manager electronic engineering department of Westinghouse, Bloomfield, N. J.), W. C. Rudd (chief engineer of Induction Heating Co., New York), Keith Henney (Electronics).

The general plan contemplates a round table discussion which it is hoped will be participated in by 400 or 500 individuals representing business enterprises in the Metropolitan area and the various engineering and technical societies cooperating in the Conference. Panel members will answer questions and serve as a source of information concerning electronic applications to industry.

## FMBI Meet Postponed

FM Broadcasters, Inc., convention which originally was scheduled for January 21-22 at the Commodore in New York, has been postponed. Present plans, made to agree with requests from the Office of Defense Transportation, are to hold the gathering some time after April 1.

## Iowa IRE Section

Another section has been added to the Institute of Radio Engineers following an organization meeting held late in November in Cedar Rapids, Iowa. T. A. Hunter, Collins Radio Co., was elected temporary chairman, and John A. Green (Collins) temporary secretary-treasurer. G. Milton Ehlers, head of the ceramics division of the Centralab Co., Milwaukee, presented a paper

on "The Romance of Ceramics." R. V. Guettler of the silver mica division of the same company spoke briefly on silver mica capacitors.

## Conventions and Meetings Ahead

**American Physical Society** (Dr. Karl K. Darrow, Secretary, Columbia University, New York); January 19-20, New York; Meeting of the Metropolitan Section of the New York, February 24, New York.

**Institute of Radio Engineers** (330 West 42nd Street, New York); 1945 Winter Technical Meeting, January 24-27, Hotel Commodore, New York.

**American Institute of Electrical Engineers** (H. H. Henline, 29 West 39th Street, New York); Winter Technical Meeting, January 22-26, New York; North Eastern District Meeting, April 25-26, 1945, Buffalo, N. Y.; Summer Technical Meeting, June 25-29, Detroit, Mich.

**Electrochemical Society** (Colin G. Fink, Columbia University, New York); Spring Convention, April 12-14, Hotel Claridge, Atlantic City.

**Optical Society of America** (A. C. Hardy, Massachusetts Institute of Technology); April 12-14, Cleveland, Ohio.

**Society for Experimental Stress Analysis** (W. M. Murray, President, Central Square Station, Cambridge 39, Mass. Post Office Box 168); 1945 Spring Meeting, May, Buffalo, N. Y.

**American Society for Measurement and Control** (L. Susany, c/o Carnegie Institute, 4400 Forbes Street, Pittsburgh); "Instrumentation for Tomorrow" Exhibit and Conference, September 17-21, William Penn Hotel, Pittsburgh.

## Plan Postwar Show

Chicago is planning a "Products of Tomorrow Exposition" which it is hoped will be to some extent electronic. It will be open to "those who can qualify with postwar products that are reasonably new," will be held in the Coliseum "approximately March 1." Marcus W. Hinson, many years manager of the National Chemical Exposition, will run it from Coliseum headquarters at 15th and Wabash.

## RMA-SAE Engineers Study Interference

Continuing its study of automobile ignition interference with television and FM broadcasts, Radio Manufacturers Association gathered late in November with engineers from the Society of Automotive Engineers for discussions and a demonstration which were held at the Westchester Country Club in Rye, N. Y. Following the demonstration, recommendations were drawn up covering instrumentation to be used at subsequent tests. Several types of automobiles were used in the demonstration and interference resulting from their ignition systems was studied.

## Audio Distortion Discussed At Radio Club Meeting

Audio distortion was the subject discussed by Jerry B. Minter, at the Dec. 14 meeting of the Radio Club of America. Mr. Minter is Chief Engineer of Measurements Corp. in Boonton, N. J. Amplitude vs. frequency characteristics and simple harmonic distortion have usually been considered criteria of audio amplifier performance. The paper offered practical remedies for the correction of other types of distortion. Practical methods of measurement were suggested and data on several practical systems given. Additional remarks concerned speaker baffle design and operation, since these factors are quite important. Minter pointed out that only \$1 need be spent to realize a very considerable improvement in the elimination of audio cross modulation distortion.

## NAB Radio-Set Statistics

Paul F. Peter, statistical director of the National Association of Broadcasters, has courteously supplied us with his compilation of the number of radio sets now believed to be in hands of the public, to wit: Radio homes, 33,100,000; secondary sets, 17,150,000; automobile radios, 8,750,000; total, 59,000,000.

Statistician Peter estimates that 8 per cent of the above sets are now "out of operation," because of tubes or minor parts lacking. The NAB figures, when thus diminished by 8 per cent (making radio homes, 30,400,000; secondary sets, 15,760,000; total sets, 54,400,000) are thus brought into close agreement with our own figures reproduced in this issue.





**In meeting  
the challenge of the future,  
*Western Electric*  
equipment leads the way**

War's end will bring a challenge to everyone. To those identified with communications and transportation, faster, better interchange of ideas and goods will be the order of the day.

We at Western Electric—with our 75-years heritage of leadership in communications equipment—believe we are peculiarly qualified to accept this challenge.

In world-wide telephony, broadcasting, aviation, marine and mobile radio—in every field where sound-transmission apparatus plays a part—Western Electric has led and will continue to lead the way. In these fields as well as in television, Western Electric will play a dominant part in the future.

*To speed Victory, buy more War Bonds—and keep them!*



**Western Electric**

ARSENAL OF COMMUNICATIONS EQUIPMENT

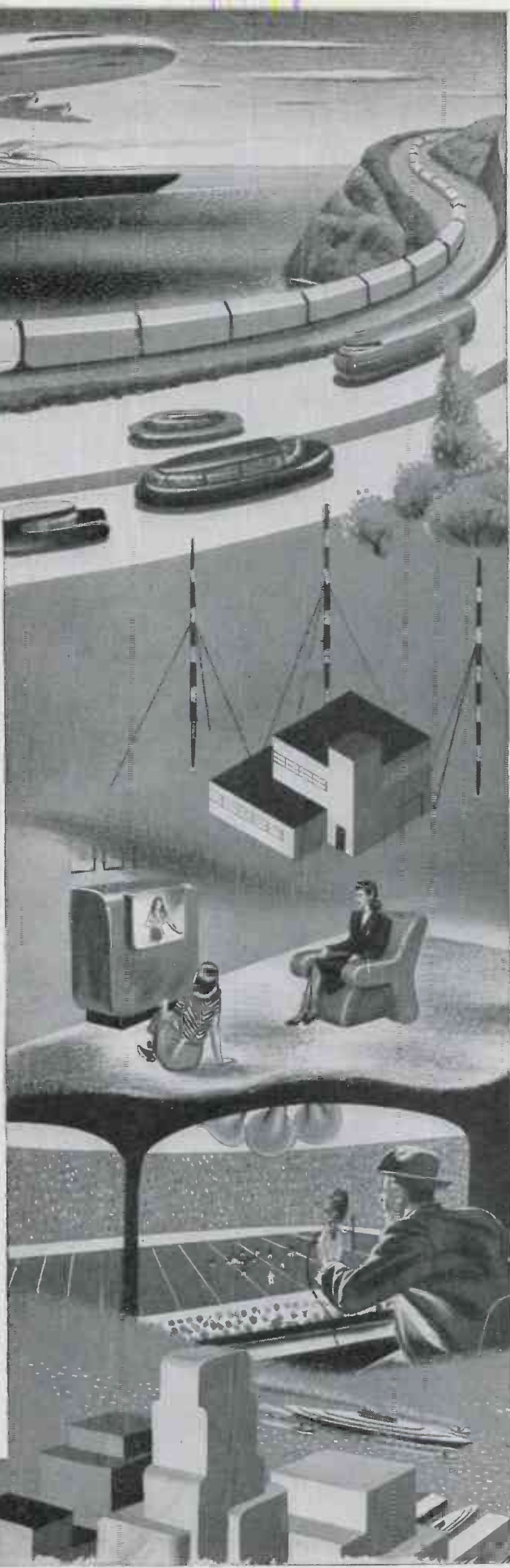

# ★ TELEVISION TODAY\* ★

## New Developments in the Video Field

### Industrial Television

Industrial television, explains J. D. McLean, General Electric commercial engineer, might be used in a large manufacturing establishment to allow management to view operations in the various departments of the factories. Hazardous manufacturing operations in dangerous or explosive atmospheres could also be watched by such a system, he explains. In fact, industrial television can be used for any application "if you want to see where you don't want to be."

Perhaps the most important application of industrial television after the war will be its use as a powerful merchandising medium by department stores, McLean points out. "Large stores have thousands of display points carefully chosen to catch and direct attention to specific products. The animation of certain of the primary display points and the addition of sound bringing an advertising message or an explanation, is regarded as a great step forward in advertising technic. The ability to televise fashion shows, demonstrations, featured products, etc., on one floor of a department store and transmit pictures and sound to display projectors on all other floors and in the show windows at the same time will provide a service long desired in the department store field."

It is impossible to estimate postwar prices for industrial television

### TELE BROADCASTERS

A report of the First Annual Conference, held by Television Broadcasters Association at the Commodore in New York, Dec. 11 and 12, will be found on page 122 in this issue—Editor.

equipment because of uncertain labor and material conditions so the figures given below are based on prewar prices for similar equipment. As an example, however, consider a typical industrial television system installed in a five-story department store. Two camera outlets and one microphone outlet are made available on each floor. Four display projectors are also available on each floor. A small control room housing the control and monitoring console and associated apparatus is built in a convenient location on one floor. The equipment required for such a system is outlined below.

Two camera channels, including camera, amplifiers, camera dolly, plugs and cable, camera sweep generator, video amplifier, monitor console, shading and camera control equipment, distribution and mixing panel at \$14,850 each .....\$29,700.00  
 One pulse generator ..... 4,500.00  
 One audio equipment, including microphone, portable pre-amplifier, audio amplifier, control and monitor equipment ..... 2,500.00

One 16-mm motion picture film projector and film pickup camera, including amplifiers and camera tube ..... 8,200.00  
 Twenty display projectors (18 by 24-in. picture) ..... 7,000.00  
 Ten camera outlets ..... 100.00  
 Five hundred feet—camera cable... 750.00  
 Two thousand feet of receiver cable 400.00  
 Twenty receiver plugs ..... 20.00  
 Four portable mercury vapor flood lamps ..... 2,000.00

Total approximate prewar price...\$55,170.00

To the above figure must be added the cost of installation.

### 90 Video Applications

Pretty quick after wartime restrictions are lifted, Television Broadcasters Association visions 100 video broadcasters in 29 states. Just now there are 90 applications on file with FCC. Following is the line-up:

California .....	15
Colorado .....	1
Connecticut .....	3
District of Columbia .....	7
Florida .....	1
Illinois .....	5
Indiana .....	2
Kentucky .....	1
Louisiana .....	2
Maryland .....	3
Massachusetts .....	7
Michigan .....	5
Missouri .....	3
Nebraska .....	1
New Jersey .....	1
New Mexico .....	1
New York .....	8
Ohio .....	5
Oklahoma .....	1
Pennsylvania .....	10
Rhode Island .....	1
Tennessee .....	1
Utah .....	2
Virginia .....	1
Washington .....	2
Wisconsin .....	1
Total .....	90

### British Postwar Television

The question of postwar operating standards for television in Great Britain have been under study by the British Institution of Radio Engineers. The following amplified statement is taken from their recently issued "Report on Postwar Development in the Radio Industry" as printed by the Journal of the Television Society.

There is a real need for a television service, broadly of a prewar character, that is, having the following characteristics in common with 1939 standards:

(a) That the service be "broadcast," i.e., there shall be a (generally) non-directional transmission without wires.

(b) That the vision and sound transmissions be of the same

(Continued on page 138)

\*Title registered U. S. Patent Office.

GE Engineer McLean's visualization of the manner in which industrial television might be used as a merchandising aid in department stores

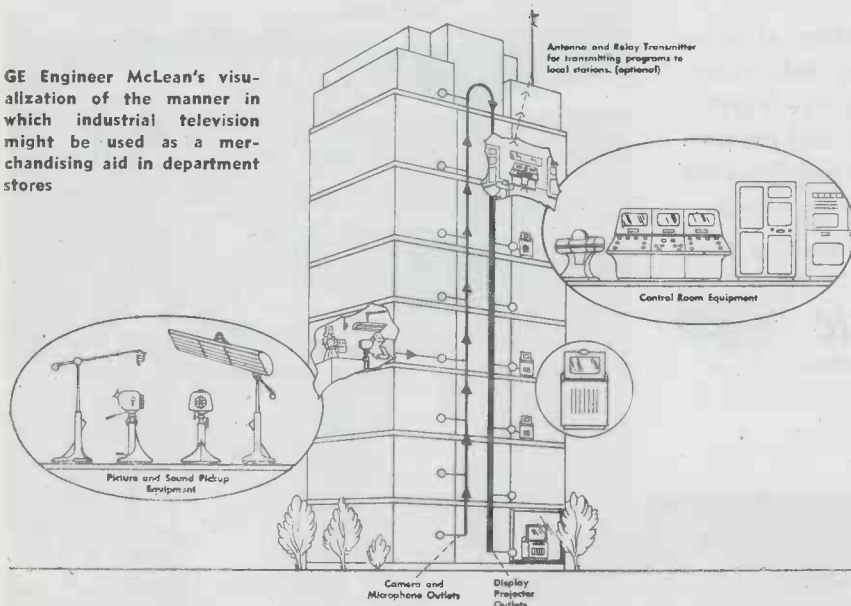



### HARVEY UHX-25

A 25-Watt General Purpose Radio-Telephone Transmitter—Available for operation between 1.5 M.C. and 30 M.C.



### HARVEY "AMPLI-STRIP"

For I-F and AUDIO Amplification.

## HARVEY

OF CAMBRIDGE

## RADIO AND ELECTRONIC EQUIPMENT

The units illustrated are representative of HARVEY OF CAMBRIDGE design and construction "know-how" as well as precision of manufacture and testing. Each is a precision product designed and developed by HARVEY OF CAMBRIDGE to fill specific needs in the radio-electronic fields.

Some, like the 206 PA Power Supply and the "Ampli-Strip" are new developments resulting from HARVEY's one-hundred per cent war work.

Others, like the UHX-25 Transmitter and

Marine 25 Radio Telephone are typical of HARVEY OF CAMBRIDGE products which have long been recognized as standards of quality and dependability.

Years of exclusive specialization in the manufacture and development of this type of equipment are your guarantee of complete satisfaction from all HARVEY OF CAMBRIDGE products and of competent intelligent assistance in bringing to a successful solution any of your present or projected radio-electronic problems.

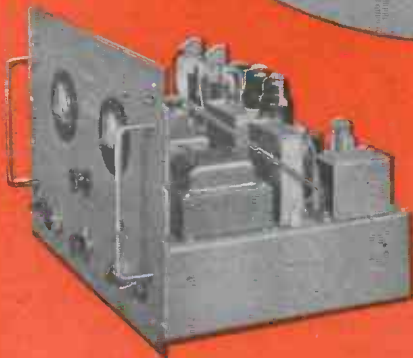

### HARVEY Regulated Power Supply 206 PA

For laboratory D.C. Source—Range 500 to 1000 volts.



### HARVEY MARINE 25

A 6-Channel Marine-Radio Telephone.

## HARVEY

OF CAMBRIDGE

## HARVEY RADIO LABORATORIES, INC.

441 CONCORD AVENUE • CAMBRIDGE 38, MASSACHUSETTS



TELEVISION BROADCASTERS ENGINEERING QUIZ PANEL: F. J. Bingley (Philco); J. E. Keister (GE); Klaus Landsberg (Television Production Inc.); Dr. Alfred N. Goldsmith (Chairman); A. H. Brolly (Balaban & Katz); C. W. Mason (Earl C. Anthony Inc.); Dr. Allen B. DuMont (DuMont Laboratories); O. B. Hanson (NBC); Dr. C. B. Jolliffe (RCA)

# TELEVISION IS READY

**Delegates to TBA Conference see green light, reward achievements, discuss engineering. Over 1000 attend**

● "Television is ready". That, in brief, is the consensus of members of the year-old Television Broadcasters Association which wound up its First Annual Conference after two crowded days at the Commodore in New York on December 12. The Association elected energetic Conference Chairman "Jack" Poppele its president for the ensuing year, added three new active members (Farnsworth, Bremmer Broadcasting Co., Newark, N. J., and the Yankee Net, Boston), and seven Affiliate members\* bringing the present total membership to 37, with 20 Active and 17 Affiliates; attracted a registration of nearly 800 delegates; fed 1050 at the banquet.

The two days were devoted largely to programming and administrative matters, but included a technical session presided over by a Panel of recognized experts under the chairmanship of Dr. Alfred N. Goldsmith, that collectively undertook to answer all engineering questions fired at it, and did so as reported elsewhere in this chronicle.

A feature of the Conference was the conferring of Awards for engineering achievements and other meritorious services to television over the past few years. Candidacy of the recipients was determined by a committee headed by Paul Ralbourn (Paramount Pictures) and including Dr. Orestes H. Caldwell, Editor of "Electronic Industries,"

Fred. R. Lack, vice-president of Western Electric; Eric Hodgins, vice-president of Time, Inc.; C. E. Butterfield, Associated Press Science Editor; Bruce Robertson, Broadcasting Magazine Editor. Those who received the awards were:

## Engineering

**FIRST AWARD**—DR. VLADIMIR K. ZWORNYKIN (RCA Laboratories)—For development of the iconoscope and the storage principle of picture pick-up, resulting in the first practical television pick-up equipment.

**CO-ORDINATE AWARDS**—PHILO T. FARNSWORTH (Farnsworth)—For work on television scanning methods and the electron multiplier.

LLOYD ESPENSCHIED (Bell Telephone Labs)—For adapting the coaxial cable to transmitting wide bands of radio frequency suitable for modern television.

DR. PETER GOLDMARK (CBS)—For work in the development of motion picture pick-up equipment and electronic analysis and control of equipment for color television.

F. J. BINGLEY (Philco)—For improvement in contrast of television pictures through flat face tubes and experiments on link operations particularly as regards outdoor events.

DR. ALLEN B. DUMONT (DuMont Labs)—For the development of the cathode ray tube to a satisfactory commercial instrument of television control and reproduction.

## Program Awards

**FIRST AWARD**—Station WABD (DuMont Labs)—For making its facilities available to all for study of the correlation of economic and artistic problems of television production.

Station WNBT (NBC); Station WRGB (GE); Station WPTZ (Philco)—For the first examples in the world of network operation and resulting division of program costs.

Station WCBW (CBS)—For successful lifting of a radio broadcasting program usually heard

## TBA OFFICERS

**President** . . . . . J. R. Poppele (WOR)

**Vice-Pres.** . . . . Robert L. Gibson (GE)

**Secy.-Treas.** . . . . Will Baltin

**Asst.-Secy.-Treas.** O. B. Hanson (NBC)

in sound only to the field of visual and sound entertainment. The program—"The Missus Goes a-Shopping."

Station W6XYZ (Television Productions Inc.)—For the introduction of motion picture techniques to television programming.

## General Contributions

**FIRST AWARD**—GENERAL DAVID SARNOFF (on leave from the presidency of RCA)—For his initial vision of television as a social force and the steadfastness of his leadership in the face of natural and human obstacles in bringing television to its present state of perfection.

DR. W. R. G. BAKER (Vice-President GE)—For his leadership in standardizing television through the National Television Systems Committee and supporting it through the Radio Technical Planning Board.

DAVID B. SMITH (Philco)—For his work on the National Television Systems Committee and his planning of television future as panel chairman with the Radio Technical Planning Board.

DR. A. N. GOLDSMITH (Consulting Engineer)—For his work on the NTSC and the RTPB and his vision of the relationship of the motion picture and television.

The "Information Please" Panel (see cut) which held forth on the second day of the conference, turned up the answers to many questions that served to indicate the trend of thinking. Some of the answers:

Q. How soon will color television be available?

A. (Hanson) In a practical commercial sense, 8 to 10 years. (Bingley) A crystal ball is a very unstable chemical compound. It may easily turn into an eight-ball.

Q. Can television transmitting antennas be readily added to vertical radiators for multibay FM antennas or is it necessary to plan for television in advance of building the structure?

A. (Landsberg) In most cases it probably would not be practical.  
(Continued on page 218)

\*RCA Victor Div. of RCA; Raytheon Mfg. Corp.; 20th Century Fox Film Corp.; Rauland Corp.; American Television Labs; Pan American Television; Federal Telephone and Radio Corp.

# SPRAGUE VITAMIN-Q\*



## A BIG STEP FORWARD . . . in Capacitors for High Temperature, High Voltage Applications

Vitamin Q impregnant, pioneered and perfected by Sprague, has resulted in capacitor developments of far-reaching importance for high temperature, high voltage applications. Although extremely compact, Sprague Type 25P Capacitors, for instance, operate satisfactorily at thousands of volts at ambient temperatures as high as 105° C. Moreover, their leakage resistance at room temperature is 20,000 megohms X microfarads—or at least five times higher than that of previous types.

Sprague Vitamin Q impregnated Capac-

itors retain all of the virtues of conventional oil-impregnated capacitors throughout the extreme range of + 105° C. to -40° C. Used where high temperature is not a factor, they result in materially higher ratings for a given size.

Standard types include hermetically sealed rectangular metal container units in styles for 95° C. and 105° C. continuous operation, and in d-c rated voltages from 1000 to 16000 V. Other types include Type 45P hermetically sealed in glass shells with metal end caps.

**SPRAGUE ELECTRIC COMPANY, North Adams, Mass.**

(Formerly Sprague Specialties Co.)

\*TRADEMARK REG. U. S. PAT. OFF.

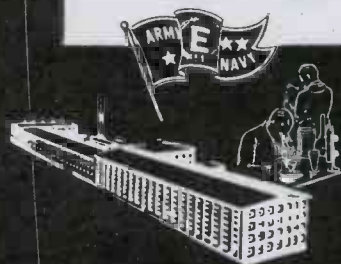

# SPRAGUE CAPACITORS KOOLOHM RESISTORS

# Extremes Meet



Thousands of these coils have gone to war . . . in the far corners of the earth . . . under the sea and in the sky . . . under the worst conditions.

Imagine . . . six miles of hair-size wire in a coil suddenly lifted from a jungle temperature of 120°F to a rarified atmosphere of -40°F and "taking it" day after day.

Only experience can wind coils like these . . . to do the job required of them.

Their use cannot be told but statistics may be interesting. In producing this one type of coil for the Army and Navy we have consumed one-half million miles of wire . . . 136,000 pounds of copper. The machines used in winding them have turned 3 TRILLION, 360 BILLION revolutions.

We hope soon to be able to put some of this production capacity and experience to work on YOUR postwar problems.

COIL SPECIALISTS SINCE 1917

COTO-COIL CO., INC.

65 PAVILION AVE.

PROVIDENCE 5, R. I.

## NEW PATENTS ISSUED

### Cathode-Follower Amplifier

The input to tube 3 is derived from the plate of cathode follower 2 and, therefore, will be 180 deg. out of phase with respect to the original input voltage to the grid of cathode follower 2. Consequently, the output currents of the two tubes through load resistor 1 will be of opposite phase and the arrangement operates in a push-pull manner.

The bias potentials applied to the control electrodes of the tubes 2 and 3 are so chosen that in the absence of input signal voltage the plate currents are small, but sufficient to insure that the tubes will oper-

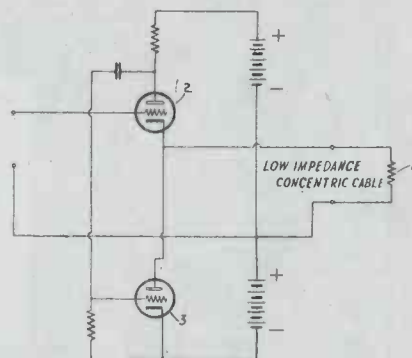

ate on reasonably straight portions of their characteristics.

In television circuits, picture signals may be supplied mainly by tube 2 and synchronizing signals mainly by tube 3.

In another embodiment the terminating impedance is a capacitance, for instance the modulating electrode of a cathode-ray tube. A resistor providing negative feedback may be inserted in the cathode lead of tube 3. The two triodes 2 and 3 are replaced by pentodes. In this arrangement, high plate currents are only drawn when sudden changes of input voltage occur.

E. L. C. White, Electrical & Musical Instruments Ltd., (F) May 15, 1943, (I) September 19, 1944, No. 2,358,428.

### Tunable Resonant Cavity

It is intended to adjust the resonant frequency and the Q of a cavity resonator. The position of conducting reed 19 can be changed (positions a, b, c) by means of the probe 39 extending into the interior of the cavity through a hole 21.

The position of the reed is adjusted while waves of the desired frequency are received

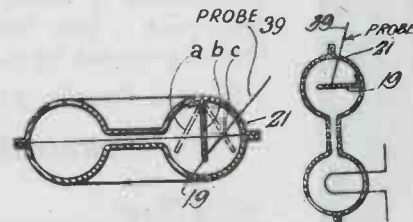

by the cavity until maximum reception is obtained. In an experimental model, the wavelength could be varied from 9.2 cm to 10.1 centimeter by bending the reed.

E. G. Linder, RCA, (F) February 26, 1941, (I) August 22, 1944, No. 2,356,414.

### Testing Fuses

In certain fuses, operated by centrifugal forces, the passage of light may be used to indicate whether or not the fuse is in its armed or unarmed position. The test-

# STRUTHERS-DUNN

INC.

~~5,288~~

5,312

TYPES OF

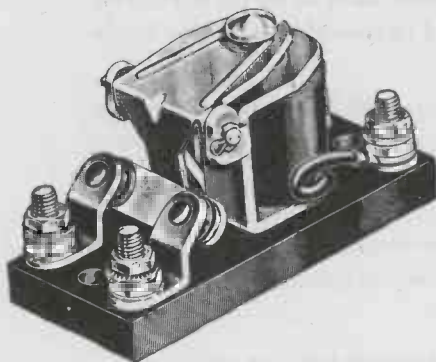

# RELAYS

Each available in  
countless coil combinations

**1321 ARCH STREET, PHILADELPHIA 7, PA.**

DISTRICT ENGINEERING OFFICES: ATLANTA • BALTIMORE • BOSTON • BUFFALO • CHICAGO • CINCINNATI • CLEVELAND  
DALLAS • DENVER • DETROIT • HARTFORD • INDIANAPOLIS • LOS ANGELES • MINNEAPOLIS • MONTREAL  
NEW YORK • PITTSBURGH • ST. LOUIS • SAN FRANCISCO • SEATTLE • SYRACUSE • TORONTO • WASHINGTON

# HARDWICK, HINDLE

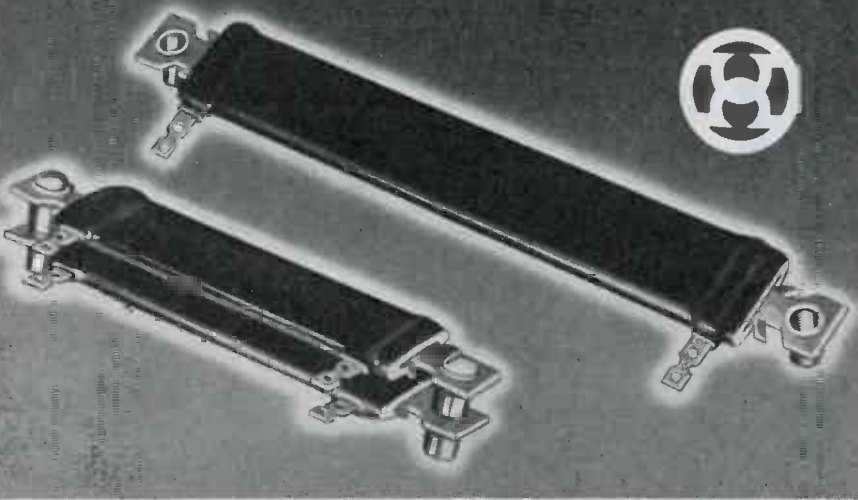

## STILL LEADING THE FIELD

Our Blue Ribbon Resistors were unique in their entirely new design and their advanced engineering when we introduced them in 1939.

They still lead the field as the most efficient:—their compactness, their toughness, and their remarkable performance offer you more than just higher wattage ratings for unit space required.

—And in our other types of resistors and rheostats we also offer you important exclusive advantages.

**HARDWICK, HINDLE, INC.**  
**RHEOSTATS and RESISTORS**  
 DIVISION OF  
**THE NATIONAL LOCK WASHER CO.**  
 ESTABLISHED 1886  
 Newark 5, N. J., U. S. A.



### NEW PATENTS

ing apparatus has two stations where the fuse is rotated at different speeds, one corresponding to the armed and the other to the unarmed position. Two photocells and a lamp are so arranged that passage and no passage of light at the respective desired station operate relays so as to maintain continued working of the apparatus, while passage of light at the station where it should not pass or non-passage at the station where it should pass stops the apparatus, indicating that the fuse does not respond to the centrifugal forces in the desired way.

L. Melster, (F) October 15, 1942, (I) August 8, 1944, No. 2,355,092.

### Multiplier-Tube Amplifier

Two electron-multiplier tubes are combined in a circuit to result in high amplification and low distortion. Negative feedback is provided by lead 51. Batteries 16 apply such large negative potentials to the grids 8 that class B or class C operation is secured.

In the case of a modulated high frequency input wave, the cathode networks 17, 18 are preferably adjusted to vary the control grid bias at the signal frequency. Rectification in the plate circuit of the starter sec-

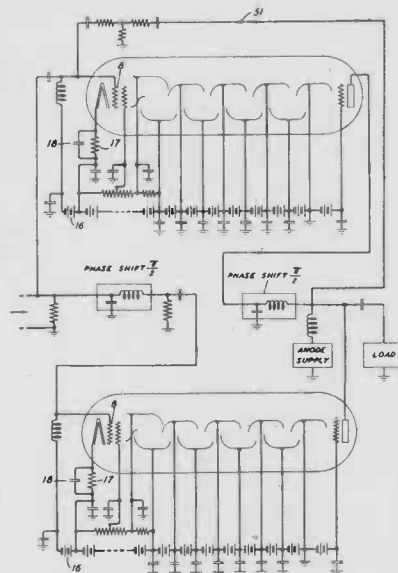

tion causes a detected current of the signal frequency to flow through resistor 17, thus producing a varying grid bias which permits only the positive tips of the high frequency wave to be transmitted. At the same time, resistance 17 and capacitor 18 provide negative feedback at the signal frequency.

J. W. McRae, Bell Telephone Laboratories, (F) October 10, 1941, (I) August 22, 1944, No. 2, 356,331.

### Transducer-Feedback Circuit

Feedback is introduced to minimize the frequency dependence of the galvanometer mirror displacement in a sound recording system. The voltage across galvanometer winding 22 is the sum of the voltage induced by the mutual coupling with modulation coil 10 and the voltage induced by the motion of the armature 15 modulating the flux through the winding 22. Only the voltage component due to the motion of the armature 15 should be fed back, out of phase with the original voltage, to minimize distortion.

According to the invention, a second galvanometer B, identical with the modulating galvanometer A but whose armature 16 is held stationary, is inserted. The voltage generated by the mutual coupling between the two coils 10 and 22 is balanced out by another equal mutual inductance voltage generated in pickup coil 23 by the current

(Continued on page 130)



# COLE

STEEL EQUIPMENT COMPANY

Experience and "know-how" are why so many of America's leading manufacturers depend upon "Cole Steel Equipment" for

*sheet metal fabrication*

We welcome tough assignments . . . instrument housings . . . water-test boxes . . . chassis; some made to extreme precision, others to gauge limits. Send us your blueprints!

Send for our Brochure  
"The Plant Behind Your Plant"

349 Broadway, New York 13, N. Y.

Factory: Brooklyn, N. Y.



**COLE STEEL  
OFFICE EQUIPMENT**

will again be available  
after the war

# Have you looked into METALLIZED GLASS?

**Y**OUR electronic problems may find an answer in Corning's process for permanently bonding metal to glass.

Which of the following qualities will help you?

1. **Hermetic bond** between glass and metal — assures positive and permanent seal against oil, water, and gas.
2. **Precision metallizing** — allows accurate control of capacitance, inductance, or resistance.
3. **Permanent mechanical and electrical qualities** — maintain accurate tolerances indefinitely.
4. **Superior electrical properties** of glass — low power factor, high dielectric strength, extremely high resistance, wide range of dielectric constants.
5. **Thermal endurance** of a high order. Metallized glass easily meets Army and Navy specifications for thermal shock.

• • •

*Write us about your problems. We'd be interested in seeing if glass can help you. Address Electronic Sales Dept. I-1, Corning Glass Works, Corning, N. Y.*

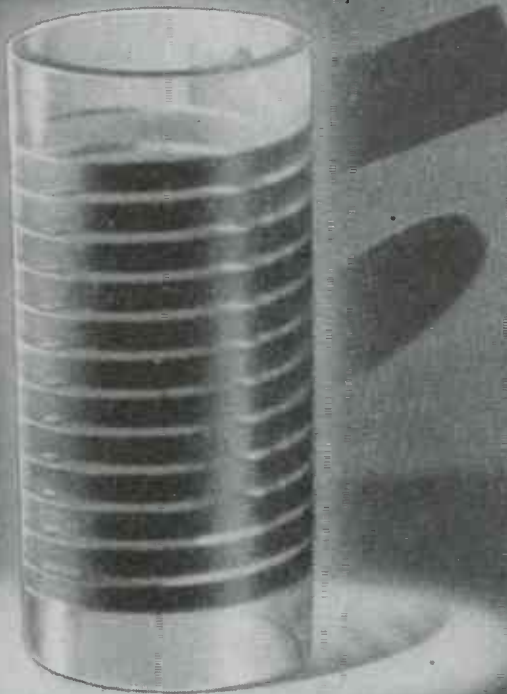

**CORNING**  
— means —  
Research in Glass

## Electronic Glassware



"PYREX" and "CORNING" are registered trade-marks of Corning Glass Works

# "THINKING" MACHINES

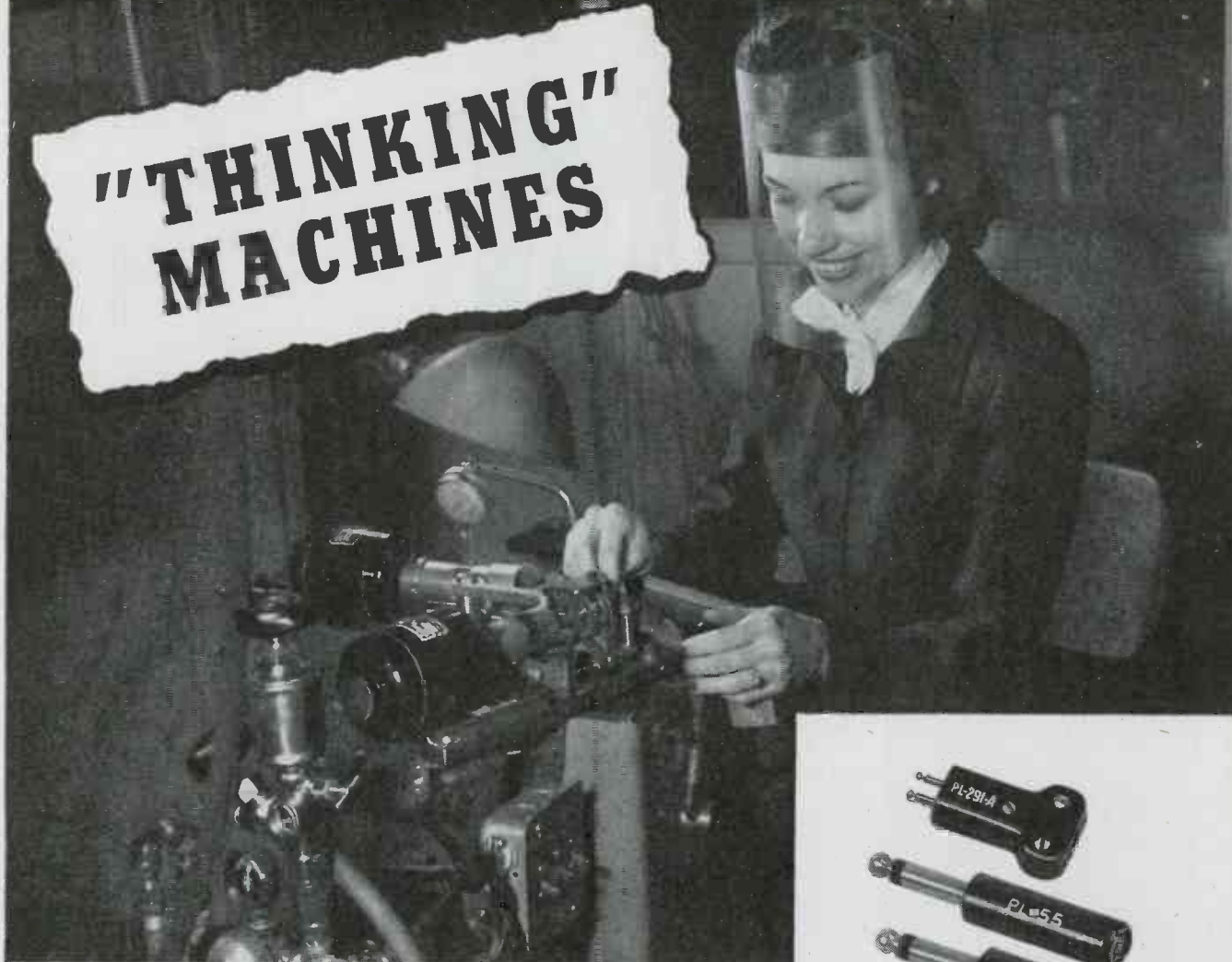

Machine designed by Remler to perform multiple operations: automatic slotting; indexing; drilling; milling and reaming.

**REMLER ENGINEERS** design and build robots with "brains" to improve production techniques. Ingenious jigs and dies, and in many instances entire machines are constructed to combine intricate operations. These innovations contribute to the precision accuracy of Remler products; release manpower for other tasks; reduce costs and speed up deliveries.

- For complete sound transmitting systems; radio; plugs and connectors and other electronic components in metal and plastic, consult . . .

REMLER COMPANY, LTD. • 2101 Bryant St. • San Francisco, 10, Calif.

## REMLER

SINCE 1918

*Announcing & Communication Equipment*



### PLUGS & CONNECTORS

Signal Corps • Navy Specifications

Types:		PL			NAF	
50-A	61	74	114	150		
54	62	76	119	159		
55	63	77	120	160		1136-1
56	64	104	124	291-A		
58	65	108	125	354		No.
59	67	109	127			212938-1
60	68	112	149			

PLP		PLQ		PLS	
56	65	56	65	56	64
59	67	59	67	59	65
60	74	60	74	60	74
61	76	61	76	61	76
62	77	62	77	62	77
63	104	63	104	63	104
64		64			

OTHER DESIGNS TO ORDER

**NO TOP HAT AND TAILS FOR**

**GREEN**



Though many of our jobs are "exclusive," Green engineers are easy to talk to, and even easier to work with. Because rectifier engineering is our business, we can tackle any assignment—even the so-called insurmountable ones—requiring DC power, and come up with the solution. We have no production line as such . . . each customer's needs are individually thought out, designed and built.

Whatever the voltage and current required, one of our widely used Green Rectifiers can be easily adjusted to your industrial or laboratory applications. Each Green Rectifier is a complete unit in itself, including all control and supervisory equipment. Each is mobile, compact and efficient. Write for our descriptive booklet.

**"Rectifier Engineering is our Business"**

*If you're knitting your brow about DC power, present or post-war, put your problem in the lap of a friendly Green engineer.*

SHARE YOUR BLOOD WITH A WOUNDED SOLDIER—THE NEED IS URGENT

**W. GREEN ELECTRIC COMPANY, INC.**

SELECTRO PLATES AND ALL TYPES OF RECTIFIER EQUIPMENT

GREEN EXCHANGE BUILDING 130 CEDAR STREET NEW YORK 6, N. Y.

RECTIFIER  ENGINEERS

**NEW PATENTS**

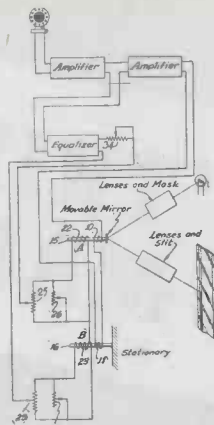

through coil 11 which voltage contains no component due to armature movements.

By adjustment of potentiometers 25 and 29 to balance the amplitudes of the mutually induced voltages, and by adjustment of resistors 26 and 30 to balance the phase of these voltages, a resulting voltage due solely to the exact motion of armature 15 is impressed on the equalizer, the amplitude of which is controllable by variable resistor 34. Equalizer 35 converts the constant-velocity characteristic of the feedback galvanometer into a constant-displacement characteristic, i.e., the displacement and not the velocity of the galvanometer mirror is proportional to the input voltage amplitude and is independent of frequency.

F. G. Albin, RCA, (F) May 26, 1943, (I) September 5, 1944, No. 2,357,623.

**Direction Finder**

The response of the automatic radio direction finder is improved for small correction voltages without impairing its operation at large correction voltages. For this purpose a transformer of special characteristics supplies the controlling voltages for the grids of the gas discharge tubes which operate the motor driving the loop antenna. This transformer introduces a phase shift for high controlling voltages so that the phase relation between plate and grid voltages at the tubes depends on the magnitude of the controlling voltage. It is thereby possible to fire the respective tube early in the cycle for small control voltages, while avoiding the firing of both tubes simultaneously at high voltage amplitudes.

G. V. Eltgroth, Bendix Aviation Corp., (F) April 27, 1942, (I) August 29, 1944, No. 2,356,922.

**Cathode-Ray Tube Circuit**

It is intended to obtain a distortionless amplification of varying voltages which should not be influenced by the amplification process; the output may be used for measurements.

The electron beam 25 of a cathode-ray tube 20 is deflected by the voltages applied to plates 43, 44 to vary the relative number of electrons intercepted by the two secondary-electron-emission faces 52a and 52b of the primary anode 52 so that the secondary anodes 53, 54 will receive a different amount of electrons, generating a potential difference across resistors 55, 56. Deflecting plates 36, 37, energized by the output voltage across resistors 55, 56, act upon the electron stream in opposition to plates 43, 44; a state of equilibrium between the two pairs of deflecting plates is established.

A substantially linear relationship exists

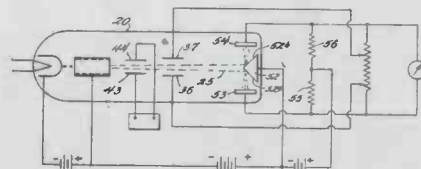

# A knack for making difficult tubes

**N**ORTH AMERICAN PHILIPS is one of the few producers of electronic tubes successfully manufacturing the type 833-A transmitting triode tube in quantity. The assembly alone calls for unusual skill and resourcefulness on the part of our engineers and craftsmen, and specially designed equipment.

Due to the unique design of the 833-A, the plate is supported from its own terminal post at the top of the glass envelope and the remaining elements from the base or stem. The tube must therefore be assembled in two sections and accurately joined on a glass lathe. Bonding of the metal grid and plate terminal posts to the glass flares is done by r-f induction heating, which is confined to the sealing points only. This operation, illustrated, is completed in a matter of seconds.

The ability to produce such difficult tube types is the result of experience gained by an organization with a background of over half a century of research and development in the electrical field. That is one of the reasons why

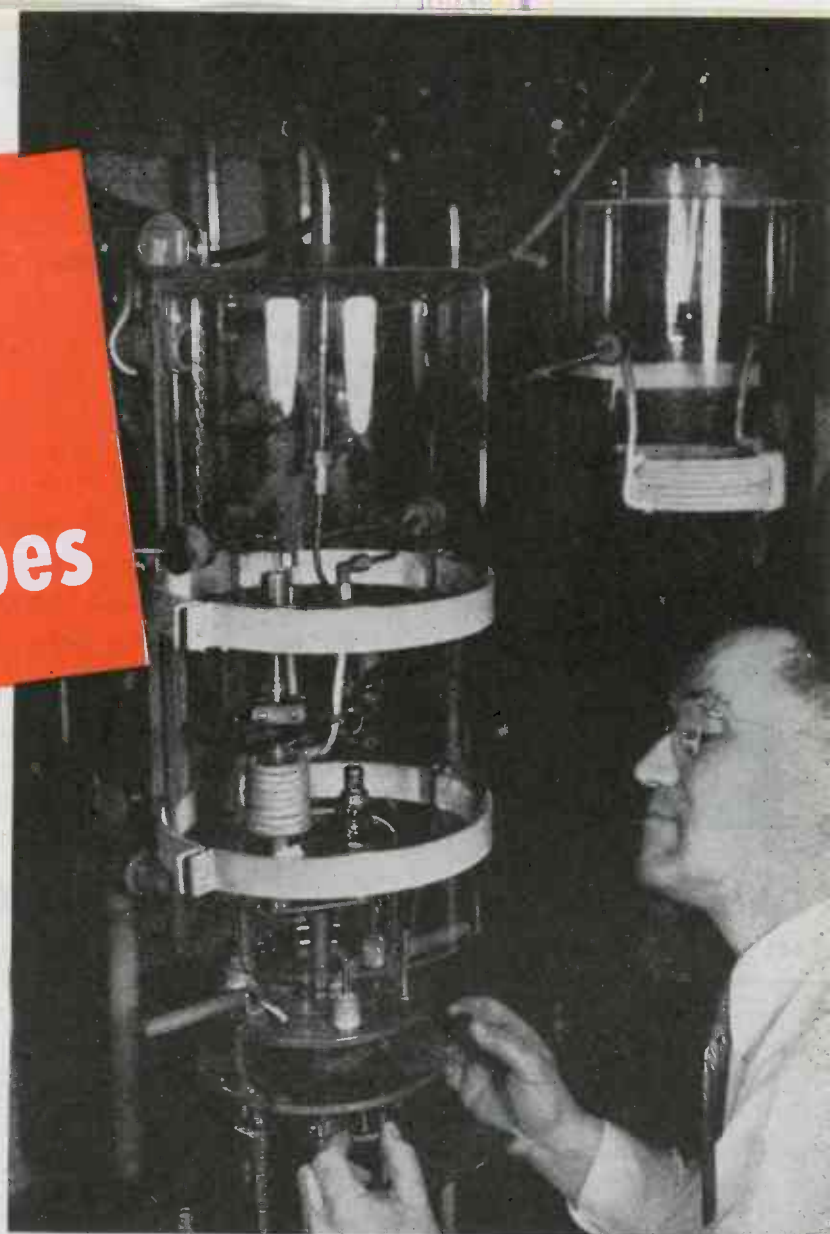

The metal plate and grid terminal posts of an 833-A being bonded to the glass envelope by means of radio-frequency heating in a nitrogen atmosphere.

manufacturers look to North American Philips as a reliable source of electronic tubes for their postwar requirements.

Although all the NORELCO tubes we produce now go to the armed forces, we invite inquiries from prospective users. A list of the tube types we are especially equipped to produce will be sent on request.

Write today for interesting booklet, describing the background of North American Philips in the science of electronics.

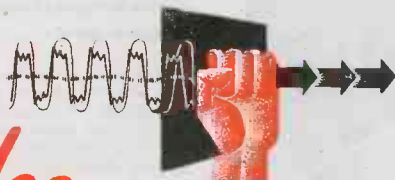

**Norelco**  
Reg. U. S. Pat. Off.

Electronic Products by

NORELCO PRODUCTS: Quartz Oscillator Plates; Amplifier, Transmitting, Rectifier and Cathode Ray Tubes; Searchray (Industrial X-ray) Apparatus; X-ray Diffraction Apparatus; Medical X-ray Equipment, Tubes and Accessories; Tungsten and Molybdenum products; Fine Wire Diamond Dies. • When in New York, be sure to visit our Industrial Electronics Showroom

**NORTH AMERICAN PHILIPS COMPANY, INC.**

Dept. D-1, 100 East 42nd Street, New York 17, N. Y.  
Factories in Dobbs Ferry, N. Y.; Mount Vernon, N. Y. (Metalix Div.); Lewiston, Me. (Elmet Div.)

Take a **TURRET TERMINAL LUG**  
LIKE THIS...



Swage it to the Board  
LIKE THIS...



And in a jiffy you have  
a good, firm Turret Terminal



It's as simple as that with these heavily silver plated C. T. C. Turret Terminal Lugs. Quick soldering, too. Sufficient metal is used to give them strength but there's no surplus metal to draw heat and increase soldering time.

C. T. C. Turret Terminal Lugs are stocked to meet a wide range of board thicknesses. Order them from

**CAMBRIDGE Thermionic CORPORATION**

441 CONCORD AVENUE

CAMBRIDGE 38, MASSACHUSETTS

**SMART IDEA:**

Though we're all absorbed in vital war work, let's give some thought to the future. Do a smart thing now — get thoroughly acquainted with Insuline's vast line of Radio-Electronic Products and the Insuline Manufacturing Facilities...

These 2 books tell the story. Write for them now.



48-page Catalogue describes Insuline's vast line of Radio-Electronic Products.



8-page Brochure presents Insuline's organization and manufacturing facilities.

What are your requirements? Send data for immediate assistance.



**INSULINE**  
CORPORATION OF AMERICA

INSULINE BUILDING · LONG ISLAND CITY, N.Y.



**NEW PATENTS**

between the input voltage and the voltage supplied to the load if the maximum unbalance between the electron currents to secondary anodes 53 and 54 is obtained by a relatively small unbalance between the deflecting forces of the two sets of deflecting plates 36, 37 and 53, 54 respectively.

Photoelectric cells and a fluorescent screen may be used instead of the secondary electron effect, or, alternatively, a Whitestone bridge, two resistances of which are dependent upon temperature and heated by the impinging electron beam.

H. Ziebolz and P. Glass, Electronbeam Ltd., (F) December 6, 1941, (I) September 12, 1944, No. 2,357,922.

**Variable Frequency Characteristic Amplifier**

Negative feedback is provided by the un-biased cathode resistors of tubes 14 and 15, and for tube 14 also by coil 21. Capacitor 30 has a low impedance only at the higher audio frequencies. Consequently, if tap 28 is at the lower end of resistor 23, there will be little negative feedback at the high frequencies and they will be comparatively strong. With the tap 28 at the grid end

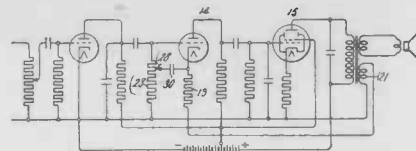

of resistor 23, the response at higher frequencies is decreased with respect to the response at lower frequencies, because capacitor 30, resistor 19 and coil 21 are in series across the grid resistor 23 so that the impedance of the grid circuit decreases with increasing frequency.

K. B. Austin, General Electric Co., (F) July 1, 1941, (I) July 4, 1944, No. 2,352,931.

**Cathode Ray Tube**

Heavy ions, for instance barium ions, damage the fluorescent screen of a cathode ray tube by impinging against it. These ions are deflected by electrostatic fields, but are hardly influenced by electromagnetic fields because the force acting on a particle in an electromagnetic field is proportional to the ratio of the electric charge to the mass of the particle—which, in the case of heavy particles, is negligibly small—while in an electrostatic field the deflecting force is proportional to the charge and independent of the mass of the particle.

To prevent the deleterious effect of the impinging ions on the screen, an electrostatic field is applied to the tube which deflects ions and electron beam to the inactive edge of the screen when there is no deflecting potential on the associated electromagnetic system. The useful deflection of the cathode ray beam away from this marginal rest position is effected by an electromagnetic field so that the path of the ions is hardly influenced and they do not impinge against the active surface but against the margin of the screen.

M. Messner, Alien Property Custodian, (F) February 4, 1939, (I) August 22, 1944, No. 2,356,418.

**Synchronizing Multi-Channel Receivers**

A phase correction circuit for synchronizing the distributor in telegraph receivers is described. The phase corrector is designed to operate effectively despite variations in the time ratio between marking and spacing signal elements. Front and/or back edges of the marking signals may, alternatively, be used as reference points in the derivation of the phase correcting pulses. Departures from synchronous phase in the rotating distributor are corrected more rap-

THESE GO TO MOLDED  
PLASTICS DIVISION

AND THOSE ARE  
FOR SMALL  
MOTORS



YES, you can obtain both molded plastic parts and small motor drives or assemblies from General Industries. Under one roof and one general management we have long supplied them to leading manufacturers in a wide range of industries.

## INQUIRE ABOUT **BOTH** FROM GENERAL INDUSTRIES



Few things "stump" our molded plastics division. Whether it's a big job or a little one, we have the facilities and the "know-how" to turn it out in any quantity. Our engineers and mold makers have a habit of reading *between* your blueprint lines, to dig out some way to do the job better, more economically or faster.

Our operators are skilled from many years of experience in compression, transfer or injection molding, to deliver work 100% to specifications and on time.



You'll find that same thorough competence in our small motors division. For many years our *Smooth Power* drives have been standard for leading makers of phonograph and radio equipment, automotive devices and other low-torque requirements. Many buyers obtain exactly what they need in our standard line, but if made-to-order units are called for, our engineers and plant can deliver them.

THE  
**GI** GENERAL  
INDUSTRIES  
COMPANY

ELYRIA, OHIO



So, for molded plastic parts or low-torque motors or drives, ask General Industries.

Our military commitments have priorities at present, but a general discussion now

can pave the way for later details. We'll appreciate it if you'll address the division involved . . . *molded plastics or motors.*

# Only "AIR WOUND" Coils Give You All These Advantages



**LESS WEIGHT...** No conventional winding form required—less critical material used in manufacture.

**LOW DIELECTRIC LOSS...** Design incorporates an absolute minimum of extraneous material in winding field.

**ADAPTABLE TO ANY MOUNTING...** Ideal for plug-in or other services where mounting problems are involved.

**LESS SUBJECT TO DAMAGE...** Nothing much to break. Can easily be repaired without tools, even if bent completely out of shape. Bumper rings or other protective features available for extreme services.

**GREATER DESIGN ADAPTABILITY...** Can be equipped with fixed or variable internal or external coupling links, special indented turns for easy tapping, and many other special features.

**MORE ACCURATE...** Can be wound to more uniform pitch. Easier to tap at the exact desired point. No coil form to cause dielectric loss.

**WIDE RANGE...** Sizes and types for any application. 10 watts to 10 KW.

*Samples to your specifications. Write for details.*

## B&W

### BARKER & WILLIAMSON

Dept. EL-15, 235 Fairfield Ave., Upper Darby, Pa.

Air Inductors, Variable Condensers, Electronic Equipment Assemblies

Exclusive Export Representatives: Lindeteves, Inc., 10 Rockefeller Plaza, New York, N.Y., U.S.A.

## NEW PATENTS

idly when such departures are excessive, and less rapidly when such departures are slight.

C. W. Latimer, RCA, (F) May 29, 1943, (I) September 5, 1944, No. 2,357,671.

### Limiter Network

By a proper choice of grid leak resistor 14 (40,000 to 50,000 ohms) the audio signal amplitude is limited to a certain level and damage to any succeeding apparatus by excessively high output amplitudes is prevented. The circuit is particularly useful where it is desired to read weak telegraph signals in the presence of crashes or static. The curves illustrate the effect of various

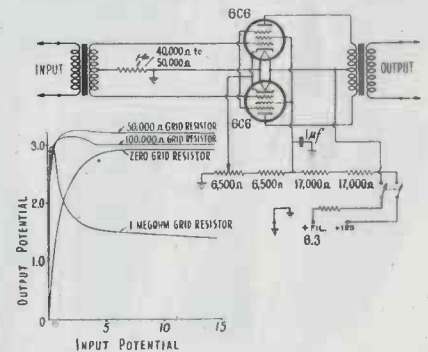

values for the grid leak resistor 14. It will be seen that the steepness of the initial rise increases with increasing resistance, but that too high a value of resistance produces a pronounced hump in the characteristic.

M. Katzip, RCA, (F) March 11, 1941, (I) September 5, 1944, No. 2,357,405.

### Multivibrator

Resistor 19 (or 19') and variable resistor 18 (or 18') are inserted to control the frequency of the multivibrator over a comparatively wide frequency range without a change in output amplitude and without

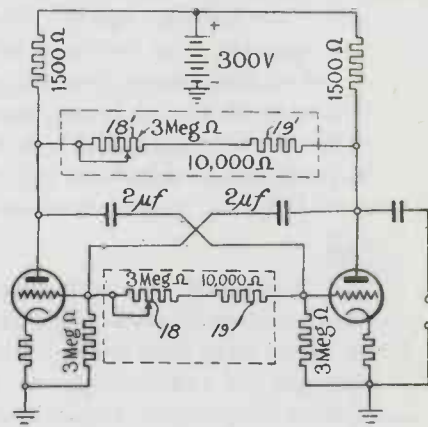

changing the symmetry of the generated oscillation.

In an experimental circuit, a variation in frequency of 120:1 was readily obtained without greatly influencing the amplitude of the oscillations. When the control resistor 18 (18') is rotated towards its minimum resistance value, the frequency of the multivibrator will increase.

A. A. Macdonald and J. L. Johnson, Westinghouse Electric & Manufacturing Co., (F) July 11, 1942, (I) August 15, 1944, No. 2,356,071.

### Tetrode Push-Pull Amplifier

Two tetrodes or beam power tubes are connected in a zero bias push-pull amplifier circuit, the conventional screen grids, 15, serving as control grids. A very low plate current will be drawn with plate voltages up to approximately twice that in a usual





**the newest member of the family  
makes the loudest noise!**

The newcomer in the G. I. family of radio components is a lusty youngster bound to make itself heard. Set manufacturers who have long looked to us for high precision, high performance, high production standards in condensers, tuning units, actuators and record changers will welcome our latest arrival — *Speakers!*

When the mammoth capacity, the engineering genius and production know-how developed by our large-scale participation in the

war effort can be diverted to peacetime activities, we are prepared to do a real job on speakers. Set manufacturers who, like us, are figuring ahead, will undoubtedly be interested to know that we plan to make our new speaker subsidiary a dominant industry factor and an important part of G. I.'s production of precision radio components.

GENERAL ELECTRONIC APPARATUS CORPORATION  
A SUBSIDIARY OF

**GENERAL INSTRUMENT CORPORATION**  
829 Newark Avenue • Elizabeth 3, New Jersey



**DANIEL  
KONDAKJIAN**

**ELECTRONIC TUBE**

**TUNGSTEN LEADS,**

**BASES, CAPS, METAL**

**SPECIALTIES ETC.,**

**AND MACHINES**

DANIEL KONDAKJIAN components offer exceptional functional advantages born of over twenty years' experience in this highly specialized field.

Micro accuracy, consistent high quality, fine finish and rugged durability are inherent mechanical features embodied in their design. Economies, efficiencies and ingenious production methods are intangible but ever present features in their manufacture.

DANIEL KONDAKJIAN facilities include those for economical precision production of metal stampings and screw machine parts to any specification; in any quantity. DKE SPOT-WELDERS embodying improvements derived of 20 years experience are also available for delivery now.

**THE ENGINEERING CO.**

27 WRIGHT STREET, NEWARK, 5, NEW JERSEY



**NEW PATENTS**

circuit. Operation is similar to that of a zero bias class B triode except that the relatively greater spacing between the grids 15 and the cathodes 12 results in much lower input capacitance so that it is possible to have much greater impedance in the control grid circuit. The polarity of the grids reverses during each alternation of the input signal and failures due to im-

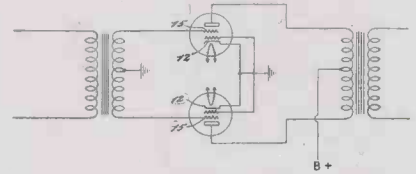

proper grid alignment and emission resulting from high operating temperatures, are eliminated.

The circuit has been found to operate with very little power input and with grid impedances as high as 40,000 ohms. Tube life is increased. Distortion is substantially less than either with zero bias class B operation or with beam operation.

W. H. Cook, Guided Radio Corp., (F) July 15, 1943, (I) September 12, 1944, No. 2,358,148.

**Engineers to Hear  
IRAC Expert**

The growing importance of the Interdepartment Radio Advisory Committee, little-known government agency, which has the responsibility for determining the Federal Government's radio frequency needs and recommending wavelength assignments to the President for his approval, will be the subject of an address at the 1945 Winter Technical Meeting of the Institute of Radio Engineers by Captain E. M. Webster, IRAC Vice-Chairman and Chief of the U. S. Coast Guard Communications. Captain Webster's address is to be given at the Technical Session B in the afternoon of Jan. 26.

IRAC has been in existence since 1922 — and Captain Webster and



Captain Edward M. Webster, USCG, who will address IRE Winter Technical Meeting

**ACCURATELY  
DESIGNED**  
for dependable performance

**GROVES**

*wire wound*

**RESISTORS**

GROVES Resistors successfully meet today's rigid requirements because of exacting manufacture backed by thorough engineering. Our staff of resistor specialists are ready to confer with you regarding your needs. Catalog on request.

**GROVES**

**CORPORATION**

CAPE GIRARDEAU

MISSOURI



**how many hours in a week?**

Electronic engineers have been working hard against time ever since Pearl Harbor. As far as they are concerned it's always "five minutes to twelve"—for they must not only keep up with, but must *anticipate* the vast requirements of modern warfare. And they are coming through—with the

most of the best electronic equipment for the Allies—on time!

Raytheon-designed equipment and Raytheon-made tubes are serving on all battlefronts—with that "Plus-Extra" performance quality that has always been associated with the name Raytheon.

Listen to  
**"MEET YOUR NAVY"**  
Every Saturday Night  
ENTIRE BLUE NETWORK  
Coast-to-Coast  
181 Stations

**RAYTHEON**

RADIO RECEIVING-TUBE DIVISION  
Boston, Mass. • Los Angeles • New York • Chicago • Atlanta



All Four Divisions Have Been Awarded  
Army-Navy "E" with Three Stars



DEVOTED TO RESEARCH AND THE MANUFACTURE OF TUBES AND EQUIPMENT FOR THE NEW ERA OF ELECTRONICS



## A NEW WORLD for TOMORROW

We are busy, as you are, with present activities in the fields of electronic, electromotive and electromechanical applications for industry and, of course, for the War Effort.



**Electro-Mechanical Controls**

**Remote Controls**

**Electro-Mechanical Operating Mechanisms**

**Fractional-Horsepower Motors  
for Special Applications**

**Engineering Development, Design and  
Production Facilities Are Available  
on the Above Equipment**

*Your inquiries will receive our prompt attention*

# ELECTROCON CORPORATION

219 West Sunrise Highway, Freeport, New York

Dr. J. H. Dellinger, Bureau of Standards Radio Chief, have served on it virtually as charter members ever since six months after its establishment. At present—as it has been during the war—IRAC is the key to Spectrum Allocations and its membership, composed of the Army, Navy, State, FCC, CAA and other governmental agencies interested in communications, has been holding frequent meetings on the FCC allocations blueprint. In fact, IRAC, because of the government's present and anticipated radio requirements has become virtually a governmental career with its members being highly specialized in allocations engineering. Besides being an independent government agency, IRAC also is an advisory committee to the Board of War Communications.

Captain Webster has been Chief of Coast Guard Communications ever since Pearl Harbor when he was called back into active service. He had established the original Coast Guard communications set-up in headquarters after World War I, having been commissioned in the Coast Guard in 1912 as an Ensign. He retired from active duty in November, 1934, to join the Federal Communications Commission as Assistant Chief Engineer. He has served as a technical adviser and delegate of the United States at a number of international radio and telecommunications conferences and also in 1933 was appointed by President Roosevelt as a member of the Secretary of Commerce's interdepartmental committee which prepared the basis for the present Communications Act.

### POSTWAR TELE

*(Continued from page 120)*

order of carrier frequency as prewar. With regard to the assignment of any new frequencies required, a conservative policy is advocated having regard to the possibility of echo trouble at higher carrier frequencies.

- (c) That the radio bandwidth for vision transmission be of the same order as prewar, viz., 4 mcs. approximately.

Serious consideration should be given to better utilization of the above-mentioned bandwidth by making use of vestigial side-band transmission and also to increasing the number of lines to that which is optimum for the increased modulation bandwidth. Tentative figures proposed are: 525 lines (gross, interlaced); 3.25 mcs. maximum modulation frequency. All other standards relative to the vision transmission should be maintained at prewar values.

The television sound transmission should be regarded as part of a nation-wide uhf high quality sound service and should, therefore,



**HASTEN VICTORY!**  
**Buy More War Bonds**

# ATR

*Preferred Precision Products*

- Vibrators
- Vibrator-Operated and
- Rectifier Power Supplies

**ATR LOOKING AHEAD!** Though now engaged in vital war work, with the immediate aim of victory, ATR is looking ahead. Our organization is being geared for the postwar requirements of the Radio-Electrical Industry. At present, only priority rated orders are being filled. However, we suggest that your postwar orders be anticipated and placed with us for prompt delivery after V-E Day. Write for catalog number 244. Backed by 14 years of "know how," **DEPEND ON ATR.**

## AMERICAN TELEVISION & RADIO CO.

*Manufacturers of Quality Products Since 1931*

**ST. PAUL, MINNESOTA, U. S. A.**



Old bulky cartridge type fuses.

New Littelfuses 3 A G and 3 A B. Saving 1 1/2 cu. in., in this example.

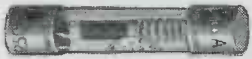

3 A G Glass-enclosed Littelfuse, 1 1/4" long, 1/4" dia. Slo-Blo construction.



3 A B Fibre-enclosed Littelfuse 1 1/4" long, 1/4" dia.



Glass-enclosed 8 A G Littelfuse 1" long, 1/4" dia.

# Better Fusing Efficiency with SPACE SAVING

Glass-enclosed 3 A G to and including 6 amps., 250 V. Use with electric appliances, heavy duty power supplies, amplifiers, radios, motors, etc. (Slo-Blo type also made for 1/100 amp., for electric fences etc., and 1/32 amp., for control circuits, small coils, etc.).

3 A B fibre-enclosed fuses for services 8 to 20 amps., 250 volts. Greater precision, space-saving and convenience in still heavier duties. Strong fibre tubes, nickel plated caps and other new features.

## 8 A G INSTRUMENT LITTELFUSES

From 1/200 to 15 amps., 250 volts AC or DC. For voltmeters, milliammeters, galvanometers, thermocouples — practically the entire range of delicate electrical instruments.



be of whatever character (viz., Frequency, Amplitude or Pulse Modulation) is selected for that sound service. But that, in the case of London, in addition to any new sound channel, the London Service should radiate on a duplicate sound channel the original amplitude-modulation transmission.

The above recommendations, referring specifically to domestic use, will provide picture entertainment of a high order and yet allow modification of existing television receivers with a minimum of difficulty.

The recommendations are based on the consideration that the future of (domestic) television is dominated more by economic than by technical factors. The more ambitious schemes which have recently been propounded are likely to be at a distinct cost disadvantage to the public in comparison with the above more moderate proposals and should, therefore, be considered as separate rather than replacement services. The more advanced developments in the fields of Stereoscopy and Color will also require provision of an alternative service to cinemas.

It is suggested that the immediate postwar television standard will, in fact, be permanent; it is, therefore, desirable that these standards should not be "frozen" at a level which is below the technical and economic limits of the present time.

If television is to recommence on a sound basis, it must be given a semblance of stability. The marketing of sets giving poor reception, having low reliability or lacking good service arrangements, will harm not only the manufacturer but the whole industry. In the early postwar days, every individual set will be a center of interest, and an advertisement for television in general.

In view of the problems involved, it undoubtedly will pay the industry to adopt cooperative research methods. If this were done, agreement could, for example, be reached upon the main types of circuits to be used, thus giving the public the best of cooperative effort. Moreover, by avoiding fancy and unreliable circuits the task of service mechanics would be made much easier.

## Experts Discuss Television Problems

The December 7 meeting of the Philadelphia section of the IRE was a session on television arranged as a symposium devoted to some of the technical problems which will have to receive engineering attention. Following the papers, the meeting was thrown open to questions from those attending. The

**LITTELFUSE INCORPORATED**  
4757 Ravenswood Ave., Chicago 40, Ill. 200 Ong St., El Monte, Calif.



# DUMONT CAPACITORS

FOR DEPENDABLE RADIO REPAIRS

SOLD ONLY THROUGH  
EXCLUSIVE JOBBER  
TERRITORIES

**DUMONT ELECTRIC CO.**

34 HUBERT ST. NEW YORK, N. Y.

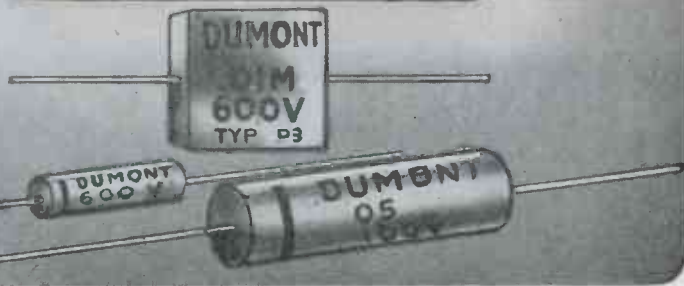

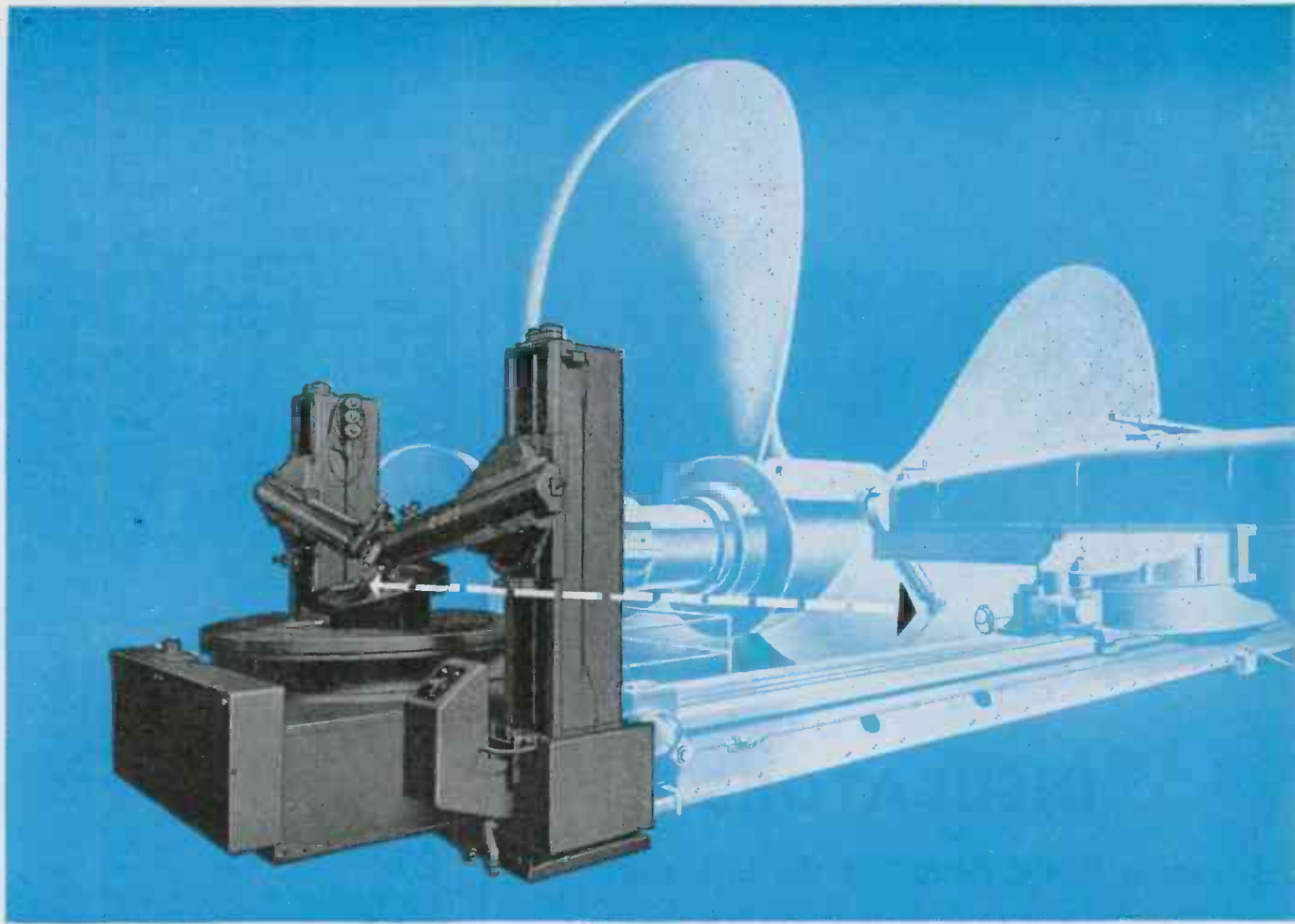

## *tracing perfect profiles...in steel*

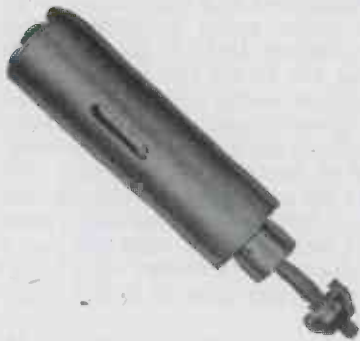

### "BRAINS" OF THE ELECTRONIC CONTROL

Shown above is the Tracer Mechanism which translates the shape of the model into a signal pattern. This pattern, through the use of electronic tubes, controls the position of the cutters as they move over the full-size casting—reproducing exactly the shape of the scale model.

Finishing large nonsymmetrical surfaces—such as ship propellers—has long been an expensive and time-consuming job. Many days of skilled hand labor were required in chipping, grinding and polishing the rough casting.

But a war-born electronic development now permits the entire operation to be done by machine—with far greater accuracy than ever before possible with the most highly skilled hand labor.

An electrically controlled Tracer Mechanism follows the contour of an accurate small-scale model—made of

metal, plastic or wood. The electronic position regulator (left) then guides the huge cutting machine over the full-size casting. Duplicates of the desired shape may be produced indefinitely from a single setup.

Now applied almost exclusively in production of ship propellers, this machine tool tracer control holds broad possibilities for speeding peacetime production, cutting costs, conserving skilled man power. It's another example of the new developments in electronics you'll want to know more about. For further information, call your nearest Westinghouse office, or write Westinghouse Electric & Manufacturing Co., P.O. Box 868, Pittsburgh 30, Pa. J-91069



TUNE IN JOHN CHARLES THOMAS  
SUNDAY, 2:30 EWT, NBC

HEAR TED MALONE  
MON. TUES WED. EVENINGS, BLUE NETWORK

ELECTRONIC EQUIPMENT FOR INDUSTRY AND HOME • ELECTRONIC TUBES • RADIO AND TELEVISION

FUSED  
QUARTZ

DEPENDABLE

RUGGED

## INSULATORS

are a "main factor" of the high power electronic tube. Quartz is the best electrical insulator known to science. Many other qualities make it ideal for the job. . . . Not subject to thermal shock. Non hygroscopic. High surface resistance. Shaped to specification.

**ULTRA VIOLET LAMPS** (quartz mercury arcs)

**HYDROGEN ARCS IN QUARTZ**

**FUSED QUARTZ ROD,**

**TUBING, PLATES and SPECIAL SHAPES**

**HANOVIA**

**CHEMICAL & MANUFACTURING CO.**

Dept. EI-12

NEWARK 5, N. J.

speakers were: Allen B. DuMont (Pres., Allen B. DuMont Laboratories), on the subject of Television Transmission Problems; Raymond F. Guy (Radio Facilities Engineer, NBC), on Television Networking, and David B. Smith (Director of Research, Philco), on Television Receiver Requirements.

Mr. DuMont stressed the problem of multiple path reflection conditions which are so prevalent in metropolitan areas, and in some more remote places where the signal level is low, due to the absence of direct path transmission. It was suggested that satisfactory handling of this problem needs the highest order of installation skill with perseverance on the part of the installer in the matter of correct antenna placement when installations are attempted in certain areas.

### **Future relay station**

Mr. Guy presented many interesting comparisons between the basic methods of transmitting television program material over networks. The coaxial line method at present seems to have the edge on the relay system as to the speed with which it can be made available for this service. On the other hand (granting the possible improvement of certain components), relaying should be somewhat less expensive per mile over the route. It is possible that a relay station might in the future turn out to be a point-to-point amplifier circuit in which the received signal is picked up, amplified and shot along to the next point, using parabolic reflectors possibly 15 ft. in diameter and raised 150 ft. off the ground. Such amplifiers would need a 60 db gain and 20 watts output, installed about 30 miles apart. They would cost a total of around \$91,000 each or 57 cents for each foot of network linkage. Rather spectacular power gains were evident with the use of well-focused reflector systems, using wavelengths of a few centimeters.

Mr. Smith outlined a few of the problems that will confront the designer of the postwar receiver, adapted to receive the multiplicity of programs that will ultimately be available in many areas. An interesting point brought out was the possibility that the television channels ultimately be shared by numerous point-to-point communication systems of low power, as one means of providing for the many new classes of services needing channels. If these services use carriers that are located in certain parts of each 6 mc television channel somewhat removed from either the video or sound carriers such facilities need not cause television interference (and vice versa) if the receiver de-



# LARGEST SHEET OF MICA CERAMIC INSULATION

*ever made*

19 $\frac{1}{4}$ " x 29 $\frac{3}{4}$ "



*now ready*

THIS new size plate of MYKROY glass-bonded mica ceramic insulation is **more than 2 times LONGER** than the maximum size available heretofore affording Production and Design Engineers many important new application advantages:

1. Because of increased size MYKROY can now be used for: Switchboard panels—Large inductance bars—Insulated table tops—Large meter panels—Transformer covers—Switch connecting rods—Bases for Radio Frequency or Electrical Equipment assemblies and structural members in R. F. equipment where low-loss insulation is indispensable.

2. Lower cost per square inch of MYKROY in the 19 $\frac{1}{4}$ " x 29 $\frac{3}{4}$ " sheet makes possible a saving of 33 $\frac{1}{2}$ % in usable material, considerably reducing the cost per fabricated unit.

3. Better cutting efficiency in the new plate lowers unit cost still further and permits employing the superior insulating properties of MYKROY in a broader range of electronic applications.



All fabricators of glass-bonded mica materials should seriously consider the use of these larger plates to reduce cost and amount of time required in filling their orders. Ready for Immediate Delivery. Most thicknesses carried in stock.

## WRITE FOR MYKROY SHEET BULLETIN #102

Just off the press, Bulletin #102 is a complete engineer's data book which combines practical data with a brief account of the dramatic story behind the development of the 19 $\frac{1}{4}$ " x 29 $\frac{3}{4}$ " sheet. It is replete with working data and comparison charts on the various sizes of MYKROY sheets. Write for your copy NOW!



MYKROY IS SUPPLIED IN SHEETS AND RODS . . . MACHINED OR MOLDED TO SPECIFICATIONS

MADE EXCLUSIVELY BY **ELECTRONIC MECHANICS INC.**

70 CLIFTON BOULEVARD • CLIFTON, NEW JERSEY  
Chicago 47: 1917 NO. SPRINGFIELD AVENUE . . TEL. Albany 4310

Export Office: 89 Broad Street, New York 4, N. Y.

# HOW EXCELLENCE IS BUILT INTO



**BUSY HANDS** There can be no letdown in any one of the critical operations required in the production of Sangamo MICA CAPACITORS. That is why every Sangamo operator in each department is fully trained in her particular duty until she becomes thoroughly capable in doing her task. These operators know the importance of accuracy and maintain faithfully the Sangamo standard of excellence.

## SANGAMO ELECTRIC

ESTABLISHED 1898 . . . MICA CAPACITORS . . .

# Sangamo

## MICA CAPACITORS

Because of the precise and accurate operations involved in the manufacture of mica capacitors, too much emphasis can not be placed upon the importance of modern equipment and adequate working facilities. The facilities used by Sangamo for gauging mica are shown in the attached picture. Other departments, utilizing equally accurate, modern, and efficient methods, for MICA SPLITTING, MICA PUNCHING, INSPECTION, and STACKING, are all vital factors in maintaining Sangamo excellence.



### Mica Gauging

The preparation of mica to be used as the dielectric in a mica capacitor requires many steps. Splitting the laminations from the mica block is the first step, but it is only the beginning in a long and carefully controlled series of operations in the final preparation of the mica. As the electrical capacitance of a mica capacitor depends upon the dielectric constant of the mica, its thickness, and the active area of the electrodes used in the unit, these factors must be accurately controlled. In some cases several thousand or more individual mica films are used in the construction of a capacitor and the dielectric failure of any one of these pieces would result in the destruction of the entire unit. Consequently, it is readily apparent that extreme care in selecting and gauging of the individual mica laminations is of extreme importance. The dielectric constant of mica is determined by precise electrical measurements, but usually this constant is fairly uniform for any group or batch of mica of equal quality when obtained from a single source or mine.

While proficient splitting operators can split mica so that approximately 80% or more of their production will come within limits of one-half thousandth of an inch in thickness, this is not sufficiently accurate to accomplish the results desired in obtaining uniformity of characteristic. Consequently, it is necessary to gauge each mica lamination on special beam gauges, as shown in the accompanying picture. Here, trained operators select mica to thickness limits of one-fourth of a thousandth of an inch or less. This gauged mica is separated into groups according to the thickness of the lamination, and each group is then ready to be punched to the special size and shape required for the particular capacitor in which it is to be used.



**COMPANY** SPRINGFIELD ILLINOIS

• • • WATT HOUR METERS • • • TIME SWITCHES • • •

# METAL STAMPINGS

IN SMALL LOTS



If you need a limited number of DIE CUT metal stampings, it will pay you to try DAYTON ROGERS metal stamping service.

**NO QUANTITY TOO SMALL  
NO PART TOO INTRICATE**

With twenty-three years' experience in this specialized service at our finger tips, we can produce all your small lot metal stamping requirements with greater ACCURACY and ECONOMY.

A quotation will convince you.

Write for illustrated  
booklet No. 176-5.

**DAYTON ROGERS MANUFACTURING CO.**

2835 12th Ave. So.

Minneapolis, Minn.

## New INLAY PROCESS

### ELIMINATES NAME PLATES ON FRONT PANELS

A proven method for placing durable characters on metal panels, chassis, etc.

- ★ Inlaid baked enamel characters, protected by background finish; resistant to abrasion and salt spray; guaranteed to pass 50 hour salt spray test.
- ★ Front panel will match finish of cabinets.
- ★ Recommended and endorsed by scores of manufacturers of electronic, sound and communication equipment.

PROMPT DELIVERIES—Send us your bare fabricated steel and within two weeks we will return it finished and marked to your complete satisfaction.

# SCREENMAKERS

64 FULTON STREET • NEW YORK 7, N.Y.

Tel.: REctor 2-9867



ALSO...  
SILK SCREENING on front panels and chassis, either metal or plastic. Sharp clear characters durably printed on finished or unfinished surfaces.

sign is carefully considered. In addition to the speedy and satisfactory solution to the present design problems, numerous plans are under way for an extensive long-range program of research toward the utilization of the higher frequency bands, considered for attaining higher fidelity, and possibly color at a later date. It was estimated that five years is none too long a period in which results can be expected from this latter program.

### Communications Pictures

The series of full page advertisements published in "Electronic Industries" the past year by the Universal Microphone Co., Inglewood, Calif., will be reprinted in pictorial portfolio form with more than a dozen pictures depicting various stages in the advancement of communications through the ages. The pictures, by Los Angeles artist Keith Thomas, start with the early days of the Phoenician and Greek runners and end with a modern drawing from World War II.

The series has attracted wide and favorable attention and has been in demand by schools and colleges for classroom study. Several army posts have also requested permission to use them for research work, and at least one encampment has reproduced the Thomas creations in mural form for study hall decorations.

The series will be published in January and distributed from Inglewood upon request and without charge. They will be of suitable size and arrangement to frame for office, den or hobby room. Brief descriptions accompany each illustration to describe the successive steps in the advance of communications methods.

### Motorola 118 mc Demonstration

The recent demonstration of the use of the 118 mc frequency for communications broadcasting at Chicago by Motorola engineers climaxes the result of over four years of painstaking, exhaustive, effort, and experiments conducted in the Kearsage and Rocky Mountains, in metropolitan and rural areas. Despite the fact that theorists said it couldn't be done, Motorola engineers, under Norman E. Wunderlich, manager of the Communications Division, Galvin Mfg. Corp. successfully demonstrated that two way FM radio-telephone communications in the 118 mc band between roving mobile units in Chicago's crowded streets and the central station was feasible.

Before a group of 85 communications engineers, with R. D. Dondanville, Chief Communications Engi-

**200°C. CONTINUOUS  
OPERATION**

\* **Cerroc 200**

## **A high-temperature ceramic (inorganic) insulation for copper, nickel and other wire**

Many engineers are already familiar with Sprague CEROC 200, a ceramic insulating coating applied to copper, nickel, and other types of wire. Many have already taken advantage of its ability to withstand 200° C. continuous operating temperature in their design of restricted war developments on which details cannot yet be announced. So far reaching are its possibilities for so many electrical products of a later date, however, that we now take this means of announcing it to the trade in general.

Briefly, Sprague CEROC 200 is a flexible, ceramic inorganic insulation for wires used in winding motors, transformers, chokes, and similar equipment, and permitting a very substantial increase in

volt-ampere ratings. It is conservatively rated for 200° C. continuous operating temperature, as compared with 105° C. for conventional organic insulations such as enamels, varnishes, etc. Actually, we believe that Sprague CEROC 200 meets all Class C insulation specifications under A.I.E.E. standards. Thermal conductivity is rapid, and space factor is extremely good. Typical percentages of copper area to total cross-sectional area of finished wire are 96% for AWG #21 wire, and 95% for #24 wire for CEROC 200, by comparison with only 69% and 59% respectively for other insulations that might be used for high-temperature applications.

**WRITE FOR BULLETIN**—Check the possibilities of CEROC 200 against the more exacting needs of your product of Tomorrow! Write today for Sprague CEROC Bulletin.

**SPRAGUE ELECTRIC COMPANY, North Adams, Mass.**  
(Formerly Sprague Specialties Co.)

\*Trademarks Reg. U. S. Pat. Off.

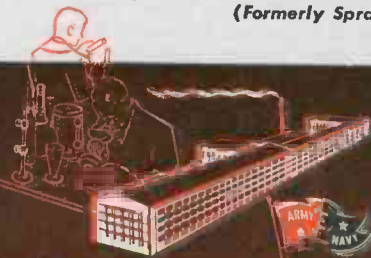

# **SPRAGUE**

**SPRAGUE CAPACITORS — KOOLOHM RESISTORS — CEROC INSULATION**

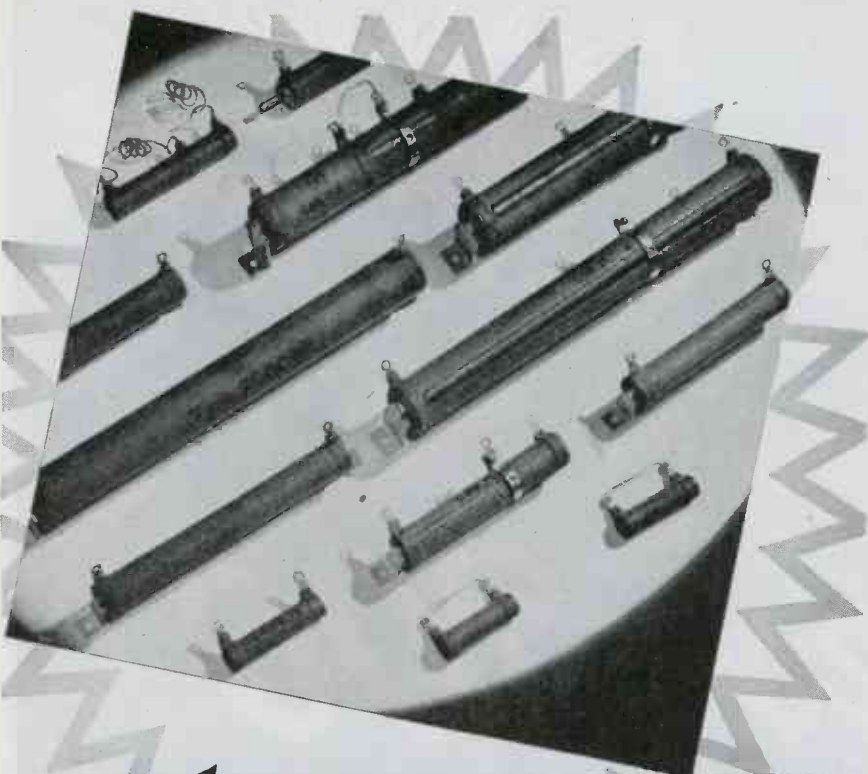

# GREENOHMS



## Products of "THE HOUSE OF RESISTORS"

Standard 10 and 20 watt fixed resistors. 1-50,000 and 1-100,000 ohms.

Standard adjustable resistors. 25 to 200 watts. 1-100,000 ohms. Brackets furnished. Additional sliders available.

Greenohms feature the exclusive Clarostat cold-setting inorganic cement coating. Won't flake, peel, crack, even under serious overload.

Greenohms can take an awful beating. Handle heavy overloads without flinching.

Available in widest range of windings, terminals, mountings, taps, etc., on special order.

★ GREENOHMS—those green-colored cement-coated Clarostat power resistors—definitely "stay put." You can positively bank on their resistance value. Proof? The fact that they are now found in the finest assemblies—quality instruments, radio transmitters, electronic equipment. The resistance is *right* to start with. And it stays *right* even after years of use and abuse.

Recently we had occasion to check a batch of Greenohms that had been lying around in a warehouse for years—part of one of our radio show displays. Each and every Greenohm checked "right on the nose." And they make out even better in use and under real abuse.

### ★ Submit Your Problem ...

Tell us about your resistance or control problem. Let us provide engineering collaboration, specifications, quotations.



**CLAROSTAT**

*Controls and Resistors*

CLAROSTAT MFG. CO., Inc. · 285-7 N. 6th St., Brooklyn, N. Y.



Norman E. Wunderlich (Galvin) demonstrates 118 mc police communication system

near for the Commonwealth Edison Co., Chicago, at the microphone and other communications engineers riding in the three test cars, two way radiotelephone service was established. Even under Wacker Drive, a two level roadway of reinforced steel and concrete in the Chicago Loop, messages were clearly received and efficiently dispatched by the test car. Station to car and car to station reception was solid for a radius of twenty miles and car to car reception was excellent short of five miles.

Broadcasting on 118.55 mc's appeared to be somewhat superior to that on the 30 to 40 mc band, the frequency ranges usually allotted to police and fire departments. Certain interferences encountered in the 30 to 40 megacycle range were totally absent in the higher range. Induction frequencies emanating from ignition systems, diathermy machines, trolley wires, and other electrical sources did not interfere with either reception or transmission on the FM 118 mc band. Static and other noises were eliminated.

In addition to the high fidelity and clarity of the 118 mc frequency, it was demonstrated that the signals wash out at a radius of 35 to 40 miles, with no skip interference such as is usual on the 30 to 40 mc band. This washing out quality opens up a whole new band of wave lengths for radiotelephone service. By allotting, say, three frequencies to each hundred miles, and controlling the power output, Motorola engineers believe that sufficient frequency channels may be made available to meet more than present needs.

### Permoflux Consolidates

Permoflux Corp., Chicago, has consolidated its engineering and manufacturing facilities at one location. The address is 4900 West Grand Ave.

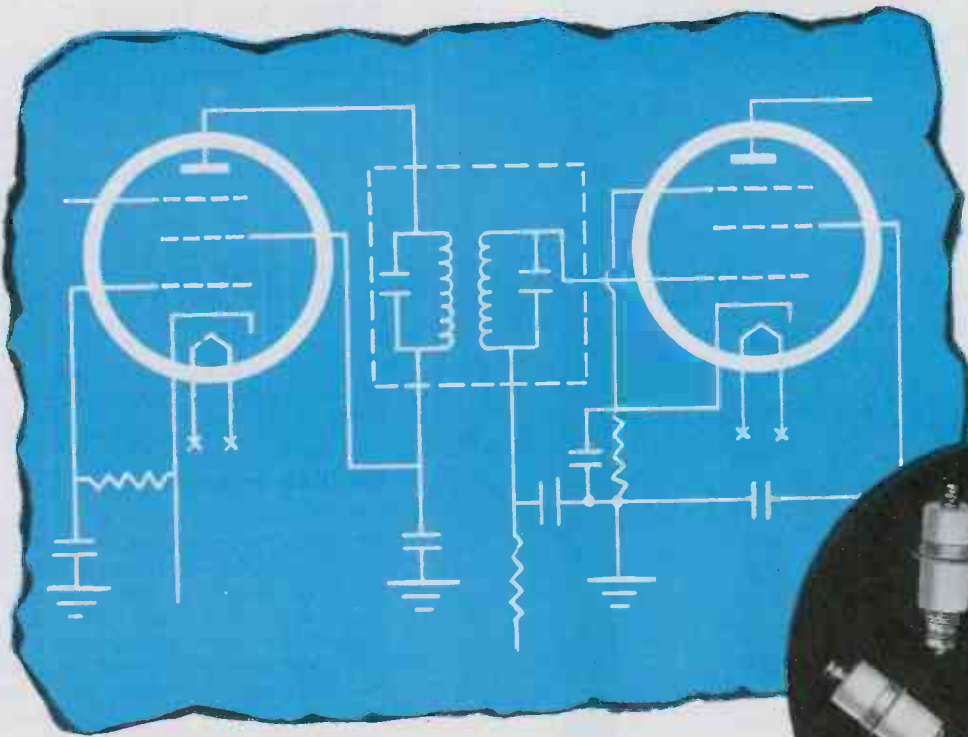

# STEEL and STEATITE bonded *PERMANENTLY*

The high mechanical strength of steel and the excellent, permanent insulation qualities of STEATITE have been combined by General Ceramics through its development of a new method of hermetically sealing and permanently bonding together STEATITE and metals in various combinations.

These SEALEX combinations successfully withstand the most severe temperature changes, and show no vibration fatigue. The metal parts are tinned to facilitate soldering where desired.

The General Ceramics method of fusing steatite and steel solves the problems of hermetically sealing and permanently protecting equipment against moisture.

For long-life, dependable, efficient service specify "Steatite" and "Sealex" Combinations.



*General Ceramics*

**AND STEATITE CORP.**

**KEASBEY  
NEW JERSEY**

# AGASTAT

ELECTRO-PNEUMATIC RELAY



**COMPACT:**  
4 IN HIGH  
2½ IN DEEP  
2½ IN WIDE  
**WEIGHT:**  
1½ POUNDS

ELIZABETH A.G.A. NEW JERSEY  
AMERICAN GAS ACCUMULATOR COMPANY

## Stewart-Warner Plans Million Sets Yearly

Within 60 days after present government restrictions are lifted, Stewart-Warner Corp., Chicago, will be producing and shipping civilian radios from what is now reputedly the largest privately-owned shell fuse plant in the United States. Production of radio-radar for the armed forces will not be affected in any manner by the reconversion of the shell fuse plant to civilian radio manufacture. At peak production on a one-shift basis, it is planned to turn out 3,500 sets daily, or more than one million radios a year.

## Bendix Versatility

As a matter of interest, the public has been permitted to know that Bendix Radio Division of Bendix Aviation Corp. is currently mass producing more than 128 types of communications equipment and radar devices for aircraft and other military uses. Included was a peak monthly output of 5,000 radio compasses. The company is relying on some 35 sub-contractors and more than 600 suppliers, employs over 500 engineers to meet continued military requirements for its standard and many new products.

## 25 for Steel Age

Corry-Jamestown Mfg. Corp., Corry, Pa., is celebrating the 25th anniversary of its founding in 1919. The company manufactures "Steel Age" chassis mounting assemblies, transformer housings and cabinets for radio and radar, as well as many other war effort products. D. A. Hillstrom, who was secretary and general manager when the company was founded is president of the organization which has grown to employ 350 people.

## Army-Navy "E" Awards

**Bliley Electric Co.,** Erie, Pa. (third star added)

**Clarostat Mfg. Co., Inc.,** 285-7 North Sixth St., Brooklyn, N. Y. (second star added)

**Fansteel Metallurgical Corp. and Tantalum Defense Corp.,** North Chicago, Ill. (second star added)

**Hoffman Radio Corp.,** 3430 S. Hill St., Los Angeles, Calif.

**Meissner Mfg. Co.,** Chicago and Mt. Carmel, Ill. (third star added)

**Solar Mfg. Corp.,** West New York, N. J. (3rd star added)

**Sprague Electric Co.,** North Adams, Mass. (third star added)

**United Electronics Co.,** 42 Spring St., Newark, N. J. (second star added)

# NORTON INSTRUMENTS

## Portable and Switchboard AMMETERS—VOLTMETERS

The scales of Norton Instruments are hand drawn and hand calibrated to meet your special requirements, thus assuring accuracy at every reading point.



Furnished for both switchboard and portable use. Magnetically shielded. Hardened, specially ground pivots, supported by sapphire jewels.

Norton has served the industrial and marine fields for fifty years. Wherever accurate measurement of electrical units is called for, there is a Norton Instrument to meet the requirements.

Send for our new catalog

**NORTON Electrical Instrument Co.**  
85 HILLIARD ST., MANCHESTER, CONNECTICUT





**EAD**  
*Control Devices*

comprise many different types with a wide variety of applications that may be electrical, electronic or mechanical, depending upon, the specific problem.

Unique research, engineering, tool design and production skill combine, not only to build control devices that fulfill the most exacting requirements, but also to build special purpose devices for which no specifications exist. Our list of customers, the most exacting in government, aviation and manufacturing, attest to these skills.



- TYPICAL EAD CONTROL COMPONENTS**
- A. Phase sensitive bi-directional motor
  - B. Multiple contact aircraft switch
  - C. Precision tachometer voltage generator
  - D. Synchronous control motor
  - E. Precision speed governed motor



**EASTERN AIR DEVICES, INC.**

An Affiliate of THE FRED GOAT CO. INC., Special Machinery Specialists Since 1893

**589 DEAN STREET BROOKLYN 17, N. Y.**

# 3 Views OF THE FUTURE

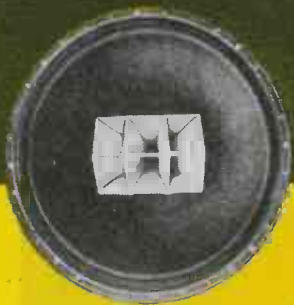

## DUPLEX SPEAKER

The Speaker that Revolutionizes the Methods of Sound Reproduction!

SEND FOR BULLETINS

# ALTEC

LANSING CORPORATION

1210 TAFT BLDG., HOLLYWOOD 28, CALIF.

## PERSONNEL

### Motorola Vice-Presidents

The Board of Directors of the Galvin Mfg. Corp., Chicago, has appointed **Elmer H. Wavering** vice-president in charge of the new Automotive Division, and **Walter H. Stellner** vice-president in charge of the new home products division. These divisions have been created in accordance with Motorola's greatly enlarged program for the manufacture and merchandising of postwar radio and electronic equipment for home and automobile use. Mr. Wavering joined Motorola as an engineer in 1930, and pioneered the design and engineering devel-



Elmer H. Wavering

Walter H. Stellner

opment of the first commercial car radio receiver during that year. Later, he became sales manager of the car radio division, which position he relinquished to become head of the quartz crystal division, an outgrowth of the war. Mr. Stellner was appointed Advertising Manager for the Home Radio Division in 1937. A year later he was made sales manager of this department. In 1942 he became head of the Washington office of the Galvin Co.

**A. M. Wiggins** has been appointed chief research engineer at the Electro-Voice Corp., South Bend, Ind. In 1942, he served in the research dept. of the RCA Mfg. Co., Camden, and later went to the RCA Laboratories in Princeton, where he remained until the present time.

**Howard Bucknell, Jr.**, formerly Minister Counselor of the American Embassy in London and Minister since January, 1944, has joined the International Telephone and Telegraph Corp. He will serve for the present as a special assistant to Colonel Sosthenes Behn, President of the corporation.

**Arnold Peterson** has been appointed Application Engineer at the United Electronics Co., Newark, N. J. He will assist and advise end users, such as war contractors and distributors of United's products.



# CONCORD

RADIO CORPORATION'S

*New*

"SPECIAL SUPPLEMENT"

**HARD-TO-FIND  
RADIO AND ELECTRONIC  
COMPONENTS**

16 pages crowded with listings and descriptions of such wartime essentials as...

- METERS
- VOLUME CONTROLS
- RESISTORS
- TEST ACCESSORIES
- SWITCHES
- TRANSFORMERS
- SPEAKERS
- RHEOSTATS
- RELAYS... and hundreds of others!

Each page overflows with critical parts and equipment . . . urgently needed by industry, laboratories, government agencies, training schools, radio servicemen, military services, etc. Everything is the product of a leading American manufacturer. All are first quality. And all are marked at prices typical of startling Concord values! Hurry! Our edition of these supplements is moving fast. And, since all items are subject to prior sale, we suggest that you wait no longer. Send for your **FREE** copy today!

Rush this coupon . . . and we will send you the new 16-page Supplement by the fastest possible means.

CONCORD RADIO CORPORATION  
901 W. Jackson Blvd., Chicago 7, Ill. Dept. J-15

Please rush me the new 16-page "Special Supplement" by Concord Radio Corp

NAME.....

ADDRESS.....

CITY.....STATE.....

**CONCORD RADIO CORPORATION**  
*Lafayette Radio Corporation*

901 W. Jackson Blvd. CHICAGO 7, ILL. 265 Peachtree Street ATLANTA 3, GA.

L. M. Leeds has been appointed manager, Electronics Laboratory of the General Electric Co.'s Electronics Department. W. C. White, formerly in charge of this laboratory, has been appointed the electronics engineer of the G-E Research Laboratory.

George F. Wunderlich has been promoted from production manager to the new position of general manager of Eitel-McCullough, Inc., of San Bruno, Calif., and Salt Lake City, Utah. Louis Pierri, manager of the Salt Lake City plant for the past year and a half, becomes pro-



George F. Wunderlich, appointed general manager of Eitel-McCullough, San Bruno

duction manager of the home plant at San Bruno. Hewitt V. Wilson, assistant manager at the Salt Lake City plant, becomes manager there.

Walter E. Peck has been made sales manager of Electronic Laboratories, Inc., Indianapolis. He has been a member of the engineering staff of the company for the past four years.

O. B. Wilson has been named New York industrial manager for the Brown Instrument Co., precision industrial instrument division, Minneapolis-Honeywell Regulator Co. Mr. Wilson has been with the Brown company for 21 years, during which time he has served in several branch offices throughout the country, lately in Chicago, and at the company headquarters at Philadelphia. J. A. Robinson has been named industrial manager of the Chicago branch.

Arthur Hull Hayes, general manager of WABC, CBS key outlet, has been appointed Office of War Information Regional Consultant for New York by John D. Hymes, Associate Chief, Domestic Radio Bureau of the OWI. Hayes will act as liaison between OWI and the radio stations within his area—stations situated in New York State and northern New Jersey.

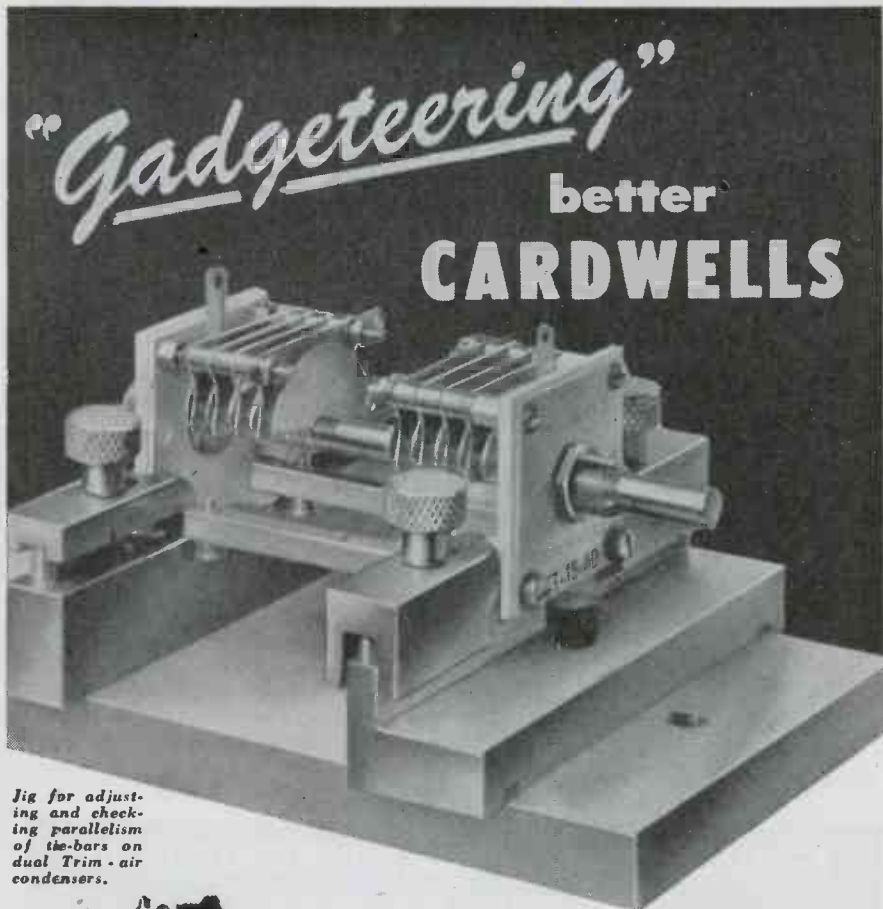

Jig for adjusting and checking parallelism of tie-bars on dual Trim-air condensers.

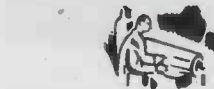

Special tools, jigs and fixtures are, in the final analysis, the key to improved quality for even the simplest devices.

Sometimes a good customer may design a fixture to improve a troublesome detail encountered in production use of one of our devices. RCA "gadgeteered" this assembly jig which insures parallel and co-planar tie-bars on dual Trim-air condensers.

We appreciate such cooperation because we are doing plenty of "gadgeteering" ourselves—some of it very complicated—and the obvious is sometimes overlooked.

Whether it is an automatic "gadget" such as Cardwell developed to electronically calibrate, and mechanically print, more than 3000 points on each of the thousands of Cardwell Frequency Meters (used by our Armed Forces), or the relatively simple device shown here, Cardwell products reflect, in improved quality, the application of intelligent "gadgeteering". This is passed on to all users of

## CARDWELL QUALITY PRODUCTS

CARDWELL  CONDENSERS

THE ALLEN D. CARDWELL MANUFACTURING CORPORATION  
81 PROSPECT STREET  
BROOKLYN 1, N. Y.

# FROM THE HOUSE OF JACKS

... and other radio and electronic components!

JK-26

America's largest producer of JK-26 jacks. All models built to strict Signal Corps specifications.

PL-55

## Experience for Sale!

Amalgamated Radio, pioneers in the field, maintain experimental and development laboratories for post-war radio and television equipment. Our components are completely engineered in a self-contained factory equipped with tools of our own design. Years of specialized experience assure high quality products at low cost. Inquiries are invited.

PL-54

ADDITIONAL JACKS & PLUGS FOR IMMEDIATE DELIVERY

JK-55 JK-48 PL-291 PL-291A PL-204

## AMALGAMATED RADIO TELEVISION CORP.

476 BROADWAY • NEW YORK 13, N. Y.

# WOKMAR

Manufacturers of  
RADIO, ELECTRICAL AND  
ELECTRONIC COMPONENTS

**ELECTRONIC PRODUCTS MFG. CORP.**  
DEXTER, MICHIGAN

Winfield G. Wagener, formerly chief engineer at Heintz & Kaufman, has been appointed chief engineer of the vacuum tube Division of Litton Engineering Laboratories, Redwood City, Calif. Prior to his previous connection Wagener spent several years in development work with Federal Telegraph Co. and later served with RCA.

Robert G. Thompson of CBS, New York, James J. Beloungy of CBS, Chicago, and Lester H. Bowman of CBS, Los Angeles, who supervise network technical operations in their areas, have been designated Managers of Technical Operations, Eastern, Central, and Western Divisions, respectively. Thompson has been with the network since September, 1929, when he joined as a field operator in the Technical Department. Since then he has held various posts in that and allied departments. He was named to his present post of Eastern Division Operations Engineer in the Technical Operations Department in August of last year.

Beloungy joined CBS in January, 1934, as chief engineer of WPG, Atlantic City, N. J. In 1937 he transferred to the CBS-owned outlet in Charlotte, N. C., WBT, also as chief engineer. He moved to WBBM, CBS-owned station in Chicago, in July, 1943, and was named to his current position as Central Division operations engineer and chief engineer of WBBM. Bowman came to the network in March, 1929, as a supervisor in technical operations at WABC. In September, 1932, he was appointed technical supervisor of WTOP (then WJSV) in Washington, D. C. In August, 1936, he was transferred to the west coast as Western Division operations engineer.

Chester C. Aiken, who has been associated with field engineering training and personnel work for the Radio Corp. of America since 1928, has joined the staff of the Electronic Apparatus Section of the RCA Victor Division in Camden. He assumes commercial responsibilities for electronic equipment now under experimental development for quality control and inspection of liquids.

Everett E. Gramer has been elected president and owner of James W. Doyle, Inc., Chicago coil winding and transformer manufacturing concern. James W. Doyle has retired but will remain with the company as a consulting engineer.

Andrew C. Jorgenson has been elected a vice-president of Mackay Radio and Telegraph Co., an affiliate of International Telephone and Telegraph Corp. He has been general manager since last April.

ELECTRONIC INDUSTRIES • January, 1945

# BH NON-FRAYING FIBERGLAS SLEEVING

ENDS  
"WIRE THREADING"  
WORRIES



**BH EXTRA FLEXIBLE  
FIBERGLAS SLEEVING**

**2 WAYS BETTER**



THIS



NOT THIS

**NON-FRAYING**

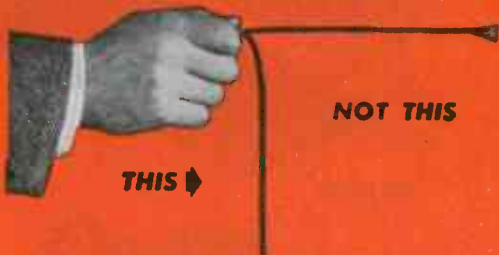

NOT THIS

THIS

**NON-STIFFENING**

INSERTING bare wire in rough sleeving that frays out on the ends is time- and patience-consuming. The job is much simpler and less irksome when you use BH *Extra Flexible* Fiberglas Sleeving, the non-fraying, smooth bore insulation that takes fine-stranded wires without a hitch.

Special-processed BH Sleeving is *permanently* flexible and non-fraying. It won't harden and crack with age, and it won't burn. In addition, it has all the other desirable electrical and physical features of inorganic Fiberglas.

If you're looking for an easy-working, long-lasting insulation, why not try BH *Extra Flexible* Fiberglas Sleeving? It's available in all standard colors and sizes from No. 20 to 5/8", inclusive. Write for samples today!

**BH SPECIAL TREATED FIBERGLAS SLEEVING  
CUTS CLEAN, DEFIES HEAT**

Here's another high quality BH Fiberglas Sleeving. No saturant is used in the exclusive BH process, yet the sleeving will not fray when cut and withstands heat up to 1200° F. Made in natural color only—all standard sizes. Try it!



SLOW-BURNING IMPREGNATED MAGNETO TUBING • SLOW-BURNING FLEXIBLE  
VARNISHED TUBING • SATURATED AND NON-SATURATED SLEEVING

**BENTLEY, HARRIS MANUFACTURING CO.**

**Dept. I Conshohocken, Penna.**

# THAT TRAIN WHISTLE STARTED ME THINKING



## APPLICATIONS FOR D-C RECTIFIERS ARE LIMITLESS

Oftentimes the possibilities for a product are overlooked. Think for a few minutes about rectifiers. A small copper-oxide rectifier supplies the d-c power to make a toy train whistle—in steel mills, large rectifiers deliver output of 60,000 amperes to supply power for tin plating. From the smallest to the largest application for direct current, there are copper-oxide or selenium or Tungar rectifiers to fit the need.

## ONLY G. E. OFFERS ALL THREE

Where other manufacturers offer one or two of these low cost, low voltage rectifiers, General Electric offers all three. Naturally, each type differs in characteristics, basic materials and construction. The most efficient rectifier for one application may be least efficient on the very next. It is in determining which type to use for each application that G.E. can help most—so look to G.E. for an impartial answer to all rectifier problems. For further information write to Section A156-124, Appliance and Merchandise Dept., General Electric Co., Bridgeport, Connecticut.

## BUY WAR BONDS AND KEEP THEM

Hear the General Electric radio programs: "The G-E All Girl Orchestra" Sunday 10 P.M. EWT, NBC. "The World Today" news every weekday 6:45 P.M. EWT, CBS.

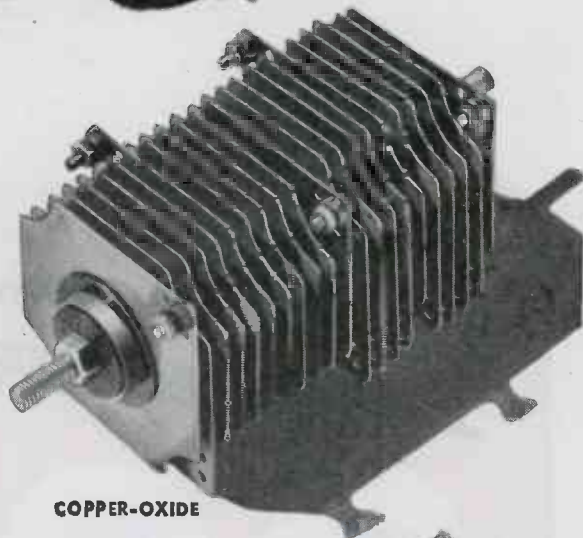

COPPER-OXIDE

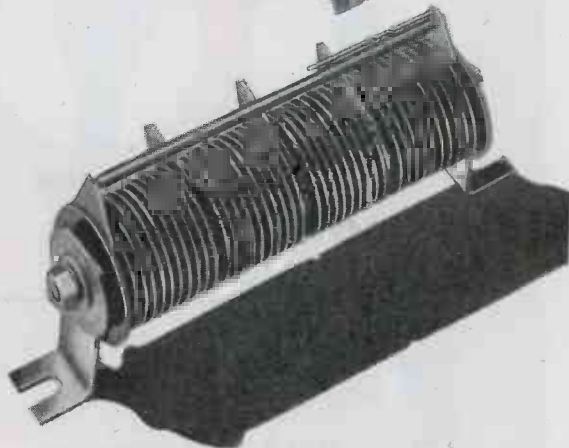

SELENIUM



TUNGAR

# GENERAL ELECTRIC

**TIME-TESTED FOR**

1937

1938

*Permanency*

1942

1943

1944

**THE Burndy  
HYDENT  
CONNECTION**



Headquarters for  
**CONNECTORS**

**Burndy**

Right from the start . . . the simplicity, the efficiency, and the economy, of the HYDENT connection has been acknowledged.

During the past 8 years, too, there has been furnished overwhelming evidence of its unequalled *permanency*. Overhead, underground, and in circuits and equipment of all kinds, millions of HYDENT connections have "held fast" under all service conditions. For indenting with the Burndy HYTOOL compresses connector and conductor into one *integral* unit . . . *a connection that is truly permanent*.

With its permanency thus proved in actual operation, isn't it now time to take advantage of the big economies which HYDENT connectors provide? Available as HY-LUGS, HYLINKS, HYTEES, HYCRABS and others. Write for complete information . . . Burndy Engineering Co., 107 Bruckner Boulevard, New York 54, N. Y.

IN CANADA: Canadian Line Materials, Limited, Toronto 13

# ANNOUNCING



## A NEW SERIES OF FISHER-PIERCE ELECTRONIC TIMERS

Measuring only  $3\frac{7}{8}$ " x  $3\frac{3}{4}$ " x  $3\frac{3}{4}$ " (exclusive of rear mounting bracket). Series 5000 Timers are compact, sturdy, and reliable.

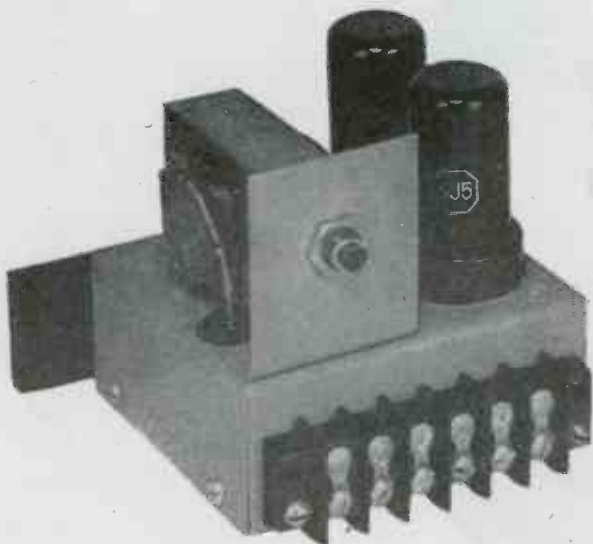

Model 5010 has been serving wartime industry for many months. Various sequences and intervals are available for industrial machine control.

*Tell us about your timing problems,  
perhaps we can help you —*



**FISHER-PIERCE**  
**C O M P A N Y**  
70 CEYLON ST., BOSTON 21, MASS.

Andrew Kaul III has been elected president of the Speer Carbon Co., the International Graphite and Electrode Corp., and the Speer Resistor Corp. with offices at St. Marys, Pa.

John M. Miller, Jr., has been made chief engineer at United Cinephone Corp., Torrington, Conn.

### CROSLEY-OWI

*(Continued from page 94)*

the pre-set electrical transcription machines simultaneously.

At the center of the desk are the general controls common to all transmitters. Immediately above is the public address speaker, which also serves as a microphone, and which may be switched to the two-way FM transmitter, communicating with the antenna service car, without being disconnected from the regular building intercommunication system. Immediately below the speaker is a volume level indicator, with its range switch and channel selector switch. Below these are the level control and selector switches for the monitoring speakers.

The frequency monitoring system is also included in the control room equipment, and consists of a secondary frequency standard, a fixed-tuned 5 mc WWV receiver, a frequency counter, and an rf signal mixing panel.

#### Three-stage RF driver

The rf driver is composed of three stages, each stage separately tuned in both grid and plate circuits, and link-coupled to the succeeding stage. Both the grid and plate circuits of the first stage, a single 807, have eight pre-tuned, plug-in coils. Each grid coil is provided with input winding which is selectively connected to the double coaxial transmission line terminating on the rf exciter patching panel.

The push-pull 813 second stage has two sets of tapped coils in both grid and plate circuits. The F129B driver third stage is push-pull, and has two sets of tapped coils in its grid. Both these stages have adjustable tuning capacitances, controlled from the front of the cabinet. The 129B plate circuit consists of a copper tubing inductance with adjustable taps and shorting bars, and a variable air condenser, controlled from front of cabinet.

A ganged band switch is mounted vertically and operated from the rear of the cabinet, by means of a horizontal handwheel, accessible from the top shelf. This mechanism switches all circuits except the 129B plate circuit, which must be changed manually. Other front controls include the third stage neutralizing, and the output coupling adjustment, which is accomplished by swinging a small link coil into the field of the cen-



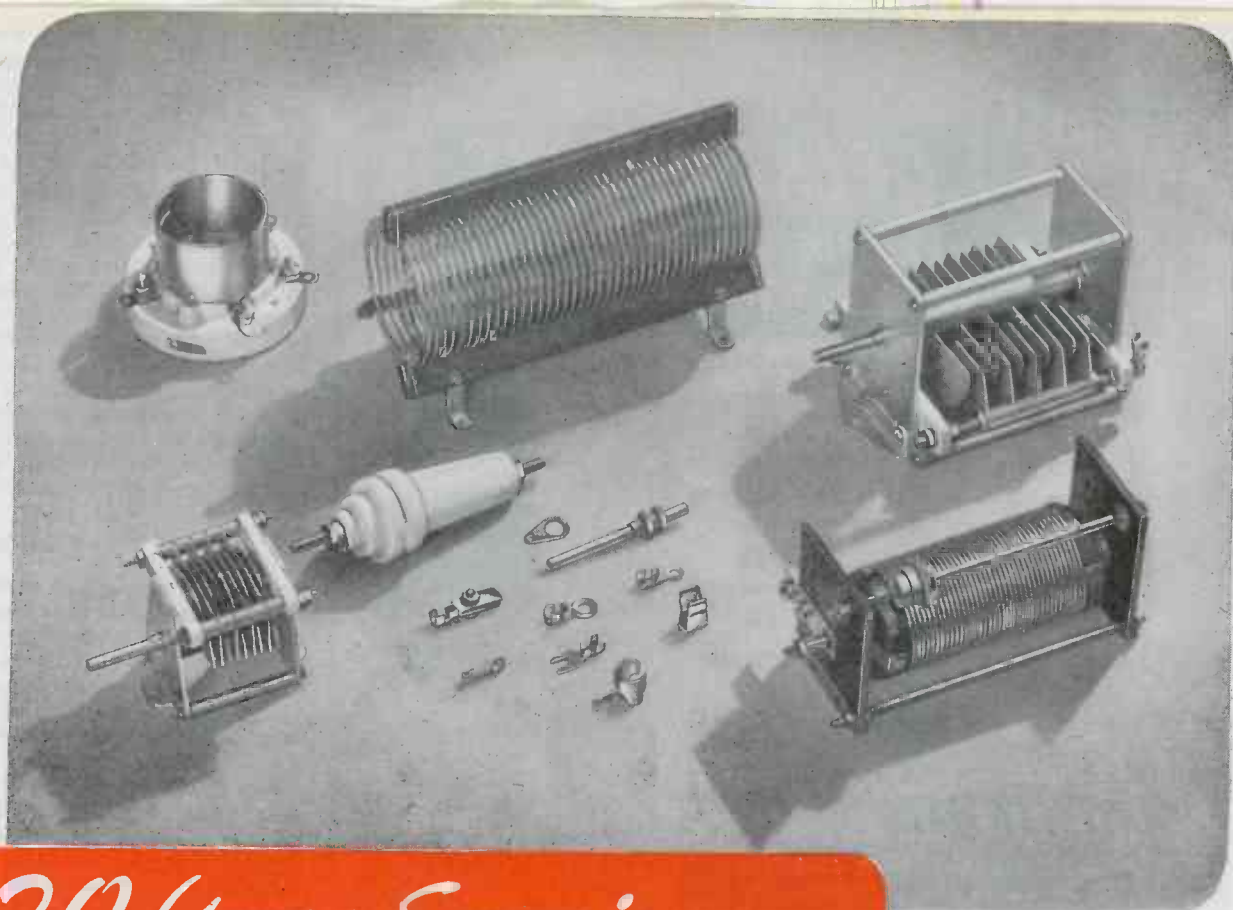

## 20 Years Experience In Parts Manufacture

- **CONDENSERS**—Variable, Fixed, Gas Filled Pressure, Neutralizing—a type for every transmitter need.
- **INDUCTORS**—Wire-wound, edgewise wound copper strip, copper tubing—fixed, tapped, or continuously variable—50 watt to 100 KW.
- **INSULATORS**—Stand-off, Thru-Panel, Cones, Bushings, Antenna Strain or Compression—a type for every requirement.
- **TUBE SOCKETS**—Steatite or Porcelain—Wafer, Bayonet, Miniature, Acorn or Special Types—a socket for almost any transmitting tube.
- **HARDWARE**—Tube Caps, Inductor Clips, Solder Terminals, Fuse Clips, Panel Bearings, Flexible Shafts—those hard-to-find constructional parts.

Ask for Catalog 9680



# JOHNSON

*a famous name in Radio*

### OTHER FAMOUS JOHNSON PRODUCTS

- Plugs and Jacks
- Couplings
- Concentric Line
- Chokes
- Antennas
- Antenna Phasing Equipment
- Antenna Coupling Units
- Heavy Duty R. F. Relays
- Make Before Break Switches
- Sampling Transformers

# AMPERITE

## THERMOSTATIC METAL TYPE DELAY RELAYS

### PROVIDE DELAYS RANGING FROM 1 TO 120 SECONDS

Other important features include:—

1. Compensated for ambient temperature changes from  $-40^{\circ}$  to  $110^{\circ}$ F.
2. Contact ratings up to 115V-10a AC.
3. Hermetically sealed — not affected by altitude, moisture or other climate changes . . . Explosion-proof.
4. Octal radio base for easy replacement.
5. Compact, light, rugged, inexpensive.
6. Circuits available: SPST Normally Open; SPST Normally Closed.

WHAT'S YOUR PROBLEM? Send for "Special Problem Sheet" and Descriptive Bulletin.

**AMPERITE CO.** 561 BROADWAY  
NEW YORK 12, N. Y.

In Canada: Atlas Radio Corp., Ltd.  
560 King St. W., Toronto



ter of the driver plate inductance. The final amplifier of each transmitter is designed to deliver 250 kw 100 per cent plate modulated, on frequencies between 6 mc and 21.65 mc, with plate voltage up to 15 kv. The grid circuit has a fixed bias which limits the tubes to a safe value of plate dissipation, in case of failure of drive. This is accomplished by obtaining bias voltage through a high resistance from one of the low voltage rectifiers. The voltage is applied continuously, and in case of failure of drive, the tubes are automatically protected from overloads without the operation of any relays. When tubes are being driven, the bias becomes negligible.

#### Cooling system

On each side of the cabinet interior, cooling air is provided through a vertical duct, connecting with the header duct, above the entire transmitter unit, and providing a blast of air on the glass of the power amplifier tubes, of sufficient velocity for effective cooling over the entire periphery of the glass.

All program material is supplied to the transmitters either by telephone circuits, or by electrical transcriptions. No provisions are made for live pick-ups at the transmitter building. At present the OWI and CIAA programs originate in studios in the East, and are fed through the WLW master control room at Crosley Square in downtown Cincinnati, to the transmitter audio equipment.

The incoming lines are terminated in matching networks which provide a means of feeding one to three amplifier channels from any one line.

The signal then is routed to one of four equipment bays which contain the amplifier channels associated with the particular transmitter inputs, and passes through a variable attenuator and an electrical transcription switching relay to the line amplifier.

The electrical transcription switching relay is controlled by keys on the control desk. Monitoring speaker amplifiers and switching equipment are also located in the control room equipment bays. Each program channel has a monitoring take-off at the output of the line amplifier, and this signal is fed through speaker selector switches so arranged that the operator is able to pre-set levels before the signal is fed to the modulator input.

Throughout all of the speech equipment in the control room, complete flexibility is maintained by use of jacks and patch cords, by which any elements, from amplifiers to fixed pads, may be isolated. In most cases, back contacts on the jacks route the signal

## BLOWERS for Electronic Equipment

Easy-to-install . . . compact . . . quiet-running . . . economical . . . these are the features which make Pilot Blowers ideal for the important job of air circulation and ventilation in Radio Equipment. Available in standard models to move from 15 to 100 C.F.M. Write for Bulletin 507.

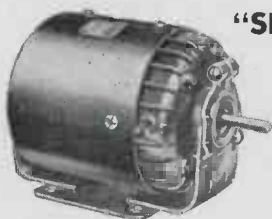
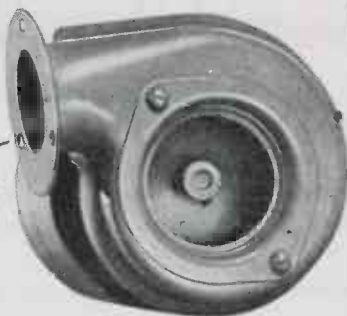

### "SHADED POLE" F. H. P. MOTORS

Tell us what your requirements are and we will send you "fact sheets" giving complete specifications on these dependable, efficient, low-cost Motors. For continuous or intermittent duty with H.P. ratings ranging from 1/15 to 1/500 H.P. and from 1550 to 3400 R.P.M. Plain round or with base or resilient mounting . . . open or enclosed cases.

**F. A. SMITH MANUFACTURING CO., INC.**

901 DAVIS ST. **FASCO** ROCHESTER 2, N. Y.

SHADED POLE **Pilot** CENTRIFUGAL  
MOTORS BLOWERS

# STANDARD FREQUENCIES — *Octaves of them*



**FREQUENCIES**  
 10, 20, 40, 60, 80, 100, 120, 140, 160, 180, 190  
*Accuracy: 10 parts in 1,000,000*  
*Output: 30 volts at 500,000 ohms*  
*Input: 105-125V, 50-60c., 40 watts*  
*Weight: 50 pounds*

*Impossible? Well, here it is —*

This Multi-frequency generator furnishes the frequencies shown above at the turn of a switch. All frequencies are obtained from a temperature-compensated tuning fork and voltage-stabilized circuit.

With this unit it is possible to calibrate oscillators at many selected points without encountering complex oscilloscope patterns. One of the uncertainties involved in development work on tuned

circuits, filters, reeds—and in time measurement can be minimized with the aid of this instrument.

Developed primarily to check frequency meters for precision war work, this Multi-frequency generator possesses a rugged durability and dependability in service that will prove an extra value to many laboratories.

Additional information available on request.

Manufacturer of  
 the  
**Watch Master**  
  
  
 and distributor of  
**Western Electric**  
 Watch-rate Recorders

**American Time Products, INC.**  
 580 Fifth Avenue New York 19, N. Y.



*Craftsmanship by*

# PAR-METAL

**CABINETS**  
**CHASSIS**  
**PANELS**  
**RACKS**

When skill of a high degree becomes habitual, and shows up in the smallest detail — that's *Craftsmanship!*

Having specialized for many years, Par-Metal has this habit of *Craftsmanship* — expressed throughout the entire line, which ranges from small chassis to housings for huge transmitters.

To get a picture of what Par-Metal can do now (and the post-war possibilities) write for a copy of Catalogue No. 41-A.

**PAR-METAL PRODUCTS CORPORATION**  
32-62 49th STREET LONG ISLAND CITY, N. Y.

Export Dept.  
100 Varick St., N. Y. C.

through its normal channel, but the presence of the jacks in the circuit makes it possible to lift a defective element quickly, and patch in a spare.

The modulator consists of a three-stage voltage amplifier, followed by a 2 to 6 tube class B power stage. The first two stages are push-pull 807 and 813 tubes, respectively, and are resistance coupled. The 813's are resistance coupled to push-pull 891's, located slightly above the main group of tubes, and operating class A as the third voltage amplifier.

The modulation transformer, weighing more than 24,000 lbs., and its reactor and dc blocking condenser are located in the transformer vault. This combination was designed to cover a frequency range of from 30 to 10,000 cycles, at a power output of 180 kw maximum.

Power is supplied to the plant from a 33 kv loop circuit, with remote controlled disconnect switches on each side of the take-off point. These switches, both normally closed, may be opened by push-button controls in the transmitter control room, in case of a fault on either line.

At the substation a 3,000 kva transformer bank provides three-phase, 2,400-volt service, divided into six main circuits to the transmitters, each equipped with fused disconnect switches. Three of these feed high voltage plate supply transformers, and the other three are fed through an induction regulator, and supply a 200 kva, 2,400/-240-v, three-phase transformer in each vault. All 240-v power for operating filament transformers, pump and blower motors, low voltage supplies, etc., is obtained from these transformers. Each transmitter becomes an independent unit from the substation to the antenna switching station.

### Transformer vault

All high voltage transformers, filter reactors, filter condensers, and high voltage control components, including the Ignitron, are located in fireproof vaults, one for each of the three transmitters, built into the bay directly behind each transmitter unit.

The high voltage plate transformer is a 750 kva, three-phase unit, with a special high speed motor operated tap switch, connected in its secondary winding, which operates under load. The transformer windings and taps are such as to provide variable dc voltages at the load from 5,500 to 15,000 volts in 32 steps. Voltage adjustment is accomplished from the transmitter control panel, by means of a rheostat connected to the panel control through a torque switch, which causes the tap changer to become instantly re-



*Listen, Jim!*  
**ASSOCIATED RESEARCH**  
NOT ONLY MAKES  
**VIBROTESTS**

for insulation resistance testing but also VIBROGROUND for ground testing, HYPOT for high voltage breakdown testing, DONUT transformers, SHUNTS, RESISTORS, and many other products.

WHERE CAN I GET ...



VIBROTEST is an outstanding name for easy, simplified and accurate insulation resistance testing. Compact, portable, operated in any position, it is in wide use in electrical power fields, industry and all electrical departments. But it's only one of the many products of Associated Research.

### BRING YOUR SPECIAL PROBLEMS TO US

The experience of our technicians is at your disposal, with complete facilities for designing, developing and manufacturing to your requirements. We serve organizations and individuals. We produce in large and small quantities. We are equipped for prompt delivery.

Engineering Service in All Principal Cities  
**WIRE OR WRITE FOR IMMEDIATE ATTENTION**

*No Cranking*  
*No Leveling*

Self-contained power source. Easily read scale shows ohms and megohms. Vibrotest Model 201 illustrated. Range 0-200 megohms at 500 V. potential, 0-2,000 ohms, 150-300-600 volts AC or DC. Send for Bulletin on all models.

**ASSOCIATED RESEARCH, Incorporated**

221-B SO. GREEN ST.  
CHICAGO 7, ILLINOIS

sponsive to adjustments of the control. At all other times, a half-minute time delay is automatically operative, as the tap changer corrects for line voltage fluctuations. The transformer also returns automatically to its lowest voltage tap each time primary voltage is removed for periods in excess of a few seconds in order that re-application of power may occur at minimum voltage.

The unregulated three-phase power for the high voltage system from the substation is fed through manual disconnect switches in the vaults, and then through series line reactors for limiting fault, or rectifier arc-back, currents, through a magnetically operated contactor, and the Ignitron interrupter before reaching the tap changing transformer. Normally the magnetic contactor remains closed, and the power interruption is accomplished by the Ignitron unit. But if an ac line overload should occur or a transmitter door should be opened, this contactor operates, following the Ignitron interruption, to provide additional protection.

#### Rectifier equipment

The rectifier cabinet contains three rectifiers, two of which are low voltage bridge circuits, one providing bias voltages of 2,000 and 4,000 volts, and the other providing plate voltages of 1,000 and 2,000. The third rectifier is the high voltage, six-phase single Y circuit, employing six 870A tubes, and provides plate voltage for the modulator and final amplifier. Two spare 870 tubes are kept continuously heated, making a total of eight tubes.

Below the tubes, at the rear of the cabinet, is a tube switching panel, so arranged as to make switching of spare tubes into the circuit an error-proof procedure. Six of the eight tubes are always connected into the circuit by means of six jumper straps, in pairs of three different lengths, no two of which are identical due to the left or right twist of the top end of each strap. The upper switch jaws just below the tubes are mounted at corresponding angles, slanting alternately left and right, and connecting alternately to cathodes and anodes of all eight tubes.

When a fault occurs, the annunciator light on the front meter panel indicates which tube is defective, and it is necessary only to remove the corresponding jumper strap and insert it into the only vacant position into which it will fit.

The heat dissipation system consists of a separate blown-air and water cooling system for each transmitter. The fan and pumping equipment for each unit is housed in the fan room directly behind the

## don't send a boy on a man's errand

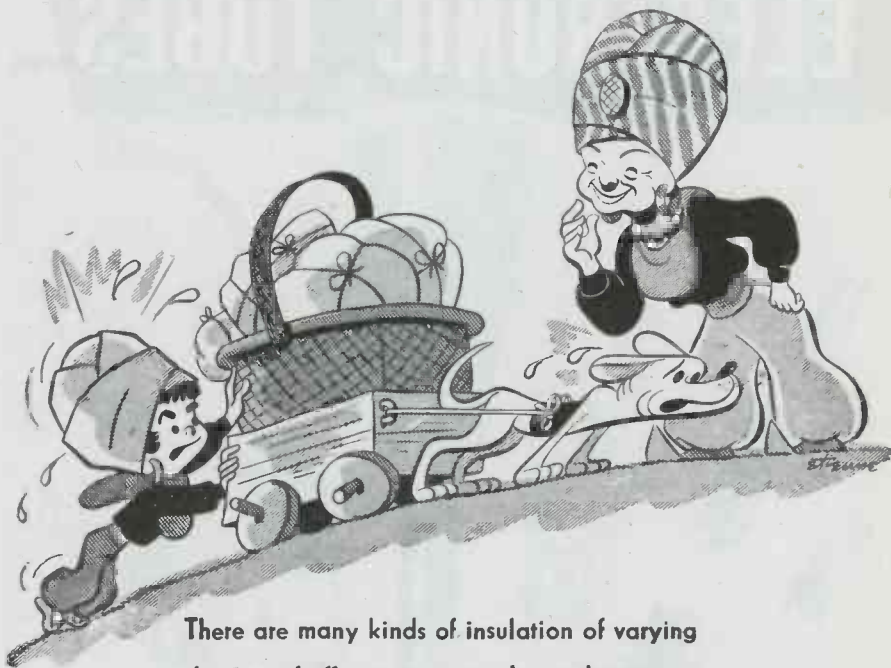

There are many kinds of insulation of varying degrees of efficiency — you know that just as you also know that under certain conditions many types of insulation cannot measure up to the responsibility — they may not break down all of a sudden, but they don't last long. Where mica ought to be used that's where nothing else will serve — no compromise.



When you think of MICA think of MACALLEN

# the Macallen Company

16 MACALLEN STREET - BOSTON 27

CHICAGO: 321 W. Washington Blvd.

CLEVELAND: 1907 Lorain Bldg.

**ONE CENTRAL SOURCE FOR**  
*All Types of Industrial*  
**ELECTRONIC TUBES**



**STOCKS ON HAND FOR**  
*Immediate Delivery*

**RECTIFIER  
 POWER  
 CONTROL  
 PHOTO-ELECTRIC  
 TRANSMITTING  
 RECEIVING**

Here you have the advantage of a complete, centralized service on all types of industrial electronic tubes. Many are "on-hand" for rush delivery! This enables you to obtain the exact type you require, in the shortest possible time. Rectifier, power, control, photo-electric, cathode ray, transmitting, or receiving . . . in RCA, G.E., Raytheon, Amperex, Eimac, Taylor, and other well known makes.

*Save time and work—Call Allied First!  
 Write, Wire or Phone Haymarket 6800*

Engineering Service Available

**EVERYTHING IN  
 ELECTRONICS & RADIO**

It's faster, simpler to get all your electronic and radio supplies from this one central source. We carry the largest and most complete stocks of parts and equipment under one roof . . . ready for immediate shipment. Besides, our procurement experts are in constant contact with all leading manufacturers. This complete service simplifies and speeds supply of diversified needs.

Helpful  
**BUYING  
 GUIDE**  
 Available  
 on Request  
 Write for it!

**ALLIED RADIO**

C O R P O R A T I O N

833 W. Jackson Blvd. Dept. 32-A-5 Chicago 7, Illinois

SUPPLIERS OF ELECTRONIC PARTS AND EQUIPMENT TO INDUSTRIAL AMERICA  
 Electronic Tubes, Rectifiers, Power Supplies, Intercommunicating Systems, Sound Systems, Photo-Cell Equipment, Batteries, Chargers, Converters, Generators, Supplies for Resistance Welders, Fuses, Test Instruments, Meters, Broadcast Station Equipment, Relays, Condensers, Capacitors, Resistors, Rheostats, Transformers, Switches, Coaxial Cable, Wire, Soldering Irons, Microphones, Speakers, Technical Books, etc.

unit. Each system is designed to dissipate 350 kw of electrical power, provide for removal of waste heat in the transmitter cabinets, provide high velocity air for cooling the mercury radiators on the high voltage rectifier tubes, and provide cooling water to the Ignitron units.

Each transmitter is equipped with a separate distilled water circulating system. The pump takes its suction from an open surge tank and discharges the water through finned cooling coils. From here it goes to a distributing supply header below the transmitter cabinets, where it is fed through individual circuits to the various tube jackets and coils. The heated water is then collected in a similar supply header which carries it back to the surge tank, which serves as an air release and automatic make-up chamber. A similar system of much smaller capacity is used for the Ignitron system.

**Control circuits**

Since the complete transmitter unit is composed of two rf sections, one power supply and one modulator, the control circuit had to be arranged to provide for individual and simultaneous operation of these sections. As it is set up, either rf section can be operated as an individual transmitter, or both can be operated from the common

**AT 100 MC**

POWER FACTOR 0.0033  
 DIELECTRIC CONSTANT 3.57

**DILECTENE**

A CONTINENTAL-DIAMOND  
 ENGINEERED U-H-F  
 INSULATING PLASTIC

**STABLE UNDER**

- ◆ High Humidity
- ◆ Temperature Extremes
- ◆ Mechanical Stress
- ◆ Chemical Conditions

READILY MACHINED  
 For complete technical  
 data, send for Bulletin DN

**CONTINENTAL-DIAMOND  
 FIBRE COMPANY**

NEWARK 50 DELAWARE  
 DC

# THIS PIVOT PROVES A POINT

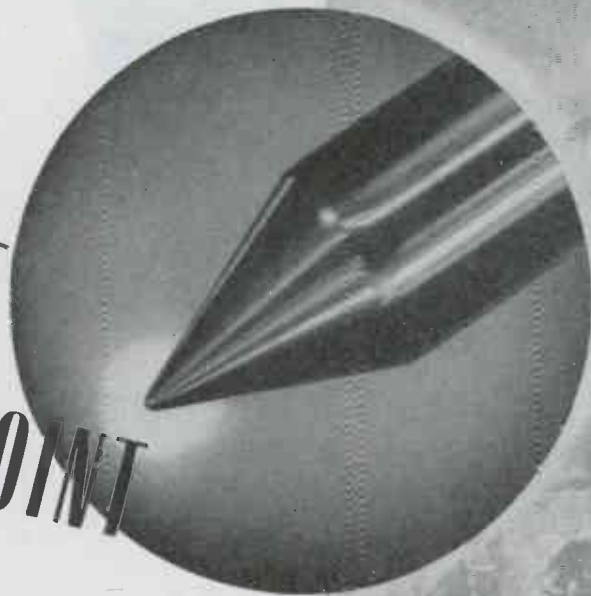

**T**HIS unretouched photomicrograph, approximately 50 times actual size, shows pretty clearly what we mean by the value of experience, when it comes to the making of electrical instruments and testing equipment.

Pivots play an important part in determining an instrument's life and accuracy. In the Simpson-made pivot above, you have what is truly a masterpiece of its kind . . . perfect in contour . . . all surfaces brilliantly polished to prevent rusting . . . rounded end properly correlated with radius of jewel to minimize friction and withstand vibration and shock . . . heat-treated for an unusual combination of strength and hardness.

The obvious explanation for this excellence rests in the fact that Simpson employs some processes others do not, and safeguards every step of manufacture by the finest and most complete control modern science can provide. But in the final analysis, it is only Simpson's long experience which makes such a pivot possible.

That experience reaches back more than 30 years. From it has come new shortcuts in manufacture, new refinements in design, which today permit Simpson to make "instruments that stay accurate" in greater volume than ever before. From this long specialization has come too a sound basis for further advance; in your postwar Simpson Instruments you will see still more forcefully the value of this experience.

SIMPSON ELECTRIC CO.  
5200-5218 Kinzie St., Chicago 44, Ill.

# Simpson

INSTRUMENTS THAT STAY ACCURATE

Buy War Bonds and Stamps for Victory

ELECTRONIC INDUSTRIES • January, 1945



MANROSS MIGHTY MIDGETS

## The Standard for Accuracy and Performance

For instruments, indicators, relays, switches—there are no finer springs than Manross hairsprings. Get the benefits of sound experience in design and modern research in materials.

Send for Brochure of Specifications and Design



**F. N. MANROSS & SONS**  
 DIVISION OF ASSOCIATED SPRING CORPORATION  
 BRISTOL, CONNECTICUT

power supply and modulator. In case of a fault or tube overload while both units are in operation, automatic isolation of the units is provided, to minimize loss of air time of the unit in operating condition.

The heart of the control system is located in the rectifier cabinet, and each function in the operation is initiated from the push button on the front control panel. The relay panel contains the primary control relays plus the annunciator relays. On the meter panel at the top of the rectifier cabinet, a set of 50 annunciator lights indicate open transmitter or vault doors, and the operation of overload relays, each of which has an associated annunciator relay, which locks up after a fault occurs, lighting the corresponding annunciator light until a reset button is pushed. Another button closes all annunciator relays to test for burned out lights.

### Locating faults

For checking faults in the control system, a series of 40 small 1/25th watt neon lights are provided on the annunciator relay chassis, each of which is connected across a particular set of overload relay contacts, door interlocks, or control relay contacts, so that in normal operation one of the lights would be lit; but, if a fault occurs, the neon light number, in conjunction with a chart, tells which circuit is open. In turn, each overload relay has a neon light across its contacts, so the exact location of the trouble can be determined quickly.

Conventional water flow and water temperature protection are provided in the filament circuits. Distilled water pumps, fans and filaments are controlled by the first pair of push buttons on the panel. A time delay provision is incorporated, to continue operation of pumps and fans until 15 minutes after filament shutdown. In addition, filament switches are provided for individual water-cooled tubes or banks of tubes (depending on number of tubes in series on one water circuit), which permit changing of tubes without turning off all tube filaments. These switches control the primary power contactor, and short out the water flow interlocks associated with each particular tube or bank of tubes. The circuit is so arranged that turning on the filaments of the separate rf section also turns on the filaments of the main transmitter, since the modulator and rectifier are needed for its operation. Conversely, turning off the filaments of the main transmitter turns off the filaments of both units.

An unusual feature of the high voltage control system is the anti-



Send for this  
**FREE  
 CHART**

**Decimal Equivalents.** Accurate to four places. Signaled in three colors for maximum speed in locating decimal equivalent of fraction. Saves time and avoids errors. Yours at no cost or obligation. Just send us your name, title and address.

See our Catalog in Sweet's File for Product Designers

**JOHN HASSALL, INC.**

Specialists in Cold-Forging Since 1850

412 Oakland Street • Brooklyn 22, N.Y.





pumping circuit. Should a fault occur while the "on" push button is held down, the power supply interrupter has only one closure, and will not reclose until the button is released and pushed again.

Dc voltage to both the rf driver and the final amplifier is fed through individual magnetically operated high voltage isolation switches. The control of these switches is arranged to operate only when the dc voltage is off. Thus, if one rf section is turned on while the other is operating, the power supply shuts down long enough for switching to take place, then automatically comes on again. The same occurs if one of the units is turned off, or if an overload occurs in either section. To facilitate neutralizing of the final amplifier, a switch is provided on the relay panel of this cabinet for individual control of the isolation switch, thus removing high voltage from the unit, and permitting to be applied to all other units.

Push buttons on the control panel operate an automatic recloser circuit. When on, this circuit automatically turns the power supply on after an overload interruption occurs. Should a second overload occur, or the first fault still exist, within fifteen seconds, that particular rf section in which the fault took place is isolated and power is reapplied to the remainder of the transmitter. If no further trouble develops within that fifteen second period, the system resets itself and is ready to repeat this cycle.

#### Carrier alarm

A relay in the cathode circuit of one of the final power amplifier tubes operates the carrier alarm system. This relay is set so that it will pull in under normal operating conditions, but drop out if excitation or plate voltage should fail, and in conjunction with another relay, it operates the alarm, a warning light above each transmitter, and a horn common to all six final amplifiers. If a transmitter goes off the air, the carrier alarm can temporarily be locked off, but becomes effective each time the transmitter is turned on.

To meet the requirements of multiple switching of antennas and transmitters at 200 kw powers, the installation has a structure carrying incoming transmitter transmission lines on a lower level, and outgoing antenna transmission lines on a higher level, at right angles with the incoming lines. Between these two levels are vertical spiral riser lines, terminating top and bottom with double pole, double throw switches. On short posts near the ground are operating cranks, which operate the switches through mechanical linkage.

Electronically, all lines continue



## PERMOFLUX *First* with a *Complete* SPEAKER LINE!

2" to 7½" Diaphragms in ½" Steps  
plus 10", 12" and 15" sizes . . .

No longer will it be necessary to choose a dynamic speaker to accommodate design requirements "as nearly as possible." The new Permoflux line of "true dimensioned" speakers covers the entire size range - there is a unit engineered to the exact needs of every design - there are speakers to provide power handling capacities from 1 to 20 watts. Incorporating exclusive Permoflux acoustic principles developed for war, these speakers mean new efficiency and tone revelation. Our engineering department invites consultation on your postwar sound design problems.

**BUY WAR BONDS FOR VICTORY!**

TRADE MARK  
**PERMOFLUX**

PERMOFLUX CORPORATION  
4916-22 W. Grand Ave., Chicago 39, Ill.

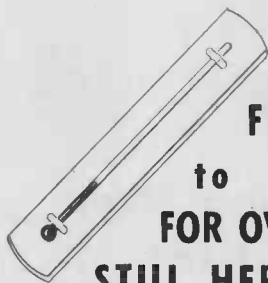

**FROM  $-55^{\circ}\text{C}$  ( $-67^{\circ}\text{F}$ )  
to  $+85^{\circ}\text{C}$  ( $+185^{\circ}\text{F}$ )  
FOR OVER 2400 HOURS and  
STILL HERMETICALLY SEALED!**

Two hundred and forty seven cycles of alternating heat and cold for over two thousand four hundred hours failed to break the seal or cause failure of oil filled Chicago Transformers.

Chicago Transformer's bushing construction and deep-sealed drawn steel cases will withstand the severest conditions.

Write for full particulars on this improved hermetic line.

**CHICAGO TRANSFORMER**

DIVISION OF ESSEX WIRE CORPORATION  
3501 WEST ADDISON STREET  
CHICAGO, 18



through the structure as long as all switches are in horizontal position. Operation of a lower switch breaks the line at that point, and connects the transmitter with its vertical riser. Operation of the associated upper switch breaks the antenna line at this point and connects the antenna to the riser, thus completing the circuit from transmitter to antenna.

No limitations are imposed on possible future expansion, since it is necessary only to add more lines and switches as antennas are added.

#### **Antenna system**

The 27 antennas are arranged in nine groups, six of these containing three antennas each, the other three containing only two each. Each group is fed by a pair of transmission lines. In the case of the two-antenna groups, lines run directly from the switching station to the antennas; but in each of the six triple-antenna groups, one transmission line runs from the switching station to the middle antenna, while the other is arranged to be switched between the small and the large antennas, since these two are never used simultaneously. A special double pole, double throw switch is located along the transmission line near the antennas and is operated through a mechanical

*Easy to Erect*

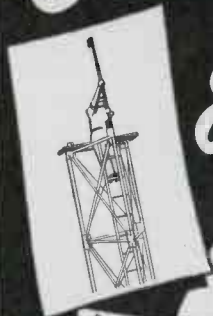

**MASTS  
AND  
TOWERS**

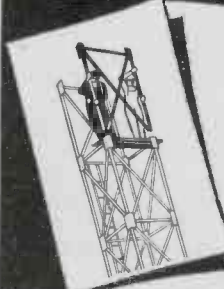
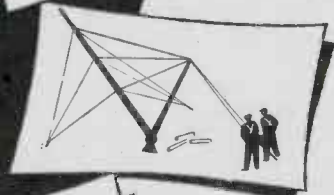

When writing for information please send complete engineering data.  
Address Dept. AE

**HARCO**  
STEEL  
CONSTRUCTION CO.  
Elizabeth 4, N. J.

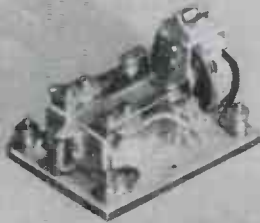
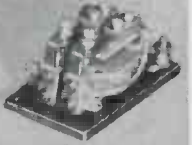
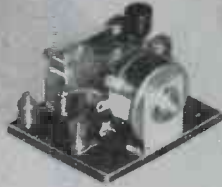
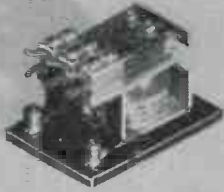
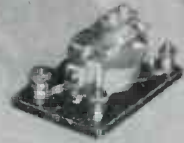
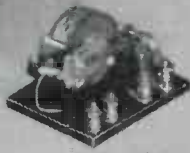

In every branch of the Army and Navy, Advance Relays are dependable components of many types of electrical equipment. Factory production is still all-out for War, but Engineering Service for Post-War products is available now.

## CO-OPERATIVE ENGINEERING FOR NEW RELAY APPLICATIONS

SIMPLIFY your product development and manufacturing problems by calling on Advance Engineers for the close co-operation they are prepared to give you *immediately*. This service not only applies to adaption of one or more of the forty basic types of Advance Relays, which are usually directly applicable to most modern electrical control requirements, but may be utilized for the development of special test models. In any event, you will have the best of relays, exactly as you want them. Write today.

 **Advance Relays**

**ADVANCE ELECTRIC & RELAY CO.**  
1260 WEST SECOND STREET • LOS ANGELES 26, CALIFORNIA

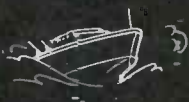

# Concentric Transmission Line

by Doolittle

*A Standard Product  
Since 1934*

• Ten years of experience in building concentric transmission line and associated impedance matching equipment assures you highest quality and workmanship.

Doolittle lines are made in seven standard sizes. Each line uses seamless copper tubing for the outer and inner conductor, except Types C-1 and C-6 which use solid inner conductors. The insulating heads are made of low loss ceramic—impervious to moisture—spaced and fastened securely for maintaining proper electrical and mechanical characteristics.

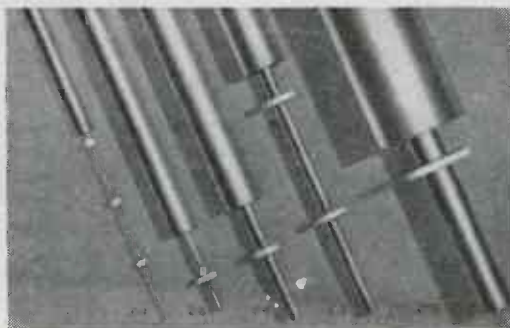

Carefully designed fittings and accessories for any requirements are also available.

Special sizes are made to order. For engineering information concerning installation and use, feel free to consult our engineering staff.

**WRITE  
FOR  
CATALOG  
AND  
PRICES**

**QUICK DELIVERY**

On All Standard  
Sizes Upon  
Suitable Priority

**Doolittle RADIO, INC.**

Builders of Precision Communications Equipment  
7421 SOUTH LOOMIS BLVD., CHICAGO 36, ILLINOIS

**IT'S DRY!**

— and so is your  
equipment when

it's been pressurized with an **ANDREW DRY AIR PUMP**

• Dry Air Pumps provide simple, inexpensive source of dehydrated air for your pressurized electronic products. You can avoid component failure due to humidity by enclosing the entire apparatus in an air tight chamber and maintaining dry air pressure.

FOR DETAILED INFORMATION  
WRITE FOR BULLETIN No. 30

For air-borne equipment, too! Condenser plates will not spark over at high altitudes if the apparatus is pressurized with dry air, because then moisture condensation is no longer a problem.

**ANDREW CO.**

363 East 75th Street  
Chicago 19, Illinois

linkage system, by a lever at waist height.

Rhombic type antennas are used for the 27 radiators. Three sizes cover the frequency range of six to 18 mc, with adjacent size pairs being used simultaneously.

These three sizes are designed at mid-frequencies of 16.33 mc, 11.67 mc and 9.33 mc, with a low vertical angle of approximately 10 deg. and a beam width of 20 deg. at these frequencies. Antennas are four wavelengths long on each side, with a tilt angle of 70 deg., and an average elevation of 1.4 wavelengths above ground. Antennas are constructed of three No. 6 copper weld wires on each side, spaced at the side poles, and converging to a point at each end. Due to low inherent coupling between adjacent rhombic antennas, common support poles could be used. Each pole is actually two poles, spliced butt-to-butt with a steel sleeve. Poles rest in a 6 in. recess in a concrete base, and are guyed at three points.

In order to avoid wasting up to 50 per cent of the power delivered to the antenna, by the conventional dissipative rhombic termination method, re-entrant transmission lines have been incorporated, whereby the normally dissipated power is returned to the input line, properly phased and adjusted as to voltage magnitude, through the use of stub lines of the proper values and spacings along the return line. Impedance of the input line is corrected in a like manner, and in some cases combined with one of the re-entrant stub lines. All stubs of the shorted variety are grounded at the mid-point of the short, to provide static drain, and lightning protection.

### Transmitters in pairs

Transmitters are scheduled in pairs so that as one frequency is becoming less effective in a chosen coverage area, the other is already in operation on the frequency next coming into maximum effectiveness.

To change frequency, two men are required to make the necessary technical adjustments in the short period allowed (usually 15 minutes). One man re-tunes the transmitter, and the other makes the necessary antenna changes and adjustments. The control operator shuts down the transmitter after the scheduled sign-off, and disconnects the frequency generator which had been driving the transmitter, connecting it to the proper generator to supply the new frequency. This change is made on the rf generator patching panel. Then he moves the dials on the transmitter unit to predetermined settings, or changes pre-tuned coil condenser circuits as required for each stage of the transmitter, beginning with the lower power stages, and ending with the high power final stage and



Type 876-A

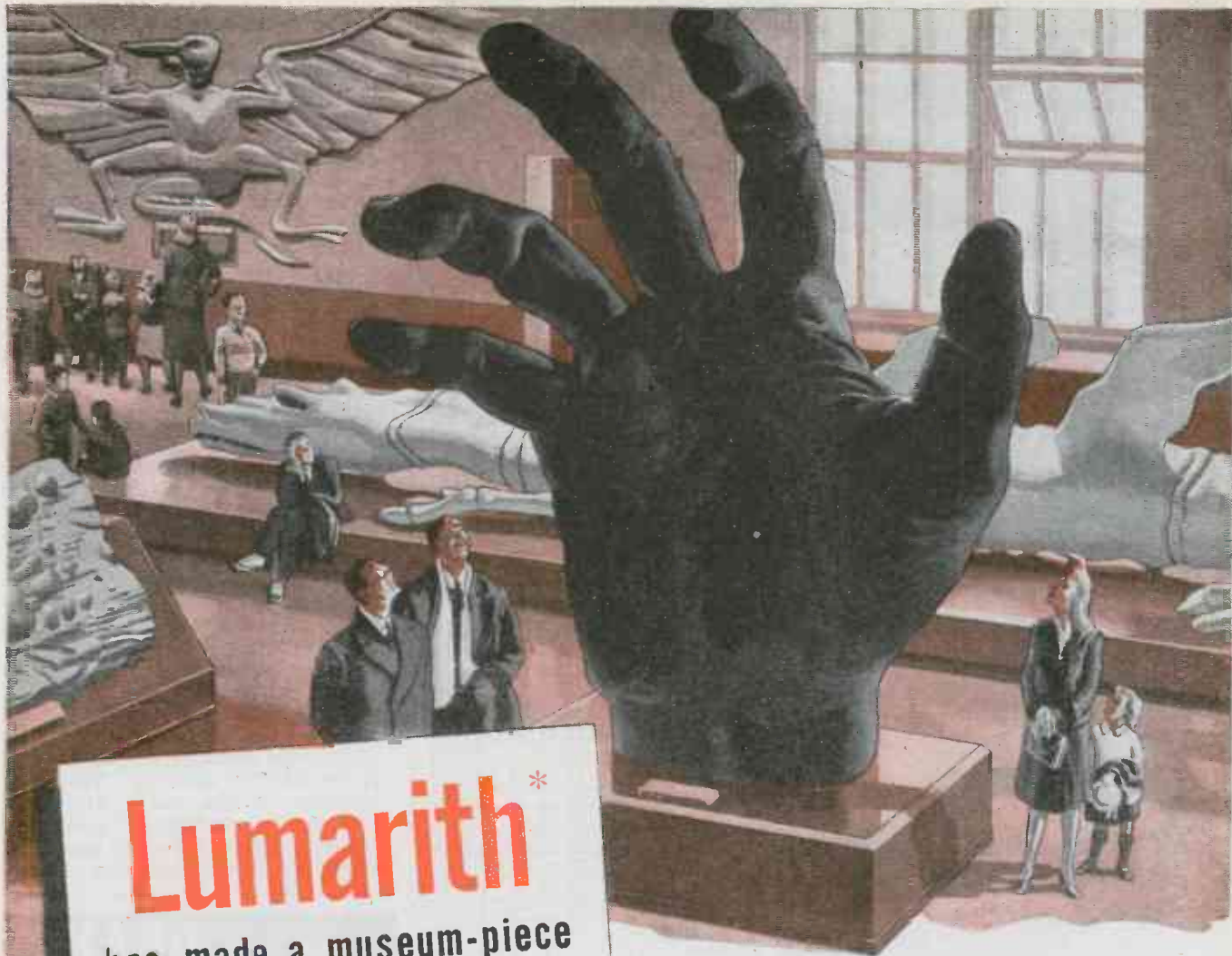

# Lumarith\*

has made a museum-piece  
of the  
**Black Hand of Corrosion**

THE BLACK HAND of corrosion feeds on the free acids released by insulating materials that are in contact with current-carrying copper wire and moisture. In delicate circuits, it can cause the wire to break—in any circuit it can create gaps in the insulation, shorts across the line and consequently interfere with operation of equipment.

Now, Lumarith (cellulose acetate base) has made a museum-piece of the black hand. Lumarith is resistant to electrolytic action. It does not combine with moisture and current, to give corrosion a breeding ground. It is unique among dielectric materials in this respect.

Check on the various forms by which Lumarith can im-

prove your electrical equipment: **FOILS** for coil linings, coverings and interlayer insulation . . . **FILMS** for spiral-wound tubes (square or round) . . . **MOLDING MATERIALS** for molded parts—coils, spools, bobbins, housings, bases, plugs . . .

Lumarith foil can be supplied with a special mat finish (A-78) that increases elongation, helps visibility and prevents wire slippage. Send for Lumarith Electrical Booklet. Celanese Plastics Corporation, *The First Name in Plastics*, a division of Celanese Corporation of America, 180 Madison Avenue, New York 16, N. Y. *Celanese Yarns and Fabrics offer the same dielectric and corrosion resistant qualities as Lumarith Plastics.* For data, address *Celanese Corporation of America, 180 Madison Avenue, New York 16, N. Y.*

\* Reg. U. S. Pat. Off.



**LUMARITH\* A CELANESE\* PLASTIC**

*Films . . . Foils . . . Sheets . . . Rods . . . Tubes . . . Molding Materials*

# SPARE PARTS BOXES

Made as per specification—42 B 9 (Int) for shipboard use,  
Electrical and Mechanical. Navy grey finish.  
Immediate Delivery.

No. 1025-1  
12" x 6" x 6"



No. 1025-11  
18" x 15" x 12"  
(Partitions extra)

## 24 STOCK SIZES

Number	Length	Width	Height
1025-1	12	6	6
1025-2	12	9	6
1025-3	12	12	6
1025-4	12	9	9
1025-5	18	9	6
1025-6	18	9	9
1025-7	18	12	9
1025-8	18	6	6
1025-9	18	15	9
1025-10	18	12	6
1025-11	18	15	12
1025-12	18	12	12
1025-13	18	18	12
1025-15	24	15	12
1025-16	24	15	15
1025-17	24	18	12
1025-18	24	18	15
1025-19	24	18	18
1025-20	24	12	9
1025-23	30	15	9
1025-14	30	15	12
1025-22	36	12	9
1025-21	42	9	9
1025-24	42	12	9

WRITE FOR PRICE LIST

**Cole Steel**  
**office equipment**  
will again be available  
after the war

# COLE

STEEL EQUIPMENT COMPANY  
349 Broadway, New York 13, N. Y. Factory: Brooklyn

the adjustable antenna coupling loop.

While these adjustments are being made at the transmitter, the second man proceeds, in an antenna service car, to the main switching station, where he connects the proper transmitter transmission line with the proper antenna transmission line. He then proceeds to the antenna group, and connects the transmission line to the desired antennas through the line switches previously described. Finally, the proper pre-tuned circuits are inserted by use of switches to adjust the antenna for its assigned operating frequency.

Upon completion of the necessary adjustments, he advises the transmitter operator, who is then ready to put the transmitter on the air on its new frequency.

The car which is used for these operations is especially designed and equipped for antenna work. Its equipment includes a complete two-way FM radio communication set, with which the technician is in constant communication with the control room.

This FM radio is just one part of the complete "intercom" system, which also includes telephones and public address systems. The combination of the three affords a complete and flexible means of communication between personnel anywhere on the property.

## THERE'S A **DRAKE** **SOLDERING IRON** FOR EVERY TYPE OF ELECTRONIC WORK

From that mighty mite



the Drake No. 400 to the high-speed production "honey"



the Drake No. 600-10 there is a high quality Drake Soldering Iron "just right" for the job.

Drake Heat Controls and the Drake "Magic Cup" Stand are important soldering aids.



SEE  
YOUR RADIO  
PARTS JOBBER

**DRAKE ELECTRIC WORKS, INC.**  
3656 LINCOLN AVE. CHICAGO, ILL.

# ALSiMAG

TRADE MARK REGISTERED U. S. PATENT OFFICE

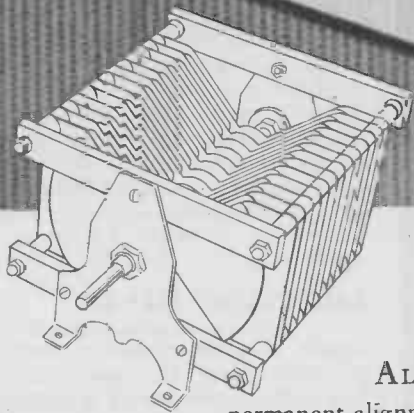
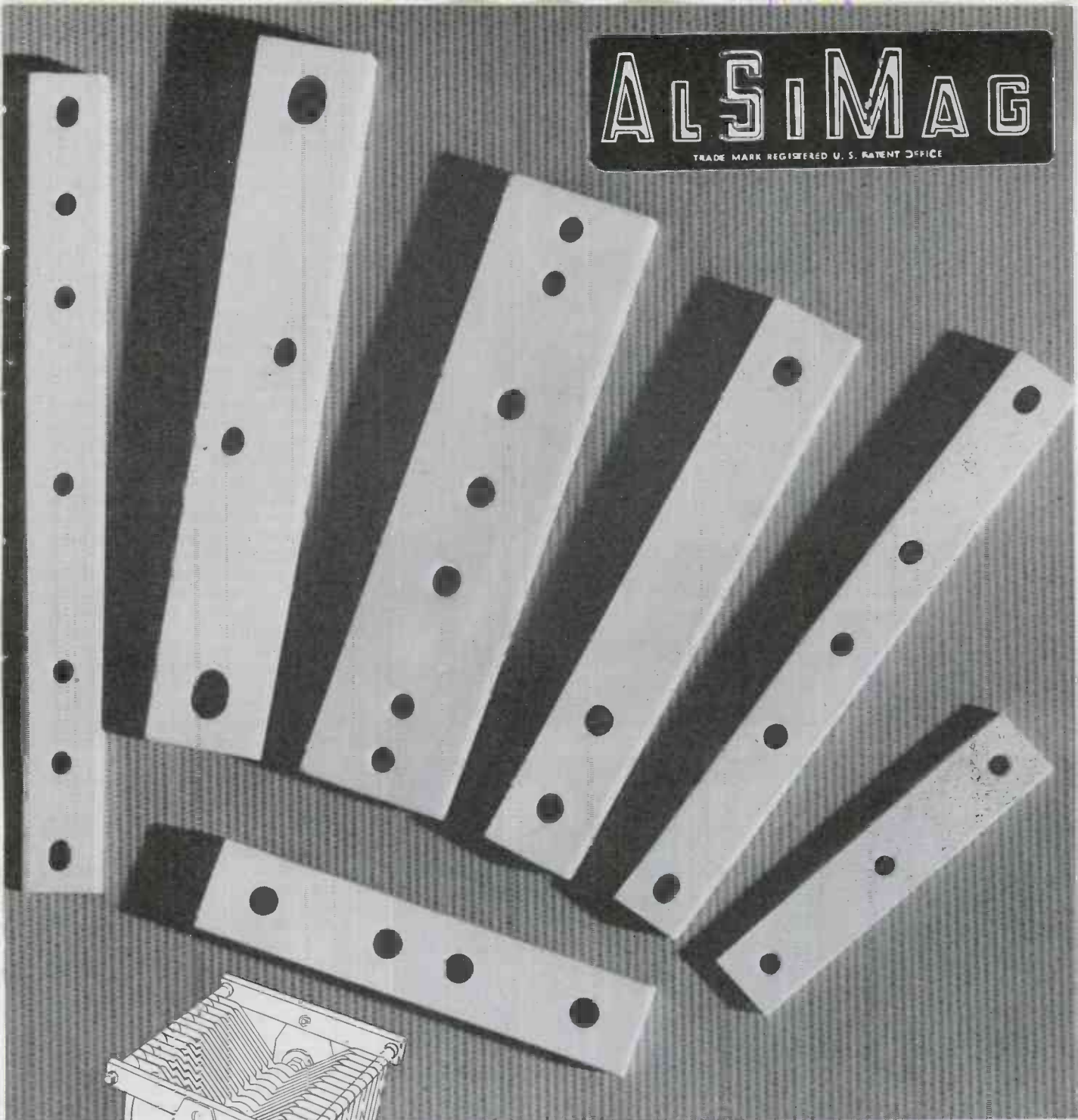

## PERMANENT RIGIDITY

ALSiMAG Steatite Ceramics are unsurpassed for lending permanent rigidity—permanent alignment and accurate spacing of elements in electrical circuits.

ALSiMAG Insulators are permanent materials. They are strong, hard, *inflexible*—do not distort by loading, nor do they shrink with time. Impervious to heat up to 1000° C. Highly resistant to thermal shock. Non-corrodible. Do not absorb moisture.

If stability is a requirement of your electronic and electrical apparatus, investigate the strength and permanent rigidity of ALSiMAG. Send us a blueprint or a sample. Let us prove that ALSiMAG is best suited to your requirements.



ALCO has been awarded for the fifth time the Army-Navy "E" Award for "continued excellence in quantity and quality of essential war production."

**AMERICAN LAVA CORPORATION, CHATTANOOGA 5, TENNESSEE**

[www.americanradiohistory.com](http://www.americanradiohistory.com)

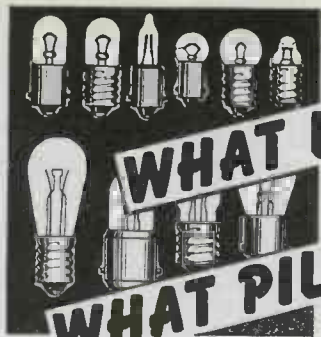

# WHAT LAMP? WHAT PILOT LIGHT?

## ANSWERS TO BOTH QUESTIONS WAITING FOR YOU AT DIALCO

Let us solve your problem with a complete unit — fitted with the proper G.E. or Westinghouse Lamp. We manufacture the most extensive line of Pilot Lights . . . Special emphasis on Neon applications. Write for Catalog today.

YOU CAN DEPEND ON DELIVERIES  
WHEN YOU DEAL WITH THE

*World's Largest Manufacturer of Pilot Lights*



# DIAL LIGHT CO. *of America, Inc.*

900 BROADWAY • NEW YORK 3, N. Y.

Telephone: ALgonquin 4-5180-1-2-3

BACK THE INVASION—BUY MORE BONDS NOW!

## CARRIER PRINCIPLES

*(Continued from page 87)*

the carrier receiver and result in what might be called a form of static. This problem usually is not particularly serious because the carrier is usually so strong at the receiver that it over-rides the noise. Such noises are also intermittent in nature, unless resulting from corona.

Surge protection includes, for instance, the protection of the tuning capacitors used in the resonant line traps. Thus small lightning arresters are used to provide protection against surges and such transient voltages as might otherwise puncture the capacitor dielectric. Similar protection must be provided for all circuits including reactive components which will be subjected to the transient voltages present on every power transmission line. For this reason spark gaps, grounding switches, and protector gaps are required on the line tuning equipment and in the base of coupling capacitors.

In conclusion, power line carrier is a field of major importance—in fact, of increasing importance to electric power systems. Its applications in the individual fields of telephone communication, relaying, telemetering, supervisory control, and load control become more and more important as the complexity of power systems increases. Inter-connected systems encounter problems which can often be solved with power line carrier as the communication link. High speed relaying and load control permit handling larger power flows over lines that otherwise could not safely handle them for fear of system instability.

Telemetering and supervisory control will permit the load dispatchers to provide more efficient operation of the system. Telephone facilities for the long distances usually involved in major system interconnections aid the system load dispatchers in providing the power interchanges required by contracts or other agreements; and the information provided by telemetering and supervisory control may be especially valuable for such systems.

## LOCATING MINES

*(Continued from page 83)*

tuned to 1,000 cycles by means of a choke and trimmer. The signal voltage developed is coupled to the tube through a coupling capacitor.

Negative grid bias voltage for both tubes is derived from the voltage drop across the potentiometer in series with the negative side of the "B" supply circuit. The voltage is then applied through resistors, which serve to decouple the stages in conjunction with the by-pass capacitors. The plate of the tube

# PLASTIC PARTS

Large or small quantities. Produced to your specifications. Precision machining, stamping and forming all plastics. No molds required. Send your blueprint, or write for bulletin.

# PRINTLOID, Inc.

93 Mercer Street

New York 12, N. Y.

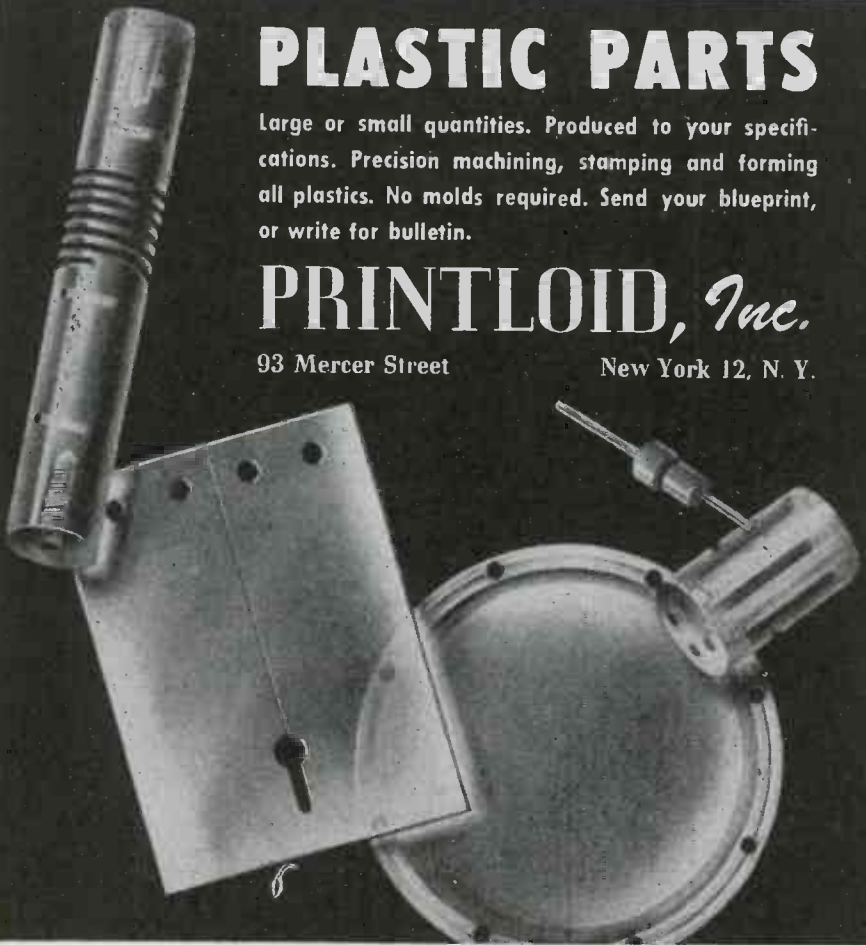



is coupled to the resonator and the output meter through a transformer.

The oscillator circuit comprises a tube, a transformer in push-pull arrangement, and their associated parts. The frequency of oscillation is controlled by the inductance of the plate and grid windings of a transformer and the capacity of the capacitors. Audible indication of the presence of metal is given by the acoustic resonator. This is an earphone encased in a housing. The acoustic selectivity of the resonator housing produces an amplified 1,000 cycle note.

The visual indicator is a full-wave rectifier-type 0-1 millimeter with pole pieces so shaped that logarithmic relationship exists between the voltage applied to the meter and the needle deflection obtained. The meter is connected in series with a capacitor, and across the output transformer.

Possibilities of this type of metallic detector in future postwar activities show promise for use in many industries. In fact, it could easily be used in the lumbering industry, to detect nails, spikes and other unwanted metallic objects before sending lumber to the saw mill. Other industries in which such a detector could be of value are linoleum, paper bag, linen, jewelry, etc.

This detector also can be used in streets in detecting misplaced or lost pipes, water mains, conduits and other metallic objects and even the detection of metal treasures and monies lost in the sands at the beaches. It may also be employed in detecting armed persons entering a premise.

## WIDE READING

### Grounded-grid Circuits

(Continued from page 112)

bias is obtained across a parallel RC circuit between grid and ground. The circuit is recommended for use as the primary oscillator in a frequency-modulated transmitter.

In the two-tube amplifier shown in the first figure, the cathode follower tube  $T_1$  drives the grounded-

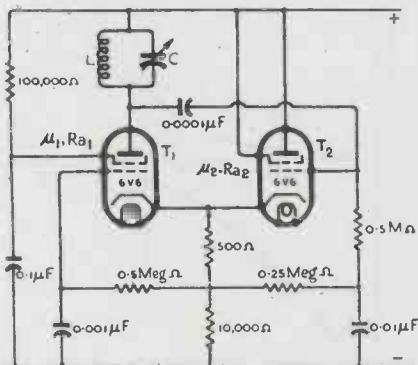

Grounded grid oscillator

# MEET THIS MEMBER OF THE FREED TRANSFORMER FAMILY

NO. 8 IN A SERIES

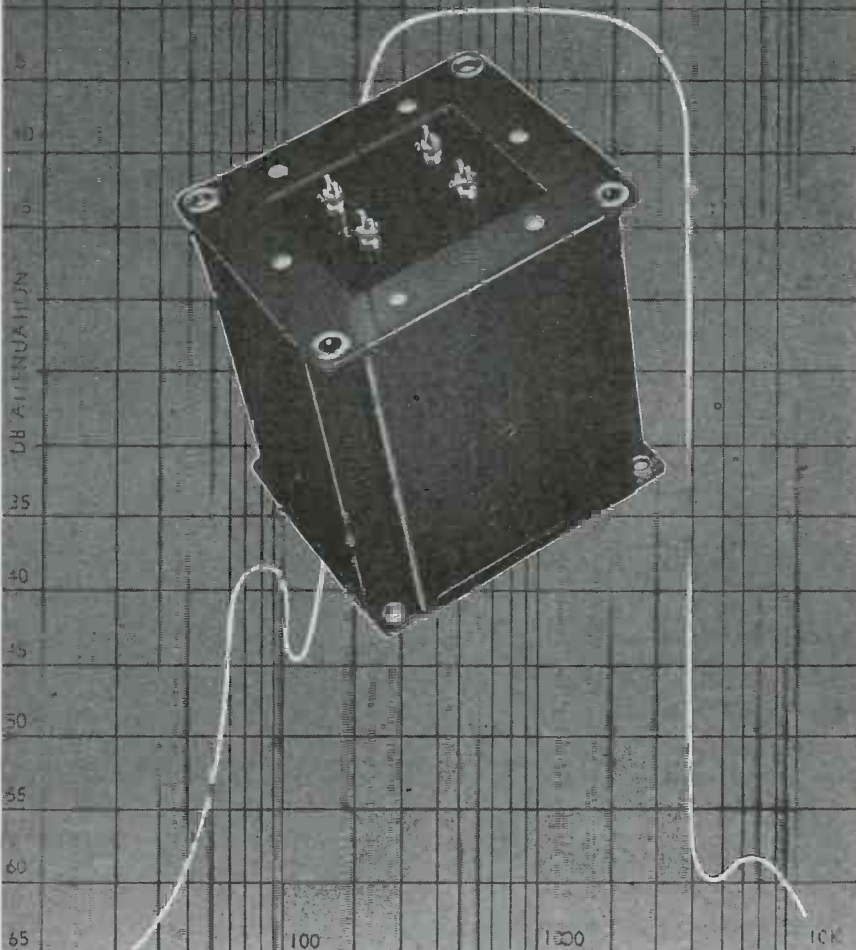

## In this BAND PASS FILTER FREED gives you all FIVE

Freed development and research created this Band Pass Filter which is the best word in rugged construction and specialized engineering. A reference to the curve provides an accurate picture of its performance. Five points of superiority are five good reasons why Band Pass Filters for your post war products should be by Freed: 1. They provide maximum performance in a minimum of space; 2. They provide high attenuation in the stop band, with low insertion loss; 3. They are rigidly tested and inspected for uniformity; 4. They are available in a complete range of frequencies to meet your requirements; 5. They are physically constructed for rugged service.

For transformers, reactors, filters for your post-war products, consult Freed Engineering Service now. Descriptive folder on request.

# FREED TRANSFORMERS

FREED TRANSFORMER COMPANY

74 SPRING STREET, NEW YORK CITY

# Shallcross Akra-Ohm ACCURATE FIXED WIRE- WOUND RESISTORS

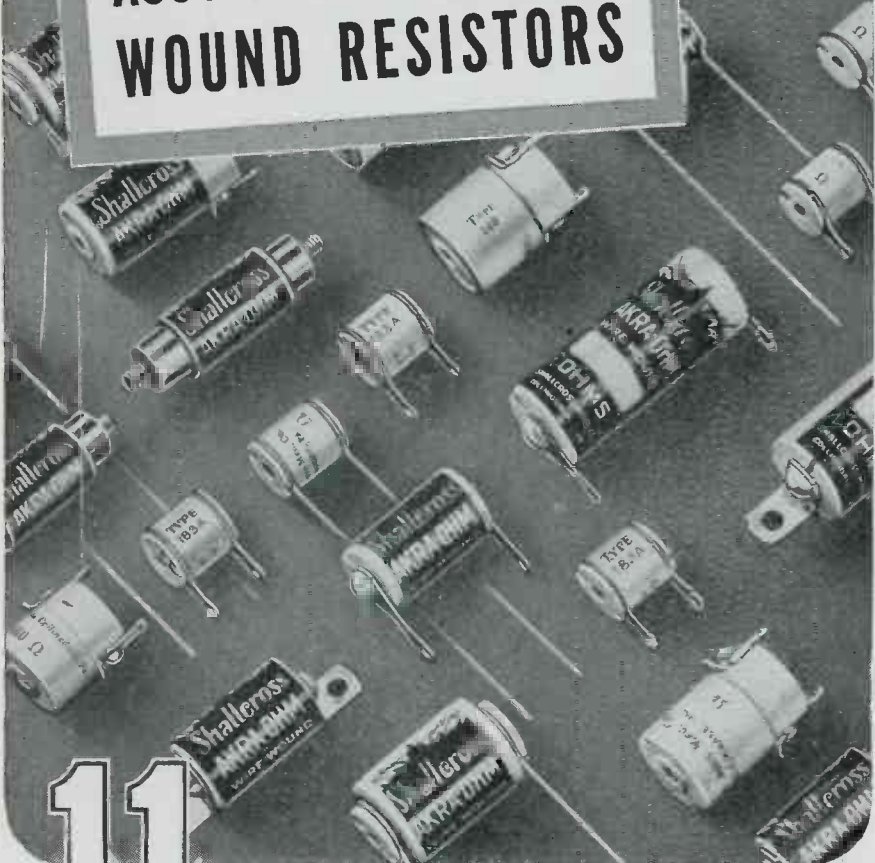

## 11 BASIC TYPES..DOZENS OF ADAPTATIONS TO MEET ANY NEED

For many years, Shallcross has devoted 100% of its extensive resistor engineering and production facilities exclusively to accurate fixed wire-wound types. This has resulted in bringing to the field of electronics 11 basic time-tested types. These types can be readily adapted to meet all engineering needs as to terminal, mounting and other physical requirements. Special processing with materials found exclusively at Shallcross provides a complete selection of resistors which retain their accuracy and stability even under the most severe conditions of temperature, humidity and fungus.

### INSTRUMENT TYPE RESISTORS

Designed to dissipate 1 watt and having a tolerance of 0.25% (or less if required) Shallcross bifilar wound Types 245 and 7525 are ideal for wide variety of precision instrument applications.

When you have need of Accurate Fixed Wire-wound Resistors, write for the complete Shallcross Akra-Ohm Catalog.



# SHALLCROSS MFG. CO.

DEPT. EI-15, COLLINGDALE, PA.

ENGINEERING • DESIGNING • MANUFACTURING

## WIDE READING

grid tube  $T_2$ . The input impedance of  $T_2$  is computed:

$$E_3/I_2 = (R_2 + R_2')/(\mu_2 + 1).$$

Assuming  $R$  to be of the same order as the tube resistance, or larger, and that the amplification factors of both tubes are much larger than 1, the stage gain is:

$$E_{02}/E_1 = \mu_2 R_2 / (R_2 + R_2' + \mu_2 R_{a1} / \mu_1).$$

A practical oscillator using a grounded-grid tube  $T_1$  and the cathode follower  $T_2$  is shown in the second figure. The high input impedance of the cathode follower imposes light loading on the main tuned circuit. Unity gain in this stage provides ample driving voltage to insure reliable oscillation up to very high frequencies, even when using low  $Q$  tuned circuits. One side of the tuned circuit is grounded for RF. Triodes or pentodes may be used. The resistance value  $R$  of the cathode-coupling network and the dynamic load resistance  $R_d$  of the tuned circuit in the plate lead of  $T_1$  are connected by the relation:

$$\mu_2(\mu_1 + 1)R_1 R_2 - (\mu_2 + 1)(R_{a1} + R_1)R - (\mu_1 + 1)R_{d2}R - (R_{a1} + R_1)R_{d2}$$

A piezo-electric crystal may be provided in the lead connecting the two cathodes to control the oscillation frequency. Two resistors would then be inserted between each cathode and ground, respectively.

### On Push-Pull Amplifiers

R. L. Russell (Wireless Engineer, London, October, 1944)

On the supposition that the transconductance characteristics ( $I_1$  and  $I_2$  as function of  $V_g$ ) of the two tubes are identical branches of a hyperbola, a geometrical explanation for the operation of push-pull amplifiers is given. The common negative grid bias of the tubes determines the relative position of the two branches of the hyperbola  $I_1$  and  $I_2$  along the  $V_g$  axis, which axis

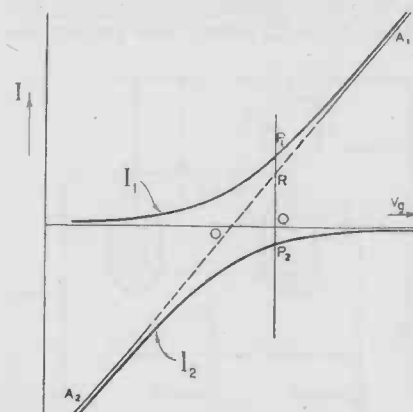

Transconductance characteristics of the two tubes in a push-pull amplifier



## Still Young at 99 . .

Who wants a tracing paper that's still good—and we mean *good*—still white, transparent, flexible—99 years later? Well, you can never tell. Maybe more tragic things have happened than having a drawing go to ruin in its sleep, but nevertheless, that can be awfully serious. That's only one reason why we developed ALBANENE white tracing paper. It's permanent, because it's made of 100% long-fibre pure white rags, treated with Albanite. In drafting rooms today there are drawings on ALBANENE that are years old and still in perfect condition.

What's Albanite? It's a crystal-clear, unaltering synthetic developed by the K&E Laboratories, and is simply tops as an impregnating medium for long-fibre paper stock. That gives ALBANENE extra transparency. And because ALBANENE stays white, it gives strong, contrasting prints. It's fine to work on too, with pencil or ink—keeps clean and takes erasures well. That's not the whole story; to get it all, write us on your letterhead for a sample sheet. Made in rolls, sheets, and pads.

**K&E**

Drafting, Reproduction, Surveying  
Equipment and Materials  
Slide Rules, Measuring Tapes



*Albanene*

REG. U. S. PAT. OFF.

**KEUFFEL & ESSER CO.**

EST. 1867

NEW YORK • HOBOKEN, N. J.

CHICAGO • DETROIT • ST. LOUIS  
SAN FRANCISCO • LOS ANGELES • MONTREAL

Proud as a sculptor when his masterpiece is unveiled

Sincere pride is a natural trait of everyone at R-B-M... justified pride in the advanced design and precision manufacture of every product; enthusiastic pride in its wide approval and acceptance. An important reason why R-B-M is a leader in its field.

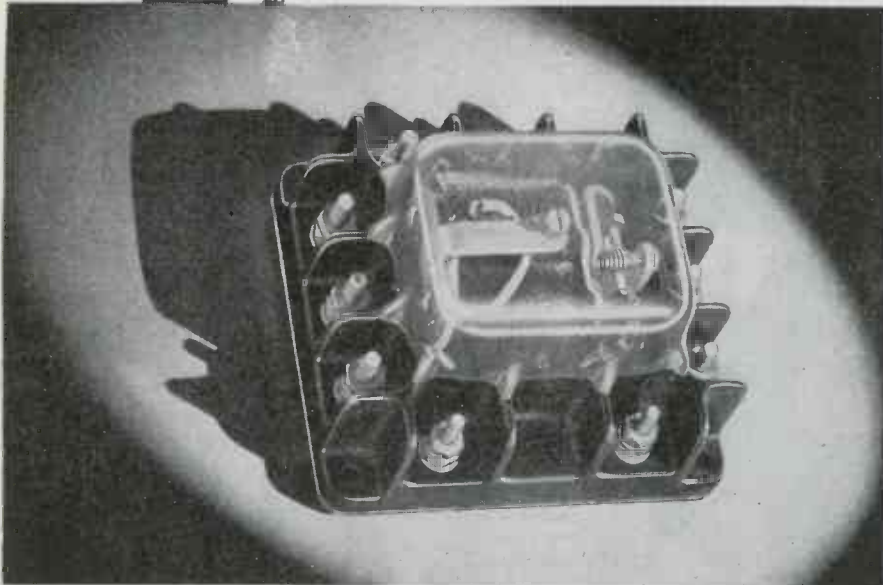

## New R-B-M 400 Cycle Relay

Designed especially to meet the exacting requirements and severe operating conditions of fast, modern aircraft, this new R-B-M 400 Cycle Relay is light in weight, high speed in operation, completely sealed against dust, and not affected by vibration. It is thoroughly insulated to prevent phase arc-over, and contact bounce has been reduced to an absolute minimum. Rigidly tested under all conditions. Now being used by leading airplane manufacturers. Available for many applications. Send for complete specifications today. Write Dept. B-1 . . .

**R-B-M MANUFACTURING COMPANY**

*Division of*  
**ESSEX WIRE CORPORATION**  
**LOGANSPORT, INDIANA**

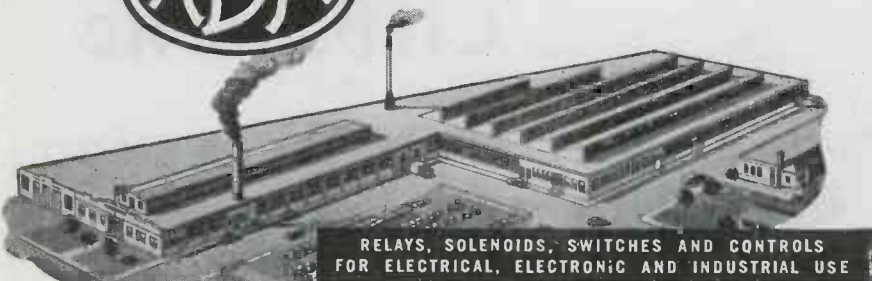

RELAYS, SOLENOIDS, SWITCHES AND CONTROLS  
 FOR ELECTRICAL, ELECTRONIC AND INDUSTRIAL USE

## WIDE READING

represents one asymptote of the hyperbola.

To obtain distortionless amplification, it is necessary to so select the grid bias that the two trans-conductance characteristics  $I_1$ ,  $I_2$  are in the conventional relative position of two branches of a complete hyperbola. In other words, the asymptote  $O-A_1$  of the branch  $I_1$  (to which the  $I_1$  characteristic approaches, as  $V_g$  increases within the normal working range should be the continuation of the asymptote  $O-A_2$  of the other branch  $I_2$  so that the two asymptotes form one straight line  $A_1-A_2$  as in the figure. It is proved mathematically that the resulting combined characteristic of both tubes ( $I_1-I_2$ ), as a function of  $V_g$ , will then be the straight line  $A_1-A_2$ , because for any hyperbola the distance  $P_1R = QP_2$  so that  $(P_1Q - QP_2) = (I_1 - I_2) = QR$ , where  $R$  is a point on the asymptote.

Methods are described by which the hyperbolic shape of a tube characteristic can be identified. Overall characteristics of a push-pull amplifier for different values of grid bias were taken with a cathode-ray tube, and, as expected, a linear characteristic could be obtained for a special value of grid bias.

(Continued on page 180)



## R. F. CHOKES

Illustrated are standard stock chokes designed to cover a band of frequencies. Uniformly flat in response, Johnson R. F. chokes are equally effective over the entire range for which they were designed. Wire is enameled, silk covered, impregnated with low loss R. F. lacquer, and wound on steatite cores. Available in several current ratings.

Also available on special order are high current chokes for large transmitter applications. These special chokes are individually designed to operate on a specific frequency in such applications as tower lighting circuits and in power supply circuits. Send your specifications to Johnson for recommendations and quotations.

Ask for Catalog 968 (O)

**JOHNSON**  
*a famous name in Radio*



E. F. Johnson Co. Waseca, Minn.



# MYCALEX PARTS



## Now-faster delivery service!

LOOK to G.E. for help in meeting those urgent production schedules. Right now our expanded facilities for fabricating G-E mycalex parts are ready to take on the job of assisting you. We can supply G-E mycalex parts more quickly, supply them in large or small quantities and, most important, make them exactly to your specifications.

More and more manufacturers are turning to this G-E service to help solve their production problems. They know that it will save them time, and, on today's production schedules, time is money. They know also, that quality will be tops, that skilled craftsmen, experienced in every operation, will do precision work and, if necessary, they can call on G-E engineers for advice.

Whatever your problem, be it milling, machining, tapping, drilling, punch-

ing or flycutting, you will find it economical to turn to G-E specialists for a satisfactory solution. Remember too, that G-E mycalex parts have the same qualities of endurance that characterize all forms of G-E mycalex. They do not shrink, warp or carbonize and are practically impervious to water, gas and oil.

Act now to step up production speed. Your inquiry on G-E mycalex parts and fabrication facilities will receive prompt attention. We will be glad to quote prices and delivery dates on the parts you need.

*Tune in General Electric's "The World Today" and hear the news from the men who see it happen, every evening except Sunday at 6:45 E. W. T. over CBS. On Sunday evening listen to the G-E "All-Girl Orchestra" at 10 E. W. T. over NBC.*

### FREE-- G-E MYCALEX BULLETIN



ELECTRONICS DEPARTMENT  
GENERAL ELECTRIC  
SCHENECTADY, N. Y.

Please send me a free sample and my copy of the booklet describing G-E Compression-Molded Mycalex.

Name.....

Company.....

Address.....

Over 21 Years of MYCALEX Experience—Your Assurance of Quality!

# GENERAL ELECTRIC

100-D1

# Dependable Power..

## WIDE READING

### A Direct Reading Audio-Frequency Meter

(Continued from page 112)

is applied to the grid of the 6V6G beam-tetrode used as a limiter. During the negative cycles the tube is cut off and during the positive cycle the plate voltage falls rapidly to a low value which remains constant throughout positive values of the grid voltage. Consequently, a square-wave voltage of repetition frequency  $f$ ,  $f$  being the unknown frequency of the input voltage, and of constant amplitude of about 125 volts is produced and applied to one of the capacitors  $C$ . As the plate potential reaches its maximum, one of the capacitors  $C$ , which is connected into the circuit by switch  $S_1$ , charges to this potential through diode  $D_1$ ; when the plate potential falls to its minimum,  $C$  discharges through diode  $D_2$ . A meter having a full scale deflection of 1.0 mA is inserted in series with diode  $D_2$ ; the current through the meter is proportional to the input frequency.

For better stability, the 6V6G tube is supplied from a 150-volt regulated source. To ensure that sufficient input is available for over-swinging the limits of cut-off and zero bias conditions of the 6V6G, a 6J7G pentode amplifier is included.

The accuracy on all ranges is within 2 per cent of full-scale reading. The range is 0-30,000 cycles, covered in six steps of 0-100, 0-300, 0-1,000, 0-3,000, 0-10,000, 0-30,000 cycles. The meter requires 1 volt for correct indication and this indication is maintained for input voltages greater than 1 volt up to at least 300 volts. The input impedance is approximately 130,000 ohms. The reading is reasonably independent of noise voltages. A 10 per cent change in supply voltage causes a 2 per cent change in meter reading.

### Experiments on Electrets

G. Gross (Physical Review, July, 1944).

An electret is a capacitor, containing an absorptive dielectric (like carnauba wax), charged at a high temperature and then cooled while still connected with the voltage source. When finally short-circuited, only a partial discharge occurs, because a part of the electric charge stored up during the preceding charging cycle behaves as if "frozen," and is retained within the dielectric as long as the temperature is kept low.

Current and charge involved in the electret effect are measured under varying conditions as a function of time. Charges having the

ELECTRONIC INDUSTRIES • January, 1945

Probably the most important single factor in modern warfare is complete, dependable communications. Dependable communications require a dependable power supply. Pincor is proud of its part in furnishing portable gasoline-driven and other electrical power supply units to the fighting front as well as to the home front.

Look to Pincor for your postwar needs in power plants, motors, converters and battery chargers.

DYNAMOTORS . . . CONVERTERS  
GENERATORS . . . D C MOTORS  
POWER PLANTS...GEN-E-MOTORS

BUY WAR BONDS!

**PINCOR**  
Products

**PIONEER  
GEN-E-MOTOR**

CORPORATION  
5841-49 DICKENS AVENUE  
CHICAGO 39, ILLINOIS

EXPORT ADDRESS: 25 WARREN STREET, NEW YORK 7, U. S. A. • CABLE ADDRESS: SIMONTRICE, NEW YORK

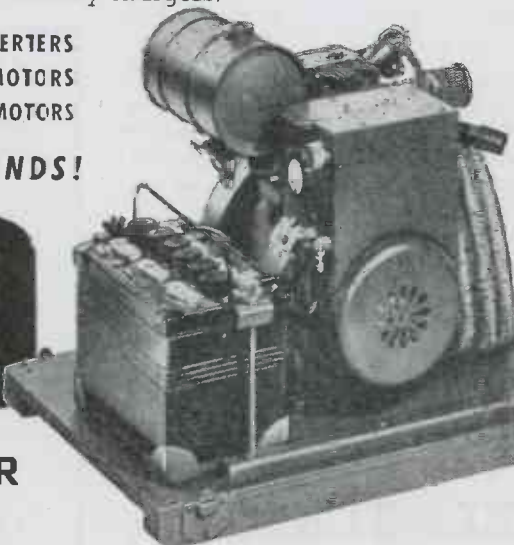

# After Victory... WHAT?

When Victory is ours, and Peace returns to the land . . . will YOU be snug in your own paid-for home—with security against illness, provision for retirement, education for your children—all ASSURED BY BONDS?

Or will you be one of those "too busy" people who "meant to buy Bonds tomorrow"? Who find themselves entering the postwar period empty-handed . . . facing the future with uncertainty? The choice is yours.

For, wherever you are, in the service, the factory, the farm, the office, YOU and that family you love so much *can* be provided for—or can be neglected . . . it's up to you.

Yes, actually! It all depends on what you do. On what you do *before* the war's over; on what you do, in fact, TODAY!

You must know by now that the best, the safest investment in the world—the one with the most liberal terms—is United States WAR BONDS. What you may not know is that they are the best insurance policy there is. If you regularly invest a percentage of your weekly income in bonds—and also buy them with your savings or extra earnings, NOW—you can accumulate that very Nest Egg which spells security for your family . . . easily, painlessly, right away. And, in just ten short years, you'll have 4 DOLLARS FOR EVERY 3 you invest!

We guess that makes War Bonds just about the best darn buy there is. You're helping the boys to come home sooner—and you're *insuring* a bright, safe future for those you love. *When you invest in Bonds, the full faith and credit of the United States Government is behind that future of yours!*

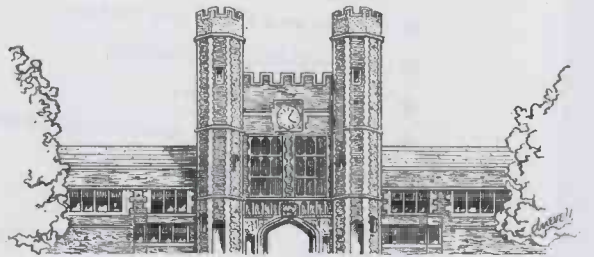

## If You Believe in America . . . BUY BONDS!

Here at Kenyon, we're proud to play our small role on the stage of a BIG war. That's why EVERY Kenyon transformer used by our fighting forces throughout the world reflects only the highest precision craftsmanship. Kenyon workers are doing their share—bringing Victory closer by turning out top quality transformers uninterruptedly—and as fast as possible!



THE MARK OF EXCELLENCE

**KENYON TRANSFORMER CO., Inc.** 840 BARRY STREET  
NEW YORK, U. S. A.

# DO YOUR ENGINEERS

# have a TOUGH POWER PROBLEM?



Are you engineers having trouble finding an exactly correct electrical power supply for today's war products? Are you planning the power supply for your future products? Then let Wincharger Engineers help you. They can save you lots of time and worries if you need:

## MOTORS

- Built in and shell type motors
- Adjustable speed motors
- Synchronous Motors
- Rotary Electrical aviation equipment
- Dynamotors and Inverters
- Motor Generator sets
- Railroad Car Lighting Generators

**BONDS for VICTORY**



**WIN-CC ROTARY ELECTRICAL EQUIPMENT**  
 WINCHARGER CORPORATION      SIOUX CITY, IOWA



## WIDE READING

polarity of the electrode potential and charges of opposite sign are both observed on the electrode surfaces, due partly to the formation of dipoles within the dielectric and partly to the transition of ions into the dielectric and of electrons extracted from the dielectric.

### Harmonic Synthesizer

J. M. Somerville (*Journal of Scientific Instruments*, London, October, 1944)

A harmonic synthesizer is described which will combine any seven sinusoidal oscillations in the frequency range from 50 to 20,000 cycles and allow separate control of the amplitude and phase of each component. The device may be used for analysis or for demonstrating and studying combined oscillations, particularly a fundamental and several harmonics. A complete circuit diagram is included.

### Submerged Repeater

R. J. Halsey and W. T. Duerdoh (*Post Office Electrical Engineers' Journal*, London, July, 1944)

A submerged repeater, believed to be the first ever included in a

**WE TAKE THE WORRIES OUT OF YOUR HANDS!**

OUR SPECIALTY

↓

**FABRICATING MYCALEX**

IN ALL FORMS, to Specifications

**COLONIAL KOLONITE COMPANY**  
 2212 W. ARMITAGE AVE., CHICAGO, ILL.



why we say —

“LET’S WORK IT OUT TOGETHER”

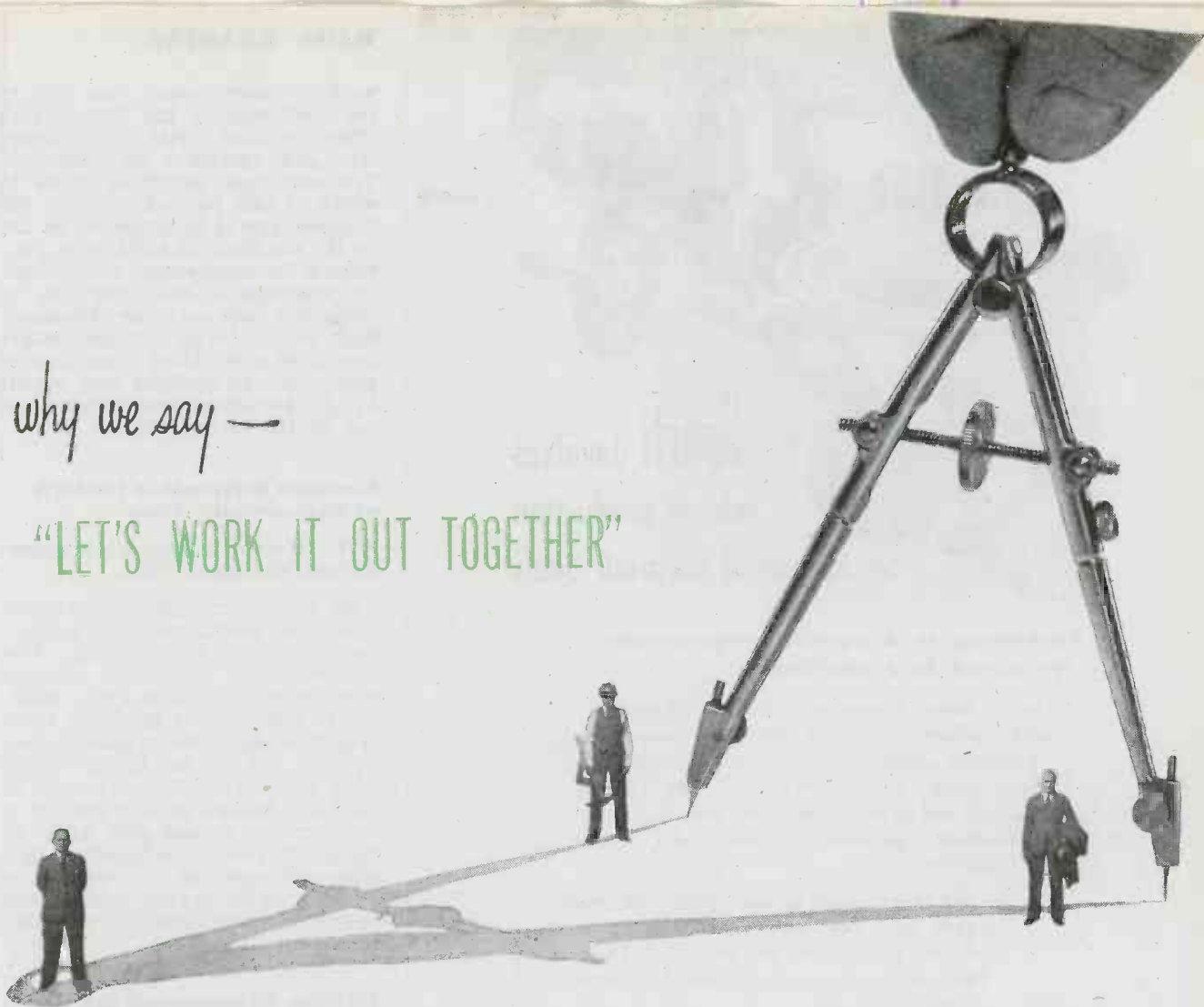

At Dow, we firmly believe there is one *sure* answer to success in plastics. It's a simple, friendly idea—yet so important that we are putting aside this advertising space to tell you about it.

Our work with many manufacturers and molders all over the country has proved the value of close and continuing cooperation with them in developing nearly every job. As plastics move into a period of even greater usefulness, this teamwork becomes increasingly important; for putting plastics to work *right* is not a one-man job. It is not even a one-industry job. Instead, it calls for the combined skill and experience of manufacturer and designer—working step by step with molder—and Dow.

That's why we say “*Let's work it out together*”—it saves time and money and puts plastics in their right place.

THE DOW CHEMICAL COMPANY • MIDLAND, MICHIGAN

New York • Boston • Philadelphia • Washington • Cleveland • Detroit • Chicago • St. Louis • Houston • San Francisco • Los Angeles • Seattle

DOW PLASTICS INCLUDE:

**STYRON** (Dow Polystyrene) . . .  
For moldings, extrusions, rods, sheets.

**SARAN** . . .  
For moldings, extrusions, pipe, tubing, monofilaments;  
also available as Saran Film.

**ETHOCEL** . . .  
For moldings, extrusions, coatings; available also as  
Ethocel Sheeting.



**PLASTICS**

Styron Saran Ethocel

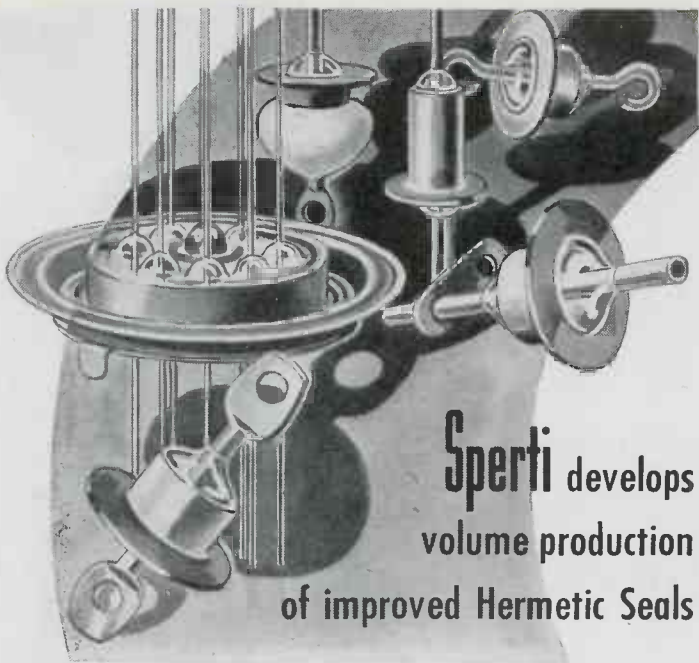

**Sperti develops  
volume production  
of improved Hermetic Seals**

**Conforming to Army-Navy requirements  
for critical field conditions**

Transformers, condensers, relays, vibrators and various component parts can now be protected against heat and tropical humidity, salt spray, sand infiltration, fumes, fungus attack and other varied conditions that cause sensitive equipment to fail under critical conditions.

In the laboratories beyond Sperti, Inc., techniques have been discovered which permit volume production of improved Hermetic Seals at low cost, safeguarded by unique inspection methods.

**Principal features of the improved Sperti Hermetic Seal are:**

1. Small, occupies little space, one piece, no other hardware needed, simple and easy to attach. (Soldering temperature not critical.)
2. Vacuum tight hermetic bond, hydrogen pressure tested for leaks.
3. Resistant to corrosion.
4. High flash-over voltage. Does not carbonize.
5. Insulation resistance, 30,000 megohms, minimum, after Navy immersion test.
6. Thermal operating range—70° C. to 200° C. Will withstand sudden temperature changes as great as 140° C.

Wire or phone for information, today. Give as complete details as possible so that samples and recommendations may be sent promptly.



**Sperti**

INCORPORATED



RESEARCH, DEVELOPMENT, MANUFACTURING, CINCINNATI, OHIO

**WIDE READING**

working cable system, was laid in the Irish Sea by the British Post Office in June, 1943; its construction and operation are described. The maximum depth of water in which it can be laid is about 200 fathoms and it is intended for use on the Continental shelf only. Provisions for mechanical and chemical ruggedness and long life of tubes and equipment are discussed. Each of the three amplifier stages has three alternative tubes, any of which can be brought into circuit by dc switching controlled from one of the shore stations.

**Electron Diffraction Pattern of Copper-Gold Alloy**

F. E. Haworth (Bell Laboratories Record, November, 1944)

By heating metallic alloys under controlled conditions their properties often can be improved. One of the many structural changes which may be made is a rearrangement of the atoms in which those of a given kind choose special positions in the crystal lattice of the alloy instead of being arranged at random. Studies of this change of structure in copper-gold alloy by means of electron diffraction patterns are reported. The process of ordering of the crystal lattice when heated can be followed on very thin specimens.

**Edison Discovered Basis of Wireless 69 Years Ago**

Discovery by the late Thomas A. Edison of an "Etheric Force," the phenomenon now known as wireless and radio, occurred on Nov. 22, 1875, 69 years ago, at Newark, N. J., several months prior to moving his laboratory to Menlo Park, N. J.

While Edison was studying the workings of a vibrator magnet that was operated by a battery current on November 22, 1875, he detected a peculiar spark coming from the magnet's core. Believing it was due to faulty instruments, he checked the connections and insulations, only to find they were perfect.

He learned that he could get the same type of new spark by touching some part of the vibrator with any substance that formed a good conductor. He then attached the wire to the end of a rod that vibrated and drew a spark from the wire and then got another by turning the free end of the wire back on itself. This discovery, which Edison termed "Etheric Force," was actually man's first knowledge of the wireless wave now used in wireless telegraphy and radio. It occurred 12 years before recognition was given Professor Heinrich Hertz

# *Ceramics* for ELECTRONIC TUBES by STUPAKOFF

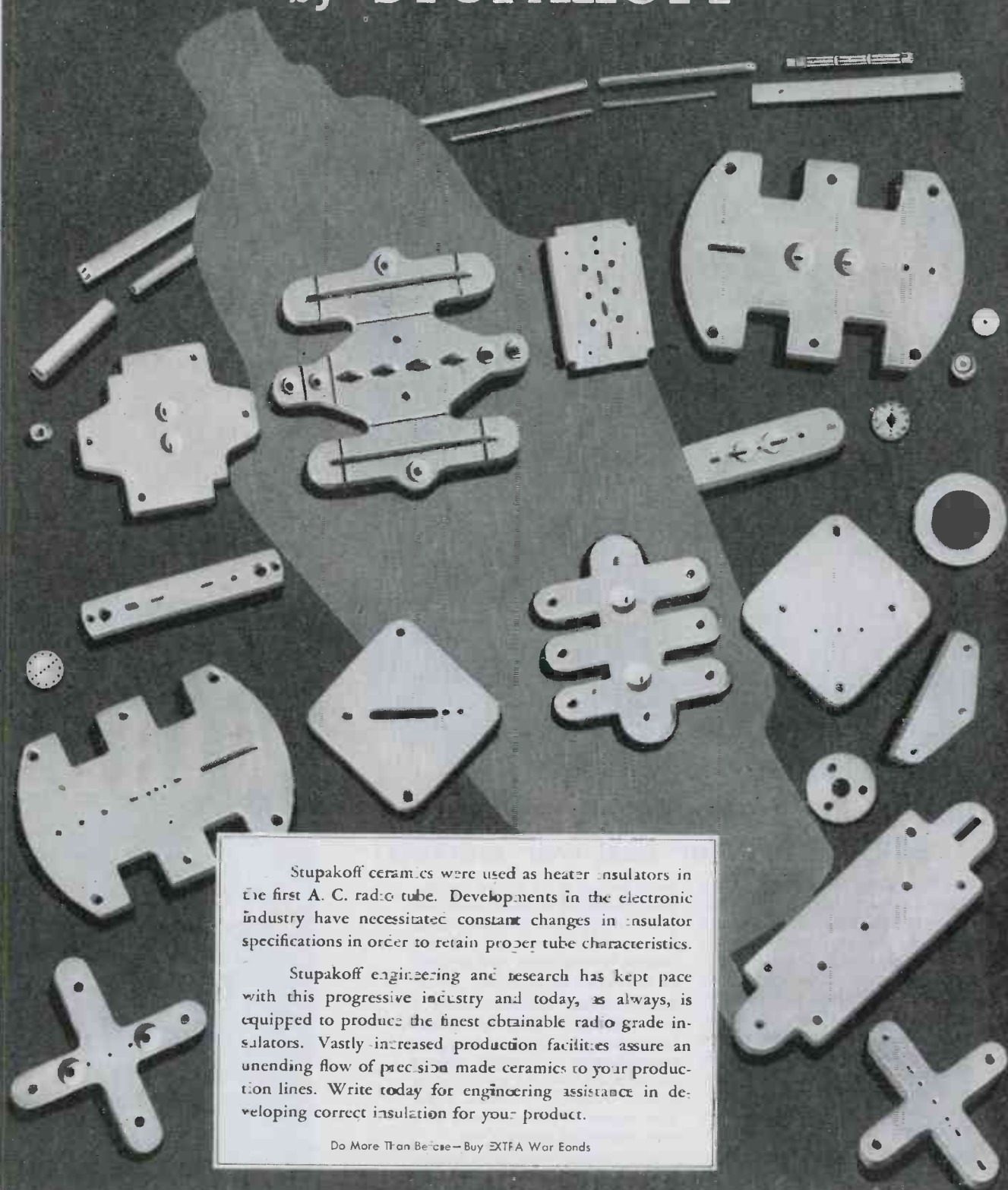

Stupakoff ceramics were used as heater insulators in the first A. C. radio tube. Developments in the electronic industry have necessitated constant changes in insulator specifications in order to retain proper tube characteristics.

Stupakoff engineering and research has kept pace with this progressive industry and today, as always, is equipped to produce the finest obtainable radio grade insulators. Vastly increased production facilities assure an unending flow of precision made ceramics to your production lines. Write today for engineering assistance in developing correct insulation for your product.

Do More Than Believe—Buy EXTRA War Bonds

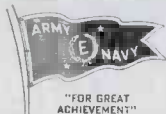

**STUPAKOFF CERAMIC AND MANUFACTURING CO., LATROBE, PA.**  
*Ceramics for the World of Electronics*

# Bogen

**SOUND  
EQUIPMENT...**

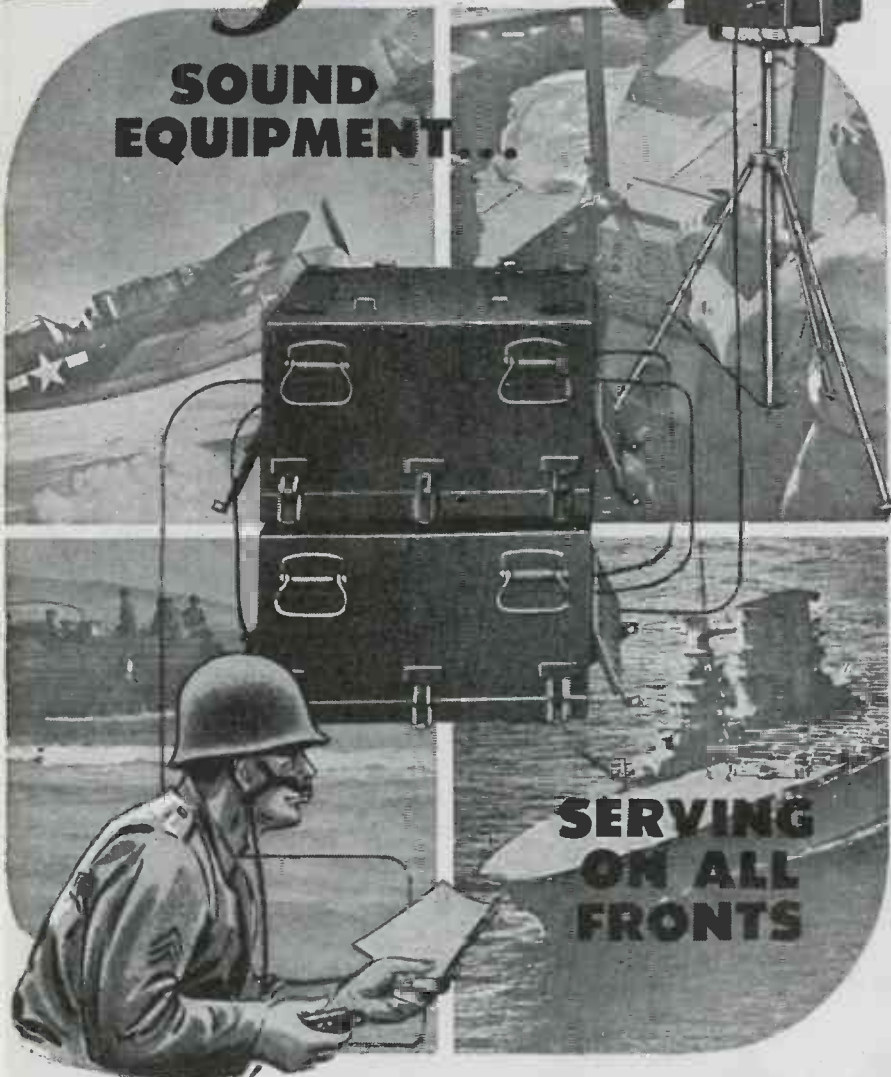

**SERVING  
ON ALL  
FRONTS**

## Ultra High-Powered Sound...another BOGEN first for post-war markets!

The BOGEN MC-225, identified by the Army as type AN UIQ-1, and by the Navy, Marine Corps and Amphibious Command as the Portable Beachmaster Announcing Equipment, is illustrated above. This system has seen extensive action in Normandy, as well as in the Battle of France in its entirety. Numerous other phases of its service include amphibious landings in the South Pacific, and more recently, a vital contribution to the success of the airborne invasion of Holland.

BOGEN sound engineers—by developing, designing and building ultra high-powered sound systems for

every branch of the Armed Forces—have gained the knowledge essential to leadership in the field. The experience gained "under fire" will lend impetus to both theory and actuality for tomorrow's applications.

BOGEN Sound Systems—setting a new standard for Industrial Program Equipment—for announcing, intercommunication and public address broadcasting—will be available for schools, hospitals, churches, industrial plants, airports, railway systems, recreation centers, etc.

BOGEN engineers are ready to assist you in the planning of sound equipment needs. Inquiries are invited.

## David Bogen CO. INC.



BOGEN SOUND SYSTEMS • AMPLIFIERS  
COMMUNO-PHONES • ELECTRONIC EQUIPMENT

663 BROADWAY, NEW YORK, 12, N. Y.

for his discovery of "Hertzian waves."

In 1885, Edison invented a system of wireless telegraphy by inductions to and from trains in motion and between moving trains and railway stations. This system was installed by the Lehigh Valley Railroad in 1887 and used for several years. In 1885 the final patent covering his ideas towards transmitting messages between ships and shore and also between ships at sea was applied for. This latter patent was sold by him to Marconi.

In 1883, in his laboratory at West Orange, Edison learned that an independent wire or plate placed between the legs of the filament of an incandescent lamp acted as a valve to control the flow of electric current. This he called the "Edison Effect," the discovery which covers the fundamental principle on which the modern radio tube is based.

### Littelfuse in New York

A New York city office at 70 Pine St., has been opened by Littelfuse, Inc., whose factories are in El Monte, Calif., and Chicago. At the same time, Jack D. Hughes, who has been production manager at the Chicago plant, has been appointed eastern division sales manager. He will be in charge of the New York office.

**CORWICO**

# WIRES

MADE BY

*Engineers* FOR  
*Engineers*

## VICTORY

concentrating upon  
for the duration . . . .

**cornish**  
WIRE COMPANY, INC.

15 Park Row, New York City, New York

**CORWICO**



# WILCO ANNOUNCES

**Larger Plant**

**New Equipment**

**Increased Facilities**

**for producing**

**TUBING**

The demand for Wilco tubing, wire and other products used in various electronic applications for the Army and Navy has caused the H. A. Wilson Company to increase its manufacturing facilities and develop new products and techniques. Both present and future customers will find these new Wilco developments of great advantage.

The H. A. Wilson Company manufactures and is interested in receiving inquiries regarding the following products—

## **WILCO RADIO TUBING**

Silver Tubing (Fine, Coin, Sterling)  
Gold Tubing (any karat)  
Gold on silver (on one or both sides)  
Gold on bronze (on one or both sides)  
Silver on copper (on one or both sides)  
Tubing made to order from special materials or any combination of materials.

## **WILCO RADIO WIRE**

Silver (Fine, Coin, Sterling)  
Silver-jacketed Invar  
Silver-jacketed Brass and Bronze  
Silver-jacketed Copper  
Gold Wire  
Gold on silver  
Gold-jacketed Bronze and Brass  
Any other type of jacketed wire desired

---

*Let us analyze your problems. Write*

## **THE H. A. WILSON COMPANY**

105 Chestnut Street, Newark 5, N. J.

Branches: Detroit • Chicago

# Meet

# "Old Faithful"

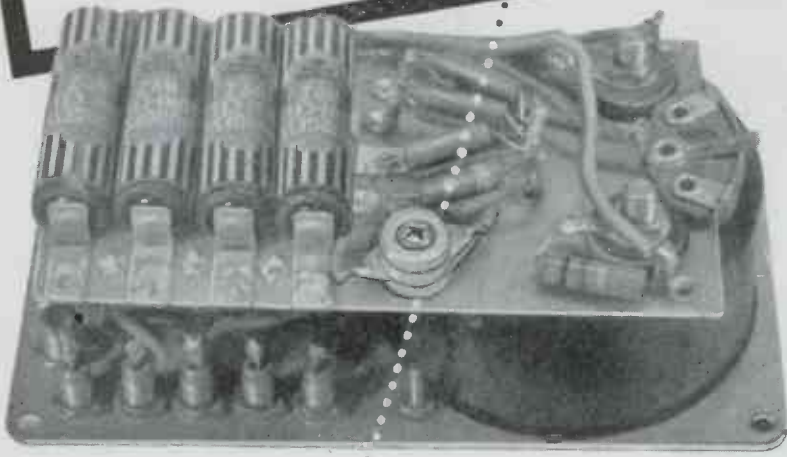

Photo courtesy  
Supreme Instruments Corp.  
Greenwood, Miss.

## Conant's SERIES 500

Series 500 (.500" diameter discs) is the general service unit of the Conant family of instrument rectifiers. Its design and construction are the result of more than eleven years of constant experience and close co-operation with instrument manufacturers.

Here is a rectifier that will take accidental overloads in its stride without damage because of its rugged construction and ample disc area.

Assembly operations are simple and speedy with its single mounting stud. For all general applications at commercial and lower audio frequencies, you'll be wise to choose Conant's "Old Faithful," Series 500.



*Instrument Rectifiers*  
**ELECTRICAL LABORATORIES**

6500 O STREET, LINCOLN 5, NEBRASKA, U. S. A.

20 Vesey St., New York 7, New York  
85 E. Gay St., Columbus, Ohio  
600 S. Michigan Ave., Chicago 5, Ill.  
1215 Harmon Pl., Minneapolis 3, Minn.

2017 Grand Ave., Kansas City, Mo.  
7935 Eustis St., Dallas 18, Texas  
4018 Greer Ave., St. Louis, Mo.  
1526 Ivy St., Denver, Colo.

4214 Country Club Dr., Long Beach 7, Cal.  
4205 N.E. 22nd Ave., Portland 11, Ore.  
Caixa Postal 930, Sao Paulo, Brazil  
50 Yarmouth Rd., Toronto, Canada

### CR TUBE

(Continued from page 107)

The power supply for the larger test unit differs from the other in that voltages are higher. In addition, an RC network is used to separate the two oscillators and amplifiers so as to prevent one pattern from modulating the other. Four VR-type tubes regulate the voltages for first anode and grid. Oscillators and amplifiers are identical.

Individual controls for focus and brilliance are located directly below each tube. Vertical hold, vertical gain, horizontal hold, and horizontal gain controls are at the lower right side of the panel. Steel pipe is used for shielding the individual cathode-ray tubes. This prevents stray magnetic and electrical fields from distorting the pattern. Centering controls are not needed. The spot will appear at the center of the screen if the shields have been properly demagnetized.

The front panel shows how three tubes can be satisfactorily mounted on a 19 x 14½ in. panel. Reduction of cost, simplification of maintenance, and conservation of space are the chief advantages credited to individual life-test units that are self-contained. A breakdown in one unit does not affect other units. Four complete life-test sets can be mounted within one vertical rack.

## El-Menco

**MOLDED  
MICA  
CAPACITORS**

IMMEDIATE DELIVERY -

ALL SIGNAL CORP. ORDERS BEARING INSPECTION AT SOURCE; INSPECTED ON PREMISES & SHIPPED IMMEDIATELY

All R.M.A. or A.S.A. color coded

A complete stock is ready for immediate shipment of quantities, ranging from 500 to 5,000 of each capacity in regular MICA CAPACITORS in 5%, 10% and 20% tolerance and silvered MICA CAPACITORS in 2%, 5% and 10% tolerances.

Write for price sheets and complete information

Territory  
'open for  
JOBBERS

SEND FOR OUR  
SPECIAL INITIAL  
ORDER OFFER

ALBERT ROTHENSTEIN

*National Distributor*

135 LIBERTY ST. New York 6, N.Y.



# RUGGED-

LIKE THE MEN WHO USE THEM

Radio transmitters and receivers are fine, sensitive instruments. • But they aren't delicate—at least not the ones in military service. • The terrific jolting and jarring received in tanks battling over desert terrain, and the tremendous strain encountered in bombers diving at enemy positions require radios that can really take it. And that's just what the U. S. Army Signal Corps and radio manufacturers have developed. • Such an achievement called for skillful design and construction, and *materials that can stand the gaff*. • Delicate elements in radio tubes are made of rugged, durable nickel. The following high mechanical properties of nickel account for its wide and successful use in tube elements.

**STRENGTH AT ROOM TEMPERATURES** — Strength properties of "A" Nickel can be altered over a wide range by rolling and annealing. However, for many radio applications a tensile strength of about 60,000 to 65,000 p.s.i. is desired in annealed nickel.

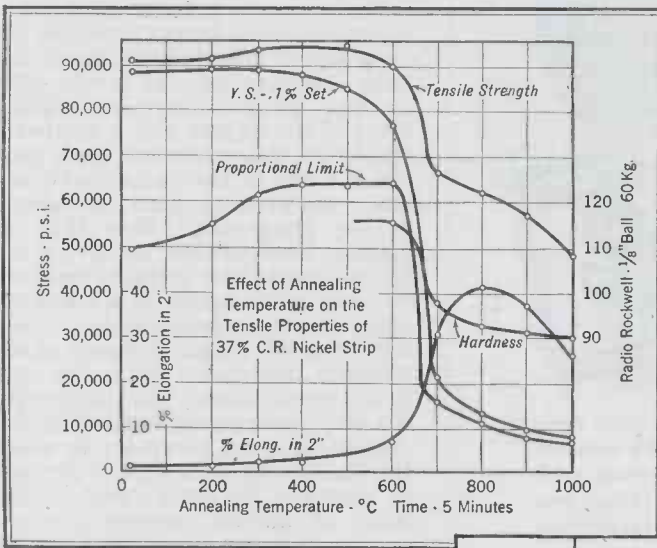

**HIGH MODULUS OF ELASTICITY**

Nickel's figure for tensile modulus (Young's) is 30,400,000 p.s.i. Assures minimum elastic displacement of tube elements. This, plus the high damping coefficient of nickel, aids in the war against microphonics.

**STRENGTH AT HIGH TEMPERATURES**

Tube parts of "A" Nickel give excellent results because of their strength at continuous elevated temperatures and withstand bombarding temperatures amazingly well.

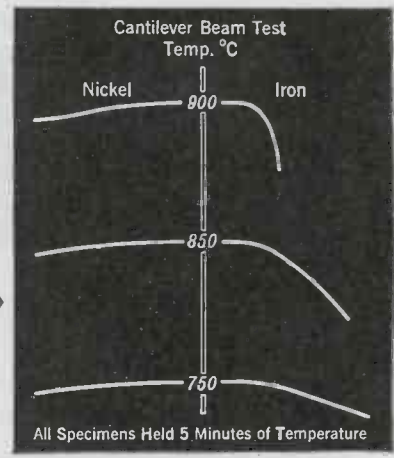

**STRENGTH AT ARCTIC TEMPERATURES**

As temperatures fall, nickel increases in strength, but unlike many ferrous metals, does *not* lose its normal ductility and toughness as measured by Charpy impact tests.

For additional information and copy of the new booklet "The Properties of Pure Nickel," please write:  
**THE INTERNATIONAL NICKEL COMPANY, INC.**  
67 Wall Street, New York 5, N. Y.

MATERIAL	Condition	Temperature °F.	Yield Strength 0.2% Offset psi.	Tensile Strength psi.	Elongation in 2 in. per cent	Reduction of Area per cent	Hardness Rockwell	Charpy Impact Strength ft.-lb.
NICKEL	Cold-drawn	Room	97,400	103,400	16.3	66.9	19C	204
		-110	101,800	112,300	21.5	60.9	22C	215

## NICKEL ALLOYS

MONEL • "K" MONEL • "S" MONEL • "R" MONEL • "KR" MONEL • INCONEL • "Z" NICKEL • NICKEL  
Sheet...Strip...Rod...Tubing...Wire...Castings Welding Rods (Gas and Electric)

# DO YOU MAKE:

## RADIO, SOUND AND COMMUNICATIONS EQUIPMENT?

Loud Speakers	Sound-powered	Vibration Pick-ups
Headsets	Telephones	Polarized Relays
Microphones	Telephoné Ringers	Generators
Hearing Aids	Voltage Regulators	Meters
Electrical Musical Instruments	Phonograph Cutting Heads	Magnetron Fields
	Phonograph Pick-ups	

## AUTOMOTIVE AND AVIATION EQUIPMENT?

Magnetos	Voltage Regulators	Generators
Tachometers	Motors	Magnetic Oil
Compasses	Speedometers	Filters

## INSTRUMENTS?

Ammeters	Oscillographs	Light Meters
Voltmeters	Flux Meters	Cardiograph
Galvanometers	Watt-hour Meters	Recorders
Seismographs	Flow Meters	Vibration Pick-ups

## MISCELLANEOUS PRODUCTS?

Magnetic Separators	Arc Blow-out Magnets	Clocks
Magnetic Chucks	Temperature and Pressure	Toys and Novelties
Magnetic Conveyors	Control Equipment	Coin Separators
Magnetic Clutches	Circuit Breakers	for Vending
Magnetic Damping Devices	Limit Switches	Equipment
	Holding Magnets	

**I**F YOU make any of the above products, it will pay you to find out how *better permanent magnets* can improve efficiency and reduce costs. Put your design, development or production problems up to The Arnold Engineering Company. Arnold engineers have been of great assistance to many manufacturers and are at your service to advise exactly what Alnico permanent magnet will solve your particular problem.



## THE ARNOLD ENGINEERING COMPANY

147 EAST ONTARIO STREET, CHICAGO 11, ILLINOIS

Specialists in the manufacture of ALNICO PERMANENT MAGNETS

## AAF EQUIPMENT

(Continued from page 103)

mately 25 feet above ground level and, with a carrier frequency of 335 megacycles, a multiplicity of lobes is obtained. The lower antenna gives the larger lobe. As more 90 cycle than 150 cycle modulated signal is radiated, the 90 cycle lobe intersects only the lower part of the 150 cycle lobe. This intersection point marks the glide-path. A glide-path angle of  $2\frac{1}{2}$  deg. is generally considered best, although angles varying between 2 deg. and 5 deg. in  $\frac{1}{4}$  deg. steps are obtained by varying the height of the two antennas on the mast.

When the glide-path signals are radiated from the antennas equally in all horizontal directions, the equi-signal zone (zone where the 90 and 150 cycle signals are equal) is shaped like an inverted cone with its apex in the ground at the base of the antenna mast.

Should the antenna mast be located on the runway it would constitute a hazard to planes. When the mast is placed a minimum of 400 ft. off the runway, the glide-path becomes a hyperbola, in which case it does not reach the ground. To make the glide-path straight and force it to the ground, the relative amounts of 90 and 150 cycle signal are varied by changing the horizontal radiation patterns of the two antennas. A study will show that a relative increase of the 90 cycle over the 150 cycle signal will lower the glide-path.

The extreme case of a 90 cycle signal infinitely larger than the 150 cycle signal would force the glide-path down to ground level. The location of the glide-path equipment at an airport and a comparison of the diagrams will show how the shaping of the horizontal radiation patterns controls the shape of the glide-path. Note that in making its approach along the localizer course, the airplane receives its glide-path signal at a continuously varying azimuth angle. Since the 90 cycle signal becomes much stronger relatively than the 150 cycle signal during this approach, the airplane is brought down to the ground. It is not necessary to make the 90 cycle signal infinitely stronger than the 150 cycle signal at the point of contact because the receiving antenna is mounted on top of the airplane. The equi-signal surface of the glide-path is like a partially opened trap door with its hinge laid perpendicular to the runway.

The method of obtaining 90 and 150 cycle modulation is illustrated. The output of the transmitter at 335 megacycles is fed into a mechanical modulator where it is divided into two channels which go to the upper and lower antennas. A tuned section of the transmission line is coupled into each of the lines



**NEW!** Get your copy of this valuable, up-to-the-minute manual on the design, production and application of modern Alnico permanent magnets. Write us, on your company letterhead, today.



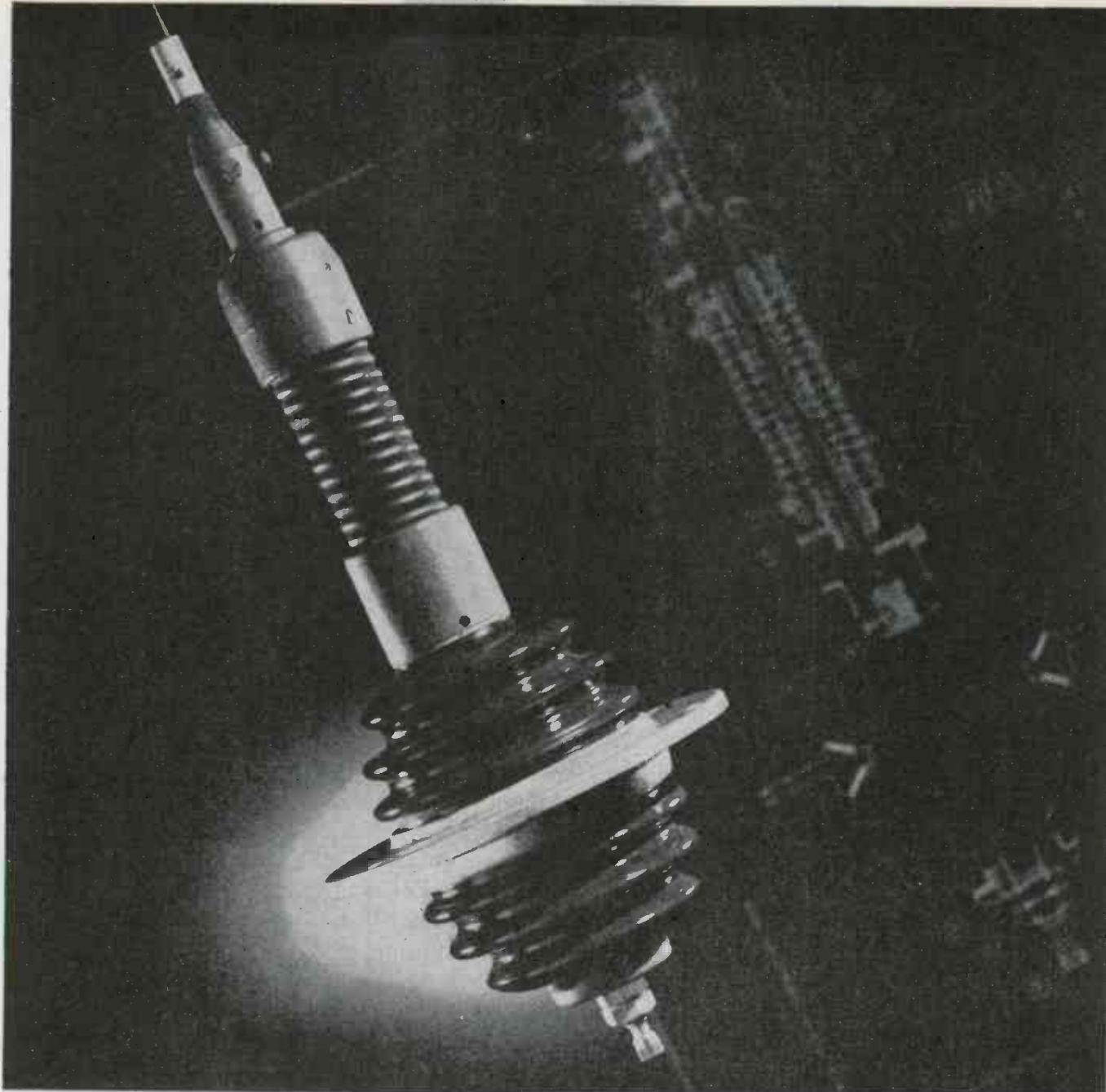

## LAPP-DESIGNED, LAPP-BUILT—TO DO A SPECIFIC JOB

This is an antenna base insulator for use on a communications center transmitter. It is one of several Lapp designs for transmitter and receiver mast bases for military vehicular radio—on jeeps, halftracks, tanks and other rolling equipment.

Whether or not this special-purpose gadget has application to anything you build or propose to build, there's a moral in it for you. In this case, as in hundreds of others, an original and impractical design was modified by Lapp engineers—to provide a part that meets all electrical and mechanical requirements, and that Lapp can build economically and efficiently.

Lapp engineering talent and Lapp production methods are such that we can say, "If it's an assembly that can be made of porcelain or steatite and metal parts, tell us what

the requirements are and how you think it might be made; Lapp will tell you how it can best be made—and will make it." Our right to that claim has been proved over and over in military electronic production; it's going to be a competitive advantage to smart post-war electronic producers. *Lapp Insulator Co., Inc., LeRoy, N. Y.*





# STEPPING UP PRODUCTION TEMPO . . .

AT its large, new, modernly equipped plant at Conneaut, Ohio, The Astatic Corporation is today supplying Microphones, Pickups, Cartridges and wartime unmentionables to the armed forces, essential industries and accredited government agencies. With all operations and departments now under one roof, Astatic looks optimistically forward into the new year with greatly increased production facilities and customer accommodations. These advantages will enable Astatic to make a quick transition to meet commercial demands when the reconversion time arrives.

**THE**  
*Astatic*  
**ASTATIC CORPORATION**  
CONNEAUT, OHIO  
IN CANADA: CANADIAN ASTATIC LTD., TORONTO, ONTARIO

**NOTE:**

● Please change Astatic address in your files to **CONNEAUT, OHIO.**

in such a manner as to prevent the passage of power.

Five blade and three blade paddle wheels are mounted on the shaft extension of a synchronous motor and are rotated between open ends of the line sections. Rotation of the paddle wheels causes the line sections to be tuned and detuned automatically, one at 90 cycles per second and the other at 150 cycles per second. By shaping the paddle wheels properly the modulation is made sinusoidal. The blocking action of the tuned line sections causes a reflection of power back to the transmitter. In order to prevent the power reflected in one channel from going out the other channel, a cross modulation bridge circuit is used.

**Phase shift control**

An examination of the bridge circuit will show that power starting from points AA will divide and travel two paths (CC and DD) to BB. Because of the transposition of two wires in the bridge circuit, the two portions of power will cancel at BB and be prevented from going to the lower antenna. The cross modulated line section which is connected at CC is designed to present the same impedance at this junction as the path back to the transmitter presents at points DD. This insures equal phase shifts at these junctions and complete cancellation at BB.

It should also be noted that this transposition results in the cancellation of power arriving from the transmitter at points CC, thus no power is dissipated in the mechanical modulator. Furthermore, the power reflected back to the transmitter causes a cyclic increase in load impedance so that the overall efficiency of the system is kept high.

Glide-path equipment supplied to the United States Army is mounted in a small portable trailer. The antenna mast is demountable and can be placed on the trailer for ease in transport. The mechanical modulator and transmitter are mounted in cabinets on the trailer in which is located a gasoline-engine-driven generator for power supply. A monitor system, operating from pickups built into the upper and lower antennas, gives audible and visual indications of abnormal operation. Provisions for remote control of the equipment are included.

The transmitter is controlled by a six megacycle crystal. The oscillator and frequency multiplying stages utilize two type 6SJ7 tubes, one 832 tube, one 829 tube and two type 8025 tubes, giving an output frequency of 335 megacycles. The power amplifier uses two additional type 8025 tubes and is connected as an inverted amplifier.

Conventional tuned circuits are

# "Tops" for Top Mounting...

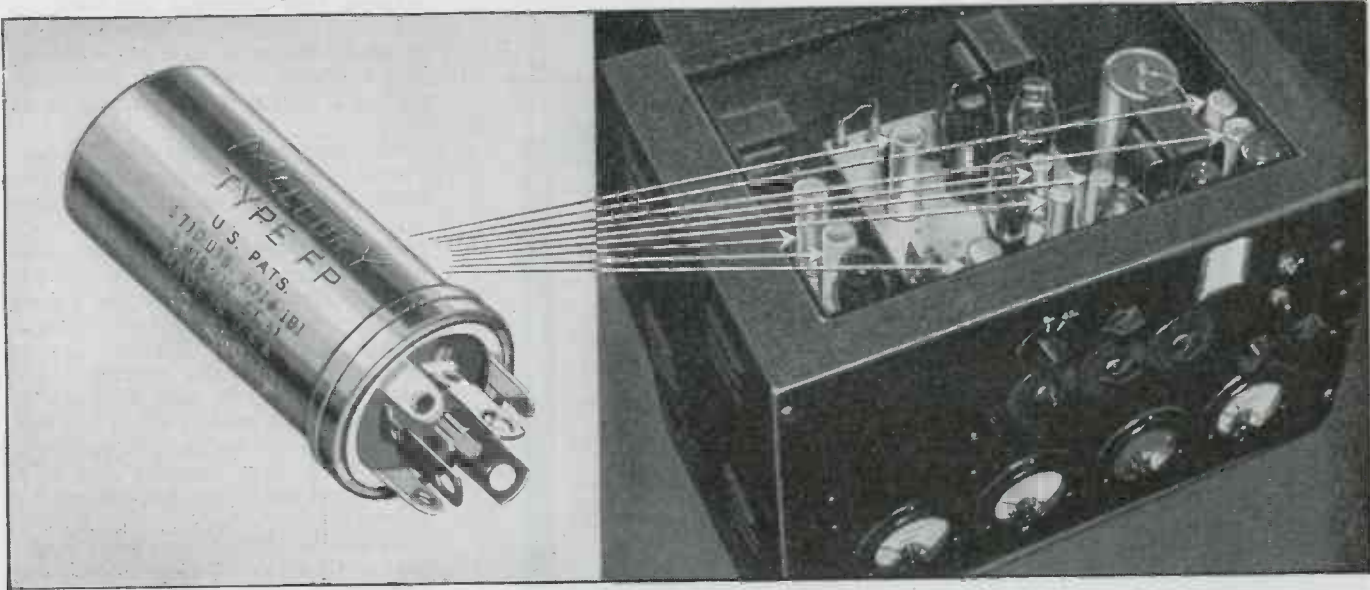

## MALLORY "FP" CAPACITORS

WHEREVER you need dry electrolytics, Mallory "FP" Capacitors are your best choice. Top chassis mounting for ease and speed of assembly is merely one advantage. Check the list of "FP" features below against your own design and manufacturing problems.

Mallory research and engineering, coupled with precision manufacturing, have built exceptionally long life into "FP" Capacitors. They save chassis space, too, since they are the smallest capacitors available for any given electrical rating.

Mallory "FP's" have been specified for the best electronic equipment . . . radio and television receivers and transmitters, the newest electron microscope, and test and laboratory apparatus of the highest quality.

Mallory "FP" Capacitors are manufactured *uniformly* to precision standards. They are ideal when you want to maintain high precision in volume production.

Check this list of "FP" advantages, and send for the Mallory catalog—containing specifications on "FP's" and many other precision electronic parts. Get your free copy of the catalog from your nearest Mallory Distributor, or write us today.

### Check List of "FP" Features

Top chassis mounting for ease in assembly and servicing.  
 "Twisted ear" mounting eliminates other hardware.  
 Internal cartridge design provides minimum coupling.  
 Identical type mounting for all rated capacities.  
 Ratings from 3000 mfd. at 10 volts to 80 mfd. at 450 volts.  
 Avoids engineering problems on special capacitors.

P. R. MALLORY & CO., Inc., INDIANAPOLIS 6, INDIANA



P. R. MALLORY & CO. Inc.  
**MALLORY**  
 Electrolytic,  
 Film and Paper  
**CAPACITORS**



# Precision-Accuracy IN CRYSTALS



**BROADCAST**

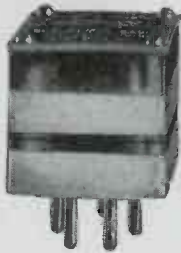

Type SR-2V. Adjustable mounting permits setting low drift crystal to exact frequency. Available with or without heating unit.

**100 KC STANDARD**



Type SR-100. 100 Kc crystal unit. New design—new stability. Designed for mounting in standard five-prong tube socket.

**POLICE**

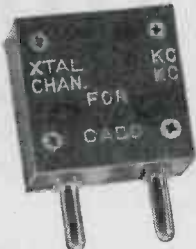

Type SR-P. Standard three-quarter inch AT or BT, pressure mounted. Available in frequencies from 1 Mc to 5 Mc. Special cuts to order.

**AIRCRAFT**



Type SR-F. Typical of a wide variety of crystals carried in stock for civilian aircraft requirements. Available in all standard frequencies.

used for all frequencies up to 111 megacycles and for the 8025 tripler stage and 8025 output stage transmission line elements are used for interstage coupling. Approximately seven watts of modulated power are radiated from the antennas, giving a range of approximately 15 miles.

Airborne equipment for the approach system comprises glide-path, localizer and marker receivers. The marker receiver is normally installed in all medium and heavy aircraft for use on the marker stations which form a part of the range navigation system within the United States. Localizer and glide-path receivers are being installed in new aircraft at factories and modification centers and are also being retroactively fitted in certain theaters and in a number of Air Transport Command aircraft.

In the airborne instrument landing equipment, the localizer and glide-path signals are received either on a combination antenna (AS-27/ARN-5) or on two separate antennas (AN-100A and AS-61/ARN-5), depending on the type of airplane involved. The pilot is provided with a small control box which gives him selection of six receiving channels for the localizer combined with three channels for

**SCIENTIFIC RADIO PRODUCTS CO.**

## SETS THE PACE!

There's always a trail-blazer with the birth of a new industry. At Scientific Radio Products we were among the first to pioneer and introduce mass production of faultless crystals to serve our nation at war. Latest development of our research engineers is a new plated crystal recently approved by the Signal Corps.

Today, in Scientific crystal units you have the **UNBEATABLE COMBINATION** of modern design,

rugged construction, jewel-like precision and time-tested performance—advantages which have made our crystals first choice with those seeking the finest.

Your plans may include equipment in which crystals are used. Perhaps other developments of our engineers may be just what you're looking for. Call on us. We'll be glad to work with you on any problem.

*Scientific Radio Products Company*

**738 W. BROADWAY, COUNCIL BLUFFS, IA**

LEO MEYERSON W9GFO  
E. M. SHIDLER W9IFI

MANUFACTURERS OF PIEZO ELECTRIC CRYSTALS AND ASSOCIATED EQUIPMENT

**Immediate Delivery!**  
**WIDE RANGE  
VACUUM TUBE  
VOLTMETERS**



- High input impedance for both AC and DC measurements.
- Convenient, low capacity "Probe" especially adapted to high frequency radio use—100 megacycles and over.
- Self-regulating operation from power line; no batteries.
- Multiple voltage ranges—accurate and stable.

*Bulletin on Request*

**ALFRED W. BARBER  
LABORATORIES**

34-04 Francis Lewis Blvd. Flushing, N. Y.

# Why MICRO SWITCH

## Provides a Long Snap-Action Life

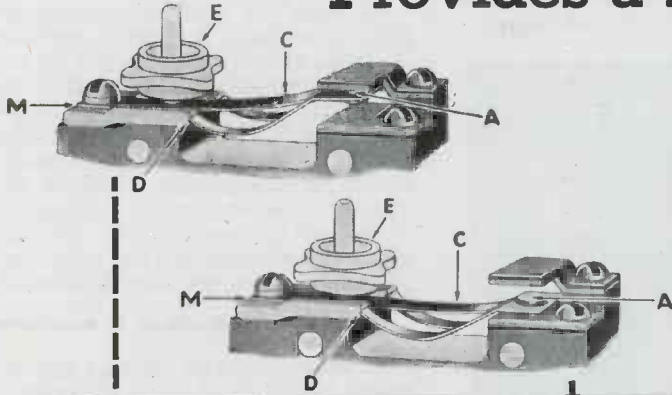

### Micro Switch Operating Principle

The operating principle of the Micro Switch as illustrated here is simple and fundamentally correct. The long member of the one-piece spring "C" is supported as a cantilever at "M". The two shorter compression members of the spring rest in specially shaped (patented) V's. When the plunger "E" deforms the long tension member, the cantilever force overcomes the vertical force supplied by the compression members and the free end of the spring "A" snaps the contact from one stop to the other with lightning-fast speed. Snap action in the reverse direction occurs when the deformation of the tension members of the spring by plunger "E" is removed.



This one-piece beryllium copper spring is heat treated to provide the high fatigue resistance necessary to insure a minimum of 5,000,000 trouble-free mechanical operations, at full overtravel.



The rivet type contact is of superfine silver 99.95% pure.



The operating plunger is a highly polished, hard, stainless steel pin molded into an accurate Bakelite head. This head is so shaped that it cannot rotate, hence bears on the switch spring at the same point through millions of operations.

The basic Micro Switch is a thumb-size, feather-light, plastic enclosed, precision, snap-action switch, Underwriters' listed and rated at 1200 V. A., at 125 to 460 volts a-c. Capacity on d-c depends on load characteristics. Accurate repeat performance is experienced over millions of operations. Wide variety of basic switches and actuators meets requirements varying from high vibration resistance to sensitivity of operating force and motion as low as 2/1000 ounce-inches. Many types of metal housings are available.

© 1944



**MICRO** MARK  
TRADE **MS** **SWITCH**

A DIVISION OF FIRST INDUSTRIAL CORPORATION

FREPORT, ILL., U.S.A., Sales Offices in New York, Chicago, Cleveland, Los Angeles, Boston, Dallas, Portland, (Ore.)

Micro Switch provides lightning-fast, snap-action control of electric circuits with reliable and positive operation accurately repeated over millions of cycles.

This performance is made possible by use of the unique, field tested, and proven operating principles of the Micro Switch. The snap motion of the Micro Switch contact is in the same direction as that of the operating plunger. There are no reverse bends in the Micro Switch spring, and there is no life-limiting "oil can" action.

The experience of design engineers with millions of Micro Switches in a great variety of applications has shown performance ability and operating characteristics never before found in snap-action switches.

Its small size, its high electrical rating, its ability to operate satisfactorily for millions of operations on minute movement and force differentials, its availability in various types of housings and a wide range of actuators . . . have made Micro Switch the choice of design engineers for precise operation of many types of plant equipment.

*Micro Switch Handbook-Catalog No. 60* will give you complete details as to electrical characteristics, construction, applications and dimensions. If you happen to be specializing in aircraft equipment, also send for *Handbook-Catalog No. 70*.

### HUNDREDS OF SPOTS FOR MICRO SWITCHES



An explosion-proof Micro Switch is used with a spray gun to cut off the ventilating system of the spray booth automatically when the gun is hung up.



Micro Switches are used as safety switches on high tension cabinet doors. A normally open switch breaks circuit as door is opened.

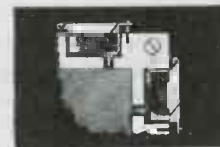

Two Micro Switches with spring type plungers are used to insure correct position of material in jigs and fixtures.

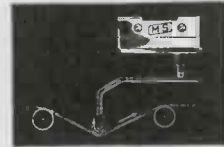

Spring plunger Micro Switches serve as break indicators in textile and paper mills.

... USES



UNLIMITED

"Uses Unlimited"—a dramatic talking motion picture of Micro Switches, in color, is available to industrial groups, training classes, schools and colleges, through Y.M.C.A. Motion Picture Bureau, New York, Chicago, San Francisco. Size: 16 mm. Length: 40 minutes. Write us for details.

A star has been added to our "E" flag as further recognition to the men and women of Micro Switch for maintaining our war production standards.



Let's All Back the Attack—Buy Extra War Bonds

# PORTABLE POWER PROBLEMS

THIS MONTH—BRISTOL PYROMASTER



**INDUSTRIAL PROCESSES** are accurately recorded, indicated and controlled by the Bristol Pyromaster Self-Balancing Potentiometer. In the illustration above, a Pyromaster maintains temperature control of a gas-fired furnace, used for case hardening steel parts.

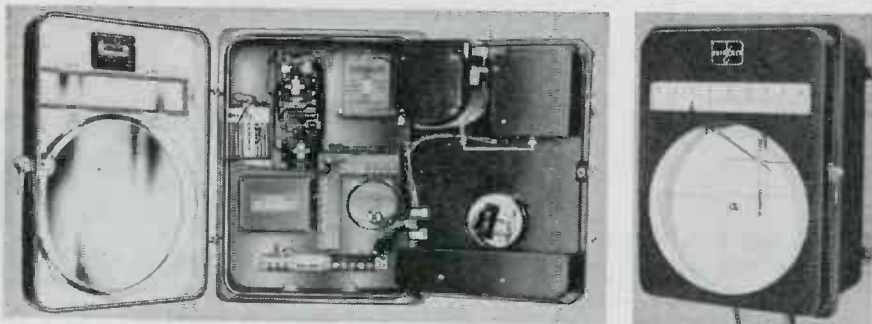

**DIRECT MARKING** pen moves instantly and continuously at the rate required to follow temperature variations. A 1½ volt Burgess Battery supplies constant current to the potentiometer circuit. Burgess Industrial Batteries are designed to meet the exacting specifications of many special instruments. Your portable power problems can be solved by Burgess engineers. Write us today about your specific needs, or send coupon for free Engineering Manual. Burgess Battery Company, Freeport, Illinois.

## FREE . . . 80-PAGE ENGINEERING MANUAL!

31 descriptive pages, 25 charts and 35 data tables on dry battery characteristics for electronic applications. Tabbed for ready reference. Write Dept. 8 for your free copy. Burgess Battery Company, Freeport, Ill.

Name . . . . .  
 Company . . . . .  
 Address . . . . .  
 City . . . . . State . . . . .



# BURGESS BATTERIES

the glide-path. The proper glide-path channel for use with the selected localizer channel is automatically taken care of by proper control box wiring at the time of installation.

In using the approach system the pilot is brought to within perhaps 20 miles of the landing field by ordinary navigational methods. In the United States, for example, such methods would include the radio range system and the automatic radio compass, while in the various theaters such navigation would be performed with the aid of the particular radio systems being employed in the specific theater.

### Landing procedure

At this point the landing system would be switched on to the proper channel, the localizer would be bracketed and flown at a safe cruising altitude until the glide-path is intersected approximately 13 miles from the field, at which time descent along the glide-path would be begun. Lowering of wheels and flaps, reduction of power, increase of rpm, etc., in preparation for final landing would then be made at the pilot's discretion, but this part of the operation should be complete before the outer marker was reached.

Descent on the glide-path while maintaining the localizer alignment would then be continued until the airplane broke out below the overcast, at which time normal descent to a visual landing would be made.

It has been determined by flight experience that a skilled pilot can continue down the instrument approach system to make a complete blind landing on the runway, but it is believed that operationally this will not be initially attempted, but rather the system will be used as an aid to low approach, the final landing being completed visually with the aid of landing lights.

A complete instrument landing installation is shown. It can be seen that the localizer defines a vertical plane giving lateral guidance to the pilot. The glide-path defines an inclined plane that gives vertical guidance, enabling the pilot to maintain the proper rate of descent. The intersections of the localizer and glide-path planes give the true path for the airplane to follow. A check of the progress of the plane along this path is provided by markers which provide reference points along the path and permit the pilots to verify their positions and altitudes.

In the plane the impulses sent from the glide-path and localizer transmitters are picked up by conventional receiving equipment and conducted to a cross pointer instrument which is a simple double dc milliammeter. The vertical pointer indicates right or left de-

# NEW OHMITE

## ARMY-NAVY AIRCRAFT

### RHEOSTATS

*with New Improved, Control Protection*



**TOTALLY ENCLOSED**  
for use in  
**SPECIAL APPLICATIONS**



Smooth, Close,  
Dependable  
Control Under  
Every Service  
Condition of  
**HEAT COLD**  
**HUMIDITY**  
**ALTITUDE**  
**SHOCK**  
**VIBRATION**

Made in Two Sizes:  
Model "J" 50 - watt  
Model "H" 25 - watt  
Linear or Taper  
wire-wound, in various  
resistances, with or  
without "off" position.

These new Ohmite Power Rheostats are made in accordance with the latest AN-R-14a (Drawing AN3155) aeronautical specifications. They offer the advantage of all the time-proved Ohmite rheostat features *plus* new improved control protection. Each unit is totally enclosed in a compact, corrosion-resisting drawn metal enclosure.

Control engineers desiring the utmost in performance and service will find further applications for these enclosed rheostats in the control of critical equipment for war and postwar. Write, wire or phone for further information.

**OHMITE MANUFACTURING CO.**  
4983 FLOURNOY ST., CHICAGO 44, U. S. A.

*Be Right with* **OHMITE**  
**RHEOSTATS • RESISTORS • TAP SWITCHES**

# Modern Components for the Modern Radio by Micarta Fabricators



Call in a  
Micarta engineer  
to consult with you on  
your postwar planning.  
Our complete facilities  
are at your service for the  
manufacture of Terminal Strips, Coil  
Forms, Jack Plugs, Battery Plug  
Assemblies, Resistor Boards, Dialites,  
and other modern components.

Write for our new Catalog No. 101.

Serving the Radio and Electronic Industries for over 20 years

## Micarta Fabricators, Inc.



5324 RAVENSWOOD AVENUE, CHICAGO 40, ILLINOIS, TELEPHONE LONGBEACH 9700

Operating Notes on

## INDUSTRIAL ELECTRONICS

by Arthur G. Mohaupt, B. A., M. S.

**NOTHING ELSE LIKE IT! DOWN-TO-EARTH INFORMATION FOR THE PRACTICAL ELECTRONIC TECHNICIAN**

A practical, useable **ELECTRONIC MANUAL**. A valuable aid to foremen, superintendents, engineers, electrical contractors, electricians—to *everyone* interested in Electronic Control devices. Packed with practical data on Thyratrons, Ignitrons, Electronic Lighting, Induction and Dielectric Heating; Photo Tubes, Photo Control devices, Relays and Timers, Resistance Welding Control, Electronic Motor Control, etc. Replete with charts, diagrams and timely data on the functions, installation, operation and maintenance of Electronic Control devices. **SEND FOR YOUR COPY TODAY!**

De FOREST'S TRAINING, INC., 2531 North Ashland Ave., Chicago 14, Ill.  
I am enclosing \$10.00 for Arthur G. Mohaupt's "OPERATING NOTES ON INDUSTRIAL ELECTRONICS." If not satisfied, I will return book in 5 days for full refund.

Name .....  
Address .....  
City ..... State ..... BEI-1

A valuable digest of 12 lectures given to engineers and practical electronic technicians from over 50 leading manufacturing concerns. Many helpful charts and diagrams.

flection from the true localizer course and the horizontal pointer indicates up and down variations along the glide-path. The two pointers cross in the center only if the correct glide-path and localizer course are being followed.

The precision and reliability of this system is such that it can be used not only for the guidance of the pilot by means of the cross-pointer instrument but also can be used to control the plane automatically. Existing models of automatic pilot are being equipped for control by the instrument landing signals.

### HEARING AID

(Continued from page 106)

mental concentration will make up the difference for a short time. Several hours of concentration, though, are rather fatiguing, after which a customer can tell the difference as to harmonic distortion.

Aids are worn much longer than they used to be—12 to 14 hours a day is very common. The fatigue factor explains why many inexpensive units sold in past years are now unused.

A belief in modern engineering ingenuity makes the hard of hearing expect better performance without significant increase in battery drain and without increase in physical size. This has been realized

## Introducing the new AIRCO GAS PROPORTIONER



**A convenient, accurate  
gas mixing device**

The Airco Gas Proportioner is a new development, designed to meet the needs of electronic tube manufacturers using mixtures of gases for protective atmospheres. It produces an accurately proportioned mixture of gases at a pressure not in excess of 5 psi. Various flowmeters can be supplied to permit flows of hydrogen of approximately 2 to 200 cfh. and of nitrogen of approximately 6 to 140 cfh.

Write to Air Reduction, New York, Dept. EI for a descriptive folder.

★ BUY UNITED STATES WAR BONDS ★

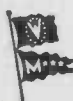

### AIR REDUCTION

60 East 42nd St., New York 17, N. Y.  
Offices in all principal cities





## COLLINS ENGINEERING AND EIMAC TUBES *achieve outstanding results*

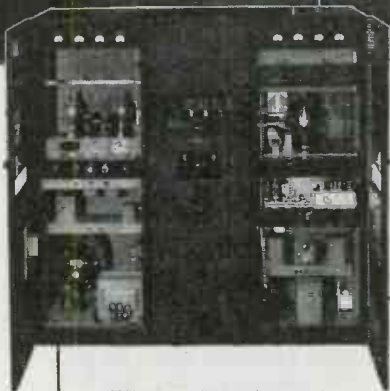

COLLINS Type 231D-11 (Navy TDH)  
Multi-frequency transmitter

Output CW—5 KW; Output Phone—3 KW 100% modulated with a pair of Eimac 450TL tubes in class "B" audio; continuous coverage from 2 MC to 18.1 MC with 11 preset channels in that range and complete manual coverage throughout whole range. Capable of completely unattended remote control operation and of A1, A2 and A3 type emission. Audio characteristics: plus or minus three DB from 150 to 3,500 cycles. Total harmonic distortion less than 10%. The transmitter can be terminated into a 50 to 1,200 pure resistive load at zero degrees phase angle. 70 to 850 ohm load at plus or minus 45 degrees and 100 to 600 ohms at plus or minus 60 degrees.



Write for your copy of Electronic Telis — a 64 page booklet fully illustrated — covering fundamentals of Electronics and many of its important applications. Written in layman's language.

This Collins type 231D-11 (Navy TDH) radio transmitter is an outstanding demonstration of the value of capable engineering coupled with the intelligent choice and use of vacuum tubes.

It is the latest of a series of Collins Autotune, quick shift transmitters which were originally introduced in 1939, and which use Eimac tubes in the important sockets. In the 231D-11, two Eimac 750TL tubes in parallel make up the power amplifier, while a pair of Eimac 450TL tubes in class "B" are used as modulators for voice and MCW emission.

Mr. F. M. Davis, General Manager of the Collins Engineering Division, says: "Eimac tubes have been found to be reliable, rugged and capable of withstanding the severe overloads encountered during equipment tests, without damage." Statements like this, coming from such men as Mr. Davis, offer proof that Eimac tubes are first choice of leading engineers throughout the world.

Follow the leaders to  
**Eimac**  
REG. U. S. PAT. OFF.  
**TUBES**



Eimac has received  
8 ARMY-NAVY "E" AWARDS  
for production efficiency  
San Bruno 5, Salt Lake City 3

EITEL-McCULLOUGH, Inc., 956 San Mateo Ave., San Bruno, Calif.

Plants located at: San Bruno, California and Salt Lake City, Utah

Export Agents: Frazer & Hansen, 301 Clay Street, San Francisco 11, California, U. S. A.

# ELECTRONICS



# Postwar

IN PEACETIME, Boonton Radio direct reading instruments were standard equipment for the Electronic Laboratory.

IN WARTIME, these dependable instruments are on the Front Lines safeguarding and protecting our fighting men against Communication Failures.

POSTWAR, these instruments will again be available for the Electronic Industry contributing to the development of the New Era of Electronics that is to come.



## BOONTON RADIO

BOONTON, N. J.

Corporation



DESIGNERS AND MANUFACTURERS OF THE "Q" METER . . . QX-CHECKER . . . FREQUENCY MODULATED SIGNAL GENERATOR . . . BEAT FREQUENCY GENERATOR . . . AND OTHER DIRECT READING TEST INSTRUMENTS

# RADIART AERIALS



## RADIART IS READY:

With a completely designed line of Radiart Quality Jobber Aerials. . . .

With eight numbers to cover the entire replacement field, according to our past experience. . . .

And embodying the proposed changes in new auto radio sets. . . .

Ensuring outstanding quality and performance for all replacement applications.

PRICES WILL BE COMPARABLE. . . . QUALITY WILL BE SUPERB. . . . Deliveries will be as prompt as war conditions and government regulations permit.

RADIART JOBBERS CAN DEPEND ON RADIART FOR AERIALS.

# Radiart Corporation

3571 W. 62nd. St.

CLEVELAND 2, OHIO

to a high degree. However, unusually low operating cost is not a long-time sales feature if it is a result of poor performance.

Distortion in the acoustic output of the product of one manufacturer, has been held below .2 per cent at 100 db, 1,000 cycles, and below 2 per cent at 95 db, 600 cycles. This has been achieved with a frequency range of 200 to 4,000 cycles, viz. it does not represent harmonic attenuation by narrowing of frequency range.

It is not very hard to secure low harmonic distortion at 1,000 cycles and above, though some units have not succeeded. Since the cost of attaining suitable performance is concentrated chiefly in the region below 1,000 cycles, some low-priced aids fail here. This is disastrous, for most of the energy in speech is concentrated below 1,000 cycles. Unskillful cutting of corners, has introduced in one low-cost unit about 35 per cent distortion at 600 cycles at the same output where the above mentioned unit has under 2 per cent. In general, experience shows that a test at 600 cycles is a very good index of low frequency performance.

### Allergic reactions

As is usual when electronic devices are engineered for entirely new fields of application, in addition to the somewhat familiar problems of frequency range, adjusted frequency response and harmonic distortion, there are a number of wholly new problems which must be considered. For example, the components of a hearing aid being rather intimately worn, allergic reaction must be prevented. The case material, the battery cord cover material and dye, and the battery carrier cover must be checked. A few people are allergic to all battery cord textile braid materials and it has been found necessary to cover the textile with plastic for them.

The standard hearing aid receiver is carried on a custom molded cast acrylic ear piece, which supports the receiver weight and cord pull on the outer ear, while making a smooth acoustically snug fit to the ear canal. The problem of making the original ear impression from which the acrylic is cast, has been a serious one and it has become obvious that the best way to get the casts made accurately is to have the hearing aid dealer do it himself. It is an art, and considerable training is necessary.

The customer insists on high amplification—hence a sensitive microphone and a good amplifier. Then he wears the microphone and insists that he hears almost no noise from clothing rubbing the case, cord vibration, and other causes. Curiously, he can be satisfied and

in at least one product, the case noise has been reduced below the threshold of audibility of the hard of hearing. Different makes of hearing aids differ from one another in case noise by 15 to 20 db, depending on the skill of the designer.

Servicing presents many problems, of which the instrument itself is the smallest part. A few individuals have perspiration of such a nature that it will corrode even monel metal, silver, and beryllium copper. For the others, use of highly corrosive resistant materials is adequate.

Permanent magnets (used in air conduction receivers and bone oscillators) are somewhat of a problem. Nearly every magnetic receiver that comes in for servicing needs re-magnetization. Likewise, many come in all fouled up with magnetic dust.

"Impaired hearing" or "hearing defect" refers to any degree of impairment at all. Probably most of the readers of this magazine have a hearing impairment—since even 5 db loss between 8,000 and 12,000 cycles would be an "impairment," but that impairment is, for practical purposes, wholly negligible.

"Hard of hearing" refers to an impairment which is great enough to have social or business effect. This group is only a minute fraction of the total. It is well rec-

## VACUUM TUBE DESIGNER

An Eastern manufacturer has an attractive opportunity for a graduate physicist or electrical engineer with several years of practical experience in vacuum tube design. It is necessary that applicants have sufficient production experience to develop designs which will improve quality and reduce cost through lowered shrinkage.

Furnish full details regarding experience, education, age, and salary requirements.

Box Y-12  
ELECTRONIC INDUSTRIES  
480 Lexington Avenue  
New York 17, New York

## IMPORTANT NOTICE TO SUBSCRIBERS OF ELECTRONIC INDUSTRIES

The present edition of the ELECTRONIC ENGINEERING HANDBOOK, published April, 1944, is almost exhausted. Paper rationing has precluded any immediate re-printing. With only a few hundred copies remaining it is necessary to renew your subscription to ELECTRONIC INDUSTRIES now, if you did not receive the HANDBOOK with your present subscription.

Unanimously praised by leading engineers, it specializes in communications and industrial electronic applications, and is edited by Ralph R. Batcher and William Moulic of the staff of ELECTRONIC INDUSTRIES. The HANDBOOK may be obtained with new or renewal subscriptions only. Two years at \$6.00 or three years at \$7.50. It is not for sale and when this edition is out of print shortly, there will be none available.

**ELECTRONIC  
INDUSTRIES**

**CALDWELL-CLEMENTS, INC.**

480 Lexington Avenue New York 17, N. Y.

## Keep Electronic Tube PRODUCTION - ON - SCHEDULE

with **GOAT**

*Precise-formed*

**DRAWN . .  
SHAPED . . STAMPED  
METAL PARTS**

Deliveries-on-schedule by Goat take one of the big headaches out of purchasing and production. Accurately made Goat precise-formed parts cut assembly time and improve tube performance.

**For Over 15 years . .**

Goat's dependable delivery of uniform high quality parts has been helping to keep production on schedule.

**GOAT METAL STAMPINGS, INC.**

AFFILIATE OF THE FRED GOAT CO., INC. • EST. 1893  
314 DEAN ST., BROOKLYN 17, N. Y.

# Oil Type EC CAPACITRONS

... Ready to Meet Your Requirements!

Up to 10 MFD. Capacity



Sturdy Single Hole Mounting

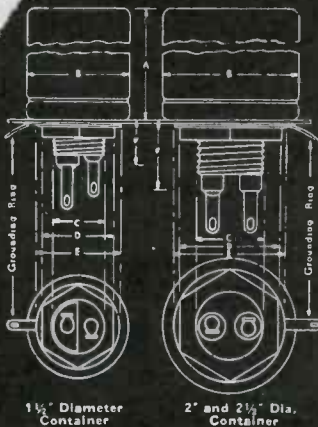

No Brackets Needed

Catalog Number	Capacity in Mfd.	Working Voltage D.C.	DIMENSIONS IN INCHES					
			A	B	C	D	E	F
6EC200	2.0	600	2 3/4	1 1/2	3/4 x 16th	1	1 1/4	3/8
6EC300	3.0	600	4 1/2	1 1/2	3/4 x 16th	1	1 1/4	3/8
6EC400	4.0	600	4 1/2	1 1/2	3/4 x 16th	1	1 1/4	3/8
6EC600	6.0	600	4	2	1 x 14th	1 1/8	1 3/8	1
6EC800	8.0	600	4 1/2	2	1 x 14th	1 1/8	1 3/8	1
6EC1000	10.0	600	4	2 1/2	1 x 14th	1 1/8	1 3/8	1
10EC100	1.0	1000	2 3/4	1 1/2	3/4 x 16th	1	1 1/4	3/8
10EC200	2.0	1000	4 1/2	1 1/2	3/4 x 16th	1	1 1/4	3/8
10EC400	4.0	1000	4	2	1 x 14th	1 1/8	1 3/8	1
10EC600	6.0	1000	4	2 1/2	1 x 14th	1 1/8	1 3/8	1
10EC800	8.0	1000	4 1/2	2 1/2	1 x 14th	1 1/8	1 3/8	1
15EC50	.5	1500	2 3/4	1 1/2	3/4 x 16th	1	1 1/4	3/8
15EC100	1.0	1500	4 1/2	1 1/2	3/4 x 16th	1	1 1/4	3/8
15EC200	2.0	1500	4	2	1 x 14th	1 1/8	1 3/8	1
15EC400	4.0	1500	4 1/2	2 1/2	1 x 14th	1 1/8	1 3/8	1

All of the Above A.W.S. Army-Navy Submersion Proof Units Available in Production Quantities for Prompt Delivery. Write, Wire or Telephone — Now!

The CAPACITRON Company

849 North Kedzie Ave.,  
Chicago 51, Illinois  
Telephone VAN Buren 3322

OUR NEW HOME - America's Most Modern Capacitor Manufacturing Plant

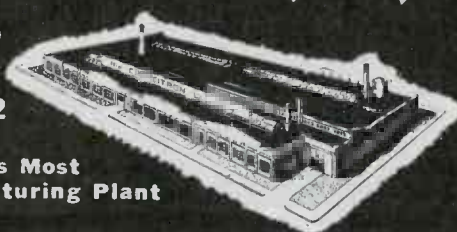

ognized that an average loss of at least 40 db in the frequency range 512 to 2,048 cycles is necessary to put one in this class.

## Market possibilities

Many studies have been made of the size of these groups. The earlier ones, performed with inadequate apparatus and with no good control of ambient conditions, may be dismissed at once. Perhaps one of the most authoritative is the Hearing Studies Series of the U. S. Public Health Service. These indicate about 1 1/4 per cent of the population has a loss of 47 db or up in the range 1,024 to 2,048 cycles, or about 1,700,000. Since 40 db, not 47, is the dividing line, we may increase the number by 15 per cent, making it about 1,955,000 total hard of hearing.

About 10 per cent of these are uncorrectible due to amount or type of loss; for example, this would include the 57,000 deaf mutes reported in the survey. This reduces the total which can be helped to about 1,800,000.

Experience shows that about 40 per cent of that number will not buy an instrument due to vanity or other reasons. This reduces the total probable market to about 1,080,000. This would include the number of aids already in use. Early in 1944 the WPB estimated

# BIRD & CO. GLASS INSTRUMENT BEARINGS

GLASS "V" BEARINGS  
made to your specifications



We welcome your inquiries

RICHARD H. BIRD

Manufacturers of Jewel Bearings  
for thirty years

23 MOODY STREET  
WALTHAM, MASS.

# PLATING

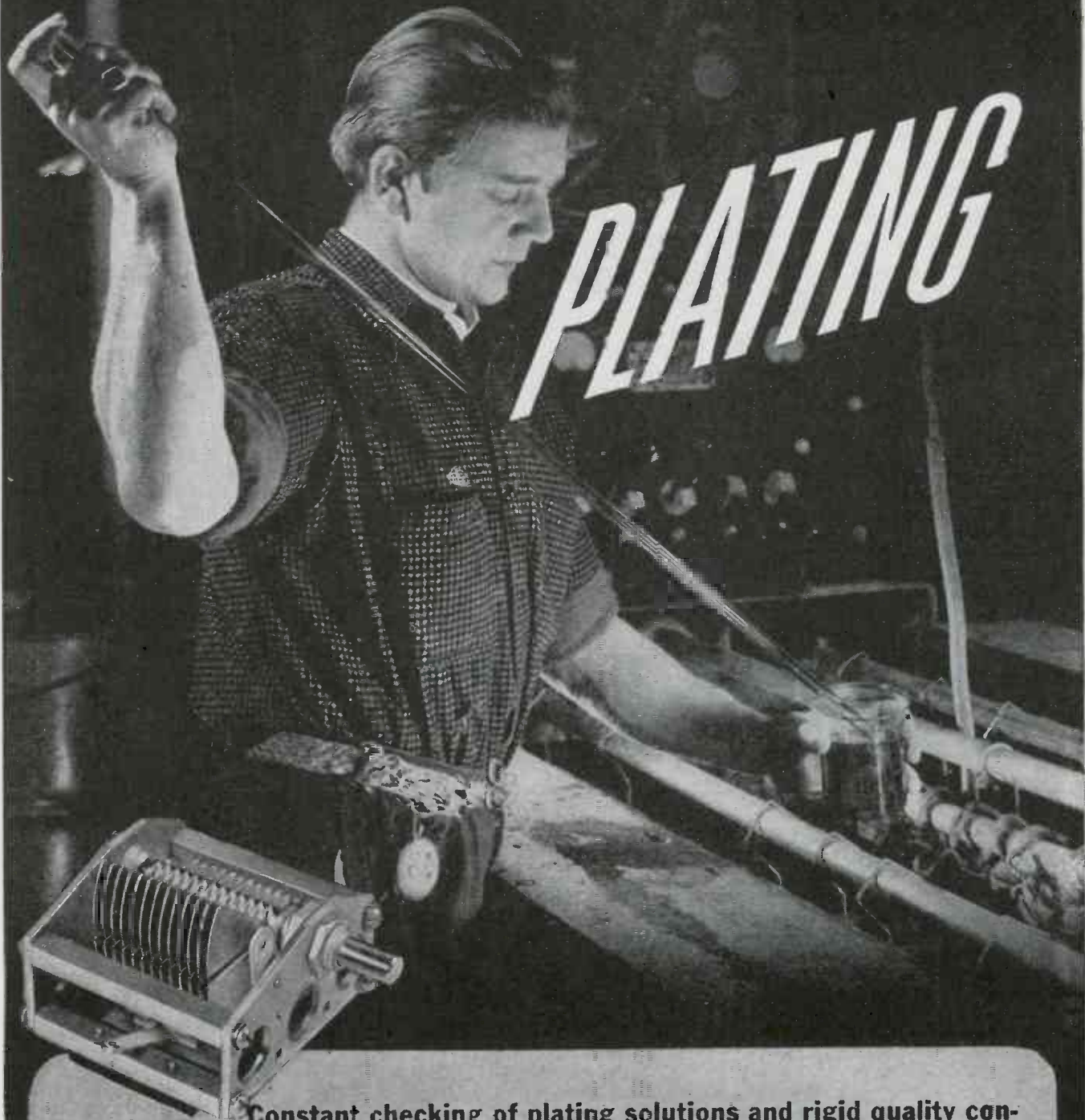

Constant checking of plating solutions and rigid quality control gives Hammarlund variable capacitors a finish that will last a lifetime under practically every operating condition.

# HAMMARLUND

THE HAMMARLUND MFG. CO., INC., 460 W. 34<sup>TH</sup> ST., N. Y. C.  
MANUFACTURERS OF PRECISION COMMUNICATIONS EQUIPMENT

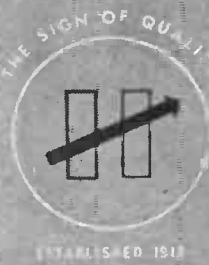

# CONNECT 2 to 12 WIRES

**BURKE** Terminal blocks provide for the centralized connection of numerous wires at one point of control. Sizes are available to handle 2, 4, 6, 8, 10 and 12 wires in one block.

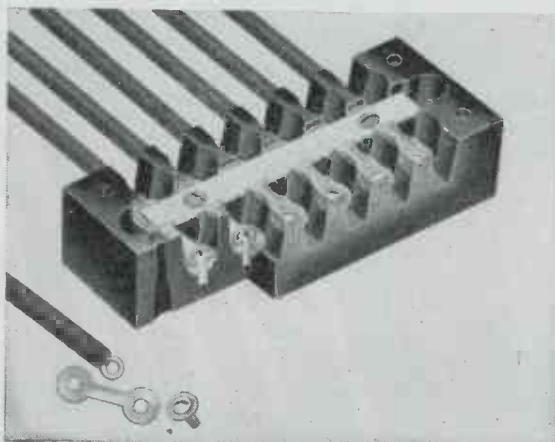

**SERIES 2000** is the heaviest design in the Burke Line—has heavy barriers and specially formed slot openings to secure free wire ends without the use of lugs—handles the small wires or stranded cable.

★ *Write for New Booklet*



AC AND DC MOTORS AND GENERATORS

**BURKE Terminal BLOCKS**  
BURKE ELECTRIC COMPANY • ERIE, PENNSYLVANIA

## WANTED—ELECTRICAL ENGINEER

Old established manufacturer of communication equipment in Boston, Mass. area requires engineer for design and development of equipment for present and post-war period.

APPLICANT MUST HAVE ELECTRICAL ENGINEERING DEGREE plus practical knowledge of electronic circuits as applied to amplified voice communication and preferably some experience in the fire alarm, telephone and signal field. Please give complete background and salary range in reply which will be held in strict confidence. Our employees know of this ad.

Box 1520, Electronic Industries  
480 Lexington Ave., New York 17, N. Y.

## MECHANICAL ENGINEER

Large manufacturer of electrical and electronic devices has an attractive opening for a young graduate mechanical engineer with a background in design and production of electronic equipment or scientific instruments. Duties will consist of the design of mechanical devices, tuning mechanisms, etc. and the design of jigs and fixtures for economical manufacture of components. Must be able to assume full responsibilities of a project engineer on jobs involving considerable mechanical construction. Please furnish full details regarding age, education, experience, and salary desired.

Box D-94  
ELECTRONIC INDUSTRIES  
480 Lexington Avenue, New York 17, New York

330,000 aids were in use. Subtracting, the actual market becomes about 750,000 instruments.

Wild claims of a market of 10 million are based on one old series of tests, which were completely repudiated by all subsequent studies. It is a figure which no competent authority today will back up. While we are on the subject of wild claims, it has been stated that there are 3 million hard of hearing school children. Let us look at the facts:

### Needs of adolescents

The first tests of school children led to all sorts of results due to lack of control and standardization. If we take recent (1943) nationwide data, we find a wide variation in percentages (1 to 30 per cent) but the average seems to be about 5 per cent having a hearing loss of 9 db or more on at least one ear. This would be 1,500,000 children having something requiring medical attention but certainly not requiring hearing aids! Public Health data shows 75,000 school children with a loss of over 47 db. We may judge then, that under 100,000 have a loss of 40 db or over, and need aids.

We have, then, about 750,000 prospective users. Of these, about one-half will be conductive type losses, and the balance nerve or mixed. Experience shows that to fit these properly, a large number of frequency response characteristics must be available, covering the range in preferably 4 to 6 db steps.

### Distortion must be low

Coupled with this must be an adequate range of undistorted power. Perhaps 75 per cent of the users can be well served by a unit with low distortion up to 105-110 db output, while the remainder require low distortion up to 120-130 db.

Needless to say, this cannot be done with one receiver and one instrument. One manufacturer has done it nicely with two instruments (each having 16 steps of adjustment) and five receivers with different response characteristics.

A small but definite fraction of the cases—about two per cent—should be fitted with bone conduction receivers rather than air conduction. Audiometric data on several thousand cases shows that this percentage is much less than has been heretofore advocated by one or two organizations, but it is still not to be disregarded completely. If the ear is suppurating, or if bone conduction hearing is over 30 db better than air conduction hearing, a bone receiver should be used. This decibel difference is necessary to allow for the fact that the best bone receivers are definitely inferior in both efficiency and fre-

quency range to air receivers, due in part to the inherent limitations of bone conduction hearing.

The size and character of the veterans market for hearing aids has been over-emphasized. The total number of veterans of World War I receiving compensation for deafness is only 12,813. On this basis, some competent authorities have estimated a probable ultimate total of 10,000 patients in the three Army hospitals devoted to hearing problems, and an ultimate 100,000 veterans receiving compensation for war-caused hearing impairment. In October, 1943, the Veterans Administration reported a total to date of 200 veterans of World War II with defective hearing, and 10 totally deaf. Their total purchase of hearing aids (for all veterans) in 1943, was a very few hundred.

No precise data have been released on the nature of the World War II veterans' hearing impairment but a good deal can be judged from the characteristics of the instruments purchased. Some cases are exactly like those in civil life. The large remainder have unusually severe losses—fittable only with the best instruments. Perhaps the average veteran's instrument must deliver a great deal more power output than the average, up to 130 db, undistorted. It is distinctly a market where the highest type of instrument only will suffice.



# Premax Antennas

—*Tested  
in war*  
—*Ready  
for peace*

Send Today For Your Copy  
Of This Interesting Booklet

**Premax Products**

Division Chisholm-Ryder, Co., Inc.  
4503 Highland Ave., Niagara Falls, N. Y.

ELECTRONIC INDUSTRIES • January, 1945



THE NEW  
*Geneva-Loc Actuator*

- NO CLUTCHES
- NO LIMIT SWITCH ADJUSTMENT
- MOTOR STARTS AT NO LOAD
- POSITIVE POSITIONING OF SHAFT INDEPENDENT OF MOTOR OVERTRAVEL
- NO CAPACITOR OR BRAKE REQUIRED

AS THE NAME IMPLIES, these new Actuators by Pacific Division exclusively incorporate a Geneva movement operated by a high speed motor. Positioning by switches has been completely eliminated.

These Actuators offer extremely accurate control (within 1°) of any series of operations up to eight positions with each position positively locked against movement.

There are no clutches, torque limiters, brakes or adjustable limit switches—eliminating major causes of trouble.

Motor comes up to speed under no load, then engages cam with varying ratio which develops maximum torque at break-away positions. Thus cutout switches always operate when motor is under no load, permitting maximum switch life.

Write or wire today for data on these simplified, positive actuators. Pacific Division, Bendix Aviation Corporation, 11600 Sherman Way, North Hollywood, Calif. Sales Engineering offices in New York City and St. Louis.

© 1945, P.D., B.A.C.





Pacific Division also manufactures an additional line of Rotary Actuators which are readily adjustable for any angular rotation of the output shaft. They incorporate a basic motor and reduction gear assembly to which may be added, in any combination, a brake, limit switches, positioning switches, torque and/or a thermal protector.

All models are conservatively rated at 100 lb. in. output torque at a speed of 9 r.p.m. Overloads up to 400% of rated torque can be handled without injury to the unit at normal temperatures.

## Ingenious New Technical Methods

Presented in the hope that they will prove interesting and useful to you.

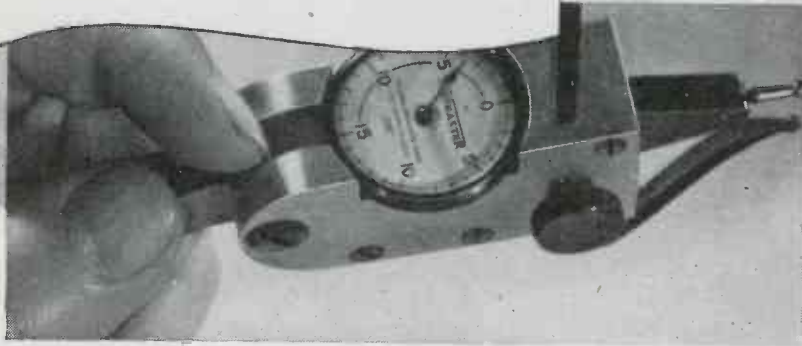

## New Internal Gage Avoids Over Cutting... Saves Wasted Man Hours

At last a gage that takes the guess work out of checking internal diameters either machine bored, or close ground and lapped. It is called the Keene Internal Gage and is the first accurate method for fast correct checking of internal splines and gears on both minimum and root diameters. The gage is ideal for machining and inspection work, and proves its value in increased production. It can be used with either a master, or micrometers.

This time saving development is constructed of aluminum, is six inches long and weighs only five ounces. Available in models designed to read in thousandths (.001) or in tenths (.0001).

When your gage has been checked the thousandths left to bore, the actual job of machining may become tedious. It is then when Wrigley's Spearmint Gum helps keep you alert and watchful. Chewing gum seems to assist you over the dull spots in the day's work. And Wrigley's Spearmint will aid you in your peacetime job by helping to keep you wide awake and efficient during that part of your work that may seem unimportant, but which actually means perfection to the completed product.

You can get complete information from Keene Electrical Machinery Co., 542 W. Washington Blvd., Chicago 6, Illinois.

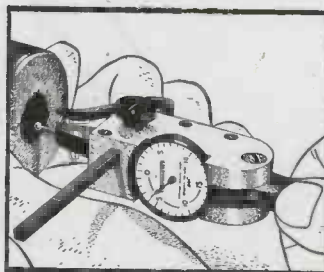

Determining correct setting for gage.

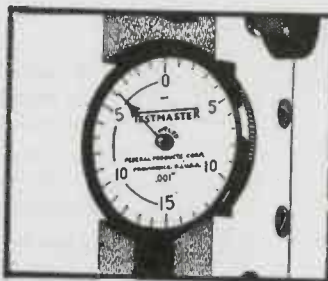

Closeup of dial showing simplicity and fast visibility.

Z-51

"ZOPHAR  
QUALITY  
GOES  
FAR"

## WAXES AND COMPOUNDS

FOR INSULATING AND WATERPROOFING OF  
ELECTRICAL AND RADIO COMPONENTS

also for

CONTAINERS AND PAPER IMPREGNATION  
FUNGUS RESISTANT WAXES

Zophar Waxes and Compounds Meet  
All Army and Navy Specifications

INQUIRIES INVITED

**ZOPHAR MILLS, Inc.**

Founded 1846

1128-131 26TH STREET BROOKLYN, N. Y.



## IRE MEETING

(Continued from page 95)

the evening of the opening day, Wednesday, January 24.

Supplementing the technical features of the meeting and the social functions which include the annual banquet to be held in the Grand Ballroom of the Commodore, 7:00 P.M., Thursday, January 25, the president's luncheon to be held in the same place at 12:30 P.M., on Friday, January 26, a cocktail party to be held in the East Ballroom on the same day at 6:00 P.M., and a luncheon in honor of the men in the Armed Forces scheduled for Saturday noon, there is to be an exhibit which will take up the entire West Ballroom and provides space for 37 exhibitors. Complete program for the meeting appears on page 95 of this issue.

## Instrumentation Conference

Looking a long way ahead, The American Society for Measurement and Control has scheduled an "Instrumentation for Tomorrow" exhibition and conference for Sept. 17-21, in Pittsburgh. The affair is to be held in the William Penn Hotel. Louis Susany is secretary, with headquarters in care of Carnegie Institute, 4400 Forbes St., Pittsburgh.



The manufacturer who has an involved precision switching problem can depend on the speed, precision and dependability of Mu-Switch.

Mu-Switch gives you continuous operation without mechanical fatigue.

With the varied types of actuators and special housings industry will find a thousand uses for Mu-Switches in electrically controlled equipment.

Send for  
FREE MU-HANDBOOK

The ORIGINAL LEAD BRESLENE PRECISION SWITCH

**MU-SWITCH CORP.**  
CANTON, MASS.

ELECTRONIC INDUSTRIES • January, 1945



## NEW BOOKS

### **Experimental Spectroscopy**

By Ralph A. Sawyer, published 1944, Prentice-Hall, Inc., New York, N. Y. 323 + VIII pages, \$5.00.

The intricate procedures that have developed in many industrial processes to obtain desired reactions and mixtures have necessitated the application of many laboratory research equipment to production line problems. This book acquaints students, laboratory research workers and process operators with the background and operating technic and maintenance of spectroscopic equipment.

It starts with the theory and principles of the spectroscope (without extended mathematical treatments) and continues with a description of the apparatus used, including light sources, optical systems, prisms and gratings, and the photographic process. Measurements of wavelength and intensity levels are discussed. The more recent extensions of spectroscopy into the infra-red and ultraviolet are also described. The book is well illustrated and interestingly written and contains many references for further study.

### **Plastic Molding and Plant Management**

By D. A. Dearle, Chemical Publishing Co. Inc., Brooklyn 2, N. Y., 1944, 196 pages, \$3.50.

This book describes and compares the technics of compression and injection molding of thermoplastic and thermosetting plastics. It discusses the processes, die and mold layout, considering both technical and economical aspects. It is useful not only to the design engineers but to operating foremen. A brief survey of the most common plastics and their suitability for various applications is included.

### **Electronics; Today and Tomorrow**

By John Mills, published by D. Van Nostrand Co., 250 4th Ave., New York City, 178 pages (5 x 8) price \$2.25.

A book in the popular style, used so effectively by this writer, giving the basic principles and operational background for all kinds of electronic devices. It gives, in non-mathematical terms, the story of why radio, television and numerous other sciences use electron tubes. It will be of interest to laymen, and those engineers who have been so engrossed in other subjects that



## A Present and a Future for Experienced Design Engineers

The Collins Radio Company has always been a pioneering organization—an *engineer's* engineering and manufacturing outfit.

It was the pioneering urge that led us to introduce professional standards of design and performance in transmitters and receivers for radio hams in the early thirties . . .

To plan and build special radio equipment that stood up to the rough-and-tumble of Admiral Richard E. Byrd's second expedition to Little America . . .

To take high quality broadcast equipment out of the laboratory and make it economically practicable for any broadcasting station . . .

To meet the individual requirements of some of the great airlines with specially engineered communication equipment, including the ingenious Collins Autotune.

To be prepared on December 7, 1941, to go into production of airborne and ground based radio gear of highly advanced design for the Armed Forces—the result of research and development looking years ahead.

We are looking far ahead today in the field of high quality radio communication equipment. Our post-war plans, well advanced, offer a very substantial opportunity for additional

junior and senior assistant design engineers with at least three years of practical mechanical design and drafting experience, and for design engineers with five to ten years of experience. Our work involves the production of small, intricate mechanical and electrical mechanisms.

This is a splendid opening for men and women who are able to make neat, accurate parts drawings with complete specifications, assembly drawings and layouts, who will assume responsibility, and who have knowledge of general standard shop and field practices.

Cedar Rapids is a human, wholesome city of about 65,000. People enjoy living here. And people enjoy working, without being distracted by weather variations, in the modern controlled-conditions Collins plant.

If you feel that you could fit happily and capably into this organization, write us fully. Tell us about your education, experience, age, desired compensation and draft status. W.M.C. regulations, or course, must apply.

Address E. H. Reinschmidt,  
Superintendent of Design,  
Collins Radio Company,  
Cedar Rapids, Iowa.

NO. 51N

NO. 50N



# NEWEST DRAKE NEON LIGHT ASSEMBLIES

DEPENDABLE  
SERVICE

LONGER LIFE



SOCKET AND JEWEL LIGHT ASSEMBLIES

## DRAKE MANUFACTURING CO.

1713 WEST HUBBARD ST., CHICAGO 22, U.S.A.

Drake No. 50N NEON Jewel Min. Bayonet Assembly is ideal where a distinct signal is required and observer is directly in front of instrument panel. Its 1/2" smooth clear jewel magnifies and intensifies the illumination from the Neon lamp. Red glass jewel can also be supplied. The No. 51N (without jewel) is applicable where 180° visibility is desirable. Both units have built-in resistors for NE51 Neon Lamps operating on standard 105 to 125 volt circuits. These rugged units offer BIG savings in power (1/25 watt), long life (3000 hours), wide voltage range, and great reliability.

### ENGINEERS WANTED

#### ACOUSTIC EXPERIMENTAL ENGINEER

Graduate Engineer with Laboratory and design experience. To design microphones and other electro-acoustical devices.

#### ELECTRO-MECHANICAL DESIGN ENGINEER

Graduate Engineer to design Electro-Magnetic Devices, such as phonograph pickups, etc.  
Write, giving phone number, education, experience and salary desired.

Well established West Coast concern.

Box 1540, Electronic Industries

480 Lexington Ave., New York 17, New York

## Permanent Magnets

All Shapes, Sizes and Alloys. Alnico magnets cast or sintered under G. E. license. Chrome, Tungsten and Cobalt magnets stamped, formed or cast.

### THOMAS & SKINNER

STEEL PRODUCTS CO. • INDIANAPOLIS, IND.

42 YEARS' EXPERIENCE

this matter of electronics has gotten away from them. It is in fact a short course in the interesting aspects of this science, with the heavy theory omitted.

### Prodigal Genius:

#### The Life of Nikola Tesla

By John J. O'Neill, published by Ives Washburn, N. Y., 1944, 326 pages, \$3.75

It is difficult, even for an engineer, to regard lightly Tesla's many claims and statements which, coming from almost any other man, would have been classed as incoherent, Jules Vernish fancies. Tesla actually produced in too many fields. Primarily, this book is the story of his successful, lifetime fight to bring his development of rotating magnetic fields and other ac inventions to commercial fruition, but it is also the semi-tragic story of his often successful efforts in mechanics, hydraulics, X-rays, electron-optics, and such colossal projects as to broadcast radio and motive-power to the four winds. Tesla never indicated any lack of faith in the technical feasibility of his more grandiose schemes, but he refused to reveal details. His secrets, if any, were cremated with his body.

### X-RAY

(Continued from page 97)

70 volts and its resulting plate current energizes a relay which opens the main X-ray contactors in the X-ray control and ends the exposure. In preparation for the next exposure, a capacitor-shorting relay by-passes to ground any charge left on the capacitor.

A safety timer, consisting of a trigger tube, an adjustable resistance, a capacitor, two relays, and a buzzer, protects the X-ray unit against any failure of the phototimer unit and against excessively long exposure times exceeding the capacity of the X-ray tube. Phototimer failure can occur only if an exposure is attempted before the unit has heated or if some component fails. Unduly dense objects, on the other hand, result in long exposure times since the phototube does not terminate exposure until correct photographic exposure is secured. There is thus the possibility that the rating of the X-ray tube might be exceeded in exposing unusually dense objects.

One of the relays prevents an exposure from being initiated until the phototimer is ready for operation. This means that the circuit will not be closed unless the timer components have heated properly and are functioning. The other relay will open the circuit when the safety trigger tube fires. Protection of the X-ray tube is assured by choosing the constants so that the trigger tube fires before the rating of the X-ray tube is exceeded.

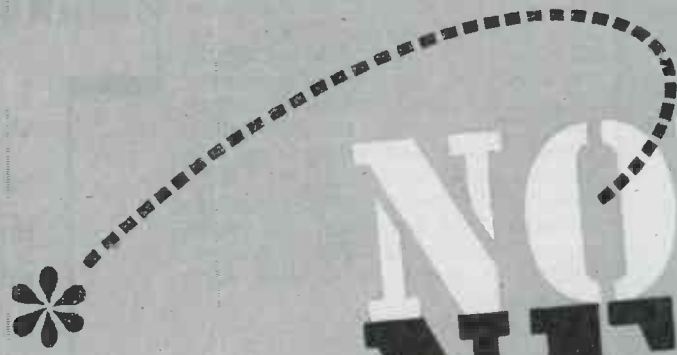

# NOW NEW!

● These two "action words" are being used by us to headline this ad for a very definite reason.

● We are NOW ready with a NEW announcement which, we are sure, will be welcomed by hundreds of dealers, radio "hams", jobbers, and industrial organizations of all types who use transformers in the course of their operations.

● We have stated before, and we must reiterate, that our first concern is to do our part in helping to win the war.

● Nevertheless, the time has arrived when we can state that we are now actually engaged in preparing new models of transformers, for civilian use as soon as war conditions permit. These new Thordarson transformers embody ideas based upon our 50 years of leadership in this industry, our war experiences, and our determination to again set the pace in the field when civilian needs can once more be taken care of.

● The new Thordarson transformers will be streamlined, modern . . . in many instances more compact . . . designed with all the skill and ingenuity that can be brought to bear in order to produce more serviceable products. When you see these new designs, you will again be reminded of how Thordarson leadership means more service, more convenience and more all-around satisfaction for you.

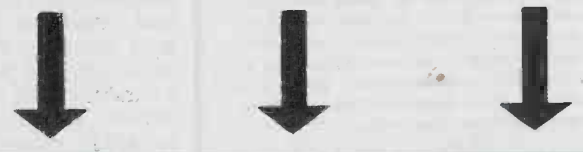

**THORDARSON**

*Transformer Specialists Since 1895*  
... ORIGINATORS OF TRU-FIDELITY AMPLIFIERS

THORDARSON ELECTRIC MFG. CO. • 500 W. HURON ST. • CHICAGO 10, ILL.

Designed for



Application



**The No. 90600 Series  
of Absorption Frequency Meters**

Both inexpensive laboratory and protected sturdy field types of this popular series of compact direct reading frequency meters are available in ranges from 300 megacycles to 200 kilocycles. Can be poked into small shield compartments, coil cans, corners of chassis, etc., to check harmonics; parasitics; oscillator-doubler, etc., tank tuning; and a host of other such applications. Quickly enables the design engineer to find out what is really "going on" in a circuit.

**JAMES MILLEN  
MFG. CO., INC.**

MAIN OFFICE AND FACTORY  
**MALDEN  
MASSACHUSETTS**



**NEW BULLETINS**

**Special Tubes**

Nine types of tubes for specialized applications are described in a new 24-page bulletin (No. 202) published by Sylvania Electric Products, Inc. (Special Products Division, 60 Boston St., Salem, Mass.). Products described include stroboscopes for the study of reciprocating and rotating motion; Pirani and thermocouple tubes for measuring vacuum; voltage regulator tubes; facsimile tubes; germicidal tubes; black light and near ultraviolet lamps. Technical sections of the bulletin give specifications, basic circuit diagrams and suggested applications for products and accessories. Fluorescent lamp characteristics are given in tabular form and curves.

**Phototube Data**

The Continental Electric Co., Geneva, Ill., has just released a new phototube booklet which in addition to giving information concerning phototubes has much valuable information useful to the users of phototubes including many curves and other data.

**Theatre Television**

A comprehensive handbook on the what, how, and why of theatre television has been prepared by the RCA Service Co., Camden, N. J., for theatre managers and projectionists. Although the contents are primarily devoted to technical discussions of the reception and large-screen projection of television programs, several chapters deal with such non-technical subjects as television commercial possibilities, the handling of programs, and audience response. In step-by-step fashion, the technical discussions provide projectionists with an abundance of data ranging from a review of electrical fundamentals to video circuits, sweep and synchronizing circuits, and the operation of a television system. The theory and operation of diodes and rectifiers, voltage amplifiers, and limiters are thoroughly explained.

**Resistance Welding**

"Resistance Welding at Work" (Bulletin WP-44) is a 60-page two-color 11 by 8½ in. book containing scores of illustrated examples of resistance welding applications. It is designed primarily as a guide to the wide variety of uses to which resistance welding adapts itself—whether it be single spot or multiple spot, seam or flash, butt or

*This is*  
**IMPORTANT**  
*to 5*  
**MANUFACTURERS**

WE will purchase one or more equipment or component manufacturing businesses in these fields

**RADIO  
TELEPHONE  
TELEGRAPH  
TELEVISION  
WIRE PHOTO  
SOUND on FILM**

OR we will purchase only a particular Department. In either case we will assume responsibility for servicing equipment now in use.

*All answers will be held confidential.*

Please Reply to BOX A-27

**ELECTRONIC INDUSTRIES**  
480 Lexington Avenue, New York 17, N. Y.

*(The publisher is authorized to furnish our name if written request is made on your company letterhead.)*

"Checked up on Bridgeport?"

"You Bet! Bridgeport will be our best postwar source for coils and chokes... and just look at their location!"



**THIS IS BRIDGEPORT, ILL.**

**YES, LOOK AT IT.** Right near the population center of America. Right for deliveries to all your plants with fast trunk-line service. Here in Bridgeport, in wartime, skilled technicians are building search coils and variometers to meet the most exacting requirements of the Armed Forces. They're doing a big war job well. After victory, Bridgeport will do your big postwar job equally well. You'll find them your most dependable source of supply for R. F. coils and chokes, I. F. transformers and transmitting coils and chokes. Write to Bridgeport today to insure early postwar delivery of the parts you need.

# BRIDGEPORT

MANUFACTURING COMPANY  
Bridgeport, Illinois

R. F. Coils • R. F. Chokes • I. F. Transformers  
Transmitting Coils • Transmitting Chokes

# MOTOR DATA

No. 129



## 4000 FRAME MOTOR

1/2 HP at 3900 RPM

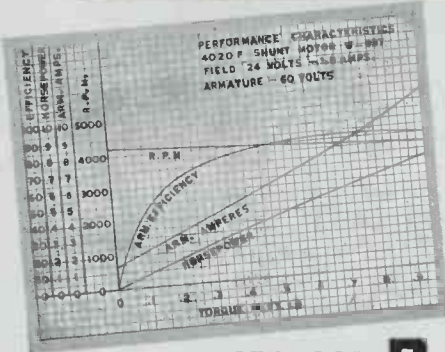

The output—the weight—the size—of these 4000 Frame Motors are features well worth remembering. Every adaptation of the standard design is engineered for the precise requirements of an aircraft, portable, or industrial application.

**ELECTRICAL**  
Series, shunt, or compound-wound  
Unidirectional or reversible  
Optional torque  
Optional speed  
Optimum efficiency  
For control circuits  
Electric braking optional

**F E A T U R E S**

**MECHANICAL**  
Ventilated or enclosed types  
Base or flange mounting  
Operation in any position  
Low space factor  
Ball bearing equipped  
Optional shaft details  
Rugged construction

4000 FRAME MOTORS		4020 Shunt	4020 Series
Watts, Output, Con.	(Max.)	375	746
Torque at 3900 RPM	(ft. lbs.)	.65	1.4
Torque at 6000 RPM	(ft. lbs.)		.88
Speed Regulation		8%	
Lock Torque	(ft. lbs.)	2.5	4
Volts Input	(min.)	12	24
Volts Input	(max.)	110	110
Diameter		4"	4"
Length Less Shaft		7 1/8"	7 1/8"
Shaft Dia.	(max.)	.625"	.625"
Weight	(lbs.)	9.2	9.2

**EICOR INC.** 1501 W. Congress St., Chicago, U. S. A.  
DYNAMOTORS • D. C. MOTORS • POWER PLANTS • CONVERTERS  
Export: Ad Auriema, 89 Broad St., New York, U. S. A. Cable: Auriema, New York

## NEW BULLETINS

projection welding—and whether the work is to be brought to the machine or the equipment brought to the work in fixtures. In this book there is an answer by examples of "how it is being done" to practically every general type of resistance welding problem. To facilitate use of the book the material has been arranged under five general headings in such a manner that the answer to a given general problem can be quickly and easily located. The divisions deal with portable gunwelding (for work assembled in fixtures); stationary spot welding, single and multiple (where work can be brought to the machine); seam welding, either in machines or in fixtures. There is also a section devoted to special uses to which resistance welding equipment can be put as well as a section illustrating, by examples, possibilities in fixture design, large or small. Publisher is Progressive Welder Co., 3050 East Outer Drive, Detroit 12, Mich.

### Trimmer Capacitors

Engineering data on two types of single and multiple mounting ceramic trimmer capacitors has been put into a four-page catalog insert by Electro Motive Mfg. Co., Willimantic, Conn. Number of plates vary from 1 1/4 to 9 and capacities from 15 to 780 mmf.

### Welding Electrodes

P. R. Mallory & Co., Inc., Indianapolis, has issued a new catalog on "Resistance Welding Electrodes and Alloys." The catalog lists the complete line of standard spot welding electrodes and water-cooled holders. A listing of "Do's and Don'ts" for improved resistance welding is featured. Stock sizes of Mallory alloys, their various applications and typical physical properties are also included.

### Listing Mikes

Universal Microphone Co., Inglewood, Calif., has just published its first price list since Pearl Harbor. Twenty-seven carbon, dynamic and velocity types are listed in palm, stand, throat, lip, hand and cartridge styles. The list is bulletin 1460, "Pre-Catalog Listing" and is preliminary to the issuance of the 1945 commercial catalog of all Universal items.

### Multi-test Units

Multi-range, multi-test units for industrial, laboratory and school uses are illustrated and described in an 8-page catalog issued by

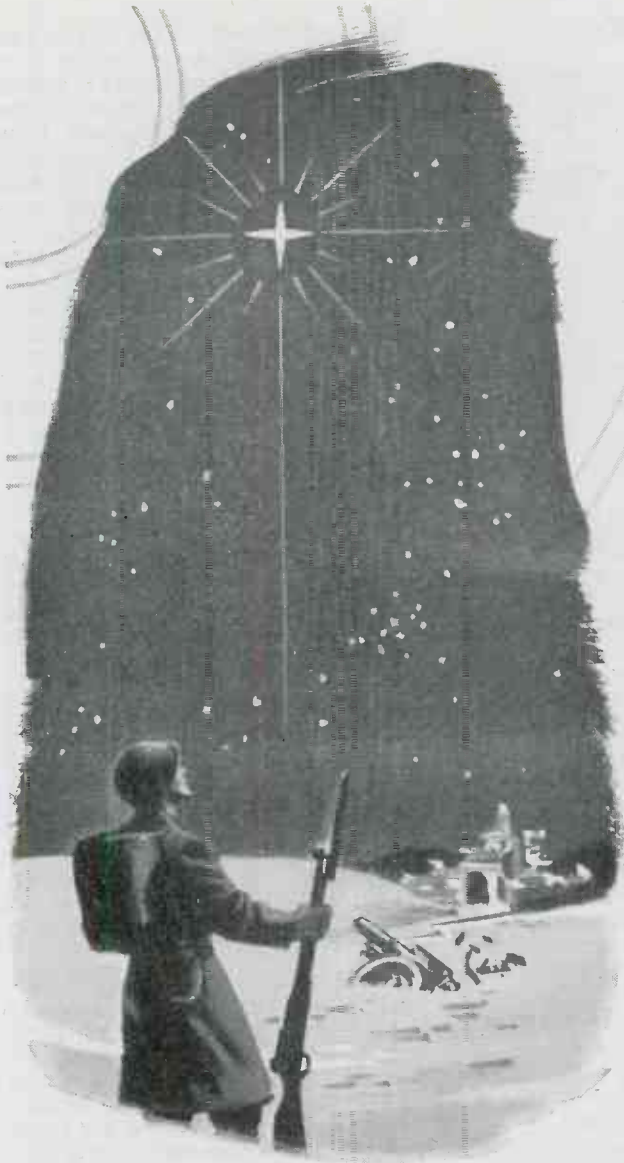

*"In times like the present, men  
should utter nothing for which they  
would not willingly be responsible  
through time and in eternity."*

*Abraham Lincoln, 1861*

*a Merry Christmas  
and Happy New Year*

**Jensen**

Jensen Radio Manufacturing Company  
6601 S. Laramie Ave., Chicago, Ill.

**SERVICE**  
THROUGH THE  
**YEARS!**



America's  
MOST COMPLETE  
Source of Supply

for

**RADIO PARTS**  
**RADIO TUBES**  
**INDUSTRIAL**  
**ELECTRONIC EQUIPMENT**  
**AMPLIFIERS**  
**SOUND SYSTEMS**  
**TEST INSTRUMENTS**  
**COMMUNICATIONS and**  
**BROADCAST APPARATUS**  
**AIRCRAFT and**  
**MARINE EQUIPMENT**  
**F/M—television—A/M**



**OVER 10,000 ITEMS!**  
**AT YOUR FINGERTIPS!**

**PURCHASING AGENTS!**  
**ENGINEERS!**

Send for this  
**FREE 800 PAGE CATALOG!**

Write today on your company letterhead for this massive 800 page Buying Guide containing everything in radio-electronics. Complete listings of all standard nationally known products in one handy, bound volume! Sent free on request by addressing Box JN.



This Book  
Can Help Answer  
Your Procurement  
Problems!



**FOR PROMPT SERVICE**  
**Telephone BARclay 7-1840**

**BUY THAT EXTRA BOND NOW**  
**and SAVE AN EXTRA LIFE!**

SUPPLIERS TO

Industrial Manufacturers • Research  
Laboratories • Schools • Colleges  
Government Agencies • Railroads  
Public Utilities • Broadcast Stations  
Hospitals • Shipyards • Police Depts., etc.

**SUN RADIO**  
**& ELECTRONICS CO.**  
212 Fulton Street, New York 7, N. Y.

## NEW BULLETINS

Weston Electrical Instrument Corp., Newark, N. J. Descriptions include an industrial circuit tester having 27 scale ranges, several types of ohm meters and volt-ohm-milliameters, an insulation tester, power level meters and an analyzer for general purposes having sensitivity of 20,000 and 1,000 ohms per volt, a combination industrial analyzer having four 4 in. meters. This instrument is intended primarily for public utility field servicemen, electrical contractors and plant maintenance engineers.

### Geiger-Counter

A new piece of literature covering the Norelco Geiger-Counter X-Ray Spectrometer has been published by North American Phillips Co., Inc., 100 East 42nd St., New York. The literature describes the wide range of applications that can be handled by this new industrial tool. It provides an entirely new method of making quantitative and qualitative analyses of crystalline and certain amorphous substances. Under optimum conditions of resolution, accuracy of  $\pm 0.03$  of a degree is obtainable. Descriptive material included covers method of operation and gives specifications for the spectrometer proper, transformers, stabilizer, scaling unit, power supply, frequency meter, impulse counter, Geiger unit, and X-ray tube.

### Sheet Insulation

The Mykroy Bulletin No. 102 contains the first comprehensive report to be released about the new, larger (19¼ x 29¾ in.) size sheet of glass bonded mica ceramic insulation now available. Also listed are heavy bars of Mykroy glass-bonded mica ceramic up to 29½ in. in length for inductance coil construction. The new sheets are made in thicknesses ranging from ¼ to 1½ in. Manufactured by Electronic Mechanics, Inc., 70 Clifton Blvd., Clifton, N. J.

### An Insert Chart

A complete, practical chart of molded AN insert arrangements for electrical connectors has been published by American Phenolic Corp., Chicago. All standard inserts from one contact to one hundred contacts are shown full size. All socket or pin arrangements are clearly indicated together with wire sizes; also included are coaxial cable connections and grounded or shorted inserts. Mechanical spacing of contacts and alternative positioning of the inserts with new position numbers are given in each case. Exploded pictures of pin and socket inserts add considerably to the

understandability of the chart. The chart is 50 x 38 in. printed in blue and black on heavy, durable yellow stock which aids in making the chart's information readable from desk chair position. A complete chart of AN and Amphenol 97 shell types and styles is enclosed with each insert chart. This includes the special purpose shell types such as pressure-tight, moisture-seal, explosion-proof, light proof and other plugs and receptacles. Also enclosed is a chart which diagrams the system clarifying the long and complex numbers used in specifying connectors.

### Plastics Engineering

General Electric (Pittsfield, Mass.) offers the product designer a 24-page booklet, PH-518, "Design Data for Plastics," which consists of a discussion on the problems of styling in plastics, as it relates to material selection, design considerations and fabrication methods. It represents useful information and tables gathered by the General Electric plastics laboratory, applicable to all types of products. A rather extensive table on the general properties of many materials is included.

### X-Ray Inspection

Considerable engineering information of a practical nature covering the application of X-ray inspection technics is contained in a new 16-page booklet issued by the Picker X-Ray Corp., 300 Fourth Ave., New York. Included are illustrations and a description of a new inspection cabinet for the continuous X-ray examination of parts on a production schedule.

### Transformer Data

Peerless Electrical Products Co., 6920 McKinley Ave., Los Angeles 1, has published a new 20-page catalog, Bulletin 431, for the fields of radio, sound, public address, television, and the electronic industry. The catalog contains photographs and illustrations, diagrams, full construction details, and prices on the complete line of Peerless transformers, windings, and reactors.

### Iron Cores

A great amount of valuable engineering data are contained in a 36-page manual entitled, "MagiCore High Frequency Iron Cores," just issued by Henry L. Crowley & Co., Inc., West Orange, N. J. Included is a careful summary of the uses of such cores, chapters on mechanical considerations and special applications and descriptions and specifications of many types together with a chart giving recom-



# RELAYS by KURMAN

Twenty-five years' experience in solving all types of Relay Problems. Complete facilities for Designing, Engineering, Manufacturing. Specialists in producing Relays of exceptional power and sensitivity for Aircraft, Intercommunications Systems, Electronic Devices. Exclusive Kurman features provide greater dependability, longer life, more precise performance.



Send data for quotations.

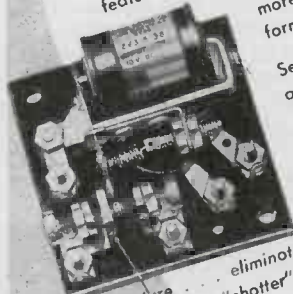

New Feature eliminates "bounce" and "chatter"



Microphone Hummer

## KURMAN ELECTRIC CO.



35-18 37th STREET • LONG ISLAND CITY 1, N. Y.

### TERMINALS for ELECTRIC WIRES

### SMALL METAL STAMPINGS

in accordance with your blueprints

### PRECISION PARTS

from Modern Equipment

### PATTON-MacGUYER CO.

17 VIRGINIA AVENUE  
PROVIDENCE 5, R. I.

Continuously  
Since 1930

PRECISION GROUND

# Crystals BY HIPOWER

AIRCRAFT  
MARINE • BROADCAST  
POLICE • COMMERCIAL • AMATEUR

## HIPOWER CRYSTAL COMPANY

Sales Division — 205 W. Wacker Drive, Chicago 6  
Factory — 2033 Charleston St., Chicago 47, Ill.



Variable Attenuators • Mixers  
Potentiometers • Tap Switches  
Meter Shunts and Other Precision Resistance Devices

Engineering and Production of  
These Components Our Specialty

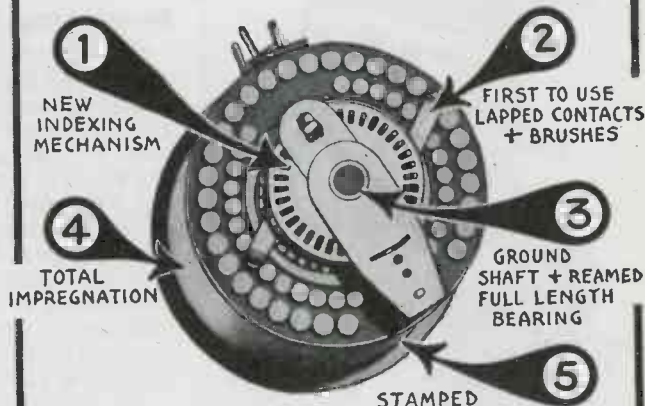

5 MAJOR POINTS  
WIN FOR VARIATEN  
IN THE VARIABLE ATTENUATOR FIELD

Point No. 2: Stone-lapped brush and contact surfaces insure long life and quiet operation. Final lapping operation is performed after soldering and impregnation, eliminating warpage due to heat.

## CINEMA ENGINEERING CO.

1508 W. VERDUGO AVE. • BURBANK, CALIF.

ESTABLISHED 1935

# ESICO

REG. U. S. PAT. OFF.

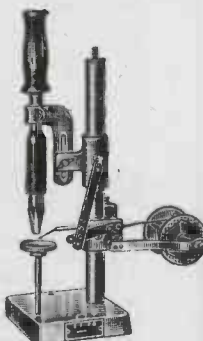

**SPOT SOLDERING MACHINE**  
designed for treadle operation for advancement of iron and solder, leaving operator's hands free for handling of product.



**SOLDERING IRONS**

are widely used in industrial plants throughout the country. They are designed to withstand the strain of continuous service required of factory tools.

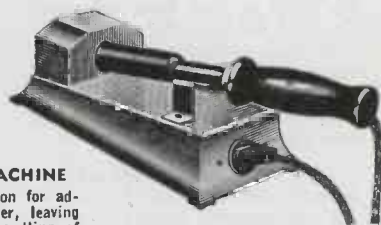

**SOLDERING IRON TEMPERATURE CONTROLS**  
prevent overheating of soldering irons between soldering operations. Irons do not deteriorate when being used. The idle period causes oxidation and shortens life.

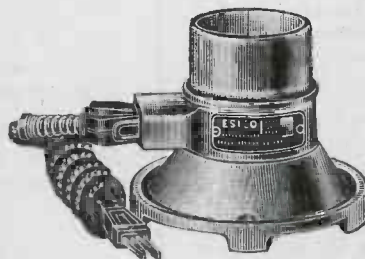

**SOLDER POTS**  
ruggedly constructed pots of various sizes designed for continuous operation and so constructed that they are easily and quickly serviced, should elements have to be replaced.

Write for Catalog

## ELECTRIC SOLDERING IRON CO., INC.

2144 WEST ELM STREET, DEEP RIVER, CONN.

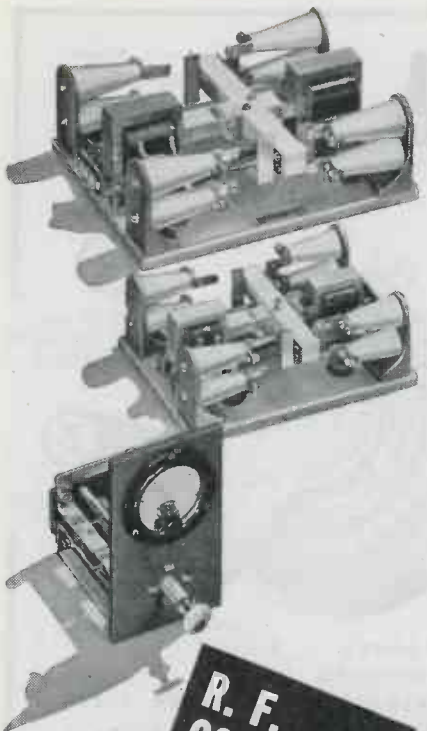

**R. F. CONTACTORS**  
and  
**M. B. B. SWITCHES**

Johnson R. F. Contactors were designed for switching high voltage antenna circuits in Phasing Equipment and for similar applications. Made in two sizes, these Contactors provide long creepage paths, high current carrying capacity, high voltage rating and no holding current is required. They can be operated on either 110 or 220 volt power circuits. Either size is available with a variety of contact arrangements including auxiliary contacts for signal or pilot light indicators. Contacts are sectionalized to provide large contact area and their wiping action makes them self-cleaning. Write today for more information and quotation giving contact arrangement desired.

Johnson Make - Before - Break Switches were designed for inserting and removing meters from antenna circuits without opening the circuit. Features include R. F. insulation, high voltage breakdown rating, high current, carrying capacity, and wiping contacts insuring low resistance.

Ask for Catalog 968. (O)

**JOHNSON**  
a famous name in Radio



E. F. Johnson Co. Waseca, Minn.

**NEW BULLETINS**

mended operating ranges. Charts of all popular types also are included. Distribution of the booklet is being confined to engineers connected with the purchasing of such equipment.

**Insulating Materials**

The almost incredible number of ways in which glass, spun into fine fibers, is being used in electrical and electronic devices are well set forth in a 24-page booklet (catalog No. EL44-7) issued by Owens-Corning Fiberglas Corp., Toledo. The book explains and pictures how cloths, tapes, cords, sleeves and wire insulation are made from two versatile basic fiberglas yarns, thus forming an inorganic fabric base for many other types of electrical insulating materials.

**Resistor Data**

Fixed and adjustable resistors in considerable variety are described in an 8-page catalog being distributed by Haines Mfg. Corp., 248 McKibben St., Brooklyn, N. Y. Included are standard lug and ferrule types as well as types with tinned leads, lug and lead, soldering lugs and Nos. 6 and 8 screws.

**Job Heat Treating**

A new job shop service specializing in electronic induction heat treating is the subject of a six-page, well illustrated folder just published by Central Boiler & Mfg. Co., 5818 Rivard St., Detroit. The folder cites the advantages of induction heat treating and points out that the company's electronic induction heat treating department is available as a job shop service.

(Continued on page 226)

**Navy Nurses Urgently Needed!**



The Navy's nurses are going electronic, or at least this one is as she administers electro-therapy treatment to a patient in one of our large base hospitals. There are 8,000 Navy nurses on duty in all parts of the world, and another 4,000 will be needed by next June. Any nurse graduated from an accredited school of nursing, and between 21 and 40, is eligible to apply for a commission in the Navy Nurse Corps, with headquarters at Bureau of Medicine and Surgery, Navy Department, Washington

**NOTICE ON CLOSING DATE**

The deadline for advertising plates in ELECTRONIC INDUSTRIES is the tenth of the month previous to the date of publication. Only complete plates, requiring no foundry work, key changes or composition can be accepted then, ready to print.

In order to assure publication of your advertising in ELECTRONIC INDUSTRIES, please try to have them in our hands as close to the first of the month previous to publication as possible.

**ELECTRONIC INDUSTRIES**

CALDWELL-CLEMENTS, INC., 480 Lexington Avenue, New York 17, N. Y.

# SYLVANIA NEWS

ELECTRONIC EQUIPMENT EDITION

JANUARY

Published in the Interests of Better Sight and Sound

1945

## Electronic Devices Broaden Sylvania's Service to Industry

The manufacture of electronic equipment for certain specialized communications and industrial applications is an important phase of Sylvania service. Manufacture of this type of equipment is carried



An electronic device undergoes test in the laboratories of Sylvania's Industrial Apparatus Plant.

on in a separate Industrial Apparatus Plant located at Williamsport, Pa.

This aspect of Sylvania's activities is a natural outgrowth of the company's intensive experience in the design and application of electron tubes.

### DID YOU KNOW...

That Sylvania Tungsten Lamps are standard equipment for signaling purposes on many telephone switchboards? They are made in a range of electrical characteristics for use in any type of switchboard.

\* \* \*

That Sylvania Near Ultra-Violet Lamps activate the fluorescent dials on airplane instrument panels? Lamps are small, compact, designed to operate from a 24-28 volt direct current source.

## Sylvania Begins Survey of Public Interest in Television Receivers

*Findings Will Assist Manufacturers in Gaging Markets, Determining Price Range*

Thousands of personal interviews and an intensive advertising campaign in the pages of leading consumer publications form the twin phases of a comprehensive survey which Sylvania is launching to gage the interest of consumers in the purchase of television sets, and to learn the extent of the potential market for receivers in various selling price ranges. The results of this survey are expected to be of great value in guiding the planning of the manufacturers of television sets.

Television, moreover, is but one of the aspects which will be covered in this

### LOCK-IN TUBES IDEAL FOR UHF

The trend toward the use of ultra-high frequencies brings to the fore the outstanding advantages of Sylvania's Lock-In Tubes. While the name of this line of tubes has tended to emphasize the physical details of mounting, one of the chief motivating forces in their design was the desire of Sylvania engineers to improve the electrical characteristics of tubes, particularly at the higher frequencies.

The Lock-In feature itself has been responsible for the extensive use of these tubes, particularly in automobile radios; electrical features point to wide utilization in television and FM.

### SYLVESTER SURVEY



"I wonder if I could have your views on what the postwar radio will be like."



The type of set people prefer—floor or table model; radio only or radio-phonograph combination—will also be studied in the Sylvania survey.

nation-wide poll. Consumers will also be queried on such points as their interest in FM; the desirability of short-wave bands; reaction to push button tuning. The reasons why people decide on new set purchases will also come in for scrutiny.

As the survey progresses, findings will be reported from time to time in future issues of SYLVANIA NEWS.

# SYLVANIA ELECTRIC

SYLVANIA ELECTRIC PRODUCTS INC., Radio Division, Emporium, Pa.

MAKERS OF RADIO TUBES, CATHODE RAY TUBES, ELECTRONIC DEVICES, FLUORESCENT LAMPS, FIXTURES, ACCESSORIES, INCANDESCENT LAMPS

ELECTRONIC INDUSTRIES • January, 1945

[www.americanradiohistory.com](http://www.americanradiohistory.com)

# EQUIPPED for SPECIAL MISSIONS



You get fastest action in meeting new conditions when you're fully prepared for any probability. That's why Bell Sound Systems, Inc., were able to get into action quickly in producing new and complex electronic devices for wartime needs—Bell had accumulated years of experience and research findings in the field of electronics. This broad knowledge of electronics and its applications, redoubled in scope by Bell's wartime accomplishments, will be ready to put this new science to work quickly, in endless ways for improvements in the industrial, commercial and domestic scenes of tomorrow.

## A TYPICAL BELL PRODUCT THAT MAY HELP YOU TODAY

In hundreds of plants and offices today, BELfone is speeding calls between executives . . . freeing telephone lines from inter-office tie-ups . . . saving steps, time and manpower in getting information from one department to another . . . reducing errors by providing for clear, concise, verbal orders. BELfone units offer every type or scope of inter-office communication. Write for details.

# BELfone

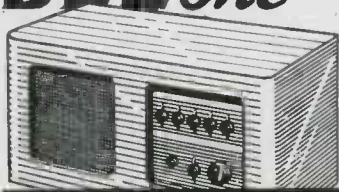

**BELL**  
SOUND SYSTEMS, Inc.  
1195 Essex Ave., Columbus 3, Ohio  
Export: 4900 Euclid Ave., Cleveland 3, Ohio

## TELEVISION IS READY

(Continued from page 122)

because of the requirement of adding two more antennas, one for sight and one for sound, plus any reflectors necessary to provide the directional coverage desired. (Hanson) At the Empire State Building, the upper antenna is used for television sound and the lower antenna for the picture and for the NBC FM station simultaneously. Many arrangements are possible and each case must be considered on its own merits. (Mason) All things considered, it appears that the tower ought preferably be designed with television in mind.

**Q.** Has anyone in the U. S. produced television pictures of more than 525 lines? If so, how many lines, who, when, where, and under what conditions?

**A.** (Du Mont) In 1937 we experimented with 735 lines. We decided that the slightly increased detail was not worth the additional trouble, expense and complexities of receivers and transmitters. (Jolliffe) In the RCA Laboratories we have experimented with 700, 800 and 1,000 line pictures. The problems are manifold. Some day television may have more lines, but the number of lines is not by any means the whole story in getting better pictures.

**Q.** Can material for dresses and the like be televised to show textures?

**A.** (Keister) This problem is the same in television as in motion pictures—basically a lighting problem. Oblique light accentuates rough fabrics while front light gives the best results on soft finish fabrics. (Hanson) Extreme close-ups, probably utilizing new lens arrangements in television cameras, are required to show texture. Anything possible in motion pictures is possible in television. We have in the past televised microbes. However, most customers want to feel the fabric they buy. We'll have to wait for "feelavision."

**Q.** Can color be telecast on the

same wavelength as black and white pictures?

**A.** (Keister) It can be done but it is not practical for a variety of reasons. (Hanson) NBC did it in 1941. The picture provided only one-half of the resolution of a black and white picture in the same channel width.

**Q.** How can a BC station about to acquire or construct new studios best anticipate future needs for television?

**A.** (Hanson) A television studio should be big enough (40 ft. by 70 to 90 ft.) and high enough (25 ft.) for handling of lighting equipment. It should be on the ground floor so you can bring in large objects. Outdoor space adjacent to studio would be useful, for open air work. (Bingley) Television also requires more space in control rooms, dressing rooms, etc. Be sure to provide adequate power line capacity to handle the lighting load. (Keister) Just design a television studio first and you will automatically have adequate facilities for a good BC studio. (Brolly) Consider means for getting video from studio to transmitter if it is located away from the studio. (Du Mont) It may be possible to use smaller studios than have been suggested. At any rate, the available space should be broken into smaller units for greater convenience, simultaneous rehearsals, and set changing.

**Q.** What is the truth about Capehart's claims to have found the answer to network operation by use of ordinary telephone lines?

**A.** (Bingley) I visited the Hall of Mechanism at the Franklin Institute and saw a number of perpetual motion machines. Alchemists wanted to make gold. Band width's relation to information transmitted seems to be fundamental. You can't get something for nothing. I'm not sure Mr. Capehart's plan falls into that category but there is that possibility. (Hanson) Like Will Rogers, all I know is what I read in the papers. We are now using a mile of telephone wire for fight pick-ups but the fre-



**PRECISION & SPEED!**

## GASKETS AND WASHERS

TO BLUE PRINT  
SPECIFICATIONS  
in all  
MATERIALS

**NATIONAL GASKET & WASHER MFG. CO.**  
122 EAST 25th STREET      NEW YORK 10, N. Y.

NATION-WIDE MAIL  
ORDER DISTRIBUTORS  
SINCE 1928



**RADIO AND ELECTRONIC**

DEVICES For Trade... Industry... Vocational  
... Communication... Public Utility and Ex-  
perimental Applications

**BURSTEIN-APPLEBEE CO.**  
1012-14 McGee St. Kansas City 6, Missouri

**SENIOR ELECTRONIC ENGINEERS**

Preferably graduates of communication engineering courses are required for designing receiving-type electronic equipment covering all frequency ranges, and other specialized electronic apparatus. Design experience necessary, and knowledge of production is desirable. Excellent post-war opportunities. Salary open. Requirements urgent. Proof of citizenship and certificate of availability are necessary.

Write giving detailed qualifications, and if satisfactory, interview will be arranged at our expense.

**SUBMARINE SIGNAL CO.**

175 State St. Dept. 420 Boston, Mass.



MOTOR-GENERATOR

**ESCO** INDUSTRIAL  
MARINE  
AIRCRAFT  
ELECTRONICS

A complete line of a.c., d.c., and Universal motors; d.c. and all Freq. a.c. generators; motor-generators; converters; dynamotors; gas & Diesel Elec. plants; explosion proof units; Machines designed for every purpose.

**COMPLETE ENGINEERING SERVICE**

Our engineers will be pleased to discuss your problems and aid in the design of machines to meet your requirements.

**ELECTRIC SPECIALTY CO.**

214 SOUTH ST., STAMFORD, CONN.

**Kahle**

**ENGINEERING COMPANY  
ELECTRON TUBE MACHINERY**

All types, standard and special design.

Specialists in equipment and methods for the manufacture of:

- |                    |                |
|--------------------|----------------|
| RADIO TUBES        | NEON TUBES     |
| CATHODE RAY TUBES  | PHOTO CELLS    |
| FLUORESCENT LAMPS  | X-RAY TUBES    |
| INCANDESCENT LAMPS | GLASS PRODUCTS |

On Production or Laboratory basis.

1307-1315 SEVENTH ST., NORTH BERGEN, N. J., U. S. A.

**STAINLESS STEEL  
FASTENING DEVICES**

**IN STOCK!**

Prompt Delivery  
of both Specials  
and Standard Items

**We Stock:**

- Cap Screws
- Machine Screws
- Bolts
- Washers
- Nuts
- Wood Screws
- Taper Pins
- Pipe Fittings
- Rivets
- Cotter Pins
- Wing Nuts
- Etc.

When you need non-corrosive fastening devices, write or 'phone Allmetal first. Chances are we have them IN STOCK ready for shipment. We can take care of your special work, too, as we have equipment for tapping, drilling, reaming, turning, slotting, etc. We also have complete centerless grinding facilities. Let us estimate on your requirements. Write us today.

**Send for FREE CATALOG**



This new, 83-page catalog helps you pick the correct size and type of non-corrosive fastening device for any particular job. Includes stock sizes, typical specials, engineering data, etc. Make request on company letterhead, please.

Write to  
DEPARTMENT D

**ALLMETAL SCREW PRODUCTS CO.**  
80 Grand Street New York 13, N. Y.

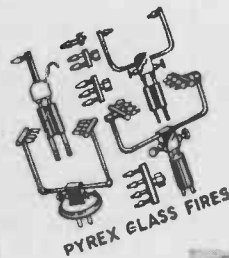

PYREX GLASS FIRES

**EISLER'S**  
*General Glass Working  
Equipment*

manufacturing RADIO, CATHODE RAY,  
ELECTRONIC and FLUORESCENT TUBES,  
ELECTRONICS LABORATORY UNITS.

WELDERS, TRANS-  
FORMERS FROM  
1/4 TO 500 KVA.



Glass Cutter



Ampule Machine

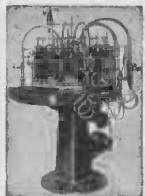

Tipless Stem Mach.

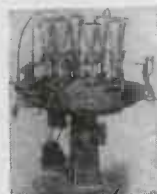

Sealing Machine

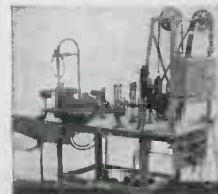

Electronics Laboratory Unit

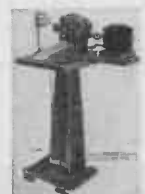

Flare Machine

**CHAS. EISLER  
EISLER ENGINEERING CO.**  
778-SO. 13th ST. NEAR AVON AVE. NEWARK, 3 N. J.

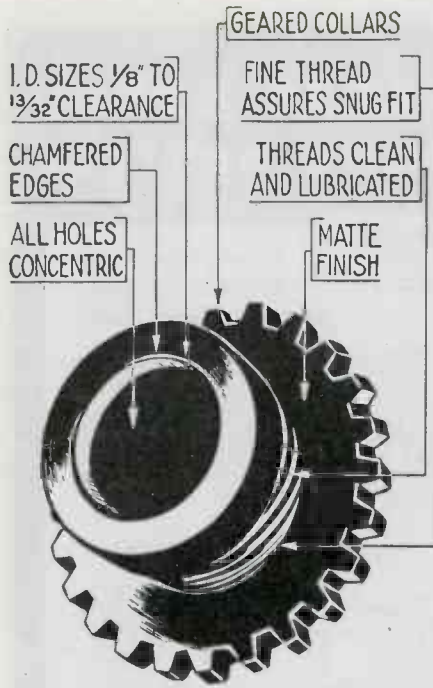

## PROTECT your WIRES with CREATIVE insulating GROMMETS

All the finest engineering on radio, electronic and electrical instruments can go to waste if you fail to protect your wires properly.

If you are not already using CREATIVE INSULATING GROMMET BUSHINGS in your chassis, by all means let us furnish you with samples. When you see the superb protection these 100% phenolic bushings give to your wires, and when you discover that they don't "pop out" when you pack your wires through them snugly, the chances are you will want to specify Creative.

Send for samples and literature.

### CREATIVE'S CUSTOM SERVICE

You don't have to build molds to get Plastic Parts with Inserts such as knobs, terminals, etc. Get the facts about this unusual custom service... Call on CREATIVE.



**Creative**  
**PLASTICS CORP.**  
968 KENT AVE. BROOKLYN 5, NEW YORK

quency characteristic must be carefully doctored up. (Goldsmith) It's like the story of the young lady who couldn't seem to find the right pair of gloves and finally told the clerk, "I've been trying for a half-hour to make clear that I want a pair of gloves large inside and small outside." Many schemes for wide band transmission in a narrow channel have been proposed but none of them has ever worked.

**Q.** How soon after V-E Day will television receivers be available in large quantities?

**A.** (Jolliffe) If manpower, materials and facilities are available, receivers could be produced in a year—maybe less. (Keister) The Pacific War will still be a big war after V-E Day. Personnel will still be tight.

**Q.** Do you think television will be practical for stations in small markets?

**A.** (Hanson) Any market can support a television station if it can support a broadcasting station. Although television costs are higher, advertisers should be able to pay 3 or 4 times as much for 10 or 100 times as much value received.

**Q.** Will 525 lines be maintained in the future? Will the pictures have the same detail when enlarged?

**A.** (Jolliffe) RTPB spent a lot of time on this question; 525 is considered adequate. We have produced 440 line pictures 12 x 15 ft. with satisfactory definition. It is going to be possible to adapt reflective optics to home receivers, providing more than adequate brightness and definition on an 18 x 24 in. screen. (Landsberg) An important factor is screen light output and gradation. Some of the new tubes have improved contrast ratio and better half tone reproduction.

**Q.** How will television affect the motion picture industry.

**A.** (Goldsmith) We'll have to remove a section of the wall here and roll in the really large crystal ball for that one! I think television and motion pictures should be mutually beneficial, just as radio and motion pictures have. I think presentation in the theater is quite different from home television.

**Q.** What are present opportunities for 16 mm. productions?

**A.** (Hanson) 16 mm. is cheaper than 35 mm. but major cost of producing film is the talent cost. (Mason) There is a splendid opportunity for 16 mm. in the presentation of news events which happen during the day and must be shown at night. (Keister) 16 mm. can provide the necessary "local touch" for satellite stations.

**Q.** Would not the use of VHF and directional receiver antennas avoid reflections and eliminate ghosts?

**A.** (Keister) It is possible for a receiver owner to have a rotatable

## Wanted ENGINEERS

Radio

\*Electrical

Electronic

\*Mechanical

Metallurgical

\*Factory Planning

Materials Handling

Manufacturing Planning

Work in connection with the manufacture of a wide variety of new and advanced types of communications equipment and special electronic products.

Apply (or write), giving full qualifications, to:

R.L.D., EMPLOYMENT DEPT.

**Western Electric Co.**

100 CENTRAL AV., KEARNY, N. J.

\*Also: C.A.L.

Locust St., Haverhill, Mass.

Applicants must comply with WMC regulations

When YOU NEED  
**ELECTRONIC PARTS**  
in a **HURRY**  
Try **HARRISON**

Send for this MASTER  
**BUYERS FREE** GUIDE... to those directly connected with high priority purchasing. Kindly write on Company letterhead, giving your title.

**HARRISON RADIO CORPORATION**  
12 WEST BROADWAY • NEW YORK CITY 7  
Telephone - WOrth 2-6276 • Cable - Harrisonrad  
JAMAICA BRANCH - 172-31 Hillside Ave. - REpublic 9-4102

# for Parts

Ten thousand different  
radio and electronic parts  
immediately available  
on priorities.

# for Service

Trained expeditors select  
and ship, same day your  
order is received.

# for Experience

Known since 1922 for the  
high character of our  
policies and practices—as  
jobbers, wholesalers and  
manufacturers.

CONTACT

## Radio Wire Television Inc.

100 SIXTH AVE., DEPT N-1, NEW YORK 13, N. Y.  
BOSTON, MASS. • NEWARK, N. J.

WORLD'S LARGEST  
RADIO SUPPLY HOUSE

Originators and  
Peacetime Marketers  
of the celebrated

# Lafayette Radio

Write today for our bargain flyers  
and special bulletins.

beam antenna but the cost would be high, and its operation would require too much of the average set owner. (Du Mont) We have made tests which prove that ghosts were worse on 80 than 50 mc VHF is still an unknown. When you go to 500 mc the shadow effect becomes serious and line of sight is almost a necessity. (Bingley) WPTZ was originally 30 ft. above sea level. There were some bad ghost problems. When we went to a location 400 ft. high, multiple images practically disappeared. (Brolly) When ghosts come from an angle close to the line from the transmitter not much can be done by directive antennas. Selecting a good reflection as the source of signal has been suggested but all too often reflections come in families. (Landsberg) The higher the frequency the greater the loss in the lead-in wires.

A panel composed of television equipment manufacturers under the chairmanship of C. A. Priest (GE) presented a comprehensive review and analysis of television from technical, economic, and social angles. David Smith (Philco) gave a review of the accomplishments of the RTPB in its study of television standards.

M. A. Trainer (RCA) outlined the progress in television camera tubes and picture tubes. He identified the Iconoscope as a good all-around tube having superior resolution and good gamma, but suffering from spurious signals and requiring key-stoning correction in scanning. The Orthicon camera tubes are four to five times as sensitive as the Iconoscope and do not suffer from spurious signals. It was reported to lack the contrast range of the "ike" however. The image dissector tube was described as requiring no shading signals and as being a good tube for film pickup. Trainer said that wartime developments could be expected to give camera tubes a "manifold sensitivity increase over currently used types."

Good progress was reported in the development of picture tubes, particularly for projection. The pre-war projection tube was reported to have a light range of 15 to 1 and current developments indicate this may be increased to 40 to 1, which is comparable with direct view types. Methods of eliminating or substantially reducing ion spot troubles were said to be assured.

Walter Lemmon (International Business Machines) discussed radio relay network systems and showed a model of a proposed tower for UHF relay work. The tower as described, would be a two-way system using parabolic reflectors and horns to achieve gain and directivity.

J. E. Keister (GE) spoke of the place for satellite stations operating in small communities and serving as network program distributors for

# harvey

... Reliable  
Supplier of

RADIO  
and  
ELECTRONIC  
PARTS and EQUIPMENT



TUBES                    RESISTORS  
RELAYS                CAPACITORS  
METERS                TRANSFORMERS  
TEST EQUIPMENT

### The Goods:

We stock and sell items bearing the names of famous manufacturers . . . people who value their reputation as much as we value ours.

### The Service:

We track down hard-to-find items, or suggest equivalent substitutions. We supply sound technical advice . . . help solve priority problems.

### The Delivery:

Fast . . . within 24 hours, at times. And whether you order by mail, wire or phone, you'll receive immediate attention. Try HARVEY and see for yourself.

Telephone Orders to:  
HRC Longacre 3-1800

HARVEY  
RADIO COMPANY  
HARVEY  
103 WEST 43rd ST., NEW YORK 18, N. Y.

# STANDARD

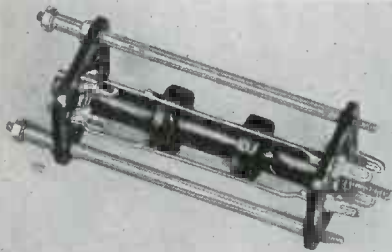

Pre-tuned  
I.F. Transformer

## PROFICIENCY

Because we are specialists . . . because we concentrate all our research engineering and production skill on meeting difficult coil requirements . . . we have achieved a degree of Proficiency that commands your investigation. Our engineering staff is available for consultation without obligation.

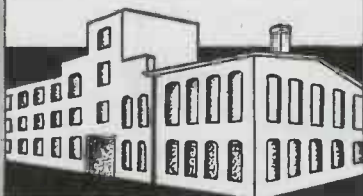

WE INVITE YOUR  
INQUIRIES

# STANDARD WINDING CO.

44-62 Johnes Street  
NEWBURGH, NEW YORK  
NEW YORK OFFICE: 53 PARK PLACE  
REctor 2-5334

the surrounding area. Such stations could be comparatively inexpensive since large studio facilities and staffs are not required.

Charles Robbins (Emerson) discussed the economic relationship of program costs, set costs and the progress of television. He predicted that television would be a three billion dollar business in five years after resumption of manufacturing.

Paul Chamberlain (GE) told of the advantages of a local circuit television system to department stores (see page 120). He emphasized that equipment and operating standards should be the same as that used by broadcasters in order to permit programs originating in the store to be fed to local stations.

Dr. Peter Goldmark (CBS) outlined the necessity of wide band channels for adequate color transmission and high line content black and white pictures. He said CBS advocated 735 lines for black and white or 525 lines in three colors. Such a system would require a 10 mc band, he stated and said that CBS had suitable amplifiers for the bandwidth in operation before the war. Dr. Goldmark stated that tubes were now in use that would give adequate carrier power in the vicinity of 500 mc.

### Ken-Rad to GE?

Negotiations are in progress between the General Electric Co. and the Ken-Rad Corp. which may develop in GE's purchase of the latter's radio tube branches in Owensboro, Ky., and four other places. The announcement was made recently by Roy Burlow, President of Ken-Rad, and Dr. W. R. G. Baker, vice-president in charge of General Electric's Electronics Department. The prospective sale does not include the electric lamp manufacturing business of Ken-Rad.

### Effect of Light on Electric Discharge in Chlorine

In the July 29, 1944, issue of Nature, S. S. Joshi of the Chemical Laboratories, Benares Hindu University, reports the following phenomena:

"Previous work on this phenomenon<sup>1, 2, 3</sup> showed that a current decrease  $\Delta i$  is produced by irradiation of chlorine and other gases referred to the rectified mean r.m.s. values of  $i$  under different conditions; changes in the corresponding current-structure and its time-delineation are revealed by a cathode ray oscillograph<sup>3</sup>. An iron core step-down transformer was introduced in series with an ac indicator. Its secondaries were connected to one pair of the deflecting plates in the oscillograph; the other pair was connected to the time-sweep potential. With but a moderate amplifier gain on each of the plate pairs and the usual adjustments, the

oscillograph revealed, besides the frequency of the ac supply, a remarkably large number of higher frequencies of widely varying strengths; they were not transients but repeatable and characteristic constituents of  $i$  the discharge current. It was also striking to observe the sensibly instantaneous and reversible diminution of the amplitudes of these component frequencies, on irradiating the discharge tube.

"It was observed<sup>1, 4</sup> that the production of a change under electrical discharge, chemical or otherwise, for example, the hydrogen chlorine reaction, the activation of nitrogen, its deactivation, etc., requires a minimum threshold potential  $V_m$  characteristic of the reaction, its operative conditions such as the frequency  $n$ , the temperature, etc. At  $V_m$ , the wattage dissipated in the system and  $i$  show a rapid rise as  $V$  is increased. In elementary gases,  $V_m$  may be identified with or related simply to the corresponding Paschen potential. Below  $V_m$ , the oscillograph showed a markedly simple current-structure; further, changes of the amplitudes due to the light-effect were not detected. It is considered that ionization by collision in fields due to the applied potential is a necessary condition for the occurrence of this phenomenon. It is found that both for the light-effect and the above type of reactions,  $V_m$  diminishes as  $n$  is increased; its influence on the light-effect expressed as  $\Delta i/i$  is also in the same direction.

An examination of a number of oscillogram pairs obtained under different conditions, showed that the proportionate reduction on irradiation of the component amplitudes was fairly uniform. These higher frequencies in  $i$  represented both the audio and radio ranges. When the latter were eliminated with a series of h.f. filters, the light-effect in the residual audio range was similar to that for the total or unfiltered current. That the above remark applies also to the radio range was indicated by similar results for the light-effect  $\Delta i/i$  observed, with and without an amplifier, for  $i$  picked up by a moderate size aerial 1-9 ft. distant from the chlorine tube."

<sup>1</sup> Joshi, Curr. Sci., 8, 548 (1939).  
<sup>2</sup> Joshi, Pres. Address, Chem. Sec., Ind. Sci. Cong. (1943).  
<sup>3</sup> Joshi, Benares Hindu Univ. J., 8, 99 (1943).  
<sup>4</sup> Joshi, Trans. Farad. Soc., 25, 120 (1929).

### Midget Transformers

Under war pressure, signaling systems, radar, and other very high frequency devices have required scores of unusual transformers that never before existed. To meet this demand transformer engineers have produced units that viewed by ordinary standards are freaks of the first order. For example, consider



...on our mark

... and set to go on Civilian production of Radio and Automotive Products—soon. Set your sights on Snyder.

**SNYDER MFG. CO.**  
 RADIO & AUTOMOTIVE PRODUCTS • PHILA. 40, PA.

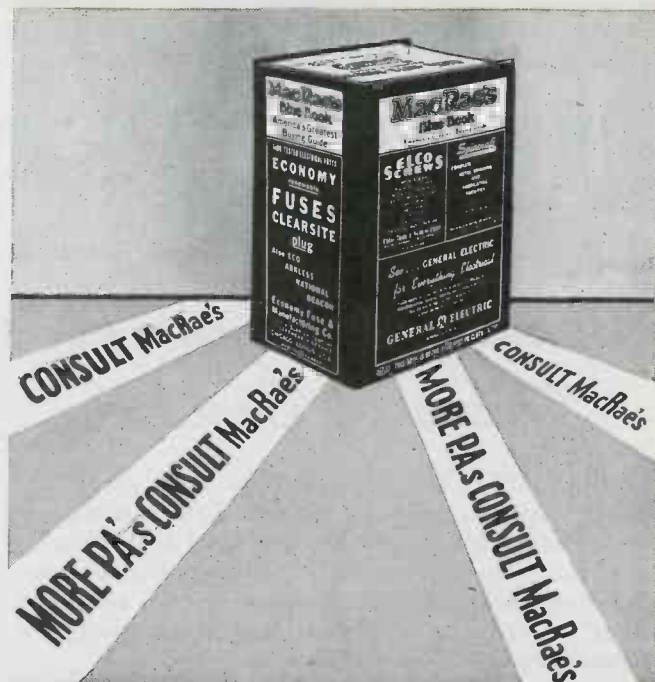
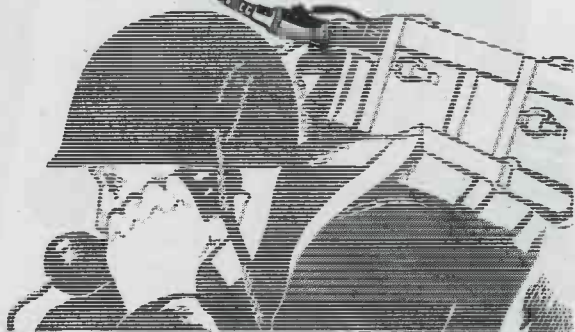

FOR ADVERTISING AND BOOK RATES, CONSULT YOUR AGENCY OR WRITE

# MacRae's Blue Book

A DIRECTORY OF AMERICAN INDUSTRY

19 E. HURON STREET

CHICAGO 11, ILL.

**WANTED NOW!**

## ELECTRONIC

Tube and Radio

### DEVELOPMENT ENGINEERS, TECHNICIANS

WAR PROJECTS — ELECTRONIC DEVICES

### PLAN YOUR FUTURE

in television  
ultra-high frequency

Write qualifications, Box 1294  
ELECTRONIC INDUSTRIES

MORE RF KILOWATT HOURS PER DOLLAR WITH

## F & O TRANSMITTING TUBES

Inquiries Invited—Let us explain how Savings are effected and the F & O greater guarantee.

**FREELAND & OLSCHNER PRODUCTS, INC.**  
 611 BARONNE STREET NEW ORLEANS 13, LA.  
 Raymond 4756

High Power Tube Specialists Exclusively  
 (1/4 to 100 KW)

## ELECTRONICS

### MECHANICAL ENGINEER WANTED

Manufacturer needs services of a skilled mechanical engineer. Radio experience is desirable but not imperative. Must have creative mind and ability to supervise others. Our company is growing steadily; its postwar prospects are unlimited. In reply, give all important particulars of education, past experience and salaries earned. Apply Box No. 4920. Please send replies to Miss Lillian Landwehr, Peck Advertising Agency, Inc., 400 Madison Avenue, New York, N. Y.

## ENGINEERS

FOR MECHANICAL DESIGN  
OF RADIO INSTRUMENTS

A good connection today can mean security for you in the postwar era. Aggressive, successful newcomers in home radio, we have openings for several men with prewar experience in producing low-cost designs for fast manufacture. Write today. Postwar program in the offing!

**MAGUIRE INDUSTRIES, INC.**  
 Electronics Division

342 W. PUTNAM AVE.

GREENWICH, CONN.

# 1,001 USES

## Condensed Power for Years of Service

VERSATILITY and dependability were paramount when Alliance designed these efficient motors—*Multum in Parvo!* . . . They are ideal for operating fans, movie projectors, light home appliances, toys, switches, motion displays, control systems and many other applications . . . providing economical condensed power for years of service.

### Alliance Precision

Our long established standards of precision manufacturing from highest grade materials are strictly adhered to in these models to insure long life without breakdowns.

#### EFFICIENT

Both the new Model "K" Motor and the Model "MS" are the shaded pole induction type—the last word in efficient small motor design. They can be produced in all standard voltages and frequencies with actual measured power outputs ranging upwards to 1/100 H. P. . . Alliance motors also can be furnished, in quantity, with variations to adapt them to specific applications.

#### DEPENDABLE

Both these models uphold the Alliance reputation for all 'round dependability. In the busy post-war period, there will be many "spots" where these Miniature Power Plants will fit requirements . . . Write now for further information.

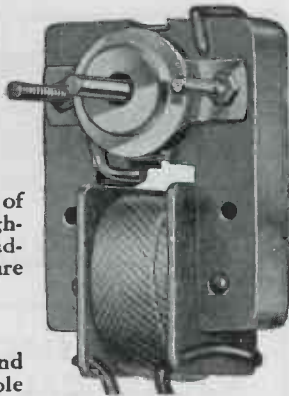

Model "MS"—Full Size Motor Measures 1 3/4" x 2 x 3 1/8"

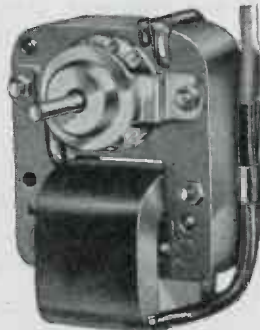

New Model "K"—Full Size Motor Measures 2 1/8" x 2 3/8" x 3 1/8"

Remember Alliance!  
—YOUR ALLY IN WAR AS IN PEACE

# ALLIANCE MANUFACTURING CO.

ALLIANCE . OHIO

# GET THIS FREE Emergency Service BUYER'S GUIDE!



A MODERN Reference Book and Buyer's Guide is ready NOW! It represents an important contribution to the field of Industrial Electronics. Between its attractive covers you'll find pertinent information and data on the most advanced types of electronic instruments, devices and tools. Here are descriptions of products such as industrial X-Ray Machines, an Electronic Comparator, Test Equipment including Signal Generators, Tube Testers, and Multimeter, Die-Less Duplicating Tools, Plastic Sectional Wiring Systems, Photo-Electric Devices, and others that have never been catalogued before. Industrial engineers and purchasing agents are invited to send for a free copy today!

FILL IN AND MAIL TO YOUR NEAREST DISTRIBUTOR!

**WALKER-JIMIESON, INC.**  
311 S. Western Avenue, CANAL 2525, CHICAGO 12  
**RADIO SPECIALTIES CORP.**  
20th & Figueroa, Phone Prospect 7271, LOS ANGELES 7

GENTLEMEN: Please send me a free copy of your Reference Book & Buyer's Guide.

NAME \_\_\_\_\_  
COMPANY \_\_\_\_\_  
CITY \_\_\_\_\_ ZONE \_\_\_\_\_ STATE \_\_\_\_\_

a transformer no bigger than a fist yet able to deliver 100 kw (for extremely brief intervals, of course). Another complete transformer weighs but one-half ounce. The production of the ultra-thin thicknesses of grain-oriented Hipersil by the engineers of the American Rolling Mill and Westinghouse has helped make possible these unusual designs.

The pressure on transformer designers for small size, light weight, and high capacity in these midget transformers comes from two directions. Much of this equipment is airborne where the need for weight and space saving is obvious. The other is that as frequency increases the thickness of the core laminations should decrease. At frequencies of several thousand kilocycles the flux changes so rapidly it is not able to penetrate fully the magnetic material. A sort of magnetic skin effect comes into play. At these frequencies the flux would not penetrate more than five or ten per cent of the standard lamination. Thus to keep down eddy current losses which at these frequencies tend to eat up appreciable proportions of the meager power available, the laminations should be thin, very thin—i.e., have as much surface as possible.

Prewar standard Hipersil laminations were 29 gage, or about 14 mils thick. Then came seven-mil Hipersil, used extensively for 400-cycle aircraft transforming equipment, with an attendant saving in about 30 per cent in total weight. As rolling-mill technics improved, the seven-mil strip was outmoded by one five mils thick. But for transformers in the high-frequency band and those that deliver power for but a tiny fraction of a second, five-mil steel is much too thick.

To provide an ultra-thin material an entirely new type of rolling mill was developed and built. With it, grain-oriented steel, consistent in quality and only two mils thick has been produced. It makes possible transformers in which iron cores have not previously been possible because of the intolerably high core losses. Such transformers will, for example, be a great boon in television, which requires high peaks of power in pulses lasting but a fraction of a millionth of a second.

Now engineers have produced on an experimental basis a Hipersil steel only half as thick as the two-mil steel. Four layers of this one-mil Hipersil would be required to equal the thickness of this paper. Such steel when it can be produced on a commercial basis will mean a 20 to 50 per cent further saving in weight, or, more important still, greater powers available for some war and postwar uses of frequencies now at the upper end of the frequency spectrum.

# Specialists

... in Assembly and sub-assembly of Precision Electronic Products

- Complete Facilities for Production and Testing of Audio Equipment
- Consult us with your Production Assembling Problems

## RADELL

C O R P O R A T I O N

6323-27 GUILFORD AVENUE, INDIANAPOLIS 5, INDIANA



If You've Been Turned Away, We're Sorry ...

*But-* **WE CAN PUBLISH ONLY 65% of ADVERTISING OFFERED US!**

With a paper quota entirely inadequate to meet the needs of product information in this field, ELECTRONIC INDUSTRIES can publish little more than 65% of the available advertising.

Paper rationing affects publishers differently. Those having many publications can shift their paper tonnage from a weak magazine to a strong one to provide for an increasing volume of advertising. Caldwell-Clements, Inc., with two magazines and a growing demand for space in both, has no secondary medium to draw upon. The impact of paper rationing, therefore is shown in a sacrifice of advertising volume.

**CALDWELL-CLEMENTS, INC.**  
480 Lexington Ave., New York 17, N. Y.

**ELECTRONIC INDUSTRIES**

Also Publishers of RADIO & TELEVISION RETAILING

## Makers Organize For Labor Relations

Organization of Electronic Manufacturers Association, Inc., reported several months ago as being a group of producers of electronic equipment and parts banded together to expedite the handling of labor relations matters in greater New York and New Jersey, has been completed with the election of these officers: President I. Walter Wyckoff (Pilot); Vice-presidents Leslie G. Thomas (Solar) and Arthur Freed (Freed Radio); Secretary J. J. Kuscher (De Jur Amsco); Treasurer Samuel J. Novick (Electronic Corp. of America); Directors, the officers and David Wald (United Scientific Labs), Jack M. Marks (Fada), Harold Shevers (Espey), Arthur C. Ansley (Ansley Radio), David H. Engelson (Federal Eng. & Mfg. Co.), Harold Golden (United Transformer). Offices have been established in the Empire State Building, New York.

## NEW BULLETINS

(Continued from page 216)

### Transformer Components

Power supply transformers, filter reactors, audio equipment, driver and modulator combinations and other allied transformer products are included in a new 20-page catalog issued by Peerless Electrical

Products, 6920 McKinley Ave., Los Angeles. Included is a line of isolation transformers.

### Tachometers

Bulletin No. 44-1, just published by Jones Motrola Co., Fairfield Avenue, Stamford, Conn., describes four models of individual-mount tachometers and the multi-range portable hand tachometer. The bulletin shows both full-face and profile views of the individual tachometers, rpm ranges available, mounting dimensions, and includes prices for tachometers and appurtenances, a section on use and operation, and general installation data.

### Thermocouple Data

Bulletin S2-5, an enlarged edition of its 40-page Thermocouple Data Book and catalog, has just been issued by Wheelco Instruments Co., Harrison and Peoria Sts., Chicago 7. It describes products and prices and offers recommendations helpful in the selection of thermocouples, lead wire, protecting tubes, heads and insulators. Also included are millivolt tables on the various types of thermocouples, temperature conversion tables, tables on wire resistance and on pipe and wire sizes, and a fraction-decimal equivalent chart.

### Soldering Fluxes

A new catalog describing its complete line of fluxes has been issued by Superior Flux Co., 913 Public Square Bldg., Cleveland. Included are 20 fluxes for welding, brazing, silver soldering, soft soldering and low temperature alloy welding of ferrous and non-ferrous metals and alloys. Different fluxes are available for welding, brazing and soldering all forms and alloys of aluminum. For cast iron and for copper there are both welding and brazing fluxes, and for stainless steel there are welding and soldering fluxes. For each flux listed there is included a detailed statement of its characteristics and a full schedule of list prices.

### "Interim Line" Catalog

To help span the gap between present wartime restrictions and postwar abundance, an "Interim Line" catalog has just been issued by Clarostat Mfg. Co., Inc., 285-7 N. 6th St., Brooklyn, N. Y. It lists such items as composition-element and wire-wound controls, switches, constant-impedance attenuators, universal metal-tube plug-in resistors, power rheostats, power resistors, voltage regulators, and glass-insulated flexible resistors which are in regular production and, priorities permitting, may be made available to the jobbing trade.

## THE CATHODE-RAY TUBE AT WORK by John F. Rider

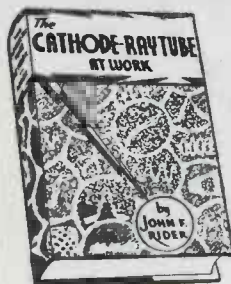

This book presents a complete explanation of various types of cathode-ray tubes and what role each element within the device plays in making visible the voltages and currents encountered in various kinds of tests.

More than half the book is devoted to the practical applications of the cathode-ray tube oscillograph.

This book has proved its value among both students and practical workers.

338 pages, 450 illustrations, \$3.00

### A-C CALCULATION CHARTS

This new Rider Book greatly reduces the time required for alternating current engineering calculations—speeds up the design of apparatus, the progress of engineering students and aids executives who check engineering calculations. 160 pages (9½ x 12 in.) \$7.50

Send for Catalogue of all RIDER BOOKS



JOHN F. RIDER PUBLISHER, INC.

404 FOURTH AVENUE • NEW YORK 16, N. Y.

EXPORT DIV.: ROCKE-INTERNATIONAL CORP. 13 E. 40TH ST., NEW YORK

## WANTED

By RBM Manufacturing Co.  
Division of Essex Wire Corp.  
Logansport, Ind.

DESIGN LAYOUT DRAFTSMAN  
PRODUCT DESIGNERS  
ELECTRICAL ENGINEERS

These positions offer real opportunities for advancement now and in the post-war era to those men who can design:

RELAYS  
SOLENOIDS  
VOLTAGE REGULATORS  
SWITCHES  
REMOTE CONTROL MECHANISMS  
OVERLOAD CIRCUIT BREAKERS  
ELECTRONIC DEVICES

Let us hear from you

# ELECTRONIC INDUSTRIES

Advertisers—January, 1945

	Page		Page		Page
Advance Electric & Relay Co.	169	Dial Light Co. of America		Manross & Sons, F. N.	166
Aerovox Corp.	26	Inc.	174	Micarta Fabricators, Inc.	198
Air Reduction	198	Doolittle Radio, Inc.	170	Micro Switch Corp.	195
Albion Coil Co.	51	Dow Chemical Co.	183	Millen Mfg. Co., Inc., James	210
Alliance Mfg. Co.	224	Drake Electric Works, Inc.	172	Mu-Switch Corp.	206
Allied Radio Corp.	164	Drake Mfg. Co.	208	Mycalex Corp. of America	23
Allmetal Screw Products Co.	219	Dumont Electric Co.	140	National Co.	40
Altec Lansing Corp.	152	DuMont Laboratories, Inc.,		National Gasket & Washer	
Amalgamated Radio Television		Allen B.	19	Mfg. Co.	218
Corp.	154	Eastern Air Devices, Inc.	151	National Vulcanized Fibre Co.	34
American Electrical Heater		Eicor, Inc.	212	New York Transformer Co.	28
Co.	228	Eisler Engineering Co.	219	North American Philips Co.,	
American Gas Accumulator		Eitel-McCullough, Inc.	199	Inc.	131
Co.	150	Electric Soldering Iron Co.,		Norton Electrical Instrument	
American Lava Corp.	173	Inc.	215	Co.	150
American Phenolic Corp.	43	Electric Specialty Co.	219	Ohmite Mfg. Co.	197
American Television & Radio		Electrocon Corp.	138	Owens-Corning Fibreglas	
Co.	139	Electronic Laboratories,		Corp.	49
American Time Products, Inc.	161	Inc.	65	Par-Metal Products Corp.	162
American Transformer Co.	63	Electronic Mechanics, Inc.	142	Patton-MacGuey Co.	215
Amperex Electronic Corp.	2	Electronic Products Mfg.		Pemoflux Corp.	167
Amperite Co.	160	Corp.	154	Pioneer Gen-E-Motor Corp.	180
Anacosta Wire & Cable Co.	39	Electro-Voice Corp.	20	Prenax Products	201
Andrew Co.	170	Engineering Co.	136	Press Wireless, Inc.	223
Arnold Engineering Co.	190	Erie Resistor Corp.	73	Printoid, Inc.	174
Associated Research, Inc.	162	Federal Telephone & Radio		Radell Corp.	225
Astac Corp.	192	Corp.	27, 54	Radiart Corp.	200
Automatic Electric Sales Corp.	50	Fisher-Pierce Co.	158	Radio Corporation of America:	
Barber Laboratories, Alfred		Formica Insulation Co.	31	RCA Victor Division.	48
W.	194	Freed Transformer Co.	175	Cover 4	
Barker & Williamson	134	Freeland & Olschner Products		Radio Receptor Co., Inc.	52
Bell Sound Systems, Inc.	218	Inc.	223	Radio Specialties Co.	224
Bell Telephone Laboratories	44	General Ceramics & Steatite		Radio Wire Television, Inc.	221
Bendix Aviation Corp.,		Corp.	149	Raytheon Mfg. Co.	137
Pacific Div.	205	General Electric Co. 5, 36, 37,		R-B-M Mfg. Co.	178, 226
Bentley, Harris Mfg. Co.	155	71, 156, 179		Remler Co., Ltd.	129
Bird & Co., Richard H.	202	General Industries Co.	133	Rider Publisher, Inc., John F.	226
Bogen Co., Inc., David	186	General Instrument Corp.	135	Rogan Brothers	228
Boonton Radio Corp.	200	Goat Metal Stampings, Inc.	201	Rogers Mfg. Co., Dayton	146
Bridgeport Mfg. Co.	211	Green Electric Co., Inc.	130	Rothenstein, Albert	188
Brush Development Co.	22	Groves Corp.	136	Sangamo Electric Co.	144, 145
Burgess Battery Co.	196	Guardian Electric Mfg. Co.	117	Scientific Radio Products Co.	194
Burke Electric Co.	204	Hallicrafters Co.	68	" S " Corrugated Quenched Gap	
Burndy Engineering Co.	157	Hammarlund Mfg. Co., Inc.	203	Co.	57
Burstein-Applebee Co.	219	Hanovia Chemical & Mfg. Co.	142	Screenmakers	146
Cambridge Thermionic Corp.	132	Harco Steel Construction Co.	168	Shallcross Mfg. Co.	176
Capacitron Co.	202	Hardwick, Hindle, Inc.	126	Simpson Electric Co.	165
Cardwell Condensers Mfg.		Harrison Radio Corp.	220	Smith Co., Inc., F. A.	160
Corp., Allen D.	153	Harvey Radio Co.	221	Snyder Mfg. Co.	223
Celanese Corp. of America	171	Harvey Radio Laboratories,		Sperry Gyroscope Co., Inc.	21
Centralab	14	Inc.	121	Sperti, Inc.	184
Chicago Transformer,		Hassall, Inc., John	166	Sprague Electric Co. 66, 123, 147	
Div. of Essex Wire Corp.	168	Heinemann Circuit Breaker Co.	53	Stackpole Carbon Co.	17, 70
Cincinnati Electric Products		Heintz & Kaufman, Ltd.	24	Standard Transformer Corp.	4
Co.	6, 7	Hipower Crystal Co.	215	Standard Winding Co.	222
Cinema Engineering Co.	215	Hytron Corp.	113	Struthers-Dunn, Inc.	125
Clare & Co., C. P.	35	Indiana Steel Products Co.	38	Stupakoff Ceramic & Mfg. Co.	185
Clarostat Mfg. Co., Inc.	148	Insuline Corp. of America	132	Submarine Signal Co.	219
Cole Steel Equipment		International Nickel Co., Inc.	189	Sun Radio & Electronics Co.	214
Co.	127, 172	International Products Corp.	16	Sylvania Electric Products,	
Collins Radio Co.	62, 207	International Resistance Co.	69	Inc.	217
Colonial Kolonite Co.	182	Jensen Radio Mfg. Co.	213	Thomas & Skinner Steel	
Conant Electrical		Johnson Co., E. F. 159, 178, 216		Products Co.	208
Laboratories	188	Karp Metal Products Co.,		Thordarson Electric Mfg. Co.	209
Concord Radio Corp.	152	Inc.	25	Tung-Sol Lamp Works, Inc.	47
Connecticut Telephone &		Kahle Engineering Co.	219	Turner Co.	33
Electric	30	Ken-Rad Tube & Lamp Co.	10	United Electronics Co.	45
Connector Div. of Inter-		Kenyon Transformer Co., Inc.	181	United Screw & Bolt Corp.	18
national Resistance Co.	9	Keuffel & Esser Co.	177	United Transformer Co.	74
Continental-Diamond Fibre		Kurman Electric Co.	215	Universal Microphone Co.	8
Co.	164	Langevin Co., Inc.	56	Utah Radio Products Co.	11
Continental Electric Co.	59	Lapp Insulator Co., Inc.	191	Walker-Jimeson, Inc.	224
Cornell-Dubilier Electric		Lavoie Laboratories	115	Ward Leonard Electric Co.	55
Corp.	64	Lectrohm, Inc.	228	Webster Products	46
Corning Glass Works	128	Leland Electric Co.	67	Western Electric Co.	119, 220
Cornish Wire Co., Inc.	186	Littelfuse, Inc.	140	Westinghouse Electric & Mfg.	
Corry-Jamestown Mfg.		Locke Insulator Corp.	72	Co.	60, 61, 141
Corp.	12, 13	Lord Mfg. Co.	58	Whitaker Cable Corp.	41
Coto-Coil Co., Inc.	124	Macallen Co.	163	Wilson Co., H. A.	187
Creative Plastics Corp.	220	Maclett Laboratories, Inc.	15	Wincharger Corp.	182
Dalis, Inc., H. L.	227	MacRae's Blue Book	223	Wrigley Co., Wm.	206
Daven Co.	Cover 3	Magnavox Co.	42	Zophar Mills, Inc.	206
DeForest's Training, Inc.	198	Maguire Industries, Inc.	223		
Delco Radio Div.,		Mallory & Co., Inc., P. R.			
General Motors Corp.	29	Cover 2, 32, 193			
Deutschmann Corp., Tobe	3				

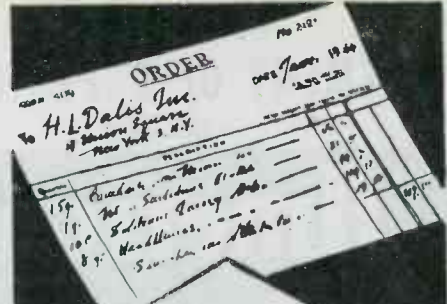

## FAST WORK ON YOUR WAR ORDERS

• If your needs are urgent, take advantage of our exceptionally large and complete stock of radio-electronic supplies and parts. Most orders can be filled immediately from stock, and shipped the same day received.

And to help you order just what you need, we have the big Dalis catalog which is yours for the asking. Write on your business letterhead for your copy.

• Try Dalis—just wire, 'phone or write . . .



**H. L. DALIS, INC.**  
 Wholesale Distributors  
**RADIO-ELECTRONIC SUPPLIES & PARTS**  
 17 Union Square  
**NEW YORK 3, N. Y.**  
 Phones: ALgonquin 4-8112-3-4-5-6-7

While every precaution is taken to insure accuracy, we cannot guarantee against the possibility of an occasional change or omission in the preparation of this index.

THERE IS AN  
ELEMENT OF SUPERIORITY

*in the*

# American Beauty

## ELECTRIC SOLDERING IRON

Not only the superior construction of the heating element, but the sturdy quality of the other units, makes this the preferred iron for all industrial uses . . . . It is dependable, durable and efficient.

### TEMPERATURE REGULATING STAND

An adjustable-thermostatically controlled stand for regulating the temperature of an electric soldering iron when at rest.

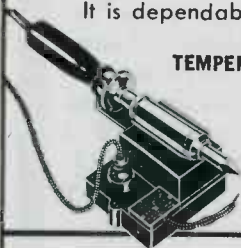

105

AMERICAN ELECTRICAL HEATER COMPANY

DETROIT 2, MICHIGAN, U. S. A.

# LECTROHM } WIRE WOUND ADJUSTABLE } VITREOUS ENAMELLED RESISTORS

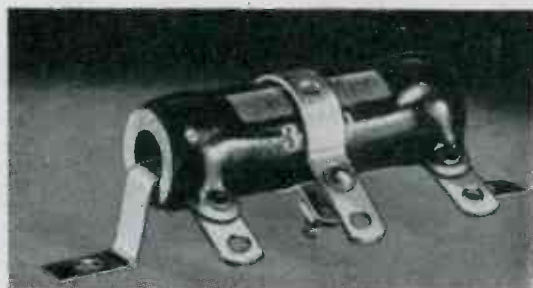

### Experience Built under personalized supervision

Lectrohm adjustable Resistors are a precision product. Resistance wire is silver soldered to the solder lugs by special process, assuring perfect electrical bond always. A thoro vitreous enamel coating completely embeds the accurately spaced winding, terminals and silver soldered connections—producing a solid, integral unit. These Resistors are used as voltage dividers, or potentiometers and can be equipped with several adjustable bands. Capacities 10 watt to 200 watt. Request complete information.



5139 West 25th Street, Cicero 50, Illinois

## NOW YOU CAN DO YOUR OWN BRANDING ON PLASTICS!

WE SHOW YOU HOW  
WE ENGINEER THE JOB  
WE BUILD THE TOOLS

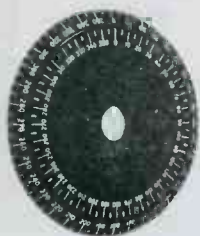

★ Rogan's exclusive plastic branding process has been employed extensively to speed production of many important war plastics. The bakelite Azimuth Dial illustrated, is one example of Rogan's accuracy in branding. In fact, this important assignment was entrusted *only* to Rogan.

However, wartime demands for this service in some ordnance plants, have required the application on their own premises. So, Rogan engineers have arranged a method whereby anyone can do his own branding on plastics right in his own plant. Rogan will engineer each job completely and build all the necessary tools. Will provide clear, simple instructions that will permit anyone to do the job expertly. All you need do is to send us blue prints and other specific data, and we'll give you a quick cost and time estimate.

Take advantage of this *new* Rogan service . . . send us your specifications today.

# ROGAN BROTHERS

2007 S. MICHIGAN AVE.

CHICAGO 16, ILLINOIS

## WANTED

One General Radio Type 732B Noise and Distortion Meter and one General Radio Type 732P1 Range Extension Filter in good condition.

Box 153,  
ELECTRONIC INDUSTRIES  
480 Lexington Ave., New York 17, N. Y.

## OPPORTUNITIES

in

### Present and Postwar Work

Senior and Junior graduate Engineers with one or more years radio experience wanted by an expanding manufacturing division of an established Communication Company. Also, Engineers with practical experience for radio communication plant installation and test in foreign countries. Phone, call or write stating experience, education, present salary, etc., to:

PRESS WIRELESS, INC.  
HICKSVILLE, L. I.

ATT: S. A. BARONE, CHIEF MFG. ENGR.

# DAVEN

## ATTENUATORS

The many different networks (illustrated) and the wide selection of characteristic variations comprising the standard lines of DAVEN attenuators, are features of great convenience to the engineer—in Radio Broadcasting, in Sound Recording, Sound Projection, in Television and in the Laboratory Equipment field. Likewise, advanced designing as embodied in recent DAVEN announcements, plus a long standing reputation for making a good product, are facts that merit consideration in your present and post-war plans.

### Balanced Circuits

### Unbalanced Circuits

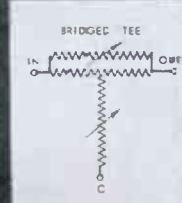
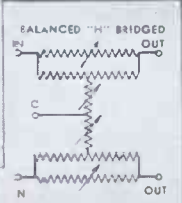
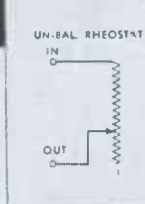
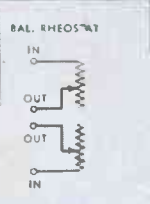
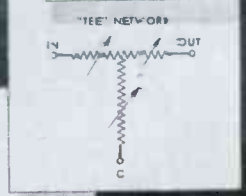
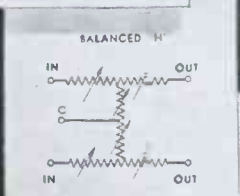
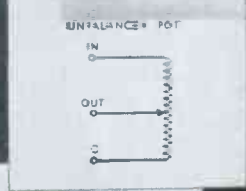
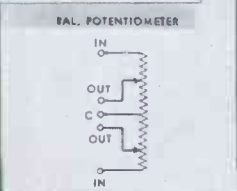
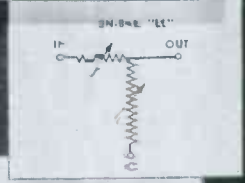
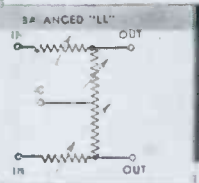
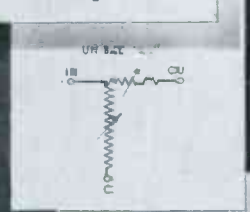
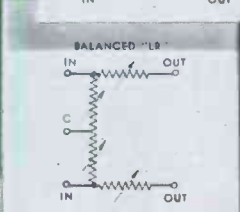
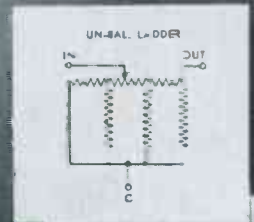
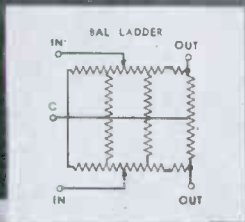

**BETTER DELIVERIES**  
 Several standard types of DAVEN Attenuators are available in moderate quantities for prompt deliveries. 30 to 60 day delivery is being made at this time on many other standard and some special types.

THE **DAVEN** COMPANY  
 151 CENTRAL AVENUE  
 NEWARK 4, NEW JERSEY

BUY MORE... HOLD MORE... WAR BONDS

**3 WAYS**

# RCA METAL TUBES SIMPLIFY DESIGN



## 1. ELIMINATE SHIELD CANS

Metal tubes are self-shielding.



• Your design and manufacturing problems are simplified both mechanically and electrically when you use RCA metal tubes. In addition, tubes with metal envelopes consistently give uniform performance... high stability... freedom from the effects of stray fields.

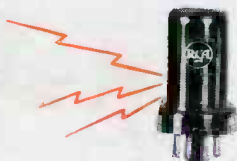

## 2. CAN BE LOCATED ANYWHERE

Metal tubes are little affected by stray fields.



## 3. ARE EASILY GROUNDED

Metal tubes provide simple grounding of the envelope through the No. 1 socket terminal.

First to manufacture metal tubes, RCA has introduced over 90% of the metal types now available... and has built more than 120,000,000 metal tubes since 1935. Metal tubes were an important factor in RCA's *prewar* Preferred Type Program... and will be in RCA's postwar Preferred Type Program.

If you have a design problem involving electron tubes... metal, miniature, or glass types... call on RCA tube application engineers. Write to RCA, Commercial Engineering Section, Dept. 62-26J, Harrison, New Jersey.

Remember, The Magic Brain of all electronic equipment is a Tube... and the fountain-head of modern Tube development is RCA.



**RADIO CORPORATION  
OF AMERICA**

RCA VICTOR DIVISION • CAMDEN, N. J.

62-6136-26