

The TALKING MACHINE WORLD

For the
makers &
sellers of
talking
machines

Published Each Month by Edward Lyman Bill, Inc., at 373 Fourth Ave., New York, August 15, 1922



The best-known trademark in the world
designating the products of the Victor Talking Machine Co.

THE INSTRUMENT OF QUALITY
Sonora
CLEAR AS A BELL



The Highest Class Talking Machine in the World

Sonora Makes Sales Where Others Fail



HEPPLEWHITE
PEMBROOK
\$165



BABY GRAND
\$200

Thousands of sales are lost by dealers who do not carry the Sonora. The prospects who say "they are not ready to buy", the purchaser who says she "will look around a bit further"—how large a percentage of these people could be turned into buyers if you offered them Sonora's exceptional tone and splendid values.

The Sonora has always been *built to sell and stay sold*. No possible advantage has been neglected. The new Sonoras have carried tone perfection beyond former dreams of possibility. The cabinets are soundly constructed and alluring in appearance. The exclusive features cannot be duplicated or equaled.

That Sonora makes sales where others fail is demonstrated regularly by the fact that so many big stores that have long held out are one by one becoming Sonora representatives.

Sonora Phonograph Company, Inc.
GEORGE E. BRIGHTSON, President

279 BROADWAY

NEW YORK

Canadian Distributors: I. Montagnes & Co., Toronto

The Easiest Portable to Sell

It's never "too late in the season" to sell the Sonora Portable. At \$50 it represents such a wonderful value that it sells regardless of seasons—and a Portable owner is a good prospect for a larger Sonora.



The Talking Machine World

Vol. 18. No. 8

New York, August 15, 1922

Price Twenty-five Cents

PADEREWSKI TO MAKE CONCERT TOUR

Famous Pianist and Statesman Will Give Limited Number of Recitals Next Winter—Is Again in Evidence in the Record Field

The members of the talking machine trade will receive with no small degree of pleasure the news that Ignace J. Paderewski, the world-renowned pianist and former Premier of Poland, his native land, has decided to re-enter the concert field next Winter, following his return from Europe. He will be heard in a limited number of concerts in the United States and Canada



Ignace Jan Paderewski

through the medium of his favorite piano, the Steinway.

For some years it had been assumed that his artistic career in the musical field was at an end, but previous to his departure for Europe early this month, after a long rest at his ranch in California, he permitted it to be known that he would again be heard in concert, much to the delight of millions of admirers. Paderewski is one of the unique characters of history, being composer, pianist and statesman, in each of which posts he has scored a success.

Paderewski is represented in the Victor catalog by seven records which he made shortly before he assumed the troublous paths of leadership as Premier in 1917.

It is pleasing to note, however, that in the September Victor list Paderewski is again in evidence with a record of his own Nocturne in B Flat. This, the first Paderewski record in many years, is significant. It may be expected that the great pianist will reach his admirers through other records now that he chooses to resume his great role in the world of music.

LEONARD WITH COLLINGS & CO.

Joins Traveling Staff of Newark Distributors—Business Shows Improving Trend

Ernest C. Leonard was recently added to the traveling staff of Collings & Co., the well-known Victor distributors, of Newark, N. J. He will divide up the territory with David Roche and A. J. Wilckens, who already represent the Collings firm.

Harold J. Lamor, manager of the sales and order departments of the company, in a chat with *The World*, stated that July business showed much increased activity. The sales campaign recently inaugurated by the Collings firm received a gratifying response from the dealers in the territory in which they serve and indications, seemingly, are that business for the balance of the year will show increasing gains.

Put yourself in your customer's place occasionally and watch results.

OUR EXPORTS OF TALKING MACHINES

Exports and Imports of Talking Machines and Records Show a Decreasing Tendency as Compared With Last Year—Our Buyers

WASHINGTON, D. C., August 10.—In the summary of exports and imports of the commerce of the United States for the month of May, 1922 (the latest period for which it has been compiled), which has just been issued, the following figures on talking machines and records are presented:

The dutiable imports of talking machines and parts during May, 1922, amounted in value to \$29,688, as compared with \$61,370 worth which were imported during the same month of 1921. The eleven months' total ending May, 1922, showed importations valued at \$492,302, as compared with \$733,520 worth of talking machines and parts during the same period of 1921.

Talking machines to the number of 3,736, valued at \$141,513, were exported in May, 1922, as compared with 2,564 talking machines, valued at \$115,000, sent abroad in the same period of 1921. The eleven months' total showed that we exported 34,387 talking machines, valued at \$1,392,206, as against 65,330 talking machines, valued at \$2,951,283 in 1921.

The total exports of records and supplies for May, 1922, were valued at \$110,598, as compared with \$212,986 in May, 1921. The eleven months ending May, 1922, show records and accessories exported valued at \$1,385,331; in 1921, \$2,817,134.

The countries to which exports were made in May and the values thereof are as follows: United Kingdom, \$11,515; Canada, \$4,334; Central America, \$4,232; Mexico, \$13,526; Cuba, \$2,328; Argentina, \$7,827; Chile, \$150; other South American countries, \$9,603; China, \$3,485; Japan, \$7,897; Philippine Islands, \$1,394; Australia, \$16,985; other countries, \$20,237.

WHY NOT A NATIONAL RECORD WEEK LATE THIS FALL?

Time for Vigorous Action by Talking Machine Retailers to Develop Trade—Must Arouse the Interest of the Buying Public in Their Line—Live, Persistent Campaign Needed

Record trade has been quiet. Whether this is due to the indifference of the public, or the dealer, is a question for the doctor to decide. The fact remains that the Fall will soon be with us, and it is time for dealers to wake up to a realization of the fact that records must be sold—that a new interest must be revived in their wonderful merits as one of the greatest entertainers in history.

A year or more ago when the automobile business was so dull that many dealers talked of retiring from the field what did the leaders in that industry do to stimulate interest? Did they arrive at the conclusion that the public was oversold on automobiles? No, they just started a campaign to show the essentiality of the automobile and they stuck at their guns until they converted the public back again to the greatest demand for automobiles in history.

Now, we are not selling automobiles, or buying them, but what was done by the automobile people can be done by the record people if a real, earnest effort is made. The manufacturers and jobbers can do their share, but the dealer, after all, is the man who must do the greatest amount of work, for he has the direct contact with the buyer.

Why not a National Record Week in one of the late Fall or early Winter months? Why not educate the public to the wonderful variety of records made and handled? To this end utilize the newspapers, the display windows, use special contest literature and inaugurate a live personal contact campaign by the sales force that will awaken the people to a realization of the great musical value of the talking machine

WOMEN DO THE BULK OF BUYING

Merchants Must Pay Attention to Details Which Please Fair Sex to Hold Patronage

The women of the Nation are the shoppers of to-day. Statistics from authentic sources show that in almost all lines of business by far the greater percentage of customers are women and even in those establishments classed as distinctly men's shops women do a large percentage of the buying for their men folks and practically all purchases for the home are first endorsed by the woman who rules it before the purchase is made.

With these facts in mind, there can be little doubt that the merchandiser of a product such as the talking machine must exert particular efforts to attract members of the fair sex to his establishment.

Now women are basically different from men in that they have and develop certain prejudices through little things which a man would never notice and if he did he would tolerantly pass by as irrelevant.

A few examples of the things which please women most are courtesy, cleanliness, artistic arrangement of stock and the appearance of the men or women in the store with whom they come in contact. No explanation concerning the achievement of these things is necessary. Anyone with a grain of sense and a little energy can accomplish them.

ELMAN MUSICAL ART CORP. FORMED

One of the most recent additions to the talking machine field of New York City is the Elman Musical Art Corp., which has been incorporated in this State, with a capital of \$500,000. M. S. and M. Elman are the incorporators.

Neglected Complaints Result in Loss of Trade and Considerable Harmful Publicity

The merchant, or salesman, who lets complaints go in one ear and out the other, unless the complainant is persistent enough to win attention as a means of keeping peace, is sometimes making a bigger mistake than he realizes, for a complaint, even if it is not justified, is like the plague, and, unless checked in the beginning, is liable to spread and cause irreparable damage.

A dealer handling a well-known line of machines and records was canvassing the residents of a select section of the city recently when he began to pick up a story of a man in that section who had purchased a machine of the same make he was selling and found it unsatisfactory. After several prospects had indicated their intention of buying another make of machine because of this man's experience the dealer felt it incumbent upon him to investigate the matter, even though he had not sold that particular machine.

He called upon the man from whom the complaint emanated and had to listen to a lengthy lecture regarding the deficiencies of the outfit before he could find the opportunity to explain that it was his desire not to sell another machine, but to inspect the one already installed and see what was the trouble. A cursory inspection showed that the reproducer was in bad condition, the diaphragm being cracked and the rubber gaskets being hard and unyielding.

He also found that one of the springs of the motor was broken, which formed the basis for the owner's complaint that the motor jumped and would not play more than two records without rewinding.

Under ordinary circumstances it would have been a simple matter to have explained the difficulties and arranged for the necessary repairs and adjustments, but the owner in this case maintained that the machine had been in that condition for a year and from within a week after it had been delivered. He had bought records for a time and told his dealer of the trouble, but the latter evinced little interest and the purchase of records stopped. Neither dealer nor his salesman had called at the house since the outfit was purchased.

It took some first-class salesmanship to prove to the machine owner that the case was an exceptional one and was due to the carelessness of one dealer rather than to any fundamental weakness

in the machine. Arrangements were quickly made for having the machine put in first-class playing condition, for which the owner agreed to pay. The result was general satisfaction all around.

The dealer who made the investigation told frankly why he had gone out of his way to look into the matter and the machine owner was quick to acquaint his friends with the service he had received and his satisfaction with the instrument after it had been repaired. The direct results of the investigation were the listing of a new record customer in the person of the ma-

Complaints Offer an Opportunity for Service Which Will Result in Business Expansion and Profits

chine owner in question, the sale of a number of machines to his friends and, finally, to the checking of a complaint that had threatened to cause many hundreds of dollars of loss to at least one talking machine manufacturer and his dealers.

It happens frequently that a talking machine dealer is faced with unjust complaints and his patience is sorely tried in meeting demands that are frankly ridiculous, but at the same time every complaint should be looked into regardless of how unfair it may appear on the surface.

It happens frequently that a machine owner, and particularly a new one, grows quite enthusiastic over the instrument and champions its qualities among his friends, but it happens just as frequently that the owner becomes dissatisfied and blames his particular make of machine indiscriminately for his dissatisfaction and then proceeds to tell his friends and the world at large just how rotten the product is in his estimation.

There is no worse sales killer in the world than one of these individuals with a grudge and if he can be headed off, even at an expense of time and money out of proportion to the value of his individual trade, the talking machine dealer is really accomplishing something. He is saving future business.

It does not always mean that the dealer must not show firmness in dealing with those customers who are unquestionably unjust and perhaps fraudulent in their claims. Firmness is most desirable where it appears necessary in handling a complainant, but the main thought is to look into the complaint in every instance. It is the neglected complaint that kills the budding sales.

JOHN ELLIOT CLARK CO. EXPANDS

Well-known Salt Lake Victor Distributor Takes Over Orton Bros. Wholesale Victor Interests in Montana Territory—An Important Move

BUTTE, MONT., August 5.—The John Elliott Clark Co., of Salt Lake City, has taken over the agency for the Victor Talking Machine Co. and has given to Butte a new wholesale Victor house, to be located at 224 South Main street. The agency was formerly handled by Orton Bros., Butte music dealers, who for years served the merchants of Butte and Montana with Victor goods in the wholesale department.

The John Elliott Clark Co. is now the exclusive wholesale distributor for the Victor people in this territory. The Salt Lake City house of this concern is one of the largest in the West, and it is purposed to make the new local firm one of the leaders in point of service in that field.

Orton Bros. will continue to handle the Victor line of talking machines and records for the retail trade.

BALLOONS BRING PUBLICITY

St. Louis, Mo., August 3.—Bauer's Music House, one of the live-wire Victor dealers of this city, is gaining considerable publicity through the medium of toy balloons with the firm name and a brief message upon them. The balloons are given to automobilists and children. The firm is also featuring its library of foreign records by consistent advertising.

THE TALKING MACHINE'S HELPMATE



EQUIPPED WITH
NYACCO ALBUMS

NYACCO Albums Aid Fall Business

Right Price, Service, Increased Sales, Quality, Strength and Durability—all are found in NYACCO albums.

These qualities mean dollars and cents to you. Plan now for your fall business. Plan to sell NYACCO albums this fall. NYACCO albums make satisfied customers and develop reorders.

Write us for quotations and prices—*Today.*

A beautiful colored display card mailed upon request. JOBBERS and DISTRIBUTORS—How many do you want?



The Only Loose-Leaf Record Album on the Market

New York Album & Card Co., Inc.

NEW YORK
23-25 Lispenard St.

A. W. CHAMBERLAIN
New England Factory Representative
174 Tremont St., Boston, Mass.

CHICAGO
415-417 S. Jefferson St.

Victor supremacy is the supremacy of performance

Of performances past and present. Just as the Victor has occupied its position of leadership for a quarter-century, so it continues to lead the way in the talking-machine industry.

Victor Wholesalers

- | | |
|--|---|
| Atlanta, Ga.Elyea Talking Machine Co.
Phillips & Crew Piano Co. | Milwaukee, Wis.Badger Talking Machine Co |
| Baltimore, Md.Cohen & Hughes
E. F. Droop & Sons Co.
H. R. Eisenbrandt Sons, Inc. | Minneapolis, Minn. ..Beckwith, O'Neill Co. |
| Birmingham, Ala. ...Talking Machine Co. | Mobile, Ala.Wm. H. Reynolds |
| Boston, Mass.Oliver Ditson Co.
The Eastern Talking Machine Co.
The M. Steinert & Sons Co. | Newark, N. J.Collings & Co. |
| Brooklyn, N. Y.American Talking Mach. Co.
G. T. Williams Co., Inc. | New Haven, Conn. ...The Horton-Gallo-Creamer Co. |
| Buffalo, N. Y.Curtis N. Andrews
Buffalo Talking Machine Co., Inc. | New Orleans, La.Philip Werlein, Ltd. |
| Burlington, Vt.American Phonograph Co. | New York, N. Y.Blackman Talking Mach. Co.
Emanuel Blout.
C. Bruno & Son, Inc.
Charles H. Ditson & Co.
Knickerbocker Talking Machine Co., Inc.
Musical Instrument Sales Co.
New York Talking Mach. Co.
Ormes, Inc.
Silas E. Pearsall Co. |
| Chicago, Ill.Lyon & Healy
The Rudolph Wurlitzer Co.
Chicago Talking Machine Co. | Oklahoma City, Okla.Oklahoma Talking Machine Co. |
| Cincinnati, O.Ohio Talking Machine Co.
The Rudolph Wurlitzer Co. | Omaha, Nebr.Ross P. Curtice Co.
Mickel Bros. Co. |
| Cleveland, O.Cleveland Talking Machine Co.
The Eclipse Musical Co. | Peoria, Ill.Putnam-Page Co., Inc. |
| Columbus, O.The Perry B. Whitsit Co. | Philadelphia, Pa. ...Louis Buehn Co., Inc.
C. J. Heppe & Son.
Penn Phonograph Co., Inc.
The Talking Machine Co.
H. A. Weymann & Son, Inc. |
| Dallas, Tex.Sanger Bros. | Pittsburgh, Pa.W. F. Frederick Piano Co.
C. C. Mellor Co., Ltd.
Standard Talking Mach. Co. |
| Denver, Colo.The Knight-Campbell Music Co. | Portland, Me.Cressey & Allen, Inc. |
| Des Moines, Ia.Mickel Bros. Co. | Portland, Ore.Sherman, Clay & Co. |
| Detroit, Mich.Grinnell Bros. | Richmond, Va.The Corley Co., Inc. |
| Elmira, N. Y.Elmira Arms Co. | Rochester, N. Y.E. J. Chapman Co. |
| El Paso, Tex.W. G. Walz Co. | Salt Lake City, U. ...The John Elliott Clark Co. |
| Honolulu, T. H.Bergstrom Music Co., Ltd. | San Francisco, Cal. ..Sherman, Clay & Co. |
| Houston, Tex.The Talking Machine Co. of Texas | Seattle, Wash.Sherman, Clay & Co. |
| Jacksonville, Fla. ..The French Nestor Co. | Spokane, Wash.Sherman, Clay & Co. |
| Kansas City, Mo.J. W. Jenkins Sons Music Co.
The Schmelzer Co. | St. Louis, Mo.Koeber-Brenner Music Co. |
| Los Angeles, Cal.Sherman, Clay & Co. | St. Paul, Minn.W. J. Dyer & Bro. |
| Memphis, Tenn.O. K. Houck Piano Co. | Syracuse, N. Y.W. D. Andrews Co. |
| | Toledo, O.The Toledo Talking Machine Co. |
| | Washington, D. C. ...Cohen & Hughes
E. F. Droop & Sons Co.
Rogers & Fischer |



Victrola VI, \$35
Mahogany or oak



Victrola IX, \$75
Mahogany or oak



Victrola No. 100
\$150
Mahogany, oak or walnut



Victrola No. 120
\$275
Victrola No. 120, electric, \$315.00
Mahogany or oak



"HIS MASTER'S VOICE"

Victrola

REG. U. S. PAT. OFF

Important: Look for these trade-marks. Under the lid. On the label.

Victor Talking Machine Company
Camden, New Jersey

How Continuous, Intelligent Advertising Has a Tremendous Trade-Making Influence

The inclination toward a general let-down in business activities during the Summer that apparently affects so many members of this and other industries frequently extends to the advertising and the result is a curtailment of publicity of all kinds during the heated season that is not only unwise but actually means money lost. No merchant with the average run of trade would think of closing his store for three or four months in the year and then be faced with the subsequent problem of winning back his customers from competitors who kept right on doing business, and yet that same merchant, or manufacturer, for that matter, will discontinue or cut down his advertising when what he accepts as the dull period of the year approaches.

Many erstwhile liberal advertisers fail to realize that when their advertising campaigns are stopped or curtailed for even a comparatively short period they are checking the business momentum developed by the advertising already done and are losing much of the value of the previous advertising. In fact, the loss in that direction may come close to offsetting any actual cash saving through a temporary discontinuance of the campaign.

The fact that in many sections of the country 20 and 25 per cent of the merchants are doing close to 80 per cent of the business affords striking proof of what happens when the majority of retailers apparently accept things as they come and rest on their oars while waiting for improved conditions. The retailer who advertises consistently and persistently throughout the so-called dull months, even though he may not use the volume of space warranted during the pre-holiday season, is keeping up with the procession,

and although the direct results may not seem to be large he is at least holding his own with competitors, keeping fairly active, and is maintaining his status among the merchants of his community against the time when that status will mean real patronage.

The modern advertiser doesn't insert his copy spasmodically as the spirit moves him, but makes his appropriation intelligently and lays out his

Curtailed Advertising Checks the Business Momentum Developed by Advertising Already Done

entire campaign for the year so that he knows just about what proportion of his overhead will be devoted to advertising. In this campaign every month in the year is properly taken care of, with special attention, of course, given to those months when extra selling effort is warranted, as, for instance, the Fall and pre-holiday period. Under this plan there are no gaps left in the advertising throughout the year and the results are therefore calculated to be the more satisfactory.

That talking machine merchants recognize the fact that stock copy will not do for Summertime is evidenced by the increasing number of retailers who have been presenting sales arguments in their advertisements calculated to make a special appeal at this season. The arguments take various forms, but are all designed to overcome the tendency of certain elements to put off musical instrument buying until cool weather.

The business man should no more think of cutting out advertising at any period than he would think of closing down his establishment and taking the sign off the door. His advertising is what keeps his name before the community and the regularity with which it appears represents the power that influences prospective buyers who select his store from among several as the one to receive patronage when they reach the point where they are ready to buy.

Mark Twain's story of the spider that looked over the newspaper files to learn the address of a non-advertiser so he could go where his web would not be disturbed carries a moral that is just as true to-day as it was when the story was first told.

USES SONORA TO BROADCAST

The Sonora Phonograph Co. recently received a letter from the Delta Electric Co., of Worcester, Mass., reading as follows: "It may be of interest to you to know that this broadcasting station is using a Sonora and has had very satisfactory results. In fact, during one concert the tone of this instrument was so clear that it was difficult to convince listeners that we were using a phonograph."

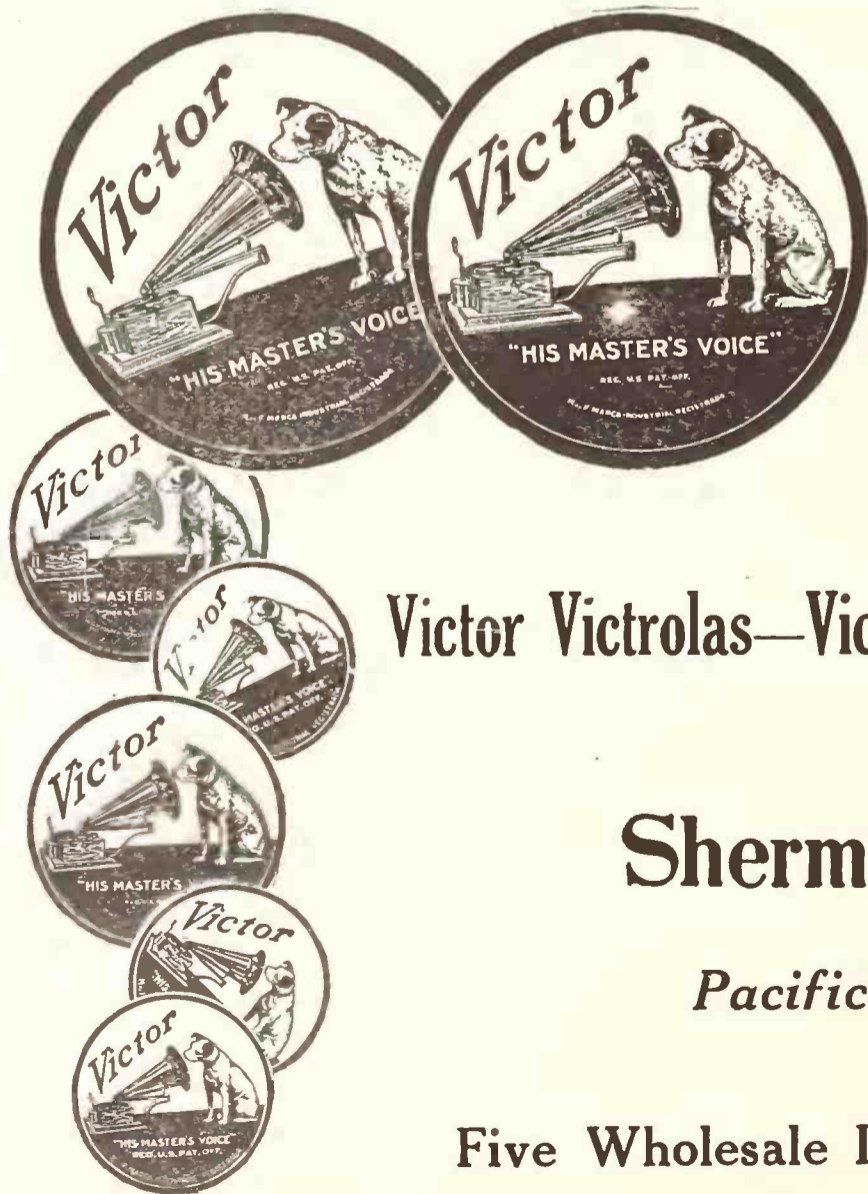

Main Wholesale Depot:

741 Mission Street, San Francisco

Branch Wholesale Depots:

10th and Santee Sts., Los Angeles, California

N.W. Corner 13th and Glison Streets
Portland, Oregon

Oceanic Bldg., Cor. University and Post Sts.
Seattle, Washington

330 W. Sprague Ave., Spokane, Washington

Victor Victrolas—Victor Records—Victor Accessories

Sherman  Clay & Co.

Pacific Coast Distributors

Five Wholesale Depots for Your Convenience

Victor supremacy is the supremacy of performance



Victrola IV, \$25
Oak



Victrola VIII, \$50
Oak



Victrola No. 90
\$125
Mahogany, oak or walnut

Chaliapin, Jeritza, Schipa, New York Philharmonic Orchestra — every new name added to the list of famous Victor artists further strengthens the position of every dealer in Victor products.



Victrola No. 130
\$350
Victrola No. 130, electric, \$390
Mahogany or oak



Victrola No. 240
\$115
Mahogany or walnut



Victrola No. 260
\$160
Mahogany or walnut



Victrola No. 280
\$200
Mahogany or walnut



"HIS MASTER'S VOICE"

Victrola

REG. U. S. PAT. OFF.

Important: Look for these trade-marks. Under the lid. On the label.

Victor Talking Machine Company

Camden, New Jersey



(Registered in the U. S. Patent Office)

PUBLISHED BY EDWARD LYMAN BILL, Inc.

President and Treasurer, C. L. Bill, 373 Fourth Ave., New York; Vice-President, J. B. Spillane, 373 Fourth Ave., New York; Second Vice-President, Raymond Bill, 373 Fourth Ave., New York; Secretary, E. L. Bill; Assistant Treasurer, Wm. A. Low.

J. B. SPILLANE, Editor

RAY BILL, B. B. WILSON, BRAID WHITE, Associate Editors

L. M. ROBINSON, Advertising Manager

L. E. BOWERS, Circulation Manager

Trade Representatives: A. F. CARTER, WILSON D. BUSH, C. CHACE, EDWARD LYMAN BILL, V. D. WALSH, E. B. MUNCH, C. R. TIGHE, SCOTT KINGWILL, A. J. NICKLIN

Western Division: Republic Building, 209 So. State Street, Chicago, Ill. Telephone, Wabash 5242

Boston: JOHN H. WILSON, 324 Washington Street

London, Eng., Office: 2 Gresham Building, Basinghall St. W. LIONEL STURDY, Mgr.

The Talking Machine World has regular correspondents located in all of the principal cities throughout America.

Published the 15th of every month at 373 Fourth Ave., New York.

SUBSCRIPTION (including postage): United States, Mexico, \$2.00 per year; Canada, \$3.00; all other countries, \$4.00. Single copies, 25 cents.

ADVERTISEMENTS: \$5.50 per inch, single column, per insertion. On quarterly or yearly contracts a special discount is allowed. Advertising pages, \$150.00.

REMITTANCES should be made payable to Edward Lyman Bill, Inc., by check or Post Office Money Order.

NOTICE TO ADVERTISERS—Advertising copy should reach this office before the first of each month. By following this rule clients will greatly facilitate work at the publication headquarters.

Long Distance Telephones—Numbers 5982-5983 Madison Sq.
Cable Address: "Elbill," New York

NEW YORK, AUGUST 15, 1922

PLANS FOR DEVELOPMENT OF FALL TRADE

WITHIN a few weeks vacationers will begin to flock back to their homes to settle for the Winter, and the season will arrive when talking machine dealers will find the opportunity for cashing in on the efforts and advertising of the Spring and Summer months and realize sales in increasing numbers.

Of particular interest this year has been the great volume of business done in portable talking machines of various types. A number of dealers have been frank to declare that the sale of portables, and the records that go with them, have proven their salvation during the Summer months. As talking machine values go the sale of a portable model does not represent a big transaction in itself, but it has a double value that should not be overlooked, because, for every portable model that is sold to the owner of a large cabinet machine, there are probably two sold to those who own no other machine. Therefore, it behooves the retailer to comb over his list of purchasers of portable machines very thoroughly with the idea of interesting them in larger models for installation in their permanent residences.

The idea is not a new one in any sense, as for years dealers have sold small models of machines with the idea of exchanging them for large cabinet types when the interest of the purchaser had been aroused to the proper pitch. There is no question but that many portable machines have acted as missionaries in acquainting individuals with the musical possibilities of the talking machine and accompanying records, and this new appreciation is ready to be capitalized by the retailer who understands it and follows it up energetically. In other words, the list of buyers of portable machines does not represent a list of closed machine accounts, but rather a prospect list for larger sales.

KEEPING THE BUSINESS HOUSE IN ORDER

CONDITIONS in the talking machine trade, and for that matter in business circles generally, during the past few months have been calculated to lend considerable importance to the question of dealer financing, and there has naturally been much discussion of this subject by the dealers themselves, as well as by manufacturers and wholesalers.

The question of financing retailers who make a practice of selling on instalments has been a pertinent one in many lines of business,

and has only been partially solved in many instances owing to the credit conditions frequently involved.

The fact that instalment paper is often frowned on by bankers is not because it has little intrinsic value, but because the payments are so long drawn out that it means a tying up of the banker's money for a lengthy period, and represents an investment rather than a loan. This condition has prevailed particularly in the piano trade, where credit terms of from thirty to forty months or more are common.

A banker in discussing piano paper recently pointed out that bankers were not enthusiastic about long-time paper, but desired a quick turnover, despite the fact that his experience has shown that even long-time piano paper paid 100 per cent as a general rule if collections were carefully followed.

In the light of the experience of other industries, there appears to be no reason why talking machine dealers cannot keep their business houses in order and do business on terms that will make their instalment paper attractive to bankers. The average talking machine instalment contract is paid out within the year and in a goodly proportion of cases can be so arranged as to pay out within six months or so. While this business may not appeal to bankers quite as much as call loans, it nevertheless compares very favorably with the usual run of commercial paper.

Talking machine dealers have the advantage of seeing what long-term contracts have done to retailers in other fields, and can very easily make it a point to avoid those pitfalls and keep their credit terms within reason. Simply to charge interest on a long-term contract does not solve the problem, because that means the dealer himself is acting as banker. What he wants is to have his instalment paper in such shape that it represents a more or less liquid asset and attractive collateral.

The easing up of the financial and banking situation and the reduction of discount rates by Federal Reserve Banks is calculated to benefit the retail merchant who is doing an instalment business, but doing it conservatively and on a sound credit basis. He may perhaps in a pinch have to go to a discount company to tide him over, but the bulk of his paper, and ordinarily a sufficient amount to keep him going if he has adequate capital to start with, should be discounted by his regular bank. Where there is lack of capital at the outset, there are few financing plans that will bring relief except at a premium almost prohibitive.

The talking machine dealer handling nationally known and established lines of machines and records has substantial collateral in his good will and franchise rights, as well as in his instalment contracts. If his business ability and integrity will stand the test, it is to be assumed that he has a genuine opportunity to build up and maintain a substantial volume of business under the protection of definite selling rights. He is dealing in a product that ordinarily suffers little, if any, fluctuation in value, and if he deals with his customers on a sound credit basis his standing with the bank should be assured.

The danger lies in offering extravagant and unsound terms in an anxiety to increase sales volume without giving thought to the individual financing problems of the immediate future.

WEDDING THE FILM AND "TALKER" RECORD

ON several occasions during the past year or so there have been published reports of more or less successful attempts to produce talking moving pictures, through the synchronization of the motion picture film and the talking machine or through some of the several announced systems for registering sound waves on the motion picture film itself through the medium of light.

The talking machine trade is naturally interested in those projects for the reproduction of talking pictures that make use of the talking machine in its present state or in some specially developed form. But the trade should also be interested in the other experiments being made, especially those concerning the photographing of sound waves, which may be expected, if carried out to a successful conclusion, to have some direct or indirect effect upon talking machine record production of the future.

At the present time the talking machine record in its accepted form has reached an acknowledged high state of development, but even the most enthusiastic will hesitate to declare that the final point of perfection has been reached. If no improvement in records or recording systems were to be expected in the future the industry would be in a bad way, for there would be nothing to look forward

to. Hence experiments in sound recording and reproduction, along whatever line they are conducted, are of interest to the trade, not so much for what they offer at the present time as for the possibilities they hold for the future of the industry.

JUSTIFICATION FOR TRADE OPTIMISM

THOSE who see a substantial improvement in business for the next Fall and Winter are likely to find justification for their optimism in the reports of the many retail concerns which have been, and are, spending many hundreds of thousands of dollars in the aggregate to enlarge and remodel their quarters in anticipation of the business to come.

It is all very well to talk about a possible improvement in business conditions, and to tell the other fellow just how good things look, but when an individual or concern goes to the extent of investing hard cash in new and better equipment to take care of better business there must be something substantial upon which to base future calculations.

It is significant that practically all the moves reported in the trade are towards expansion and improvement. Those who have "given up the ghost," or who have resorted to a policy of conservatism, are so far in the minority as to be insignificant, which is an added reason for the prevailing feeling that a much healthier condition may be expected.

RETAILERS MUST BE AGGRESSIVE TO WIN

AT no time in history was it so necessary to be aggressive in the retail field as to-day. The dealer or dealers who are going to command the largest measure of success are those who are giving serious thought to the question of presenting their establishment and the product which they handle to the public in a manner to invite its support and confidence. There has been a slowing down of things in the talking machine field, largely because there has been a slowing down of effort on the part of the trade.

The World has recorded time and time again that where individual dealers have made extraordinary efforts to get after trade they have been successful. This has been done without any sacrifice of prices or special sales. Business has been developed by recourse to

unusual methods of personal contact—by analyzing the conditions prevailing in the dealers' territory and becoming acquainted with the people who have as well as those who have not machines in the home.

Dealers must get away from the idea that trade is coming their way without effort. It is not. Those days are past and he who succeeds to-day is the man who is getting out of the beaten track and building up his trade by methods that are out of the ordinary. Thinking men, not automatons, are going to win the largest measure of success the coming Fall and Winter.

RADIO APPEAL IS ON BASIS OF MUSIC

A FACT in connection with the selling of radio equipment that has not escaped the attention of those who are interested in the possible effects of the existing radio craze on the sale of musical instruments is that in the great majority of cases the appeal to the buyers of radio receiving sets is made on the basis of music.

A member of the trade who has had considerable experience in radio is authority for the statement that the men who have to do with the selling of radio equipment have practically abandoned most of the arguments looking to the sale of receiving sets except that based upon the class of music broadcasted and which the owner of a set can listen to in his own home.

It has been found that the average fan is not enthusiastic over the fact that he can listen to lectures on the care of infants or of hogs or reports of crop conditions and of the weather, by means of the radio. Even the fact that news is broadcasted apparently means little to the average man unless it be, perhaps, the scores of baseball games or the results of prize fights. What gets an immediate response is the statement that certain groups of artists, whether classical or jazz, are playing at broadcasting stations.

So long as music holds such a high place in the radio world; so long as the chief appeal to the purchaser of radio equipment is that of music he can hear, sellers of musical instruments need fear no permanent harm to their business. Whether the music merchants as a class will eventually act as distributors for radio equipment is beside the question. The thing that should interest them most is whether radio is going to injure or help their business, and in the long run it may be expected to prove beneficial rather than otherwise.

Victor Scholars

Pearsall Service is an essential part of Good Selling.

Ask any Pearsall dealer—he will tell you.

"Desire to Serve—Plus Ability"

10 EAST 39th ST.

NEW YORK CITY

SILAS E. PEARSALL COMPANY

DISTRIBUTORS

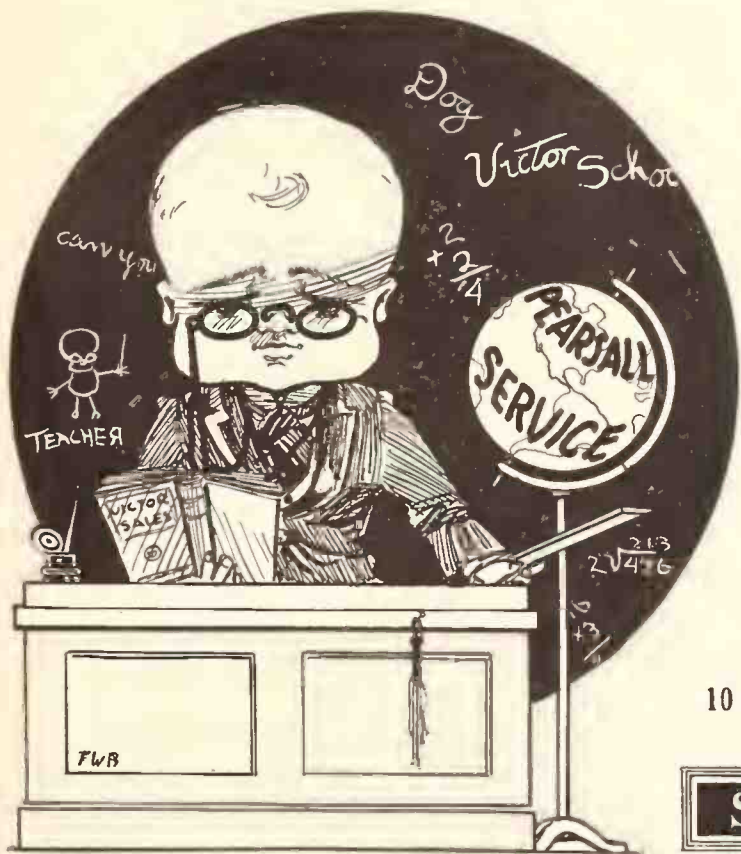

Getting Out of the Beaten Path in Making the Effective Selling Appeal :: By W. Bliss Stoddard

In the Summer there are bound to come some dull days—people are away on vacations, and those at home do not want to venture out in the heat unless it is absolutely necessary. Instead of sitting back and waiting for business to revive, Cline Vick, of Carterville, Ill., goes after the trade that refuses to come to the store. On dull days Miss Griggs, the saleswoman in charge of the talking machine department, selects a few records from her stock, places them in an envelope, takes along the general record catalog, with the latest monthly supplement, and starts out. She makes up a list of persons to be visited before starting out, selecting her records according to the class she intends to visit. For example, if she intends to call on old women she takes religious and old-time songs; if middle-aged people, she takes both old and new selections, but of a conservative nature; while if she intends to visit young matrons she takes the liveliest dance music and the snappiest songs from the new musical shows. She calls only on those she knows possess a talking machine and rarely returns with orders for less than ten records. She makes it a point to do all her calling in the afternoon, as she figures the average woman will have her housework over and be in a more receptive mood by that time. She never goes out on Saturday or Monday, the busiest days of the housewife. If she gets a call for a record she does not have with her she makes a note of it and the store delivers it the following morning. Being of a pleasing personality these personal calls put the store before the public in a very favorable light. Even when no purchase is made much good is accomplished, for Miss Griggs leaves her card with the 'phone number of the store printed on it,

and suggests that the patron call her up when records are needed for special occasions.

Appealing to Sentiment

The McKelvey Co., Youngstown, O., has been very successful during the past few months in arousing interest in records by means of circular letters which it sends out at intervals. Like all live-wire concerns, it has a complete list of all purchasers of records and at intervals Mr. Dan-

Constructive Selling Appeals by Well-known Dealers Which Are Entitled to Consideration and Emulation

forth, the manager, picks out some new record, writes a human interest story about it, and mails the letter to everyone on the list. The entertaining manner in which the selection is talked about results in many requests that it be sent out, and in all events it keeps the firm and its records constantly before all lovers of the talking machine and causes them to instinctively drop into that store when in need of new records.

Getting the Trade of Music Students

All music teachers and students realize that

proper interpretation of a piece of music is one of the greatest elements of success, and it is strange that more dealers have not seized upon this phase of phonograph publicity. By the use of talking machine records the best music of every period, sung by the greatest artists, is available for the student in the smallest hamlet as in the largest city. Several of the live-wire dealers have thought of this, and the way in which they have worked up a big music student trade should prove of interest to others. In talking to a special class newspaper advertising is of little value—or rather it is an expensive manner of reaching them—and the firms who have given it careful consideration regard the carefully written circular letter as the best means of increasing business. This letter should be made as individual as possible, and the subject presented in an interesting manner. Two letters recently sent out by firms in different parts of the country might well serve as models which each dealer could adapt to suit his own particular clientele.

The first sent out by the Morehouse-Martens Co., Columbus, O., read as follows:

"Miss Dorothy Moore,

"1720 Devon Road, Columbus, Ohio.

"Dear Miss Moore: Knowing of your interest in vocalization or a well-trained voice, and fully appreciating the difficulty encountered in the training, it affords us much pleasure to offer the Oscar Saenger course for consideration.

"We sing a great deal by imitation; then, of course, the artist's own interpretation means much. We believe you could follow no better leaders in coloratura work than Galli Curci, Garrison or Tetrizzini. They all sing Charmant Oiseau from Perle de Bresil, each perhaps differently, yet from each you can get a splendid thought that you may apply to your own work.

"All the necessary technique and exercise for the development of perfect vocalization are provided and explained in Oscar Saenger's own school. Mr. Saenger is, and has been, the teacher of such artists as Althaus, Garrison, Jacoby, Rappold, Baker, Scott and Hempel. We know it to be a wonderful advantage to be able to possess these lessons.

"In our music room we have all of the Victor artists' records, and desire to give you such service as will enable you to enjoy and appreciate this much-prized course. Yours very truly,

"The Morehouse-Martens Co."

The second letter, sent out by the Victrola department of the Rosenbaum Co., Pittsburgh, Pa., read:

"Galli Curci said, 'The Victrola has been my greatest teacher.' With this statement in mind we wish to tell you of the real value the Victrola and Victor Red Seal records can be to the music teacher and student.

"By listening to the records of the Red Seal artists you can benefit by their masterful rendition of many of the world's famous compositions. You can study opera with Caruso, Melba, Farrar or Scotti; oratorio with Even Williams, Louise Homer, Witherspoon; concert songs with McCormack, Alma Gluck, de Gogorza, Galli Curci or Mabel Garrison; you can study violin with Heifetz, Kreisler, Elman, Maud Powell or Zimbalist; violoncello with Hans Kindler; piano with Paderevski, Cortot or Rachmaninoff.

"You can repeat their records as often as desired and, by playing over the part you are particularly interested in, become familiar with the artist's vocalization and interpretation.

"We extend an invitation to the music teachers, musicians and students of Pittsburgh to come to our Victrola department and make use of our large library of Victor records. We will gladly play any of them for you at any time. Yours very truly,
The Rosenbaum Co."

SEND FOR YOUR SAMPLE TO-DAY

This is the New Design



Mr. Victor Retailer—

Would you spend 15c to bring a customer into your store and keep your name constantly before a Victrola owner?

We'll say you will! That is why we will send you a free sample on request of our Advertising Sales-Building Record Brush.

YOUR ad inserted without extra charge.

KNICKERBOCKER TALKING MACHINE CO.

Victor Wholesalers

138 West 124th St.

New York City

PEERLESS ALBUMS

The Incomparable Medium—

RESPONSIBILITY

TALKING MACHINE DEALERS, as a class, have a reputation for being merchants. Too, they are looked upon as leaders in the community in cultural development along musical lines.

There is no other industry today in which so much educational enterprise is necessary, where so large a responsibility devolves upon a merchant to step out of his store and take an active part in the social and domestic affairs of his neighbors.

In this position it is an easy matter for the talking machine man to combine his altruistic and commercial endeavors and concentrate them upon one focal point—A RECORD LIBRARY IN THE HOME.

The PEERLESS RECORD ALBUM is the one incomparable medium for accomplishing notable results along these lines.

Phil Ravis

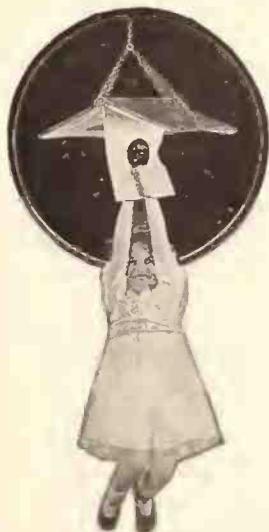

for a thousand and one different merchandising plans in connection with records. But there is one plan you can depend upon as offering the greatest opportunity for steady, constant sales. It is the *Home Record Library plan*.

To the consumer

PEERLESS

—the Album

Stands Steadfast and Reliable as:—

- A protection to fine and expensive records.
- A means of classification for the HOME RECORD LIBRARY.
- An incentive to collect and preserve the world's best music.
- A storage house for the overflow of records from the instrument cabinet.

To the talking machine dealer

PEERLESS —the Album

is an ever-ready business partner which means:—

- An additional service to the patrons of your store.
- An actually profitable item of constant demand.
- An implanted idea which brings customers back to your store for more records.
- An accessory as important to your business as rubbers are to the shoe man.



Display This Sign—It Will Sell Peerless Albums for You—Send for Yours at Once.

It Does Make - A Difference What Albums You Sell

PEERLESS ALBUM COMPANY

PHIL. RAVIS, President

WALTER S. GRAY
San Francisco
942 Market St.

636-638 BROADWAY
NEW YORK

L. W. HOUGH
Boston
20 Sudbury St.

PUT CAN'T IN THE CAN

By EDWARD FRASER CARSON

"I can't" gives up ere the fight begins,
In fear of the strife and stress.
"I can" will try. He may quit with a sigh.
But "I WILL" is INSURED SUCCESS.

I never have heard who the author was of the above, but that quatrain hits the nail squarely on the head. Cut it out. Paste it in your hat or over your desk. Read it once in a while. And Can the Can't.



Edward Fraser Carson

Don't think because you have failed ONCE that you never will succeed. Don't be discouraged. If things go wrong keep smiling and keep going. Keep going, keep at it even if you don't smile—though you will find it considerably easier if you do.

The greatest successes in the world have come because some man didn't know he was licked. Every time fate knocked him down he bobbed up serenely and took another wallop at it. And in the end he WON.

Edison, Whitney, Westinghouse, Wright, Stephenson, Columbus—in every line of endeavor, whether invention, discovery or otherwise—they all kept everlastingly at it. And to-day they have statues and streets and rivers and continents named after them—just because they put Can't in the Can.

In fact ALL of the really BIG THINGS of life are made possible only after repeated failure. For failure is the goad that drives genius on to its goal—SUCCESS.

And it is right that it should be so. Success wouldn't be worth while if it came without effort. What we get for nothing is seldom worth more than the price we pay for it.

Remember the story of Robert Bruce. Six times the Scottish leader had been defeated. Six times he had been forced to retreat. Six times he had failed.

Retiring from the last field of battle he stopped at a cottage to refresh himself and when resting

awhile he watched a spider spinning its web.

The spider would lower itself on the end of its web from the top of the door and then try to swing over to reach the jamb. Time and time again it failed. Six times its efforts were thwarted. But again it tried and the seventh time it succeeded.

Hope again thrilled the breast of the warrior. He had learned a lesson. Gathering his followers about him he bravely returned to the attack—and was victorious.

So runs the story. Maybe it is true. Maybe not. But that makes no difference. The lesson is there for him who reads to learn. You CAN succeed if you refuse to be beaten.

You may be a salesman, prize fighter, mail clerk or merchant—it makes no difference. You have your problems. Everyone has. You may oftentimes get discouraged. Often it may seem that the only thing to do is to lie down and quit. That is the time to do just the opposite.

No matter what your task may be you CAN succeed. And you WILL if you persist.

Don't be a quitter. Take pattern by the bulldog. Nothing can discourage him. He will fight as long as he has strength to stand. And even in dying he will close his jaws on his antagonist—and nothing can pry them loose but death itself. A kick only makes him more determined to put over the job he started out to do.

If you will only shoot often enough you are BOUND to hit the bull's-eye.

ALBUS CO. IN NEW QUARTERS

LOUISVILLE, Ky., August 3.—The Albus Talking Machine Co. is now located in its new big store in the Commercial Hotel Building, where in quarters double the size of those formerly occupied a very attractive display is made of Strand console model talking machines and Okeh, Emerson and Gennett records. Mr. Albus has been in the business quite some years, and during the war did a large trade in the way of repairing for the great army of soldiers who were at Camp Taylor. The repair department, then as now, is in charge of Mr. Smith.

LOESER & CO. ADD RADIO STOCK

Popular Brooklyn Store Operates Fine Radio Department in Conjunction With Music Section—H. E. Erickson in Charge

A spacious radio department was recently opened by Frederick Loeser & Co., Fulton street, Brooklyn, N. Y., as an adjunct to their talking machine department. The new department is modernly equipped and is under the management of H. E. Erickson. The products of the Radio Corp. of America and Westinghouse radio supplies are handled.

In connection with the merchandising of radio outfits and supplies, Mr. Erickson stressed the necessity of service of a high order. "Nine out of every ten people entering this department do so for the purpose of making inquiries regarding the relative merits of the different outfits," said Mr. Erickson, "and it is up to those connected with the department to give out intelligent and courteous information because the inquirer of to-day may actually be in the market next week or the week following."

KEEPS MAILING LIST UP TO DATE

H. V. Beasley Music Co. Evolves Effective Plan for Keeping Mailing List Straight—Saves Waste and Unnecessary Expense

TEXARKANA, ARK., August 3.—The H. V. Beasley Music Co., 111 East Broad street, this city, Victor dealer, has evolved a simple and effective plan of determining whether prospects are interested in its line of instruments. A folder with a tear-off return postal was mailed to all persons listed as prospects. The text of the folder was in the form of a questionnaire, asking if the recipient were interested in a talking machine or records and to notify the concern promptly of any change of address. The response was good and from this the concern revised its mailing list, with the result that considerable time and money are now saved in the useless mailing of literature to disinterested persons.

RADIO BUGS HAVE HOUSE ORGAN

Organization Formed by Fay Luyster, Manager of Cline-Vick Victor Interests, Issues Snappy Little House Organ—Is Full of Pep

The Egyptian Radio Bugs, an organization composed of radio enthusiasts and those dealing in radio outfits and supplies, formed recently through the efforts of Fay Luyster, live-wire manager of the Victor department of the Cline-Vick Stores, which operate branches in a number of Illinois towns, with headquarters in Marion, have just issued the first number of a house organ, entitled Egyptian Radio Broadcasting News. The publication is well edited and contains live news pertaining to radio as well as club notes. Mr. Luyster is one of the most active and aggressive persons engaged in the merchandising of talking machines in the State of Illinois. Besides his duties in connection with the management of the Victor department of the Cline-Vick stores he edits the music section of one of the local papers.

RECORD SERVICE AIDS SALES

Victor Dealer Sends Selected List of Records to Customers for Try-out Each Month—Service Produces Very Satisfactory Results

SPRINGFIELD, ILL., August 2.—"A New Kind of Record Service" is the title of a small folder sent to customers by R. L. Berry, Victor dealer, of this city. These folders have been indirectly the means of increasing the record business of this concern. The message contained in the folder tells of the willingness of the concern to send to customers each month a special selection of records for a "try-out," with the privilege of exchange within two days. The record selection is suited to the taste of each customer.

THE INSTRUMENT OF QUALITY
Sonora
CLEAR AS A BELL

Greater City Phonograph Co., INC.
311 SIXTH AVE. Tel: Chelsea 9237 NEW YORK
SONORA DISTRIBUTORS EXCLUSIVELY
for New York, Staten Island & the lower Hudson Valley

The superiority of the Sonora is as marked
as the ease with which it sells.

"Sonora & Sales are Synonymous"

When Marconi heard the AERIOLA GRAND



© Underwood & Underwood

"It comes closest to the dream I had when I first caught the vision of radio's vast possibilities. It brings the world of music, news and education into the home, fresh from the human voice. It solves the problem of loneliness and isolation.

"The Aeriola Grand is at present the supreme achievement in designing and constructing receiving sets for the home—a product of the research systematically conducted by scientists in the laboratories that constitute part of the R C A organization."

G. Marconi

Perfect in Tone Quality—Easy to Manipulate

In tone quality, in simplicity of manipulation the Aeriola Grand is unrivalled. A child can snap the switch and move the single lever that tunes the Aeriola Grand and floods a room with song and speech from the broadcasting station.

The Aeriola Grand is a product of

the research systematically conducted by the engineers of the Radio Corporation of America and the companies affiliated with it. Because it has been so carefully designed, because it embodies the approved principles of the foremost radio engineers, it will give pleasure for years after it has been purchased.

Backing the Dealer with National Advertising

The Aeriola Grand and other R C A receivers will be nationally advertised in the Saturday Evening Post, leading radio, electrical and musical magazines, and the principal newspapers of the country.

Think of this vast circulation, aggregating 10,139,000, and what it means to every R C A dealer with a stock of Aeriola Grands on hand.

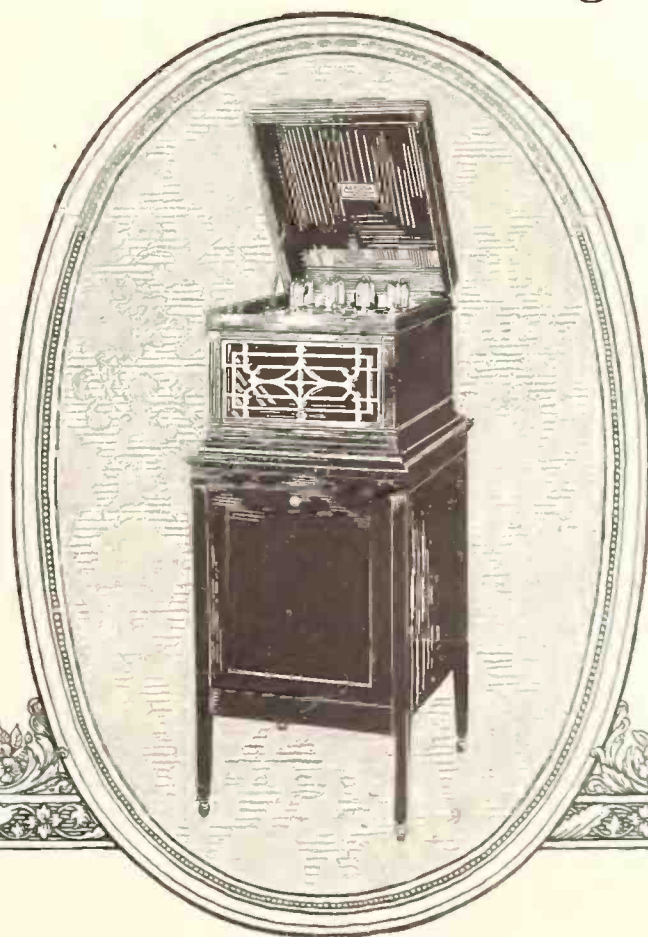

There is a radio set for every purse — Retail prices range from \$18 up.

Aeriola Grand with stand Retail price \$350

Radio Corporation of America

Sales Dept., Suite 2076
233 Broadway
New York City

District Office
10 South La Salle St.
Chicago, Ill.



Co-Operation of Sales Force Necessary to Insure a Larger Volume of Sales :: By F. V. Faulhaber

"Only by improving our methods can we hope to make more and easier sales," observed a talking machine dealer the other day. "It is not alone my own experience upon which I must rely; every individual salesman must play his part and be on the alert seeking and thinking about improvements which should make for better salesmanship."

Other talking machine dealers may be interested to know just what novel tactics this particular merchant is using in order to bring about improvements in his establishment. He distributes cards each day to the individual salesmen for the purpose of recording any new suggestions that may crop up. The salesmen are

also directed to jot down such remarks as may hint of further improvement in the store. Many of these suggestions and remarks, naturally, are based largely on the salesmen's observation while waiting upon different customers. Let us show specifically how this idea works out.

One salesman, during his experience in this store, has noticed that a certain customer dislikes to be accompanied to a booth while trying out a number of records. Well and good. That very fact may justify jotting down for the benefit of other salesmen who may not yet have waited upon that particular customer. He will jot down, for instance: "The tall, well-built chap, who usually comes in before noon, greeting

'Mornin'!', which we all can hear, dislikes to be bothered when trying out records. I usually sell more to this customer when I let him be by himself."

Another suggestion will be: "Mrs. Doring, who comes in here quite frequently, never buys any popular records and seems to show impatience when offered any, or when you discuss them. She dotes on classical pieces. I find that by showing her some old ones which she may have missed I make a hit with her, and many additional sales result. She delights in discussing classical pieces."

Then we have: "Never keep Mrs. Bardell, that stout woman, waiting for any records for which she inquires. She is very impatient. She usually comes in here, asking for about seven or eight records, which she has listed on a piece of paper. I give her the first one I find that she wants, then she makes a bee-line for a booth. The first few times she came in here I used to keep her waiting until I found those we had in stock which she had asked for, during which time she had indicated her restlessness and shown a tendency to grumbling."

Then we have the hint: "Let's have Barton (meaning the porter) unpack those cases in back of the store. A young lady nearly tore her dress on a nail protruding from a board at 10.50 to-day."

Who cannot see the possibilities in the foregoing suggestions? These cards are collected daily and during such times when the business is slowest a conference ensues relative to subsequent sales policies, discussing the various remarks and suggestions for the benefit of all, laying particular stress on the most important.

It will pay all the salesmen in the talking machine retail establishment to know that the customer who loudly greets "Mornin'!" wishes to try new records by himself; that Mrs. Doring wants to know nothing about popular pieces; that the stout Mrs. Bardell wants action, and that it is out of place for Barton, the porter, to unpack his cases in the front of the store. Herein are suggestions for other talking machine dealers.

USES TIMELY PUBLICITY

Pacific Coast Columbia Dealer Features Attractive Sales Message—Publicity Produces Sales

SAN PEDRO, CAL., August 5.—The San Pedro Furniture Co., of this city, Columbia dealer, recently carried an attractive full-page advertisement on the back cover of *The Periscope*, the official magazine of the United States Navy boys on the Pacific Coast. This advertisement was headed "How About Your Divisional Phonograph?" and featured a liberal offer to the sailors in order to encourage them to include a Columbia-Grafonola as part of their divisional equipment.

An interesting feature of this advertisement was the use of an illustration divided into four sections, entitled "The Demonstration," "The Sale," "A Friend for Life," and "Personal Delivery." The page attracted considerable attention and the San Pedro Furniture Co. received direct results from the use of this timely publicity.

ENJOYED VACATION AT LAKE PLACID

Amos E. Russell, manager of the talking machine department of the Cluett Store, in Troy, N. Y., and president of the Music Merchants' Association, of that city, has just returned from a very pleasant vacation spent at the Lake Placid Club, Essex County, N. Y. Mr. Russell reports a decidedly better condition in the record field, and is optimistic regarding trade generally for the Fall.



Two Good Reasons

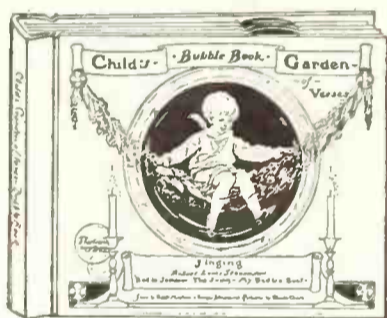

Why Bubble Books Will Go Big This Fall

THE two new Bubble Books — No. 13, "Child's Garden of Verses" and No. 14, "The Chimney Corner"—just ready to ship, are going to help you to big Bubble Book sales this fall.

These splendid books will give new life to the whole line.

Display them. Talk them up. Start your public on the new books, and you'll find they will come back for the old ones, too.

BUBBLE BOOKS "that Sing"

When you sell one you sell a habit and when you sell a habit, you're building business.

HARPER & BROTHERS, BUBBLE BOOK DIVISION

Established 1817

Franklin Square

New York, N.Y.

Successful Salesmanship in the Domain of Talking Machines and Records :: By Jos. T. Lange

[Joseph T. Lange, educational manager of System Magazine, talked on "Salesmanship and Selling Musical Merchandise" before the dealers who attended a recent meeting at the Knickerbocker Talking Machine Co., New York. His remarks are of more than usual interest and we are passing them along to our readers because of their general application to the development of sales in the talking machine business.—EDITOR.]

If business isn't good or if business is bad, it is because of a definite law that underlies it. There is one law of life and that is we must give if we would get. The sooner you recognize this law the sooner you will find business much better.

The best thing I can give you, outside, of course, of an order for Victrolas, and then I couldn't use more than one at a time, is ideas on how to serve the other fellow in order to get his business, and I will try to give you a short talk on this subject, near and dear to your heart.

Whether you are an owner or whether you are a clerk, there are only three things that any man can sell, and we are selling one or the other of them from the time we leave the cradle until we enter the grave. The first is the idea, the second, merchandise, and the third—service. Those are the only things any man can sell and we are engaged in selling one or the other of them all the time. If you are not as successful a merchant or salesman as you would like to be, or as others are, it is not the fault of the proposition, but the fault of yourself. You have failed in selling one of these three things.

Every normal being wants to succeed. If you are not succeeding you have failed to develop factors in yourself and instill them into your clerk or clerks.

Everything is a condition of the mind and has to do with the mind. There are plenty of men doing time in the prisons to-day who have a better brain than some of you or I have. They failed to develop the part of the brain where the sense of feeling is. The only physical factor has to do with endurance. If you are not succeeding, or if business isn't good with you, it would pay you to hesitate and analyze yourself or your business, or those who represent you in business, and you can tell in a jiffy why a clerk is succeeding or failing.

I assume you are all hustlers, reliable business men, all willing and all physically fit, with staying qualities, and I now want to talk upon the subject of your ability.

The only reason that you have for living, or that I have for living, is because we serve, and

in the proportion we give, in the same proportion we receive. If you give little you get little. The hobos are giving nothing; they are getting nothing. Some business men are giving very little; they are getting very little. In order to give with a view to getting you have got to develop yourself and multiply it into those who are working with you. You have got to develop head, hand and heart and then go into the business with a view to giving service to the people. Don't give poor service, give quality of service. You will get customers, which will mean money, contentment and growth as your reward.

Selling is a science, the same as medicine. Many men have never taken the trouble to find out what

may not come in right then to buy it. Selling is a study of the mind. As soon as the salesman pours something into the mind of the customer that pleases him, that results in the sale. Just as soon as you pour something into that customer's mind that he does not like or want he claps the lid right down and walks out and says, "I am not interested." The next step is desire. Thousands of people who have a desire to own a talking machine or automobile do not, because there has not been aroused in back of that desire as a result of the advertising anything to bring a definite motive. If your salesman could arouse in the minds of more of the customers who enter your store definite motives for their taking the action you would carry them all to the top, which is the making of the sale.

Four motives prompt a man to own a talking machine, or to do anything, even to committing murder. The first motive that prompted the action was the motive to gain or make money. If you can show people where they are going to earn in dollars and cents by owning a machine or anything else it would be easy to close a sale. I might buy a Victor machine to-day. I didn't buy it to satisfy gain because I couldn't sell it to-morrow for what I paid for it to-day. It was the merchant who gained in dollars and cents. I bought it to utilize. I purchased a Victor machine five years ago and have never spent a nickel on it since. The utility of that machine was very good. I bought a Victor because I wanted to get the best the market had, which suited my pride. You must play upon the pride of a prospect. That is another strong motive. John Wanamaker carries six million dollars' worth of insurance, which takes in all three motives mentioned, gain, utility, pride, as well as the fourth motive, and that is caution. None of us knows when we are going to kick in (to use a slang expression) and we buy insurance because we are cautious and to take care of those who are dependent upon us and are dear to us.

Make the customer feel about it as we feel about it. After you get the order and after the Victrola is delivered, and after payment is received, you must recognize one more step. That is the step called satisfaction. So many men overlook that step in business and work on the basis to get, not to give. Your individual suc-

(Continued on page 18)

There Are Only Three Things Any Man Can Sell—First, Ideas; Second, Merchandise, and Third, Service

the fundamental principles are. Some clerks have no knowledge of them, which is the reason why many customers are not sold when they come into your store, although they are brought in as a result of the advertising which the Victor Co. and you get out. The reason for this is that salespeople often do not consider the customers' reasons for visiting the store.

In retail selling customers enter the store because anything we are vitally interested in we want to own. They come in with the idea of buying and sometimes these customers walk out without buying. Everything in life is based upon law, as I said before. No two objects can fill the same space at the same time. The same is as true of the mind as of a teapot. We can concentrate only on one thing at one time. When a person comes in to look at a Victrola it shows there is a desire there to own it although he



TELEPHONE NUMBERS
FITZROY 3271—3272—3273



DEFINING ORMES SERVICE



We are not content with just giving so-called service to our dealers.

Ours must be Exceptional to satisfy us. That's why we have been saying for several years—

"Ormes Really Means Exceptional Service"

ORMES, Inc.

Victor Wholesalers

15 West 37th Street

New York

A Portable of Distinction

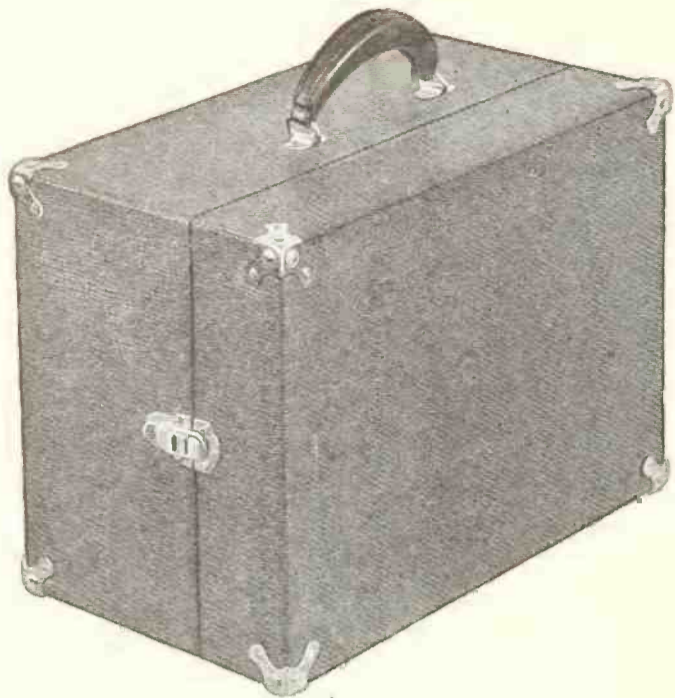

INTO the Columbia Portable Grafonola have been built the requirements of the finest musical instrument. Sturdy and compact in form, it has still all the best reproduction features of the cabinet Grafonola. From the sound chamber in the upper lid, regulated by adjustable tone leaves, there is produced a volume of tone which will surprise you. And the scientific perfection of its construction loses nothing of the sweetness and purity.

Here is an instrument that is always ready to play. Every part has been cleverly fitted into this small cabinet in the most convenient position. Lift the lid, insert the winding crank and everything is ready. The Columbia Portable will find a place of usefulness in every home. The young folks can move it to the porch for summer evenings of dancing and the children can make it their own. Its sturdy construction is made to withstand the hardest usage.

For vacation time it is an ideal partner—an asset to every outing. Music out of doors—on the river—at the summer camps—on lawn parties—picnics—what a sales vista this opens up among your customers.

Into the Columbia Portable Grafonola go only the finest selected materials and careful workmanship. You will be pleased at the perfection of detail of this instrument. Metal tops fit tightly over the needle cups when the cabinet is closed, and every part fits snugly for a journey. The handle of the case has been given a perfect adjustment, which makes carrying easy. You will not find such a list of sales features embodied in any other portable.

You can make many summer sales with this instrument that you can make in no other way. Put it on display in your windows and its appearance alone will produce inquiries. Demonstrate its compactness, its lightness, its perfect musical qualities, and sales will follow.

COLUMBIA GRAPHOPHONE COMPANY

NEW YORK



Columbia



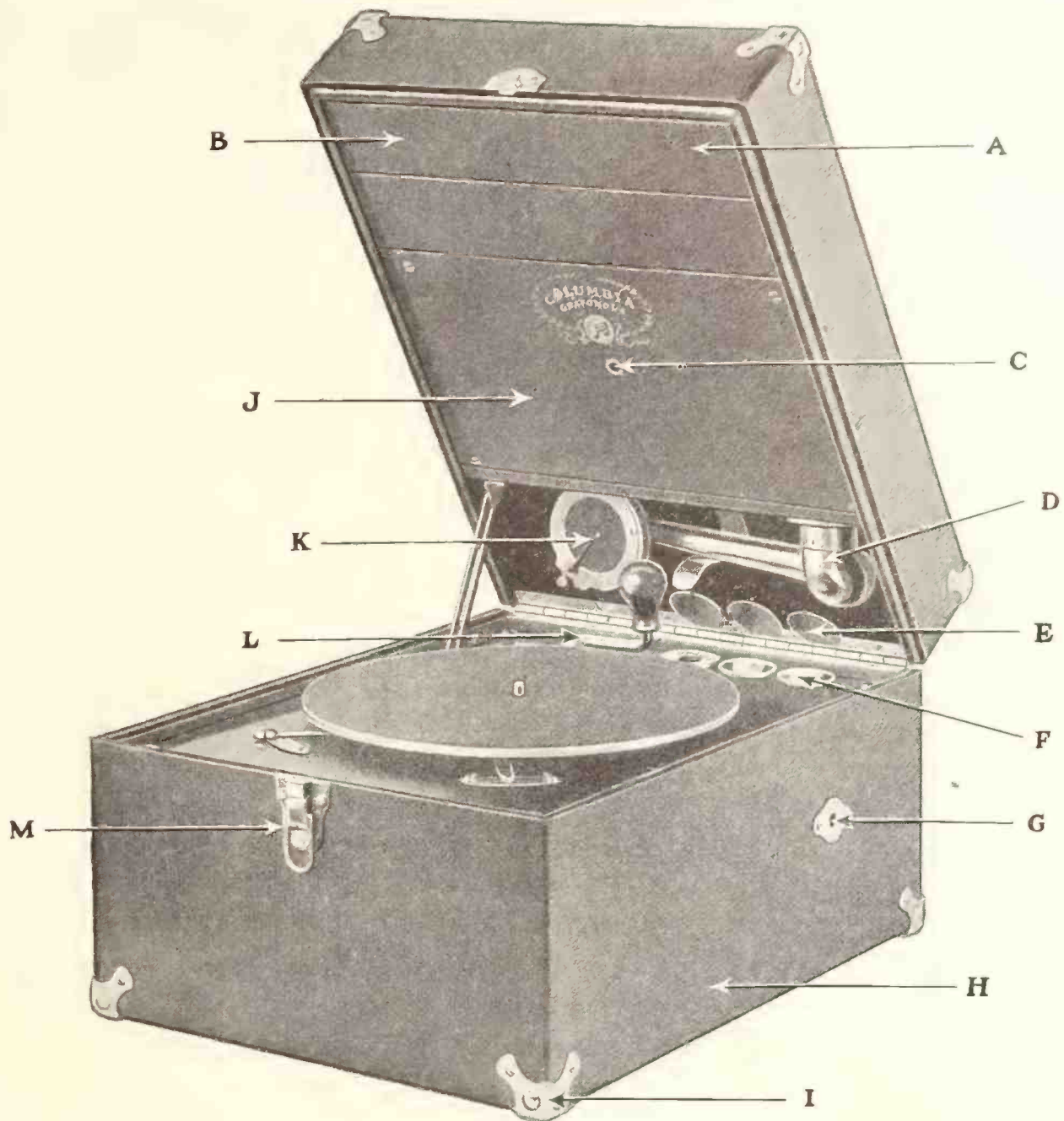

a—Two-pivoted tone-control leaves at the mouth of the amplifying chamber permit modifying the volume of tone as desired.

b—The cover encloses the scientifically shaped amplifying chamber (or horn) which permits the full and natural development of the sound-waves (as in the big cabinet Grafonolas) from the neck of the tone-arm to the mouth of the horn.

c—An escutcheon at this point fits over the motor pinion and secures the turntable against rattle or damage during transportation.

d—The standard Columbia bayonet-joint tone-arm conveys the sound-waves directly into the amplifying chamber in a continuously widening channel without obstruction or the necessity of employing special turns or adjustments to suit this type of a phonograph.

e—Needle cup covers seal needle cups when cover is lowered for carrying.

f—Three shaped nickel needle cups (one for used needles) prevent aggravating forgetfulness.

g—The position of the winding spindle gives the crank a wide swing which permits easy and safe winding of motor.

h—Complete exterior is covered with the best grade of heavy black Fabrikoid.

i—Heavy nickeled corner protectors give strength, withstand abuse and save scratching of furniture.

j—The inside is finished in highly polished Red Mahogany which, with the highly polished nickel parts and black Fabrikoid exterior, makes this instrument very attractive in the playing position.

k—Tone-arm and improved standard Columbia reproducer swing back without adjustment and are safely positioned by a spring for carrying.

l—Winding crank is conveniently positioned here for transportation.

m—Ingenious safety catch permits dust-proof closing of cover.

Portable Grafonola

The ALBUM method EXCELS all other RECORD FILING systems EVER TRIED



SELECTING THEIR FAVORITES

NATIONAL PUBLISHING CO., 239 S. American St., PHILADELPHIA, PA.

New York Office, 54 Franklin Street, Telephone, Franklin 1227, James E. Maguire, Representative

To the Trade:

Our Record Album factory—all or any part of it—is at *your command*. Hundreds of customers can and will gladly testify as to the good quality of our production.

Our large and growing business is due to satisfied customers and repeat orders.

Inprint (firm name or trade mark) stamped on covers if desired when orders are sufficiently large to justify it.

OUR ALBUMS ARE MADE TO CONTAIN VICTOR, COLUMBIA, EDISON, PATHE, VOCALION AND ALL OTHER DISC RECORDS

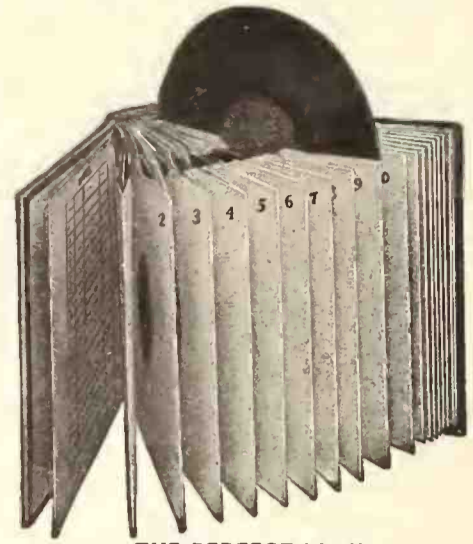

THE PERFECT PLAN

TALK ON SUCCESSFUL SALESMANSHIP

(Continued from page 15)

Success depends financially upon your doing all you can for a customer after a sale is made. The best recommendation anyone can give you is a personal recommendation. For instance, if a customer knows of a friend who wants to buy a talking machine and he says to him, "Buy it from Mr. ———, the Victor store man. What he persuades you to buy will give you satisfaction." If a customer gives you that sort of a recommendation you are headed the right way, the direction known as success instead of failure. It is much easier to go right than wrong.

There you have the scientific steps of a sale which carry the customer from the first step to the top, or the step of satisfaction. The more you satisfy and serve the more you will succeed. There is another law in life you must recognize and that is the law of gravity. Everything that goes up must come down. The scientific ladder is up in the air. The keystone is based upon one word. If I didn't have confidence in the Victor machine or in you as a business man you couldn't give me a machine. Therefore, that is confidence, but there is still a rock-bottom foundation. You may get my confidence once, but you won't hold it very long unless you develop character, because success is an expression of character and right here is the first principle of success. What you do depends upon what you are. What you are depends upon what you think. As a man thinketh so is he, and what you think depends upon the stimuli and impressions you get from the outside world and accept as your own. If a fellow tells you business is rotten and you accept that, business is rotten—for you. Business isn't rotten; it has been good for months as far as I am concerned.

As I said before, the first principle of success is this: what you do and what you are, and this depends upon the impressions you get from

the outside world. What you do not accept as your own is not yours. Develop character and confidence. Surround yourself with a thick blanket of self-confidence to keep out pessimists. Business is just as you make it.

There you have in a nutshell the science of selling. There is no secret of success. If there were we would all be out of luck, because someone else would have cornered that market long ago. The part that luck plays in life is so small, it is negligible. Everything is law. Luck is an effect without a cause and "there ain't no such animal" in this life. If business is rotten there is a cause for it. If business is good there is a cause for it, so don't depend upon luck.

This formula I have mapped out is the secret of success if there ever was any. You will then get lots of customers, which will mean lots of money. You will be content and you will grow. You will have to make additions to your store and the result will be that you will get the reward. All I can do or anyone can do is to show you the guideposts that lead to the paths.

JOINS J. K. POLK CO.'S STAFF

Chas. J. Rey Now Associated With Okeh Jobber Well Known in Southern Talking Machine Trade

ATLANTA, GA., August 4.—Chas. J. Rey, well known in the Southern talking machine trade, has joined the sales force of the J. K. Polk Furniture Co., of this city, Okeh distributor. Mr. Rey has had several years' experience in the talking machine business, having been associated with the Elyea Talking Machine Co., Atlanta, and the Southern Sonora Co., of Atlanta. The J. K. Polk Furniture Co. recently completed arrangements whereby it will handle a complete line of main springs, supplies and other accessories, in addition to its Okeh record line, and Mr. Rey has joined the organization in order to take care of the company's fast-growing business.

RADIO DEMAND CONTINUES ACTIVE

De Forest Radio Telephone & Telegraph Co. Reports No Let-up in the Call for Its Products

The opinion was quite prevalent that the sale of radio apparatus to the consumer would be greatly curtailed during July and August. A recent report, however, from the De Forest Radio Telephone & Telegraph Co., Jersey City, N. J., shows that there has been no let-up in the demand for this company's goods. While it is true that some of the shipments now being made are for dealers who have not heretofore handled radio, the fact that the outlets appointed some months back are sending in substantial re-orders justifies the conclusion that the wave of radio popularity has not waned. Naturally, with the opening of the Fall season the interest and demand will show heavy increases. The De Forest Radio Telephone & Telegraph Co. has a large volume of unfilled orders and the company's two plants, both in Jersey City and Jackson, Mich., will work at capacity for the balance of the year.

RENTS TALKING MACHINES

At the Lake Placid Club, Essex County, N. Y., quite a big business is being done by the Club store in renting talking machines and records at fifty cents a day. Pianolas and rolls are also rented—a rather novel idea. The Lake Placid Club has from fifteen hundred to two thousand guests during the Summer months.

QUEENS PHONOGRAPH CO. CHARTERED

The Queens Phonograph Co., of Queens Borough, New York City, was recently granted a charter of incorporation under the laws of New York State, with a capital of \$10,000. Incorporators are S. Bloom, D. Leibowitz and J. J. Marcus.

Patented
1914

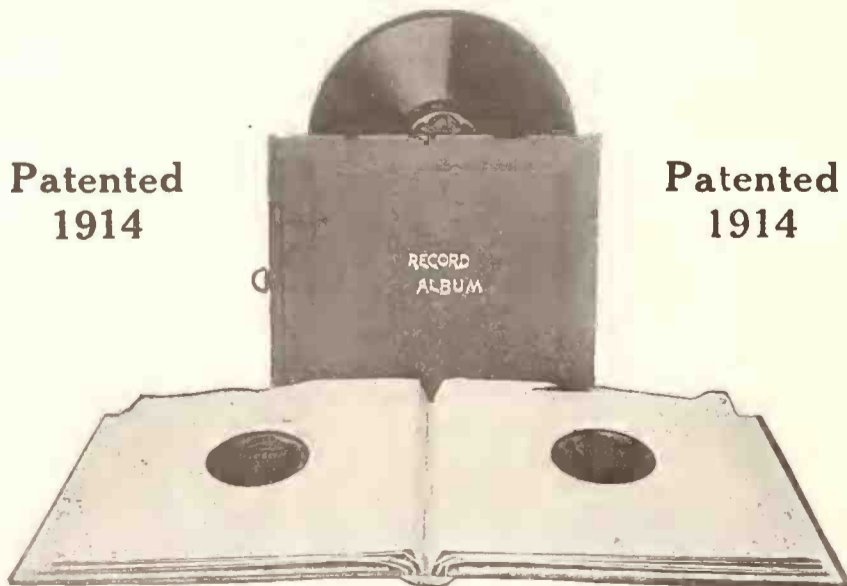

Patented
1914

STABILITY

The word is of tremendous importance to the talking machine trade—to retailers, jobbers and manufacturers alike. It indicates accurately the present condition of the market.

Why can we say the trade is now Stable?

Because:—The days of inferior goods are gone—

Because:—Inferior goods will never be welcomed again.

Because:—Determination of many manufacturers to produce and of many dealers to handle only goods of the highest quality.

Boston Albums were patented and placed on the market in 1914 and have ever since maintained their superiority by virtue of their high quality, materials and workmanship. Boston Albums are stable albums and are, therefore, used by the trade as a factor in stabilizing retail business.

BOSTON BOOK COMPANY
501-509 PLYMOUTH COURT CHICAGO, ILL.

PHONOGRAPH'S 45TH ANNIVERSARY

Thomas A. Edison Tells of Perfection of Phonograph—Discusses Radio Experiments—Recording Beethoven's Ninth Symphony—Looking to Future, Not the Past, Is General Policy

Thomas A. Edison and his great invention, the phonograph, were much in the public eye on July 18, when the daily papers devoted a great deal of space to his achievements, giving the history of the invention of the phonograph and quoting the data which Edison made on the draft of his invention on July 18, 1877, the day he wrote this prophetic declaration:

"Just tried an experiment with diaphragm having an embossing point and held against paraffin paper moving rapidly. The speaking vibrations are indented nicely and there's no doubt that I shall be able to store up and reproduce automatically at any future time the human voice perfectly."

Naturally, the forty-fifth anniversary of the invention of the phonograph attracted quite a lot of newspaper men to Orange to interview Mr. Edison. They found him in a new light suit, apparently in the best of health, sitting at his desk in the laboratory rapidly calculating a group of figures. In the first few minutes of conversation Mr. Edison added another to his already extensive list of epigrams: "All things come to him who hustles while he waits."

"No," said Mr. Edison in reply to a question, "I don't think the radio will ever replace the phonograph. I worked on the radio after the war, using the apparatus we had on our submarines, but I found when I tried it for recording there was too much mutilation of sounds, which is rather difficult to overcome. A low voice or a baritone carries fairly well on the radio, but it is not perfect. Talking is very good on the radio, because of the even pitch."

"I believe I have the phonograph close to perfection," Mr. Edison continued. "The piano can now be perfectly reproduced. I am trying now to achieve a reproduction of Beethoven's Ninth Symphony, played by seventy-five instruments. I can't say when I shall be able to accomplish it, but I think I can."

In speaking of the original model of the phonograph, now in South Kensington Museum, London, Mr. Edison said: "Nobody around here seemed interested in it, and the museum wanted some things. I also gave them the original of the first incandescent light. I am not interested in old models. I suppose it is because they take so much time and trouble to make them right that I lose the sentimental interest. It's what is ahead that interests me, not the past."

REJOINS PETERSBURG MUSIC CO.

J. K. Fletcher, Reappointed Manager of Successful Victor Establishment, Prominent in Retail Circles—Making Plans for the Fall

PETERSBURG, VA., August 5.—J. K. Fletcher, for a long time manager of the Petersburg Music Co. in this city, and more recently manager of the Victrola department of the Andrews Bros. Co., has returned to his old position as manager of the Petersburg Music Co. Mr. Fletcher's many friends in the trade will undoubtedly be pleased to know that he is "back on the job," for he is well known to the retail talking machine trade in the South and has a host of friends in the retail business. Mr. Fletcher is now going after business aggressively and is making plans for a healthy Fall trade.

RELEASES OF STANDARD RECORDINGS

The Apex Recording Laboratory, 1126 Broadway, New York City, announces the release to the general trade of standard recordings in the form of mother matrices in seven, ten and twelve-inch form. The purchasers can either take a complete catalog of all or any of the above-size records or can compile a variety catalog giving them diversified selections. Sales of the mother matrices are made outright for pressing purposes.

"ANNUAL FRIVOLITY RELEASE"

Distinctive Brunswick Copy Appearing in National Mediums Features Dance Records and Makes Strong Appeal to the Masses

A very striking double-page advertisement carried above the name Brunswick-Balke-Collender Co. in the July issue of the Saturday Evening Post bears the title "Here It Is! Brunswick's Annual Frivolity Release." The first page is devoted to a list of popular numbers played by the Isham Jones Orchestra, the Oriole Terrace Orchestra, Benny Krueger's Orchestra, Carl Fenton's Orchestra, Rudy Wiedoeft's Californians and Selvin's Orchestra.

The text matter on the opposite page is written in a light vein, but right to the point, reading in part as follows: "Nothing serious—just the newest conceits of world-famous dance orchestras to fill dainty slippers with toes that tingle from one end of the land to the other."

"For eleven months of the year Brunswick is serious."

"We talk about the New Hall of Fame of

world-noted artists who have chosen Brunswick as the most fitting means to perpetuate their art. For we are proud of that for which Brunswick stands in the world of musical art. And, quite humanly, like to talk about it.

"But for one month seriousness is cast aside. Frivolity supplants art, with brightness and gaiety, and happy Summer evenings, beguiling the world to play. That's all we have to say."

This is followed by reference to the personalities of the various orchestras, constituting altogether a very clever appeal to the public—one that inclines the reader to buy records. There are some very clever illustrative conceits throughout the advertisement, and it must be said that this latest Brunswick publicity is valuable not only for its sales-creating possibilities, but also for the fact that it is a distinct departure from much of the customary advertising in its special appeal to the rank and file of people.

The merchant who possesses a correct and live mailing list is the owner of a gold mine from which he will garner wealth if he makes the most of it.

Are You Going to Lock the Door After the Horse is Stolen?

The
HARPONOLA
RADIO
de
LUXE



If you dealers and distributors of Talking Machines let the electrical and radio shops "cop" all the cabinet radio orders, it will be your own fault.

Let the radio stores sell the experimenters and the boys. You phonograph dealers should sell the folks who want a "drawing-room" radio outfit—and there is a great and growing host of people who want these well-finished cabinet radios.

You can't afford to wait until the cream of this trade is attracted elsewhere. Establish yourself NOW as a cabinet radio shop. There is nothing intricate about the business. In HARPONOLA RADIOS, the units are standard and dependable.

Get our proposition. We'll show you the way to introduce cabinet radios successfully. The profits and volume of sales are going to set new records in money-making.

THE HARPONOLA COMPANY

Makers of the Phonograph with the Golden Voice

CELINA, OHIO

Edmund Brandts, President

Just compare any record of any make with the needle cut Pathe Actuelle and then you will know why the Pathe Actuelle is—

The Best Record in the World

Play on any phonograph with steel needles

For Example, try

"Stumbling"	No. 020746
Romany Love	No. 020777
Parade of the Wooden Soldiers	No. 020780
'Neath the South Sea Moon	No. 020781
Three o'Clock in the Morning	No. 020791
My Yiddisha Mammy	No. 020782
Swanee River Moon	No. 020803

Pathé
Actuelle
REG. U.S. PAT. OFF.

2 for \$1.00 - 55c each

(59c in Rocky Mountain States)

Partial List of Famous Artists—

Tito Schipa
Yvonne Gall
Adamo Didur
Margarethe Matzenauer
Rudolph Ganz
Anna Fitziu
Eleonora de Cisneros
Claudia Muzio
Luigi Montesanto
Kathleen Howard
David Bispham
Grace Hoffman
Alexander Debruille
Helen Yorke
Roberto Rotondo

DEALERS—

If you don't act quick your neighbor will be selling Actuelle Records. Write to us at once for information regarding the Blue Ribbon Order.

PATHÉ FRÈRES PHONOGRAPH CO.

20 Grand Avenue

Brooklyn, New York

Some Practical Ideas That Helped Not Only to Promote but to Close Sales :: By Thornton Hall

August is the month of vacations, but it is also the month of ideas. Several excellent notions for developing the sale of talking machines and records have already cropped up this month. The first case in point that comes to mind is that of a dealer in one of the larger Long Island towns about half-way down the Island.

This chap operates a sheet music department in connection with his talking machine business. It is a very good sheet music business, but like all other sheet music merchants the end of each month finds him with a fair-sized supply of popular music dead on his hands. He calculates the demand and when the popular run on a number has burned itself out or failed entirely to materialize he finds himself with a certain quantity of unsalable copies.

On the first day of this month he looked over his stock and sorted out copies until he had a pile several feet thick of popular "hits" which had passed out of the picture of popular desire. There was a very slim chance that he could sell more than thirty cents' worth. He might bale it and sell it to an old paper merchant, but it was an expensive pile of paper. Some of the numbers had cost him twenty-three cents a copy. He might throw it in the window and cut the price in two, but he had tried that and it never worked. If the public wants a number it wants it when it is fresh. Price is not an inducement.

Here is where idea number one comes in. Why attempt to sell them? Why not give them away? Accordingly he got himself a rubber stamp and an ink pad and stamped every copy, "Compliments of The Music Shop, 171 Main street." It was Saturday night and he knew where he could dispose of every copy. The movie house on the

corner had a very good bill and a crowded house. The curb was lined with automobiles on both sides of the street for a block. In each sheet of music he inserted a circular advertising a portable talking machine and the record releases for July and August. Packing them all in a bushel basket he set out personally to distribute them. Along the line of machines he went, placing

The Man on the Firing Line Gives Away the Secret How Some Dealers Really Close Substantial Orders

several copies in each car until he had disposed of the entire lot.

He considers that he has secured at a small expense some very effective advertising of the most direct type. A great many of the motorist-movie fans were very pleased with the music, and those who had already owned copies appreciated the dealer's spirit. He was able to reach a great many new prospects direct and he advertised his store, his talking machine department and his sheet music department. He not only eliminated

a charge for envelopes and postage, but he created the impression in the minds of several score of desirable prospects that he was a live-wire merchant.

Dealers who are confronted with the monthly problem of disposing of their surplus music copies might do well to profit by this chap's stunt. This dead merchandise is usually a flat loss and this method of clearing it off your shelves paves the way for some future business. It also goes to show that a sheet music department is closely and naturally allied with the business of selling talking machines.

Putting Sales Over Satisfactorily

So much for idea number one. Let us consider another of the practical August-born merchandising stunts. This one has to do with an Indiana dealer who decided that the Summer slump in machine business gave him a fine opportunity to experiment with a hunch he had been considering. Experiment he did and the hunch went over big.

The equipment for carrying out this idea included a list of every home in the territory which was without a talking machine, a Ford roadster and a live, energetic canvasser-salesman. He succeeded in obtaining a very good list of names, and sent the salesman out in the Ford to dispose of one hundred machines to these prospects. Here is the way he worked it.

Ford stops at the house of Mrs. Brown, who happens to be the first prospect on the list. Salesman hops out and rings the bell, which is answered by Mrs. Brown.

"Good morning, Mrs. Brown. I know just what you're thinking. You see my Ford out there and a phonograph on behind. You think I'm here to

(Continued on page 22)

The Recent Chicago Radio Show

Resulted in quantity orders from concerns ranging from Florida to California on—

THE RADIO BUILDER SET



Shipped to customer in "knock-down" form and requiring only a screwdriver and a few moments to complete its assembly.

When finished it provides a vacuum tube set which is very selective, giving extremely loud and undistorted signals.

Price - \$30.00

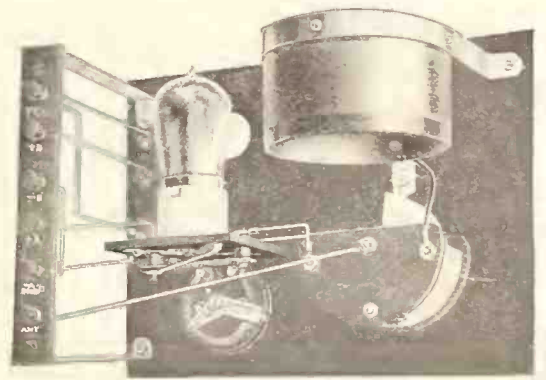

SOME DEALER PROPOSITIONS STILL OPEN

The above type set is available in one, two and three tube form.

RAYMOND RADIO CORPORATION

Manufacturers to the Radio Industry

Offices: 309 Lafayette Street, N. Y.

Works: Farmingdale, L. I.

PRACTICAL IDEAS PROMOTE SALES

(Continued from page 21)

sell you that phonograph and you're all prepared to say 'No'.

"Not at all," he continues, glibly and pleasantly, before Mrs. Brown can interrupt. "Not at all. That's a ——— talking machine. The ——— company is a big advertiser and they do things in a big way. Just now they are putting on the biggest advertising stunt you or I ever heard of. For one month, Mrs. Brown, they are going to loan one of the ——— talking machines to every home in this city that hasn't already a talking machine of some kind.

"This is being done merely to advertise music. There is absolutely no obligation incurred by you to buy the machine at the end of the month. The company figures that by doing this in every home in the country without a talking machine they are going to sell the idea of music to the country. The more musical the country is the better the company's business will be. You see the idea?"

"Another thing, Mrs. Brown. The ——— company is represented in this city by the Beethoven Music Shop. The allotment of instruments for this city is limited, so the Beethoven people have had to cut down the list of homes to those in which they know the instrument will be well taken care of. You may be pleased to know that you were first on the list."

This settles Mrs. Brown. This surprising offer had rather bewildered her. She was suspicious; it seemed too good to be true. There must be a catch somewhere, but the subtle flattery of the salesman removed all doubts. He easily obtained her permission to place the instrument in the home for a month. He showed her how to operate and take care of the instrument and left. The next day Mr. and Mrs. Brown dropped in and bought a few records.

Now what happens? A few evenings later the Browns are sitting in their parlor when their neighbors, the Lathrops, come to call. "Oh, I didn't know you had a talking machine! Isn't it a handsome instrument! What a fine tone it has."

Do the Browns confess that it isn't really their

machine, but merely loaned to them as an advertising stunt? They do not, and their silence implies ownership. They cannot return the machine now. What would the Lathrops think? Anyway, they are becoming imbued with the desire to own it.

Soon the dealer telephones Mrs. Brown. Is the machine working all right? Can he be of any assistance? What's that? Oh, yes, Mrs. Brown, I think it can be arranged that you can keep the machine at the end of the month.

The next day the salesman makes another call at Mrs. Brown's and the terms of sale are arranged. This dealer had one hundred prospects on the list. Eighty per cent of the prospects were persuaded to take a machine for a month. Only 25 per cent failed to keep their machines at the end of the month, so the campaign netted him sixty sales of machines, a great deal of record and needle and accessories business, and twenty live prospects for future sales.

Co-operating With the Local Newspapers

The third of these sales-producing ideas originated with a merchant in Massachusetts. It commends itself to us because we think it is a practical one that can be adopted with a good deal of success by other talking machine dealers. It is an extremely simple stunt and consists of a music department in a local newspaper. He made a co-operative arrangement with the editor to provide a music page every Saturday evening.

The dealer agreed to take complete charge of the department. It was decided that the salary of such an editor would amount to just about the cost of the merchant's advertising in the paper, so that was the financial arrangement.

The subject matter in the music page was along the lines of the music pages that appear in the several metropolitan dailies. There were short sketches on musical men and affairs, both past and present. A regular list of popular records, player-piano rolls and sheet music was given, showing the relative popularity of the selections week by week. Experts on musical topics were engaged to write pertinent articles. Concert notices and reviews were given. The report is that the page resulted in much mutual benefit.

These examples indicate that even though business may show a falling off during the hot weather the merchant's gray matter must be kept working at top speed. When business lags it affords an opportunity to put on the thinking cap and to evolve some ideas that may be used later on, when the demand gets better and the competition grows keen.

PLANS ACTIVE SALES CAMPAIGN

A new use for the talking machine which can be included in the "indoor sports" was recently introduced by the Phon-o-Game Co., Elizabeth, N. J., samples of which are now being forwarded to the trade gratis. The main feature of the game is a twelve-inch disc somewhat resembling a standard record. Upon the outer edge of this disc is printed in red and black a series of numbers. The disc is placed upon the machine (without the tone arm or needle) and the brake is released. The record spins at high speed and when the brake is applied the winning number is indicated by a brass arrow, a part of the outfit. A set of rules accompanies the Phon-o-Games, showing the variations of playing the disc. Incidentally, there is an extra circle on the disc whereby the favorite "put-and-take" game can be played.

The manufacturer has planned an active Fall sales campaign and has issued window display signs and other publicity matter for dealers' use.

DELAWARE INCORPORATION

The Redorad Park Corp. of America, of Wilmington, has been granted a charter of incorporation under the laws of Delaware for the manufacture of talking machines. The concern is capitalized at \$500,000.

Past experiences often indicate the things to avoid in the future.

Are You Selling "ORPHAN" Machines?

GRANBY EDITORIAL LETTER

Number Six

From Granby Phonograph Corporation, Newport News, Va.

There was a time in nearly every State when someone was trying to start an automobile company. Promoters sold stock, made promises, and built a few cars. A lot of people lost a lot of money.

Some of the promoters were honest, and some were not. The less said about those who were not honest the better. This country wants to rid itself of dishonesty.

But a great many of the promoters were honest. They tried. Tried hard. They failed because they didn't have enough capital to tide them over the hard spots.

And when they stopped manufacturing automobiles what happened? Who suffered? The investors—yes, but more:

A LOT OF DEALERS SUFFERED, TOO. They had cars on hand which were no longer being made. Would customers want to buy these "ORPHAN" cars? No!

Suppose you are an automobile dealer. You have a lot of cars on hand which are no longer being made. Stuck, perhaps! Because "Who wants to buy a car when it isn't good enough to keep the makers from going in the hole?" That is what possible purchasers would figure. "Those cars you have are ORPHANS. They have no father or no mother." In just such a way the prospects would reason.

Let's turn to phonographs. Before and during the war great numbers of manufacturers started making machines that sold simply because people bought up everything. And then all of a sudden competition began again. You know the story, you dealers who THINK.

The makers didn't have enough capital to keep going. Most of them failed. THERE was the crop of "ORPHAN" phonographs, without manufacturer backing.

This is a condition that dealers should beware of. It is dangerous to the growth of their profits. Now you see why we tell you about the financial backing behind the GRANBY PHONOGRAPH.

The Granby is made and distributed by the Granby Phonograph Corporation of Newport News, Virginia. Capital is \$2,500,000.00. That is the FIRST fact,



Lifetime Construction
EARLY VIRGINIAN CONSOLE
Granby No. 51—\$175

The Granby Corporation is in turn OWNED and FINANCIALLY BACKED by the FOUR AND ONE HALF MILLION DOLLARS of the AMERICAN HOME FURNISHERS CORPORATION of Norfolk, Virginia. That is the SECOND fact.

The entire resources of the American Home Furnishers Corporation are behind GRANBY. And that is why GRANBY is now gradually and surely growing. The Granby Phonograph is a sterling-true product, backed by plenty of capital. These facts give CONFIDENCE to Granby dealers. These facts give CONFIDENCE to Granby owners. They HEAR for themselves the "Mellow as Southern Moonlight" tone, and they KNOW that their machine is now and ever shall be fathered and mothered by its makers.

There is a generous offer awaiting you in Newport News. Send for it. Write a letter to us today and let us show you how the GRANBY FRANCHISE will positively bring greater PROFITS to you. We shall send you this liberal offer the same day we get your letter.

GRANBY Phonograph CORPORATION

Capital \$2,500,000.00

Offices and Factory

Newport News,

Virginia



"The road to profit is as plain as the road to market"



Movies Present a Real Profit Opportunity

"Movies" in the home spell opportunity for the progressive dealer who is first to introduce them in his territory. There is a satisfactory profit in the sale of the machine, but there is a continuous profit in the steady demand for Daypho Paper Prints---the Safety film that is made of paper.

The Demand for Paper Films Brings Customers to Your Store Every Day—A Steadily Growing Demand

You need a small and varied stock of Daypho Films to start with, in addition to catalogs covering the entire Daypho-Bray Library. Then each customer can choose his Library of Films at his leisure.

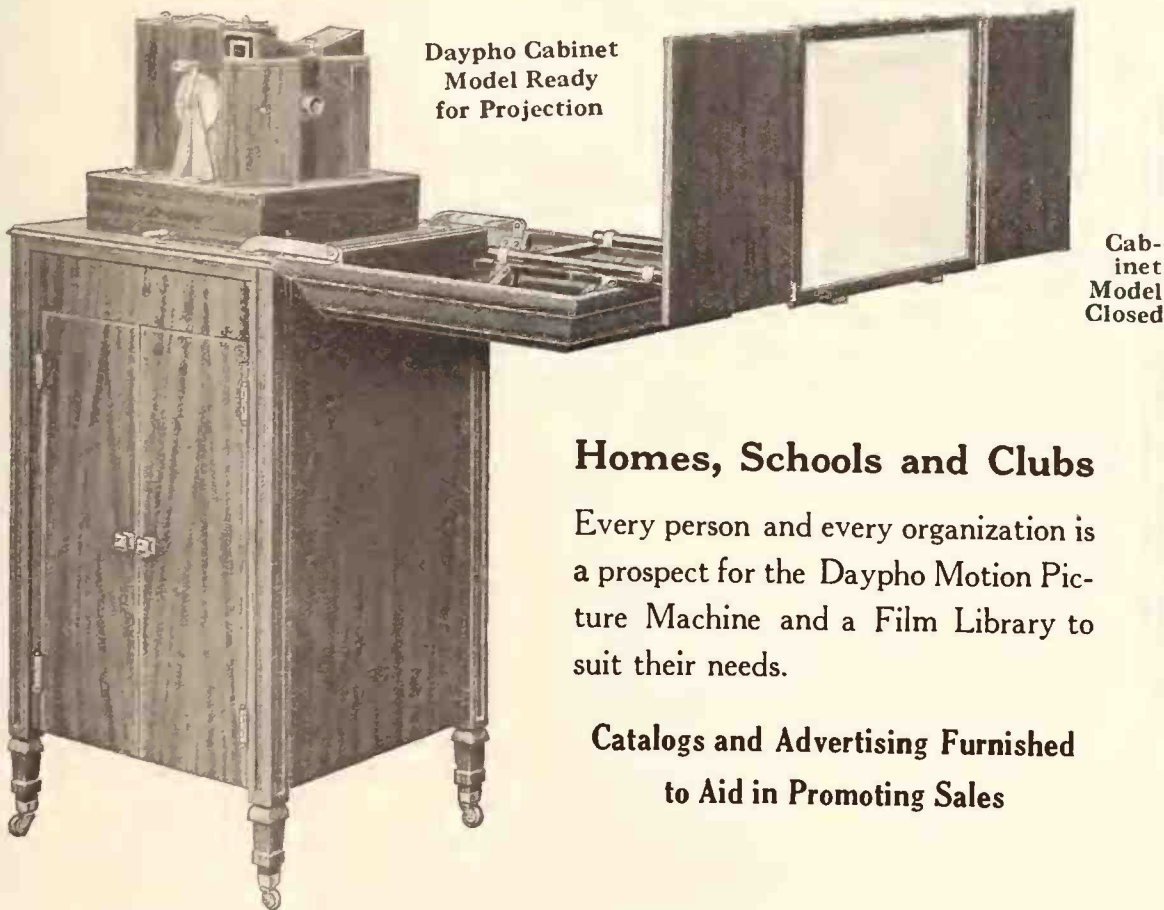

Daypho Cabinet Model Ready for Projection

Cabinet Model Closed

Homes, Schools and Clubs

Every person and every organization is a prospect for the Daypho Motion Picture Machine and a Film Library to suit their needs.

Catalogs and Advertising Furnished to Aid in Promoting Sales

Daypho Paper Films Absolutely Eliminate Fire Risk

CUT OUT - - - Pin to Letterhead

- Send Catalog ()
 - Send Advertising ()
 - Quote Prices and Terms ()
 - Send Sample of Film ()
 - Have You Sold Projectors ()
 - Do You Sell Photo Supplies ()
- Please check (✓) for "Yes"
Use cross (X) for "No"

These Paper Prints (or Films) are made of a specially treated paper of extremely tough fiber, which will not crack or break. It provides a picture of remarkable clarity, is less expensive than celluloid, and is absolutely safe.

The Dayton Photo Products Co.
DAYTON, OHIO, U. S. A.

Some Practical and Valuable Tips on How to Conduct Your Retail Business :: By Jos. W. Schwetz

Joseph W. Schwetz, who for twenty years has been connected with the firm of I. Davega, Jr., Inc., and its successor, the Knickerbocker Talking Machine Co., made his first public address in all those years at the last dealers' meeting of the Knickerbocker Talking Machine Co., Victor wholesaler, New York. In view of Mr. Schwetz's reticence as a public speaker his remarks on "How to Conduct Your Business" aroused a great deal of interest among the dealers present. He presented his ideas in a modest way, setting forth that whereas he felt that perhaps a great many of his listeners may be utilizing the ideas he was about to set forth, yet he might present some thoughts that are new which may be overlooked by some during the days when the cash register is working overtime. He also pointed out that in all the years he had been doing business he had always tried to practice the theories he was about to preach. He then proceeded:

How and Where to Find Customers

"The first and most important thing in most businesses is to find customers. Therefore it is advisable to utilize every plan you can think of to get in touch with those with whom you are likely to do business. Customers are often found where least expected. Do not miss any customers that may be right in your own circle of acquaintances, or let your acquaintances put you in touch with interested parties.

Read the Newspapers

"Keep in touch with all that is going on in your locality. There is often an item of news in the paper that will show you where you can find a customer. For instance, several newspapers, one in particular, called The Chief, has a column exclusively devoted to marriage licenses. Here is an exceptional opportunity for you to get in touch with newly married couples who would be interested in the merchandise you sell. If you read of a person's house or flat being damaged by fire it will probably pay you to visit the party at once, for as soon as he collects insurance, which he undoubtedly has on his property, he may be in the market for Victrolas or records which you can sell him. Notices of engagements in

your local papers also suggest opportunities for making sales.

"Make friends with children, for through children you will often reach the parents and learn of their desires, which you may be able to fill. Make inquiries among those whom you meet in your store, lodges, at meetings, etc. Let people know you are a Victor dealer. Impress this upon them by courtesy and ask them to let you



Jos. W. Schwetz

know if they have any friends or know of anyone who may be a Victrola prospect.

Be Systematic

"Keep the name and address of anyone who may be a prospective customer in an index file. Keep after them by letter, 'phone or personal calls. Remember, keeping everlastingly after them brings the business. Remember also that you should sell to those who sell to you. If you are doing business with a grocer, butcher, baker or tailor be sure to get all the business possible

out of them. If you are giving them business they should return the favor by giving business to you whenever they need anything in your line. You in turn can help them by aiding them to get new customers among your friends and acquaintances.

"To cite an example of this: The other day I had lunch with one of our retailers. It was not the first time he had taken me to lunch and I noticed that every time he took me to a different restaurant. I asked him why he changed his restaurant so often when the service and food were so good in the places where we had dined before. He told me that he had made several sales to the various employees in these different restaurants and in the particular restaurant where we were having our lunch that day he had sold three Victrolas to the waitresses and one to the chef, and his next prospect was the proprietor, who promised him an order for a period Victrola as soon as his house was completed. This dealer made the most of his opportunities and he let everyone know he was a Victor dealer. This was the way in which his order was carried to the chef, 'One order of roast chicken for the Victrola man,' and, believe me, when that order was brought out everything was on the table but the kitchen stove.

"If you are a member of a club or some organization that brings you in touch with a number of people that should be a good basis to work up a list of prospective customers.

Be an Advertiser

"Advertising for customers by means of letters, by special circulars or through newspapers is very important.

"If you can get your relatives, friends and acquaintances to help you advertise and boost the sales of Victrolas it will help wonderfully in getting in touch with customers. Do not forget that a good time to sell something is when you are purchasing something yourself. For instance, 'Three new specials will be released next week,' 'We have just received the new model Victrolas,' or 'Stumbling,' 'Some Sunny Day' and 'Coo Coo' are Whiteman's best numbers this month. Tell these things to all with whom you do business. Invite them into your store to hear these records and see the new model Victrolas, for, as I have said before, people whom you give your business to should give their business to you.

Show Appreciation

"Do not forget to show your appreciation for every little help you receive whenever a sale is made to a person whose name was suggested by or secured from some other customer or friend. Be sure to call upon the party who gave you this new customer's name and give him at least a hearty word of thanks.

"Treat your customers as if you hoped to do business with them the rest of your life. Try your best to please them. Make your customers your friends. Then, when they hear of anyone in the market for a Victrola they will go to any reasonable amount of trouble to let you know about it and recommend you.

Go After Summer Business

"During the Summer a great many retailers and salesmen discontinue their efforts to get business. This is a mistake. It is just because of this condition that you have a chance to do plenty of business if you will push as hard as you usually do. With less competition you ought to do as well in the Summer months as during the other seasons of the year.

Study to Please Customers

"In dealing with your customers be sure to impress upon them your desire to please and satisfy their wants. Your success depends upon pleasing customers, and in handling record customers the Victor catalog offers you enough variety to suit all customers. After a record sale has been

(Continued on page 26)



**BRUNS
MADERITE**

MADERITE
WATERPROOF
PHONOGRAPH MOVING COVERS

Cover, Straps Attached



A cover that will fully protect against damage in delivery and against the ravages of inclement weather.

Why be troubled with packing and unpacking? Why not just slip a MADERITE Padded Delivery Cover over the machine? No fuss, no dirt and positive insurance against damage incident to delivery.

The use of the BRUNS MADERITE Covers, made of highest grade waterproof fabric, heavily padded, is not only serviceable but profitable. This cover is highly recommended.

Consult your regular jobber or write us for sample of cloth and prices.

A. BRUNS & SONS
50 Ralph Ave., Brooklyn, N. Y.
Manufacturers of Everything Made of Canvas

A. BRUNS & SONS
50 RALPH AVE.
BROOKLYN
N. Y.

The Swanson

PORTABLE PHONOGRAPH

Sweeping the Country

This marvelous portable with its wooden tone-arm is proving a revelation to talking machine dealers. The splendid tone quality of the SWANSON makes it superior to any portable on the market.

Weight—15¼ lbs.

Compact, attractive and absolutely fool-proof. Heineman double spring motor; high grade sound box and needle container. *A real portable.*

Write for details of liberal jobber and dealer proposition

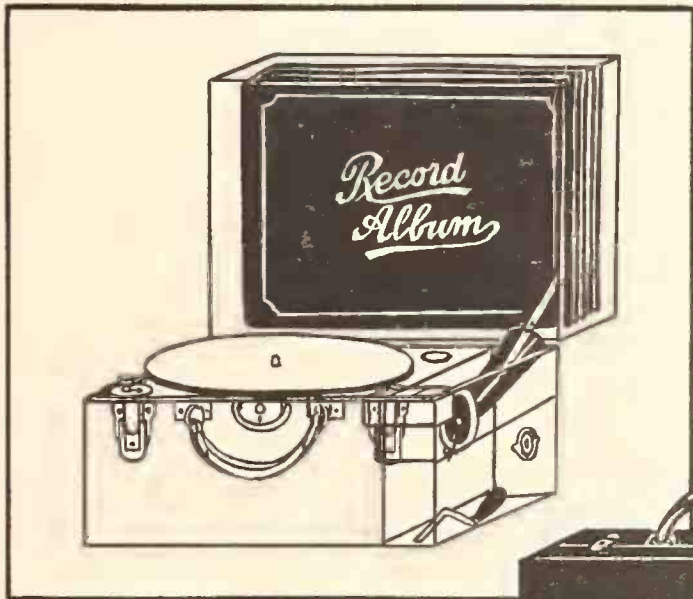

Phantom View—showing each part in place ready for carrying



The Swanson—ready for playing

List price of the SWANSON — \$40. Unusually liberal discounts to live jobbers and dealers. Write our nearest sales office for details.

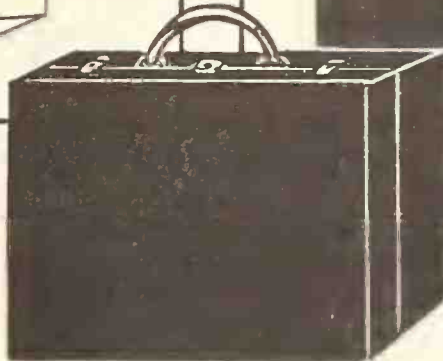

Weight complete, 15¼ lbs. Dimensions, 11⅞" x 13" x 7½"

We have an exceptionally attractive sales proposition for successful established jobbing houses. *Wire* our nearest office today. Territory now being allotted.

Swanson Sales Company

R. W. MOON, General Manager

1133 Broadway
New York, N. Y.

308 West Ontario Street
Chicago, Ill.

536 Merchants Nat'l Bank Bldg.
Los Angeles, Cal.

TIPS ON CONDUCTING RETAIL TRADE

(Continued from page 24)

consummated and you have bid your customer good-day a little remark such as, 'I hope you and your family will be pleased with your selection,' tends to show your customer that you have his best interest at heart. This will do a great deal towards inducing them to call again when they wish to make other record purchases and will also induce them to recommend others to your store.

"Study the people with whom you come in contact. Gain their friendship, their confidence, for that is one of the biggest factors in getting business. Learn their likes and dislikes. A knowledge of people with whom you are trying to do business will help you greatly.

Study Yourself

"You can learn a lot of these general principles by studying yourself, for if you yourself know what sort of treatment you would like to receive or what motives will induce you to buy and what methods will attract or repel you, you are pretty sure to have a good line on the other fellow.

"We all have our faults and weaknesses and we will be more successful when we learn what they are and overcome them. If a salesman has a cold or repellant manner he should endeavor to change it. Meeting people with a smile and a warm, hearty handshake goes a long way towards winning friends and customers and, by the way, one of our retailers who pays the highest rent for any one store in New York City is the greatest handshaker in the world. His success is attributed to his handshake, his smile and his interest in his customers.

"Care in personal appearance is an important matter. The salesman whose shoes need cleaning, whose linen is soiled and who needs a shave is not likely to attract the right kind of people. Never be too 'fresh' or too familiar with customers. Familiarity breeds contempt. Business matters are serious matters with most people, and if any joking is to be done let your customers do it. Always be polite. Politeness may not in itself secure any customers, but it will surely create a favorable impression and cannot possibly cause you to lose customers, as may a cold or brusque manner.

Do Not "Knock"

"Do not try to win customers for yourself by knocking the other fellow, his merchandise, and what he is trying to sell. Every time you talk about a competitor you advertise him and when you are talking about another man's goods you are neglecting to talk up your own merchandise. A wise salesman learns all about his own merchandise and tells his customers about it. If he studies what his competitor is selling it is

only for the purpose of pointing out the difference in the article offered and not for the purpose of defaming his competitor or misleading his prospective customer.

Be Continually Active

"The way to find customers is to be as industrious as possible in your search for them. Intelligent activity is the thing that counts and when you are not active in searching for customers be active in thinking out new ways to find them and how to create and increase your sales of records and Victrolas. Keep your mind on your business. Do not waste time and energy on outside lines that cannot help you any. Victrolas and records are your main line. That is your calling. Remember, you are selling the best talking machines and records in the world. Go after that business."

EXPANSION OF MAGNAVOX CO. PLANT

Addition Just Completed to Meet Increased Demand for Special Magnavox for Use With Radio Receiving Sets—Davis Ends Trip

The Magnavox Co., manufacturer of amplifying loud speakers heretofore used in telephones, which talking machine dealers have installed in stores for publicity purposes, is now manufacturing a loud speaker on the same principle for use with radio receiving sets. At the present time the company is devoting a considerable portion of its large factory in Oakland, Cal., to the manufacture of these radio loud speakers, but the demand for them necessitated the construction of a large addition, which was completed last month and is now being occupied. W. R. Davis, sales manager of the company, has just returned from a two months' trip which took him to the plant in California. En route he visited all of the important trade centers and conferred with talking machine men in the interest of both the radio loud speaker and the speaker used in conjunction with the talking machine. He stated that everywhere talking machine dealers were in a very receptive mood as regards radio, and that all are making plans for a very fine Fall and Winter business. Although the month of July showed little activity in actual sales many orders were booked for early Fall delivery, and the Magnavox plant has been kept busy accumulating a stock to meet these future orders, and all indications point to a brisk demand.

The sales offices of the company in New York City have been moved into larger and more commodious quarters at 370 Seventh avenue, where they are much better prepared to take care of the expected increase in business during the coming Fall.

THE MELODIOUS AND TUNEFUL
A "HIT" EVERYWHERE
STAGE AND DANCE
THREE LITTLE WORDS
FOX-TROT
SHEET RECORDS ROLLS
JOE MITTENTHAL INC. NEW YORK

LECTURES AID RECORD SALES

Representative of Columbia Co. Delivers Lectures on Music Appreciation to College Students and Boosts Sale of Records

FAYETTEVILLE, ARK., August 5.—Increased sales of talking machine records followed the recent appearance of Miss Florence E. Hazlet, of the educational department of the Columbia Graphophone Co., before the students of the University of Arkansas, to whom she demonstrated how very young children may be taught to appreciate music by forming small bands and following the music on records. Miss Hazlet also discussed music appreciation as taught to grammar and high school students. The public was invited to listen to her lectures and the result was a noticeable increase in the sale of records by local merchants.

SPECIALIZES IN STANDARD RECORDS

The Emerson Phonograph Co., 206 Fifth avenue, New York City, announces that its efforts are being entirely concentrated upon the production of standard records. A catalog of standard American works, vocal and instrumental, secular and sacred, operatic, Hawaiian and foreign records is to be featured under the new plan. The foreign record catalogs are particularly interesting, including universally known works, and are quite comprehensive in scope.

Nick Nelson, who was formerly vice-president of A. L. Cummings, Sheridan, Wyo., has purchased the Ball Music Co., of Billings, Mont., and will continue that business under his own name, handling the Victor line exclusively.

THE NEW PHILLIPS OCTAGON THROW BACK ARM No. 5

Pleasing to the Eye
and
Pleasing to the Ear

Also equipped with our regular
No. 3 Reproducer if desired

Tone Arm measures 8½ in., and
9 in. from centre to centre

Tone Arms and Sound Boxes
complete from \$2.00 up

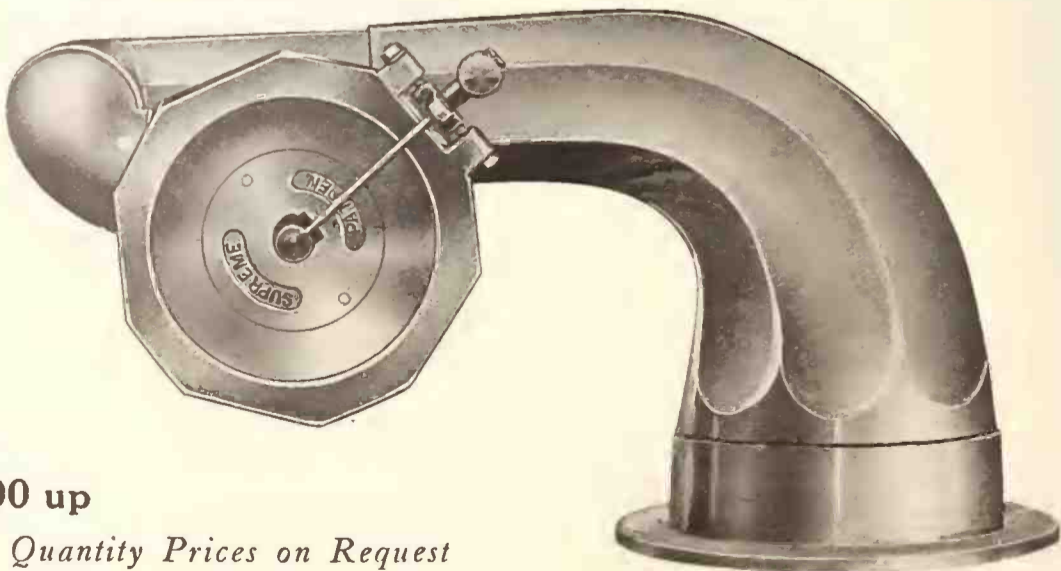

Quantity Prices on Request

The William Phillips Phono Parts Corp.

Manufacturers of Tone Arms for Portable, Medium and High Grade Machines

145 West Forty-fifth Street

New York City



Reputation Counts

MR. VICTOR DEALER

You cannot afford to overlook the reputation of the Victor Distributor you select as your main source of supply.

Your Distributor investigates your reputation before giving you credit. He wants to know your reputation for keeping promises and meeting obligations. You are generally served and supported accordingly. Why not investigate your Distributor's reputation?

Your source of supply should be dependable under all conditions. Choose your Victor Distributor as you would your doctor or lawyer. The best is none too good in critical times. You may need financial support or advice to meet your particular situation during a business depression. You have learned the need of a dependable source of supply during a great shortage.

Experience and reputation are extremely important. In our experience of over twenty years we have seen manufacturers, wholesalers and retailers come and go. The failures, however, seldom suffer alone.

Do not overlook the value of representing a product of a strong manufacturer with a source of supply through a wholesaler of corresponding strength and reputation. Profit by the experience of others.

The Victor Talking Machine Co. and its product are supreme. The events of recent years pay tribute to that fact. As the Fall and busy holiday season approaches, you should weigh carefully the reputation of various Victor Distributors in your territory and make your choice accordingly. If you do, you will not disregard the Blackman reputation, through experience, financial strength, preparedness and, above all, dependability. They are all at your service, Mr. Victor Dealer. Can you afford to overlook the opportunity?

Take this seriously, Mr. Victor Dealer, and interview us if we are not your main source of supply. Blackman preparedness and dependability, we are confident, will convince you of the need of the combination—the Victor and Blackman.

Yes, reputation counts, Mr. Victor Dealer, and it is going to count big between now and January 1st.

Blackman
TALKING MACHINE CO.
28-30 W. 23RD ST. NEW YORK N.Y.
VICTOR WHOLESALE DISTRIBUTORS



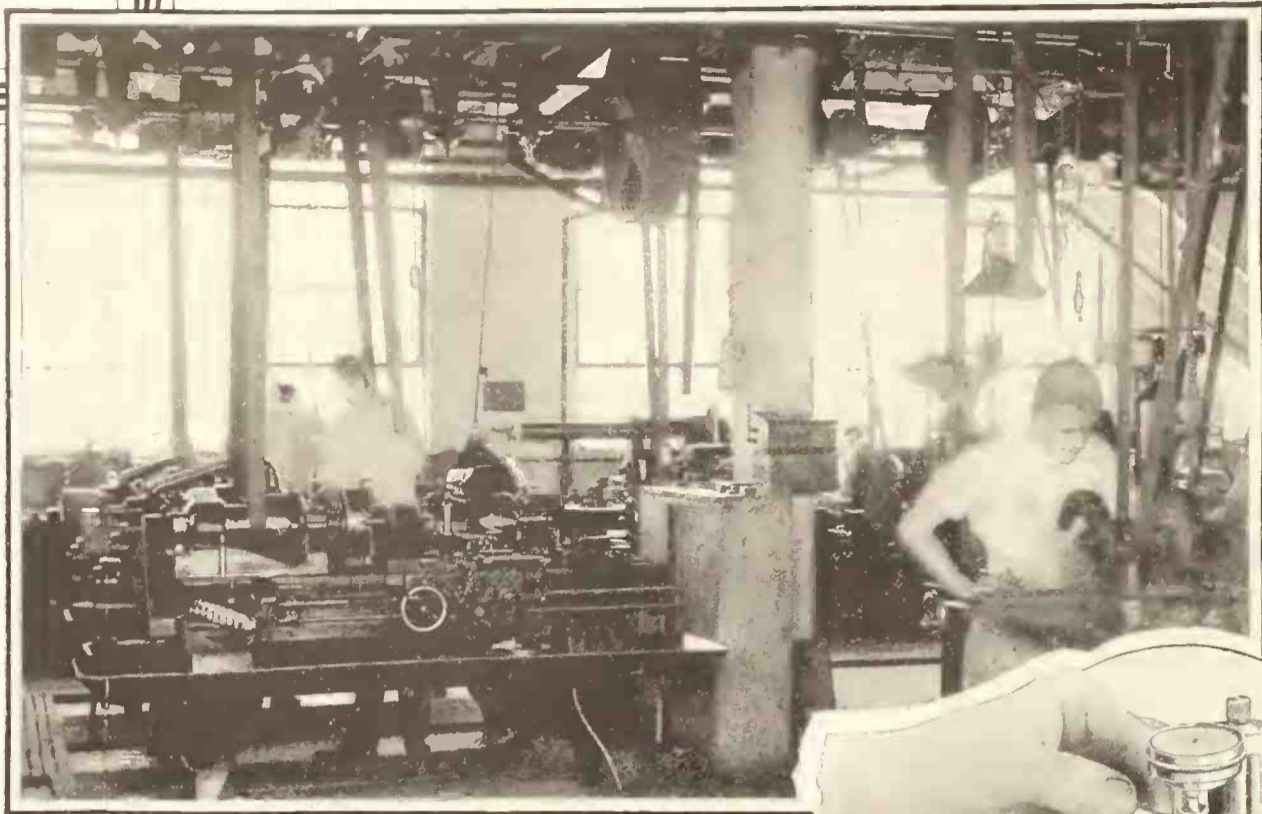

*"Genius is but the
infinite capacity
for taking pains"*

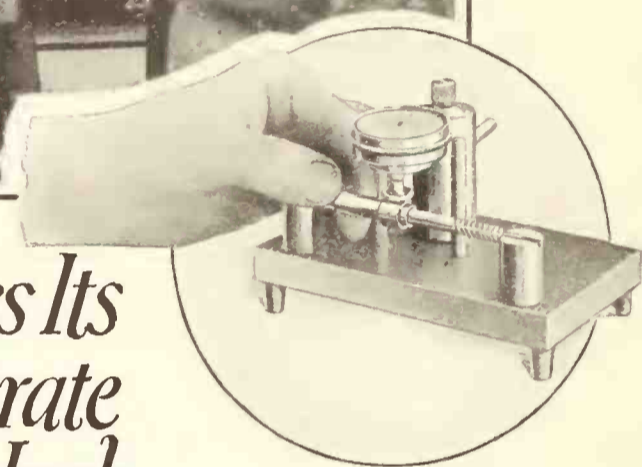

Where Cheney Makes Its Own Gauges Accurate within .0005 of an Inch

This is part of the tool room in the Cheney metal plant—where Cheney experts make many of the gauges used in The Cheney.

In other advertisements we have told you how practically every part of The Cheney mechanism is required to be perfect within the limits of $2/10,000$ ths to $4/10,000$ ths of an inch. Cheney gauges with which these most exacting tests are made must be more perfect yet—perfect within $5/10,000$ ths of an inch.

How can we tell you what that means? Possibly by saying that an average human hair is $4/1000$ ths of an inch in diameter, and that the utmost limit of variation permitted in the manufacture of Cheney gauges is only $1/8$ th of that. Think of it— $1/8$ th of the diameter of a hair!

Only such precision and such care could build for The Cheney its reputation as the "Master Instrument."

THE CHENEY TALKING MACHINE COMPANY · CHICAGO

The dial gauge illustrated above is only one of scores of special testing devices originating in The Cheney factories. The sensitive finger of the dial will point out a variation as small as $1/10,000$ th of an inch, a variation so minute that it is microscopic.

It is with such devices, made perfect under the trained eyes of its own experts, that Cheney is able to maintain its own high standards of quality of manufacture for its instrument.

Regular Cheney models sell from \$115 to \$325. Cheney console art models are priced as low as \$250.



The CHENEY

THE MASTER INSTRUMENT

Four-Minute Conference on Business Topics

No. 4—Your Reputation

[This is the fourth of a series of four-minute conferences on topics of direct interest to business men in the talking machine trade which have been prepared for this publication by Lester G. Herbert.—EDITOR.]

Business reputation is quite as important as personal reputation. In fact, it is difficult to separate one from the other. But oftentimes a business principal with an excellent record will be surprised to learn that curious rumors are afloat which may be true, and he has supposed that he has kept the facts to himself. Or the rumors may be entirely false and intensely annoying.

As a rule, the cause of such reports can be traced to too much talking. Someone has been too ready to give information. The business principal himself can be genial, straightforward and a good mixer, without giving away facts which concern himself and his own affairs only.

There will be plenty of people ready to pump him for no reason at all save to gratify curiosity and to have something to peddle about, and there will be others who will be anxious to get business tips in order to determine just where competition will hit the hardest. The old maxim, "A wise head keeps a close mouth," applies here.

A recent case came to notice where a business man boasted of having been able to buy a lot of goods at a price so low that it enabled him to make a 200 per cent profit. The story became current and much was made of it, and a general impression prevailed that this man's prices were exorbitant on all of the goods and service

which he offered. It cost him a lot of patronage and much advantage which it had cost him years to win.

Then employes are often thoughtless in the details which they impart. Many people make a point of placing workers in any and every capacity in order to discover something of a startling nature. All employes having records to handle should be impressed with the responsibility laid upon them by reasonable loyalty, and records containing details should be properly cared for and not left lying about for everyone to read and perhaps misinterpret.

Our war experience proved to us that it is even possible for spies to dwell deliberately in our midst and to gain our confidence. It is not desirable to be suspicious of everyone, nor to give ourselves unnecessary worry. Nevertheless freedom from worry is purchased by sound business methods and wise discretion which insure safety and do not make public affairs which are justly of a private nature.

A business man who had been disappointed in moneys which he had expected to receive and who had been called upon to pay out more than he had planned to do on a certain day drew his bank account down to \$11. This gave him no anxiety, however, as he was amply prepared to protect himself by deposits from various other sources. Knowing, however, that he was to have a substantial sum of money paid to him

that day he hesitated to disturb any other matters. The money came in and the deposit was made and everything was tidied over without trouble.

But in the meantime an employe had seen that record, "Balance, \$11.47," and forthwith a rumor was sent flying abroad that the firm was on the edge of bankruptcy. Much embarrassment resulted, and not a few creditors pressed their claims insistently. The business man learned his lesson, but at no small expense.

Your business reputation takes a long time to build up. It can be torn down in short order. It pays to be careful!

WISCONSIN VICTOR DEALERS MEET

Eastern Wisconsin Victor Dealers' Association Holds Second Meeting—J. A. Sandee Elected Chairman of Next Meeting

APPLETON, Wis., August 2.—The second monthly meeting of the Eastern Wisconsin Victor Dealers' Association was held here recently, resulting in the election of J. A. Sandee as chairman of the third meeting of the organization, to be held in Fond du Lac this month. The local meeting was held in the Hotel Appleton and followed by a banquet. Among those who attended were: Mr. Bleck, Sheboygan; J. A. Sandee, Fond du Lac; Henry Brauer and O. A. Look, Kaukauna; Henry Christen, Manitowoc; Thomas Dowring and Mr. Zobrowsky, De Pere; Otto Schopen, Milwaukee; D. M. Grioux, Green Bay; Ralph Wilson, Oshkosh. There was quite a profitable exchange of ideas.

NEW OKEH RADIO RECORDS

Interesting Records Featuring Radio Code Now Ready for Trade—Okeh Jobbers Enthusiastic as to Their Value

The General Phonograph Corp., New York, manufacturer of Okeh records, has just released two new records for the purpose of furthering the interest of radio enthusiasts in the radio code. These records are known as radio code lessons number one and two on Okeh record 4633 and lessons number three and four on Okeh record 4634. The first record is a complete explanation and instruction in a new method of learning the radio code, which it is stated will enable radio fans to learn the code in one-tenth of the time usually required.

These very interesting records were made for the Okeh library by Jack Binns, the famous COD wireless operator of the S.S. "Republic" and radio editor of the New York Tribune. The short-cut system for learning the code, which is featured by Okeh, was presented by J. C. H. Macbeth, code expert and author of the Marconi code.

The General Phonograph Corp. is planning a vigorous sales campaign in behalf of these two records and a feature of this campaign is the publication of an instruction book, which accompanies the records and forms a complete outfit. The book is a detailed explanation regarding the new system on which the records are based and is also written by Mr. Macbeth. The complete outfit of two records and the book retails for \$2.00 or may be sold separately by Okeh dealers at 75 cents each for the record and 50 cents per copy for the book. Okeh jobbers have evinced keen interest in these radio records and the Moore-Bird Co., of Denver, Colo., wrote the following interesting letter to J. A. Sieber, advertising manager of the company:

"You have 'hit the ceiling' again with your two new radio records and we are anxiously waiting to receive our samples, together with the sample of the book. This thing is so simple that it is hard to understand why it has not been done before, but it is only another tribute to the efficiency of the Okeh organization in being the first with new, fast-selling merchandise."

The Pierian Phonograph Mfg. Co., of Goshen, Ind., has filed a decree of dissolution.

Cash in on the Wireless Demand

Our specially equipped Cabinets, with horn and all apparatus out of the way, sell themselves. Also in stock as complete Phonographs or Cabinets for assemblers. Write for Prices



Seaburg Mfg. Co.
Jamestown, N. Y.

The Biggest Value on the Market. A Trial Order Will Convince

No. 250T, List Price \$195.00
Usual discounts to dealers
48"x28"x31" high. Finished all
around
Genuine Mahogany, Walnut or Oak

VOCALION PHONOGRAPHS

THE VOCALION LINE

Combines High Grade Distinction with the
Best Merchandising Value in the Trade



Style No. 550



Style No. 1623



Style No. 1627



Style No. 720



Style No. 1624



The Graduola

The great Tone-controlling device —
obtainable only on The Vocalion



Style No. 1593

The
NEW YORK

A E O L

CINCINNATI

VOCALION

RED RECORDS

Plavable on All Phonographs

THE DISTRIBUTORS OF
THE VOCALION AND VOCALION RECORDS

- MUSICAL PRODUCTS DIS. CO.,
37 E. 18th St., New York City
- A. C. ERISMAN CO., 174 Tremont St., Boston, Mass.
Vocalion Record Distributors
- WOODSIDE VOCALION CO., 154 High St., Portland, Me.
- LINCOLN BUSINESS BUREAU,
1011 Race St., Philadelphia, Pa.
- GIBSON SNOW CO., 306 West Willow St., Syracuse, N. Y.
Vocalion Record Distributors
- CLARK MUSICAL SALES CO.,
324 N. Howard St., Baltimore, Md.
- SONORA DISTR. CO., 505 Liberty Ave., Pittsburgh, Pa.
Vocalion Record Distributors
- PENN-VOCALION CO., 16 W. King St., Lancaster, Pa.
- O. J. DE MOLL & CO., 12th and G Sts., Washington, D. C.
- VOCALION CO. of OHIO,
328 W. Superior St., Cleveland, Ohio
- VOCALION CO. of OHIO, 420 W. 4th St., Cincinnati, Ohio
- LIND & MARKS CO., 530 Bates St., Detroit, Mich.
- THE AEOLIAN COMPANY,
529 S. Wabash Ave., Chicago, Ill.
- LOUISVILLE MUSIC CO., 529 S. 4th St., Louisville, Ky.
- HESSIG ELLIS DRUG CO.,
Memphis, Tenn.
Vocalion Record Distributors
- THE AEOLIAN CO., 1004 Olive St., St. Louis, Mo.
- GUEST PIANO CO., Burlington, Iowa
- D. H. HOLMES CO., New Orleans, La.
- STONE PIANO CO., Fargo, N. D.
- STONE PIANO CO., 826 Nicollet Ave., Minneapolis, Minn.
- CONSOLIDATED MUSIC CO., Salt Lake City, Utah
- COMMERCIAL ASSOCIATES,
754 N. Spring St., Los Angeles, Cal.
- THE MAGNAVOX CO., 616 Mission St., San Francisco, Cal.
Vocalion Record Distributors

*Let Us Get in Touch With You Regarding
the Complete Vocalion Line*

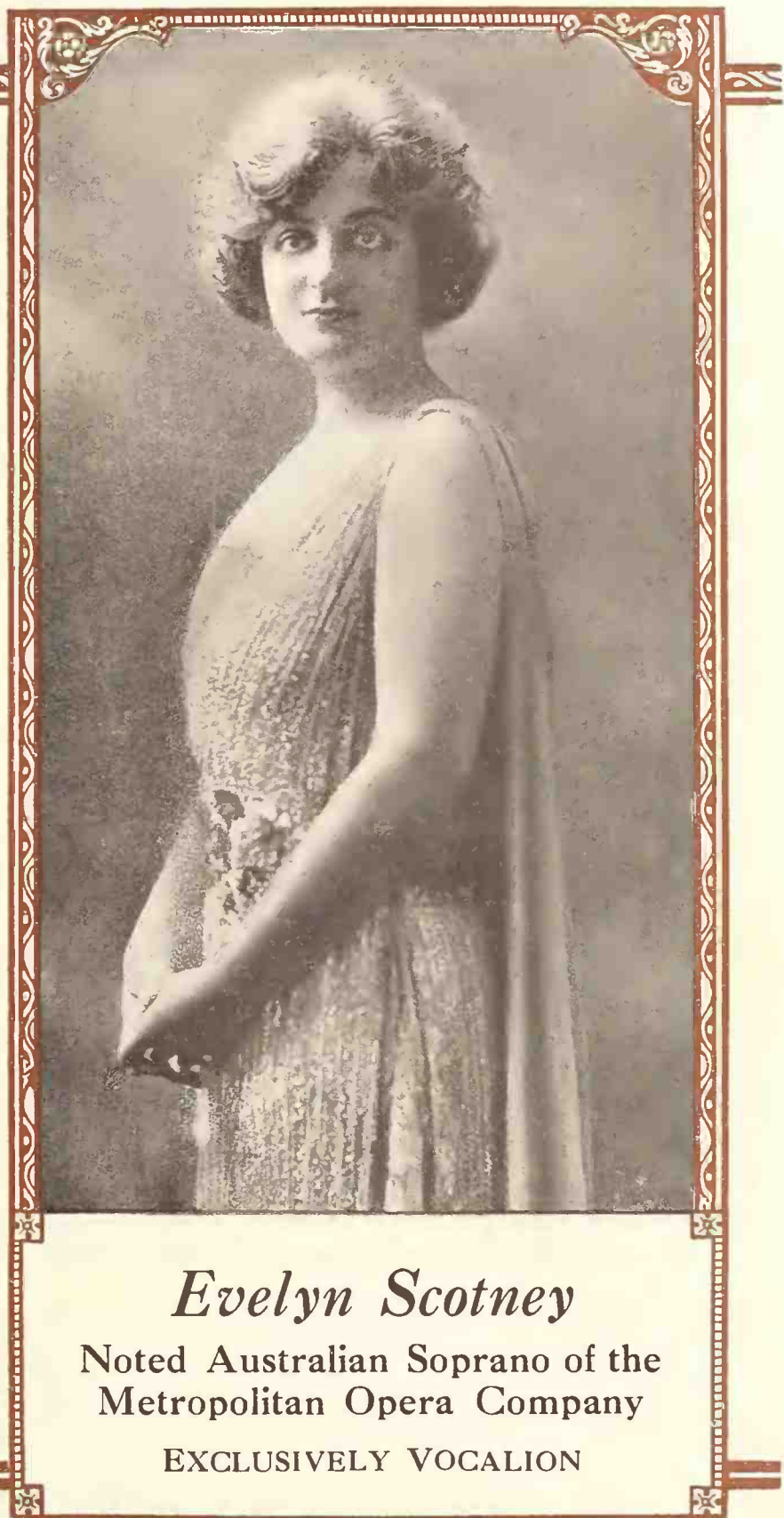

Evelyn Scotney

Noted Australian Soprano of the
Metropolitan Opera Company

EXCLUSIVELY VOCALION

I A N Company
CHICAGO ST. LOUIS BOSTON



You pick a winner when you order A-3652. This is Nora Bayes in two typical Bayesesque songs, "You've Had Your Day" and "I Ain't Never Had Nobody Crazy Over Me." Nora has a wheedling, whimsical way in these swinging melodies that makes one just have to have that record.

Columbia Graphophone Co.
NEW YORK

DETROIT

Vacationists Keep Trade Volume Up—Music Contest Helps—Dealers Adopt Aggressive Tactics

DETROIT, MICH., August 6.—The talking machine business in this city, while not as brisk as a few weeks ago, remains comparatively active. This fortunate state of affairs is attributed to the fact that the vacation season is in full swing and that many people desire to take some music with them. As a result there is a steady demand for used machines at prices ranging from \$15 upwards, depending of course upon the model and its general condition. The new portables are also finding big favor with the public and the majority of dealers say that they cannot get them fast enough. Dance records are selling briskly and there is a slightly increasing demand for the more enduring type of music.

Music Memory Contest Stimulates Trade

Dealers believe this demand is created by the Music Memory Contest, which is city-wide in its scope and is well under way with over 15,000 contestants already enrolled and more coming in, despite the lateness of the date. Many of the leading music stores, in addition to being donors of prizes, are keeping the contest well to the fore by means of weekly concerts in their various shops. Among such firms featuring these

concerts, at which themes used in the contest are played, we find the following: J. L. Hudson Co., Kimball Piano Co., Grinnell Bros., The Edison Shop, Peoples Outfitting Co., White Furniture Co., Gardner-White Co. The concerts are well attended and serve as a means of bringing in many new faces to the shops. One of the good things resulting from the contest is the bringing into prominence of much local talent of exceptional ability. Many people are buying records of the themes used, both from a desire to become more familiar with them and also because they are awakening to a better appreciation of music.

The majority of dealers here are putting forth strenuous efforts to land business and are achieving very gratifying results. Grinnell Bros. are among the leaders in aggressive sales tactics and they are doing a remarkable amount of business, all things considered. One of the members of the firm stated that, "We are working hard for the business we are getting but we are inclined to believe that anybody could do it if they wanted to."

The majority of dealers are anticipating a brisk Fall trade and are setting the stages early, so to speak. One of the dealers on Woodward avenue remarked that he had noticed a different attitude on the part of the buying public, a happier attitude, and he attributed this to the fact that the large Detroit industries are running full time and in many cases overtime. This means that there is plenty of work for everyone and also means that nearly every one has some

ready money. With the return of prosperity the need for strict economy is passing. "As soon as the people return to the city in sufficient numbers, from their vacations, I confidently expect to see my sales greatly increased. At present I am disposing of all the second-hand machines I receive and this business is not to be despised," he says.

"Vacations cost money and without money are not to be indulged in. If the people who are away on vacations did not have a source of income they would remain in town and look for work. People able to indulge in vacations are able to buy and upon their return will undoubtedly do so, if the record of the last two or three months can be regarded as any indication."

George W. Bourke, of the Kimball Piano Co., also handling the Kimball phonograph, returned the first of the month from a fishing trip to the upper peninsula of Michigan. Accompanied by friends he motored through, covering over 1,500 miles, and reports it the most successful and enjoyable trip he has ever taken. He also reports a good demand for Kimball phonographs and believes that 1922 will set a new record for his store.

FOR ALL-SEASONS' SALES

Pal Phonograph Seems to Have Won Favor With Purchasers Along These Lines

According to a recent announcement the Portable Phonograph Co., 20 West Twentieth street, manufacturer of the Pal phonograph, will include the manufacture of this instrument for all-seasons' sales. The officers of the company state that there is no reason why sales of portable machines should be confined to the Summer season. A survey of the sales possibilities in various parts of the country shows that there will be a substantial demand throughout the year.

In speaking of the position the Pal portable has taken in the trade a member of the sales organization said: "From the large volume of sales which followed the first announcement of our company it is evident that the Pal type of machine has found favor with buyers in general. Some of the excellent features of our product are the universal tone arm and sound box, special sounding board which gives a clear, strong tone, as well as the Triangle motor which we use and the album which carries twelve ten-inch records.

"We believe the design and finish, either in mahogany or walnut, or encased in a genuine cowhide box, make the Pal portable as desirable for use in the home as for outdoors."

OCCUPYING ATTRACTIVE QUARTERS

The Cantlon Piano House, of Great Falls, Mont., has moved into attractive new quarters next to the Hotel Rainbow. In addition to a complete line of pianos and musical instruments talking machines and records are handled.

VELVET COVERED TURNTABLES

ADD TO THE QUALITY OF MACHINES

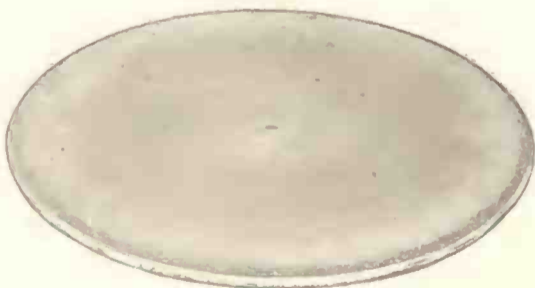

A.W.B.

Boulevard
VELVETS

THE BEST TALKING MACHINES ARE EQUIPPED WITH

A. W. B. BOULEVARD VELVETS

GRAND PRIZE—GOLD MEDAL, ST. LOUIS EXHIBITION

WRITE FOR SAMPLES AND PRICES

A. WIMPFHEIMER & BRO., Inc.
450-460 Fourth Avenue, New York

ESTABLISHED 1845

CATERING TO THE AUTOMOBILIST

Vogue of the Motor Car Offers Live Dealers an Opportunity for Sales Impossible Under Conditions Which Prevailed in Former Days

One of the most popular outdoor pastimes during the Summer and Fall in the present day is motoring. Every city, town or hamlet, no matter how isolated and distant from the congested centers of population, has a steady stream of motor cars passing through it during the entire Summer and Fall and especially on Saturdays and Sundays. Many dealers have capitalized the motor vogue through billboard advertising and other means of bringing motorists to their establishments.

One dealer recently sent out folders describing the portable type of talking machine as an adjunct to the motor trip to all persons in his territory owning motor cars and the results from this bit of publicity more than justified the expense and trouble. Another dealer is using large billboard space which is devoted to advertising of a dignified type. He, too, has realized good results on his investment.

People on the outskirts of towns and cities who own automobiles usually motor to town at least once each week to do their shopping and advertising of this character is bound to draw their attention.

ARTIST TIE-UP BOOSTS SALES

Boyer Music Co. Takes Advantage of Appearance of Isham Jones' Orchestra to Feature Brunswick Records by These Artists

ELKHART, IND., August 3.—The Boyer Music Co., 417 South Main street, this city, took advantage of the recent appearance of the Isham Jones Orchestra in Christiana Park here to boost the sale of Brunswick records by these artists. During the appearance of the orchestra the company used extensive publicity in the local newspapers, emphasizing the entertainment value of the recordings of the Isham Jones Orchestra, with the result that a substantial increase in the demand for these records was enjoyed.

BOOM HOME RECORD LIBRARIES

Phil Ravis, president of the Peerless Album Co., New York, recently stated that the increased demands for his company's product coming from various sections of the country showed a decided return towards normal conditions. "This renewed activity," he said, "coming at the Summer period leaves no doubt as to Fall activity. Every indication seemingly showed the Fall season would be quite active."

The early Fall sales campaign of the Peerless Album Co. will include a plan to increase the demand for "home record libraries." This, the company has found, increases the sales of records for the retailer as well as sells its product.

THE ESSEX CO.'S ATTRACTIVE STORE

The Essex Talking Machine Co., of Montclair, N. J., recently opened its new warerooms to the public, where a full line of Victrolas and Victor records is on display and daily demonstrated. The new home is one of the show places of New Jersey. It is an attractive, well-arranged and lighted store, the interior woodwork of which is in old English style.

BUSINESS-GETTING STATEMENT

Wm. Hengerer Co. Increases Record and Machine Sales Through Monthly Statements Sent to Customers Having Charge Accounts

BUFFALO, N. Y., August 2.—The talking machine department of the Wm. Hengerer Co., of this city, which handles the Victor line of talking machines and records, has adopted a unique and effective method of keeping this department and the line handled before the patrons of all sections of the store at all times.

The store has a clientele of customers numbering about 20,000, who have accounts, and each month statements are sent to these people. That part of the statement which the customer retains contains a cut of a console model Victrola, No. 300, together with the price of the instrument. Immediately below this an attractive arrangement of type calls attention to the company's Victrola studios.

These statements reach many people who possess talking machines and considerable record business has resulted. To those who do not own a Victrola the statement is a monthly reminder that the store which they patronize can serve them in this respect.

STUDENTS SEE "MOVIE" OF VOICE

Interesting Apparatus and Mirrors Used in Transferring Voice to Screen

The Columbia Summer school students were shown motion pictures of the human voice in the Horace Mann Auditorium, in New York City, last week. For three hours the students, most of them teachers from other States, witnessed demonstrations of recent advances in wireless telephony by leading engineers.

A projecting machine, the stereopticon-oscillograph, was used and the demonstration accomplished by transferring the voice waves as they were transmitted by Mr. Mills electrically over a telephone circuit to the light by means of delicately balanced mirrors. These light beams were then projected upon a motion picture screen, appearing in the form of waves and varying in intensity, amplitude and character as the voice of the speaker varied in vowel and consonant sounds.

By means of the oscillograph it is possible to determine the relative audibility of various words and expressions. The vowel "o," it was pointed out, is the easiest human sound to understand, as illustrated by the word Chicago, the final vowel of which produced on the screen a marked broadening of the light in contrast with the weaker effects of the other letters.

A feature of the demonstration was the use of college yells, "Harvard," with its broad vowel sounds, leading in magnitude of light impressions. Yale, Columbia, Chicago and other university yells were shown on the screen, where the sound impression made by Yale was noticeably weak.

D. C. STEEL SECURES COLUMBIA

McPHERSON, KAN., August 3.—The Upshaw Furniture Co., of this city, has sold its agency for Columbia Grafonolas and records, including its entire stock of Columbia products, to D. C. Steel, who recently opened the City News & Music Shop on South Main street. The establishment is well equipped.



POPULAR ITALIAN RECORDS LATEST RELEASES

10 Inch Records \$.75 Each

- 1007 Pulcinella Ad Una Festa Da Ballo. Scena Comica. Un Balbuziente in Tribunale. Scena Comica.
- 0991x L'Altalena. Song.....Cav. G. Godono
- E L'Ammore. Song....Cav. G. Godono
- 1000 'O Guarracino. Part 1. Song. P. Mazzone
- 'O Guarracino. Part 2. Song. P. Mazzone
- 0957x Luntano 'A Te, Mari'. Song. Cav. G. Godono
- L'Acquaiola. Song....Cav. D. Giannini
- 0997x Serenatona. Song.....R. Ciaramella
- Vipera. Song.....Jole Baroni
- 0955x Tic-Ti-Tic-Ta. Song.....R. Ciaramella
- Piererotta. Song.....R. Ciaramella
- 0993x Venerdi'. Song.....F. Rondinella
- 'E Ssignurine D' 'O Palazzo. Song. R. Ciaramella
- 0989x Mia Dolce Amica...Cav. Uff. G. Godono
- Voce D'Amor.....Cav. Uff. G. Godono
- 0995x Totonno 'E Quagliarella.....Ciaramella
- Niru TeLangella
- 1001x Signora Mia (Duetto), Donnarumma-Ciaramella
- 'A Cura 'E Mamma' (Duetto), Donnarumma-Ciaramella
- 1003x Canzone AmericanaDonnarumma
- Donna Fifi'Ciaramella
- 1005x Mo Esce Achille. Scena Comica. Il Cavamacchie. Scena Comica.
- 1019x Momenti Gioiosi. Orchestra. Al Bosforo. Polka.
- 1021x Carmen (Selection). Bells. Nozze D'Oro. March.
- 1033x Abat—Jour (Salomè), Ciaramella-Rondinella
- Ninnolo....Cav. Uff. G. Godono, Tenore

We Are Also Manufacturers & Distributors of Italian Popular Music Rolls
New Hits Released the 15th of Each Month

JUST OUT

- 209—'O Viaggio 'E Nozze. Versi e Musica di M. Nicolò. (Word Roll).....\$1.25
- 181—Legenda Di Guerra. Versi di A. Giuliani. Musica di G. Bonavolontà. (Word Roll) 1.25
- 192—La Figlia Della Strada. Versi di A. Giuliani. Musica di A. Granozio. (Word Roll) 1.25
- 054—Lassanno Napule. Versi e Musica di F. Pennino. (Word Roll)..... 1.25
- 227—Se-Malia-E. Mancini. F. P. Tosti. (Word Roll) 1.25
- 228—Non E' Ver. Romanza di F. P. Tosti. (Word Roll) 1.00
- 212—In Viaggio. Polka di D. Ietti..... .90
- 057—L'Incantevole. Mazurka by J. Gioè.. .90
- 051—Napule, Addio! Versi di R. Cacace. Musica di D. Ietti. (Word Roll) 1.25

ITALIAN BOOK CO.

Music Dep't
145-47 Mulberry St.
New York City
DISCOUNT TO DEALERS—ASK FOR CATALOGUES



PHONOGRAPH CASES RADIO CASES

Reinforced 3-ply Veneer

The Standard Case for Talking Machines and Radio Sets

Let us figure on your requirements

MADE BY PLYWOOD CORPORATION, Goldsboro, N. C.
Mills in Va., N. C. and S. C.

THE PHONOGRAPH AN ONLY SURVIVOR

Filmer "Nanook of the North" Tells This Story—Eskimo Carried It 312 Miles—After Years of Adventure It Is Now Out of Tune

Anyone who has ever been lulled into sleep, or out of it, by the dulcet melodies of one of these faithful, dependable household pets will find that all his sympathetic chords will respond to this tale of the plain, ordinary little talking machine that ventured into the frozen North. It is a tale of the pluck, heroism and courage under circumstances which would have made even a \$3-a-record grand opera tenor quail, of one small phonograph which at the present moment is probably doing its humble, unassuming bit to make life more endurable for some rugged factor, some candle-fed Eskimo or some dashing Northwest mounted cop in the great open spaces up there in the Hudson Bay country.

The tale comes from Robert J. Flaherty, F. R. G. S., who has been in the colder North off and on for the better part of the past decade, and

was written for the New York Sun. He just returned after spending two years filming a picture of Eskimo home life, which he called "Nanook of the North," and which, as everyone knows, New York has had opportunity to see at a Broadway theatre.

And if the story of this plucky little phonograph doesn't remove the prejudice of every flat-dweller, then the writer is no Eskimo.

On one of his trips to the North Mr. Flaherty, who is a mining engineer by profession, experienced more than the ordinary difficulty. In fact, the good ten-ton schooner "Laddie," which had carried the party to Belcher Island, in Hudson Bay, had to be chopped up for kindling wood. All had to be chopped up save honor, the food and the instruments and papers.

There was a talking machine present. This would have gone to the axe, too, except that something about it that was appealing restrained the hand of the executioner at the last minute.

"I can't do it," he said, probably with a frozen tear just outside his eye.

It was at that moment that Wetalltak, Mr.

Flaherty's expert hunter and sledgeman—Eskimo, of course—came up and said, "Woodman, spare that phonograph," or words to that effect. The result was that Mr. Flaherty on leaving for the trip down James Bay gave Wetalltak the phonograph to have and to hold and to do with what he willed, until death did them part. Mr. Flaherty and his party went out into the snow and thought no more of the donated phonograph.

With the characteristic thrift of the Eskimo, Wetalltak saw a chance to make some money. He did not want the phonograph, because he had tired of music. Besides, it was October and night was coming on and he knew that if he played the phonograph very much the neighbors would complain sooner or later, by March at the latest.

He decided to take the phonograph to Mavor, the factor at Great Whale River, 125 miles away. Mavor, Wetalltak knew, would give him a skin or two for it. That is, he knew Mavor would do the right thing; he would skin him and yet he wouldn't.

Wetalltak later told of that trip with the phonograph. It was across "rafted," that is, rough ice. Wetalltak stood it all right because he used to be an iceman. But the phonograph was a product of civilization. In the States it had been handled by expressmen and wound by children, but it never had had a time like this.

Many times it weakened and would fain have given up, but Wetalltak, the sturdy, was always there to wind it up and hearten it. For days it was without needles until Wetalltak finally took the needle from his compass and gave it to the phonograph.

At last the 125 miles across the rough ice were accomplished and they reached the trading post at Great Whale River. Even Wetalltak was all in and the phonograph—you should have seen it. Then they told Wetalltak that Mavor, the factor, had been transferred to Fort George, 187 miles further on down James Bay.

There is no use going into details. Wetalltak made the trip. He was so mad that he just made the trip anyhow to spite Mavor for being transferred. And he got the phonograph to Fort George!

But when Mr. Flaherty returned to that country on his latest trip to take the Nanook pictures he came across his friend Mavor, who said to him:

"Say, Wetalltak brought me down an old phonograph of yours two or three nights ago—I think it was about 1917—and I wisht you'd take a look at it. IT'S OUT OF TUNE! ! ! !"

DOUBLES 1921 SALES TOTALS

CLEVELAND, O., August 5.—In a recent chat with The World, W. J. McNamara, president of the Empire Phono Parts Co., of this city, stated that the company's orders for tone arms, sound boxes and attachments during the past few months had been far beyond expectations. In fact, the sales totals for June and July were double those of the corresponding period of last year and Mr. McNamara believes that the talking machine industry is going to enjoy a healthy trade this Fall.

DUTY ON RECORDS IN FIJI

According to a decision of the Commissioners of Customs of Fiji, states the Board of Trade Journal, London, Eng., gramophone records are to be classified for customs purposes under tariff item, "Goods not specified," the rates of import duty being 27½ per cent ad valorem for the General Tariff and 15 per cent ad valorem for the Preferential Tariff, which applies to all goods produced in the British Empire. Ad valorem duties are based on the invoice value of the goods, plus 10 per cent to cover insurance and freight.

The Mamaroneck Music House was recently opened at 82 Mamaroneck avenue, Mamaroneck, N. Y. Included in the stock handled by this concern are Victor and Columbia talking machines, records, sheet music and music rolls.

Genuine Manhattan Radio Telephone Headsets are identified by the M-Seal-Flash on the back of each receiver case.



It is a mark that stands for high quality and dependability—a protection for dealers and consumers.



63,548 Headsets!

Outstanding Features of the New Manhattan Radio Telephone Headsets

- Extreme Sensitivity
- Amplifying Qualities
- Freedom from Distortion
- Sanitary Head Band with friction grip adjustment
- No Hair Catching Obstructions
- Concealed Cord Tips
- Polarity Indicating Cords
- Matched Receivers

For the four weeks ending July 1st—this was the production AND SALES of the new Manhattan Radio Telephone Headsets. Since the first new Manhattan Radio Headset was produced on March 20th—over 130,000 have been manufactured and SOLD.

Only by producing the highest grade of headset—a headset built with the precision of a watch—a headset designed to STAY on the market—could such an achievement be accomplished.

The materials that enter into the manufacture of Manhattan Radio Telephone Headsets are the same as used in the most expensive headsets.

Precision in manufacture, highest quality materials and most rigid tests and inspection during manufacture, are the factors that insure Manhattan Headsets a position of leadership and permanency in the market.

Get ready for the big fall and winter business—place your order with your jobber for Manhattan Headsets NOW.



Makers of the famous Red Seal Dry Batteries

NEW YORK ST. LOUIS
CHICAGO SAN FRANCISCO

Each Manhattan Headset is individually boxed in the distinctive Manhattan carton and is identified by the M-Seal-Flash insignia.



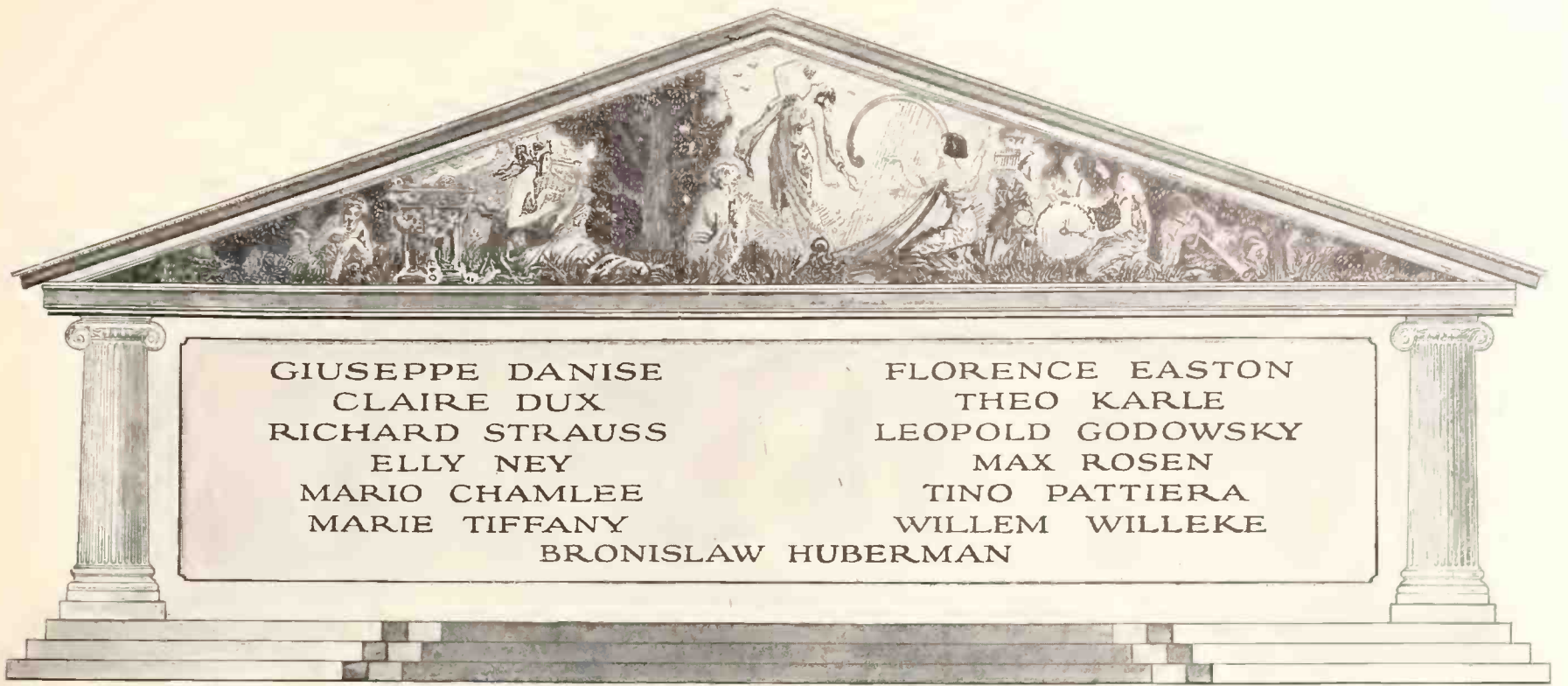

The NEW HALL OF FAME

OPERATIC and CONCERT



FLORENCE EASTON
 Prima Donna Soprano
 Metropolitan Opera Co.
 as Fiordiligi in "Cosi Fan Tutte"

THESE great artists, whose names are on the lips of musical critics the world over, have confined their artistic achievements exclusively to Brunswick Records, as the most fitting medium to perpetuate their art and to safeguard their fame.

THE BRUNSWICK-BALKE-COLENDER CO.
 Established 1845
 CHICAGO NEW YORK CINCINNATI TORONTO



CLAIRE DUX
 Soprano
 Chicago Opera Co.
 as Mimi in "La Boheme"



GIUSEPPE DANISE
 Premier Baritone
 Metropolitan Opera Co.
 as Scarpia in "Tosca"



MARIO CHAMLEE
 Tenor
 Metropolitan Opera Co.
 as Cavaradossi in "Tosca"



ELLY NEY
 Pianiste
 "The Woman Paderewski"

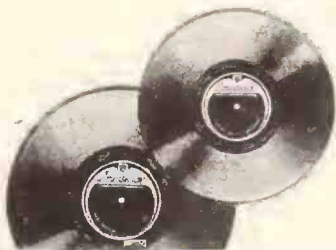

THEO KARLE
 Foremost in ranks
 of American tenors



BRUNSWICK
 PHONOGRAPHS AND RECORDS

Percy Grainger, at the piano, playing Grieg's "Norwegian Bridal Procession," then pausing a moment and playing Liszt's "Liebestraum." That is the musical treat Columbia has prepared in Symphony Record A-6217. The pause comes when one turns the record over.

**Columbia Graphophone Co.
NEW YORK**



CONFERENCE OF VICTOR TRAVELERS

Representatives of Victor Talking Machine Co. Come From All Parts of Country to Attend Annual Conclave in Camden

CAMDEN, N. J., August 5.—The annual conference of members of the traveling department of the Victor Talking Machine Co. was held at the company's plant in this city recently. Victor traveling men from all parts of the country were present at the conclave, which lasted the greater part of a week, and problems confronting them were discussed and analyzed.

Frank K. Dolbeer, manager of the traveling department, welcomed the representatives at the opening of the meeting, following which attention was given to the consideration of the problems of the department. The usual custom of executives and officials of the company to address the travelers at the annual conferences concerning the work of their respective departments was followed out this year and both the inside and outside staff of the traveling department were given an insight into the ramifications of the promotional and development work carried on by the company. Practically a whole day was devoted by the men to the exchange of ideas which have been found effective in sales promotion in various sections of the country.

The business discussions at the conference ended with a luncheon and sports. Tennis enthusiasts among the travelers repaired to the courts of the Overbrook Country Club, where several hotly contested matches were played. The remainder of the men engaged in a golf tournament on the links of the Bala Country Club, the result of which was the acquisition of a handsome handbag as first prize by James A. Frye, the Boston representative.

In the evening the travelers departed for their respective territories as follows: R. A. Bartley, eastern Pennsylvania; B. F. Bibighaus, New York City; R. S. Cron, Chicago; W. T. Davis, Maryland, Virginia and West Virginia; R. A. Drake, eastern New York, Vermont and New Hampshire; F. C. Erdman, eastern Ohio; J. A. Frye, Massachusetts and Maine; W. G. Gaston, Michigan; R. P. Hamilton, California and Nevada; R. C. Hopkins, northern New Jersey and eastern Pennsylvania; T. L. Husselton, Missouri; E. W. Killgore, Connecticut; A. H. Levy, Brooklyn and Long Island; E. J. F. Marx, western Pennsylvania and West Virginia; A. C. Mayer, western Ohio and Indiana; L. S. Morgan, Wisconsin; K. B. Owen, Texas; D. S. Pruitt, North and South Carolina, Georgia and Florida; G. L. Richardson, Iowa and Nebraska, and P. W. Willis, western New York.

The Music Shoppe, Casper, Wyo., recently celebrated the formal opening of its fine new exclusive Victor store. The new quarters are modernly equipped, all the booths and counters being finished in French gray.

L. A. Peck has opened a new talking machine store in Hay Springs, Neb., handling the Victor line.

MEASURING MUSICAL TALENT

Scientific Methods Now Being Used in Educational Centers Are Most Interesting

Modestly but earnestly there have been in progress at a few educational centers of this country during recent years most interesting efforts to develop a scientific method of musical education. The method is based largely on psychology, and various instruments have been devised not only for making tests of nerve reactions but also for measuring musical talent and classifying it.

Apart from the psychological element, an instrument for visibly registering tonal vibrations, known as a tonoscope, has been under development for some twenty years, though it is only within the last few years that it has been practically applied. This instrument indicates the exact number of vibrations a second of any tone tested by it, and as, of course, the number of vibrations of all tones is known the instrument determines whether the pitch is correct. It consists of a perfectly balanced drum that rotates horizontally, making exactly one revolution a second. The white face of the drum is covered with black dots arranged in rows, which, in connection with a scale, enable the operator to read the number of vibrations a second made by a small gas flame in front of the drum, which is caused to vibrate in accordance with the tone of a voice or instrument conducted to it through a speaking tube.

Other instruments have also been developed for making various tests to determine the natural aptitude and musical talent of students, says Popular Mechanics. Many of these are now being practically applied at the public schools in Evanston. Among them are instruments for measuring nerve reactions to discover the degree of susceptibility to pitch of sound, others for testing precision, and still others for testing free and controlled rhythm.

THE IDEAL SONG SHOP OPENS

WAKEFIELD, MASS., August 5.—The Ideal Song Shop is the name of the latest addition to the music stores here. A complete stock of talking machines and Edison records is handled. In addition pianos, sheet music and small musical instruments are handled.

NEW BUILDING FOR ORSENGO CO.

Demand for Period Styles Made by This Company So Great That Manufacturing Facilities Have to Be Expanded—Looks for Busy Fall

The Orsenigo Co., manufacturer of high-grade period model talking machines, of Long Island City, N. Y., is firmly establishing itself with the talking machine trade throughout the entire country. The Orsenigo period phonograph is being presented to the trade in several artistic designs, and dealers have shown such interest in these models that all indications point to a very healthy demand for the Fall and Winter trade.

T. Davies, general manager of the company, stated that the plant had been so rushed for the past seven months that it has been found necessary to find additional floor space to take care of the increased business which the company is receiving. Consequently the company purchased a large lot adjoining the present plant, on which a new building is being erected, modern in every respect, which will supply additional floor space of more than 100,000 square feet. This new addition is being rushed to completion and it is expected that equipment will be installed in this new plant and that it will be running in full swing by September. This addition will enable the company to take care of its increased business in a very efficient manner. The new plant will be devoted almost exclusively to the manufacture of the period phonographs, of which there are now twenty-five models. With increased facilities orders can be taken care of promptly and the company will be placed in a position to provide for the future growth of the business.

SELLS SONORAS TO SCHOOLS

LANSING, MICH., August 4.—E. E. Cummings, of the Michigan Sonora Shop, of this city, recently sold fifteen Sonora "Etudes" to the Lansing Board of Education. Mr. Cummings is naturally delighted with the closing of this sale, for there was keen competition over this order.

The Gaskill Music Co., Nebraska City, Neb., has moved the Victor talking machine department to the front part of the store and added two Unico booths, a service counter and a large record rack.



The "VICSONIA" REPRODUCER

For Perfect interpretation of Edison Disc Records on Victrolas and Grafonolas.

Fitted with permanent jewel point. No loose parts.

Meet the demand—Serve your customers

Sample Model "A" or "B" Vicsonia, nickel plated, will be sent on receipt of \$4.50. Retail price \$7.50.

Note: Model "B" Vicsonia plays both Edison and Pathé records.

VICSONIA MFG. CO., Inc.

313 E. 134th STREET

NEW YORK, N. Y.



The New EDISON
Baby Console

(See page facing this)

The New EDISON Baby Console \$175.00

THIS newest addition to a famous group of consoles completes a line that contains a model for almost every prospective purchaser of a quality instrument.

The conservative design of the Baby Console assures a widespread demand for it as a unit of household furnishing, while the best indication of its mechanical fitness is the fact that it incorporates the best features of Mr. Edison's latest laboratory experiment.



THOMAS A. EDISON, Inc.
Orange, New Jersey

HOT LIPS

The New "Wang Wang Blues"
by the same Writer.

"You can't go wrong
With any FEIST song"

HEAR IT NOW!

He's got hot lips — When he plays Jazz, — He draws out steps, —

NATIONAL SALES CODE FOR USE IN HARDWOOD FIELD

Trade Members, Representing the Music Industries Chamber of Commerce, Endorse Recently Adopted Code of Procedure Intended to Simplify Transactions and Prevent Trade Disputes

Conditions surrounding the sale and purchase of hardwood lumber, which constitute a matter of vital importance to the members of the music industry, have been the subject of a recent conference of the National Hardwood Lumber Association, as the result of which a "National Sales Code" was adopted for the purpose of establishing uniform practices in lumber transactions and providing practical and responsive means for the settlement of disputes between buyers and sellers.

This code, which is the outcome of several years' preliminary work by the Lumber Association, establishes definite rules governing quotations, orders, acceptances and cancellations, stipulates the terms of settlement of accounts growing out of transactions under the code and provides for the inspection of lumber upon receipt by the purchaser when desired. The matter has been under discussion for some months past, with the Music Industries Chamber of Commerce as the representative of wood consumers in the music field, and a committee has been appointed by the Chamber to study the subject, consisting of: Thure A. Johanson, of the Cable Company; Howard C. Darnell, of the Victor Talking Ma-

chine Co.; Percy A. Deutsch, of the Brunswick-Balke-Collender Co.; A. G. Gulbransen, of Gulbransen-Dickinson Co., and Warren Thayer, of the Thayer Action Co. The conference recently held in Chicago was attended in person by Messrs. Johanson, Darnell and Gulbransen.

An important feature of the code is the provision for arbitration of disputes arising between buyers and sellers of lumber. In case of such a dispute involving a member of the Music Industries Chamber of Commerce, the arbitrators would consist of the secretary of the National Hardwood Lumber Association and the secretary of the Chamber, who, in case of their failure to arrive at an agreement, would select a third arbitrator, the decision of a majority of the arbitrators to be binding on the disputants.

In expressing his approval of the National Sales Code Mr. Johanson, chairman of the committee appointed by the Music Industries Chamber of Commerce, said:

"The committee is of the opinion that this revised code is quite fair to manufacturers, jobbers and consumers. It would seem as if this initial step in the standardization of selling and buying lumber as designated in this code is a good move

forward and we hope similar steps will soon be taken to clarify and simplify the grading, marking, etc., of lumber.

"Secretary Hoover's representative made quite a brilliant talk on this subject, pointing to this lack of standards as one of the weak points in the business and suggesting methods for remedying the same. Along this subject of standardization it might be a good thing to spend some thought on standardizing our own lines of trade.

"The committee also heard discussed other subjects pertaining to the lumber industry, all of which were of interest to the trade and its relations, and the energetic, businesslike method in which these discussions were conducted was a pleasure to behold.

"While the reported output of lumber is greater than the consumption, which would seem favorable to the consumer, yet it seems that prices of lumber in many instances have increased, while the grading of the stock has correspondingly lowered. The business outlook of the lumber industry seems to be favorable and both manufacturers and jobbers are quite optimistic as regards the future."

COLUMBIA ARTIST IN BUFFALO

Famous Hungarian Violinist Receives Ovation During Recent Vaudeville Engagement

BUFFALO, N. Y., July 31.—Duci di Kerekjarto, the famous Hungarian violinist and exclusive Columbia artist, appeared in this city recently at Shea's Vaudeville Theatre, where he received an ovation from Buffalo's music lovers and theatre patrons. During the week he was here Kerekjarto and M. H. Batz, city representative of the Buffalo branch, visited Columbia dealers, who were co-operating with this artist's appearance in Buffalo through the use of attractive window displays. While Kerekjarto was not the programmed star act at Shea's Theatre, he scored a hit that easily overshadowed all of the other acts on the bill. Incidentally, his visit to Buffalo stimulated materially the demand for his records.

Silvestre Teixeira, a talking machine and bicycle merchant of New Bedford, Mass., was recently declared bankrupt and H. A. Luder was appointed trustee by the court.

The agency for the Victor line of talking machines and records, formerly held by the Hofstetter Drug Store, of Warsaw, N. Y., has been taken over by the Ballantine Hardware Co.

EIGHT FAMOUS VICTOR ARTISTS

In Concert and Entertainment
Personal Appearance of
Eight Popular Victor Favorites on One Program
A live attraction for live dealers and jobbers
Bookings now for season 1922-1923
Sample program and particulars upon request
P. W. SIMON, Manager
1658 Broadway New York City

HENRY BURR
ALBERT CAMPBELL
JOHN MEYERS
FRANK CROXTON
MONROE SILVER
BILLY MURRAY
FRED VAN EPS
FRANK BANTA

Famous Ensembles including
Campbell & Burr - Sterling Trio - Peerless Quartet

REGAL
PREDOMINATES
IN THE
50¢ RECORD FIELD

JAPANESE LIKE EFREM ZIMBALIST

Famous Violinist and Victor Artist Plays for Music Lovers of Nippon

Efrem Zimbalist, the world-famous violinist and Victor artist, who has been touring the Orient, accompanied by G. Ashman, pianist, has attracted widespread attention from music lovers in Ja-



Messrs. Zimbalist and Ashman in Tokyo pan, where he recently gave a number of concerts, according to advices received by The World from the firm of Jiujiya Gakkiten, Victor dealer, one of the largest music houses in Tokyo, Japan, and an old-time subscriber of The Talking Machine World.

While in Tokyo Mr. Zimbalist visited the establishment of Jiujiya Gakkiten several times and the photograph reproduced herewith was taken in this concern's talking machine department during one of these visits. The photograph shows Mr. Zimbalist, Mr. Ashman and Miss Ai Kurata,

the pretty daughter of K. Kurata, proprietor of the establishment.

PLANS ACTIVE FALL CAMPAIGN

H. G. Neu, Manager of Regal Record Co., Tells of Impressions Gained From Recent Trip

H. G. Neu, manager of the Regal Record Co., Inc., 18 West Twentieth street, New York City, returned recently from a visit of several weeks to the trade centers of the Middle West. In speaking of his trip he said: "Dealers in some of the territory visited reported the usual falling off in Summer business. The outlook, however, was quite satisfying everywhere."

Mr. Neu made it a point to visit the merchandising managers of several of the leading department stores and he said, without exception, they all predict an unprecedented demand for records during the coming Fall.

The plans for the Fall Regal record campaign have been completed and call for much advertising material for dealers' use and other cooperative "hook-ups."

NEW LANDAY STORE IN BRIDGEPORT

BRIDGEPORT, CONN., August 5.—Landay Bros., who operate a chain of music stores in New York and surrounding cities, have leased attractive quarters at 1194 Main street, this city. The building is a four-story structure and the lease is for a period of ten years. Landay Bros. handle Victor talking machines and records and musical instruments of all kinds.

FRIEDA HEMPEL SCORES IN LONDON

Frieda Hempel, famous soprano and Edison artist, received a royal welcome from music lovers in London where she was recently heard in recital. The press was unanimous in its praise of this American favorite, and she has promised to give some extra recitals previous to returning to the United States.

SUGGESTS NEW "TALKER" MARKET

Writer in Printers' Ink Brings Out Possibility of Talking Machine Sales to Business Men for Office Use—Why Not Sell the Music Idea

The business man as a field for talking machines is suggested in a recent article appearing in Printers' Ink. The article, entitled "Couponless Advertising That Brought in 1,800 Dimes," by George H. Wicker, states, in part:

"A short time ago a salesman called to see the general manager of a large concern in the export field. As he sat waiting he heard the sound of music. It seemed to come from the general manager's office, the door of which was closed. He listened attentively and, being a music lover, was able to make out a violin rendition of the Meditation from 'Thais.' The selection was played twice over.

"Soon after the salesman got his audience, transacted his business and, when rising to leave, said:

"As I sat outside waiting I heard someone playing a violin. I'd like to know who played it and how music comes to occupy a place in your day's work, if it does."

"Thereupon the general manager pointed to a screen in one corner of his office, back of which stood a cabinet phonograph.

"That is what you heard," he said; "I've had that in my office for several months now. I get relaxation and refreshment from music. I have a habit of working too fast for my own good health. When my nerves get the best of me I quit, shut the door, turn off all telephone calls and visitors and give myself up to music for fifteen minutes. As a knitter of the raveled sleeve of care I find it better than sleep."

"Right there is a use for music that few people know about. Making a business man understand how he could use music that way would ordinarily require a longer story than it takes to induce people to buy popular dance music."

Here's an idea well worth thinking about! The field is entirely undeveloped.

WHY NOT YOU?

Wide-awake Dealers are increasing their profits thru the sales of De Luxe Needles

Before you place your next order don't fail to write us for samples and full particulars about

DE LUXE NEEDLES

DUO-TONE COMPANY, INCORPORATED

Sole Manufacturers of De Luxe Needles

ANSONIA, CONN.



Full Tone



Medium Tone

DON'T FORGET THESE FACTS
 Perfect Reproduction of Tone No Scratchy Surface Noise
 PLAYS 100-200 RECORDS

Three for 30 cents (40 cents in Canada)

COLUMBUS

Dealers Optimistic Regarding Trade Outlook for Fall—Vacations Under Way—The News

COLUMBUS, O., August 5.—A busy Fall for talking machines and records is the prediction of dealers and jobbers alike. Perry B. Whitsit, president of the Perry B. Whitsit Co., Victrola jobber, of this city, stated that the building activities now noticeable in this territory are bound to help the talking machine trade. Hundreds of houses are now going up all over the city and it is these new homes that will offer a new field for talking machines and records.

C. E. Avery, manager of the Victrola department of Stewart Bros., also looks for a busy Fall season. Having been engaged in an intensive campaign for an increase in volume of business, Mr. Avery anticipates the results of this campaign to be in evidence during the Autumn months. During the Summer months Mr. Avery put into being a plan to arouse interest in talking machines and records among people who formerly did not profess any interest at all in this line. "Two young women from our firm made house-to-house canvasses in territories in close proximity to our store. Out of 1,272 calls we secured 250 good prospects and 402 fair prospects. We have sold a number of machines as a result of this campaign and we expect to sell more in the near future. Experience has shown us that it takes about ninety days before the actual results of such a campaign can be calculated. As our campaign has only been going on for two months, it is too early to state definitely the degree of its success. At the present time, however, our sales have increased 20 per cent each week," said Mr. Avery.

Just as soon as Mr. Avery received a report of the interview which a representative of the firm had with the prospect he sent a follow-up letter. These letters brought many customers to the store.

An outstanding policy of the Stewart Bros. Furniture Co. is to have as many numbers of Victor records as have been issued by the Victor Talking Machine Co. An evidence of the completeness of this firm's stock may be had from the fact that only two customers were turned away inside of three months because records

asked for were not in stock and these particular discs could not be obtained in the city.

Visits to a number of the local talking machine firms revealed the fact that July, more than any other month, is the month of vacations. Those on vacation during July included: F. J. Connor, manager of the Victrola department of the Z. L. White Co., Victrola dealer, 106 North High street, who visited Cleveland, Cedar Point and Detroit; Mrs. Besse Bell, of the same concern, spent one month in Gloucester; Miss Vera Hammond, who visited her home in Amarilla, Tex.

Members of the C. C. Baker Co., 43 South High street, who enjoyed July vacations were: Mr. Baker, Mrs. F. Barnes, of the record department; Miss Julia La Rue, of the sheet music department, and Kenneth Pyles, of the player roll department.

Leslie I. King, manager of the music department, of the Morehouse-Martens Co., Victrola dealer, together with his family, is visiting his parents in Oakland, Md. Miss Mildred King, sister of Mr. King, accompanied them.

The Victrola department of this store took the honors in the sales contest that has just been concluded. Miss Dorothy Dawson, of the record department, headed the team that won the prize offered in this contest. Prize consists of three days' vacation with pay in addition to the regular vacation period that is granted to employes by this firm. Fifteen people constituted one team. Miss Dawson was the captain of team No. 2. At the close of the contest Miss Dawson's team was \$1,051 ahead of any other team.

In connection with the contest meetings were held frequently and salesmanship methods were emphasized to each member of the team by Miss Dawson. There were thirteen young women and two young men on this team. Each one of the 15 members received three days' vacation with pay.

Mrs. Esther Reynolds Beaver, educational director of the Perry B. Whitsit Co., is visiting relatives in San Francisco, accompanied by her mother and aunt. She visited many points of interest en route, such as the Grand Canyon and Yellowstone National Park.

Out-of-town visitors at Perry B. Whitsit Co. during the past month included: O. A. Rider, Gem Pharmacy, Nelsonville, Ohio; A. E. Sargent, Crooksville, Ohio; Henry Ackerman, Jr., Marion, Ohio, and M. L. Phillips, Mt. Gilead, Ohio.



NO. VIII

Dear Bill:

In my last letter to you I stressed the necessity of going after business during the Summer months and outlined several good plans for conducting a profitable and sales-building Summer service. Now, I want to point out the necessity of taking advantage of the waning vacation season to prepare for the Fall and holiday business. This may seem a little premature to you, but remember that I have been through the mill myself and know whereof I speak.

In a little more than two weeks the vacation season will be practically over and once again the schools and churches will reopen their doors. People who have been away during the sweltering days will be back to their homes ready to settle down for the Fall and Winter. Experience has shown me that at this time, with longings for home life and comforts at their highest, people are most susceptible to the approaches of salesmen engaged in the selling of musical instruments.

It is well to plan a definite campaign to turn this susceptibility to good account. In this connection your advertising should make the home appeal and the value of your instruments as a means of home entertainment should be put forth most strongly. You will find that this sort of publicity at this time will be most effective in bringing customers to your store.

During the Summer you undoubtedly sold a number of the portable models of talking machines to people who desired them for use in camps and other vacation places. If you have a list of these people now is the time to capitalize on it by approaching them regarding the purchase of a larger instrument.

Now, in connection with the reopening of schools and churches, there is a big field for sales. In every church there are one or more organizations of a social character which offer fine prospects of not only making a sale of a machine to the society, but to individual members as well. You will probably find that most church organizations are hampered by lack of funds and you can secure their everlasting gratitude by helping them raise the money through one or more talking machine concerts. You carry a large stock of records and it would be an easy matter for you to arrange a well-balanced concert to be given in the church. Members of the congregation would be more than willing to pay an admission fee when they were told what the money was to be used for and by doing this you would also obtain some very fine publicity for your store and the line you handle.

Schools also offer a fine field for sales. The talking machine is being used more and more as an educational medium and Boards of Education are always willing to listen to plans whereby they can make their schools more efficient. Then there are concerts at the store or in the school for the school children which, while not resulting in any immediate sales, would provide live news for the local papers and widespread publicity for your store.

These are only a few of the opportunities which await the live dealer who takes time by the forelock and beats his competitor in getting to the prospects. It is a mighty good thing to have your plans prepared beforehand, so that you can start operations at a moment's notice. Thus, if one of your competitors should suddenly start work along these lines you are in a position to start something yourself without too much loss of time. As always, your friend, Jim,

IN the Swim as usual

Regardless of the season of the year, Mickel service to the Victor dealer is complete, up-to-date and practical.

For the Summer months—Swimming time—we are equipped to offer Victor retailers timely dealer helps that are well worth careful investigation.

MICKEL BROS.
DES MOINES IOWA

JEWETT RADIOPHONOGRAPH
No. 10



(Licensed under Armstrong Regenerative Patent No. 1,113,149, Oct. 6, 1914, and under pending patent application Serial No. 807,388)

"Guaranteed—Electrically and Mechanically—The Best That Money Can Buy."

Are You An Ostrich— Or A Lion?

The Ostrich tucks his head into the sand and reasons that the Lion can't get him because he can't see the Lion.

With equal logic many a music dealer shuts his eyes to Radio, and proclaims that therefore it will never affect his business.

Ostriches, every one of them! And the fate of the Ostrich will surely be theirs, for Radio—one year old—is already the biggest and fastest money maker in the Musical Instrument field.

For distributors who are not Ostriches but Lions—merchants who know and appreciate Radio—this Company has territory, a product, and a proposition that means Profits.

Jewett Phonographs and Radiophonographs—the only actually complete line in the world—can be yours to sell if you're a Lion. The line is tested, approved and in full production. Our proposition is waiting for you.

You Lions! Let us hear you roar!

THE JEWETT RADIO and PHONOGRAPH CO.
DETROIT, MICHIGAN

The Stewart Sales Co., 18 W. Georgia St., Indianapolis, Ind.
Distributors for Indiana and Kentucky

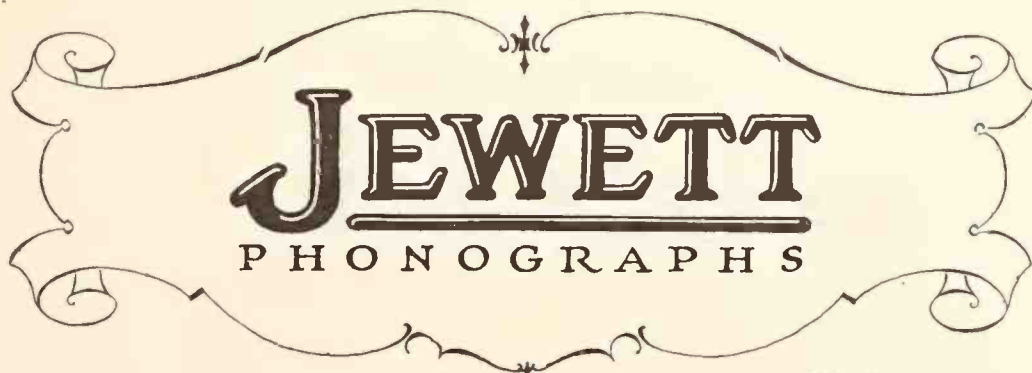

The **REGAL** 50¢ Record "Predominates" **R**

**Regal's good quality
is not "accidental"**

The artists are the same talented stars who record for other leading record companies.

The recording supervisors are *experts* who have had long experience in this very important branch of record making.

The materials are of a high quality because *good materials are necessary for a good record.*

And the pressing is perfectly done in a factory that is the third largest record producer in the world.

That comprises Regal's quality!

But add to it the service of the organization that is back of the Regal Record.

Consider the tremendous scoops that Regal has made these past few months.

Remember that Regal is invariably out with the hits *first!* And that it maintains a 24 hour delivery service to ship these hits to the dealer!

Isn't it logical that Regal is the kind of a record company you could deal with profitably and satisfactorily?

Write for exclusive dealer proposition!

REGAL RECORD CO., Inc.
20 West 20th Street NEW YORK

RECORDS OF ALL RACES AND TRIBES

German Professor Has Collection of More Than 2,000 Recordings of Songs of All Races and Tribes—Says Wicked Do Not Sing

A museum for living voices—more than 2,000 phonograph plates of prominent personages, of wild tribes and all races—has been collected by Prof. Wilhelm Doegen, of the Public Library in Berlin, Germany.

The professor believes that from this extraordinary museum he could start a movement which would solidify peace in the world, and he is now trying to arrange for contact with American and other scientists.

"Furthering the mutual understanding of the peoples as well as of scientific progress," he said, "has always been the aim of our work. For instance, the general idea about the Ghurkas is that they are a savage tribe glorifying in bloodshed. Now take this record."

The sounds of a beautiful and melancholy tune ceased.

"Can anyone imagine a tribe having such songs and being a mere set of cut-throats?" he continued.

"'Wicked people do not sing,' says the German proverb. All human tribes, as we have confirmed, possess songs, some of which are merry and harmless ones, others full of passion and love, and some, the Slavic and Oriental races principally, which seem to be distilled out of sobs and tears."

Prof. Doegen says that wherever he had given performances in Germany and abroad the press has been unanimous in affirming that a wave of practical pacifism had emanated therefrom, more effective than the speeches made by political pacifists.

ARE YOU DOING YOUR SHARE?

If the organization with which you are connected offered a star to the worker who during the month contributed the idea which helped the most to increase income or decrease unnecessary expenses, would you be the one to wear it or would it go to someone else? asks Tom Dreier in Forbes' Magazine.

Without being impertinent, we want to ask you right now how much you have done during the past month to increase the sales of your company. Have you contributed one real, original idea? Has some thought of yours made the work of your associates easier and more efficient?

If you haven't helped to increase sales what have you done to effect economy? Have you been able to suggest anything that would eliminate certain unnecessary expenses? Have you suggested any short-cuts?

Just for your own pleasure and to test your own value to yourself and to your organization, ask yourself some searching questions like these.

HAVE MONEY TO BUY "TALKERS"

Savings Deposits in Banks in the United States
Total More Than \$16,500,000,000

Savings deposits in banks in the United States total more than \$16,500,000,000, according to a survey just completed by the American Bankers' Association through its savings bank division. Leo D. Woodworth, deputy manager of the division, under whose direction the study was made, points out that the total conflicts with the estimates recently issued by a United States Government bureau, which places the total savings for the country at \$27,000,000,000, a figure based on mutual savings bank deposits and outstanding United States bonds. The present figure of \$16,500,000,000 includes savings deposits, certificates of deposits and postal savings.

Ideas are everywhere. Good, bright, new ones abound in every line. When applied to your business they are valuable.

Pep is wasted energy unless it is directed along effective lines.

NEW VICTOR SHOP IN ALBANY

F. C. Henderson Co. Opens Attractive Store—
E. J. Yerick in Charge

ALBANY, N. Y., August 7.—A new, up-to-date Victor shop, to be known as Henderson's, has been opened by the F. C. Henderson Co., at 23 Steuben street. A complete assortment of Victrolas and records is stocked. E. J. Yerick, who formerly had charge of the talking machine department of the W. M. Whitney Co., has been made manager of the new establishment. No modern detail has been omitted in making Henderson's a store where practical service can and will be given its patrons. Its equipment includes sound-proof record-hearing rooms and large marble demonstrating rooms.

RADIO CHAMBER OF COMMERCE

First Annual Meeting of Radio Manufacturers in Capital Results in Finishing Touches to Organization Recently Formed

WASHINGTON, D. C., August 4.—The first annual meeting of the National Radio Chamber of Commerce was held at the Wardman Park Hotel, this city, during the last week of July. The process of organization was completed during the convention and a constitution and by-laws were adopted.

The opening address was made by Herbert Hoover, Secretary of Commerce, and other interesting addresses were made by Secretary of War Weeks, Major General George O. Squier, chief signal officer of the Army; Dr. S. W. Stratton, Director Bureau of Standards, and others prominent in the radio field.

The delegates enjoyed the pleasure of a trip to the big naval radio station at Arlington, Va., and an inspection of the radio equipment at the Bureau of Standards.

SLIDE SERVICE PRICE REDUCED

Columbia Co. Announces Reduction in Price on Motion Picture Slides

The advertising department of the Columbia Graphophone Co. announced recently that the moving picture slide service for Columbia dealers had been reduced from \$2.40 to \$1.00 per month. For this nominal sum the Columbia dealer receives four different hand-colored moving picture slides with his individual imprint. Each slide features a different record, as, for example, one set of slides presented Marion Harris singing "Fickle-Flo"; Eddie Cantor singing "I Love Her, She Loves Me," while the other two records featured several of the latest dance hits.

MOTROLA PRICES INCREASED

Jones-Motrola, Inc., 29 West Thirty-fifth street, New York City, manufacturer of the Jones-Motrola, an electric winding device for the talking machine, has announced an increase in the price of the product. Effective August 15, the retail price of the Motrola is advanced to \$25, maintaining the regular trade discounts to dealers and jobbers. The previous price of the Jones-Motrola was \$19.50.

Jones-Motrola, Inc., has also recently entered the radio manufacturing industry, manufacturing jacks, plugs, lamp sockets and other parts.

ISSUES FOREIGN RECORD POSTER

The Victor Talking Machine Co. has just issued an exceptionally handsome window poster for dealers' use in connection with the sale of foreign language records on the August list. The poster contains the national colors of Arabia, Bohemia, Croatia, Germany, Greece, Hungary, Italy, Spain, Poland, Portugal and Sweden and beneath these are listed the records in these languages.

To-day is the day to get down to business; to-morrow never comes.

The Stand-Patter Hinders Business Progress

By J. H. TREGOE, Secretary-treasurer, National Association of Credit Men

Make us thoroughly dissatisfied with ourselves is my earnest prayer for our business men, for the stand-patter in business is quite as much of an obstacle to progress as the stand-patter in politics, religion or other fields. To go on the principle that things merely happen, that the proper attitude is to take things as they come and make no effort to understand the whys and wherefores of past and present, just to accept as a matter of course that business must have its ups and downs, it is this sort of attitude that keeps us from moving forward and registering real progress in commercial affairs.

Progress is predicated on having the right point of view, the acceptance of the principle that to-day's events grow out of yesterday.

As business men, therefore, it is our duty to know the reasons for our present situation and, knowing them, to equip ourselves to bring new

forces to bear to make the new situation better. If well-directed action were ever needed it is needed now. If good thoughts ever had place it is now. The stand-patter must be jogged along and carried with the crowd or left behind. In full appreciation of the past, with right appraisal of the present and clear determination for to-morrow, we must go forward. What business shall be in the Fall of 1922 or the year following rests with us. It is not to be merely a matter of opinion.

A first dividend of 7 per cent has been allowed creditors of the Regina Co., Newark N. J., which was recently declared bankrupt, according to Atwood L. DeCoster, referee in bankruptcy. Creditors who consented to receive stock in the company in satisfaction of claims were exempt from the dividend.

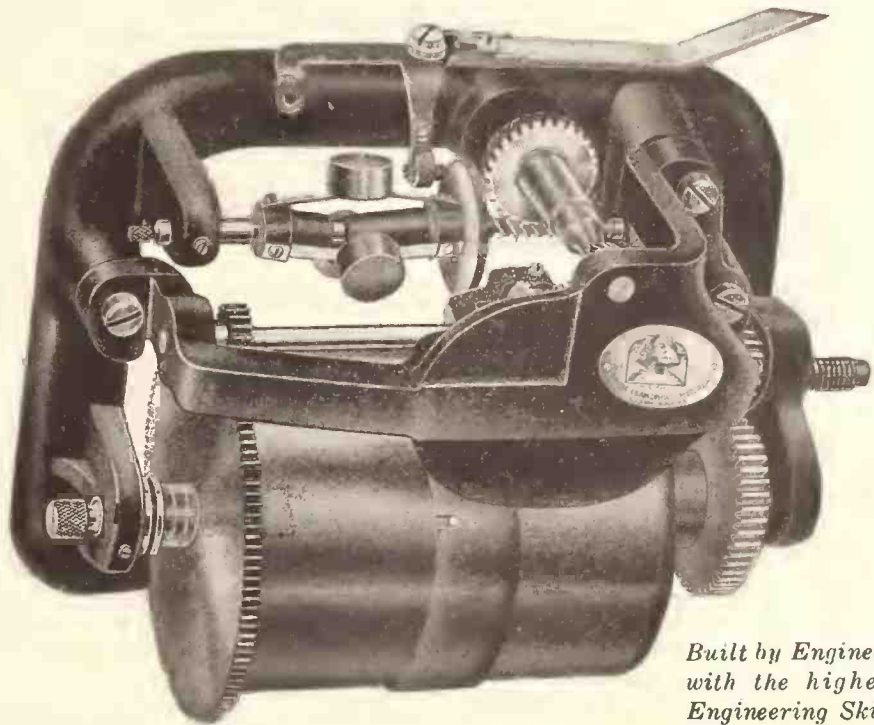

*Built by Engineers
with the highest
Engineering Skill.*

DESIGNED to stand the shocks of hard usage.

BUILT to run smoothly and noiselessly under varying conditions.

OPERATED with uniformity, and constant in speed.

Write for prices



Sphinx Gramophone Motors Inc.

21 East 40th St.
NEW YORK CITY

No Wireless Receiving Set is complete without

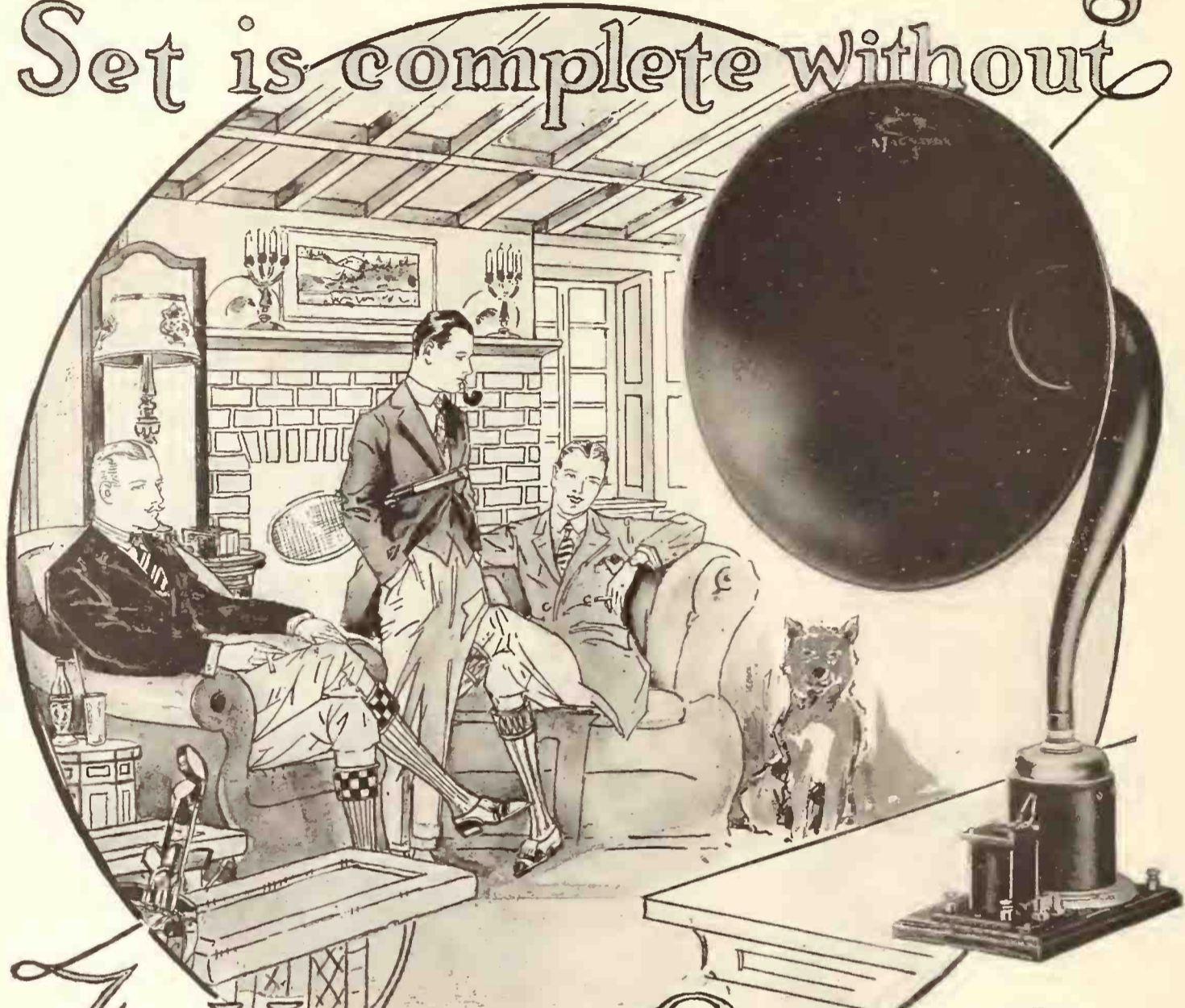

The MAGNAVOX Radio

The Reproducer Supreme

TO show your customer the full use and enjoyment of a receiving set, demonstrate it equipped with Magnavox Radio—the Reproducer Supreme.

The Magnavox Radio opens up a large and most profitable radio market—by making it possible for the entire family to “listen in” at the same time.

Your profit margin is ample—your turnover on the sale of Magnavox Radio is rapid and sure. Carry it—understand it—demonstrate it—push it in your community.

Magnavox National advertising is producing “prospects” everywhere. Write for name of nearest distributor, and information as to how we help you sell Magnavox Radio.

Magnavox Radio consumer folder and other valuable “sales helps” link you up with the most interesting consumer advertising campaign in the entire industry.

The Magnavox Company Home Office and Factory
Oakland, California
New York Office, 370 Seventh Avenue

R-2 Magnavox Radio with 18-inch Horn

FOR those who wish the utmost in amplifying power; for large audiences, dance halls, etc. Requires only .6 of an ampere for the field
Price, \$85.00

Type R-3 Magnavox Radio with 14-inch Horn

THE same in principle and construction throughout as Type R-2, and is ideal for use in homes, offices, amateur stations, etc. Price, \$45.00

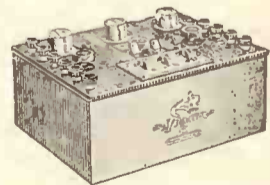

3-Stage

Magnavox Power Amplifier Model C

INSURES getting the largest possible power input for the Magnavox Radio. Can be used with any “B” battery voltage which the power tube may require for best amplification.
AC-2-C, 2-Stage..... \$80.00
AC-3-C, 3-Stage..... 110.00

The playing of Brahms' "Hungarian Dance No. 1" by Toscha Seidel is fireworks set to music. With broad sweeping bow strokes he plays the opening theme, then dashes into a fiery torrent of glistening notes that fairly trample each other in their rush to burst from his violin, then by almost magical transitions he regains the original quiet, halting rhythm. 49690 12-inch Symphony.

Columbia Graphophone Co.
NEW YORK



NOW THE "DAPHO" MOVIES

Moving Picture Machine for the Home Introduced by Dayton Photo Products Co.—Paper Films That Are Effective and Fireproof

DAYTON, O., August 4.—The Dayton Photo Products Co., of this city, recently embarked on an extensive merchandising campaign of the "Dapho." This is a moving picture projection machine for use in the home and which, in design, is constructed along lines that closely resemble the talking machine.

This company also manufactures the Dapho paper prints—films of especially treated paper of extremely tough fibre that are fireproof and which, therefore, eliminate the fire handicap with which moving picture instruments have hitherto had to contend. This company is already in production of the "Dapho" motion picture machines, and has assembled an extensive library of films, including the entire "Dapho-Bray" Library.

Already retail dealers in several fields have become interested in securing the agency for this unique product and, according to the present outlook, a very substantial portion of the national distribution will be accomplished through retail talking machine dealers, because the new product is also essentially an instrument for home entertainment.

Quite a number of prominent American business men are interested in the Dayton Photo Products Co., and included among its directors and officers is one of the most prominent figures in the American music industry.

WALTER CAMP'S "DAILY DOZEN"

Health Builders' Record Course Is Steadily Extending Its Popularity

To make two blades of grass grow where one grew before is a goal for which most business houses are striving. Robert B. Wheelan, president of Health Builders, Inc., New York City, reports that the Health Builders' record course, consisting of Walter Camp's "Daily Dozen," set to music, is developing additional sales for dealers selling this set. A number of dealers have recently written Mr. Wheelan that they have definitely traced additional sales from friends of the original purchasers. Mr. Wheelan attributes the popularity of the Health Builders' course to the prestige of Mr. Camp and his "Daily Dozen."

MAX LANDAY WINS GOLF PRIZE

That Max Landay, president of Landay Bros., Victor retailers in the metropolitan territory and vicinity, can play golf as well as sell talking machines in a scientific manner was demonstrated recently, when he won the prize for turning in the low net score at the Advertisers' Golf Tournament in Cooperstown, N. Y. Mrs. Landay, who accompanied him, showed her skill in the ladies' tournament, going around the nine-hole course in 56 and winning a prize.

ALL PERSONS HEAR DIFFERENTLY

Research in Western Electric and American Telephone Laboratories Brings Out Interesting Facts Regarding Vocal Sounds

What you hear when you listen to talk or music is not the same thing that anyone else hears. All human ears hear the same thing differently. This is one of the discoveries made in the research laboratories of the Western Electric and the American Telephone & Telegraph companies, according to Dr. Harvey Fletcher, who has given this subject much consideration.

The normal human voice can be reduced to one-millionth of its volume and still be heard, says Dr. Fletcher, but if the voice is reduced to one ten-millionth it becomes inaudible. The ear will receive a human voice amplified to 100 times its normal volume without distress, but if increased a thousandfold the sound is painful to the ear. At this volume of sound also the words are indistinguishable. Thus the range of good hearing is from one-millionth the volume of the normal voice to 100 times its volume.

By a series of filters which eliminate any desired group of vibrations from the slowest to the most rapid Dr. Fletcher has discovered that E is the hardest sound in the English language to hear. Next to it is I. Th is the black sheep of the family. This sound, together with V and F, accounts for more than half of the errors in understanding what is said. Ou was found to be the easiest sound for all ears to recognize and the most difficult to misunderstand.

Dr. Fletcher has a perfect telephone apparatus which carries the voice without distortion. This is still a laboratory product, too expensive and fragile for commercial use. The results of 8,000 tests, which are still being studied, will, he says, eventually be of great value in improving the commercial telephone and revealing to actors, singers, teachers and public speakers what sounds must be stressed in order to be heard perfectly by the greatest number of hearers.

You may think a whisper does not start a sound wave, but Dr. Fletcher's perfect phone shows there is no difference in clearness in the reproduction of whispered sounds. Radio telephone orators take notice. Dr. Fletcher has compiled a list of sounds, giving the following order in which they are easy to recognize: OU, L, NG; long O, FR, Y; long A, I, D, O, W, T; long U, M; long E, Sh, B, H, A, U, A, J, Z, N, Ch, K, S, G, P, E, V, F, Th.

WONDA PHONOGRAPH CO. CHARTERED

One of the latest additions to the talking machine establishments of New York City is the Wonda Phonograph Co., which recently incorporated under the laws of this State, with a capital of \$10,000. Incorporators are: H. Tausig and C. E. Bilkes.

"A man who boasts he never changes his mind after it is made up," says Trude Hills, "is about as valuable as a glue-pot that has glued its own stopper in."

THE PHONOMOTOR CO.

121 WEST AVENUE
ROCHESTER, N. Y.

W. F. HITCHCOCK, Proprietor

5 years of success everywhere



THE PHONOSTOP

100%
Efficient

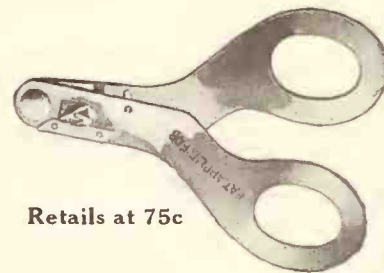

Retails at 75c

THE NEED-A-CLIP

Two Well-known Phonograph Accessories Needed in Every Instrument of Class. Satisfaction Guaranteed in Every Case

Once adapted becomes permanent.

A WHOLE PAGE of references if desired.

DON'T DALLY with inferiors, get THE BEST.

PHONOSTOPS are universal, STANDARD, and finished in nickel and gold.

NEED-A-CLIPS in nickel only.

Get Our Printed Price List Immediately

Samples sent by parcels post C. O. D.; money back if unsatisfactory, but you'll want more.

A Selling Point That Can Be Proved



LAFAYETTE
\$165



IMPERIAL
\$150

The following statement of fact, from a Sonora advertisement, is typical of the arguments that are winning new victories for Sonora dealers:

"Playing the same record, some phonographs are so sharp and shrill that one's ear-drums vibrate almost painfully, while some go to the other extreme and are dead, weak, or sound as though played in a barrel, so noticeable are the unnatural overtones and reverberations.

"These objectionable effects cannot be created on the Sonora. The patented Sonora sound box, tone arm and laminated all-wood horn, designed according to the correct basic principles of sound waves and acoustics, refine and make clear and sweet the sounds of a high pitch such as piccolo tones, harsh bass notes and those of the middle register which frequently reproduce unnaturally on other phonographs.

"One of the most important of these factors contributing to Sonora's tone is the scientific design and substantial construction of the Sonora amplifier. Unlike the thin, flimsy horns found on some phonographs, the Sonora all-wood laminated amplifier is made of from five to fifteen thick, cross-banded veneers, impervious to climatic changes, and incapable of opening up or cracking."

Experience has shown you that the talk that can be *proved* is the most powerful influence for sales. With the new, improved Sonoras on your floor you can *demonstrate* the facts related above.

Write for information about our liberal discounts and other advantages of handling the Sonora line.

Sonora Phonograph Company, Inc.

GEORGE E. BRIGHTSON, President

NEW YORK : 279 BROADWAY

Canadian Distributors: I. Montagnes & Co., Toronto

THE INSTRUMENT OF QUALITY
Sonora
CLEAR AS A BELL



The Highest Class Talking Machine in the World

The distributor named below who covers the territory in which you are located will be glad to answer all inquiries regarding a Sonora agency on receipt of a letter from you.

Syracuse, N. Y.

State of New York with the exception of towns on Hudson River below Poughkeepsie and excepting Greater New York.

605 Broad St., Newark, N. J.
State of New Jersey.

Memphis, Tenn.

Arkansas, Louisiana, Tennessee, Mississippi.

Indianapolis, Ind.
State of Indiana.

Omaha, Nebr.

State of Nebraska.

221 Columbus Ave., Boston, Mass.

Connecticut, Rhode Island, Massachusetts, Maine, New Hampshire and Vermont.

514 Griswold St., Detroit, Mich.
Michigan, Ohio and Kentucky.

616 Mission St., San Francisco, Cal.

Washington, California, Oregon, Arizona, Nevada, northern Idaho, Hawaiian Islands.

BESIDES possessing important patents of its own, Sonora is licensed and operates under BASIC PATENTS of the phonograph industry. Sonora's future and the future of Sonora's dealers' business are secure.

Houston, Texas.

Southeastern part of Texas.

310-314 Marietta St., Atlanta, Ga.
Alabama, Georgia, Florida and North and South Carolina.

Wichita, Kans.

Southern part of Kansas, Oklahoma (except 5 N.E. counties) and Texas Panhandle.

Minneapolis, Minn.

States of Montana, North Dakota, South Dakota, Minnesota.

613 Arcade Bldg., St. Louis, Mo.
St. Joseph, Mo.

Missouri, northern and eastern part of Kansas and 5 counties of N.E. Oklahoma.

1751 California St., Denver, Colo.
States of Colorado, New Mexico and Wyoming east of Rock Springs.

Salt Lake City, Utah.
Utah, western Wyoming and southern Idaho.

720 S. Michigan Ave., Chicago, Ill.
Illinois and Iowa.

Milwaukee, Wis.
Wisconsin, Upper Michigan.

1214 Arch St., Philadelphia, Pa.
Eastern Pennsylvania, Maryland, Delaware, District of Columbia and Virginia.

505 Liberty Ave., Pittsburgh, Pa.
Western Pennsylvania and West Virginia.

150 Montague St., Brooklyn, N. Y.
All of Brooklyn and Long Island.

311 Sixth Avenue, New York.
Counties of Westchester, Putnam and Dutchess; all Hudson River towns and cities on the west bank of the river, south of Highland; all territory south of Poughkeepsie, including Greater New York, with the exception of Brooklyn and Long Island.

A SURVEY OF SUMMER BUSINESS IN THE RETAIL MUSIC FIELDS

Trade Service Bureau Presents Interesting Analysis of Factors Which Enter Into Summer Music Business, With Suggestions for Increasing Sales

The Trade Service Bureau of the Music Industries Chamber of Commerce has recently made an extended survey of retail business in the music trade during the Summer months and has embodied the results of that survey in an interesting report, including charts showing sales

evident that those who want to keep up their sales averages during otherwise dull months must cultivate out-of-town business.

The answers to the questionnaire of the Trade Service Bureau on "Bracing Up the Dull Months" prove conclusively that the two great fields for

The music merchant in an agricultural community having Summer resort attractions is, of course, especially favored in this respect. (See Chart No. 4.)

The fact is generally known and is emphasized by the reports that the great majority of

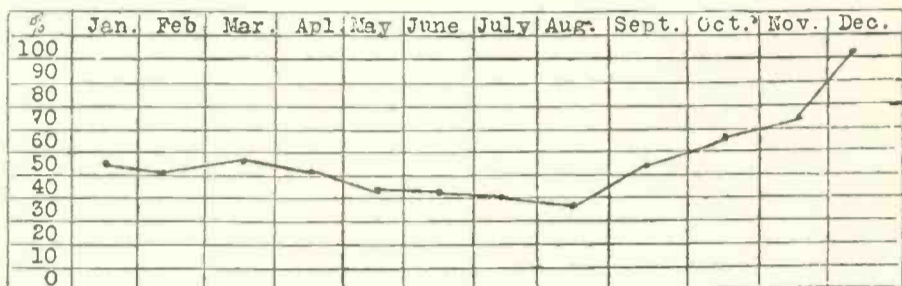

No. 1—General Monthly Sales Averages

This chart represents the average monthly percentage of sales of nearly 200 stores of all classes throughout the United States. Compare your own monthly sales percentages with these to find out whether you are above or below the average during the dull months. The 100 per cent month is December, while June, July and August are each below 50 per cent of the peak month.

averages during the various months of the year and suggestions based upon the experiences of those retailers who have managed to overcome in some measure the Summer quietude. While none of the suggestions for increasing Summer sales may be termed radical or sensational a number of retailers may find in them some material that they can put to good use in their own locali-

intensive special effort to raise the sales averages of the most difficult months, July, August and early September, are as follows:

(1) Among the farmers who find time for mid-Summer diversion, before harvest, on the one hand, and

(2) Among city workers who are seeking vacation pleasures, on the other.

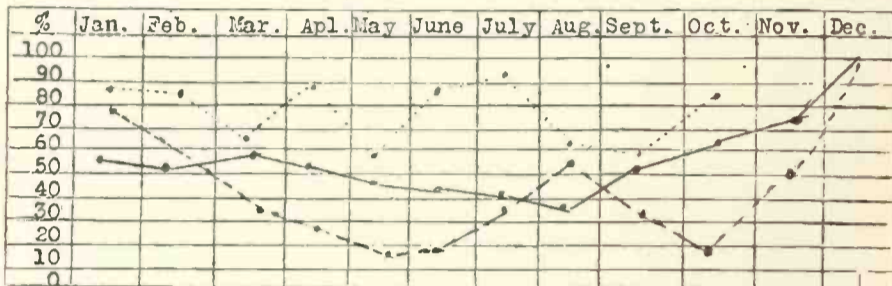

No. 2—Average City or Industrial Sales

In the cities, particularly those which are industrial centers, Summer sales drop down to 40 per cent, and even below that during August. The dotted line shows what one merchant was able to do in an industrial city, the dashes showing the monthly business of another merchant, under identical conditions, who apparently was willing to accept the dull period without a struggle.

music business is done with city people, thereby emphasizing the opportunity for developing demand in rural and resort districts. The exodus of city workers into the country creates an obvious opportunity to transfer the city appreciation of music to country residents. At the resorts, Summer hotels and boarding places the country dwellers see what kind of diversions the Summer

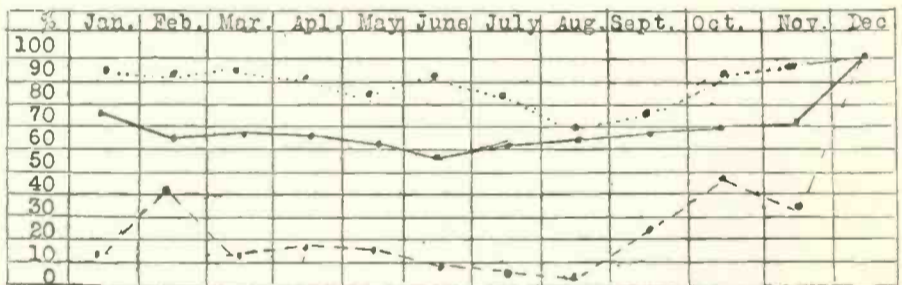

No. 3—Average Sales in the Country

One of the most uniform individual reports returned on the questionnaire is shown by the dotted line, representing monthly sales in an agricultural community, with half the sales to country people and half to city people. The dashes represent a report showing the greatest variation, and although the business thus represented depends upon the agricultural element the fluctuation is explained by the statement that industrial and city people make up most of the sales. Apparently the farm trade has not been cultivated.

ties. For that reason the report is published in full as follows:

When the business done during the Summer months by music merchants who cultivate country trade averages better than 60 per cent (see Chart No. 3) of the peak month of December, while the city business in industrial centers drops below 40 per cent (see Chart No. 2), it becomes

The great army of stay-at-homes of all classes is susceptible to special arguments for musical equipment to break the monotony of the quiet Summer months and there should be no let-up of advertising and canvassing effort in the regular field. After all, it is only a relatively small minority of prospects who are away at a given time.

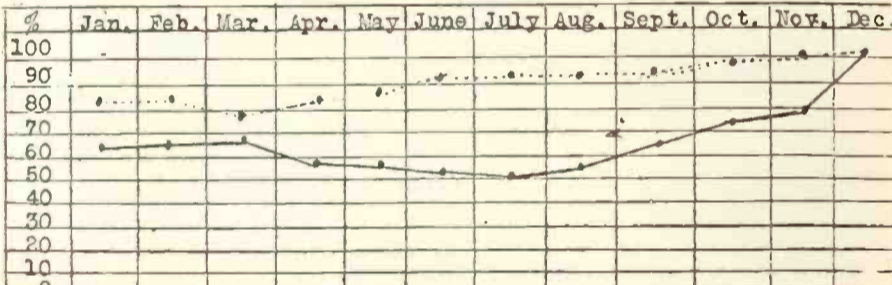

No. 4—Mixed Sales

Where the reports show the business to be evenly divided between city and country people, or industrial and agricultural workers, the monthly sales percentages run about parallel with the general averages of Chart No. 1, but there is greater evidence of sales opportunities being grasped. Here was found the most uniform report, as shown by the dotted line, with the explanation: "We do not have dull months. We have a big resort business in Summer and our regular good Winter trade, 60 per cent agricultural (with farmers)."

visitors enjoy, and if music takes its proper place in such diversions a new market is created, not only for the dull months, but for continued cultivation.

The figures secured by the Trade Service Bureau prove that the music merchants who keep after their regular business persistently and add to their usual efforts a special drive for busi-



A QUALITY SOUND BOX

Here is a sound box that has won a reputation for its quality features of design, construction and tone.

It reproduces a full, mellow, resonant tone of unrivalled volume and clearness.

Good enough for the highest-class phonographs and cheap enough for the lowest-priced machines.

Get acquainted with the superior qualities of the Presto rubber-hub sound box and you will realize why it has been adopted by the leading independent manufacturers.

PRESTO PHONO PARTS CORPORATION

124-132 Pearl Street

Brooklyn, N. Y.



ness among farmers and city people who are spending the Summer in the country or at resorts can maintain a fair degree of uniformity in their monthly sales averages.

Work alone is not the solution, unless that work is intelligently directed with certain definite ends in view. Every business presents different problems, but the following three channels of effort are representative of the methods by

(3) Building Up the Prospect List

Even when the cultivation of Summer prospects does not result in immediate business there has been created the opportunity for future sales. People's minds are out of the rut of routine thoughts. Under the different conditions which surround their Summer activities they may be approached from some new angle. A man who is thinking in terms of golf or an auto

creating community spirit and friendly rivalry between towns, institutions and organizations.

The foregoing will suggest other avenues of approach, perhaps, and other methods of creating immediate or prospective business.

The report is intended to show that sales volume can be built up during otherwise dull months and that it is up to the individual enterprise of the music merchant to produce results at a time when

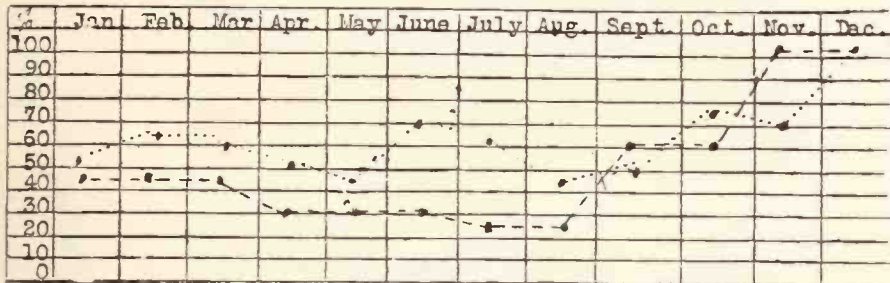

No. 5—Two Merchants in the Same Town

An interesting comparison of the attitude of two merchants working the same territory. The dotted line represents the one who reports a "great slump" in the particular field from which he was getting the most business, stating further that his poorest months (even though they were twice as good as his competitor's) were due to "not working hard enough on other prospects." Evidently this merchant is studying how to keep up his monthly sales percentages.

which higher monthly averages can be maintained:

(1) Offering of Seasonal Goods

There are certain offerings which are more likely to appeal to the indifferent prospect and create a desire in him to make music a definite part of his Summer diversion. The following are examples:

Used pianos, players and talking machines which can be priced low enough to make their installation in Summer bungalows within the means of many more prospects than could afford new instruments.

Small pianos of the type which are increasing rapidly in popularity, and which take up little room in limited Summer quarters.

Automatic pianos (coin-operated) for various resorts and public places frequented during the Summer.

Rental instruments of various types.

Portable phonographs which can be used in camps, on boats, on motor trips and, in fact, almost every place.

Special assortments of rolls and records, selected with particular reference to outing conditions and pleasures and all ready made up to save the time of the last-minute purchaser. Some old numbers, more or less out of demand, might be incorporated in such assortments, like "The Good Old Summertime."

Radio equipment for the Summer place.

Small goods like the banjo, ukulele, guitar and mandolin and novelties.

Band and orchestra instruments, especially the former.

Other items may suggest themselves to the music merchant who makes a careful study of his possible markets.

(2) Adapting the Sales Arguments

In order to develop the demand for Summer music special arguments adapted to the season must be put forth in advertising, window displays and sales solicitation, while the canvass for prospects must be suited to changed conditions.

Music for impromptu dances and concerts, music on motor and boating trips and in camp; music at boarding places, Summer cottages and clubs, and music as a happy addition to every kind of outdoor diversion and amusement should be pictured vividly. The lure of music across the water is irresistible.

Advertising should be very pointed, less detailed and should concentrate on a few basic ideas. People give less time to reading and less thought to what they read.

Window displays should associate music with outdoor ideas—the settings should show music on a cottage porch, amid grass and trees, along with fishing tackle or tennis outfits and other equipment which individualizes the window.

If there is a resort center nearby, but too far distant for convenient sales contact, a Summer branch headquarters might be desirable. The resort business might seem too small a factor to make this profitable, but the reports indicate that enough volume is gained in certain cases to make such a move practical.

trip may be more easily approachable than one who is buried in business during other months.

One may cultivate resort proprietors, provide concerts for the entertainment of Summer visitors in order to develop the idea and secure lists of guests. At some resorts and hotels time begins to hang heavy on the hands of many guests, who will welcome impromptu musical programs or the diversion of dancing. There is business to be built upon this awakened desire.

Informal contact with prospective customers under Summer conditions opens up a wonderful opportunity to secure information which can be used later—with regard to musical equipment in the home, music study for the children when vacation time is over, etc.

Summer is a good time to organize and teach bands. Community spirit may be stirred up, whether in a Summer colony or an industrial center, and band music is an important factor in

it is easy to let business drift, when sales usually drop to a minimum and when the monthly percentage of overhead expense goes up to a peak which may be disastrous to the year's profits.

SECURES OAKLAND VICTOR AGENCY

OAKLAND, CAL., August 5.—The local branch of the California Music Co. was recently purchased by Harry N. Chesebrough, giving him a Victor agency, in addition to the Kimball and Pathé lines that he now handles. Mr. Chesebrough's main store is located at 1448 San Pablo and it is understood that he will run both stores until the first of next year, when the two establishments will be consolidated at 1432 San Pablo.

Boost your sales by going after prospects as soon as they return from their vacations.

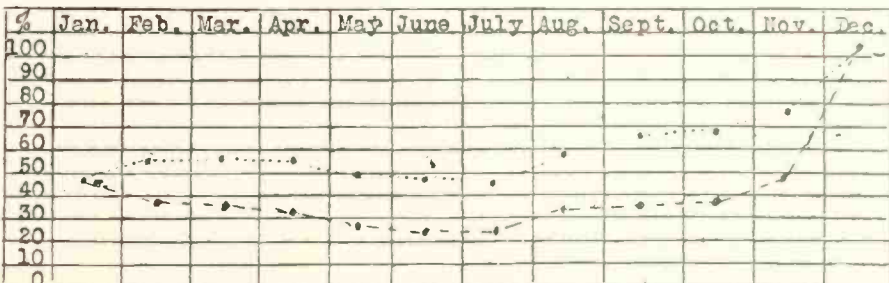

No. 6—Piano and Talking Machine Percentages

A comparison of the monthly percentages of piano and talking machine sales, the dots representing piano sales and the dashes showing the talking machine sales. The percentages were furnished by a large organization having retail interests operating in many localities and under varying conditions, making the comparison above fairly representative of a national average.



Wall-Kane Needles
Protect the Record

WALL-KANE NEEDLES

Used by 80% of the population, sold by the leading jobbers throughout the world.

A nationally advertised article that has been in ever-increasing demand since it was established in 1913

WALL-KANE needles are packed in metal display stands holding 60 packages, 24 loud, 24 extra loud and 12 medium.

They are also packed in cartons of 100 packages of a single tone, either loud, extra loud or medium.

JOBBERS ONLY—APPLY FOR
SPECIAL PROPOSITION

WALL-KANE NEEDLE MANUFACTURING CO.

Successors to

The Greater New York Novelty Co.

Sole Manufacturers of

WALL-KANE NEEDLES

3922 Fourteenth Avenue

Brooklyn, N. Y.



Clear as the notes of a nesting thrush, tender with deep mother love is Lucy Gates' rendering of "Sleep, Little Baby of Mine," an old-fashioned lullaby that has hushed babies to sleep the world around. As a complement for this, making an unusually complete record, she sings "Son O' Mine" a mothering song of exquisite sentiment. A-3639.

Columbia Graphophone Co.
NEW YORK

GRIFFITH BRANCH STORE OPENED

Well-known Piano Firm of Newark, N. J., Opens Branch in Scranton

SCRANTON, PA., August 3.—The Griffith Piano Co., with headquarters in Newark, N. J., has opened its third retail branch at 211 North Washington avenue, this city. A branch of this concern is also operated in Paterson, N. J. The local store is one of the finest in this part of the State and the lines of instruments handled here make it one of the most representative piano houses in this vicinity.

Included in the stock are Steinway, Sohmer, Krakauer, Hallet & Davis, Lester, Brambach and Griffith pianos, players and Sonora phonographs, Vocalion records, Q R S melody rolls and also reproducing rolls. The finishing and rebuilding shop is located in the rear of the store. Surplus stock is carried in the basement.

T. M. Griffith is president; P. O. Griffith, treasurer; Paul Griffith, who is in charge of the Scranton store, secretary; F. E. Griffith, vice-president, and H. G. Griffith, general manager.

H. MICHLOSKY VISITS GOTHAM

Harry Michlosky, partner with Hyman Landau in the firm of Landau's, Victor dealer, operating stores in Wilkes-Barre, Hazleton and other cities in Pennsylvania, was a recent visitor to New York City. While in the metropolis Mr. Michlosky visited various Victor jobbers.

The person who is "just looking around" to-day may be the buyer of to-morrow.

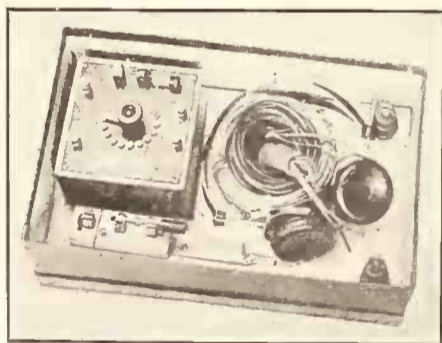

ATLANTIC JR.

Crystal Receiver

\$18.00

Ready for Installation

Atlantic Instrument Co.
INCORPORATED

13-21 PARK ROW NEW YORK

OBTAINING CUSTOMERS' CONFIDENCE

Salesman Who First Serves Customer Has Best Opportunity of Promoting Further Good Will by Follow-up of Original Visit

A simple plan to retain the patronage and confidence of customers has been put in effect by a certain aggressive merchant in a medium-sized city with considerable success. Realizing that customers who make the acquaintance of a salesman through having made a previous purchase would probably be better satisfied with the services of that particular man than a stranger on the second visit, each salesman received instructions to present his card to customers after the sale has been concluded and request that if the customer desired anything in the future to ask for him personally and he would see that his or her wants were satisfied.

These salesmen were also instructed to keep track of the names and addresses of persons to whom they had given their cards and at certain intervals they were told to communicate with these customers by letter or telephone, calling their attention to records which would be most likely to arouse their interest—a plan which promoted good will and increased sales.

LANDAU FIRM LEASES BUILDING

Plan to Convert Theatre Building Into a Number of Stores—Expansion of Business Makes Larger Quarters Necessary

HAZLETON, PA., August 4.—The Landau firm, of this city, well-known music merchants, operating stores in Wilkes-Barre, Pittston and this city, have completed arrangements for the leasing of the Campbell Theatre Building at 27 Broad street.

The building will be converted into a number of stores, one of which will be occupied by the Landau firm, which has outgrown its present quarters on Wyoming street.

The company, besides handling Victrolas, jewelry and musical instruments, has added to its lines the Lester and Pease pianos, uprights and grands, in all stores; also radiophones and radio accessories.

Landau's expect to occupy the new quarters on or about October 1 of this year. When completed this will be one of the most beautiful establishments of its kind in the State.

MITCHUNK GIVES CONCERTS

Columbia Artist Heard in Series of Afternoon Concerts in Buffalo

BUFFALO, N. Y., August 4.—A. Maisel, live-wire Columbia dealer in this city, announced a series of concerts recently by L. Mitchunk, well-known accordionist and Columbia artist. Mr. Mitchunk gave a series of concerts from 3 to 5 o'clock in the afternoon and from 7 to 9 o'clock in the evening, playing a group of Russian and Polish selections, which were enthusiastically received.

ITALIAN RECORDS FIND BIG MARKET

Interesting Report on Business Progress by Italian Book Co.—A. De Martino Visiting Europe in Interest of Company

The Italian Book Co., sole American distributor for the Phonotype record, manufactured in Italy, and who also distributes special releases of popular Italian numbers, of the Neapolitan line of records, reports that its business has shown a steady increase since January 1, and that the demand for its records has grown country-wide. Plans are now being made for an intensive Fall campaign which will introduce these records into every center in this country. In order to procure a record that will appeal more strongly to the Italian-speaking people in this country, A. De Martino, one of the officials of the company, is now in Italy, conferring with the officials of the Phonotype Co. there with a view of establishing a closer contact and to offer suggestions in giving these records an American color that will appeal to record buyers in this country.

Mr. De Martino, who has several copyrighted Italian popular songs under his control, is planning to offer these to the manufacturers of Phonotype records in Italy with a view of having them recorded, so that they will be ready to market in the early Fall. While in Europe he plans to visit France and Germany in the interest of his company, and will return by way of England some time during the month of September.

Victor Wholesalers



The House
of
Mellor
in
Pittsburgh
since
1831

An Enormous Demand Exists

For Records By

MAMIE SMITH

Colored Queen of Syncopation

Her records can be secured only of Okeh Dealers because Mamie Smith is an Exclusive Okeh Artist and sings only for

Okeh Records

The Records of Quality

If you want to get in on this valuable trade write your nearest Distributor for full particulars



MAMIE SMITH

COMPLETE LIST OF OKEH DISTRIBUTORS

CALIFORNIA—*San Francisco*,
KOHLER & CHASE, 26 O'Farrell St.

COLORADO—*Denver*
MOORE-BIRD Co., 1751 California St.

GEORGIA—*Atlanta*,
J. K. POLK FURNITURE Co.,
294 Decatur St.

ILLINOIS—*Chicago*,
CONSOLIDATED TALKING MACHINE Co.,
227 W. Washington St.

W. W. KIMBALL COMPANY,
Wabash Ave. & Jackson Blvd.

INDIANA—*Indianapolis*,
KIEFER-STEWART Co.,
Capitol Ave. & Georgia St.

LOUISIANA—*New Orleans*,
JUNIUS HART PIANO HOUSE,
703 Canal St.

MARYLAND—*Baltimore*,
A. J. HEATH & Co.,
321 Park Avenue.

MASSACHUSETTS—*Boston*,
THE BAY STATE MUSIC CORP.,
142 Berkeley St.

MICHIGAN—*Detroit*,
CONSOLIDATED TALKING MACHINE Co.,
2957 Gratiot Ave.

MINNESOTA—*Minneapolis*,
DOERR-ANDREWS & DOERR

MISSOURI—*St. Louis*,
THE ARTOPHONE CORP., 1103 Olive St.

NEBRASKA—*Omaha*
LEE-COIT-ANDREESSEN HARDWARE Co.,

NEW YORK—*Buffalo*,
IROQUOIS SALES CORP., 210 Franklin St.

New York City,
BRISTOL & BARBER Co., INC.,
3 East 14th St.

NEW YORK DISTRIBUTING DIV.,
15 W. 18th St.

NORTH CAROLINA—*Goldsburo*,
INDEPENDENT JOBBING Co.,

OHIO—*Celina*,
HARPNOLA COMPANY

Cleveland,
THE RECORD SALES COMPANY,
1965 E. 66th St.

Cincinnati,
STERLING ROLL & RECORD Co.,
137 W. Fourth St.

PENNSYLVANIA—*Philadelphia*,
A. J. HEATH & Co.,
27-29 So. Seventh St.

SONORA COMPANY OF PHILADELPHIA,
1214 Arch St.

Pittsburgh,
THE RECORD SALES COMPANY,
806 Penn Ave.

Williamsport,
RISHELL PHONOGRAPH Co.

TEXAS—*Dallas*,
MARTIN WEISS Co.,
903 Elm St.

Houston,
HOUSTON DRUG COMPANY.

WISCONSIN—*Milwaukee*,
YARR & LANGE DRUG Co.,
207 E. Water St.



General Phonograph Corporation

OTTO HEINEMAN, PRESIDENT



25 West 45th Street, New York City



No matter what your customers ask for be sure to let them listen to Ray Miller and His Orchestra as they put their hearts and heads and hands into "Neath the South Sea Moon" from Ziegfeld's *Follies of 1922* and "It's Up to You." They'll Fox-Trot all over your store. A-3649.

Columbia Graphophone Co.
NEW YORK



BROADCASTING OF VOICES AND MUSICAL INSTRUMENTS

Radio Fans Often Wonder Why Some Notes of Music Are Intense While Others Weaken and Drag —Noted Expert Tells Interestingly Why Some Concerts Are Often "Blurred"

The Radio Editor of the New York Times carried a very interesting story the other day on the broadcasting of music. After pointing out how the Radio telephone commenced to gain recognition among Radio operators, both amateur and commercial, a couple of years ago, and how its entertainment features began to influence thousands of others to listen in, he said:

"Many people hear a concert which is 'blurred' and far from being as perfect as the original tones. This is not due to radio defects, but to the receiving operator's failure to understand his set properly, a run-down battery, or some defect in tuning because of inexperience. Transmitting operators have their troubles, but experiments and study are fast overcoming the agencies which in the early days of the radio telephone made it difficult to produce with true fidelity and clearness all classes of voices, and the tones of musical instruments.

"It is a question in the minds of many radio fans why some notes are heard with abnormal intensity and others have a tendency to weaken and drag. This effect can best be understood by considering the manner in which the notes of the piano reproduce and transmit. All who have listened to a piano recital by radio are familiar with the way some notes 'push through' and do not sound normal in their relation with other notes. This increase in the volume of certain piano notes is called 'blasting.' There is a definite group of notes on the piano in the middle register closest to the particular frequency at which the microphone or transmitter diaphragm vibrates best. The combination causes the increase in volume and creates a 'blast.' Much of this unpleasant sound has been eliminated by building microphones which are particularly adapted for use with the various types of instruments and by placing the instruments at the correct distance from the transmitter. In one of the early broadcasting stations the piano was shifted for six months before a position was found which overcame certain acoustic effects, harmful to radio transmission. Many of the peculiar problems presented by the piano in radio work have been solved in this way, but further improvements are still to be made before the piano music can be broadcasted perfectly.

Brass Instruments Carry Well

"Brass instruments, such as the horn and cornet, have characteristics which require care in handling, especially in their position and dis-

tance from the microphone, but when properly placed they are most successful in radio transmission. If these instruments are played directly into the transmitter, 'blasting' is certain to result.

"The cornet is considered one of the best musical instruments for radio concert work. The saxophone ranks high so long as the musician stays away from the extremely low notes. Traps carry very well over the radio because of their sharp, clearly defined characteristics. The bass drum is too slow and low. The music of the clarinet carries exceptionally well, but care must be taken to place it far enough from the microphone so that the mechanical click of the stops is not picked up by the transmitter. The flute at times reaches too high and piercing a pitch. The violin has characteristics which make it a great favorite and one of the finest instruments for radio entertainment. Its tones are reproduced by the microphone almost to perfection.

"Bells and the xylophone sound very good by wireless, as they produce tones which are clear and sharp, generally having a higher frequency than the natural vibrating frequency of the metal diaphragm of the transmitter. The ukulele is not as good as the banjo and mandolin. The ukulele produces what might be termed dead accompaniments, as its notes, clearly defined at the beginning, suddenly die away or fade, making reproduction difficult. The mandolin can be reproduced a trifle more efficiently than the banjo or harp. The tenor banjo and harp when struck vibrate at certain frequencies and die out gradually, making them well suited for a place in the radio orchestra.

Baritone Best Radio Voice

"The human voice can be reproduced and broadcast to a finer degree than any of the musical instruments. Voices, like the instruments, have their peculiarities for radio transmission. Articulation and correct breathing must be given

every consideration to render the concert a success.

"Male voices reproduce and carry far better than female because of more efficient modulation. This explains why the majority of announcers are men. The baritone has the vocal strength and quality which produces excellent modulation and places it first among the voices adapted to radio. The bass has to be placed closer to the transmitter than the baritone and the tenor still nearer.

"Soprano may be broadcast effectively and can be heard over great distances because of the high pitched notes. The alto and contralto singer must be careful in striking notes too low and deep for they are apt to fade out and the beauty of the song cannot help being lost in the microphone.

"All singers do not have voices desirable for the radio, although on the concert stage they may be beyond reproach. In some cases personality and appearance capture an audience, but radio has not reached the stage where its invisible waves can transmit personality, therefore it is vocal qualities alone which make a singer a success as a radiophone artist. The distance of the singer from the microphone and the correct selection of the proper microphone for each class of music add in a great degree to the perfection of the concert. Each instrument and each voice present a different problem.

"The most popular and pleasing music to the average radio fan is the well-known jazz, and the ideal combination of instruments to send forth the tones as near to the originals as possible is the violin, saxophone, tenor banjo and piano. With a well-tuned receiving set the music is as clear as if its source were a few feet rather than many miles away. As observed, much depends upon the set and the competency of the operator."

Experience is a good teacher, but only a fool selects this method of gaining knowledge when he can, by very little effort, take advantage of the experiences of others.

REGAL
PREDOMINATES
IN THE
50¢ RECORD FIELD



TRUCKS

The Lea Phonograph and Talking Machine Truck must be used to be appreciated.

With it one man can handle the Edison Chippendale, Victor No. XVII, Cheney No. 6 Queen Anne and other large models. This truck also fits the smaller sizes.

It is only a one-man job to deliver your instrument from the showroom to any apartment floor.

Piano trucks, hoists, covers, straps, movers' supplies. May we send you a circular and prices?

Made only by

Self Lifting Piano Truck Co.
FINDLAY, OHIO

Okeh



Okeh



CONSOLIDATED SERVICE

is famous for its Promptness and Efficiency. It's the foundation upon which we have built our business. We handle Okeh Records because they give the public utmost satisfaction, and increase the dealer's trade. You can build a *lasting business* on Okeh. We give you co-operation and sales helps which make your trade grow. Write and ask us about an Okeh Agency.

Consolidated Talking Machine Co.

227 W. Washington Street, Chicago, Ill.

Branch: 2957 Gratiot Ave., Detroit, Mich.

CLEVELAND

Tie-up Between Theatre and Dealer Pays — Interesting Sales Stunts — Buying Holiday Stock — Ohio Merchants Boost Music

CLEVELAND, O., August 9.—The biggest tie-up between a theatre and a music concern that this city has ever witnessed took place here this month, when the Columbia Graphophone Co., under the able direction of George Krauslick, service manager, arranged with the State Theatre that songs suggested by the Cleveland branch should be featured each week, and that a sign should be hung in the lobby of the theatre, which lists the selections and gives the Columbia record number.

A striking stage setting, which depicts a music shop, is used. The scenery is all Columbia. Through the courtesy of E. Strong, manager of the Loew Theatres, and Al Wolman, a Grafonola, Columbia records, fixtures and sign and framed artists' posters of Al Jolson, Eddie Cantor, Rosa Ponselle and Jeanne Gordon are used as stage decorations.

G. J. Murray, manager of the record department of the Columbia Graphophone Co., states that this "stunt" has created a great deal of interest about town. People are curious to find out how Mr. Krauslick managed to do it.

Columbia Song Tie-up With Theatre

Not very long ago Al Wolman, stage director at the State Theatre, put over "Moonshine" in great style, and then he informed the audience that they could hear the song over again on their Grafonola. His rendition of "Mr. Gallagher and Mr. Shean" scored heavily and it is expected that this will add to the sales of record A-3609.

"Safety First" Campaign Aids Business

The Buescher Co. is also giving an example of keeping right up to date. Cleveland Boy Scouts have been painting large footsteps at every crosswalk to help in a "Safety First" campaign in the city, and an idea of utilizing this "stunt" for novel advertising purposes was conceived by I. H. Buescher. The border of the advertisement, which is run in the dailies, is made of many black footprints, and in the center is the following: "FOOTSTEPS!—you see them at every crosswalk for 'Safety First.' When buying a Victrola and Victor records let your feet carry you to our new store at 1310 Huron road."

Vocalion Co. Co-operates With Dealers

A "cut-out" list, which is aiding dealers in the sale of records, has been started by the Vocalion Co. of Ohio. A plan has been arranged by which Aeolian dealers may return records

that have lost popularity. The list, which now has about forty records on it, is called the "cut-out" list, and is proving popular among dealers, as it enables them to add more popular pieces to their stock without fear of having them left over on their hands.

Simple Stunt Boosts Sales

Since a simple improvement has been installed in the Randolph House of Good Music, at St. Clair and Parkwood Drive, this establishment has found drawing new clientele during the hot Summer months an easy matter. A block distant from the Randolph House is one of the biggest food markets in this section of the country. Crowds flock to this market every evening, since they have the best selection of foodstuffs direct from the growers.

C. H. Randolph, head of the Randolph House, decided that he would let the people who visit the market know of the music store nearby. So a frame was fitted into the transom of one of the doors facing the market, a Magnavox connected and music distributed all over the neighborhood. A likely number of prospects has already been acquired through this medium, asserts the energetic Mr. Randolph.

Orders Christmas Stock

Louis Meier, president of the Northern Ohio Talking Machine Dealers' Association, and member of the L. Meier & Sons Co., is showing dealers in this city that the old saying, "Do your Christmas shopping early," applies to the dealer as well as the consumer. Business has so far been good, and the outlook for the future is so bright that Mr. Meier went ahead and bought in his Christmas stock. He explained that machines cannot be made in a day, and as the demand will be large he wants to be prepared to meet it. Mr. Meier is also having twelve-foot Victor dogs with the name and address of the L. Meier & Sons Co. on them distributed along the country roads outside of Cleveland.

Growing Demand for Edison Records

The Bailey Co. is finding a large market for the white label Edison record, the only difficulty being, members of the company say, that there is such a demand for it that the black label Edison will have to fight to hold its place.

New Starr Console Popular

A new type of console model has been introduced by the Starr Piano Co., and is proving

quite successful. A rather curious incident occurred at this establishment the other day. Several orchestra men entered the store to listen to the Gennett record, which is becoming popular here, to improve their style of playing.

Giving Suggestions to Dealers

L. G. Hart, sales representative of the Pittsburgh district, was a visitor at the new Brunswick headquarters in Cleveland, and he was greatly pleased with the facilities for improving the service to the dealers.

A. F. Hughes, service manager of the Brunswick Cleveland branch, has been visiting dealers in surrounding towns for the past few weeks giving them many new ideas on sale suggestions which will improve business.

Columbia Co.'s Prize Contest

The Columbia Co. is sending out a list to the different dealers to find out what are the best records, in their opinions, under different classifications, such as dance music, etc. These lists are then to be returned to the company, and three lists will be made out consisting of the records which have received the most votes. The dealer who turns in a list which nearly complies with the list put out by the company will receive a prize.

Some Live News Brieflets

The Tabak Music Co. has secured the Columbia agency and will handle this line exclusively. This store opened Saturday, July 15, and visitors were entertained by a five-piece orchestra.

The Buescher Co. has acquired the agency for the Cheney phonograph, and members of the firm expect that this will greatly increase the sales of the company, as this machine is one of the most popular makes in the city.

The Oriole Terrace Orchestra has made its first record for the Brunswick-Balke-Collender Co. This is considered by the company as a wonderful addition to its catalog. This company also announces that the merger of the Buffalo, Pittsburgh and Cleveland districts has been completed, and all business will hereafter be handled from the Cleveland office.

Howard J. Shartle, general manager of the Cleveland Talking Machine Co., is now visiting dealers in northern Ohio, and he expects to aid and assist dealers to procure increased sales. He will return in about a week.

Ohio Merchants Organize Music Committee

The Ohio Music Merchants' Association will organize its "Advancement of Music" committee at the annual convention at Toledo. This committee was authorized by amendment to the by-laws at a meeting of the council at Columbus, O., January 31, 1922. It was decided that the committee should consist of five mem-

(Continued on page 55)

Model 17, Mahogany, Golden Oak or Fumed Oak, 75-record file. Emerson Music Master horn and Thrush Throat tone arm. Heine-man No. 44 motor. All exposed metal parts gold-plated. A beautiful machine worth many dollars more than we ask. We have also a number of Emerson Model 20's.



Emerson Phonographs

at startling low prices

WHAT would it mean to you to be able to offer your customers a beautiful, nationally known, high-grade Emerson Phonograph at a price so low that it seems ridiculously impossible—and yet be able to make a fine profit on them? You can do so. We have a number of Emersons, fine, new machines, which we made up for the Emerson Co., which we can sell you at a price you will scarcely believe possible. We want to break even and that's all. You and your customers get the benefit. You know the Emerson—how really high grade it is—and what a splendid reputation it has. Cash in on this real buying opportunity!

Write for full information

The UDELL WORKS :: Indianapolis

28th Street and Barnes Avenue

Starr

PHONOGRAPH



The Soul of the Artist

again finds expression when the record is Starr-played. The Starr searches out each shade, each refinement, each warm glow of inflection and tone color entrusted to the record. Through the Starr's singing throat of silver grain spruce, the tones pure, and untinged by obtrusive mechanical sounds come to the music lover's ear.

To realize new records delight, hear your favorite record Starr-played. Any Starr dealer will gladly give you this opportunity. Also ask to hear the ultimate in record perfection—The New Gennett Records.

THE STARR PIANO COMPANY
RICHMOND, INDIANA

New York—Chicago—Los Angeles—Birmingham
Detroit—Cincinnati—Cleveland—Indianapolis
Boston—Jacksonville—London, Canada

STYLE III



TRADE HAPPENINGS IN CLEVELAND

(Continued from page 53)

bers who shall choose their own chairman, and who shall be originally appointed to terms of one, two, three, four and five years by the president, and thereafter the president shall annually appoint one member for five years.

The duty of this committee will be to assist the national as well as the local organizations in Ohio in their effort to advance the interest in good music.

The committee has already been appointed. Its membership is as follows: One year, A. L. Maresh, of Cleveland; two years, Marie C. Kratz, of Akron, O.; three years, Robert C. Wilkin, of Columbus, O.; four years, Charles H. Yahrling, of Youngstown; five years, F. B. Reinkamp, of Cincinnati.

ALTERATIONS AT MEIER & FRANK CO.

Portland Concern Makes Extensive Changes in Talking Machine Department—Mary E. Godwin Resigns From Seiberling-Lucas Co.

PORTLAND, ORE., July 31.—The Meier & Frank Co. is making extensive improvements in its phonograph department. The entire department is torn up, but business is being conducted as usual. Harry Andrews, manager of the department, says that the alterations will be finished about September 1 and that this will then be one of the largest and best-equipped talking machine departments in the city.

Mary E. Godwin, who has so ably filled the position of Victor educational director of the Seiberling-Lucas Music Co., has severed her connection with the firm, as the position of educational director has been discontinued during the Summer months. Miss Godwin was a live wire and only recently put over the Victor float, which took the first prize during the recent Rose Festival.

GEORGE JARROW IN TOWN

Chicago Columbia Dealer and Party of Friends Visit Columbia Co. Offices

Geo. Jarrow, well-known Columbia dealer in Chicago, accompanied by Mrs. Jarrow and a party of friends, visited the executive offices of the Columbia Graphophone Co. in New York after a four weeks' motor trip to various sections of the country, including Ohio, Indiana, Pennsylvania and New York State. While visiting the Columbia offices Mr. Jarrow took advantage of the opportunity to hear Ray Miller and Nora Payes record in the Columbia laboratories and then left for Bridgeport to visit the Columbia factories. Mr. Jarrow is keenly enthusiastic regarding Columbia product and states that he is making plans for an active, healthy Fall trade.

Courtesy means kindness, sympathy, a desire to serve and a willingness to help.

MULTUM IN PARVO

A careful reading of the business publications, a receptive attitude toward real selling ideas and the ability to adopt them and pass them on will do more to bring business back to normal than any number of inspirational appeals or speeches.—Printers' Ink.

WHY BUSINESS MUST IMPROVE

Rank and File of American People Are Saving Money, Thanks to Prohibition, Says One of Our Subscribers—To Resume Buying This Fall

One of our prohibition friends who is a "bull" on the United States, and also on the future of the talking machine business, is looking for an immense demand for talking machines and records when the people get ready to buy, because reputable authorities estimate that before prohibition some three billions of dollars a year was spent by the American people for intoxicating beverages. About 20 per cent of this amount has gone into the savings banks, while the rest has gone into the building of homes and the buying of merchandise, which raises the standard of living of the American people. Next!

INCORPORATES FOR \$200,000

Emerson Phonograph Co., Recently Reorganized, Plans Expansion of Foreign Record Business—Some Jewish, Russian and Italian Issues

The Emerson Phonograph Co., which was recently reorganized, has been incorporated under the laws of the State of New York, with an active capital of \$200,000. The incorporators are the purchasers of the Emerson assets, B. Abrams, Rudolph Kanarek and L. Guth. As announced in these columns, the company will continue the manufacture of Emerson records, confining its activities to its comprehensive catalog of standard and foreign records. Particular attention is being given to the foreign issues and this is to be greatly enlarged in scope. The new releases of the company repeat a series of records that were issued some time back, but were not cataloged, and, in addition, it announces some interesting new records in Jewish, Russian and Italian.

BRUNSWICK SHOP OPENS IN SALEM

SALEM, MASS., August 5.—The Brunswick Shop was formally opened at 60 Washington street, this city, recently by Charles and F. B. Odell. The demonstration booths, service counter, etc., were constructed by the Unit Construction Co. The Brunswick line is handled exclusively.





Superior Tone Quality

Bell Hood Needle

does it

Most natural tone reproductions

Try your favorite record with a Bell Hood Needle

Now selling at 15 cents per package

BELL HOOD NEEDLE COMPANY
183 Church Street, New Haven, Conn., U. S. A.



Made of High Grade
Hardened Steel
Specially Treated
to Give
Frictionless Surface

Reg. U. S. Pat. Off.
No. 995758 which will
be strictly enforced

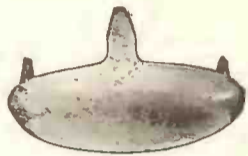
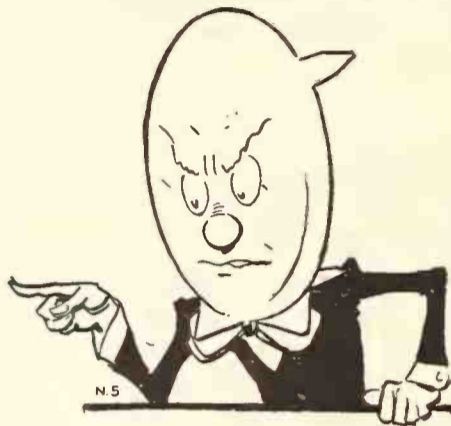

Extra Heavy
Size—1 1/8 in.



7/8 in.



3/4 in.



5/8 in.



1/2 in.



3/8 in.

Furniture Footwear *Silence*

Noise in the home is particularly annoying.
There is but one form of furniture footwear
that permits of furniture being moved silently
and that is

DOMES of SILENCE

Which also has these additional important
qualities which ordinary devices do not possess:

- Economy*
- Simplicity*
- Invisibility*
- Adaptability*—Suitable for covered and un-
covered floors alike.
- Service*— Long wear.

Protection to furniture, floors and rugs.
The perfect footwear for furniture—

DOMES of SILENCE "Better than Casters"

Henry W. Peabody & Co.
DOMES OF SILENCE DIVISION
17 State Street, New York City

In All Your Talking Machine Orders,
Specify DOMES of SILENCE

F 66

*What we say above about Furniture applies also
to Phonographs*

TWO VICTOR RED SEAL CLASSES HELD IN NEW YORK

F. A. Delano Directs Two Most Successful Classes Under the Auspices of the Victor Distributors of Metropolitan New York—Guests of Jobbers at Brighton Beach and Theatre at Close

Two Victor Red Seal sales classes were held in New York during the month of July at the Hotel Pennsylvania, under the direction of F. A. Delano, of the Victor Talking Machine Co. Both of these classes were signally successful, and Mr. Delano was delighted with the attention and consideration given the courses by the Victor

ance at the first, indicating that the dealers keenly appreciated Mr. Delano's efforts to cooperate with them. The second class closed on July 20, and the same program of entertainment was furnished to the members of this class as the entertainment of the previous week.

Mr. Delano received the hearty congratulations

ris Nimcowitz, New York City; Miss E. Cohen, Max Rosen, Brooklyn, N. Y.; J. F. Crosson, Sedgwick & Casey, Hartford, Conn.; H. Cunningham, New York Talking Machine Co., New York City; H. G. Dillon, New York Band Instrument Co., New York City; I. Donlon, Rye Music Shop, Rye, N. Y.; J. B. Elwood, Quackenbush Co., Paterson, N. J.; A. Eskild, Manor Music Co., Brooklyn; F. W. Evans, McManus Bros., Elizabeth, N. J.; V. J. Faeth, Winterroth Piano Co., New York City; D. Feiner, Woodhaven Music Shop, Woodhaven, L. I.; Miss F. L. Fitzgerald, Dunlap Sporting Goods Co., Far Rockaway, N. Y.; Miss M. Fowles, Alfred Fox Piano Co., Bridgeport, Conn.; C. Geller, Montauk Music Shop, Rockville Centre, L. I.; W. Helfer, Paul Helfer, New York City; R. H. Henning, Wm. H. Keller & Son, Easton, Pa.; J. Herchenroder, Ormonde Music Shop, Brooklyn; Miss Heeyde, Baumer Piano Co., New Rochelle, N. Y.; Miss A. Howley, Alfred Fox Piano Co., Stamford, Conn.; James Jenkins, Cool & Schaller, New York City; Sam Kaminsky, Graham T. M. Shop, Brooklyn; G. P. Kasmiri, C. P. Wing Co., New Bedford, Mass.; M. Klaus, Ideal Music Co., Brooklyn; V. Lanzaro, Neopolitan Talking Machine Co., Brooklyn; S. Larschan, L. R. Sherman, Brooklyn; Miss A. Lazarus and Mrs. S. Lazarus, Sol Lazarus, New York City; B. Lehrer, M. Rappaport Music Shop, New York City; A. Lerat, Hyde Music Co., Jersey City; A. Levine, Emanuel Blout, New York City; D. Levine, A. Lesser, Brooklyn; Mrs. I. A. Lynn, R. P. Dunlap, Peekskill, N. Y.; V. McGuinness, McGuinness & McGuinness, Jersey City; Paul McNulty, Kay T. M. Co., New York City; J. H. Mayers, International Phono Co., New York City; H. A. Micha, Traeger's Music House, Stapleton, S. I.; A. A. Miller, Franklin Music Parlors, Englewood, N. J.; R. Montalvo, Jr., New Brunswick, N. J.; A. R. Murray, C. Bruno &



Snapshot of the Attendants at the First Red Seal Sales Class

dealers in the metropolitan territory. All of the Victor jobbers in Greater New York co-operated with Mr. Delano, and a jobbers' committee consisting of Lloyd L. Spencer, Silas E. Pearsall Co.; Fred P. Oliver, Blackman Talking Machine Co., and Chas. B. Mason, New York Talking Machine Co., worked indefatigably in the interests of the classes.

The first class opened on July 10 and the last session was held on July 13. On the evening of that day all of the members of the class were the guests of the local Victor wholesalers at a dinner party held at the Hotel Shelburne, Brighton Beach, followed by a theatre party at the Brighton Beach Theatre. The members of the class, together with the representatives of the jobbers, were conveyed by automobile buses to the Hotel Shelburne, where a delightful shore dinner was served, during which the dancing devotees were given an opportunity to indulge in their favorite pastime. After the close of the performance at the Brighton Beach Theatre the party was conveyed to Manhattan by automobile buses.

On Monday, July 17, the second class opened and it is gratifying to note that the attendance at the second class was larger than the attend-

ance at the first, indicating that the dealers keenly appreciated Mr. Delano's efforts to cooperate with them. The second class closed on July 20, and the same program of entertainment was furnished to the members of this class as the entertainment of the previous week.

Mr. Delano received the hearty congratulations



Those Who Attended the Second Red Seal Class

ditional department, was a visitor, and many of the dealers discussed important educational subjects with her. The Victor jobbers who cooperated with Mr. Delano consisted of the following: American Talking Machine Co., Blackman Talking Machine Co., Emanuel Blout, C. Bruno & Son, Chas. H. Ditson & Co., Knickerbocker Talking Machine Co., New York Talking Machine Co., Ormes, Inc., Silas E. Pearsall Co. and the G. T. Williams Co.

The members of the first Red Seal sales class were: C. N. Abelowitz, Abelowitz Phono Co., New York City; J. W. Ackerly, J. W. Ackerly, Patchogue, L. I.; H. H. Ahrens, Carl Fischer, New York City; R. S. Allen, Ideal Music Co., New York City; Miss E. H. Bann, Lord & Taylor, New York City; L. F. Barg, Crescent Hill Music Co., Brooklyn; F. W. Baumer and F. Baumer, Baumer Piano Co., New Rochelle, N. Y.; Miss E. Beel, R. Montalvo, Jr., New Brunswick, N. J.; J. O. Benton, Lynbrook Music Shop, Lynbrook, L. I.; Miss H. Bjaanes, C. A. Hansen & Bros., Brooklyn, N. Y.; Clem Boling, New York T. M. Co., New York City; Arthur Boxer, University Music Shop, New York City; F. Bullenkamp, New York City; Miss K. R. Burnite, W. N. Burnite, Riverhead, N. Y.; T. A. Cabasino, Corona, L. I.; Miss L. M. Campbell, Mor-

Son, Inc., New York City; H. Nimcowitz, Morris Music Shop, New York City; D. Owens and R. B. Owens, Gibbons & Owens, Brooklyn; Mrs. C. PerLee, John Wanamaker, New York City; W. S. Phillips, W. S. Phillips, Cedarhurst, L. I.; Miss C. Pickett, Kay Talking Machine Co., New York City; C. M. Price, Jersey Music Co., Bloomfield, N. J.; A. B. Ross, Miss Ross and Chas. Ross, A. I. Ross Music Store, Astoria, L. I.; F. B. Roth, E. Leins Piano Co., New York City; I. Schlanger, Henry Mielke, Inc., New York City; Mrs. L. Schlein, Jersey City Talking Machine Co., Jersey City; H. G. Schoennauer, Koch & Droge Piano Co., Brooklyn; Miss E. Scholl, Fred G. Scholl, Woodhaven, L. I.; S. L. Schott, S. L. Schott, Inc., Mt. Vernon, N. Y.; Miss E. Schultz, Hunts Leading Music House, White Plains, N. Y.; E. Schwartz and Mrs. M. Schwartz, Schwartz & Chakrin, Brooklyn; H. E. Schweiger, E. A. Schweiger, Brooklyn; W. H. Shearer, Arthora Music Shop, Brooklyn; E. M. Sheetz, Blackman Talking Machine Co., New York City; Al Siegel, A. H. Mayers, New York City; S. B. Simms, Weil Bros., New York City; G. Sinisgallo, Max Rosen, Brooklyn; H. L. Smith, Brooklyn; H. Steinhart, Jacob Piano & Phono. Corp., Brooklyn; Miss Stevens, F. F.

(Continued on page 58)

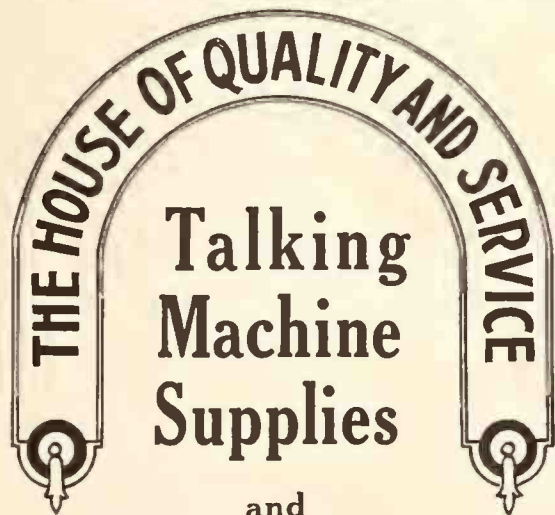

and

Repair Parts

SAMUEL ESHBORN

65 Fifth Avenue
New York

C. R. JOHNSTONE
VICE-PRES., GEN. MGR.

THE BELL RECORDING CORP.,

Associated With National Metals Depositing Corporation

BEST RECORDING
EXPERIENCED SPECIALISTS
LOUD AND CLEAR
LAST WORD IN QUALITY

9 East 47th Street, New York City

We Specialize in Private Recording

and

General Recording for the Phonograph Trade

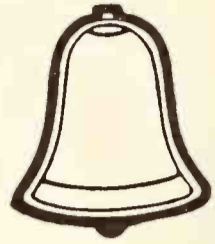

TWO VICTOR RED SEAL CLASSES

(Continued from page 57)

Herrman Talking Machine Corp., Port Richmond, S. I.; Miss L. Sweeney, James Donnelly, So. Norwalk, Conn.; T. Tollefson, S. Kjeldsen, Brooklyn; E. M. Veith and H. T. Veith, Franklin Music Parlors, Englewood, N. J.; Miss A. Wernick, L. Wernick, Holyoke, Mass.; Harry Wernick, Holyoke Phonograph Store, Holyoke, Mass.; W. R. Wielage, Whitehall Co., Jamaica, L. I.; Miss H. Wylie, Wm. Berdy, Brooklyn; Miss E. Zapf, Fred G. Scholl, Woodhaven, L. I.; Miss D. Zvirin, Jacob Zvirin, Larchmont, N. Y.; Helen T. Coffman, Cool & Schaller, New York; M. Strangfeld, Empire Music Co., New Rochelle.

Those Who Attended the Second Class

The members of the second Red Seal class consisted of the following: Miss A. Allstrom, Muklijohn Piano Co., Providence, R. I.; M. Bachenheimer, Joseph Donlan, New York City; H. B. Baggett, Ormonds Music Shop, Brooklyn, N. Y.; Miss Tilly Bahnert, White Music Shop, Danbury, Conn.; Geo. A. Baker, Blackman Talking Machine Co., New York City; E. Bartels, Chevalier's, Inc., Brooklyn; H. L. Behrman, Savoy Music Shop, New York City; Wm. Berdy, Brooklyn; Albert Bersin and Miss R. Bersin, Albert Bersin, Brooklyn; John H. Bieling, Hempstead, L. I.; W. H. Bishop, Blackman Talking Machine Co., New York City; Barrie C. Bloedon, C. Bruno & Son, Inc., New York City; I. Bobowick, Island Musical Shop, Coney Island; Edw. G. Brown, Jr., E. G. Brown, Bayonne, N. J.; Gus Brown, Baumer Piano Co., New Rochelle, N. Y.; Miss Ruth A. Burke, Norman A. Burke, Nyack, N. Y.; C. Caradaglies, Greek American News Co., New York City; Miss M. Cocharan, Empire Music Co., New Rochelle, N. Y.; Wilson R. Casell, New York Talking Machine Co., New York City; T. T. Cavanaugh, Ideal Music Co., New York City; Geo. L. Cooper, Dunlap Sporting Goods Co., Far Rockaway, N. Y.; Mrs. Arthur

Dunkerley, Dunkerley & Co., Passaic, N. J.; R. P. Dunlap, Peekskill, N. Y.; Mrs. V. J. Faeth, Winterroth & Co., New York City; Fred E. Fuller, M. Rappaport's Music Shop, New York City; M. Goldblatt, Park Slope Talking Machine Shop, Brooklyn; Miss F. Goldfinger, Liberty Music Shop, New York City; Moe Goldsmith, M. Goldsmith & Son, New York City; David Goran, Morris Goransky, Miss S. Goransky and Charles Granett, Yenkens Talking Machine Co., Yonkers, N. Y.; Max Hanover, Talking Machine Shop, Norwich, Conn.; Sidney Helfer, Paul Helfer, New York City; William Herchenroder, Ormonde Music Shop, Brooklyn, N. Y.; F. F. Herrmann, F. F. Herrmann Talking Machine Corp., Stapleton, S. I.; Miss Edna Hoffer, Baumer Piano Co., New Rochelle, N. Y.; Fred R. C. Hoffmann and Mrs. M. A. Hoffmann, Hoffmann's Music Shop, Valley Stream, L. I.; Miss Hulst, Frederick Loeser & Co., Brooklyn; J. A. Johnson, Ormes, Inc., New York City; Jos. C. Kerr, Emanuel Blout, New York City; Miss Alice Kripe and Miss Ella McLean, Frederick Loeser & Co., Brooklyn; A. Koslitz, Fred Ponty, Portchester, N. Y.; John Lanzaro, Neapolitan Talking Machine Co., Brooklyn; Raoul Larue, Muklijohn Piano Co., Woonsocket, R. I.; H. C. Littlefield, Sedgwick & Casey, Inc., Hartford, Conn.; Horace Lubin, Schwartz & Chakrin, Inc., Brooklyn; William Luscher, Luscher's Music Shop, New York City; Sol Mahl, Modern Music Shop, Brooklyn; Miss M. C. Manley, Quackenbush Co., Paterson, N. J.; Geo. Martin and Wm. W. Miller, G. T. Williams Co., Brooklyn; Frederick Merritt, Ponty's Art & Gift Shop, Greenwich, Conn.; J. P. Middleton, Pittsfield, Mass.; Harry Meyers, Meyers Store, Pittsfield, Mass.; Miss H. M. Moses, The Carpenter Co., New York City; James Murray, McManus Bros., Elizabeth, N. J.; Miss Rena Nathan, White Hall Co., Jamaica, L. I.; Phil Palatrack, A. H. Mayers, New York City; Miss Ella V. Peck, Gunther-Kenny, Inc., Middletown, N. Y.; C. B. Perry, Ideal Music Co., Brooklyn; Theo-

dore Peyser, S. B. Davega Co., New York City; Mrs. May Relyea, H. L. Schott, Inc., Mt. Vernon, N. Y.; Paul Rescouis, Woodhaven Music Shop, Woodhaven, L. I.; J. Rosenberg, Max Davis, West Hoboken, N. J.; Albert I. Ross, A. I. Ross, Astoria, L. I.; Mrs. Leo Schlein, Jersey City Talking Machine Co., Jersey City, N. J.; Mrs. Rex L. Schott, S. L. Schott, Inc., Mt. Vernon, N. Y.; A. V. Schouler and Miss E. M. Schouler, A. V. Schouler, Inc., New York City; I. Seldin, Montauk Music Shop, Rockville Centre, L. I.; Miss Sophie Sherry, Carl Fischer, New York City; Chas. S. Simonson, Lynbrook Music Shop, Lynbrook, L. I.; Miss D. Smith, New York Band Instrument Co., New York City; Herman Spitz, Sag Harbor Music Shop, Sag Harbor, N. Y.; Miss F. Steadman, Frank Steadman, Yonkers, N. Y.; H. E. Terhune, Haverstraw, N. Y.; Frank W. Tillinghast, Kay Talking Machine Co., New York City; Miss L. M. Tisch, Adam B. Tisch, Elmhurst, L. I.; Wm. R. Tyler, Lord & Taylor, New York City; Edward Ugast, Ludwig Baumann & Co., New York City; Miss E. White, White Music Shop, Danbury, Conn.; I. Wolfson, M. Goldsmith & Son, New York City; Milton P. Young, Harmony Talking Machine Shop, Brooklyn; Marie R. Zak, James Donnelly, South Norwalk, Conn.; Miss J. Ziemkewicz, Dunkerley & Co., Passaic, N. J.; William Zvirin, Jacob Zvirin, Larchmont, N. Y.; Gus Sclafani, LaScala Phonograph Co., New York.

CANTLON PIANO HOUSE TO MOVE

GREAT FALLS, MONT., August 2.—The Cantlon Piano House, 415 Central avenue, will move into more advantageously located quarters next to the Hotel Rainbow on August 5. In addition to the Knabe and other high-grade pianos handled, the A. B. Chase line was recently added by this concern. Musical merchandise, including talking machines, records, sheet music, etc., is also handled.

NATIONAL METALS DEPOSITING CORPORATION

FACTORY
34 East Sidney Ave., Mt. Vernon, N.Y.
Telephone: Oakwood 8845

MOUNT VERNON — NEW YORK
MANUFACTURERS OF

LABORATORY
415 Fourth Ave., New York, N.Y.
Tel. Madison Square 6635



WE DEPOSIT THE
FINEST COPPER
IN THE WORLD

FOR YOUR CONVENIENCE
DELIVER RECORDED WAX
TO OUR LABORATORY



OUR
IMPROVEMENT
ALL STAMPERS
HAVE
HIGHLY POLISHED
MACHINED BACKS



Appealing to the Individual Record Buyer

By GEORGE FOSTER PARSONS

Accurate analysis by the dealer of his prospect list is necessary if maximum results are to be obtained. There are many dealers who, realizing the value of the prospect list, obtain the names of people visiting their stores and who send the customary literature descriptive of the machines and the monthly record supplements each month and let the matter go at that. There are some who send canvassers and salesmen to sell both records and machines, but in the majority of cases this is as far as the merchant goes.

How many talking machine dealers have taken advantage of their opportunities and have analyzed their prospect lists in an endeavor to learn just what the significance of the name which they have secured means? It is a safe venture to say that the number is comparatively few. Probably not one talking machine merchant in ten has stopped to think that for each name at hand from two to six more can be added in the majority of instances by the expenditure of very little effort. Each name on the dealer's list represents only one unit of a family and it is also safe to assume that in most families there are a variety of tastes in music which the wise dealer can turn to his advantage through catering to the musical tastes of the individuals in the family.

What pleases son and daughter may be entirely at variance with the musical likes of father and mother. It is up to the dealer to gain the knowledge which will enable him to increase his sales in this manner. With the wonderful variety of music recorded by the various companies every musical taste can easily be satisfied. Jazz, hymns, light classics, operas, etc., they all have their admirers and in one family may be found devotees of each of these classes of music. The practice of many merchants of sending special lists of records to customers containing music designed to please each individual can easily be amplified so that several individuals in one family will receive lists of the records which will appeal to each. In

other words, if the members of the family are particularly fond of operas or hymns special lists of recordings of these numbers should be sent to them and if dance music appeals to the younger element the special list should be confined to records of this character. This same method could also be followed in using the telephone for drawing the attention of customers to certain records.

BUSINESS WAKING UP, SAYS EDISON

American Manufacturers Making Study of Cost of Doing Business

"For the first time in his life the American manufacturer is beginning to know what it costs him to run his business, and he's beginning to appreciate that it isn't the first cost, but the last cost that really counts," declared Thomas A. Edison, in a recent interview, pointing out, at the same time, that the English and Germans do business on a "much firmer basis."

"When a German manufacturer puts up a building he builds for all time—solid, tremendous foundations, tessellated floor and everything possible to make for permanence. When we build a factory we build a shack," the inventor said.

"This hurry to get wealth was the fundamental basis upon which the American manufacturer went into business. Put as little as you can in, get as much as you can out. But it's changing now. We were beginning to see that it doesn't pay for one thing, and then there is more available money. The American manufacturer is beginning to wake up."

INTRODUCE NEW TONE ARM

Mutual Phono Parts Co. Introducing New Product Particularly Adapted for Portable and Upright Machines—Business Is Improving

The Mutual Phono Parts Co., New York City, has placed on the market a new tone arm, which is described as particularly adaptable for portable and upright machines, known as the IA tone arm. It ranges in size from seven inches to eight and one-half inches and has a straight tone passage from the reproducer to the tone chamber. It is claimed that this new tone arm has exceptional tone value. It has already met with much favor with the trade and it is reported that dealers and manufacturers are placing good-sized orders for the same.

Andrew Frangipane, secretary and general manager of the company, reports that business is now on the increase and so far results have been very gratifying. He states that indications point to a prosperous Fall and Winter.

FEATURES VICTROLA ON FINE FLOAT

BLAIR, NEB., August 3.—An exceptionally fine Victor float was featured in the Fourth of July parade here by James Mose, Victor dealer and one of the most aggressive talking machine merchants in this vicinity. A console type Victrola was placed on the rear of a handsomely decorated automobile and a large Victor dog occupied a prominent position on top of the auto hood, while smaller dogs graced the front of the float.

TAKE OVER VICTOR DEPARTMENT

HERKIMER, N. Y., August 1.—Rudd & Rex have bought the Victor department of the Keefe Co., of this city. The entire department will be moved to the headquarters of Rudd & Rex, but the Keefe Co. will continue the merchandising of small goods and other musical instruments in which it has built up a large business.

The Radio Symphony Phonograph Co., of Huntington, W. Va., was recently incorporated in that State, with a capital of \$500,000.

PORTABLE PAL PHONOGRAPH

An all-year-'round phonograph—particularly adapted for portable use!

PAL'S excellent quality and beautiful appearance make it as suitable a phonograph for the home as it is for outdoor use.

The guaranteed motor is smooth running—long lasting! The tone arm and soundbox could not be improved upon. The tone is sweet, clear—as strong in volume as the regulation cabinet size.

The finish is beautiful—walnut or mahogany; with nickel-plated hardware. (Each machine is equipped with a twelve-pocket album.)

That gives it quality—the quality which is the lever for an all-year-'round portable business. It offers people an excellent phonograph at a price they are willing to pay.

This means good business—something that you have been waiting for. Write us. TODAY!

Dealers' price \$20.00

F. O. B. New York

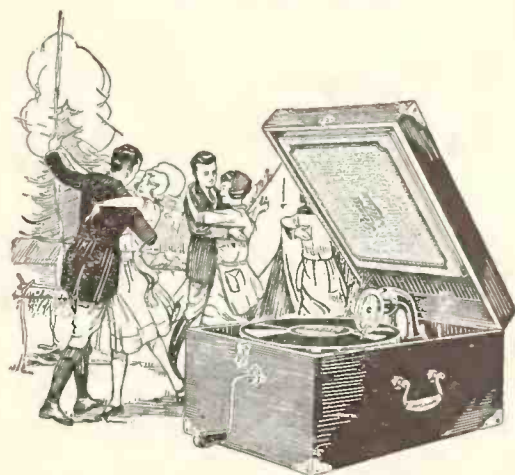

Plaza Music Co.
18 West 20th St. New York

PLAZA MUSIC CO.

(Portable Division),

18 W. 20th St., New York

Please send complete details on the "PAL" portable.

Name

Address

City State

H. N. McMenimen

Consulting Engineer

Consultation by appointment on every phase of the phonograph industry, including:

Recording, Plating and Pressing

Motor, Tone-Arm and Reproducer Design

Patent and Model Development

Sales Promotion and Advertising Plans

Laboratory:

Scotch Plains, N. J.

Tel. Fanwood 1438

Offices:

2 Rector Street, New York

Tel. Rector 1484

T O L E D O

Dealers Consider Plans for Fall Activities—Railroad and Coal Strikes Affect Trade—The News

TOLEDO, O., August 7.—Talking machine merchants are persistent in their efforts to obtain all possible Summer business before the warm weather comes to an end, and while the vacationist is in the buying mood. They are not overlooking the turn of the year, however, and are giving close attention to Fall plans.

The railroad and coal strikes are having some effect on a few industries in that the delivery of freight has slowed up, hampering deliveries of musical instruments to some extent. None of the large local industrial plants has as yet curtailed production or reduced its working forces.

Announces New Victor Model

Announcement is made by the Toledo Talking Machine Co. of the new Victor model No. 111, which is to take the place of No. 110, which will be discontinued. This new machine will be available in October, according to Chas. H. Womeldorff, general manager.

Adds Pathé Records

At the LaSalle & Koch Co. Victrola Shop a marked increase in July sales was experienced, R. O. Danforth, manager, declares. This growth amounted to fully 25 per cent over July, 1921.

One of the contributing factors of the July increase, it is believed, was the changing around of the departments and placing those which naturally fit together in close proximity to one another. Such a move took place on the seventh floor where the Art and Gift Shop, one of the finest in the State, is now a neighbor of the Victrola department.

The Actuelle-Pathé line of fifty-cent records was added during the past month and has proved a big winner. The Madison portable, an imported model, was offered as a special recently, and moved so rapidly that the entire lot was sold within a few hours.

Fine Victor Business at Lion Store

The Lion Store Victrola rooms recorded a fine increase for July, Manager A. J. Pete reports. This showing brings the total sales for the seven months up to a point which has exceeded expectations. Seasonable merchandise has played a leading part in putting Summer sales ahead. At no time within recent years have so many port-

able machines been sold. Many of these small machines will be exchanged in the Fall for larger instruments.

Moreover, store events had much to do with making the favorable showing possible. For example, a recent sale day—Dollar Day—which is a seasonable event, proved a big factor in closing talking machine sales. This showing explodes a theory often heard that a talking machine department cannot hook up with store events to advantage. These sale days always draw large crowds to the store and offer a golden opportunity for the Victrola rooms to share in the benefits of the occasion.

The annual store field day held July 19 at Sugar Island was attended by 1,700 employees and friends of the store. Among the prize events was a waltz. This was won by Orville Schaffer, of the Victrola rooms. This marks the third consecutive season that this section has won the dance prize.

Grinnell Bros. Plan Fall Drive

At Grinnell Bros. July sales were double those of last year during the same period, and the outlook for a continued run of business was never brighter, R. C. Elwell, manager of the Victrola department, states. Plans are in formation for an early Fall drive for talking machine volume. The farmer as well as the city dweller will be solicited. New equipment has been ordered in order to facilitate the campaign.

Henry F. Stucke, general manager of Grinnell Bros., is angling for the finny tribe in the Au Sable River in northern Michigan.

Downstairs Store Aids Sales

The downstairs store recently inaugurated by the Goosman Piano Co. is proving a great aid to closing talking machine sales. By starting customers with the used and repossession instruments and then showing them the newer finishes and designs it is often easier to secure the signature on the dotted line, whereas if the reverse process is employed folks sometimes feel they cannot afford a machine which involves such a large outlay.

Merchants Enjoy Outing

Fred N. Goosman, president of the Goosman Piano Co., was chairman of the Retail Merchants' Board entertainment committee for the annual outing, which was held at Monroe, Mich., July 25. Thirty automobiles transported the group. Practically every music dealer in the city is a member of the Board.

Good Business at Compton Bros.' Stores

The Record Shop, one of the Compton Bros. chain of stores, is experiencing an improved de-

mand for records, Pratt Egbert, manager, declares. Brunswick, Vocalion and Kimball machines are dealt in. At the Findlay, O., store a steady run of business has been recorded nearly all year. The Carey, O., shop is experiencing an awakening in the demand for machines.

Exhibits Laddie Boy's Cake

At Grubbs Music Shoppe, the birthday cake sent to Laddie Boy, President Harding's famous Airdale, by Chas. Quetschke, of the Caswell Kennels, breeder of the canine, was on exhibition and drew wide interest. The cake is a three-tier affair, built up pyramid fashion and mounted by three birthday candles. It was made of dog biscuit held together by red, white and blue ribbons.

New Da-Lite Displays

The Da-Lite Electric Display Co., 116 North Erie street, announces the following panel releases for August: "Lonesome Mama," "Nobody Lied," "Neath the South Sea Moon" and the Victor Physical Exercise records.

At the J. W. Greene Co. the Victor panel sign enumerating ten records which should be in every home is the center of attraction in a very effective window display. Each of the ten records is exhibited mounted upon a stand. A ribbon is extended from the panel title to each record, thus connecting the two. This window has brought a volume of sales greater than expectations, according to E. A. Kopf, manager of the department.

Farmers Again in Market

At the J. W. Greene Co. branch stores in Fostoria, Fremont and Stryker, O., the farmer is again becoming a buying factor. His crops are maturing and prices are favorable to him. With the abundant yield of nearly all farm products the outlook for a brisk Fall trade is very promising.

Ohio Merchants to Meet in Toledo

The Ohio Music Merchants' Association, of which Fred N. Goosman is president, will hold its annual convention at the Hotel Secor, Toledo, September 26 and 27. Rex Hyre, of Cleveland, secretary of the Association, recently made a trip to Toledo for a conference with the president and to complete arrangements for the convention.

Henry Dreher, Cleveland, and Chas. Yahrting, Youngstown dealers, challenged any two members of the Association to a golf match during the convention. Their challenge has been accepted by Wm. R. Gaul and A. M. Dom, both of Cincinnati.

The Toledo Music Merchants' Association, of which Henry F. Stucke, manager of Grinnell Bros., is president, will co-operate with the State organization to make the convention one long to be remembered.

News Brieflets

Doyle N. Wyre, formerly assistant to A. J. Pete, manager of the Lion Store Victrola rooms, and more recently in charge of the electrical shop, on August 1 assumed the position of manager of the Victrola department of the McAlpin store, Cincinnati, O.

Henry Dreher, president B. Dreher's Sons Co., Cleveland, was a caller recently on Fred Goosman.

Warren E. Kellogg, representative of the Toledo Talking Machine Co., and family are motoring in western Pennsylvania.

W. C. Wiant, Marion, O., Victor dealer, wife and son are enjoying their vacation in the wilds of Canada.

C. A. Ericsson, president of the Toledo Talking Machine Co., spent a few days in Toledo on his way East from the Pacific Coast.

Geo. Schweitzer, Victor dealer, Leipsic, O., made an extensive motor trip East. Stops were made at Washington, Baltimore, Philadelphia, New York and other centers.

Chas. H. Womeldorff recently returned from a business trip to Indiana and Ohio points. He found crop conditions very good and the Fall outlook promising.

A. L. Leyborn, of the Toledo Talking Machine Co., recently occupied his new cottage on the Toledo Beach line on Lake Erie.

KIMBALL Phonographs

Invite good customers and Ready Sales

Because the line is attractive from a business-getting standpoint and is thoroughly reliable the Kimball is the phonograph for the dealer who is building wisely and well.



Style R
Equipped with Albums
37 in. High 40½ in. Wide
23½ in. Deep

Write for Agency terms and the Kimball direct co-operative plan for financing sales.

Variety of Models in Console and Upright types.

W. W. KIMBALL CO.

306 So. Wabash Ave.

Kimball Bldg.

CHICAGO

Manufacturers of Phonographs, Pianos, Player-Pianos, Pipe Organs, Distributors of Okeh Records.





THE ORSENIKO PERIOD PHONOGRAPH



QUENBY WALNUT

Reproduction of an English Piece
 Front doors and side panels made
 of beautiful burl walnut. Note
 particularly the graceful sweep
 of the hand-carved legs. No detail
 of construction omitted; its work-
 manship is of the highest order.

Are your windows and showroom in the mediocre
 class? A selection from our line will create new interest
 in your display and put you in the progressive class.

The same model as above, only
 finished in lacquer, with decora-
 tions done by real artists. Fin-
 ished in antique cracked effect,
 which gives it an unusual charm.



QUENBY LACQUER

THE ORSENIKO COMPANY, Inc.

Showroom: 112 West 42nd Street
 New York City, N. Y.

Factory: Skillman Ave. and Rawson St.
 Long Island City, N. Y.



SALT LAKE CITY

*Industrial Outlook Brighter—Greater Activity Among Local Dealers
—Radio Much Discussed—Plans Under Way For Music Week*

SALT LAKE CITY, UTAH, August 4.—The industrial outlook grows brighter than ever. The big steel project talked of so long is an accomplished fact. A \$15,000,000 corporation has been formed and a large plant will be built at Springville in the near future. The actual manufacture of steel is expected to be under way in eighteen months or less. The crops look excellent with prospects of fair prices and everyone is looking for a better Fall business than has been enjoyed for some time.

An announcement of considerable interest is to the effect that the big Salt Lake Hardware Co. on Main street, which has been enjoying an annual business of millions, is to drop its retail departments and confine its attention entirely to the wholesale business. The company has been selling talking machines for some time, but it is not known yet whether they will continue to handle them on a wholesale basis. Vice-president and General Manager H. A. Schweikhart tells your correspondent that no immediate changes would be made, but confirmed the report that the building had been sold and that it was the intention of the company to confine its attention to the wholesale end of the business. He said he had thought for a long time that the retail business should not be connected with the wholesale.

The Glen Bros.-Roberts Piano Co. is supplying the Telegram broadcasting station with records for their talking machine music. Miss Nan Browning is giving a series of piano recitals.

The Daynes-Beebe Music Co. had one of the best windows during the early part of the month that has been seen in any music store here for a long time. It was an advertisement for the

portable talking machine and represented a young lady listening to an instrument as she sat beside the campfire. The scene was in the canyon and it was a most realistic one and attracted a lot of attention.

The Christensen Ashton Music Co., 2381 Hudson avenue, Ogden, has been offering records at a special sale.

The Lyric Music Co., Washington avenue, Ogden, has given up all other talking machine lines, but will retain the Sonora agency. Miss Bernice Foster is leaving the company. Miss Foster said she did not know just where she would go, but wanted to get into an exclusive Victor house. She is a capable and charming young lady.

Harry O'Loughlin, president, and "Ukulele" Hughes, manager of the small goods department of O'Loughlin's, Main street, are planning a fishing trip in the Duchesne country, southern Utah.

A prominent local radio concern is advertising "Better than a talking machine and practically no expense for upkeep." This message is, to a large extent, bunk. Some of the dealers, however, say radio is helping them. They report orders where people have asked for a certain record that they have heard on the radio.

Miss Ethel Karney, of O'Loughlin's for several years past, has married a local business man and, as a result, resigned her position with the firm.

George A. Bolduc, popular manager of the Glen Bros.-Roberts Piano Co.'s talking machine department, has accepted an important position with the Larson Music Co., Sidney, Neb. Friends in this city are sorry to part with Mr.

Bolduc. He was regarded everywhere as a fine, likable fellow and a good business man. Mr. Bolduc's successor has not been appointed yet. Another change in the department is the appointment of Miss A. Hillstead in the place of Miss Bessie Jackson, head of the record department, under Mr. Bolduc. Miss Jackson has gone to Montana.

Col. J. J. Daynes told the correspondent recently that he looked to a combination radio and talking machine to solve the radio problem for talking machine men. Colonel Daynes, who is, of course, the head of the big Daynes-Beebe Music Co., did not think radio would hurt the phonograph business.

George S. Glen has resigned as president of the Utah Association of Music Industries and is succeeded by Charles H. Norberg, treasurer of the Daynes-Beebe Music Co. Mr. Glen said he thought a Salt Lake man should hold the position as practically all the meetings are held here, and Ogden is thirty miles away.

Plans are under way for Music Week, which will be held in the Fall, but so far no definite program can be announced.

Salt Lake City celebrated its diamond jubilee on July 24.

VISITORS AT COLUMBIA OFFICES

Among the recent visitors at the executive offices of the Columbia Graphophone Co. was S. H. Nichols, manager of the company's Pittsburgh branch; Fred E. Mann, manager of the Boston branch, and W. S. Parks, manager of the Baltimore branch. All of these out-of-town managers were optimistic regarding the business outlook, stating that the dealers were preparing for an active Fall trade. Another caller at the Columbia executive offices was Miss M. Gross, assistant bookkeeper of the Cincinnati branch, who is spending her vacation in the East and who dropped in at the Columbia offices in order to become acquainted with the executive organization.

How to Increase Your Sales and Decrease Overhead

The particularly desirable elements of foreign-born population residing in Northern New Jersey and Northeastern Pennsylvania afford Collings dealers a lucrative market for the famous Victor foreign records.

If a dealer is not cultivating the possibilities open in the newly-enlarged Victor foreign repertoire, he is not getting either the volume or the net profit from his operations that he very easily can.

Let us go over this matter with you.

COLLINGS & COMPANY

Victor Distributors throughout Northern New Jersey and Northeastern Pennsylvania

Clinton & Beaver Sts.

(Plum Building)

Newark, N. J.

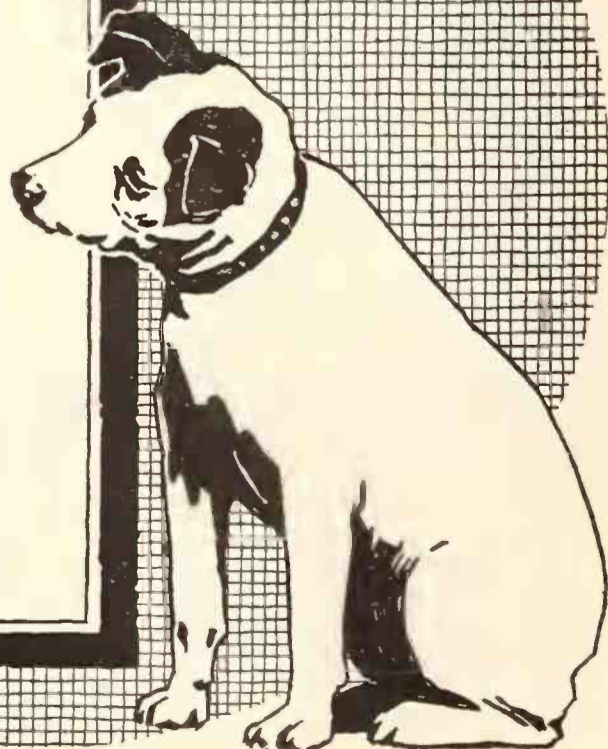

THE OLDEST, LARGEST EXCLUSIVE RADIO EQUIPMENT MANUFACTURERS ANNOUNCE A NEW TRADE NAME FOR THEIR LINE

Radak

Trademark Reg. U. S. Pat. Off.

RADIO has come to stay! And RADAK is going to hasten the process of stabilizing the radio equipment business.

The Clapp-Eastham Company has spent sixteen continuous years of exclusive radio specialization, working in the interests of radio professional and amateur alike. Now their experience and manufacturing skill are to be turned to the advantage of the dealer.

In announcing the adoption of the new trade name RADAK, Clapp-Eastham announce also the distribution of RADAK Receiving Sets and other radio equipment through jobbing distributors exclusively. These distributors will quote discounts to the dealer direct. And the new distribution plan enables the dealer to secure the maximum discount without quantity stipulation.

Advertising to a 25,000,000 Audience

The adoption of the new trade name RADAK gives the dealer an easily remembered, quickly identified line of merchandise for his store. To stimulate the process of identification, a new and more widespread advertising program has been entered upon.

A consistent schedule on a yearly basis is under way in the following publications, reaching a receptive audience of well-to-do individuals in varied lines of occupation.

Saturday Evening Post.....	2,100,000	Copies
American Magazine	1,634,000	Copies
Farm Journal	1,012,000	Copies
Country Gentleman	829,000	Copies
Farm & Fireside.....	803,000	Copies
Successful Farming	862,000	Copies
Radio News	125,000	Copies
Wireless Age	45,000	Copies
Radio	60,000	Copies
Q. S. T.....	17,800	Copies

A very conservative estimate of four readers to the copy per magazine gives a total of well over 25 million people reached by this list.

Let's Get Together

RADAK spells opportunity. Opportunity for every wide-awake dealer. Look into it. RADAK will soon become a household word. Make your store the RADAK headquarters. If you do not know the RADAK distributor in your locality, write us for the name and address.

CLAPP-EASTHAM COMPANY

America's Oldest, Largest Makers of Radio Equipment Exclusively, Established 1906

131 Main Street, Cambridge, Mass.

REGENERATIVE RECEIVING SETS AMPLIFIERS VARIOMETERS CONDENSERS
RHEOSTATS AMPLIFYING COILS UNIVERSAL TUBE SOCKETS
ELECTRO AMPLIPHONES

READ WHY CLAPP-EASTHAM EQUIPMENT SELLS

THESE ARE UNSOLICITED COMMENTS FROM RETAILERS

SEVER-BEACHAM RADIO COMPANY
 Santa Fe, New Mexico

"Some time ago we purchased one of your Type H. R. Regenerative Receivers and Two-stage Amplifier used in connection with a Magnavox. This outfit has brought in more stations and longer distance than any set we have handled. Everybody else in the surrounding country with more expensive outfits than ours is not getting results this time of the year, and we still hear the broadcasting stations as usual. We have heard Cleveland, Ohio, many times, which is about 2,000 miles, I should think. This was news and music, not wireless. We hear all the stations within a radius of 1,000 miles every night."

KEHLER RADIO LABORATORIES
 Abilene, Kansas

"We have just recently been testing your improved regenerative sets and wish to state that we think they are a little wonder. For signal strength they are unexcelled by any of the highest priced sets on the market and are superior to some in this respect. They are also the least critical in tuning of any set which we have operated, as well as comparing favorably in selectivity. We are surprised at the absence of capacity effects from the body. We have a set in operation in our display department in the heart of Abilene, and with but two stages of audio-frequency amplification and a large magnavox, music and speech may be easily heard within a block of the horn which is

placed in the doorway. We have decided to specialize on this set, due to its reasonable price and its remarkable performance."

HOWARD S. BARLETT
 Knox, Pa.

"Am writing to you direct to compliment you on your Type H. R. Receiver and your Two-step Amplifier. They are the most wonderful receivers that there are on the market today. I have had them set up along with other standard makes that cost double and triple the price of yours, and will say that spark C. W. and voice come in over it more clear than with any of the rest. The only trouble that I find with them is to get them. I do my buying in Pittsburgh and the distributors are out of them."

OUTING OF TALKING MACHINE MEN AN IMMENSE SUCCESS

Members of Progressive Retail Organization From New York, New Jersey and Connecticut Have Most Enjoyable Time at Glen Head, L. I.—Manufacturers and Jobbers in Evidence

The largest Summer gathering in the history of the Talking Machine Men, Inc., was held on Wednesday, July 26, at Karatsonyi's, Glen Head, L. I. Members of the organization came from New York, New Jersey and Connecticut and a splendid representation from the Eastern talk-

ball game of dealers was played, following which two teams selected from the ranks of the jobbers played a three-inning game. The dealers' teams were captained by Irwin Kurtz and Sol Lazarus; the latter faction carrying off the honors. The winning team was composed of

Forster, of the Brilliantone Steel Needle Co., and M. W. Owens, of Owens & Gibbons. The Forster aggregation, after a bad start, made a whirlwind finish and won the game handily. E. F. Latham, of the Silas E. Pearsall Co.; W. J. Haussler, of C. Bruno & Son, Inc., and Paul Carlson, of Chas. H. Ditson & Co., were the shining stars of the jobbers' performance.

Following the ball game the track and field events were programmed. David Goldman, auditor of the General Phonograph Corp., proved



Some Snapshots at Outing of the Talking Machine Men, Inc.

No. 1. A. H. Murray, Mrs. Bloedon, Jack Bliss, Florence Hulett, E. B. Bloedon and Mrs. Bliss. No. 2. Phil Ravis, I. Halperin, George Seiffert. No. 3. C. L. Price, of Ormes, Inc.; W. H. Bishop, Blackman Talking Machine Co.; George Kelly, New York Talking Machine Co.; Lloyd Spencer, Silas E. Pearsall Co. No. 4. Jack Glogau. No. 5. William H. Ross and Elias Gottfried, winners of the three-legged race. No. 6. E. L. Sampter, William Brand, Miss A. M. Kennard and George Seiffert. No. 7. Miss Sadie Goldman, of the winning relay team for men and women. No. 8. Miss E. Goldman, winner of one of the ladies' events. No. 9. Ann Lazarus, daughter of Sol Lazarus, who won the ladies' 40-yard dash.

ing machine jobbers and manufacturers also attended. Sight-seeing buses and private autos left East Fifty-seventh street shortly after 10 o'clock in the morning, proceeding over Queensboro Bridge and the beautiful Long Island roads to the resort, where, upon arrival, a luncheon was served.

In the forepart of the afternoon a four-inning

Messrs. Bersin, Zimmer, Goldman, Brodbeck, Jacobs, Gordon, Guthrie, Barg and Radle. It was rumored that the other team had several "ringers," but despite this it went down to defeat. The losing team was composed of Messrs. Bliss, Bloedon, Present, Kramer, Kurtz, Janeli, Hoffman, Titefsky and Murray.

The jobbers' teams were captained by Byron

himself to be the star all-around athlete by winning the seventy and forty-yard dashes. Oscar Zipf won the fat man's race; M. Brodbeck, H. A. Jacobs, B. Birnbaum and Ed Ugast won the four-man relay race. Miss Sadie Goodman and Mr. Ugast also won the relay race composed of teams for men and women. The forty-yard

(Continued on page 66)



New Model "E"

The General Phonograph Mfg. Co.

Model "E" TABLE PHONOGRAPH

The Greatest Value on the Market

IMMEDIATE DELIVERIES IN ANY QUANTITY

Plays All Makes of Records

Superior Tone Quality

Write for our Proposition

The General Phonograph Mfg. Co.

ELYRIA, OHIO

STEGER

*the finest reproducing
Phonograph in the World*

THE highest praise of the artistic Steger comes from those who are the most critical judges of music.

Dr. Anthony C. Lund, famed as the conductor of the celebrated Tabernacle Choir, has enthusiastically endorsed the Steger, as have Professor J. J. McClellan, organist; Professor Willard E. Weihe, violinist, and hundreds of other musicians and music-lovers.

Listen to a piano record on the Steger, a band, an orchestra, the human voice—and in all the reproductions you will recognize the distinctive qualities of excellence due to the exclusive Steger features. The patented, adjustable tone-arm, which plays all makes of disc records correctly, without change of parts, the unique tone reproducer and the vibrant tone-chamber of even-grained spruce are eloquent reasons for Steger supremacy.

INSURE YOUR SUCCESS

The strong advertising and sales co-operation plan back of the Steger makes Steger representation valuable to the aggressive dealer. Write to-day for details of the Steger proposition and a copy of our latest style brochure.

Phonograph Division

STEGER & SONS

Piano Manufacturing Company

Established by John V. Steger, 1879

Steger Building, - - CHICAGO, ILL.

Factories: Steger, Illinois, where the "Lincoln" and "Dixie" Highways meet.

"If it's a Steger—it's the most valuable Piano in the world."

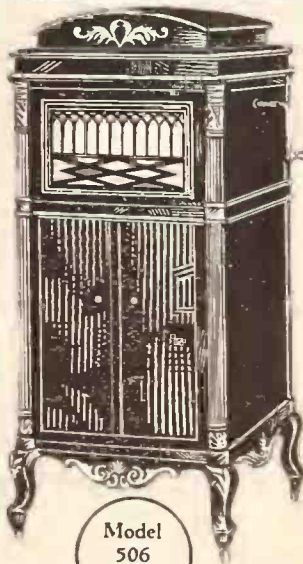

Model 506
\$250



Model 505
\$200

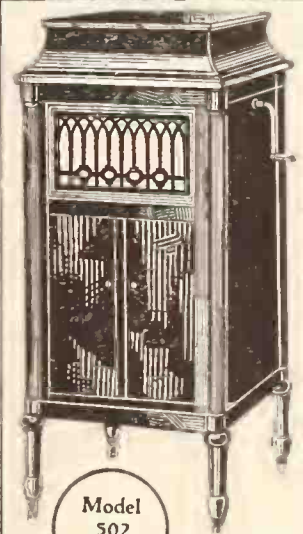

Model 502
\$125

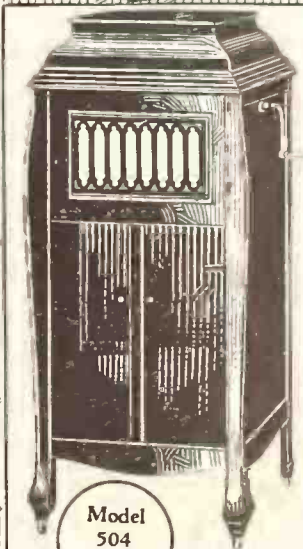

Model 504
\$160

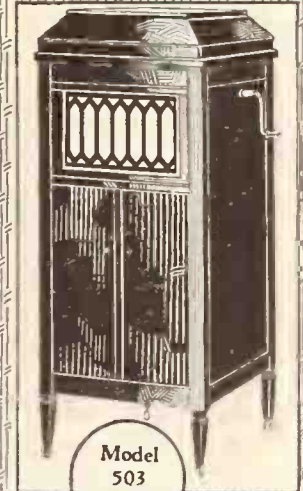

Model 503
\$165

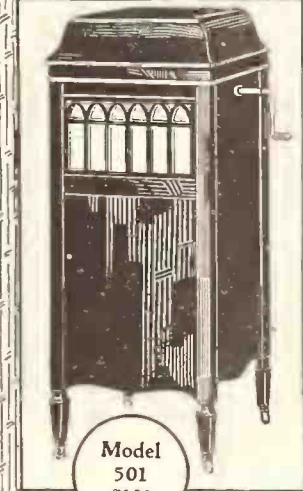

Model 501
\$100

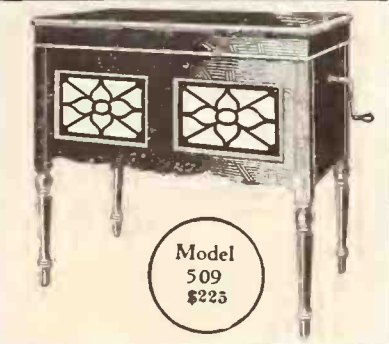

Model 509
\$225

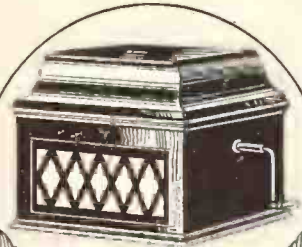

Model 500
\$65

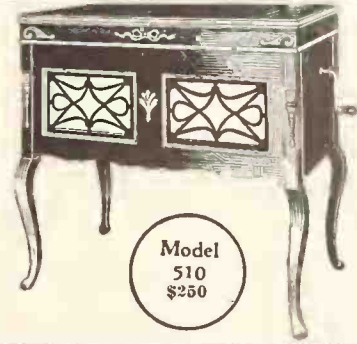

Model 510
\$250

OUTING OF TALKING MACHINE MEN

(Continued from page 64)

dash for ladies was won by Miss Ann Lazarus, daughter of the well-known Sol; Mrs. Frank Mandel won the contest for heavyweight ladies and the honors for the three-legged race went to William M. Ross and Elias Gottlieb. Miss E. Goodman was also a winner in one of the women's contests.

The jobbers of the metropolitan district, although only associate members of the Talking Machine Men, Inc., and taking no active part in the functions of that body, have always shown keen interest and given substantial support to the Association; many of the prizes for the afternoon's events being contributed by the wholesalers. Among the representatives of the Victor jobbers who attended were: W. J. Hausler, E. G. Evans, Miss H. Marjorie Brown, A. H. Murray and Joseph C. Schlich, of C. Bruno & Son, Inc.; Paul Carlson and W. H. May, of Chas. H. Ditson & Co.; David Roach and A. J. Wilckens, of Collings & Co.; Mr. and Mrs. Abram Davega, Joseph Schwetz and Max Berlow, of the Knickerbocker Talking Machine Co.; Charles H. Offerman and M. M. Rountree, of the American Talking Machine Co.; George E. Thau, W. H. Bishop and George A. Baker, of the Blackman Talking Machine Co.; Cass Riddle and Joseph Kerr, of Emanuel Blout; C. R. Wagner, Musical Instrument Sales Co.; Charles B. Mason, George Kelly and Ernest Fontan, of the New York Talking Machine Co.; W. Miller, of G. T. Williams Co., Inc.; Clarence Price and H. T. Hawkins, of Ormes, Inc.; Mr. and Mrs. Thomas F. Green, Lloyd L. Spencer and Eugene F. Latham, of the Silas E. Pearsall Co. The manufacturers were also well represented, including: B. W. Jennings, C. H. Baker, D. B. Allen and C. W. Lukas, of the Columbia Graphophone Co.; Paul E. Bearwald, David Goldman and E. L. Sampter, of the General Phonograph Corp.; Frank J. Coupe, vice-president, and F. V. Goodman, assistant sales manager, of the Sonora Phonograph Co.; Mr. and

Mrs. Chester Abelowitz, Brunswick-Balke-Collender Co.; Walter Brunner, Manufacturers' Phono. Corp.; George A. Seiffert, Modernola Sales Co.; R. H. Keith and J. J. Schratweiser, of the Long Island Phonograph Co., Sonora jobbers.

In the evening an elaborate shore dinner was served, the diners all disporting multi-colored novelty paper hats. Music for dancing was rendered throughout the course of the dinner and was furnished by Paul Whiteman, Inc., the members of which were all exclusively Victor Talking Machine Co. artists and composed of the following combination: Alex Brasin, violin; George Lehritter, banjo; Keith Pitman, bass; Ric Atkins and William Asmus, cornets; Dave Bretthauer, trombone; Harry Rosenberg, drums; Al Mitchell, piano. The lucky number contest was a feature of the dancing, handsome prizes being awarded the winners.

Without doubt, it was the most successful affair in the history of the Association and the entertainment committee and the officers of the Association received a wealth of congratulations. The entertainment committee was composed of Sol Lazarus, chairman; Max Berlow, Otto Goldsmith, C. B. Riddle, Albert Galuchie, N. Goldfinger, E. G. Evans, Henry Conn, Fred Herrman, C. Abelowitz, E. G. Brown and Valentine Faeth.

NEW POST FOR KANTNER

Appointed Manager of San Francisco Branch of Columbia Graphophone Co.

Geo. W. Hopkins, general sales manager of the Columbia Graphophone Co., announced this week the appointment of P. S. Kantner as manager of the San Francisco branch. For some time past Mr. Kantner has been acting manager and his appointment to the actual management of the branch is a distinct tribute to the results that he has attained as manager of one of the most important Columbia branches in the country.

In announcing Mr. Kantner's appointment,

Mr. Hopkins called attention to a recent campaign conducted by Mr. Kantner with the Eastern Outfitting Co., of San Francisco, Cal., Columbia dealer. This campaign, which lasted for a period of only three months, resulted in the sale of 509 Grafonolas.

The general sales department of the Columbia Graphophone Co. was advised recently by Mr. Pickering, sales representative at the San Francisco branch, that another carload of Grafonolas had been sold to Fred R. Howe, Columbia dealer at Santa Cruz, Cal. The first carload sale inaugurated by Mr. Howe last Spring was a signal success, and he was so well pleased with the results achieved at this sale that he made arrangements for another carload of Grafonolas.

SENDING LITERATURE TO PROSPECTS

Continuous Bombardment of Literature Is Necessary for Best Results

The prospect list is one of the powerful weapons in the hands of the dealer with which he can add to his profits through increased sales, provided, of course, that he makes proper and effective use of the list. Indeed, this list is more potent than ordinary newspaper advertising because each person listed thereon can be approached individually, whereas in an advertisement the appeal must be made general.

Now, there are many dealers who through many months of hard labor have built up fine prospect lists, on which all necessary information, including financial standing, musical preference, etc., is listed. With all these valuable data at hand merely sending out the monthly record supplements is not enough. A continuous stream of high-class direct-by-mail literature should be sent to these customers or prospects and this should be diligently followed up either through a canvasser or salesman.

Yesterday is past, so forget it. To-day is here, make the most of it and at the same time plan for to-morrow.



ST50
H37W40D23



ST53
H37W40D23

A New Model in the Natural Voice Line

To the models already manufactured to meet the needs of the trade we have added this new style.

The NATURAL VOICE is a high-quality product selling at a popular price. It is a complete line including several period models.

Manufactured by expert cabinet makers it has achieved a position of prominence as a sales creator and profit maker.

Also a Full Line of
Cabinets Without
Equipment.

Write for Prices

It will pay you to investigate
our proposition.



ST9
H50W23D24

The New Style No. 9 is a worthy addition to this complete line

Natural Voice Phonograph Co.
ONEIDA, NEW YORK

The Trade in PHILADELPHIA and LOCALITY

PHILADELPHIA, PA., August 2.—Without a doubt, more of a stir has been created in the talking machine trade of the Quaker City by the announcement of the Victor Co. concerning the new Collins physical exercise records than has been caused by any other event in the talking machine business during the last few months.

Every one of the five Victor distributors in this city announces that it has received large orders from the dealers for these records. An instance of the volume of the first demands made for the records may be seen in the statement made by T. W. Barnhill, president of the Penn Phonograph Co., to the effect that they have received orders for nearly one thousand sets before the records have actually been received for distribution to the trade.

The importance which the Victor distributors of this city attach to the issuance of these records may be judged by a letter that has just been sent out by H. A. Weymann & Son to all of their Victor dealers, informing them of the fact that these records will soon be ready for distribution.

Demonstration Before Kiwanis Club

H. Royer Smith, the progressive talking machine dealer, located at Tenth and Walnut streets, has taken a step that will do a great deal toward bringing these records before the public and that will undoubtedly arouse widespread interest in them, through arranging for a demonstration of the Collins records before the members of the Philadelphia Kiwanis Club, at its weekly luncheon, to be held at the Bellevue-Stratford Hotel on August 15. Mr. Smith, who has been a leading member of the Kiwanis Club for a number of years, has arranged to have a physical instructor from the Collins Institute, which is located here in this city, appear at the Kiwanis luncheon and to the accompaniment offered by the Victor records demonstrate the exercises as they were worked out by Professor Collins.

Mr. Smith has also arranged to have a young lady demonstrator from the Collins Institute appear in the show windows of his store during the week of August 7, to give demonstrations of the exercises. These demonstrations will also do a great deal toward arousing the interest of the public, as thousands of people pass the Smith store each day.

Penn Phonograph Co. Plans Display

Another novel window display that is being arranged at the present time is that of the Penn Phonograph Co. Mr. Barnhill has secured a huge reproduction of the familiar tungsten needle that is more than six feet in height and over twelve inches maximum diameter. This metal reproduction will be shown in conjunction with a comprehensive display of talking machine accessories in general and the needles in particular.

Harry Trawitz a Benedict

Harry Trawitz, manager of the record department of the J. H. Troup Music House, Harrisburg, Pa., one of the Penn Phonograph Co.'s dealers, is in line for the congratulations of his many friends in the trade, following his recent marriage. At the present time Mr. and Mrs. Trawitz are on their honeymoon through the New England States. Before going away Mr. Trawitz said that the month of July witnessed a big improvement in the volume of the record

business for the Troup Music House and he anticipates a great increase in their business during the coming Fall.

Miss McFadden Now Mrs. Nagle

Congratulations are being tendered to the former Miss Mary McFadden, in charge of the Victrola department of B. E. Block & Bros. store at Norristown, Pa., also dealers for the Penn Phonograph Co. Miss McFadden caused great surprise among her many friends by announcing her secret marriage to Walter Nagle. Fortunately, Mrs. Nagle, upon her return from her honeymoon, intends to keep right on with her Victrola work, in which she is so greatly interested and concerning which she is most enthusiastic.

Exhibit Magnavox and Grafonola

The Frankford Music Store, Columbia dealer, held an exhibition of a Grafonola and a Magnavox at a recent celebration held at the Frankford Driving Club. The Magnavox and Grafonola were placed in the grandstand and could be heard clearly at any point in the grounds. The music was so distinct that people sitting on their verandas five blocks away thought it was a band playing and telephoned for further details regarding the celebration.

Outing of Foster Bros. Employees

Foster Bros., Columbia dealers at Manayunk, gave their army of employees a day's outing at Spring Mount, Pa. R. H. Foster was in charge of the outing and, beginning at 9 o'clock in the morning and lasting until late at night, a delightful program was prepared for the entertainment of the employees.

News With a Vacation Trend

F. B. Reinecke, secretary of the Louis Buehn Co., 835 Arch street, has just returned from an extended visit to Atlantic City, where he was registered at the Hotel Strand. Mr. Reinecke states that he is preparing to make large shipments of the Collins physical exercise records to the Buehn dealers and hopes to be able to make the first shipments during the latter part of the week. C. W. Miller, vice-president of the Buehn Co., is planning to leave the city on his vacation in a short time.

Morton Stern, the advertising manager of the

Talking Machine Co. of Philadelphia, has just returned to the city, after a vacation trip to Schroon Lake, N. Y., in the Adirondack Mountains. He is most enthusiastic over the success that has attended the advertising campaign conducted by the Talking Machine Co. in connection with the No. 240 Art Model Victor machine, which has "gone over with a bang." This company has also been doing a fine business in the Victor portable model machine. According to Mr. Stern the Talking Machine Co. had made only a few sales of this type machine until it arranged a most attractive window display at its Chestnut street store, next door to the Adelphi Hotel. This display included a miniature camping scene with a small, but "real," tree in the background, and with a canoe in the foreground, in which the Victor portable machine was placed. The great interest which this display aroused is most efficiently indicated by the numerous sales which this up-to-date company has made.

F. Marcellus Heppe left Philadelphia yesterday for Poland Springs, Me., where he will join his father, Florence J. Heppe, head of the well-known piano and talking machine company.

A. E. Wilcox, the manager of the Heppe piano department, has left the city on an extended automobile trip along the New Jersey coast and through western Pennsylvania.

R. F. Lehman, manager of the Heppe uptown store, at Sixth and Thompson streets, has just returned from a two months' trip through the West to California, returning by way of Canada.

New Vocalion Records Well Received

The Aeolian Co. has just issued a new group of Vocalion Red Records for August that is meeting with a most hearty reception, according to B. H. Rogers, treasurer of the Lincoln Business Bureau, 1011 Race street, the Philadelphia distributor for the Vocalion records.

"The new August Vocalion records," said Mr. Rogers, "feature a number of the latest Pacific Coast fox-trots. For a long time we have heard of the climate of California, but now we seem to be hearing more and more about her fox-trots, and a good percentage of the most 'whistleable' tunes have crossed the Rockies to the East. in-

(Continued on page 68)

On Guard



Penn-Victor Dogs are the best watchmen of Victor Welfare in the Home.

Sold by most Victor Distributors.
Write them or us for prices.

Penn Phonograph Company

913 Arch Street

Philadelphia, Pa.

Victor Wholesale Only

REGAL
PREDOMINATES
IN THE
50¢ RECORD FIELD

THE TRADE IN PHILADELPHIA AND LOCALITY—(Continued from page 67)

H. A. WEYMANN & SON, Inc.

1108 Chestnut Street

Philadelphia, Pa.

VICTOR WHOLESALERS

Q. R. S. PLAYER ROLLS

WEYMANN "KEYSTONE STATE" STRING INSTRUMENTS

**YOUR BUSINESS
and OUR BUSINESS**

are very much the same," Mr. Victor
Retailer. We have the common pur-
pose of increasing Victor merchan-
dise sales. Getting together
will prove mutually
advantageous



cluding 'Whispering,' 'Do You Ever Think of Me,' 'Hindustan' and many others. The latest fox-trot from this source is 'The Sneak,' which has been played by the Yerkes S. S. Flotilla Orchestra for the August Vocalion records, and it certainly has a 'sneaky little tune'."

Joseph McKay, of the Heppe Victor department, has just gone to Atlantic City on a two weeks' vacation trip.

No Association Meeting Until Next Month

According to H. G. Hoover, whose store is located at 1031 Chestnut street, and the affable and popular president of the Philadelphia Victor Dealers' Association, there will be no further meetings of this Association until September, when a number of matters of general importance to the talking machine trade will be brought up before the members of this organization. Mr. Hoover anticipates a very busy Fall season.

Return From Vacation Trips

Frank J. Osman, who is widely known throughout the talking machine trade in this city, as he has been connected with the Penn Phonograph Co. for many years, has just returned

from his vacation, which he spent at Atlantic City and visiting relatives at Newark, N. J.

Miss Rose Schmidt, also with the Penn Phonograph Co., has just left the city on a two weeks' vacation, which she will spend at Wildwood, N. J.

J. M. Martin and Horace Blake, both of the Hoover sales force, have just returned from their vacation, while Russell Weldy left last Saturday for Asbury Park and H. M. McGrath has just gone to Atlantic City for two weeks.

**ECKHARDT DISCUSSES
RADIO DEVELOPMENTS**

President of the General Radio Corp. of Philadelphia Optimistic Over Future—High-class Goods and Proper Merchandising Necessary to Success—A Timely and Interesting Analysis

PHILADELPHIA, PA., August 5.—Walter L. Eckhardt, president of the General Radio Corp., has given much attention to analyzing the future of the radio situation. In a recent conversation with The World he called attention to how radio popularity developed and swept the world like wild-fire, claiming the attention alike of amateurs, experts and the common people. He pointed out how myriads of industries sprang up over night, cashing in on the demand for equipment, and how the world seemed to go radio crazy. "Many conservative and sound individuals began to take the radio seriously. Soon telephone, telegraph, public service, talking machine, electric appliance and other allied industries began to show interest. Many important alliances were made. Interest in radio kept right on increasing. Newspapers and department stores fanned the coals into flame. New broadcasting stations appeared everywhere until the ether was so crowded that only very finely adjusted sets were of any real value.

"To-day we are seeing the end of makeshift and poorly constructed equipment," remarked Mr.

Italian Music Rolls

Largest collection of Italian and other foreign music rolls in the United States. Catalogs and discounts on application.

UNITED MUSIC STORES619 Cherry Street
225 W. Mulberry St.Philadelphia, Pa.
Baltimore, Md.

Eckhardt. "We are entering into the period of standardization and utility. The future will throw out thousands of sets, not because of a revolution in wireless telephony, but because the apparatus is so poorly constructed that it will not meet requirements. It cannot be stated too forcefully that the days of the radio toy are numbered. The best advice for those who are already selling and those others who are hesitating on the brink is to insist upon handling radio material only after they are convinced that it is the best. A difference of a few cents, or even dollars, should not determine a sale. A sound merchandising policy is just as essential in the radio business as it is for the electric appliance or talking machine dealer and manufacturer.

"We have little precedent to follow in predicting the future of radio. We might parallel it with the automobile or the talking machine, but we cannot get very far even when we collect a dozen different ideas and choose a part of each. We do know, however, that there will be further development of the radio. We also hope that there will be certain restrictions placed on the use of the ether or whatever it is that carries the radio messages. For unless we are able to cut out the static and other interruptions more effectually things will soon be a bedlam. Lack of restriction of amateurs will make radio useless to all. We can say with confidence that the solution of the many radio problems is at hand. Proper apparatus will be just as good ten years from now as it is to-day. Changes in set-up will doubtless be advisable; new devices and attachments will be developed, but the basic principles of wireless telephony are as standard to-day as the assembly of an automobile.

"As time goes on the wireless meddler will be limited in his operations. Broadcasting will be better organized and limited in distribution so that it will not interfere with the great commercial stations. Therefore, guard well your reputation. See to it that you serve your trade to its satisfaction. Sell only the apparatus in which you have confidence. Build for to-morrow and to-day will take care of itself. It will not be hard to choose the right lines; they will stand out head and shoulders above competition."

JAMES WATTERS IN RADIO FIELD

James Watters, who was at one time secretary of the Pathé Frères Phonograph Co., has now entered the radio industry. Mr. Watters is an executive of considerable ability and is well fitted to undertake his new and responsible duties with the Eastern Radio Corp., with which he has become identified.

BUSINESS OPPORTUNITY IN ITALY

WASHINGTON, D. C., July 31.—A musical instrument dealer in Italy wishes to purchase musical instruments and talking machines, according to information received by the Bureau of Foreign and Domestic Commerce here. Quotations should be f. o. b. New York and c. i. f. Italian port. Further information can be secured by communicating with the Bureau or any of its district offices and referring to Opportunity No. 2937.

Selling is a game and the best sportsman wins.

**For Fall Business
The PHONO-TONER**TRADE MARK
(Registered in U. S. Patent Office)**Clarifies and Modulates the Tone**

It appeals to every owner of a talking machine. It sells itself. Display a card on your counter. Keep one on a demonstrating machine.

Send for sample today, no charge.

Profitably retailed at 35c and 50c
in nickel finish and gold plate.

The Phono-Toner (actual size)



Forms handle
for needle set-
screw.

The Phono-Tone Co.
310 Lincoln Building
PHILADELPHIA, PA.

DECALCOMANIA

Name Plates for Talking
Machines, Pianos, etc.

High Class Workmanship

Write us for further information

National Decalcomania Co.
220-230 N. 60th St., Philadelphia, Pa.



Waterson-Berlin & Snyder Co., Chicago, Ill.

Unico Equipped Thruout.

Musical Merchandising Efficiency

is developed by

The Unico System

MMUSICAL MERCHANDISING embraces a wide field of activity. Talking Machines—Phonographs—Pianos—Player Pianos—Records—Player Rolls—Musical Instruments—Sheet Music—Small Goods.

UNICO EQUIPMENT includes a special fixture of the most efficient type for merchandising musical commodities of every kind and description.

FURTHERMORE—musical stores and departments equipped thru the Unico System possess an atmosphere which constitutes

THE BACKGROUND OF SALES

PATRONAGE is quickly attracted and permanently attached to the progressive establishment which offers its customers the service, comforts and attractive surroundings afforded by Unico Equipment.

UNICO DEPARTMENTS ARE CREATED BY MERCHANDISING EXPERTS

During July

Unico Equipment was installed by progressive dealers in:

- Connecticut and California
- Massachusetts and Missouri
- Oklahoma and Ohio
- New York and New Jersey
- Pennsylvania and Panama
- Illinois and Indiana
- Texas and ten other states



During August and September

Unico Service can convert your establishment into the musical headquarters of your community. Better still—this change can be accomplished at moderate cost.

Consult us *at once!*

No obligation or expense.

UNICO SERVICE IS NATIONAL SERVICE

SOUNDS EXPENSIVE, you will say—but it isn't! Unico Equipment is no higher in cost than ordinary equipment.

Complete Unico Departments available for immediate shipment, \$350 upwards.

YOUR BEST INTERESTS will be conserved by referring your problems to us, whether a single fixture or a complete musical department store.

Consult our nearest branch today.

Unit Construction Company

RAYBURN CLARK SMITH, *President*

- | | | |
|---------------------------------------|---|---|
| NEW YORK, N. Y.
299 Madison Ave. | 58th Street and Grays Avenue, Philadelphia, Pa. | CHICAGO, ILL.
30 N. Michigan Blvd. |
| ATLANTA, GA.
49 Auburn Ave. | DALLAS, TEX.
209 Dallas Bank Bldg. | NEW ORLEANS, LA.
506 Marine Bank Bldg. |
| SAN FRANCISCO, CAL.
942 Market St. | | SALT LAKE CITY, UTAH
150 Main St. |
| | | DENVER, COLO.
1642 Arapahoe St. |

H. A. MOORE & CO., LTD. (Sales Agents)
Premier House, London (W.C.I.), England

Unico Radio Merchandising Equipment now available—send for literature.

ENTERTAINS DEALER'S SALES STAFF

Eastern Outfitting Co.'s Staff Guests of P. S. Kantner, Columbia Branch Manager—Success of Sales Campaign Occasion for Banquet

SAN FRANCISCO, CAL., August 4.—The members of the sales staff of the Eastern Outfitting Co., of this city, Columbia dealer, were the guests at a recent banquet given by P. S. Kantner, manager of the San Francisco branch of the Columbia Graphophone Co. During the course of the banquet Mr. Kantner gave an interesting address on

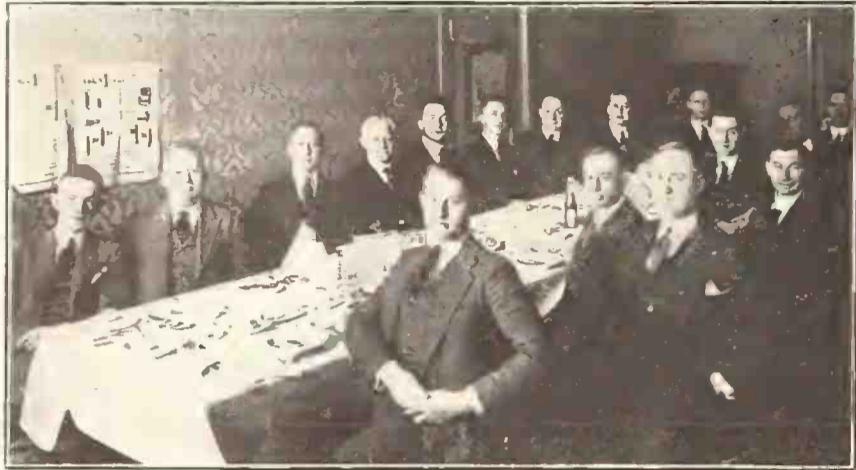

Sales Staff of Eastern Outfitting Co. Entertained at Dinner

the educational value of the Grafonola, being followed by T. J. Walker, advertising manager of the Eastern Outfitting Co., who discussed cooperation from a sales angle.

The occasion of the banquet was the conclusion of an extensive advertising campaign featuring Grafonolas that was recently conducted by the Eastern Outfitting Co. in the "Daily News." During this campaign this successful dealer sold more Grafonolas in ten days than had been sold in any four months' period in the past.

I. Shemanski, president of the Eastern Outfitting Co., and Mr. Sieroty, secretary and treasurer, who attended the banquet, are so pleased with the results attained from the recent campaign that they have decided to conduct another campaign in the Daily News, consisting of approximately 730 inches additional advertising to spread over a period of three weeks.

Thos. E. Wilson & Co., talking machine dealers, at 706-708 Green street, Chicago, Ill., suffered considerable damage in a recent fire in that building.

CLOSES MANY IMPORTANT DEALS

Geo. W. Lyle Appoints Several New Strand Representatives—Important Territories Will Receive Efficient Service Through New Arrangements—Optimistic Over the Trade Outlook

Geo. W. Lyle, president of the Manufacturers' Phonograph Co., New York, manufacturer of the Strand phonograph, returned recently from an extended trip to the Pacific Coast, during which he closed several important deals whereby well-known companies and individuals were added to the fast-growing list of Strand representatives. Mr. Lyle's reports regarding general conditions throughout the country are optimistic and Strand representatives and dealers are making plans for an active Fall trade.

In St. Louis, Mo., Mr. Lyle made arrangements whereby the Artophone Corp., of this city, will become a Strand representative in that territory. This company is one of the best-known talking machine concerns in St. Louis and is in an excellent position to give the Strand line efficient representation.

While on the Pacific Coast Mr. Lyle conferred with Walter S. Gray, California representative for the Strand line, and made arrangements whereby Joseph Grimsey, for many years Seattle manager of the Columbia Graphophone Co., will move to Los Angeles and represent the Strand line exclusively. Mr. Grimsey will carry a complete stock of Strand products and his thorough knowledge of conditions on the Pacific Coast will enable him to co-operate with Strand dealers.

L. D. Heater, of Portland, Ore., and for a number of years manager of the Columbia Graphophone Co.'s branch in that city, will become the Strand representative for Washington and Oregon, with headquarters at Portland. Mr. Heater numbers among his personal friends Columbia dealers throughout the Northwest territory and Mr. Lyle was delighted to include him in the list of Strand representatives.

If you're doing good work, don't worry, somebody will find it out.

MICA DIAPHRAGMS

Absolutely Guaranteed Perfect
We get the best India Mica directly.
We supply the largest Phonograph Manufacturers.
Ask for our quotations and samples before placing your order.

American Mica Works
47 West St. New York

INTRODUCES VICTROLA NO. 111

Handsome New Model Will Be Ready for the Trade in October—List Price, \$225

The Victor Talking Machine Co. has just announced a new type of instrument known as the Victrola No. 111. This instrument, which is shown in the accompanying illustration, embodies

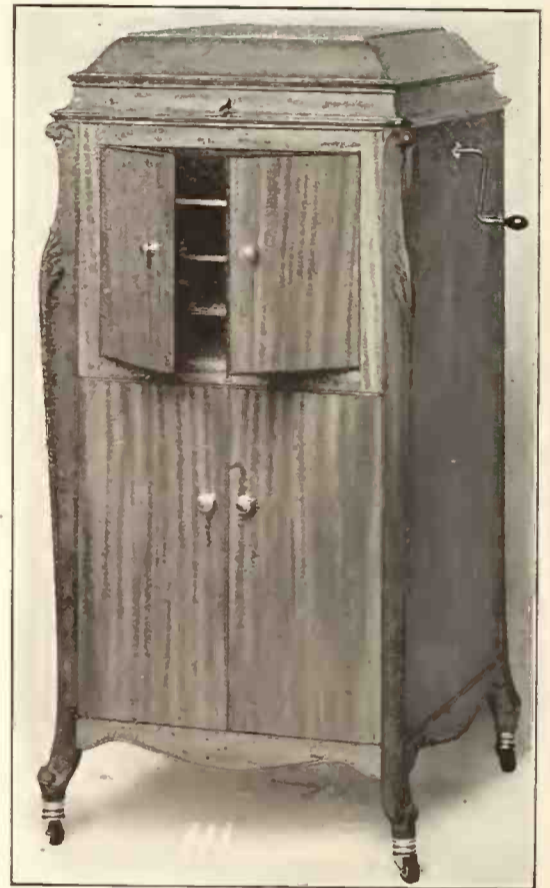

The New Victrola No. 111

all of the exclusive Victor mechanical features, and one of the most important sales arguments for this new Victrola is the fact that all exposed parts are gold-plated.

At the present time the Victrola No. 111 is manufactured in mahogany (red and English brown) and walnut, but it is expected that the various oak finishes will be ready in October, during which month the initial distribution of the new instrument will be made. The list price of the Victrola No. 111 is \$225 with a spring motor and \$265 with the electric motor.

WALT WHITMAN ON MUSIC

Here is how Walt Whitman, the great American sage and singer, puts it: "All music is what awakes from you, when you are reminded by the instruments. It is not the violins and the cornets; it is not the oboe nor the beating drums, nor the notes of the baritone singer singing his sweet romanza, nor those of the men's chorus, nor those of the women's chorus. It is nearer and farther than they."

REGAL
PREDOMINATES
IN THE
50¢ RECORD FIELD

Sherburne Automatic Stop

Stops When You Want It to Stop



Manufacturers: Has *your* automatic stop ever helped your dealers make a sale?

Investigate the Sherburne

Sample sent upon request

SHERBURNE MANUFACTURING COMPANY
948 Penobscot Building Detroit, Mich.



IRVING KAUFMAN
Famous Phonograph Star

Recording his
First KODISK

A METAL DISK FOR
HOME RECORDING

KODISK

TRADE MARK
"SNAPSHOTS OF YOUR VOICE"

You, as a merchant desirous of supplying your trade with up-to-the-minute merchandise, should know all there is to know about KODISK, the marvelous new home recording medium.

KODISK is made of a special silvery metal, and can be used on any phonograph with the ordinary steel needle as a recording and reproducing point.

KODISK

TRADE MARK
"SNAPSHOTS OF YOUR VOICE"

Is Popular in Price

and within reach of all, and, therefore, will be a quick, big seller and will repeat and continue to do so. KODISK records are 8 in.—double sided, which has an approximate recording capacity on each side of the ordinary 10 in. phonograph record. All KODISK records are neatly packed in individual envelopes, on which appear full directions.

Retail Price, 60c.



U. S. Patent No. 1421045

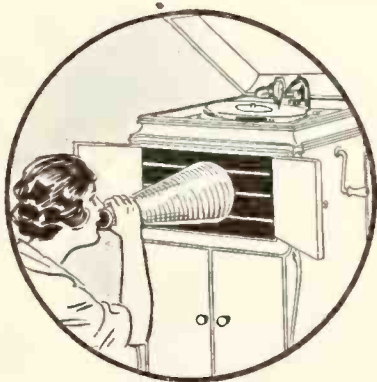

The KODISK record, the successful result of years of careful experimenting, achieves results so startling that it wins the enthusiastic admiration of all who try it.

It is possible to record on a KODISK record by talking or singing into the horn of an ordinary phonograph by using a megaphone as an amplifier. The best KODISK results are obtained by the use of the KODISK recorder. It is an attractive device which will set on any phonograph and may be placed and removed instantly.

The KODISK Recorder

TRADE MARK
"SNAPSHOTS OF YOUR VOICE"

will multiply in many ways the pleasure-producing qualities of all phonographs.

Retail Price, \$6.00

Be first in your locality to show KODISK records. Make your store headquarters for the fastest seller in the phonograph industry. Get the details.

METAL RECORDING DISC CO., Inc.

Manufacturers

FISK BUILDING, 57th Street and Broadway, NEW YORK

PHONOVATIONS CO., Inc., 37 East 18th Street, New York
Distributors for New York State

FOX PHILADELPHIA CO., 723 N. 26th Street, Phila., Pa.
Distributors for Pennsylvania

WARNING! KODISK Records are manufactured under United States Patent No. 1421045, issued June 27, 1922. Our patent protection extends not only to all kinds of sound records made in metal tablets with any type of groove, but also covers broadly the process of recording in metallic substances, including the grooved blanks intended for home use on ordinary phonograph machines. We accordingly advise the trade that only the blanks sold under the KODISK trade mark and manufactured by the Metal Recording Disc Company are authorized to be made, sold or used.

ASK TO HEAR IT



THREE O'CLOCK in THE MORNING

Tempo di Valse Lente



It's three o' clock in the morn - ing.

"You can't go wrong with any 'Feist' song"



The WORLD FAMOUS CHIMES WALTZ THAT IS MOVING A MILLION FEET

H. A. BRENNAN IN NEW POSITION

Well-known Talking Machine Man Now Sales Manager of Allen D. Cardwell Co.—Company Is Making Complete Line of Radio Apparatus

Herbert A. Brennan, formerly sales manager of the Lloyd Wireless Telephone Corp., and well known in the talking machine trade in the East, has been appointed sales manager of the Allen D. Cardwell Mfg. Corp., Brooklyn, N. Y., which is manufacturing a complete line of radio apparatus under the trade-name of "Cardwell" products. Mr. Brennan has already assumed his new duties and is preparing plans for an intensive sales campaign.

Allen D. Cardwell, president of the Allen D. Cardwell Co., has for many years been a prominent figure in the radio field. He is the inventor of important radio apparatus, and is also the inventor of the automatic transmitting system

recently installed in the New York Stock Exchange, and the American Telegraph-Type-writer. B. G. Smith, formerly comptroller of the Guaranty Trust Co., is vice-president and general manager of the company, and the directors include: W. R. K. Taylor, a member of the stock exchange firm of Taylor, Smith & Hard; D. H. Haynes, treasurer and sales manager of the American Machine & Foundry Co., and Ashbel Green, president of the New York Quotation Co.

NEW VICTOR NEEDLE DISPLAY CASE

Collings & Co., Victor distributors, Newark, N. J., are calling the attention of the retailers in their territory to the new Victor needle display case. It is pointed out that a display of needles will greatly increase sales and the additional activity for such goods will more than offset the initial cost of this sales-creator.

THE NEW UDELL BLUE BOOK

Latest Volume Illustrates and Describes Entire Udell Line of Roll and Record Cabinets—Special Catalog of Console Designs

The Udell Works, Indianapolis, Ind., the prominent player roll and talking machine record cabinet manufacturers, have just issued a new edition of the Udell Blue Book of Dependable Cabinets, a most attractive and comprehensive volume in which is illustrated and described the entire Udell line of cabinets, including recent additions. Full details are given regarding each cabinet, such as size, finish, weight and special structural features. Several pages are devoted to attractive crayon sketches, showing the roll and record cabinets in actual use and as they appear in the home setting. A page at the back of the volume is given over to illustrations and descriptions of Udell construction methods.

In the Udell line are to be found cabinets of many sizes, finishes and designs and arranged to suit the taste and pocketbook of practically every owner of rolls and records, and the Blue Book offers a medium for shedding proper light on the extensiveness of the line.

In connection with the Blue Book there has been issued a small catalog devoted entirely to the new console designs in Udell player roll cabinets. There are five handsome models illustrated and described in the special volume, including the Renaissance, the Colonial, the Adam, the Shcraton and the Queen Anne. These latest additions to the Udell line have proved popular with both the trade and the purchasing public.

DALLAS FIRM PLANS MUSIC HALL

Will A. Watkin Making Arrangements for Recital Hall to Be Opened in Fall

DALLAS, TEX., August 4.—The Will A. Watkin Co., of this city, will open a modern and imposing new recital hall early in the Fall. The hall has been arranged on the studio floor and will be one of the finest in the city, both from the standpoint of acoustics and artistic appointment.

The hall will be offered for the use of the music clubs and local professional musicians.

RADDER CO. OPENS MUSIC SHOPPE

SENECA FALLS, N. Y., August 7.—The Music Shoppe, operated by the Radder Vending Machine Co., recently opened a store on Fall street, this city. In addition to Victor talking machines and Brunswick phonographs and records Baldwin, Hamilton and Howard pianos are handled. The new establishment is in charge of Osgood Radder and Mrs. Jessie Mathews.

Will the "can't-be-done" crowd keep in mind that a postage stamp will get them close to their prospects even when bank presidents are kept out?

The *Modernolette*

A REAL
Talking
Machine

in
Portable Form



Retail Price

Wax Finish
Case
\$35.00

Leatherette
Covered Case
\$40.00

MODERNOLA CO., Johnstown, Pa.

The Modernola Sales Co., Inc.

No. 929 Broadway

New York City

DEATH OF MRS. ELIZABETH WELSH

The local talking machine trade learned with regret recently of the death of Mrs. Elizabeth Welsh, who had been in charge of the record department at Bloomingdale Bros., Fifty-ninth street and Third avenue, for the past three years under H. D. Berkeley. Mrs. Welsh, who died at Kings County Hospital, after an illness of several months, is survived by two children. She was well known in the local trade, having been associated with the Victor department of Frederick Loeser & Co., Brooklyn, N. Y., before joining the Bloomingdale staff.

IDEAL MFG. CO. INCORPORATES

The Ideal Talking Machine Mfg. Co. was recently incorporated under the laws of the State of Delaware, with a capital of \$200,000. T. C. Gettell, Frederick W. Wilkins and Thomas W. Terry are the incorporators.

The man to whom difficulties are an added spur to achievement is bound to win success.

"TOM" GREEN PASSES A MILESTONE

President of Silas E. Pearsall Co. Guest at Birthday Party—Friends in Trade Offer Congratulations to Popular Member of the Industry

After the close of the outing of the Talking Machine Men, Inc., held at Glen Head, July 26, several friends of Thos. F. Green, president of the Silas E. Pearsall Co., New York, Victor



Thos. F. Green

wholesalers, journeyed to his estate at Kensington Gardens, where they celebrated Mr. Green's birthday. "Tom," as he is known to all of his friends in the trade, was the guest of honor, but, during the course of the evening, heard so many expressions of good will and good fellowship by those present that he decided to become the host and show the "boys" just how he and Mrs. Green entertained their good friends.

Although "Tom" admits being in the early forties, he has shown such a fondness for hard work during the past few years that his intimate friends believe he is only in the thirties and is adding ten years to his age in order to gain additional prestige and dignity. Among those who were present at Mr. Green's informal birthday party were: C. L. Price, of Ormes, Inc.; C. R. Wagner, of the Musical Instrument Sales Co.; Herbert D. Berkeley, Bloomingdale Bros.; Lloyd L. Spencer, sales manager of the Silas E. Pearsall Co., and several others.

OPERATING AT FULL CAPACITY

DeForest Radio Telephone & Telegraph Co. Active at Both Plants—Distributors in Musical Instrument Field Are Steadily Growing

The DeForest Radio Telephone & Telegraph Co. is operating both of its plants, in Jersey City, N. J., and Jackson, Mich., at full capacity to care for the increasing demands for DeForest products. In addition to its established retail outlets, the DeForest sales organization has appointed six wholesalers in the musical instrument field and this has necessitated added production. A traveling representative of the company returned late last month from a trade trip to the Pacific Coast, where distribution plans were completed for the talking machine trade in the larger centers in that territory.

Charles Gilbert, president of the DeForest Radio Telephone & Telegraph Co., has returned to his Jersey City office, after having spent some time in the Berkshire Hills, Mass., motoring, accompanied by his family.

PORTABLE PHONO. CORP. CHARTERED

The Portable Phonograph Corp., of New York City, has been granted a charter of incorporation under the laws of this State, with a capital of \$300,000. Incorporators are: M. H. Freimark, L. J. Samalman and D. Kaye.

NEEDLE MAKERS ASK PROTECTION

Want Special Duty on Imported Talking Machine Needles Provided for in New Tariff Bill

A claim for a protective tariff on talking machine needles has been presented to the proper officials at Washington by a number of the leading talking machine needle manufacturers of this country, including: John M. Dean, Norwich, Conn.; W. H. Bagshaw, Lowell, Mass.; J. A. Crabb, Newark, N. J., and others, who went to the National Capital recently to bring the matter strongly to the attention of the tariff makers.

At the present time talking machine needles are included under the general head of musical instruments and parts and have no separate listing in the tariff bill. It is not fair to American manufacturers that they should face the competition of German needle makers particularly in view of the low value of the mark. Protection is required to enable the domestic manufacturers to meet harmful foreign competition on an equitable basis.

Mr. Edison Man:—

Don't Say

"KAN'T," say "KENT"

Write for catalog of complete line

The KENT No. 1

With "S" Sound Box

Has given complete satisfaction for years

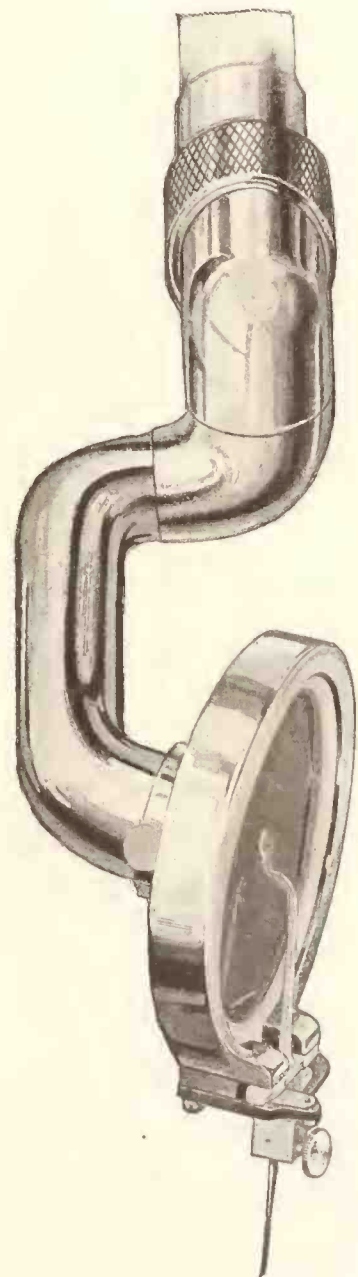

Reg. U. S. Pat. Off.

F. C. KENT CO.

Irvington, N. J.

ALBUM SPECIAL

A twelve-pocket, cloth covered album, each one guaranteed, no seconds

10-inch at 45c. each
12-inch at 55c. each

Place your orders now and take advantage of the special price

Write for our 100-page encyclopedia containing illustrations and prices of

Outing, Swanson, Plymouth, Standard, Orpheus and Stewart Portables

Radio Apparatus

Jones Motrola

Recordola

Attachments for Edison, Victor and Columbia

Albums and Album Sets

Bubble Books

Cabinets, Record and Roll

Record Carrying Cases

Corrugated Boards

Moving Covers

Dust Covers

Dancing Toys

Envelopes, Record Delivery

Stock and Supplement

Geer and Gold Seal Repeaters

Needles, Steel and Tungsten

Fibre Needle Cutter

Display Fixtures

Record Lights

Lubricants

Motors

Nameplates

Piano and Duet Benches

Player-Piano Cleaner

Polishes

Record Cleaners

Tonearms and Sound Boxes

Springs

Strings

GENUINE BRILLIANTONE STEEL NEEDLES

The Needle of Quality All Tones



The Cabinet and Accessories Co.

Incorporated

OTTO GOLDSMITH, Pres.

145 East 34th St.

New York

DENVER

Expect Big Console Trade This Fall—Radio Station Is Using Edison—Portables Are Favored

DENVER, COL., August 6.—If the console talking machine, the period design type, at lower prices than heretofore offered, does not sell well this Fall then the predictions of Denver music dealers are all wrong. Talking machine dealers here are convinced that the console is to be the big selling factor this Fall. Already a number of the houses are working up attractive sales campaigns to take care of this type of machine.

Business has shown some increase since the middle of July. Some of this is due to unusual methods adopted by local dealers. Colorado has a bumper fruit crop, and if the mine and rail strikes are settled soon dealers believe money will be available to buy musical instruments, but if drawn out too long the situation is problematical.

That there is a tendency to buy the higher-priced talking machines is the contention of Oscar Frazier, manager of the talking machine department of the Darrow Music Co. July sales went beyond expectations, he says. The increased business in records has meant the employment of more help. The company has opened a sub-agency at Golden, Col., putting in charge Dr. Claude C. Crawford.

"Where Music Is Sweetest"

With this as its slogan a new store has been opened in Denver by the Emrick-Nadler Music Co., at 1624 Tremont street. The company handles the New Edison. A. E. Emrick, of this firm, has been a traveling salesman for the Edison department of the Denver Dry Goods Co., distributor in the Colorado division, for some time. Previous to this he was employed by

the Victor Co. He resigned his position to go into business with Mr. Nadler, a resident of Basin, Wyo., who will move to Denver early in September. The new store is handsomely decorated and carpeted, the color scheme being ivory, blue and gray. The company bought out the record stock of a store going out of business and the opening was held on July 26.

She Wanted Music

Frank Darrow, of the Darrow Music Co., tells of a recent sale of a phonograph which is out of the ordinary. A woman living forty-five miles from Denver was giving an afternoon party. At the last moment she decided she wanted music at this party. She jumped in her auto and drove the distance to Denver in one hour and forty-five minutes. She stopped at the Darrow House and bought a Brunswick, paying \$310 for it, loaded the machine in her car, drove back home and got there in time for her party. And music helped to make the afternoon a pleasant one.

Business Better

Roy E. Thompson, manager of the talking machine department of the Charles E. Wells Music Co., is spending a vacation at Estes Park and other points in Colorado. His office, however, reports that July business in talking machines exceeded that of July a year ago. The company is making a special campaign on the console type.

Edison at Radio Station

Norman D. Tharp, buyer of the Edison department, wholesale and retail, of the Denver Dry Goods Co., reports business picking up. His department has just placed an Edison at the new radio station of the Colorado National Guard, corner University and Grant streets. Captain Winner, of this station, says the Edison is giving eminent satisfaction.

Mr. Tharp finds that it pays to keep his mailing list alive in the matter of sending out the list of Re-creations for the New Edison each month. Those who do not respond to the list are cut off. A postal also was recently sent

THE SENSATIONAL NOVELTY
FOX-TROT
THE FRENCH TROT
SHEET RECORDS ROLLS
JOE MITTENTHAL · INC · NEWYORK

out to inquire if the list was of value to the owner of an Edison. Space was given to write on return card if the list should continue to be sent. The owner was asked also to give the name of anyone who might be interested in buying an Edison and in this way a new list of names was obtained as prospects. As jobbers the company gets out a postal card at intervals, on the back of which are printed the latest Edison hits, flashes from Broadway.

Aim to Increase Membership

In order to increase the membership of the newly organized Edison Dealers' Association of the Colorado division W. Leroy Larson, of Sidney, Neb., president of the Association, and Carl Schultz, of Denver, secretary, are getting out a letter to be sent to all Edison dealers in the State comprising the Colorado division.

Blinn Earns Rest

One of the live wires in the Denver trade is J. H. Blinn, manager of the talking machine department of the Baldwin Piano Co. His sales record shows a 25 per cent increase in business for July over the corresponding month in both

EVERY DEALER PUSHING HALL FIBRE NEEDLES

is enjoying larger and steadier profits because they have done more towards encouraging the collection of Record Libraries than any other single argument connected with the sale of talking machine records and the Record Collector is a growing asset to every Dealer.

HALL MANUFACTURING CO.

Successors to B & H FIBRE MFG. CO.
33-35 W. Kinzie St. Chicago, Ill.



Date.....

Jobber's Name

Address

Gentlemen:—Please forward via.....

..... CARTONS COMBINATION HALL FIBRE NEEDLES
25 pkg. No. 1—50 pkg. No. 5.

..... CARTONS NO. 5 PACKAGES HALL FIBRE NEEDLES
100 pkg. in carton.

..... CARTONS NO. 1 PACKAGES HALL FIBRE NEEDLES
50 pkg. in carton.

DEALER'S NAME

ADDRESS

1921 and 1920. For the first six months of this year business has shown an increase of 40 per cent over a similar period in 1921 and 30 per cent over the same period in 1920. Mr. Blinn writes all his own newspaper display ads and is window display manager. His clever windows have attracted no end of attention and have been real business-getters. Recently another plan was devised to bring the people into Mr. Blinn's department. The company is selling a miniature piano, bearing the Baldwin name, for 25 cents, such as would delight any child for its play-house. Several hundred of these toy pianos have been sold and are proving most valuable in an advertising way.

Install Radio Merchandise

According to H. V. Huntoon, manager of the retail Victrola department of the Knight-Campbell Music Co., radio merchandise will be installed and sold in the talking machine department this Fall. He believes radio and music go hand in hand and that the two will co-ordinate satisfactorily. He reports a big increase in the sale of records for the month of July. New and used machines have sold well and a better down-payment was made in every instance than for some time past. The Walter Camp series of health exercises selling at \$15 has been quite popular with the general public.

Giving Service Quickly

A little framed sign hanging on the door of the Darrow Music Store has done much to attract people to step inside and to promote the sale of records. Mr. Darrow traces a lot of business to this sign, reading: "Courteous and efficient record service just inside the door." The records are kept close to the door and patrons are served quickly. The Darrow people report a good talking machine business.

Plans Sales Campaign

The McKannon Piano Co. is planning a sales campaign on the Edison console models this Fall. Mr. McKannon does not look for a tre-

mendous business, but an increase over the Summer months. The outlook for the piano business he believes is even better than that for the phonograph.

Portables Continue to Sell Well

Russell Gates, dealer in Grafonolas and Brunswicks, reports a large sale of portables this Summer. After a quiet period he says that business with the console type has shown an increase since the middle of July. He predicts good business this Fall.

PURCHASES THE SUPERTONE STOCK

The Phonograph Jobbers Corp., 206 Fifth avenue, New York City, some time ago purchased from the creditors' committee of the Supertone Talking Machine Co. all the complete cabinets and those in various stages of production and the right to manufacture and market the Supertone machine.

The officers of the above distributing corporation are B. Abrams and Rudolph Kanarek. It is the company's intention to continue the activities of the Supertone Co. and an announcement of the new arrangement has been forwarded to the trade.

MUSIC MASTER HORNS POPULAR

It is reported that the Music Master horn, produced by the General Radio Corp., of Philadelphia, is meeting with considerable success throughout the talking machine trade. Walter L. Eckhardt, president of the company, has devoted considerable attention to the perfecting of this horn, which is of laminated wood construction, designed to fulfill the functions of a loud speaker without metallic amplification. The fact that this radio horn embodies phonographic amplification principles has appealed strongly to the trade and new dealers are being constantly added to the already large number selling this horn

USES TIMELY WINDOW DISPLAY

Galperin Music Shop Features New Ted Lewis Columbia Record—Display Produces Tangible Results in the Way of Increased Business

CHARLESTON, W. VA., August 4.—The Galperin Music Shop, of this city, Columbia dealer, is quick to pick up a big selling record and feature it in an attractive window display. The accompany-



ing illustration shows a window prepared to feature a new Ted Lewis Columbia record, "Down the Old Church Aisle." The window illustrated the church aisle, the altar, the bride and groom and the minister, and this enterprising dealer also used good-sized space in the local newspapers in behalf of this record. Needless to say, this campaign produced splendid results and the record went over big in Charleston.

Worry takes more human energy than work.

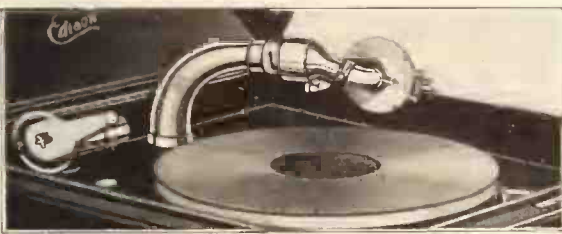

Showing Reproducer of Jewel Needle Equipment Turned Up to Change Needle; Also Position When Not in Use



Showing Reproducer of Jewel Needle Equipment in Position for Playing Vertical Cut Records on Edison Phonograph

Jewel
NEEDLE EQUIPMENT

For The New Edison

NOT

Just Another Equipment

BUT

a distinct improvement in Tone Reproduction as well as in Mechanical Construction and Finish.

Send for descriptive circular which contains "HINTS REGARDING THE CARE OF A PHONOGRAPH."

If your jobber does not handle, write us.

Price the same. Liberal discount to dealers.

GUARANTEED IN EVERY WAY.

MONEY BACK IF NOT SATISFIED.

We handle highest grade Jewel Point Needles.



Showing Reproducer of Jewel Needle Equipment in Position for Playing Lateral Cut Records on Edison Phonograph



Showing Back View of Jewel Needle Equipment in Position for Playing Lateral Cut Records on Edison Phonograph

Plays all types of records. Operates the same as the "EDISON" with the LEVER.

No adjustments necessary when changing from lateral to vertical cut records. Stop prevents swinging to the right.

Needle scratch almost entirely removed.

Turning back of Reproducer permits of easy access to needle socket and saves records from unnecessary scratching.

Is the ONLY equipment that plays vertical cut records in the proper "EDISON" position with the Reproducer turned FACE DOWN to the record, giving it a floating action.

Needle CENTERS on all records.

Straight air-tight construction and absence of movable joints insure perfect reproduction and great volume.

Pivoted ball-joint insures perfect reproduction and freedom of movement both vertically and horizontally.

Weight is the lightest that can produce perfect results, thus saving the record, and permitting a freedom and sweetness of tone considered impossible.

Indestructible NCM-Y-KA diaphragms do not blast, crack, split or warp, and are the greatest development in phonographic sound reproduction in years.

JEWEL PHONOPARTS COMPANY 154 W. Whiting St., Chicago

LONG
QUALITY
HANOVER, PA., U.S.A.

FALL TRADE and LONG CONSOLES

All indications point to a healthy, active season for the talking machine industry in the Fall of 1922. Competition will be exceptionally keen, and the progressive, wide-awake dealer will get the lion's share of the business.

LONG CONSOLES can be used as a sales leader by talking machine dealers everywhere. They embody quality of workmanship with attractiveness of design and represent the acme of perfection in cabinet construction.

LONG CONSOLES are made by one of the country's pioneer cabinet manufacturers, and are backed by responsibility, experience and prestige.

Write today for our catalog.

**The Geo. A. Long
Cabinet Company**
HANOVER, PA.



Style 600
Sheraton



Style 601
Colonial



Style 602
Louis XV



Style 603
Chippendale



Style 604
Hepplewhite

RADIO INTERESTS ORGANIZE TO SUPPORT BROADCASTING · CAMPANARI RETURNS TO NEW YORK

Radio Apparatus Section of Associated Manufacturers of Electrical Supplies Formed for Purpose of Standardizing Apparatus and Stabilizing Industry Generally—Leading Concerns Interested

A development of much interest and importance in the radio field from several angles has been the organization recently of the Radio Apparatus Section of the Associated Manufacturers of Electrical Supplies, for the purpose of protecting the interests of manufacturers of radio apparatus, of promoting the standardization of such apparatus, collecting and disseminating information, and promoting co-operation among the members.

The two objects of special interest to those who have engaged in the wholesale and retail distribution of radio equipment are, first, the plan for standardizing apparatus which is calculated to protect the dealer against inferior products and against tying up excessive capital in a great variety of equipment, and, second, the plan to promote the consistent support of broadcasting.

It has been realized by the manufacturers that broadcasting up to this time has been carried on without assistance and, although many newspapers, department stores and other agencies throughout the country have erected broadcasting stations, the general public has turned for entertainment and instruction chiefly to about half a dozen stations maintained by manufacturers at their own expense. The question has been raised as to just how long this gratuitous broadcasting work will be carried on and what would happen if it were suddenly discontinued.

The officials of the new Radio Apparatus Section hold that in order to insure the future of broadcasting and with it the continued interest of radio fans some plan must be developed whereby the industry as a whole will contribute to the maintenance of broadcasting stations.

The members of the Radio Apparatus Section have already pledged themselves to give financial support to broadcasting stations, and it is hoped that other interests in the trade will be enlisted along the same lines.

The new section includes in its membership some of the most prominent of the manufacturers of radio apparatus, including: Acme Apparatus Co., American Radio and Research Corporation, L. S. Brach Supply Co., C. Brandes, Inc., Burgess Battery Co., Clapp-Eastham Co., Cutler-Hammer Co., DeForest Radio Telephone and Telegraph Co., Dictograph Products Corp., Edwards & Co., Electrical Products Mfg. Co., General Insulate Co., A. C. Gilbert Co., Holtzer-Cabot Electric Co., Manhattan Electrical Supply Co., W. J. Murdock Co., Pacent Elec-

tric Co., Radio Corporation of America, Signal Electric Co., Stromberg-Carlson Telephone Mfg. Co., Telenduron Co., Western Electric Co., Westinghouse Electric & Mfg. Co.

Of equally high standing are the officers of the Radio Apparatus Section of the Associated Manufacturers of Electrical Supplies. M. C. Rypinski, who is now vice-president and sales manager of C. Brandes, Inc., is chairman of the Radio Apparatus Section. The Eastern vice-chairman is L. G. Pacent, president of the Pacent Electric Co., Inc. The Western vice-chairman is C. E. Hammond, secretary-treasurer of the Signal Electric Co.; Charles Gilbert, president of the DeForest Co., is treasurer of the Association. The secretary is Elmer E. Bucher, who is sales manager of the Radio Corporation of America.

PLANNING AUTOMOBILE TOUR

Otto Goldsmith, Although Just Recovered From Accident, Will Join Party of Local Dealers On Extended Upstate Motor Trip

On July 11, last, Otto Goldsmith, president of the Cabinet & Accessories Co., suffered serious and painful injuries in an accident while driving his car. He was in the hospital several weeks, but Mr. Goldsmith showed his indomitable spirit by getting back to his many duties as chief executive of the company at the earliest possible date. Although suffering from effects of the mishap Mr. Goldsmith is well on the way to recovery and clearly shows that he has not become automobile shy through the announcement of a contemplated trip which he plans to make on or about August 17 to Fort Ticonderoga on Lake Champlain. Mr. Goldsmith will go as the guest of Al Galuchie, treasurer of the Talking Machine Men, Inc. Others who will take the trip in Mr. Galuchie's car are Irwin Kurtz, president, and E. G. Brown, secretary of the Association, and Sol Lazarus, well-known New York Victor retailer. It is expected that the trip will be from a week to ten days' duration.

The Cabinet & Accessories Co. has announced that the Kodisk, a metal record for home recording, has been added to the large list of accessories of which this firm is a distributor.

Arthur Walsh, advertising manager of Thos. A. Edison, Inc., returned last week from a very enjoyable vacation.

Well-known Baritone and Columbia Artist Re-opens Studios—Will Conduct Special Course in Cincinnati—A Most Distinguished Artist

Giuseppe Campanari, the eminent baritone and Columbia artist, returned from abroad some weeks ago and is again teaching at his New York studios. For seventeen years Mr. Campanari was leading baritone at the Metropolitan Opera House, previous to which he appeared in various first baritone roles with the Gustave Hinrichs-Basta Tivary Opera Co. in this country.



Giuseppe Campanari

Prior to his appearance as an operatic baritone Mr. Campanari was first 'cellist with the famous La Scala Orchestra in Milan, Italy, and later with the Boston Symphony Orchestra; previous to that he had sung in Italy with much success.

Mr. Campanari stands at the top of his profession, not only as a musician but as a master of operatic stagecraft. These talents would seem to have been inherited by other members of his family, inasmuch as his daughter, Marina, has just made her debut in opera in Italy, appearing in "Rigoletto" with pronounced success. Mr. Campanari has been chosen to conduct master classes for a five weeks' special course in Cincinnati this Summer, after which he will again resume his teaching in New York.

DEATH OF WM. H. CHESHIRE

William H. Cheshire, for fifteen years connected with Thos. A. Edison, Inc., Orange, N. J., most of that time as an official in the purchasing department of the company, died at his home in South Orange on Monday, July 31.

The Dawn of A New Day

In the talking machine business also means the dawn of thorough effort and careful business methods.

The recent industrial revision has taught as no other thing could the need for sound business methods, intense development and close cultivation of the territory particularly suited to the dealer.

Better a thorough supervision over a limited field than scattered efforts over a wide one.

Credits are safer and what you get you hold. True Victor sales mean true credits.

ECLIPSE MUSICAL CO.

Victor Wholesalers
CLEVELAND OHIO.

BETTER
BUSINESS

ECLIPSE

BROOKLYN DEALERS REPORT IMPROVED TRADE

Summer Resort Business Has Been of Good Volume Throughout Long Island—Jobbers and Dealers Optimistic Regarding Fall Outlook—Many Houses Considering Radio—Some Successful Trade Drives—News of the Month

Talking machine dealers in Brooklyn and Long Island are especially fortunate in regard to Summer business, for these sections abound with Summer resorts of every description, a source of sales which a good many parts of the country are not favored with. Brooklyn proper has many resorts of this nature while on Long Island almost every city or town is considered a Summer resort. Large numbers of visitors come here in the early months and the majority stay during the entire season. Consequently talking machine dealers in every section of Brooklyn and Long Island each year make plans far in advance for intensive drives for this trade, and the result is that sales of machines and records remain brisk throughout the season. No effort is spared by the progressive dealers to capitalize on this business, and in most cases a large outside force is employed which canvass the territory thoroughly for both machines and records.

This situation is a very fortunate one for the progressive dealers in this territory, as July and August are considered slow months for the average merchant.

Dealers Considering Radio

Dealers are discussing now with considerable favor the taking on of radio equipment as part of their regular stock, and in all probability a percentage of them will add radio equipment this Fall and Winter. The possibility of increased revenue from these sales is the incentive which is inclining dealers to carry a stock of radio receiving units.

Doing Brisk Victor Business

The American Talking Machine Co., Victor distributor for this section, reports that although business during June and July showed a slight decrease, dealers at the present time are beginning to show real signs of activity and August promises to be one of the best months the company has experienced for some time past. R. H. Morris, general manager of the company, has been consistently hard at work laying plans for the past three months and has spared no effort to help dealers move their stocks. As a result optimism is prevalent and all are confident

HAVE YOU DONE IT?

PLACED YOUR MACHINE ORDER FOR
MONTHLY DELIVERIES BETWEEN NOW
AND DECEMBER 31ST.

DO IT NOW
DON'T HESITATE
BE PREPARED

DON'T EXPECT THE IMPOSSIBLE AT THE
LAST MINUTE.

AMERICAN

TALKING MACHINE CO.

BROOKLYN, N.Y.

VICTOR WHOLESALE



that Fall business will be good. Mr. Morris was instrumental in bringing together several of his dealers to the Red Seal School held last month. He remarked that all who took the course were keenly enthusiastic and it is bound to show results in increased sales. The Victrola portable model has met with considerable favor this Summer, Mr. Morris stated, and many of these small machines were sold.

Victor Dealers Commend W. A. Delano

Herman Spitz, the popular Victor dealer of Sag Harbor, L. I., was one of the thirty-five pupils who attended the Red Seal course, and while in Brooklyn made his headquarters at the American Talking Machine Co.'s offices. Mr. Spitz, in conjunction with J. W. Ackerly, prominent dealer of Patchogue, was so enthusiastic over the course that a resolution of commendation and thanks was drafted, which was signed by every member taking the course, which they

presented to W. A. Delano, of the Victor Co., who conducted the course. This co-operation offered to Victor dealers reflects the high regard which these same dealers have for the product they handle and the continual effort made to educate salespeople, to make them more efficient in the handling of Victor machine and record customers.

Successful Sonora Drive

The Long Island Phonograph Co., Sonora distributor for this section, has made an enviable record during the past month in the number of machines distributed to its dealers. A worth-while scheme was put into effect whereby one particular model of machine was concentrated on for a period of one week with the result that many of this style were sold. In the case of the drive on the Sonora Elite model, which retails for \$265, in one week's time twenty-seven of these machines were sold, which helped materially to boost the totals at the end of the month.

Of course, J. J. Schratweiser, sales manager of the company, accompanied by other officials, was present at the Talking Machine Men's Outing, held on the 26th, and was instrumental in helping out to make the day a complete success for Sonora dealers who attended. Through his effort a representation of more than thirty-five Sonora dealers took in the outing and all had a most enjoyable day.

J. J. Jones and T. J. Lyon Making Good

Gratifying reports are being received from the new Sonora stores recently opened by J. J. Jones, at 2844 Church avenue, and T. J. Lyon, 306 Seventh avenue, both of whom are making rapid strides toward the successful conduct of their business. In spite of the general feeling that July and August are slow months, these two men, through their intensive effort, have shown surprisingly large sales totals, and have proven that Summer business can be good if gone after in a determined way.

Arell Phonograph Co. Features Sonora

Last month it was reported through a typographical error that the Arell Phonograph Co., which was recently opened by A. J. Freeman, at 220 Utica avenue, was a Victor shop. This is not the case, however, as this shop will carry and feature the Sonora line of machines exclusively.

Offering Trade New "Talker" Cover

A. Bruns & Sons, of Brooklyn, manufacturers of the Bruns "Made-rite" cover for talking ma-

WE offer our dealers a Service which is in keeping with the standards of "the Highest Class Talking Machine in the World."



The bond between us and our dealers is "more than a business connection." It is said of us that we are "Suppliers to Satisfied Sonora Dealers."

Any communication from you will have our prompt and careful attention.

Long Island Phonograph Co., Inc.

Sonora Distributors for Brooklyn and Long Island

150 Montague Street, Brooklyn, N. Y. Telephone Main 4186

chines, are now offering to the trade an entirely new water-proof cover which has already met with considerable favor from members of the trade who have seen it. This cover is made of rubberized, guaranteed water-proof, specially treated material, in brown, and is a decided addition to the other lines which the company has marketed for some time past. H. N. Karpen, sales manager of the company, is very enthusiastic about this cover and stated that they were not satisfied in giving the talking machine trade merely a line of covers, but it is the purpose of the company to be pioneers in the development of any new ideas which would tend to make the delivery of talking machines more efficient. Consequently, members of the trade who have particular ideas as regards delivery covers are welcomed at the company's offices, where they will be given every attention, and if the idea has a marketable value the company immediately will take steps to produce that cover in every detail. An instance of this is the portable machine cover, of which the company has made many, which was suggested by a prominent dealer, and which has been sold to dealers throughout the country in considerable quantities.

"Business with us," says Victor Bruns, president of the company, "has not been slow in any sense of the word. On the contrary, we have shown an increase every month for the last year and all indications point to a very prosperous Fall and Winter trade."

E. A. Schweiger Enlarges Store

E. A. Schweiger, one of the best-known Victor dealers in metropolitan New York, with headquarters at 1525 Broadway, Brooklyn, has just completed arrangements to acquire the store adjoining his present one, which will give much needed additional floor space. A partition between the two stores is to be torn down, and one complete large wareroom made. New booths and fixtures will be installed as well as every known modern convenience for the selling of talking machines and records. When completed this will be one of the most attractive stores in Brooklyn. This live dealer is one of the pioneers in the Victor retail trade in Brooklyn, having built up a business of large proportions through aggressive merchandising. The new store will be finished in ample time to take care of Fall and Winter business and, when completed, it is planned to properly introduce it to the trade with a formal program which will be announced during the latter part of August.

Big Sale of Victor Physical Records

The sales force of the G. T. Williams Co., Inc., Victor distributor, are quite enthusiastic over the new Victor physical exercise records. They look forward to an active demand for these records over a long period—in fact as a permanent and profitable adjunct to every dealer's stock. Special emphasis is being placed on the display of these new issues and the announcement of the new Victrola model No. 111.

Remodeling Arthora Shop

The Arthora Shop, conducted by Ruckgaber Bros., 60 Court street, has just completed the renovation of the rear of the store. Several small private hearing rooms have been dismantled and the space devoted to one large room where the complete line of Victor machines can be shown at one time and where customers can listen to all models under the same condition and make their choice.

New Sonora Agency

The latest addition to the Sonora list of dealers in Long Island is D. L. Golden, who conducts a general store at East Setauket. He has given over a part of his store to the Sonora line of machines. Mr. Golden has long conducted a retail business there and this is his first venture in the music business. A phonograph department has been opened for the display of these machines

VICTROLAS



The Victor Physical Exercise Records

The new physical exercise records placed on the market by the Victor Talking Machine Co. are prepared under the supervision of Prof. Chas. H. Collins, of the Collins Health Institute, and are a simple, complete physical exercise program with illustrated charts.

These Victor outfits will have a very active sale and every Victor retailer should be prepared to demonstrate and display the sets at once.

This, another source of profit for Victor retailers, is standard and non-seasonable merchandise.

VICTOR RECORDS

G. T. WILLIAMS CO. Inc.

217 DUFFIELD ST. ~ BROOKLYN, N.Y.

and Mr. Golden plans to place a competent man in charge. Lee Coupe, genial representative of the Long Island Phonograph Co. for Long Island, is responsible for closing this deal and is co-operating with Mr. Golden to give him an auspicious send-off in his new venture.

Hardman, Peck & Co. Add Victor Line

Hardman, Peck & Co., prominent talking machine dealers at 47 Flatbush avenue, have secured, in addition to their other lines, the complete Victor line of machines and records. This company recently purchased the entire stock of machines and records from the Pease Piano Co., which is giving up its talking machine department. Mr. Franke, manager of Hardman, Peck & Co., is very enthusiastic over acquiring the Victor line, as he will now be in a position to offer to the large clientele of this store a choice of the leading lines of talking machines and records in the market to-day. The Victor line will be given special prominence in warerooms, and it is planned to feature it for some time to come in order to properly introduce it to the trade. To announce this important event newspaper advertising was resorted to and an appropriate window display of an attractive nature was used in the large show windows of the store with the result that many sales of machines were made during the month of July.

Edward F. Callaghan, popular salesman for the company, has just returned from a three weeks' vacation spent in the mountain resorts of northern New York and is to devote from now on considerable of his time in this new department.

R. H. Keith Sets Golf Record

R. H. Keith, general manager of the Long Island Phonograph Co., finds time in his busy career to spend some time on his favorite golf links at Garden City. Mr. Keith made for himself an enviable reputation on these links the other day by turning in a net score that will stand as a record for some time for other members of the club to shoot at. This low score is probably one of the best turned in by players this season and Mr. Keith is receiving the congratulations of friends on his ability as a golf player.

ALTERATIONS AT A. I. ROSS STORE

Elaborate Plans for Extensive Remodeling and Enlarging of Exclusive Victor Shop

Plans are being filed for extensive alterations to take place in the near future at the A. I. Ross Music Store, at 206 Main street, Astoria, L. I., exclusive Victor dealer.

Mr. Ross intends to have an extension of forty feet added to the rear of the store and a complete remodeling of the front. Ten booths will be added and an enlarged and beautiful Victrola display room. The upper part of the building will be turned into a Victrola concert room. The whole building will be finished in stucco, with a beautiful design of the famous Victor trade-mark worked out on the front of the building.

When alterations are completed this will, no doubt, be one of the most attractive shops on Long Island. The A. I. Ross Music Stores also have a branch at 309 Steinway avenue, Astoria, which is also a model exclusive Victrola shop. The motto of the firm is, "If it's to be had on a Victor record we have it."

ATTEND WOMEN'S CONVENTION

W. A. Willson, manager of the educational department of the Columbia Graphophone Co., attended the recent convention of the American Federation of Women, held at Chautauqua, N. Y. The educational work was an important feature of this convention and prior to Mr. Willson's arrival in Chautauqua Mrs. Sharpe and Miss Davis represented the Columbia Co. The D-2 Grafonola with pushmobile was a prominent factor in the convention activities and won favorable comment everywhere. E. S. Germain, representing the Buffalo branch of the Columbia Co., was also on hand to assist Mr. Willson.

COTTON FLOCKS OF SUPERIOR QUALITY

ARE ESSENTIAL IN THE PRODUCTION OF QUALITY RECORDS
THE WISE RECORD MANUFACTURER

Who places his orders NOW for deliveries over the next few months, will be assured of an ample supply when he needs it, and will save money

CLAREMONT WASTE MFG. CO. - - - CLAREMONT, N. H.

ACME-DIE

- CASTINGS -

ALUMINUM-ZINC-TIN & LEAD ALL TYPES

Acme Die-Casting Corp.

Boston Rochester Brooklyn, N.Y. Detroit Chicago



Bert Williams, shuffling comically along behind the footlights, rocking packed houses with his delicious darky dialect, never told anything funnier than the two stories on A-6216, "You Can't Do Nuthin' 'till Martin Gets Here" and "How? Fried!" Trying to do business without this record is like trying to run the "Henry" without gas.

**Columbia Graphophone Co.
NEW YORK**

BRIGHTSON'S INTERESTING TALK

President of Sonora Phonograph Co., Inc., Makes Principal Address at Recent Meeting of the Talking Machine Men, Inc.

The Talking Machine Men, Inc., the organization composed of talking machine men of New York, New Jersey and Connecticut, held its monthly meeting on Wednesday, July 19, at the Café Boulevard, New York City, and, as usual, the meeting proper was preceded by a luncheon.

The main speaker of the afternoon was George E. Brightson, president of the Sonora Phonograph Co., Inc., and one of the pioneers of the industry. He was introduced by President Irwin Kurtz, who reviewed some of Mr. Brightson's activities in the industry, his ideals and the co-operation both he and his company have extended the Talking Machine Men, Inc.

Mr. Brightson said in part: "The main thought I wish to convey to your minds is—stabilization in selling—a point that you control, and, if done, will protect you and your invested capital. Many of you, though you began small, gradually expanded, acquiring expensive rentals and increased overhead. You are entitled to a profit on your sales. But just what profit you choose to take is known by you and you only. The law does not permit the manufacturer to interfere with you, as you are well aware, but I believe that if you, as an organization, will follow up the thought that I am advancing, you will protect yourselves from what I would call gyp trading.

"If you will trust to my judgment, I feel sure that you will protect yourselves by condemning cut prices. Continued price-cutting will un-

doubtedly convince manufacturers that you do not need such a great discount and that it would be better for all concerned to reduce discounts and lower list prices.

"As to the future, there is nothing but a bright outlook for the phonograph industry. There is a future and a good one, and manufacturers are making plans to create a demand for their products, which must be supplied by retail dealers. This is a world of dependence and no one realizes more fully than I that you, coming into contact with the consumer, are indispensable to the industry.

"When a manufacturer publishes broadcast in nation-wide periodicals that the product he makes is of extraordinary quality and you, the dealer, offer extraordinary discounts as an inducement to bring customers to your store, they cannot have the same faith in the manufacturer's claims, even though they purchase an instrument. Price-cutting pulls down confidence as fast as it is built up. The manufacturer interests the consumer in his product and the price-cutter creates a customer, but such customers seldom interest new buyers. When they do, these new buyers also expect a big reduction. Phonograph 'Boosters' are always recruited from among those who are thoroughly sold on the 'Quality and Service' idea—never on so-called bargains. Price-cutting never has and never will build up a substantial business.

"Another problem that had to be faced by the manufacturers of high quality phonographs was the great number of phonographs of doubtful origin, bankrupt stocks and others made with no consideration whatever of quality. These phonographs were gradually fading out of the picture, but, like Banquo's ghost, are again making their presence felt. Thousands of people now realize that these machines do not produce what was originally intended through the records, and many people possessing a large number of records prefer to dispose of these unsatisfactory phonographs for those bearing a favorable reputation. Sell a good new phonograph to the owners of these machines—do not let them sell you their worthless machines at their price.

"Now, I wish to say to you that this latter influence will be felt in the selection of many phonographs sold from this time on, and a little effort should be made to avoid anything being sold that will be unsatisfactory, and not encouraging to the thought that everyone now wishes a good phonograph. It will be helpful to you, and you should see the results quickly.

"Gentlemen, I appreciate the opportunity at all times to make efforts for your good, as your president so nicely mentioned, and you may rely on me to work with you for our mutual welfare."

Henry Teller, of Fred Fisher, Inc., the well-known popular music publishing house, addressed the gathering and called its attention to the plans of his company for the Fall season. Jack Glogau, with the aid of a number of songwriters, then demonstrated some of the current numbers of the Fred Fisher catalog, as well as those that

will be featured during the early months of the Fall season. Included in these were: "My Honey's Lovin' Arms," "I Wish There Was a Wireless to Heaven," "Strawberries," sung by Sam Ehrlich, who wrote the lyrics of the number; "My Idaho," sung and played by the writers, Harry Tobias and George J. Bennett; "Ji-Ji-Boo," a new novelty number, for which Joseph Meyer



George E. Brightson

supplied the music, and Fred Fisher's latest success, "Chicago" (That Toddling Town).

There will be no meeting of the Association in August and the next meeting is scheduled for September 13.

The Association is to hold its annual Fall dance at the Hotel Pennsylvania on October 31, detailed plans of which are to be announced later.

The assets of Talking Motion Pictures, Inc., of New York City, consisting of the contents and machinery of the recording laboratory, were disposed of at a bankruptcy sale on July 31.

PERRY B. WHITSIT Co.

WHITSIT co-operation and service to the Victor dealer has been enhanced by the exceptional facilities afforded us in our new home. Visit us on your next trip to Columbus.

COLUMBUS OHIO

VICTOR DISTRIBUTORS

No. 35767/10 Palm Plant, natural prepared, everlasting in green.

My SEASONABLE CATALOGUE No. 35 containing illustrations in colors of Artificial Flowers, Plants, Vines, Garlands, Hanging Baskets, etc., will be MAILED FREE ON REQUEST.

	Inches High	Palm Leaves	With Pot	Without Pot
35767/24	24	10	\$1.50	\$1.00
35767/5	30	5	1.00	.75
35767/7	42	7	2.00	1.50
35767/10	48	10	2.50	2.00

FRANK NETSCHERT
61 BARCLAY ST. NEW YORK, N. Y.

The "DAILY DOZEN"

Universally Recognized as the Standard and Most Beneficial of Health Building Exercises

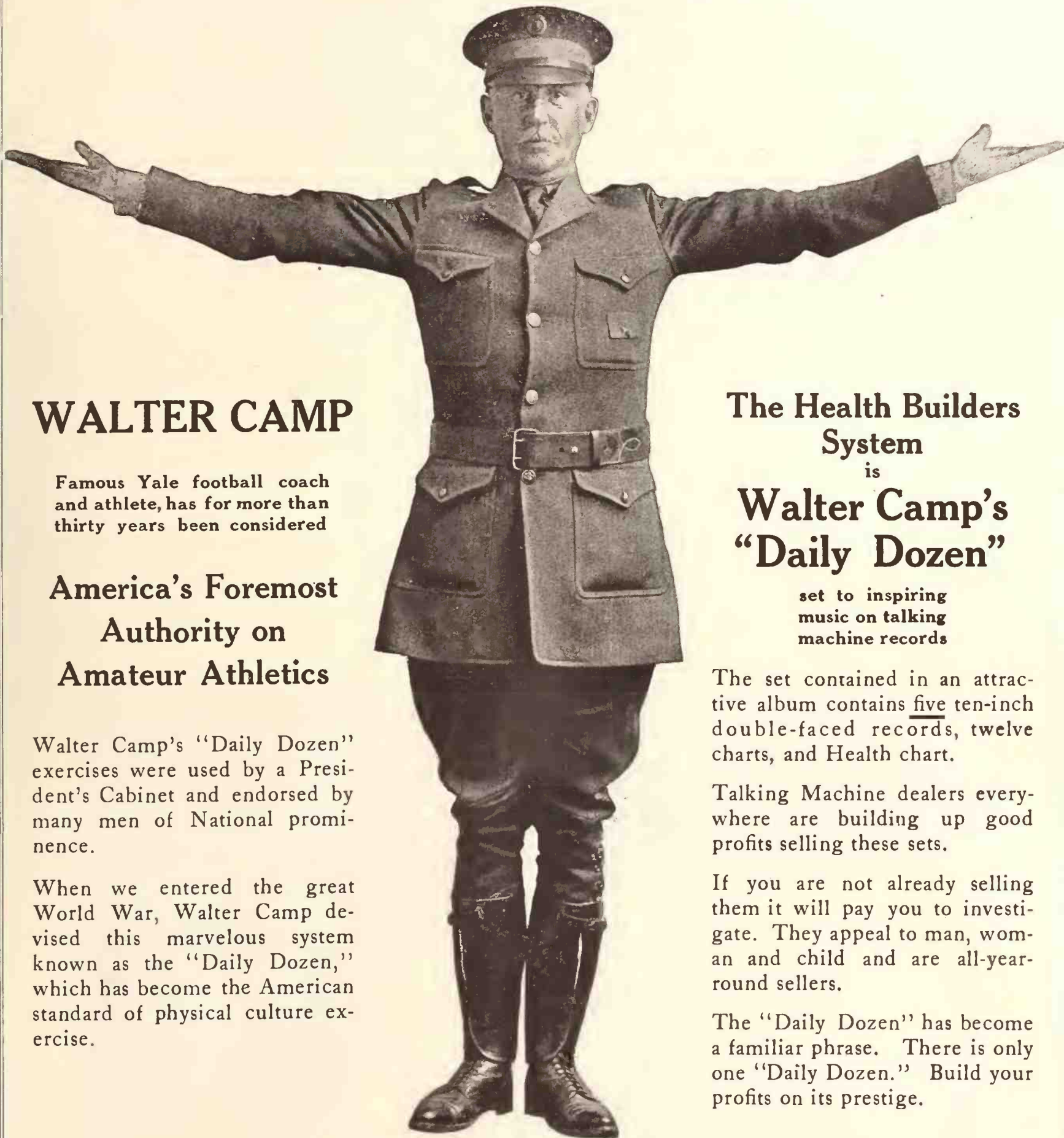

WALTER CAMP

Famous Yale football coach and athlete, has for more than thirty years been considered

America's Foremost
Authority on
Amateur Athletics

Walter Camp's "Daily Dozen" exercises were used by a President's Cabinet and endorsed by many men of National prominence.

When we entered the great World War, Walter Camp devised this marvelous system known as the "Daily Dozen," which has become the American standard of physical culture exercise.

The Health Builders
System

is

Walter Camp's
"Daily Dozen"

set to inspiring
music on talking
machine records

The set contained in an attractive album contains five ten-inch double-faced records, twelve charts, and Health chart.

Talking Machine dealers everywhere are building up good profits selling these sets.

If you are not already selling them it will pay you to investigate. They appeal to man, woman and child and are all-year-round sellers.

The "Daily Dozen" has become a familiar phrase. There is only one "Daily Dozen." Build your profits on its prestige.

waltercamp

OUR NATIONAL ADVERTISING HAS CREATED THE DEMAND—NOW IS YOUR OPPORTUNITY TO CASH IN

Write us today for sample and full information

HEALTH BUILDERS

DEPARTMENT W8

334 FIFTH AVENUE

NEW YORK, N. Y.

Getting Prospects a Business Proposition

By JOHN D. VANCE, Mason City, Ia.

"Getting Prospects" is the title of an interesting article which appeared recently in the very successful house organ issued regularly by Mickel Bros., Des Moines, Ia., Victor wholesalers. This article, which was written by John D. Vance, of the Vance Music Co., Mason City, Ia., read in part as follows:

"In my estimation, getting prospects is very much of a business proposition. It is the outgrowth of 'have beens,' others you have sold or their friends. I am confident I am selling the best talking machine in the world. We have stock sufficient to give first-class service and we have a sales force whose main performance is to make a friend out of every customer. We treat our sales persons absolutely square, which impresses them with the fact that they must treat the customer fair. During our twenty-two years of business we have adhered to this policy religiously, with the result that every one of our customers is continually working for us, and through them we get most of our prospects.

"We keep in touch with the Chamber of Commerce and learn when any new families arrive in Mason City and immediately learn whether they have any kind of a talking machine. If they have one then we solicit them for their record business.

"We instruct our sales force to call to the attention of every customer something other than what he asked for. We do not urge him to buy, but endeavor to draw him into a conversation. If a shipment has just arrived we mention it to him and emphasize the finish, or even the method of packing—anything to start him talking. In nine cases out of ten before we are through he has given us the name of at least one prospect. If he has a Victrola or some other make of talking machine occasionally we can induce him to trade it in for a larger size. Whenever this is possible we always try to close the deal on

the spot and if we are unsuccessful we always get his name and address, treat him extremely cordial and assure him that the offer is open whenever he cares to take advantage of it.

"We have a Chinese laundry in Mason City, conducted by one Chow Lung. His establishment consists of a little shop about nine feet by fifteen feet, in the rear of which is a little room about nine feet by ten feet. The room in the rear is his living quarters, fitted in regular cave-man style. He came to Mason City about a year ago and the customary crowd of small boys immediately commenced to make his life miserable. One day I discovered 'the gang' standing in front of his window, each trying to make the funniest face through the window at Chow. With a few kind words I shamed the boys at their tricks and then got acquainted with Chow. I was in his store just thirty minutes and came out with \$75 in cash for Victrola No. X. Later three other Chinamen in Mason City bought Victrolas, and let me tell you that as a rule Chinamen are exceptionally good pay. Chow is a good record buyer now and tells me that 'jazz-e mak-e fine music.'

"As a friend recently remarked to me, don't be content with working the highways for prospects. Most everyone has worked the highways, but look unto the byways and your reward will depend upon what effort you make."

RADIO BUGS AID RECORD SALES

Young Radio Enthusiasts Sell Records to Obtain Radio Parts

LOUISVILLE, Ky., August 7.—Talking machine dealers of this city are manifesting considerable interest in radio and several of them have added radio outfits and parts to their stocks.

Ben L. Loventhal, of the Louisville Music Co., has tied up the radio craze with his talking ma-

ILSLEY'S GRAPHITE PHONO SPRING LUBRICANT

Ilsley's Lubricant makes the Motor make good. Is prepared in the proper consistency, will not run out, dry up, or become sticky or rancid. Remains in its original form indefinitely.

Put up in 1, 5, 10, 25 and 50-pound cans for dealers. This lubricant is also put up in 4-ounce cans to retail at 25 cents each under the trade name of

EUREKA NOISELESS TALKING MACHINE LUBRICANT

Write for special proposition to jobbers

ILSLEY-DOUBLEDAY & CO., 229-231 Front St., New York

chine business in a clever manner by offering to give to young boys the radio parts they desire for selling records. The plan is proving productive of increased record sales.

HOW UNCLE SAM DELIVERS MAIL

The accompanying illustration is a facsimile of an envelope which was mailed in a rural free delivery box nineteen miles from Thibodaux, La.



The only address on the envelope was "The Columbia Grafonola, an American Achievement," and the letter was promptly delivered to A. E. Malhiot, Columbia dealer at Thibodaux. The delivery of this envelope not only emphasized the countrywide popularity of the Columbia product, but indicates that Mr. Malhiot is well established in his particular territory.

Among the prominent music houses in Washington, D. C., to add radio recently is the Gibson Co., 917 G street, N. W., representative of the Columbia Grafonolas and Brunswick lines.

Some of the Things You Get with a Flexlume Sign

When you buy a Flexlume Electric Sign you are not simply buying glass and metal. You are buying years of experience in electrical advertising. You are buying artistic design. You are buying 24-hour-a-day advertising at lowest cost, for Flexlumes are day signs as well as night signs—raised, snow-white glass letters on a dark background. You are buying greatest reading distance, lowest upkeep cost and a sign which will give your place of business an atmosphere of distinction.

Let us send you a sketch showing a Flexlume for your particular needs.

FLEXLUME CORPORATION, 36 KAIL STREET
BUFFALO, N. Y.

The Trade in **BOSTON** *and* **NEW ENGLAND**
 JOHN H. WILSON, Manager
 324 WASHINGTON ST., BOSTON, MASS.

BOSTON, Mass., August 7.—Seven months of the current year have now been brought to a close and it is interesting to note the varying aspects that jobbers and dealers take of the situation. On the whole, the Summer trade has been good and of a rather healthy character; that is to say, the demand for goods has not been of a spasmodic nature, business has been coming in at rather an even pace. An effort will be made by jobbers to have the dealers lay in their stocks early this Fall in anticipation of the good business that is looked for during October, November and December, especially, for the careful observers of conditions are enthusiastically confident that the Fall season will not be far advanced before business will begin to take a pronounced jump. Just now, apart from the fact that it is mid-Summer, a period of natural dullness, the strike situation is having a deterrent effect on business, particularly in those sections most immediately affected. But things will adjust themselves shortly and then look for an improved situation—that is about the sentiment one hears expressed when calling on members of the local trade.

Pleasant Welcome at Vocalion Hall

Vocalion Hall holds a pleasant welcome these Summer days for the passers-by in Boylston street, where Manager William E. Birdsall is ever ready to interest lovers of music in the merits of the Vocalion proposition. Mr. Birdsall returned this week from New York, where he and his family have been spending part of their vacation, the rest of it having been consumed in making tours through Greater Boston and eastern Massachusetts in Mr. Birdsall's Packard car. Charles T. Foote, of the retail staff of this house, leaves town to-morrow for his vacation and Frank Lincoln will take his departure the middle of August.

Demonstrates the Cheney Phonograph

Stephen Colahan, New England manager for the Cheney phonograph, spent a week in Springfield toward the latter part of July, where he gave a demonstration of the Cheney machine at the well-known Main street establishment of Forbes & Wallace. As a result of the demonstration the members of the firm were so well satisfied that they speedily took over the exclusive rights to handle the Cheney for Springfield and Greenfield. William F. Larkin, the general manager of the musical department of this store, which is one of the largest in the city, expressed

himself as eminently satisfied with the Cheney and a large initial order of goods is now on the way from Chicago. Manager Colahan has made a contract with James A. White, of 181 Tremont street, whereby the latter will be the efficiency man for the Cheney in the New England territory.

New Columbia Agency in Worcester

One need not long be in conversation with Fred E. Mann, the Columbia branch manager here, to sense a condition of rapidly improving business not only with the Columbia Co. generally, but in the particular field over which Mr. Mann has supervision. Among the new accounts which the Columbia Co. has taken on is that of the American Upholstering Co. in Worcester, of which M. Sobel is the owner. This talking machine department, featuring the Columbia line, was opened a fortnight ago and the arrangement, decorations and general accessibility have been highly spoken of. There are four demonstration rooms, which are among the most artistic of any in the city.

Manager J. H. Burke Primed for Campaign

Joseph H. Burke, manager of the Musical Supply & Equipment Co., is home from a two weeks' automobile trip into the White Mountains, on which he was accompanied by Mrs. Burke. Mr. Burke returned in fine condition and in full anticipation of a good Fall season in the Sonora line. Mr. Burke has lately formed several new connections for Sonora representation and he reports that all the latest models of machines are in growing demand among the trade.

Hallet & Davis Phonograph Progress

In the third issue of the Hallet & Davis Salesman there is considerable attention given to the talking machines put out by this house and mention is made of large shipments to the Pacific Coast, and a sample order has been dispatched to Australia. Mention is also made of a five-copy advertising campaign that has just been prepared and arrangements have been completed by the talking machine division of the house to share the cost of advertising with dealers in their local newspapers. Lester G. Jones, for several years the representative for another house, has joined the Hallet & Davis forces and will travel through the State of Pennsylvania in the interests of the talking machines. In the New England field George Kimball, whose transfer to the talking machine division of the company was announced

in last month's issue, is traveling in his Cadillac car, which is especially equipped to carry a sample talking machine, and by this means Mr. Kimball is making a most aggressive campaign, working under the supervision of R. O. Ainslie, who has a special interest in this end of the Hallet & Davis business.

J. W. Miller, a Hallet & Davis dealer at Harrisburg, Pa., has sent a letter to headquarters which testifies to the special worth of the talking machines made by this house. It appears that Mr. Miller sold the City Star Laundry in his city a Hallet & Davis phonograph as the result of the choice of the force of the 800 employes, who voted for its selection after hearing three different makes of machines in a test. This Hallet & Davis phonograph will be used for entertainment in the Recreation Hall.

Brunswick Line With Vose & Sons Piano Co.

Harry Spencer, who reports a very good July business in Brunswick machines and records, has signed up the Vose & Sons Piano Co. and hereafter at the Boylston street warerooms of this widely known music house a full line of the Brunswick goods is to be carried. Harry Stevens, manager of the Vose retail warerooms, will have general supervision over this new department. This is an important connection for the Brunswick, as the Vose house is one of the oldest and best-known in New England.

Some More New Accounts

Mr. Spencer went down to Salem a fortnight ago for the opening of the new Brunswick Shop, which is located on Washington street, and in charge of Odell Bros. This store formerly was located on a second floor, but the new quarters, which are equipped with six booths of Unico construction, are handsomely furnished in antique style, making one of the most attractive places of the kind in Salem. Carl Fenton's Orchestra came over from New York for the opening. Another establishment that is now carrying the Brunswick line is the Summerfield Furniture Co., of Boston, and still another is the Terminal Phonograph Co., in Canal street, which has become an exclusive Brunswick headquarters.

Plan Salesmanship School

The three Victor distributors here are making arrangements for the Victor Red Seal salesmanship school, which is to be held in Boston for five days beginning August 14. The sessions will be
(Continued on page 84)

**DITSON
 VICTOR**



SERVICE

**“The Coming Fall” Is Here
 Make It a Victor Fall**

There is little time for putting record and machine stocks in perfect form to meet the coming post-summer demand. Fill in the gaps now. Arrange for future requirements.

Ditson Service will lighten the task for you

**CHARLES H. DITSON & CO.
 NEW YORK**

**OLIVER DITSON CO.
 BOSTON**

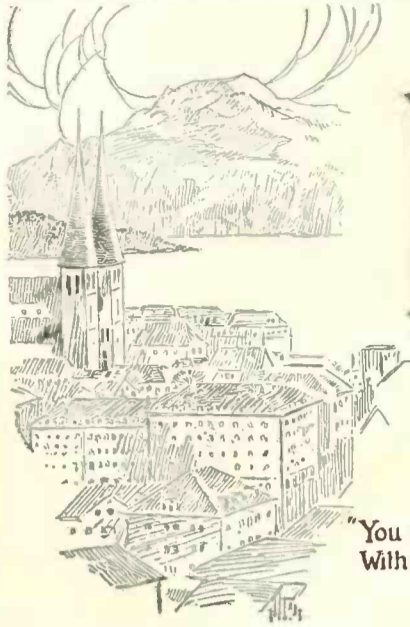

LONDON'S NEWEST WALTZ HIT!

LOVELY LUCERNE

As Beautiful as "Valse Septembre" and by the same Writer



When falls the calm of e-ven-tide, There comes a vis-ion glow-ing.

"You can't go wrong
With any FEIST song"

THE TRADE IN BOSTON AND NEW ENGLAND—(Continued from page 83)

held daily at Steinert Hall, in Boylston street, which is admirably adapted to such purposes. The sessions, of which there will be two each day, will be under the supervision of F. A. Delano. The Oliver Ditson Co., M. Steinert & Sons and the Eastern Co. all have sent out announcements to dealers of the proposed salesmanship school and they are urged either to attend themselves or to see that their houses are in some way represented. The classes will be conducted along much the same lines as those conducted at the Victor factory at Camden. The local Victor distributors will give every possible assistance to making the classes a success.

On the last night of the class the three jobbers already mentioned plan to entertain the dealers at Pemberton and the arrangements include a departure for this beach resort by boat early in the afternoon so that there will be time for a game of baseball and a program of sports, to be followed by a banquet at the Pemberton Inn, after which there will be dancing to the music of Bert Low's Orchestra. It is expected that

there will be an attendance of about seventy-five persons at the class, but there is not likely to be any dealers present from Connecticut as a similar class is being held at New Haven this week at the Victor establishment of Horton, Gallo & Creamer; and there is one also to be held next week at the Portland, Me., store of Cressy & Allen, which means that there is not likely to be anyone coming to the Boston class from the Pine Tree State.

Our Congratulations Extended

A wedding that is to be celebrated on September 4 is of special interest to the talking machine trade because both parties have been closely identified with the business for several years—Miss Marguerite Taylor and Stephen A. Colahan. Miss Taylor has been with the Hallet & Davis Co. several years and much of that time was secretary to R. O. Ainslie. As a thoroughly informed woman on matters pertaining to the talking machine end of the business she has proved herself a valuable factor to the company. Mr. Colahan is the New England representative

of the Cheney instrument and he has made many friends since coming to Boston a couple of years ago.

Herbert Shoemaker's Father Seriously Ill

Herbert Shoemaker, general manager of the Eastern Talking Machine Co., has the sympathy of his many friends in the trade in the serious illness of his father, Joshua Lippincott Shoemaker, of Philadelphia, who at this writing is not expected to recover. Mr. Shoemaker returned only a few days ago from Philadelphia, where his father has been in a hospital for several weeks. Mr. Shoemaker, Sr., is sixty-four years of age and has long been prominent in the business affairs of Philadelphia.

Mr. Shoemaker has been finding his special exercise this Summer in rowing on the Charles River and in this especial field of sport he is winning laurels fast. Lately he had been qualifying so as to enter some of the events of the National Regatta to be pulled off soon at Philadelphia, but he has practically decided not to participate in any of the races in that city.

Herbert L. Royer Visits New York

Herbert L. Royer, of the Bay State Music Corp., the distributor of the Odeon records, was over in New York a while ago visiting the quarters of the General Phonograph Corp. While there he also went over to Philadelphia, where he had a conference with the officials of the King-O-Tone Phonograph Co., whose line Mr. Royer also carries.

M. Steinert Sons Co. Store Remodeled

The Lowell branch of the M. Steinert Sons Co. has been entirely remodeled and is now one of the most complete and handsome music establishments in this section of New England. The store has an advantageous location at 130 Merrimack street and consists of a spacious main floor and basement.

The Victor talking machine and record department is located on the main floor. The record department is well toward the front of the store and adjoining this there are six sound-proof record demonstration booths. The entire room is finished in old ivory. The piano department is in the basement, where the several lines of fine instruments handled by the concern are on display. The store is in charge of W. Blake Irvine, who has had a wide merchandising experience.

Fire in Miller's Damages Stock

On the night of July 27 the Henry F. Miller Co.'s Boylston street warerooms suffered a fire which entailed a loss of \$50,000. On the second floor Walter Gillis has his large stock of Victor goods, which suffered somewhat from smoke. In the fire sale subsequently advertised talking machines were included.

A Visitor From St. Louis

A recent visitor to Boston was Sydney Baer, of Stix, Baer & Fuller, one of the largest establishments of St. Louis carrying the Victor line. Mr. Baer made his headquarters while here with the M. Steinert & Sons Co.

New Columbia Store

A new Columbia store has been opened at East Weymouth, which is operated by Edward E.

KRAFT-BATES AND SPENCER INC.
NEW ENGLAND DISTRIBUTORS

Brunswick
PHONOGRAPHS AND RECORDS

**The Phonograph Found Where
Good Taste Predominates**

The satisfaction derived from handling Brunswick Phonographs and Records is twofold.

For it not only means offering your trade a line of admitted leadership, but one which also proves most profitable to you.

Fewer Brunswick dealers mean less competition in handling the business created by Brunswick unsurpassed national advertising.

Kraft, Bates & Spencer Inc.
1265 Boylston Street
BOSTON, MASS.

New England Distributors

Steel Needles Albums
Record Brushes
Khaki Covers



Nash, at 260 Broad street. The quarters are equipped with two beautiful demonstration rooms.

Geo. A. Dodge Candidate for Legislature

Boston newspapers recently carried a story that George A. Dodge, of the Eastern Talking Machine Co., Victor distributor of this city, had been mentioned as a candidate for the Massachusetts State Legislature. Mr. Dodge is very well and favorably known throughout Boston and vicinity. At one time he built and since has rebuilt several times Paragon Park, which is described as a million-dollar property, and kept the management of it until several years ago. It is stated that Mr. Dodge owns and conducts the Hotel Pemberton and Pemberton Inn. He has also been responsible for the rapid growth of the city of Hull, Mass., and has several times been urged to represent this city, which he has previously declined. Although declining this as a political honor Mr. Dodge has been approached by his fellow-citizens and urged to accept the nomination as a civic duty, which he finally did.

A Striking Victor Window

In the remodeled Tremont Talking Machine Store, which is now operated by the Iver Johnson Sporting Goods Co., which recently acquired the business, there is one window given over to the Victor products, and its artistic arrangement is attracting any amount of attention. All of the second floor of the store is devoted to handling the Victor line.

C. O. Giles, traveling representative of the General Phonograph Corp., has been in Boston for more than a week and while here was in frequent conference with Herbert L. Royer, of the Bay State Music Corp.

Assistant Manager G. P. Donnelly, of the Columbia headquarters, is back from Portland, Me., where he spent nearly a fortnight familiarizing himself with business conditions and renewing acquaintance with the dealers.

Miss Martha Candage, of the F. C. Henderson Co., in Boylston street, has just returned from a month's trip to Chicago, which she and her mother and sister took by automobile. At one place in Indiana the three women traveled nearly 150 miles by moonlight over the prairie roads.

Open New Broadcasting Station

One of the largest radio broadcasting stations in New England has been opened by Edwin C. Louis, Inc., 121 Federal street. Elaborate ceremonies marked the formal opening of the station, the feature of which was an address by Mayor Curley. The company plans to hold weekly radio concerts.

The Shepard Stores are also planning to open

EASTERN SERVICE

NEW ENGLAND SERVICE FOR NEW ENGLAND DEALERS



Join the Eastern Family

and enjoy the exceptional service which our efficient organization is rendering to New England dealers.

Victor Wholesalers Exclusively

85
ESSEX
ST.

THE EASTERN TALKING MACHINE CO.

VICTOR DISTRIBUTORS

BOSTON
MASS.

a large broadcasting station in the near future from which nightly programs will be sent.

Vacations in the Hub

Ernest A. Cressey, of the C. C. Harvey Co., is spending his vacation at Jackson, N. H., whither he motored with Mrs. Cressey. Winthrop A. Harvey, head of this same house, has been on several cruising trips along the New England coast during the month, the last one being to Block Island and subsequently into Maine waters. A look at Mr. Harvey and one would know he'd been on the briny deep.

Herman N. Baker, of the A. M. Hume Co., Victor and Cheney distributor, spent a part of July at Brookfield, Conn., where he had his family with him.

Joseph T. Sayward, of the M. Steinert & Sons Co., with Mrs. Sayward, has been at Kennebunkport, Me., where they spent an enjoyable several weeks.

In Field for State Senator

Henry L. Kincaide, the music merchant of

Quincy, who carries a large line of talking machines, is in the field for State Senator. Mr. Kincaide does business under the firm name of Henry L. C. Kincaide & Co. and his house is one of the best-known in that city.

Mr. and Mrs. E. E. Conway to Europe

E. E. Conway, president of the Hallet & Davis Co., and Mrs. Conway and their two daughters, Miss Virginia and Miss Janet Conway, sailed for Europe on July 21 by the steamship "Scythia." Mr. Conway's associates in the home office made his departure especially pleasant through the gift of flowers and other remembrances, due appreciation of which was subsequently expressed through the medium of a radio message which he sent back when the ship was out at sea. This is the first real vacation Mr. Conway has taken in several years.

Discuss Business Conditions

Kenneth Reed, manager of the wholesale Victor department at the M. Steinert & Sons establishment, reports that business is moving along

(Continued on page 86)

"Perfection" Edison Attachments and "Perfection" Reproducers

The "Perfection" Flexi-Tone Edison Attachment (No. 4 and No. 7) as illustrated, attached to all types of Edison Disc Machines, makes the most perfect attachment available for playing all makes of lateral cut records requiring steel, tungstone or fibre needles. Only first quality mica diaphragms used in "Perfection" reproducers, giving clear, natural tone. The horizontal ball-joint and direct uplift construction give freedom of movement so that attachment may be used with or without lever, giving excellent results.

Retail price \$9.00 Gold. \$8.00 Nickel.

The "Perfection" Pur-I-Tone Edison Attachment (No. 6 Universal) plays All makes of records on New Edison Disc Machine.

Retail price \$10.00 Gold. \$9.00 Nickel.

The "Perfection" Edison Attachment (No. 4 and No. 2) plays all makes lateral cut records on New Edison Disc Machine.

Retail price \$7.00 Gold or Nickel.

The "Perfection" Pur-I-Tone Reproducers to play all makes hill and dale records on Victor Machines.

Retail Price \$6.00 Gold. \$5.00 Nickel.

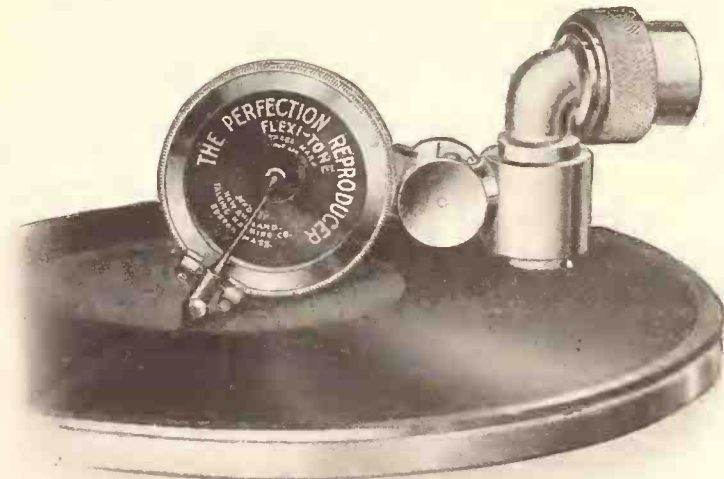

The "Perfection" Flexi-Tone Reproducers to play all makes lateral cut records on Victor and Columbia Machines.

Retail Price \$6.00 Gold. \$5.00 Nickel.

The "Perfection" Pur-I-Tone Reproducers to play all makes hill and dale records on Columbia Machines.

Retail price \$6.50 Gold. \$5.00 Nickel.

NOTE—Special Discounts to Dealers, also Quantity Prices on Request

New England Talking Machine Co. 16-18 Beach St., Boston, Mass.



Your plans for this season, no doubt, include an exhibit at the Fair or Chautauqua. See the Columbia Dealer Service Man. He can help you with ideas and provide the necessary advertising, displays and novelties.

Columbia Graphophone Co.
NEW YORK

THE TRADE IN BOSTON AND NEW ENGLAND—(Continued from page 85)

about as one would expect in mid-Summer and as for the demand for records he adds that about 80 per cent of the call is confined to a dozen popular numbers. He adds that there are a number of requests for "Shuffle Along," now playing in Boston, and these numbers will shortly be on sale here. Mr. Reed is not planning to take any extended vacation this Summer, contenting himself with spending long weekends at his Summer home on Cape Cod, where he divides his time between golf and fishing, and in the latter field he is getting to be as good a story teller as the rest of these alleged fishermen.

WALSH & HINES IN NEW HOME

Brunswick Dealer Moves to Larger Quarters as a Result of Business Expansion

WALTHAM, MASS., August 5.—A rapid business growth is emphasized by the recent removal of the firm of Walsh & Hines to 265 Moody street. The firm, which is composed of V. S. Walsh and G. A. Hines, opened a studio in an upstairs room at the corner of Moody and Walnut streets May 1 of this year, handling Brunswick phonographs and records. Their volume of business since that time has grown to such proportions that more room was necessary. In addition to Brunswick phonographs a line of Hallet & Davis pianos is carried in stock, as well as sheet music and player rolls.

HALLET & DAVIS PUBLICITY MAN

James A. Mango Appointed Publicity Manager of Hallet & Davis Piano Co.

BOSTON, MASS., August 5.—James A. Mango, who is now the publicity manager of the Hallet



James A. Mango

& Davis Co., bids fair to do his share toward bringing the products of this company to the

fore, for he is a man of ideas which in print are well expressed, as witness his excellent work in the Hallet & Davis Salesman, the third issue of which is now out. Mr. Mango comes from the Middle West, is a man of studious mien, always eager to acquire such a fund of knowledge as will prove of value in lines of publicity exploitation, and can talk as fluently and interestingly as he can write.

ADVERTISING PRODUCES SALES

The Winograd Music Store, progressive Columbia dealer at New Bedford, Mass., recently decided to use advertising in a New Bedford Portuguese paper. This advertising produced



The Letter Tells the Tale

splendid results, and several sales of Grafonolas were closed as a direct result of the campaign. Among the inquiries received was one from Santa Cruz, Mex., which developed into a sale.

OPEN STORE IN FITCHBURG

On August 1 the Iver Johnson Co. opened a new store in Fitchburg following a purchase of the Victor stock heretofore carried by Nichols & Frost, a large department store of that city. The new store is at 466 Main street, which is a very central location and there is every indication that good business will be maintained right along.

MILLER CO. OPENS BRANCH STORE

WEST CHESTER, PA., August 7.—The Miller Piano Co., of Coatesville, Pa., is planning to open a music store here. In addition to the line of pianos which the company handles, Victor talking machines and records will be stocked, the company having purchased the Victrola agency of George J. Palmer.

PHONOGRAPH AND PIANO ACCESSORIES

Manufacturers

LANSING KHAKI COVERS

The Pioneer Moving Cover

SLIP AND RUBBER COVERS FOR PHONOGRAPHS AND PIANOS

Distributors

Bradley and Plymouth Portable Machines	Piano Benches
All-in-One Reproducers	Piano Stools
Nyacco Record Albums	Piano Chairs
Universal Fixtures	Piano Scarfs
Victrolene Polish	Player Benches
Jones Motrolas	Music Cabinets
Hall Fiber Needles	Lesley's Patching
Steel Needles	Outfits
Sapphires	

The Electora for the Player Piano

TRY OUR SERVICE!

Lansing
SALES CO.

170 Harrison Avenue

BOSTON, 11, MASS.

An Antidote for
Summer Dullness

IS FOUND IN

"LONG QUALITY" CABINETS
"PEERLESS" ALBUMS

They are both good all-year-'round sellers. If you do not already carry these lines, write today to

L. W. HOUGH

New England Representative
20 SUDBURY STREET BOSTON, MASS.

ANNOUNCEMENT

An open letter to

Talking Machine Dealers

Since the appearance of our first National advertising May 27th, in the "Saturday Evening Post," we have received many letters from talking machine dealers regarding our line, due no doubt to the fact that we have a Nationally priced line, Nationally advertised. They have all asked us this question:

"CAN A SUCCESSFUL TALKING-MACHINE STORE SELL PLAYER-PIANOS AND REPRODUCING PIANOS, AND WHAT IS THE BEST WAY TO GET STARTED THIS FALL?"

We have hesitated urging these men to enter the piano business. We did not know ourselves what to recommend. So we had our salesmen and company officers study this question, with the following results.

Any responsible talking-machine dealer in open territory will be given the same consideration by us as a piano dealer. Any responsible talking-machine dealer who will agree to use the selling plans we have worked out and proven to be right will be offered the Hallet & Davis franchise in his territory.

The only requirement that we insist on is that you have been a success with talking machines. If you have been successful we want to talk to you personally either in your office or at our New York or Boston offices, regarding the Angelus Reproducing Piano with its exclusive Artrio Library and a list of such artists as Bauer, Zeisler, Paderewski, Hofmann, Gabrilowitsch and Lhevinne. And the Virtuolo Player-Piano which is popularly priced.

Both of these lines are being advertised Nationally in the finest women's magazines and in big city newspapers. Both have an organization back of them equipped with experience, money and exceptional advertising and selling ability.

Territories are being closed every week. Our salesmen will be on the road all Summer and Fall. If you want to add one of the best profit-making lines in this country and obtain the Hallet & Davis franchise, we suggest that you write or wire us immediately.

HALLET & DAVIS PIANO CO.

146 Boylston Street

Boston, Mass.

SAINT LOUIS

Dealers Expect Start of Fall Revival This Month—Record Demand Holds Up—Favorable Federal Reserve Report—Month's News

St. Louis, Mo., August 7.—There has not been an overwhelming improvement in the talking machine business in St. Louis since this time last month, but conditions are as favorable as can be expected at the peak of a Summer that has been unusually hot. But August is looked upon as the open door to Autumn and dealers are beginning to bestir themselves in anticipation of the beginning of an improvement that is confidently expected to become steadily more marked as the season advances.

The record business has held up steadily through the Summer. In some quarters there has been a marked improvement in the record demand during the past month. Manager Hosier, of the Scruggs, Vandervoort & Barney talking machine department, who is one of the men reporting this improvement, says the bulk of it has been in high-class records.

Cheery Federal Reserve Report

On general business conditions in the St. Louis trade territory, William McC. Martin, Chairman of the Board of Federal Reserve District No. 8, has this to say in his monthly report:

"In a majority of instances reports to this bank by leading interests in all lines scattered through the district indicate further improvement in business during the past thirty days. The rate of progress was somewhat less marked than during the preceding month, and in certain localities and industries a slight reaction from the recent activity was noted. The usual seasonal slowing down in production and distribution of certain commodities was emphasized by labor difficulties, and in the areas directly affected by strikes the retail branch of trade reflected the money losses involved in stoppage of operations and workers' pay. In those localities there is

decided hesitation on the part of merchants in the matter of filling their requirements for goods of all sorts.

"On the other hand defections from the list of employed, due to the strikes, were in a large measure counterbalanced by the augmented pay rolls of industries which have increased their operations, and by the enormous absorption of workers by harvesting and other agricultural activities. For the first time in many months there has developed a scarcity of laborers, both common and skilled, and the trend of wages is upward. This is true particularly of the iron and steel and building industries. Labor agencies report an unusual demand for skilled artisans and are unable to supply all the requests made upon them for common labor. Generally throughout the district farmers have been able to obtain all the help required and are paying about the same wages as at this time last year."

Ill Health Forces Vacation on F. J. Ennis

F. J. Ennis, manager of the talking machine department of the Stix, Baer & Fuller Dry Goods Co., has been compelled by a break-down in health to take a vacation and has gone East. In his absence the department is looked after by Miss Helen Hatfield, the assistant manager. Improvements which had been planned are being made, including the installation of additional record racks and washed air ventilation.

Tri-State Victor Dealers Meet

The Tri-State Victrola Dealers' Association held a most enjoyable mid-Summer meeting recently at the Century Boat Club, a delightfully cool spot on the Mississippi River. The meeting was called solely for pleasure and not for business. T. H. Maetten presided. The chief talk of the evening, given at the end of the dinner,

was that of T. L. Husselton, of the Victor traveling staff. He discoursed in an interesting manner on tungs-tone needles and the console Victrola. Besides the ability to tell things well, Mr. Husselton possesses a remarkably fine voice and much of the pleasure of the evening was due to his vocal numbers.

Miss A. Clayton in New Post

Miss Anna Clayton, formerly in charge of the Victor record department of the T. E. Clark Music Co., of Cape Girardeau, Mo., is now in charge of the new Victrola store of Grinnell Bros., of Kalamazoo, Mich.

Scruggs, Vandervoort & Barney Activities

A. W. Hosier, manager of the Scruggs, Vandervoort & Barney Victrola department, is enjoying a visit from his father, whose home is in Kansas City.

Miss Rosebrough, manager of the Victor educational department, has returned from a vacation. Miss Ella Marklin and Miss Miriam Wasserman, of the talking machine department, also have returned from vacations.

Opens Foreign Record Department

A Victor foreign record department was opened this month by Manager J. F. Ditzell, of the Famous & Barr Co.'s talking machine department. The opening order was one of the largest ever placed with the Chicago Talking Machine Co. Language records of Germany and other of the principal European nations are stocked. Letters have been received by Manager Ditzell from the foreign consuls thanking him for the opportunity that is given for obtaining the foreign language records. The response on the opening days was beyond the greatest expectations. The department is in charge of Miss Elizabeth Swimmer.

Interesting News Brieflets

The Kieselhorst Piano Co. has received the first shipment of Zenith radio outfits, for which it has taken the agency.

Miss Marian R. Fox, of the Silverstone Music Co., has been spending a three weeks' vacation in the Ozarks. Miss Vivian Dewes has returned from a vacation trip.

Among the Edison dealers who have lately

Improve Your Service AND Increase Your Sales

By Equipping With The OGDEN "UNIT" or Sectional System

which has been used by thousands of dealers for the past six years and "Sold" to all on our UNCONDITIONAL GUARANTEE OF SATISFACTION, QUALITY AND PRICE.

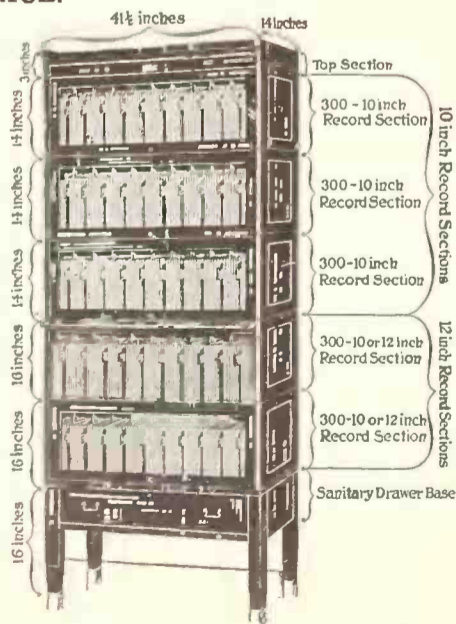

Model No. 1 and No. 31 Sectional Cabinet

FILES YOUR RECORDS so you can find them for QUICK SALE and SERVICE. Fits any space and Stock. Visible Tab Indexes locate every Record Instantly. \$14.00 per 1,000.

ORDER PORTABLE VICTROLAS NOW

and be ready to "Tie Up" with National Advertising and "Cash In" this opportunity for an extra profit by Selling

OGDEN STAND YOU-NITS

For the Portable Victrola No. 50, Also No. IV and No. VI

Don't wait but be ready and go after the Summer Business with a VICTROLA-STAND OUTFIT for Sea Shore or Camp,—Town and Country, with Music for every Occasion.

Order a Stand for every Portable Victrola (to Match) and we will Guarantee the Sale if only Displayed and Advertised.

Positively Rigid and Strong

Matches the Victrola in Material, Finish and Design. If your Jobber does not have Stock order direct and we will deliver them FREE.

Improved Model No. 50a is a dandy.

Delivered \$7.00 each

Write for New Catalogue and Cuts free.

OGDEN SECTIONAL CABINET CO., Inc.
LYNCHBURG, VA.

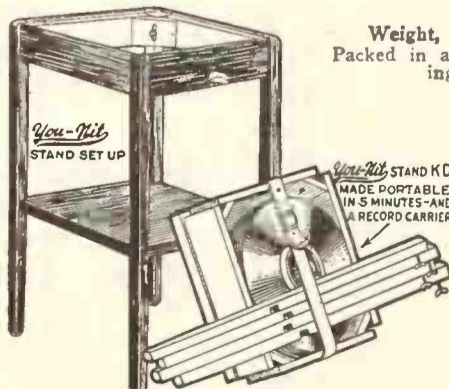

Weight, each, 10 lbs.
Packed in a Portable Carrying Case.

Six Pieces Assembled or "Packed Down" as a Record Carrier in Five Minutes

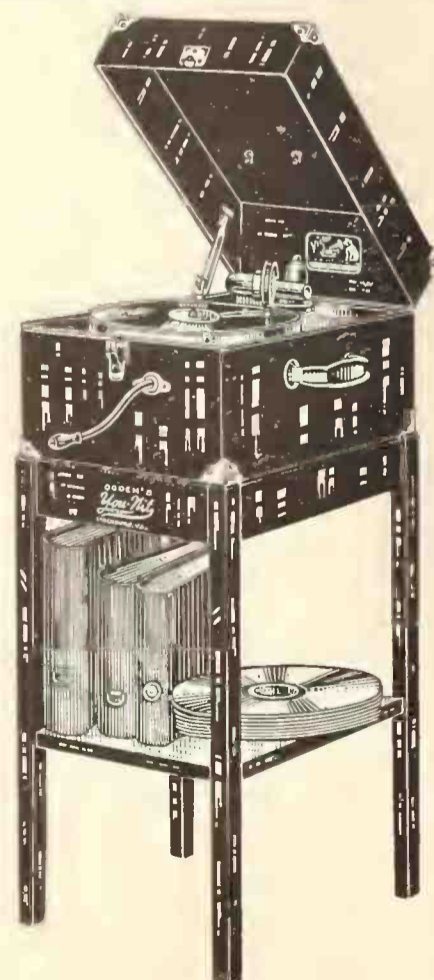

visited the Silverstone Music Co. were Frank Sigman, Flat River, Mo.; C. J. Jacoby and E. L. Jacoby, Alton, Ill., and R. N. Monaghan, Gillespie, Ill.

T. W. Maetten, manager of the talking machine department of the Kieselhorst Piano Co., and secretary of the Tri-State Victor Dealers' Association, has returned from a trip to Chicago.

A. L. Bruner, a Brunswick dealer of Rock Island, Ill., recently visited St. Louis on a motor trip.

Miss Golda Airy, of the Koerber-Brenner Co., Victor distributor, has returned from a three weeks' vacation which she spent at the Lakes.

Announces New Columbia Agency

The local branch of the Columbia Grafonola Co. announces that the Nokomis Music House, of Nokomis, Ill., has recently opened with a complete line of Columbia Grafonolas and records. Fred L. Crumbaugh, who has had broad experience in musical lines, is the manager.

Miss Florence E. Hazlett, of the educational department of the Columbia Graphophone Co., New York City, gave a demonstration of "How to learn to appreciate music," on the campus of the University of Arkansas, at Fayetteville, Ark. Miss Hazlett was well received by the public, and the demonstration was a complete success.

Y. H. Helwig is now the city salesman for the local branch of the Columbia Graphophone Co. Mr. Helwig succeeds E. O. Melcher, resigned, and is a man of broad sales experience.

NEW MUSIC DIRECTOR OF STARR CO.

Thomas Griselle was recently appointed musical director for the Gennett recording laboratories of the Starr Piano Co., Thirty-seventh street, New York City. Mr. Griselle was formerly assistant to Pietro Florida, who resigned to devote his time to teaching and composing.

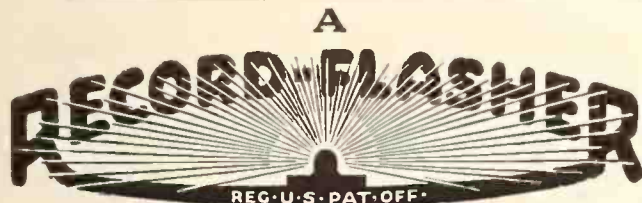

Should be on Every

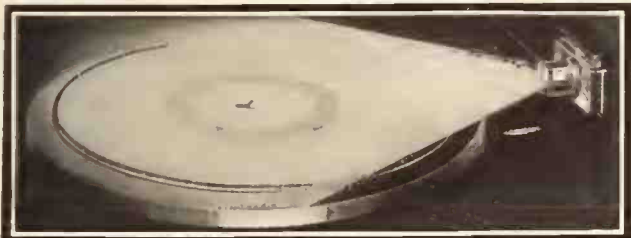

Phonograph and Player Piano

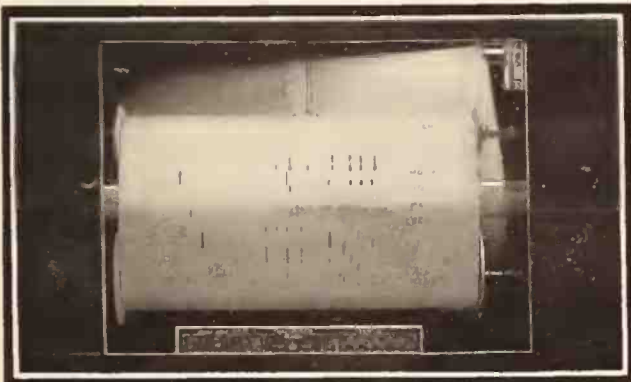

Beautifully finished in Nickel or Gold

It applies perfectly to every phonograph and player piano, no instrument is complete without it.

For phonographs this light makes cumbersome operations easy and simple in darkest corners where phonographs are usually placed. It prevents scratching of records and makes setting of automatic stop positive and simple.

For player pianos it is indispensable, gives an abundance of illumination for singing or inserting music rolls.

Easily and quickly attached, comes complete ready for use, no electricity or wiring necessary.

RECORD FLASHERS last indefinitely and are fully guaranteed. Batteries last from 6 to 12 months in service. Renewals can be had at 75 cents.

Prices { Nickel Plated with Battery - - \$3.00
Gold " " " - - 3.75

Special Discounts to Dealers and Manufacturers
Write for descriptive circular

Standard Accessory Corporation

Sole Manufacturers and Patentees

1015 Third St. Milwaukee, Wis.

DEATH OF DR. ALEXANDER G. BELL

Famous Inventor of the Telephone, Who Was Also Associated With the Development of the Graphophone, Passes Away in Nova Scotia

Dr. Alexander Graham Bell, inventor of the telephone and who, in association with his brother, Dr. Chichester A. Bell, and Sumner Taintor, is credited with making possible the commercial success of the talking machine industry in its early days, died at his Summer home near Baddeck, N. S., on August 2. Dr. Bell celebrated his seventy-fifth birthday on March 3 of this year and although his health has not been of the best for some time his death when it came was unexpected.

Dr. Bell's basic patent on the telephone, granted March 17, 1876, is said to be the most valuable single patent ever issued, and it is held by many to have marked the greatest forward step in modern civilization. Certainly, from a cold business standpoint, it is doubtful if any single device can equal the telephone for usefulness in its present-day development. Fortunately Dr. Bell lived to witness the full development of his invention.

The talking machine industry is particularly interested in Dr. Bell for his work in association with Chichester A. Bell, his brother, and Sumner Taintor in the sound recording field. The patent, which was issued to C. A. Bell and Mr. Taintor in 1886, is credited with having made possible the commercial success of the graphophone and for that matter of the industry in its early days. Dr. Alexander Bell contributed much to the invention through his intimate knowledge of acoustics. The Bell and Taintor patent had to do with the recording of sounds by the process of engraving on a solid material such as wax or waxlike compositions, and made possible for the first time records that could be removed from the recording machine and handled and replayed many times without detriment.

PUTS WORLD STORY TO GOOD USE

J. M. Callahan, Music Merchant, of Seaside, Ore., Finds Talking Machine World Valuable—Many Letters of Similar Tenor Received

The following letter from J. M. Callahan, proprietor of Callahan's Music Shop, Seaside, Ore., is one of many similar communications received by The World, which indicate that the valuable suggestions and sales ideas embodied in its columns each month are widely read and put to profitable use:

"Gentlemen: I arranged a window display for the week of July 22 to 29 which has drawn a large number of people to my window and has been an aid in selling a large number of Victor Red Seal records by John McCormack. I am going to tell you how I arranged this display, as it can be used by other Victor dealers at a very small cost.

"In the July 15 issue of The World was an article relative to John McCormack singing for a host of friends at his birthday party at his country home near London. I cut out this small news item, placed it on a show window card size 14 x 22 inches, with the following writing in fair-sized lettering: "John McCormack sings in London." "Famous Irish Tenor Sings at Birthday Party." "Come in and hear some of his records." I decorated my window with red

crepe paper, on which I neatly arranged about two dozen of McCormack's Red Seal records.

"I have heard many comments since the recent illness of Mr. McCormack as to whether he would ever be able to sing again. The above fact put before the public interests them and is sure to bring them into the store to listen to a few of his records.

"I have found many valuable window display aids in The World and possibly this little suggestion will aid others."

RUDD & RIX BUY KEEFE STOCK

HERKIMER, N. Y., August 7.—Rudd & Rix, exclusive Victrola dealers of this city, recently purchased the entire Victor business of John C. Keefe, a pioneer in the talking machine business here, who intends to devote his time exclusively to the sporting goods business. The firm of Rudd & Rix possesses one of the finest establishments devoted to the sale of talking machines in this part of the State and, due to aggressive merchandising policies, a steady growth has been enjoyed.

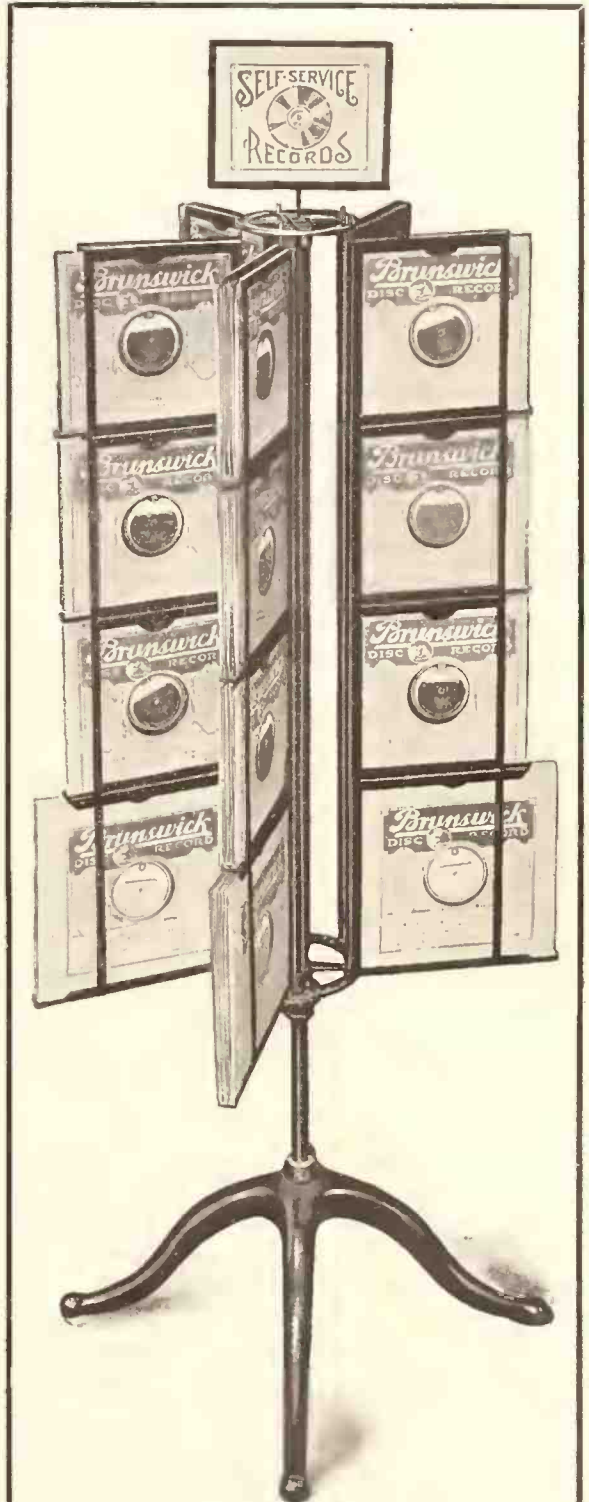

NO. 578. UNIVERSAL SELF-SERVICE RECORD DISPLAYOR made to hold 5 swinging leaves, each leaf accommodating three 10" pockets and one 12" pocket. Each pocket holds four records. Total number of records shown is 40 records and holding a reserve stock of 160 records. Height 6 ft. Width 30 in. Weight 125 lbs. Constructed of steel throughout, with heavy cast-iron base and finished in two coats of ebony enamel. Complete.....\$38.00

Write for complete catalogue

UNIVERSAL FIXTURE CORP.
133 West 23rd St. New York

OSLAND, Inc.

122 Fifth Avenue, New York City
Alpha Reproducer

Pivot stylus with spring tension

- Radio products
- Variocouplers
- Variometers
- Variable condensers

MANUFACTURED TO SPECIFICATIONS



Hot-dog! Here's a Fox-Trot that will keep 'em dancing 'till the candles burn out. It's "Dancing-Fool," out of which Frank Westphal and His Rainbo Orchestra wring every last spasm of syncopated jubilation. "Serenade Blues," on the other side, is a delightful Fox-Trot arrangement of Schubert's Serenade. It's like dancing in the moonlight. A-3654.

**Columbia Graphophone Co.
NEW YORK**

SAN FRANCISCO

Business Improves Steadily—Optimism for Fall—F. B. Corcoran Ends Trip—Columbia Drive Gaining—Trade Changes—Other News

SAN FRANCISCO, CAL., August 4.—Notwithstanding the general feeling of industrial unrest throughout the country, business conditions on the Pacific Coast continue to improve steadily and practically all of the leading talking machine dealers show no hesitation in predicting a normal Fall business. During the Summer business has held up fairly well in all the Coast cities and, while there has been no rush in the interior, this is nothing to worry about, as the hot weather drives a considerable portion of the population to the seashore or mountains and business is naturally sidetracked for a time.

Brunswick Manager Returns From Trip

F. B. Corcoran, manager of the local office of the Brunswick Co., and George Morton, manager of the talking machine department of the White House, have returned from a motor trip through southern California. They were entertained by A. G. Farquharson, secretary of the Music Trades Association of Southern California. Mr. Corcoran says the North has much to learn from the methods employed by the talking machine dealers of the South. "The piano and furniture houses of southern California," remarked Mr. Corcoran, "take the talking machine business more seriously than they do in the Northern section. The business is not considered a side issue, but is given the prominence it deserves in the stores and in advertising. The South is naturally a splendid market for talking machine merchandise, but business could hardly help being good when the trade is so much alive to its opportunities."

Columbia Campaign Gaining Impetus

The latest Columbia campaign engineered by P. S. Kantner, local manager of the Columbia Co., is making good headway, both in the larger cities and in the country. Co-operative advertising in the local press is a telling feature of the selling campaign.

Sherman, Clay Employes on Picnic

The launch ride around the Bay and picnic at Paradise Cove of the employes of Sherman, Clay & Co. this month was a big success, with an at-

tendance of several hundred employes and their families and friends. Billy Morton was chef, as usual, and the committee on arrangements consisted of W. Shaughnessy, Mrs. Alea Rosa and Miss Lillian Bain. A barbecue luncheon was the main gastronomical attraction and dancing the most popular diversion.

Hale Bros. Sell to Nathan-Dohrmann

Hale Bros. are closing out their talking machine department, after having conducted it for several years with varying success. The Victor stock has been sold to the Nathan-Dohrmann Co., which recently opened a new talking machine department, featuring the Blue Bird phonograph and Vocalion records.

F. A. Levy, president of the California Phonograph Co., has been motoring with his family through southern California on a vacation trip.

New Victor Arouses Interest

The trade is much interested in the new No. 111 upright Victor machine which has just been announced. Console types continue very strong also in the general demand and the new models of different makes are marvels of beauty.

Adds Hallet & Davis Phonographs

Clark Wise has just taken on the Hallet & Davis console phonograph and has three beautiful models on display. Special values are given in these machines, the prices ranging from \$135 to \$250. Clark Wise has long had the local agency for Hallet & Davis pianos.

Vacation Season at Sherman, Clay & Co.

B. R. Scott, assistant wholesale manager of the Victor department of Sherman, Clay & Co., spent his vacation this year at Carmel-by-the-Sea. Billy Morton, manager of the retail talking machine department, has returned from a two weeks' sojourn at Rio Nido. Andrew McCarthy, secretary of the company, is spending the week at Bohemian Grove, on the Russian River, this being the time when the annual jinks of the Bohemian Club take place.

Alterations at Eastern Outfitting Co.

The whole front of the Eastern Outfitting Co., Market street, has been remodeled. The show

windows now extend almost to the center of the building and, in consequence, the Columbia department is accorded much more prominent space than heretofore. A large stock of late Columbia models is on display, both in the show windows and in the rear.

Installs Large Radio Stock

Charles Mauzy, manager of the talking machine and radio departments of the Emporium department store, has installed one of the finest stocks of radio receiving sets in the city. Sales in this branch of the business have been very brisk, according to Mr. Mauzy.

Month's News Gleanings

The Wiley B. Allen Co. is putting in a stock of Zenith radio equipment in its talking machine department. There is quite a demand for radio sets installed in console or cabinet phonographs.

J. M. Abrams, manager of the wholesale and retail phonograph departments of Kohler & Chase, has been down the San Joaquin Valley twice recently. He finds the trade giving much attention to the development of modern salesmanship, a fact which is of special importance at this time, when good salesmen are needed badly.

Kohler & Chase, Sherman, Clay & Co. and the Sonora Phonograph Shop all featured "outing" windows last month, with a portable phonograph as the center of attraction.

Hunkins & Linton have opened a piano and talking machine store at Sonora, Cal. Mr. Linton was formerly with the Redwell Music Co., at Turlock. His wide experience in music merchandising will prove valuable in his new venture.

The Pacific Music Co., Modesto, has moved to a beautiful new store, which is most conveniently arranged and exquisitely furnished. R. S. Smith is the proprietor.

The special release of "Sneak," a Victor record from a publication of Sherman, Clay & Co., is announced for August. It is played by the Club Royal Orchestra. The demand for jazz dance records is greater than ever on the Coast and continues to grow.

NEW SHERMAN, CLAY & CO. BRANCH

Will Be Located in Watsonville, Cal.—George B. Marriott in Charge

WATSONVILLE, CAL., July 31.—Sherman, Clay & Co., with headquarters in San Francisco, Cal., are planning to open a retail branch of the business here in the Appleton Hotel Building. This will be a sub-branch of the San Jose establishment and will be under the management of George B. Marriott, widely known in the piano trade throughout the country. Mr. Marriott was connected with Steinway & Sons for seventeen years, both in New York and London.

COTTON FLOCKS

.. FOR ..

Record Manufacturing

THE PECKHAM MFG. CO., 238 South Street, NEWARK, N. J.

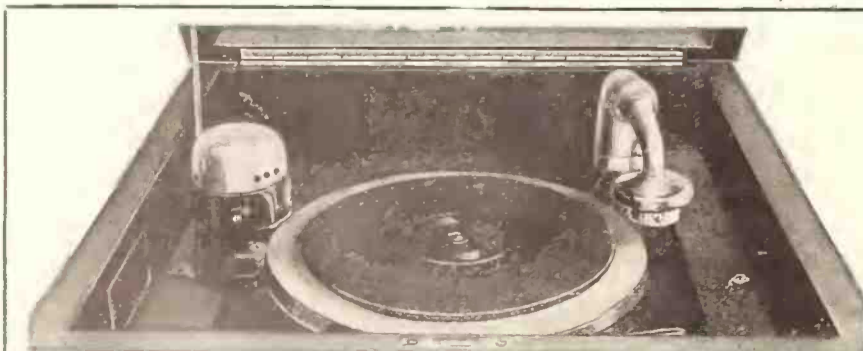

THE SHELTON Electric Motor

The "Simplicity" electrifies Victor, Edison and Columbia phonographs by simply taking off winding handle and placing motor against turntable. Automatic switch in motor operated when the turntable is started or stopped. Operating on AC or DC current of 110 volts. Specify type of current when ordering.

SHELTON ELECTRIC CO., 16 East 42nd Street, New York

A Real Musical Instrument for Children

Cabinet—Durable Diamond construction throughout. Made from selected veneers and hardwoods. Built with infinite care by experienced cabinet makers. Height, 24 inches; width, 14 inches; length, 28 inches.

Finish—Enameled in Gray, Blue and Ivory. Washable Finish. Blue or old rose silk grille.

Motor—Heineman motor — cut gears—cast frame—fully guaranteed—removable motor board.

Tonearm—Die cast—nickel plated—Artois reproducer.

Turntable—Special 9-inch felt faced—plays all records, 10-inch or smaller. Particularly adapted to all children's records, including Bubble Books.

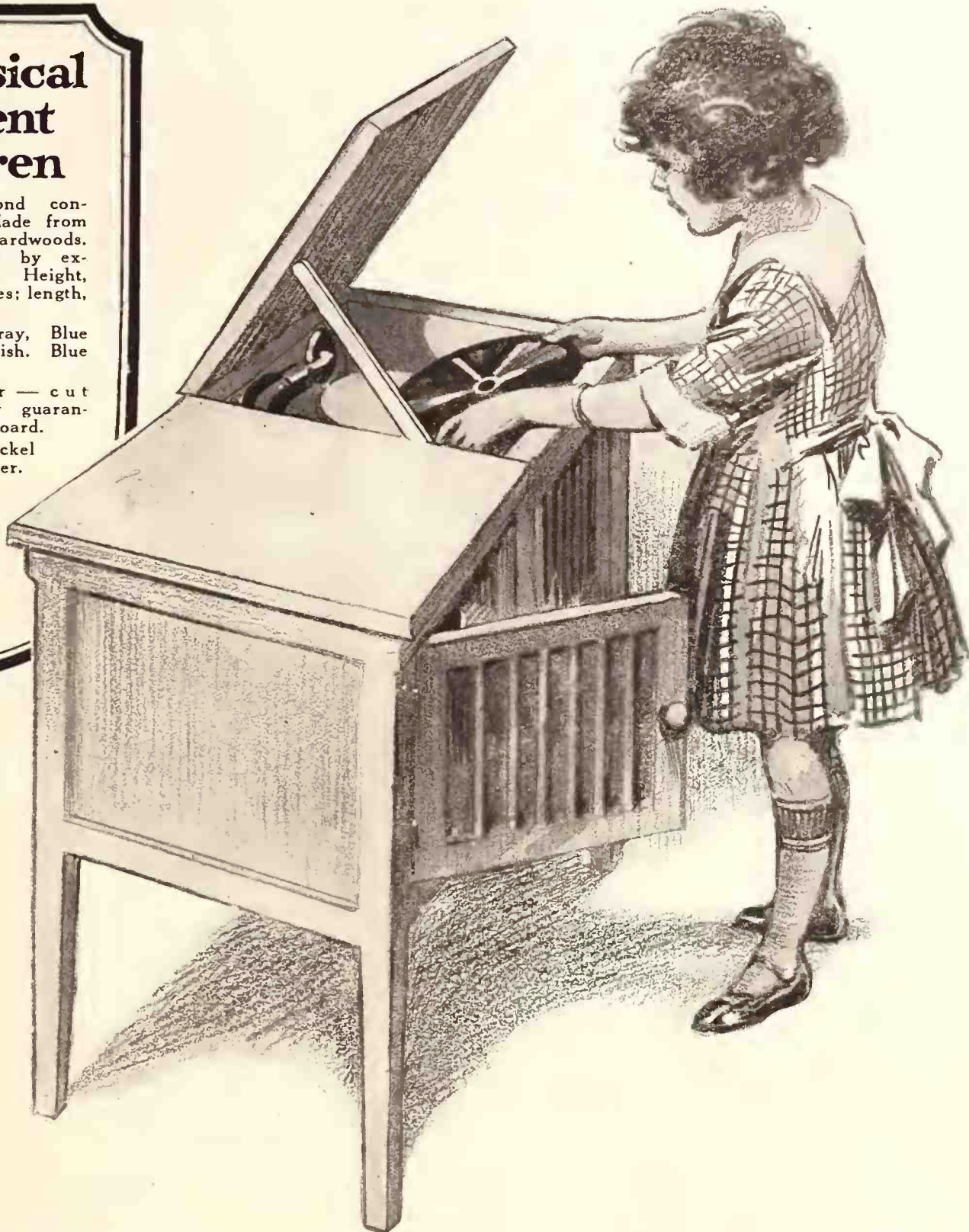

List Price, \$25.00 each.

Six machines or over,
\$15.00 each

Less than six machines,
\$16.50 each

The Diamond Juvenile Console Does Three Things:

Diamond Juvenile Furniture

Six pieces—4 chairs, table and hat rack. Juvenile proportions. Durably made. Beautifully enameled and decorated. Makes perfect juvenile booth when installed with the Diamond Console. Fine for window display.

Six Pieces — \$17.50
F.O.B. Oswego, N. Y.

Sells Itself—Its ideal proportions, finish and tone instantly win the hearts of youngsters. Strong, practical construction appeals to parents. Gives you generous profit. Six machines cost \$90; sell for \$150. Profit is \$60 on a \$90 investment. Repeat orders testify to rapid turnover.

Sells More Juvenile Records—Creates a real child's department and brings children into the store which produces the obvious result on juvenile record sales.

Sells More Regular Records—Children bring parents into the store with them. This is 90% of your battle to sell more regular records.

If you haven't already ordered the Diamond Juvenile Console, write us for full particulars.

The Diamond Products Corporation

Executive Offices and Showrooms:

25 West 43rd Street, New York

Factories: Oswego, N. Y.

Your Feet Won't Keep Still When You Hear—

"SILVER STARS"

Percy Wenrich's New Fox Trot Hit—Hear It Once—Remember It Always



You can't go wrong With any FEIST song

TALKING MACHINE JOBBERS DISSOLVE ASSOCIATION

Special Meeting of Executive Committee of the National Association of Talking Machine Jobbers Results in Recommendation That the Organization Be Disbanded Immediately

The following letter was mailed recently by W. F. Davisson, secretary of the National Association of Talking Machine Jobbers, to the members of the Association, advising them that at a special meeting of the executive committee it was recommended that the Association immediately dissolve:

"It will come as a surprise to the members of the National Association of Talking Machine Jobbers and to the trade that the executive committee of the Association, at a special meeting held in July, recommended that the Association immediately dissolve. The reason for this action is that at the convention of the Association in Atlantic City in June, 1922, statements were inadvertently, but innocently, made by several officers of the Association that might be distorted into expressions of policies and views which were not intended by these officers, and

are not approved by the members, nor are representative of the Association, nor are in accord with the history or purposes of the Association. Neither the policies, nor the views, nor the history, nor the purposes, nor the acts, nor the intentions of the Association or its officers or members have been in any wise violative of any State or Federal law, or in any wise warrant any such inferences. How to repudiate and deny such inferences from such statements in a manner so unequivocal and positive as to eradicate the impression which they may have created was the question which the executive committee of the Association considered long and carefully. The executive committee finally decided that the good faith of the Association and its members in such repudiation and denial could be most conclusively demonstrated by dissolving the Association.

"Accordingly, by direction of the executive committee of the National Association of Talking Machine Jobbers, I enclose two copies of the recitals, recommendation, direction and request of the executive committee, adopted at its special meeting above mentioned, and of the resolution and ballot therein mentioned. Please fill out and sign one copy as your ballot for or against this resolution, and mail it immediately to me."

The recommendation adopted by the executive committee, embodying the resolution to dissolve, reads as follows:

"WHEREAS, at the convention of National Association of Talking Machine Jobbers, held in Atlantic City in June, 1922, statements were inadvertently, but innocently, made by several officers of the Association that might be distorted into expressions of policies and views which were not intended by said officers, and are not approved by the members, nor are representative of the Association, nor are in accord with the history or purposes of the Association or the acts and intentions of the Association or its members; and

"WHEREAS, neither the policies, nor the views, nor the history, nor the purposes, nor the acts, nor the intentions of the Association or its officers or members have been in any wise violative of any State or Federal law, or in any wise warrant any such inferences; and

"WHEREAS, the executive committee of the Association desires to repudiate and deny such inferences in a manner so unequivocal and positive as to eradicate the impression which they may have created; and

"WHEREAS, in the opinion of the executive committee the good faith of the Association and its members in such repudiation and denial can be most conclusively demonstrated by dissolving the Association;

"NOW, THEREFORE, the executive com-

mittee of the Association at a special meeting held in July, 1922, hereby recommends that the following resolution be adopted, and that the Association be immediately dissolved, and hereby directs the secretary of the Association to mail to each member of the Association a copy of the above recitals and recommendation and of the following resolution, and hereby requests each member to mail immediately to the secretary a ballot for or against the following resolution, which ballot shall be in substantially the following form and signed by such member:

"The undersigned acknowledge receipt of a copy of the recitals, recommendation, direction and request of the executive committee of National Association of Talking Machine Jobbers, adopted at a special meeting held in July, 1922, and the undersigned hereby vote [for or against] the following resolution:

"RESOLVED, that National Association of Talking Machine Jobbers and its members hereby adopt the recitals and approve the recommendation, direction and request above-mentioned of the committee and hereby dissolve said Association and hereby authorize the executive committee, out of the funds in the Association's treasury, to liquidate all the financial obligations of the Association, and to refund pro rata to each former member of the Association any surplus remaining, or to assess and collect pro rata from each former member of the Association, in lieu of any future dues, such sums as shall be necessary to complete said liquidation (not exceeding, however, \$50 from each member), and hereby authorize the executive committee, or any sub-committee or legal counsel acting under its direction, to take all appropriate steps for the purpose of carrying out this resolution."

The official tabulation of the ballots for or against this resolution has not yet been announced, but the ballots already received indicate that there will be an overwhelming majority in favor of accepting the recommendation of the executive committee and, in fact, ballots received to date are almost unanimously in favor of the dissolution of the Association.

Gilbert H. Montague, 40 Wall street, New York, legal adviser to the National Association of Talking Machine Jobbers, stated to a representative of The World that there was nothing additional to be said at this time regarding the recommendation of the executive committee, and that the recommendation and resolution spoke for itself.

A company is judged by the men it keeps.

REGAL

PREDOMINATES
IN THE
50¢ RECORD FIELD

Main-Springs

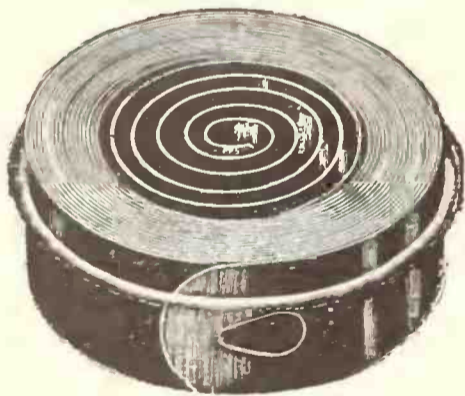

For any Phonograph Motor
Best Tempered Steel

	Each
3/8" x 10 feet for all small motors.....	.30
1" x 10 " " Pathe, Columbia, Heineman.....	.35
1" x 10 " " Columbia.....	.40
1" x 11 " " Columbia with hooks.....	.50
1" x 13 " " Victor, old style.....	.45
1" x 15 " " Victor, new style.....	.50
1 1/4" x 18 " " Victor, new or old style.....	.70
1" x 12 " " Heineman and Pathe.....	.45
1" x 10 " " Saal, Silvertone, Krasberg.....	.45
1" x 13 " " Saal, Silvertone, Brunswick.....	.50
1" x 16 " " Sonora, Brunswick, Saal.....	.60
1 3/16" x 18 " " Heineman and Pathe.....	.75
1 1/2" x 25 " " Edison Disc.....	1.50

SAPPHIRES—GENUINE

Pathe, very loud tone, each 15c, 100 lots \$11.00.
Edison Loud-tone, each 15c; in 100 lots, \$11.50.

TONE-ARMS

The very best, loud and clear, throw-back.....\$4.50
With large reproducer, very loud, Universal..... 4.00
With smaller reproducer, but loud and clear..... 2.50

PHONOGRAPH NEEDLES

We can give you best price on Brillantones, Magnedo, Wall-Kane, Tonofone, Nupoint, Gilt Edge, Incas and Velretone Needles.

ORDER RIGHT FROM THIS AD

Send for price list of other repair parts and motors.
Terms—F. O. E. St. Louis, Mo. Send enough to cover postage or goods will be shipped by express.

The Val's Accessory House
1000-1002 Pine St. St. Louis, Mo.

The Player-Tone

IT'S SIMPLY GREAT.

No Better Tone Instrument In the World

—PRICE—

Will Sell Phonographs Today And We Have It

Every Player-Tone phonograph is exceptionally good, with the house back of it for years.

Player-Tone phonographs are masterful in their perfection of high grade cabinet work, exquisitely finished by skilled workmen, and when you sell one of these perfect tone producing instruments, you prepare the way for another Player-Tone sale.

The more closely you analyze our high grade construction, combined with perfect tone quality, the more fully will you realize its unqualified value.

Write us for dealers' proposition.
It will pay you.

Player-Tone Talking Machine Co.

Office and Salesrooms

967 Liberty Avenue Pittsburgh, Pa.



\$65.00
Model 551
Mahogany Only



\$75.00
Model 601
Mahogany Only



\$85.00
Model 701
Mahogany Only

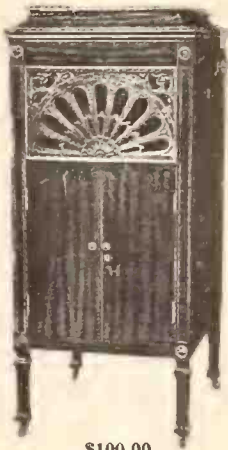

\$100.00
Model 801
Mahogany Only



EMERSON
Model 40
All gold equipment,
with 5 record filing
albums. \$150.00



\$150.00
Model 901
All Gold Equipment



\$75.00
Model 310
Oak or Mahogany



\$90.00
Model 311
Oak or Mahogany



\$110.00
Model 314
Oak, Mahogany or Walnut



\$125.00
Model 316
Oak or Mahogany

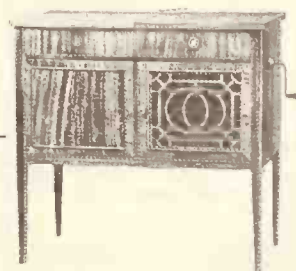

EMERSON
Model 30
All gold equipment,
with 5 record filing
albums. \$135.00

Permanency—In Wareroom Equipment and the Organization Behind It

In years to come when moving or expanding will the builder be in business to make good?

Van Veen & Company have been preaching the economy of honest and efficient construction for fourteen years and it is conceded by the trade that the patented double construction hearing rooms and musical merchandise selling equipment



built by Van Veen & Company fulfill every claim made for them by the builders.

In buying your installation, let price and quality be guaranteed by the responsibility of a house of old and established reputation.

You expect to stay in business; Van Veen & Company build equipment that will stay in business with you.

Write for Catalogue. If you want immediate action our representative will call

We have equipment ready for immediate shipment

VAN VEEN & COMPANY, Inc. 413-417 E. 109th St., New York City

Phone 7758 Harlem

Offices and Warerooms

HICKEY'S FINE NEW STORE OPENED

Remodeled Establishment of Hickey's Lyceum Music Store, Ithaca, N. Y., One of the Finest in the State—Artistic Victor Department

ITHACA, N. Y., August 7.—Hickey's Lyceum Music Store, 105-111 S. Cayuga street, this city, following extensive alterations and the installation of the most modern equipment, is one



Hickey's Lyceum Music Store

of the finest and best arranged music establishments in the State. A disastrous fire about a year ago made the remodeling necessary and Joseph F. Hickey, proprietor of the business, which has been in existence for approximately thirty years, spared no expense to make the store a model of its kind.

Everything in music is handled, including Victor talking machines and records, pianos, musical merchandise of all kinds and sheet music, and each line has its own specially equipped department. The Victrola department is one of a number of features of the complete establishment. An unusually artistic arrangement of

stock and furnishings makes this department an inviting place for the shoppers of the city to visit for records and machines. A number of

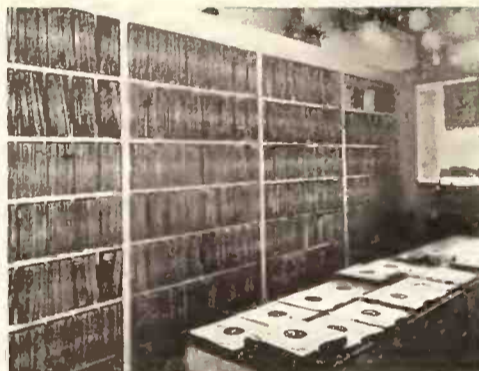

The Record Department

sound-proof record demonstration booths, together with a large stock of Victrolas and a complete Victor record library, insures patrons of a wide selection to choose from.

In connection with the opening of the remodeled store a rather clever business and goodwill building stunt was put into effect. A num-



Artistic Victor Department

ber of small booklets were printed in which were illustrated the various departments of the store. Accompanying the illustrations, the many lines featured in these departments were described and

in diplomatic language patrons were invited to inspect the departments. These booklets were sent to all customers and prospects.

THE EVIL OF PRICE CUTTING

M. Wulpi Says Price Cutting Demoralizes Business, Destroys Reputation of High-grade Goods and Good Will and Restricts Sales

M. Wulpi, commissioner of the National Veneer and Panel Manufacturers' Association and well-known in the music trade, in a circular letter, recently sent out, entitled "Price Cutting Is All Right—But," remarks:

"On this subject the American Fair Trade League, in a recent flyer, says:

"The profiteering price cutter ruins the reputation of high-grade goods and destroys the good will of the makers, thus stealing both purse and good name in one operation. He advertises standard goods at a loss and then seeks to persuade the public to accept substitutes on which he makes money. He demoralizes the price and the product. He forces other dealers to follow his lead or refuse to handle the article. He restricts sales and lessens distribution. His unfair practices leave the manufacturer helpless to protect his business, into which he has put his name, his labor and his money.

"The profiteering price cutter drives the small distributor to the wall by the worst form of illegitimate competition. He destroys competition by the very practices the anti-trust laws were intended to prevent. He is the cut-throat competitor who is everywhere and always the forerunner of monopoly. He is a restrainer of trade and a lessener of competition. He robs the neighborhoods of their corner stores, which can give best service under fair competition. He shouts for a free market where, in a jungle war, his unscrupulous tactics may give him a stranglehold on business."

"When all is said and done, is there not a 'whole lot' of truth in this? All have heard Maud Mueller's 'It might have been.' The price cutter generally can soliloquize and say, 'I might have won doing so—if my creditors had not come in on me and the sheriff hung up his crepe.' The average price cutter in business not only confiscates what little cash he got together by hook or crook, but that of his stockholders as well, not to speak of the loss to his co-workers and their families—when his funeral comes off—and it generally does, but is a demoralizer and creates loss to manufacturers who endeavor to play the game square. Can and will his ashes 'rest in peace'?"

Okeh Records

OUTING PORTABLES

GRANBY
PHONOGRAPHS

MASTER TONE

TALKING MACHINES

NEEDLES

Okeh — Truetone — Wall-Kane
Tonofone — Gilt Edge

Delivery Bags, Accessories, etc.

Complete Stocks—Prompt Service

IROQUOIS



IROQUOIS SALES CORPORATION
Wholesale Distributors
210 Franklin St. BUFFALO, N. Y.

BETTER TRADE IN MEMPHIS

Good Crops Stimulate Buying—Bright Outlook for Fall—Activities of the Trade

MEMPHIS, TENN., August 7.—The talking machine business here has been very good during the past month despite the ill effects of the railroad strike which are being felt generally in all lines of business. Good crops throughout the entire South have been mainly responsible for the brisk trade and conditions now point to an excellent Fall business.

Remodeling of the Peabody Hotel Building is about to be started and the Reinhardt's, Inc., music store will be moved one door north of its present location in that building as a result.

The Hessig-Ellis Drug Co., distributor of the Sonora line, recently took over the Sonora wholesale interest of the Bond Hardware Co., at Little Rock, Ark.

The Leo Kahn Furniture Co., which features the Columbia line of Grafonolas, has made extensive improvements in its phonograph department on the main floor of the establishment.

C. L. Wainwright has rejoined the Armstrong Furniture Co., talking machine and furniture dealer of this city.

Reid's Music Shop, at Brownsville, Tenn., has purchased the music department of Felsenthal Sons, Edison dealer.

TRIBUTE TO W. C. DAUMUELLER

On Occasion of Twentieth Anniversary of Existence of Business

LEBANON, ILL., August 7.—The Advertiser, a local paper of this city devoted a column recently to W. C. Daumueller, music dealer, who has a flourishing Victrola department, on the occasion of the twentieth anniversary of the establishment of the business.

Miss E. Heumann, who is now in charge of the Victrola department, assisted in the Junior Chautauqua this year, which consisted entirely of music appreciation and music memory contests with the use of the Victrola. Miss Heumann will continue the work with the children at the store during the Summer months.

NEW VICTOR RECORD BAGS

CAMDEN, N. J., August 7.—Victor wholesalers throughout the country are now prepared to supply dealers with the new record envelopes designed by the Victor Talking Machine Co., according to an announcement made at the headquarters here. The new bags have the advantage over others used for holding records because of their superior strength and finish. A variety of attractive lithographs have been secured by the company for the exterior finish of the envelopes.

HENRY S. DORAN CO. IN NEW HOME

DETROIT, MICH., August 4.—The Henry S. Doran Co., well-known Victor dealer of this city, has moved from the quarters on Michigan avenue to 1416 Washington avenue. Before moving into the new store complete alterations were made and this is now one of the finest talking machine establishments in the city.

W. P. MANNING HONORED

W. P. Manning, prominent Columbia dealer, of Augusta, Ga., was recently elected State Commissioner for Georgia for the National Association of Music Merchants.



**To Your Public,
Trained in Quality—**

The people you sell are people of discrimination; they are customers who appreciate the finer things of life; they are lovers of music; and ever since musical instruments first came on earth they have been things of beauty, adorned with all the craftsmanship and skill their makers could summon.

To this public, trained in quality, you are now offering the added joy of Radio, and the wise music dealer is offering it not through an apparatus which compares unfavorably with the other beautiful musical instruments in his stock, but with the finest, most beautifully finished equipment — the De Forest apparatus, which is not only famous for dependability, but also famous for beauty of line, finish, and the utmost attention to the smallest refinements in manufacture.

The more the talking machine dealer knows about Radio—the more he knows about a beautiful instrument—the more sure he is to prefer De Forest.

Such a wise choice finds its echo in success—for the De Forest dealer is in business to stay, backed by the name whose reputation is your customer's assurance of satisfaction.

DE FOREST RADIO TEL. & TEL. CO.
Jersey City, N. J.



MOTORS
(Swiss)
DOUBLE SPRING
Suitable for Portable Phonographs
Stock On Hand, Ready For Delivery
Sample \$3.75—Write for One
MERMOD & CO., 874 Broadway
N. Y.

NO DOUBT AS TO THE PERMANENCY OF THE INDUSTRY

Geo. W. Lyle Gives Reasons Why the Members of the Talking Machine Trade Should Be Optimistic Regarding Its Future—Will Last as Long as Music Maintains Its Appeal

Geo. W. Lyle, president of the Manufacturers Phonograph Co., New York, manufacturer of the Strand phonograph, and one of the recognized veterans of the talking machine industry with over twenty years' experience to his credit, in a recent chat with *The World* made deductions and predictions regarding the general outlook for business that carry with them the weight of knowledge. In the past two decades Mr. Lyle has become familiar with every phase of the talking machine industry and from coast to coast he has won the friendship and esteem of talking machine dealers.

When he introduced the Strand phonograph last Fall, at a time when the talking machine trade was in a state of uncertainty, it was freely predicted that the venture would be unsuccessful. However, Mr. Lyle proved otherwise and the Manufacturers Phonograph Co. is recognized

to-day as permanently established in the ranks of successful talking machine manufacturers. The company has appointed representatives in practically every important trade center in the country and Strand dealers everywhere are enthusiastic regarding the sales value of the product, the results they have already attained and the outlook for the future.

After emphasizing the fact that he is not a professional optimist but an optimist by analysis, Mr. Lyle stated as follows: "I am fully convinced that no one need have any doubt as to the soundness and permanency of the talking machine business. Just as long as people have ears, and as long as quality music appeals, phonographs will be in high standing and in active demand. The question is, however, who is going to do the business, for it is going to be done by somebody. A considerable measure of the pessimism and demoralization in our industry may be attributed to liquidation sales as much as anything else, and we have been watching closely all of these liquidation sales by department stores and others. We saw them coming when we put out the first Strand phonograph. Therefore, they have not in any way changed our belief that the dealer who is a merchant, and who is in this business because he likes and understands it, can turn over, even in the slowest part of this unnatural season, merchandise that is really high grade and low-list

priced, if it still carries the margin of profit that covers the increased cost of doing business and the inevitable cost of instalment methods.

"We seek our market among those many thousands of dealers who know phonograph and



George W. Lyle

furniture quality, who have a fairly clear idea of the trend of design, and who care a good deal for tone and price. We seek our Strand market among those dealers who didn't fall into the phonograph business, but entered it as we did, after careful consideration, and are building for the future."

The Season's Creation

NEW MODEL
(Pat)

S. S. STEWART MANDO-UKULELE



Genuine mahogany, 10 ribs, inlaid edge and sound hole with black and white celluloid extension rosewood veneered finger board, German silver frets. Rosewood pegs. Exceptionally fine tone and workmanship. This unusual shape has made this instrument one of the most popular sellers.

Also a Few Quick Sellers such as

UKULELES
UKULELE-BANJOS
BANJO-MANDOLINS
MANDOLINS
HARMONICAS, Etc.

A LINE OF THESE INSTRUMENTS WILL INCREASE YOUR SUMMER BUSINESS INCLUDING

DURRO

VIOLINS—BOWS—STRINGS

VIOLIN OUTFITS
and
ACCESSORIES

THE BEGINNER OR ARTIST MUST HAVE A GOOD VIOLIN OUTFIT

NOTHING BETTER ON THE MARKET THAN

DURRO

If you have not received our New, Complete, Illustrated Catalog No. 120, Write at Once



BUEGELEISEN & JACOBSON

5-7-9 Union Square
NEW YORK

TO DISTRIBUTE THROUGH JOBBERS

Clapp-Eastham Co. Selects Trade Name of "Radak" for Its Line of Radio Equipment—Tells of Distributing and Advertising Plans

The name of "Radak" has been selected by the Clapp-Eastham Co., Cambridge, Mass., as the trade-mark distinguishing its line of radio equipment. The Clapp-Eastham Co. claims to be the oldest exclusive maker of radio equipment in the field, having been established since 1906. The complete line consists of "Radak" receiving sets, regenerative receiving sets, amplifiers, variometers, condensers, rheostats, amplifying coils, universal tube sockets and electro-ampliphones.

At the same time the company announced the adoption of the new trade name it also announced that in the future "Radak" products would be distributed exclusively through jobbers. It is expected that this new system of distribution will enable the dealer not only to receive supplies with the least possible delay, but also to secure maximum discount without quantity stipulation, these discounts being quoted directly to the dealer by the distributor. Dealers carrying "Radak" products will be interested in the announcement of an extensive national advertising campaign which is now under way, on a yearly basis. The combined circulation of the magazines used will reach an audience of about 25,000,000 people.

A number of dealers in the talking machine trade have already taken on the Clapp-Eastham Co.'s "Radak" products and new names of talking machine dealers are constantly being added to the list.

NEW GRETSCH CATALOG ISSUED

New Volume Describes Entire Extensive Gretsch Line of Musical Merchandise—Confidential Price List Also Mailed to Trade

The Fred. Gretsch Mfg. Co., manufacturer and importer of musical merchandise, Brooklyn, N. Y., is mailing a new catalog and confidential price list to the trade. This new catalog has an attractive cover in many colors and completely describes the extensive Gretsch line. E. E. Strong, general sales and advertising manager, reports that the company is doing a tremendous

business. The new Clarophone banjo series, which was announced last month, has been enthusiastically received by the trade and heavy orders are coming in for this new instrument. Good results are also reported in the Couturier line of band instruments, which the Fred. Gretsch Mfg. Co. distributes. Dealers are achieving much success with this popular line and many new agencies are being appointed. Mr. Strong states that Gretsch dealers report that the business in their musical merchandise departments is not only good at the present time, but has held up steadily throughout the entire year.

MUSICALE FOR BRIGHTON BATHERS

Brighton Beach Baths recently had "the first bathing suit morning musicale ever given in the world" with Dorothy Jardon, soprano, once with the Chicago Opera Company, singing; a Steinway grand piano trundled out on the sand and Bennie Krueger and his Brunswick Orchestra jazzing things up.

All but the beach police and the piano porters enjoyed the freedom of bathing suits.

Radio 40% Profits

Dealer's Opportunity of the Hour
Radio Supplies Sell like Hot Cakes

The radio craze is on. Millions of receiving sets are being built by amateurs. Almost every schoolboy is constructing his own radio receiving apparatus. The real profits are being made in supplying the amateur with his needed parts such as detectors, condensers, wire, etc., etc.

Sell Radio Parts and Supplies

Technical knowledge is not necessary. Anybody can sell them. Most buyers point out exactly what they wish. You merely hand it to them. Sells on sight.

Complete Dealer Assortments

Includes window and counter display cards to which the smaller items are tacked, named and priced. Consists of standardized staple parts needed by every amateur and are interchangeable with all leading makes. Every item is a live seller such as tuning coils, binding posts, detectors, condensers, and dozens of other necessary items in an assortment of sizes to suit every buyer.

List Price Complete Assortment \$75

Based on uniform standard list prices adopted nationally by all reliable manufacturers.

Dealers' Discount 40% \$30

Net Cost to Dealer \$45

Note: Other assortments list at \$100 and \$50 and take the same 40 per cent discount as above. We recommend the above. Repeat orders or fill ins take the same 40 per cent discount. Terms: 15 per cent cash with order. Balance by express C.O.D. Mail your order now. Be one of the first to cash in on radio's popularity. Immediate Delivery.

WHITE RADIO CO.

141 West 33rd St. New York City



PHONOGRAPHS

For beauty, for tone, for price

The dealer who makes money
 this Fall and Winter will be
the dealer who sells STRANDS

The policy that has succeeded:

1. Quality and Design

To build none but first class instruments and to concentrate on correct flat-top consoles, every instrument guaranteed.

2. Low List

So that you may offer better values, make sales easier and oftener and increase your rate of turnover.

3. Long Discounts

To give you a liberal profit on each sale and make it doubly attractive to handle Strand Consoles.

4. Trouble-proof Shipping

Prompt, safe deliveries assured by an ample output and a trouble-proof shipping system.

5. Protection

Exclusive territory; you are protected against dividing your trade with near-by competitors.

"It's the Dealer's Turn Now"

These Direct Strand Representatives Are Ready to Serve You:

- RICHARD H. ARNAULT, 95 Madison Avenue, New York City
- W. O. CARDELL, P. O. Box 1271, Tulsa, Okla.
- A. H. DANKMAN, 327 Adams Street, Buffalo, N. Y.
- CONSOLIDATED TALKING MACHINE CO., 227 W. Washington Street, Chicago, Ill.
- A. C. ERISMAN, 174 Tremont Street, Boston, Mass.
- W. S. GRAY, 942 Market Street, San Francisco, Cal.
- STERLING ROLL & RECORD CO., 137 West Fourth Street, Cincinnati, Ohio
- ARTOPHONE CORPORATION, 1103 Olive Street, St. Louis, Mo.
- H. KALISKI, Hotel Monteleone, New Orleans, La.
- G. C. SILZER, 1019 Walnut Street, Des Moines, Ia.
- WALTER L. ECKHARDT, 624 Market St., Philadelphia, Pa.
- RICKEN, SEEGER & WIRTS, Globe Bldg., Detroit, Mich.
- W. F. STANDKE, 1120 Grand Avenue, Kansas City, Mo.
- MERVIN E. LYLE, 214 Peachtree Arcade, Atlanta, Ga.
- R. J. JAMIESON, 25 Taylor Arcade, Cleveland, Ohio
- H. J. IVEY, General Delivery, Dallas, Texas
- L. D. HEATER, 614 East 28th Street, Portland, Ore.
- OTIS C. DORIAN, 11 Bloor Street, E. Toronto, Ont.
- R. L. CHILVERS, 49 Lincoln Avenue, Montreal, Que.

For Example:
 Strand Queen Anne
 Period Console
 Lists at \$125



To responsible dealers we offer a profitable franchise in localities not being yet covered. *Write or wire.*

MANUFACTURERS PHONOGRAPH CO., Inc.
 95 Madison Avenue New York
 GEO. W. LYLE, President

Mid-West Point of View

WESTERN DIVISION OF THE WORLD, CHICAGO, ILL., Aug. 10, 1922. As these words are written Chicago has just passed through that social process known as a street-car strike. We decline to admit that

**We Ride
Again to
Work**

Chicago was "in the grip of" the said social phenomenon, which is now, happily for all concerned, past history. As usual, the strike ended in a compromise and the gains expected by the workers did not materialize; instead the force of public opinion made itself felt, and certain developments which will probably take place in the near future as a result will undoubtedly be disadvantageous to both employers and employes of the street railways. Some businesses suffered, of course, but there were some who turned the unfortunate situation to good account and made capital of it. We hear, for instance, of talking machine men who as soon as the street cars were out of commission got out their autos, and chased around from house to house among their prospects, visiting them, condoling with them on the subject of the general inconvenience of life in a great but "struck" city, and then suggesting a nice little run down-town to do some shopping. When coupled with the promise to furnish transportation home again in the same way, the bait was eagerly swallowed in most cases. Result: a nice journey down to the store, some inspection of machines and listening to music, some salesmanship . . . and a return home in a nice car with the knowledge that a talking machine would be delivered next day. If schemes like these can be worked out successfully within twenty-four hours of the beginning of a car strike, what would not our ingenious talking machine men be able to do if the tie-up lasted a month?

It will hardly be doubted that general business is on the up-turn when we scan the news of the doings of talking machine merchants throughout the Middle-West. Everywhere, it would seem, retail men are utilizing the present holiday time to put their establishments in smarter trim than ever, anticipating great activity during this Fall and Winter. That there is excellent reason for the hopes which these preparations disclose cannot be doubted. The rail and coal-mining disputes will shortly be settled without a doubt, for the temper of the country is rising and there is already a belief that if the present Administration does not find some way to compose the industrial situation it will receive a rebuke at the polls in November next. Good judges, therefore, look forward toward an active Fall followed by a still more active Winter. Moreover, there is no doubt that the people as a whole are awfully weary of strife and depression, and less than ever interested in abstract theories about the order of Society. Their ideals may not be very high, but they are very simple. A vast majority of them want, above all things, Peace and Activity. These ideals that majority propose to realize, and in their present temper are not much more likely to weep on the bosom of Labor than to fall in adoration before entrenched Capital. The plain citizen is getting awfully tired of extremists in both camps. With this temper, we may look for a general improvement. When the plain man, neither socialist nor financier, neither Croesus nor communist, makes up his mind, he can rule the roost. There are some signs indicating that he is beginning to make up his mind.

**Neither
Croesus Nor
Communist**

THE Pageant of Progress is in full swing as these words are written, despite the jam in transportation owing to the car strike. Visitors during its early days were at once struck with the very large place which music has assumed in this year's show. Last year music was somewhat slighted; this year it seems to dominate everything. Talking machine exhibits are numerous and interesting. Other musical instruments also are shown in a surprising number, and there is a fair display of the latest ideas in radio telephony. Since the object, or one of the objects, of the Pageant of Progress is annually to chronicle in graphic and visual form the commercial, industrial and economic importance of Chicago, the displays

**Our
Pageant's
Progress**

are mainly native. The talking machine industry, in all its branches, is finding one of its centers at the capital of the mid-West, and the Pageant of Progress shows the casual visitor how important that industry is coming to be in our town. Despite some enthusiastic boosters, Chicago is not yet the world's music center, but if she continues to progress some day she will be. The talking machine branch of the music industries will be found to have contributed its share to this attainment, when it actually has been reached. Meanwhile we should register the undoubted fact that, whatever reason may once have existed for the somewhat uncomplimentary belief that Chicago's contributions to the talking machine industry were cheapness and mass production only, no such reason exists to-day. We are producing here both machines and accessories of nation-wide celebrity, and of a quality which calls for no apologies. The exhibits at the Pageant have shown this plainly.

DURING a recent conversation with Otto Schulz, president of Magnola Talking Machine Co., M. Schulz Co. and the Werner Piano Co., the relation of the talking machine to radio came up for discussion. It had been urged that the combination of a radio receiving outfit in one cabinet with the reproducer and motor of a talking machine represents the most logical and natural development. To this, in principle, Mr. Schulz quite agreed, but he put forward a very valuable warning, on a point which hitherto seems to have been neglected by the music industries. He observed that there is need for careful educational work by all talking machine dealers who are interested in radio, especially in combination outfits; work needed entirely because of the ignorance of the public. There is a vast difference between the reproduction of music through the talking machine, and its reception via radio telephone. In ideal conditions, of course, sound may be picked up by radio and heard satisfactorily at all times when it is available; but ideal conditions seldom prevail. In consequence, the ignorant purchaser is very likely to acquire a wholly wrong idea of the value and utility of radio receiving, through failing to make due allowances for the many interferences which at present occur and which are likely to continue until invention has progressed much further. When, however, the people are warned as to what to expect they will be satisfied with the wonderful thing that radio telephony already is, and will not ask impossibilities. But in default of educational propaganda on the part of those who sell the outfits, thinks Mr. Schulz, there is likely to be much dissatisfaction. We think Mr. Schulz is quite right and that his warning comes at a most opportune time.

**Radio
Education
Needed**

WE are in danger of being set down as boosters as well as boosters in this city of ours, but in some respects we are entitled to an occasional crow. For instance there is the matter of the application of music to therapeutic ends. Our local Health Department has done pioneer work here in the most practical way, by bringing music as often and as richly as possible before the patients in the various hospitals and institutions which the department controls. The work is being carried out with special earnestness at the institutions for persons who suffer with mental troubles and chronic diseases. Talking machines and pianos have been purchased in generous quantity, and the department has wisely realized the stimulatory effect of good music, an effect which is often quite positively therapeutic. Here is a thought for dealers in other cities. Meanwhile it is interesting to note that the example of the Six Brown Brothers, the saxophonists, has fired the spirit of emulation among the employes of the Chicago Health Department, so that a sextet of C. H. D. saxophonists has been organized in that office, which is already visiting the Tuberculosis Hospital and other institutions regularly, to play to the inmates. This is fine work and one hopes that more of it will be done in this city and elsewhere. The talking machine, be it remembered, is the institutional instrument par excellence.

**"Music
Hath
Charms..."**

From our CHICAGO HEADQUARTERS

REPUBLIC BLDG., 209 SOUTH STATE ST TELEPHONE WABASH 5242

EDWARD VAN HARLINGEN

WILLIAM BRAID WHITE

EUGENE F. CAREY

ARTHUR E. NEALY

A. SNYDER

CHICAGO, ILL., August 8.—After all, the month of July turned out better than the trade had figured it would be. This was disclosed in a great many instances, both manufacturing and retail, when concerns took inventory. This business of inventory was a semi-annual affair in some cases, while in others it was an annual one, coupled up with election of officers. The inventories revealed that during the year 1922, up to the end of June and including some weeks in July, business as a whole was not so badly off as had been thought.

One fact brought to light was that many manufacturers and numerous retail men were exceptionally short of stocks. It also brought out that the business, both retail and wholesale, was very stable in comparison to last year. It will be remembered that last year was a very hectic one and for a time it looked as though there were going to be many more bankruptcies than there actually happened. The shortage of stocks, however, is more in evidence among the retail men than among wholesale. There are quite a number of manufacturers, however, who lay down on the job during the months of June and July and they too are somewhat short of made-up materials. They are, therefore, getting ready to fill up their warerooms again, preparatory to the Fall business. Business this coming Fall is going to be good.

As stated above, retailers are very low in their stocks, as they have been curtailing expenses during the Summer months. Many of these expenses, such as advertising, soliciting, etc., were curtailed to too great a degree, and the men who authorized this curtailment are now sorry. For

some reason or other, when a certain kind of institution decides to save money, the first thing it does is to go after the advertising appropriation and knock off a big gob. Then the economical ones go down the line, chopping everything else, until before long they have taken from one to six chops at their publicity appropriation. Why they do it no one knows, but they do it. Now this, according to some of the country's biggest business men, is one of the most foolish things that an institution of any kind can do. The really big men in our commercial life believe that when business is slowing down, whether wholesale or retail, the advertising appropriation should never be lessened; in fact, it should be increased. If one cares to note the really successful businesses and the way they are handled, one is sure to find out that this is an absolute fact. One man, who is clearly in a position to know whereof he speaks, says that too severe a curtailment of advertising expenses reminds him of the story of a man who wanted to put an idea during a Chautauqua meeting. The man called on the manager of the Chautauqua and asked how much it would cost to tell his message to the audience. The manager told him that it would cost him ten dollars a shout or a dollar a whisper, and the man, thinking to cover the most for his money, took ten whispers, but no one heard him and consequently he was ten dollars out.

The early part of July certainly had the dealer guessing as to what business would be when the end of the month rolled around. The first week brought on real Summer weather and there was a general letting up in the retail trade. This was

true in all lines of business. The retail dealers had very little to do and they naturally thought that the entire month of July as well as August would be absolutely listless. But such was not the case. By about the end of the second week the buying public of Chicago and vicinity had acclimated themselves to the hot weather, and began buying again. Business started up as usual with a gradual demand for dance records, followed in turn by demand for small goods and portable machines. Portable talking machines, by the way, seemingly have come to stay. It took the dealer some time to put the idea over, but at last to all appearances it has gone over and will continue to grow. The small talking machine has in many instances been the means of getting a great number of people interested in larger instruments and many recent sales of larger instruments are traceable directly to previous purchases of a portable. Chicago still loves to dance in spite of hot weather and nearly every portable that was sold also brought an order for half a dozen or more dance records.

In our rounds about the trade we have failed to find one retailer or manufacturer who does not believe that business will be very good in the Fall. These men feel that business has at last settled down and that we are now through with spasmodic buying and selling. It goes without saying that the upheaval our trade and every other one have gone through for the last year or more has been a very trying ordeal. Few really knew where they were at times, for business was so bad that no one really cared. However, now that all indications at present are point-

(Continued on page 100)

Announcement

“The Jewel Phonoparts Co., 154 Whiting St., Chicago, Ill. have added many refinements and improvements to their line of Jewel Tone Arms and Reproducers, and from Sept. 15th will be in production and will be pleased to furnish the Manufacturing Trade, on request, with illustrations, samples and prices on the highest grade Tone Arms and Reproducers that long knowledge of the business, money, skill and carefulness in manufacture, assembling and inspection can produce at the lowest possible cost consistent with the quality.”

FROM OUR CHICAGO HEADQUARTERS—(Continued from page 99)

ing to real stability in the trade, the dealers and manufacturers are very optimistic and are determined at last to get out of business all there is in it. They have come to a point where they know what the people want and what price they want to pay, and are, therefore, making all preparations to supply the necessary goods. They do not believe, however, that the trade will see during this Fall a wave of buying such as overwhelmed the country during the war days, but they do see a good substantial business that is destined to grow according to the intelligent and aggressive efforts put behind it.

Reopens in Republic

The Burns-Pollock Electric Mfg. Co., of Indiana Harbor, Ind., has just opened a new retail salesroom in the Republic Building. This company manufactures the well known Capitol talking machine, which is a combination of an artistic electric lamp and talking machine. The new warerooms are in charge of I. Lowenthal, retail sales manager for Burns-Pollock, assisted by F. J. DeLisle.

The new retail warerooms were opened formally to the public on July 1st. A year or more ago this company operated the combined retail and wholesale establishments in the Republic building, but some months ago found it necessary to rearrange plans and confine local activity to retail business. The warerooms were, therefore, closed and when the process of establishing retail Capitol shops throughout the country was formulated the new place was decided upon.

Brunswick Frivolity Releases

The Brunswick-Balke-Collender Co. once a year devotes its entire list of releases to frivolity. For eleven months out of the year the releases include selections of a wide variety, from the highest grade of classical music by famous singers and instrumental artists to the popular type of present-day music, but for this one month, when most people are pleasure-bent, it devotes its list to the best dance music of the day. These records certainly go over big, which is natural when one takes into consideration the artists they have to put them over. There is

Isham Jones, the saxophone wizard; Bennie Krueger, Carl Fenton and Rudy Wiedoeft's Californians, each one among the best representatives of popular music in the East, West and Middle West. The annual frivolity release comes at a particularly opportune time, for the month of August means vacation, dancing and good times.

Brunswick dealers all over the country experienced a very busy week as a result of the tie-up with the double-page spread which appeared in the Saturday Evening Post announcing this special release. The advertisement was a very striking one, and was gotten up so as to catch the eye of the dancing public, as well as all those interested in the music of to-day. On one page appeared one of Brunswick's beautiful period models and a list of the releases, which include the best sellers for the month. On the other, surrounding a clever bit of text, were several dancing figures on Brunswick records which were grouped about the page in a very attractive manner.

Cheery News of Cherries

A market report recently printed in one of the Chicago dailies stated that in Dorr County, Wisconsin, over 5,000 cherry pickers are engaged preparing a most wonderful cherry crop, estimated to be worth \$1,500,000. Dorr County is located in the center of America's principal cherry growing territory, and when final reports from all of the cherry growing counties are in we have every reason to believe that some records will be broken. It looks to us at present as though the talking machine men were going to have a pretty good business, especially in Dorr County.

In New Location

The Sterling Devices Co., which since the time of its entrance into the talking machine field had been located in the Lake Shore Building, on Lake Shore Drive, has moved and is now located in its new and larger plant at 1819 Carroll avenue. The new plant is in a modern mill-construction building and is in area about twice the size of the former plant.

This company is now manufacturing and marketing a 3,000 ohm super-sensitive radio head-set, which embodies the very latest electrical and mechanical features. The head-band of this head-set is encased in a patent leather covering and is easily adjustable.

W. O. Miessner, of the Sterling Co., designer of the Sterling head-set, is a pioneer in telephony and for many years has been recognized as an expert in complicated electrical apparatus. In order to get perfect winding on the magnetos of this head-set, Mr. Miessner worked for many months in bringing out a small but accurate winding machine which automatically stops when the requisite number of turns of wire have been wound upon the magneto bar.

New Starr Style Arrives

The Chicago division of the Starr Piano Co., of Richmond, Ind., recently received its first shipment of the new Style 19 Starr phonographs. Upon the arrival of these instruments notices were sent out to Starr dealers in Chicago and from the reception dealers accorded Style 19 it is only fair to believe that this new instrument will in time become one of the most popular models in the well-known Starr line.

This new model is thirty-three inches high, thirty-six and one-eighth inches wide and twenty-one and one-eighth inches deep, and its mechanical equipment includes all of the distinctive Starr features that have contributed so materially to the success of the Starr line.

Right Off His Chest

The following is a clipping from the Columbia Record, published by the Columbia Graphophone Co., and applies to a Chicago man:

"The same ingenuity that enabled Joseph Lazar, of the Lazar Music Center, 1976 Milwaukee avenue, Chicago, to become an expert electrician and, during the war, an aero expert, follows him in his present business, that of conducting a Columbia Grafonola and record shop:

"Mr. Lazar participated in a recent Masonic

The Best Motor Money Can Buy

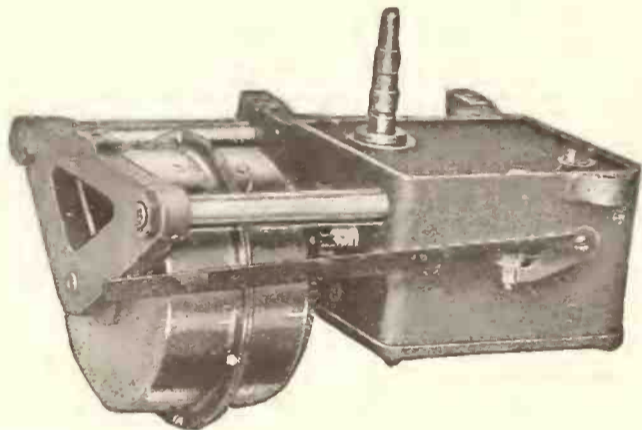

1. The wick lubricating system, an exclusive feature of our motor, keeps every part in the gear box running in a film of oil. Not a mere smear of grease to dry away and get gummy and hard with exposure to the air, causing noise and variable speed within a short space of time, but constant circulating lubrication.

For at least two years after our motors are installed the wick will circulate pure oil and governor and gears will be perfectly lubricated. Some of the high-priced motor cars have recently adopted wick lubrication—because it is right—continuous, automatic, certain.

2. The enclosed construction makes this lubricating system possible and also keeps dirt, bits of excelsior, lint and phonograph needles, etc., from getting into the works. This prevents those trouble cases that cost the dealer money and cause his customers annoyance.

3. The design of our motor lends itself to accurate alignment of bearing and springs. When our box-like casting is clamped into the holding tools to be machined it does not distort with pressure as open castings do. The reason we have almost no spring breakage is that perfect alignment does away with the side strain which causes crystallization and breakage of springs.

REAL PRICES

1. We have a modern, complete, specially designed equipment solely devoted to the production of this motor.

2. Our plant is spacious, light, modern in every feature and our organization is seasoned and imbued with spirit of quality.

We have the necessary volume of output and can produce efficiently. Because of these facts we are furnishing a motor of positively unequalled merit, at unmatched prices.

Let Us Furnish You Samples

United Manufacturing and Distributing Company

536 Lake Shore Drive

CHICAGO

FROM OUR CHICAGO HEADQUARTERS—(Continued from page 100)

masque ball at Chicago. He had previously arranged a Columbia three-spring motor on a wooden board strapped to his body and entirely concealed by his novel costume. Between dances, the latest Columbia records were sent forth from the horn, which he attached to his side.

"He won first prize for costume as well as the novelty of the idea.

"Mr. Lazar, who aroused considerable curiosity, went all through the party without being recognized. His costume was well decorated with Columbia notes and also one large blue Columbia decalcomania pinned on with Peter Rabbit bangle pins."

Walbert Mfg. Co. Activities

The Walbert Mfg. Co. reports the foreign business for Geer repeaters has picked up remarkably well in the past few months. The English representative for this company with headquarters in London is sending in numerous large orders for the well-known Geer repeater and a big shipment of several thousand was sent early in the month.

The London representative stated in his letter to Mr. Huth that the Geer repeater has won favorable recognition in all sections of the British Isles. From the present indications it will not be long before every talking machine shop in that territory will be handling Geer repeaters.

The Western traveler for the Walbert Co., Oscar Hoberg, left on the first of the month for an extended trip through the West. The trip will cover over a four months' period and will terminate in Mexico City. It is the intention of Mr. Hoberg to call on all dealers and jobbers in the territory he will traverse for the purpose of stimulating sales of Geer and Gold-Seal repeaters. Much attention will be given to the jobbers in assisting them in the work of supplying these well-known accessories to dealers in their localities. Mr. Hoberg is taking with him a number of demonstration outfits for the purpose of teaching dealers unacquainted with these well-known repeaters just how they work. The

demonstration equipment consists of an electric motor and turn table supported by a small stand.

New Utylyty Unyt

The Unyversal Utylyty Unyts Co., of 6111 Winthrop avenue, is preparing to market a new record-filing device which it will offer to the trade in a short time. This device from a casual glance is seemingly a series of slides, for the purpose of holding records. However, these slides in reality are narrow compartments arranged in a row and so constructed as to move forward and backward by just a slight touch of the finger. When any of the record-containing units is merely touched with the finger it instantly slides out and the record projects into full view, the label on the record being plainly visible. The material used in the construction of this new device may be of wood insert center veneer or thin pressed composition boards.

Flivv to Chicago

Fred Firestone, manager of the Schumann Piano Co., Victor dealer of Rockford, Ill., flivved to Chicago from there recently to see his old friends in the trade. Fred is one of the best-known retail men in the Central West and in his twenty-five years' activity in the music field has been connected with some of the biggest houses in Chicago. He says that the trade in Rockford promises to be an exceedingly good one for the coming Fall and he is telling his Chicago friends that they will have to go some this season if they sell as many instruments as the boys down in Rockford insist they are going to sell.

Music as a Therapeutic

For a number of years the Six Brown Brothers, headed by the well-known Tom Brown, have been appearing all over the country in a clever saxophone act. The trade knows all about the Brown Brothers, having tied up on many occasions with them for the purpose of selling Six Brown Brothers records. Recently, however, an organization was formed for the purpose of emulating the Brown boys, and the members

are aiming so high that they feel that in due time they, too, will be well-known saxophone stars. However, they will not become professional saxophonists. Their mission in the field of harmony is merely to cheer patients at Chicago's Tuberculosis Sanitarium.

The sextet are employes of the Health Commissioner's office in Chicago. Nearly every day they congregate on the roof of the City Hall and "let 'er rip." Chicago's health commissioner, Dr. Bundesen, like his predecessor, Dr. John Dill Robertson, believes that music has a stimulative effect, especially on patients suffering with chronic diseases. For that reason a sum of money from the Health Commissioner's appropriation is devoted each year to the purchase of musical instruments, especially talking machines, which are purchased and placed in the wards of the sanitarium.

Congratulations, Mr. Kapp

J. Kapp, who is very well known to the trade of Chicago, is receiving the congratulations of his friends on his marriage to Miss Frieda Lutz, which took place at the Parkway Hotel, August 6. Mrs. Kapp is a familiar figure to the talking machine trade and has won many warm friends through her charming personality. We all join in wishing the couple all the good luck and happiness which they deserve.

Among Department Stores

A canvass of the retail trade in the Loop discloses a very optimistic outlook for the month of July and especially for the Fall. Rothchild & Co., who have been advertising every week in the daily papers and going after business in an earnest way, report that they have doubled last year's business. One week they did \$25,000 worth of business and they have been selling from six to ten machines a day. Although this does not look like an enormous amount of sales, the significance of these statements should not be overlooked. What is meant is that through advertising, hard work and special sales this con-

(Continued on page 102)



"Built by tone specialists"

IN ITS SEVENTH YEAR OF STEADY SUCCESS

4 Cabinet Styles:

Mahogany, Walnut and Oak Finishes.

Patented Tone-Deflecting System:

Unsurpassed Workmanship.

Vertical Record Filing:

Mechanical and Acoustic Equipment Beyond Criticism.

Write for our *Revised Wholesale Prices*

Magnola Talking Machine Company

OTTO SCHULZ, President

711 Milwaukee Avenue

Chicago



Magnola Style Louis XVI

FROM OUR CHICAGO HEADQUARTERS—(Continued from page 101)

cern is creating a goodly number of prospects for the Fall. However, with all this optimism, we have a little pessimism thrown in—the fact that the record business has fallen off considerably during the hot spell.

W. B. Papineau, who was recently appointed manager of the musical department of the Fair, has made things "hum" since his arrival. He has changed the department and made attractive displays of small goods. He also put on advertising stunts such as demonstrating Wallace records and special sales for ukuleles, having Miss Jennie Durkee, the originator of the American way of playing the ukulele, give demonstrations. Thus by injecting a bit of enthusiasm in the department it has resulted in a good report for the Summer months. Mr. Papineau says that portables are in the lead. However, portables have been the means of stimulating a desire for better music and they have had numerous cases where prospects have come back and bought higher priced machines.

It seems that the higher priced machine is very much in vogue this month. Mandel Brothers, who handle the Vocalion, report that the first two weeks of July witnessed more business than the whole month of July last year, and the higher priced machine is the largest seller. People are looking for price and willing to pay for a higher grade machine provided they get quality. And along with the higher class models there is a larger cash payment. In fact, terms have been the least consideration and large down payments have been a dominating factor this month.

T. W. Hindley, manager of the talking machine department of Mandel Brothers, left the latter part of June for the East, and was away about a month. He visited Philadelphia, Atlantic City and spent a week at the Aeolian Co., at New York. The remainder of his vacation was spent summering at Shattuck Inn, Jaffery, N. H.

Marshall Field & Co., who represent the

Cheney Talking Machine Co. in Chicago, are also coming in for their share of the higher grade business, as the Cheney stands the test of the most critical public.

Although conditions are still somewhat spotty the tendency throughout the trade is for better business in spite of the strikes and labor troubles that we are going through.

"Note the Notes"

W. C. Bartelt, of Fort Atkinson, Wis., was a visitor at the Columbia's offices in Chicago recently. He is proprietor of a successful music shop handling Columbia Grafonolas and records.

An exclusive Grafonola shop, complete in every detail and constructed to give the public a comfortable and convenient place to buy their phonographs and records, has been opened by Claude L. Beisel in Lafayette, Ind. Nothing has been left undone to make this shop the most modern of its kind in the Hoosier State.

Earl Clark, Columbia dealer of Monroe, Wis., spent the day recently at the Chicago office of the Columbia Graphophone Co.

Tom Butler, Columbia dealer at Wabash, Ind., dropped into the offices of the Columbia Graphophone Co. the other day. Business in Wabash is picking up and prospects for a large Fall business look good, according to Mr. Butler.

Open New Store

A new music store is being opened in South Bend, Ind., under the supervision of Lang Bros., to handle the Brunswick line. One of the brothers, J. E. Lang, is very prominent in talking machine circles, and for several years was sales manager for Elbell Bros., of that city.

On Vacation

C. W. Hyde, of the Chicago Talking Machine Co.'s sales force, has just returned from a motor trip which took him through Wisconsin and Minnesota, and announces that he is now full of pep and will immediately begin activities for a Fall campaign.

V. K. Tremblett, also of this company's sales

forces, spent two weeks at Wausau, Wis., in the company of H. S. Wright, Victor dealer. During the two weeks that these gentlemen were together they succeeded in cleaning out all the lakes around Wausau. The cleaning-out process consisted of capturing the largest string of fish that was ever told about.

We understand that R. E. Kane, who travels Illinois and Iowa for this company, is in Michigan on his vacation, also demonstrating his prowess as a fisherman.

But after all is said and done, the above gentlemen will have to go some to keep up with Fred Putnam, of the Putnam-Page Co., of Peoria, Ill. Fred spent two weeks up around the Wisconsin fishing grounds and was as brown as a berry when he came to Chicago en route for Peoria. Fred did not have much to say about the fish which got away, but we're willing to bet that very few did after giving his waistline the once over!

Takes on Brunswick

A copy of a Milwaukee newspaper recently came into the Chicago office, and this particular issue carried a third-page announcement that Bradford's have taken on the Brunswick line, "As an added feature" of this institution's music service. The advertisement was illustrated by a cut of the "Georgian" Brunswick period model de luxe. The text matter carries the message that this move marks "Another step forward, further emphasizing Bradford's position as Milwaukee's most prominent distributor of talking machines and records, making this most popular music house even more popular. All music-lovers will welcome this announcement. With the addition of the famous Brunswick phonographs and records to our other established lines, here is service supreme that makes for complete satisfaction."

Illinois Dealers Who Are Doing Things

News reaching the Chicago office of The Talking Machine World from various parts of the

(Continued on page 104)



RADIO — PHONOGRAPH



A COMBINATION CABINET

Made so you can install

Radio Panel or Panels

In One Side and Phonograph
in the Other

This cabinet is Flexible to the wants of your trade— can even be sold by the dealer to the Radio Enthusiast who wishes to install his own Radio Set.

Made in Quantities and Carried in Stock by Us—so can give you Prompt Service on "Hurry-Up" Orders, Large or Small.

WRITE TODAY To THE WOLF MANUFACTURING INDUSTRIES

Sales Offices
123 WEST MADISON STREET
Chicago, Ill.

Factory and General Office
110-126 3rd STREET
Quincy, Ill.



HERE IT IS!

The
**FLETCHER UNIVERSAL
 TONE ARM and REPRODUCER**

Gives Proper Playing Weights for All Records. No Adjustment Screws or Springs
 SAMPLES \$8.00 Specify 8½" or 9½" arm

FLETCHER-WICKES CO., 6 East Lake Street, Chicago, Illinois

THE McLAGAN PHONOGRAPH CORPORATION, LIMITED, STRATFORD, ONTARIO, EXCLUSIVE CANADIAN AGENTS

TONE ARMS
Fletcher
 REG. TRADE MARK
REPRODUCERS

Fletcher
 REG. TRADE MARK



Reproducer
 and Connection
 for
NEW EDISON
 Plays all Records

Dealers, Send for Prices and Terms

FLETCHER-WICKES CO.

6 East Lake St., Chicago, Ill.

THE McLAGAN PHONOGRAPH CORPORATION, LIMITED, STRATFORD, ONTARIO, EXCLUSIVE CANADIAN AGENTS

SOMETHING ENTIRELY NEW IN TONE ARMS
THE FLETCHER "STRAIGHT"



STRAIGHT INSIDE—Taper Outside
BALL BEARINGS THROUGHOUT
NEW DESIGN NEW CONSTRUCTION

Yes, it is universal and equipped with the Regular Fletcher Reproducer, giving the same natural tone quality as heretofore
 Made in two lengths, 8½" and 9½" SEND FOR PRICES AND TERMS

FLETCHER-WICKES COMPANY
6 EAST LAKE ST. CHICAGO

THE McLAGAN PHONOGRAPH CORPORATION, LIMITED, STRATFORD, ONTARIO, EXCLUSIVE CANADIAN AGENTS

FROM OUR CHICAGO HEADQUARTERS—(Continued from page 102)

State discloses the following, among other facts:

H. S. Bassett, of Tuscola, Ill., is preparing for increased business this Fall by enlarging and remodeling his retail store. His store is being equipped with the most modern sound-proof hearing and demonstration booths.

Tedens' Music Store at Lamont, Ill., will also be remodeled and redecorated for Fall business. Mr. and Mrs. W. H. Tedens were recent visitors to Chicago and while here spent a great deal of their time picking out equipment and purchasing goods for the coming season.

The store of Barker & Sullivan, at New Rochelle, Ill., will be redecorated during the month of August and will likewise be fitted out with up-to-date sound-proof demonstrating and hearing rooms.

Changes in Sales Force

Harry B. Bibb, sales manager of the Brunswick-Balke-Collender Co., of Chicago, has announced the following sales changes in the sales department supervised by him: K. McInnis, who formerly looked after the Milwaukee territory, has been transferred to Detroit, Mich., where he will maintain headquarters.

P. H. McCulloch has been transferred from the Brunswick central Illinois territory to Milwaukee, where he will establish headquarters. Both of these changes were effective August 1.

Victrola 111 Arrives

The Victor Co.'s latest Victrola 111 has just arrived in Chicago. The jobbers are jubilant, likewise the dealers, over this new model. It is very simple in design, but carries the same graceful proportion that characterizes all Victor models. This new instrument is furnished in either mahogany, oak or American walnut. It is equipped with a spring motor, and carries a retail price of \$225. When equipped with an electric motor it retails at \$265. The new instrument has Victor record albums, twelve-inch gold-plated turntable, gold-plated sound box, tone arm, etc. It also carries an automatic

stop, speed regulator and speed indicator. It is forty-five and three-quarter inches high, twenty-two and a half inches wide and twenty-four and three-quarter inches deep.

F. S. Spofford's Protege

F. S. Spofford, who conducts a Sonora shop on the seventh floor of the Republic Building, is receiving congratulations upon the remarkable hit made by his seventeen-year-old protege, Aldo del Missier. The young violinist recently played at Madison, Wis., before the Lions Club, at the executive mansion before Governor Blaine, and again at the home of Mrs. Dawson Butler, who is Mr. Spofford's sister-in-law. This young man is making remarkable progress as a violinist, and Mr. Spofford is seeing to it that his protege is getting the best of training.

Barnhart Bros. Add Space

A good many years ago some wise old philosopher broke into print with a little line which said: "Actions speak louder than words." What said philosopher really meant is neither here nor there, but the fact still remains that the old adage contains more truth than poetry. In reality we have come into the state of being that really demands action. In the business world action is, as a general rule, proportionate to ability, and when a concern is really active we may justly estimate highly the ability of the men behind the guns. Also we may usually praise the product of that concern.

These thoughts were brought to mind recently by a visit paid by the writer to the plant of Barnhart Bros. & Spindler, who manufacture the well-known Scotford tone arms and reproducers, and who do a great deal of die-casting for many concerns throughout the country. The activities noticed out at this plant were very significant and were centered about a building program. The plant of this firm is a very large one and covers a great many feet of ground. The die-casting plant is probably one of the biggest, if not the biggest, in Chicago.

but still it is not big enough. Therefore, it has been found necessary to increase the floor space to the extent of an additional story. The plant now housing the die-casting department contains a basement, first and second floors, but within a few weeks the third floor will have been completed and in operation. As soon as this work is finished, the builders will begin adding a third floor to the office building. The additional office space and die-casting department were necessitated by increasing business in the Scotford tone arms and reproducers, as well as in radio parts. The demand for the latter has grown to great proportions during the past few months. This company is supplying everything usable in radio that can be die-cast.

Handling Clapp-Eastham Sets

The Clark Radio Shop, carrying a complete line of Clapp-Eastham sets and supplies, has been opened in the DeKalb factory building by the Clark Orchestra Roll Co. This retail service has been determined upon as a response to the many local demands for reliable apparatus, and is but an extension of the musical activities of the Clark music roll plant. B. H. Clark, secretary of the company, and a one-time amateur operator, is in charge of the sales of this well-equipped shop.

Victor Show Case

The Chicago Talking Machine Co. is getting splendid results from the campaign on Victor needle show cases. The case is sold to the dealers for \$3 and offers quick service in the sales of Victor needles. It is of all-metal construction, seventeen and one-half inches wide, seven inches high and eight inches from front to back. The door is all glass and the case is indexed on the rear. The case is finished in full mahogany color with gold edges, and bears the Victor dog trade-mark.

Baldwin Sales Force Meets

The sales force of the Chicago branch of the Baldwin Co. has planned an intensive selling

The PORTOPHONE



Open

The Biggest Value in the Talking Machine Industry Today

A Portable Phonograph built into a leatherette Traveling Case. Plays all makes of disc records with perfect tone.

The PORTOPHONE is the pioneer in the portable phonograph field, and more than 40,000 have been sold. Equipped with the highest grade, powerful, double-spring motor, regulator and turntable brake.

An instrument that is pleasing to the eye and the ear—a favorite in any home. The tone of the PORTOPHONE is equal to any instrument selling at from 5 to 10 times its price, a fact that is made possible through quantity production and organized distribution.

The Big Season for instruments of this class is just starting—tourists, campers, autoists and people with money to buy will soon be looking for a portable phonograph—and the PORTOPHONE is the answer.

A comparison of the PORTOPHONE will quickly prove our contention that it is the biggest value in the talking machine industry today. Made complete from the motor to the cabinet in one factory and sold through the legitimate channels of trade at a good margin of profit to the dealer.

Write us for full particulars at once.

**The CONSOLIDATED
Talking Machine
Company**
229 West Washington St.
CHICAGO

Branch, 2957 Gratiot Ave., Detroit, Mich.

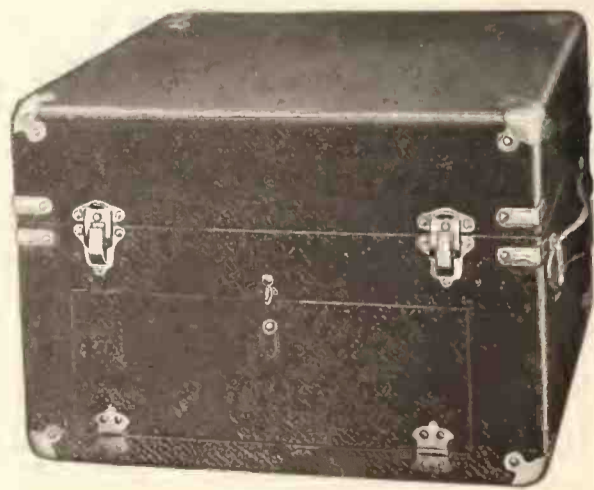

Closed

FROM OUR CHICAGO HEADQUARTERS—(Continued from page 104)

campaign at a conference with salesmen from Baldwin branches all over the United States. If the enthusiasm demonstrated at this conclave is any forecast for the remainder of the year the Baldwin Co. will undoubtedly go through one of the very busiest periods of its existence.

Business was the order of the day and every representative of the Baldwin Co. had an opportunity to familiarize himself with the newest features of the Baldwin line of pianos and talking machines. After the meeting the conventionists went out to the Marigold Gardens for a little party, at which time they presented to W. S. Price, the new manager of the Indianapolis division, a beautiful watch as a token of appreciation for his excellent work in behalf of Baldwin in his territory.

"Buck" Wheat Visits

"Buck" Wheat, of William H. Reynolds, Victor wholesaler, of Mobile, Ala., recently spent a two weeks' vacation in Chicago. The vacation was really a home-coming, as Mr. Wheat spent nearly all of his time visiting with his folks of this city. This is the first time in nearly two years since he has visited Chicago.

Another Southern Victor man to visit Chicago during the latter part of July was J. D. Moore, of Maison Blanche, of New Orleans, La., who came on a buying trip, and while here called on many of his friends in the trade.

A Progressive North Side Dealer

One of the most progressive dealers on the North Side of Chicago is Carter B. Cordner, owner of the Symphony Music Co., 1020 Wilson avenue. Although limited for space he has his shop arranged in a most attractive and tasty manner. The service he renders the public is another item not overlooked. A complete stock of Columbia records is always kept and his display of period model Grafonolas is probably the most extensive in the city. His window displays, which are always of a high grade, embody ideas and suggestions that call for the

unusual, practically always in colors and carry a sales message to the pedestrian in a most unique manner.

Mr. Cordner has returned from his vacation at Eau Claire, Wis.

Fine Business With Hall Mfg. Co.

When F. D. Hall, of the Hall Mfg. Co., returned to Chicago early in the month from his Western trip he immediately paid a visit to headquarters, where he received a very pleasant surprise at the hands of H. J. Fiddelke. The surprise was none other than a complete report of the inventory disclosures for the fiscal year which ended in June. The reports show that business consummated by the Hall Mfg. Co., from June, 1921, to June, 1922, was far in excess of what had been anticipated. In fact, almost double that of the preceding year.

The outlook for the coming year is very promising. Mr. Fiddelke hopes to see greater production than ever before in the history of the country.

Mr. Fiddelke is one of the few men in Chicago who will not make a visit to the seashore or countryside for a two weeks' vacation rest. It is true that he will have a vacation, but his rest will consist of more work. He is building a home out in the Beverly Hills district in the southern part of Chicago and he intends to spend his vacation with a hammer and saw, helping the good work along.

L. C. Wiswell Vacating

L. C. Wiswell, manager of the wholesale Victor department of Lyon & Healy, left Chicago on the 24th for his vacation. Accompanied by his family he motored to his Summer home at Belvidere Beach, near South Haven, Mich.

Otto Heineman Visits Chicago

Otto Heineman, president and general manager of the General Phonograph Corp., spent a week in Chicago during the month of July. Accompanied by S. A. Ribolla, manager, Mr.

Sharpen the Fibre Needle

Without removing it from the Tone Arm of the Phonograph

It's 5 years ahead of the times

CONVENIENT

FAST SELLER



GOOD PROFITS

MECHANICALLY RIGHT

Very Simple

LIDSEEN FIBRE NEEDLE CUTTER

LIDSEEN PRODUCTS

832-840 So. Central Ave. CHICAGO

Heineman spent quite a bit of time calling on the local trade in Chicago and Milwaukee. Mr. Heineman then left for St. Louis and other points in the Central West. After his visit to this territory he returned to New York, stopping

(Continued on page 106)



Announcing the Uradiola Line of De Luxe Radio Receivers

The General Radio Laboratories handle only tried and tested radio apparatus. Following this policy, we have adopted the URADIOLA line of DE LUXE radio receivers and are now offering to the dealer a line of apparatus which will move fast, bring in returns, and sell itself on its own merits (two models illustrated). In appearance, any URADIOLA model, from the URADIOGRAND to the series AI Tuner and Audion Detector, rank among the finest in harmonizing with home appointments. The cabinet work is unexcelled.

A genuine hand-rubbed piano finish gives the instruments that touch which appeals to the particular buyer—the man who knows how to judge good furniture. For the man who knows radio, all that is necessary is to show

him the inside. The buss-bar wiring, bakelite sockets, breakdown tested transformers and change-over inductance (for waves up to 10,000 meters) have been built into the apparatus by radio engineers of long standing.

Waves up to 10,000 meters are received with this instrument, giving a broad range should the broadcasting wave lengths be increased. This is of untold value to the buyer. The manufacturers of the set state that the daylight range of the receivers is about 500 miles, while at night this range is more than doubled.

Models not shown are AI Tuner and Audion Detector, Series C3; Tuner Audion Detector with Two-Step Amplifier, and Two-Step Amplifier alone.

We are also distributors for the super-sensitive Red Star radiophone head sets and Non-Leak variable condensers. Head sets come in 2000, 2400 and 3200 ohms resistances. Condensers are made in 14 plate, 22 plate, 44 plate and 64 plate sizes. Manufactured with or without vernier adjustment. These two pieces of "Quality Radio" apparatus are symbolical of our entire line and are fast sellers. Cool weather is coming, with long evenings indoors, when the demand for radio sets will again be beyond the capacity of the output.

Are you ready for this demand?

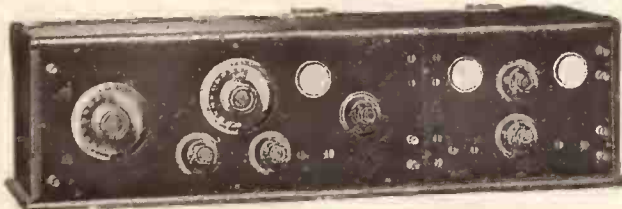

Series B2



Dealers and jobbers, write for catalog, discounts and information. We positively do not retail.

1730 Tribune Building

General Radio Laboratories

INCORPORATED

7 So. Dearborn St. CHICAGO



I don't know why I should cry o-ver you, sigh o-ver you, e-ven be blue,

The Big Waltz Ballad Hit

Why Should I Cry Over You

It's Another "I'm Sorry I Made You Cry"

"You can't go wrong
With any FEIST song"

HEAR IT NOW!

FROM OUR CHICAGO HEADQUARTERS—(Continued from page 105)

off en route at the factory at Elyria. Mr. Heine-man was quite optimistic concerning the coming Fall business and has already made provisions for the purpose of increasing to capacity production at the Okeh plants.

Swanson Portable Well Received

R. W. Moon, general manager of the Swanson Sales Co., of Los Angeles, Cal., stopped off in Chicago for a few days' visit, calling on the jobbing trade while en route to his headquarters at Los Angeles. He also visited quite a number of dealers for the purpose of establishing accounts for the Swanson portable talking machine.

This is one of the smallest portable machines ever introduced to the trade and is manufactured by the Swanson Phonograph Co., of Chicago. It weighs 15¼ pounds and is equipped with a wooden tone arm, to which the sound box is permanently attached. The tone arm, in turn, is connected at one end with a swivel joint. The tone waves travel through the arm and are directed into one corner of the lid. This amplification is much greater than one would suppose. The little instrument, when furnished to the dealer, comes completely equipped in every detail, with needle cups and an album capable of holding twelve records. That the Swanson was favorably accepted by the Eastern trade is evidenced by the number of orders Mr. Moon exhibited. The Chicago

trade also showed great interest and placed substantial orders for this product.

Prof. Cheney at Chicago Piano Club

J. L. Mitchell and E. J. Exter, of Lyon & Healy, arranged a musical program of rare talent for the music men at the August 2nd meeting of the Chicago Piano Club. Signor Liberati, premier cornetist, played several selections and accompanied his music with many humorous remarks. William Lum played several solos as well as a number of popular pieces on the Hawaiian guitar. Well-known radio artists consisting of Harold Saxler, violin; Henry Geiss, saxophone, and Miss Turner, piano, entertained with the latest hits and popular songs. In all it was a very lively meeting. Prof. Forrest D. Cheney, president of the Cheney Talking Machine Co., who was a guest of the club, became so enthusiastic over the prospects of the coming picnic that he offered a cash prize of \$5.00 to the person making the best two-minute salesmanship talk on any subject of the music industry on that day.

When he entered the club rooms he was merely a guest. When he donated his prize for the best two-minute talk on salesmanship he was a good fellow, and after his little talk which was requested of him by Chairman Schoenwald he was unanimously elected a member of the Piano Club of Chicago.

Professor Cheney responded to Chairman Schoenwald's request for a few words by quoting Elbert Hubbard. "Do your work as well as you can and be kind." He went on:

"Each of you men is putting out something of value to the music-loving public and by doing this you members of the club are promoting harmony. Rhythm is the expression of impulse. Melody is the form and harmony is the color. Music sounds are periods of impulses. The period impulses are the mechanical expression of life. For example, when the heart beats in perfect rhythm we have a demonstration of perfect health, but when it records non-periodic impulses or vibration we have an unhealthy condition. Therefore, music is the vibratory expression of life and if it is non-periodic in vibration it is the expression of dissolution and death.

"You men," he continued, "by belonging to this club, are spreading a gospel of good fellowship. It makes your competition wholesome, and wholesome competition is the life of good business, and there is still plenty of room in this world for all wholesome producers and propagators of good music. Your success is like all success, the result of action under proper direction. Envy and jealousy are the beginning of a demoralized state of business and tend to ultimate failure. By your harmonious meetings here each week you accomplish a great purpose and that is the banishment of envy and jealousy.

"Business is the backbone of civilization and is the method whereby all commodities of value are brought in touch with the ultimate consumer. Direct methods and sincere, honest representation as practiced by you boys will bring about a normal condition, establish confidence between the producer and consumer more quickly than any other theoretical methods, either political or otherwise.

"The good will developed by your close association tends to establish a co-operative and kindly feeling which will be of mutual benefit to all concerned. It gives me great pleasure to be a guest of your club and to know the fine spirit among you. You are boys, all of you, old or young. You are boys in spirit and these meetings will have a tendency to keep you boys. The success of each member of this club makes for success of the entire trade. A success built up on the failure of another is not a true success, nor is it constructive in its results. and I know that each and every one of you here to-day is standing on his own foundation. Therefore, I wish you all the success and prosperity you deserve and hope I may again enjoy the pleasure of your company."

Needless to say, the few remarks quoted above are what turned the trick and caused a bond of friendship to spring up immediately between the club and Professor Cheney. He told them just what he had in his heart in a way that won him everlasting friendship and it is to be hoped that his election as a member of the Piano Club means that he will be present at many future meetings.

Canadian Visits

D. M. Wright, president of the McLagan Phonograph Corp., Ltd., Stratford, Ont., spent the first week of August in Chicago. Mr. Wright is the Canadian distributor for the Fletcher-

VIS-MATIC

The Most Wonderful Trade Stimulator and Profit Puller in the Talking Machine Field. Exasperated users groping to touch the record wished for, when wanted, has discouraged the use of machines.

"SELL" every tenth record buyer one VIS-MATIC and the records become at once accessible, accurately, assuredly and with but the finger tips of one hand. Resuscitates the playing of records and using of machines. Old records are discarded. New records and even machines purchased. THE PULMOTOR OF THE TALKING MACHINE TRADE. "SELL" the first VIS-MATIC and repeat orders are insured. Albums, unused, are discarded. A new lease of life is begun with this easy, convenient, accurate, accessible, instantly automatic, all-open, all-receptive, all-numbered, all-labeled, all-in-one "at-last" accomplishment. The "impossible" overcome. MUCH MORE ACCURATELY AND EASILY ACCESSIBLE UPON A STOOL OR CHAIR OR OPENED UPON THE FLOOR, NEAR THE MACHINE, THAN ANY ALBUM SPREAD OPEN OVER THE REQUIRED LARGE AREA UPON A LARGE SPACE UPON A LARGE TABLE.

VIS-MATIC IS THE AVAILABLE MEANS FOR MAKING SALES. A WONDER WORKER. 10" RECORDS ARE AS INSTANTLY FINDABLE IN THE 12" ALBUMS AS IN THE 10". A MARVELOUS FILING GAIN.

UNYVERSAL UTLYTY UNYTS CO.

6111 Winthrop Ave.

Chicago, U. S. A.

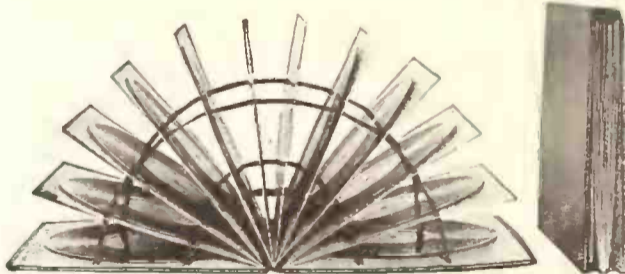

FROM OUR CHICAGO HEADQUARTERS—(Continued from page 106)



MELODY CONSOLE

Height 36½, Width 36, Depth 20½. Helman No. 77 Motor, Improved Blood Tone Arm and Reproducer. Genuine Mahogany. List Price \$125.00. Dealers' Price, \$60.00.

MELODY NATIONAL SALES CO.

190 N. State Street, Chicago, Ill.

Manufacturer

MELODY PORTABLE PHONOGRAPH

Wickes Co., manufacturer of the famous Fletcher tone arms and reproducers. He spent the entire week in company with Messrs. Fletcher and Wickes, in calling on the various wholesale and retail concerns in Chicago. The purpose of the visit was to compare the business methods of manufacturers and retailers in Chicago with those of Canada. Mr. Wright was well pleased with his visit to Chicago.

Speaking of Canadian business, Mr. Wright remarked that the Canadian trade was going along very nicely and was doing a business that was very commendable for this season of the year. "There is one thing I notice about the American business," he said, "and that is that the men are a little slower to take hold after a period of depression, but after they do take hold they go ahead in a remarkable way. In Canada we take hold a little quicker, and when we do take hold we go along in a remarkable way and methodical manner. We are accustomed to take our time, but we get there nevertheless. We are just starting on what we believe will be one of the best seasons we have ever experienced and it would not surprise me in the least if the business of Canada went way over our anticipations."

Oro-Tone Radio Activities

The Oro-Tone Co. has added so greatly to its force of employes within the last few weeks that it is now able to give immediate delivery on Oro-Tone sea-horn loud speakers, precision condensers, vacuum-tube sockets and other accessories incidental to radio. The sea horn marketed by this company is heralded as nature's perfect amplifier. This horn is a genuine sea horn or trumpet shell of the conch family and is a product of the southern seas, recognized for ages as nature's most wonderful and perfect sound amplifier.

This product is a very artistic and ornamental one and comes mounted on a mahogany finished base, complete with phone clamp. They are original conch shells, ranging from twelve to sixteen inches in height and come in three sizes, namely, the twelve, fourteen and sixteen. The horns when shipped from the seaports arrive with the original crusts, and these mosses cling to them, but when completed they are very beautiful and carry a high polish, which brings out each and every color placed there by nature. These colors range from a coral red to a pearl and opal.

The Oro-Tone Co. is also manufacturing, besides its extensive line of high-grade talking machine tone arms, reproducers and Victor-Edison attachments, a very cleverly constructed talking machine spring clamp, which enables the radio fan to use the amplifier of his talking machine as a loud speaker. The phone clamp is attached to the earpiece of the receiver and this in turn is

slipped on to the tone arm in place of the reproducer. These clamps are made especially for the utilization of Edison, Victor, Columbia and Oro-Tone tone arms.

Lakeside Activities

The Lakeside Supply Co. has in the past few weeks turned a great deal of its attention to the rural trade, for the purpose of stimulating radio. The Lakeside people have come to learn, through correspondence with rural dealers, that the farmer who a few months ago was just beginning to notice radio has at present taken hold of it, as he now sees its advantages, not only as regards daily market reports, but he now sees the advantages offered him by the musical programs being broadcast each evening.

There is no getting away from the fact that the rural trade took hold of radio very quickly last Spring, when broadcasting was just beginning to be popularized, but the people who took hold of it then were, in a sense, merely the pioneers, who made their purchases and erected their equipment more out of curiosity than anything else. These pioneers have since relegated their curiosity to the background, as they have come to see the practicability of radio, and their neighbors who come from miles around to listen in have also found that radio is not a fad, and they, too, are now coming into the market.

United Motor Success

Much activity is to be seen in and about the plant and offices of the United Mfg. & Distributing Co. This concern, which manufactures the well-known United motor, has within the last week or two increased its output to a percent-

age which is without doubt five to six times larger than its output of last year. The United motor is gaining more favor each day throughout the trade by virtue of its many exclusive features, particularly its wick lubricating system, which keeps every part in the gear box running in a film of oil. The lubricating system is made possible by the enclosed construction of the motor proper, and this in turn keeps out all foreign material, which has a tendency of getting into and clogging up the gears and other delicate parts of the motor.

Wurlitzer News

Ed H. Uhl, formerly manager of the Chicago division of the Rudolph Wurlitzer Co., has left for a six months' business and pleasure trip to the Orient, accompanied by Mrs. Uhl.

L. E. Eichholz, formerly credit manager of Wurlitzer's Chicago division, has severed his connections with that company. His plans for the future have not as yet been announced.

Percy Kimberly, formerly retail manager of the Cable Piano Co.'s Chicago branch, is now manager of the Chicago division of the Rudolph Wurlitzer Co. Mr. Kimberly is one of the old-timers in the music game and is a very popular man in the Chicago trade.

Hans Schloessinger, formerly manager of the Wurlitzer Co.'s wholesale Victrola division at Chicago, has resigned his position to open an exclusive retail Victor shop in Albany Park. The new retail shop was opened on August 1, and nearly every man connected with the Victor jobbers of Chicago attended the grand opening.

(Continued on page 108)

THE NEW ORO-TONE CONCERT EDISON EQUIPMENT

No. 2-E. C.

MAY WE SEND SAMPLE ON APPROVAL?

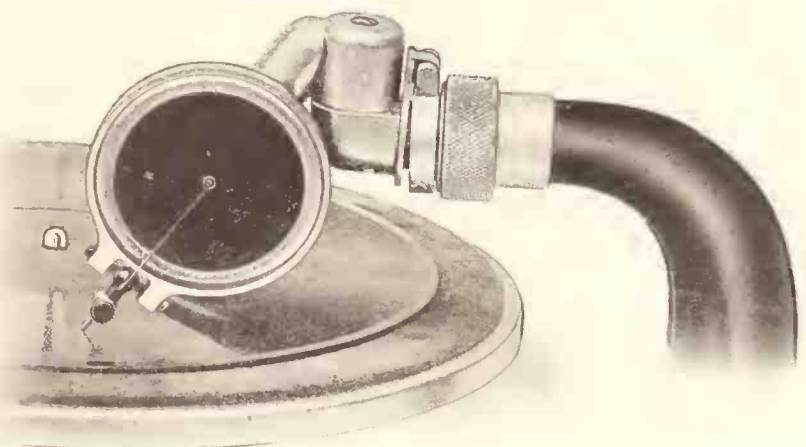

You and Your Customers will be Delighted with the Deep, Powerful Tone Quality Operated with the raising and lowering lever the same as the regular Edison reproducer. Retail price—Highest grade nickel plate..... \$7.25 Retail price—Highest grade gold plate..... 9.25 Usual Discount to Dealers

The above prices include this very essential and attractive needle cup case. Substantial and durable mahogany color leatherette. Fitted with gun metal finish needle cups as shown. Just what every Edison phonograph requires for needles and to hold either reproducer when the same is not in use. These cases will be supplied separately at 25c. each, less the usual discount.

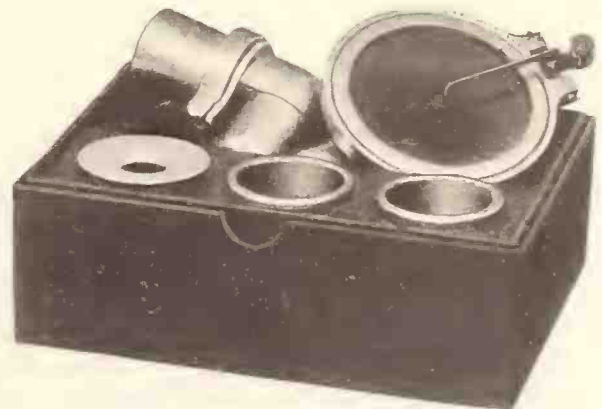

Order Your Sample To-day—It Will Be Sent on Approval Send for Folder Showing Wireless Equipment

THE ORO-TONE CO.

Manufacturers of Highest Grade Phonograph and Wireless Equipment

1000 to 1010 George Street, Chicago, Ills.

FROM OUR CHICAGO HEADQUARTERS—(Continued from page 107)

L. E. Noble, who formerly looked after the management of Wurlitzer's Chicago division, retail Victor department, is now also in charge of the company's wholesale Victor department, assuming the duties of Mr. Schloessinger. Mr. Noble left Chicago on August 5 for an auto trip to northern Wisconsin. He intends to hit the wildest parts of Wisconsin and spend his two weeks fishing.

A. J. Tucker, formerly connected with the traveling forces of the Columbia Co.'s Chicago branch, has now affiliated himself with the Wurlitzer Co., as wholesale Victor traveler, and will cover Illinois.

H. Elthorn has again taken up activities with the traveling force of the Wurlitzer Co. Mr. Elthorn was for a number of years wholesale Victor traveler for this concern, but severed his connections some time ago. His new duties with the Wurlitzer Co. are in the wholesale Victor traveling forces and he will cover the Indiana and Michigan territory for this concern.

Brunswick Picnic a Great Success

Rainbo Spring, St. Charles, Ill., was the scene of much gayety on July 16, when the Brunswick-Balke-Collender Co. held its annual picnic. There was nearly a 100 per cent attendance among officers and employes of this company and everyone proclaimed after the picnic that it was the best one ever held.

Unico Mid-West Activities

W. D. Montgomery, district manager of Unico's Chicago division, is being kept very busy calling on the Central West trade. He recently made a trip through the St. Louis-Omaha section and the day after his return he left for Minneapolis, St. Paul, Duluth and other North Central points. He reports that dealers in all sections are anticipating good Fall business and are making preparations accordingly. There are more dealers remodeling and equipping their stores with the latest fixtures than there have been for a couple of years.

While in East St. Louis Mr. Montgomery closed a deal with the Lehman Music House, of that city, for extensive remodeling. The Unico Co. has already begun working on this store and expects to have it finished for a grand opening on or about September 15. The equipment will consist of specially designed fixtures in ivory finish, and the lighting system will be of the indirect type. In all there will be fourteen of the Unico's most modern designed hearing rooms and demonstration booths. In a sense the store will be set up on the order of Ted Snyder's Music Shop

STERLING



The Sterling Reproducer with Edison Attachment plays any and all records. It is different from other Edison Attachments. It is the only attachment that can be successfully operated by the lever the same as the Edison Reproducer. Distinguished for its clear, flexible, non-metallic tone. Supplied also with Victor and Columbia attachments.

STERLING DEVICES CO.

Manufacturers of
No. 11 Sterling non-infringing tone arm, the Sterling No. 31 tone arm with non-set automatic stop, the Sterling No. 41 non-tapering tone arm and No. 82 Sterling Throw-Back tone arm. Also the Sterling Radio Head-set.

1819-21 CARROLL AVE. CHICAGO

in Chicago, and when completed will be one of the most attractive retail music stores in East St. Louis. The company carries a complete Victor line of talking machines and records, as well as a line of high-grade upright grands, player-pianos, small goods and sheet music.

New Jewel Products

The Jewel Phonoparts Co., through Vice-president and Sales Manager A. B. Cornell, announces that on September 15 it will offer to the trade its new line of tone arms, reproducers and attachments. This new line is very comprehensive and designed so as to meet all requirements. All the new goods contain original patented improvements, the like of which has never before been offered to the trade. One of the reproducers is designed for the purpose of playing either hill-and-dale or lateral-cut records, as desired. The patented features of this new Jewel attachment are brought into action when playing hill-and-dale

records. Instead of the diaphragm being turned to face toward the front of the machine, it is so arranged that it will swing down and under so as to face flatly against the upper surface of the record. This enables Edison records to be played on other machines when the reproducer is in proper position. The stylus bar is also arranged with a double needle holder, one going directly from the end of the stylus bar, for playing lateral-cut records and the other one going out at an angle of forty-five degrees from the anterior surface of the stylus bar, so that the needle may be held in proper position when playing Edison records.

Another Jewel feature is a spring tension tone arm which properly distributes the weight over the surface of the record. This spring tension is longitudinally situated on the inferior external surface of the tone arm.

Still another new Jewel feature is the bell-base tone arm. This is so arranged that the roller bearing and collar joint are completely hidden from view by a bell-shape extension or continuance of the body of the tone arm. When mounted on the talking machine this tone arm is very attractive and the design not only lends beauty, but prevents the encroachment of dust particles upon the roller-bearing system.

The stylus bars of all these new Jewel products carry a special feature which is thoroughly patented and which Mr. Cornell claims has never been offered to the trade before. This comprises a new construction which permits the playing of Edison records with a fiber needle. Manufacturers have already written for samples of these new Jewel products, but Mr. Cornell says that they will in no case be offered to the trade prior to the aforementioned date, September 15.

Selling in Spite of the Strike

During the street car strike the music men throughout the Loop called for and delivered their prospects via automobile, and in this way they kept their business on a fairly normal basis. Orders for the latest releases of records, music rolls and sheet music were taken over the phone, as was the case with the department stores.

The Victor jobbers of Chicago met a few days prior to the first of the month for the purpose of working out a plan whereby the August releases of Victor records would be on the market in good time. Proposal was made that the August releases go on sale two days before schedule and this proposal was carried out. Consequently, for the first time in history, monthly releases of Victor records were put on the market ahead of the

LAKESIDE — EVERYTHING IN RADIO

**A HIGH GRADE
DETECTOR TUBE**

TRY ONE AND YOU'LL
WANT MORE

List \$5.00



**NEW TYPE
Balanced Condenser**

TRY THESE FOR
CLOSE ADJUSTMENT

14 Plate.....	List \$3.00
22 Plate.....	List 4.00
42 Plate.....	List 5.00

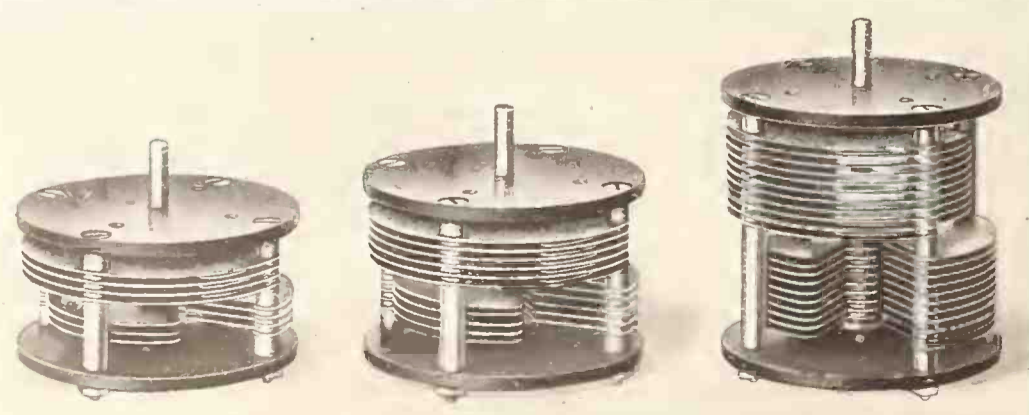

LAKESIDE SUPPLY COMPANY, 339 So. Wabash Avenue, Chicago, Illinois
PHONE HARRISON 3840

FROM OUR CHICAGO HEADQUARTERS—(Continued from page 108)

regular schedule, beating said schedule by at least two days. The August Victor library, however, was not offered to the trade in any other section of the country ahead of the regular date. This idea of advancing the schedule two days prior to the car strike enabled Victor dealers in all parts of the city to get the August records to the public in good time before the strike.

New Chicago Retail Openings

That a concerted effort is being made by music dealers of Chicago for new and bigger business this Fall is shown by the many new retail stores being opened and by the vast program of alterations and remodeling now being carried out by progressive houses.

Among the foremost of these is the J. M. Dvorak Music Co., which opened its new store at 3844 West Twenty-sixth street on August 1. The new shop is located in a modern two-story building which affords the company a great deal more space than heretofore and thus enables it to handle a larger line of talking machines and pianos. The original location of this company was at Crawford avenue and Twenty-sixth street, but it was decided that these quarters would be inadequate for the contemplated activities beginning August 1. Besides a full line of Victor goods, the Dvorak Music Co. is handling upright, grand and player-pianos.

Another new retail shop which was opened in Chicago on August 1 was that of F. H. Clark, formerly of the Reichardt Piano Co., at 2135 North California avenue. This gentleman has had a great deal of experience in retail sales.

Visits Chicago

T. G. Devine, Kansas City representative of the Columbia Graphophone Co., was a recent visitor to Chicago. He stopped here while en route to Kansas City from a vacation trip spent in the northern part of Canada.

Radio Show in October

Chicago is to have an official radio exposition from October 14 to 21, which has been endorsed by the Chicago Executive Radio Council. The Coliseum has been selected as the place, and the

time is one considered highly advantageous from the standpoint of those who manufacture and market radio instruments. To those interested in radio throughout the United States, among which, of course, are included large numbers of music merchants, a communication has been directed by the Chicago Executive Council, setting forth that it was the voice of the meeting of the Executive Radio Council that there should be but one annual radio show for manufacturers held in Chicago. "Before giving this endorsement," it says, "we took into consideration the caliber, ability and financial responsibility of the Chicago Radio Show management, the location and adaptability of the Coliseum, which is Chicago's big exposition building and the only suitable place for holding a show of the importance such as the magnitude of radio merits. The October dates we consider particularly opportune for stimulating the best interests of radio."

A radio show of this nature and magnitude will provide an excellent opportunity for those music merchants who are interested in radio and who want to settle upon a definite line of radio merchandise, to inspect the latest improvements in all their varied forms under one roof and at one time. A large sum of money will be expended before the doors are open, according to James F. Kerr, manager; forty per cent of the amount

being appropriated for advertising in newspapers and on billboards. The Coliseum, being an internationally known center of trade expositions, will not only provide excellent facilities for display of the many different radio companies planning to exhibit, but will also lend color to the proposition and give it an aspect of importance calculated to impress people of Chicago. The show is under the direction of men of unlimited experience and the ability to make an unqualified success of the event.

New Blood Equipment

The Blood Tone Arm Co. has just added a new tone arm and reproducer to its list, which embodies a new principle. Hitherto it has always been the custom to confine the weight of the reproducer to five and one half or six ounces, as the record will not stand a greater pressure. Although this reproducer weighs twelve ounces, the weight on the record is only five and three-quarters to six ounces, due to a novel arrangement of parts. Another thing, there is but one joint to contend with, which is so accurately made that it can't rattle. "We are using only the best two nine-sixteenths mica in this equipment, as we have found that there is nothing that can equal it for detail of tone. This equipment for lateral records is by far the best we have ever built," says Mr. Blood.

MANY TALKING MACHINES SHOWN AT PROGRESS PAGEANT

Chicago's Annual Civic Show, Held on the Big Municipal Pier, Attracts Great Crowds—Something of the Displays and Those Who Made Them—Radio Not Strongly in Evidence

CHICAGO, ILL., August 7.—Chicago's Pageant of Progress opened its doors to the public on the morning of July 29. The Pageant is an annual affair, under the auspices of the city fathers; and is, in fact, an annual world's fair. It is held on Chicago's big Municipal Pier, and commercial exhibits from all over the world are shown. Particular attention is always paid to the activities of the industries of the City of Chicago and the

State of Illinois. The show closes on August 14.

This year elaborate preparations were made for music. Last year music was neglected, but this year it is well out in the limelight. In fact, music bosses the show and is to be heard in every style, from grand opera to the latest popular songs, with exhibits of every conceivable kind of musical instruments well in evidence.

(Continued on page 110)

The BLOOD Arm

326 RIVER STREET CHICAGO

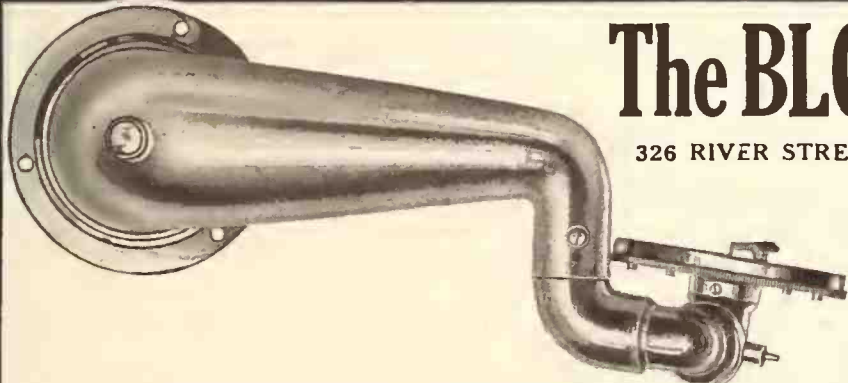
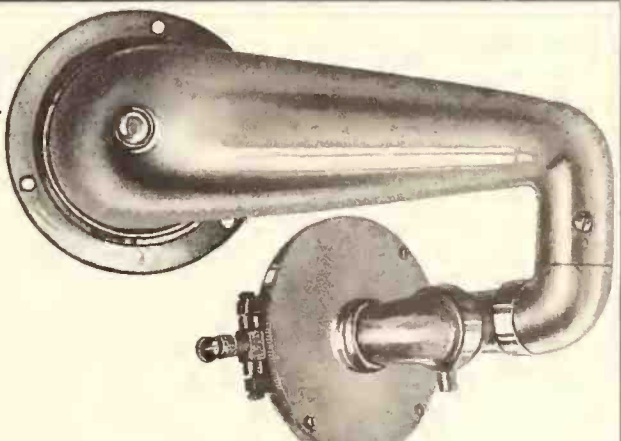
Notice perfect alignment of Arm and Reproducer

Observe throwback when in Edison position

This arm is the consummation of all that is sought after in such a device. Beauty, durability and efficiency are its merits. The high mark of distinction attained by "Blood" products is admirably upheld by this equipment. The price is very low, compared to its high quality.

Blood Arm No. 2 is the best arm that was ever put on a phonograph. For clearness and scope its reproduction is unequalled. Will play equally well with the loudest or softest needle, losing none of its quality in either extreme. In this arm is developed a new principle which has proved of wonderful value in sound reproduction, in that it reproduces in greater detail and much more volume. **IF YOU WANT THE BEST GET THIS ARM.**

We are also ready to supply a radio arm, which is interchangeable, on the base of our regular arm, designed to meet the demand of the manufacturer who builds combination radio and record machines.

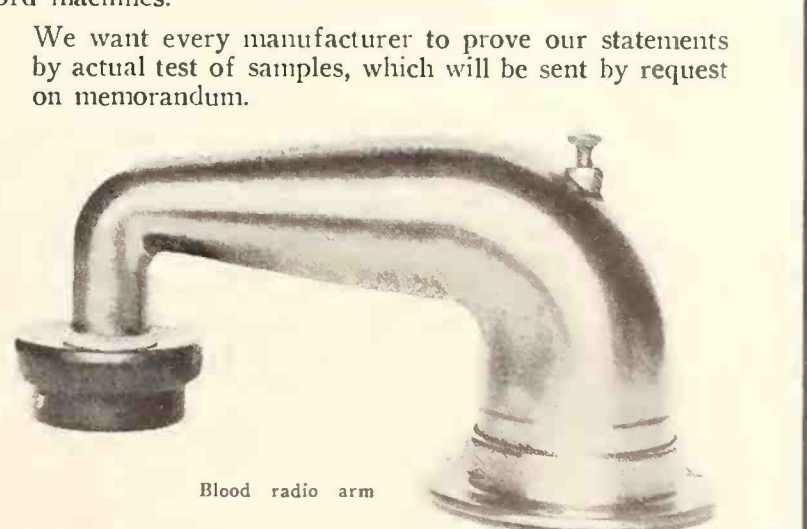
Blood Arm No. 2.
Made of a new material equal to brass in every respect

Blood radio arm

We want every manufacturer to prove our statements by actual test of samples, which will be sent by request on memorandum.

FROM OUR CHICAGO HEADQUARTERS—(Continued from page 109)

Nearly all exhibitors, especially the talking machine and piano men, took advantage of the opportunity offered them in getting up comprehensive mailing lists. This was done by means of either cards or visitors' registers. In order to induce the people to sign up some of the companies got them in by offering souvenirs or votes on prize instruments. The Jewel Phonoparts Co., Lyon & Healy, Gulbransen-Dickinson, Kranich & Bach and other well-known concerns made use of the vote scheme for the purpose of building up mailing lists. Each visitor was given a small card, whereon he placed his name and address and deposited it in the ballot box. The last evening of the Pageant the drawings will be

is constructed so that, in playing hill-and-dale records, the sound box swings under, so that the diaphragm faces over against the record, instead of being merely swung sidewise, as is generally the case. The stylus bar is designed so that a needle may be inserted at an angle of forty-five degrees downward from the foot of the diaphragm. These new stylus bars carry special patented improvements that permit the use of fibre needles when playing either the hill-and-dale or the lateral records. The exhibit was in charge of A. B. Cornell, who had his booths arranged to show seven different types of tone arms that his company manufactures. These were on display in a handsome showcase and they were also seen

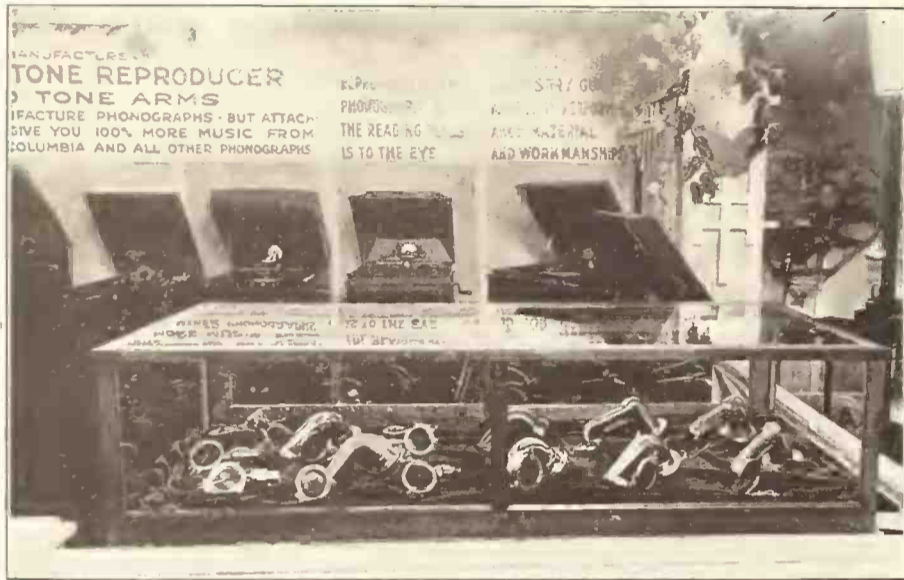

Partial View of Jewel Phonoparts Exhibit

made at each company's booth and the winners will receive a tone arm, banjo, piano or something else, as the case may be.

Jewel Phonoparts Co.

The Jewel Phonoparts Co. displayed a full line of its product and special attention was called to its new "throw under" tone arm. This

on several well-known types of talking machines arranged behind the case.

Burns-Pollock Electric Mfg. Co.

The Burns-Pollock Electric Mfg. Co., of Indiana Harbor, Ind., exhibited its well-known Capitol talking machine in copper, silver and gold. This is in the form of a handsome electric table lamp, the base of which is utilized as an amplifier. The exhibit was in charge of I. Rosenthal.

Brenard Mfg. Co.

The Brenard Mfg. Co., of Iowa City, Iowa, exhibited, under the direction of L. J. Ingram, sales manager, and F. W. Kracher, advertising manager, its full line, with special emphasis on its Claxtonola Portable. The portable was shown by itself, backed by a very artistic setting suggesting a camping spot in the woods.



Wallace Institute

The Wallace Institute of Chicago exhibited its well-known line of Wallace reducing records. The display was in charge of Walter C. Eckhardt and much interest was developed in the demonstration of "How to Get Thin to Music." A beautiful young lady demonstrated the use of the records to onlookers and the walls of the booth exhibited life-size "before and after" photographs of women who sent testimonials.

Steger & Sons Piano Mfg. Co.

The Steger & Sons Piano Mfg. Co., was on deck with a complete line of Steger instruments, both pianos and talking machines. The piano exhibit comprised all models of uprights, grands and player-pianos, as well as a complete showing of upright and console talking machines.

Starr Piano Co.

The Starr Piano Co. exhibited its lines of talking machines, records and pianos. This exhibit was in charge of F. D. Wiggins, of the Starr Co.'s Chicago branch. The background of this booth was taken up by a heroic facsimile of a Gennett record.

Magnola Talking Machine Co.

The Magnola Talking Machine Co., together with its parent concern, the M. Schulz Co., attracted considerable attention with its lines of Magnola talking machines and M. Schulz pianos, such as uprights, grands and players. The company's new small grand was featured strongly. This company was one of the few which took advantage of seasonal trade stimulators in the form

VITANOLA

The Phonograph of Marvelous Tone

News of Importance



No. 43—List \$125.00

Write us for DEALER'S price

We are now opening new agencies, and if YOU are a live dealer who appreciates merchandise of the highest quality, carrying a dealer profit, too, that makes it a line far "above par," please write.

We need some dealers to join the hundreds of OLD Vitanola dealers who continue to handle and make a success of what one of them characterizes as "the one line we never had a kick on."

When you get our proposition we think you will be glad you wrote, so at least investigate—and "do it now."

We now have in process an entirely new line of uprights and consoles, at prices that will make them predominate in the customer's eye and attention. You may have descriptions and prices NOW, if you drop us a line.

"IT IS EASIER TO SELL THE VITANOLA THAN TO COMPETE WITH IT"

Good Salesmen Wanted to Represent Us in Territory Not Already Closed

Vitanola Talking Machine Co.

1920 So. 52nd Avenue

Cicero, Ill.

of fans, which were passed out to the visitors. All during the Pageant the fans were much in demand and continually in use.

Lyon & Healy

The Lyon & Healy exhibit consisted of "everything known in music" and radio. This exhibit was in charge of Charles Hindringer, who was ably assisted by a corps of workers from Lyon & Healy's sales force. This exhibit was really remarkable, as there was nothing in the way of a musical instrument which could not be seen. Their radio exhibit consisted of all the well-known radio products, such as Aeriola, junior and senior sets; De Forest equipment, De Veau loud-speakers, Clapp-Eastham receiving sets, Bowman radio receivers, Remler supplies, etc. Quite a bit of attention was centered about the Lyon & Healy Victor exhibit, which comprised a full line of Victor talking machines, and special attention was given to the new Victrola model No. 111.

O. W. Richardson & Co.

O. W. Richardson & Co., one of the largest furniture stores in the Loop, exhibited a full line of their wares and paid particular attention to the talking machines it carries. The talking machines on exhibit at this company's booth were Widdicombe, Aeolian and Sonora, as well as a library of Aeolian records. The exhibit was in charge of A. J. Gosswiller, sales manager of the talking machine department, who was assisted by J. W. Lane.

Detmer Piano Co.

The Detmer Piano Co. exhibited its line of upright and console talking machines and attracted the kiddies with little paper cut-outs of the product it handles.

Radio Displays Few

It had been anticipated right along that radio would be a more prominent feature at this year's exhibit than music. However, as an actual fact, there were very few radios, whereas there were very many musical instruments. The companies exhibiting their wares were as follows:

The booth of the Westinghouse Electric & Mfg. Co. was in charge of A. D. Turner, pub-

licity representative. The exhibit consisted of an extensive line of electrical equipment, together with the detector units they manufacture. The Radio Corp. of America distributes the product of Westinghouse and much activity was centered about its Aeriola receiving sets.

The Commonwealth Edison Co. exhibited a full line of electrical equipment for the home, as well as its line of Federal electrically driven talking machines. This company also retails Grebe receiving sets, which were exhibited in both the table model and talking machine cabinets.

The Magnavox Co., of Oakland, Cal., was last year, and again this year, the official announcer and broadcaster of the Pageant. Every place that a visitor went he was sure to see a Magnavox and hear it making announcements. The official press car of the Pageant was also equipped with a broadcasting station which made use of the Magnavox loud-speaking unit, and this in itself attracted attention not only at the pier, but also over the Loop as well.

Loud speaking units manufactured by the Western Electric Co., as well as a modern broadcasting station manufactured by this company, were on exhibit at the Western Electric booth. The particular type of broadcasting station manufactured by this company is identical with the one made use of by the Chicago Daily News in broadcasting its evening concerts.

Paul G. Niehoff & Co., of Chicago, exhibited their line of Resodon detector and audio-frequency-radio-frequency receiving units. This exhibit was in charge of C. E. Niehoff and was the only display of this type of radio on the pier.

The General Electric Co. attracted attention to its booth with its loud-speaker unit and demonstration of detector, amplifying and broadcasting tubes.

Other Musical Exhibits

Other corporations and firms exhibiting musical instruments of sundry kinds were: Gulbransen-Dickinson Co., player-pianos; Kranich & Bach, "Grandette" pianos; Samuel C. Osborne Mfg. Co., pianos; Conn Chicago Co., band in-

struments; Martin Band Instrument Co., band instruments; Ludwig & Ludwig, drums and traps; Geo. C. Diver, Holton band instruments; E. A. Couturier Band Instrument Co., band instruments; Wilson Bros. Mfg. Co., drums; Six Brown Brothers, Buescher saxophones; Illinois Vocational Training, piano tuning, School for the Blind.

RECORDS FOR SENATOR'S CAMPAIGN

Senator France, of Maryland, Plans to Use 50,000 Talking Machine Records to Aid Him in Forthcoming Fight for Re-election

BALTIMORE, Md., August 9.—The phonograph is going to make its debut as a factor in politics in Maryland next week when United States Senator Joseph Irvin France, who is being opposed in the Republican primary by John W. Garrett, is going to send out some 50,000 records to the voters of the State on one side of which will be the "Star Spangled Banner," by the Marine Band, of Washington, and "Maryland, My Maryland," by the Fifth Regiment Band, of Maryland, while on the other side will be the Senator's history in public life.

The records are to be distributed free throughout the State by phonograph dealers. Each recipient will be asked to pass his record along after he has played it for the family several times. So the musical campaign will be more or less on the order of a chain letter, plus the charms that music has to offer.

In the country districts the records are expected to prove an efficient method of campaigning, for people don't like to travel long distances to attend political meetings, and farmers especially are busy these days.

As this is the first time in the history of Maryland that phonograph records have been put to use to get votes, the experiment is being watched with considerable interest.

R. N. Parker, of Enfield, Ill., recently added the Columbia line to its stock.

THE EMPIRE UNIVERSAL TONE ARMS

Will Give Your Product Individuality That Will Greatly Strengthen Its Selling Force

Send for sample of our new
Tone Arm for Portable
Machines.

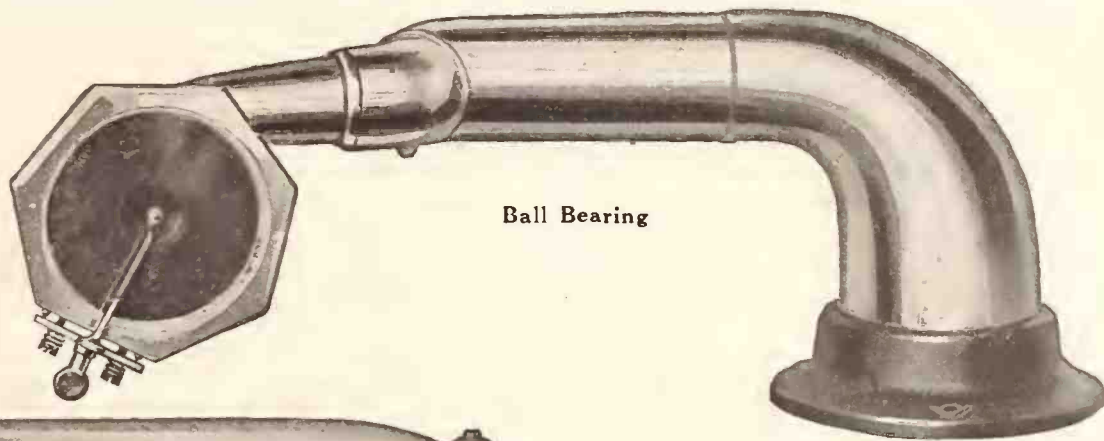

Pivot Base

We invite a personal test. There is nothing more convincing. Order a sample arm and test it out. It will win you on merit only. Our prices are low and the quality second to none.

Write or wire us for samples and quotations and give us an outline of your requirements.

THE EMPIRE PHONO PARTS COMPANY, 1362 East Third Street, Cleveland, O.

Established in 1914

Manufacturers of High-Grade Tone Arms and Reproducers

W. J. McNAMARA, President

BAGSHAW

First in Use—First in Sales—First in Satisfaction

NEEDLES

THE W. H. BAGSHAW Company are the Oldest and Largest Manufacturers of Talking Machine Needles in the World. Of course, they make the needles that stand first in the esteem of the public, the dealer and the jobber: Brilliantone and Petmecky Steel Phonograph Needles.

W.H.BAGSHAW CO.

FACTORIES: LOWELL, MASS.

SELLING AGENTS

BRILLIANTONE STEEL NEEDLE CO. OF AMERICA
INCORPORATED

347 FIFTH AVENUE

AT 34th STREET

NEW YORK

SUITE 610



Everybody's Doing it~

Phonograph Departments and Stores everywhere are selling Brilliantone Needles in tin boxes, on which their names are imprinted. These stores know the value of having their names go into customers' homes. They know that every time a phonograph is played their name is seen and their store remembered.

Brilliantone Needles

*Packed Expressly for You
With Your Name Imprinted
on Orders for 1750 Tin Boxes*

Three Tones: Extra Loud, Loud, Medium

Link your name with the largest manufacturer of talking machine needles in America. Prices and samples upon request. Tell us to whom you desire shipment billed.

BRILLIANTONE STEEL NEEDLE CO. OF AMERICA, INC.

Selling Agent for W. H. Bagshaw & Co.
Factory: Lowell, Mass.

347 FIFTH AVENUE NEW YORK

Canadian Agents: The Musical Merchandise Sales Co.
79 Wellington Street West Toronto, Canada

Let
us put
Your
name
here

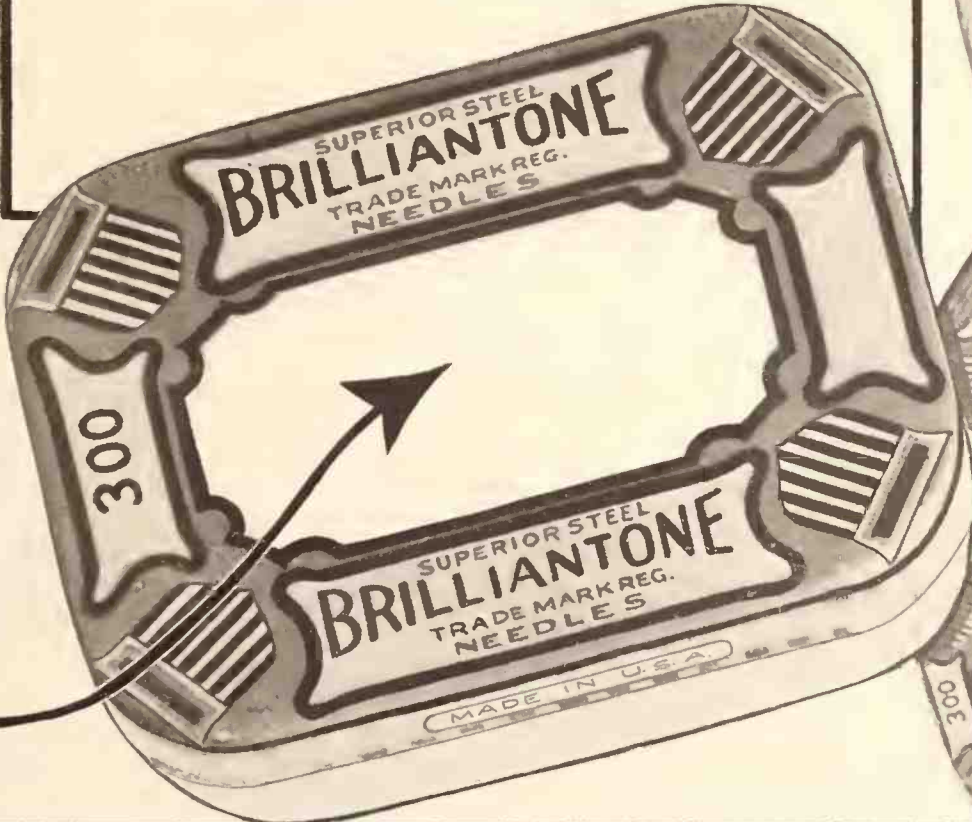



For dance music it's hard to equal Eddie Elkin's Orchestra. "Just Because You're You" and "Rose of Bombay" are two prime peaches that Eddie has picked in the garden of Fox-Trots. A-3648.

Columbia Graphophone Co
NEW YORK

THE TWIN CITIES

*Bumper Crops Boom Trade and Optimism Prevails Despite Strikes
—Dealers Ordering Fall Stock—All Lines Enjoy Good Demand*

MINNEAPOLIS and ST. PAUL, MINN., August 7.—While the Northwest is awaiting the marketing of the predicted bumper crops of grain the talking machine dealers are scratching gravel to get business. Distributing agencies are getting orders for the Fall trade in goodly quantities and the retail merchants are doing a nice Summer business. Labor difficulties are hampering trade considerably, but no serious effects are in evidence as yet, and if the promises of an early settlement between the workers and the employers is effected all will be well.

The entire Northwest is full of enthusiasm and hope and as soon as the leash on industry has been slipped trade will develop. Indications are that grain prices will be remunerative. There is a fear that the prices on potatoes will not satisfy the farmers, and should this be realized it will be a hardship, as many farmers have great crops of potatoes and not much of anything else.

Goodly Demand for Edison Line

It can be said for the Edison distributors and dealers that they seem to live in an atmosphere of prosperity. Laurence H. Lucker, Northwestern distributor, reports that the orders are coming from the rural dealers at a highly satisfactory rate. Some dealers still are very cautious and want to see the grain in the elevators before taking any chances with orders. On the whole, however, the situation is very good. Retail stores in the Twin Cities under the control of the Minnesota Phonograph Co. are doing excellently well. There has been a most gratifying demand for the William and Mary console models at \$325 and the baby consoles at \$175. Edison records are in good demand, according to Milton Lowy, of the Minneapolis store. It is to be a big year for Edisons if the prospects mean anything.

Starr Reputation Growing

Starr phonographs are winning their way not only in Minneapolis, but in the hinterland, says a report from M. L. McGinnis & Co., distributors. The persistent campaign, backed by the proven merits of the machine, is building up a nice reputation and increasing the volume of business.

RECORDING FOR THE TRADE

We have a modern well-equipped laboratory with facilities for producing the highest grade recordings. *We Solicit Your Business*

Manhattan Recording Laboratories
48 West 39th St. New York

ness. The Gennett records also are sharing in the growth.

Victor Dealers Enjoy Steady Business

Victrolas are so staple here that the sales run very evenly right along. Retail establishments such as the Golden Rule Store, St. Paul, report substantial increases in trade, with a big call for records all the time, particularly when the new lists appear. Distributing houses such as W. J. Dyer & Bro., St. Paul, and Beckwith-O'Neill Co., Minneapolis, have not yet reached their Fall stride, owing to the handicap imposed by labor troubles.

Open Many New Brunswick Accounts

Brunswick dealers are more than satisfied with their contracts and promise to produce better results than ever before. E. L. Kern, director of the Brunswick-Balke-Collender Co., states that the phonograph department is making a splendid showing and is constantly growing. New contracts are closed continuously.

Reports Substantial Pathé Orders

Manager Sharar, of the phonograph department of G. Sommers & Co., informs The World that Pathé machines and records are holding their own in the Northwestern territory. The new orders are fully as substantial as in former years and he looks for a little avalanche in a few weeks, when some of the present uncertainties have been removed. The record stock is being depleted very rapidly and reorders will soon be necessary.

Fine Vocalion Business

Manager Monson, in behalf of the Stone Piano Co., distributor of Vocalion phonographs and Red records, authorizes the statement that business is fine, not only with the retail store in Minneapolis, but throughout the company's jobbing territory.

PLAN ACTIVE FALL CAMPAIGN

PHILADELPHIA, PA., August 5.—The Phono-tone Co., of this city, manufacturer of the Phono-toner, an attachment for the talking machine devised for the clarifying and softening of the tone, is making energetic plans for the Fall and Winter seasons. Attractive counter cards containing the attachments have been prepared and it is expected that these cards, together with a sample on a demonstrating machine, will act as a valuable sales stimulant.

MANOPHONE CORP. CHANGES NAME

The Manophone Corp., of Adrian, Mich., has increased its capital stock from \$250,000 to \$400,000, with 25,000 shares of stock of no par value, and has also changed the firm name to the Clough & Warren Co.

JOINS ORMES SALES FORCE

E. B. Losee Will Travel in New York State—Well Known in Eastern Victor Trade

Clarence L. Price, vice-president and general manager of Ormes, Inc., New York, Victor wholesaler, announced this week the appointment of Ernest B. Losee as a member of the company's traveling staff. Mr. Losee, who is well known in the Victor trade throughout New York State, will represent Ormes, Inc., in this important territory and his intimate familiarity with the requirements of the Victor dealers should enable him to give valuable service to the Ormes clientele in this territory.

During the past three months Mr. Price has been strengthening his sales staff in preparation for the Fall season and to-day his sales force is one of the strongest in the metropolitan territory. The members of the staff include H. C. Hawkins, who covers New York City; J. A. Johnson, who travels through New Jersey territory, and Chester Luhman, who visits the dealers in certain parts of New York State.

A. B. REINCKE VISITS NEW YORK

Arno B. Reincke, president of the Reincke-Ellis Co., Chicago, printers of Victor sales literature, was a recent visitor to New York, calling on his many friends in the trade and bringing with him optimistic reports regarding general business conditions through the country.

Mason & Weidensaul, Victor dealers at Denver, Col., have opened a branch store at Evergreen, Col.

We Have It!

A HIGH-CLASS TABLE MACHINE AT
A PRICE THAT SELLS



Mahogany, 16x16x10, Double Spring, Universal
T. A. Back Casting and Metal Horn
Sample Price to Dealers Now—\$12.50
Send for Sample To-day
Phonographs and Accessories, Repair Parts
for All Makes,
Best Steel Needles of American
Manufacture at 30c. per M.

FULTON TALKING MACHINE CO.
253-255 Third Ave., New York City
Between 20th and 21st Streets

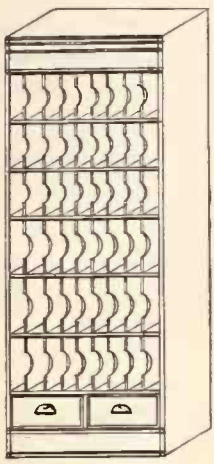

Record Rack

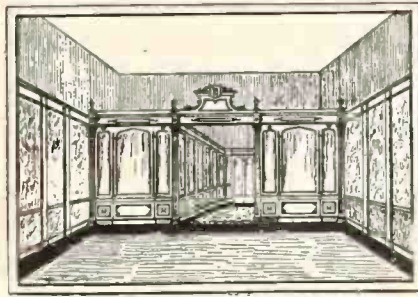

Gothic Design

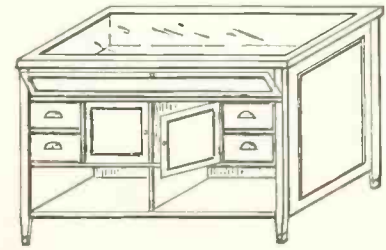
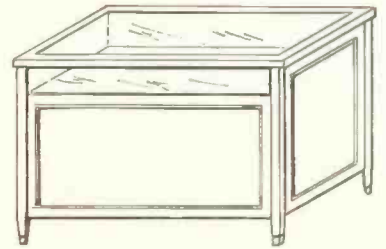

Display Counter

Zimmerman-Bitter Construction Co.

Specialists in
Sound-Proof Hearing Rooms — Record Racks — Service Counters
 and General Store Equipment for the Talking Machine Trade
WHY EXPERIMENT?

Let us figure on your needs—we can save you money

OFFICES, FACTORY AND WAREROOMS:

325-327 East 94th Street

New York City

C I N C I N N A T I

Dealers Slow in Placing Orders for Stock—Industrial Differences Hurt Trade—Extra Efforts to Get Orders Well Rewarded

CINCINNATI, O., August 7.—Little change, either of advance or slump, is noted in the talking machine market in this city. Throughout the month sales of records at most houses were very fair—as good as could be expected, according to dealers—but sales of machines were quiet. Jobbers note unwillingness on the part of retailers to “stock up” until considerably later in the season, not caring to burden themselves with large orders until assured that business conditions justify large orders. The tendency is to let the jobbers carry the goods and the risk.

This attitude is due in part, according to C. H. North, secretary of the Ohio Talking Machine Co., jobbers in Victor goods, to a remote fear that prices may drop in all lines. This, Mr. North says, is not likely. The tendency in the general manufacturing policy, he says, is not to decrease prices, but to augment the value of the goods sold, either in appearance, durability or tone quality. For instance, he points out the plan of the Victor interests to gold-plate all metal parts of machines which hitherto have been plated in silver or nickel and to enlarge and amplify sound boxes in order to deepen tone volume. As evidence of this latter tendency he cites the new No. 111 Model Victrola, to sell at \$225, which embraces both improvements mentioned above.

J. R. Jones, Indianapolis representative of the Ohio Talking Machine Co., reports a very fair business in and about that city. There is just now a good business in console types. Mr. North doubts that the popularity of the console type will continue to be greater than that of the upright style. The upright, he points out, is much more convenient in most homes, inasmuch as it gracefully occupies any corner, whereas the console type is effective as a furnishing only when placed against a side wall, where it requires greater space.

A. H. Bates, manager of the Ohio Talking Machine Co., visited Lexington, Ky., over the last week-end. The trip was for the purpose of discussing business with Mr. Rowbotham, formerly manager of the Baldwin Victrola Shop in Cincinnati, who has established a store at Lexington. Mr. Bates and Mr. Rowbotham formerly

were associated in the talking machine department of Wanamaker's at Philadelphia, where Mr. Bates was manager and Mr. Rowbotham assistant.

Industrial Differences Hurt Trade

The Edison jobbing house here, the New Edison Co., reports a fair business done over the Cincinnati territory, which includes parts of four States, Ohio, Kentucky, Indiana and West Virginia. A. E. Oelman, manager of the New Edison Co. here, said that business was progressing as well as disorganized labor conditions and the dull season would permit, and that at such a time when the differences were composed in the industrial world, both general and local, and the usual Fall business opened up, he thought trade would show a general increase.

J. F. VanCourt, of the Otto Grau Piano Co., said: “Business in talking machines and records has been fair. There is nothing in the trade to brag about and until general agreement is made among labor and employers and the hot weather leaves little will be doing.”

Going After Country Business

The Baldwin Piano Co. has been doing a fair business during the last month. Especially was an increase noted in record business, since the inauguration of a new forty-eight-hour approval plan, whereby customers may take their chosen records home, play them and decide in the leisure of two days which most appeal to them. Heretofore the plan has been to refuse the return of rejected records, and the new arrangement already has made a hit with Baldwin customers. Also, the Baldwin Victrola Shop is scouring the territory round about Cincinnati for sales. Two experienced men are touring the nearby territory with a truck, carrying with them three or four Victrolas and an adequate supply of records. These machines and records they sell even as the itinerant bookman in Morley's “Parnassus on Wheels” hawked his books. The plan has resulted in a surprising amount of cash business, and other business as well.

At the Aeolian Co. store, West Fourth street, business has been very fair during July, and the belief is expressed there that as soon as conditions are somewhat revised, probably in the Fall of this year, trade will pick up at once.

Steinway Departments Under Way

H. E. Browning, formerly manager of the Victrola department of the H. & S. Pogue Co., now manager of the talking machine department of Steinway & Sons, dealing in Brunswick products, reported a quiet business during July. “The time,” said Mr. Browning, “is not right for good business and I hardly care to predict when business will be good. Conditions here and every-

where are in too much of a turmoil for even the most experienced observer to predict with any degree of certainty what will come next. We only hope—and work.”

Miss Yates, who succeeded Mr. Browning as head of the Victrola department of the H. & S. Pogue Co., plans to install the flag system of classification of standard records, devised by A. H. Bates, of the Ohio Talking Machine Co.

Some Good Window Displays

The ingenuity of Howard L. Chubb, of the Chubb-Steinberg Music Shop, East Sixth street, in the matter of clever window displays seems to be inexhaustible. His windows are quite the most attractive of any like displays in the city, and one never passes the store without noting a crowd of interested persons viewing the window. The latest innovation is a very lifelike camping scene, with tent, campfire, utensils and all equipment of the vacationist camper. This display is employed to exploit smaller types of Victrolas for camp use and also a clever device which, when the record is played through, silently and instantaneously throws the needle back again to the beginning. Mr. Chubb also is specializing in radio equipment, of which he sells considerable and exploits with like good window displays.

J. E. Henderson Promoted

J. E. Henderson, of the Brunswick selling division in Atlanta, Ga., has been called to take the position of sales manager of the local branch, succeeding Stanley Reis, who has been promoted to director of sales of all the products manufactured by the Brunswick Co. Mr. Henderson was formerly connected with the local branch and was sent from here to Atlanta. Before associating with the company he was connected with the local Columbia headquarters.

L. L. SPENCER VACATIONING

Lloyd L. Spencer, sales manager of the Silas E. Pearsall Co., New York, Victor wholesaler, is at present away on his Summer vacation. Mr. Spencer has left no forwarding address, but it is understood that he is somewhere in the heart of Virginia, making some record scores in golf and taking a well-deserved rest.

The Milton L. Love Music Co., of Denver, Col., has moved from 1519 Larimer street to larger quarters at 1608 Larimer street.

MOTORS

Double spring, plays three 10-inch records without rewinding. Nickel plated, worm drive. Complete with all accessories. Sample \$3.25. Special prices in quantity lots. Motor suitable for portable machine.

Pleasing Sound Phonograph Co.

Manufacturers—Jobbers
 204 East 113th St., New York City
 Jobbing Territory Open

REGAL
PREDOMINATES
 IN THE
50¢ RECORD FIELD

WONDERFUL SONG HITS OF 1922

BY JACK SNYDER

America's Youngest Composer

**IN
MAYTIME**

(I LEARNED TO LOVE)

WALTZ

**MEET ME
NEXT SUNDAY**

(I'LL WAIT FOR YOU)

FOX-
TROT

**SING A SONG
AS YOU WALK
ALONG**

FOX-
TROT

**PLAY ME THAT SWEET
MELODY**

FOX-
TROT

**ON
BAMBOOZLE
ISLE**

NOVELTY
FOX-
TROT

**I HATE
TO BID YOU
GOOD-BYE**

YET
(I WILL COME BACK TO YOU)

FOX-
TROT

**NOVEMBER
ROSE**

GOOD-BYE

WALTZ

*These Numbers
Are Also
Published
For
ORCHESTRA
" BAND "
And
MALE
QUARTETTE*

**" JACK SNYDER'S
MELODIES
WILL LIVE
FOREVER "**



THESE SONGS WILL TAKE YOU OFF YOUR FEET

**John Steel's Feature Song
"IN MAYTIME" (I Learned to Love)**

ALSO ON COLUMBIA, GENNETT AND CAMEO RECORDS

John Steel is also singing "NOVEMBER ROSE" (Good-bye)

JACK SNYDER PUBLISHING CO. INC.

The House of Master Compositions 1658-BROADWAY, NEW YORK.

SING A JACK SNYDER SONG AS YOU WALK ALONG

GLEANINGS *from the* WORLD *of* MUSIC

UTILIZING WINDOW PUBLICITY FOR VISITING ARTISTS

"Hooking Up" the Store Window With Visiting Concert Artists, Vaudeville Headliners and Photo Plays Whose Records Are Handled—A Most Profitable Means of Augmenting Sales

The average talking machine record dealer invariably overlooks an excellent opportunity to create record sales by failing to announce in his window the appearance of concert artists and others in his city who program numbers which are found in his record catalog.

A plan of "hooking up" by window publicity with the current appearance of a concert artist, vaudeville headliner and photo plays in which a musical theme is one of the outstanding features has been tried out successfully by only a few dealers in the record field, although in the sheet music trade this idea has been carried out advantageously for a number of years. Particularly is this true with the syndicate stores which invariably announce the appearance of vaudeville performers or others singing particular songs in theatres adjacent to their establishments.

There is no reason why this plan should not receive more attention, as it is a very successful means of adding to sales totals. The dealers in the smaller centers can even use this idea to greater advantage, although in the past they have given it very little attention. In their territory it is often possible, in co-operation with the theatre, concert hall or motion picture house, to receive in return for such window publicity an announcement on the screen of the motion picture or vaudeville theatre and in the program of the concert hall to the effect that given numbers in the program can be obtained at So-and-So's music house.

Owing to the competition in the larger centers it is hardly possible for an individual dealer to get the support of the theatrical managers in this respect, but this obstacle does not hold true in smaller communities.

There is another value in arranging the window with such current announcements, for, after all,

they have a news value—it makes the window a source of information and, if carried out over a period, would result in many people using it as a semi-information bureau. There is little expense attached to the carrying out of the idea, particularly when it is considered that in the majority of cases the results are most substantial.

Too much cannot be said for the well-arranged and artistic window. Practically every one concedes nowadays that it is an important part of any up-to-date store. As one dealer recently remarked: "The show window is the introduction to the store," and no one would suggest the abandonment of arranging therein unusually at-

PLANNING STRONG FALL CAMPAIGN

Irving Berlin, Inc., Makes Big Appropriation for Publicity on Live Numbers

Max Winslow, vice-president and professional manager of Irving Berlin, Inc., returned late last month after a tour of Bermuda and Europe. Shortly after he returned he outlined plans for the Fall professional campaign of his company. The Berlin organization has appropriated a particularly large fund for Fall publicity and the campaign, which in its initial stages is already under way, will feature six songs from the catalog. Probably the feature number will be "While the Years Roll By," which, in a number of tryouts, has exceeded expectations. "Truly," a number from the Pacific Coast, will no doubt follow closely in popularity. "Night," a fox-trot, is quite popular with the orchestras and before the Fall season is well under way it should be quite prominent. The novelty number from the Middle West, "Don't Bring Me Posies" (It's Shoesies I Need), seems assured of no

tractive displays. We would like to emphasize, however, that placing in the window material of a news value is an inexpensive adjunct which will attract attention and at the same time give the onlooker a feeling of satisfaction that his time has been well spent.

Where the dealer is able to persuade his local theatre to reciprocate by giving his store a screen announcement the results obtained can hardly be overestimated. Certainly under such a plan the returns are considerable. Take the screen announcement, for instance. If the dealer had to go out and purchase it he might find the expenditure prohibitive and by using the co-operative angle he gets the result without the expense. But even if the theatre fails to co-operate the plan has such merits as a sales-creating medium that it should command the utmost consideration of all dealers who are alive to opportunity.

little success, and "Bring Back My Honey Man" should be a big favorite in vaudeville circles. "Way Down South" and "Don't Wonder I'm Lonesome" are two other Berlin numbers that will be heard from during the weeks to come.

"STORIES" RELEASED

The J. W. Jenkins' Sons Music Co., Kansas City, Mo., just released a new ballad entitled "Stories." The number is from the pens of Richard Powers, Herb Marple and Dick Parkington. It is a combination mother and love song which, as its title indicates, tells a story.

HAS SECOND STORE IN CHARLESTON

CHARLESTON, S. C., August 7.—The United Phonograph Co., of this city, has opened its second store here. The new establishment is located on lower King street, where attractive quarters house the business. A large and complete stock of talking machines, records and musical instruments of all kinds is handled by M. and D. Vane, proprietors.

OH! WHAT A HIT!

The Brilliant Novelty Fox Trot ~

LONESOME MAMA BLUES

The fascinating melody that is keeping the feet of the entire country moving

THE TERRIFIC SALE OF THIS RECORD IS UNPRECEDENTED ABSOLUTELY THE BIGGEST SELLING RECORD of the SEASON!

PUBLISHED BY J.W. JENKINS SONS MUSIC CO. KANSAS CITY, MO.



The Tune That Sticks

TRICKS

The New Fox Trot Surprise by "Zez" Confrey Writer of **STUMBLING**



Very cute tricks, very cute tricks, very cute tricks they played, Wonderful tricks, quite a lot of wonderful tricks,

"You can't go wrong With any FEIST song"

BIDE DUDLEY'S NEW SHOW

Well-known Columnist Produces Musical Comedy Which Promises to Be a Success—Leo Feist, Inc., Publishing the Score

Bide Dudley, the well-known humorist who runs a daily column in the New York Evening World, has at various times tried to "crash the gates" and enter the realm of those who are known as writers and co-writers of musical comedies. This particular chap, who has been more than successful in parading the weaknesses of his fellowman, has, despite his wealth of experience, failed in his endeavors in that direction, with the exception of his latest effort, "Sue, Dear," which recently opened at the Times Square Theatre, New York City. It is true that in this instance the well-known Mr. Dudley was assisted by C. S. Montanye in preparing the book. However, he is exclusively guilty of the lyrics for the songs. The music is by Frank H. Grey, in whom the composing profession acknowledges an energetic worker and a persistent caller at the "doorsteps of publishers."

In extenuation we might say, however, that Mr. Grey, despite his voluminous offerings, has succeeded in writing a number of successes which are nationally acknowledged and to continue further on this line we might add that "Sue, Dear," which is described as a musical comedy of youth, love and beauty, is, as a musical offering, a decided treat.

Among the songs that are incorporated in the show are "Smile and Forget," a very optimistic offering; "Lady Lingerie," "Love's Corporation," "The Loveship," "Hiram Skinner's Comb," full of life; "My Little Full Blown Rose," "Lovers' Lane With You," and to be up-to-date, there is a song "By Radiophone," and the other offerings include "Up on Riverside," "Piggie Wiggie," "Key to My Heart," and "Lorayne." Leo Feist, Inc., publish the music.

SOUSA'S BAND ON TOUR

Famous Conductor and His Company Now Being Heard in Eastern Section of Country—To Write American Opera This Fall

The early Summer tour of Sousa and his band started on July 19 in Albany, N. Y., following which it is booked for engagements in several other cities in upper New York, Canada and Vermont, arriving at Willow Grove, Pa., on August 6, where Sousa will appear for five weeks.



John Philip Sousa and His Band

No announcement has been made of engagements to follow, but it is known that he will accept no bookings after November 1, when he is to return to his home and devote himself to the writing of an opera on a strictly American subject. It is said he has in view for the principal role the world-famous Mary Garden, who some time ago expressed to him a desire to appear in a real American opera with love and romance as the underlying theme.

During the present tour many musical novelties will feature the concert programs by Sousa's

Band. Included in these are: "A Bouquet of Beloved Inspirations," from the well-liked operas; the bandmaster's new march, "The Gallant Seven"; a new suite called "Leaves From My Note-book," "Romany Love," "Nola," "Eleanor."

A real genius of the cornet with the organization is John Dolan, whose thorough musicianship is apparent in the brilliancy and proficiency of his solo work. Among his offerings will be "Love in a Little Cottage" and "Only a Smile," the former work by the well-known Geoffrey O'Hara.

Seventy-five musicians are in the organization

and the personnel includes Miss Marjorie Moody, soprano; Miss Winifred Bambrick, harpist; George Carey, xylophonist, and R. Meredith Wilson, flautist.

It is understood that Miss Moody will make a feature of the song, "Out of the Dusk to You." This number is by Dorothy Lee, of "One Fleeting Hour" fame.

John P. Schueler, trombonist, is again with the organization. He is credited with giving to the slide trombone the allurements of more generally recognized solo instruments. Then there is the unique instrument, the Sousaphone, invented by the bandmaster and demanding a player of fine ability. William Bell offers novel solos for that inflated member of the "brass" family. The Sousa Band is on the recording staff of the Victor Talking Machine Co.

MARKS CO. SONG A HIT

"Little Red Schoolhouse" Proving a Good Seller, Say Music Dealers

The Edward B. Marks Music Co., publisher of "Little Red Schoolhouse," has received numerous letters from sheet music, record and player roll dealers complimenting it upon the success of the above number.

A letter from the Windsor Poling Co., Akron, O., recently received, reads: "No doubt you will be interested to know that we have had a phenomenal success with the Victor record of 'Little Red Schoolhouse' on the opening day. In fact, it boosted our sales something like \$200 in records over any previous Saturday in the last two months."

HEARD THE MOST - FROM COAST TO COAST!

The Greatest Series of "INTERNATIONAL" MUSICAL SUCCESSES ever published!!!

1. PARADE OF THE WOODEN SOLDIERS (CHARACTERISTIC INSTRUMENTAL)
2. NO USE CRYING (famous weinen song)
3. JOLLY PETER (BUMMEL PETRUS)
4. SAL-O-MAY (SALOME)
5. LOVE'S LAMENT (plainte d'amour)
6. FORGET-ME-NOT (vergiss-mein-nicht)

LOOK FOR THE TRADE-MARK IF YOU WISH TO SECURE "REAL MUSIC"

ON SALE EVERYWHERE OR DIRECT FROM THE PUBLISHERS 35¢ EACH 4 FOR \$1.00

Edward B. Marks Music Co. 221 25th St. New York

RECORDS-ROLLS-SHEET-MUSIC

Each a FOX TROT OR WALTZ GEM! Each a LYRIC OR SONG GEM!

FIVE RECORD-BREAKING SONG HITS

While the Years Roll By

We stake our reputation on this one

Don't Bring Me Posies

It's Shoesies That I Need

This is the Overnight Song Hit everyone is talking about

BRING BACK MY HONEY MAN

A Real Hit Song

TRULY

*Whispering came from the West—
So did this one—Watch It*

NIGHT

The Orchestras' Favorite

IRVING BERLIN, Inc., 1607 Broadway, New York

FINE BRUNSWICK RECORD PUBLICITY

Co-operation of Leading Orchestras in Announcing Melodies Played Supplies Excellent Brunswick Record Publicity in Dallas Theatres

DALLAS, TEX., August 7.—An unusually effective plan for obtaining publicity for Brunswick records, and one in which the leading orchestras of

the records are secured by the company for the use of local orchestras. An enlarged photographic reproduction of the Brunswick label is placed on a stand beside the leader of the orchestra playing. The name of the tune and that of the publisher is interchangeable and when the orchestra changes tunes the title and the name of the publisher are changed on the large label on the stand.

Three of the leading orchestras of the city, which have been playing selections appearing on Brunswick records, are using these stands through the efforts of Mr. Smith and widespread publicity for the Brunswick records, the Brunswick Shop and the publishers of the music has resulted. The names of the selections are easily seen by those listening to the music.

This is in line with a growing realization of the value to be derived by dealers in the sale of records, music rolls and sheet music throughout the country by having orchestras announce in some manner the melodies as they are played.

NEW SONGS FOR MARKS CO.

Several New Numbers Announced for Release by E. B. Marks Music Co.

Since its removal to its new quarters in the Navex Building on Forty-sixth street, next to the home of the National Vaudeville Artists, the Edward B. Marks Music Co. has shown unusual activity. Its new location is ideal for the reception of vaudeville artists and orchestra leaders, and the result is that the professional, bank

and orchestra and executive departments are quite busy.

Edward B. Marks, head of the music publishing concern bearing his name, recently announced the acquisition of a number of new songs by prominent writers. Included in these are "Way Down Home," by Walter Donaldson, writer of "Georgia," "Mammy," "Gin, Gin, Ginny Shore," and other successes; "At the Darktown Flappers' Ball," by Bernie Grossman and Irving Maslof, writers of "Tell Her at Twilight," and a new promising number by Bennie Davis, writer of "Margie," "Angel Child," etc. Other numbers have been selected from the pens of Pete Wendling and Max Kortlander, who in the past have contributed many popular hits to the world of music.

This new announcement includes the news that the Edward B. Marks Music Co. has arranged a contract with Gus Edwards whereby the Marks firm will publish his two latest numbers, "Wonderful You," and "Let's Mend the Crack in the Liberty Bell."

"Wonderful You" is a melody fox-trot song, with a lyric that should assist it greatly in achieving popularity. "Let's Mend the Crack in the Liberty Bell" is a very catchy tune with clever and timely lyrics by Will D. Cobb.

Both of the latter numbers are features in Gus Edwards' Fifteenth Annual Song Revue now playing the Orpheum Circuit and are also featured in Murray's new revue by Miss Nester and Mario Villani.

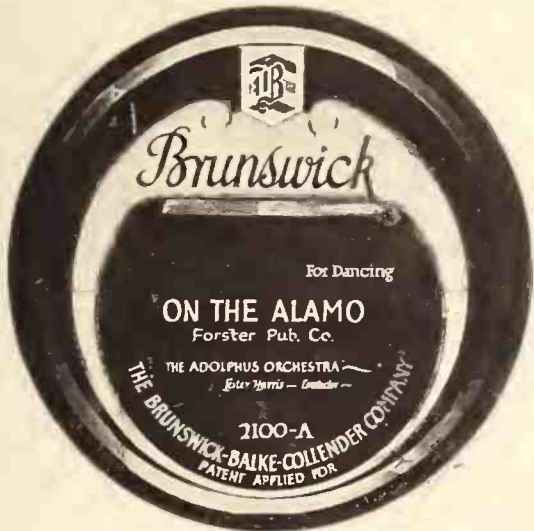

How Orchestras Tie Up With the Record this city play a large part, has been formulated by H. B. Smith, of the record department of the Brunswick Phonograph Shop, 1211 Elm street, this city.

Orchestrations of the selections appearing on

THE 19TH HOLE

Get HIM a copy today
It's funny—of course

IF HE GOLFS — HE will enjoy this NEW "Sportsong"

*"You can't go wrong
With any FEIST song"*



SHEET MUSIC WITH UKULELE ARRANGEMENT PLANNED

Jerome Harris, of C. Bruno & Son, Inc., Interesting Music Publishers in Plan Whereby Popular Music Will Contain a Ukulele Score Printed on Flyleaf of Each Song

Next to the talking machine the ukulele is one of the popular musical instruments of the day. In this connection we may mention that Jerome Harris, secretary of C. Bruno & Son, Inc., New York, musical merchandise wholesaler, has evolved a very feasible and practical plan for tying up the sale of sheet music with



Jerome Harris

the ukulele. He recognizes that most sheet music dealers sell ukuleles and vice versa.

Mr. Harris recommends that the music publishers print on the flyleaf of each new song release a ukulele accompaniment arrangement of the number. This plan is being carefully considered by the music publishers who realize that its adoption will afford them a greater scope for the sale of their numbers.

Mr. Harris' co-operative idea should stimulate business in ukuleles and in sheet music. Persons who see the ukulele arrangement on songs will decide to purchase instruments and learn to play, while on the other hand ukulele players will purchase copies of songs which have ukulele arrangements. Many ukulele owners now content themselves with a hit-or-miss method of finding chords and this plan will enable them to take a keener interest in playing the ukulele. It will thus result in a wider demand for the better grade instruments.

Mr. Harris points out that his own experience shows him that every gathering-place for young people of Summer evenings finds from one to a dozen ukulele players. Nearly all of them make random attempts to produce the best music possible since they are unable to find a correct arrangement of the latest hits.

Mr. Harris further points out that publishers have long followed the custom of adding quartet or march arrangements on many of the new numbers. He reasons that since there is no real demand at present for either quartet or march arrangements this space can be profitably devoted to an arrangement of the number for the ukulele.

TWO NEW FEIST NUMBERS

"Coal Black Mammy" and "The Nineteenth Hole" Already Very Popular

Among the new songs added to the catalog of Leo Feist, Inc., is the English success, "Coal Black Mammy," originally published by Francis, Day & Hunter, and written by Laddie Cliff, who is well known through a series of vaudeville tours made in this country. It is said that "Coal Black Mammy" has been the biggest popular song hit ever published in England, not only

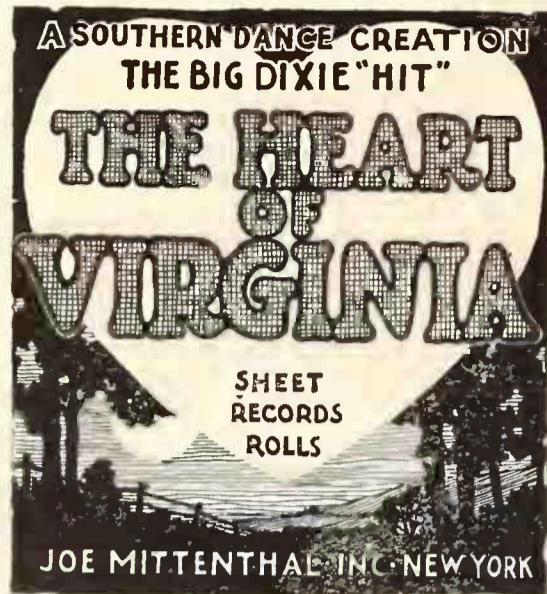

Mr. Harris has already held conferences with several of the more prominent publishers. He has placed his plan before them and urged that they put it into immediate operation. In nearly all cases he reports that the idea has secured the hearty approval of the publishers, who recognize the opportunity of increasing the demand and widening the market for the sale of popular song hits. It is Mr. Harris' conviction that the adoption of the plan will benefit all concerned and, through a personal letter just sent out he is inviting the co-operation of the trade.

from a vocal standpoint but also as an instrumental fox-trot. It has already been heard in this country, having been introduced by Ethel Levy, for whom the song was restricted during her recent vaudeville tour. It is also the feature song in the Canadian soldier show, "The Dumbbells," which has played steadily in Canada for over two years.

"The Nineteenth Hole," also recently released by Feist, is said to be the first golf song ever published. It is a comedy number which has achieved some success, this despite the fact that it is only a few weeks old. As a follow-up song to "Three o'Clock in the Morning," Feist has also released the English waltz "Lovely Lucerne."

SINGS "IN MAYTIME" AT WEDDING

John Steele Features That Song at Pickford-Miller Nuptials in California

John Steele, well-known American tenor, attended the Pickford-Miller wedding in California early this month and took part in the musical program connected with the festivities. Among the songs he sang was "In Maytime" (I Learned to Love You), a number which he has featured on his tour of the country. Mr. Steele is now appearing in the Middle West and Jack Snyder, Inc., the publisher of the song, recently received a letter from him in which he stated that "In Maytime" (I Learned to Love You) is being received favorably everywhere.

ARTISTS FEATURING "IN MAYTIME"

Among the vaudeville headliners featuring songs published by Jack Snyder, Inc., is Charles Adams, now appearing in the act of Jack Wilson, the well-known vaudevillian. He is singing with success "In Maytime" (I Learned to Love You) and "Meet Me Next Sunday." Dolly St. John, who recently appeared at the Loew Lincoln Square Theatre, New York, is using the former number as the musical theme for her act. Many other prominent vaudeville singers are also using "Meet Me Next Sunday."

The George M. Cohan Comedians opened at the Tremont Theatre, Boston, July 31, in Mr. Cohan's new musical play, "Little Nelly Kelly," in which Elizabeth Hines is featured. Julian Mitchell arranged the dances. Mr. Cohan is responsible for book, lyrics and music of "Little Nelly Kelly." The consensus of opinion among those who have been privileged to witness rehearsals is solidly one of enthusiasm for the new piece and many predict big things for the score, which is published by M. Witmark & Sons.



ROMANY LOVE

The New Gypsy Fox Trot Hit

The New High Class Ballad Success

"Only a Smile"

Three Active Sellers
STOCK THEM IN
RECORDS
PLAYER ROLLS
and **SHEET MUSIC**
"Romany Love," "Nola" and
"Only a Smile"

SAM FOX
New York



PUB. CO.
Cleveland, O.



NOLA

The Dance Sensation





Widdicomb console phonographs have many distinctive features of design. The Adam model illustrated is finished in Red or Antique Mahogany, or Walnut, and is equipped with divided top, partitions for albums, automatic stop and patented tone control. The Widdicomb plays all records. New prices range from \$90.00 to \$260.00.

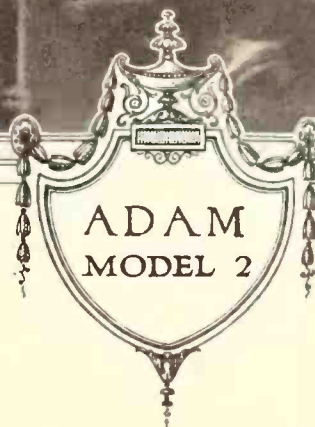

Merchants with the Widdicomb franchise find that they are building a steadily increasing prestige and patronage among discriminating buyers. If you are really interested in increasing *your* business with the best class of trade write for catalog and complete information regarding the Widdicomb franchise.

THE WIDDICOMB FURNITURE COMPANY
Grand Rapids, Michigan
Fine Furniture Designers Since 1865

Widdicomb
PHONOGRAPH
The Aristocrat of Phonographs

In an effort to discover the cause of a marked decline in sales of phonographs, the National Retail Dry Goods Association recently sent out a questionnaire. The results of this survey have just been formulated.

The high prices of phonograph records was another complaint made by the stores, which have been able to increase business during this period, have done so through the sale of low-priced records selling for about 49 cents. They contend that these records have the same quality and class of music as is furnished on the more expensive records, and, although the lasting qualities of the cheaper record may not be as good, the service to the public is just as satisfactory because the average life of the popular dance record is only about two months, so these records will fully suffice for that time.

READ
*what the
 National Retail
 Dry Goods Ass.
 says about the
 50¢ RECORD*

Banner 50c. Records

have been a great factor in helping the dealer increase his record sales.

People see that BANNER gives full 75c. value—in tone—in recording quality—in durability—in every way!

Therefore they buy BANNER. They tell their friends and they, too, buy. They all buy—continually—because they get the quality they want at the price they are willing to pay.

That's the story in a nutshell! That explains why BANNER turnover is so rapid and so certain. And it explains why BANNER dealers are continually stepping into new and bigger business.

You, too, need BANNER now. With its up-to-the-minute hit list, plus the 50c. price, plus the BANNER quality, it is an unusual sales producer.

*Write for the proposition
 today.*

PLAZA MUSIC CO.
 18 West 20th St. New York

BUFFALO

*Despite Handicaps From Strikes
 Trade Is of Fair Volume—Some
 Live Trade Happenings of Month*

BUFFALO, N. Y., August 7.—There is a wide difference in reports of talking machine and record business as gathered from the wholesale and retail dealers of the city. While some retailers say the depression in business was more than seasonal others say the volume of sales was much better than they had anticipated. One or two large retailers say July was their best month of this year, as compared with the corresponding period of 1921.

Certainly dealers have seldom had so many obstacles to overcome in attempting to produce a good month's business. For some time before the month began there had been strikes of railroad shopmen and dock employes. These strikes, in addition to throwing thousands of men out of employment, had the greater effect in causing uncertainty of employment among other transportation men.

Then, on July 1, came the strike of trolley operators. Service was at a standstill for several weeks and, when it was resumed with the use of strikebreakers, the cars carried few passengers. A makeshift jitney service which was offered was unreliable at best and thousands of persons who visit the shopping district one or more times each week have been staying at home.

Facing all these handicaps plus that of the season, it is nothing short of remarkable that business was as good as it was during the past month. There is a feeling among dealers that the early Fall is going to witness a revival of buying on a scale such as has not been known for the past eighteen or twenty months.

C. N. Andrews, Victor jobber, has returned, after accompanying a delegation of Buffalo Rotarians, who visited the Rotary clubs of Cleveland and Detroit. Mr. Andrews reports retailers eagerly awaiting distribution of the new Victrola 111. He predicts that it will be especially popular in this district, with the motor equipment which is to be offered at a smaller additional cost than has been the rule heretofore.

Meetings of the Victor Talking Machine Dealers' Association of Western New York are to be resumed early in September. It is planned to hold meetings throughout the Fall and Winter at least once a month. The Music Group of the Chamber of Commerce will also resume its meetings in September, Chairman Andrews has announced. He is now preparing a program of activities which he will outline to the group at its first meeting.

An especially attractive Sonora department will have place in the enlarged store of the John G. Schuler Piano Co., in Main street, near West Utica street. The company has leased the store-room adjoining its present quarters and is having the two thrown into one large store. New show windows and fixtures are being installed and many improvements made.

Goold Bros. announce the opening of their third music store, in Main street, Medina, N. Y. G. V. Lynch, who was formerly with the J. N. Adam music store here, is manager of the Medina store, in which a line of talking machines will be carried.

A brand new feature has just been added to the attractive talking machine department of the William Hengerer Co. It is an "exercise room," set apart and specially furnished for demonstration of the new reducing records. Charts adorn the walls and not only show how the record exercises are to be executed, but others also show the value of exercise. The company is handling the Walter Camp, Wallace and Victor exercise records.

Circular letters calling attention to the new department have just been mailed to 1,500 teachers in Buffalo schools. The room has two large windows opening into the street, thus assuring plenty of fresh air for those who desire to test

Specialists in
MICA DIAPHRAGMS
 FOR
Phonograph and Radio
Finest Ruby Mica
Diaphragms in All Sizes
 for
IMMEDIATE DELIVERY
WILLIAM BRAND & CO.
 27 East 22nd Street New York City

the exercise records before making purchases.

A certificate has been filed in the Niagara County clerk's office by the Estey-Welte Corp., which proposes to manufacture musical instruments, including phonographs. The company will begin business with a capital of \$5,000. The directors for the first year are: M. Campbell Lorina, Yonkers; Valentine J. Factiti, Forest Hills, L. I.; S. Carl Kapff and Albert F. Hollert, Brooklyn; H. Warren Ashmore, Asbury Park; Wilner A. Vossler, Freeport, and Noie E. Burnham, New York City.

Neal, Clark & Neal recently obtained exceptional advertising by placing a handsome Victor machine before the Greater Buffalo Advertising Club. It was announced that a new type machine had been perfected and would be demonstrated. A boy soprano concealed behind the instrument sang, thus giving the 300 club members present a double surprise when the "plot" was unfolded.

The Andrus Music Shop at North Tonawanda has been featuring nightly radio concerts through its complete receiving set.

BRILLIANTONE NEEDLE LINE SHOWN

At Merchandise Fair in Grand Central Palace—
 Domestic and Export Business Better

Good needle business is reported by the Brilliantone Steel Needle Co., New York City. H. W. Acton, secretary of the company, stated that business was not only good at the present time, but that orders were on the increase, presaging good business through the Fall and Winter seasons. The export business of the company is also in a healthy state, several substantial orders having been recently shipped to Australia and Japan.

The Brilliantone Steel Needle Co. is an exhibitor at the Merchandise Fair, held at the Grand Central Palace from August 7 to 25. This fair is held strictly in the interest of buyers and the general public has been excluded. The Brilliantone Co. is attractively situated at Booth 573 and is welcoming the many talking machine retailers who are attending.

DEVOTED TO ARTISTIC DECORATION

Mohawk Works of Art Opens Studios for the
 Decoration and Finishing of Talking Machines

The Mohawk Works of Art has been recently established for the artistic decorating and special finishing of talking machines. The new company, under the direction of M. Robichek and M. E. Estrin, who has had considerable experience in the talking machine field, has opened studios in the Mohawk Building, 160 Fifth avenue, New York. At this studio machines will be received from dealers in all sections of the country and decorated strictly in accordance with the special requirements of the individual customers of the dealer. Important connections have already been established with a number of department stores and talking machine retailers in the metropolitan district and it is reported by the officials of the company that its clientele is constantly growing.

Profits are not money stolen from others; they are the reward of service and efficiency—and the greater the service and efficiency, the greater the profits.

SIMPLEX

Electric Phonograph Motors

The SIMPLEX Electric Phonograph Motor Represents a New Phase in the Development of Sound Reproducing Instruments.

NOISELESS

ELIMINATES WINDING

TROUBLEPROOF

Make This Your
LEADING
Line for the
Coming Season

Sample
Price **\$19.50**



GUARANTEE
The SIMPLEX Electric Phonograph Motor is guaranteed Trouble-proof throughout and any parts or part thereof that should prove defective at any time, we will repair or replace same by a new motor, free of charge.

Particulars,
Quantity Prices, etc.,
on Application.

TRADE

MARK

The Mission of the SIMPLEX Electric Phonograph Motor is to reproduce music just as it was originally rendered. For its perfect and faithful reproductions of all disc records the SIMPLEX Electric Phonograph Motor will play any record you wish to hear and play it as it should be played.

It has an absolute constant speed under variations of voltages and frequency and records may be set at any speed desired—and it is built absolutely without a governor.

BETTER BUILT

BETTER DESIGNED

The SIMPLEX Electric Phonograph Motor has no competition because it is the only electric phonograph motor of its kind in the world. There are many features by which one can determine the efficiency of the SIMPLEX Electric Phonograph Motor. The essential features are:

- | | | | |
|----------------|----------------|------------|--------------|
| No Gears | No Commutator | No Springs | No Oiling |
| No Governor | No Brushes | No Winding | Noiseless |
| No Adjustments | No Transformer | No Belts | Troubleproof |

Record Stops Automatically on Last Note

It represents the very best of inventions and improvements and we therefore confidently say that the SIMPLEX Electric Phonograph Motor is combined with the highest precision of workmanship and select material.

TEST A SIMPLEX ELECTRIC MOTOR ON OUR 30-DAY TRIAL OFFER

When a Simplex Electric Motor is sent out, it is not sold until the motor has demonstrated in your own shop, in your own cabinet, during a 30-day test, that it will do all we claim. An extremely fair proposition in which the Simplex Motor is judged by its performance in your cabinet under your inspection. No strings to this offer. Your decision is final.

Manufactured in United States and Canada by the

Simplex Electric Phonograph Motor Co.

104 NEW WILDER BUILDING, 321 BLEURY ST., MONTREAL. CAN.

INDIANAPOLIS

W. E. Kipp Shows 'Em How—Pearson Piano Co. Back in Remodeled Quarters—Window Displays Create Sales—Trade Gains Continue

INDIANAPOLIS, IND., August 7.—Working under the incentive of added duties growing out of the absence on vacation trips of H. G. Anderson, general sales manager of the Kipp Phonograph Co., Edison distributor, and of W. O. Hopkins, manager of the Edison Shop, Walter E. Kipp, president of the Kipp Co., did the first retail salesmanship the latter part of July that he had done in many years. He found it necessary to step out and work hard with two prospects who were being carefully solicited by competitors. The result of his labor was that he landed both prospects and discovered that his talents as a "go-getter" had been in no wise impaired through years of executive activities.

"It did make me feel kind of good to find that

I could go out and get the business in just the same way as I expect my salesmen and dealers to do," Mr. Kipp said. "Those prospects I landed were not easy ones, by any means. I had to gather together all the tricks I had learned as a salesman and I had to think fast all the time to prove to those folks that the Edison was their best buy. It is a sure thing that business is to be had by the man who goes out after it."

Mr. Kipp reports increasing optimism throughout his territory. This, he says, is due to rapidly improving conditions on the farms and to the fact that the dealers have responded to the consistent and progressive sales policy developed by the Edison Co. in behalf of the individual dealers. Mr. Kipp says that the dealers are convinced

that the general sales policy of the Edison Co. is sound and is certain to develop an extraordinary business during the coming Fall and Winter.

Pearson Co. Back in Old Quarters

After spending more than three months in temporary quarters as a result of the fire which damaged the store of the Pearson Piano Co. on April 23 that company has moved back into its store and is bidding for business with a talking machine stock that is practically all new. The store has been completely redecorated and has the appearance of a new place. The company is continuing to handle the Victor, Edison, Cheney and Vocalion lines and is planning to feature more than in the past the fine art models.

H. A. Brown, manager of the talking machine department, says he is starting business after the clean-up sale of the last three months with a library of Victor records second to none in the State. He is preparing for the Fall campaign, in which he proposes to rely in large measure on circulars. He has completely revised his mailing list and will depend on the circulars, he says, to accomplish virtually as much in bringing in business as would be accomplished by individual salesmen.

Baldwin Business Excellent

The talking machine business of the Baldwin Piano Co. during the month was somewhat better, than during the corresponding period of last year, according to C. P. Herdman, manager of the talking machine department of that company. He says the only reason the month did show up better was because he and his sales force worked harder than they did in July, 1921. Part of the increase he credits to two penny record sales of two days each, in which Cameo records were sold at the rate of one for 75 cents or two for 76 cents. Mr. Herdman started the penny sales last Fall with Medallion records. He says the drawing power of such sales materially affects the regular record business, so that for a week or two after each sale the business is noticeably increased.

Console Models Continue Popular

F. R. Follis, manager of the talking machine department of L. S. Ayres & Co., reports that the best seller of the month was the new console model of the Victor Co. It is the opinion of Mr. Follis that the business of the month was somewhat less than it should have been, because his appropriation for advertising was less than for the corresponding period last year. He argues on the question of advertising expenditure that steady, consistent advertising throughout the year is the best policy and that such sales effort put forth in July assists in developing Winter business as well as Summer business.

Window Displays Pull Business

H. E. Whitman, manager of the Circle Talking Machine Shop, notes a tone of improvement in both machine and record business, with the latter playing the most important part during the hottest weather. He has relied chiefly for the last two months on window displays to pull in the business, he says. During the first part of August he featured an attractive window by fitting up a woodland scene in which by use of a phonograph he displayed a revolving sign which read, "Away to the woods with a Victrola—only \$1 a week." This was designed especially to promote the sale of portables.

Walter Baker, of the Brunswick Shop, is more than usually optimistic over the business prospects. He is preparing to sell more machines and records this Fall than have ever been sold from his store. The chief difficulty he is meeting now, he says, is that of keeping his supply of records up to the requirements of the trade.

Talking machines sold better last month than did pianos, according to T. H. Bracken, of the Starr Piano Co. The Starr store now presents a dressed-up appearance as the result of alterations which have increased the window display space 100 per cent and has improved the general arrangement of the front noticeably. The entire front exterior has been painted.

"An exceptionally good month" is the way W. G. Wilson, of Widener's Grafonola Shop, re-

SEPTEMBER vs. DECEMBER

HERE IS A CHANCE TO MAKE YOUR SEPTEMBER SALES RESEMBLE A CHRISTMAS MONTH

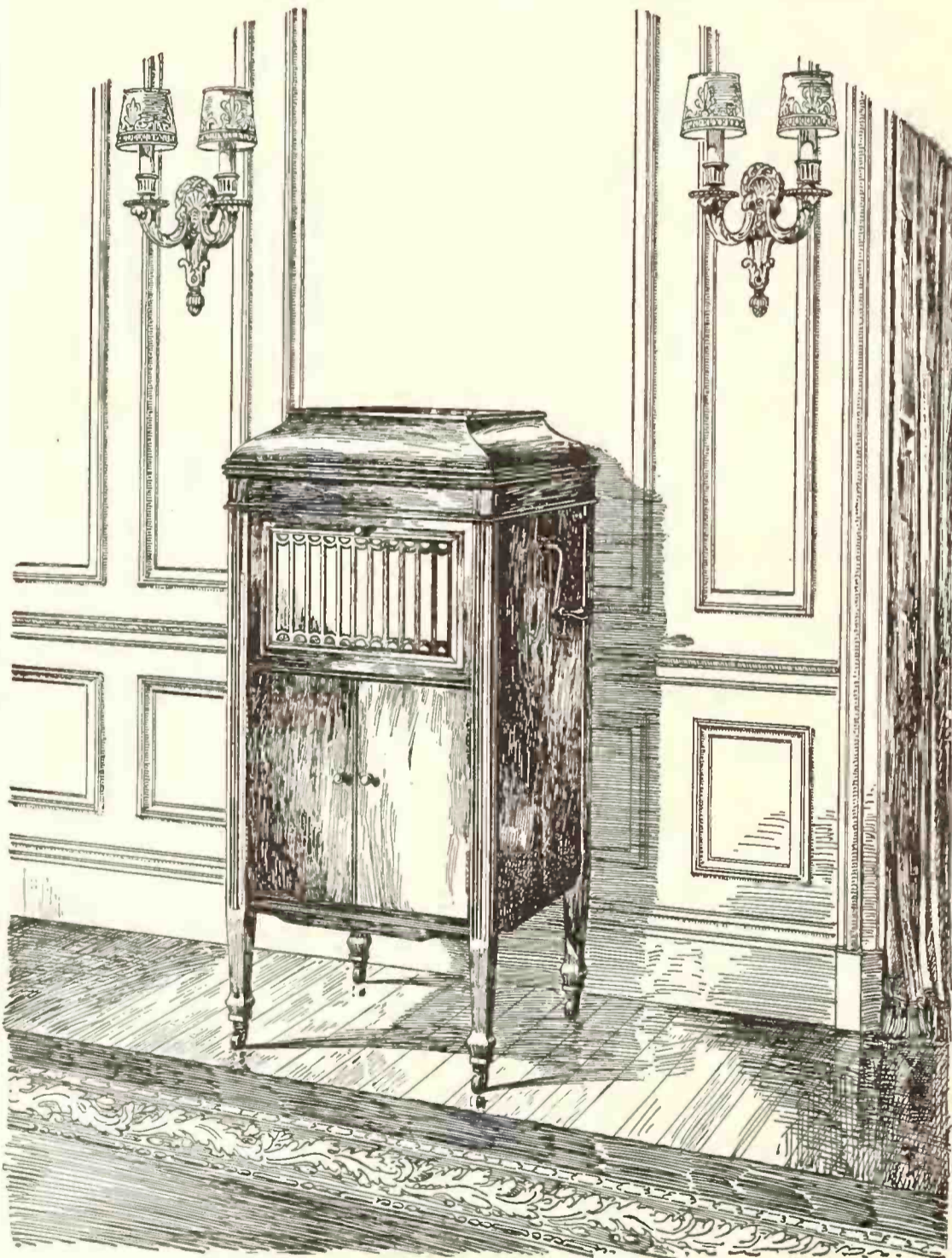

You can buy now this Model No. 5 Supertone at about one-third of the original dealer price. We bought the entire stock from the Creditors Committee of the Supertone Talking Machine Co. and are ready to pass the benefit of the price to you. In order to avail yourself of this opportunity, you must act at once.

PHONOGRAPH JOBBERS CORP. 206 FIFTH AVENUE NEW YORK CITY

ports his business in Granby and Columbia machines. The trend of trade during that month, he says, has given him more encouragement than anything else that has occurred in many months.

Farmers are not buying anything they do not need, according to C. S. Dearborn, who has charge of the distribution of Pathé machines and records for the Mooney-Mueller-Ward Co. He says that little effort is being made to develop the business just now and that virtually all the sales of machines and records are on mail orders from the established dealers. No plans are being made by Mr. Dearborn as yet for the annual meeting of dealers which has been held in the past.

Period Sonoras in Demand

Sonora business throughout the State has been noteworthy during recent weeks by an increase in the demand for new period models, says Edward Mayer, manager of the Sonora department of the Kiefer-Stewart Drug Co. All the Sonora dealers, he says, are speeding up their sales, while the company is preparing to add to its force in the early Fall some twenty-five merchants in various parts of the State who have signified their desire to handle Sonora machines.

Seventy Per Cent Increase in Business

A. C. Hawkins, manager of the Indianapolis Talking Machine Co., says last month's business was very gratifying for the reason that it represented a 70 per cent increase over the business of July, 1921. The gain was chiefly in machines, he says, although the sale of his Victor records remained normal. "Such a gain appears to be wonderful," Mr. Hawkins said. "I am at a loss to account for it except by the fact that we worked hard and general business conditions during the month were greatly improved over conditions a year ago. When business keeps up in such a fashion, despite strikes and vacations, it is time for dealers to rejoice."

Ira Williams, manager of the talking machine department of the Pettis Dry Goods Co., conducted a sale of Emerson machines during the first twelve days of July which resulted in the sale of thirty machines on which price reductions were made. He says the sale was instrumental also in moving twelve Victor machines, which were sold at the regular prices.

Big Volume of Repair Work

The talking machine repair business is keeping up this Summer very much above such work in previous Summers; according to A. D. Smith, of the Acme Talking Machine Co., which specializes in repair work. Mr. Smith says he cannot account for the unusual situation in this respect unless it be that machines are being adversely affected by hot weather.

In reference to damaged machines, Mr. Smith says there is an increasing amount of damage resulting from permitting machines to run down, a thing he advises strongly against. He says, also, damage results frequently from winding too tight. He advises against the repair of old spring, a thing which injures gears, he says, and advises also that motors be oiled every two months, as well as cleaned and graphited at least every year.

Mrs. Mollie Springer, mother of Miss Minnie Springer, of the Taylor Carpet Co., died the latter part of June, after an illness of only three days. She lived with her daughter in this city.

PLAZA MUSIC CO. EXHIBITING

Showing Full Line of Banner Records, Pal Portable Machines and Accessories at National Merchandise Fair at Grand Central Palace

The Plaza Music Co., 18 West Twentieth street, New York, manufacturer of Banner records, the "Pal" portable phonograph and talking machine accessories, is showing a full exhibit of its line at the National Merchandise Fair being held at the Grand Central Palace, New York, for three weeks, commencing August 7. This fair is under the auspices of the National Retail Dry Goods Association and thousands of buyers of retail establishments are attending.

The business of Burns & Kibler, Columbia dealers, Persia, Ia., has been taken over by J. A. Burns.

LEO SCHWARTZ JOINS BENEDICTS

Popular Member of Ormes Staff Forsakes Ranks of the Single Men—Identified With Industry for Fifteen Years and Highly Esteemed

Leo Schwartz, who has been associated with Ormes, Inc., Victor wholesaler, for the past eight years as a member of its shipping and delivery department, was married on Friday, August 4, to Miss Sarah Rothstein, the ceremony taking place at Miss Rothstein's home, 730 Oakland place, New York. Mr. Schwartz is well known in the local Victor trade, having been identified with the industry for the past fifteen years. At one time he was associated with Sol Bloom, Victor jobber, New York, and eight years ago joined the Ormes organization, where he has rendered splendid service and co-operation to the dealers.

There is only one proper way to do a thing, and that is the right way.

G. T. WILLIAMS' NEW QUARTERS

Well-known Victor Distributor of Brooklyn Acquires Temporary Quarters at 272 Flatbush Avenue Extension, Corner of Willoughby Street—A Central Location and Well Arranged

The G. T. Williams Co., Inc., Victor distributor, formerly located at 217 Duffield street, Brooklyn, N. Y., announces its removal to temporary quarters on the ground floor at the corner of Willoughby street and Flatbush avenue extension. The location is well arranged, easily accessible, and the Williams Co. is prepared to give the Victor retailer efficient service.

The G. T. Williams Co. some months back acquired a large plot of ground for the purpose of building a modern, well-equipped distributing plant. Building conditions did not, however, justify the immediate carrying out of the plans and these have been postponed until a more favorable situation arises in the building trades.

Get This

"GERACO" means a lot to Radio! The word identifies Radio accessories made to justify our policy that "only the best is good enough!"

Geraco products are the final result of months of careful experiments. They are the best that competent experts can do. They meet every test that any one can devise—and make good.

Thus "Geraco" is our guarantee to YOU—and your guarantee to the Radio devotee.

"Geraco" identifies the Music Master Radio Amplifier, the Geraco Variometer and dial (illustrated), along with the Variocoupler. Each item is absolutely good in every sense of that word. Depend on that!

All Geraco products are made from only the best dielectric materials, either hard rubber or special Geraco compound.

THE Music Master Radio Amplifier greatly magnifies volume and reproduces sound entirely free from that harsh, metallic screeching. It is unequalled in resonance, the beautifully grained mahogany horn insures that.

- 21-inch for concert and out-of-doors....\$15.00
- 14-inch for general use in home.....\$35.00



Geraco Variometer and Variocoupler assemblies are a long step ahead in the development of accurate tuning instruments.

- Variometers\$6.00
- Variocouplers\$5.00

Write for complete information on Geraco:

- | | |
|----------------------------|------------------------|
| Variometers complete | Variocoupler complete |
| Variometer rotors | Variocoupler tubes |
| Variometer Post Assemblies | Variocoupler balls |
| Variometer stators | Vacuum tube sockets |
| Dials | Crystal detector bases |
| Knobs | Aerial insulators |

Music Master Radio Amplifiers

Manufacturers, Jobbers and Dealers—
Write at once for complete schedule of discounts

Announcing

The exclusive distributorship for STRAND Phonographs and Okeh RECORDS for Pennsylvania, Southern New Jersey, Maryland, Delaware, District of Columbia, Virginia and West Virginia.

General Radio Corporation

Walter L. Eckhardt, President

Manufacturers and Distributors of

High Grade Radio Apparatus
624-628 Market St.
PHILADELPHIA

GERACO Moulded Dials, smooth black surface accurately calibrated. Equipped with Special Geraco Chuck.
Size 3 1/4 inches, \$7.5



GERACO
PROVEN RADIO PRODUCTS

A NEW DANCE CRAZE STUMBLING

By
ZEZ CONFREY

A FOX TROT ODDITY

"You can't go wrong
With any FEIST song"

HEAR IT NOW

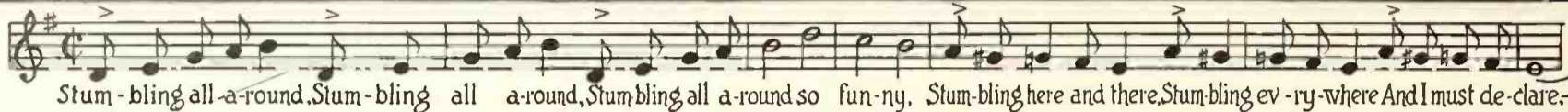

Stum-bling all-a-round. Stum-bling all a-round, Stum-bling all a-round so fun-ny, Stum-bling here and there, Stum-bling ev-ry-where And I must de-clare-

CENSUS SHOWS GROWTH OF TALKING MACHINE INDUSTRY

Figures Published by Government Indicate Great Development of Talking Machine Manufacturing Business Between 1914 and 1919—Interesting for Reference Purposes

Although general figures regarding the 1919 census of manufactures were published some time ago, it has only been recently that there have been made available authentic figures relative to the music industry in detail. The statistics regarding the talking machine trade in 1919, as compared with the previous census year 1914, are of particular interest despite the fact that the

increased from eighteen to 166, or an increase of 822 per cent, while the number of employes increased from 11,366 in 1914 to 33,826 in 1919. The development of the trade during a decade is well illustrated in the increase in capital. From \$14,363,361 in 1909 to \$33,770,511 in 1914, and to \$105,241,359 in 1919.

Of particular interest is the heavy increase in

with producing 35 per cent of the total output of talking machines and records, with other States following in the order named: New York, 10.4 per cent; Illinois, 8.1 per cent; Indiana, 5; Ohio, 3.9; Michigan, 2.7, and Wisconsin, 2.4. It would seem that the Government workers elected to figure the output of at least one State that has held a prominent place in talking machine production.

There is no question but that the present-day census would necessitate a material revision, mostly downward, in most of the figures offered in the 1919 report, but nevertheless the last census has been the means of making public the substantial character of the talking machine industry.

VAUGHN DE LEATH'S NEW RADIO IDEA

Popular Okeh Artist Sings Duet With Herself From WJZ Station—Entertainment Pleases Fans

Miss Vaughn De Leath, well-known contralto and exclusive Okeh artist, who is a prime favorite among radio fans, recently conceived a unique idea for her radio program. This plan involved singing a duet with herself from the WJZ station, with the assistance of one of her Okeh records.

Miss De Leath first broadcast "Some Sunny Day" with her Okeh record and for the second chorus, recorded by the orchestra alone, she sang in person. For the third chorus she sang a duet with herself in conjunction with her Okeh record. This unique idea proved to be the hit of the evening's entertainment, and telephone requests by the score were received at the WJZ station asking that Miss De Leath repeat her program at an early date.

WHITNEY CO. ADDS ANOTHER LINE

ALBANY, N. Y., August 7.—The talking machine department of William M. Whitney & Co. has recently undergone extensive alterations and has been considerably enlarged. The company has been handling the Victor line of machines and records exclusively for a number of years, but the Pooley line of phonographs and Federal records have now been added to the stock.

OPENS COLUMBIA DEPARTMENT

TRINIDAD, COL., August 7.—The Andrews Music & Stationery Store, of this city, has succeeded to the Columbia Graphophone department of the Burkhard Saddlery Supply Co. A formal opening of the department was held in the attractive quarters of the former concern.

RECEIVER FOR AIR-O-PHONE CORP.

Walter L. Bryant has been appointed receiver for the Air-O-Phone Corp., 122 Fifth avenue, New York City, manufacturer of radio equipment. The liabilities of the concern are estimated at \$15,000 and assets at \$7,500.

Concentration breeds power and success.

industry has undergone many changes during the past few years and there would be little or no basis for some of the figures to-day.

The Government report, however, serves to

the value of the products of the trade, which jumped from \$11,725,996 in 1909 to a grand total of \$158,547,870 in 1919. This latter figure is compared with that showing the total value of the

Class	Census Year	Number or Amount		Per Cent of Total		
		Total	Male	Female	Male	Female
All classes	1919	33,826	26,540	7,286	78.5	21.5
	1914	11,366	9,854	1,512	86.7	13.3
Proprietors and officials	1919	43	43	0	100.0	0
	1914	11	6	5	54.5	45.5
Proprietors and firm members	1919	43	43	0	100.0	0
	1914	11	6	5	54.5	45.5
Salaries, officers of corporations	1919	234	229	5	97.9	2.1
	1914	43	43	0	100.0	0
Superintendents and managers	1919	625	609	16	97.4	2.6
	1914	140	139	1	99.3	0.7
Clerks and other subordinate salaried employes	1919	4,203	2,269	1,934	54.0	46.0
	1914	1,791	1,236	555	69.0	31.0
Wage earners (average number)	1919	28,721	23,390	5,331	81.4	18.6
	1914	9,381	8,430	951	89.9	10.1

Table 2—PERSONS ENGAGED IN THE TALKING MACHINE INDUSTRY, 1919

give some indication of the tremendous growth of the talking machine industry during the five-year period 1914-1919, during which the trade saw the greatest expansion.

During the five-year period, for instance, the number of manufacturing establishments was

products of the piano trade during the same year as \$149,850,945.

The accompanying tables, 1-2, give the complete figures for the industry and offer interesting comparisons.

During 1919 the State of New Jersey is credited

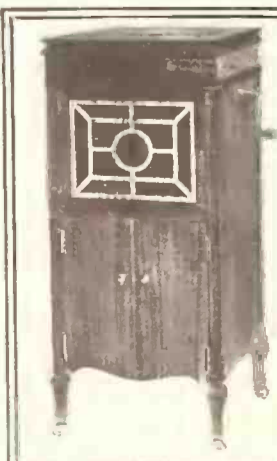

TALKING MACHINES COMPLETE TALKING MACHINE CABINETS RADIO CABINETS

Golden Oak, Fumed Oak, Red and Brown Mahogany

Cabinets that will satisfy your customers—
Cabinets at prices that will make big profits

Send us your inquiries at once—Order Now.

THE H. LAUTER COMPANY
INDIANAPOLIS, INDIANA

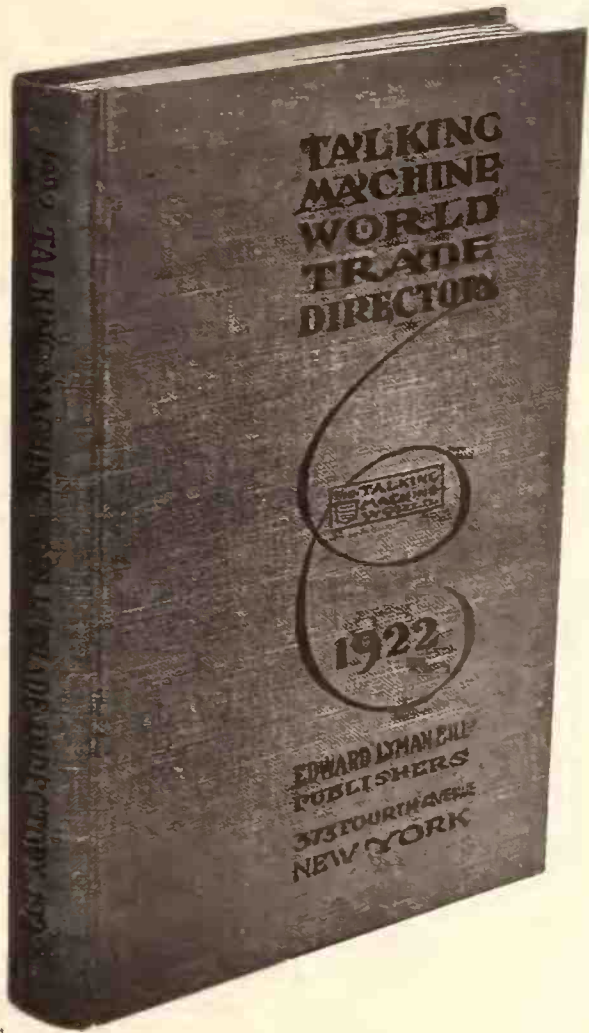

You Need It!

The Talking Machine World Trade Directory has filled a long standing want of the industry. It is kept as a handy reference volume on the desks of a large number of the members of the talking machine industry where, in an instant, it provides detailed knowledge about this or that company and the products made by each company.

It gives the kind of information it would otherwise consume much time to secure. For instance, it will give you a complete up-to-date list of the manufacturers and jobbers who comprise the talking machine industry, including the invaluable data about each concern, such as location of factories, names of officers, location of branch offices, trade names controlled, policy of marketing product, etc., etc.

TWO TYPICAL TESTIMONIALS

"Your 1922 Model Talking Machine World Trade Directory reached us all right, and the writer went over it carefully yesterday at his home, and we wish to compliment you. There has never been a Trade Directory got up that has been so accurate as regards firms listed and that has covered the field so thoroughly.

"There is no question but that this Directory will prove of real, tangible benefit, not only to its advertisers and those who are listed in same, but to the general dealer trade at large, who have needed a directory of just this nature."

"We congratulate you on the appearance of The Talking Machine World Trade Directory and trust that you will make it a yearly feature of your business.

"We could use two more copies of this publication in our organization to great advantage, therefore request that you send them to us, proper billing.

"Just before closing wish to state that we consider the move on your part of issuing a directory of the talking machine industry as being one of the most forward movements occurring in the industry for several years."

Only 50 Cents

Only 50 Cents

USE THIS COUPON NOW

Send Stamps or Check



EDWARD LYMAN BILL, Inc.,
373 Fourth Ave., New York City.

Gentlemen:

Please send me postage prepaid a copy of the 1922 edition of The Talking Machine World Trade Directory, in payment for which I enclose 50 cents.

Name

Firm

Street

City and State

MILWAUKEE

Talking Machine Sales Climb as Unemployment Decreases—Food Exposition Claims Dealers' Attention—Month's Trade Activities

MILWAUKEE, WIS., August 8.—Increased employment in nearly every industry in the city and in Wisconsin and Upper Michigan territory is reflected in an improvement in sales of talking machines. During the past month 12,340 placements were made by the employment offices in Wisconsin, according to the report of the Wisconsin Industrial Commission. Little unemployment is seen among the skilled workers, and as for common labor, every factory in the city, with few exceptions, has "Help Wanted" signs posted. This alleviation of the employment situation has created a steadying and firmer undertone in the talking machine market.

The same condition prevails in the country trade districts. The average small-town dealer had little to do in the Spring of the year, and naturally he expected a customary Summer slackening period to arrest what feeble motion his stocks had. To his surprise, trade improved and continued through June and July to hold its high average. Fall orders are placed confidently by the small-city dealer, who expects a good Fall trade as a result of the excellent crop conditions in his district. Wisconsin especially has had very favorable returns from its rural districts regarding harvests. The average farmer will be in sound financial condition in the Fall as a result of bumper hay, grain and fruit crops and will have the necessary surplus on hand to satisfy his taste for music.

Preparing for Exposition

All local talking machine wholesalers are preparing their displays for the Fourth Annual Food and Household Exposition, to be held here in the municipal auditorium, October 23 to 29, inclusive. The musical instrument department will be the

biggest ever held in the city. The talking machine exhibitor will get his product demonstrated to nearly 100,000 people in a week's time. The exposition will be a wonderful means of getting good publicity and of securing direct sales as well. Spaces are going fast, indicating that the distributors in this territory are alert to realize this opportunity of popularizing their machines. Unusual efforts are being made to arrange striking displays.

Excellent Columbia Record Display

The Winter Piano Co. has an attractive and attention-compelling display of records that it would pay other talking machine dealers to pattern. One hundred Columbia records of the new dance hit, "Stumbling," are displayed in the company's Grand avenue window. The records with a royal blue center are shown on separate mounds of rich blue velvet drape that slopes up gradually from the horizon of the passing street traffic to the center of the large window. Three horizontal cards bearing the name, "Stumbling," in blue letters are attached to the window. The display is neat, well-balanced and artistic and has not the usual fault of record exhibits—that of an overcrowded appearance.

Moves "Talker" Department

The Flanner-Hafsoos Music House has moved its talking machine department from the basement to the first floor. The department has been enlarged, redecorated and rearranged. New display and demonstration rooms have been installed and larger, and modern record racks have been constructed, F. F. Flanner, president of the company, announced.

C. Niss & Sons to Enlarge

A three-story addition, 70 by 150 feet, to C. Niss

& Sons is planned. The addition will be of reinforced concrete and will be constructed at 697-700 Third street. Architects M. Tullgren & Sons are in charge of the plans. The C. Niss & Sons Co. is one of the largest distributors of phonographs in this city, specializing in the Edison.

A. G. Kunde Home From Europe

A. G. Kunde, formerly one of the prominent Columbia dealers of the city and who now markets the Gennett records and handles the Starr phonograph, has returned to his headquarters at 344 West Water street from a three months' European tour. Mr. Kunde plans to start an intensive Fall advertising campaign, featuring Starr phonographs and Gennett records. He has secured prominence in the city as an authority on industrial conditions in Europe. The Wisconsin News, one of the city's leading newspapers, has run feature stories signed by Mr. Kunde, bearing his picture. Mr. Kunde in the stories tells of the industrial conditions of Europe—Germany especially. He declares that the average worker in Germany fares among the best of European laborers, this being due to his industry and thrift.

Milwaukee Association Plans for Fall

At the July meeting of the Milwaukee Association of Music Industries a large and enthusiastic attendance greeted President Frederic W. Carberry, Brunswick dealer, who as chairman of the ways and means committee presented a comprehensive plan of work. The plans of the organization for Fall have been withheld for later publication. The efforts of Chairman Leslie C. Parker, head of the Badger Victrola Shop, were rewarded by the admission of three new members at the meeting. They include I. H. Klein, of the Badger Shop; C. A. Schowalter and W. E. Pugh, assistant sales manager of the Yahr & Lange Co., Wisconsin and Upper Michigan distributor of the Sonora phonograph and Okeh records.

Brunswick Artists Boost Record Sales

When the famous Isham Jones Orchestra played here in July talking machine men in the city got busy and proceeded to capitalize the presence of these famous musicians. A Brunswick

Puritan Records

FALL and WINTER PROVIDE BIG SELLING SEASONS
for 50c. RECORDS

It is not too early to make your plans for the coming season **NOW**. A big market has been created for 50 cent records and it will pay you to be able to fill this demand.

Puritan Records offer you the best value in the 50c field—new hits, good material, recording and artists—quick turnover and satisfactory profits.

If you are located in territory East of the Ohio and North of the Potomac it will pay you to write today for full details.

The BRIDGEPORT DIE & MACHINE Co.
170 ELM ST. BRIDGEPORT, CONN.

Invite your customers to chase the Willies over the hills by listening to Marion Harris sing "Haunting Blues." This is dyed-in-the-wool indigo song stuff. For an encore there is Marion on the reverse side in "Nobody Lied" (when they said I cried over you). A-3646.

Columbia Graphophone Co.
NEW YORK



phonograph playing Brunswick records made by the Isham Jones Orchestra was placed in a conspicuous position in the lobby of the Palace Theatre, in which the musicians performed. The orchestra was so popular that hundreds of persons lined the lobby of the showhouse waiting in line for tickets. The Brunswick phonograph played the records of the orchestra to the impatient crowd. Result—the next morning Brunswick dealers were overwhelmed with the call for the dance records and popular songs played the evening before. One dealer declared that within two hours he sold sixty records of the popular dance piece, "Stumbling." Similar stories were told all along Music Row. The Frederic Carberry Co. took advantage of the occasion by conducting a special advertising campaign featuring the Brunswick record department and the Chickering piano, also used by the orchestra. Gimbel Bros., one of the largest department stores in the city, held a large sale of Brunswick records during the week Isham Jones appeared. The phonograph section of the store was crowded with persons demanding the popular records. All in all, the appearance of the orchestra came at an opportune time for Brunswick dealers, who secured a great deal of advertising for their music houses, their phonographs and their records.

J. B. Bradford Co. Adds Brunswick

The J. B. Bradford Piano Co., owner of two stores here, has been made representative of the Brunswick phonographs and records. New art display rooms will be opened for the exclusive display of the period types of these machines. Hugh W. Randall, president of the company, announced.

Improvements at Kittelmann Co.

The Kittelmann Furniture Co. has redecorated and rearranged its music department, featuring Columbia and Sonora phonographs. A complete section for records has been constructed, new demonstration rooms and special record racks having been installed. Reading lamps, upholstered chairs, imported rugs and paintings make the demonstration rooms the best furnished in the city, officials claim.

Wilson Co. Secures Victor Stocks

The Wilson Music Co., of Stevens Point, Wis., has purchased the Victor department of the Boston Furniture Co., including all Victrolas and Victor records in stock and the exclusive local agency for this line. George M. Farrin, recently of Oshkosh, is the new manager of the department. The stock of Victor records will be enlarged and the department will be rearranged.

Mrs. L. J. Daly Operates Successful Business

Mrs. Louise Jefferey Daly, owner and manager of the Daly Music Store, Wisconsin Rapids, Wis., well known among the talking machine dealers of the State, was honored recently by the Wisconsin Rapids Tribune. A brief sketch of Mrs. Daly's life was given in the "Who's Who in Wisconsin Rapids" column of the paper. Mrs. Daly is the widow of F. P. Daly, well-known jeweler and music house owner of the city. At her husband's death Mrs. Daly, undaunted, took up the business, disposed of the jewelry store and concentrated on building up what is now equal in

equipment to any store of its kind. Her daughter manages one of the musical instrument departments of the store, her eldest son, Francis, is manager of the talking machine department, and her youngest son, Glen, is manager of the piano department.

Gennett Records in Good Demand

A. G. Kunde, Wisconsin distributor of the Gennett records, declared the records to Summer vacationists were moving in endless quantities. Music lovers moving to their Summer homes purchased large numbers of the latest releases. These are the popular records, he said: "Swanee Bluebird," "Romany Love," "Hopeless Blues," "Lonesome Mamma Blues," "Stumbling" and "Three O'Clock in the Morning." There are now eight Gennett dealers located in various sections of this city.

To Build New Store Front

Joseph Goldman, a dealer of prominence here, is taking bids through his architects on a new twenty-four-foot copper and plate-glass front for his store at 510 Mitchell street. A modern and attractive store front is planned by Mr. Goldman. He will feature phonographs and records for a special opening display, when the new front has been constructed. He plans to make his show window one of the best of the many talking machine houses on the South Side of the city.

Yahr & Lange Pass Half-century Mark

The Yahr & Lange Drug Co., a leading wholesale house and jobber for the Sonora in Wisconsin and northern Michigan, recently celebrated the fiftieth anniversary in business in the city. Fred E. Yahr, president of the company, declared that the Sonora department has increased its sales steadily since the first of the year; that business this Summer is far in excess of the same period last season, and that an excellent Fall trade in records and phonographs is expected, especially in the rural districts of Wisconsin.

Cheery Message From H. A. Goldsmith

Henry A. Goldsmith, secretary of the Badger Talking Machine Co., reviewing the current market conditions for the sale of talking machines, said: "We find in our Wisconsin and upper Michigan territory that talking machines are showing a record-breaking improvement. More machines have been sold this season than ever before in our history. We think that the 'evil days' are safely behind us and we now look forward to a slow and steady movement of stocks in the hands of all our dealers scattered throughout the State. Since the slack Spring months have passed we have watched our machines move in fair quantities, improving as the Summer advanced.

"Through the Summer months trade continued to improve and has not the slightest indication of decreasing as Fall approaches. Trade secured a nice impetus in the early weeks of July. For a time this was checked by the strike of the railroad craftsmen and the coal miners. The succeeding days, however, have shown a decided improvement and trade has resumed its former brisk pace. Although many dealers in the larger cities of the State, in the industrial centers especially, claimed that the cessation of buying due to the

acute strike situation checked what would otherwise have been a bumper Summer sales season, dealers in the rural communities claim that the momentum of sales has never had a setback and that the season advanced in its healthy condition right through the Summer.

"We are now taking orders for Fall machines and they are found to be of a large number and higher price. Trade in general for Fall looks very encouraging. The rural trade, especially, is in the market for large purchases. We can differentiate the bumper crop sections from the crop failure districts by the size of Fall orders for talking machines. For the greater part of the State it must be said that crop conditions are encouraging and that bumper harvests will put the country in a sound financial condition. On the other hand, in a few more or less scattered spots, where harvest yields were not faring as well as the more fortunate districts, Fall orders have fallen down on their last year's average.

"The country cannot help but receive some of the prosperous trade that talking machine dealers in the city are enjoying. The good feeling percolates out into the rural districts slowly, but it inevitably is felt there. The city dealer is the first to feel any setbacks of trade and the first to enjoy the prosperity.

"Records, of course, are keeping pace with the movement of talking machines and will hold up to the high average set by them. Popular hits are going better than ever this season. Dance pieces have been bought in large quantities by vacationists.

"As for types of machines that are the most in demand, we find that people are buying more of the horizontal models this year than they have ever before purchased. The machines are listed at all prices and the trade is choosing the medium-priced instruments. The middle class is our strongest buyer now, which accounts for the better feeling in the trade. In the Spring the wealthy class was the only one in the market. We sold a large number of high-class machines, but our total volume of business was not as great as at this period when the middle class comes into the market.

"Portable machines proved to be so popular this Summer that our stocks at the end of the season are depleted. Every camper and tourist seemed to ask for this little machine.

"Collections are improving. The strikes seemed to have affected them somewhat, but our collections are in better condition now than they ever have been this year."

Columbia Line in Better Demand

R. H. Walley, representative of the Columbia line in eastern Wisconsin, says Columbia phonographs and records are moving in better quantities at this period than they were a year ago. Business for the Summer has been far ahead of last year and, judging from Fall indications, Mr. Walley believes a record business will be registered.

The Swann-Schulle Furniture Co., of Austin, Tex., recently added Victor talking machines to its stock.

Featuring the MUSICAL POSSIBILITIES of the TALKING MACHINE

[EDITOR'S NOTE.—This is the twenty-second of a series of articles by William Braid White, devoted to the various interesting opportunities which prevail in the domain of education for the retailer of talking machines. The subject is one of great interest and we commend these articles to the consideration of all who are devoting attention to the featuring and developing of the musical possibilities of the talking machine.]

4—HOW TO KNOW BY LISTENING

When once the instrumental voices have been individualized in the way suggested in the previous articles it is time to listen more analytically to music, in order to penetrate the secrets of its form. Just as a matter of salesmanship it is important to know forms of music. The arguments in support of this statement have been made too often to need repetition at this time.

Composers do not work by frenzy or chance

or mysterious inspiration. Ignorant people harbor many queer ideas on these subjects. But the truth is that, while the power of invention, in music as in poetry or painting, is the prime requisite for good composition, still the medium in which the tone-master works is just as rigid, and subject to just as many rules, as the poet or the painter must master. True, there is what is called "free verse" in poetry, which pretends that it does away with all the old rules of metre and scansion; true, also, there is painting, so-called, which boasts that rules mean nothing to it. And there is music, too, which seems to have been written by children who have learned to put down black marks on paper, but who neither know nor care what these may signify.

Yet these modern absurdities do not represent anything worth while nor anything that will live. We may safely forget them until we know so much about real music that we can afford to waste our time on the screechings of men who care nothing for purity or beauty, but everything for notoriety.

Music, then, depends upon form. There is no better way of expressing what is meant by this term "Form" than to say that Architecture was once aptly called "Frozen Music." In other words, the material of music is sounds. These sounds are built up into relations with each other very similar to the relations which the bricks of a building bear one to the other. The bricks must be arranged according to a plan. Without a plan there would be a mere heap; with it there arises a building, scientifically planned and beautiful to look at. So with the sounds which form the raw material of music. When put together according to a correct architectural plan these sounds may form tonal structures which have just as much definite shape, ornament and beautiful detail as a Gothic cathedral.

The Kinds of Form

Just as there are schools of architecture, variously known as Greek, Romanesque, Byzantine, Gothic, etc., so there are definite styles of musical form. All these styles are easily distinguishable, when once the keystone in each has been recognized. Architecture began with the simplest structures, the merest lean-to shacks, mere shelters placed against the opening of a cave scooped out from the side of a hill. So, too, music has evolved into unfinished art from the simplest beginnings, from the rough tunes of primitive peoples. From the earliest days these song and dance tunes have been taken by musicians as the material for their experiments in more artistic combinations. In due course they have come to form one part of the foundation on which has been built up the great structure of art music. The other part of the foundation was laid centuries ago in the Christian Church, which from the first recognized the value of singing and bit by bit evolved a set of rules for conducting voices in several parts, a system which in time developed into counterpoint, itself the basis of all the more important evolutionary work in musical composition.

Slow and Painful Conquests

If we go back three hundred years we shall find the art of music gradually but steadily emerging from the limits of ecclesiastical music, and simultaneously working out the rough simplicities of the popular songs and dances into ordered and artistic forms, using the learning of ecclesiastical music to furnish a sort of mortar wherewith to bind together the folk-song fragments into an ordered structure. The process was long and tedious. It is only necessary to hear seventeenth century music to realize that composers had to learn slowly and even painfully how to work their material and to master its peculiarities. These things are not done in a day.

But by the time when the earliest of music now often heard had come into being—that is to say, by the end of the seventeenth century—the stage was set for the emergence of the art of Fugue in all its glory, to be followed almost immediately by the art of the Symphony and the Sonata. Upon the double rock of these forms stands all modern music. They may most simply and pleasantly be studied through the medium of talking machine records.

Study Through Hearing

Let no one, however, fall into the gross error of supposing that he will find anything dull or repulsive in the study of musical form through the unique medium of talking machine records. On the contrary, the study will be found delight-

Study the SILENT Motor

Its Advantages for Your Line of Talking Machines Are Self-Evident

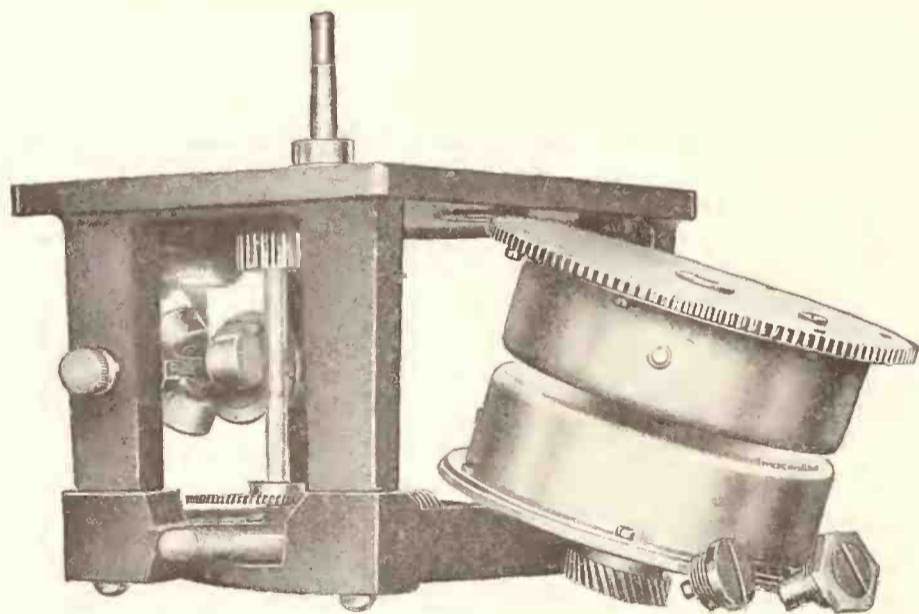

The Silent Motor With Spring Barrels Demounted. Note the Sturdy and Simple Construction.



An Exclusive SILENT MOTOR Feature.

Self-aligning governor shaft, mounted on universal ball-and-socket bearing. Eliminates governor trouble forever.

Send for Sample and Prices

THE SILENT MOTOR CORPORATION

CHARLES A. O'MALLEY, President

321-323-325 Dean Street,

BROOKLYN, N. Y.

ful from start to finish. Let the student understand that he is going to learn by actual listening, instead of indirectly by printed examples which he must play or get someone to play for him on the piano.

What Is Counterpoint?

In the glossary of musical terms to be found at the end of the Victor catalog will be seen these words: "Counterpoint: The art of combining melodies." This is almost a model of a short, compact definition, but it needs to be extended somewhat if it is to be complete as well as accurate. Counterpoint, in fact, is the art of combining melodies in such a way that when played simultaneously they form a good harmony. The word itself is just the English of "punctum contra punctum," or point against point, that is to say, voice set against voice so that each shows off by itself and yet all together sound musically satisfactory.

Now counterpoint is the oldest of devices for building up a musical structure. Long before anyone knew anything about putting sounds together so as to form chords, indeed, long before there existed any musical instruments on which simultaneous sounds could be expressed, the musicians of the Christian Church had experimented with the device of setting two voices to sing the same melody at a distance of a fifth in pitch. From the crude and often distressing results of these early experiments the art was gradually developed until the fifteenth century the art of contrapuntal writing for four sets of voices, soprano, contralto, tenor and bass, was far advanced; so that to-day it still offers technical problems by no means insignificant.

Out of the early counterpoint developed finally the marvelous art of Fugue, which was brought to its highest point of beauty and grandeur by Johann Sebastian Bach, of Leipzig, who died in 1750 at the age of sixty-five. Every musician who, from the end of the eighteenth century till to-day, has made any mark as a composer, has had to acknowledge indebtedness to his genius, for he is the founder of all modern music.

The Art of Fugue

Fugue, as Bach perfected it, is a system in which one special musical idea, tune or theme (the terms all mean the same in this case, noting only that for fugue purposes it must always be a short, snappy sort of tune), called the "Subject," is sounded in one voice, or instrument, or in region of instrument (according to whether the fugue is written for choir, orchestra, organ or piano). This subject is immediately "answered" by a similar tune, completing the idea begun by the first, and called the "Answer." The subject and answer are now sent off on their musical travels, appearing first in one voice and then in another, according to various rules which have been worked out by gradual experience through three centuries of development. The voices skip from place to place, from soprano to tenor, to contralto, to bass, while never losing touch with each other, and running so that whichever one is at any moment most prominent the others will furnish a true harmony and support for it. It is a way of making music run "horizontally," that is to say, by simultaneous melodies, instead of by one melody with chords underneath it. It makes more demands upon the ear for delicacy and judgment than an ordinary tune and accompaniment do, but the result is worth the trouble. All modern music is built upon this idea of counterpoint, that is, of keeping many melodic voices running together, and all orchestral music of to-day is simply filled with it. Wagner, for instance, is contrapuntal from his first page to his last. His melodies cross and recross each other like the woof and warp of a great woven arras, in a constant succession of simple, double and triple counterpoint. And all his successors have yielded their homage, too, in conscious imitation, to the great art which old Bach perfected over two hundred years ago.

Some Practical Examples

And now, after all this, for some examples. Careful search through the wealth of musical literature in the talking machine catalogs will reveal some excellent examples of pure Fugue,

both classic and modern, although in this respect, as in others which might be mentioned, the distribution is uneven. There is too much space given to inconsequent stuff, for not everything sung or played by a great artist is worth hearing. However, to our muttons:

I suggest that the listener choose, first of all, the vastly entertaining and interesting record from the Victor catalog of the "Overture," so-called, to Bach's D-Major Suite for orchestra. Now a Suite is a set of pieces, all written in the same key, and Bach wrote several such Suites for orchestra when he was directing the private band of the Prince of Anhalt-Coethen. Each consists of an Overture, so-called, or opening piece, followed by a set of dances, Gavotte, Bourree, Sarabande and Gigue, which latter is simply a good old "jig," and is put last to make a merry finish.

Now, I simply ask you to take the Overture to this Suite, as you will find it on a 12-inch record, played by orchestra, and listen to it. You will note that Bach scored his music for first violins, second violins, violas, 'cellos and contrabasses; that is to say, chiefly for the strings; and he added flutes, trumpets and drums to fill in from time to time. But the subject, the answer and the contrapuntal interweaving are almost entirely given to the main choirs of strings, simply because in Bach's time the wind instruments were too imperfect to be entrusted with important work, and many musicians even thought them altogether out of place in a string band.

The overture begins with a slow and graceful movement, in which all the strings, with trumpets and flutes, are joined together. The melody is stately, the harmony graceful. But note: each part is individual, so that you could take, for instance, the 'cellos and make them play their part separately and you would find it to be in itself almost a complete melody. But this is not yet a Fugue, though it is contrapuntal.

Subject and Answer

The stately melody draws to a close and there begins a sharp, incisive, snappy tune in the first violins. Listen to it carefully. It is the subject of the Fugue. After a few seconds this is answered in the second violins, a fifth lower. This is the answer. Note how, when the first violins finish the subject, they go on playing a sort of secondary melody or counter-subject, thus maintaining the harmony till the second violins have made their answer. Then immediately the 'cellos take up the subject, while first and second violins continue their secondary melodies. The violas come in with the main subject, then the first violins again; and so on, till the whole orchestra has been drawn into the loom and is weaving the marvelous web of flashing melodies, crossing, recrossing, running parallel, leaping from point to point, till the master has worked out his material, and has brought all to an end, with one sweeping modulation into the key of D.

This is Fugue at its finest. You will want to listen to it many times, but do not allow yourself to be satisfied till you can trace the shining strands of subject and answer through the whole glittering garment of tone. Then you will begin to hear some things in music which you have never heard before.

I could go on forever in this strain, but space forbids. The road I have opened up stretches far and wide. The listener will wish to hear more music like this, and so, in closing, let me suggest two very fine additional examples. One is the overture to Mozart's opera, "The Magic Flute," which is fugued from the beginning of the allegro, after the trombone introduction, to its end, and is a beautifully clear example of the form. The other is Wagner's Overture to "The Mastersingers of Nuremberg," in which he uses a five-part fugue in the middle section, very modern and wonderful, albeit as clear as crystal.

We may next go on to think of the forms, like that of the symphony, which were built on this great art of fugue.

NOTE—The English catalog of the Columbia Graphophone Co. has some fine organ records, including one of the magnificent Toccata and Fugue in D minor by Bach. But please do not think that Fugues are only to be found (for orchestra anyway) in Overtures. The three examples I have quoted just happen so.

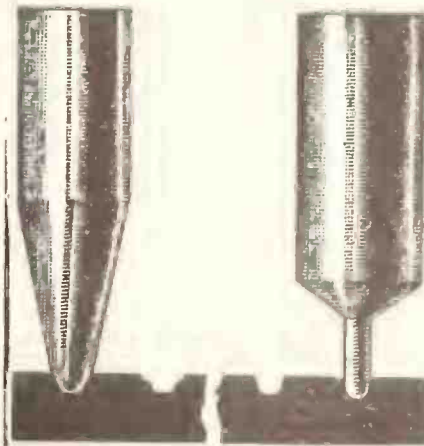

Make This Two-Minute Demonstration to Your Customers

It will bring many profitable sales per day

All you need is an ordinary steel needle, a Sonora Semi-Permanent needle, and the illustration above. Show them how the ordinary needle's tapered point wears down, broadens, and abrades the record grooves. Show them how the uniform shaft of the Sonora S. P. Needle remains the same width, and plays as long as it lasts—fifty or more records.

THE INSTRUMENT OF QUALITY
Sonora
CLEAR AS A BELL

Semi-Permanent NEEDLES

should be displayed and sold by every phonograph dealer.

Sonora Phonograph Company, Inc.

GEORGE E. BRIGHTSON
President

279 Broadway New York

Canadian Distributors:
I. Montagnes & Co., Toronto

Geor - gia! Geor - gia! My home sweet home

GEORGIA

Irresistible Fox Trot - Full of Rhythm and Snap - It's a Hit

"You can't go wrong with any 'Geist' song"

Proved Instantly Popular in Vaudeville
—A Great Favorite with Dancers.

HEAR IT NOW!

KANSAS CITY

Optimism Features Trade—Rail Strike Curtails Business—Reluctance on Part of Dealers to Place Orders Noted—The News

KANSAS CITY, Mo., August 8.—Business in the talking machine trade in this city has not been over active for some time past, and satisfactory sales records have been in the minority, but a distinct improvement is now being noticed and the majority of jobbers and dealers have confidence that trade is coming back very strongly during the Fall months. They do not look for a volume of business that will measure up to the peak of 1919 and 1920, but expect sufficient sales to insure substantial turnover and profits.

The majority of the trade is of the opinion that the wave of price-cutting and of liquidating stocks has run its course, and that the public will soon come to a realization of the fact that the prices on machines of standing have been stabilized and are equitable.

Effect of Railroad Strike

There is no doubt but that the railroad strike is having a bad effect on the business. It is interfering a little with the movement of the machines and is having a tendency to slow up things. There are many dealers who are reluctant to order, when they are not sure but that the goods will be tied up on the way. Then there is a large number in territory dependent upon the selling and delivery of the wheat crop for their prosperity, who are waiting to see if the wheat will be gotten to market. Then there are a number who live in towns which are dependent

to a large extent for their prosperity on the operation of the railroad shops. When there are a thousand or two thousand men whose income is suddenly cut off there is not much hope for a lively trade in musical instruments in that town. And there are a number of such towns in the Kansas City territory.

Miss Florence E. Hazlett, educational representative of the Columbia Co., working out of the Kansas City branch, has had some very interesting and profitable engagements during the past couple of months. Miss Hazlett recently attended the Normal School at Hays, Kans., where she talked to almost 1,000 school teachers from western Kansas. Her work was received most enthusiastically and many of the teachers promised to get busy early in the Fall and see that Grafonola outfits were put in their schools. Included in the places where Miss Hazlett had most successful engagements were Warrenburg, Mo.; Jasper, Ark.; the State University at Fayetteville, Ark., and the Kansas State Normal School at Emporia, Kans., and Pittsburg, Kans.

New Edison Baby Console Popular

The Baby Console, the new Edison machine, which is offered at the low price of \$175, has been received in Kansas City, and is being distributed to the dealers. It is creating quite a sensation on account of its attractive lines and its price. Dealers are ordering freely. H. M. Lee, Enid, Okla., has been in Kansas City during the past month and freely predicts a fine Fall business.

M. M. Blackman, manager of the Edison branch here, has recently returned from a trip to the factory. He reports that there is much optimism there over the general outlook, and the plans which are being worked out to meet the expected big Fall business.

Credit Situation Improves

Fred Jenkins, of the wholesale Victor department of the J. W. Jenkins' Sons Music Co., reports that there has been a very decided improvement in the credit situation. He says that there are many dealers who have been slow in the past who are now paying promptly, and a number are sending cash with the orders. He says that in the towns where the railroad shops are located the business has been slowed up very perceptibly. There has been a nice business in records, however, throughout the territory.

The Victor department of the Gunn Drug Store, of West Plains, has been sold to the Powell Drug Store of that place.

The recent advertising campaign of Cowman's Pharmacy, Inc., Sapulpa, Okla., was certainly a success and is perhaps best described by a press notice which appeared on the front

page of the Sapulpa Herald, reading as follows:

"In less than thirty minutes after the Herald was off the press with a page advertisement telling of the sale of Columbia Grafonolas at Cowman's Pharmacy, the first deal had been consummated. An even dozen Grafonolas was sold the first day on the strength of that one advertisement.

"A half carload of Grafonolas was brought here for the sale. This caused considerable comment as it was probably the largest shipment of phonographs ever made at one time in this part of the State. The first day's sale was followed by good sales on following days and Mr. Oliver, in charge, has been well satisfied with the results."

The Dodge City Music Co., Dodge City, Kan., exclusive Columbia dealer, recently sold a Grafonola, taking in trade an old type A Columbia cylinder graphophone made by the Columbia Co. twenty-five years ago. The customer stated that he was rather reluctant to part with this old instrument because he had had it about twenty-five years and during that entire time he had only spent \$1 for repairs, and he further stated that the graphophone worked as good now as it ever did. The Dodge City Music Co., after making the trade, put the graphophone, including the large horn and the assortment of some forty or fifty records, in its window and made up a large window card telling the complete story. It created considerable comment.

Working With the Educators

Educational representatives of the Victor Co. are spending the month in Kansas, attending the teachers' institutes and giving lectures on music appreciation, memory contests and other features of school work. There will be twenty-two counties served by these representatives up to September 2. The representatives are S. Dana Townsend, Miss Alice Keith and Miss Marie Finney.

A. O. Drake, of the Dodge City Music Co., Dodge City, Kan., believes in getting business from those to whom he is giving business. He places considerable advertising with the Dodge City Globe, and recently sold the editor of the Globe a Columbia Queen Anne period design Grafonola and also an upright Grafonola to the advertising manager of the same paper.

Good News From Oklahoma

Manager Briggs, of the local Brunswick branch, had in hand a bunch of letters from Oklahoma and western Kansas when The World representative called and said they all read mighty good to him. There was only one note in them that was not most encouraging—the threatened bad effects of the strikes. The wheat crop, the splendid prospects for a big corn crop, and in Oklahoma the renewed activity in the oil fields were all factors in the problem of the Fall trade, and all indicated a big volume. But better than all this is the attitude of the dealers who write or call. He said, "There is but one note and that is encouraging." Mr. Briggs is expecting a gradually improving market.



Artistic Decorating On Phonographs

Dealers and manufacturers, send your phonographs to us for decorations and special finishes. We maintain a high-class studio devoted entirely to this work. We will decorate your phonographs from our large selection of designs or from designs you may particularly specify.

Let us show you our work and submit estimate

MOHAWK WORKS OF ART
Mohawk Building
160 Fifth Avenue New York

BALTIMORE

Business Continues to Improve With Both Wholesalers and Dealers—Store Improvements and Trade Changes of the Month

BALTIMORE, Md., August 10.—July business in talking machines was considerably better than the trade generally had looked for. The sales of portable machines exceeded all expectations and practically every wholesaler in the city was cleaned out by the end of the month. This demand was unusual and the dealers had a hard time supplying the trade, many of them borrowing machines from other branch houses.

The record business also has been good, dealers generally finding it impossible to supply the demand for the latest issues. This is especially true of the new Victor Health records. The three Victor jobbers, Cohen & Hughes, Eisenbrandt's and E. F. Droop & Sons, have been cleaned out of these records for some time, with additional orders accumulating daily.

A new talking machine, the Volunia, will shortly be put on the market. This machine will be manufactured in Baltimore by the Volunia Corporation. It is claimed by the inventor, James T. Cook, to give unusual results. It has several unique and interesting features. It is made in this city. The Volunia Corporation recently opened a demonstration store on North Howard street.

Victor dealers here report an unusually heavy advance sale of the Victrola Model 111, which they expect to have for delivery next month. Wholesalers generally report heavy buying for the Fall trade, most dealers placing orders for considerably more and better quality of goods than last year.

The local Columbia branch reports a good business from the southern section of its territory, especially North Carolina, where business has taken an unexpected boom.

C. F. Shaw, manager of the local branch of

the Brunswick Co., has just returned from a trip to North Carolina and reports opening the following accounts as exclusive Brunswick dealers: R. C. Thompson, Graham, N. C.; Stadiem-Cohn, Thomasville, N. C.; Levy, Page Co., in Norfolk, and L. R. Brown, of Richmond, Va. Mr. Shaw also gives a glowing account of business revival in North Carolina as well as several other States in the South. The Brunswick people have started an extensive campaign of billboard advertising in this vicinity, which is reported to be bringing good results. Edward Strauss, of New York, divisional manager of the Brunswick Co., spent a week at the local branch this month.

Quite a number of men in the trade are now taking their vacations, including W. F. Roberts, manager of the E. F. Droop & Sons Co. branch.

The Rosenstein Piano Co., under the direction of Manager George P. West, has inaugurated a semi-monthly salesmanship meeting of its outside sales force, which is bringing good results. The meetings this month were addressed by William H. Swartz, sales promotion manager of the Columbia Co., and C. F. Shaw, manager of the local Brunswick agency.

Miss Irma Groell, manager of the record order department of Cohen & Hughes, is in New York on a two weeks' vacation, and while there she will visit a number of the larger jobbing houses for the purpose of getting new ideas of the business.

F. S. Harris, manager of the Washington branch of the same house, is spending two weeks' vacation in Atlantic City, and H. T. Bosee, sales manager, and wife will leave for a ten-day trip on the nineteenth.

I. Son Cohen, head of Cohen & Hughes, was

in New York last week to meet his wife and daughter and son-in-law, who just returned from a trip to Europe on the "Mauretania." The marriage of Miss Elizabeth Son Cohen to William Biel, a son of Mr. and Mrs. Lewis Biel, of New York, one of the founders of the United States Cigar Stores Co., took place in New York last month at the Ambassador Hotel, and immediately after the ceremony the couple left for Europe, where they met Mrs. Cohen, who had preceded them by several weeks.

A. Burdwise is featuring and making a special window demonstration of the new phonoreel and reproducing attachment for talking machines. This is the only working demonstration that is being given in the city.

Leonard Trout, of Trout's Music Shop, Highlandtown, is feeling rather "chesty" these days over the fact of having won out with a Grafonola in a recent voting contest at Camp Holabird in competition with four other well-known makes of talking machines. Trout's entry was a K-2 Grafonola on which he featured Ted Lewis selections with the result that when the vote was taken, which included both officers and enlisted men, he was declared the winner by a comfortable margin.

L. & K. Snyder, 2132 East Monument street, are remodeling their place and when improvements are completed will have a store about four times the former capacity in addition to one of the handsomest display rooms in that section of the city. The firm handles the Columbia line exclusively.

Cohen & Hughes are making an extensive display of period Victor machines at their salesrooms on Saratoga street, which is meeting with great success from the trade, many of the dealers bringing prospective customers there, where they can see all the latest styles of machines, something which hardly a dealer in the city has the space to carry or exhibit.

S. C. Cooke, assistant manager of the Baltimore branch of the Columbia, is making an automobile tour of the Eastern section of the country during his two weeks' vacation.

EMERSON FOREIGN RECORDS



Are Good Sellers

Because they please the greater number of 30,000,000 foreigners

Emerson Records in Italian, Hebrew, Jewish, Polish, German, Russian, Ukrainian

Are Leaders in Their Field

DEALERS, CATER TO YOUR FOREIGN TRADE WITH
EMERSON RECORDS

Send for Catalogs and Information Today

EMERSON PHONOGRAPH CO.

206 FIFTH AVENUE

NEW YORK, N. Y.

LOS ANGELES

Business Continues to Move Apace Despite Strikes and Vacations — Console Models Continue in Favor — Other News

LOS ANGELES, CAL., August 7.—The past month has proved to be an exceedingly good one for talking machine departments in spite of the fact that vacations are in full swing and many families are out of town enjoying the beaches and mountains. However, this city has grown to such a size and there is such a large influx of settlers arriving all the time that seasons and different months of the year can be practically disregarded. The number of new homes which are being built is very great and, of course, this is having a stimulating effect on business.

Console Models Popular

Console and period types of talking machines continue to grow in popularity, and dealers are experiencing difficulties in keeping up with the

demand for some of the models. This is particularly true with the Victor line of consoles, which, in the case of several models, are unobtainable throughout this territory; however, relief is promised in the near future and large shipments are expected soon.

Cheney Headquarters Well Established

The Munson-Rayner Corp., Cheney distributor for the State of California, has fitted up a suite of very attractive offices in the Homer Laughlin Building, and a complete line of de luxe period models is on display. Quite a number of dealers in southern California outside of Los Angeles are now representing the Cheney, and announcement of the names, accompanied by display advertisements in the newspapers, of the city dealers will be made within the next thirty days. Headquarters for the northern California territory will be established in San Francisco in the near future, according to Sales Manager Darvill.

H. Jackson With Sherman, Clay & Co.

Harold Jackson has been appointed assistant to C. H. Ruggles, manager of the local wholesale Victor branch of Sherman, Clay & Co. Mr. Jackson was until recently manager of the phonograph department of the Wiley B. Allen Co.

Columbia Stores to Open in Pasadena

The Columbia Stores will open in Pasadena about September 1, under the management of R. L. Tamplin, who has been operating similar stores in San Diego and San Bernardino. Mr. Tamplin started his first Columbia exclusive store in San Diego last October and made a great success of it from the beginning. He followed this up by a second store in San Bernardino and will operate in Pasadena with his third after September. Originally from England, Mr. Tamplin operated a phonograph store, carrying the Columbia line exclusively, in Windsor, Canada, and built up a very fine business, which he eventually sold out and then came down to southern California.

R. W. Moon Back From Gotham

R. W. Moon, general manager of the Swanson Portable Phonograph Co., returned to this city last week after an extended trip to Chicago and New York. Mr. Moon has established the Munson-Rayner Corp. as distributor for California of the new Swanson portable phonograph, but will retain his offices here, as well as those in Chicago and New York. He will remain in Los Angeles for about ten days and will then leave for the East and Middle West.

New Manager of Phonographs at Wiley B. Allen

E. P. Tucker, general manager of the local branch of the Wiley B. Allen Co., has appointed W. Bell sales manager of the talking machine department.

J. J. Grimsey Returns After Long Absence

After an absence of seventeen to eighteen years, J. J. Grimsey—or Joe, as he is known by his friends—has returned to Los Angeles. Joe Grimsey established the first Columbia headquarters here in 1904 and left soon afterwards for Seattle, where he managed the Columbia branch in that city for a number of years. He afterwards obtained the Dictaphone agency for Seattle and conducted it for some time. He has now returned to manage the southern California branch of the Walter S. Gray Co., talking machine accessory distributor and Pacific Coast jobber of the Strand phonograph and Strand Console, and is very welcome.

Music Trades Association Meets

The July meeting of the Music Trades Association was attended by over fifty members, the occasion being the return of those members who had attended the National Jubilee Convention in New York. Speeches were made by all the delegates and satisfaction expressed by them at the benefits derived by all who were there. President Boothe announced that a banner had been

awarded to the Southern California Association for the best organized effort and that it had been anticipated that the formal presentation would be made at the present meeting, but that the banner, with its suitable inscription, had not yet arrived.

Members of Paul Whiteman's Orchestra Here

Several members of the celebrated Paul Whiteman's orchestra visited this city during July, including Donald E. Clark, M. Pingatore, Harold McDonald and Paul Whiteman himself. Practically all of the members of this orchestra claim this city as their home town and long before they went to New York and recorded for the Victor Talking Machine Co. they were famous in this part of the country as the Hotel Alexandria Dance Orchestra.

Platt Music Co. Enjoys Outing

On July 19 the entire Platt Music Co. organization were guests of their president, Ben Platt, at a unique outing. One hundred and twenty employes of the store journeyed down to San Pedro, twenty-five miles away, where they were received on board the Marco Hellmann houseboat. A sumptuous banquet was enjoyed. A cabaret show, composed of members of the Platt organization, was given. Speeches were afterwards made by Marco Hellmann, president of Hellmann's Bank; E. Cohen, vice-president, and by the celebrated actor, George Beban. A trip was also taken by the ladies around the harbor in Mr. Hellmann's steam yacht.

E. D. Sloat at Wurlitzer's

The new branch of the Rudolph Wurlitzer Co., which was recently opened in this city and occupies the quarters formerly leased by the Bartlett Music Co., has E. D. Sloat as manager of the Victrola department.

Barker Bros. Close San Diego Store

The Barker Bros. branch in San Diego has been closed after having been established in that city for over two years. Earl S. Dible, former manager, after disposing of the lease, has joined the sales department of the Los Angeles music department of Barker Bros.

Some Columbia News

A rousing welcome was extended to Duci De Kerekjarto, famous Hungarian violinist and exclusive Columbia artist, on the occasion of his appearance at the Orpheum Theatre in this city recently. Columbia dealers all tied up very strongly with this appearance through the use of appropriate window displays and they all report an active demand for Kerekjarto records. A unique feature of the publicity was a large replica of a Columbia record twelve feet in diameter mounted on a truck with appropriate banners which paraded the downtown streets every day during the artist's appearance and which attracted considerable interest everywhere.

A new addition to the long list of Columbia dealers in this territory is that of Smith Brothers at Van Nuys, Cal. This concern was formerly a Columbia dealer at Maricopa, Cal., but two years ago moved to San Pedro, where it engaged in another line of business. Owing to the ill health of one of the partners the San Pedro business was closed out some time ago and the concern moved to Van Nuys, where it made application immediately for the Columbia franchise.

Among other Columbia dealers recently established by the Los Angeles branch are Rosenblatt Bros., 2501 Central avenue, and M. Chernoff, 2101½ East First street. Both of these dealers cater to extensive Hebrew-Jewish clientele, and carry complete stocks of these records of all kinds.

The Los Angeles branch recently appointed a new exclusive Japanese dealer in Los Angeles, K. Okasawa, at 124 South San Pedro street, where it placed an order for a complete stock of Grafonolas and a representative record library.

G. C. Vasquez, 11 South Meyer street, Tucson, Ariz., has recently been appointed a Columbia dealer, and with this appointment the Columbia Co. has three exclusive dealers in Tucson. The other two Columbia representatives in this city are R. R. Floras and the Morrison Music Co.

THE PORTABLOOP



Size 24 x 27 inches over all

The next big seller in radio.

Opening an entirely new field for the radio dealer.

Don't hesitate, order a sample now.

List Price

\$10.00



210 Central Avenue

SENATE FINANCE COMMITTEE LOWERS DUTY ON RECORDS

Recommends Duty of 30 Per Cent on Talking Machine Records and Needles, Based on Foreign Valuation—Senate Adopts Foreign Valuation Plan as Basis for Levying Taxes

(Special to The Talking Machine World)

WASHINGTON, D. C., August 8.—During the consideration yesterday of the paper schedule of the McCumber-Fordney tariff bill the Senate Finance Committee made a number of recommendations of direct interest to the talking machine industry. Rates on albums, phonograph records, wholly or partly manufactured, were reduced from 35 per cent to 30 per cent ad valorem, on the foreign valuation plan. The House rate was 23 per cent ad valorem on the American valuation plan. A rate of 15 per cent ad valorem has been provided to cover music in books or sheets, when of bona fide foreign authorship, and 25 per cent for all other music in books or sheets.

The Senate will soon reach the provisions deal-

ing with musical instruments. The Washington Bureau of The Talking Machine World is in receipt of a number of inquiries from importers and dealers as to the rates on phonograph needles. These needles will take the same rate as phonographs and talking machines, which are dutiable at 30 per cent ad valorem.

The ad valorem rates adopted by the Senate are to be based on the foreign valuation plan that is now the practice. The Senate is decidedly opposed to the American valuation plan as adopted by the House and indications are that their opposition will be successful and that the House plan will be completely rejected. It is charged that the American valuation plan would not be workable.

JEWETT PHONOGRAPH CO. EXPANSION

Will Have Three Radio Combinations to Be Marketed in Our Trade—Capital Increased to \$1,250,000—New Distributors Appointed

DETROIT, MICH., August 8.—In addition to the regular line of Jewett phonographs, the Jewett Phonograph Co. announced recently its entrance into the radio field. It will have three radio combinations, which will be marketed through the phonograph dealer, as the company feels that the radio and phonograph industries are more or less closely associated. There will be featured a cabinet in which will be combined the phonograph and radio set; a cabinet which has been especially designed for radio only, or, in other words, a cabineted radio and, lastly, radio sets which are not housed in cabinets of the phonograph type. Thus the Jewett Co. will have really four products, including its phonographs, with which to attract sales.

The cabinets were especially designed in the Jewett laboratories and the radio sets are the first to be scientifically designed to meet the

need of phonograph reproduction. These sets are very powerful, highly selective affairs—all that experienced radio technicians would be expected to turn out. The company is at present selecting its representatives very carefully, and is offering them a franchise proposition that is said to be very attractive. It is planned to spend 10 per cent of the net sales from each district in advertising in that district. This is only one of the many ways in which the company will cooperate with its representatives, in addition to its liberal discounts to dealers. The Jewett Co. also announced an increase in capitalization from \$750,000 to \$1,250,000.

The Jewett Phonograph Co., Ltd., of Canada, has been recently incorporated and will start business in December, with a capital of \$400,000. The general offices and factory will be located at Walkerville, Ont. E. H. Wilkinson, who came to Detroit in May, 1921, from the Vocalion Co., of New York, to act as production manager of the Jewett, and who is now general manager of the company, has been elected assistant secretary of the company. He is also secretary

of the Jewett Phonograph Co., Ltd., of Canada.

The Stewart Sales Co., of Indianapolis, has been appointed distributor for the Jewett phonographs and radio for Indiana and Kentucky. The new jobbers are particularly enthusiastic over their new line.

The Radio Shop, 1501 Washington Boulevard, recently opened under the management of M. Otto, will feature the Jewett radio equipment, and is planning on pushing these sets and combinations very strongly.

The Pettis Drygoods Co., of Indianapolis, has been appointed Jewett dealer under the Stewart Sales Co.

The Vitullo & Ulisse Co., of Utica, N. Y., will handle the complete Jewett line in that city.

OKEH EXHIBIT AT FAIR

General Phono. Corp. Has Attractive Exhibit at National Merchandise Fair—Records, Needles and Wireless Apparatus on Display

The General Phonograph Corp., New York, is maintaining a very attractive exhibit at the National Merchandise Fair, which opened Monday, August 7, and which will probably continue until near the end of August. The company occupies Booth 571 at the Grand Central Palace, where this fair is being held, and among those in attendance at the exhibit are E. L. Sampter, W. C. Giles and Homer Stephens.

The products exhibited by the General Phonograph Corp. at this fair for buyers include the following: Okeh, Odeon and Fonotopia records; toy phonographs, made at the Elyria factory; Truetone and Okeh steel needles; Meisselbach fishing reels and wireless apparatus.

J. W. JENKINS INSTALLS RADIO

TOPEKA, KAN., August 7.—A complete line of radio receiving sets and accessories to be handled at retail in connection with the talking machine end of the business is being installed by the J. W. Jenkins' Sons Music Co., of this city. Manager Clyde Farris made the announcement.

An Addition to the MUTUAL LINE

The New No. 1 A Tone Arm

Designed for both PORTABLE and UPRIGHT machines. Superiority in tone and appearance combined with low price make this one of the best values obtainable. It will make your business grow.

If you manufacture portable or small upright machines you will be interested in this combination. A trial order will convince you.

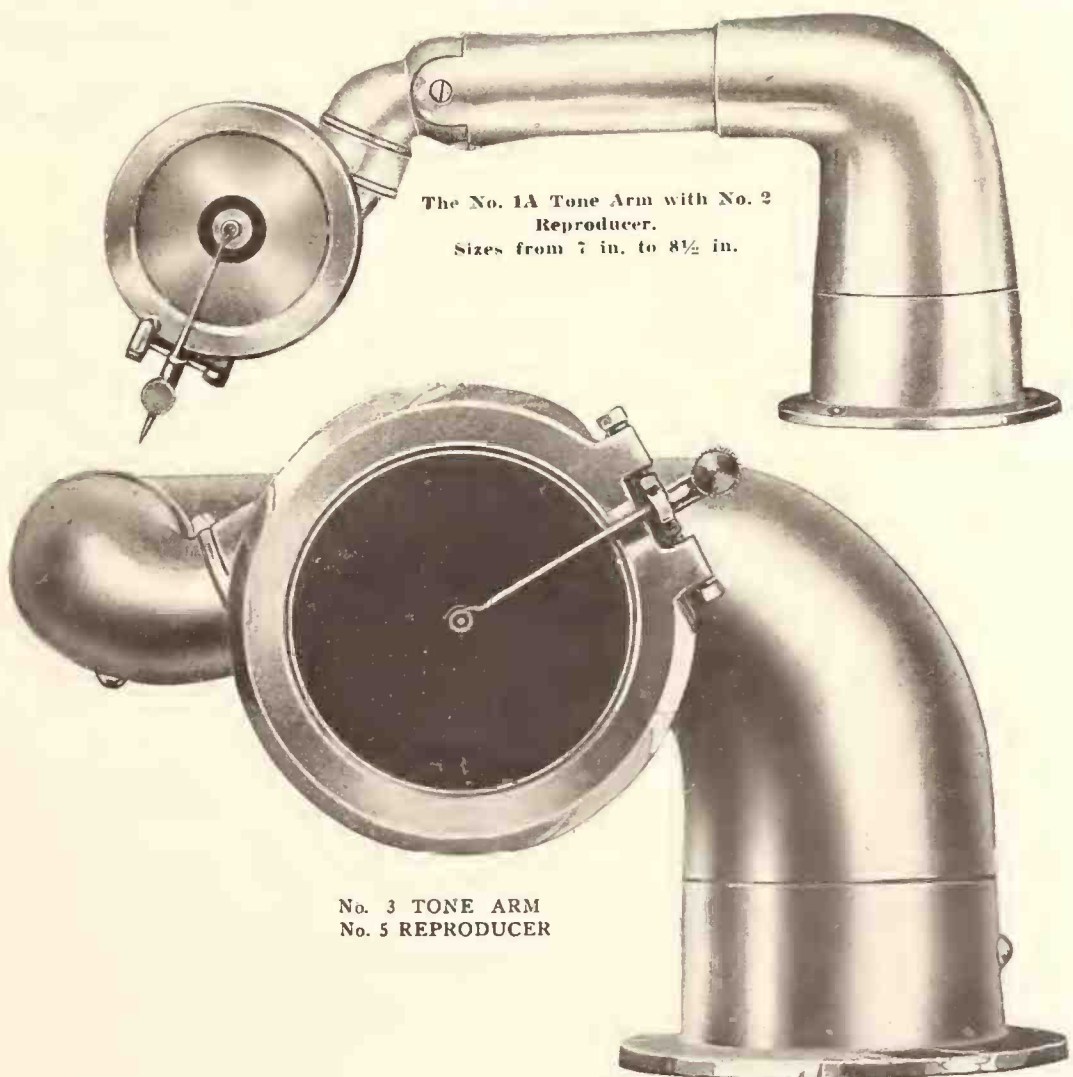

Mutual Phono Parts Manufacturing Corp.,

**149-151 Lafayette Street
New York City**

The Russell Gear & Machine Co., Ltd., 1209 King St., West, TORONTO, CAN., Exclusive Distributors for Canada and All Other British Possessions

The Last Word in Electric Phonograph Motors

Make this *your*
leading line for
the coming
s e a s o n

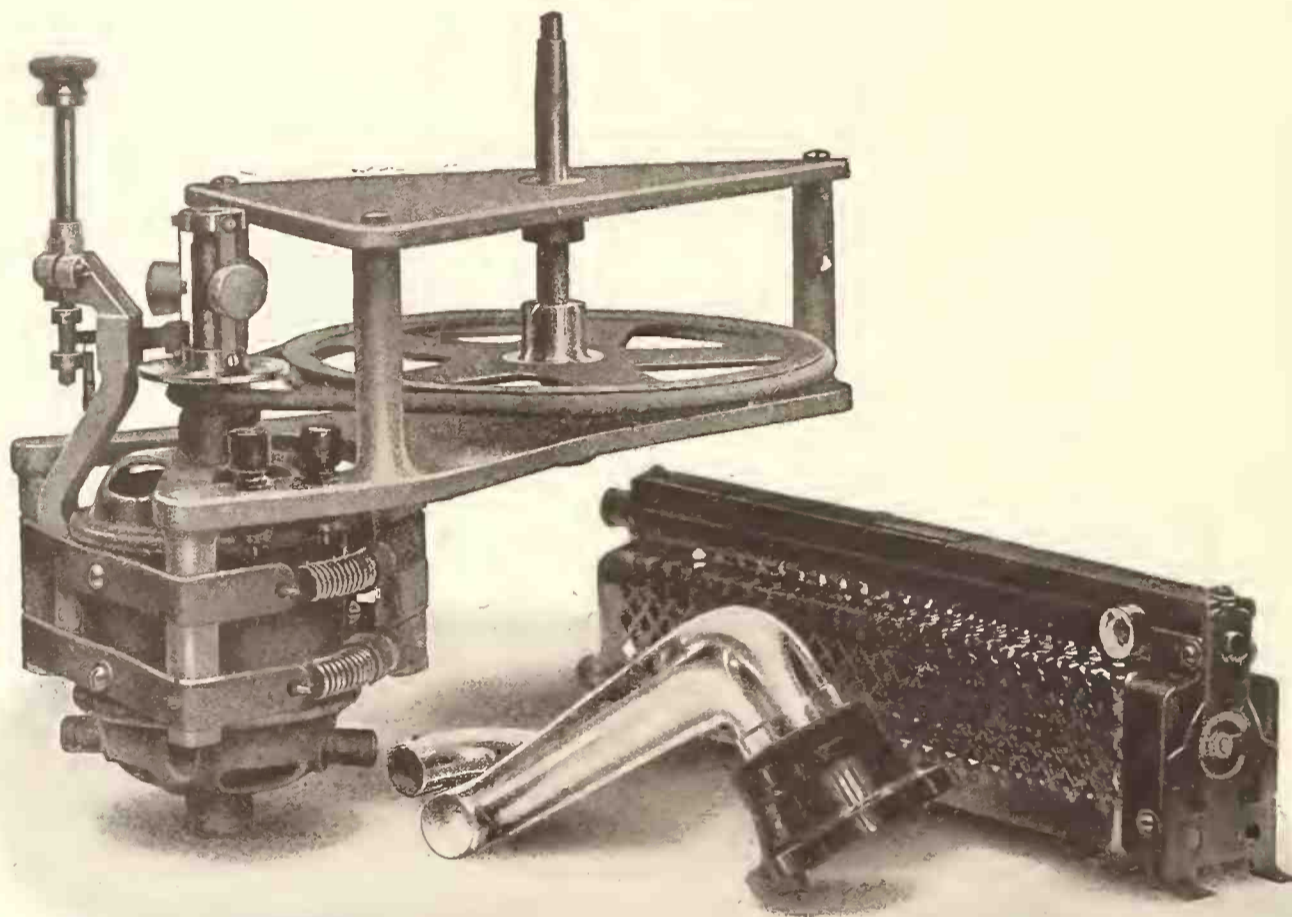

The Electromophone

Absolutely Silent

Adjustable to any voltage. Tone arm equipped with electrical stopping device, which operates in conjunction with the Electromophone—Record stops automatically on last note—Never fails!!

The Sole Selling Rights of This Unique Mechanism Are in the Hands of

THE STERNO MANUFACTURING CO.

19 CITY ROAD

LONDON, E. C., ENGLAND

HAPPENINGS IN THE DOMINION OF CANADA

INTERESTING WINDOW DISPLAYS AID TORONTO SALES

R. S. Williams & Sons Co. Features Edison Machines and Radio in Attractive Window Display
—Offer Study Course in Exporting—Getting Business by Phone—Trade Changes

TORONTO, ONT., August 6.—The large show window of the Ottawa branch of the R. S. Williams & Sons Co., Ltd., recently had an interesting exhibit in the form of a radio-receiving outfit with a female figure seated at the table with the receivers on her ears as if listening to a concert. Another section of the display included several Edison models, and signs referred to the two wonderful inventions, one by Marconi and the other by Edison. Incidentally, Manager Arthur Mandy has been going right after Summer business and has made a special play for sales of portable phonographs for Summer cottages, camps, canoe outings, etc.

A short course for those interested in exporting is to be instituted by the University of Toronto at the request of, and in co-operation with, the Federal Department of Trade and Commerce. The course will last two weeks, commencing January 15, 1923. It is being held on condition that Canadian manufacturers will lend their support by making it possible for their export managers to attend in sufficient numbers to make the course worth while. The course will be both theoretical and practical.

The proprietors of the West Toronto Music Co., formerly at 2823 Dundas street West, have erected a large new store on the same side of the street, a little farther west, at 2989 Dundas street West, the ground floor of which they are now occupying. The new store, which has been tastefully designed, is under the management of E. D. Lott and carries Columbia, Brunswick, Apex and other lines.

Robertson, Pingle & Tilley, Ltd., of Ottawa, known as The Brunswick Shop, are putting the ordinary telephone to a new and unique use. The company has invited the general public to ask to hear selected records over the telephone. When a request is received over the wire for a certain selection the record desired is played on a phonograph immediately in front of the telephone. If the selection is acceptable to the auditor at the other end the record is forthwith delivered to the home. This plan of selling practically goes the radio one better, as the telephone is continuously available for the purpose.

The Edison Phonograph Shop, formerly located at 382 Yonge street, Toronto, has moved to new quarters at 12 Queen street East. The new location has been artistically fixed up to meet the needs of Edison phonographs and records. The store is finished in mahogany. Seven sound-proof rooms have been installed for demonstration purposes and record racks that will accommodate 10,000 records form part of the store's equipment. A show window at the front that is convex in shape further enhances the high degree of artistry within.

Elliott's Music Store, Vocalion dealers, at 3085 Dundas street St. W., Toronto, had an attractive float in the recent parade conducted by the West Toronto Business Men's Association. A big red Vocalion record eight feet in diameter was the particular drawing card of the float.

New Ontario incorporations include Gold Medal Radio Corp., Uxbridge, Ont., capitalized at \$300,000.

John A. Croden, president of the Starr Co., of Canada, Ltd., who underwent an operation in Victoria Hospital early in July, is recovering very satisfactorily, to the delight of his friends.

A big window display that proved to be a selling proposition was presented in the large window of Orme, Ltd., Ottawa, as a demonstration of the use of the new portable Victrola for camping purposes. The whole window was pro-

vided with a background of evergreen trees and a tent, canoe, logs and other appropriate "props" were added to the life-size setting. In the foreground was a dummy camper in khaki trousers and sweater seated in front of a Victrola model. The firm reported that a number of these phonographs were sold as a direct result of the display.

Leach, Clegg & Leach, of the same city, provided an interesting window display for several days recently in the form of a Marconi wireless demonstration set, which attracted much attention, as the radio movement is yet in its very infancy in Ottawa.

B. A. Trestrail, of Musical Merchandise Sales Co., Toronto, has survived the first year of married life. To impress the fact upon the minds of his friends, he and Mrs. Trestrail entertained some forty friends on the occasion of their first wedding anniversary at a dance and supper at the Lakeview Golf and Country Club.

The stock and shipping department of the General Phonograph Corp., of Canada, Ltd., which has been at the same address at the Toronto office at 172 John street, has been

transferred to the firm's Canadian factory at Kitchener. C. J. Pott, the Canadian manager, informed your correspondent that this move would mean even prompter shipments of motors and equipment than in the past. The office mailing address remains 172 John street, Toronto.

Manager Arthur Mandy, of R. S. Williams & Co., Ltd., Sparks street, Ottawa, gave a striking demonstration of the use of the special Walter Camp physical instruction phonograph records which carry the title of "Daily Dozen," and offers direction for various setting-up exercises. To explain the use of the record Mr. Mandy secured the services of a local athlete, who gave an exhibition of calisthenics in keeping with the "Daily Dozen" directions. The exhibition was given in the show window of the Ottawa store at noon and just before closing time, so that it would be seen by the maximum number of people. The stunt was such a success, even in the hot weather, that Mr. Mandy intends to repeat the whole thing early in the Fall.

E. D. Coots, assistant to the sales manager of the Sonora Phonograph Co., Inc., of New York City, is spending some time in Canada with the Canadian distributors of the Sonora, Messrs. L. Montagnes & Co., Toronto. This is Mr. Coots' first visit to Canada and he expects to remain here some weeks visiting Sonora dealers.

MONTREAL MERCHANTS WILL ACT ON "GYP" DEALERS

Retail Merchants' Association Calls Meeting to Consider Curtailment of "Gyp" Phonograph Dealers
—Movements of the Trade—Dealers Profit by Sousa's Appearance—Other News

MONTREAL, August 7.—We understand the Retail Merchants' Association of Montreal, which have in the past accomplished good work in eliminating several evils and remedying others, will shortly convene for the purpose of endeavoring to see what action can be taken with reference to "gyp" dealers handling and selling phonographs from private addresses, thus avoiding the payment of taxes, which legitimate dealers are forced to pay. One of their first actions will be to try to interest the newspapers in having them refrain from inserting advertisements of this nature.

Leopold Authier, of Montreal, has secured a Canadian patent on a system of cabinet lighting, for which many claims are made. The cabinet has a plurality of panels of transparent matter, a disc rack in said cabinet, arranged to provide a free space within three sides of said cabinet, and electric lamps suitably secured within said space for the purpose of illuminating the transparent sides of said cabinet.

J. A. Bienjonetti, who has had charge of the piano and phonograph departments of N. G. Valiquette, Ltd., has resigned to join the advertising department of La Patrie, Montreal.

Miss Faucher, of the phonograph department, and Miss Casselman, in charge of the record department, C. W. Lindsay, Ltd., are on vacation, the former in Edmonton, Alta., and the latter in Ottawa and vicinity.

A. W. Landay, of Landay Bros., New York

City, was a recent visitor to Montreal. He called upon Layton Bros. and was shown through their warerooms by Armitage Layton.

At the recent annual meeting held in Toronto of the Canadian National Institute for the Blind, C. W. Lindsay, president of C. W. Lindsay, Ltd., Sonora and Columbia dealers, was elected one of the vice-presidents for the ensuing year.

Ernest C. Bray, sales and advertising manager of Layton Bros., Ltd., is spending his vacation at Old Orchard Beach, Me.

The Champion Music Co. has made an assignment for the benefit of its creditors.

At the St. Denis Theatre, Montreal, next season, will be heard such great artists as Gallucurci, the Boston Symphony Orchestra, Kreisler, Rachmaninoff, Geraldine Farrar, Muratore and Heifetz. These bookings have been made.

"Going like hot cakes" was the expression of Layton Bros., Ltd., regarding an inquiry as to how Marconi radio outfits were selling.

Sousa's Band has just terminated its engagement of a week at Dominion Park. The public never seems to weary of his programs or his music. Naturally, His Master's Voice local dealers cashed in on his appearance in person.

"Never to my knowledge have our show windows proved such magnetic drawing power as during the past week," said Leopold A. Poulin, of C. W. Lindsay, Ltd., "when we had on display the attractive nickel-plated demonstration

(Continued on page 138)

Talking Machine Springs and Repair Parts

NONE BETTER IN QUALITY NONE LOWER IN PRICE

THE RENÉ MANUFACTURING CO.
MONTVALE, NEW JERSEY



WARNING! This Melody is Contagious!
Once you get it you can't forget it!

COAL BLACK MAMMY

Europe's Latest and Biggest Fox Trot Tune

"You can't go wrong With any FEIST song"

Cause I'm goin', yes, I'm goin' with a love that's ever growin' to that Coal Black Mammy o' mine

NEWS FROM DOMINION OF CANADA

(Continued from page 137)

stand of the Simplex electric motor, manufactured and advertised every month in The Talking Machine World, by the Simplex Electric Phonograph Motor Co., Wilder Building, Montreal. This motor was seen in full operation running continuously without a stop, and was the identical motor that caused such favorable comment at the New York Music Convention. "It certainly should stimulate the sale and interest in phonographs," said Mr. Poulin, "and we intend having it on exhibition again very shortly. Several thousand persons were attracted to our window within three hours' time," concluded Mr. Poulin.

The Canadian Graphophone & Piano Co., St. Catherine street, East, likewise had a model on display, which also created considerable interest, the street being blocked at times that made it impossible for pedestrians to pass along.

Mr. Bermister, one of the best informed men in the accessory field, intimated that on the occasion of the recent trip to Montreal of Philip E. Grabuski, of Everybody's Talking Machine Co., Philadelphia, arrangements were made whereby he has added to his agencies that of "Honest Quaker" mainsprings, made by that firm. Mr. Bermister has the Canadian agency for a number of American phonograph accessories, and the "Honest Quaker" mainsprings will be an important acquisition.

Reginald L. Chilvers, who until January last was sales manager of the Berliner Gramophone Co., Ltd., and whose long connection with that institution has previously been referred to in The World, has linked up with the Manufacturers' Phonograph Co., Inc., of New York City, maker of "Strand" phonographs. The Manufacturers' Phonograph Co., Inc., which Mr. Chilvers will represent in the Canadian territory east of Kingston, is presided over by George W. Lyle. It makes a line of moderately priced, artistically arranged flat-top console phonographs selling in Canada at \$165, \$210, \$250, \$275 and \$350. Mr. Chilvers will make Montreal his headquarters, his address being 49 Lincoln avenue. With the growing popularity of console designs and the fact that a greatly increased production of console cabinets has brought the price to a figure that almost any reasonably good prospect can afford, Mr. Chilvers is quite optimistic over the field for the Strand consoles in Canada.

Emile Berliner, of Washington, inventor of the gramophone, and president of the Berliner Gramophone Co., Ltd., recently spent a few days in the latter city. While in Montreal Mr. Berliner, who is undoubtedly reputed to be one of the greatest technicians in the talking machine and record art, spent considerable of his time in the record factory examining the changes and improvements which have been made in record manufacturing during the past year.

Eugene Widmann, president of the Pathé Co., of New York, visited Montreal and Quebec recently on the occasion of a holiday in Canada.

NEW ORLEANS

Business Shows Increase—Good Results From Active Sales Campaigns—New Columbia Home—Some Artistic Windows—The News

NEW ORLEANS, LA., August 5.—Nearly all the talking machine stores and departments in this city and vicinity report business on the increase, the good work of June being repeated in July. With this improved business as an incentive the various stores are preparing for an active Fall season by ordering liberal quantities of stock, particularly machines, horizontal and console models receiving the most attention.

That people have money now and will buy, provided the proper selling effort is used, was demonstrated recently by J. D. Moore, manager of the talking machine department of the Maison Blanche, who closed out a full carload of machines representing a special purchase. There were not enough of the special-sale machines to meet the demand and a surprising volume of business was switched over to the regular lines handled by the company.

Philip Werlein, Ltd., have attracted much attention locally with an elaborate window display, featuring "Stumbling" and "Memphis Blues," some idea of which may be obtained from the accompanying illustration. A real negro jazz band is shown in the background playing for the couple dancing. A big Victor record, with a knockout hole in one side shows just how "Memphis Blues"



A Fetching Werlein Window

is taking here. The record is six feet in diameter and were it real would take two hours and forty-five minutes to play. This window was designed entirely by Mr. Powell, manager of the Victrola department.

The Columbia Graphophone Co. branch here has not only signed a lease for a big new three-story home on North Peters street, into which it will move at an early date, but has launched a drive on the sale of records which, though only in progress a few days, has been a grand success.

A. A. Sparrow, district manager of the Columbia Co., has just returned from visiting two of the local country dealers. These dealers, at Oakdale, and Biloxi, were selected as the ones to begin the house-to-house canvass on records.

Prizes, in addition to the usual 10-cent commission on every record, are being offered by the company as a further incentive to the record solicitors. Three prizes will be awarded in every district where a dealer agrees to inaugurate a record contest. The prizes are to be awarded to those selling the highest number of records over a period of four weeks. The three prizes are: a Roamer racing bicycle, a radio receiving set and a leather suitcase lined with silk, with a complete toilet set. The winner of the first prize gets his choice and the second winner his choice of what is left.

A unique plan was thought out in Oakdale by one of the dealers. Two or three of the local Boy Scout troops had just returned from a vacation and their treasure was sadly depleted. At a meeting of the Scouts with the local dealer it was decided that they would start selling records, turning into the treasury all the commissions collected and have the boys compete for the prizes. The plan is working excellently.

"Business is improving every day," said Mr. Sparrow. "We have just opened up new agencies in El Dorado, Ark., in the center of the oil field, and also in Haynesville, another big oil center in Louisiana. In El Dorado it is the McShilling Furniture Co. and in Haynesville it is the McConnel Furniture Co."

Word received from Morgan City, La., from J. J. Goldman tells of how an attractive window netted him seventeen Grafonola sales in two days. He has also ordered, since then, twenty-two Grafonolas by wire. He decorated his window with brand new dollar bills and advertised a dollar sale. A machine could be bought by putting a dollar down. The only other requirement was that they had to buy \$10 worth of records. After the sale was over he found that there was not one down payment of less than \$10 and also that the demand was bigger than the supply.

At Dwyer Piano Co. W. T. Berry, sales manager of the Victrola department, states that business has increased steadily all through the month. Portable and horizontal types have been popular.

His record sales have been even better than his Victrola sales. This he attributed to the club plan which he has inaugurated among his old customers. J. T. Dwyer, president of the company, is away on a four to six weeks' vacation in Santa Fe, N. M.

Ralph Young, at Grunewald's, is very enthusiastic over the showing which his department has made in the past month. "It is phenomenal," said Mr. Young. "The horizontal Victrola is going like wildfire."

C. E. Sadler, of the Victrola department, is leaving the Werlein house to take charge of a Victor branch house in Hammond, La.

Meet Me Next Sunday

(See Page 116)

Jack Snyder

TRADE GLEANINGS FROM PITTSBURGH

Outlook Bright for Fall Trade, Says Evans—Columbia Dealers Report Improved Sales—Standard Co. Making an Aggressive Campaign

PITTSBURGH, PA., August 7.—In a chat with the representative of The World, regarding general conditions, T. T. Evans, manager of the wholesale Victor department of C. C. Mellor Co., said:

"The outlook is very bright for Fall business, provided the coal situation is straightened out and we are able to keep our mills going and open up additional mills that have been closed down due to the shortage of coal. The unfilled tonnage in practically every steel concern around Pittsburgh is very great at this time and if they can get sufficient coal we will have unlimited production indefinitely.

"The stocks of Victrola instruments that are now in the hands of Victor wholesalers are dwindling rapidly and I firmly believe we are going to have an acute shortage of Victrolas at the holiday season. This is due, in a measure, to the fact that dealers are working on skeleton stocks and a moderate amount of buying on the part of the public will create a shortage."

The Columbia Graphophone Co.'s branch in Pittsburgh has received many interesting reports from its dealers regarding conditions and unusual sales. For example, the graduating class of the Eastover High School voted a Columbia Grafonola as a gift to the school at the close of its school term, this instrument being purchased from the McNutt Furniture Co.

The various department stores in Pittsburgh handling Columbia products, including Kaufman & Baer, the Rosenbaum Co. and the Joseph Horne Co., report an improvement in record sales with excellent prospects for Fall business.

Among the recent visitors to the Pittsburgh branch of the Columbia Graphophone Co. were Hays Bros., of Bellaire, Ohio; William Polangin, of Farrell, Pa.; O. F. Benz, record sales manager, of the Columbia Co., and J. Moore, of the Omaha branch.

E. J. Dingley, assistant sales manager of the Victor Talking Machine Co., accompanied by Mrs. Dingley and her sister, stopped over at Pittsburgh a fortnight ago on their return from an automobile trip to Mr. Dingley's former home in Richmond, Ind. While in Pittsburgh the Dingleys were the house guests of J. C. Roush, of the Standard Talking Machine Co. Mr. Dingley was also a guest at a luncheon attended by representatives of the three local Victor jobbers; the C. C. Mellor Co., the W. F. Frederick Piano Co. and the Standard Talking Machine Co.

The Standard Talking Machine Co. is making an aggressive campaign on the new Victor Health Exercise records. One of the items in this campaign is a corps of men and women demonstrators which the Standard Talking Machine Co. furnishes to its dealers for window and store demonstrations. First shipments of these record sets were oversold before their arrival and orders have been received for large quantities.

E. J. Marx, traveling representative for the Victor Co. in this territory, has just returned after a week spent at the factory and a two weeks' vacation spent in the East.

NEUMEISTER BACK FROM EUROPE

Charles W. Neumeister, one of the most popular members of the wholesale record trade in Chicago and New York, arrived Sunday on the "Nieuw Amsterdam," after spending six weeks in Europe. Mr. Neumeister states that his trip was in the nature of a vacation and, judging from all indications, he enjoyed it thoroughly.

W. H. S. ROOKE HONORED

W. H. S. Rooke, of Cassidy's, Limited, Columbia dealers, Winnipeg, was recently elevated to the board of governors, Manitoba division of the Canadian Credit Men's Association, at the recent meeting held in Winnipeg, Man.

NEEDLE BUSINESS IMPROVING

ANSONIA, CONN., August 8.—The Mellowtone Needle Co., of this city, manufacturer of the Superb semi-permanent stylus, finds that business is steadily improving and is optimistic regarding conditions for the Fall and Winter seasons, due to a consistent increase in its business.

E. E. MITCHELL HOME FROM COAST

MONTGOMERY, ALA., August 7.—E. E. Mitchell, manager of the Victrola department of Montgomery Fair, this city, has just returned from an extensive trip to the Pacific Coast. Mr. Mitchell was so charmed with the beauties of the West that he is now one of its greatest boosters. While in California he visited the San Joaquin Valley, San Francisco, Oakland, Berkeley, and on the return trip stops were made at Salt Lake City, Colorado Springs, Pikes Peak and other points of interest.

AN EFFECTIVE PUBLICITY STUNT

SAN ANTONIO, TEX., August 7.—Thomas Goggan & Bro., wide-awake Victor dealers of this city, are enjoying a good business due to their aggressive methods. One of the plans recently put in effect by this concern is the enclosure of a small, artistically prepared pamphlet, calling attention to the lines handled by the company, with the record supplements for mailing to customers.



Patent Pending
Size: 8 in. x 14 in.
x 15 in.
Weight: Complete,
including album,
22 lbs.

"One handle handles it"

Outing

TALKING MACHINE

Perfection in a Portable
Phonograph

Made in Mahogany
and Fumed Oak Finishes

THE OUTING is the most complete and up-to-date portable phonograph ever made.

It is unique and attractive in design. Superior tone quality. Built to give years of satisfactory service.

JOBBERS:

- | | | | |
|--|---|--|--|
| <p>GENERAL PHONOGRAPH CORP.
New York Distributing Division
15 West 18th Street
New York, N. Y.</p> <p>CABINET & ACCESSORIES CO.,
145 East 34th St.,
New York, N. Y.</p> <p>BRISTOL & BARBER
3 East 14th St.
New York, N. Y.</p> <p>THE GRAFONOLA CO. OF NEW ENGLAND
174 Tremont St.,
Boston, Mass.</p> | <p>GEO. C. ULRICH & CO.
718 Lincoln Bldg.,
Philadelphia, Pa.</p> <p>ART EMBROIDERY CO.
Louisville, Ky.</p> <p>IROQUOIS SALES CO.
210 Franklin St.,
Buffalo, N. Y.</p> <p>UTICA'S GIFT & JEWELRY SHOP
Utica, N. Y.</p> <p>DAVENPORT PHONO. & ACCESS. CO.,
217 Brady St.,
Davenport, Ia.</p> | <p>VOCALION CO. OF OHIO
Cincinnati, O.</p> <p>VOCALION CO. OF OHIO
Cleveland, O.</p> <p>BURNHAM, STOEPEL & CO.
101 East Larned St.,
Detroit, Mich.</p> <p>WALTER S. GRAY CO.
942 Market St.,
San Francisco, Cal.</p> | <p>J. K. POLK FURN. CO.
294 Decatur St.,
Atlanta, Ga.</p> <p>CANDIOTO PIANO CO.
120 S. Limestone St.,
Lexington, Ky.</p> <p>WM. ANDERSON PIANO CO.
79 Eighth St., S.,
Minneapolis, Minn.</p> <p>RICHMOND SPORT & SPECIALTY SHOP
(Newton Corp.)
616 E. Broad St.,
Richmond, Va.</p> |
|--|---|--|--|

There are still several good States and large Cities open. Full details or samples will be furnished responsible jobbers on application.

Outing

TALKING MACHINE CO., Inc.

A. J. COTE, President
MT. KISCO, N. Y.

Dealers in Mexico and Cuba should send orders and inquiries to
R. C. ACKERMAN
291 East 162nd Street New York, N. Y.

Foreign Export—**CHIPMAN LIMITED**
8-10 Bridge Street New York City
Cable Address, **CHIPMUNK**, New York



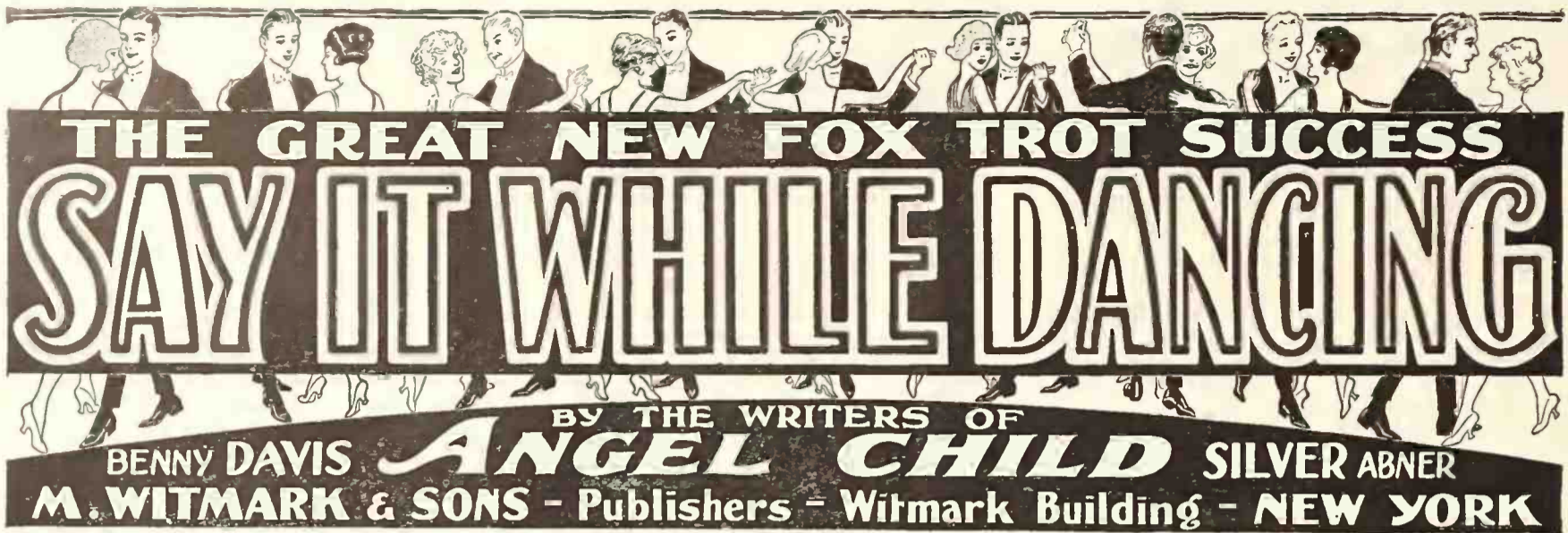

THE GREAT NEW FOX TROT SUCCESS
SAY IT WHILE DANCING
 BY THE WRITERS OF
BENNY DAVIS ANGEL CHILD SILVER ABNER
M. WITMARK & SONS - Publishers - Witmark Building - NEW YORK

AN OLD PERIL IN A NEW GUISE

By Julius Klein, Director, Bureau of Foreign and Domestic Commerce

Well-authenticated confidential advices received by the Department of Commerce from various sources indicate the recurrence in a virulent form of an old evil, which has from time to time imperiled individual interests in the export trade, but now seems to be directed against certain exporting industries as a whole.

The means employed are to tie up the American exporter in an agency agreement and to push competing goods of foreign make under the protection of the existing agency arrangement.

Agency Agreements Should Be Examined

This practice is not new, but apparently it has never been tried so extensively as at present, according to indications, for which reason it is deemed expedient to issue a word of caution to American exporters. It is absolutely essential, for the present prosperity and the future welfare of the American export trade, to exercise the most rigid scrutiny over the details of agency agreements which tie up the exporter in a certain territory.

Is your agent bound by open or secret affiliations to interests other than American? Does the agency agreement permit him to paralyze the active promotion of your interests and to devote himself actively to the sale of competing goods? The danger outlined is not a mere bugaboo, but actually exists, and flagrant cases have been submitted to the Department of Commerce as evidence.

The problem which the situation presents is exceedingly delicate and difficult. The solution—to entrust the agency of an American firm to a strictly American agency organization—is simple enough, but cannot be everywhere applied in practice because such organizations are comparatively few. But it is imperative to examine most closely the existing and the proposed agency arrangements with firms whose affiliations are not entirely American.

It has been suggested that where an American firm cannot be found a native firm, free from any suspicion of foreign affiliations, should be entrusted with the agency, but even this expedient may not always answer. In many markets the distribution of imported goods has never been in native hands.

Need for American Agencies

The sad fact remains that in the task of distributing American goods abroad American traders had largely depended before the war upon European agencies and other foreign channels. Even until very recent days they had depended

upon foreign-owned bottoms to carry them. It is the obvious and immediate task of American business to create throughout the world a network of American agencies, or at least agencies whose loyalty is not pre-empted by racial or commercial ties antagonistic to American interests.

This is not a task to be accomplished in a day. But until it has been accomplished American export business will be greatly handicapped, dependent for its progress upon alien and frequently unwilling effort. The thing to be done at once is to examine the basis of all agreements with foreign agents and to analyze the affiliations of the agents.

The Department of Commerce urges exporters to take advantage of the full resources of American banks, credit institutions and Government agencies, particularly the Commercial Intelligence Service and the Commercial Laws Division of the Bureau of Foreign and Domestic Commerce, in connection with inquiries as to the general scope of agency contracts.

PROOF THAT ADVERTISING PAYS

Mississippi Columbia Dealer Tells of Successful Publicity Campaign

BILOXI, Miss., August 8.—J. A. Abrams, Columbia dealer in this city, recently forwarded an interesting letter to the Daily Herald, advising this publication that remarkable results have been obtained from a newspaper campaign inaugurated by him several weeks ago. In this letter Mr. Abrams stated that during a period of three weeks he had used two full pages and six half-page advertisements in the Daily Herald, and as a result of this advertising had sold thirty-four Grafonolas ranging in price from \$60 to \$175. In addition to these sales over 200 inquiries had been received, many of which will undoubtedly be turned into sales in the near future. Another proof that advertising pays.

MISS MARION I. BEACH ENGAGED

The engagement of Miss Marion I. Beach, daughter of Mr. and Mrs. Harry A. Beach, of Merchantville, N. J., to Clarence C. Larkin, of Ithaca, N. Y., has been announced. Mr. Beach is widely known in the trade as vice-president and general manager of the Unit Construction Co., Philadelphia, Pa.

MORE TRUTH THAN POETRY

He who hitches his wagon to a star,
 And works to attain his goal
 Is bound to travel fast and far,
 And works to attain his goal.

GOLDMAN SUMMER BAND CONCERTS

Programs for Closing Half of Season Will Be of Exceeding Interest

Judging from the increased attendance, the delightful concerts being given by the Goldman Band on The Green at Columbia University have been keenly appreciated this season. Mr. Goldman has been providing programs of exceeding interest which are rendered by a splendid organization of artists. After a week's vacation the Goldman Band will resume its concerts on August 21, but instead of three concerts a week, there will be nightly programs from Monday to Friday evenings each week up to September 8. In this period there will be festival concerts and a series of operatic and popular nights. The World extends its felicitations to Mr. Goldman on the great work he is doing for the advancement of music in New York City. His efforts merit the substantial backing of every lover of music.

AMERICANS BARRED FROM FAIR

WASHINGTON, D. C., August 3.—American musical instrument manufacturers will be barred from exhibiting at the coming Basle, Switzerland, trade fair, according to a recent announcement made by the Bureau of Foreign and Domestic Commerce here. In a previous statement the bureau announced that American manufacturers would be given an opportunity of exhibiting at this fair, but information recently received indicates that only Swiss manufacturers will be allowed to participate.

E. P. LITTLE A VISITOR TO NEW YORK

Edward P. Little, who was recently elected president of the National Association of Sheet Music Dealers, and head of the music publisher's department of Sherman, Clay & Co., San Francisco, Cal., arrived in New York on Thursday of last week and made a ten days' stay in this city, following which he visited other large Eastern trade centers.

A big exploitation campaign has been inaugurated by Sherman, Clay & Co. on the new novelty fox-trot, "The Sneak," and several other numbers from the catalog. Mr. Little seemed much pleased with the situation in the East.

The Consolidated Music Stores, of Newark, N. J., have changed their name to the Cardinal Sales Co.

Meet Me Next Sunday
 See Page 116
Jack Snyder

REGAL
PREDOMINATES
 IN THE
50¢ RECORD FIELD

AURADION

THE SUPER RADIO RECEIVING SET

A RADIO CABINET SET DESIGNED TO MEET THE EXACTING DEMAND OF THE TALKING MACHINE TRADE

List Price, \$150.⁰⁰

Customary Talking Machine Discounts

Represents the latest and best in radio design equipment. The result of extensive experimenting to produce a perfect receiving instrument that would function with the greatest efficiency even in the hands of persons utterly unfamiliar with radio.

SIMPLICITY IN ITSELF

Fine tuning and elimination of interference is made possible by a simple adjusting lever.

Will receive messages and broadcasting programs from distant stations.

The A. R. 2 Loud speaking model combines beauty with reproducing powers and enables several persons to listen in at one time.

Outstanding features of the Auradion A. R. 2 Loud speaker type that make it

THE SUPER MACHINE of SUPER VALUE

1. Genuine solid mahogany cabinet of beautiful piano finish.
2. Three stages of amplification insuring maximum volume.
3. Loud speaker of scientific design concealed in cabinet.
4. Loud speaker phone W. E. type papier mache horn for perfect amplification without distortion.
5. Cabinet designed with compartments to house all batteries.
6. No wiring whatsoever exposed.



AURADION—STYLE A. R. 2

EXCLUSIVE TERRITORIES NOW BEING ALLOTTED

Write for Particulars and Our Dealer Cooperation Service Plan

Inter-Ocean Radio Corporation

ELECTRICAL EXCHANGE BUILDING

136 Liberty Street

New York City

OUTING SALES SHOW INCREASE

Sales for First Week of August Exceed Month's Quota—New Louisville Jobber Appointed

The Outing Talking Machine Co., Mount Kisco, N. Y., manufacturer of the Outing portable, announced recently the appointment of the Art Embroidery Co., Louisville, as an Outing portable distributor. This company is planning to feature the Outing aggressively and has placed a good-sized order for immediate delivery.

A. J. Coté, president and general manager of the Outing Talking Machine Co., recently sent an interesting letter to Okeh jobbers commenting upon the fact that business to date exceeded all expectations. Mr. Coté in his letter pointed out that the orders received during the first week were equal to the month's quota of business, and he suggested to Outing jobbers that they anticipate their requirements in order to receive maximum co-operation and service for the Fall and holiday trade. Mr. Coté also commented upon the fact that the Outing export department has been very active the past fortnight, several substantial shipments to Mexico being a feature of the business.

COURTESY AS A BUSINESS BUILDER

One of the principal policies on which the business of the King Furniture Co., of San Antonio, Tex., has been built up is that of courtesy. Many sales of Columbia Grafonolas have resulted because of the reputation of the concern, which is generally known as the "friendly house."

A novel stunt in operation in the Grafonola department of the King Co. consists of a bulletin board in the reception room of the store on which the names of the latest recording stars appear each week.

Louis & Co., Victor dealers, of Washington, D. C., have remodeled the upper floors of their establishment to accommodate a toy department.

NEW BRUNSWICK CONSOLE

Chippendale Period Model Added to Line—Equipment Includes All Distinctive Brunswick Features—Is Finished in Burl Walnut

CHICAGO, ILL., August 5.—The new Chippendale concert model, which was recently announced by the Brunswick-Balke-Collender Co., is meeting with considerable success, and Brunswick dealers everywhere are planning to feature this instrument extensively during the coming Fall season. The illustration herewith will give some idea of the handsome appearance of this new Brunswick period model.

This new Chippendale Brunswick, which retails at \$450, is beautifully finished in burl walnut, and has dimensions which will make it suitable for installation in almost any home or apartment. The cabinet is 41½ inches wide, 41 inches high and 21 inches deep. The equipment of the Brunswick Chippendale includes the new double Ultona reproducer, automatically balanced lid, equipment for electric operation, eight albums for filing records, a compartment for accessories and gold-plated trimmings.

Miss Lucy A. Goldsmith, export manager for the Aeolian Co., is spending her vacation in Nantucket, Mass.

DEMONSTRATE HEALTH RECORDS

Fairway Co. Introduces Sales Plan for Victor Health Records—Staff of Demonstrators Will Co-operate With Dealers in Developing Trade

Victor distributors and dealers in Greater New York have evinced keen interest in a new service offered by the Fairway Co., New York, in con-



New Brunswick Chippendale Concert Model

nection with the new Victor health exercises. This company has inaugurated a service which consists of a demonstrator who goes through the first eight exercises as outlined in the record. The demonstration is given either in the showroom of the dealer's store or in any other suitable place.

The exercises take about fifteen minutes; the demonstrator going through them and then resting for about fifteen minutes in order to attract different crowds. This continues for three hours, any time during the day or evening as the dealer may desire, and continues for a full week.

Paul Rescouie, well known in the local talking machine trade, who is general manager of the Fairway Co., has already completed plans whereby an efficient corps of demonstrators is ready to co-operate with the dealers in the interest of Victor health exercise records.

NOW THE HOMOPHONE CO.

Company Making New Home Recording Device Announces Change of Name

The Home Sonarograph Co., 293 Plane street, Newark, N. J., manufacturer of a home recorder, announces the change of the name of the company to the Homophone Co. and the name of the recording device to the Homophone. The device has been introduced in a number of stores in the metropolitan district. The company is under the management of H. A. Miller.

Recently Arthur Kopp, who is attached to the sales department, demonstrated the Homophone to a gathering of the Talking Machine Men, Inc. Without any prearranged program Jack Glogau, the well-known songwriter, who attended the luncheon, was requested to make a recording. He sang one of Fred Fisher's new publications and the result was a clear recording without any flaws.

At the present time the device can be attached to only a few of the leading makes of machines unless the manufacturer is informed in advance of the make. It is understood, however, that in a very short space of time the instrument will be so arranged that it can be attached to any make of machine. The wax records accompanying the device can be used nearly fifty times by shaving off the recording after each use of the record, the company announces.

"—the most perfect,—the most beautiful reproduction of my playing that I have ever heard."

That's how a famous artist described the reproduction of his art by a Violin Spruce Reproducer.

DEALERS QUICKLY DISCOVER

that demonstrations with the Violin Spruce Reproducer help the sale of phonographs and records as well as the Reproducer itself.

The Violin Spruce Reproducer

Eliminates all metallic sounds. Classifies reproduction of the voice. Individualizes every instrument. Improves with use—like a violin. Is unaffected by climatic conditions.

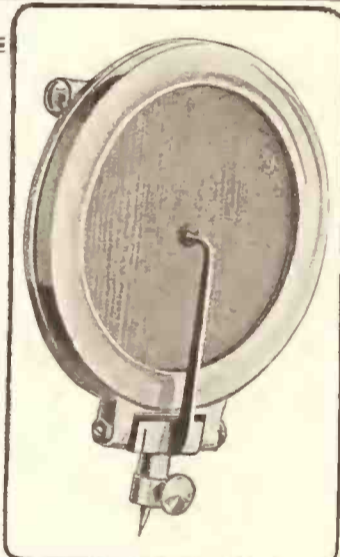

Of Special Interest to Manufacturers

We are prepared to furnish in any quantity the following items adapted to any make of phonograph: Tone Arm, equipped complete with Violin Spruce Diaphragm Reproducer; Violin Spruce Diaphragm Reproducer; or Violin Spruce Diaphragm alone to assemblers in 2-9/16" diameter only.

Violin Spruce Diaphragm Reproducer as illustrated retails for \$7.50

THE DIAPHRAGM COMPANY
Room 311, 5005 Euclid Ave., Cleveland, O.



Violin Spruce Diaphragm

PORTLAND

Dealers Look Forward to Buyers' Week—Expect Large Attendance—Trade Activities of the Month

PORTLAND, ORE., August 4.—Music dealers of this city are looking forward to the tenth annual Buyers' Week, which will be staged in Portland from August 7 to 12, at which time it is expected that there will be over 2,000 retail dealers from the Northwest who will be in the city to purchase their stocks for the coming year.

Elmer Hunt, manager of the Sherman, Clay & Co. wholesale department, reports two new Victor dealers, one at Seaside, Ore., J. M. Callahan, manager, and one at White's Pharmacy, Vancouver, Wash.

Howard Rose, of Rose Bros., Victor dealers, of Ashland, Ore., was a recent visitor to Portland and while here he called on Mr. Hunt.

P. T. Clay, president of Sherman, Clay & Co., visited this city for several days on his return from the East, where he attended the music convention. G. P. Guppy, wholesale manager of the Seattle branch, and A. S. Cobb, from Spokane, accompanied Mr. Clay to Portland.

Wm. Smith, for the last ten months territory salesman for the Columbia Graphophone Co., resigned his position August 1. He left for Lake Tahoe, Cal., where he will take a vacation for several months, when he expects to go to Los Angeles and open a store of his own. Mr. Smith established a new Columbia agency in July at Stayton, Ore., in the Sloper Drug Co., V. Dare Sloper, proprietor and manager. Landstrom & Smith, exclusive Columbia dealers, of Lebanon, Ore., have increased their sales force on account of rapidly growing business.

L. D. Heater, Portland's most active and progressive jobber in phonograph accessories and exclusive agent in Oregon and Washington for the Portophone, returned from a trip to Seattle and other Northwest points, with good reports of business done up North. Mr. Heater's business has gone ahead so fast that it has been necessary for him to put on extra men. He has placed C. H. Williams in charge of eastern Oregon and Washington, with headquarters in Spokane; H. L. Williams has been placed in charge of Seattle and vicinity and Henry Norton is looking after Mr. Heater's interests in California. Mr. Heater expects to spend several weeks in San Francisco and Los Angeles and expects to put on another man in that territory. He has recently been appointed distributor for Oregon and Washington of the Strand console phonograph.

Clyde Freeman, the popular manager of the Remiek Song and Gift Shop, has been replaced by I. E. Sklare, who was assistant manager of the Los Angeles store before they closed out last month.

Allen E. McLean has been appointed sales manager of the Virola and Edison phonograph department of the Reed, French Piano Co. Mr. McLean came here from Great Falls, Mont., where for nine years he was manager of the Great Falls Phonograph Co.

Frank Anrys, general manager of the Wiley B. Allen Co., was a recent visitor here and, with Frank M. Case, manager of the local branch, journeyed to Rainier National Park, where they took in the sights.

Miss Anna Baggs, private secretary in the San Francisco executive offices and manager of the Allen publicity department, was also a visitor. Miss Baggs is on a month's vacation tour.

Vern L. Wenger, the Talking Machine Man, located for the past five years at Second and Alder streets, has moved and is now occupying a store at 244 Alder street.

J. F. Shidell, formerly associated with the San Antonio Music Co., San Antonio, Tex., is now manager of the William A. Parker Co. phonograph department in that city.

There is no such thing as a short cut.

WIDENER BRANCH MANAGERS MEET

Twelve Branch Managers Assemble at Boston—Business and Social Program Enjoyed

Managers of twelve Widener branch stores held a meeting in Boston recently and returned to their respective stores filled with enthusiasm and many new ideas for the promotion of sales. During the convention, which lasted two days, there were talks on current subjects by J. G. Widener, president of the company, who presided, and later open forum was held and the exchange of ideas and the discussion of problems proved beneficial to all present.

Pleasure was not forgotten. A boat trip to Nantasket was staged, swimming was enjoyed and, following an excellent shore dinner, the party returned to this city.

Those present included: J. G. Widener, R. E. Demarest, treasurer of the company; D. F. Follin, sales manager, and R. C. Mulligan, secretary and attorney. The various stores were represented by Messrs. Arbuckle, St. Louis; Wil-

son, Indianapolis; Fantle, Cincinnati; Perrett, Philadelphia; Black, West Philadelphia; Dexter, Newark; Speare, New York; Clifford and Caldwell, Hartford; Warner, New Britain; McNeill, New Haven; Kennedy, Worcester, and Demarest, Boston.

HAYWARD CLEVELAND'S NEW POST

Hayward Cleveland, well known in the Eastern talking machine trade and one of the veterans of the industry, has been elected vice-president of the Commerce Advertising Agency, which recently moved to 1819 Broadway, New York. This agency concentrates its activities in behalf of the journals issued by the various Chambers of Commerce throughout the country, and Mr. Cleveland is in charge of national space sales—a post he is well capable of filling.

Someone has said that there is nothing so broadening as kindness and in business there is nothing so effective as courtesy and consideration for your customers.

Licensed under the Geer patents issued Nov. 10, 1914, and Feb. 29, 1916. Infringers will be vigorously prosecuted and dealers are warned against handling infringing products.

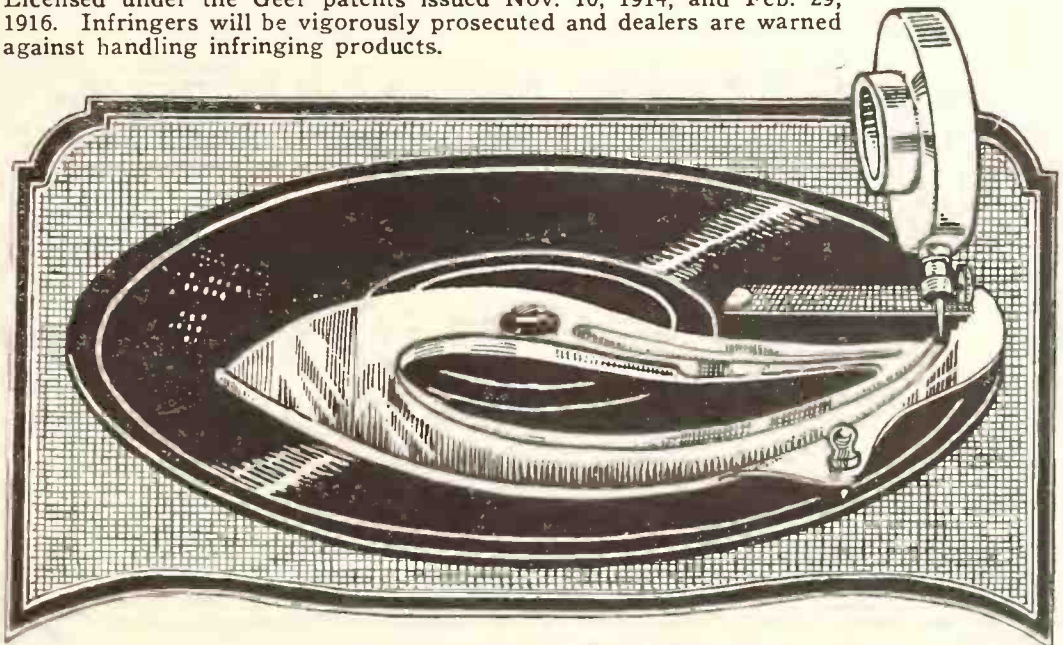

ADJUSTABLE

PHONOGRAPH records differ in length. A record repeater, therefore, needs some adjustable feature to give perfect results. The small, movable slide of the Geer Repeater, which can instantly be set to the end of the music and which cannot get out of order, perfectly supplies this need.

This adjustable feature of the Geer Repeater gives it exceptional value for playing vocal as well as instrumental records, and the steadily increasing popularity of the Geer means that it will prove an unusually profitable line for fall and winter sales.

Gold Seal Repeaters

The Walbert Manufacturing Company is the exclusive sales representative for the Gold Seal Repeater in the territory west of the Alleghenies, including Canada west of Toronto. Send orders direct to address below.

Our Special Window Demonstrating Record Will Increase Your Sales

For the benefit of our dealers, we have developed a special window demonstrating record, without music, that plays through in 18 seconds. This quick-playing record is given free with orders for 12 Geer Repeaters or with 25 Gold Seal Repeaters and is surprisingly effective in making sales.

A repeater window demonstration will prove one of your best drawing cards—as has been proved by hundreds of stores—and can be set up in a few minutes.

Write your jobber or clip and mail the coupon—Today.

WALBERT MANUFACTURING COMPANY,
925-941 Wrightwood Ave., Chicago, Ill.

Please send by return mail Geer Repeaters and Gold Seal Repeaters—price to be 40%* off list—retail prices to be \$2.50 and \$1.00 respectively.

Check here if you want window demonstrating record and sales helps.

Name
Address
Jobber

* IMPORTANT—On orders for less than 100 Gold Seal Repeaters discount is 35%. Window demonstrating record is free with orders for 12 Geer Repeaters or 25 Gold Seal Repeaters. Terms C. O. D. to firms not rated.



**THE SATISFIED
CUSTOMER
IS THE
DEALER'S
GREATEST ASSET**

Federal

RADIO INSTRUMENTS

**ARE MOST SATISFACTORY
In Design, Finish, Simplicity of Operation and
GENERAL RESULTS**

We Manufacture a Complete Line of RADIO
Instruments and Parts, all of which typify
FEDERAL QUALITY and TRADITION.



FEDERAL CRYSTAL
RECEIVER

FEDERAL JUNIOR
AMPLIFIER



TO THE DEALER

You may be assured of SATISFIED
CUSTOMERS if you sell FEDERAL
apparatus.
Write for DEALER'S discounts.

Federal Telephone and Telegraph Company
BUFFALO, NEW YORK

TRUCKS BRING GOOD BUSINESS

Grinnell Bros. Find Selling From Trucks So Satisfactory That They Have Increased Their Fleet—To Cover More of Outlying Districts

DETROIT, MICH., August 10.—A review of business for July has brought out the fact that sales for that month were very good, all things being considered. Most of the dealers who are acknowledged live-wires report a very gratifying increase

over July, 1921. Grinnell Bros., who have literally carried the phonograph into the homes of hundreds of Detroiters, by means of a truck and three or four capable salesmen, find that method so productive of results that they are putting on a third truck to take care of the outlying districts. Manager Porter, of the Victrola department, explained that Grinnell Bros. proceeded on the belief that the public had money and that, since they evinced no very great desire to come into the store and spend it, they would take their ma-

chines out to them and close the deal in their own homes. Two trucks were put on this work, each manned by experienced salesmen, and as a result of this campaign business has been greatly stimulated. Every dealer in Detroit is convinced that Fall will usher in a season of brisk buying and the wide-awake dealers are stocking up heavily so as to insure being in shape to meet this demand.

INTRODUCE THE AURADION

Inter-Ocean Radio Co. Announces Radio Cabinet Receiving Set for Talking Machine Trade

The Inter-Ocean Radio Co., of New York City, is introducing to the trade this month a radio cabinet receiving set, known as the Auradion, designed primarily to appeal to the talking machine dealer and his trade. It is enclosed in an artistic cabinet which resembles closely the lines of the ordinary talking machine, and it is the opinion of officials of the company that "it is the radio unit which the talking machine dealer has been looking for."

The radio apparatus is a three-stage amplification unit connected with a loud speaker horn constructed on strictly scientific lines, which is the result of extensive experiments conducted in the company's laboratories by engineers who are well known in the radio field.

According to present plans the machine is to be distributed throughout the country to dealers on an exclusive territory basis following closely in this respect the policies of the leading talking machine concerns.

These plans also call for a merchandising policy that will enable them to sell the dealer at the regular talking machine trade discount, which will allow the dealer to carry a representative stock and sell at a fair profit. This merchandising policy, it is the opinion of General Manager A. E. Pollock, should appeal strongly to the talking machine dealer. Mr. Pollock stated that his company is sparing no effort to give the dealer every form of co-operation to enable him to carry on a radio business in conjunction with his talking machine business successfully. An extensive publicity campaign, such as form letter, circular and general advertising material, is being planned by the company and it is expected that this product will be distributed in all sections of the country in time for Fall trade.

MILWAUKEE DEALERS AT PICNIC

MILWAUKEE, WIS., August 10.—The Milwaukee Association of Music Industries and the Victor Dealers' Club of Milwaukee were the guests of the Chicago Piano Club on August 9 at their first intercity picnic in Ravinia Park, Chicago. The local delegation numbered more than 100, who made the trip in a special car. The music stores of the city were closed during the afternoon to give all employes an opportunity to attend. Athletic contests were included in the program arranged by the Chicago Piano Club.

REPORTS INCREASING DEMAND

The Encore Sales Corp., New York City, sole factory distributor of the Encore record replayer, reports steadily increasing demand for this talking machine accessory. M. S. Davis, president of the company, stated that this replayer was originally placed on the market last May and has enjoyed steadily growing distribution among both dealers and jobbers. A new factory was recently obtained in Newark, N. J., equipped with modern machinery and allowing larger production.

RECEIVER FOR STEWART CORP.

Harry E. Harkness has been appointed receiver of the Stewart Phonograph Corp., manufacturer of phonographs, of Binghamton, N. Y. The concern was recently forced into bankruptcy with liabilities of over \$50,000.

**A NEW
ETHEL WATERS RECORD**

No. 14117



"Jazzin' Babies Blues"



and

"Kind Loving Blues"

To Be Had Only On

BLACK SWAN RECORDS

Buy From Your Nearest Jobber, or Direct From

PACE PHONOGRAPH CORP.

2289 Seventh Avenue

New York, N. Y.

INVALUABLE



Here is the handbook of the talking machine industry for which you have long been waiting. It is a directory you can keep on your desk to give you, in an instant, detailed knowledge about this and that company, which would otherwise consume much of your time to secure.

ONLY 50 CENTS

For instance, it will give you a complete up-to-date list of the manufacturers and jobbers who comprise the talking machine industry, including invaluable data about each concern, such as location of factories, names of officers, location of branch offices, trade names controlled, policy of marketing product, etc., etc.

ONLY 50 CENTS

Also it will give you a full, up-to-date list of the manufacturers who make any given class of product, such as talking machines, records, parts, accessories, store equipment, etc.

ONLY 50 CENTS

This book contains the kind of data about each concern which cannot be put into the company's current advertising for lack of space and which is nevertheless a kind of data that is valuable from your standpoint.

ONLY 50 CENTS

This volume also contains a number of pertinent articles on highly important topics and much other material too extensive to enumerate here in detail.

ONLY 50 CENTS

It is the only book of its kind ever published and is a volume which no enterprising member of the industry can fairly afford to do without. It has been produced by the publishers of The Talking Machine World.

USE THIS COUPON NOW

Send Cash, Stamps or Check

EDWARD LYMAN BILL, Inc.,
373 Fourth Ave., New York City.

Gentlemen:
Please send me postage prepaid a copy of the 1922 edition of The Talking Machine World Trade Directory, in payment for which I enclose 50 cents.

Name

Firm

Street

City and State.....

APPOINTED RADIOLA JOBBER

General Radio Corp., Philadelphia, Will Distribute Products of Radio Corp. of America—Walter L. Eckhardt, President, Is Planning Extensive Sales Campaign on New Line

The General Radio Corp., Philadelphia, Pa., the president of which is Walter L. Eckhardt, has recently been appointed a distributor of RCA radio products, manufactured by the Radio Corporation of America, New York. This important announcement was made recently by the sales division of the latter company, and Mr. Eckhardt is receiving the congratulations of his friends upon the acquisition of this valuable jobbing franchise. A complete stock of Radiola receiving sets, together with the other products manufactured by the Radio Corporation of America, has already been ordered by Mr. Eckhardt, and plans are being made for an extensive sales campaign.

The General Radio Corp. is exceptionally well qualified to handle the products of the Radio Corporation of America as, under Mr. Eckhardt's able direction, his company is rapidly becoming one of the most successful jobbers of radio products in the country. Owing to the fact that he has been identified with the talking machine industry for more than twenty years, Mr. Eckhardt thoroughly understands the requirements of the talking machine dealers, and in the introduction of Radiolas he will be able to give the trade the benefit of this valuable and lengthy experience.

DEATH OF ROSS L. DOUGLASS

President of National Co. Passes Away Unexpectedly From an Attack of Indigestion

BOSTON, MASS., August 8.—Ross L. Douglass, for many years president of the National Co. of this city, recently died suddenly as the result of an attack of acute indigestion shortly after his return from a visit to Europe. The products of the National Co., Ragtime Rastus, the Boxing Darkies, Shimandy and other mechanical toys for the turntable, are well known throughout the talking machine industry. Mr. Douglass had been abroad in the interest of his company and his recent report of foreign conditions was read with interest by readers of The World. The success of the National Co. is a monument to the business ability of Mr. Douglass and his untimely death will be received with distinct sorrow by his many friends in the talking machine industry.

OWNS IMPORTANT RADIO PATENT

Radio Corporation of America Owns Armstrong Super-Regenerative Patents—Invention Not Yet in Commercial Form

The Radio Corporation of America, New York, now owns the important Armstrong super-regenerative patents, having purchased recently the rights to this invention. It is understood that the invention is not yet in commercial form, and that it will require additional development over a period of a number of months before it can be brought on the market. This will be interesting information to the radio industry, as there has been considerable discussion regarding the Armstrong super-regenerative patents.

MOVES SUIT TO U. S. COURT

Trade-mark Suit Brought by Lyon & Healy Against Wurlitzer Co. Transferred From Superior Court to United States District Court

CHICAGO, ILL., August 9.—The Superior Court of Cook County, Ill., has granted the petition filed by Percy Kimberly, head of the Chicago division of the Rudolph Wurlitzer Co., to move the trade-mark law suit filed against the Wurlitzer organization by Lyon & Healy, of this city, from the Superior Court to the United States District Court in accordance with the formality in such proceedings. The Chicago division of the Wurlitzer Co. filed its bond of \$500 to secure the costs.

GIVES VICTROLA OPERA CONCERTS

Crowds Attracted to John Wanamaker Auditorium by Well-arranged Operatic Concerts, in Which the Victrola Was the Star

Opera concerts on the Victrola are drawing the crowds of shoppers in the John Wanamaker store, New York City, to the piano and Victrola departments. These concerts are novel in that at each performance the various recordings of the operas as sung by a number of artists are played. The magnificent auditorium adjoining the piano department is used for the purpose and on the stage, given prominence by a clever lighting arrangement, stands an upright model Victrola.

An example of the program may be gleaned from the fact that a recent concert was devoted entirely to "Aida," as sung by Louise Homer, Johanna Gadske, Lucy Marsh, Emmy Destinn, Enrico Caruso and Paul Althouse. Other programs of a similar nature were arranged daily for an entire week. The attendance at these concerts was exceedingly large and much valuable publicity resulted.

Radio and phonograph combined in the LYRADION—your customers will prefer this line

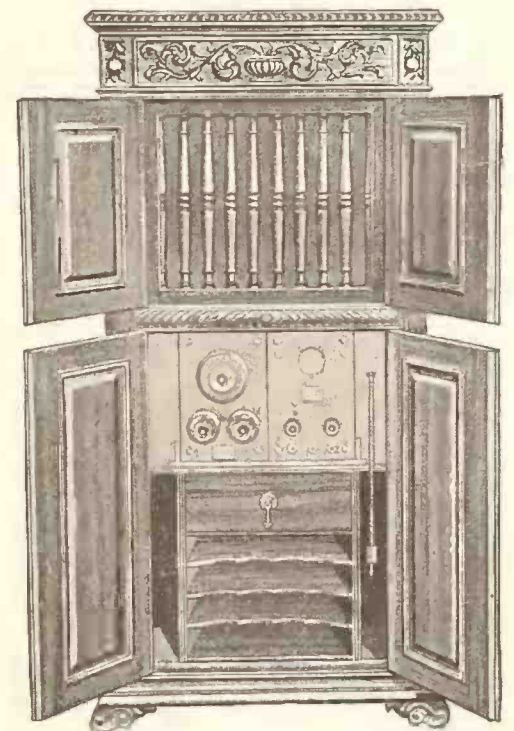

Lyradion Italian Renaissance

Combination radio and phonograph. A beautiful hand-carved cabinet in polychrome finish for large homes and clubs. Wired for Westinghouse "set" or complete with Lyradion 5 stage non-regenerative set. All instruments and batteries completely housed.

Radio enthusiasts are expressing their preference for the Lyradion line of attractively housed radio sets in no uncertain terms. While the lady of the house has tolerated the old method of placing batteries and sets on the library table and floors as a matter of necessity in the past, she is now demanding the attractive Lyradion combination radio and phonograph completely housing instruments and batteries and offering dual and perpetual entertainment features. Besides these attractive cabinets harmonize with the furnishings of the modest as well as the most luxurious home surroundings.

The wonderful Seabrook amplifying horn used on all models is responsible for the remarkable reproducing qualities of Lyradion instruments. This horn employs entirely new principles of sound reproduction which are fully protected by basic U. S. patents.

Lyradion cabinets can be furnished wired complete for Westinghouse two-stage R. C. sets or with Lyradion five-stage non-regenerative receiving sets.

Territory is being rapidly allotted—dealers or jobbers should write or wire immediately for proposition.

Lyradion Sales & Engineering Company

Mishawaka, Indiana KENTON W. MIX, Director

AKRON, O.

Battle of Rail Workers Affects Trade—Plan Industrial Exhibition—Starr Store Changes Hands

AKRON, O., August 8.—The rail and coal strikes the past two weeks are being reflected in retail business locally and several dealers interviewed declared that people are showing a tendency to hold off buying because of the future uncertainty of employment and conditions generally over the country.

Plans are being made by the exposition committee of the South Akron Board of Trade for a South Akron Industrial Exposition. Piano and talking machine houses in the South Akron district will be represented at the exhibition.

M. M. Mell, president of the M. M. Mell Co., is the new president of the East Akron Board of Trade, and practically all retail music stores in this section of the city are affiliated.

The Superior Music Parlors has acquired the Starr Piano Co.'s store at 87 South Howard street. It will be operated under the same firm name, continuing to feature the Starr phonograph and the Starr piano lines as heretofore.

"Since moving our record section from the second floor to the main street level, record sales have been doubled," said George S. Dales, head of the well-known music house of this name.

Talking machine sales in the music section of the M. O. Neil Co. department store were better last month than during July of a year ago. The Victor and Cheney machines both moved well during the month.

The Windsor Poling Co. kept after records last month and succeeded in closing one of the biggest volumes of trade in a long time. Mr. Poling is now busy arranging details for the opening of the music season when the company will promote the local appearances of a number of noted artists.

EXPLOITING THE TALKING MACHINE IN COMMUNITY WORK

Clever Stunt Staged by the Community Service of Texarkana Brings the Talking Machine to the Fore—Local Artists Appear on Same Program With Artists on Records

Local artists in Texarkana were given the unique opportunity of appearing on the same program as the world-renowned musicians when Community Service arranged a concert there recently. And not only did they appear on the same program, but they rendered the same selections as did such luminaries of the opera and concert stage as Galli-Curci, Rachmaninoff, Heifetz and others. The Texarkans had the best of it, however, being there in person to receive the applause of an enthusiastic audience, while the others were represented by talking machine records.

The affair was managed in this way: First, a record was run on the phonograph, and then a local singer, violinist or pianist gave the same composition. Those who attended found it interesting to note the similarities and differences between the resident talent and the more famous singers and instrumentalists. Through a bulletin which national headquarters of Community

Service has issued telling of the concert, other communities have become interested and are planning similar affairs.

This same bulletin contains another suggestion for a new music feature which has appealed particularly to music clubs and teachers. It tells in detail how the work of local musicians, vocal or instrumental, may be reproduced with a recording machine. For instance, the directions call for the use of a dictating machine, a blank record and an improvised horn. Two artists may sing the same song, one after the other, on one record, so that comparisons of tone, technique and expression may be made, or the experiment may show the progress of one person from week to week or from month to month. Music teachers find this method of recording improvement very satisfactory. Miss Marie Daschbach, of Teachers' College, Columbia University, New York, keeps track of the development of her pupils in this way.

The talking machine section of the A. B. Smith Piano Co. will be remodeled and placed in readiness for a big Fall business, according to an announcement this week by A. B. Smith, Jr., manager of the local store. More sales space will be available and the store in general will be redecorated and renovated.

Miss Elsie Baer, manager of the talking machine section of the M. O. Neil Co., is spending a several weeks' vacation in Michigan and nearby States.

make an extended investigation into express rates until the coal and railroad strikes are settled. Some days ago the investigation was about to be undertaken at the request of numerous shippers in various industries who had pointed out to the Commission that while freight rates were reduced 10 per cent last month express charges were still as high as they had been at any time during and after the war. It was intended to make a very full investigation of the matter similar to the investigation of freight rates made last Winter. The rates for coal and the wages which must be paid the railroad men now on strike will have considerable to do with the question of the rates at which the railroads will be able to handle freight in the future, and the Interstate Commerce Commission is desirous of awaiting a settlement of those questions before taking up the question of express rates.

ANENT LOWER EXPRESS RATES

Interstate Commerce Commission Expected to Let Matters Rest Pending Settlement of Strikes

WASHINGTON, D. C., August 9.—It is not likely that the Interstate Commerce Commission will

Greatest Talking Machine Value in the World!

Lundstrom
CONVERTO

Patented December 11, 1917

Talking Machine Cabinets

These new, rock bottom prices enable you to sell the greatest talking machine value in the world—a Victrola IV or VI and a genuine Converto Cabinet at a *combined price* far below anything ever offered either in a cabinet machine or a combination.

The Converto is the only cabinet that permits use of the Victrola tone regulating doors.

Converto Cabinets are now sold direct to dealers. The prices are so *extremely low* as to enable live dealers to use the combination as an effective stimulant for immediate business.

ORDER NOW for your Fall and Holiday business as these prices are subject to withdrawal.



ONLY
\$15

STANDARD MODEL
OAK OR MAHOGANY



ONLY
\$25

DELUXE MODEL
MAHOGANY ONLY

THE C. J. LUNDSTROM MFG. CO.

LITTLE FALLS, N. Y.

Lundstrom "Converto" Cabinets are broadly covered by patents. Infringements will be promptly prosecuted.

APPOINTS NEW OKEH JOBBER

General Radio Corp., of Philadelphia, Takes Over Stock and Accounts of A. J. Heath Co.—W. C. Fuhri Closes This Very Important Deal

PHILADELPHIA, PA., August 7.—Walter L. Eckhardt, president of the General Radio Corp. of this city, announced recently that arrangements had been completed whereby his company would take over the Okeh record stock of the A. J. Heath Co., Philadelphia, Okeh jobber, together with the accounts handled by that company. W. C. Fuhri, general sales manager of the General Phonograph Corp., New York, closed this important deal on a recent visit to Philadelphia, and by the terms of this new arrangement the General Radio Corp. becomes distributor for Okeh products in Pennsylvania, Maryland, Delaware, District of Columbia, West Virginia, Virginia, North Carolina, a portion of Ohio and the southern part of New Jersey.

A. H. Pope, who has been associated with Mr. Eckhardt for the past fourteen years, will assume charge of the Okeh record division, and a thoroughly trained sales staff is now ready to co-operate with Okeh dealers in this important territory. The General Radio Corp. will continue to act as distributors for Strand phonographs, with which line it has been remarkably successful, and, in addition, this concern is also jobber for important groups of the radio products.

ORGANIZE PATHE SOUND WAVE CORP.

The Pathé Sound Wave Corp. was recently formed in Brooklyn, N. Y., for the purpose of manufacturing combination radio and phonograph console machines, loud speakers and other radio parts. Its formation is in direct accordance with the plan of the creditors' committee of the Pathé Frères Phonograph Co. which was submitted to the creditors for approval. The plan, which was described in a recent issue of The World, was almost unanimously approved and the creditors' committee is now acting as a reorganization committee. The directors of the Pathé Sound Wave Corp. are Eugene A. Widmann, H. T. Leeming and Frank T. Lewis. A product which will be particularly featured is the loud speaker, which possesses remarkable volume and tone. It is planned to market the products principally through the talking machine trade.

H. C. NAILL VISITS NEW YORK

H. C. Naill, of the Geo. A. Long Cabinet Co., Hanover, Pa., manufacturer of the Long console and record cabinets, was a recent visitor to New York, calling on some of the company's Eastern representatives. Mr. Naill was optimistic regarding the general outlook for Fall business, stating that his company had several important plans in process of completion which would prove of keen interest to the trade.

H. C. BROWN ENDS LONG AUTO TRIP

A recent visitor to New York City was Henry C. Brown, of the Victor Talking Machine Co., Camden, N. J., on his way home after a 1,600-mile automobile trip through Pennsylvania, New York and Canada. While in Canada Mr. Brown visited his son, Henry, Jr., who operates a large and successful moving picture house in a city "over the border."

Order Your Supply of the New Encore Record Replayer Now

THE MOST EFFICIENT DEVICE OF ITS KIND EVER PRODUCED

The Record Replayer Without a Fault



Made of Steel. Nickel-Plated. Celluloid Adjuster

Retails at \$1.00

Discount to Dealers 40%

ORDER NOW AND WATCH YOUR SALES INCREASE

Some Territory Still Open for Jobbers

ENCORE SALES CORPORATION

Sole Manufacturers' Representative

6 CHURCH STREET

NEW YORK, N. Y.

COMPLETING DISTRIBUTION PLANS

Radio Corp. of America Appoints New Jobbers in Musical Industry—Company Studying Distribution Possibilities—Over 150 Jobbers Now Handling This Nationally Known Product

During the past month the Radio Corporation of America, 233 Broadway, New York, manufacturer of RCA radio products, has appointed several new jobbers, and at the present time the company has established the following distributors in the musical industry: Landay Bros., New York; Lyon & Healy, Chicago; W. F. Frederick Piano Co., Pittsburgh, Pa., and the Albany Radio Corp., Albany, N. Y. The recent appointment of the General Radio Corp., Philadelphia, Pa., as a Radiola distributor may also be considered an appointment in the musical industry, as Walter L. Eckhardt, president of this company, has been identified with the talking machine industry for over twenty years.

It is understood that the Radio Corporation of America will increase its distribution through musical channels in a limited degree, and applications for jobbing franchises have been received by the company's sales division from prominent talking machine concerns in all parts of the country. These applications are now being given careful consideration and important announcements will probably be ready for the trade in the very near future.

At the present time RCA radio products are being distributed by 159 jobbers, controlling 206 establishments all over the country. The majority of these jobbers are members of the electrical trade with quite a number of radio specialty jobbers and also distributors in other fields of standard merchandise. The sales department of the Radio Corporation of America is making a careful study of the sales possibilities for RCA

products through various distribution channels, and nothing is being left undone to give the jobbers maximum service and co-operation in the introduction of Radiolas and other products manufactured by the Radio Corporation of America.

NO INSPECTION OF MAIL PACKAGES

Postoffice Department Expected to Take Action Against Those Who Advertise Examination Privilege on Goods Sent by Mail C. O. D.

WASHINGTON, D. C., August 7.—Music dealers and others who advertise that their merchandise may be purchased by mail, C. O. D., with the privilege by prospective patrons of inspection before acceptance and the payment of charges will shortly find themselves unable to advertise through the mails unless they discontinue this practice.

Ever since the establishment of C. O. D. service there has been a rule in effect prohibiting postal employes from permitting addressees to open packages for inspection before acceptance. Instructions have been sent to all postmasters to refuse hereafter to accept for mailing any packages containing labels stating that the recipients may open them before paying charges, and to report to the Postoffice Department at once any firms or individuals whose advertisements hold out this privilege. Under the control which the Postoffice Department exercises over advertising matter, the transmission by mail of advertisements that merchandise may be examined before accepted may be easily stopped.

A number of complaints are received regularly from patrons of the postal service that they are not permitted to open packages before acceptance, although the senders assured them of the privilege, and great difficulty has been experienced by carriers in convincing patrons that they are not entitled to inspect C. O. D. parcels.

WILL MAKE EMERSON MACHINES

The Emerson Phonograph Co., 206 Fifth avenue, New York City, announces that it has closed arrangements with the Wasmuth-Goodrich Co., of Peru, Ind., whereby that company is to have the right to use the name "Emerson" on talking machines, manufactured by it, for a period of one year. The Emerson Phonograph Co. will, for the present, confine its activities to the manufacture of records exploiting its foreign and standard record catalog.

"SUPERB" SEMI-PERMANENT NEEDLE

THE PERFECT NEEDLE

Plays 100 to 200 Records :: Retail 4 for 30 cents

Send for Samples and Discounts

MELLOWTONE NEEDLE CO.

ANSONIA, CONN.

Meet Me Next Sunday
See Page 116
Jack Snyder

CANTON AN EDISON CONSOLE WINDOW DISPLAY FOR SEPTEMBER

Business Holds Its Own—Dealers Are Optimistic—Rural Demand Grows—Situation Reviewed

CANTON, O., August 6.—Although the rail and coal strikes are still on there appears to be but little depression in the industrial world locally, and from reports gleaned from the Canton district business with the leading talking machine dealers the past month has been, in most instances, better than the preceding months and the morale of the industry appears far brighter than at any time in the past three months. Talking machines moved better in July than they did in either June or May and records showed a decided improvement the latter part of the month. Collections are better and talking machine sections of the department stores report sales of portable machines on the increase.

W. E. Pyle, manager of the talking machine department of William R. Zollinger & Co., this week reported the sale of a \$900 Chippendale Electric Victor machine, for cash, which is an achievement to be proud of. The Zollinger store displays these models regularly.

Mr. Pyle reports that business in the talking machine department in July, despite the fact that the store was closed two and a half days, owing to the death of William R. Zollinger, founder of the store, was almost three times that of the corresponding month a year ago.

Rhines Edison Shop, featuring the Edison machine exclusively, has just completed a most active month, so far as talking machine and record business is concerned. The Massillon store, of the same company, also reports a good July business.

The talking machine section of the Klein-Heffelman-Zollars Co., largest department store in the Canton district, enjoyed a good month during July, said P. Q. Schrake, manager of the music division of the store. Since moving the talking machine section from the fourth to the main floor, rear mezzanine, sales of records as well as machines have been on the increase. The store held its annual picnic on July 26 at Springfield Lake Park and Mr. Schrake was in charge of the sports program.

The talking machine department of the Springholzworth Co., Alliance, O., which for years occupied a prominent place on the fourth floor of the original department store, has been moved to the second floor rear of the newly completed annex. The section is spacious and pretty in its appointments. The store has added several



The window display which Thomas A. Edison, Inc., has prepared for use of Edison dealers during the month of September is concentrated upon console models. An artistic layout is provided of attractive posters which por-

tray each of the console models included in the standard line, together with a pertinent description of each. In the center is a horizontal poster devoted to the general idea of console models. The drapery is of heavy velour.

lines of pianos since the reopening and is making a strong bid for the talking machine trade of the district. The department has installed a section for records.

Miss Ethel Walthower, head of the talking machine section of J. H. Johnson Sons, Alliance, O., says the bulk of talking machine sales this month will come from the rural districts. A crew of three men, carrying with them two different models of machines, is scouring the countryside for 20 miles about Alliance placing machines in farmers' homes on trial. She says good results are reported and business has been very satisfactory despite conditions.

Buys Drake & Moninger Booths

Booths and other talking machine equipment of the Drake & Moninger Co., bankrupt, of Alliance, O., music dealer, have been purchased by the J. H. Johnson Sons Co. of that city. The booths have been installed at the Johnson store and have greatly improved the appearance of the main floor. This company conducts the largest furniture and music house in Alliance with a talking machine and record department.

Talking machine dealers of Canton are affiliating with the newly organized Canton Retail Merchants' Association, an organization which will take over the activities of the Canton Retail Merchants' Association. D. W. Lerch, well-known Canton music dealer, has been appointed chairman of the music dealers' committee in the drive this week for new members and it is indicated that when the canvass is completed the Association will have 100 per cent of the music dealers of the city.

Holding Off for Fall

Starr and Cheney sales during the month of July were rather slow, stated C. M. Alford, head of the Alford & Fryar Piano Co. He says the firm has many prospects but that they appear to be holding off until Fall to buy. This concern is making a strong bid for the rural trade and has a crew of men working the farm districts.

Music dealers of the Canton district announce that they will again feature their piano and talking machine exhibits at the Stark County Fair, which opens Labor Day.

MOTORS OF SUPERIOR QUALITY

SILENT WINDING

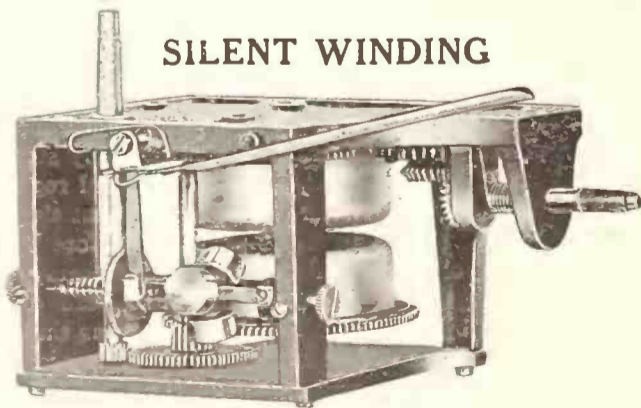

M No. 3

SPECIFICATIONS FOR M 3—Double Spring, Motor Playing Three 10-inch Records without Rewinding. Cast Iron Frame. Worm Drive. Beveled Gear Winding. Furnished complete, with graduated regulator, winding key of desired size, turntable stop working under turntable, fibre-back escutcheon, washers, screws, felts; also stamped 10-inch turntable covered with all-wool felt. Built especially for high-grade portable machines.

Sample Price for M No. 3 Complete \$5.25

Sample Price for M No. 4 Complete \$6.25

Write for Quantity Prices

SILENT RUNNING

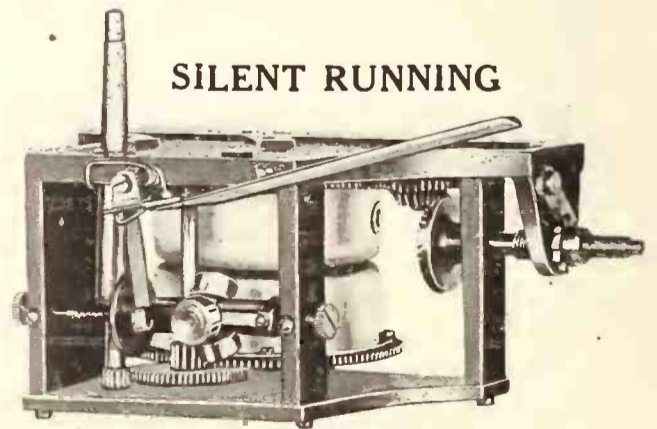

M No. 4

SPECIFICATIONS FOR M 4—Double Spring, Motor Playing Four 10-inch Records. Cast Iron Frame. Worm Drive. Beveled Gear Winding. Ratchet device that prevents clicking furnished complete, with graduated regulator, winding key of desired size, turntable stop working under turntable, fibre-back escutcheon, washers, screws, felts; also 12-inch turntable, covered with all-wool felt. Built especially for high-grade machines.

MAGIC PHONO MOTOR CO.

261-273 Lorimer Street, Brooklyn, N. Y.

Last call for advertising fans for summer. This is good, inexpensive and practical publicity which repeats an attractive suggestion to your neighbors every time the weather heats up. Ask the Columbia Dealer Service Man.

**Columbia Graphophone Co.
NEW YORK**



H. L. TUERS' NEW POSITION

Resigns From Columbia Co. to Enter New Field —Retirement From Industry Will Be Keenly Regretted by Many Friends in the Trade

H. L. Tuers, manager of the Dealer Service department of the Columbia Graphophone Co. for the past five years and associated with the Columbia Co. for the past ten years, resigned from the Columbia organization August 1. Mr. Tuers has joined the staff of W. F. Powers Co., New York, one of the leading lithographers in the



H. L. Tuers

city and a company which has built up a quality clientele that is equaled by few lithographers in this country.

During his ten years' association with the Columbia Graphophone Co. Mr. Tuers has won the esteem and friendship of Columbia dealers from coast to coast. He worked indefatigably in their interests and his thorough knowledge of their requirements enabled him to give the Columbia dealer representation unusual service and co-operation. Mr. Tuers enters upon his new work with the hearty good wishes of the Columbia dealer organization and the Columbia staff throughout the country.

DEATH OF MISS MAXINE HART

Popular Columbia Artist Dies Suddenly After Short Illness—Well Known in Theatrical World

Miss Maxine Irene Hart, of the well-known musical comedy and vaudeville team of the Hart Sisters, died on Sunday at the French Hospital, after a brief illness. Miss Hart and her sister, Bernice, constituted one of the most popular teams in the theatrical world, and some months ago arrangements were completed whereby the Hart Sisters became exclusive Columbia artists. Their first recordings were announced recently and it was predicted that their Columbia records would meet with a ready sale. Miss Hart's last appearance in New York was in Al Jolson's show, "Bombo," where she was one of the stars.

SOME EXHIBITORS AT THE NATIONAL MERCHANDISE FAIR

Members of the Talking Machine Trade Take Advantage of Opportunity to Present Their Products to the Consideration of Visiting Buyers Who Attended This Great Buying Mart

The National Merchandise Fair, of which much has been promised for several months past and which has the backing of some of the big business interests of city and country, opened at the Grand Central Palace and the Seventy-first Regiment Armory on Monday, August 7, with close to 1,000 manufacturers and wholesalers exhibiting their products for the benefit and convenience of visiting buyers. The fair was launched with the idea of enabling buyers from out of town to inspect a great number of lines under one roof and at a great saving of time and expense, and it is estimated that at least 50,000 buyers will have attended the fair before it closes, on August 26. That the buyers are interested was quite evident during the opening days, when representatives of retail concerns from all sections of the country registered at the fair.

Members of the talking machine trade particularly were quick to take advantage of the opportunity to present their products to the visiting buyers and a number of them had spaces. They included the Brilliantone Steel Needle Co., 347 Fifth avenue, New York, which displayed a full line of needles of various sorts; Diamond Wood Products Co., 25 West Forty-third street, New York, miniature cabinet talking machines and furniture; General Phonograph Corp., 25 West Forty-fifth street, New York, which displayed

Okeh records and phonograph parts and supplies; the Gold Seal Co., 105 West Fortieth street, New York, which displayed and demonstrated the Geer and Gold Seal record repeater; Harper & Bros., Franklin square, New York, who included a number of Bubble Books in their exhibit of publications; La Valle Mfg. Co., New Haven, Conn., Bobolink record books; Mermod & Co., 874 Broadway, New York, who showed small phonographs and parts, together with music boxes; the Perfection Talking Machine Co., 228 Seventh avenue, New York, who displayed several models of combination talking machines and radio receivers, together with a radio receiving set, to be installed in the ordinary talking machine cabinet after the motor board has been removed; the Plaza Music Co., 18 West Twentieth street, New York, which had a display of Banner records, Pal portable talking machines, together with Jewel music rolls; Peerless Album Co., 638 Broadway, New York, which exhibited talking machine record albums, photograph albums and autograph albums; Cameo Record Co., 102 West Thirty-eighth street, New York, which demonstrated Cameo records, and the Averill Mfg. Co., New York, which displayed talking dolls equipped with small cylinder talking machine records. These exhibits were the center of much interest on the part of visiting buyers.

Some Musical Merchandise Specials For the Phonograph Dealer



BANJOS

Banjo-Mandolins and Banjo-Ukes are selling briskly. Take our new "Claro- phone" line, for instance—

\$10.00 and \$15.00

at retail, and you nearly double your money!

Musical Merchandise Buying Is Easy With These Two FREE Books!

Our complete Illustrated Catalog is being mailed this week. With it goes our new

Confidential Trade Price List No. 5 for Fall 1922.

These books are the key to successful buying. Practically every instrument and accessory you'll ever have a call for is offered here, and priced to help you make the sale. These books are free!

WRITE FOR YOURS



UKULELES

Selling as never before! Everybody wants one. Our line includes a wide choice of popular styles.

\$2.00 to \$15.00

at retail. You double your money on every sale!

The FRED. GRETSCH MFG. CO.

Musical Instrument Makers Since 1883

60 BROADWAY

BROOKLYN, N. Y.

REPAIRS

TALKING MACHINE TROUBLES AND HOW TO REMEDY THEM

Conducted by Andrew H. Dodin

Repair Adjustments That Help Trade!

The coming of September means to many thousands of homes the ending of the vacation season, with the occupants straightening out their homes in preparation for the coming Winter. It also means, officially, that the talking machine again comes into active use after a rest of two or three months. How many dealers take advantage of the opportunity thus offered at this season of the year to have a salesman or repairman make an inspection trip among their customers to look over the various talking machines and adjust the many little things which may require it after the machine has been idle for some time?

Perhaps nothing may be found wrong with the machine, and, in fact, in most cases the ma-

chine will be in first-class condition, but the mere fact that the dealer has shown enough interest in his customer to see that the machine is in perfect running condition should strike a responsive chord in the customer and sooner or later bring him, or her, to the store in quest of new records, or, perhaps, a larger or more elaborate type of machine.

Seeing to it that the customer's machine is in proper playing condition is not to be regarded as profitless service to that particular machine owner. One of the ideas behind the move is that the customer is very likely to have friends calling at intervals and for them to hear a perfect playing machine and to learn of the dealer's interest is the best kind of an advertisement for that particular dealer's store. Such interest on the part of friends means further sales for the dealer.

What better advertisement can a dealer have than a perfect playing machine in the customer's home? Surely it does not suffice to say, "I sell the — machine: there is none better." Even the best constructed motor and sound box are liable, sooner or later, to go wrong, either through natural causes or through unskilled han-

dling by the owner. Under such conditions the dealer cannot afford to have representing his store a machine that will not play or plays indifferently.

When he sells the outfit it is good business to sell with it upkeep service to a reasonable degree. It is one of the liveliest business-building opportunities at the dealer's command.

The dealer may say "I do not maintain a repair department" or "I have all my repair work done at the shop of my jobber and he could not possibly do this for me." The conclusion is wrong, for this particular service should be the duty of one of your salesmen—the man who is in a position to take immediate advantage of buying interest. The salesman should be sufficiently versed in the minor adjustments of the motor or sound box to be able to make them in the home without difficulty. The motor that needs a new mainspring or the sound box that needs a new diaphragm should be sent to the repair shop.

When the machine has been adjusted and put in good condition the salesman should bring into play his selling ability. If he has been observant he has found out by looking at the records what class of music the machine owner favors, and he can suggest new records of the same type. If he has with him samples of the latest records he can demonstrate them and sell them on the spot. This is being done every day in the week by certain dealers I know and with surprising results.

The adjustments that a salesman is competent to make depend largely upon the salesman himself and the interest he has taken in studying the mechanical features of the machine. I suggest that he obtain from the manufacturer of the particular machine he is selling all the printed matter possible in reference to the construction and repair of that particular product. Let him study the matter carefully, take one of the motors in the store apart and then reassemble it and study the replacing of minor parts, such as a broken governor spring. He should learn particularly the proper places to inject oil, where gear grease is required, etc. He should wind the motor up full and allow it to run down, listening to the sound it makes in running so that he is enabled to determine whether it is noisy or if the springs jump, a sign that the motor needs to be sent to the shop to have more graphite put in the springs.

The sound box should be studied carefully, particularly the manner in which the needle arm is tensioned. The salesman should be able to judge when the sound box blasts whether the trouble is in the tensioning of the arm or in the fact that the gaskets have become dead and do not hold the diaphragm tight enough.

Experience is always the best teacher and practice makes perfect. A few days of work and study should make the salesman competent to discover and adjust the minor talking machine troubles and, in fact, to tell what is the matter with a machine that doesn't work.

Grease Gun for Springs

Gloversville, August 3, 1922.

Editor The Talking Machine World:

I understand that there is a grease gun made for the purpose of lubricating Edison spring barrels. As I would like to get one I wish to know where I can obtain it. So far I have been unable to find one. "Can you help me in this matter?" (Signed) Walter C. Lair.

Answer—You can obtain a grease gun for use in placing graphite in the Edison spring cage from almost any automobile supply store. It will probably be necessary for you to make some gauge or method of marking the handle of the gun so that you can easily tell the amount of graphite that you are placing in the cage.

Andrew H. Dodin.

VICTOR SHOP CHANGES HANDS

The Victor talking machine establishment of A. H. Taylor, Inc., at Jamaica, Long Island, has been purchased by Mathushek & Sons Piano Mfg. Co., who operate a chain of retail piano and talking machine stores in the metropolitan district.



PIANO BOOKS

THE Edward Lyman Bill, Inc., technical library represents the only books written in English for the men who constitute the piano and player-piano industry of the United States. Each book covers its respective subject clearly and completely. Each volume is the standard work of its particular field. Every one of these books should be in the hands of every progressive man who wants to help keep the American piano industry the world's leader, both from an artistic and commercial standpoint.

Modern Piano Tuning

A very comprehensive book covering principles and practices of tuning, regulation of piano action, elementary principles of pneumatics, general construction of player mechanisms, repair of old pianos or player mechanisms. 331 pages, \$2.00.

Theory and Practice of Pianoforte Building

An essential book for every manufacturer, scale draftsman, superintendent, dealer or piano salesman. The only work of its kind in the English language. 160 pages, fully illustrated, tables, diagrams, etc., \$2.00.

Player-Piano Up to Date

The best available source in English for player-piano knowledge. Principles of construction, regulation and use of pneumatic mechanisms. Descriptions of leading mechanisms. For salesmen, tuners, repairmen, etc. 195 pages, illustrated, \$1.50.

Regulation and Repair of Pianos and Player Mechanisms

Indispensable for salesmen and executives in piano factories, two books in one, illustrated, tables, diagrams. 158 pages, \$1.50.

Mail This Inspection Coupon

Edward Lyman Bill, Inc.
373 Fourth Ave., New York City.

You may send me on five days' free inspection the book or books I have marked. I will return them to you within five days or remit \$..... in full within ten days.

Name

Address..... City.....

Mark which books you want to see

<input type="checkbox"/>	Modern Piano Tuning
<input type="checkbox"/>	Theory and Practice of Pianoforte Building
<input type="checkbox"/>	Regulation and Repair
<input type="checkbox"/>	The Player Pianist
<input type="checkbox"/>	Player-piano Up to Date

Edmund Vance Cooke is a great entertainer of children. His child dialect poem, "Moo-Cow-Moo," has been read and recited to children all over this land. He has made a Columbia record of this and three other favorites, "The High Giraffe," "Monkey Man" and "The Shave Store." A-3151.

**Columbia Graphophone Co.
NEW YORK**



MARION HARRIS WITH BRUNSWICK

Well-known Vaudeville Star and Comedienne to Record Exclusively for Brunswick

William A. Brophy, managing director of the Brunswick Recording Laboratories, New York, has just announced that Marion Harris, the well-known vaudeville star, will now make recordings exclusively for Brunswick records. Miss Harris



Marion Harris

is perhaps one of the best-known character song artists and vaudeville comediennes in the country. Her first recording, a double-disc, with "I'm Just Wild About Harry" on one side and "My Cradle Melody" on the reverse, will be sent to the trade on September 1, so that Brunswick dealers can have them to start their Fall business. This record introduces an innovation in Brunswick recording in that Miss Harris is supported in her song by the Isham Jones Orchestra, a combination which is bound to meet with decided favor.

VICTOR ARTISTS AID SALES

Alma Gluck and Efrem Zimbalist Autograph Many Records for Society Folk at Southampton Fair—Jedlicka Bros. Dispose of Stock

SOUTHAMPTON, N. Y., August 8.—Jedlicka Bros., well-known talking machine dealers of this section, profited by the recent appearance of Alma Gluck and Efrem Zimbalist at a street fair held here for society folks. The artists visited the establishment, secured all of the records made by them, and returned to the fair, where they autographed them. The records were quickly disposed of. Chas. Jedlicka, manager of the Bay Shore store, and Mr. Baker, representing the Blackman Talking Machine Co., Victor distributor, greeted the Victor artists on their arrival.

BUSINESS NOW ON THE UPGRADE

Otto Heineman Brings Back Optimistic Reports From Central West—Found Okeh Dealers Loyal and Enthusiastic—Record Sales Show Decided Improvement Throughout Country

"The talking machine business is gradually getting back to a normal basis, and record trade in particular has shown a decided turn for the better during the past few weeks," said Otto Heineman, president of the General Phonograph Corp., manufacturer of Okeh and Odeon records, who returned recently from a visit to the trade in Wisconsin, Illinois, Missouri, Ohio and New York. "On my recent trip I visited hundreds of Okeh dealers and I was delighted to find practically every dealer optimistic and confident regarding Fall business. This optimism, moreover, was substantiated by improved sales figures since the first of July, and as a whole there seems to be a better feeling all around.

"Perhaps the most impressive feature of my trip was the loyalty towards Okeh and Odeon records manifested by our dealers. Throughout my entire trip I did not receive a single complaint regarding the recording or the quality of our records, but on the contrary found the dealers exceptionally well pleased with the quality of our product. No business can hope to succeed without the good will of the dealer, and with the present loyalty and friendship of the Okeh dealers the permanent success of our records is assured.

"There is no question but that the talking machine industry, and particularly the record branch of the business, was badly hit during the business depression, but we have undoubtedly reached the turning point and are now on the upgrade. The liquidation sales of inferior machines are gradually dwindling out and the public now recognizes the fact that a standard trademarked talking machine is the only profitable investment."

DOING A LARGE RECORD BUSINESS

The Pathé Frères Phonograph Co., Brooklyn, N. Y., is experiencing excellent record business. Daily production records have not only reached large figures but are steadily growing. The recent reduction of the price of Actuelle records to 55 cents has proved very popular with the buying public and has created an exceptional demand. The Actuelle catalog offers not only popular but many classical selections sung by well-known artists.

R. L. FREEMAN TO VISIT CANADA

Ralph L. Freeman, director of distribution of the Victor Talking Machine Co., Camden, N. J., is planning to leave about September 1 on a vacation, which he will spend in Canada on a visit to his parents. Mrs. Freeman and their children will probably accompany him to his parents' home.

FELT

We are prepared as never before to give prompt delivery.

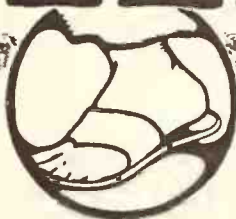

Turntable Felt

The name of a special product made by the American Felt Company for the Talking Machine Trade.

It possesses features which distinguish it from Felts made by this company for other purposes.

Only our special Turntable Felt is good enough for leading Talking Machine Manufacturers, who use it exclusively.

American Felt Company

TRADE MARK



BOSTON
100 Summer St.

NEW YORK
114 East 13th St.

CHICAGO
325 So. Market St.



Wake up lit-tle girl you're just dream-ing pret-ty dreams, Dream-ing the hours a-way,

WAKE UP LITTLE GIRL

YOU'RE JUST DREAMING

HEAR IT NOW

"You can't go wrong
With any FEIST song"

ATLANTA

Growth of Home Buildings Bright Augury of Machine and Record Sales Throughout South

ATLANTA, GA., August 7.—Southern construction for the first six months of this year reached a very high level. Increases in most instances are impressive and indicative of the acceleration of this work. The value of Atlanta's permits for the first half of the year was more than \$8,500,000, and a gain of more than \$3,000,000 over the same period of last year was registered. This is providing a great year for Atlanta. Memphis also has done exceedingly well. Its record for the first six months is in excess of \$7,000,000, and marks a gain of more than \$3,500,000 over the same period in 1921. New Orleans is above \$4,000,000, while Birmingham lacked about a quarter of a million of reaching that mark. Knoxville, Tenn., nearly doubled last year's figures. Permits this year amounted to \$2,494,022, while for last year they aggregated \$1,337,102.

The above indicates the circulation of a large quantity of money, from which the talking machine trade should feel the benefit.

The world-wide demand for Okeh records, and the international reputation of the Polk Furniture Co., Atlanta, are strikingly evidenced by a recent inquiry received in Atlanta from a firm in Budapest, Hungary, relative to the Okeh.

John Mohl, assistant manager of the local branch of the Columbia Graphophone Co., who has made an extended trip through Florida, returned to Atlanta to assume charge while Westervelt Terhune spends his vacation in the mountains of North Carolina.

Manley Robison, of the Phillips & Crew Co., has recently returned from Savannah, where he had been looking after the interests of the company's branch store there.

Dealers report July business as well ahead of June, one gratifying feature being the number of machines sold for cash.

The Victor Health Building records were placed on sale August 1. All the dealers report a fine initial demand.

The Roby Music Store is now settled in its new location on Decatur street near Pryor.

Special mid-Summer terms have been announced by the Cable Piano Co.

A sample of the new Strand model, No. 16, which lists at \$250, has just been received by M. E. Lyle. This machine has won the favorable interest of everyone who has seen it.

The Cochran Furniture Co. will move from its present store on Broad street to a larger place on East Alabama street. Sonoras are especially featured.

Record sales have been stimulated during the past month by many of the Peachtree shops which have placed a talking machine at the store entrance and demonstrated the latest records to the passers-by.

Ludden & Bates have recently added the entire Brunswick line of machines and records.

The Stone-Moore-West Co., of Gainesville, Ga., has taken larger quarters on the square. August 12 has been set as the opening day. This new store will be run in addition to the one occupied by them at present.

"Lonesome Mama Blues" is featured on both Victor and Okeh records, and is reported as the most popular one of the month.

The first of the new Pal portables has reached Atlanta. One of the prominent talking machine shops in the Peachtree Arcade has especially featured this model in its windows.

W. C. Fuhri, sales manager of the Okeh record, New York, was met in Savannah, Ga., by P. C. Brockman, who has charge of the Polk Furniture Co. wholesale phonograph division. After visiting Macon they returned to Atlanta, where Mr. Fuhri spent several days, leaving later for New Orleans.

Joseph Crews, who was for years a Victor dealer in Atlanta, and is now a resident of Tampa, Fla., has recently spent several weeks here meeting his old acquaintances.

Among recent out-of-town visitors who called to discuss prospects for Strand Fall business were W. A. Evans, of Sterchi Bros. & Fowler, Chattanooga, and T. W. West, of Stone-Moore-West Co., Gainesville, Ga.

A. C. Gourlie, of the Gourlie Music Co., Tampa, Fla., recently spent several days in Atlanta.

E. A. Ackley, from the Sterling Roll & Record Co., Cincinnati, was a recent visitor.

"Bill" Parks, for years with the Atlanta branch of the Columbia Co., now manager of the Baltimore store, was here for several days.

If sales of the record "Lonesome Mama Blues" were in proportion to the interest displayed in the Phillips & Crew show window the week of July 20 they should indeed be gratifying. Mr. Stokes, the well-known Atlanta artist, modeled a typical black mammy and surrounded her with a "piney woods" log cabin atmosphere. The "ole banjo," red bandana and rusty wash boiler were all part of the picture. Even the Victor dog, who sat in the cabin doorway, wore a wistful look. This display was so successful that it will be forwarded to Birmingham, Ala., for use in the windows of the Clark-Jones Piano Co.

GRAFONOLA IN LAND OF ESKIMO

Noted Explorer Gives Grafonola to Eskimos—
Instrument Popular With Northern Residents

Robert J. Flaherty, noted explorer, who returned recently from a ten years' stay around the North Pole, brought with him an interesting photograph showing the use of an A2 Grafonola in the land of the Eskimos. This photograph was taken on the most northerly point of Labrador, where Mr. Flaherty lived in intimate association with a small tribe of Eskimos, studying their



A Picture From the Far North

habits and daily life. Mr. Flaherty reports that the Grafonola proved so popular among the Eskimos that he had his choice of valuable furs on an exchange basis.

JOINS RANKS OF VOCALION ARTISTS

Virgilio Lazzaro, basso of the Chicago Opera Co., has joined the ranks of the Vocalion record artists and made his first record from the "Barber of Seville" for the August list.

THE HOMOPHONE



Do you sing or play a musical instrument? Preserve your talent by recording it on a Phonograph by means of the HOMOPHONE. Instructive and entertaining. Hear yourself as others hear you. May be attached to Victor, Edison or Brunswick. When ordering state kind and model. Price \$42.50. Write for particulars.

HOMOPHONE CO.
293 Plane St., Newark, N. J.

Meet Me Next Sunday
Jack Snyder

(See page 116)

WORLD'S CLASSIFIED ADVERTISING

Any member of the trade may forward to this office a "Situation" advertisement intended for this Department to occupy a space of four lines, agate measure, and it will be inserted free. Replies will also be forwarded without cost. Additional space will be at the rate of 25c. per line. If bold faced type is desired the cost of same will be 25c. per line. Rates for all other classes of advertising on application.

WANTED—As a representative by a well-known Chicago talking machine manufacturer a man thoroughly acquainted with Greater New York territory. Also a man who is acquainted with the talking machine trade in the East, to handle our line of talking machines, either exclusively or as a side line. Address with full details to "Box 1177," care The Talking Machine World, 373 Fourth Ave., New York, N. Y.

SALESMEN WANTED—IF YOU CALL ON TALKING MACHINE DEALERS you can easily increase your income selling the Phon-O-Game. Combined adaptation of roulette wheel and put and take game. Plays on any phonograph. Tremendous human interest. Includes 12-inch record in red, green and black. Advance sales tests demonstrate this as a big-profit proposition for you. Salesmen secure absolute protection on all their prospects. Big commissions paid instantly. Write at once, in confidence, to The Phon-O-Game Co., 128 C Fulton St., Elizabeth, N. J.

POSITION WANTED—Chemist with years experience here and abroad with a composition for manufacturing a 10-inch record for 6 cents; also recording expert with twenty-five years' experience, and his own outfit. Both are open for engagement. Address "Box 1186," care The Talking Machine World, 373 Fourth Avenue, New York.

POSITION WANTED—Retail store manager, having had six years' experience in managing stores, merchandising talking machines, records and sheet music, desires similar position. Highest references. Address "Box 1179," care of The Talking Machine World, 373 Fourth Ave., New York, N. Y.

POSITION WANTED—Many years as technical phonograph laboratory expert, can work and capable of superintending work from start to finish. Recordings, plating and matrix making. Use finest methods, wishes interview. Address "Box 1180," care of The Talking Machine World, 373 Fourth Ave., New York, N. Y.

WANTED—We now have openings for live salesmen to represent us in all parts of the U. S. A., either as a side line or on full time. Write at once, giving territory you cover, to Vitanola Talking Machine Co., 1920 South 52nd Ave., Cicero, Ill.

POSITION WANTED—Phonograph salesman, 10 years' experience, wholesale and retail musical instruments, sheet music, desires connection outside of New York City. Capable manager. Character, ability and integrity will stand most exhaustive inquiry. Address "Box 1178," care The Talking Machine World, 373 Fourth Ave., New York, N. Y.

POSITION WANTED—Practical phonograph and record man, ten years' manufacturing experience, familiar with all technical details of record making, desires position in factory or sales department. Would consider position with jobber or dealer anywhere in United States. Technical knowledge should prove valuable asset in jobbing or retail selling fields. Address "Experience," Talking Machine World, 373 Fourth Ave., New York, N. Y.

WANTED—Good phonograph salesman experienced in selling to retailers in New York, Brooklyn and suburbs. Address "Box 1184," care The Talking Machine World, 373 Fourth Ave., New York.

WANTED—An experienced phonograph salesman to cover the New England territory. One who has had experience and knows the trade in the New England district. A good live proposition for a live man. No others need apply. Playertone Talking Machine Co., 967 Liberty Ave., Pittsburgh, Pa.

POSITION WANTED—Experienced man in varnishing, rubbing and polishing on phonographs. Good references. Twelve years' experience. Address "Box 1185," care Talking Machine World, 373 Fourth Ave., New York.

ALL-AROUND MECHANIC, inside and outside, on a'l makes of talking machines with 8 years of experience. Can also sell. Wishes position anywhere. Address "Box 1183," care Talking Machine World, 373 Fourth Ave., New York.

SPRINGS

VICTOR		
1 1/4"x.022x18' 6" marine ends.....	No. 3014	\$.58
1 1/4"x.022x17' marine ends.....	No. 3014	.55
1 1/4"x.022x17' bent arbor.....	No. 5362	.57
1 1/4"x.022x13' bent arbor.....	No. 5423	.50
1 1/4"x.022x9' bent arbor.....	No. 5427	.42
1 1/4"x.022x9' bent each end.....	No. 6546	.42
1"x.020x13' 6" marine ends.....	No. 2141	.32
1"x.020x15' marine ends.....	No. 3335	.35
1"x.020x15' bent arbor.....	No. 5394	.38
1"x.020x15' bent each end.....	No. 6546	.43
3/8"x.020x9' marine ends.....	No. 988	.29
COLUMBIA		
1"x.028x10' Universal.....	No. 2951	.33
1"x.028x11' Universal.....	No. 2951	.35
1"x.030x11' hook ends.....		.45
1"x11' for motor No. 1.....		.35
HEINEMAN		
1"x.025x12' motors.....	No. 33 & 77	.33
1 3/16"x.026x19', also Pathé.....		.75
1 3/16"x.026x17'.....	No. 4	.59
MEISSELBACH		
3/8"x10' motors.....	No. 9 & 10	.29
1"x9' motors.....	No. 11 & 12	.29
1"x16' motors.....	No. 16, 17 & 19	.49
SAAL-SILVERTONE		
1"x.027x10', rectangular hole.....	No. 144	.42
1"x.027x13', rectangular hole.....	No. 145	.48
1"x.027x16', rectangular hole.....	No. 146	.58
BRUNSWICK		
1"x.025x12', rect'glar hole, regular... No. 201		.45
1"x.025x18', rect'glar hole, regular... No. 401		.65
1"x.025x16', rect'glar hole.....		.58
KRASBERG		
1"x12' motor 2A, pear-shape and rect. holes.		.49
1"x16' motor 3 and 4 on outer end.....		.60
EDISON DISC		
1 1/2"x.028x25', regular size disc motors....		1.47
1"x.032x11', Standard.....		.55
1 5/16", Home.....		.70
1 5/16"x18' type A 150, old style disc.....		1.28
1" Amberola 30-50-75.....		.56
SMALL MOTORS		
3/8"x.023x10', marine ends, Hein. Col., etc....		.29
3/8"x.025x10', marine ends, Hein. Col., etc....		.27
3/8"x.020x9', marine ends.....		.21
1/2"x.020x9', marine ends.....		.18
Victor Gov. springs, No. 1729.....	per 100	.95
Victor Gov. spring screws, No. 3304.....	per 100	.92
Victor Gov. balls, n/style, No. 3302.....	each	.07
Victor Gov. spring screw washer.....	per 100	.72
Columbia Gov. springs, No. 3310.....	per 100	.95
Columbia Gov. spring screws, No. 439.....	per 100	.92
Columbia Gov. spring screw washers.....	per 100	.72
Columbia Gov. ball, lead, flat and spring...		.08
Columbia Gov. ball, new style & spring...		.08
Turntable felts, all wool, green, 10", round.		.15
Turntable felts, all wool, green, 12", round.		.18
Terms, 2% cash with order.		

TALKING MACHINE SUPPLY CO., PARK RIDGE, N. J.

FOR SALE OR RENT

PHONOGRAPH

Recording Laboratory

Completely equipped for all classes special and regular commercial work. Established trade. Address inquiries, "Recording Laboratory," care The Talking Machine World, 373 Fourth Ave., New York, N. Y.

FOR SALE

Music house, well established for 14 years in a large middle West city. Pianos and Victor and Brunswick Depts. High-class clientele. Good reason for selling. All cash preferred, but terms to reliable party, or parties. Address "Box 1161," care The Talking Machine World, 373 Fourth Ave., New York, N. Y.

CARVED LEGS

Eight designs in gum, oak and mahogany. Prices reduced. Send for circular. Klise Mfg. Co., Grand Rapids, Mich.

FOR SALE

Several thousand standard make records, late numbers, also sacred, instrumental standard numbers, etc., at thirty-five cents each. Send for catalog. Central Phonograph Co., 127 N. 11th St., Philadelphia, Pa.

For Sale—Krasberg Motors

are known throughout the entire talking machine industry and were conceded to be the best enclosed type motor on the market. Any institution desirous of getting all the Krasberg motor business in its entirety is now offered the opportunity of a lifetime. All tools, dies, machinery, patents, etc., necessary for the manufacture of the famous Krasco enclosed motor can be had outright at a sacrifice. James X. Galbaugh, Room 1204, Consumers' Building, Chicago, Ill.

Consoles at Special Prices

A prominent manufacturer has a number of Adam and Queen Anne consoles for sale at a price. These instruments are of 3/4-inch five-ply panels throughout, equipped with three-spring motor, balanced lid supports, etc., but were unable to pass a rigid factory inspection, being only slightly defective. All manufacturers' identification marks removed. Address "Box 1176," care of The Talking Machine World, 373 Fourth avenue, New York, N. Y.

FOR SALE

Completely Equipped Record Factory

All machinery of latest type, built in many cases from exclusive designs. Entire plant laid out by competent engineers to operate at highest possible efficiency. Address "Box 1181," care The Talking Machine World, 373 Fourth Ave., New York.

FOR SALE

An established, well-paying and exclusive Victor business in suburb of Los Angeles. Store attractive and novel. Open seven months. Stock new and complete. Inventory and fixtures, \$8,500. Reason for selling, owner has two such stores and unable to take care of both. Only Victor franchise in town. Address Chas. P. Mack, 1050 South Magnolis street, Los Angeles, Cal.

Phonograph Executive Wanted

Capable executive with some capital to manage Kurtzmann Electric Phonograph Co. Exclusive basic patents. No factory investment required. An unusual opportunity for one capable of organizing and managing selling force to dealers. Satisfactory information furnished. Kurtzmann Electric Phonograph Co., 121 Franklin St., Buffalo, N. Y.

Hydraulic Press and Pump

Watson-Stillman hydraulic press (70 ton chilling) with hydraulic hand pump (double plunger) and pressure gauge in excellent condition, ready to use, is for sale. Ideal for experimental work or limited production phonograph records or radio parts. Address Richard Berger Laboratory, 1928 North Ave., Bridgeport, Conn.

New Recording Method

I have new method of recording for talking machine records (lateral cut) which will revolutionize the record business. If you know a real man acquainted with the record business do him a favor, call his attention to this. I will "show my hand" to a proper party. Address "Box 1182," care Talking Machine World, 373 Fourth Ave., New York.



EUROPEAN HEADQUARTERS

2 GRESHAM BLDG., BASINGHALL ST., E.C. LONDON.

W. LIONEL STURDY, MANAGER

Improvement in Industry Continues With a Reduction in the Number of Unemployed—The Radio Situation in the Gramophone Trade—Dealers' Surplus and Unsalable Record Stocks Discussed by the Gramophone Dealers' Association—Reduction in Freight Rates Welcomed—Unit Construction Co. Has London Representation—Exhibits at London Fair—Trade Happenings of General Trade Interest

LONDON, E. C., August 3.—From various quarters optimistic reports reach me of an improvement in industry generally and continued reduction of the number of unemployed. To be perfectly frank, the improvement spoken of is not very solid; it would be difficult to weigh it up, but what is of importance is that signs, however slight, do point to a recovery from the low depth of business depression experienced for so long. That certainly justifies an optimistic outlook upon the gramophone trade prospects for the coming season. Time of year and conditions, sales here are really not bad: there is, of course, always room for improvement, but on the whole I think most firms are satisfied that the trade is doing 99 per cent of the business possible. In other words, British manufacturers and jobbers are not missing anything for want of effort and so long as that spirit prevails we can all carry on with a good heart.

Radiophony and the Trade

Sound attention is given by the gramophone trade this side to radiophony. Perhaps because we are not so susceptible to "booms" as folk in U. S. A. and Canada the wireless stunt will move slowly but steadily, rather than on sensa-

tional lines. This, to some extent, may be ascribed to official restrictions on the use of transmission apparatus, licenses for which are not issued broadcast, as I believe is the case on your side. For receiving sets applications have been made for licenses to the tune of about 12,000. The Marconi Co. advises me that it has approached all the principal music retailers with full details of its service. Marconiphones of the cabinet type are being issued. Prices will range "as compatible as possible with the different types of gramophones"; price cutting is to be avoided and in every possible way the dealers' interest will be protected. The company's service includes the installation of aerials, etc., and local offices and demonstration centers are being opened in a number of the chief provincial towns.

Musical instrument dealers are regarded as a very appropriate channel through which to market wireless receiving apparatus. The view held in some quarters that broadcasting will interfere with the sale of gramophones and records is not a general one. Gramophone men of prominence in the trade believe, on the contrary, that listening-in will serve to stimulate the call for a "free" home music service and that can only be met by the acquisition of a gramophone. And despite its scientific wonder the new wireless broadcasting programs, once the novelty has departed, cannot be regarded, at least in its present stage of development, as quite so satisfying as the quality and musical range of the gramophone. This I stress for the benefit of any retailer who may hesitate to handle radiophones in the belief that to do so would damage his gramophone trade.

With every confidence I believe the musical trader is well advised to handle this new branch of business and develop a sound connection by making himself proficient, not necessarily in a technical sense, with what I term radiophony.

Important Subjects Discussed by G. D. A.

At the last committee meeting of the Gramophone Dealers' Association several matters of pertinent interest were discussed. The vital question of dealers' surplus and unsalable record stocks received special attention and the committee is now in a position to state that an interesting record exchange scheme will be disclosed to the trade in a week or so. In this connection I am in a position to intimate that the line upon which this scheme is based is that a definite percentage of past purchases—which have proved more or less unsalable—should be exchanged or credited twice yearly by the manufacturers. That is, full credit should be given the dealer without obligation, I believe, to purchase a like quantity, or three for one, as under the old arrangements. It is in the interests of all parties that records should be sold rapidly and not be allowed to rusticate on dealers' shelves perhaps for years.

After persistent representation the G. D. A., through the Federation of British Music Industries, has obtained an important concession from the railway companies. Hitherto gramophone records were only carried at owner's risk, but can now be dispatched conditionally at companies' risk. When carried at the risk of the railway company full parcel scale rates will be charged and the records must be packed properly



"His Master's Voice"

Copyright

This intensely human picture stands for all that is best in music

—it is the "His Master's Voice" trade-mark, and it brings to you, no matter where you are, the very best music of every kind, sung and played by the world's greatest artists—the greatest singers, pianists, violinists, orchestras and bands—all enshrined in the unequalled "His Master's Voice" records

'His Master's Voice'

—the trade-mark that is recognized throughout the world as the

HALL-MARK OF QUALITY

DENMARK: Skandinavisk Grammophon-Aktielselskab, Frihavnen, Copenhagen.

FRANCE: Cie. Française du Gramophone, 115 Boulevard Richard Lenoir, Place de la République, Paris.

SPAIN: Compañía del Gramófono, 56-58 Balmes, Barcelona.

SWEDEN: Skandinaviska Grammophon-Aktiebolaget, Drottning Gatan No. 47, Stockholm.

RUSSIA: The Gramophone Co., Ltd., 45, Nevsky Prospect, Petrograd (Petersburg); No. 1 Solyanka, Solyanoi Dvor, Moscow; 9, Golovinsky Prospect, Tiflis; Nowy-Swiat 30, Warsaw; 11 Michalovskaya Ulitsa, Baku.

INDIA: The Gramophone Co., Ltd., 139, Balighatta Road, Calcutta; 7, Bell Lane, Fort, Bombay.

Great Britain:

The Gramophone Company, Ltd.

HAYES

MIDDLESEX

ENGLAND

AUSTRALIA: S. Hoffnung & Co., Ltd., Sole Concessionaries of The Gramophone Company, Limited, 163, Pitt Street, Sydney.

NEW ZEALAND: Gramophonim, Ltd., 118-120 Victoria Street, Wellington.

SOUTH AFRICA: Darter & Sons, Post Box 174, Capetown; Mackay Bros., Post Box 251, Johannesburg; Mackay Bros. & McMahon, Post Box 419, Durban; Ivan H. Haarburger, Post Box 105, Bloemfontein; Franz Moeller, Post Box 108, East London; B. J. Ewins & Co., Post Box 86, Queenstown; Handel Honsse, Kimberley; Laurence & Cope, Post Box 132, Bulawayo; The Argus Co., Salisbury.

EAST AFRICA: Bayley & Co., Lourenço Marques.

HOLLAND: American Import Co., 22a, Amsterd Veerkade, The Hague.

ITALY: A. Bossi & Co., Via Orefici 2, Milan.

EGYPT (Also for the Soudan, Greece and the Ottoman Empire): K. Fr. Vogel, Post Box 414, Alexandria.

FROM OUR LONDON HEADQUARTERS—(Continued from page 150)

to the satisfaction of the railway people. When not so packed they go at the owner's risk.

By the foregoing example alone the value of the G. D. A. is exemplified to the advantage of its dealer-members. Such a live association merits the support and encouragement of the whole trade.

Rail Freight Reduction Announced

Amid a chorus of acclamation the commercial world has received the good news of a substantial reduction of freightage charges on English and Welsh railways, to operate as from August 1. It takes the form of a general percentage reduction to 75 per cent above the rates in operation immediately before the first of the war increases was made. On flat rate increases the reductions (which vary) amount in some instances to 50 per cent. Merchandise carried by passenger train is expressly excluded from these reductions. These freight reductions are the first since the war terminated and will prove particularly welcome to retail traders who dispatch daily quantities of small parcels by rail. One big store figures on a saving of at least £5,000 per annum. The Scotland Railways are not parties to the agreement, but it is expected they will come into line.

Unico Audition Rooms in London

The value of audition rooms is not generally recognized by our gramophone dealers. For this the chief reason, no doubt, must be ascribed to the fact that audition room equipment service has been entirely lacking. As far as I know we haven't a firm which specializes this equipment. Most audition rooms (and few dealers are so equipped) have been built to order. Though an outside firm, the advent here of the Unit Construction Co. should therefore prove "a boon and a blessing to men." H. A. Moore & Co., Ltd., this city, will handle the Unico line in the United Kingdom, and it is certain when they get going that a big trade can be done. While, of course, some spade work is necessary, the idea of audition rooms being practically a new thing to British gramophone dealers, its sales value is sufficiently apparent to justify the belief that the Unico equipment will be wanted by all enterprising traders. In due time, no doubt, Messrs. Moore will make known their service to the trade at large. An editorial boosting the Unico system appears in this month's Voice. Beyond this I have seen no publicity, even in the trade journals. The Unico is just the thing required here because the average dealer entertains his customers in open shop instead of comfortably in a Unico sound-proof audition room. But the dealer must know about this good thing; he will then move.

New Zonophone Record Program

Among the newly released Zonophone records which will interest oversea readers of these notes special mention is made of two exceptionally pleasing twelve-inch doubles. A-263 carries a couple of well-known songs—"For All Eternity" and "The Last Watch," most brilliantly recorded

and sung by that prince of tenors—Ernest Pike. The Peerless Dance Orchestra is at its best on A-262 with a fox-trot, "Buddha" (My Own), and a waltz, "The Moon Lute." Of the ten-inchers we have the popular pianist, Melville Gideon, in two of his own compositions, "Burnt Sugar" (a triple rag) and "If Winter Comes" (from the Co-optimists), both on No. 2231. An instrumental quintet comprising violin, 'cello, harp, organ and celeste offers two beautiful renditions, "Dance of the Blue Butterfly" and "Air of King Louis XIII." These pretty morceaux figure on record No. 2234. A couple of sentimentals of a not unattractive character are provided by Herbert Payne on 2227, "Sleepy Little Curly Headed Baby" and "Masks and Faces." The expected hit of the coming season is "Sally, the Sunshine of Our Alley." Its refrain is catchy and, for this type of song, there is for once a little sense in the wording. Sally is already a favorite at some of the holiday resorts. She figures on record 2229 in company with "Tell Me That Story of Old Missouri." Both are very well rendered by Stuart Vaughan.

Some other good records are listed on the same program, which generally is of a high musical standard, consistent with a varied selection of titles.

Exhibits at the London Fair and Market

Styled the London Fair and Market a trade exhibition of all kinds of goods was held at the Agricultural Hall, July 3 to 14, inclusive. Owing, it was felt, to insufficient publicity, the attendance proved decidedly unsatisfactory, with, of course, corresponding results on the sales side.

Some of the exhibits were excellent. Musical instrument firms put up a fair show, though German productions outnumbered the British, sad to say. As to comparative prices, quite a good German overstrung piano at £45 (about \$250) and well-made gramophones at—hornless, twenty-one shillings; table grand, £5; cabinet, £10, were obtainable. These rates (quality of instrument and construction considered) represent about 10 or 15 per cent under value of similar British productions.

One of the best stands was that of A. Balcombe & Co., Ltd., agents here for the "Motor of Quality" and other Heineinan productions. This famous motor-mechanism was fitted to a fine series of "Alba" gramophones of the table-grand, pedestal, cabinet and period types. Of the latter class this firm has just introduced a really magnificent range. The cabinet work is exquisite—in construction, in appearance and in fidelity to the period represented. Messrs. Balcombe's enterprise in producing such high-class models bespeaks a real attempt to cater to the better-class trade, which is much on the increase here. At one time £15 or £20 was considered an outside price for a gramophone. But the public is getting accustomed to paying more for a good instrument, just as it can pay almost any price for a piano, and to-day one can pay as

much as £750 for a super gramophone model.

The aluminum-frame gramophone—the "Bestoni" portable—attracted much attention at the exhibition. It is a fine-toned machine, very attractive in appearance, well-made and is backed with a three years' guarantee.

Signs of Trade Activity

It is to be observed that quite a number of new firms which manufacture, deal in, or otherwise have some interest in the sale of gramophones or accessories, are registered each month. The easier financial conditions now prevalent have certainly helped to release long pent-up schemes and commercial ventures, and encouraged the development of established businesses. All of which may reasonably be taken as a sign of the awakening of a too long dormant trade.

Records Packed in Pianos to Avoid Tax

An unsympathetic inspector of the German Export Bureau has disclosed a method adopted to avoid the export tax. A firm bought pianos from a manufacturer at a price on condition that when packing he would conceal in the piano and case a large number of gramophone records. This would obviate the trouble and expense of obtaining an export permit. But it was found out and the piano firm has been struck off the register of the Bureau. The instigator—evidently a resident in a foreign country—should also be punished. In recording the case the German trade journals properly express regret that a German piano maker should lend himself to such a trick.

Winners and Edison-Bells at Hastings

The staff of J. E. Hough, Ltd., made its annual outing on Saturday, July 15, to Hastings. The belated party who saw the back of the 7.30 a. m. "special" at Charing Cross joined-up an hour or so later, but was just too late to participate in a wedding on the seashore, which several of us enjoyed as welcomed guests, though uninvited! Little incidents like this—sure, there were many others—served to the pleasant passing of time until one o'clock when all met at the Metropole for lunch. An excellent affair, at which about 200 participated, including Mr. and Mrs. J. E. Hough and daughter, other directors and executives of the firm. Mr. Hough, in the course of a few after-lunch remarks, referred to the happy nature of the occasion and it was very evident that he felt a pride and gladness in being among them all—quite as happy, I thought, as they were to have him there. Charles Lawren, the treasurer and organizer of the whole affair, carried out his task to the satisfaction of all, and well deserved the happy recognition made by Mr. Hough, who concluded his speech to the singing of "He's a Jolly Good Fellow, etc." After an afternoon blessed with brilliant sunshine, which gave occasion for trips on the somewhat stormy briny, the whole party entertained for town at 7.30 and reached home in

(Continued on page 152)

EDISON BELL

WINNER

TRADE MARK

GRAMOPHONE RECORDS

CABLE
"PHONOKINO,
LONDON"

ARE THE GREATEST VALUE FOR MONEY PRODUCED IN GREAT BRITAIN

TEN INCH

DOUBLE SIDED

NEEDLE CUT

PLAY ON ALL GRAMOPHONES

Catalogue contains 4000 Titles by the Premier Artistes, Instrumentalists, Orchestras and Bands of the British Empire

DEALERS PREPARED TO DO BUSINESS ARE INVITED TO COMMUNICATE WITH

Proprietors and Manufacturers, J. E. HOUGH, Ltd., 62 Glengall Road, London, S. E. 15, England

FROM OUR LONDON HEADQUARTERS—(Continued from page 151)

**Horn, Hornless and Table-Grand
GRAMOPHONES**

FOR
EXPORT

Please State Your Requirements
**REX GRAMOPHONE CO. 2 Elizabeth Place
Rivington Street, LONDON, E.C. 2, England**
Cable Address "Lyrecodisc, London"

good time. I was glad to be present on this occasion if only to witness the splendid feeling which exists between masters and men. It makes for smooth working throughout all departments of Winner and Edison-Bell record production, and that is the kind of spirit, perhaps, which inspired the christening of their latest record as "Velvet Face." May the velvet faces continue to smile and prosper!

Miscellaneous Items of Trade Interest

A report here states that the Russian Soviet Government has canceled the Patent and Trade-Marks Act and as a result there is no protection for either a patent or trade-mark in that country.

At the annual general meeting of the Association of Gramophone Manufacturers and Wholesale Dealers Louis Sterling (Columbia) was elected president for the ensuing year in place of M. F. Cooksey. D. J. Blaikley (small goods section) was appointed vice-president. C. E. Timmins, secretary, presented the annual report and statement of accounts, which were duly passed.

The Woman's Exhibition arranged by the Daily Express newspaper made an excellent show at Olympia, attracting crowds of folk daily. The Bestone portable gramophone proved a center of interest on a stand of remarkably effective design.

The "His Master's Voice" people have issued a set of melody lecture records recorded by that eminent professor of music, H. Walford Davies. The records are primarily for school teachers and school use. Juvenile students and even grown-ups will find these lesson-records of exceeding interest, and calculated to inspire a love and knowledge of different phases of music.

The report that Brunswick records may be

handled here by A. Graham & Co. has aroused interest. How far the probable arrangement may be carried into effect between the two firms is still a matter of speculation.

On July 14 a further reduction in the bank rate was announced. It is now 3 per cent. While this reduction is in part due to bad trade, the feeling prevails that cheaper money will help a trade revival and cause borrowings for business developments. We hope it will!

STATISTICS SHOW TRADE GAINS

Increases in a Number of Basic Industries During Past Six Months Are Indicative of General Business Improvement Throughout the U. S.

One of the very best and most widely used indicators of fluctuation in general business is the weekly record of freight car loadings. In spite of serious curtailments of the coal industry, which is the largest user of freight facilities, the freight car loadings have increased nearly 50 per cent since January, which is not at all a seasonal increase, as in 1919 the increase was less than 3 per cent, according to statistics presented by the Music Industries Chamber of Commerce.

The increase in production of basic raw materials for the industries such as pig iron, copper and lumber tell the story clearly. The following are index numbers of production of these commodities recently compiled by the Department of Commerce, one hundred being the average for 1913, except for lumber, for which 1919 is the base:

	Pig iron	Copper	Lumber
1921—			
July	34	17	85
1922—			
January	64	25	90
February	64	37	95
March	79	61	103
April	81	75	107
May	90	87	127

A general increase in activity is likewise reflected by bank clearings, which a year ago were: For New York City, 195 per cent of the 1913 average, and increased to 219 per cent in January and 244 per cent in May; similar percentages for bank clearings outside of New York City are 188, 189 and 204. Interesting, likewise, are the figures for building construction, which last

year at this time were only 68 per cent of the monthly average in 1919 and which further declined to 65 per cent in January of this year, but since then have constantly advanced to 129 per cent in May, and are still increasing rapidly at present.

General public buying demand is shown by sales of mail-order houses, which last July were only 133 per cent higher than the monthly average for 1913, and which this year have been:

	Per cent
January	175
February	161
March	211
April	196
May	194

Other indications pointing to a still more favorable immediate future in business are the monthly increases of the unfilled orders of the U. S. Steel Corp., the upward trend of stock prices, fine crop yields in various parts of the country and the increased prices obtained by the farmer for his produce.

tone arm and amplifier patents

A New Improvement in This Special Field Patented by V. Minnelli, of Pittston, Pa.

V. Minnelli, of Pittston, Pa., was recently granted patent letters No. 1,395,053 covering a combined tone arm and amplifier. According to the patent papers this invention relates to certain new and useful improvements in a combined tone arm and amplifier, constructed and arranged for a special tone arm connected with one end of the amplifier mounted on a support, taking the place of the usual form of tone arm support, while the combined tone arm and amplifier take the place of the usual tone arm and amplifier or horn.

The invention has for another object the provision of a combined tone arm and amplifier with a special form of tone arm to which is connected the sound reproducer adapted to be turned so as to position the same for playing different types of records such as the records having vertical undulations and those having horizontal undulations for the needle to travel in.

Initiative and success go hand in hand.

You Ought to Know

In case you are contemplating expanding the sphere of your business to include departments devoted to Pianos, Player-Pianos, Musical Merchandise or Sheet Music, that you'll find news and comments about them all in



ESTABLISHED 1876

The oldest and leading music trade weekly, which covers every branch of the industry

It Contains

Instructive and educational articles. Hints on salesmanship and advertising. Editorials that are timely and authoritative. Facts about the new things in the trade. Trade happenings in all parts of the United States

"Review the Music Trade With Us"

Send your \$2 now for a full year's subscription to

THE MUSIC TRADE REVIEW
373 FOURTH AVENUE NEW YORK

LATEST PATENTS RELATING TO TALKING MACHINES AND RECORDS

WASHINGTON, D. C., August 8.—Phonograph. George B. Burch, New York, assignor to Leslie Stevens, Glen Ridge, N. J. Patent No. 1,414,802.

This invention has been made especially with the idea of providing an improved phonograph reproducer of the class having a large direct-acting diaphragm by which sound waves are set up directly in the surrounding atmosphere without requiring any horn or other amplifying device; and the invention aims to provide an improved device of this class which shall be highly sensitive and responsive to sound vibrations, and which when used as a phonograph reproducer shall operate to reproduce sound recorded on a phonograph record very perfectly as to quality and in the desired volume. The invention is not limited to instruments or devices for use in reproducing sound through the mediation of a

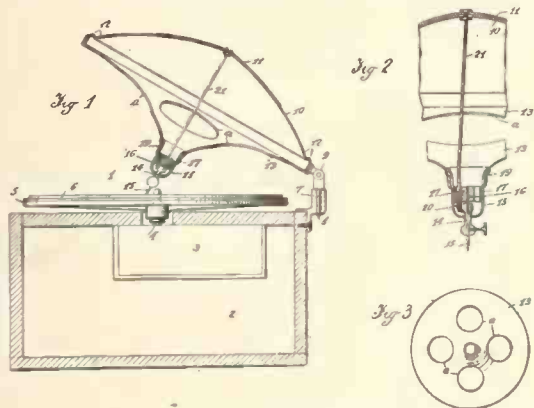

record such as the usual phonograph record, but may obviously be applied to other uses in sound reproduction and recording.

Figure 1 is a sectional view of a phonograph provided with a reproducer embodying the invention; and Fig. 2 is a partial sectional view taken at right angles to Fig. 1 and showing the stylus holder and transmission rod and portions of the diaphragms. Fig. 3 is a face view of the lower diaphragm.

Drop-cover Check. George E. Rudnick, Boston, Mass., assignor to the Victor Talking Machine Co., Camden, N. J. Patent No. 15,350 (re-issued).

The invention relates to cover supporting and checking means for retaining in open position, and checking or controlling the closing action of a top or cover for talking machines, music boxes and similar cabinets.

Figure 1 is a vertical sectional view of a conventional form of talking machine cabinet with novel cover check in position thereon; Fig. 2, a detail plan and partial section on the line 2—2 Fig. 1; Fig. 3, a partial sectional view on the line 3—3 Fig. 1; Fig. 4, a similar view of a modified form of construction; Fig. 5, a detail of a modified form of construction of the hinge for

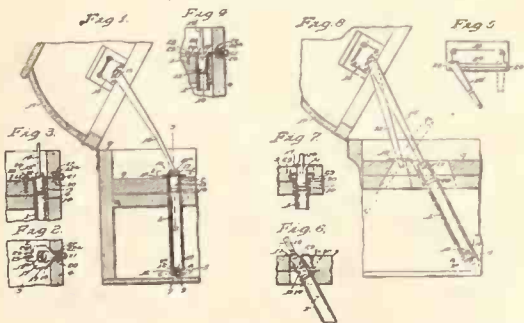

the supporting rod; Fig. 6, a detail of a modified form of the cylinder construction; Fig. 7, a vertical section on the line 7—7 Fig. 6, and Fig. 8, a modified form of cylinder and supporting rod construction.

Phonograph Attachment. Peter Simon, Elizabeth, N. J. Patent No. 1,418,101.

This invention has for its object to provide means whereby the sound box and tone arm of a phonograph may be raised and returned to their initial position upon the termination of a record.

A further object is to provide means whereby the sound box may be thus moved irrespective of the inner diameter of record grooves, thus permitting records of different sizes and capacity to be operated in a like manner.

A still further object is to provide a brake applied to the record table at the termination of the record, the same operating to stop its rotation.

Figure 1 is a fragmentary side elevational view showing a conventional type of phonograph and indicating the application of the device, the parts being shown in an operative position; Fig. 2 is

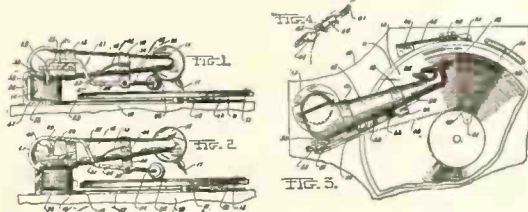

a similar view of the same, showing the sound box in a raised position; Fig. 3 is a fragmentary plan view showing the device and sound box in operative engagement with the record plate, and Fig. 4 is a perspective view of the braking device.

Sound Box for Talking Machines. Albert Hardy Gay, London, England. Patent No. 1,418,249.

This invention relates to sound boxes for talking machines and has for its object to increase the volume of the reproduction, and to obtain a reproduction more closely approaching the original, as regards tone and articulation.

The invention has also for its object to reduce to the minimum the hissing and other undesirable surface noises incidental to talking machines and the like sound reproducing instruments.

Figure 1 is a sectional side elevation of the complete sound box; Fig. 2 a front elevation corresponding to Fig. 1, but with the cap 22 removed; Fig. 3 is a sectional side elevation corresponding to Fig. 1, but turned through an angle of ninety degrees; Fig. 4 is a front elevation looking in the direction of the arrow in Fig. 3; Fig. 5 is a sectional side elevation showing

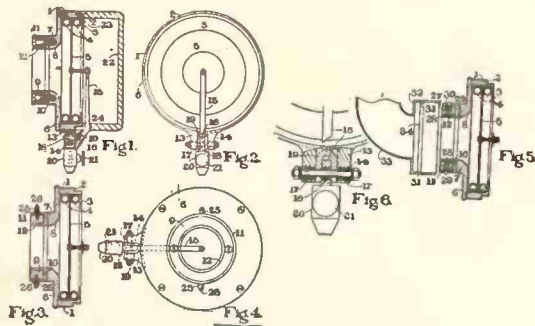

modified connecting means for the tone arm, and Fig. 6 is an enlarged detail view showing more clearly the means for insulating the stylus bar and bracket for the fulcrum pin, from said fulcrum pin.

Sound Box. Forest Cheney, Chicago, Ill., assignor to the Cheney Talking Machine Co., same place. Patent No. 1,417,499.

This invention relates to sound reproducing machines and particularly to a novel sound box for use in connection therewith. Inasmuch as it is desirable to maintain a balance of tone power between the higher and lower tone registers of a musical composition when it is being reproduced from a record, one of the principal objects of the present invention is to so design the reproducing diaphragm with relation to the adjacent chamber that the reproduced low tones are full and resonant and the high tones clear and brilliant. The desired result is secured by forming a cavity of increasing depth from the center to the periphery of the diaphragm, the cavity being defined by a wall of the sound box at one side and the diaphragm at the other side. Preferably the

desired result is secured by concaving the diaphragm and convexing the wall, although a similar result might be secured by so shaping only one of the parts. A still further object is to provide a loading chute by means of which the removable needles may be accurately placed in the needle holder from the rear end thereof.

Figure 1 is a front view of a sound box constructed in accordance with the invention; Fig. 2 is an enlarged sectional view through such a sound box; Fig. 3 is a fragmentary transverse

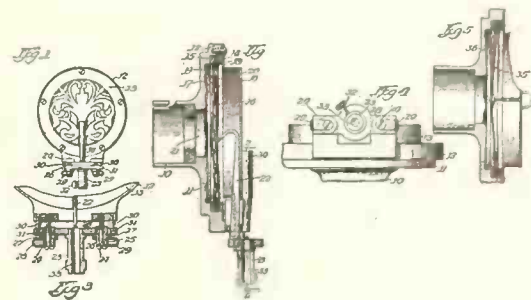

vertical view on the line 3—3 of Fig. 2, the loading chute being omitted; Fig. 4 is a bottom plan view, and Fig. 5 is a horizontal sectional view showing a slightly modified form of this interestingly designed diaphragm.

Mounting for Sound Reproducing Machines. Eugene F. O'Neill, Minneapolis, Minn., assignor to Beckwith-O'Neill Co., same place. Patent No. 1,418,016 and Patent No. 1,418,017.

The first-named relates to a mounting or cabinet for sound reproducing machines particularly designed to be used in salesrooms.

As is well known, the records for these machines are now sold in very large numbers. The customers purchasing the records usually wish to hear them played in the salesroom. It has been the common practice heretofore to provide booths in which a machine will be located and in which the customer may listen to a record played thereon. These booths are required in considerable numbers and occupy much floor space. As the salesrooms are located largely in downtown stores where floor space is very expensive, the erection of a large number of these booths has become a serious item of expense. Even with a large number of booths it is often impossible to accommodate all of the customers desiring to hear a record played. It is an object, therefore, of this invention to provide a mounting for a sound reproducing machine which is of small dimensions, as compared with a booth, and by means of which a customer can satisfactorily listen to the record being played without disturbing or being disturbed by another customer who is also listening to a record.

Figure 1 is a view in front elevation of the device with some parts broken away; Fig. 2 is a side elevation of the device, as viewed from the right of Fig. 1, also having some parts broken

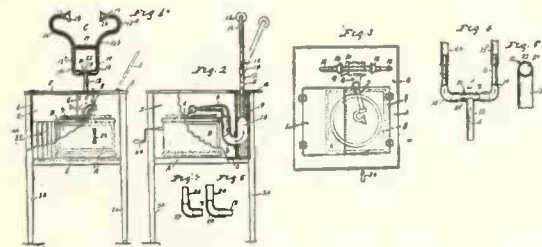

away and shown in section; Fig. 3 is a top plan view thereof; Fig. 4 is a view mostly in section of a portion of the sound transmitting tube; Fig. 5 is a section on the line 5—5 of Fig. 4, and Figs. 6 and 7 show modifications in section of the elbow shown in Fig. 4.

Patent No. 1,418,017 relates to a mounting or cabinet for sound reproducing machines particularly designed to be used in salesrooms where the records for such machines are sold.

The customers purchasing such records usually
(Continued on page 154)

PATENTS RELATING TO TALKING MACHINES AND RECORDS—(Continued from page 153)

wish to hear the same played in the salesroom and it has been a common practice heretofore to provide booths in which the machines will be located and in which the customer may listen to a record played thereon. These booths are required in considerable numbers and occupy much floor space. Such floor space is very expensive and the erection of a large number of these booths becomes a serious item of expense. Even with a large number of booths, it is often impossible to accommodate all of the customers desiring to hear a record played.

It is an object of this invention, therefore, to provide a mounting for a sound reproducing machine which is of small dimensions as compared with a booth and which mounting is so constructed that a customer can satisfactorily listen to the record being played without being disturbed by or disturbing another customer who is also listening to a record.

It is a further object to so construct such a device that a plurality of the same may be placed adjacent to each other to form a sales counter, which counter may define the customer's portion of the salesroom and the salesman's portion.

Figure 1 is a vertical section through the device; Fig. 2 is also a vertical section taken substantially at right angles to the section of Fig. 1; Fig. 3 is a sectional plan view of the device

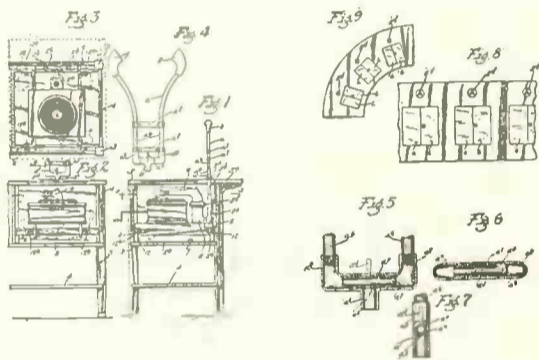

taken substantially on the line 3-3 of Fig. 1; Fig. 4 is a front elevation of the listening device for the mounting; Figs. 5 to 7 are sectional views showing the construction of the valve in the base of the listening device; Fig. 8 is a plan view showing the arrangement of a plurality of the devices to form a counter, and Fig. 9 is a similar view showing a plurality of the devices forming a semi-circular counter.

Sound Transmitting Means. Harry J. Durborow and Bayard L. Winders, Philadelphia, Pa. Patent No. 1,418,909.

One object of this invention is to provide sound transmitting means for talking machines which will include a resonator and amplifier having vibratory portions of such character as to allow all complex sound to find sympathetic or suitably formed vibratory parts which will accurately and discriminately resound and amplify sound waves impinging upon them and thereby reproduce an audible analysis of complex sound. Thus by the use of the present invention on talking machines the sounds of voices, instruments or the like, which were originally recorded in the record, will be reproduced in such manner as to be readily distinguished one from another without any blurring or false intermingling of sounds which were not originally present or recorded in the record.

Figure 1 is a top plan view showing sound transmitting means made in accordance with this

invention and illustrated in connection with a portion of a cabinet of a talking machine; Fig. 2 is a sectional elevation taken on the line 2-2 of Fig. 1; Fig. 3 is an end view illustrating the invention; Fig. 4 is a side view of one of a number of sections of an amplifying resonator, which

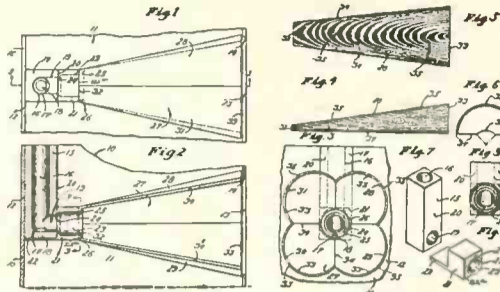

forms a part of the invention; Fig. 5 is a top plan view of Fig. 4; Fig. 6 is an end view of Fig. 4; Figs. 7 and 8 are perspective views of certain of the elements of the invention, and Fig. 9 is a fragmentary section taken on the line 9-9 of Fig. 2.

Repeating Phonograph. Jacob H. Ling, Detroit, Mich. Patent No. 1,418,584.

This invention relates to a repeating phonograph.

Figure 1 is a plan view of the improved phonograph; Fig. 2 is a vertical sectional view taken on line 2-2 of Fig. 1; and showing the mechanism of the phonograph in front elevation; Fig. 3 is a horizontal sectional view taken on line 3-3 of Fig. 2; Fig. 4 is a vertical sectional view taken on line 4-4 of Fig. 3 and showing the parts of the phonograph in side elevation; Fig. 5 is a vertical section on line 5-5 of Fig. 3, illustrating

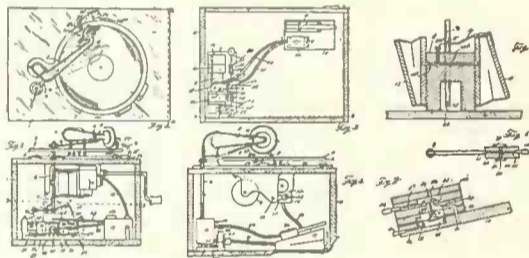

certain air passages; Fig. 6 is a vertical section taken on line 6-6 of Fig. 3 showing certain valve mechanism carried by a swinging arm; Fig. 7 is a vertical section on line 7-7 of Fig. 3 showing a pneumatic action.

Phonograph Brake. Robert G. Brown, George School, Pa., assignor to John E. Streitmeier, Cincinnati, O. Patent No. 1,419,214.

This is a division of a co-pending application No. 2,834, filed January 18, 1915, and this case covers more particularly the mechanism including especially the brake element and the means for automatically controlling and operating the same.

One object of this invention is to provide a mechanism adapted first to be set in operation and then after a predetermined time interval to in turn cause a brake element to function in stopping the turntable of a phonograph.

The primary object is to provide a mechanism that will very effectively enable a given record to be automatically replayed as many times as desired and then to automatically stop the machine.

Another object is to provide a unitary self-contained mechanism which can easily be applied to a conventional type of phonograph and which will render the same automatic to the extent of enabling it to replay a record any predetermined number of times and then to automatically stop the operation of the machine.

An object of the herein illustrated specific embodiment of this invention is to provide a mechanism that will normally be entirely free from the turntable, but which by an appropriate electrical or mechanical latch will be thrown into engagement with said turntable so as to derive motion therefrom and to utilize this motion for resetting the tone arm and finally for automatically stopping the turntable.

Figure 1 is a plan view diagrammatically illustrating a conventional sound arm, record and

turntable with the invention as an attachment applied thereto. Fig. 2 is an enlarged plan of a mechanism embodying the improvement; Fig. 3 is a front elevation thereof; Fig. 4 is a left-end elevation with the casing in section; Fig. 5 is a plan, similar to Fig. 2, showing the transmission unit in its tripped motion-receiving position, and showing some of the parts broken away to more clearly show the details of the escapement device; Fig. 6 is a right-end elevation, with the casing in

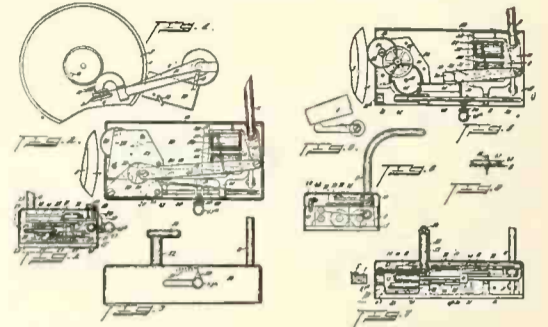

section; Fig. 7 is a front elevation, with the casing in section to more fully show the brake mechanism; Fig. 8 is a detailed elevation of the counting wheel showing its beveled ratchet-releasing nose; Fig. 9 is a plan of the sound conveying arm and of a modified construction of stop mechanism therefor.

Sound Box. Frank Stevens, Philadelphia, Pa., assignor to Charles R. Keegan, same place. Patent No. 1,419,774.

This invention relates to sound boxes for the reproduction of phonographic sounds and its objects are to improve the distinctness and clearness of enunciation as well as to amplify the volume of such sounds, and to provide a simple means of varying the angular relation between the talking machine needle and a record upon which it is operating.

These objects are attained by the combination of twin diaphragms with other specially devised members as is fully set forth and explained in the following description and the accompanying drawings, in which—

Figure 1 is a side elevation, partly in vertical central section, and with parts broken away to disclose underlying construction; Fig. 2, a horizontal central section through the line 2-2 of

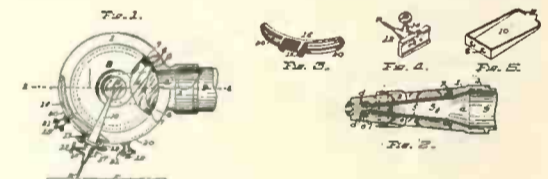

Fig. 1; Fig. 3, a perspective of the adjustable base for the stylus arm, and Figs. 4 and 5 perspective views of the two component parts of the stylus arm.

LATEST PURITAN RECORDS

(Play on All Phonographs)

(Ten-inch Double Disc)

DANCE RECORDS

- 11142 'Neath the South Sea Moon—Fox-trot, Majestic Dance Orch.
- Don't Pan Me—Fox-trot....Original Memphis Five
- 11141 Parade of the Wooden Soldiers—Fox-trot, Majestic Dance Orch.
- I'm Going Away to Wear You Off My Mind—Fox-trot.....Original Memphis Five
- 11140 Do-It-Again—Fox-trot.....Frisco Syncopators
- Coo-Coo—Fox-trot.....Earl Randolph's Orch.
- 11139 Cavalleria Rusticana—Opera Fox-trot, Moulin Rouge Orch.
- Indiana Home—Fox-trot....Earl Randolph's Orch.
- 11138 Deedle-Deedle-Dum—Fox-trot,Original Memphis Five
- Keep on Building Castles—Fox-trot, Frisco Syncopators
- 11137 Gee, but I Hate to Go Home Alone—Fox-trot—Vocal Chorus, Arthur Hall, Majestic Saxophone Sextet
- Buzz, Mirandy—Fox-trot....Original Memphis Five
- 11136 Thru the Night—Waltz.....Frisco Syncopators
- Nobody Lied—Fox-trot—Vocal Chorus, Arthur Hall.....Majestic Dance Orch.

STANDARD RECORDS

- 15059 One-Two-Three-Four—Hawaiian Trio—Waltz Ballad.....Ferrer-Franchini-Lufsky
 - Missouri Waltz—Hawaiian Duet...Ferrer-Franchini
 - 15060 Cohen at the Movies—Monologue....Monroe Silver
 - Cohen at the Radio—Monologue....Monroe Silver
- VOCAL RECORDS
- 9117 Only a Smile From You—Tenor Solo.Hugh Donovan
 - Why Should I Cry Over You?—Tenor Solo, Arthur Hall
 - 9118 My Cradle Melody—Baritone Solo....Bob Thomas
 - I Wish There Was a Wireless to Heaven—Tenor Solo.....Sam Ash
 - 9119 In the Little Red School House—Duet.Thomas-West
 - Whenever You're Lonesome—Duet....Thomas-West

REPAIRS

All Makes of Talking Machines Repaired Promptly and Efficiently

REPAIR PARTS FOR ALL MACHINES

ANDREW H. DODIN

25 Sixth Avenue New York TELEPHONE, SPRING 1194

Advance RECORD BULLETINS for September, 1922

VICTOR TALKING MACHINE CO.

- POPULAR SONGS
18918 Kicky-Koo—Kicky-Koo.. Billy Murray-Ed. Smalle 10
A Sleepy Little Village.. Billy Murray-Ed. Smalle 10
18922 Sweet Indiana Home..... Aileen Stanley 10
Why Should I Cry Over You?.. Victor Roberts 10
DANCE RECORDS
18917 Oogie Oogie Wa Wa—Fox-trot, The Benson Orch. of Chicago 10
Deedle Deedle Dum—Fox-trot, The Benson Orch. of Chicago 10
18919 Who'll Take My Place (When I'm Gone)?—Fox-trot..... Club Royal Orch. 10
Georgette—Fox-trot..... Club Royal Orch. 10
18920 Hot Lips—Blues Fox-trot, Paul Whiteman and His Orch. 10
Send Back My Honeyman—Fox-trot, The Virginians 10
18921 The Sneak!—Fox-trot..... Club Royal Orch. 10
Are You Playing Fair?—Fox-trot, Zed Confrey and His Orch. 10
18923 My Rambler Rose—Medley Fox-trot, Paul Whiteman and His Orch. 10
Dancing Fool—Fox-trot..... Club Royal Orch. 10
18924 Swanee Bluebird—Fox-trot, The Benson Orch. of Chicago 10
Just Because You're You—Fox-trot, All Star Trio and Their Orch. 10
BLUE LABEL VOCAL RECORDS
45320 The Lost Pocket-book..... Edgar A. Guest 10
The Old Wooden Tub..... Edgar A. Guest 10
45321 Solvejg's Cradle Song..... Lucy Isabelle Marsh 10
(a) The First Primrose, (b) Greeting, Lucy Isabelle Marsh 10
45322 No Night There..... Elsie Baker 10
Leave It With Him..... Elsie Baker 10
RED SEAL RECORDS
FRANCES ALDA, Soprano—GIOVANNI MARTINELLI, Tenor (In Italian)
89163 Madame Butterfly—O quanti occhi fisi (Oh, Kindly Heavens)..... Puccini 12
ORVILLE HARROLD, Tenor
66071 My Mother..... Wagstaff-White 10
JASCHA HEIFETZ, Violinist
74764 Concerto in A Minor—Andante..... Goldmark 12
MME. LOUISE HOMER, Contralto
87345 My Ain Countrie..... Demarest-Hanna 10
FRITZ KREISLER, Violinist
66079 Chanson Arabe (From "Scheherazade"), Rimsky-Korsakow 10
HUGO KREISLER, Violoncellist
(Piano Accompaniment by Fritz Kreisler)
66082 Viennese Folk Song—Fantasy. Arr. Hugo Kreisler 10
JOHN McCORMACK, Tenor
66080 Wonderful World of Romance..... Wood 10
MENGELBERG AND N. Y. PHILHARMONIC ORCHESTRA
74766 Oberon—Overture—Part 1..... Weber 12
74767 Oberon—Overture—Part 2..... Weber 12
IGNACE JAN PADEREWSKI, Pianist
74765 Nocturne in B Flat..... Paderewski 12
PHILADELPHIA ORCHESTRA
74768 Tannhäuser Overture—Part 3..... Wagner 12
TITO SCHIPA, Tenor (In Spanish)
74753 Ay-Ay (Creole Song)..... Perez-Freire 12
ERNESTINE SCHUMANN-HEINK, Contralto
87340 Lead, Kindly Light..... Newman-Dykes 10

COLUMBIA GRAPHOPHONE CO.

- SYMPHONY RECORDS
98003 Parted—Tenor Solo..... Charles Hackett 12
A3643 Two Little Stars—Mezzo-Soprano Solo, Barbara Maurel 10
Calm as the Night—Mezzo-Soprano Solo, Barbara Maurel 10
A3639 Son o' Mine—Soprano Solo..... Lucy Gates 10
Sleep, Little Baby of Mine—Soprano Solo, Lucy Gates 10
49690 Hungarian Dance, No. 1—Violin Solo, Toscha Seidel 12
A6217 Norwegian Bridal Procession—Piano Solo, Percy Grainger 12
Liebestraum—Piano Solo..... Percy Grainger 12
A6216 You Can't Do Nothing 'Til Martin Gets Here, Bert Williams, Comedian 12
How? Fried!..... Bert Williams, Comedian 12
A3637 A Camp Meeting at Pumpkin Center, Cal Stewart, Comedian (Uncle Josh) 10
Last Day of School at Pumpkin Center, Cal Stewart, Comedian (Uncle Josh) 10
A3151 Moo-Cow-Moo—The High Giraffe, Edmund Vance Cooke 10
Monkey Man—The Shave Store, Edmund Vance Cooke 10
A3649 'Neath the South Sea Moon (Intro. "My Rambler Rose," from "Ziegfeld Follies")—Medley Fox-trot..... Ray Miller and His Orch. 10
It's Up to You—Fox-trot, Ray Miller and His Orch. 10
A3648 Just Because You're You, That's Why I Love You—Fox-trot..... Eddie Elkins' Orch. 10
Rose of Bombay—Fox-trot. Eddie Elkins' Orch. 10
A3654 Dancing Fool—Fox-trot, Frank Westphal and His Rainbo Orch. 10
Serenade Blues—Fox-trot, Frank Westphal and His Rainbo Orch. 10
A3652 You've Had Your Day, Nora Bayes, Comedienne 10
I Ain't Never Had Nobody Crazy Over Me, Nora Bayes, Comedienne 10
A3651 Pinkie "The Flapper Song"—Tenor Solo, Frank Crumit 10
By the Riverside—Tenor Solo..... Frank Crumit 10
A3646 Nobody Lied (When They Said That I Cried Over You)..... Marion Harris, Comedienne 10
Haunting Blues..... Marion Harris, Comedienne 10
A3638 Song of Persia—Tenor Solo..... Edwin Dale 10
In Maytime (I Learned to Love)—Tenor Solo, Edwin Dale 10
A3650—Sleepy Little Village (Where the Dixie Cotton Grows)..... Hart Sisters, Harmonizers 10
Why Should I Cry Over You?—Tenor Solo, Billy Jones 10
A3655 I Wish There Was a Wireless to Heaven—Tenor Solo..... Billy Jones 10
Mary, Dear—Baritone Solo..... Elliott Shaw 10
A3653 He May Be Your Man..... Edith Wilson and Johnny Dunn's Original Jazz Hounds Comedienne and Jazz Band 10
Rules and Regulations..... Edith Wilson and Johnny Dunn's Original Jazz Hounds Comedienne and Jazz Band 10
THE MID-MONTH LIST
DANCE MUSIC
A3647 Sunshine Alley—Fox-trot, Ted Lewis and His Orch. 10
We'll Build a Dear Little, Cute Little Love

- Nest Some Sweet Day—Fox-trot, Ted Lewis and His Orch. 10
A3640 Deedle Deedle Dum—Fox-trot, Ray Miller and His Orch. 10
I'm Just Wild About Harry (From "Shuffle Along")—Fox-trot. Ray Miller and His Orch. 10
A3645 Nobody Lied (When They Said That I Cried Over You)—Fox-trot..... The Happy Six 10
If I Had My Way, Pretty Baby—Fox-trot, The Happy Six 10
POPULAR SONGS
A3644 Buzz, Mirandy..... Dolly Kay, Comedienne 10
It's the Last Time You'll Ever Do Me Wrong, Dolly Kay, Comedienne 10
A3641 Rock Me in My Swanee Cradle—Male Quartet Shannon Four 10
Gee! But I Hate to Go Home Alone—Tenor Solo..... Billy Jones 10

EDISON DISC RE-CREATIONS

- 50937 Slidus Trombonus—A Trombone Comedy, Sodero's Band
Royal Italian March..... New York Military Band
50938 I Found the End of the Rainbow.... Irving Kaufman
Route Marchin', Harvey Hindermeyer and Male Chorus
50939 The World Is Hungry for a Little Bit of Love (Even You and I)..... Vernon Dalhart
There Are Two Things on Earth Below—Day and the Night..... New York Light Opera Co.
50940 The Argentines, the Portuguese and the Greeks, Edward Meeker
I Want a Jazzy Kiss..... Collins-Harian
50986 Everybody Calls Her Sunshine, George Wilton Ballard and Chorus
Kindness..... The Harmony Four
50942 The Larsen Kids Go Bathing—Norwegian-English Monologue..... Ethel C. Olson
Uncle Josh and the Sailor—A Rural Story, Cal Stewart
50927 For You a Rose..... George Wilton Ballard
A Girl I Know..... Arthur C. Clough and Chorus
50944 Huckleberry Finn..... Premier Quartet
Good-bye, My Baby..... "We Girls" Quartet
80720 Passing By..... Paul Reimers
It Pays to Serve Jesus... Mr. and Mrs. G. E. Nhare
80721 Inca Rhapsodie, No. 5—Part 1 (Rapsodia Incaica)—Piano Solo..... Carlos Valderrama
Inca Rhapsodie, No. 5—Part 2 (Rapsodia Incaica)—Piano Solo..... Carlos Valderrama
80722 Chimes of Normandy Airs—No. 1, New York Light Opera Co.
Chimes of Normandy Airs—No. 2, New York Light Opera Co.
82264 La Danza—Tarantella Napolitana.... Mario Laurenti
Il Libro Santo..... Mario Laurenti
FLASHES
51008 'Neath the South Sea Moon—Fox-trot, Intro.: "My Rambler Rose," from Ziegfeld Follies of 1922..... Atlantic Dance Orchestra
J'en ai marre' (It's Up to You)—Fox-trot, Broadway Dance Orchestra
51013 Georgette—Fox-trot..... Atlantic Dance Orchestra
Haunting Blues—Fox-trot. Broadway Dance Orchestra
51018 If Winter Comes—Fox-trot. Atlantic Dance Orchestra
Dancing Fool—Fox-trot... Broadway Dance Orchestra
Released on Order
51014 The Sunset Trail of Gold, Betsy Lane Shepherd-George Wilton Ballard
Why Should I Cry Over You?..... Walter Scanlan
51015 Meet Me Next Sunday (I'll Wait for You)—Fox-trot..... Nathan Glantz and His Orchestra
The Sneak—Novelty Fox-trot, Nathan Glantz and His Orchestra
51017 Ain't Love Grand?—Fox-trot, Green Brothers' Novelty Band
Those Longing-for-You Blues—Fox-trot, Atlantic Dance Orchestra
82272 The Evening Star, from "Tannhauser", Thomas Chalmers
Angel of Light, from "La Favorita". Albert Lindquest

EDISON AMBEROLA RECORDS

- 4577 Moon River—Medley Waltz, Intro.: "Colorado and You"..... Green Brothers' Novelty Band
4578 I'll Wed the Girl I Left Behind, George Wilton Ballard
4579 Yiddisher Jazz—Vaudeville Specialty.... Julian Rose
4580 Memorics of You—Fox-trot, Atlantic Dance Orchestra
4581 I Want You Back Again, Betsy Lane Shepherd-George Wilton Ballard
4582 When the Mists Have Rolled Away, Metropolitan Quartet
4583 Serenade—Spanish Waltz..... Edison Concert Band
4584 Flanagan and His Motor Car—Vaudeville Specialty..... Steve Porter
4585 There's Silver in Your Hair (But There's Gold Within Your Heart)..... Lewis James
4586 La Marseillaise—French National Anthem, Orpheo Langevin
4587 Sweet Mamma..... Grace Woods-Arthur Fields
4588 (a) Mighty Lak' a Rose (b) The Prayer Perfect, Marie Tiffany
4589 Erin, You're Wearin' a Wonderful Smile, Walter Scanlan and Chorus
4590 In Our Bungalow (The Rose of China), Helen Clark-Joseph Phillips
4591 Some Sunny Day—Fox-trot. Atlantic Dance Orchestra
AMBEROLA HITS for September
4610 Stumbling—Fox-trot..... Broadway Dance Orchestra
4611 Soothing—Fox-trot..... Ernest L. Stevens' Trio
4612 I'm Gonna Buy a One-Way Ticket to a Little One-Horse Town..... Al Bernard and Chorus
4613 Hawaiian Nightingale..... Palakiko's Hawaiian Orchestra
4614 Parade of the Wooden Soldiers—Novelty March from "Chauve Souris".... Vincent Lopez Orchestra

BRUNSWICK RECORDS

- TWENTY-NINTH RELEASE
50014 La Paloma (The Dove) (Yradier)—Baritone with Orch. (in Spanish)..... Giuseppe Danise
Torna a Surriento (Come Back to Sorrento) (De Curtis)—Baritone with Orch. (in Italian), Giuseppe Danise
5145 Down in the Forest (Ronald-Simpson)—Soprano with Orch. Irene Williams
Far Off I Hear a Lover's Flute (Cadman)—Soprano with Orch. Irene Williams
25012 Dance of the Hours—Part I (From "La Gioconda") (Ponchielli)—Concert Band,

- Vessella's Italian Band
Dance of the Hours—Part II (From "La Gioconda") (Ponchielli)—Concert Band, Vessella's Italian Band
2287 Swing Along (Cook)—Male Quartet with Orch., Criterion Quartet
Mammy's Lullaby (Adapted from Dvorak's "Humoresque") (Nowland-Spross), Criterion Quartet
2298 Missouri Waltz (Shannon-Logan)—Violin with Orch. Frederic Fradkin
My Wild Irish Rose (Chauncey Olcott)—Violin with Orch. Frederic Fradkin
2288 Dreamy Moments (Ehrich)—Violin, Flute, Harp, Gondolier Trio
Beautiful Dreams (Foster)—Violin, 'Cello, Harp, Riviera Trio
2289 General Boulanger March (Desormes)—Bell Solo with Orch. George Green
Rendez-Vous (Rococo-Aleiter) — Intermezzo — Bell Solo with Orch. Joseph Green
2296 Rock Me in My Swanee Cradle (Parish-Young-Squires)—Tenor and Baritone with Orch., Charles Hart-Elliott Shaw
Sunshine Alley (West)—Tenor with Orch., Billy Jones
2297 Nobody Lied (Norman-Berry-Weber)—Comedienne with Orch. Margaret Young
Oh! Is She Dumb (Clarke-Leslie-Gotler)—Comedienne with Orch. Margaret Young
2291 'Neath the South Sea Moon (Intro.: "My Rambler Rose," from "Ziegfeld Follies of 1922") (Hirsch-Buck-Stamper)—Fox-trot, for Dancing..... Gene Rodemich's Orch.
Piano Trio by Gene Rodemich-David Silverman-Allister Wylie
It's Up to You (J'en ai Marre!) (De Sylva-Yvain)—Fox-trot, for Dancing, Gene Rodemich's Orch.
Piano Trio by Gene Rodemich-David Silverman-Allister Wylie
2292 State Street Blues (Thompson-Williams)—Fox-trot, for Dancing..... The Cotton Pickers
Hot Lips (Busse-Lange-Davis)—Fox-trot, for Dancing..... The Cotton Pickers
2293 Barcarolle (From "Tales of Hoffmann") (Offenbach) (Adapted by Bennie Krueger)—Fox-trot, for Dancing..... Bennie Krueger's Orch.
Kicky-Koo (Young-Lewis-Meyer)—Fox-trot, for Dancing..... Bennie Krueger's Orch.
2294 Georgette (Brown-Henderson)—Fox-trot, for Dancing..... Oriole Terrace Orch.
Keep on Building Castles in the Air (Wenrich)—Fox-trot, for Dancing..... Oriole Terrace Orch.
2295 Send Back My Honeyman (Creamer-Hendman) Fox-trot, for Dancing..... Carl Fenton's Orch.
Count the Days (Tilson-Bason)—Fox-trot, for Dancing..... Carl Fenton's Orch.
2286 Birdie (Keyes-Crawford)—Fox-trot, for Dancing, Isham Jones' Orch.
Yankee Doodle Blues (Caesar-De Sylva-Gershwin)—Descriptive One-step, for Dancing, Isham Jones' Orch.
2290 Bamboo Bay (Donaldson-Egan-Whiting)—Fox-trot, for Dancing..... Gene Rodemich's Orch.
Broken-hearted Blues (Ringle-Klickman-Bargy)—Fox-trot, for Dancing..... Gene Rodemich's Orch.
Piano Trio by Gene Rodemich-David Silverman-Allister Wylie

AEOLIAN CO.

- OPERATIC SELECTIONS
52040 Mignon—Polonaise (Thomas) (in French)—Soprano. Aeolian Orch. Accomp. Evelyn Scotney 12
30158 Zaza—Canzone di Milio (Leoncavallo) (in Italian)—Tenor, Aeolian Orch. Accomp., Giulio Crimi 10
STANDARD SELECTIONS
52039 I Due Granatieri (The Two Grenadiers) (Schumann) (in Italian)—Baritone, Aeolian Orch. Accomp..... Giacomo Rimini 12
24029 When I Awake! (Wright)—Tenor, Orch. Accomp., Colin O'More 10
I Love a Little Cottage (Stott-O'Hara)—Tenor, Orch. Accomp..... Colin O'More 10
14373 Oh, Promise Me (Scott-Reginald de Koven)—Baritone, Orch. Accomp..... Elliot Shaw
Passage Bird's Farewell (Morgan-Hildach)—Tenor and Baritone, Orch. Accomp., Chas. Hart-Elliott Shaw 10
14374 At Parting (Peterson-Rogers)—Contralto, Orch. Accomp. Emma Roberts 10
I Hear a Thrush at Eve (Eberhart-Cadman)—Mezzo-Soprano, Orch. Accomp. Helen Clark 10
14375 Nancy Lee (Stephen-Adams)—Tenor, Orch. Accomp. Charles Harrison 10
Rocked in the Cradle of the Deep (Knight)—Bass, Orch. Accomp..... Wilfred Glenn 10
14376 Honey, I Wants Yer Now (Coe), Criterion Male Quartet
De Sandman (Griffin-Protheroe), Criterion Male Quartet
14377 Aeolian Symphony Dance ("Samson and Delilah") (Arranged by Adrian Schubert), Yerkes' S.S. Flotilla Orch.
Aeolian Symphony Dance (Arranged by Adrian Schubert)—Egyptian Ballet, Yerkes' S.S. Flotilla Orch. 10
14378 They Gotta Quit Kickin My Dawg Aroun' (Oungst-Perkins)—Orch. Accomp. Cy Stebbins
Sally King (Arranged by Criterion Quartet)—Orch. Accomp..... Criterion Male Quartet 10
14382 I'll Sing Thee Songs of Araby (Wells-Clay)—Tenor, Orch. Accomp. Charles Hart
Love's Dream Is O'er (Vincent-Ascher)—Tenor and Soprano, Orch. Accomp., Charles Hart-Esther Nelson 10
14383 Washington Post March (Sousa), Played and Conducted by Lieut. Francis Sutherland and His 7th Regiment Band
Semper Fidelis March (Sousa), Played and Conducted by Lieut. Francis Sutherland and His 7th Regiment Band 10
20006 Drink to Me Only With Thine Eyes (Jonson-Traditional)—Orch. Accomp., Nellie and Sara Kouns 10
14391 In a Gondola (Elman)—Violin, Piano Accomp., Marie Dawson Morrell 10
Orientale (Caesar Cui)—Violin, Piano Accomp., Marie Dawson Morrell 10
SOME FOREIGN AND OTHER SELECTIONS
14379 Der Griner Cosin (Morris Rund)—Orch. Accomp., S. Paskel 10
Mit Tausend Yhor Zurik (Rumshinsky)—Orch. Accomp. S. Paskel 10
14380 Chepe Nisht (Abe Schwartz)—Orch. Accomp., (Continued on page 156)

ADVANCE RECORDS FOR SEPTEMBER—(Continued from page 155)

- Morris Goldstein 10
- Die Sise Kinder Yuhren (Abe Schwartz)—Orch. 10
- Accomp. Morris Goldstein 10
- 14381 El Shaday (Weisser-Rund)—Orch. Accomp., 10
- Joseph Feldman 10
- Ich Bin und Bleib a Yid (Weisser-Rund)— 10
- Orch. Accomp. Joseph Feldman 10
- 14390 My Cradle Melody (Young-Lewis-Geo. Meyer)— 10
- Orch. Accomp. The Strand Quartet 10
- Rock Me in My Swanee Cradle (Mitchel Parish- 10
- Eleanor Young-Harry D. Squires)—Tenor, 10
- Orch. Accomp. Vernon Dalhart 10
- 14385 Whenever You're Lonesome (Just Telephone Me) 10
- (Max Kortlander-Peter Wendling)—Tenor, 10
- Orch. Accomp. Billy Jones 10
- Send Back My Honeyman (Henry Creamer- 10
- Lou Handman)—Orch. Accomp. Honey Hurst 10
- 14372 Neath the South Sea Moon (From "Ziegfeld 10
- Follies of 1922") (Hirsch-Buck-Stamper)—Fox- 10
- trot Bar Harbor Society Orch. 10
- List'ning on Some Radio (Intro. "My Rambler 10
- Rose," from "Ziegfeld Follies of 1922") 10
- (Hirsch-Buck-Stamper)—Fox-trot, 10
- Bar Harbor Society Orch. 10
- DANCE SELECTIONS
- 14384 Hot Lips (Henry Buese-Jack Lange)—Fox-trot, 10
- The California Ramblers 10
- Nobody Lied (When They Said I Cried Over 10
- You) (Karyl Norman-Ilyatt Berry-Edwin J. 10
- Weber)—Fox-trot The California Ramblers 10
- 14386 Who'll Take My Place (When I'm Gone)? 10
- (Raymond Klages-Billy Fazioli)—Fox-trot, 10
- Emil Coleman and His Montmartre Orch. 10
- Georgette (Lew Brown-Ray Henderson)—Fox- 10
- trot Emil Coleman and His Montmartre Orch. 10
- 14389 Say It While Dancing (Benny Davis-Ahner 10
- Silver)—Fox-trot Bar Harbor Society Orch. 10
- Blue (Grant Clark-Lou Handman)—Fox-trot, 10
- Yerkes' S.S. Flotilla Orch. 10
- 14388 Sunshine Alley (Eugene West)—Fox-trot, 10
- Yerkes' S.S. Flotilla Orch. 10
- The French Trot (Intro: "If I Had My Way, 10
- Pretty Baby") (Milton Davis)—Fox-trot, 10
- Yerkes' S.S. Flotilla Orch. 10
- 14387 Old-time Waltzes—Part 3—(1) Two Little Girls 10
- in Blue, (2) Comrades, (3) There's Only One 10
- Girl in the World for Me, (4) And the Band 10
- Played On (Arranged and Compiled by R. H. 10
- Bowers (Vocal Chorus by Charles Hart), 10
- Selvin Dance Orch. 10
- Old-time Waltzes—Part 4—(1) In the Shade of 10
- the Old Apple Tree, (2) Just One Girl, (3) 10
- My Gal Sal, (4) Yip-i-Addy (Arranged and 10
- Compiled by R. H. Bowers) (Vocal Chorus by 10
- Chas. Hart) Selvin Dance Orch. 10

OKEH RECORDS

- RADIO RECORDS
- 4633 The Radio Code—No. 1.....Jack Binns 10
- The Radio Code—No. 2.....Jack Binns 10
- 4634 The Radio Code—No. 3.....Jack Binns 10
- The Radio Code—No. 4.....Jack Binns 10
- CLASSICAL SELECTIONS
- FONOTIPIA RECORD
- 72801 I Pagliacci—Serenata d'Arlecchine (Harlequin's 10
- Serenade) O Colombina—Tenor with Orch. 10
- Accomp. (Sung in Italian) Giovanni Zenatello, 10 3/4
- ODEON RECORD
- 53102 Marche Militaire (Schubert-Tausig)—Piano Solo, 12
- Eugene D'Albert
- (Recorded in Europe by the International Talking 10
- Machine Co.)
- BAND RECORD
- 4637 Cushing Academy March (Joseph Kiefer) (Dedi- 10
- cated to Louis H. Eisenlohr)—Band, 10
- Philadelphia Police Band 10
- Lights Out March (E. E. McCoy)—Band, 10
- Philadelphia Police Band 10
- (Lieut. Joseph Kiefer, Bandmaster)
- VOCAL RECORDS
- 4622 Erin, You're Wearin' a Wonderful Smile (Bart- 10
- ley Costello-Jack Stanley)—Tenor with Orch., 10
- Charles Hart 10
- When It's Moonlight in Mayo (Two Irish Eyes 10
- Are Shining) (Jack Mahoney-Percy Wenrich) 10
- Tenor with Orch. Charles Hart 10
- 4632 K-K-K-Kiss Me Again (Every Time He Tried to 10
- Say Good Night) (Wynn Stanley-Andrew 10
- Allen)—Tenor with Orch. Billy Jones 10
- When You and I Were Young, Maggie, 10
- Blues (Jack Frost-Jimmy McHugh)—Tenor 10
- with Orch. Billy Jones 10
- 4635 The Coulin (Thomas Moore)—Tenor with Orch., 10
- Gerald Griffin 10
- The Risin' of the Moon (Dermot MacMurrough) 10
- Tenor with Orch. Gerald Griffin 10
- JUBILEE RECORD
- 4636 Nobody Knows the Trouble I See (Colored Male 10
- Quartet) Excelsior Quartet 10
- Sinners Crying, Come Here, Lord (Colored Male 10
- Quartet) Excelsior Quartet 10
- MAMIE SMITH RECORDS
- 4623 I Want a Jazzy Kiss (Milo-Rega) (Popular 10
- Colored Singer), 10
- Mamie Smith and Her Jazz Band 10
- A Little Kind Treatment (Is Exactly What I 10
- Need) (Howard Rogers-Maceo Pinkard) (Popu- 10
- lar Colored Singer), 10
- Mamie Smith and Her Jazz Band 10
- 4630 Lonesome Mama Blues (A. W. Brown-E. Nickel- 10
- Billie Brown) (Popular Colored Singer), 10
- Mamie Smith and Her Jazz Hounds 10
- New Orleans (Vaughn De Leath) (Popular 10
- Colored Singer), 10
- Mamie Smith and Her Jazz Hounds 10
- 4631 Dem Knock-out Blues (Geo. Butts) (Popular 10
- Colored Singer), 10
- Mamie Smith and Her Jazz Hounds 10
- Mean Daddy Blues (F. Hamburger-I. Bloom- 10
- J. Durante) (Popular Colored Singer), 10
- Mamie Smith and Her Jazz Hounds 10
- DANCE RECORDS
- 4624 Swanee River Moon (H. Pitman Clarke)—Waltz, 10
- Markels' Orch. 10
- In the Little Red Schoolhouse—(Al Wilson-Jas. 10
- A. Brennan)—Fox-trot Markels' Orch. 10
- 4625 Happy Days (J. B. Foster-Vincent Lopez)—Fox- 10
- trot, 10
- Vincent Lopez and His Hotel Pennsylvania Orch. 10
- Lovable Eyes (From "Make It Snappy") (Jean 10
- Schwartz)—Fox-trot, 10
- Vincent Lopez and His Hotel Pennsylvania Orch. 10
- 4626 Isle of Zorda (M. Hagen-H. Crooker-V. Nurn- 10
- berg)—Fox-trot Markels' Orch. 10
- I'm a Sentimental Dreamer (Mel. B. Kaufman) 10
- Fox-trot Markels' Orch. 10
- 4627 Gypsy Love Song (From "The Fortune Teller") 10
- (Victor Herbert)—Fox-trot, 10
- Erdody and His Famous Orch. 10
- Rustie Ann (Percy Wenrich)—Fox-trot, 10
- Erdody and His Famous Orch. 10
- 4628 You've Had Your Day (Cliff Edwards)—Fox-trot, 10
- Markels' Orch. 10
- Southern Moonlight (Philip Ponce)—Fox-trot, 10
- Markels' Orch. 10
- 4629 Oh! Sing-A-Loe (Lew Pollack)—Fox-trot, 10
- Rega Dance Orch. 10

- Geel But I Hate to Go Home Alone (J. F. Han- 10
- ley)—Fox-trot, 10
- Natzy's Biltmore Orch. (Jack Green, Director) 10
- 4638 Parade of the Wooden Soldiers (From Balieff's 10
- "La Chauve-Souris") (Leon Jessel)—Fox-trot, 10
- Vincent Lopez and His Hotel Pennsylvania Orch. 10
- Oh, Geel Oh, Gosh! (I Love Him) (From the 10
- Musical Comedy, "For Goodness Sake") (Wil- 10
- liam Daly)—Fox-trot, 10
- Vincent Lopez and His Hotel Pennsylvania Orch. 10
- FOR THE COLORED CATALOG
- 8034 Every Ship Must Have a Harbor (Colored Male 10
- Quartet) The Norfolk Jazz Quartet 10
- Norfolk Religion (W. A. Brown-N. E. Reed) 10
- (Colored Male Quartet) Palmetto Jazz Quartet 10
- 8035 Down by the Old Mill Stream (Teli Taylor) (Col- 10
- ored Male Quartet) Excelsior Quartet 10
- Over the Green Hill (Excelsior Quartet) (Col- 10
- ored Male Quartet) Excelsior Quartet 10

PATHE FRERES PHONOGRAPH CO.

- (ACTUELLE RECORDS)
- SACRED
- 020789 Come Unto Me.....Christine Church 10
- When I Look in His Face, 10
- Charles Hart-Elliott Shaw
- BAND
- 020790 The Irish Regiment—March, 10
- Empire State Military Band 10
- Turkish Patrol—March, Empire State Military Band 10
- NOVELTY TALKING
- 020786 The Bureau.....The Original Michael Casey 10
- Casey Taking the Census, 10
- The Original Michael Casey
- STANDARD VOCAL
- 020787 I Love a Little Cottage.....Adrian Da Silva 10
- Thank God for a Garden.....Charles Hart 10
- 020788 Dixie.....Peerless Quartet 10
- Massa's in De Cold, Cold Ground.....Peerless Quartet 10
- OPERATIC
- 025081 Comin' Thro' the Rye.....Grace Hoffman 10
- The Wind's in the South.....Grace Hoffman 10
- Pathé and Actuelle Records
- POPULAR VOCAL
- 20796 My Cradle Melody.....Crescent Trio 10
- Mary, Dear (Some Day We Will Meet Again), 10
- Charles Harrison
- 20797 Bring Back the Roses.....Lewis James 10
- in costume.....Elliott Shaw 10
- 20798 Old Kentucky Moonlight.....Lewis James-Elliott Shaw 10
- Sweet Indiana Home.....Lewis James-Elliott Shaw 10
- DANCE
- 20799 Say It While Dancing—Fox-trot, Orlando's Orch. 10
- Fascination—Fox-trot California Ramblers 10
- 20800 The Sneak—Fox-trot Orlando's Orch. 10
- Just Because You're You—Fox-trot, 10
- California Ramblers
- 20801 Eleanor—Fox-trot Casino Dance Orch. 10
- Jolly Peter—Fox-trot Casino Dance Orch. 10
- 20802 Dancing Fool—Fox-trot California Ramblers 10
- Pharaoh Land—Fox-trot California Ramblers 10
- 20803 Hymn to the Sun—Fox-trot Casino Dance Orch. 10
- Swanee River Moon—Waltz Casino Dance Orch. 10
- 20804 Georgette—Fox-trot Piedmont Dance Orch. 10
- Soothing—Fox-trot Piedmont Dance Orch. 10
- 20805 Rose of Bombay—Fox-trot Barth's Mississippi Six 10
- Those Blue-eyed Blues—Fox-trot, 10
- Barth's Mississippi Six

Records 20796 to 20805 may be obtained in both Pathé (sapphire) and Actuelle (needle-cut). Other numbers shown are Pathé numbers. The Actuelle number is the same as the Pathé but prefixed with a cipher, as 020796.

GENNETT LATERAL RECORDS

- S4890 La Copa Del Olvido—Tango, 10
- Nathan Glantz y su orquesta
- Vision de Amor—Vals.....Banda Siciliana 10
- 4891 Orange Airs (Slatter) "Rise, Sons of William," 10
- "Fermanagh Boys," "England Expects Every 10
- Man to Do His Duty," "Cock o' the North," 10
- "Croppies Lie Down"—Medley, 10
- McConnell's Irish Band
- Orange Airs, "The Orange Lily O," "No Sur- 10
- render," "The Boyne Water," "Orange and 10
- Blue," "The Prentice Boys," "The Union 10
- Jack of England"—Medley, 10
- McConnell's Irish Band
- 4892 Orange Airs (Slatter) "Protestant Boys," "God 10
- Bless the Prince of Wales," "Battle of Lisna- 10
- gade," "Orange Heroes," "Rule Britannia"— 10
- Medley.....McConnell's Irish Band 10
- Orange Airs, "Rule Britannia," "Red, White and 10
- Blue," "Men of Harlech"—Medley, 10
- McConnell's Irish Band
- 4893 "Daddy" and "That Little Chap o' Mine" 10
- (Nichols)—Recitation.....Homer Rodeheaver 10
- "The Mother's Love" (To My Mother) (To 10
- My Son) (Conley-Wiggin-Griffin)—Recitation, 10
- Homer Rodeheaver
- 4894 The Old, Rugged Cross (Rev. Geo. Bennard)— 10
- Baritone, Contralto, Quartet, with Orch. 10
- Accomp. Rodeheaver, Asher and Criterion Quartet 10
- Open My Eyes That I May See (Scott)—Bari- 10
- tone.....Homer Rodeheaver 10
- 4895 Flower of Hawaii (Gravelle-Haring)—Waltz, 10
- Frank Ferera's Hawaiian Quartet 10
- Hawaiian Nightingale (De Leath)—Waltz, 10
- Frank Ferera's Hawaiian Quartet 10
- 4902 Lovable Eyes (Schwartz)—Fox-trot, 10
- Harry Raderman's Orch. 10
- Roaming (Kelly-Rosso)—Fox-trot, 10
- Harry Raderman's Orch. 10
- 4903 Little Thoughts (Billings-Straight-Bargy)—Fox- 10
- trot Harry Raderman's Orch. 10
- Rock Me in My Swanee Cradle (Young-Squires) 10
- Fox-trot Bailey's Lucky Seven 10
- 4904 Haunting Blues (Hirsh-Busse)—Fox-trot Blues, 10
- McMurray's California Thumpers 10
- Just Because You're You, That's Why I Love 10
- You (Turk-Robinson)—Fox-trot, 10
- McMurray's California Thumpers 10
- 4905 Why Should I Cry Over You? (Miller-Cohn)— 10
- Baritone.....Arthur Fields 10
- I'm Just Wild About Harry (Sissle-Blake)— 10
- Contralto.....Vaughn De Leath 10
- 4906 Georgette (Henderson)—Fox-trot, 10
- Reiser Trio—Piano, Banjo, Saxophone 10
- Kitten on the Keys (Confrey), 10
- Reiser Trio—Piano, Banjo, Saxophone 10
- 4907 Stumbling (Confrey)—Tenor.....Sami Ash 10
- Nobody Lied (Norman-Berry-Weber)—Contralto, 10
- Vaughn De Leath
- 4908 Dancing Fool (Snyder)—Fox-trot, 10
- Bailey's Lucky Seven 10
- Rose of Bombay (Ward-Dyson)—Fox-trot, 10
- Joe Samuels and His Master Players 10
- 4909 Sunshine Alley (West)—Fox-trot, 10
- Joe Samuels and His Master Players 10
- Nobody Lied (Norman-Berry-Weber)—Fox-trot, 10
- Bailey's Lucky Seven 10
- Featuring Cliff Edwards (Ukulele Ike) 10
- 4910 Sweet Indiana Home (Donaldson), 10
- Bailey's Lucky Seven 10
- The Sneak (Brown)—fox-trot, 10
- Joe Samuels and His Master Players 10
- 4911 What a Friend We Have in Jesus (Scriven- 10

- Converse), 10
- Criterion Quartet Accomp. by String Quartet 10
- There's a Light in the Valley (Bliss), 10
- Criterion Quartet Accomp. by String Quartet 10
- S4912 Arco Iris (Danzon) (Obdulio Ponce Reyes), 10
- Nathan Glantz y su orquesta 10
- El Cisne (Danzon) (Tomas Ponce Reyes), 10
- Nathan Glantz y su orquesta 10

BANNER RECORDS

- DANCE RECORDS
- 1085 Listening on the Radio (Intro: "Rambler Rose," 10
- from "Follies of 1922")—Fox-trot, 10
- Roy Collins' Orch. 10
- Blue-eyed Blues—Fox-trot Roy Collins' Orch. 10
- 1086 Georgette—Fox-trot Eddie Davis' Orch. 10
- Who'll Take My Place When I'm Gone?—Fox- 10
- trot Moulin Rouge Orch. 10
- 1087 My Cradle Melody—Fox-trot Eddie Davis' Orch. 10
- J'en Ai Marre (It's Up to You)—Fox-trot, 10
- Majestic Dance Orch. 10
- 1088 The Sneak—Fox-trot Majestic Dance Orch. 10
- Thru the Night—Waltz Banner Dance Orch. 10
- 1089 Dancing Fool—Fox-trot Eddie Davis' Orch. 10
- Don't Bring Me Posies—Fox-trot, 10
- Banner Dance Orch. 10
- 1090 Hot Lips—Fox-trot Specht's Jazz Outfit 10
- You Can Have 'Em, I Don't Want 'Em Blues— 10
- Fox-trot Specht's Jazz Outfit 10
- POPULAR VOCAL RECORDS
- 1091 Sweet Indiana Home—Tenor Solo—Orch. 10
- Accomp. Bert Trevor 10
- My Cradle Melody—Baritone Solo—Orch. 10
- Accomp. Bob Thomas 10
- 1092 Mary, Dear—Tenor Solo—Orch. Accomp., 10
- Lewis James 10
- Only a Smile From You—Tenor Solo—Orch. 10
- Accomp. Billy Burton 10
- LUCILLE HEGAMIN RECORD
- 1093 Send Back My Honeyman, 10
- Lucille Hegamin and Her Blue Flame Syncopators 10
- I've Got to Cool My Puppies Now, 10
- Lucille Hegamin and Her Blue Flame Syncopators 10
- COMEDY RECORDS
- 2050 Cohen on His Honeymoon—Comic Monologue, 10
- Monroe Silver 10
- Cohen's New Auto—Comic Monologue, Monroe Silver 10
- 2052 Uncle Josh Takes the Census.....Cal Stewart 10
- Uncle Josh and the Honey Bees.....Cal Stewart 10
- HAWAIIAN RECORD
- 2054 Honolulu Rag—Hawaiian Guitars.....Ferera-Franchini 10
- One, Two, Three, Four—Hawaiian Guitars, 10
- Ferera-Franchini 10
- OPERATIC RECORD
- 2055 E Lucovan le Stelle (Tosca)—Tenor Solo—Orch. 10
- Accomp. Max Bloch 10
- Vesti La Guibba (Pagliacci)—Tenor Solo—Orch. 10
- Accomp. Max Bloch 10
- MARCHES
- 2060 Invincible Eagle—March Banner Military Band 10
- Our Director—March Banner Military Band 10

REGAL RECORDS

- DANCE RECORDS
- 9336 My Cradle Melody—Fox-trot Eddie Davis Orch. 10
- Who'll Take My Place When I'm Gone?—Fox- 10
- trot Moulin Rouge Orch. 10
- 9337 J'En Ai Marre (It's Up to You)—Fox-trot, 10
- Majestic Dance Orch. 10
- Listening on the Radio (Intro: "Rambler 10
- Rose") (From "Follies of 1922")—Fox-trot, 10
- Moulin Rouge Orch. 10
- 9338 Don't Bring Me Posies—Fox-trot Regal Dance Orch. 10
- Thru the Night—Waltz Regal Dance Orch. 10
- 9339 Dancing Fool—Fox-trot Eddie Davis Orch. 10
- Blue-eyed Blues—Fox-trot Moulin Rouge Orch. 10
- 9340 Georgette—Fox-trot Eddie Davis Orch. 10
- The Sneak—Fox-trot Majestic Dance Orch. 10
- 9341 Hot Lips—Fox-trot Specht's Jazz Outfit 10
- You Can Have 'Em, I Don't Want 'Em Blues— 10
- Fox-trot Specht's Jazz Outfit 10
- POPULAR VOCAL RECORDS
- 9342 Sweet Indiana Home—Baritone Solo—Orch. 10
- Accomp. Bert Trevor 10
- My Cradle Melody—Baritone Solo—Orch. 10
- Accomp. Bob Thomas 10
- 9343 Mary, Dear—Tenor Solo—Orch. Accomp. Lewis James 10
- Only a Smile From You—Tenor Solo—Orch. 10
- Accomp. Hugh Donovan 10
- LUCILLE HEGAMIN RECORD
- 9344 I've Got to Cool My Puppies Now, 10
- Lucille Hegamin and Her Blue Flame Syncopators 10
- Send Back My Honeyman, 10
- Lucille Hegamin and Her Blue Flame Syncopators 10
- HAWAIIAN RECORD
- 9345 Rio Nights—Waltz—Hawaiian Guitars, 10
- Ferera-Franchini 10
- Hilo March—Hawaiian Guitars.....Ferera-Franchini 10
- STANDARD RECORDS
- 9346 La Donna e Mobile (Rigoletto)—Tenor Solo— 10
- Orch. Accomp. Stanislao Berini 10
- Che Glinda Manina (La Boheme)—Tenor Solo— 10
- Orch. Accomp. Stanislao Berini 10
- 9347 Owl and Pussy Cat—Male Quartet.....Strand Quartet 10
- A College Medley—Male Quartet.....Strand Quartet 10
- 9348 Stars and Stripes Forever—March, 10
- Regal Military Band 10
- Under the Double Eagle—March, 10
- Regal Military Band 10
- 9349 Serenade (Drigo)—Violin Solo—Piano Accomp., 10
- Rigo Jancsi 10
- Minuet in "G"—Violin Solo—Piano Accomp., 10
- Milan Lusk 10

BLACK SWAN RECORDS

- 10071 Honeymoon Blues.....Laurel Dance Orchestra 10
- Cherry Blossoms.....Laurel Dance Orchestra 10
- 10072 Love Days.....Henderson's Dance Orchestra 10
- Say It While Dancing.....Henderson's Dance Orchestra 10
- 10073 Tiger Rag.....Ethel Waters' Jazz Masters 10
- Pacific Coast Blues.....Ethel Waters' Jazz Masters 10
- 40003 Not Lately.....D. L. Haynes 10
- I'm a Voo Doo Doctor.....D. L. Haynes 10
- 14118 Early Every Morn Blues.....Etta Mooney 10
- Lonesome Monday Morning Blues.....Etta Mooney 10
- 25003 One, Two, Three, Four.....Kaluana-Brown 10
- Hawaiian Lullaby.....Kaluana-Brown 10
- 16058 Cast Away.....Georgia Harvey 10
- Just Because You're You.....Georgia Harvey 10
- 60003 Happy Days—Violin, Flute and Harp, 10
- Sterling Trio 10
- Sweetest Story Ever Told—Violin, Flute and 10
- Harp.....Sterling Trio 10
- 18048 Drink to Me Only With Thine Eyes—Tenor, 10
- Lorenzo Wells 10
- When You and I Were Young, Maggie—Bari- 10
- tone.....Herbert Black 10
- 18049 Kiss Me Again—Soprano.....Revela Hughes 10
- Homing—Soprano.....Revela Hughes 10
- AUGUST SPECIAL RELEASE
- 14117 Jazzin' Babies' Blues, 10
- Ethel Waters and Joe Smith's Jazz Masters 10
- Kind Lovin' Blues, 10
- Ethel Waters and Joe Smith's Jazz Masters 10

Some Leading Jobbers of Talking Machines in America

TEST IT. 

OUR VICTOR

Record Service

has a reputation for efficiency.
Suppose you try it.

E. F. DROOP & SONS CO.
1300 G. STREET, WASHINGTON, D. C.
281 N. HOWARD STREET, BALTIMORE, MD

W. J. DYER & BRO.
DYER B'LD'G, ST. PAUL, MINN.
NORTHWESTERN DISTRIBUTORS
OF THE

 **VICTOR**
Machines, Records and Supplies

Shipped Promptly to all
Points in the Northwest

Mickel Bros. Co.

Omaha, Nebraska
Des Moines, Iowa

Victor Distributors



Where Dealers May Secure

COLUMBIA

Product

Ready, Full Stocks, and Prompt Deliveries
from Convenient Shipping Centers
all over the United States.

Distributors

Atlanta, Ga., Columbia Graphophone Co., 561-563 Whitehall St.
Baltimore, Md., Columbia Graphophone Co., 16 South Howard St.
Boston, Columbia Graphophone Co., 1000 Washington St.
Buffalo, N. Y., Columbia Graphophone Co., 737 Main St.
Chicago, Ill., Columbia Graphophone Co., 325 W. Jackson Blvd.
Cincinnati, O., Columbia Graphophone Co., 317-321 East 8th Street.
Cleveland, O., Columbia Graphophone Co., 1812 East 30th St.
Dallas, Tex., Columbia Graphophone Co., 316 North Preston St.
Denver, Colo., Columbia Stores Co., 1608 Glenarm Ave.
Detroit, Mich., Columbia Graphophone Co., 115 State St.
Kansas City, Mo., Columbia Graphophone Co., 2006 Wyandotte St.
Los Angeles, Cal., Columbia Graphophone Co., 809 S. Los Angeles St.
Minneapolis, Minn., Columbia Graphophone Co., 18 N. 3rd St.
New Orleans, La., Columbia Graphophone Co., 517-525 Canal St.
New York City, Columbia Graphophone Co., 121 West 20th St.
Omaha, Neb., Columbia Graphophone Co., Eighth and Jackson Sts.
Philadelphia, Pa., Columbia Graphophone Co., 40 N. 8th St.
Pittsburgh, Columbia Graphophone Co., 632-640 Duquesne Way.
Salt Lake City, Utah, Columbia Stores Co., 221 South West Temple.
San Francisco, Cal., Columbia Graphophone Co., 345 Bryant St.
Seattle, Wash., Columbia Graphophone Co., 911 Western Ave.
Spokane, Wash., Columbia Stores Co., 161 South Post St.
St. Louis, Mo., Columbia Graphophone Co., 1127 Pine St.
Tampa, Fla., Tampa Hardware Co.

Headquarters for Canada:
Toronto, Ont., Columbia Graphophone Co., 347 West Adelaide St.
Montreal, Que., Columbia Graphophone Co., 824 St. Denis St.

Executive Office
COLUMBIA GRAPHOPHONE CO.
Gotham National Bank Building New York

Sherman, Clay & Co.

San Francisco, Los Angeles, Portland, Seattle, Spokane
PACIFIC COAST DISTRIBUTORS OF
VICTOR PRODUCTS

**SOUTHERN
VICTOR WHOLESALERS**

The Corley Company

RICHMOND VIRGINIA

The
Toledo Talking Machine Co.
Toledo, Ohio

*Wholesale Victor
Exclusively*

**CONSTRUCTIVE ARTICLES IN THIS
ISSUE OF THE WORLD**

Ready Reference for Salesmen, Dealers and Department Heads

Why Not a National Record Week This Fall?	3	How the Stand-patter Hinders Business Progress	43
Catering to the Women as Buyers... Neglected Complaints Result in Loss of Trade and Considerable Harmful Publicity	3	A Survey of Summer Business in the Retail Music Fields	48-49
How Continuous Intelligent Advertising Has a Tremendous Trade-making Influence	4	The Importance of Obtaining the Customers' Confidence	50
Plans for the Development of Fall Trade	6	The Broadcasting of Voices and Musical Instruments	51
Wedding the Film and the Talking Machine Record	8	Two Successful Salesmanship Classes Held in New York	57-58
Keeping the Business House in Order Justification for Optimism in the Talking Machine Trade	8	Appealing to the Individual Record Buyer	59
Retailers Must Be Aggressive to Win Trade the Coming Fall	9	Why Continuous Bombardment With Literature Is Necessary	66
Significant That the Radio Appeal Is on the Basis of Music	9	Trade Happenings in the Quaker City and Pennsylvania	67-68
Getting Out of the Beaten Path in Making the Effective Selling Appeal	9	Radio Interests Organized to Support Broadcasting	77
Keeping the Mailing List Up to Date. Improved Methods Are Necessary to Secure a Large Volume of Sales..	10	Geo. E. Brightson Discusses the Trade Situation	80
Successful Salesmanship in the Domain of Talking Machines and Records	12	Getting Prospects a Real Business Proposition	82
Some Practical Ideas That Helped Not Only to Promote but Close Sales	14	Review of Trade Conditions in New England Territory	83-86
Some Practical and Valuable Tips on How to Conduct Your Retail Business	14	The Evil of Price-cutting	94
Four-minute Conferences on Business Topics	15	Mid-West Point of View and General Western Trade News	98-111
Catering to the Automobilst	21-22	Records Being Used for Senator's Campaign	111
A Means for Measuring Musical Talent	21-22	Utilizing Window Publicity for Visiting Artists	117
National Sales Code for Use in Hardwood Field	24	Census of Manufactures Shows Growth of Talking Machine Industry	126
A New Talking Machine Market Suggested	29	Featuring the Musical Possibilities of the Talking Machine	130-131
Letter of a Veteran Salesman to a Friend	33	Senate Finance Committee Lowers Duty on Records	135
	35	Interesting Budget of News From the Dominion of Canada	137-138
	38	The Talking Machine Situation in Europe	150-152
	39	Late Patents of Interest to the Talking Machine Trade	153-154
	40	Advance List of September Bulletins of Talking Machine Records	155-156

INDEX TO ADVERTISERS

<p>A</p> <p>Acme Die Casting Corp. 79</p> <p>Aeolian Co. 30, 31</p> <p>American Felt Co. 147</p> <p>American Mica Works. 70</p> <p>American Talking Machine Co. 78</p> <p>Atlantic Instrument Co. 50</p> <p>B</p> <p>Bagshaw Co., W. H. 112</p> <p>Barnhart Bros. & Spindler. Inside back cover</p> <p>Bell Hood Needle Co. 55</p> <p>Bell Recording Co. 58</p> <p>Berlin, Inc., Irying. 119</p> <p>Blackman Talking Machine Co. 27</p> <p>Blood Tone Arm Co. 109</p> <p>Boston Book Co. 18</p> <p>Brand, William 123</p> <p>Bridgeport Die & Machine Co. 128</p> <p>Brilliantone Steel Needle Co. 113</p> <p>Bruns & Sons, A. 24</p> <p>Brunswick-Balke-Collender Co. Insert following page</p> <p>Buegeleisen & Jacobson. 96</p> <p>C</p> <p>Cabinet & Accessories Co. 73</p> <p>Cheney Talking Machine Co. 28</p> <p>Clapp-Eastham Co. 63</p> <p>Claremont Waste Mfg. Co. 79</p> <p>Classified Want Ads. 149</p> <p>Collings & Co. 62</p> <p>Columbia Graphophone Co. 16, 17, 32, 35, 45, 50, 51, 80, 86, 90, 114, 129, 145, 147</p> <p>Consolidated Talking Machine Co. 52, 104</p> <p>Corley Co. 157</p> <p>D</p> <p>Dayton Photo Products Co. 23</p> <p>De Forest Radio Telephone & Telegraph Co. 95</p> <p>Diamond Products Co. 91</p> <p>Diaphragm Co. 142</p> <p>Ditson & Co., Chas. H. 83</p> <p>Ditson Co., Oliver. 83</p> <p>Dodin, Andrew H. 154</p> <p>Droop & Sons Co., E. F. 157</p> <p>Duo-Tone Co. 39</p> <p>Dyer & Co., W. J. 157</p> <p>E</p> <p>Eagle Radio Co. 134</p> <p>Eastern Talking Machine Co. 85</p> <p>Eclipse Musical Co. 77</p> <p>Edison, Inc., Thos. A. 36, 37, Back cover</p> <p>Eight Famous Victor Artists. 38</p> <p>Emerson Phono. Co. 133</p> <p>Empire Phono. Parts Co. 111</p> <p>Encore Sales Co. 143</p> <p>Eshborn, Samuel 57</p> <p>F</p> <p>Federal Tel. & Tel. Co. 142b</p> <p>Feist, Leo. 38, 55, 72, 84, 92, 106, 108, 119, 126, 132, 138, 148</p> <p>Fletcher-Wickes Co. 103</p> <p>Flexlume Sign Co. 82</p> <p>Fox Pub. Co., Sam. 120</p> <p>Fox-Vliet Drug Co. 47</p> <p>Fulton T. M. Co. 114</p> <p>G</p> <p>General Phonograph Corp. Insert following page</p> <p>General Phonograph Mfg. Co. 64</p> <p>General Radio Corp. 125</p> <p>General Radio Laboratories. 105</p> <p>Gibson-Snow Co. 47</p> <p>Gramophone Co., Ltd. 150</p> <p>Granby Phono. Corp. 22</p> <p>Greater City Phono. Co. 12</p> <p>Gretsch Mfg. Co., Fred. 145</p> <p>Griffith Piano Co. 47</p> <p>H</p> <p>Hall Mfg. Co. 74</p> <p>Hallet & Davis Piano Co. 87</p> <p>Harper & Bros. 14</p>	<p>Harponola Co. 19</p> <p>Health Builders 81</p> <p>Hessig-Ellis Drug Co. 47</p> <p>Homophone Co. 148</p> <p>Hough, J. E., Ltd. 151</p> <p>Hough, L. W. 86</p> <p>I</p> <p>Isley, Doubleday & Co. 82</p> <p>Inter-Ocean Radio Co. 141</p> <p>Iroquois Sales Co. 94</p> <p>Italian Book Co. 33</p> <p>J</p> <p>Jenkins' Sons Co., J. W. 117</p> <p>Jewel Phonoparts Co. 75, 99</p> <p>Jewett Phono. Co. 41</p> <p>K</p> <p>Kent Co., F. C. 73</p> <p>Kiefer-Stewart Co. 47</p> <p>Kimball Co., W. W. 60</p> <p>Knickerbocker T. M. Co. 10</p> <p>Kraft, Bates & Spencer, Inc. 84</p> <p>L</p> <p>Lakeside Supply Co. 108</p> <p>Lansing Sales Co. 86</p> <p>Lauter Co., H. 126</p> <p>Lee-Coit-Andreesen Hdw. Co. 47</p> <p>Ldseen Products 105</p> <p>Long Cabinet Co., Geo. A. 76</p> <p>Long Island Phono. Co. 78</p> <p>Lundstrom Mfg. Co., C. J. 142d</p> <p>Lyradion Sales & Engg. Co. 142c</p> <p>M</p> <p>Magic Phono. Supply Co. 143</p> <p>Magnavox Co. 44</p> <p>Magnola T. M. Co. 101</p> <p>Manhattan Elec. Supply Co. 34</p> <p>Manhattan Recording Laboratories. 114</p> <p>Manufacturers' Phono. Co. 97</p> <p>Marks Music Co., Edw. B. 118</p> <p>Marshall Co., Inc., C. L. 47</p> <p>McMenimen, H. N. 59</p> <p>Mellor Co., C. C. 50</p> <p>Mellowtone Needle Co. 143</p> <p>Melody National Sales Co. 107</p> <p>Mermod & Co. 95</p> <p>Metal Recording Disc Co. 71</p> <p>Mickel Bros. Co. 40</p> <p>Minneapolis Drug Co. 47</p> <p>Mittenthal, Inc., Jos. 26, 74, 120</p> <p>Modernola Co. 72</p> <p>Mohawk Works of Art. 132</p> <p>Montagnes, I., & Co. 47</p> <p>Moore-Bird & Co. 47</p> <p>M. S. & E. 47</p> <p>Mutual Phono. Parts Co. 135</p> <p>N</p> <p>National Decalcomania Co. 68</p> <p>National Metals Depositing Corp. 58</p> <p>National Publishing Co. 18</p> <p>Natural Voice T. M. Co. 66</p> <p>Netschert, Frank 80</p> <p>New England Talking Machine Co. 85</p> <p>New York Album & Card Co. 4</p> <p>O</p> <p>Ogden Sectional Cabinet Co., Inc. 88</p> <p>Ormes, Inc. 15</p> <p>Oro-Tone Co. 107</p> <p>Orsenigo Co. 61</p> <p>Osland, Inc. 89</p> <p>Outing T. M. Co. 139</p> <p>P</p> <p>Pace Phono. Co. 142c</p> <p>Pathé Frères Phono. Co. 20</p> <p>Peabody & Co., Henry W. 56</p> <p>Pearsall Co., Silas E. 9</p> <p>Peckham Mfg. Co. 90</p> <p>Peerless Album Co. 11</p>	<p>Penn Phonograph Co. 67</p> <p>Phillips Phono. Parts Co., Wm. 26</p> <p>Phonograph Jobbers Corp. 124</p> <p>Phonomotor Co. 45</p> <p>Phonotone Co. 68</p> <p>Playertone T. M. Co. 93</p> <p>Plaza Music Co. 59, 122</p> <p>Pleasing Sound Phono. Co. 115</p> <p>Plywood Corp. 33</p> <p>Presto Phono. Parts Corp. 48</p> <p>R</p> <p>Radio Corporation of America. 13</p> <p>Raymond Engg. Co. 21</p> <p>Regal Record Co. 42</p> <p>Rene Manufacturing Co. 137</p> <p>Rex Gramophone Co. 152</p> <p>S</p> <p>Seaburg Mfg. Co. 29</p> <p>Self-Lifting Piano Truck Co. 51</p> <p>Shelton Elec. Co. 90</p> <p>Sherburne Mfg. Co. 70</p> <p>Sherman, Clay & Co. 6</p> <p>Silent Motor Corp. 130</p> <p>Simplex Elec. Phono. Motor Co. 123</p> <p>Smith Drug Co., C. D. 47</p> <p>Snyder, Inc., Jack. 116</p> <p>Sonora Co. of Philadelphia. 47</p> <p>Sonora Distr. Co. of Texas. 47</p> <p>Sonora Phonograph Co., Inc. Inside front cover, 46, 47, 131</p> <p>Sonora Phonograph Co. of Pittsburgh. 47</p> <p>Southern Drug Co. 47</p> <p>Southern Sonora Co. 47</p> <p>Sphinx Gramophone Motors. 43</p> <p>Standard Accessory Corp. 89</p> <p>Starr Piano Co. 54</p> <p>Steger & Sons Piano Mfg. Co. 65</p> <p>Sterling Devices Co. 108</p> <p>Sterno Manufacturing Co. 136</p> <p>Strevell-Paterson Hardware Co. 47</p> <p>Swanson Sales Co. 25</p> <p>T</p> <p>Talking Machine Supply Co. 149</p> <p>Talking Machine World Trade Directory. 127</p> <p>Toledo Talking Machine Co. 157</p> <p>U</p> <p>Udell Works 53</p> <p>Unit Construction Co. 69</p> <p>United Mfg. & Distr. Co. 100</p> <p>United Music Stores. 68</p> <p>Universal Fixtures Co. 89</p> <p>Unyversal Utylyty Unyts Co. 106</p> <p>V</p> <p>Val's Accessory House. 92</p> <p>Van Houten, C. J., & Zoon. 47</p> <p>Van Veen & Co. 94</p> <p>Vicsonia Mfg. Co. 35</p> <p>Victor Talking Machine Co. Front cover, 5, 7</p> <p>Vitanola T. M. Co. 110</p> <p>W</p> <p>Walbert Mfg. Co. 142a</p> <p>Wall Kane Mfg. Co. 49</p> <p>Waltham Music Co. 47</p> <p>Weymann & Son, H. A. 68</p> <p>White Radio Co. 96</p> <p>Whitsit Co., Perry B. 80</p> <p>Widdicomb Furniture Co. 121</p> <p>Williams Co., G. T. 79</p> <p>Wimpfheimer & Bro., A. 32</p> <p>Witmark & Sons, M. 140</p> <p>Wolf Mfg. Industries. 102</p> <p>Y</p> <p>Yahr & Lange Drug Co. 47</p> <p>Z</p> <p>Zimmerman-Bitter Constr. Co. 115</p>
--	---	--

The NEW Scotford Tonearm and Superior Reproducer



A new external shape of grace and beauty—without changing the internal design:



That same angle turn with the solid inclined plane deflecting the sound waves straight downward into amplifying chamber. That same famous Scotford tone—the tone of refinement—genuinely musical. Now in a tonearm of accepted, conventional, popular design. WRITE FOR SAMPLES.

NEW CONSTRUCTION



The long straight tube is of drawn Yellow Brass. Tonearm Base, Main Elbow and Connection Elbow and the Reproducer Frame, Face Ring and Back Plate are cast of TENSO White Brass Alloy—an alloy more than double the tensile strength of cast iron—much stronger, harder and lighter in weight than ordinary white metal alloys. New dies have been produced for casting all parts. The new parts are solidly cast, and are very substantial and durable.

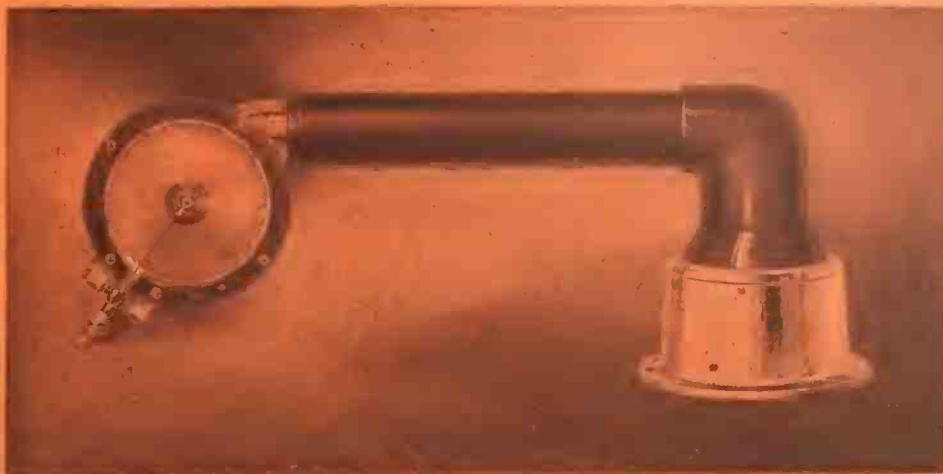

STYLE No. 1 FINISH
A combination of Nickel or Gold Plate and Black Rubber Japan



STYLE No. 2 FINISH
A different combination of Nickel or Gold Plate and Black Rubber Japan



STYLE No. 3 FINISH
All parts Plated in Nickel or Gold

In ordering specify whether Reproducer should have Plain Gilt Plate or "Superior" Name Plate. To obtain Individual Name Plate, customer must furnish Decalcomania Transfer

Samples Will be Submitted on Approval

Style 1 Tonearm long tube and main elbow, Reproducer face ring and back Black Japanned; other parts Plated.	Style 2 Tonearm long tube and main elbow Plated, base Black Japanned; Reproducer back Black Japanned, the face ring and frame Plated.	Style 3 All parts of Tonearm and Reproducer are Plated.
No. 1 New Scotford Tonearm and Superior Reproducer . Nickel \$7.00 Gold \$ 9.00	No. 2 New Scotford Tonearm and Superior Reproducer . Nickel 7.75 Gold 10.00	No. 3 New Scotford Tonearm and Superior Reproducer . Nickel 8.50 Gold 11.00
<i>Samples Prepaid at the Above Prices</i>		

Write for Our
Specification Sheet and Quantity Price List

BARNHART BROTHERS & SPINDLER

Monroe and Throop Streets

CHICAGO, ILLINOIS

*The newest addition to the
Edison line of consoles*

The Baby Console



See Pages 36, 37 inside

**JOBBER OF THE NEW EDISON, EDISON RE-CREATIONS, THE NEW EDISON DIAMOND AMBEROLA
AND BLUE AMBEROL RECORDS**

CALIFORNIA
Los Angeles—Edison Phonographs,
Ltd.
San Francisco—Edison Phonographs,
Ltd.

COLORADO
Denver—Denver Dry Goods Co.

GEORGIA
Atlanta—Phonographs Inc.

ILLINOIS
Chicago—The Phonograph Co.
Wm. H. Lyons (Amberola only).

INDIANA
Indianapolis—Kipp Phonograph Co.

IOWA
Des Moines—Harger & Blish.

LOUISIANA
New Orleans—Diamond Music Co.,
Inc.

MASSACHUSETTS
Boston—Pardee-Ellenberger Co.
Iver Johnson Sporting Goods
Co. (Amberola only).

MICHIGAN
Detroit—Phonograph Co. of Detroit

MINNESOTA
Minneapolis—Laurence H. Lucker

MISSOURI
Kansas City—The Phonograph Co.
of Kansas City.
St. Louis—Silverstone Music Co.

MONTANA
Helena—Montana Phonograph Co.

NEBRASKA
Omaha—Shultz Bros.

NEW JERSEY
Orange—The Phonograph Corp. of
Manhattan.

NEW YORK
Albany—American Phonograph Co.
Syracuse—Frank E. Bolway & Son,
Inc., W. D. Andrews Co.
(Amberola only).

OHIO
Cincinnati—The Phonograph Co.
Cleveland—The Phonograph Co.

OREGON
Portland—Edison Phonographs, Ltd.

PENNSYLVANIA
Philadelphia—Girard Phonograph
Co.
Pittsburgh—Buehn Phonograph Co.
Williamsport—W. A. Myers.

RHODE ISLAND
Providence—J. A. Foster Co.
(Amberola only).

TEXAS
Dallas—Texas-Oklahoma Phono-
graph Co.

UTAH
Ogden—Proudfit Sporting Goods Co.

VIRGINIA
Richmond—The C. B. Haynes Co.,
Inc.

WISCONSIN
Milwaukee—The Phonograph Co. of
Milwaukee.

CANADA
Montreal—R. S. Williams & Sons
Co., Ltd.
St. John—W. H. Thorne & Co., Ltd.
Toronto—R. S. Williams & Sons
Co., Ltd.
Vancouver—Kent Piano Co., Ltd.
Winnipeg—R. S. Williams & Sons
Co., Ltd.
Babson Bros. (Amberola only).