

The TALKING MACHINE WORLD

For the
makers &
sellers of
talking
machines

Published Each Month by Edward Lyman Bill, Inc., at 373 Fourth Ave., New York, March 15, 1920

*The instrument by which
the value of all musical
instruments is measured*

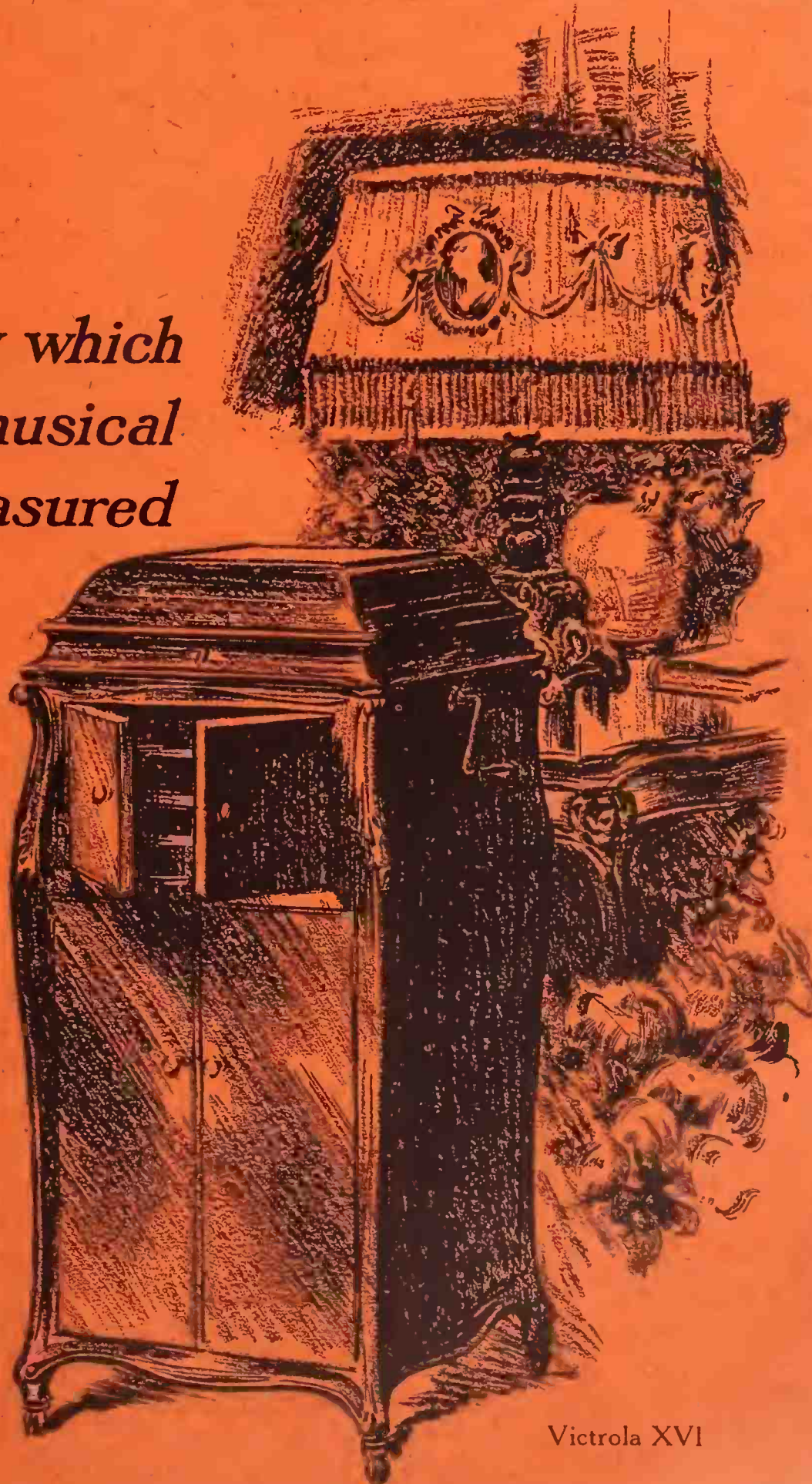

Victrola XVI



EACH year a Sonora sales agency becomes increasingly valuable. Sonoras are so wonderfully popular that every time production is doubled it seems that demand quadruples. We are forced to build new factories without cessation.

THE INSTRUMENT OF QUALITY

Sonora

CLEAR AS A BELL



is the leader of the phonograph world because its tone is of matchless beauty, because its design lines are of unequaled elegance, and because it is unrivaled for important features.

SONORA IS LICENSED AND OPERATES UNDER BASIC PATENTS OF THE PHONOGRAPH INDUSTRY

Sonora brings more cash sales to dealers than does any other phonograph, for it is sold on a quality basis and has at no time made easy payments the leading attraction.

Superb upright and period models are available. Prices, \$60 to \$2500.

Sonora Phonograph Company, Inc.

GEORGE E. BRIGHTSON, President

NEW YORK: 279 Broadway

Canadian Distributors: I. Montagnes & Co., Toronto

For list of jobbers see double page advertisement in this publication.

The Highest Class Talking Machine in the World

The Talking Machine World

Vol. 16. No. 3

New York, March 15, 1920

Price Twenty-five Cents

EDISON JOBBERS START SALES PLANS MEETING

William Maxwell Will Attend Conferences Which Will Be Held to Discuss the 1920 Sales Ideas He Originated and Perfected

The big conferences of Edison dealers, to be held in various parts of the country for the consideration of the Edison 1920 sales plans, began with the meeting at Kansas City March 9-10, for dealers in the Kansas City zone. William Maxwell, vice-president of Thomas A. Edison, Inc., and originator of these plans, attended this as well as the other conferences. For March 11 the Silverstone Music Co., jobber at St. Louis, arranged a conference for all of its dealers, and on March 12 the Kipp Phonograph Co., of Indianapolis, entertained its dealers with a thorough explanation and discussion of the 1920 plans.

The Edison laboratories have been working hard finishing the immense volume of work that will make the 1920 prospectus a finished product ready for the jobbers' travelers. William Maxwell promised the jobbers and dealers that the portfolio would be shipped from the laboratories by March 1. It is very probable that some of the jobbers received them before that time.

The 1920 prospectus, which an American advertising expert recently said incorporates one of the greatest advertising and sales promotion campaigns ever planned, is a most carefully designed and prepared sales direction book. It is asserted by those who had the privilege of examining this prospectus that "for originality, comprehensiveness, conciseness and as a maker of record sales, it has no equal in the world."

Every jobber and those dealers to whom the sales plans have been explained are enthusiastic over the business outlook for 1920 and say that the new prospectus will produce an immense volume of sales—in dollars and cents—of Edison instruments.

MAKE YOUR NAME VALUABLE

Arthur Brisbane, whose mind seems to comprehend many things with remarkable facility, recently said something about advertising that is worthy of the consideration of men in the talking machine trade desirous of progressing—a thought that is well worth accenting:

"When you start out to advertise, select the one thing most important and advertise THAT. Heinz had fifty-seven different things to sell, but his real asset was HIS NAME—Heinz. Now that he is dead, his name, because it was properly advertised, is worth more in real cash than all his pickle factories; more than all the millions accumulated by him. Let scientific advertising men show you how to make your NAME, which can't burn down or be stolen, worth more than all the rest of your plant."

K. R. MOSES GOES TO OMAHA, NEB.

K. R. Moses, Amberola sales manager for Thomas A. Edison, Inc., has resigned his position to become sales manager for Shultz Bros., Edison jobbers at Omaha. Mr. Moses was succeeded on March 1 by P. J. Burns, long in the employ of Thomas A. Edison, Inc., and who is now the Edison supervisor for Canada.

OPENS DEPARTMENT IN MARIETTA, O.

The Carroll Music Co., Marietta, O., opened last month its new talking machine department in which several sound-proof demonstration booths have been installed. Other improvements will be added to the store in the near future and it will be one of the best equipped music houses in Southeastern Ohio.

JUDGING VOICES BY RECORDS

How Bonci, the Famous Tenor, Came to Select Miss Brock as an Associate for His Recent Concert in Brooklyn—Interesting Happening

A great tribute to the perfection of the talking machine record was recently paid by Alessandro Bonci, the famous operatic tenor, who has been giving a series of recitals throughout the country. Desirous of selecting a soprano singer who would assist him at his concert at the Academy of Music, in Brooklyn, he sent for a number of records of well-known singers so that he might choose a voice that would blend with his in duets and to intersperse the program with songs. He was especially taken with the voice of Miss Eleanor Brock, and the wisdom of his selection of this clever artist was demonstrated in the success which she and the great Italian tenor scored at this concert.

The important point, as far as our industry is concerned, is that managers are giving trials to artists whose voices are submitted to them by means of the talking machine record. Because of its modern perfection it presents an exact photograph of the range and quality of the voice, and thus arouses sufficient interest on the part of managers to invite artists for a personal hearing.

PHILLIPS & CREW CO. IN SAVANNAH

Branch Store of Prominent Atlanta House to Be Opened in That City This Month

The Phillips & Crew Co., the prominent and old-established music house of Atlanta, Ga., have arranged to open a branch store at 139-145 Barnard street, Savannah, Ga. The new quarters are now being prepared for occupancy and the opening will occur some time around March 15. A complete line of pianos and player-pianos with the Steinway as the leader will be carried in the new store and there will also be a very substantial Victrola department.

ATLANTA EDISON SHOP ENLARGED

C. William Bingeman Made Manager and Secretary of Phonograph Corp. of Georgia

ATLANTA, GA., March 1.—C. William Bingeman has been made manager and secretary of the Phonograph Corp. of Georgia, which recently took over the retail department of Phonographs, Ltd., southeastern distributors of Edison phonographs. The store at 182 Peachtree street will in the future be known as the Edison Shop and will be completely remodeled and improved. A repair and service department will be added.

NOW SECRETARY OF CORNISH CO.

F. R. Alleman, of the Solotone Co., Assumes New Post—Cornish Co. Activities

WASHINGTON, N. J., February 24.—F. R. Alleman, of the Solotone Mfg. Co., of Philadelphia, has been elected secretary of the Cornish Co., of this city, which has been established for many years in the production of pianos and players. This large plant, with its great facilities, is now also producing phonographs which it will supply for the Solotone Mfg. Co. The Cornish Co. is organizing for a considerable increase of production.

A VICTOR FOR BEDFORD SCHOOLS

The school board of Bedford, Mass., has decided to add a talking machine to the list of necessary equipment of its schools and to this end a Victor machine was ordered from the Steinert Music House and will be used in the classes in musical appreciation.

NEW HOME FOR C. B. HAYNES CO.

Large Virginia Edison House Expands and Moves Into Handsome New Quarters—Its Remarkable Growth Since Establishment

RICHMOND, VA., March 1.—The opening of the handsome new home of the C. B. Haynes Co., Inc., 19-21 West Broad street, marks the latest expansion of this well-known Virginia music house. The new building is modern in every detail and the interior store arrangement contains all facilities for efficient service to patrons. Ten large demonstration booths are situated on either side of the main aisle, at the end of which are the executive offices, while a large record department is another feature. This house is exclusively Edison and has been since 1906, when C. B. Haynes became an Edison distributor.

This business, begun in a modest way by Mr. Haynes, has grown rapidly and to-day controls a home and a volume of trade that testify to the position won. In 1915 a half interest in the company was acquired by E. Bowman, who became secretary and treasurer, and the firm took the name of the C. B. Haynes Co., Inc. In the fourteen years of its career this enterprising Edison house has established an enviable reputation throughout Virginia, the Carolinas and the District of Columbia. When the new home was opened admirably arranged full-page announcements in the daily press carried the news to the public. Many congratulatory letters were received by Mr. Haynes and his confrères on the occupancy of their new quarters.

PARTY LEADERS IN HEATED DEBATE

But Trouble Is Averted by Shutting Off Talking Machine on Which New Campaign Records Are Being Played at Republican Club Contest

A novel departure from usual campaign procedure was staged at the Central Republican Club of the Nineteenth Assembly District, New York, which took place at the clubrooms, 23 West 124th street, on the evening of February 25. By means of the new campaign records the club was able to stage an interesting debate on the League of Nations, the high cost of living and other national problems. The debaters who gave their views through the medium of the talking machine were: United States Senators Lodge and Harding, Republicans; William C. McAdoo and Attorney General Palmer, Democrats. In commenting on the affair the New York Tribune said:

"Some see in the innovation the beginning of the end of the spellbinder and the mass meeting. It will be much simpler, they point out, for John Voter to sit at home and put a William Jennings Bryan or a Charles Evans Hughes disc on the old phonograph than to sally forth to Madison Square Garden to hear them in person.

"And then, one can always shut it off and put on Bert Williams or somebody."

A. E. QUERINJEAN OFF TO EUROPE

A. E. Querinjean, sales manager of the Cardinal Phonograph Co., Newark, O., sailed for Europe on Saturday, February 21, on the "New Amsterdam." His sudden trip was caused by the illness of his mother, who is on the other side. Mr. Querinjean plans to return during the early part of April.

TO INCREASE CAPITAL TO \$100,000

The Southern Photo Material Co., Victor dealer of Atlanta, Ga., has made application for a revision of its charter and authorization to increase its capital to \$100,000.

Collection Problems Hinge Primarily Upon the Manner in which the Salesman Operates

Tell the average talking machine salesman that he is a collector of instalment accounts and he is liable to feel somewhat incensed over the reflection on the dignity of his position. He will argue that selling is one thing and collecting is quite another, yet the collection problem hinges primarily upon the manner in which the salesman operates in the first instance and upon the basis on which the sale is closed with the customer.

There is not, or at least there should not be, a talking machine dealer or music merchant today who has not impressed strongly upon his salesmen the necessity of insisting upon proper terms when making sales, considering the ability of the customer to make the payments as provided and taking every other precaution to prevent repossession. It would seem that the average salesman would realize that the repossession of an instrument meant the loss of his commission on the sale, but it seems as though in some instances this loss does not have the desired effect and it is necessary for the merchant himself to make drastic rules governing the situation in order to protect his business.

Sales that lead to repossessions are, in a great many cases, due not to the ignorance of the salesman, but rather to his inclination to take a chance. He realizes that there is a possibility that the customer cannot meet the terms of the contract, but gambles on the chance that once the instrument is in the house the customer will strain his resources to keep it there. Quite often the idea works out, but it proves faulty a sufficient number of times to make it a bad gamble.

It is not always possible to close every sale for cash, even in these days of prosperity, but it is possible to arrange for terms that will clean up the sale within a year, or eighteen months, and give the customer a substantial equity in the instrument within three, four, or at most six months. It is this equity that discourages any inclination to skip payments through carelessness or with the idea that it can be done with impunity.

A sale properly made really serves to make unnecessary the work of the collector, for it makes it obligatory on the customer to meet the payments on his own accord. Sometimes a letter may be necessary to refresh the memory,

but that should be the only requirement to bring in the payments in regular order.

A salesman has been known to offer as an argument that a customer desired a certain type of machine and could not purchase it on terms such as 20 per cent down and 10 per cent monthly. It is quite possible in such a case to turn the sale to a lower-priced instrument and thereby do the customer a favor by preventing him from putting himself under an obligation he cannot hope to meet without sacrifice. It is to be remembered that 75 per cent of customers, especially those in limited circumstances, are inclined to over-estimate, rather than under-

The Sales That Lead to Repossessions Are Often Due to the Inclination of Salesmen to Take a Chance . .

estimate, their ability to meet payments. They gauge their resources on a maximum basis and do not take into consideration unusual expenses, temporary loss of income, etc. The salesman, for his part, should value their promises on that basis.

There was an Eastern dealer some years ago who brought up the salesmen with a sharp turn by making them liable for cartage charges and repair costs on repossessed instruments, in addition to loss of commission. There was naturally considerable protest, but the salesmen for their own protection improved their selling methods, watched terms, took more precaution in studying customers, and soon reached the point where repossessions dropped off almost entirely. In this particular case the merchant was fair enough to stipulate that the salesman should not be punished for repossessions made under circumstances over which he had no control, as

in cases where the customers appeared to be all right, met the minimum terms in full or better, but had fraudulent intentions, or where the customer met with serious reverses that could not be ordinarily foreseen.

A plan adopted by a Philadelphia house provides a bonus for the salesman where accounts are closed up ahead of schedule time, as provided under the minimum term arrangement. Both the salesman and the house benefit under this plan, for, while the salesman gets the bonus, the house gains in interest charges on the money thus brought in ahead of time.

The old idea of making the sale and then letting the collector worry about getting the money has long gone by the boards, and the concern that permits its salesmen to follow that plan is not going to get very far in these days of heavy overhead costs. The new system is tough on professional collectors, but good for business.

JOHN McCORMACK'S WORLD TOUR

Famous Victor Artist Leaves in June for Tour of Australia, Great Britain and the Continent

John McCormack, the famous Irish tenor and Victor artist, has planned an extensive world tour. He will leave San Francisco for Vancouver early in June for a tour of the Commonwealth of Australia and the Dominion of New Zealand. Leaving the Southern hemisphere early in 1921, he will go direct to London by way of the Suez. Following a series of concerts in Great Britain and Ireland Mr. McCormack will visit several of the European capitals, and in all probability the capital of Egypt, returning to America in October, 1921. The party will include Mr. and Mrs. McCormack, the three McCormack children and brother James McCormack; Edwin Schneider, accompanist; Donald McBeath, violinist, and D. F. McSweeney, manager. It is a matter of satisfaction, however, that John McCormack will still be with us during his absence, through the medium of his delightful Victor records.

Edward Barnes Towne, manager of the Hartford, Conn., branch of the Columbia Graphophone Co., was married last month to Miss Ida Simoneau, of Bridgeport, Conn.

Figure No. 1 shows the cabinet in uniform when equipped with 10-in. container in a 12-in. cover together with a regular 12-in. album.



SIMPLIFIED INDEX SYSTEM

Boston, Mass.: BOSTON TALKING MACHINE ACCESSORIES Co.
Chicago, Ill.: T. J. CULLEN.
COLE & DUNAS MUSIC Co.
Cleveland, Ohio: CLEVELAND TALKING MACHINE Co.
Milwaukee, Wis.: YAHR & LANGE DRUG Co.
New York: PLAZA MUSIC Co.
ANALGAMATEO PHONOGRAPH ACCESSORIES CORP.
Pittsburgh, Pa.: THE REEO Co.
C. C. MELLOR Co.
STANDARD TALKING MACHINE Co.
Washington, D. C.: E. F. DROOP & SONS Co.

NEW YORK ALBUM & CARD CO., Inc.

Executive Office and Factory: 23-25 LISPENARD STREET, NEW YORK
Chicago Factory: 415-17 S. JEFFERSON STREET, CHICAGO

Chicago factory is now in full swing on the loose leaf record album.

Redoubled factory space gives us facilities that save money and time for you.

Quotations F.O.B. N. Y. or Chicago.

Our Album is constructed under our own patents for durability and style.

Figure No. 2 illustrates a 10 in. container with a 12 in. cover; also shows the staples lifted from position for removal of pockets should they become worn.

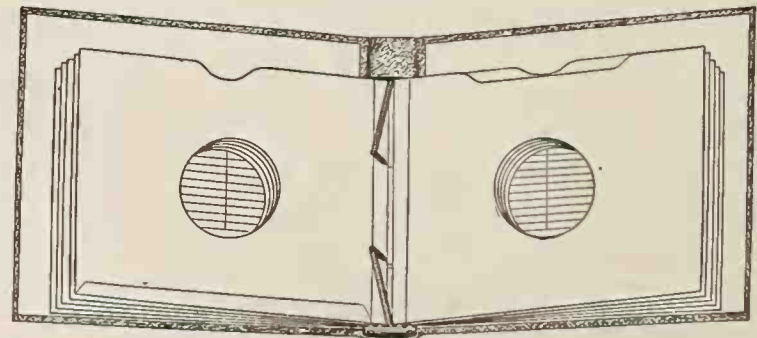

Figure No. 3 shows the staples replaced into position by means of pressure of thumb.



THE ALBUM FOR RECORDS THAT HAS A RECORD

Victor Supremacy

Victor supremacy is a real asset for every music retailer.

Just how much of an asset depends upon the retailer himself—with no limit to the measure of his success.

“Victrola” is the Registered Trademark of the Victor Talking Machine Company designating the products of this Company only.

Warning: The use of the word Victrola upon or in the promotion or sale of any other Talking Machine or Phonograph products is misleading and illegal.

Important Notice. Victor Records and Victor Machines are scientifically co-ordinated and synchronized in the processes of manufacture, and should be used together to secure a perfect reproduction.

Victor Wholesalers

Albany, N. Y. Gately-Haire Co., Inc.
 Atlanta, Ga. Elyea Talking Machine Co.
 Phillips & Crew Piano Co.
 Baltimore, Md. Cohen & Hughes.
 E. F. Droop & Sons Co.
 H. R. Eisenbrandt Sons, Inc.
 Birmingham, Ala. ... Talking Machine Co.
 Boston, Mass. Oliver Ditson Co.
 The Eastern Talking Machine Co.
 The M. Steinert & Sons Co.
 Brooklyn, N. Y. American Talking Mach. Co.
 G. T. Williams.
 Buffalo, N. Y. W. D. & C. N. Andrews.
 Buffalo Talking Machine Co., Inc.
 Burlington, Vt. ... American Phonograph Co.
 Butte, Mont. Orton Bros.
 Chicago, Ill. Lyon & Healy.
 The Rudolph Wurlitzer Co.
 Chicago Talking Machine Co.
 Cincinnati, O. The Rudolph Wurlitzer Co.
 Cleveland, O. The Cleveland Talking Machine Co.
 The Eclipse Musical Co.
 Columbus, O. The Perry B. Whitsit Co.
 Dallas, Tex. Sanger Bros.
 Denver, Colo. The Knight-Campbell Music Co.
 Des Moines, Ia. Mickel Bros. Co.
 Detroit, Mich. Grinnell Bros.
 Elmira, N. Y. Elmira Arms Co.
 El Paso, Tex. W. G. Walz Co.
 Honolulu, T. H. ... Bergstrom Music Co., Ltd.
 Houston, Tex. The Talking Machine Co. of Texas.
 Indianapolis, Ind. .. Stewart Talking Machine Co.
 Jacksonville, Fla. .. Florida Talking Machine Co.
 Kansas City, Mo. ... J. W. Jenkins Sons Music Co.
 Schmelzer Arms Co.
 Lincoln, Neb. Ross P. Curtice Co.
 Los Angeles, Cal. ... Sherman, Clay & Co.
 Memphis, Tenn. O. K. Houck Piano Co.

Milwaukee, Wis. ... Badger Talking Machine Co.
 Minneapolis, Minn. ... Beckwith, O'Neil Co.
 Mobile, Ala. Wm. H. Reynolds.
 Newark, N. J. Collings & Co.
 New Haven, Conn. ... The Horton-Gallo-Creamer Co.
 New Orleans, La. Philip Werlein, Ltd.
 New York, N. Y. ... Blackman Talking Mach. Co.
 Emanuel Blout.
 C. Bruno & Son, Inc.
 Charles H. Ditson & Co.
 Knickerbocker Talking Machine Co., Inc.
 Landay Bros., Inc.
 New York Talking Mach. Co.
 Ormes, Inc.
 Silas E. Pearsall Co.
 Omaha, Nebr. A. Hospe Co.
 Mickel Bros. Co.
 Peoria, Ill. Putnam-Page Co., Inc.
 Philadelphia, Pa. ... Louis Buehn Co., Inc.
 C. J. Heppe & Son.
 The George D. Ornstein Co.
 Penn Phonograph Co., Inc.
 The Talking Machine Co.
 H. A. Weymann & Son, Inc.
 Pittsburgh, Pa. W. F. Frederick Piano Co.
 C. C. Mellor Co., Ltd.
 Standard Talking Mach. Co.
 Portland, Me. Cressey & Allen, Inc.
 Portland, Ore. Sherman, Clay & Co.
 Richmond, Va. The Corley Co., Inc.
 Rochester, N. Y. E. J. Chapman.
 Salt Lake City, U. ... The John Elliott Clark Co.
 San Francisco, Cal. ... Sherman, Clay & Co.
 Seattle, Wash. Sherman, Clay & Co.
 Spokane, Wash. Sherman, Clay & Co.
 St. Louis, Mo. Koerber-Brenner Music Co.
 St. Paul, Minn. W. J. Dyer & Bro.
 Syracuse, N. Y. W. D. Andrews Co.
 Toledo, O. The Toledo Talking Machine Co.
 Washington, D. C. ... Cohen & Hughes.
 E. F. Droop & Sons Co.
 Robt. C. Rogers Co.



Victrola VI, \$35
Mahogany or oak



Victrola IX, \$70
Mahogany or oak

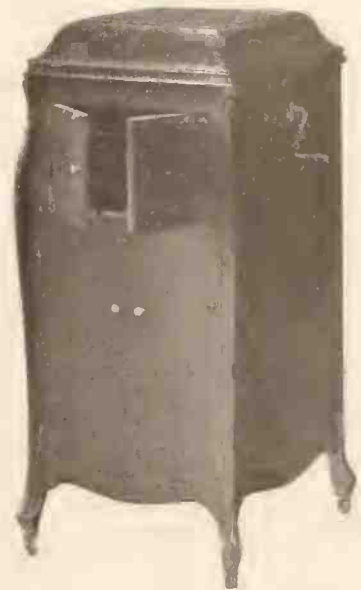

Victrola XI, \$130
Mahogany, oak or walnut



Victrola XVI, \$250
Victrola XVI, electric, \$312.50
Mahogany or oak

Victor Talking Machine Co.
Camden, N. J., U. S. A.



"HIS MASTER'S VOICE"
REG. U.S. PAT. OFF.

AN IMPORTANT ACCESSORY—ALBUMS FOR FILING DISC RECORDS

The enormous demand for "National" Record Albums keeps pace with the ever increasing demand for machines and records, and our output capacity has been enlarged to meet the greater needed supply. Record Albums have proved themselves to be the best and most convenient, as well as economic, method of filing and keeping disc records.



MAKING THEIR SELECTION

Illustrating the daily actual usage of the Album, the most convenient and satisfactory record filing system extant.

THE ALBUM

soon pays for itself in time-saving and preserving records. The initial cost is really an investment which comes back four-fold.

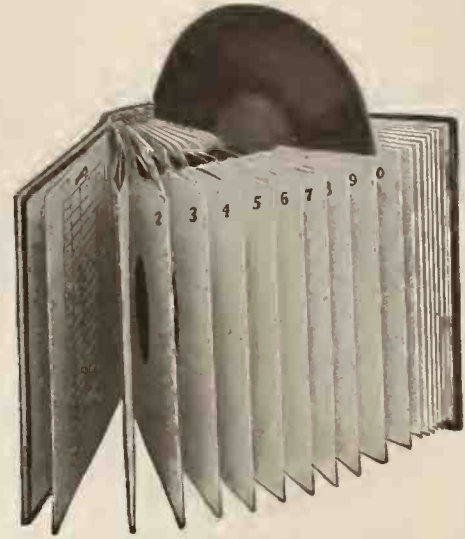

THE PERFECT PLAN

The pockets holding the records are substantially made from strong fibre stock, firmly joined together and bound in attractive covers.

A PLACE FOR EVERY RECORD AND EVERY RECORD IN ITS PLACE

Albums are an Indispensable Requisite in the talking machine business and wherever records are sold. An accessory that is necessary and worth while. Practical and handy. Save time and records. A profitable adjunct to the business. All owners of machines and records want Albums to file and preserve their records.

We manufacture disc Record Album containing 12 pockets to fit cabinets of all sizes and styles. We also make Albums containing 17 pockets. With the indexes they are a complete system for filing all disc records.

For durability, finish and artistic design, our Albums are unsurpassed. We have unexcelled manufacturing facilities, and considering quality our prices are the lowest. Write us, giving quantity you may desire, and we will quote prices.

WE MAKE ALBUMS TO CONTAIN VICTOR, COLUMBIA, EDISON, PATHE, VOCALION AND ALL OTHER DISC RECORDS

NATIONAL PUBLISHING CO. - 239 S. American Street - PHILADELPHIA, PA.
CHICAGO OFFICE: 508 S. Dearborn Street

TALKING MACHINE EXPORTS GROW

Exports, Including Records, for Twelve Months Ending December 31, 1919, Total \$6,193,387

WASHINGTON, D. C., March 6.—In the summary of exports and imports of the United States for the month of December, 1919 (the latest period for which it has been compiled), which has just been issued, the following figures on talking machines and records are presented:

The dutiable imports of talking machines and parts during December, 1919, amounted in value to \$67,843, as compared with \$15,542 worth

which were imported during the same month of 1918. The twelve months' total ending December, 1919, showed importations valued at \$558,253, as compared with \$312,966 worth of talking machines and parts imported during the same period of 1918.

Talking machines to the number of 4,855, valued at \$133,336, were exported in December, 1919, as compared with 7,286 talking machines, valued at \$329,424, sent abroad in the same period of 1918. The twelve months total showed that we exported 66,157 talking machines, valued at \$2,490,719, as against 64,459 talking machines, valued at \$1,906,052 in 1918, and 89,161 talking machines, valued at \$2,395,775 in 1917.

The total exports of records and supplies for December, 1919, were valued at \$391,570, as compared with \$171,579 in December, 1918. For the twelve months ending December, 1919, records and accessories were exported valued at \$3,702,668; in 1918, \$2,276,357, and in 1917, \$1,953,852.

INCORPORATED

The Fromkess Phonograph Co., New York, has recently been incorporated with a capital of \$20,000. The incorporators are E. Propper and M. and S. Fromkess, 341 East Eighty-second street.

Peerless
Metal Back Album

Albums Sell Records

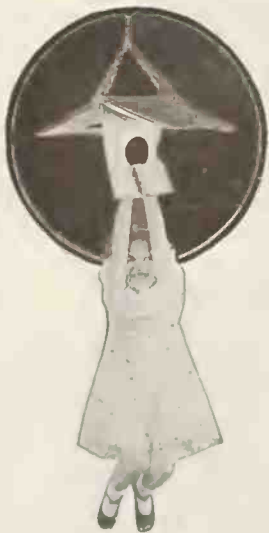

Does it stand the strain?
I'LL SAY IT DOES!

It's not hard to sell an umbrella when it's raining—it's no trouble at all to sell furniture to a man who has just built a house—it's a cinch to sell records to the owner of an empty record album.

Manufacturers: give your dealers a chance to sell more records by giving them a phonograph with a liberal filing capacity in the form of Peerless albums.

Dealers: expose yourselves to greater record sales—throw them in your way by throwing the album temptation in the way of each of your customers—sell one Peerless album today and twelve records tomorrow.

Prices and samples on request

PEERLESS ALBUM COMPANY

PHIL RAVIS, President

43-49 Bleecker Street

NEW YORK CITY

Representatives: BOSTON, L. W. Hough, 20 Sudbury Street;
 CHICAGO, W. A. Carter, 57 E. Jackson Blvd.; SAN FRANCISCO, Walter S. Gray Co., 942 Market St.

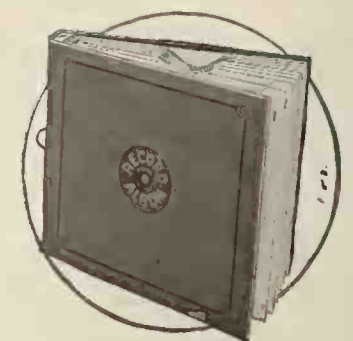

Our Standard Grade

Lowest-Priced Quality
Album on the Market



Victrola IV, \$25
Oak



Victrola VI, \$35
Mahogany or oak

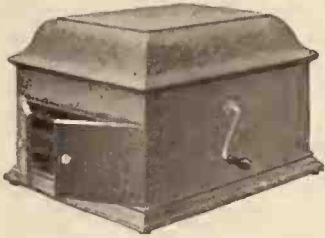

Victrola VIII, \$50
Oak



Victrola IX, \$70
Mahogany or oak

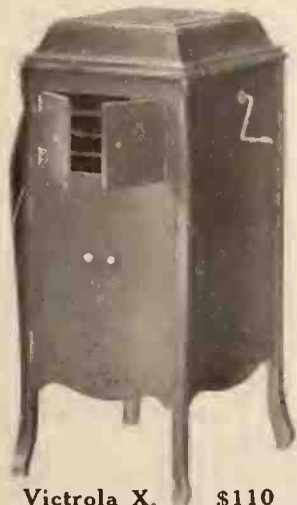

Victrola X, \$110
Mahogany, oak or walnut



Victrola XI, \$130
Mahogany, oak or walnut



Victrola XIV, \$200
Mahogany, oak or walnut



Victrola XVI, \$250
Victrola XVI, electric, \$312.50
Mahogany or oak



Victrola XVII, \$300
Victrola XVII, electric, \$365
Mahogany or oak



Victor Supremacy

is firmly established on a basis of great things actually accomplished.

A supremacy that is growing greater every day—that insures ever-increasing prosperity to every Victor retailer.

"Victrola" is the Registered Trade mark of the Victor Talking Machine Company designating the products of this Company only.

Warning: The use of the word **Victrola** upon or in the promotion or sale of any other Talking Machine or Phonograph products is misleading and illegal.

Important Notice. Victor Records and Victor Machines are scientifically co-ordinated and synchronized in the processes of manufacture, and should be used together to secure a perfect reproduction.

Victor Talking Machine Co.

Camden, N. J., U. S. A.

The **TALKING**
For the makers & sellers of talking machines **MACHINE**
WORLD

PUBLISHED BY EDWARD LYMAN BILL, Inc.

President and Treasurer, C. L. Bill, 373 Fourth Ave., New York; Vice-President, J. B. Spillane, 373 Fourth Ave., New York; Second Vice-President, Raymond Bill, 373 Fourth Ave., New York; Assistant Treasurer, Wm. A. Low.

J. B. SPILLANE, Editor

RAYMOND BILL, B. B. WILSON, Associate Editors

L. M. ROBINSON, Advertising Manager

Trade Representatives: WILSON D. BUSH, C. CHACE, EDWARD LYMAN BILL, V. D. WALSH, E. B. MUNCH, CHAS. A. LEONARD, SCOTT KINGWILL, L. E. BOWERS, A. J. NICKLIN

Western Division: Republic Building, 209 So. State Street, Chicago, Ill. Telephone, Wabash 5774.

Boston: JOHN H. WILSON, 324 Washington Street

London, Eng., Office: 2 Gresham Buildings, Basinghall St. W. LIONEL STURDY, Mgr.
 The Talking Machine World has regular correspondents located in all of the principal cities throughout America.

Published the 15th of every month at 373 Fourth Ave., New York.

SUBSCRIPTION (including postage): United States, Mexico, \$2.00 per Year; Canada, \$3.00; all other countries, \$4.00. Single copies, 25 cents.

ADVERTISEMENTS: \$5.50 per inch, single column, per insertion. On quarterly or yearly contracts a special discount is allowed. Advertising pages, \$150.00.

REMITTANCES should be made payable to Edward Lyman Bill, Inc., by check or Post Office Money Order.

NOTICE TO ADVERTISERS—Advertising copy should reach this office before the first of each month. By following this rule clients will greatly facilitate work at the publication headquarters.

Long Distance Telephones—Numbers 5982-5983 Madison Sq.
 Cable Address: "Elbill," New York.

NEW YORK, MARCH 15, 1920

EDISON'S ANALYSIS OF LABOR CONDITIONS

THERE are few figures in the public eye to whose natal day is accorded such universal recognition as that of Thomas A. Edison, whose seventy-third birthday occurred recently. From President Wilson, members of the Cabinet and public men in all walks of life, as well as from his associates and fellow-workers in the great Edison plant he received the most cordial testimonials of affection and esteem. The leading papers of the country also discussed in a very interesting way Thomas A. Edison's comments upon labor conditions, which formed the basis of an interview which he gave out in connection with his birthday festivities.

The present trend in labor circles toward shorter hours and less production was pertinently covered by Mr. Edison, who said: "To-day I am wondering what would have happened to me by now if fifty years ago some fluent talker had converted me to the theory of the eight hour day, and convinced me that it was not fair to my fellow-workers to put forth my best efforts in my work. I am glad that the eight hour day had not been invented when I was a young man. If my life had been made up of eight hour days I don't believe I could have accomplished a great deal. I am not against the eight hour day, or any other thing that protects labor from exploitation at the hands of ruthless employers, but it makes me sad to see young Americans shackle their abilities by blindly conforming to rules which force the industrious man to keep in step with the shirker."

Mr. Edison further pointed out that the present conditions make it difficult for the working man to improve his condition and station in life by his own efforts, and dwelt upon the fact that one of the principal reasons why American progress in the past was possible was that every man had a chance to become whatever he wanted to be. "It used to be fashionable to be ambitious," further remarked Mr. Edison. "The employe planned to become an employer; the unskilled man sought to become more skillful; the young man was not well thought of if he was not striving for a higher place in life. There appears to have been a change within recent years. The present disposition is seemingly to say in effect: 'I am what I am and so shall I remain. I aspire to nothing better than my present job. I ask for nothing except larger wages and shorter hours.'"

In this analysis of conditions Mr. Edison goes right to the

bottom of things and affirms what is a truism—that work makes success. No individual or business can prosper by accident. There must be determination, concentration, to win out, and this calls for work, enthusiasm, efficiency.

Mr. Edison sets forth in this timely sermon the old American ideal that has made our nation what it is to-day and his remarks should form the basis of lectures and discussions in our great educational institutions—they merit the closest consideration of every American, no matter what his station in life.

GREAT INCREASE IN FOREIGN TRADE

IN the figures bearing upon the exports and imports of talking machines and records which appear elsewhere in The World, it will be noted that there has been a steady increase in all branches of our foreign trade. Exports of talking machines for the twelve months ending December, 1919, were valued at \$2,490,719 as against \$1,906,052 in 1918. The greatest increases in exports were in records and supplies, which for the twelve months ending December, 1919, were valued at \$3,702,668 as compared with \$2,276,357 in 1918. Records of American manufacture are undoubtedly growing in favor throughout the world, and in South America particularly they have obtained quite a market, which is destined to increase as the merits of these products become more widely known.

The imports of talking machines, records and parts continue to be small, comparatively speaking, the twelve months total ending December, 1919, being placed at \$558,253 as compared with \$312,966 in 1918. The closing months of last year, however, have been showing a steady increase in imports, and in December alone the imports of talking machines and parts were valued at \$67,843 as compared with \$15,542 for the same month of 1918. This, of course, can be attributed to the fact that shipments to and from Europe are now being made with more regularity than just after the war, and this satisfactory condition is being felt in both domestic and foreign trade.

CONCENTRATING ON THE WHOLESALE END

THE general tendency among talking machine jobbers to discontinue such retail departments as they have maintained with a view to concentrating their efforts on the wholesaling of machines and records has been viewed with satisfaction by dealers generally who for several years have been advocating such a move. Under ordinary circumstances, with goods plentiful, the retail department of the jobber's establishment represented simply one more retail competitor, and in most cases not a very active competitor. With the serious shortage of stock, however, both in machines and records, the jobber's retail department appeared to grate more and more on the nerves of the retailer who felt that no matter how fair and just the wholesaler might be in the allotment of goods to his own store, machines and records were being placed therein that might have served to relieve one or more dealers of embarrassment, temporarily at least.

There are, of course, a number of cases where wholesalers conduct tremendous retail musical establishments, handling musical goods of all kinds from pianos down to sheet music. In such cases the retail talking machine department is an essential factor not alone for the volume of retail business that might be done in comparison with general business, but as bearing out the company's advertised statements that it handles everything in music. It has been noticeable, however, that during the shortage even these big houses kept in their departments only a sufficient stock to give some indication of what the department was intended to carry, but did not endeavor to stock up at the expense of their dealers.

Where feasible the "wholesale only" idea is spreading rapidly and is in a sense a form of preparation for the future. When production catches up in some measure with the demand, the wholesalers who have no retail business to worry about will find plenty of opportunity for keeping goods moving from the factory to the dealer's shelves.

CAPITALIZING CONCERTS OF RECORD ARTISTS

THAT the talking machine has proven a powerful factor in developing a wide appreciation for music of all kinds, and particularly of the better sort, is undisputed, and the manufacturers of records generally are proceeding along proper lines to capitalize this increased interest by hooking up their advertising with the appear-

ance in concert and recital of the various leading recording artists.

This tendency of record companies to call attention, through special advertising, to the fact that certain concert artists record exclusively for this or that company has been particularly noticeable during the present season. The advertising must of necessity be special and local in character, fitting in with the concert recital dates as announced through ordinary channels.

There is no question but that a recording artist has a distinct fascination for that great proportion of the public owning talking machines, for it almost generally happens that the records by well-known artists are purchased before the artist has been heard in person. Under such circumstances the record owner feels a personal interest in his favorite recording artist.

This interest has been proven on more than one occasion through the concerts given by the group of record artists, including Collins & Harlan, Van Eps, Meyers, Henry Burr and several others. In cities where regular dramatic or musical comedy companies could not make expenses the record makers have made it necessary to hang out the S. R. O. sign, and it is safe to say that for everyone who came solely for the purpose of hearing a program of popular music there were ten who came because they felt that they were acquainted with the artists through their records and were anxious to see and hear those artists in person.

The advertising of the manufacturers in connection with the concert appearance of artists offers an example that should be followed by dealers either in advertising concerts on their own account, or in supplementing the advertising of the manufacturers. It is the sort of advertising that is direct in interest and direct in results.

SELF-SERVICE IDEA ENCOURAGES SALES

THE self-service idea in record selling is steadily gaining ground in all sections of the country as the retailers learn to appreciate the value of such service in building up record sales. The idea is not entirely original in the talking machine trade, for the same plan has worked out in book stores and other channels for a number of years, and is based primarily on the theory that while some customers demand the services of a salesman there are others who prefer to browse around themselves—look over records at their leisure and feel free to select or reject any of them without having the salesman cast upon them a glance of deep regret.

The self-service idea gets away from the obligation to purchase in one sense, but on the other hand encourages purchase. The average customer enters the talking machine store with a definite object in view. He wants this or that record, or to hear certain styles of records from the new monthly list. The salesman may, or may not, be able to persuade the customer to spend enough time to listen to two or three other records on the chance that they may appeal to him. It often happens that even when a customer cares to listen to an extended demonstration he does so with the feeling that he

must make some purchase to justify taking the salesman's time. With a hundred or more records in the rack before him, however, the customer is inclined to look over the lot at his leisure, and in the course of the inspection frequently finds one or several records regarding the existence of which he was in ignorance. He frequently is highly elated over his find and a purchase is made with practically no selling effort.

This saving of selling effort alone in many ways serves to more than pay for the cost of installing the self-service equipment. No customer can hope to inspect all the records in a dealer's stock, nor can any salesman be expected to demonstrate to any one customer even a small fraction of those records, but if the self-service rack is well filled with the lesser known selections and the assortment is changed at frequent intervals, the regular visitor can with little effort inspect almost the entire line. This, in truth, represents service that goes beyond the selling point.

RECORDS OF QUALITY GROW IN FAVOR

A FEATURE of the record situation that is, or should be, gratifying to the trade at large is the tendency of the various record manufacturers—and they have increased in number greatly during the past couple of years—to give closer attention to the quality of their product. It is not stretching a point, to say that the success of the talking machine business depends primarily upon the quality of the records made available to the public.

A machine without records is useless and a machine for which only poor records are available quickly loses interest for its owner. When, as at present, a talking machine owner can secure records of the great artists, whether in the operatic or popular field, and can find in those records music of a quality that makes the preservation of the record worth while, then the industry is bound to broaden out and develop.

The value of a record lies not alone in the cost of labor and material entering into it. It hinges largely upon the cost of securing artists of reputation and ability. So long as the record companies realize this fact and feature good artists and good music rather than the price argument, so long will they enjoy the proper recompense for their efforts.

STIMULATING AN INTEREST IN MUSIC

THE action of a number of talking machine dealers in central New York State in organizing a concert bureau for the purpose of developing musical interest among the public in that section through the bringing of prominent record artists to the various cities to appear in concert is a move worthy of emulation in other sections of the country. Through co-operation the effect of the concerts is increased immeasurably and the cost to the individual dealer cut to a minimum. It is building for the future of the trade along constructive lines calculated to keep musical interest constantly at high pitch.



AN EQUATION

Ormes Service is to Victor Merchandising as a setting is to a perfect diamond.

ORMES, Inc.

Wholesale Exclusively

26 East 125th Street

NEW YORK

The Advertising That Keeps a Store Before the Public in a Profitable Way :: By Joseph I. Carroll

Mgr. of Sales, Emerson Phono. Co.

In a previous article in *The World*, I talked on a few unusual angles of advertising, some of which are not generally in mind when the subject is discussed. However, what follows is more in the light of what most everyone thinks of when the matter of advertising is considered.

In writing on most any subject it is rare that anything new is told. More often it is something most of us know, but served up with a bit different dressing. Therefore I claim no originality but put before you some thoughts on the general subject of advertising which may bring more vividly before you a picture that, while familiar, has perhaps become somewhat blurred and indistinct, because of other and more urgent things having demanded all your attention.

Did it ever occur to you that if a pretty girl were to wear a heavy veil to conceal her good looks from the admiring gaze of the great majority of the public, ever eager to revel in the thrill of a beautiful face, many restaurants would go out of business; likewise theatres would go a-begging for patronage, while ministers would be far less active in tying the nuptial knots? The reason is obvious.

As a pretty face and a modish gown attract admiration so, too, a merchant's show windows can be made a valuable asset in interesting the passer-by, provided the windows be dressed in effective fashion, employing advertising helps that portray pleasingly and distinctively faithful and engaging descriptions of the merchandise carried within.

The dealers who sell talking machine records and who are bent upon building up thriving departments invariably subscribe to the handsome "window display services" which various record

companies offer their dealers at a very reasonable cost. These "services" are done in bright colors, the subjects closely linked with the month's releases. The display, as a whole, is bound to draw that intensely inquisitive and fixed attention which automatically leads to sales.

The profit from a very few extra records sold

*Why Not Capitalize
Window Advertising?
---How Movie, Bill-
board and Newspaper
Publicity Will Help*

will pay for the "service." All live dealers recognize this "display service," which changes monthly, as something decidedly good, and especially productive of results.

It is almost unbelievable that a merchant could possibly blind himself to the considerable increase in sales certain to follow the showing of this "window display" which is designed particularly to invite attention favorably to certain records. Strange to say, there are some dealers who stubbornly refuse to appreciate the value of this specialized display. They alone suffer.

They wonder why they don't sell more records; why folks pass their door and stop in at their competitors'. Too often they blame it on the records, whereas the loss of sales—meaning profits—is practically always directly traceable to their false and narrow economy; their niggardly methods. They may be storekeepers but rarely become really up-to-the-minute, successful merchants. Let every retail merchant take displays of all kinds out of his windows, and the loss of sales would be so great that few could afford to stay in business.

The advertising power of your show window is valuable. Why not capitalize it to the most productive degree? Change the display frequently. Make each change tell a new story. Whenever there is a holiday season, such as Christmas, New Year's, Thanksgiving, Halloween, Election Day and the like, as well as any special local occasion, link up your window display and also your newspaper advertising with it, so that it will have a strikingly timely significance. It is bound to create favorable attention.

The window can be made a decided asset for valuable publicity. It's the narrow-minded, short-sighted dealer who fails to grasp it. The merchant who is keen, and building for the future, forgets the slight initial expense in his eagerness to use to best advantage a pronouncedly good "window service," that cannot but add largely to his list of customers.

Another source of available publicity is your neighborhood moving picture theatre. It is a constant gathering place for practically all classes. Many people will go there several times

(Continued on page 11)

Phonograph Fodder

AFTER all is said and done, hits are what people want—and hits are what most people will continue to select, when they are buying phonograph fodder.

If you handle hits, business will come walking right in your front door. If you don't handle hits, trade will tag the man who does.

Emerson has a reputation for getting out the worth-while hits—both song hits and dance hits—and getting them out well in advance of the "trailers."

We are distributors of Emerson Standard 10-inch Gold Seal Records in the Metropolitan district. When you need quick-selling records—real lively steppers—give us a call.

Emerson Record Sales Company, Inc.

Exclusive Distributors of Emerson Standard 10-inch
Gold Seal Records in the Metropolitan Territory

6 West 48th Street, New York City



each week. Some folks never miss a night. In consequence, it offers excellent opportunities for gaining instant sales-producing attention from your public at a time when they are in good humor, and ready and willing to assimilate bright, pointed and clever advertising notices.

Resourceful dealers appreciate the value of arranging for display on the screen of attractive slides, keeping the latest records and machines insistently and interestingly before the prospective buyer's mind.

Still another use of the moving picture house is to have the monthly bulletins of new releases placed in movie programs, or put upon a stand or table at the entrance or foyer where the bulletins can be taken up at the same time that weekly announcements of new pictures are sought by the "movie fan." Both of the above ideas are commonly used and agreed to be worth-while advertising.

The dealer who is alive to the big and constantly expanding future of the phonograph and record industry, the man who is earnestly reaching out for the most productive forms of advertising, will readily agree that outdoor "billboards" afford a "pulling force" for increased demand of the highest voltage.

I have in mind certain dealers who have tried out this idea and found it so instantly successful that they increased this form of permanent display many times over, with the result that their sales have multiplied in quantities far beyond their most hopeful expectation.

The locations for these boards, needless to say, must be selected with infinite care. They should be placed, above all, where they are certain to receive the greatest degree of attention. It must be where the interest encouraged is not idle, but among that class of buyers most likely to patronize the store. However much such signs are read or noticed they are of little or no value if brought before the notice of people who do not and would not trade, for various reasons, at the store conducting the advertising.

Sometimes such signs placed on either side of the store and within reasonable distance therefrom give best results; again, locations at either end of the town, along the trolley lines, or at both ends of the main business street, opposite the railway station, or at the center of the town, furnish the most lucrative sales possibilities. Care should be shown in the colors used on such signs, the appropriateness of the illustrations, the style of lettering and particularly the wording of the "message" to the public. It is always well to have the signs artistic, but not fantastical or overdone. The effectiveness of the advertising depends largely upon these important points.

It would seem superfluous to call a dealer's attention to the unquestionable "returns" from well-placed newspaper advertising. Nevertheless, it is true that many dealers fail to use this instant form of profitable publicity. A neighborhood dealer in a big city may, with some justice, hesitate to use this means of selling, but nothing can justifiably be advanced to excuse the lack of progressiveness of the dealer in the small or comparatively small city or town who refuses to recognize the local paper as a certain means of developing large and ever-increasing sales.

Newspaper advertisements should be prepared with care and designed to have the maximum "pulling" power. Many important things should be given deep thought. The "copy" or "wording," as a rule, should be brief, clear and snappy—conviction behind every phrase or sentence. The illustrations must be live, smart and catchy, each bringing vividly to the eye a picture closely associated with the song, dance or particular music described.

Effort should be made to make the advertisements especially distinctive, so they will stand out prominently and conspicuously beyond all other advertising. Frequently a novel border or unusual style of type will accomplish this very necessary result. I particularly favor borders as giving individuality to advertisements.

It is well to have an advertisement somewhat similar to the general characteristics of the paper. In other words, I doubt if an "ad" set up in a big city "daily" style would be quite in harmony with the layout of a small village or town paper, and vice versa. What would appeal in a turbulent city may be entirely out of place in a quiet town.

"Position" is vital in advertising. An "ad" prepared to appeal to men would lose much of its force if placed on a page read principally by women; so, too, an "ad" on women's things would be sadly misplaced on or opposite a "sporting" or "editorial" page.

Whether it is advisable to use a full column long or employ the same space in two-column width, half column long, or three-column width, third column long, is also a matter requiring thoughtful consideration.

Let your advertisements be timely, right up to the minute. Each holiday season or local occasion should speak through your "ads." Local appeal is always well taken.

Study always to keep your publicity within the bounds of "good taste." Never, for an instant, let it become coarse, vulgar or offensive in the slightest degree. Bring out the prominent features in striking type that gives individuality. Less important matter is satisfactorily expressed in more modest type. Art! Indeed, yes. Artistic arrangement is most desirable. It attracts—even more, it pleases. By no means fail to grasp its importance.

And last, but perhaps more important than any other single idea, is "originality." Let it stick out all over—copy, illustrations, type, arrangement. Ah, yes, "originality" is a rare gift that cannot be employed too often or too prodigiously.

Perhaps I've bored you. You knew all this before—even better than I. Well, granting that, won't you admit a repetition has done no harm? Possibly it has revived your waning interest or the value of some minor detail—if so, the effort is not entirely wasted.

We Build PHONOGRAPHS to an Ideal— At a Price That Will Appeal!

We won't say we build the best as we do not deal in superlatives (there's too much competition in that line) but when it comes to Phonographs, well—we will leave it to your judgement as a connoisseur and business man.

**"WE DO CLAIM SUPERIORITY
WHEN IT COMES TO SERVICE"**

Three big plants operating continuously give us an output that enables us to supply some of America's biggest jobbers promptly.

THREE LARGE



Plays
All Records
Correctly

Retailers—We have a jobber in your territory who can supply you over night with big value phonographs at a liberal discount.

6 Models—Retail Prices \$85 to \$200

FACTORIES

— ADDRESS —
**GENERAL SALES
CORPORATION**
1520 Buffum St.
MILWAUKEE, WIS.

OWNING AND OPERATING
General Mfg. Corporation
Recordeon Phonograph Co.
Heaney-Schwab Billiard Mfg. Co.
Makers of Billiard Tables Since 1882

The Heywood-Wakefield



“Absolutely Non-Resonant”

IN this instrument there are no counter-vibrations of sound in the cabinet to interfere with tonal purity—because we use a *non-resonant* cabinet of reed.

And in this instrument there is no metallic tone taint whatever—because we use a non-resonant, “cushioned” reproducer.

Thus is the Heywood-Wakefield made free of the two great impurities which have been a blemish upon phonograph tone in the past.

You have only to *hear* it to recognize the brilliance of the achievement which it represents in music production. In the reed cabinet there are no closed-in air spaces as in wood cabinets. The music flows through the open spaces of the reed without any vibratory interference whatever. The cushioned repro-

ducer moves, flexible, pliant, bringing out the hidden beauty of the music *in every detail*.

Again, you have only to *see* the Heywood-Wakefield to recognize that its reed cabinets offer decorative values heretofore unobtainable in a phonograph. The Heywood-Wakefield can be had in three hundred color tones, appropriate for any and every decorative scheme.

The announcement of this *new* and *different* reproducing instrument, made under the extensive Perfek'tone patents, is an event of importance both to the music lover and the dealer in musical instruments.

Write today for details of models, prices and specifications. Address the nearest office of

HEYWOOD BROTHERS AND WAKEFIELD COMPANY

New York Philadelphia Boston Baltimore Buffalo Chicago Portland, Ore. San Francisco Los Angeles

Factories: Gardner, Mass.; Chicago; Wakefield, Mass.

When you visit Atlantic City see all models of the Heywood-Wakefield at the Perfek'tone Store, 517 Boardwalk

Methods for Taking Record Inventories that Will Meet Demands of the Average Business

One of the problems of the talking machine retailer is that of devising some definite method for inventorying his records so that he may at all times know just how his record stock stands and be able to order intelligently and to best advantage. It is true that during the past couple of years the question has been not of ordering records but that of getting them, a blanket order for anything available being almost as good as a detailed order for certain specified records. However, as the record situation improves, this question of ordering will again become one requiring accurate knowledge and the inventory will again come into its own.

The period at which record inventories are to be taken depends largely upon the individual business demands of the retailer and particularly the size of the business he is doing. If there is constant and heavy turnover of record business, as in a big central establishment, a daily inventory of records is generally considered necessary, for under any other system confusion would result. With the dealer doing a medium sized business, however, a weekly inventory proves quite satisfactory. This permits the making up of weekly record orders and combines the work of inventorying and ordering at a considerable saving of time.

Certain dealers combine a weekly inventory of general record stock with a daily inventory of the big selling numbers, such as "Smiles" happened to be a few months ago, or as "Dardanella" is to-day. Under this plan, accurate information is easily obtainable regarding the really live numbers at all times. Some retailers simply have one inventory a month, but unless business is very small the monthly inventory

is considered by well-versed trade members as inadequate to provide proper information.

The development of an inventory plan that will suit best the needs of his particular business rests largely with the dealer himself. Practically all the large companies as a part of their dealer service see to it that some inventory system is made available for the dealer's use. But

Weekly Inventory Essential Although a Daily Analysis May Be Necessary Where Turnover is Heavy

such systems are general in character and the dealer must study them in order that he may be sure that they will provide him with all desired information and at the same time do not overburden him with unnecessary details and system.

Many retailers, some with very large businesses, use specially designed automatic or semi-automatic systems for checking up record stock. Some of these systems call for the marking on a special slip on or near the record bin the number of records of a certain number in stock.

As each record is sold, a check is made against the number and in making up the order it is simply necessary to look at these records to determine what record stocks are low.

Another system adopted by several houses is to set a fixed minimum of safety covering the stock of each record. For instance, two records of a given number may be considered sufficient, while in other cases the minimum may be five or ten records. Under this system a specially colored or marked envelope is provided and in this envelope is placed the second or tenth record as representing the danger line. When records are sold down to this special number, the envelope itself acts as an automatic warning that new records of the number must be ordered. In such a case it is only necessary to go over the stock and watch for special envelopes in order to make up a record list quickly and accurately.

Retailers who are in doubt as to the method of inventorying that will prove most suitable to their particular businesses will do well to keep in touch with the representative of the manufacturer, or wholesaler, in their territory, who, in view of his experience and as a result of observation, is most generally able to make practical suggestions of particular value.

INCREASES CAPITAL STOCK

The Master-Tone Phonograph Co., of Cohoes, N. Y., has increased its capital stock to \$75,000 and has leased new quarters in that city. The mechanical force will be increased to one hundred workers and the new building is rapidly being put into shape for increased production.



Style A

Dulcitone

Dulcitone Figured Walnut, Rich Mahogany, red or brown

Dulcitone

Superiority of Finish Unquestioned

It is not only necessary that a Phonograph should have tone, proper reproductive and amplifying power, which is the result of right equipment, but it should also have sightliness, appearance. Sight is the medium of the greatest of all impressions. As a selling proposition appeals to the eye of your customer first, please it, then, all else being equal, your sale is made.

Dulcitone Finish both appeals and satisfies. Years of specializing in the selection and matching of veneers enables us to produce a finish that for beauty is absolutely not duplicated.

The equipment is right, too, of the highest order, giving to the dealer a combination of finish, reproducing accuracy, and musical perfection that is not found in other phonographs. Not a good machine housed in a poor cabinet, nor a poor machine housed in a good cabinet, but a FINE machine housed in a FINE cabinet.

Prompt deliveries.

Write for prices and particulars.

Dulcitone Phonograph Company

SOUTH HAVEN, MICHIGAN

Bringing the Talking Machine to the Attention of the Public in Texas :: :: By W. Bliss Stoddard

New uses for the talking machine are constantly being found. It is no uncommon thing to find it employed to take the place of a piano or even an orchestra for a dance, but its possibilities as a crowd drawer on the streets were recently demonstrated to good advantage in San Antonio, Tex. Attracted by a throng of people gathered on a street corner and the strains of the "Miserere" emanating from the midst, the writer pushed through the mob, and there, under the flickering gaze of a big oil torch, was a phonograph grinding away, while a shrill-voiced woman was proclaiming the low price and remarkable beauty of some mechanical dolls she was demonstrating. "Music hath charm"—and those who sell know it is a factor to interest the general public.

The Tri-State Talking Machine Co., El Paso, Texas, recently used a very effective comparison to show the immense stock of records carried. At one side was a framed picture of the Mills Building—one of the largest office buildings in El Paso, and at the other a cartoon showing a stack of records piled at an angle to represent the leaning tower of Pisa. A card between them said:

WHAT IS IT?

A stack of 9,500 records. A stack that would reach to the eighth floor of the Mills Building—and no two records alike.

This is the size of the Victor and Columbia records that we carry. It is the largest stock in El Paso and the southwest.

Seventy new ones received each month. Call in and look them over. We will be delighted to play just as many of them as you care to hear.

This company makes good use of the tele-

phone in calling attention to its records. It has a complete list of names and addresses of all who have purchased a phonograph or records the past year, and during her leisure one of the saleswomen calls them up in turn and suggests the purchase of at least one new record each month. A complete list of the new records is sent each month to the different customers, with the printed suggestion: "Telephone your order for the month—Records promptly delivered at regular rates."

The Phoenix Furniture Co., Beaumont, Texas, has a large room with several demonstration chambers, and pays much attention to its talking machine department. A recent ad run by it suggested:

HOME IS THE ALTAR WHERE TRUEST BLISS IS FOUND

Did you ever visit or inhabit a cheerless home, where the children and even the older folks spend most of their evenings at a vaudeville or the movies? If so, send the head of the home to us.

Or tell them to invest in a Victrola, and stay at home, and in comfortable chairs listen to the greatest music of the age, instead of the cheap and trashy songs of the music halls.

The company complemented this printed ad by taking from its extensive stock furniture and draperies and fitting up a cozy music room—cheery and beautiful, but not too fine for active, growing children. At one side was shown a Victrola, upon which a child was placing a record. In the chair sat a mother, and sprawled out upon a rug was a second child. All of these figures were borrowed from a local dry goods store and appropriate credit given for the courtesy. A large card advised: "Happy is the

home where good music is a nightly occurrence."

Thos. Goggan & Bro., Houston, Texas, attracted considerable attention to their Victrolas and added many sales of records through their recent artistic display. In honor of a recital by Charles Wakefield Cadman they arranged a setting of his beautiful song, "Land of the Sky Blue Water." The window was floored with moss, in which was imbedded a large mirror. Overhead was hung a blue cloth, which was reflected in the mirror. On the simulated lake was a little birch bark canoe guided by an Indian doll. On the shore back of the lake was a small tepee. At one side was a camp fire over which was suspended a big iron kettle, and on a log covered with an Indian blanket were a couple of tom-toms. Hung on the wall were bows and arrows. At the other side was placed a Victrola. On an easel was a framed picture of Cadman, and scattered at the base records of a number of his compositions. A large card advised: "Hear Charles Wakefield Cadman play a number of his own compositions at the recital Thursday night—and then come in and select the records of his that please you most. You can hear the great artist perhaps only once in a lifetime, but you can enjoy his music every evening in the year as reproduced upon a phonograph."

Having accumulated a considerable stock of second hand Victrolas, which they had taken in part payment for machines of a later date, they determined to dispose of their stock in a short period. They accordingly inserted in the paper a very practical ad:

YOU FOLKS WITH NO TALKING MACHINES—BUY AN OLD ONE TO START WITH

You can never know how much pleasure can be introduced into a home until you have a talking machine. If you think that you cannot afford a new talking machine at this time, buy one that has been used and later, when you can afford it, trade it in for a new one. But—

DO IT NOW

Do not deprive the family of the joy of music for a single day longer.

Come in and see our large stock of slightly used talking machines, and learn the easy rates upon which they may be secured.

The group of used machines was segregated from the new ones, and a tag, indicating the price, placed upon each machine.

In a number of the Texas music stores and others handling talking machines, special St. Patrick's Day decorations were used, featuring records of Irish melodies. One catchy way of indicating the price was to use large shamrocks cut from green cardboard, with the price printed on same in black letters. Another firm used the same device to feature the name of each record, the green shamrock being attached to the center of the black disc.

VICTOR FOREIGN SUPPLEMENTS

The March monthly supplements issued by the Victor Co. contain an attractive list of new recordings by some of the most celebrated Victor artists. This supplement is furnished to Victor dealers in the following languages: Bohemian, Danish, Hebrew, Hungarian, Italian, Mexican, Norwegian, Polish, Portuguese, Rumanian, Serbian, Slovene, Swedish and Turkish. These foreign supplements are printed attractively in the colors of the respective nations. The usual newspaper ads and record reviews are also furnished dealers.

C. H. Moore, Jr., has organized the Moore Phonograph Co., in Tacoma, Wash., and has secured the exclusive agency for the Mandel phonograph, manufactured in Chicago, for Tacoma. The showrooms are at 1145 Broadway.



Yes, We Are Teaching Better Selling

Any sales force can, if the store has the merchandise, fill the needs of the people who come in and ask for certain models or "hits" among Records. That's the old familiar business of order-filling.

To create a desire for some model that the customer didn't come in to buy—to introduce Records that the customer didn't ask for but which are "just as good" as those asked for, maybe a lot better—that's REAL SALESMANSHIP.

Miss Grazella Puliver, formerly of the Educational Department of the Victor Talking Machine Company, has immediate charge of this interesting work. Mr. S. Roland Hall, formerly head of the International Schools of Advertising and Salesmanship, will play a part, particularly in the Better Selling pointers that will appear regularly in *The Victor Turnover*, our publication.

This service is open to all dealers and salespeople in our part of the country. Several classes have been formed and are making excellent progress.

THE CLEVELAND TALKING MACHINE CO.

1125 Oregon St., Bingham Building, Cleveland, O.

Victor Products Exclusively

*We are pleased to
announce that we have
appointed*

CONDON & CO., Inc.
200 Fifth Avenue
New York

Sole Agents for the Sale of
**COPPER PROCESS TONE
ARMS**

and other Copper Parts
Manufactured under our new
secret process of fabri-
cating Copper



COPPER PROCESS COMPANY
19 West 44th St. New York

The next page contains
an interesting message from
CONDON & CO., Inc.
which deserves your attention.

Four Secrets of

Wonderful New

COPPER

TONE ARM

Only one manufacturing process can produce this wonderful product, the *copper* tone arm. It is made by a remarkable new secret process of fabricating copper—in the only plant of its kind in America.

THE Copper Process Tone Arm has 11 distinct features of superiority. Chief among them is the fact that it can be made in any design the manufacturer desires. Whatever design you may require can quickly be made through this wonderful new secret process.

The Production You Demand
Can Be Speedily Obtained

—11—

Amazing Features

- (1) Greater manufacturing *speed* and *production*.
- (2) Adaptable to any design you submit—through new secret process of fabricating copper.
- (3) No liability of breakage. Could hammer it flat, same way as gold, without its breaking.
- (4) No possibility of imperfection in manufacture.
- (5) No peeling of the plating.
- (6) Lighter in weight.
- (7) Smaller assembling costs.
- (8) No leakage—seamless copper arms specially moulded or of our regular stock designs.
- (9) Can be brought to a higher polish.
- (10) Produces better tone—more natural, mellow and full.
- (11) Real advertising and selling strong points which will prove just as evident to and effective with your dealers as with their customers.

Production through this process is now available to you in whatever quantity you may desire. When you read the 11 special features of the Copper Process Tone Arm you will understand why you should act at once. Every manufacturer wishing to learn more about the Copper Process Tone Arm should promptly mail the coupon on the opposite page. It is a product which is just as attractive from a manufacturing and selling viewpoint as from an advertising and selling angle. The coupon will bring you all the facts. Mail this coupon now.

CONDON & CO., Inc.

Sole Agents

200 Fifth Avenue
New York City



C O N D O N ' S S U R E T Y E X P R E S S

Bigger Profits for You



Torrington Uniform Needles

Made with the famous "ball-point." Eliminates scratching. Improves tone. Each Torrington Uniform Needle perfectly uniform in size, finish, tone value and merit.

Don't make the mistake of supplying your customers with the sort of needles which discourage record sales.

Torrington Uniform Needles make better friends for you—and bigger profits. Our Plan K will interest you.

—GLISS— The New Kind of Cabinet Polish

HERE is a new kind of cabinet polish—Gliss. Not only does it produce a bright, glistening lustre—but the polished surface *stays* that way; "the lustre lasts." A special chemical compound insures this remarkable result. Gliss does not smear and quickly wear off. It does not catch the dust. A phonograph or any other piece of furniture when polished with Gliss looks as though it had an outer surface of shimmering glass. The pleased face of your customer is reflected as she gazes at the results Gliss brings.

When you consider that Gliss is absolutely free from all injurious substances and that it quickly produces, without hard rubbing, a shining

lustre which *lasts*, it is not so surprising that it has won the endorsement of one of the largest manufacturers of musical instruments in the world, praise from households which use it, and profit for dealers who handle it.

Gliss is *made* so that your customers are pleased with their purchase—and *marketed* so that you are pleased with your profit.

MAIL COUPON

For full information about this marketing plan and further facts about this wonderful new kind of cabinet polish, mail the coupon printed below. But do it at once, because altho production is going forward on a large scale yet prompt delivery can be assured only by prompt action. Mail the coupon *today*.

GROOVITE

Improves Record Tone Over 30%

THE grit and dust which each little record groove carries pays no attention to brushes or dusters. There is only one way to clear the groove-track—one way to enjoy from each record *all* of its beauty and purity of tone. "Groovite" is the answer. This wonderful new liquid cleans each record groove as the needle goes over it—and improves the record tone over 30 per cent.

"It Cleans As It Plays"

No mess or trouble in using "Groovite"—altho the difference in results would be well worth it. It is a liquid which runs around the grooves, absorbing and dispelling all the tone-killing dust and grit particles, and making each groove as clean as a whistle—enabling the needle to bring out over 30 per cent. more sweetness and purity of tone.

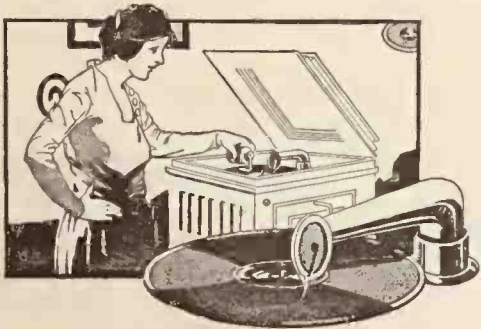

"Groovite" is sold at a price attractive to the consumer, but also bringing a profit that well satisfies the dealer. It is an article that commands repeat business because of its merit and boosts record sales because it makes each customer's records sound better and "taste like more."

Mail Coupon for Special Proposition

This coupon, mailed promptly, will bring you full information about our special proposition on "Groovite." Learn more about this proposition and about "Groovite" itself. Learn how "Groovite" makes the needle go as smoothly

and-noiselessly over the record as a rubber ball rolls over glass. Let us tell you more about "Groovite" and our special proposition.

MAIL THIS COUPON TODAY

This coupon will bring you full information about any or all of these four propositions. Let us tell you more about them. Let us show how you can profitably market them. Every manufacturer should learn more about the Copper Process Tone Arm. Everyone in the trade should learn the facts about Gliss, Groovite, and Torrington Uniform Needles. Specify on this coupon in which product(s) you are interested—and mail it *to-day*.

Wm. A. Condon & Co., Inc.
Sole Agents
200 Fifth Ave., New York

(COUPON)

CONDON & Co., INC.,
200 Fifth Avenue, New York City.

Please tell me more about Copper Process Tone Arms, Gliss, Torrington Uniform Needles, Groovite. I understand, of course, that this request obligates me in no way.

Name
Address
City



The Line to Greater Profits



That most beautiful of all "Barcarolles" from Tales of Hoffman is the first duet for Columbia Records by Rosa and Carmela Ponselle. Columbia 78846.

**Columbia Graphophone Co.
NEW YORK**

NEW DOEHLER CO. EXECUTIVES

John Kralund Elected Second Vice-President and Chas. Pack Secretary of the Company

At an executive meeting of the Doehler Die-Casting Co., held recently at the offices of the company in Brooklyn, N. Y., John Kralund was elected second vice-president and Chas. Pack secretary of the company. Mr. Kralund has been connected with the Doehler Die-Casting Co. from its inception, starting as a die maker in 1906. It was through his inventive genius that a practical casting machine was perfected, and his advancement with this company has been rapid.

Chas. Pack became connected with the company in 1911, directly after he left college. Since then he has won a reputation as a chemist of national standing and advanced with the company to the position of secretary.

Announcing the election of these two new officers, H. Doehler, president of the company, predicted a bright outlook for the future in the following words: "The development of the die-casting industry for the next ten years, compared with the past ten years, will not only be greater, but also in consequence thereof will bring forth greater opportunities for our executives than ever before."

Roy M. Chapman and Cecil E. Allen have purchased the Hamilton Stationery Store in Grand Junction, Col., and the firm will in the future be known as Chapman, Allen & Co. The Pathé machines and records are carried.

THE BOICE VOICE SHOP

A Thriving Victrola Shop in Kansas City That Is Very Attractively Arranged

KANSAS CITY, Mo., March 3.—The Boice Voice Shop, the exclusive Victrola shop recently opened by Mr. Boice under the management of Mr. Hendricks, reports that the business during the month of January was so heavy that the company was handicapped in supplying the machines ordered. A number of



Partial View of Boice Voice Shop

styles were so far in demand that the company experienced considerable delays. However, according to Mr. Hendricks, the business has now almost been caught up with and the demand is seemingly finding no stopping point. The company has one of the best appointed shops in the city, having an exceptionally large space on the second floor at 1104 Walnut Street, which is centrally located in the heart of the retail business district.

The establishment is well appointed, and it has a number of demonstration booths of double-paneled glass which are attractively designed and absolutely sound-proof.

The Smith Phonograph Co., Sioux Falls, S. D., has been incorporated with a capital stock of \$50,000. The incorporators are J. Frank Smith, George E. Secrest and S. A. Reike.

VICTOR 1920 NUMERICAL LIST

Volume Containing Many Useful Helps for Victor Dealers Sent Out to the Trade

The 1920 Numerical List of Victor records, containing a complete summary of the titles and numbers of all records in all languages made by the Victor Co., has been sent out to Victor dealers and is a volume which will prove of great value to the dealer in the keeping of his accounts. Twelve ruled spaces, one for each month in the year, preceding each record number provide a practical method of keeping stock. Dealers are urged to make use of this special feature, for it enables them to tell at all times just how their stock is in regard to any record. A ready-reference classification for salesmen is found at the front of the book and shows the series of numbers which denote certain classes of records. The volume is strongly bound and is meant to be used constantly by the dealer.

NEW POST FOR NORMAN B. SMITH

Becomes Assistant Manager of Chicago Branch of Columbia Graphophone Co.—H. C. Cooley Also Appointed to Assistant Managership

Geo. W. Hopkins, general sales manager of the Columbia Graphophone Co., New York, announced recently that Norman B. Smith had been promoted from the post of assistant manager of the company's Cincinnati branch to assistant manager of the Chicago branch, which is under the management of Kenneth Mills. Mr. Smith, who is one of the most popular members of the Columbia sales organization, attained signal success at Cincinnati and his work at that branch well warranted his promotion to the important position of assistant manager of the Chicago branch.

Mr. Hopkins also announced last week the appointment of H. C. Cooley as assistant manager of the New Haven branch. Mr. Cooley was formerly connected with the record department at the Bridgeport factory.

REGINA
Phonograph

Plays all disc records with an unusual clearness, richness and beauty in tone.

Attractive Proposition for active Dealers

The REGINA Co.
47 W. 34th St.,
New York

209 S. State St.,
Chicago

AUTOMATIC STOPS

The simplest and most efficient Automatic Stop on the market. They give excellent service, are easily installed and are absolutely guaranteed.

Send 50 cents for Sample Stop

Kirkman Engineering Corporation
484-490 Broome St., New York



Seventh Supplement

Okeh Records

Ready Soon

- | | | |
|--------------------------|---|--|
| 4069
10-in.
\$1.00 | } | FRECKLES—Fox-trot. Instrumental.
Paul Biese and His Novelty Orchestra |
| | | PLEASE—Fox-trot. Instrumental.
Paul Biese and His Novelty Orchestra |
| 4070
10-in.
\$1.00 | } | MYSTERY—Fox-trot. Instrumental.
Paul Biese and His Novelty Orchestra |
| | | MEET ME IN BUBBLE LAND—Waltz. Instrumental.
Paul Biese and His Novelty Orchestra |
| 4071
10-in.
\$1.00 | } | TENTS OF ARABS—One-step. Instrumental. Conway's Band |
| | | NOBODY EVER—Fox-trot. Instrumental. Conway's Band |
| 4072
10-in.
\$1.00 | } | HOT FOOT (Xylophone solo with Conway's Band)—One-step. Instrumental. George H. Green |
| | | DON'T YOU REMEMBER THOSE SCHOOL DAYS—One-step. Instrumental. All Star Trio |
| 4073
10-in.
\$1.00 | } | ONLY—Tenor, with Orch. Accomp. Sam Ash |
| | | SWEET AND LOW—Vocal Trio, with Orch. Accomp. Crescent Trio |

- | | | |
|--------------------------|---|---|
| 4074
10-in.
\$1.00 | } | FOR EV'RY DOOR THAT CLOSES (Another Will Open for You)—Tenor, with Orch. Accomp. Reed Miller |
| | | I LOVE YOU JUST THE SAME (Sweet Adeline)—Vocal Quartette, with Orch. Accomp. Peerless Quartette |
| 4075
10-in.
\$1.00 | } | LEND ME JIM—Contralto Duet, with Orch. Accomp. Watson Sisters |
| | | NEVER LET NO ONE MAN WORRY YOUR MIND—Contralto, with Orch. Accomp. Fannie Watson |
| 4076
10-in.
\$1.00 | } | LULLABY BLUES (In the Evening)—Vocal Trio, with Orch. Accomp. Crescent Trio |
| | | JUST FOR ME AND MARY ('Twas a Beautiful Wedding Day)—Vocal Trio, with Orch. Accomp. Sterling Trio |
| 4077
10-in.
\$1.00 | } | MOTHER MACHREE—Tenor, with Orch. Accomp. William Robyn |
| | | BELLS OF ST. MARY'S—Baritone, with Orch. Accomp. Joseph Phillips |
| 4078
10-in.
\$1.00 | } | SWANEE—One-step. Instrumental. Green Brothers' Xylophone Orch. |
| | | BLUES (My Naughty Sweetie Gives To Me)—Fox-trot. Instrumental. Harry Raderman's Jazz Orch. |

Dealers' Service

Our Window Display Service has tremendous sales value. Every Okeh dealer should use it. There is nothing better to solve your window decorating problem. Tell your distributor to enter your order beginning with the display for the Seventh Bulletin of Okeh Records at the low price of \$2.00 monthly. DO IT NOW.

General Phonograph Corporation

OTTO HEINEMAN, *President*

25 West 45th Street, New York City, N. Y.

Factories: NEWARK, N. J.; ELYRIA, OHIO; PUTNAM, CONN.; SPRINGFIELD, MASS.; KITCHENER, ONT.

Branch Offices: CHICAGO, ILL.; SAN FRANCISCO, CAL.; TORONTO, CAN.

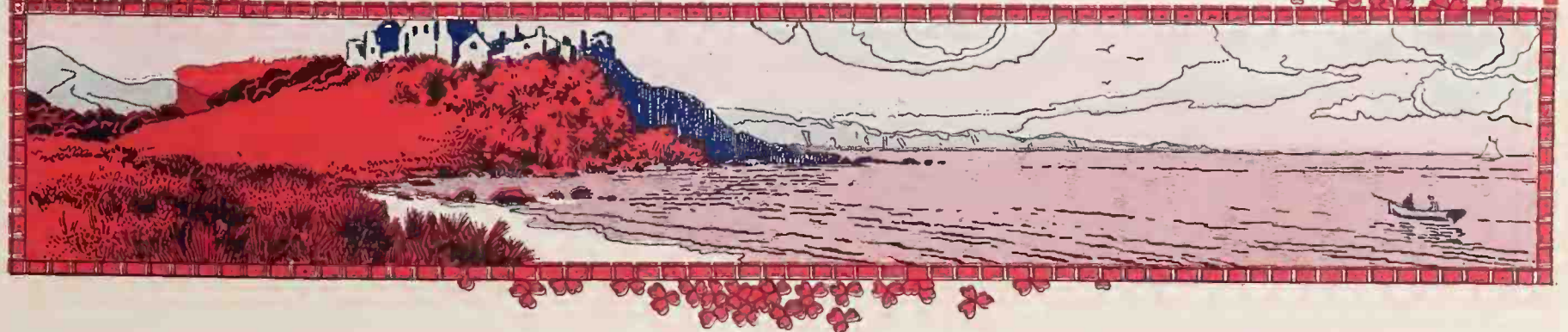



"CERAMIPHONE" APPEARS IN OHIO

East Liverpool China Concern Enters Talking Machine Field With Ceramic Amplifier—Retail Trade Flourishing in That Section

EAST LIVERPOOL, O., March 3.—The manufacture of talking machines has been started here by the Smith-Phillips Music Co., the firm developing the "Ceramiphone." In addition to the machine, the company is presenting a new amplifier, the latter being manufactured by the Smith-Phillips China Co., of this city. The amplifier is a ceramic product and produces a very mellow tone. Wilson F. Smith, head of the Smith-Phillips Music Co., is spending much of his time on the road looking after the distribution of the "Ceramiphone." Extensions to their manufacturing department will be undertaken very soon. This is the only talking machine manufactured in this section of Ohio.

A very satisfactory business is reported in the distribution of the Brunswick talking machine by Reed Ashbaugh, a local druggist, who also carries a very liberal stock of records. The department is a new one, and it is the first of the kind to be installed in any drug store in the Upper Ohio Valley.

The retail talking machine trade in this section of Ohio has never been better and all dealers find their business growing steadily. The Frank Crook Furniture Co., local Columbia distributor, has found its trade in January and February to be three times that done in the same period last year. Manager Edward Simms declared that the demand for records is so great that new shipments are often sold out on the day they arrive. The Lewis Bros. Co., Victor dealers, have also greatly exceeded their sales record of 1919.

Davis, Burkham & Tyler, Victor dealers for southeastern Ohio, have found their talking machine trade growing remarkably, especially since the war. In discussing this phase of the industry Olan Dawson, general manager of the local branch, declared that many sales have been traced directly to returned soldiers who had come to appreciate music through the work of the Y. M. C. A. and the army itself. It is noticeable that classical selections are selling as well as the popular songs.

The William Marik Mfg. Co., Sturgeon Bay, Wis., is making a talking machine which is known as the Starik Phonograph.

"The Music Without the Blur!"

This ideal of talking machine manufacture is attained more nearly than by any other, in the construction of the

MARVELOUS MAGNOLA
"Built by Tone Specialists"

"Magnola's Tone Deflector eliminates the scratch"



Watching the Music Come Out

We want to show you how to make money with MAGNOLA; and how MAGNOLA is the best buy on the Talking Machine Market to-day.

Send us your name and let us send you some real Talker Tips.

MAGNOLA TALKING MACHINE COMPANY

OTTO SCHULZ, President

General Offices 711 MILWAUKEE AVENUE CHICAGO
Southern Wholesale Branch 1530 CANDLER BLDG. ATLANTA, GA.

E. N. UPSHAW HAS RECORD MONTH

Southern Sonora Co. Does Large Business in First Month Following Its Organization

E. N. Upshaw, president and general manager of the Southern Sonora Co., which was recently organized in Atlanta, Ga., is more than pleased with the business done by his company in the first few weeks of its organization. In a chat with The World Mr. Upshaw said:

"It was very gratifying to us to do such a business the first month. During my fourteen years in the wholesale talking machine business I have had the pleasure of piling up some pretty hefty months' business, and to be able to go out with a brand new firm and exceed any previous month the very first thirty days of our career is, I consider, a very striking tribute to the lines we handle, namely, the Sonora phonograph and Emerson records."

The Southern Sonora Co. is exclusive distributor in the States of Alabama, Georgia and Florida for Sonora phonographs and Emerson records. It does only a wholesale business and expects to be able to give the dealers in its territory the kind of service which will make its business successful.

LEAVES FORTUNE TO SECRETARY

School Teacher Made Sole Heir to Estate of Walter P. Phillips, Former Columbia Man

OAK BLUFFS, MASS., March 1.—Miss Frances A. Wood, twenty-six years of age, a teacher of languages in the local high school for over two years and confidential secretary to Walter P. Phillips, well-known newspaperman, and one time connected with the Columbia Graphophone Co., has been named sole heir to Mr. Phillips' estate, which is estimated to be more than \$50,000. Miss Wood is a graduate of the University of Maine and came to this city in 1917 following her graduation. She boarded at the same house as Mr. Phillips and soon after was offered the position of private secretary by him.

FRIEDA HEMPEL SCORES IN CONCERT

Frieda Hempel, the distinguished soprano and Edison artist, scored a remarkable success at her recital at Carnegie Hall, New York, last month, when she revealed her consummate art and musicianship in a song recital which was admirably conceived, embracing some delightful numbers which were sung in French and English, her diction in both languages being absolutely a delight. She was assisted by August Roderman, flutist, Robert Gaylor, who presided at the organ in the opening number, Handel's "Arioso," and Coenraad V. Bos, accompanist at the piano. Mme. Hempel has demonstrated that she is a concert artist of the first rank, and her delightful singing at this recent concert deservedly aroused a great deal of enthusiasm.

HOW TO GET A CHANGE OF AIR

There is more than one way of obeying a doctor's orders as was proven by a New Yorker recently. He was feeling poorly and went to a physician who advised him that what he wanted was a change of air. Instead of buying a ticket for Florida, the patient bought two new records for his talking machine. It is quite possible that the "change of air" benefited the neighbors quite as much as it did himself.

SEABROOK LABORATORIES MOVE

The Seabrook Laboratories, formerly located in New York for the demonstration of the Seabrook phonograph, have been moved to 44 Harrison street, East Orange, N. J., where larger and more suitable quarters have been secured.

The Central Talking Machine Shop, New York, last month increased its capital stock from \$50,000 to \$250,000.

U D E L L
CABINETS
OF
QUALITY
FOR
QUALITY
TRADE
U D E L L

MEANS SATISFACTION BASED ON EXPERIENCE AND VALUE.

THE CITY

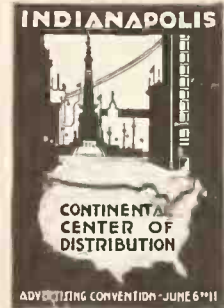

THE PRODUCT



(Horizontal Shelves) No. 1405

For New Victrola IX-A
Height, 36½ in. Width, 19 in. Depth, 22½ in. Holds 10 Victor albums. Mahogany Front or Quartered Oak Front. Average weight, crated, 90 pounds.
[If vertical interior is desired, order No. 405.]
[If felt interior is wanted, ask for No. 405F.]

Catalog on Request
THE TRADE MARK



The Udell Works
1205 Twenty-eighth St.
Indianapolis, :: :: Ind.

Columbia

The Best Selling

AL JOLSON records are red hot hits, but they've never been known to warm any counters. Al Jolson makes records for Columbia *exclusively*.

HARRY FOX records fascinate all those fortunate enough to hear them. Harry Fox makes records for Columbia *exclusively*.

BERT WILLIAMS records never remain in the shop for long. Bert Williams makes records for Columbia *exclusively*.

These popular stars are only a few of the best-selling artists of every kind who make records for Columbia *exclusively*.



© Strauss Peytonke

Al Jolson



© Apeda, N. Y.

Harry Fox



© White N. Y.

Bert Williams

Records

Exclusive Artists

NORA BAYES records are always bought just as fast as she can make them. Nora Bayes makes records for Columbia *exclusively*.

VAN and SCHENCK records go fast as soon as they are put on sale. Van and Schenck make records for Columbia *exclusively*.

TED LEWIS' JAZZ BAND records are just what all jazz dancers like. Ted Lewis makes records for Columbia *exclusively*.

COLUMBIA GRAPHOPHONE COMPANY

NEW YORK

Canadian Factory: Toronto

© White N. Y.

Nora Bayes



Ted Lewis' Jazz Band

© Strand, N. Y.



Van & Schenck

© Press Bureau, Inc.

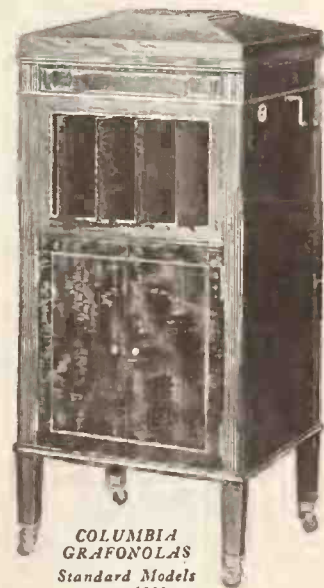

COLUMBIA
GRAFONOLAS
Standard Models
up to \$300
Period Designs
up to \$2100

Velvet



THE VELVET contact of these smooth little domes between furniture and floor means:

- No more rasping noises on polished floors.
- No more strain on furniture legs and joints.
- No more dig and scratch to your flooring and rugs.
- No more chipped leg bases.
- No more discomfort to the nerves.

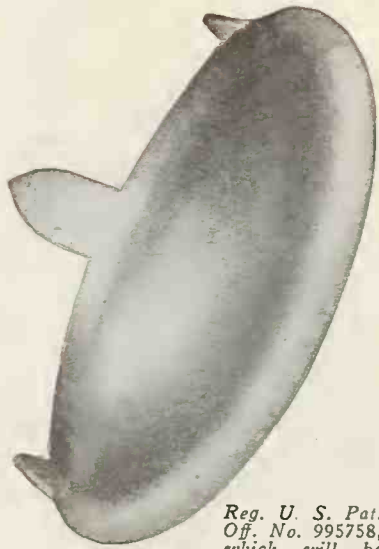

*Reg. U. S. Pat.
Off. No. 995758,
which will be
strictly enforced*

Our National Advertising and the many million sets already in use have taught the public to expect Domes of Silence on their furniture.

DOMES *of* SILENCE

Why, the dollars they save in damage alone is reason enough why Domes of Silence should stand protectively beneath each piece of furniture.

Trifling in cost, tremendous in value.

HENRY W. PEABODY & COMPANY
Domes of Silence Division

17 STATE STREET

NEW YORK

SPECIFY DOMES *of* SILENCE

The Importance of Imbuing Salesmen With Enthusiasm for Their Work :: :: By J. L. Stephenson

The problem of getting the best results from a sales force is one which every executive seeks to solve and perhaps the best answer is: Make their work a game and teach them to play it. In other words, infect salesmen with the joy of doing a good job. Foster the spirit which makes each man put forth his best efforts to reach the top or win the race. Many large business houses in this country are acting on this principle and are doing all in their power to foster this game spirit among their salesmen. They set a goal which all can reach with sufficient effort, but this goal is not set too high or too low. To those who reach the goal there are tangible rewards which stand as concrete proof that the winning salesmen are doing their best. The progressive house is willing to divide with its salesmen the profits from increased business due to their efforts and has found that it pays to stimulate its sales force.

Valuable as this method of stimulating salesmen is, the plan has been neglected by some smaller concerns because of the difficulties of keeping it up. The cost has been thought to be too great and indeed in some cases this has been true. But it might be worth while to cite the example of one concern and show what the system used was and what its advantages are in the hope that some executives may derive information which they may be able to apply to their own business. An Indianapolis concern has developed a plan which is both a guide to managers in determining the value of their men and at the same time acts as a spur to the men who represent the house on the road and in the store. The plan is simple, easy to keep up. It is an adaptation of the percentage system and is susceptible of use in a variety of interesting contests.

The form used is divided into two parts, one for the sales manager and one for the men, with a perforated line marking the division between the two columns. The names of all the men to be graded were written in the Name column of the Salesmen's Report section. Next the amount of their sales for the month was entered in the Sales column and the amount of salary earned posted from the pay roll in the Salary column. As the third step, the amount of salary earned by each man was divided by his sales to find his percentage. The figures were entered

after each man's name in the Per Cent column. Finally each man's standing was determined by comparing the various percentages. The salesman who showed the lowest percentage was graded No. 1 and others were ranked accordingly. Then their names were written in the standing column of the Salesmen's Report section. When this simple task was completed the name and the rank of each salesman were written in the Salesmen's Standing section. This section may be detached and posted where every man may see it.

Obviously this record was taken on the sales

Something of a Simple and Inexpensive System That Will Speed up Sales or Whip up Production

of one line and certainly it would not do for salesmen selling a large number of lines at varying rates of profit and expense. The principle of percentages on which the form is based may, however, be adopted without change. If the amount of sales of a certain line or lines is not a fair basis, the percentage of selling expense for the month may be the grounds for the contest. Salesmen may also be graded on the percentage of sales quota filled. The amount of profit made may be a fair way of figuring. Gain over the previous year's business, complaints, canceled orders, bad accounts, new orders, may all be factors on which to base a contest. But no matter what variation ingenuity suggests, the simple little form which has been illustrated will go far in telling the busy manager or proprietor little and big truths about the ability of his men.

The plan is suitable for retail stores as well as for wholesalers, and if the store is too large

a unit, it may be kept by departments. In the shop the basis may be the output of the worker. In short, the record with but slight modification may be adopted to almost any line of business.

In all cases the use of the simple and inexpensive system will speed up sales or whip up production as the case may be. When it is used, there need be no guessing on the part of an employe as to how he stands with the boss. The man who wants a raise or who needs one, knows that the best way to get more money is to work to the top of the list and to stay there. The man at the bottom of the list will certainly make Herculean efforts to attain a higher standing because he'll know that his job is in jeopardy. He'll be spurred in his efforts by the certainty that the man next above him will leave no stone unturned to advance or at least to hold his old grade. The same situation holds at the top of the list. Number 1 will scratch hard to hold his position, while Number 2 will do his best to displace him.

In this way the executive may bring system into his work and enthusiasm to his men. By his organization working precisely and accurately he can secure the fullest returns from dollars invested in his working force.

C. J. IANNELL LEAVES THE TRADE

C. J. Iannell, for some time past in charge of the talking machine department of Gimbel Bros., New York, resigned recently to enter the silk business. Mr. Iannell has been in the talking machine business in and about New York for over twelve years, and before going with Gimbel Bros. was in charge of the talking machine department of Frederick Loeser & Co., Brooklyn, and Bloomingdale Bros., New York.

FIRE DAMAGES HECTOR FACTORY

Fire that started early in the morning of February 17 in the building at 55 Commercial street, Newark, N. J., occupied by the Hector Talking Machine Co., destroyed a large part of the building and many thousand dollars' worth of stock.

Wehrley & Co., Inc., Columbia dealers, have opened up in Stroudsburg, Pa.

Schmelzer Arms Co.

Kansas City, Missouri

Exclusively Wholesale
Victrolas and Victor Records

REORGANIZATION OF EDISON ADVERTISING DEPARTMENT

New Organization of Experts, Headed by Joseph B. Gregg as Advertising Manager, to Specialize on Service to Dealers—Something About the Men Associated with This Important Department

Joseph B. Gregg succeeds A. J. Palmer as advertising manager of Thomas A. Edison, Inc. Mr. Gregg, who is known as one of the most thoroughly experienced men in all lines of printing in the Greater New York district, will devote himself chiefly to dealer service and the production end of advertising. He has been attached to the advertising department for the past six months as manager of advertising production.

C. G. Wood has been appointed assistant advertising manager. He is a highly trained advertising man and has been "breaking in" for this position for several months. He was formerly manager of the advertising department of the Universal Film Exchange of New York and manager of important departments with the Gage Publishing Co. and the William R. Gregory Publishing Co. of New York. He has had a wide experience in retail sales.

D. B. Babcock, who is an expert on window display and store display, and who prepared the Edison exhibit at the recent national Music Show in New York City, has been appointed manager of dealers' store service. He was at one time on the reportorial staff of the New York World, and has also had a broad training in retail sales.

Roy T. Burke succeeds C. H. Miller as editor of Along Broadway, Diamond Points and the Amberola Monthly and will continue in charge of the Edison feature news service which he originated, as well as trade paper and other publicity. Mr. Burke has had an exceedingly broad and comprehensive education in editorial work and publicity. He formerly was a feature writer and later city editor and in charge of other important editorial departments of leading American metropolitan papers. As a director of advertising sales he brought several metropoli-

tan papers to a leading position in their field. He also directed political and corporation publicity, and because of his work was twice appointed to represent states in hearings before Congressional committees.

The position of editorial director has been

VALUABLE TIPS FOR SALESMEN

Stewart Talking Machine Co. Bulletin Offers Good Suggestions for Selling Records—Give the Customer a Chance to Look Around

Among the many hints for dealers in the matter of salesmanship the following from the bulletin of the Stewart Talking Machine Co., Indianapolis, is of interest to every dealer in talking machines:

Beyond making an unpleasant commotion in the store, the custom of snapping in quick response to a customer's inquiry, "We're out of that record!" has a distinctly harmful effect upon the sales total of any Victor store.

Smooth and pleasant order should prevail in every store. The store decorum should be regarded just as highly as clever salesmanship. In fact, the good salesman is always quiet and pleasant of manner.

And no good salesman tells his customer that his store is out of any record without first giving that customer a chance to look about and think of some other record which he would like to hear.

Take, for example, this occurrence in a model Victor store:

Mrs. Customer asks for "Bubbles."

The salesman knows perfectly well that the record is out of stock, but he says:

"Please wait a moment and I will see if we have the record in stock." While he is looking

created in the Edison advertising department and will be filled by a man who has had many years' editorial experience on leading magazines.

The personnel of the new organization has been selected with particular reference to its practical knowledge of printing and the service end of advertising. The Edison Co.'s sales promotion plans for 1920 involve a great amount of detail and it is believed that the new organization is qualified to give nearly 100 per cent service.

through the racks Mrs. Customer sees an attractive advertisement of the latest Galli-Curci record; she reads through the list of February records on the display bulletin; she notices one after the other the lithographed cards in which the record that they advertise is set.

When the salesman returns with the information that "Bubbles" is out of stock, Mrs. Customer is at least prepared to listen to his suggestions of other choice numbers, if she has not another desire of her own to express.

In stores that are continually bombarded by requests for records that they do not have, this practice of giving a customer time to think cannot, perhaps, be followed. The salesman of such a store, nevertheless, should have other suggestions on the tip of his tongue. The customer must not be made to feel that he or she is being shunted out of the store.

MERIDEN PATHE DEALER TO MOVE

John W. Fearnley, a Pathé dealer in Meriden, Conn., now located at 62½ East Main street, will move into new quarters in the Nissen block at 17 State street. The decision to enlarge his business was made following his visit to New York during Music Week.

The Musicola Talking Machine Co., Brooklyn, N. Y., was recently incorporated with a capital of \$10,000 by A. Di Benedetto, M. Cicio and F. Maggio, 242 Knickerbocker avenue.

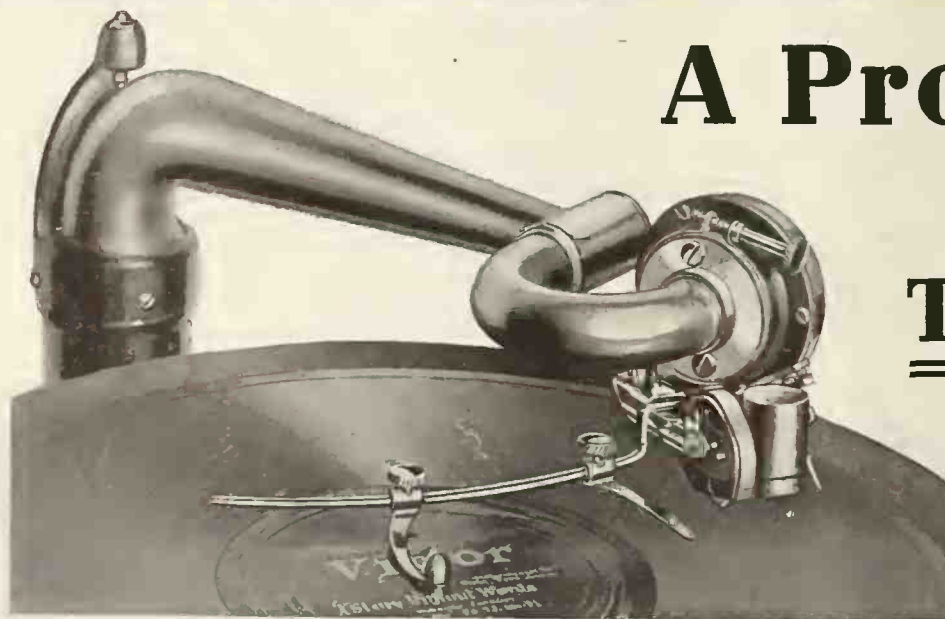

A Profit Producer

for Victor Dealers

The MYERS REPLAYER

Easy to Attach—Automatic in Operation—Practical—Dependable

Can be Attached to any Victrola. Replays the Records. Creates New Enthusiasm. Increases Sale of Records

EASY TO ATTACH: One thumb screw does it. Any child can quickly and easily attach The Myers Replayer.

AUTOMATIC: The Myers Replayer does exactly what its name implies,—replays a record without interfering in any way with the usual operation of the machine. It does not deface or injure any mechanical part or the ornamental appearance of the machine. Attaches to the tone-arm only,—and with a single thumb screw.

PRACTICAL: Once The Myers Replayer has been properly attached and adjusted, no further attention is necessary. No need to dis-assemble or remove when changing records. Instantly adjusted for non-operation without having to be removed from machine.

SAFE—CAN'T DAMAGE NEEDLES OR RECORDS: The Myers Replayer is equipped with a patented air-cushion dash-

pot which returns needle to record with the deftness and ease of the human fingers. This not only protects the needle point but also prevents the defacement of the record by scratching, marring or nicking.

PERMITS USE OF ANY LENGTH NEEDLE: Any style or length of needle can be successfully used with The Myers Replayer without special adjustment or changing height of Replayer attachment.

All parts nickel plated and highly polished to correspond with similarly finished parts of machine

Present model made only for Victor Machines. Models for other machines now under construction. Dealers are requested to watch for future announcements.

Retail price \$5.00. Quickly pays for itself in the increased pleasure it brings. Sample for dealers sent postpaid for \$3.00. Send for sample. Begin Now to Boost Your Accessory Profits.

The Myers Replayer Co., Dept 183 Toledo, Ohio, U. S. A.

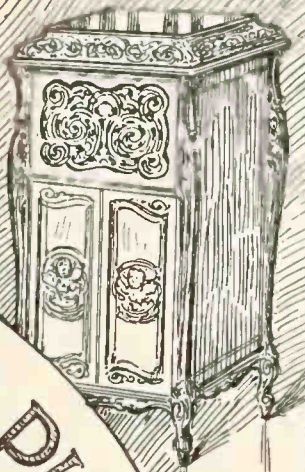
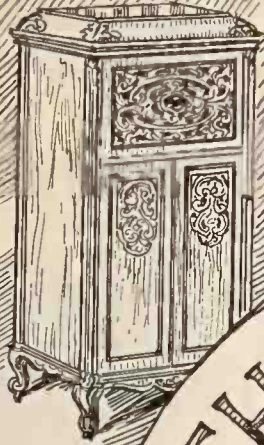

THE ORIGINAL
THE WINDSOR PHONOGRAPH
THE ARISTOCRAT.

They All
Follow the Leader

Have you noticed how many makers who formerly considered themselves leaders in the phonograph industry are now following the leadership of the Windsor Console Phonograph?

The success of the Windsor Console Phonograph seems to have inspired these makers to accord the Windsor the most sincere form of flattery.

When we decided to make phonographs we did not try to copy or imitate the cabinets of some other maker, but we originated a cabinet of our own, the Windsor Console Phonograph, patented November 9, 1915, and September 24, 1918.

The acknowledged leader of all phonographs, "The Windsor," is sold direct from the factory to the dealer, no jobber's profit to pay.

We invite progressive dealers to consider the Windsor when making their plans for the coming year.

An attractive catalogue on request to dealers only.

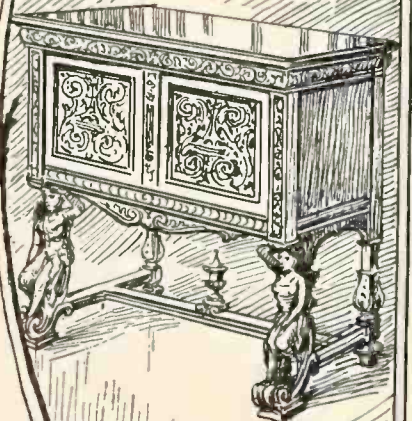
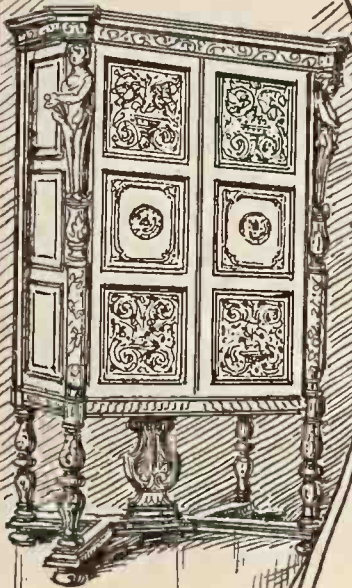

THE WINDSOR FURNITURE COMPANY,
1420. CARROLL AVE. CHICAGO, ILL.:
: ESTABLISHED 1885. :

LIST OF THE WINDSOR PHONOGRAPH CABINET PATENTS
48122 • 49655 • 50479 • 1279743 • 50480 • 50481 • 50483 •
49654 • 50478 • 50482 • 50484 •

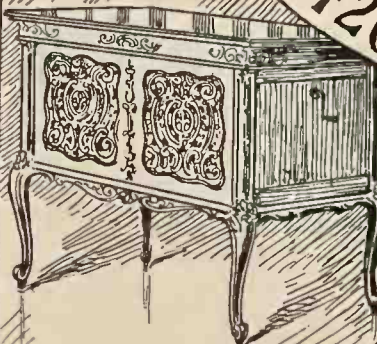

F. A. Meyersheim

DOEHLER CO.'S NEW CHICAGO PLANT

New Building About Ready for Operation Occupies 56,000 Square Feet—Wonderful Plant for the Manufacture of Die Castings

The new Chicago plant of the Doehler Die-Casting Co. is now reported in operation. The initial building of the group, occupying 56,000 square feet, with a capacity for about forty-eight machines and employing between 200 and 300 workers, is now completed. The building is a real daylight factory of saw-tooth roof construction, with every modern device to facilitate and protect the health and welfare of their employes. A well-equipped first aid room, showers, cooled water drinking fountain system, modern plumbing and syphon ventilators are some of the features included. The plant will manufacture white metal and aluminum die castings.

Some members of the Doehler organization connected with the Brooklyn and Toledo plants will sever their connection with the parent plants and compose the initial executive force of the Chicago plant.

EFFECTIVE COLUMBIA PUBLICITY

C. E. H. Whitlock Features Columbia Records in Connection With Yale Junior Prom

NEW HAVEN, CONN., March 6.—C. E. H. Whitlock, head of Whitlock's Book Store in this city, successful Columbia dealer, was responsible recently for one of the most effective and valuable sales ideas that have ever been introduced to the public by a talking machine dealer in this territory.

This sales idea was introduced in connection with the annual Yale Junior Prom, which took place in this city last week. This Prom is one of the greatest social events of the season and is attended annually by prominent members of society life from all parts of the country. It is given publicity in the leading newspapers everywhere, and among its participants each year are members of the Yale Alumni from all walks of life.

Realizing the importance and significance of this event, Mr. Whitlock, after considerable effort, completed arrangements with the chair-

ILSLEY'S GRAPHITE PHONO SPRING LUBRICANT

Ilsey's Lubricant makes the Motor make good
Is prepared in the proper consistency, will not run out, dry up, or become sticky or rancid. Remains in its original form indefinitely.
Put up in 1, 5, 10, 25 and 50-pound cans for dealers.
This lubricant is also put up in 4-ounce cans to retail at 25 cents each under the trade name of

EUREKA NOISELESS TALKING MACHINE LUBRICANT

Write for special proposition to jobbers.

ILSLEY-DOUBLEDAY & CO., 229-231 Front St., New York

man of the Prom dance committee, whereby every dance number on the program was a selection that is included in the Columbia dance library. After making these arrangements, Mr.



C. E. H. Whitlock

Whitlock used a full page advertisement in the official Prom program stating that all of the dance numbers could be secured on Columbia records and mentioning that he carried a complete stock of these records.

As a mark of their appreciation of Mr. Whitlock's progressiveness and energy, the Columbia Graphophone Co. used an effective and attractive advertisement in the leading New Haven newspapers, co-operating with Mr. Whitlock, and featuring special copy that produced excellent results for Whitlock's Book Store.

BIG WAREHOUSE FOR WHITSIT CO.

COLUMBUS, O., March 6.—Construction will soon start on a \$100,000 fireproof warehouse at Fifth and McKee streets for the Whitsit Realty Co., a subsidiary of the Perry B. Whitsit Co., wholesale dealers in talking machines. The new warehouse, which will be devoted to the storage of musical instruments, will be of reinforced concrete, three stories high.

A BOSTON INCORPORATION

The Cenola Talking Machine Co., Boston, Mass., has been incorporated with capital stock of \$50,000, by William B. Gulliver, Alfred A. Tutin and James H. Burns, all of Boston.

FAULTLESS

PIVOT BEARING

CASTERS

Casters that roll easily across the floor—and smoothly. No chatter—no unsteadiness.

Simple construction—no complicated parts to get out of order, nothing to retard easy movement. Strong—plenty of metal in required places to resist strains.

Silent—neat appearing—a real necessity to YOUR talking machine, these FAULTLESS CASTERS.



Full Size—C.65

Made with leather, fibre, felt, steel and lignum vitae wheels. A word from you puts all our caster experience at your service and brings you a copy of Faultless Catalog "G".

FAULTLESS CASTER COMPANY

EVANSVILLE, INDIANA

"Move the FAULTLESS Way"

Eastern Sales Office:

Geo. Mittleman, 487 Broadway, N. Y.

ROTTEN STONE

We are the only miners and manufacturers in this country of Rotten Stone for use in Phonograph Record making. Our product is now in use by practically every record manufacturer in this country. We are also headquarters for all other minerals for record making and everything we handle is made especially for this purpose and absolutely guaranteed. Expert advice given upon any formula.

KEYSTONE MINERALS CO.

41 Union Square, New York City

Oscar Seagle's rich baritone in "Mah Lindy Lou" and "Sorter Miss You" makes a beautiful record that many will buy. A-2875.

Columbia Graphophone Co.
NEW YORK



H. A. LAMOR WITH COLLINGS & CO.

Well-known Victor Man Joins the Forces of Newark Victor Distributors—David Roach Added to Sales Force—Business Developing

L. W. Collings, president and general manager of the Collings & Price Co., the well-known Victor distributors of Newark, N. J., has purchased the interests of the late Malcolm Price and hereafter this company, as



L. W. Collings

briefly referred to in The World last month, will be known as Collings & Co.

In order to further extend their service to their dealers, they have been adding to the executive staff a number of very prominent men in the talking machine trade. Only recently they announced the appointment of John L. Spillane in charge of their record department, and now we learn that H. A. Lamor will head the traveling department of this company. Mr. Lamor was formerly the east of Pittsburgh Victor representative and by reason of his wide knowledge of the industry, both in the factory and on the road, is in a position to lend valuable aid to those with whom he does business. Some very original plans are already being developed which will be put into force, by the executive of the traveling department, of which more later.

Another well-known talking machine man who recently joined the sales force of Collings & Co. is David Roach, formerly associated with one of the leading talking machine companies. He joined the above organization in the capacity of outside salesman and will call regularly on the trade in the vicinity of Newark.

W. R. Long, who recently assumed charge of the Columbia Grafonola department of the Will A. Watkin Co., Dallas, Tex., reports that the business of his department has already shown a very satisfactory increase.

The Pathé is now being handled in Norwalk, O., in the retail store of the A. B. Chase Piano Co., in charge of E. J. Fishbaugh, manager.

DENVER MUSIC CO. NOT TO RETIRE

Old Colorado Music House Will Not Be Exclusively a Talking Machine Store—Same Policy to Be Followed as in the Past

DENVER, COL., March 1.—The Denver Music Co. is not going to be exclusively a talking machine store as was announced some time ago. When the announcement was first made it was the intention of some of the members of the firm to retire from business and those who were to remain thought that it would be best to discontinue the line of pianos and other instruments and devote their energies entirely to the retailing of talking machines. However, after some consideration, it was decided that all kinds of musical instruments should be carried in a music store and the business should be conducted as formerly.

E. A. Cox, who has been in the music business for the past twenty-six years in this city and Chicago, has been chosen president; F. R. Flannigan, for four years a member of the Denver Music Co, is vice-president; John C. Kraus becomes secretary and treasurer. Mr. Cox will really serve in the capacity of general manager, and has announced that no change will be made in any department policy, for the talking machine department as well as the piano department in future will remain the same as before.

MADE KNIGHT-CAMPBELL MANAGER

Darius Allen Advanced to Position of Manager of Colorado Springs Branch Store

COLORADO SPRINGS, COL., March 3.—Darius Allen, a prominent young business man of this city and for the past year assistant manager of the Knight-Campbell Music Co. branch here, has been promoted to the post of manager to succeed J. Hugh Cooley, who has held that position for the past six years. Mr. Cooley leaves the music trade and will enter the automobile business in Spokane, Wash. Mr. Allen was with the local branch before the war and during his service with the military forces won a captaincy overseas, returning last summer to resume his duties. He has made a thorough study of the requirements of the trade and has earned an excellent reputation in his chosen field.

MUSIC CONTEST IN LOUISVILLE

A music contest very similar to the "Music Memory Contests" with which the trade is already familiar has been worked out by Carl Dorr, of the J. L. Riehn Piano Co. of Louisville, Ky. According to Mr. Dorr's plan, 100 standard pieces of music are played for children in the public schools, each piece being explained by a short talk.

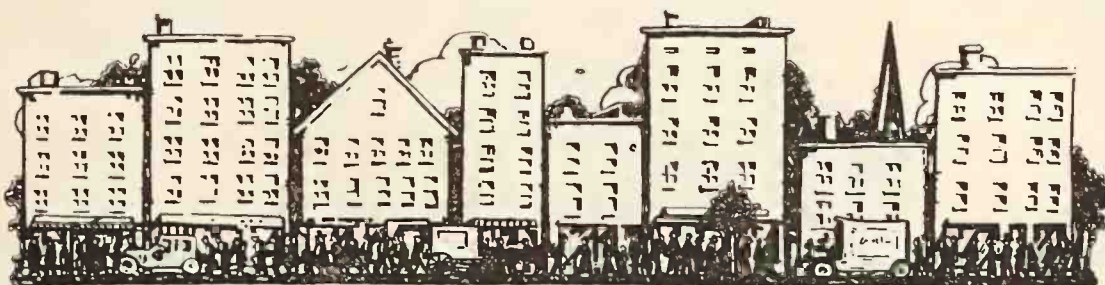

Follow Through!

The music trade is spending a King's ransom in national advertising which is made doubly effective when it is "hooked-up" with the dealers through window advertising. Ask *your* manufacturer about the importance of window display.

EINSON LITHO
INCORPORATED

NEW YORK Originators of Window Advertising for CHICAGO
71 W. 23rd St. Phonograph and Player Roll Manufacturers 332 S. Michigan Ave.

The New Model "E" Garford Phonograph

The Greatest Value on the Market

Immediate Deliveries in Any Quantity.

*High in
Quality
Low in
Price*



*High in
Quality
Low in
Price*

New Model "E" Garford Phonograph

The New Model "E" Garford Phonograph has every desirable feature of the high price phonograph.

- 1 Plays all makes of records without an attachment.
- 2 Superior Tone Quality.
- 3 Standard Motor of Recognized Merit.
- 4 Artistic Appearance.
- 5 Guaranteed to give Excellent Service.

Order Now For Immediate Delivery

Sells like "Wild-Fire" the Year Round

We have an Attractive Dealer Proposition

The General Phonograph Mfg. Co.

(FORMERLY NAMED THE GARFORD MFG. CO.)

ELYRIA, OHIO

DEALERS FORM A CONCERT BUREAU

Victor Retailers of Central New York Organize Capitol Concert Bureau to Bring Noted Record Artists to That Locality

ALBANY, N. Y., February 28.—There has been recently organized and incorporated in this city the Capitol Concert Bureau, an organization unique in character made up entirely of talking machine dealers of central New York and designed to arouse and keep alive musical interest in that district in a manner calculated to prove of direct benefit to Victor dealers.

The president of the Capitol Concert Bureau is Louis H. Schutter, of Albany; the vice-president is James S. Gray, prominent piano manufacturer and talking machine dealer of this city; the secretary is Albert Edelstein, manager of the Strand Talking Machine Shop, which recently took over the retail business of the Gately-Haire Co. The members include R. F. Heidner, Holyoke, Mass.; Harry Meyers, Pittsfield, Mass.; Thomas C. Connolly, Rensselaer, N. Y.; William Kempf, Utica, N. Y.; Louis H. Schutter, Albany, N. Y.; James S. Gray, Albany, N. Y.; Edward C. Dorwaldt, Jr., Albany, N. Y.; Albert Edelstein, Albany, N. Y.; George A. Cassedy, Schenectady, N. Y.; Mrs. William T. Morrison, Amsterdam, N. Y.; Conrad L. Peltier, Gloversville, N. Y.; Mannie Feldman, Little Falls, N. Y.; Edwin Moak, Utica, N. Y.; Alexander Williamson, Binghamton, N. Y.; M. Doyle Marks, Elmira, N. Y.; Frank H. Burdick, Troy, N. Y.; Royal Braydon, Glens Falls, N. Y.; Henry Phillips, Whitehall, N. Y.; N. M. Bradley, Rutland, Vt.; William Finley, Hudson, N. Y.; C. A. Winter, Kingston, N. Y.; Albert

Wood, Pittsfield, Mass.; Paul R. Burt, Greenfield, Mass.; James B. Towne, Saratoga Springs, N. Y., and Roy M. Peltier, Cohoes, N. Y.

The object of the Bureau is to present musical events of interest in the cities and towns of Central New York and in the neighboring section of Massachusetts. It is planned to bring prominent record artists to the different cities and to advertise and otherwise exploit their appearance in a big way, emphasizing the fact that their records may be found in the catalog of the Victor Co.

SCHMELZER ARMS VICTOR SCHOOL

Kansas City Victor Distributors to Have Salesmanship School in New Home

KANSAS CITY, Mo., March 2.—The Schmelzer Arms Co., Victor distributors, who will occupy a handsome new home on Grand avenue some time this Spring, will establish a Victor salesmanship school along the lines found so successful by the Victor Co. in its school at Camden, N. J. In conducting this department it is hoped to have men and women who are experts in exploiting all phases of the Victor business.

WM. A. PENN TENDERS RESIGNATION

Wm. A. Penn, who for the past four years has been director of the recording department of the Pathé Frères Phonograph Co., recently tendered his resignation, and after a brief season of rest and a much needed vacation intends to enter the same field of endeavor in an important capacity, of which he will announce details later.

STORE COURTESY A BIG FACTOR

Manager of Day Drug Co. Says It Helps to Build Up Good Business—Co-operative Advertising Used to Feature Columbia Line

The Day Drug Co., Akron, O., is carrying on an active publicity campaign, using some of the attractive advertisements furnished by the Columbia Co. James M. Ervin, manager of the Grafonola department, is enthusiastic over the way his Columbia business is developing and lays much stress on store courtesy as a factor in building up a substantial trade. In speaking on this point he said: "When people get older they learn a lot of things they did not know in their youth. One of them is courtesy. This is also true of drug stores. The Day Drug Co. has been twenty years learning. That is why people like to trade with it."

REPORTS SATISFACTORY CONDITIONS

Max Willinger, president of the New York Album & Card Co., has just returned from Chicago, where he reports conditions in the Chicago factory of the company as in first-class shape. Production has been considerably increased and the point has been reached where prompt deliveries are possible.

HARTFORD MEN HONOR EDISON

Members of the Brown-Howland Co., Hartford, Conn., were among the many who honored Thomas A. Edison on his recent birthday. Each member of the company wore the Edison button made especially for the occasion.

The Motrola

will be backed up with a big National Advertising Campaign during 1920

Ask your jobber to tell you all about the *big profits* other dealers are receiving through the sale of the Motrola, or drop us a line direct and give the name of your jobber.

JONES-MOTROLA, Inc.

29 West 35th Street
New York City



Worth Its W and It Weighs

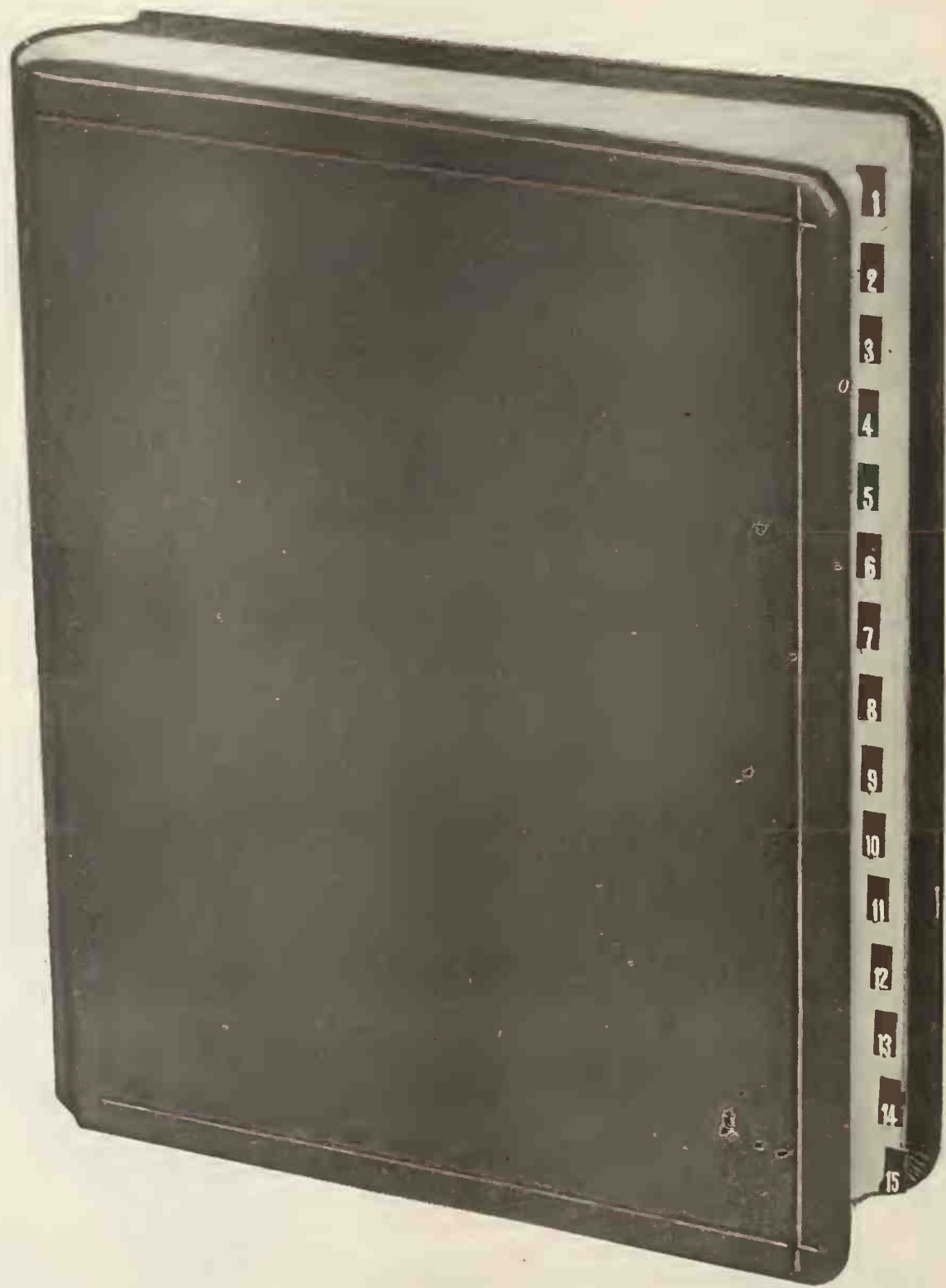

eight In Gold Fifteen Pounds!

To Every Edison Dealer:

The mammoth portfolio reproduced on the page opposite is the book of knowledge, the encyclopædia of facts, the *modus operandi* for increasing your business.

Every Edison jobber, the best advertising men we could find and the entire Edison Sales and Advertising personnel have been working on this book for the past three months.

We have been told that our 1920 Sales Promotion Plans are the most comprehensive ever undertaken by any manufacturer. To lay these plans before you necessitated this portfolio.

Your jobber's salesman has a copy of this book and will be glad to show it to you.

THOMAS A. EDISON, Inc.

Orange, New Jersey

SALESMANSHIP SCHOOL A SUCCESS

Several Classes Instructed in the Art of Selling Victor Machines and Records in the School Established by Mickel Bros. Co.

DES MOINES, IA., February 28.—One of the features of the Mickel Bros. Co. service to its dealers that have proven particularly successful during the past couple of months has been the school of Victor salesmanship which was estab-

lished by that company in this city early in November. The opening of the school had been duly announced, and the result was the sessions opened with full classes and enough enrollments to provide the basis for a second-class.



Where Classes in Salesmanship Are Held at Mickel Bros. Co.

lished by that company in this city early in November. The opening of the school had been duly announced, and the result was the sessions opened with full classes and enough enrollments to provide the basis for a second-class.

The school is under the supervision of Miss Mayme Jardine who, with her broad experience in retailing Victor goods in Omaha and the knowledge she received at the Victor Red

Seal School in Camden, is thoroughly competent to carry on the work. The course of study includes the following subjects: Store department, meeting the trade, how to acquire a knowledge of records, how to present records to customers, Victrola salesmanship, selling Red Seal records systematically and others of equal importance.

The school has been held on the third floor of the Mickel Building at 411 Court avenue, which was entirely remodeled for the purpose.

In connection with the school there has been installed a service room, in which has been placed all the advertising matter pertaining to Victor products. There has also been installed a complete Unico system, including booths, racks, record counters, etc., for instruction purposes. Practically two score salesmen and saleswomen from all sections of the State have taken advantage of the opportunity to improve

their knowledge of salesmanship by attending the school.

In speaking of the success of the venture, one of the officers of the company said:

"The classes have been a wonderful success; in fact, greater than we had ever anticipated. This is very evident from the complimentary letters received from every dealer who attended or who sent his salesman or saleswoman. The instruction has given them a bigger and broader vision of the Victor line, inspired them with a larger conception of the Victor possibilities and made each one an enthusiastic Victor booster, naturally increasing their efficiency and value to the employer. From the dealers' testimony the Mickel School of Victor Salesmanship has done more for Victor prestige in the State of Iowa than anything we have ever undertaken."

PATHE EXHIBIT AT GIMBEL'S

Handsome Display Shown in Special Room at New York Store Attracts Attention

The exhibit made by the Pathé Frères Phonograph Co. at the National Music Show was recently set up in a special room in the large talking machine department of Gimbel Bros. New York store. The various models of the Pathé line together with the regular and period models of the Actuelle were exhibited, as were the pictures of Pathé record artists, which graced the walls of the exhibit at the Grand Central Palace. The Gimbel store has had very gratifying results with the Pathé line in the short time in which it has been carried and the exhibit drew large numbers of visitors.

PROMINENT LUMBERMAN DIES

In the death of Alfred Struck, of the Prestonia Mfg. Co., Louisville, Ky., the trade loses a prominent lumberman and talking machine cabinet manufacturer. His death was due to pneumonia. His son, Charles Struck, will take over the affairs of his father's business.

Emerson Hits Hitting Hard In Western Pennsylvania

Folks living in Erie, Warren and Oil City like to hear the newest songs, the latest dance hits.

They buy Emerson Records because Emerson is first to bring out the new hits that every one is humming and whistling.

Our job is to see that the dealers in these and other Western Pennsylvania cities are

supplied with the new Emerson hits—as they come out.

To that end, we carry a complete line of Emerson hits, and make a point of filling orders the same day they are received.

Let us give you a dollars-and-cents demonstration on the advantages of being an Emerson dealer. Write today.



Emerson Sales Company

4018 JENKINS ARCADE BUILDING
PITTSBURGH, PA.

A RECORD-FLASHER

REG U S PAT OFF

Should Be On Every TALKING MACHINE



AT LAST

A NEW LIGHT that will apply to every make of talking machine in the world.

It is reliable, easily applied, and will give perfect satisfaction.

Beautifully finished in nickel and gold.

Both lights and batteries are fully guaranteed.

Low in price, within reach of every talking machine owner or buyer.

Big discounts to dealers. Write your jobber or direct to us for descriptive circulars outlining our selling and advertising campaign.

RETAIL PRICES

Nickel Finish	\$2.25
Gold Finish	3.00
Special RECORD-FLASHER Battery75



ENTIRELY NEW PROPOSITION



Angular

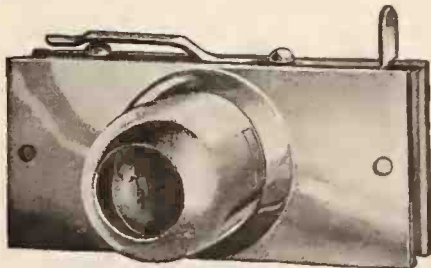

Vertical

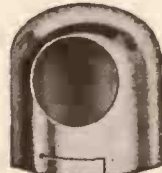

Horizontal

Each package complete as illustrated above



STANDARD ACCESSORY CORPORATION

355-357 East Water Street

MANUFACTURERS
and
PATENTEES

Milwaukee Wisconsin U.S.A.



"Dear Little Boy of Mine" in Stracciari's splendid baritone will break many sales records. Columbia 78686.

**Columbia Graphophone Co.
NEW YORK**

BI-PARTISAN RECORDS NOW READY

Nation's Forum Records Will Be Merchandised Through Columbia Dealers Exclusively—Attractive Window Display Prepared for Trade

The dealer service department of the Columbia Graphophone Co. has mailed to Columbia dealers an interesting sixteen-page pamphlet entitled, "Mobilizing Phonographs for the Presidential Campaign." This publication,

important in view of the coming presidential campaign.

Every Columbia dealer subscribing to the regular Columbia window display service has received a very attractive window card announcement of the Nation's Forum records. Columbia branches have been furnished with a large supply of these display cards, which are at the disposal of all Columbia dealers. Some idea of the attractiveness of this display may be gleaned from the accompanying illustration.



Nation's Forum Window Display

which was prepared by the Nation's Forum, New York, describes in detail a monthly service of publicity news records which will carry the living voices of presidential candidates and other prominent public officials into homes, clubs and meetings. The records, which will be bi-partisan, will be merchandised exclusively through Columbia dealers and are particularly

On either side of the center display are facsimile reproductions of the first records in this important series, consisting of timely and informative messages by Henry Cabot Lodge, Republican leader of the U. S. Senate, and William G. McAdoo, former Secretary of the Treasury, and possible Democratic presidential nominee.

It is planned to issue two records each month, one record being a message from a prominent Republican and the other from a prominent Democrat. The list of speakers scheduled for this record library comprises the leaders in both parties and an extensive advertising campaign featuring these records is now in course of preparation. It is expected that these records will prove very popular if results may be forecast from a recent demonstration held at one of the clubs in New York City.

The Vitanola agency in Steamboat Springs, Col., has been taken by the Chamberlain-Gray Drug Co.

AEROPLANE DELIVERY A SUCCESS

E. H. Jones Piano Co. Closing Contracts With Many Vitanola Dealers for Aeroplane Delivery—A Unique Advertising Idea

DES MOINES, IA., March 5.—The E. H. Jones Piano Co., of this city, distributors of Vitanola phonographs, has closed contracts with practically all of its dealers providing for the aeroplane delivery of Vitanola phonographs. This unique sales and advertising plan, which was evolved last Fall by DeWitt Jones, president of the company, has attracted countrywide attention.

The E. H. Jones Piano Co. has contracted for a State advertising campaign through the medium of the aeroplane service connected with the Herring Motor Co., of this city. As an advertising novelty the E. H. Jones Piano Co. delivered a Vitanola phonograph by aeroplane, and this unusual method of delivering the instrument has produced invaluable publicity for the Vitanola dealer. Many of the Vitanola representatives who have tried out the plan for a single delivery are repeating it several times, advising the E. H. Jones Piano Co. that the proposition is a profitable one from every standpoint.

ISSUE BOOKLET ON ARROW RECORDS

CLEVELAND, O., March 5.—The Arrow Phonograph Corp., of this city (formerly the Liberty Phonograph Co.) is mailing to its dealers an interesting folder giving details of the company's merchandising plans and policies. The first list of records has been favorably received by the trade, and it is now a question of quantity production. Referring to the technical manufacture of Arrow records, this folder stated in part: "Arrow records are made with a lateral groove formed in an entirely new manner, carrying the most minute sound qualities to an exceptional degree of accuracy."

S
SERVICE

S
SELLS

S
SERVICE

OKeh HITS a Combination Hard to Beat

YELLOW DOG BLUES ————— **The Great Big "Hit"** ————— **4061**

- | | | | | | | | |
|------|---|-------------------------------|------------|------|---|-----------------------------|----------|
| 4060 | { | Bo-La-Bo..... | Fox-Trot | 4058 | { | Ching-A-Ling..... | One-Step |
| | | When You're Alone..... | One-Step | | | A La Carte..... | One-Step |
| 4067 | { | Pickaninny Blues..... | Vocal Trio | 4066 | { | Little Girls, Good-Bye..... | Vocal |
| | | When Two Hearts Discover..... | Duet | | | Just Like the Rose..... | Vocal |

Exceptional facilities for New York, New Jersey and Connecticut dealers to get the livest Record Proposition in the trade

Phone Barclay 5728
for Service

ZIEGLER, BAKER & JOHNSON

100 Chambers Street
New York City

Brunswick



LEOPOLD GODOWSKY
Premier Pianist



DOROTHY JARDON
Prima Donna Soprano
Chicago Opera Company



ARCHER CHAMLEE
Tenor

Destined to win

WHEN the House of Brunswick sets out to do a thing, all are certain that it will be done well.

No expense will be spared — nothing left undone. You all know what these resources mean when you contemplate the phenomenal success of the Brunswick Phonograph.

And so it should point a lesson in regard to Brunswick Records, now commencing to be advertised to the public.

It means that Brunswick Records are *right* in principle and that they bring superiorities.

It means that Brunswick would never be satisfied with the common or the mediocre.

And the result will be a positive success. Every Brunswick dealer will reap new profits.

To be widely advertised

An appropriation for advertising Brunswick Records has been made. The first page appears in The Saturday Evening Post. Then begins a continuous campaign of education.

We will offer the masterpieces of famous artists, such as pictured here. Together with all such numbers as are necessary to make a complete and wanted list.

Throughout the land, music lovers will come to know and appreciate the selections we offer, and their superior reproduction.

Thus we bring to the Brunswick Phonograph its inevitable team-mate, Brunswick Records.

Thus we offer again something that is distinctly better. And to prove it, we are asking the American people to hear and compare.

In our story to the public, we state that it is again the privilege of the House of Brunswick to bring to music lovers another innovation, another advancement in the art of phonography—

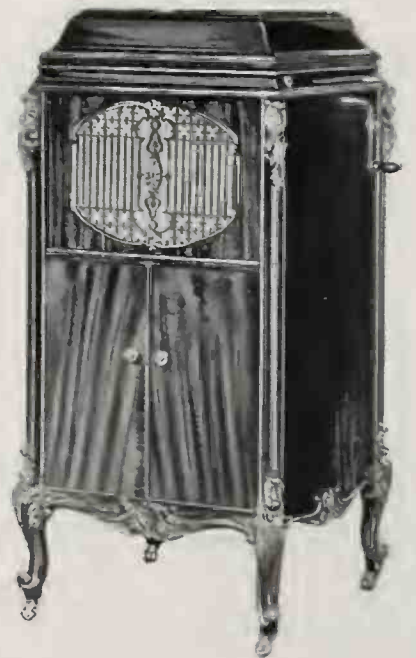

Brunswick

Records

universal applause

— one as advanced as those revolutionary ideas introduced in the Brunswick Phonograph four years ago.

Thus we fulfill our great ambition to bring something better, something superior into the making of records.

What we mean by "Individuality graven into them"

We bring not only world-famous artists with their individual interpretations — not only the historic masterpieces of music, but in addition that third factor — direction of concerted selections.

Some will venture that this is nothing new. Nor is it, as an idea. It is the fulfillment of the idea, the actual laboratory practice, that makes it real or fiction.

We have long felt that in concerted numbers there was much to be accomplished. Too frequently the members of an orchestra, for instance, played as individuals. Master direction was too rare.

This we have insisted on avoiding. Our first interest in all but solo numbers has been to attain the utmost from sympathetic direction.

Hence we bring to ensemble numbers a finer spirit, a new and added charm.

The method is difficult to explain. But the result is obvious. To tell the public too much about the mechanics of recording robs music of its spiritual flavor.

So again, in advertising Brunswick Records, we ask people to hear and compare. We abide by the decision of music-lovers, people who know and appreciate betterments.

We invite the trade to watch Brunswick developments and to note the success of Brunswick Records.



The Brunswick-Balke-Collender Company

General Offices:
623-633 South Wabash Avenue, Chicago

Branch Houses in Principal Cities of
United States, Mexico and Canada

Canadian Distributors:
Musical Merchandise Sales Co.
819 Yonge St., Toronto



MAX ROSEN
Violinist



IRENE PAVLOSKA
Mezzo-Soprano
Chicago Opera Company



THEO KARLE
Tenor

Phonographs



MAKE EXHIBIT AT TOY SHOW

Homer Stephens in Charge of Display of Garford Phonographs—Booked Large Orders

The General Phonograph Mfg. Co., Elyria, O., formerly named the Garford Mfg. Co., conducted a very attractive exhibit at the annual Toy Show, which was held at the Hotel Imperial, and which closed on Saturday. Homer Stephens, sales manager of the company, was in charge of this exhibit, and a number of large orders, including several export orders, were closed as a direct result of the exhibit.

Among the instruments on display at the company's booth were the popular Model E Garford phonograph, which has achieved international success, and two toy phonographs, retailing at \$10 and \$6. These toy phonographs were ordered in large quantities by buyers representing well-known houses, and judging from the comments of these purchasers the demand for toy phonographs is constantly increasing.

At the annual meeting of the American Toy Exhibitors' Association Mr. Stephens was re-elected president of the organization. During the past year Mr. Stephens occupied this post and his work in behalf of the association well merited his re-election as president.

INTRODUCING THE "REED-ER"

PITTSBURGH, Pa., March 6.—The Reed Co. of this city, manufacturer of Reed demonstrating booths, record racks and efficiency counters, and distributor of Regina phonographs and Operaphone records, has just issued an attractive house organ named the "Reed-er." According to the editor, this publication is "edited by the Reed-man and published monthly in the interest of Reed dealers." Its chief purpose is to tell important things, but it aims not to be too strenuous.

The first three numbers of this newsy house organ have been enthusiastically received by the Reed Co.'s dealers, who are pleased with the informal contents of the publication and the various practical ideas featured in the news columns. Each issue contains a page devoted to personal items, and a semi-humorous column emphasizes the thought that good-fellowship and informality are important factors in the compilation of the "Reed-er."

INCREASE BOOTH EQUIPMENT

The Silver Grafonola Shop, 22 Delancey street, New York, successor to the Marconi Phonograph Co., has recently increased its demonstration booths from six to ten—all of which are necessary to meet the demands of this business which has been steadily expanding. This concern is now under the able management of J. Morris, assisted by I. A. Silver, who report very excellent business in Victor and Columbia machines and records.

Mr. Gunst, of the Gunst Piano Co., was almost entirely cleaned out by the great hurricane that swept through Corpus Christi, Texas. He related a strange incident that occurred while the storm was at its height. A party who had been rescued in a boat saw a wrecked house floating along, with broken furniture scattered about. In the center of the wreckage stood a Victrola, apparently intact.

DEFENDERS FOR "CANNED MUSIC"

Number of Newspapers Take Occasion to Call Editorial Attention to Usefulness of Art

A number of newspapers in New York State and New England have recently taken up the cudgels editorially in behalf of talking machine music. The thought back of all the editorials is practically the same and the article reproduced herewith, from the Niagara Falls, N. Y., Gazette, is a fair sample.

"In our more or less witty slang, the product of the phonograph is frequently referred to as 'canned music.' The phrase is commonly used disparagingly. But 'canning' is one of the most useful arts that civilization has developed and it takes one of its highest forms in the mechanism of the phonograph.

"A leisure half hour might be spent pleasantly and not unprofitably in recalling some of the uses of 'canning.' Of course fruits and vegetables are conserved in that way for future use

and the shelves in the grocery and the rubbish piles in the alley tell eloquently of service to men along that line.

"But very many of the things that make life worth while are 'canned' products that would not otherwise have been available. Books are the 'canned' wisdom or foolishness of the ages. Without this 'canned' process the wisdom of Solomon would have died on the eastern winds and Shakespeare and Longfellow and Mahon and Bancroft and all scientists and seers and singers would have died with their own generations."

BUYS VICTROLAS FOR SCHOOLS

The Oldendorf Music House, Mt. Carmel, Ill., has again sold a Victrola to the schools of that city and now the Berry School is the possessor of one of these instruments. The machine was purchased through the efforts of the parent-teachers' association, which is taking an active part in the school music work.



FEDERAL ELECTRIC SIGN

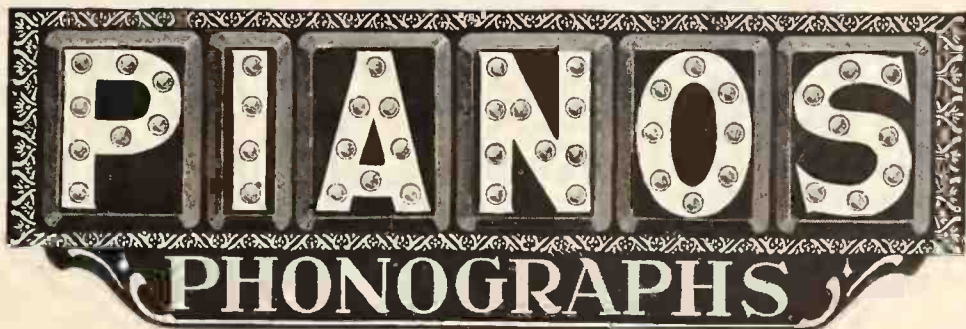

-12 Months to Pay

The first payment brings you the sign—and you have the 12 months to complete the payments. Pays for itself many times over.

—A Permanent Fixture That Soon Pays for Itself, Many Times Over



Everyone who passes within blocks of your store is a prospective customer. If you put your name and business before the public, you may expect them to buy. But the store that is lost in darkness loses many a sale and also much prestige with the people of the community. Electric sign advertising is indispensable to every merchant. It carries your message day and night, attracting the attention of people from blocks around. It gives a timely suggestion to the prospective customer that here is a store ready to take care of his needs. And a timely suggestion brings many a sale. But it pays to invest in a sign that will be a permanent fixture in front of your store. This Federal Electric Sign is made of porcelain-enameled steel, will not rust, decay or fade—never needs refinishing. An occasional washing keeps it sparkling like new. Costs but a few cents a day for electricity—no other expense. It is strongly legible both day and night from a distance in either direction. It will last a lifetime and will pay for itself many times over in increased business.

Send the coupon to-day for full information—no obligation.

Tear Off and Mail Coupon Now

FEDERAL ELECTRIC COMPANY

representing Federal Sign System (Electric)

Lake and Desplaines Streets, Chicago, Ill.

Please send me full information on Porcelain-enameled Steel Sign for my business. Explain your 12-months-to-pay Plan.

NameCity State

Street and No.Business

Store FrontageNo. of Floors

T. M. W.-3



New Automatic Cover Support

Practical—Inexpensive
Fool Proof

Made in two different styles
No. 1 Fit Cover at any angle
No. 2 Hinge Plate bent to Fit Cover

Samples on Request
Quantity Discount

AUTOMATIC COVER SUPPORT MFG. CO.
77-81 MILL STREET BLOOMFIELD, N. J.



INACCURATE TERMS AND COMPARATIVE PRICES DECRIED

Richard H. Lee, Special Counsel for Associated Advertising Clubs of the World, Condemns Use of Misleading Terms and Comparative Prices in Address on Truth in Advertising

Decrying the use of comparative price advertising and warning against deceptive trade terms, Richard H. Lee, Special Counsel of the Associated Advertising Clubs, in an address before the convention of the National Retail Dry Goods Association in New York, recently, urged the elimination of practices which undermine confidence in advertising and business and jeopardize the good will of a retail store. Mr. Lee, who has in the past made some forceful addresses before the piano men, said, in part:

"One of the enigmas to me in present-day business life is the careless way in which business houses treat their greatest asset, their own good name. You insure your building; you insure your stock; you bond your employees; you even insure your accounts; you protect yourself as to all of these tangible assets; yet any of them could be replaced in the open market.

But what are you doing to protect your own good name—the biggest asset in any business?

"In my opinion one of the most destructive influences in retail merchandising is the use of comparative prices and comparative values—\$125 Suits, \$79.50; worth \$50, our price, \$37.50, etc. Comparative values are fraudulent on their face. They bespeak a fact which is nothing more or less than the opinion of the merchant. And comparative prices involve changes in season's styles and other matters which are very apt to create dissatisfaction with the customer. But the real evil which lies in both of these practices is the avenue you open for the use of your illegitimate competitor. Assuming that you are perfectly honest, that your comparative prices are fair, and that your comparative values are based on your best judgment, you must realize that your competitor, who thinks

IN THE
HANDY
CAN



NYOIL

FOR YOUR
PHONOGRAPH

**Made in Our
Watch Oil
DEPARTMENT**

which for half a century
has made 80% of all the
watch, clock and chronom-
eter oil used in America.

The Best Oil For Any Talking Machine

In refining, Nyoil is given the same care as our famous watch oil receives. All gums and impurities are removed, leaving it

Colorless, Odorless and Stainless.

Housekeepers say they would not be without Nyoil because it is best for phonographs and sewing machines—for polishing furniture and woodwork and is odorless and will not stain. It is free from acid and will not gum, chill or become rancid. Sportsmen find it best for guns because it prevents rust.

NYOIL is put up in 1-oz., 3/4-oz. and 8-oz. Bottles and in Quart and Gallon Cans.

**For Sale by all Talking Machine Supplies Dealers
WILLIA F. NYE, New Bedford, Mass., U.S.A.**

less of the future of his business than you do of yours, has thrown open to him a field, apparently legitimized by you, in which he has no limits. It only takes a pencil to send his former sales price up and his present sales price down, and while I would concede that this is a practice which will eventually relieve you of his competition, you must admit that it is confidence-destroying in character and that the shopper who loses confidence in his advertising is very apt to lose confidence in all advertising.

"The farseeing and successful merchant to-day believes in pyramiding on his advertising investment. He looks forward to the day when his institution will be so well advertised as to begin to advertise itself. Advertising is but a means of contact with the public. It is a method of bringing the public into your place of business. Any merchant can pyramid on his advertising by taking just as great pains in satisfying a customer as he does to get a customer into the store. The satisfied customer is an advertising asset. A dissatisfied customer is a heavy liability. Where pains are taken to satisfy the customer, the strength of your advertising is pyramided. The merchant who depends on his copy to get a new crowd into the store each day is playing long on a falling market. It should be the aim of every business man who expects to stay in business to so firmly establish his own good name that his business house becomes an institution. When he can get the public to saying that his place of business is a safe one in which to shop, he has established an advertising value which will go on and on and continue to pour dollars into the till long after he ceases to use the printed word.

"That kind of a reputation cannot be built on a foundation of deception. The merchant who advertises a bargain which he cannot produce when the customer calls has created a handicap which he must overcome if he desires to stay in the good graces of that particular individual. It is far better for any institution to lose a sale than the good-will of a possible customer."

J. Vernon Davis, prominent in business in Spokane, Wash., has been selected to take charge of the phonograph department of the Simon Piano Co., that city. Mr. Davis has been with the company since last spring and has given special attention to the development of the talking machine business.

SEND FOR ILLUSTRATED PRICE LIST
AND FREE SAMPLE

"GLOBE" TRANSFER NAME PLATES

DEALERS EVERYWHERE APPLY THEM
ON PHONOGRAPHS, PIANOS, ETC.

GLOBE DECALCOMANIE CO.

JERSEY CITY, N. J.

Okeh Records



We are direct factory distributors for these new lateral cut records and our dealer plan is unusually attractive.

Okeh Records

are a quality proposition and they feature timely vocal and dance hits.

*Write us for catalogs
and sample records*

Stoffer & Stackhouse Co., Inc.
Bourbon, Ind.

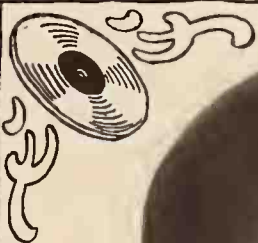

The Phonograph Salesman

SAYS:

“It’s my job to sell Talking Machines, and I want to tell you that the machines equipped with the best motors are the easiest to sell. That’s why it is easy to sell Phonographs equipped with the New Enclosed KRASCO Motors.” And he’s right.

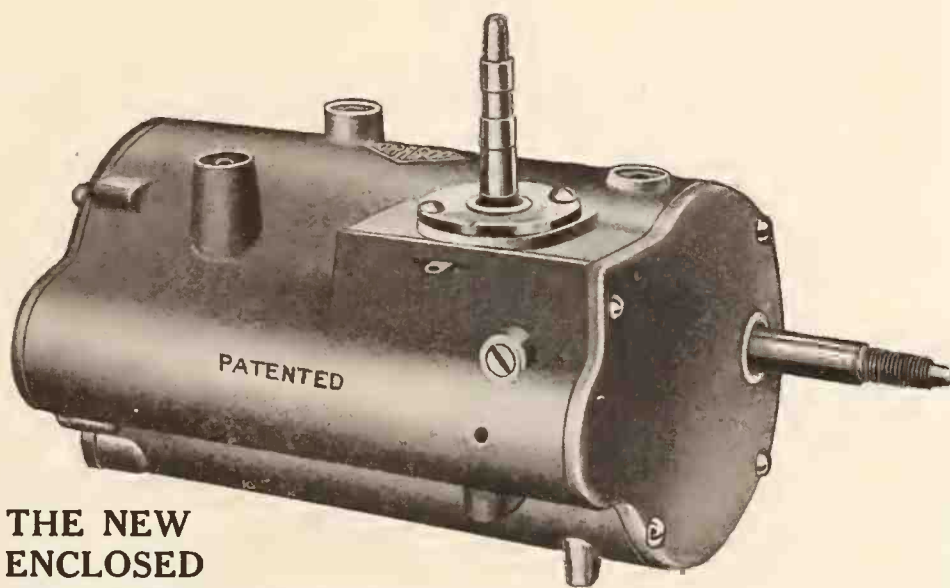

Send for Literature on KRASCO open and Enclosed Motors Sterling Reproducers and Tone Arms.

THE NEW ENCLOSED KRASCO MOTOR— THE SENSATION OF THE NEW YORK SHOW

Krasberg Engineering & Manufacturing Corporation

536 Lake Shore Drive

Chicago Illinois U.S.A.

Krasberg



Announcement

We have opened offices and show rooms with
warehouse facilities in

THE BUSH TERMINAL BUILDING

130 WEST 42nd STREET

NEW YORK

showing L'ARTISTE PHONOGRAPHS in
regular and console models of unusual merit,
unequaled in tone, finish and design.

You are cordially invited to call.

Prompt and courteous service.

Good territory now open.

THE PHILADELPHIA SHOW CASE CO.

Main Office:

127 NORTH 13th STREET

PHILADELPHIA, PA.

New York Office
THE BUSH TERMINAL BUILDING
Room 845

Pittsburgh Office
JENKINS ARCADE BUILDING
Pittsburgh, Pa.

FIGHT MAIL ORDER COMPETITION ON ITS OWN GROUNDS

Practices of a Chicago Mail Order House Featuring Phonographs Formed the Basis of a Discussion at a Recent Gathering of the National Association of Retail Secretaries in New York

That the best way to meet mail order competition is by comparative prices and by the stores themselves doing a mail order business was the opinion generally held in a discussion of that subject at the session of the National Association of Retail Secretaries, held recently at the Hotel Pennsylvania, New York.

The country-wide campaign which was put on last Fall by one of Chicago's prominent mail order houses was discussed, and the secretaries expressed themselves on the way in which this competition had been met in individual cities—a matter of direct interest to talking machine dealers.

One of the important items which had been offered by this Chicago mail order house had been phonographs. T. M. B. Hicks, secretary of the Association, said that at Boston they had not tried to have the newspapers suppress the advertisements, but that the dealers had gone ahead to meet the competition. He stated that in a Boston warehouse at the present time there were over 3,000 machines that had been returned by the purchasers as being defective and unsatisfactory.

The opinion in Boston had been, Mr. Hicks stated, that unless the local retailers could sell phonographs as cheaply as a mail order house could from Chicago they had no right to be in business. He advised meeting mail order competition on its own level and not trying to circumvent it by other means.

Newspapers Refuse Advertisements

In speaking of this same series of advertisements, President K. F. Niemoeller said that in St. Louis they had pointed out to the newspapers that these advertisements were inimical to the retailers' interests, and that the press had refused to accept more of the ads. Particularly was this so, he said, since the department stores of St. Louis had been greatly restricted as to advertising space, and to allow a mail order house to dominate with full pages would have been manifestly unfair.

A. Jacobsen, of South Bend, Ind., said that the merchants of his city were getting out a catalog which was about half the size of the catalog issued by the Chicago mail order house, and which would compete with them in prices.

E. M. Trowern, of the Merchants' Association of Canada, told of how they intended to curtail the activity of mail order houses. Catalogs are

carried in the Dominion by the post office at a cheap rate, he said, and, as a matter of fact, it costs the people about \$2,000,000 a year to do this, which must be raised from other sources.

Legislation is to be proposed before the legislative body of the Dominion, he said, which will make the mail order people pay the actual cost of this distribution of catalogs. He gave further information on how mail order business is conducted in Canada by the statement that a customer cannot take a catalog and go to the home office of the concern and buy at the prices stated. In other words, the catalog prices are special prices. The general opinion of the secretaries was that the same condition did not hold true in the United States.

FINE FEBRUARY SALES REPORTS

Iroquois Sales Corp. Closing Healthy Okeh Record Business—Master-Tone Sales Increasing Steadily—Road Men Tell of Progress

BUFFALO, N. Y., March 8.—In a recent chat with The World L. M. Cole, sales manager of the Iroquois Sales Corp., of this city, stated that the company's sales totals for February were very satisfactory. The new retail price of \$1 for Okeh records has been favorably accepted by the trade, as the great majority of dealers appreciate the fact that the unprecedented advances in the cost of raw material and labor have made the \$1 retail price of records an absolute necessity. Mr. Cole states that many new accounts have been opened since the first of the year, and the older accounts have been ordering so heavily that there is a substantial increase in Okeh business as compared with the holiday figures. Master-Tone business is showing a satisfactory growth, with every indication of continuing along similar lines throughout the Spring.

Harry H. Dahl and A. C. Bentzen, of the Iroquois sales staff, are sending in gratifying reports from the East. Bertram H. Gould started on a trip to Ohio territory a few days ago, and Pennsylvania is also being covered to excellent advantage. Mr. Cole is concentrating his activities on the western New York field, and has established excellent representation in Rochester, Syracuse, Buffalo and adjacent localities.

HEAT MOISTURE OXYGEN

When properly combined
produce the most ideal
condition for drying

All air delivered to the dry-rooms is thoroughly washed, making a deep, clean finish.

The temperature and humidity are automatically controlled, making the finishing process independent of outside weather conditions.

stain, filler and varnish.

Years of experience have
taught us the combination

The users of our system are licensed under and protected by the Grosvenor process patent No. 1,186,477

DRYING SYSTEMS, Inc.
322 No. Michigan Ave. Chicago, Illinois

Note: Send for descriptive bulletin



Compare them!

COMPARE Sonora Semi-Permanent Needles with other needles. Remember that Sonora S. P. Needles sell for 25c a package instead of 10c or 15c and they bring you a bigger and easier profit than any other needles.

THE INSTRUMENT OF QUALITY
Sonora
CLEAR AS A BELL

Semi-Permanent
NEEDLES

are extensively advertised, are well known, and are in strong demand. Buyers of these needles return to your store with their friends for more.

Attractive counter cards, leaflets and display material are available free. No matter what makes of phonographs you stock you need Sonora S. P. Needles. They play many times, are used on ALL MAKES of steel needle records, sweeten the tone, do away with constant needle changing and are most economical. Having parallel sides (not tapered) they do not increase in diameter as they wear and do not harm the record grooves. This means a longer life for the records. If you haven't ordered, order now.

THREE GRADES
LOUD, MEDIUM, SOFT
25c per card of 5 40c in Canada

Sonora Phonograph Company, Inc.
GEORGE E. BRIGHTSON, President
NEW YORK: 279 Broadway
Canadian Distributors:
I. Montagnes & Co.
Toronto

Caution! Beware of similarly constructed needles of inferior quality.



Manufacturers



1920

To handle this year's business we have greatly increased our production and are now prepared to care for a few hundred more live dealers.

The standards and quality of our product will not be changed; on the other hand this season's models have added features that will make for sales.

Our three factories are now in a position to supply you with an ample stock at once and immediate deliveries at all times.

The Excel Cabinet Co.'s dealers' proposition is one that you should investigate at once. There are large profits for you in handling this line of fast selling machines.

May we not send you our circulars, discounts, etc.
Write now—line up with a winner.

EXCEL CABINET CO.

Executive Offices: 136 West 23rd Street

New York City

Factories: Benton Harbor, Mich.; Holland, Mich.; Chicago



Manufacturers of
High Grade
Talking
Machines



BIG VICTOR GATHERING IN PEORIA

As Guests of the Putnam-Page Co. Great Army of Dealers Listen to Interesting and Constructive Addresses on Various Important Topics—Enjoy Luncheon and Banquet

PEORIA, ILL., March 3.—Victor dealers from all parts of Illinois were guests of Putnam-Page Co., Inc., Victor distributors, at that city on February 21, when they enjoyed an informal luncheon tendered to them exclusively and later the annual banquet of the Creve Coeur Club, an event of national importance, which was attended by over one thousand diners. While the Victor men were in evidence at two prominent tables at the banquet, the big event of the day for them was their own gathering of the afternoon, which was presided over by Fred H. Putnam, president of the Putnam-Page Co. Mr. Putnam took this occasion to introduce P. A. Ware, who was just beginning his connection

the Putnam-Page Co., where they attained a more intimate knowledge of the effective organization of this important distributor of the Victor Co. under the guidance of Roy Page, secretary of the company, and A. E. Severe and Leonard Putnam.

Among those who attended the luncheon and the great banquet later were: E. J. Dingley, of the Victor Co., Camden, N. J.; E. T. Froyd, of Froyd's Music Shop, Paxton, Ill.; P. R. Fritsche, Mackinaw, Ill.; T. A. Conboy, of the Up-To-Date Music House, Sterling, Ill.; M. E. Wright, Eureka, Ill.; G. E. Lester, Hoopeston, Ill.; F. A. Doyle, of The Doyle Furniture Co., Galesburg, Ill.; T. J. Griggs, of The Griggs Music House, Kewanee, Ill.; Fred Lehman, of Lehman's Music House, East St. Louis, Ill.; Geo. Cheatle, of The Music Shop, Springfield, Ill.; Thor. Norberg, of The Norberg Music House, Rock Island, Ill.; Will Haley, of J. Haley & Son, Arcola, Ill.; R. N. Smith, Carthage, Ill.; C. N. Lenhart, Mattoon, Ill.; A. E. Sundquist, of A. Sund-



E. J. Dingley, of Victor Co., and Illinois Dealers, Guests of Putnam-Page Co., Peoria, Ill.

with Putnam-Page Co., to whom he was transferred from the Victor factory, and after a brief talk Mr. Ware introduced E. J. Dingley, manager of the machine order department of the Victor Co., who addressed the dealers in behalf of the Victor factory. He spoke at length on topics close to the heart of Victor dealers and his address was something different from that usually expected at gatherings of this kind. Mr. Dingley reviewed some of the problems of manufacturing with which the Victor Co. has to deal and gave in a very interesting manner an exposition of how ably these problems are met. He gave a most intimate word picture of the remarkable manufacturing achievements necessary to turn out such great volumes of machines and records as are produced by the Victor plant. Later Mr. Dingley answered questions regarding the more intimate problems of the dealers. He took occasion to congratulate them on the progressive attitude which prompted the questions.

During the latter part of the afternoon the dealers visited the new exclusive Victor department of the Block & Kuhl Co., which is a store in itself, and here again, through effective organization of the hosts and with the aid of J. D. O'Malley, department manager, a further general discussion of progressive methods ensued. During the day most of the visiting dealers took occasion to survey the headquarters of

quist & Son, Toulon, Ill.; L. L. Archibald, of P. A. Bergner & Co., Peoria, Ill.; F. M. Leslie, Urbana, Ill.; H. C. Kupfer, of Mandel & Schwartzman, Bloomington, Ill.; J. F. O'Malley, of Block & Kuhl Co., Peoria, Ill.; J. E. King, of King & Bailey, Virginia, Ill.; W. W. Bond, of D. H. Lloyd Co., Champaign, Ill.; H. J. Waldschmidt, Metamora, Ill.; Harry Duncan, of Duncan-Schell Furniture Co., Keokuk, Iowa; A. R. Meyer, Havana, Ill.; Lyle Straight, of A. Livingston & Son, Bloomington, Ill.; E. E. Hanger, of Hanger Bros., Lincoln, Ill.

APPOINT ILLINOIS JOBBERS

The Reed Co., Inc., Pittsburgh, Pa., has announced the appointment of the Cole & Dunas Music Co., Chicago, Ill., as distributors in the State of Illinois for the popular Reed record demonstrating booths, record and player roll racks and efficiency counter. Reed efficiency furniture has attained considerable success throughout the country, and the Cole & Dunas Music Co. is planning to institute an aggressive campaign featuring this furniture throughout the State of Illinois.

Money is not always power. There are scales on which an ounce of integrity is worth a mine. The noisiest welcome is not the most continuous cheer.

Phonographs and Show Window Record Stands

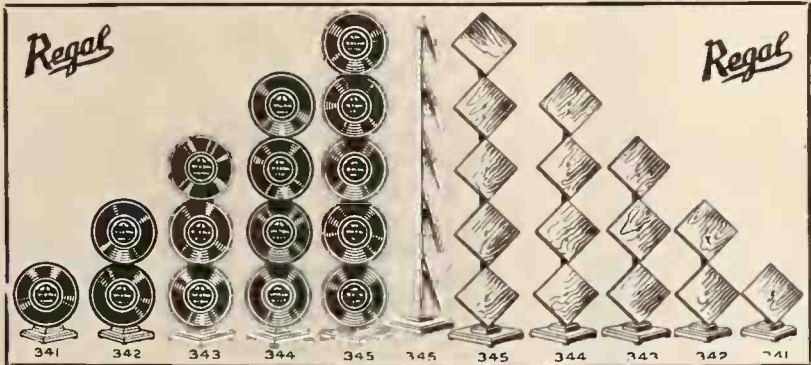

These Show Window Record Stands will increase your sales on records and help you make attractive window displays. Send for Dealers' Price.

THE OSCAR ONKEN CO., 6651 4th Street, Cincinnati, O.



PLAZA

BUY YOUR ACCESSORIES
"All From One Source"

Gold Finish
MAGNEDO
Multi-playing
STEEL NEEDLES
Retail at 10c.
per box of 50

Magnedos are the STANDARD Steel Multiplaying needles.

Extensive advertising has established a ready market for you.

Attractive packing sells Magnedos on sight—and every sale means repeat business.

Each needle is guaranteed to play 10 records.

There are large profits waiting for you if you handle Magnedos.

To Jobbers

We have an interesting merchandising proposition for you. Write for details.

To Dealers

A sample carton will demonstrate how your needle sales can be developed.
Order One Now
Loud and Medium Tones

REPAIR PARTS
NEEDLES
CLEANERS
ENVELOPES
SAPPHIRES
ALBUMS
RECORDS

ALL FROM ONE SOURCE

PLAZA MUSIC CO. TRADE MARK

PLAZA MUSIC CO.
18 WEST 20TH STREET
NEW YORK

REPAIRS

TALKING MACHINE TROUBLES AND
HOW TO REMEDY THEM

Conducted by Andrew H. Dodin

[This department of The Talking Machine World is designed for the service of all classes of our readers, including those who make, and those who sell, talking machines.

Andrew H. Dodin, who conducts this department, has a wide and enviable reputation as a repairer of talking machines at 176 Sixth Avenue, New York. Tell him your troubles through The World and he will help you if possible. The service is free.—Editor.]

SOME QUESTIONS AND ANSWERS

Hints on Sound-Box Repairs

Trenton, N. J., January 24, 1920.

A. H. Dodin,

Care The Talking Machine World, New York.

I have but recently engaged in the phonograph business and I find several problems to solve, and it occurs to me you may be willing and able to give me some information. I have just had returned from the Edison factory a

speaker or reproducer as used on a late style Amberola. When playing some notes appear to produce a rattle similar to that caused by a loose needle sometimes when it has fallen into the machine below the motor. Can you write up for publication in The World some of the methods of procedure when putting new mica in reproducers, and some of the most usual repairs required in repairing reproducers? As a beginner on phonograph repairing I like to see the department in The World devoted to repair problems as large as possible.—Edward Aller.

Answer—The trouble with the Amberola speaker is probably due to the fact that the gasket ring is not tight enough, allowing diaphragm to blast on certain notes. As to sound-box troubles, the troubles and causes are about the same in all makes of boxes—bad diaphragms, dead rubber gaskets, weak tension springs, or loose needle bars. The two most important points in assembling a sound-box are first to shellac the diaphragm to the gasket in such a position that its edge does not touch the frame of the box at any spot, and second, that the needle bar is placed in a proper posi-

tion, if with pivot screws, that the arm is held snug with no side motion, and if with tension springs, that the springs are drawn down to the frame in such a manner as to insure an equal tension in both directions from the mica.

For good results when you have a box with two tension springs on the needlearm, one of which is broken, it is always best to put on two new springs, insuring a more even tension on the arm. This also applies to the rubber gaskets—always put in two new ones when one has become dead; you can be assured that the other is not much better, and changing both gaskets will prevent blasts and insure the proper back spacing. Another important point is to wax the connection of the mica and needle bar so that box is positively airtight.

Preventing a Metallic Blast

Meridian, Miss., January 17, 1920.

A. H. Dodin,

Care The Talking Machine World, New York.

Could you give me any information about the Nystrom motor which is to be used in the new "Brunswick" models?

Please, also, can anything be done to relieve the shrillness of the Columbia sound-box? There is nothing loose and it is perfectly assembled, still there is a shrill metallic blast occasionally. Do the paper insulators have anything to do with this?—Donald Tanner.

Answer—Have not as yet seen the "Nystrom" motor but will be pleased to inform you of same as soon as I do. In reference to the Columbia sound-box: The paper washers are used to insure the proper distance between the diaphragm and the back facing of the box, as the rubber gaskets are not always the proper thickness. These paper washers cannot have any effect on the sound of a box providing the clamp ring is screwed in tight enough. You will find in many cases that a box will not sound good when the clamp ring has been screwed in too tight; it should be just tight enough to hold mica firm. The same applies to the needle bar pivot screws; they should not be so tight that they lock the arm; just firm enough to hold the arm tight without any side motion or play. If you look to these points and the mica diaphragm is in good condition I can see no reason why the box should sound shrill or do anything but play satisfactorily.

How Springs Should Be Left

Editor, Talking Machine World:—There seems to be a wide difference of opinion among repairmen and salesmen as to how the main springs in talking machines should be left when through playing the instrument. I should certainly appreciate your opinion.

Answer.—If a machine is to be put away for some months and not used, the proper thing to do is to see that the springs have entirely run down. Where a machine is being used, say every week or so, it is not necessary to let the springs run down each time, though they should not be left under any great tension.

ADVERTISING THE STEGER

The Smith & Nixon Co., Louisville, Ky., which handles the Steger & Sons talking machines and pianos, has been featuring the fact that the Steger Co. has announced that prices will not be advanced. Full pages in the local newspapers have been used in this campaign.



PRECISION CASTINGS COMPANY, INC.
SYRACUSE, NEW YORK.

Manufacturers of Die Castings in
**Aluminum, Zinc, Tin, Lead Alloys,
Babbitt Bearings**



The Certainty of Promised Delivery

One of the most important elements in the service of this company is *the certainty of promised delivery*, which is largely assured by the fact that we are probably the largest complete organization in the country devoted to the production, manufacture and distribution of

Mahogany Lumber and Veneers

With the largest mill on the Atlantic and Gulf Seaboard, centrally located at Long Island City, New York, with half a mile of dock frontage and immediate accessibility to railroads, we enjoy unusual facilities both for the receipt of logs and for the shipment of lumber and veneers either by water route or rail.

Astoria Mahogany Company, Inc.

347 Madison Avenue, New York

Successors to

Huddleston-Marsh Mahogany Co.

Astoria Veneer Mills and Dock Co.

F. W. Kirch, Inc.

Mills and Yards, Long Island City, New York

BRANCHES:

44 North Market Avenue
Grand Rapids, Mich.

2256 Lumber Street
Chicago, Ill.

The Heineman Motor

The Standard Motor For High-Grade Phonographs

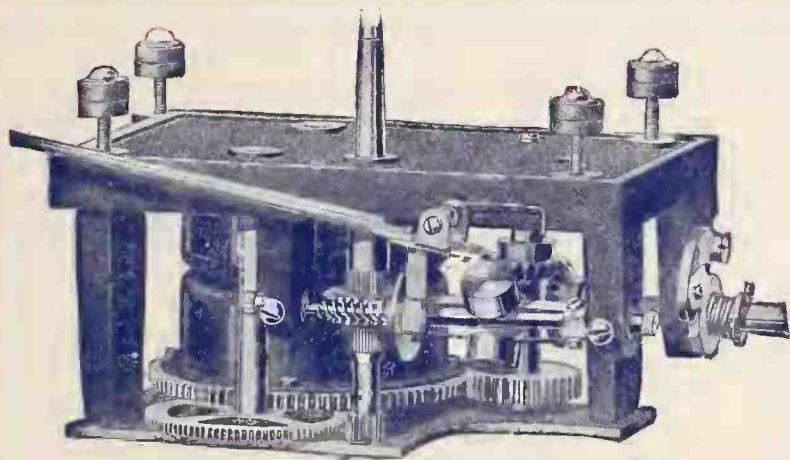

THE HEINEMAN MOTOR No. 77

The Motor of Quality

The World's Leading Phonograph Manufacturers

have shown a preference for the Heineman Motor No. 77 because it always gives satisfaction and has mechanical precision.

Your phonograph becomes "high class" as soon as you equip it with a Heineman Motor No. 77.

You will find unvarying quality in these motors and we can promise prompt shipments in any quantities

The Motor of Quality

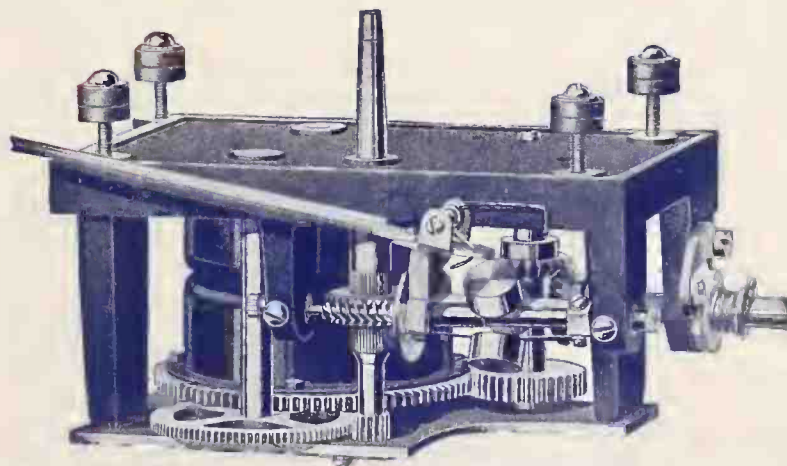

THE HEINEMAN MOTOR No. 77

GENERAL PHONOGRAPH CORPORATION

25 West 45th Street

OTTO HEINEMAN, Pres.

New York City, N. Y.

FACTORIES: Newark, N. J. Elyria, Ohio Putnam, Conn. Springfield, Mass. Kitchener, Ont.

BRANCHES: Chicago, Ill. San Francisco, Cal. Toronto, Can.



Al Jolson Wrote "Chloe" himself. Then he sang it in *Sinbad* and for us. Yes, we're turning out these records as fast as we can. A-2861.



**Columbia Graphophone Co.
NEW YORK**

CLEVER WINDOW DISPLAY

Aldrich-Howey Co. Uses Design of Eclipse Musical Service Department to Advantage

CLEVELAND, O., March 4.—The Aldrich-Howey Co., one of the big retail furniture stores, at East Fourth and High streets, this city, featuring



An Attractive Victor Window Exhibit

extensively the Victor talking machine, now and then puts across a window display worth while. The window display shown in the accompanying picture was designed by the Eclipse Musical Co.'s service department, under the personal direction of George W. Savage, service director. Victor dogs occupied the baskets of the small Ferris wheel which was revolved by an electric fan. The firm carries a complete stock of Victrolas and records and finds them to be good sellers.

BRUNSWICK MILWAUKEE AGENCY

In a half-page display published in the Sunday newspapers, Gimbel Bros., Milwaukee, Wis., announced last month the acquisition of the Brunswick line of phonographs, which henceforth will be featured in connection with the Victor. A year ago the New York store of Gimbel Bros. added the Brunswick, and later the Philadelphia store did likewise. The results have been so eminently satisfactory that similar action has been taken at the Milwaukee store. A complete stock of Brunswick models has been installed in the music section of the big store and the line will be energetically advertised and pushed by the salesforce, which has been increased in size to handle the dual representation.

INITIAL "REED" EQUIPMENT

The Beckwith-O'Neill Co., of Minneapolis, Minn., Victor distributors, have installed in their handsome new quarters a complete equipment of Reed efficiency furniture, consisting of booths, record and player roll racks and efficiency counters. This equipment has won the praise of visiting dealers, who have commented particularly upon its numerous and very practical features.

The Smith Phonograph Co., Sioux Falls, S. D., has been incorporated with capital stock of \$50,000 by J. Frank Smith, George E. Secrest and S. A. Reik. The company will handle Edison phonographs, attachments and supplies, with M. E. Crew as manager.

A STEP IN THE RIGHT DIRECTION

Name of Record Used on Program as Well as Name of Piano Used—Brunswick-Balke-Collender Co. Makes First Move in New York

While the name of the piano used in a recital or concert is usually found on the printed program, it has in the past been very seldom that the name of the record company for which the artist records has been mentioned. A step in the right direction has been taken by the Brunswick-Balke-Collender Co. At a recent recital in Carnegie Hall given by Theo. Karle, the exclusive Brunswick artist, the close of his program contained announcement of the fact that he recorded his art on the Brunswick records. The fact that an artist may be heard on records made by this company or that is certainly of as much interest to the music-loving public as the fact that such-and-such a piano is used. With the present tremendous demand for records, not only popular records, but selections from the

operas as well, the mention on a recital program of the records on which the artist of the day records is the most effective kind of publicity.

NATURAL VOICE PHONO. CO. GROWS

Under Direction of Ben Ferrara This Concern in Oneida Has Grown Rapidly in Three Years

During the past three years Ben Ferrara, head of the Natural Voice Phonograph Co., at Oneida, N. Y., has built up a large trade. He has had many years' experience in all kinds of wood-working, and with most of his equipment for making talking machine cabinets already at hand, he decided to turn over his factory to the manufacture of this product. The factory at Oneida is well situated and employs the most modern machinery. The first floor is devoted entirely to the making of cabinets. On the second floor are the polishing and finishing rooms and on the third floor the machines are assembled and shipped.

**Delpheon
the
Incomparable**

A Valuable Franchise

One Delpheon Dealer in a place—room for only limited number of new dealers.

An unusual opportunity for securing exclusive rights for your locality.

A contract with us means your orders filled.

A tone that is ineffably exquisite—not phonographic

STEADILY INCREASING PRODUCTION ASSURES DELIVERIES

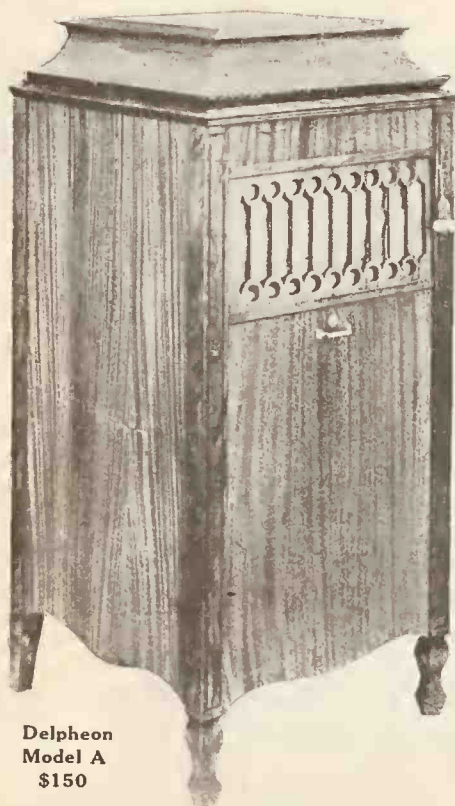

Delpheon Model A \$150

**THE DELPHEON COMPANY
Bay City, Michigan**

New York Office, 25 Church Street
Rosen Phono. Sales Co., 27-28 Court Street, Boston, Mass.
Delpheon Shop, Peachtree Arcade, Atlanta, Ga.
Walter Verhalen Co., 703 Busch Building, Dallas, Texas
Verbeck Musical Sales Co., Buffalo, N. Y.

"A new Gennett!"



REFLECTIONS

As the face in the crystal mirror is true to the gazer so are **Gennett Records** faithful to the original voice or instrument.

To know the utmost in music's reproduction hear **Gennett No. 9020**. In the "Dardanella" Fox Trot the famous Cordes' Dance Orchestra makes your toes fairly tingle, and this same orchestra unites with the clear tenor of Billy De Rex to bring out all the sweetness of "When My Baby Smiles at Me."

Betters all Phonographs—Hearing is *Believing*.

Write for record catalog

THE STARR PIANO COMPANY

Los Angeles

Richmond, Indiana

New York

Birmingham, Ala.

London, Canada

COURT DECISION CONCERNING INTERESTING PRINCIPLE

Vice-Chancellor Leaming's Finding in the Case of the Victor Talking Machine Co. Versus Chas. P. Stitt and the Columbia Graphophone Co. Presented in Full

There is presented herewith in full a recent decision of Vice-Chancellor Leaming in a bill of injunction filed by the Victor Talking Machine Co. against Charles P. Stitt, former employe of the company, and the Columbia Graphophone Co. The Vice-Chancellor's order is published in view of the general interest of the trade at large in the principle involved in the litigation.

IN CHANCERY OF NEW JERSEY.

Between: Victor Talking Machine Co., Complainant and Charles P. Stitt and Columbia Graphophone Co., Defendants.

On Bill for Injunction. Hearing on return of order to show cause. Conclusions. LEAMING, V. C.:

Complainant corporation seeks an injunction to restrain defendant Stitt, its former assistant superintendent of its cabinet department, from communicating to defendant Columbia Graphophone Co., a trade competitor, trade secrets which it is alleged that Stitt has become familiar with in the course of his confidential employment as assistant superintendent of the cabinet department. It is also sought to enjoin defendant company from using such trade secrets as have been communicated to it by said Stitt, and from procuring further trade secrets from him.

On the return of an order to show cause, with restraint, answering affidavits have been filed on behalf of defendant Stitt; defendant corporation has appeared specially to contest jurisdiction over its person; these conclusions accordingly relate alone to defendant Stitt.

No doubt can exist touching complainant's right to the relief sought if the several matters set forth in the bill can be established at final hearing. The only field of controversy at this time is whether, in view of the matters contained in the answering affidavits, restraint against defendant Stitt can be properly retained pending final hearing.

It is admitted that complainant has for many years manufactured in its cabinet department the cabinets for its sound reproducing machines, and that defendant Stitt has long occupied the position of assistant superintendent in that department, and that up to this time defendant company has never made its own cabinets, but has recently determined to build and equip an establishment of its own for that work. The claim of complainant is that defendant company employed defendant Stitt, while he was still employed by complainant, to divulge trade secrets pertaining to complainant's cabinet department.

The averments of the bill touching the secret processes of complainant's cabinet department, verified by the superintendent of that department, are as follows:

"An essential part of complainant's plant or factory is the Cabinet Department in which the cabinets for its sound-reproducing machines are made. This department is a vast wood-working establishment in which lumber, glue, varnish and other materials are stored, aged and at the proper moment put through carefully-planned secret processes and treatment in connection with machinery which it has devised and had specially constructed for the purpose until they are transformed into complete and perfect cabinets. As a result of great expense, time and experience, machinery and appliances have been so arranged, grouped, located and combined, and horse power and speed have been so regulated, as to provide ways, not in use or to be found elsewhere, of cutting and using material to advantage, eliminating waste and reducing the cost of production. These results cannot be accomplished elsewhere without the data so obtained by the complainant. The secrets of the Cabinet Department consist, however, not only in the peculiar construction of that part of the plant and in the character and combination of the machinery, materials, chemicals and utensils used, but also in the methods of their use and application. These secrets always have been and are

guarded with the utmost care and every precaution has been and is taken to prevent their becoming known. Only certain officers and trusted employes of the complainant are made acquainted with these secrets and all the employes of the Cabinet Department, including the defendant, Charles P. Stitt, were employed with the understanding that all inventions and discoveries used or devised for or in connection with the business or discovered by its employes were the complainant's exclusive property and were not to be disclosed to others or utilized in any manner by said employes or any of them."

Defendant Stitt, in his answering affidavit, states that there is nothing secret about the manufacture of complainant's cabinets; that the machines that make them can be bought upon the open market; that there is nothing secret in the handling of the material as it is fed to the machines; that as a scientific proposition this a mere matter of making the best use of the floor space available, and the system in use by complainant for handling the wood and grouping the material and its allotment among the machines is adapted to the particular layout of complainant's plant with nothing unique or secret about the system; that it has long been the custom in complainant's factory to furnish guides to visitors through that department; that he has acquired valuable experience while working for complainant, but that experience is the experience that anyone would have acquired working among machinery of the type employed, and could have been acquired in numerous plants in this country of the type of complainant's plant and is in nowise peculiar to complainant's plant.

The bill further charges that defendant Stitt obtained and took away drawings, blue prints and photographs of the complete layout of complainant's cabinet department, and detailed specifications and allocations of the material going into its cabinets and of the grouping of all machines on the different floors, and that he remained in complainant's employment for the purpose of being enabled more accurately to furnish information from time to time to defendant company with reference to complainant's cabinet department, the equipment and arrangement thereof and contemplated improvements thereon and the operation under said secret processes.

All these latter charges are specifically denied by defendant Stitt. He admits, however, that during the latter portion of the time that he was employed by complainant he was employed by one Palmer, who was constructing engineer for defendant company and who had been instructed by defendant company to lay out and equip with the necessary machinery a plant for making sound-reproducing machine cabinets; that his employment by said Palmer was not to include the hours of labor which he owed to complainant; that Palmer's experience did not enable him to determine the kinds or numbers of machines necessary for that class of work and he accordingly supplied to Palmer the necessary information as to the kinds of machines and numbers of the several kinds which would be required to manufacture a given number of cabinets per day, each containing a given amount of lumber, and that he also assisted Mr. Palmer in the selection and purchase of these machines for use in the proposed plant of defendant company. Both Palmer and defendant Stitt testify that this was the full extent of the information imparted and assistance rendered by defendant Stitt, and that neither arrangement of floor space, grouping of machines or material nor any matters other than the number and kinds of machines necessary for the proposed work were or have been at any time considered or suggested by either of them.

Defendant Stitt nowhere specifically denies the statements contained in Mr. Keiffer's affidavit to the effect that his employment and duties were of a confidential nature; his distinctive claim appears to be that the disclosures which he has made to a trade competitor of complainant's were not in the nature of trade secrets, and that no trade secrets existed in his department.

The foundation and basis of all equitable relief of the nature here sought is to be found in the trust and confidence either expressly or impliedly reposed in the employe by the employer; it is the breach of trust by an employe which may be injurious to an employer that a court of equity seeks to prevent. In the language of Judge Story:

"It matters not in such cases (secrets communicated to

an employe in the course of his confidential employment) whether the secrets be secrets of trade, or secrets of title, or any other secrets of the party important to his interests." 2 Story's Equity Juris. Sec. 952. "The word property, as applied to trade marks and trade secrets, is an unanalyzed expression of certain secondary consequences of the primary fact that the law makes some rudimentary requirements of good faith." DuPont Powder Co. vs. Masland, 244 U. S. 100. The mere circumstance that the possession of the trade secret may at some future time embarrass the employe in his work for others affords no obstacle to the appropriate enforcement of the trust. "The first thing to be made sure of is that defendant shall not fraudulently abuse the trust reposed in him. It is the usual incident of confidential relations. If there is any disadvantage in the fact that he knew the plaintiff's secrets he must take the burden with the good." DuPont Powder Co. vs. Masland, supra.

Accepting as true, for present purposes, all that appears in the affidavits filed on behalf of defendant Stitt it is obvious that what defendant company sought and procured from defendant Stitt, while he was still employed by complainant as assistant superintendent of its cabinet department, was the benefit of his knowledge acquired through his experience as such assistant superintendent. Mr. Palmer, defendant company's engineer, did not know the kinds of machines necessary for the work, and even with that information admittedly would not have been able to determine the kinds most desirable or the numbers of the various kinds of machines necessary to turn out the aggregate amount of treated material entering into the proposed daily output of sound-reproducing machine cabinets, each containing a given amount of material. That information defendant Stitt possessed. His own affidavit touching his experience elsewhere fully discloses that that information was obtained in the course of his work in complainant's cabinet department. With that information imparted to Palmer defendant company would be enabled to equip a plant for the manufacture of sound-reproducing machine cabinets which, when completed, would, so far as equipment was concerned, begin its initial operations with the same degree of efficiency and avoidance of waste that long experience and experimentation had enabled complainant to obtain. Defendant Stitt necessarily knew that such information imparted to a rival concern was of great economic benefit to that concern and a like detriment to the concern whose best interest he was employed to serve. It is only to conjecture why defendant company did not apply to the management of complainant for this information to become reasonably assured of the inherent spirit and aim of the entire transaction.

It may perhaps be, as stated by defendant Stitt, that the machines used by complainant were standard wood-working machines, and that nothing unique was to be found in their use, and it may also be true that like information could have been procured elsewhere—although it is not pointed out where; but when it is borne in mind that the proposed plant was solely for the manufacture of sound-reproducing machine cabinets by a trade competitor of complainant and that the information imparted embraced not only the kinds of machines needed but also the correlation of uses and capacities of various machines in kinds and numbers to insure economic efficiency in the desired production of cabinet output per day, and that this information was in fact the result of experience by long operation and experimentation of complainant's plant and had come to defendant Stitt's knowledge through his confidential employment by complainant, it seems impossible to regard the disclosure of this information by a trusted employe as other than a breach of faith to complainant, resulting alike in detriment to complainant and great benefit to defendant company, or to regard the kind of information thus admittedly imparted to the business rival as less entitled to protection than would have been a secret chemical formula or a new and patentable mechanical device discovered and in use at complainant's plant, since it is the breach of confidence of the employe to the detriment of the employer, and not the inherent quality of the secret information, which a court of equity primarily considers and seeks to prevent. While the affidavits filed on behalf of defendant Stitt are to the effect that no disclosures have yet been made by him touching complainant's methods and processes in the aging of its lumber and at the proper moment putting it through carefully planned secret processes and treatments, or touching the grouping of material and mechanism in ways not in use or to be found elsewhere for eliminating waste and cutting and using material to advantage and reducing cost of production, yet the admitted disclosures should, in my judgment, impel the retention of restraint against further disclosures pending final hearing, especially in view of the circumstance that to withhold such restraint would wholly defeat the objects of the bill. Soloman vs. Hertz, 40 N. J. Eq. 400.

I will advise an order retaining restraint until final hearing against further disclosure by defendant Stitt of secret processes and methods used in complainant's cabinet department.

Submitted: February 11, 1920. Determined: February 16, 1920.

Messrs. French & Richards, for complainant. Joseph Coult, Jr., Esq., for defendant Stitt. Frank S. Katzenbach, Esq., for defendant company.

The Eastern Commission House, Brooklyn, N. Y., has been incorporated with a capital of \$10,000 to do a business in talking machines. The incorporators are C. B. Glover and H. L. and H. Williamson, 619 Eastern Parkway, Brooklyn.



HENRY BURR



ALBERT CAMPBELL



JOHN MEYERS

PEERLESS RECORD MAKERS

In Concert and Entertainment Personal Appearance of Eight Popular Favorites on One Program

A live attraction for live dealers and jobbers Bookings now for season 1920-1921 Sample program and particulars upon request

P. W. SIMON, Manager 1604 Broadway New York City



FRANK CROXTON



MONROE SILVER



BILLY MURRAY



FRED VAN EPS



FRANK BANTA

Famous Ensembles including Campbell & Burr - Sterling Trio - Peerless Quartet

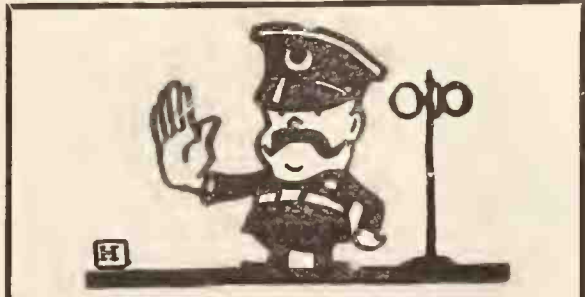

STOP - STOP! You're headed the wrong way if you quit advertising your Victor records because you can sell them all without advertising. Use that advertising space you secure without cost—the face of your wrapping envelopes. We have some clever cuts designed especially for you, Mr. Victor Dealer. Investigate. Clip coupon TO-DAY. My Name is... The Firm Name... Our Address is... LU-FRANC SALES SERVICE 1202 Dime Bank Bldg. Detroit, Mich.

The Highest Class Talking



Louis XVI

THE INSTRUMENT OF QUALITY
Sonora
 CLEAR AS A BELL



Prices \$60 to \$2,500

HERE are just a few of the famous Sonora phonographs which for quality of tone, for beauty of design, for elegance of finish, for importance of constructional features, and for popularity, are unrivaled.



Jacobean

Sonora offers and carries *in regular stock*, (as distinct from "specials"), a far larger variety of superfine instruments, selling at prices commensurate with their quality, than does any other manufacturer.



Chippendale

Sonoras sell with ease against all competition and are wonderful money accumulators for progressive dealers.

Write for information if you'd like to handle the Sonora.



Supreme



Invincible

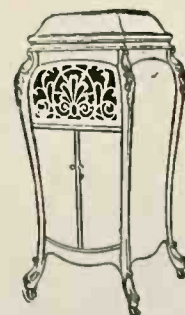

Grand

Machine in the World

THE INSTRUMENT OF QUALITY
Sonora
 CLEAR AS A BELL

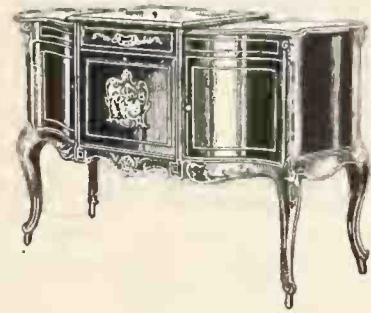
Louis XV

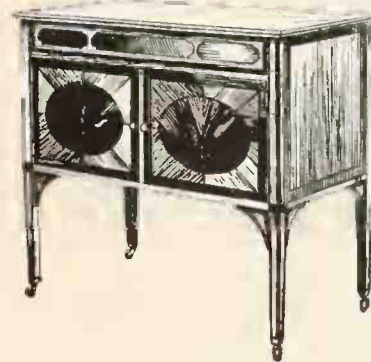

Sheraton



Italian Renaissance

Gibson-Snow Co.
 Syracuse, N. Y.
 State of New York with the exception
 of towns on Hudson River below
 Poughkeepsie and Greater New York

W. B. Glynn Distributing Co.
 Saxtons River, Vt.
 States of Maine, New Hampshire,
 Vermont and part of Massachusetts.

Griffith Piano Co.
 605 Broad St., Newark, N. J.
 Northern New Jersey.

Hessig-Ellis Drug Co.
 Memphis, Tenn.
 Arkansas, Louisiana, Tennessee, Mis-
 sissippi.

Hillman Phonograph Co.
 Wheeling, W. Va.
 Virginia and West Virginia.

Kieler-Stewart Co.
 Indianapolis, Ind.
 Entire State of Indiana.

C. L. Marshall Co., Inc.
 Cleveland, Ohio., Detroit, Mich.
 States of Michigan and Ohio.

Minneapolis Drug Co.
 Minneapolis, Minn.
 States of Montana, North Dakota,
 South Dakota, Minnesota.

L. Montagnes & Co.
 Ryrie Bldg., Toronto, Canada.
 Dominion of Canada.

M S & E
 221 Columbus Ave., Boston, Mass.
 Connecticut, Rhode Island and east-
 ern Massachusetts.

American Hdw. & Equipment Co.
 Charlotte, N. C.
 North Carolina and South Carolina.

C. D. Smith Drug Co.
 St. Joseph, Mo.
 Nebraska, Missouri, northern and
 eastern part of Kansas and 5 counties
 of N. E. Oklahoma.

Smith, Kline & French Co.
 Philadelphia, Pa.
 States of Pennsylvania, Maryland,
 Delaware, District of Columbia, and
 New Jersey south of and including
 Trenton.

The Magnavox Co.
 616 Mission St., San Francisco, Cal.
 Washington, California, Oregon,
 Arizona, Nevada, Hawaiian Islands,
 Northern Idaho.

Sonora Phonograph Company, Inc.
 279 Broadway, N. Y.
 Distributors for Greater New York.

Southern Drug Co.
 Houston, Texas.
 Southeastern part of Texas.

Southern Sonora Company
 Atlanta, Ga.
 Alabama, Georgia and Florida.

Southwestern Drug Co.
 Wichita, Kans.
 Southern part of Kansas, Oklahoma
 (except 5 N. E. counties), and Texas
 Panhandle.

Strevell-Paterson Hardware Co
 Salt Lake City, Utah.
 Entire States of Utah, Colorado,
 Wyoming, New Mexico and South-
 ern Idaho.

C. J. Van Houten & Zoon
 Marquette Bldg., Chicago, Ill.
 Illinois and Iowa.

Sonora Distributing Co. of Texas
 Dallas, Texas.
 Western part of Texas.

Yahr & Lange Drug Co.
 Milwaukee, Wis.
 Wisconsin, Upper Michigan.

Lee-Coit-Andresen Hdw. Co.
 Omaha, Nebraska.
 State of Nebraska.

Robinson-Pettit Company, Inc
 Louisville, Kentucky.
 State of Kentucky.

Sonora is licensed and operates under BASIC
 PATENTS of the phonograph industry

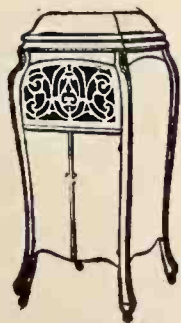

Elite

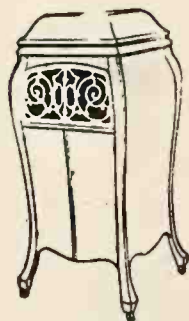

Baby Grand

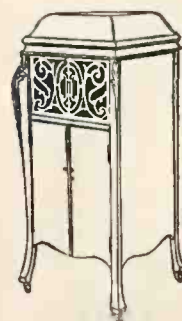

Minuet

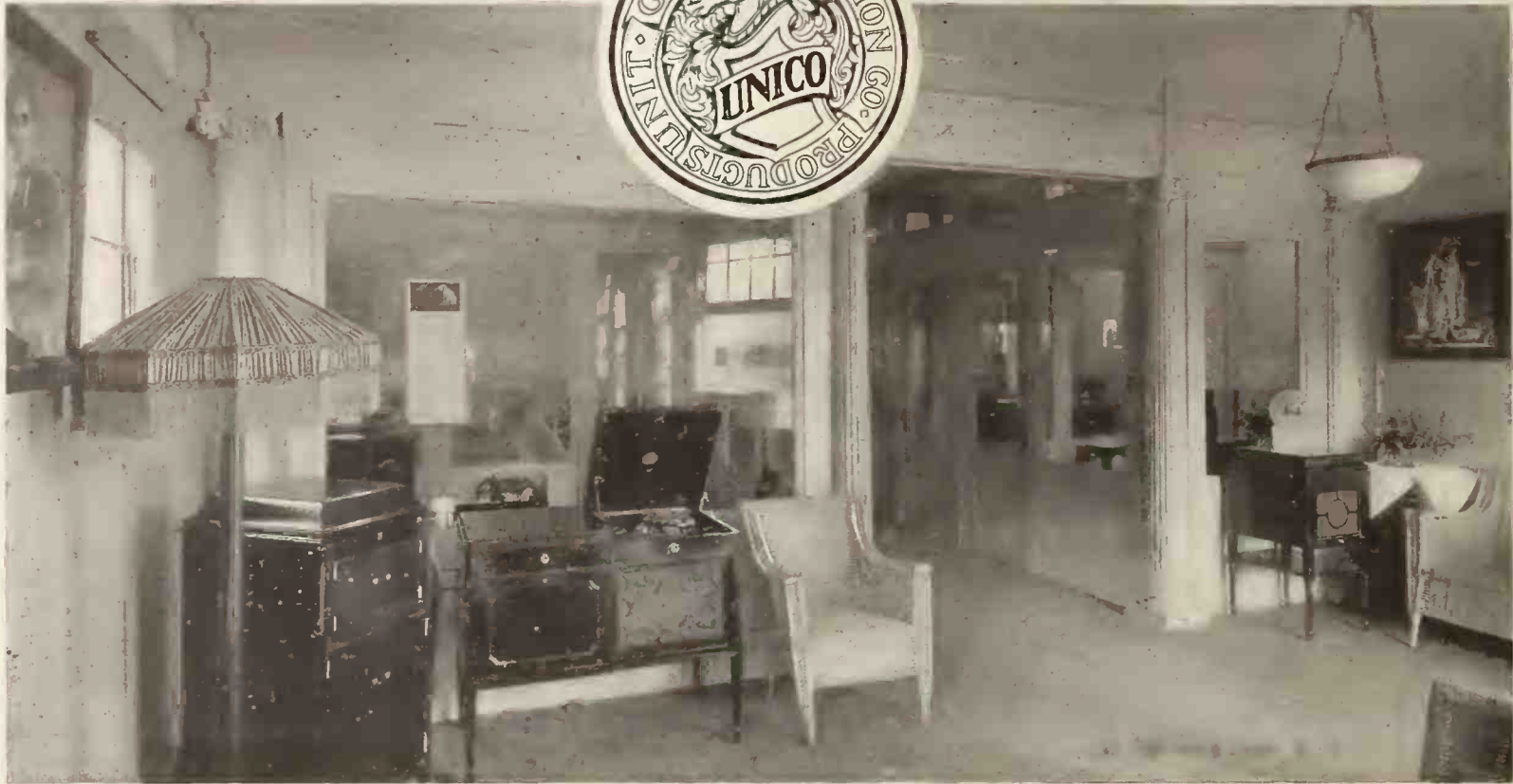

Unico Equipment always increases business

EFFICIENCY in organization, production and management is rapidly finding its way into American retail business. Of recent years there has been no greater step forward in this direction than the installation of Unico Equipment in music stores.

As a sales help Unico Equipment provides for proper and get-at-able display of stock. It speeds the transactions between the sales force and the customers. Decorative in design and finish, its attractiveness creates an atmosphere pleasing to the customer. As an efficient means for serving the individual customer it is in a class by itself.

Our increased facilities in production enable us to give you prompt service and put you in a position to have the full benefit of our installation in time for the Spring rush.

We can ship from stock in ten designs and our Planning Department is in a position to co-operate with you to the fullest extent. Write us for our booklet, "Musical Merchandising." Its contents will be a help to you.

Talking Machines
Victor Records

STILES' MUSIC STORE

Player Piano
Q. R. S. Player Rolls

Moorestown, N. J. January 8, 1920.

Unit Construction Co.,
Philadelphia, Pa.
Dear Sir:-

We have just closed the most successful Christmas season since our entering the Victor business. Our Sales on Machines show a gain of fifty percent over 1918. Records sales naturally showed an increase as we were able to give much better service to our customers due to the efficient way in which you arranged our demonstrating booths.

Our customers tell us, our store is a credit to the town, and is the prettiest and best arranged store for the sale of Victor Machines and Records in South Jersey.

Thanking you for your help in the designing of our store, we are,

Yours very truly,
Stiles' Music Store

H. S. / H. L. S.

RECEIVED
A. M.
JAN 9 1920
Ans. UNIT CONSTRUCTION CO.

Send us today dimensions of your floor space. Plans and estimates will be submitted promptly without cost.

UNIT CONSTRUCTION COMPANY

Rayburn Clark Smith.....President
58th Street & Grays Ave.
PHILADELPHIA

Unico Construction is Patented

NEW YORK
299 Madison Ave.
Corner 41st St.

BOSTON
85 Essex Street

CHICAGO
Lyon & Healy Building

SAN FRANCISCO
Holbrook Building

Unico Designs are Patented

COLUMBIA DEALERS HOLD FIRST MEETING OF THE YEAR

Lambert Friedl Presides at Most Interesting Gathering Held Recently—George W. Hopkins Talks on Service—Margaret Romaine, Columbia Artist, Arouses Great Enthusiasm

More than 400 Columbia dealers in local territory, with members of their sales staffs, attended a dealers' meeting at the Hotel McAlpin on Wednesday, February 18. This meeting marked the inauguration of a series of 1920 gatherings and, judging from the success of this session, the meetings this year will far outdistance in importance and practical value the very successful series of 1919 gatherings.

Lambert Friedl, manager of the local Columbia branch, presided, and, as this meeting was held under the auspices of the New York wholesale branch, Mr. Friedl and his associates well deserved the encomiums which they received from the Columbia dealers. Mr. Friedl inaugurated this idea of dealer gatherings in this territory more than a year ago, and under his able guidance the plan has developed and increased in importance month after month. Each meeting is more interesting than its predecessor, and



Lambert Friedl

there is a get-together spirit among Columbia dealers in local territory that can be traced directly to these informal gatherings.

The company had arranged to accommodate about 300 Columbia dealers and their sales people, but the attendance was far beyond this figure and, although the Winter Garden, one of the largest meeting rooms at the McAlpin, had been secured, quite a number of the visiting dealers were able to secure standing room only.

Mr. Friedl opened the meeting with a brief address of welcome to the dealers and during the course of his talk referred to delays experienced by Columbia representatives the past few weeks in the delivery of Columbia Grafonolas and records, but explained that transportation conditions had been demoralized. He pointed out incidentally that the local Columbia branch had utilized extraordinary resources to co-operate with its clientele and expressed his appreciation of the forbearance of the dealers during the past six weeks.

In connection with the musical program of the afternoon, Mr. Friedl presented Theodore Bauer, head of the Columbia Co.'s operatic and concert department, who has been an important factor in the acquisition of famous artists for the Columbia library exclusively. Mr. Bauer introduced to the dealers Mme. Jeanne Gordon, famous mezzo-soprano of the Metropolitan Opera Co. and exclusive Columbia artist. Mme. Gordon had planned to sing several selections but as an important dress rehearsal of "Parsifal" was scheduled to take place that afternoon, she was obliged to change her plans and was unable to sing. Mme. Gordon promised the dealers, however, that she would be present at their next meeting and would be very happy to appear on the program.

The next speaker introduced by Mr. Friedl was H. L. Tuers, manager of the Columbia Co.'s Dealer Service department and one of the

trade's foremost exponents of profitable merchandising methods for the progressive dealer. Mr. Tuers only recently returned from an extensive trip, upon which he addressed Columbia



George W. Hopkins

dealers in the leading cities of the country as far West as Kansas City.

Mr. Tuers gave a very important message to the Columbia dealers in this territory, stating that the Dealer Service department had made plans whereby a Model Shop would be installed in every Columbia wholesale branch in the country. This plan represents an expenditure of \$250,000 and the Model Shop will be complete in every detail. It will be installed in the new home of the local wholesale branch at Sixth avenue and Twentieth street as soon as possible, and the dealers will be welcome to use the Model Shop in any way which they may deem advantageous and profitable. According to present plans this shop will measure 50 feet by 25 feet, and will embody every idea or plan

which the Dealer Service department of the Columbia Co. considers worthy of recommendation to its dealers. Mr. Tuers promised that motion pictures, showing every detail of this important idea, will be ready for presentation at the next meeting of the dealers.

The next artist on the musical program was Miss Margaret Romaine, celebrated soprano of the Metropolitan Opera Co. and an exclusive Columbia artist. Miss Romaine rendered several selections, which were enthusiastically received, and she was obliged to sing a number of encores before the applause subsided. Miss Romaine has made several Columbia records which are now being offered to the public, and which, judging from all indications, will attain signal success.

The following number on the program was unique in many respects and proved to be one of the most interesting ideas that have been introduced at a dealers' meeting. The "actors" in this scene were H. E. Speare, manager of Widener's Columbia Shop at 407 Fifth avenue,



Miss Margaret Romaine

and Albert H. Lee, of the Dyckman Grafonola Shop, New York. Mr. Speare represented a salesman in a Columbia store and Mr. Lee took the part of a discriminating purchaser, who entered the store with an open mind as to the machine he wanted but with every intention of

(Continued on page 50)

ALBUMS

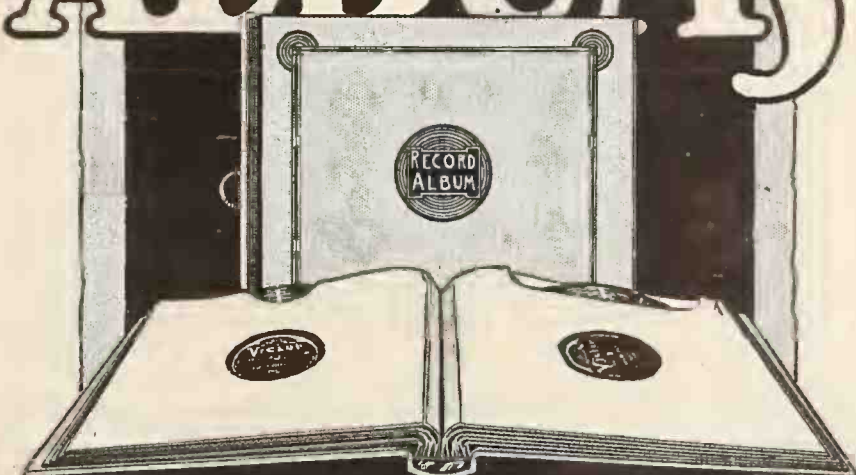

BUY DIRECT
FROM MANUFACTURER

THE BOSTON BOOK CO. INC.

57-65 Hope Street, Brooklyn, N. Y.
501-509 Plymouth Court, Chicago, Ill.



“Wond’ring,” Ted Lewis’ latest jazz, will make you wonder where the crowd all comes from when you play it in your store. A-2857.

**Columbia Graphophone Co.
NEW YORK**

MEETING OF COLUMBIA DEALERS

(Continued from page 49)

making a purchase. Mr. Speare overcame every possible “objection” offered by his customer, admirably answered every question propounded by Mr. Lee, and closed the sale of the \$250 model Grafonola amidst the enthusiastic applause of the Columbia dealers. The practical nature of this demonstration was evidenced in the keen interest of every one present and the various questions which were asked at the close of the “sale.” In response to the request of his dealers, Mr. Friedl stated that a similar demonstration would be given at future meetings.

Mr. Bauer introduced the next artist on the program in the person of Sascha Jacobsen, whose violin recordings in the Columbia library have met with a phenomenal sale from coast to coast. Mr. Jacobsen, who is an exclusive Columbia artist, favored the dealers with several selections which emphasized the excep-

tional beauty of his playing and also reflected the opinions of musical critics who predict that this young violinist will soon be entitled to recognition as one of the world’s greatest artists. Mr. Jacobsen played a group of selections which he has recorded for the Columbia library, and the dealers received his playing with hearty applause.

In introducing Geo. W. Hopkins, general sales manager of the Columbia Graphophone Co., Mr. Friedl paid a well deserved tribute to Mr. Hopkins’ indefatigable and untiring efforts in behalf of every phase of Columbia products and merchandising. A considerable measure of the phenomenal success achieved by the Columbia sales organization the past few years must be attributed to the executive acumen and remarkable merchandising ability of the company’s general sales manager. Mr. Hopkins has addressed Columbia dealers several times in the past year or two, and in his talks he has invariably embodied practical merchandising suggestions that the dealers have utilized to ex-

cellent advantage. His talks are, therefore, awaited expectantly by the dealers and the members of the Columbia sales organization, for he has the faculty of driving home straight-from-the-shoulder sales arguments that are based on sound logic.

In the opening part of his interesting address, Mr. Hopkins pointed out several distinctive features of the Columbia Grafonola that had been partially overlooked in the sales demonstration the early part of the afternoon, and these sales arguments won immediate recognition from the dealers because of their practicability. Referring to the company’s plans for the coming year, Mr. Hopkins stated that “Service is the Columbia watchword for 1920.” He mentioned some of the measures which can be followed by Columbia dealers to increase their sales of Symphony Series records, and emphasized the fact that one of the policies of Columbia advertising during the coming year will be the featuring of exclusive Columbia artists. He stated that there is not a single vaudeville artist of recognized fame and prestige who is not making Columbia records, and that Marion Harris would be a Columbia artist in June.

In bespeaking the sincere co-operation of the Columbia dealers, Mr. Hopkins called attention to the fact that the company had increased its business 100 per cent in 1919 with less dealers than it carried in 1918, its previous biggest year. This co-operation on the part of the company is further reflected in its tremendous advertising campaign inaugurated the first of the year. According to Mr. Hopkins’ figures his company is the world’s largest individual user of advertising space. It is the company’s intention to use large space in color in forty national magazines this year, with a circulation of 23,000,000. In addition to its vast advertising appropriation in the newspaper, magazine and general advertising fields, the Columbia Co. has just completed arrangements whereby it becomes the country’s largest individual user of advertising space in farm papers. Mr. Hopkins presented facts and figures which amazed the dealers because of their magnitude and which visualized the unlimited scope of the service and co-operation being afforded Columbia representatives by the company. Mr. Hopkins told concretely why the Columbia Co. considers itself a full-fledged partner with every Columbia dealer and why it is interested in developing the business of every one of its representatives along profitable and progressive lines. This address was thoroughly enjoyed by every one in the audience and Mr. Hopkins was congratulated upon the invaluable data which he had furnished the dealers as to the aims and ideals of the Columbia Co.

Ward’s Khaki Moving Covers

Distributors

BRISTOL & BARBER, INC.
111 E. 14th St., New York City

YAHR & LANGE DRUG CO.
207-215 E. Water St., Milwaukee, Wis.

COHEN & HUGHES, INC.,
Washington, D. C.

BECKWITH-O’NEILL CO.
Minneapolis, Minn.

STREVELL-PATERSON HARDWARE CO.
Salt Lake City, Utah

OHIO SALES CO.
Beckman Bldg., Cleveland, Ohio

THE REED CO., 237 Fifth Avenue
Pittsburgh, Pa.

CHAS. H. YATES
311 Laughlin Bldg., Los Angeles, Cal.

W. D. & C. N. ANDREWS
Buffalo, N. Y.

THE C. E. WARD CO.
(Well-Known Lodge Regalia House)
101 William St., New London, Ohio
Also Manufacturers of Rubberized Covers
and Dust Covers for the Wareroom



Grade “D” Cover with No. 3 Straps.

COTTON FLOCKS

.. FOR ..

Record Manufacturing

THE PECKHAM MFG. CO., 238 South Street
NEWARK, N. J.

STRADIVARA

" KNOWN FOR TONE "

NO UNCERTAINTY

A few high points of policy which make the Stradivara appeal to substantial dealers

A fixed and exceedingly high standard of Quality throughout a complete line.

A permanent and liberal sales policy. The dealer handling the Stradivara knows what he can depend upon now and for years to come.

A most enviable reputation won through sheer merit of tone, construction and finish.

* * *

To permanently insure the profits of your phonograph department you owe it to yourself to make a very careful investigation.

Your territory may be open for 1920 allotment.

Write today. It will pay you

The Compton-Price Company
COSHOCKTON OHIO





SUPREME COURT DECISION BARS RESALE PRICE FIXING

District Court of Ohio Reversed and Supreme Court Declares Sherman Law Was Violated—Colgate Case Decision Invalidated by Latest Judgment Rendered by Justice McReynolds

WASHINGTON, D. C., March 2.—Members of the trade learned to-day with surprise that the Supreme Court yesterday handed down a decision which reverses the verdict obtained last June in the Colgate case which maintained that manufacturers were within their rights in fixing a resale price for their goods. The Supreme Court reversed a Federal Court decree which held that the Sherman Anti-Trust Act did not prohibit a resale price fixing unless there was an intention of creating a monopoly in restraint of trade.

The opinion was rendered in the Government's appeals from dismissal in Ohio of indictments charging A. Schrader's Sons, Inc., with entering into a combination in restraint of trade by compelling the manufacturers to whom the concern sold its products "to execute uniform contracts concerning resales and refusing to sell those who did not enter into such contracts and adhere to uniform resale price fixed by it."

Justice McReynolds, who gave the opinion, said, in answering the opinion of the lower court, that the main defense of the defendants was that the effect of the Colgate decision was to prevent their prosecution for resale price fixing; that the opinion of the court was that this was not the intent and application of the Colgate decision, and that resale price fixing is a violation of the Sherman Anti-Trust act.

The Federal Court in Ohio in quashing the indictment construed the Sherman Anti-Trust act to mean that in the absence of allegations charging an intent and purpose to monopolize trade the statute does not make the alleged acts of the defendants a crime.

There appears to be different issues in the two cases where the resale price fixing point was involved. In June, 1919, the United States Supreme Court affirmed the judgment of the District Court for the Eastern District of Virginia sustaining a demurrer to an indictment returned in that district in December, 1917, against Colgate & Co.

The indictment charged that the defendants indicated to wholesale and retail dealers by letters and circulars and orally the prices they desired to have maintained on their products and that dealers failing to maintain such prices were placed on so-called "suspended lists" and refused further supplies until they gave assurance that the prices indicated would be observed.

The defendants said that this had been their

practice for years and that there was no intent to monopolize trade.

While the United States Supreme Court held that this method did not come in conflict with the Sherman Anti-Trust act the opposite was held in the Schrader case, just decided. An indictment was returned June, 1918, against this firm, manufacturer of valves and valve parts, pneumatic pressure gauges and other accessories in connection with pneumatic tires.

The defendants were charged by the Government with requiring tire manufacturers and jobbers to whom it sold its products "to execute uniform contracts concerning resales, and with refusing to sell to those who did not enter into such contracts and adhere to the uniform resale prices fixed by it." In this way it was alleged by the Government that competition was suppressed and prices to retail dealers and the consuming public were maintained and enhanced.

The United States Court for the Northern Ohio District sustained the demurrer and held in effect that the case came within the opinion previously rendered by the United States Supreme Court in the Colgate case, wherein it was held that the resale price fixing practiced by the Colgate firm was not illegal within the meaning of the Sherman Anti-Trust act.

MISS HOWARD MAKES HER DEBUT

GRAND RAPIDS, MICH., March 1.—E. C. Howard, well known throughout the talking machine trade through his former connection with the Widdicomb and L'Artiste phonographs, and who is now importing sapphires and diamonds for the trade, has an entirely new announcement to make to the trade. Miss Howard, weighing eight and one-half pounds, recently arrived, which has caused Mr. Howard to lay extensive plans for the increase of his business so that young Miss Howard may have all the comforts of life which are rightly hers.

RUTLAND STORE ADDS NEW BOOTHS

The United Talking Machine Co., Rutland, Vt., which is located at 7 Center street, is making improvements on its present store and has doubled the number of demonstration booths. This latest addition makes a valuable improvement in the store equipment.

PLAZA

BUY YOUR ACCESSORIES
"All From One Source"

Supertone

American Made

Steel Needles

EXTRA LOUD LOUD MEDIUM SOFT HALF TONE

Only the finest grade of Carbon Steel wire is used in our product.

The points are ground by experts. Thus you are assured of a uniform product of consistent high quality.

This means superior tone quality, maximum volume and minimum surface noise.

Packed in tin boxes of 200, in envelopes of 100, or in bulk.

Can be supplied in Extra Loud, Loud, Medium, Soft and Half-Tone.

Write for Samples and Prices

REPAIR PARTS
NEEDLES
CLEANERS
ENVELOPES
SAPPHIRES
ALBUMS
RECORDS

ALL FROM ONE SOURCE

PLAZA MUSIC CO. TRADE MARK

IOWA DEALERS
LOOK US OVER

We are the Iowa Distributors of

Vitanola Phonographs
"THE PHONOGRAPH OF MARVELOUS TONE"

— AND —

Story & Clark Pianos
"MANUFACTURED SINCE 1857"

We Are Equipped To Give You Service

E. H. JONES PIANO CO.
DES MOINES Shops Building IOWA

PLAZA MUSIC CO.
18 WEST 20TH STREET
NEW YORK



The Proof of the Pudding—

“The proof of the pudding is in the eating thereof.”

The proof of the merits and value of a talking machine is had by comparing it with other talking machines.

The salesman who sells talking machines may tell, fairly well, by the way the cabinet looks, how it will sell. But it takes a careful examination and test of the instrument to learn of its true worth. The cabinet work and its finish must be examined. The hardware must be scrutinized. The motor must be gone into. And last, but not least, the tone must be thoroughly tested.

If this test is applied to a Crippen “Interpretone” it will be found to be ten years ahead of any other talking machine on the market in salability.

In cabinet work and finish, in size, in hardware and in its motor it is on a parity with any talking machine made which sells for an even hundred dollars more, at retail.

But in tone—it is superior to all other machines at any price. There is a clarity and life-like character to the tone of the Crippen “Interpretone” such as have not, heretofore, been produced on any talking machine, it matters not what its size or price—and this can only be determined and experienced *by comparison*.

I will ship any reputable talking machine dealer in the United States a Crippen “Interpretone” by express, at my expense.

He may make any test with it he wishes.

He may test it beside any other talking machines he likes and with any and all records he likes.

If after 10 days’ test he is not thoroughly convinced that my Crippen “Interpretone” is the “best talking machine buy” on the market, and if he cannot see that it is a machine with which he can make a lot of money, he may ship it back—also at my expense.



If on the other hand he is thoroughly sold on the machine, as I know he will be, we will then get together on the details for his representation of it.

Walter Crippen

President

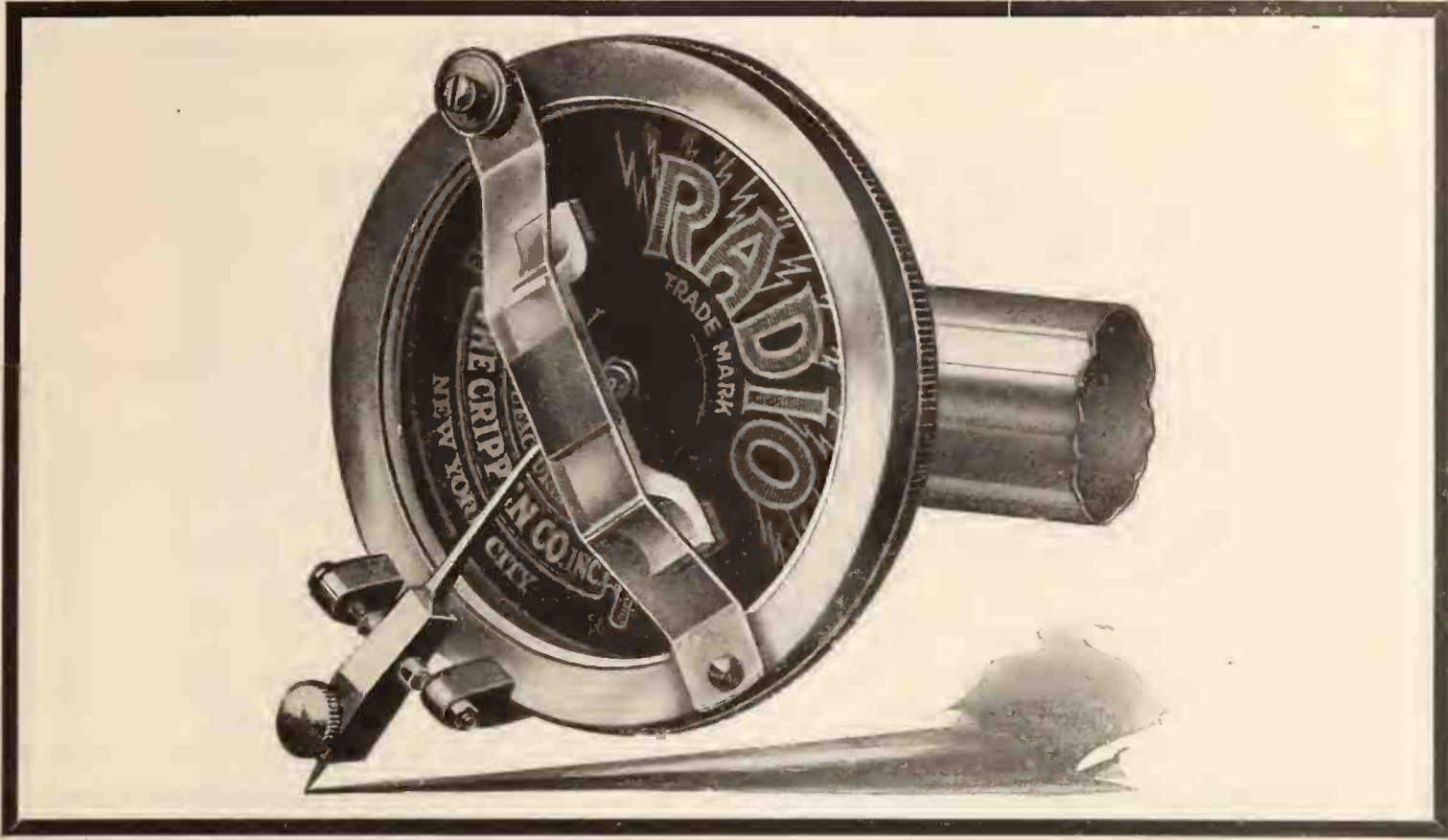

Radio Sound Box

Just as the dampers make the piano possible, the damping device incorporated ONLY in the Crippen "Interpretone" puts it ten years ahead of any talking machine on the market, and makes it **the most widely discussed machine of recent years.**

Specifications

The Crippen "Interpretone" has a mahogany veneered case, 45 inches high, 20 inches wide, 22 inches deep. It has a Revolving Record Cabinet (a remarkable selling feature) equipped with 8-record albums, each holding four ten-inch and four twelve-inch records. Plush Turntable that runs true. All metal work gold plated. "Radio" Sound Box of concert size entirely different from anything hitherto placed on the market. It is the only box which eliminates interference of one tone with the succeeding tone. System of "damping" has been introduced. Suspended Non-Rigid Horn. **Machine guaranteed for one year, which includes spring breakages.**

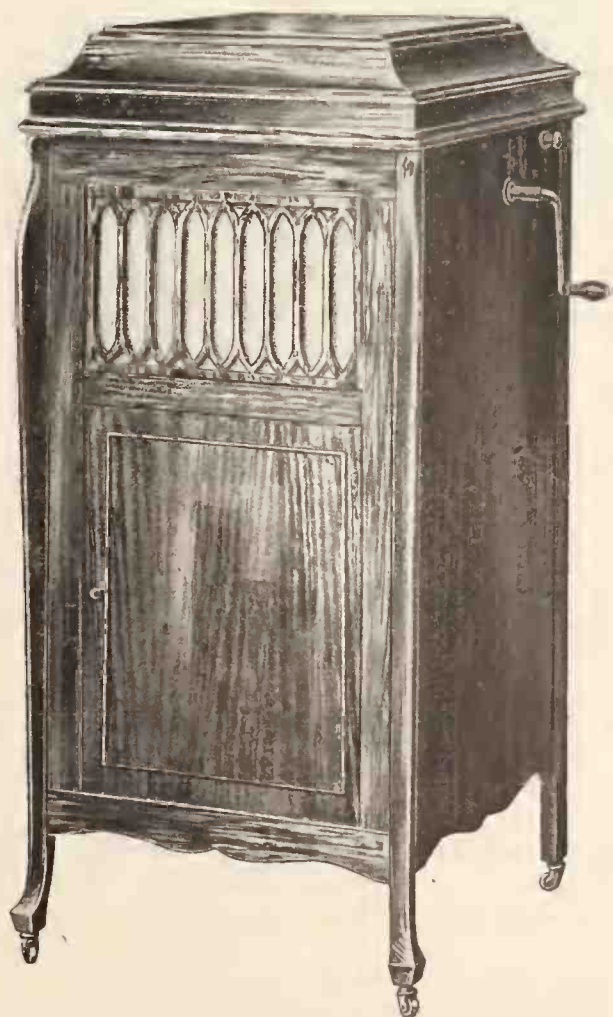

We can guarantee deliveries

THE CRIPPEN COMPANY, INC., 437 Fifth Avenue, New York



Barrientos and Stracciari, in their beautiful duet from *Rigoletto*, are two great opera singers in a supremely dramatic aria. Columbia 49611.

Columbia Graphophone Co.
NEW YORK

BRUNSWICK AT INDUSTRIAL SHOW

Attractive Exhibit a Feature of Indianapolis Show Staged by the Optimists' Club

The Optimists' Club of Indianapolis, Ind., staged an industrial show at Tomlinson Hall during the week of February 17 and one of the prominent displays was that of the Brunswick



Brunswick Display at Optimists' Club Shop. George Standke, manager of the shop, is the member of the club representing the talking machine industry. This display was designed to bring out the special points of the Brunswick machine and the Brunswick method of sound reproduction and received many favorable comments from members of the trade.

THE VALUE OF INITIATIVE

Initiative is a big factor in scoring success in private or business life, and it is interesting to note Elbert Hubbard's definition of what is initiative. He said: "It is doing the right thing without being told. But next to doing the right thing, without being told is to do it when you are told once. Next there are those who never do a thing until told twice—then there are those who do the right thing only when NECESSITY kicks them from behind." To which category do you belong?

CHANGES AND ADDITIONS IN VICTOR TRAVELING STAFF

Important Announcement Made by the Victor Talking Machine Co. Regarding the Respective Territories to Be Covered by the Various Staffs

The following important additions and changes have been effected in the traveling department of the Victor Talking Machine Co. The new members of the staff and their respective territories are as follows:

T. L. R. Husselton, North and South Carolina, Georgia and Florida.

O. C. Pearson, Iowa.

E. R. Dunning, assistant to Mr. McCready in New York City.

P. G. Roberts, New York State.

William B. Gannon, Michigan.

The changes just announced by the Victor Talking Machine Co. are as follows:

Harold B. Smith from New York State to Philadelphia.

W. E. Witham from the Pacific Coast to Pittsburgh and West Virginia.

W. G. Gaston from Eastern Pennsylvania to the Northwest Coast.

R. H. Bartley from Iowa to Eastern Pennsylvania.

In addition to the above changes, Harold Lamor, who formerly traveled in Michigan, Wisconsin, New York State, Pittsburgh and Western Pennsylvania, has resigned to become affiliated in an important capacity with Collings & Co., Victor wholesalers of Newark, N. J.

CLOSES DEALS IN THE WEST

L. B. Williams, of Independent Talking Machine Co., Takes Orders From World Ad

L. B. Williams, sales manager of the Independent Talking Machine Co., returned early this month, after visiting several of the trade centers in the Middle West. He was successful in closing negotiations with several large firms in the territory mentioned for the exclusive state rights of Independent machines.

After arriving in Chicago it was found that Mr. Williams' baggage, which contained, among other things, the new Independent model No. 110, had been lost in transit. This forced him to close his deals from photographic reproductions of the machines which he found in his firm's advertisement in the February issue of *The Talking Machine World*, copies of which he obtained from the Chicago office of *The World*.

The Vitanola department of the Johnston Furniture Co., 227-229 South Main street, Memphis, Tenn., has been considerably enlarged.

F. C. KENT CO. REORGANIZED

Incorporated With Capital Stock of \$125,000—
F. C. Kent Elected President

The F. C. Kent Co., Newark, N. J., well-known manufacturers of Kent tone arms and sound boxes, and specialists as manufacturers of attachments for Edison machines, recently filed papers of incorporation with an authorized capitalization of \$125,000. The following were announced as officers in the reorganized company: F. C. Kent, president and general manager; Robert L. Kent, Jr., vice-president and production manager; Wilfred S. File, secretary and treasurer.

The F. C. Kent Co. has during the past year felt a steadily increasing demand for its products and this has necessitated the company not only enlarging its plant, but installing much new equipment, especially designed by F. C. Kent, head of the company, and among the machines is one for the purpose of manufacturing tone arms, the parts of which are turned out under a high pressure hydraulic process.

Wagner Phonograph Co.

139 EAST FIFTY-FOURTH STREET

NEW YORK CITY

Offers to the Trade:

Motors: Double and triple Spring, of any standard make :: :: ::

Needles: Brilliantone, any tone. :: Cabinets: Any size and price.

Tone Arms: With sound boxes, springs, lid supports, turntable felts

Large Selections in Standard Make RECORDS



Individuality

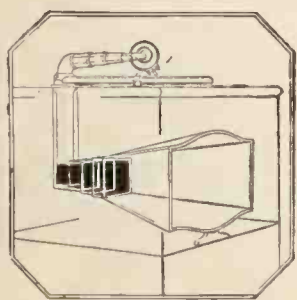

Through a series of orchestral chambers, The Cheney gains complete mastery over its tones, and gives them that rich quality which distinguishes the original from an ordinary reproduction.

THE CHENEY is an instrument of remarkable individuality. Its rendition of all records sets it in a class apart.

More than melody and harmony are revealed in the music of The Cheney. Its delicacy of tonal shading reflects the very personality of each artist.

The acoustic principles of the violin and pipe organ, have been combined in The Cheney. Through the special construction of The Cheney reproducer, needle scratch and mechanical noises are muted. Basic patents protect Cheney individuality, every dealer's franchise is invaluable.

The CHENEY

CHENEY TALKING MACHINE COMPANY

CHICAGO

AROUSING INDIANAPOLIS PUBLIC TO THE NEED OF MUSIC

Great Campaign Under Way Will Help Talking Machine Trade—Experience With Mail Order Houses—Columbia Dealers Meet at Lincoln Hotel—Interesting News Budget of Month

INDIANAPOLIS, IND., March 5.—A campaign to arouse the interest of the public in music has been started by the Indianapolis park and school boards and Community Service, Inc., that should prove a big stimulant to the music business. "Like music?"

This two-worded question will be blazed into the public's mind in advertising all the musical enterprises the municipal authorities will sponsor. A municipal musical program covering the next six months has been prepared, including band concerts, community sings, orchestra recitals and organ recitals.

The talking machine is playing an important part in the effort of the school authorities to get school pupils familiar with the best music. The high school students are now preparing for a music memory contest. Fifty selections of the best music have been made for the students to become familiar with so that when they hear the airs they can name the selection and give the composer's name. The talking machine is being used to get the students trained to know the selections.

Each of the three high schools will conduct a test soon and the ten students making the highest grades in the music contest from each of the high schools will be entered in a public contest, when certain pieces will be played by orchestra or band. Like the old-fashioned spelling matches, the contest will be carried on until the winner is determined.

Edward Birge, director of music in the Indianapolis schools, is endeavoring to arrange with the school board to permit prizes to be awarded in the music memory contest. Mr. Birge said that C. M. Tremaine, of the National Bureau for the Advancement of Music, had offered to give a prize and that several talking machine dealers had offered to contribute prizes. The dealers are highly pleased with the musical campaign and they believe it will result in bringing more musical instruments into the homes.

J. B. Ryde, of the Fuller-Ryde Music Co., had an experience with a purchaser of a mail order house talking machine which he said shows the mistake people make in ordering machines through such houses. A man brought in a motor from the mail-order machine and wanted to know whether it could be repaired. Mr. Ryde looked at the motor and told the man that his shop was not prepared to repair it. The man became very indignant, but before he left Mr. Ryde impressed on him the fact that had he purchased a reliable machine from a

reliable local dealer he would have had no difficulty at all in getting it repaired.

"Here was a man who invested more than \$100 in a machine and yet as far as its ability to give him music was concerned, it was worthless," commented Mr. Ryde. "Now he might be able to send it back, but all the time he is waiting, he is without music which he has paid for and is entitled to. Local dealers should never forget the service they are able to give their customers and this fact should be impressed on the public's mind."

Gennett records are enjoying a heavy demand and their sales are steadily increasing in volume, T. H. Bracken, manager of the Starr Piano Co. branch, reported. C. H. Sallee, sales manager of the store, has left to accept a position with the American Piano Co. in New York City. B. T. Clay succeeded Mr. Sallee as retail sales manager of the Starr store.

E. R. Eskew, manager of the Pathé Shop, told The World that the February Pathé business was exceedingly good and Mrs. J. Ellison Fish, manager of the Pearson Piano Co.'s talking machine department, reported the heavy record business continues. H. E. Whitman, of the Circle Talking Machine Shop, said that the chief complaint was the shortage in Victor goods.

Sickness has crippled the sales force of the Widener's Grafonola Shops, Inc., and the rush of business has kept W. G. Wilson, manager, on the jump. Miss M. Byfield has been added to the record sales force.

Columbia record business has been very brisk at the Baldwin Piano Co. store, C. P. Herdman, manager, said. Ernest Arthur, manager of the Sonora department of Charles Mayer & Co., is boosting Sonora business through a series of clever newspaper advertisements.

W. F. Standke, brother of George Standke, manager of the Brunswick Shop, was a visitor here last week. W. F. Standke and Otto Standke, brothers, run the Grafonola Shop in Kansas City, Mo.

C. O. Mueller, in charge of the talking machine department of the Mooney-Mueller-Ward Co., distributors of the Pathé line, reported that the Pathé dealers were highly gratified at the way Pathé record hits were getting out first. J. M. Wallace, Jr., of the Wallace Music Co., of Marion, who visited here last week, reports that the Wallace store is adding six new booths to the four it already has to take care of increased business. The D. N. Foster Co., of

this city, is putting in three demonstration booths in its Pathé department. The Spurgeon-Baum Co., of Anderson, is putting in demonstration booths for its Pathé business.

The Amplifone Co. is receiving orders from all parts of the world for the Amplifone, some of the latest sales being to McAlpin's Dry Goods Co., Cincinnati; the Penn Phonograph Co., Philadelphia; A. Hamburger & Sons, Los Angeles, Cal., and the Root Dry Goods Co., Terre Haute, Ind. Carl Anderson, of the company, has gone to Chicago to arrange with the Chicago Telephone Co. for the use of Amplifones in the Chicago Loop district. An inquiry has been received about this telephone device which is used in selling records and machines over the telephone from a World subscriber in Norway.

Cuyler Supplee, Indiana representative of the Victor Co., spent several weeks this month in visiting the local Victor dealers. He arranged with the seven local Victor dealers for co-operation in newspaper advertising, it being arranged so that at least one Victor dealer's advertisement will appear in every issue of the newspapers during the week.

The Stewart Talking Machine Co., Victor distributor, held its second monthly salesmanship course for Victor dealers and retail salesmen this week. George Stewart reported that the Victor shipments continued to improve.

A meeting of Columbia dealers was held at the Lincoln Hotel on February 26, which was attended by twenty-five dealers. Preparations were perfected by the Columbia dealers for Novelty Record Week. The dealers reported that the Green Label records are becoming more and more popular and that "Something Different" is greatly in demand. There was discussion of the various ways and means of appealing to the country trade.

Ben Brown, manager of the Columbia Indianapolis district, called attention to the exclusive Columbia artists booked in Indianapolis during March—Al Jolson, Bert Williams, Van and Schenck—and the dealers are planning to boost the sales of records by these artists.

The A. C. Hoffer Music Co., Vincennes, Ind., has just opened its new music shop, which handles Columbia Grafonolas and records exclusively. The Kaufman Hardware Co., at Anderson, Ind., has also opened a very attractive Grafonola department.

The concerts of Sascha Jacobsen, violinist, and exclusive Columbia artist, at New Albany, Ind., under the direction of the Gable Furniture Co., and at Bowling Green, Ky., under Will B. Hill, Columbia dealers, were a tremendous success, and the Columbia Stellar Quartet, booked at these places April 22 and 23, are eagerly awaited.

If you want the Best, insist on getting

The De Luxe Stylus

THE BEST SEMI-PERMANENT NEEDLE MADE

Plays 100-200 Records

Produces Rich, Clear Tone

FULL TONE

MEDIUM TONE

3 for 30 cents

LET THE "DE LUXE" SPEAK FOR ITSELF AND
SEND FOR FREE SAMPLES, DISCOUNTS, ETC.

DUO TONE COMPANY, Inc.

Manufacturers of Talking Machine Needles

ANSONIA, CONN.

The Cardinal



The Manor Model—An excellent piece of cabinet work and an instrument of perfect reproduction



An Ideal Line to Handle

Real value is so obvious in Cardinal Phonographs that they always find ready sale wherever they are displayed. To a customer they immediately look like *more for his money*—they sound like better instruments than he thought such a price would buy. He *sees* the quality—*hears* it—and *buys* the Cardinal on the strength of it.

We invite comparison. Stand any Cardinal instrument alongside a similar type of phonograph from some other line. Note, first of all, the Cardinal's excellent cabinet work and its beautiful symmetry of design. Then play the same record on both instruments. Compare the Cardinal's rendition with that of the other. Note the velvet smoothness of its reproduction. Make a thorough test of this kind and you will quickly see why the Cardinal is *an ideal line to handle*.

We will gladly grant exclusive territory to the man who can handle it. Get in touch with us today for proposition.

**The Cardinal
Phonograph Company**

NEWARK, OHIO

Factories at Zanesville, Ohio

CLOSED MANY IMPORTANT DEALS

Kesner & Jerlaw Have Been Displaying Their Line of Instruments in the Pennsylvania Hotel for the Past Month With Splendid Success

Kesner & Jerlaw, manufacturers of the Sonata phonograph, and specialists as producers of exclusive phonographs for jobbers and large distributors, had a display of their line in room 1420-21 in the Pennsylvania Hotel, New York, during the month of February, and they closed a number of important deals with several large jobbers and other users of talking machines in quantity.

The Kesner & Jerlaw line is known for its

necessary to state that their shipments to the trade average over a car-load a week to the individual house. During the most trying periods of the past season their deliveries were very prompt, and much of this was due to the fact that two of their eight factories are run by water power. Herewith is reproduced the original Kesner & Jerlaw factory, Quincy, Ill., from which they have progressed until they now have eight large plants situated in Chicago, Ill., Dayton, O., and Ostego, Mich. All their plants are most modern and the shipping facilities are of the best.

The 1920 volume of business of the firm will be much larger than that of 1919, inasmuch as plans are already in effect to increase the output,

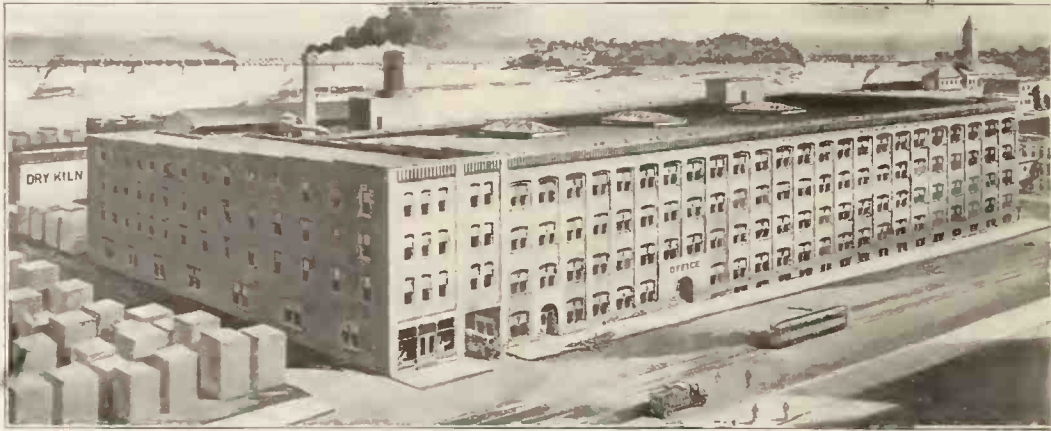

Plant of Kesner & Jerlaw in Quincy, Ill.

distinctive cabinet workmanship and the equipment throughout is of high grade. The machine has large tone volume and the amplifying horn is all wood.

The executives of the concern state that the biggest part of the territory of this country has now been contracted for, and the duplicate orders received for the year 1920 show that their machines have given excellent satisfaction.

The company are proud of their reputation for prompt deliveries, and to show the size of the houses they are doing business with it is only

and according to the officers of the company this will be done without lowering the standard of their products. It is estimated that they will have an output of well over 100,000 machines during the year 1920.

Smith Bros., Ridgway, Pa., have moved their Victor department from the second to the first floor of their store, which is now one of the finest show rooms in Pennsylvania. Their equipment includes six large new booths and extensive record racks.

EFFICIENT ENVELOPE SERVICE

Lu-Franc Sales Service Co-operates with Victor Dealers to Excellent Advantage—Service Requires Speed and Precision

DETROIT, MICH., March 6.—The Lu-Franc Sales Service of this city, manufacturers of record envelopes for Victor dealers, has received many letters during the past few months commenting upon the value of the service that it is rendering to the trade. This company has built up a country-wide demand for its envelopes, and on the first day of every month enterprising Victor dealers in every locality receive from the Lu-Franc Sales Service a new supply of record delivery envelopes, printed in a very attractive fashion and carrying advertising with a "punch" to it that helps sell records.

The extent and scope of the service offered the dealers by this organization are visualized when it is considered that the Victor Talking Machine Co. rarely has its advance list of new records ready more than thirty days before the records themselves are offered for sale to the general public. As the Lu-Franc Sales Service incorporates in its advertising these new lists of records, as well as lists of previously issued records, it is not difficult to realize how fast the company's organization must work in order to co-operate efficiently with the subscribers to its service. No time is lost in the making of the engravings from which to print the envelopes, the actual printing, the preparation for shipment and the shipment of the completed envelopes, and regardless of the dealer's location the envelopes are in his hands before the first of the following month. This work is accomplished with a smoothness and precision that is little short of marvelous.

Bartenders are fast forgetting their wine lists and are learning the names and tunes of the latest syncopated melodies. Thus music has a new mission.

OKeh Records

We Have Them

We have the new February Releases and shall be glad to demonstrate them to you. All the latest and best in vocal and dance music—a quality record.

COMPLETE CATALOG AND SAMPLES READY FOR YOU

The Steinola Company, Inc.

1113 WALNUT STREET

KANSAS CITY, MO.

The Sign of a Good Shop
DID YOU GET YOURS?

Tonofone HAS NO EQUAL
NO OTHER IS LIKE IT
IT HAS SET A NEW STANDARD

ASK FOR

Tonofone

THE MASTER NEEDLE



Plays All Records
on All Machines
Plays 50 Records
and Plays them Right
Gets All the Tones
but Not the Scratch

4 for 10¢

ABOVE IS PHOTOGRAPHIC REDUCTION OF 11x15 IN. ART POSTER IN 5 COLORS
EMBOSSSED ON HEAVY BOARD WITH EASEL BACK AND CORD HANGER
FURNISHED FREE TO DEALERS WHO SELL TONOFONE NEEDLES

EASTERN AND EXPORT REPRESENTATIVES
EMERSON INTERNATIONAL, INC.
1780 BROADWAY, at 57th STREET
NEW YORK CITY
PHONE, CIRCLE 3;8;2;2

WRITE FOR FULL PARTICULARS
AND NAME OF NEAREST
DISTRIBUTOR

INVENTORS AND SOLE MANUFACTURERS
R. C. WADE CO.
110 SOUTH WABASH AVENUE
CHICAGO
PHONE RANDOLPH 2045

PLAZA

BUY YOUR
ACCESSORIES
"All From One Source"



PERFECTION RECORD ALBUMS

THE ALBUM OF QUALITY

These albums are made of heavy stock and neatly bound with the finest grade of Binder's Linen.

The pockets are made of the best grade of green kraft paper, bound securely together, and protected by metal ends that insure long life.

In fact, Perfection Albums are constructed with a view to giving maximum service under constant use.

We carry large stocks on hand at all times, so that your wants will be promptly supplied here.

For Victor, Columbia, Pathe and Edison Records.

Write for Prices



PLAZA MUSIC CO.
18 WEST 20TH STREET
NEW YORK

SPECIALIZING IN SALES OF TALKING MACHINE RECORDS

Departments for Special Records Leading Rapidly to the Formation of the "Opera Room," "Concert Room," "Jazz Parlor" and Other Features That Appeal to Buyers

As developments become apparent in talking machines and records, ways and means materialize for marketing these products most efficiently and successfully. Those engaged in the retail trade perceived years ago that they were not engaged in a fly-by-night industry and, therefore, began to build up their establishments on a permanent basis. As the trade advanced, methods of handling the trade progressed, until to-day many of the talking machine establishments throughout the country are veritable palaces of music, with thousands of dollars invested in attractive equipment alone.

What the future holds for the talking machine establishment is an interesting question, but recent developments would appear to indicate that the day of the talking machine shop with special departments is coming fast. In a number of shops already there have been introduced departments devoted exclusively to this or that type of records. One concern out West has gone so far as to make a special appeal to the children by including in its remodeled quarters a children's room, decorated and furnished with special reference to the tastes and requirements of the little ones, with Mother Goose wallpaper, small tables and chairs, and all that goes with the usual nursery. In this room the little ones can remain while they listen to records of Mother Goose and Uncle Remus stories, or play songs or other music that appeals to the kiddies.

It is only another step to the "opera room," the "concert room," or the "jazz parlor," where the record customer may listen to operatic concerts or popular songs as he will in an environment best calculated to be in harmony with the class of music selected, and which he desires to hear.

The power of suggestion is a big factor in salesmanship and explains why talking machines, pianos and other similar articles are displayed amid normal furnishings of a room at home, thereby giving the prospective purchaser an excellent idea of how the instrument will look when placed in his own domicile. An opera room, the walls of which are hung with scenes from the various popular operas and with portraits of noted artists, while the demonstrating machine is devoted entirely to the reproduction of operatic records, is calculated to keep the mind of the customer in proper tune for the buying of records of the better sort.

A number of talking machine stores already have large departments devoted exclusively to the demonstration and sale of foreign records, that is, records in foreign languages, and it is not beyond the realm of possibility to see some of these stores divide their foreign record departments in order that a special room may be provided for the demonstration of records in each language.

So many talking machine establishments have already shown the way in the matter of providing separate rooms for special purposes that it would seem that it will not be long before the practice becomes general. It is the latest development in distributing methods.

REMARKABLE VOCALION EXHIBIT

Large Model of Record Mounted on Truck Attracts Much Attention in Hamilton, Ont.—Prepared by Nordheimer Co.

HAMILTON, ONT., March 5.—An Aeolian-Vocalion record eight feet high was recently



Featuring the Vocalion in Hamilton exhibited on a motor truck through the streets of Hamilton, Ont. In the evening it was lighted with electric lamps, the power being generated by the motor of the truck. This novel display was arranged by Harry Bolton of the Vocalion department of the Nordheimer Piano & Music Co., Ltd., Hamilton branch, and to him credit is due for the working out of the scheme. This display created great interest in Hamilton and materially stimulated the sale of Vocalion records in the "Ambitious City."

PRESERVE PHONOGRAPH RECORDS

WITH A



"TONAR"

TRADE MARK

RECORD BRUSH

Our special treatment not only removes the dust but lubricates the record so as to bring out the most delicate tone qualities

It Not Only Cleans But Preserves the Tone

RETAIL PRICE, FIFTY CENTS

PARKS & PARKS, Inc.

TROY, N. Y.

New York Office, C. E. Peabody & Co., 143 Chambers St.

NO PHONOGRAPH
COMPLETE
WITHOUT IT



*Invented by JOSEPH MENCHEN inventor
and patentee of the first liquid fire
appliances used by the Allied armies*

VACUUM RECORD LIFTER

THE FIRST RECORD LIFTER ON THE MARKET

IT RAISES THE RECORD WITHOUT TOUCHING
THE TONE ARM · IT PREVENTS SCRATCHING
THE RECORD · AVOIDS SOILING YOUR FINGER
NAILS · NOTHING TO GET OUT OF ORDER,
NEVER WEARS OUT · CAN BE ATTACHED TO
ANY MACHINE WITHOUT THE USE OF TOOLS.

Its a 1919 Master Patent!

DIRECTIONS :

Press your finger downward on the lifter until the cup
grips the record, place other hand beneath the record,
remove finger slowly from the vent and record is released.

Price: Nickel plated \$2.50 complete. Gold plated \$3.50

To obtain more detailed information concerning the Record
Lifter write your jobber—or
better still, write directly to us.



VACUUM RECORD LIFTER Ltd.
701 SEVENTH AVENUE, NEW YORK CITY, U.S.A.



Trade Mark
Registration
Applied for

Do ALL of Your Customers Know the Advantages of the B & H Needle?

SOME do — and they are the enthusiastic clientele of constant buyers, the record collectors — but do they *all* know that records last forever when played with B & H Fibre Needles?

Are they familiar with the Fibre Needle's pure, sweet, unalloyed reproduction of the best operatic and orchestral selections, free from scratch?

Suggest these facts to your customers. It is decidedly to your interest to do so. Make them realize that it is *safe* to buy expensive records if they buy B & H Fibre Needles, too. Do this and watch the increase in your record sales.

B & H FIBRE MFG. CO.

33-35 W. Kinzie Street, Chicago, Ill.

SOME PLAIN TALK ON MACHINE SITUATION IN NORTHWEST

Invasion of "Cheap" Machines Hurting Legitimate Trade—Dealers Urge Manufacturers of Established Makes to Supply Market—Beckwith-O'Neil Co.'s Handsome New Quarters—News of Month

MINNEAPOLIS and ST. PAUL, MINN., March 7.—Unless the manufacturers of the well-established makes of talking machines take some decisive action toward supplying the Northwestern demand they will find their market to a large extent ruined. This is not a bluff to expedite the shipment of talking machines into the Twin City territory, but a bald statement of the convictions of all the talking machine dealers, wholesalers and retailers in this territory, as gathered by *The World*. Already great damage has been done and it is not going to be any easy task to make repairs.

Ever since the shortage of talking machines became acute machines inferior in quality have been appearing in the Minneapolis and St. Paul territory. The numbers have increased by leaps and bounds and scores upon scores of practically unknown and poorly constructed machines have been literally dumped upon the market.

Certain sash and door factories, box factories and other kinds of industrial plants have been converted into talking machine factories, although the concerns were and have been without experience in the manufacturing of musical instruments and had not an organization trained for such work. The output of these assembling plants has been sent in large part into the Northwest, and now there is a deluge. As a result well-established retail talking machine houses by the hundreds have undertaken to add piano departments, feeling better assured of good profits in this end of the music business as against their old stand-by, the talking machine.

Much of the stuff referred to above is trash, but it has been bought and paid for and taken the place of the more reputable machines. The promoters are working tooth and nail to push the wares, while the pushing is good, while the legitimate dealers who would not touch the clap-trap with a pitchfork see their sales disappear by the hundred.

If the manufacturers of the machines which are regarded as high grade wish to retain this great Northwest as a lucrative territory it behooves them to take speedy measures to ship goods into the territory and then to join with the retailers in an aggressive campaign for eradicating the toadstools. So say all the phonograph dealers and the foregoing language, though strong, may be attributed to any of them.

Business is fine in spite of the active competition of scores of "opportunist" assembling houses. Machines of good quality are appearing in greater and greater numbers and there is a fervent hope in every breast that the manufacturers now have adequate facilities for producing an output that will be commensurate with the demand.

Jay H. Wheeler, Pathé manager for the G. Sommers Co., returned last week from New York, where he visited Pathé headquarters when the condition of municipal traffic would permit. He was filled full of hope by the optimistic talk of the Pathé chiefs and is home confident that there will be enough machines consigned to him to meet all the normal calls. Mr. Wheeler reports that the volume of trade continues to increase with each succeeding month. The new Actuelle has become an excellent seller and has attained a degree of popularity that Mr. Wheeler frankly acknowledges he at first thought was impossible.

George A. Mairs, the Victrola mogul for W. J. Dyer & Bro., also visited New York. His objective was the general office of the Victor Co. He was highly elated over the strenuous efforts of the company to increase its output and hopes that all the promises and assurances handed him in New York will eventuate into facts.

P. Benson, one of the old-time music dealers of Minneapolis, has bought the building at 1227 Washington avenue S., and is making alterations. He will greatly increase the space for all departments and particularly the Victrola department.

Two cars of Edison phonographs reached Lawrence H. Lucker one day last week. Minnesota demanded fourteen machines, which already had been sold and as many more as could be spared. It was allotted eight machines to cover the fourteen, the remainder of the two carloads being scattered over the Northwest.

It does one good to hear E. F. O'Neill, of the Beckwith-O'Neill Co., tell about the establishment he soon will dominate at 14-16 South Fifth street, Minneapolis. This he hopes will be the great Victrola distributing center of the Northwest and he correspondingly is elated and enthusiastic. The building is five stories high, has a frontage of sixty-six feet, is located midway between Nicollet and Hennepin avenues, the two leading retail business streets of Minne-

PLY-WOOD HORNS
(Phonograph Sound-Chambers)
 U.S.A. PATENT No. 1047789-1912
 (and corresponding foreign Patents)
Inventor and Registered Proprietor:—
J. GREEN
 38 Rutland Gardens - Hove, Sussex, England.

apolis, and is right across the street from the General Electric Co.'s building, the most brilliantly lighted building in the Northwest. So Beckwith-O'Neill will virtually be in the limelight all the time and at slight expense. There could be no better location for a Victrola headquarters than the one chosen.

The first and second floors will be sublet. The three upper floors, which will be reached by a private elevator, will be devoted entirely to Victor business. The third floor will be devoted to the executive offices, the fourth to show and storage rooms and the fifth to records, with equipment for a million or more. The work of remodeling is under way and will cost about \$35,000. The new Victrola home should be ready for occupancy about the middle of April, according to the Unico construction representatives on the job. It cost a bonus of \$20,000 to obtain possession of the lease, which has fifty years to run.

Two hundred Dardanella records reached the Metropolitan Music Co. one day last week—by express—and every one was gone within two hours, according to the veracious J. A. Simon, head of the talking machine department.

Miss Gladys Hutchins, manager of the Victrola department of Davis & Rubin, has gone to Washington to visit her father, who is ranching in the Wenatchee valley.

Walter E. Polzin, a well-known dealer of Rapid City, S. D., died February 13, from an old ailment. He came through the Twin Cities not long ago on his way to the Mayo Hospital at Rochester for an operation.

PROFIT SHARING FOR EMPLOYEES

The Pacific Phonograph Mfg. Co., Portland, Ore., will in the future be operated on the profit-sharing basis. This plan has been tried out in some departments of the factory and has proved so satisfactory that it has been adopted in the entire plant. Shortage of material from the East no longer hampers production, it is said, and the plant is running at capacity turning out the Stradivara machine.

W. A. Carey of Rochester, N. Y., has increased his business and has taken the name of the W. A. Carey Talking Machine & Record Co. For some time Mr. Carey has been engaged in selling talking machines at his store on State street and the growth of trade decided him to enlarge.



ARE YOU LOOKING

for something new and different? Are you interested in improving the appearance of your record delivery envelopes? Do you want to advertise YOUR Victor store in a way that will command attention? Yes? Then clip the coupon on page 45 or pin this ad to your letterhead and mail to

LU-FRANC SALES SERVICE
 1202 Dime Bank Bldg. Detroit, Mich.

PHONOGRAPH ENVELOPES IN STOCK

PROMPT DELIVERY

What Are Your Requirements?

WE SPECIALIZE ON PAPER AND PAPER PRODUCTS FOR PHONOGRAPH MANUFACTURERS AND DEALERS. LET US HELP YOU SOLVE YOUR PROBLEMS FOR PACKING PHONOGRAPHS, MOTORS, HARDWARE, ETC.

P-A-P-E-R

H. G. Neu & Co.,

108 WORTH STREET
 NEW YORK CITY



Phonograph Motors

*Motors That Meet
YOUR Requirements*

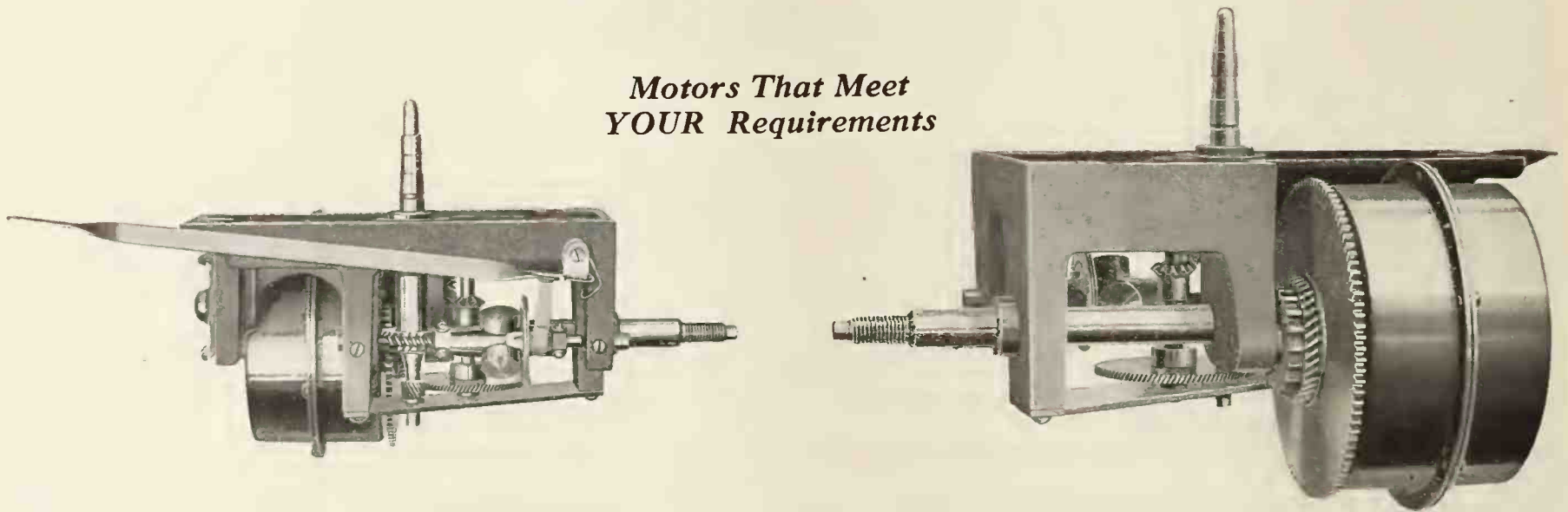

Quality Motors—Prompt Deliveries

We manufacture motors, tone arms and reproducers for some of the largest phonograph makers in the country.

Our product is guaranteed A-1 as to material, workmanship, silence and general qualities. An enlarged, completely equipped plant enables us to keep the supply up to the demand.

Covered on our material requirements, we can assure a reliable source of supply. The fact that leading phonograph concerns find our products satisfactory in every way is sufficient recommendation of their high quality and mechanical perfection.

Phonograph makers, jobbers and dealers needing a *dependable* supply of motors and tone arms will find it greatly to their advantage to get in touch with us at once.

SALES DEPARTMENT

UNITED MANUFACTURING & DISTRIBUTING Co.
LAKE SHORE DRIVE AND OHIO ST. CHICAGO, ILL.

THE VALUE OF MUSIC AS A THERAPEUTIC

Prominent New York Physicians and Musicians Organize to Develop Definite Plans to Determine by Experiment and Analysis the Exact Value of Music as a Therapeutic Agency

The talking machine will soon occupy an established place as a medium for treatment under the new methods of therapeutics which are being formulated by prominent New York physicians and musicians, who have organized with a view to carrying out certain definite plans to determine by experiment and analysis the exact value of music in healing diseased mind and body. Prominent in the movement are such men as Charles D. Isaacson, editor of the Music page of the New York Globe and a writer on many musical subjects, and Dr. Siegfried Block, a well-known neurologist, who is chairman of the new organization. These two men have for several years carried on experiments in musical healing and will ask all physicians and surgeons to submit results of any observations made by them on cases where music has been a factor in the treatment. Mr. Isaacson will undoubtedly prove a most valuable witness for the proponents of musical therapeutics. He has actually been applying the musical treatment—under medical direction, of course—for over five years. His field has covered such institutions as Bellevue, Central Islip Insane Asylum, Ward's Island, Randall's Island, Paupers' House and Sing Sing prison and hospital.

Experiments have already shown that music is of great use in healing and the talking machine is becoming more and more popular as a means of furnishing this music. Indeed, in many institutions and in the majority of homes it is the only means by which such music can be obtained. Authorities agree that treatment of diseases by music requires a varied selection of subjects, each case demanding a special type of music. With the vast resources of the record libraries of the present day it is possible to obtain at once any kind of music desired.

In discussing the relation of music to the science of healing and outlining some of his experiments, Mr. Isaacson said:

"My experiments, however, have not been by any means confined to mental cases," said Mr. Isaacson, "unless such ailments as insomnia, indigestion and various other organic and chronic troubles can be so classed.

"The best music for curative effects is the violin and the soprano voice. It is only the liquid, flowing notes—not the strongly cadenced ones—that are soothing; certain instrumental music has the same effect on a patient as a saw drawn across his bare flesh. A 'cello, for instance, would be absolutely injurious, for it induces melancholy, and most wind instruments are not suitable.

"Sometimes, however, the effect desired is to startle the patient out of some temporary mood, and in such cases music can be used, as a doctor would use, for instance, strychnine to stimulate heart action.

"Almost every one vibrates or responds to certain notes or tunes more than to others. Theodore Roosevelt could never hear Massenet's 'Ouvrez Tes Yeux Bleus' without showing emotion. This individuality of note appeal is something to be reckoned with in musical treatments.

"Hungarian music and jazz are not for sick people. One of the most effective pieces for musical treatments is Mendelssohn's 'On Wings of Song.' Others are Dvorak's 'Songs My Mother Taught Me,' and both Gounod's and Bach's 'Ave Maria.' As in medicine music is sometimes desired as a counter-irritant, to stimulate by its vigorous contact with the nerves. For this purpose the selection would be such pieces as the prelude of Rachmaninoff or Wagner's 'March of the Valkyries.'"

A man may be a born genius, but if he will not exert himself he can achieve little. Laziness is fatal to success.



HARPONOLA

The
PHONOGRAPH
with the

**GOLDEN
VOICE**

THE Harponola tonal chamber of alluringly beautiful and ideally resonant golden spruce represents the first big improvement in phonograph design developed within the past two years.

When the grille of a Harponola is removed the average customer thrills with approval as the golden interior breaks on his vision.

The rich tone, the superb general appearance and finish, the thoroughly high grade mechanical equipment,—all combine to make the Harponola one of the quickest-selling and most desirable of lines.

The dealer who wants the most profitable independent record finds our Okeh records exceptionally satisfactory. We job them on advantageous terms.

THE HARPONOLA CO.

EDMUND BRANDTS, Sales Manager
CELINA, OHIO

Harponola Cabinets are built by the Mersman Brandts Brothers in a separate up-to-date factory



MARDI GRAS IN NEW ORLEANS FAILS TO BOOST TRADE

Carnival Followed Period of Strikes and Industrial Troubles—B. G. Powell, Manager of Maison Blanche Talking Machine Department, a Live Wire—"Dardanella" Sales Big

NEW ORLEANS, La., March 2.—Despite three rather demoralizing events during the past month, talking machine business in New Orleans was excellent. The retail merchants report their sales were good, considering interferences; and the wholesalers did still better, except those whose shipments were delayed. Practically every other business suffered.

The three events were a second edition of a freight handlers', car loaders' and dock workers' strike. The coastwise longshoremen struck and let freight stand on wharves and none could be unloaded from steam cars. One house reports a big shipment tied up by this strike.

This was followed by Mardi Gras. Retail stores followed the lead of the larger department stores and closed all day. It was the first Mardi Gras the stores did not remain open at least part of the morning. The crowd was small, due to the rain, and there were few out-of-town visitors, with the result the wholesale houses did not profit.

Parham Werlein of Philip Werlein, Ltd., says his house is going after the business during the Spring buyers' meet. He must be getting it, then, his competitors graciously acknowledge. He may have an advantage on some because he is both retailer and wholesaler.

"People have no time to think of much else but superficial pleasures during the carnival," Mr. Voges said. "Business usually picks up about the carnival season, but this year the Mardi Gras was a failure and business remained as it has for the past two months."

"Dardanella" has broken all sales records for any song in the South except "Bubbles," according to retailers. Every dealer in the city said he was unable to supply the demand.

W. J. Voges of the Grunewald music store, said "Bubbles" broke all records in that store a few months ago and still is going big.

"Dardanella," he admits, is running close if not already ahead and he does not doubt that it would break the record of "Bubbles" if enough records could be procured.

J. V. Dugan, president, of Dugan Piano House, said he would welcome the opportunity to buy lots of a thousand of the popular number. The initial supply of Victor and Emerson records was exhausted within a week and no more can be procured.

J. L. Billet, manager of the Diamond Disc Shop, said the Edison record would be available in a few days, but he had lost many sales already because he was unable to get "Dardanella" on the Edison record. The Amberola record of the number had a great sale.

It has been said that the lowly newsboy is a true indicator or barometer of the musical standards of a community, and here in New Orleans, if we may judge by this humble illus-

tration, music has reached the mass of the people as it has in few other centers of this country. Newsboys whistle an aria from "La Boheme," while even their tiny sisters of tender years have very decided tastes between the melodies of different operas. Critics agree that nothing has done so much to popularize the opera as the talking machine. The Maison Blanche has found, according to Edgar Newman, that the talking machine trade here is



B. G. Powell

growing by leaps and bounds and the people are buying the best class of selections.

The talking machine department at this store boasts of the very latest in accommodations. The unprotected male who seeks an hour of rest while selecting his favorite songs can make himself at home in the luxurious smoking rooms and listen to the newest releases. But he has nothing on the female of the species, who also has her own special smoking rooms finished in old ivory and gold, silks, satins, and even goldfish to make the setting complete.

B. G. Powell, new manager of the enlarged talking machine department of Maison Blanche, says he was made manager almost by accident. He was traveling for the Cheney Talking Machine Co., from Atlanta, Ga., when he called on Edgar Newman, one of the officers of the "Biggest Store South." He talked to Mr. Newman about putting in a larger department and handling his goods. Mr. Newman was willing, but did not have the manager. Then things began to happen with the result Mr. Powell was engaged

and became manager of the largest talking machine department in the South. It has fifteen demonstration booths, furnished by Philip Werlein, Ltd., and made by the Unit Construction Co., of Philadelphia. The design is Adam in old ivory enamel finish. Columbia, Victor and Brunswick machines and records are handled.

Before becoming a traveler for the Cheney Co. Mr. Powell was with the Columbia Co., working out of Atlanta. He was the oldest man on the road out of that office in point of service. He covered Tennessee, Alabama, Georgia, Florida and part of Mississippi. When he went with the Cheney Co. he was assigned to Louisiana, Mississippi, Alabama and Georgia.

NEW VOCALION RECORDS POPULAR

Are Now All of the Lateral-cut Type—Dealers Display Much Interest in the New Listings—Addition to Roll of Recording Artists

The recent release by the Aeolian Co. of the first of the company's lateral-cut Vocalion records served to arouse an unusual amount of interest among Vocalion dealers throughout the country, and the testing of the records themselves, upon receipt, served to add to the general enthusiasm. At the present time the current releases of Vocalion records are all of the lateral-cut type, the March list including the first recording by Mme. Marguerite D'Alvarez, together with a number of other special features.

In the production of the Vocalion lateral-cut records the Aeolian Co. has endeavored to eliminate any possible faults and to offer a record of a quality, musically and mechanically, to measure up with the general standing of the Vocalion products in the field of music.

The number of new artists of standing who have been added to the list of those recording exclusively for the Vocalion have served to lend increased prestige to the product. Many of these artists enjoy national and international reputations in the opera and concert field and their names alone are sufficient to interest the general public in their recordings.

Negotiations are now under way to add still more names to this list of artists, information that should prove interesting to dealers.

The regular monthly bulletins of Vocalion records are gotten up in elaborate style, with an abundance of descriptive matter for the information of both the dealer and the customer, and with unconventional portraits, of the various recording artists. These monthly bulletins are supplemented with mid-month specials of selected records that are released far enough ahead of the regular bulletin to afford the dealer an opportunity for enjoying a much greater volume of sales than were he compelled to wait two or three weeks until the new records were released with the regular monthly list. In these days of over-night hits, special mid-month releases of the new records are especially desirable from the viewpoint of the dealer.

FOR VICTOR SERVICE
PHILIP WERLEIN, Ltd.
 OF NEW ORLEANS
 THE LEADING SOUTHERN WHOLESALERS



New Window Display Service For

Okeh Records

TWO DOLLARS MONTHLY

We take pleasure in announcing that our Dealers' Service Department has evolved a new and attractive idea in window display service for Okeh Dealers. Each month we will have a different display, treating completely and harmoniously the new records as they are issued.

The subject of window decoration and display is not new. Every dealer knows that a clean, attractive window draws business. This new service will sell more Okeh records, at the

same time solving your problem of window decorating. Each display will be in several colors and so designed as to fit into any size window. Easy to set up—easy to "read."

YOUR WINDOW IS 80% OF YOUR RENT. IT IS EASILY WORTH \$2.00 MONTHLY TO MAKE IT THE LIVEST WINDOW IN YOUR NEIGHBORHOOD. TELL YOUR DISTRIBUTOR SO — T O - D A Y.

NOTE: The photo shows the Sixth Bulletin Okeh Display. The Seventh is now ready.

GENERAL PHONOGRAPH CORPORATION

25 West 45th Street

OTTO HEINEMAN, President

New York City, N. Y.

FACTORIES: Newark, N. J. Elyria, Ohio Putnam, Conn. Springfield, Mass. Kitchener, Ont.

BRANCHES: Chicago, Ill. San Francisco, Cal. Toronto, Can.

Disc Record Manufacturers ATTENTION

If you are not satisfied with your product—

If some part of the manufacture needs perfection—

Let me help you.

I was the pioneer to introduce the present disc record into Europe in 1901. Successful factories were erected in England, France, Spain, Germany, Austria, and Brazil under my management. I know the record business from A to Z, and can straighten out your difficulties.

The present system of permanent masters was perfected in my laboratories in 1904 and has never been improved upon.

The double-sided record was my patent and brought out in 1903.

If you want the best to be had in recording machines; if you want the latest development in pressing records from shells; if you want increased record production in power-driven presses—I can help you.

*Complete installations
taken charge of*

F. M. PRESCOTT
RIVERDALE, N. J.

Phone Telegrams
No. 2 Pompton Lakes Prescott, Pompton Lakes
N. J. N. J.

HOW EDISON TESTS SALESMEN'S GAMENESS

Leading Insurance Journal Uses William Maxwell's Experiences, As Told in "The Training of a Salesman," for Featured Article

"Have you ever been 'bawled out' for something you didn't do?" questions The Underwriters' Review, the leading insurance journal of the Middle West, in a featured article in the issue of January 25.

"Nearly everybody has, even William Maxwell, one-time star salesman and now vice-president of Thomas A. Edison, Inc. He tells about the experience in his book, 'The Training of a Salesman,' just recently published.

"One day," relates Mr. Maxwell, 'Mr. Edison summoned me to his library and asked me to explain something with which I had absolutely no connection. I started to alibi myself. His eyes flashed with scorn. I was in the position of a policeman who had permitted a crime to be committed because the scene of its perpetration was beyond his beat.'

"There is no truer test of a salesman's qualities for permanent success than the way in which he takes criticism. The little-minded man can't stand it. It pricks his egotism. He 'crawfishes.' He makes excuses. Then, when he finds that excuses won't take the place of results, he sulks and pouts. It never occurs to him that he might profit from the incident."

"Mr. Edison gave me the worst tongue lashing I have ever received. It was the exact chronology of all the stupid and ineffective things I had done from the first day I entered his employ, but more particularly it was a recital of the things I had not done that might have been done.

"His arraignment of me was not altogether just; however, it was extremely beneficial. He punctured my self-complacency without impairing my self-confidence. That "bawling out" was worth a good deal to me, and I am sure it was worth more to Mr. Edison. He may have been, and probably was, irritated with me, but I believe his outburst was not primarily a show of temper. I think it was chiefly a test of my gameness."

"Now the interesting point about this experience of Mr. Maxwell's is not the fact that he got 'bawled out' at all," continues The Underwriters' Review. "It is the way he took it. How many insurance salesmen do you know who would say that being called down for something they didn't do was good for them? What would your feelings be?"

"There is no truer test of a salesman's qualities for permanent success than the way he takes criticism. The little-minded man can't stand it. It pricks his egotism. He 'crawfishes.' He makes excuses. Then, when he finds excuses won't take the place of results, he sulks and pouts. It never occurs to him that he might profit from the incident.

"But the truly big salesmen see the other side. They don't like to be criticized any more than the little fellow, but they are shrewd enough to know that 'a little criticism now and then is good for the best of men.' We are all like boys in training—if left to run wild and imbibe too freely of praise, we degenerate into weaklings.

"Your gameness is reflected in the attitude you show when improvement in your work is suggested, or personal handicaps are pointed out. If you were not worth developing you would not be worth keeping on the pay-roll. The right sort of a salesman welcomes constructive criticism just as Mr. Maxwell does. Do you?"

B. F. WHITE IS MANAGER

B. F. White has been made manager of the record department of the W. B. Fulghum Victrola Shop, Richmond, Ind.

PLAZA

BUY YOUR ACCESSORIES

"All From One Source"



REPUBLIC PLAYER ROLLS

Every Phonograph Shop Can Sell Player-Piano Rolls Just As Well As Records.

The public look upon you as a logical source of supply for everything musical. This means Player-Piano Rolls as well as Records.

Why You Can Sell Player Rolls

1. 80% of all Pianos sold are Players.
2. This means a big demand for Rolls.
3. The experience of other Phonograph Shops proves this.

Why You Should Handle Player Rolls

1. Profits are larger than on Phonographs and Records.
2. The stock is clean and easy to handle.
3. 90% of your customers own Player-Pianos and buy Rolls.
4. Only a small initial investment is required.

We are prepared to serve you with the two best lines on the market—

REPUBLIC WORD ROLLS
and
PIANOSTYLE INSTRUMENTAL ROLLS

Write to-day for catalogues of the latest hits, prices and discounts.

ALL FROM ONE SOURCE

REPAIR PARTS
NEEDLES
CLEANERS
ENVELOPES
SAPPHIRES
ALBUMS
RECORDS

PLAZA MUSIC CO. TRADE MARK

PLAZA MUSIC CO.
18 WEST 20TH STREET
NEW YORK

L'Artiste

THE ARTIST IN REALITY

The Phonograph That Pleases Eye and Ear Is Easiest to Sell

Phonographs are judged by their cabinet beauty and by the fidelity with which they reproduce music. These are the things the dealer in phonographs has to sell to his customers.

L'Artiste phonographs were designed to make their selling easy, to make them quick turnover merchandise at good profits.



L'Artiste cabinet beauty is beyond cavil. Both consoles and uprights win the approval of prospective buyers in a first admiring glance at their chaste splendor of design and finish. Next, the buyer hears music reproduced by L'Artiste with a volume and beauty of tone that is captivating. He notes numerous mechanical superiorities and up-to-date improvements. L'Artiste prices are strikingly reasonable, all these things considered. Thus a sale is made. This is the invariable experience in selling L'Artiste. What more can a dealer ask?

These instruments present all the most desirable elements of salability, and, what is more, L'Artiste STAYS sold. Buyers like them better the longer they own and enjoy them.

There are nine beautiful
Console and Upright Models

PRICES RANGE FROM \$110 TO \$340

GRAND RAPIDS PHONOGRAPH COMPANY
GRAND RAPIDS, MICHIGAN

THE PHILADELPHIA SHOW CASE COMPANY

123 North 13th Street
Philadelphia

Eastern Distributors
Bush Terminal Bldg.—128 West 42nd Street, New York

2002 Jenkins Arcade
Pittsburgh

FOX MUSIC CO. TO CHANGE HANDS

Wisconsin Victor Store Becomes Badger Music Shop Co., and Incorporates for \$25,000—E. R. Sweeney Vice-President and Manager

FOND DU LAC, Wis., March 3.—E. R. Sweeney, son of Mr. and Mrs. Eugene Sweeney, Forest avenue, will take over the management of the Fox Music Store March 1, the store to be known as the Badger Music Shop. Articles of incorporation were recently filed with Merlin Hull, Secretary of State, at Madison for \$25,000. Mr. Sweeney is vice-president of the company and general manager of the business. Aside from the regular line of pianos and other musical instruments carried by Mr. Fox, the new shop will carry an exclusive line of Victor goods.

The Fox Music Store has been a well-known music stand since 1882. For one year Mr. Fox was in business with J. W. Trout. The latter disposed of his interests to Mr. Fox about seven years ago and Mr. Fox has continued the business alone since that time.

Mr. Sweeney graduated from the Fond du Lac High School in 1906 and left here almost immediately after, when he engaged in the music business. He has followed this line since, having been with music interests in Milwaukee for the past eleven years. He was connected with one of the largest music houses in the United States for several years and during this time traveled extensive territory.

The interior of the Fox store is undergoing extensive improvements. New fixtures are being installed with the addition of six additional booths to accommodate the patrons of the shop. The walls are being refinished and everything put in readiness for the opening the first of the month.

A new talking machine articulator will soon appear on the market and is the product of Frank B. Ling, head of the Melodia Mfg. Co., San Francisco.

LEND A HAND FOR INDIANAPOLIS

Tom Griffith, Udell Works Sales Manager, Sending Out Copies of an Indianapolis Creed

Tom Griffith, sales manager of the Udell Works, Indianapolis, Ind., who has been very active in all the affairs of that city and largely instrumental in securing the convention of the Associated Advertising Clubs of the World for Indianapolis on June 6 to 10, has sent out to his friends a copy of an Indianapolis creed which has been written by Meredith Nicholson for the Board in charge of arrangements. The creed follows:

LEND A HAND FOR INDIANAPOLIS

Indianapolis is the capital of the land of opportunity. Bring your dreams to Indianapolis, the city of vision, a place where dreams come true. The pulses of the city throb with an energy drawn from the most fruitful soil in all the world.

LEND A HAND FOR INDIANAPOLIS

One hundred years ago destiny marked Indianapolis for steady and triumphant progress. It is the natural center of distribution for North America. Our commerce and industries have a continent for their market. The Indianapolis label guarantees an honest job and an honest price.

LEND A HAND FOR INDIANAPOLIS

From this city of homes James Whitcomb Riley sent winging his songs of light and cheer to gladden the hearts of a nation. The Riley spirit is the Indianapolis spirit of confidence and hope.

LEND A HAND FOR INDIANAPOLIS

This best of cities rests solidly upon the enduring foundation of American liberty under law. By serving my city, I serve my country. Each day I will help, not hinder; work, not shirk.

The Venetian Phonograph Co., Wilmington, Del., has incorporated with \$250,000 capital.

STRADIVARA MOVIE SLIDES

Slides Being Offered Dealers by Compton-Price Co. are Exceedingly Attractive

One of the features of the service which the Compton-Price Co., Coshocton, O., offers to its dealers in connection with the exploitation of Stradivara phonographs is the series of moving picture slides which may be used in connection with local moving picture performances. These slides have been very carefully prepared



Slides for Use of Dealers

and are of a most distinctive nature, displaying in natural colors a model of the Stradivara, together with suitable text, each phrase of which embodies a forceful selling argument. At the bottom of these slides a space is reserved for the name of the dealer.

NEW VICTOR AGENCY IN HERRIN

Cline's Drug Store, Herrin, Ill., has taken on the Victor line of talking machines and records and the department has been made complete in every detail. Miss Ruby Chitty is in charge.



Model
145

The Brooks Automatic Repeating Phonograph

is justly termed The Wonder Instrument. It has all the good

Dealers

There are some communities where the Brooks is not represented effectively as yet. Perhaps yours is one of these. There is as much profit and satisfaction in selling the Brooks as there is in owning it.



Model
165

qualities of other high grade makes, but is completely put in a class by itself by virtue of the inbuilt Repeating Device, which enables the operator to play any make of record, any desired number of times.

There are three Brooks models, of different sizes, all beautifully carved and finished. Each style may be had with electric motor, if desired.



Model
250



Automatic Repeating Phonographs

BROOKS MANUFACTURING COMPANY, SAGINAW, MICH.

The Repeating Device

The Brooks Automatic Repeating and Stop Device is an exclusive Brooks feature. It gives this phonograph a broader scope than any other make and requires no attention beyond setting the needle and turning a little knob.

*The
Wonder
Instruments*

Tone Arm Headquarters

The Mutual
TONE ARMS & SOUND BOXES

Vibration and harsh tones are greatly minimized by the perfected ball-bearing Tone Arm with its new improvements.

SUPREME
TONE ARMS & SOUND BOXES

Rugged and simple in construction, powerful and pleasing in tone—the Supreme is in a class by itself.

A Tone Arm for Every Need

MANHATTAN
Wooden Tone Arm

This highly efficient Wooden Tone Arm produces an exquisite tone and provides the talking machine manufacturer with a sure-fire talking point.

What are your requirements?

INCREASE the selling possibilities of your talking machine by increasing its tonal merits. Tell us your troubles. Our engineering department is equipped to give you expert advice. Come to "Tone Arm Headquarters" for tone arms that make good. Unchanging quality is assured by our force of skilled workmen under the supervision of engineers:

Herman Siegel

Nathan Kurman

Fred G. Hoppe

Write to-day for descriptive literature and prices.



W^M PHILLIPS

145 West 45th St.
New York

Chicago Representative:
H. Engel, Republic Building.

**TONE
ARM
SERVICE
DEPARTMENT**

SUGGESTS CO-OPERATION BETWEEN TRADE TECHNICIANS

Honest Exchange of Ideas and Findings Regarding the Scientific Problems That Have Developed and Will Develop in Connection With Sound Reproduction Urged by World Reader

A subscriber to The World who is deeply interested in the scientific, musical and mechanical development of talking machines and records generally, makes the pertinent, although somewhat Utopian, suggestion that the leading manufacturers of machines and records, particularly those who have been chiefly responsible for the development of the industry to its present status, should get together with a view to organizing a general consulting board to solve the various technical problems that come up in the industry.

According to the suggestion the board should be made up of the technical men of the various leading companies, together with scientists from outside fields who have specialized in the study of acoustics, sound reproduction, etc. Under this plan he believes that the progress of the industry as a whole will be much more rapid than under present conditions, with the experts of each company wrestling with the various problems in their own particular way.

The subscriber cites instances of industries that have pooled their brains, as it were, for the purpose of concentrating upon general problems, and arriving at solutions much more quickly than were each of the experts to seek to solve the problems along individual lines. It is his opinion that the art of sound reproduction, although apparently far advanced, is really in its infancy, and that the greater developments are of the future. In a letter to The World he said:

"There are a great many capable men in the talking machine industry to-day—men who have grown up with the business, as it were—who have devoted the greater part of their lives to carrying on experiment after experiment for the purpose of finding ways and means for improvements in machines, records, and particularly recording and reproducing methods and in perfecting those improvements when found. Their work has been slow in that probably a score of the experts have been engaged at one time or another in going over the same ground and finding out for themselves what some of their confrères could have told them.

"Every so-called expert or trade scientist has had occasion to work out problems for himself that are, or were, common to the industry. He has experimented in this or that way in going over ground already covered by some other specialist without having the advice and counsel of the other man to save him from unnecessary work and worry. As soon as one

new development has been announced by a certain company, all competitors naturally set to work to progress from that given point and place on the market some new improvement. Many of these improvements are not basic in character and their general adoption would not in any sense interfere with any patent rights.

"The talk to-day is of co-operation—of associations designed to bring about trade betterment—and in my opinion this co-operation cannot find a better starting place than in the bringing together of trade scientists for mutual and helpful discussion. Let them pool their stories of success and failure in this or that given line and we will have a basis to work upon that should advance the industry more within a period of two years than it has advanced during a decade.

"Competition we will admit is helpful to trade and it spurs the individual to new efforts, but there are so many openings for competition in the general manufacture and sale of instruments

and records that this factor can be lost sight of in some measure in the case of scientific development. The public has become well acquainted with the talking machine as it is, and its interest in the instrument is at high pitch. The continuance of this interest depends upon the development of the art—not simply the creation of new 'talking points,' but of a more perfect, scientific and satisfying means of recording and reproducing.

"A conference of the scientific men of the trade will not in any sense necessitate the unfolding of vital secrets, but there are so many common problems, the proper surfacing of records, the eliminating of scratch and of overtones, etc., to be given attention that there should be no reason to go into the details of any one or another process of general manufacture. Take the question of motors alone. The losses that have been sustained by many companies through experimenting with motors of new design that proved faulty could have been avoided very readily had it been possible to bring motor experts into consultation—men who had gone over the same ground and who had made the same mistakes—before advancing to the production of a satisfying mechanism."

ATTRACTIVE MUSIC WEEK WINDOW AT AEOLIAN HALL

What was considered to be the most striking and artistic window display arranged by a New York piano house during the recent Music Week

The display was backed by a row of gilded pillars, between which were placed a Duo-Art piano, a couple of attractive models of the



Artistic Window Display at Aeolian Headquarters During Music Show Week

celebration was that installed at Aeolian Hall. Simplicity was the keynote of the display. The features were a series of greatly enlarged portraits of noted artists who have, and are, recording exclusively for the Duo-Art piano and the Aeolian-Vocalion.

Vocalion, together with cabinets of rolls and records. Elaborate lighting effects served to add to the attractions of the display during the evening hours. The entire arrangement of the display was under the direction of R. Alston Brown, head of the Aeolian art department.

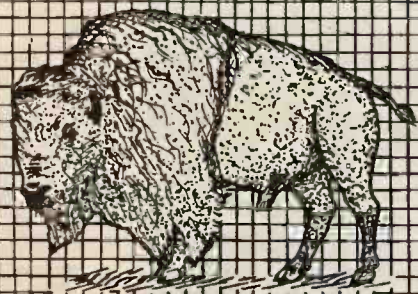

BUFFALO TALKING MACHINE CO., INC.

BUFFALO, N. Y.

Wholesale

Victor

Service



PUTTING OVER 100-PROOF MUSIC IN PROHIBITION DAYS

How One Talking Machine Man Broke to the Waiting Public the News That Well-selected Melodies Have Much the Same Effect as a Few Drinks of the One-time Private Stock

With the news that national prohibition, instead of being a nightmare, or an anticipated pleasure, according to the individual idea, had become a reality, there likewise came the statement that there were many substitutes for alcohol to keep humans in the proper spirits, among them sugar and music. Swift, the talking machine man, heard all the stuff about the jazz tune being as good as a highball, and a melancholy ballad having power equal to a slow gin fizz, but he was one of those babies who demanded to be shown.

Swift naturally found that much of the money that formerly went over the bar between the quitting whistle and the "father-come-home-with-me-now" stuff had found its way into his cash register in payment of instalment accounts. This amount was not sufficient to cause any great elation, because with machines scarce Swift wasn't selling any more on instalments than he had to. The thing to find out was if prohibition was going to do him any direct good, beyond keeping his stomach lonesome and his pocketbook intact.

If music was to take the place of liquor as a direct stimulant of the human mind, Swift wanted to be positive of the fact so he could inform the public in general of the glad news. He felt that even the professional prohibitionist, with a cellar full of "bitters," might like a little musical stimulus in his parlor to save the private stock.

Swift had heard, and was almost moved to adopt, the slogan in his advertising, "Lushers listen, lose the lust for liquor, lay in a library of limpid lyrics," but he felt that this direct reference to so painful a subject would not have the desired effect. Then he thought of a line something like this: "Shutters are upon the ginmill. Now you've got to stay home. Make it pleasant with a talking machine and some jazz."

But even this did not seem to have the proper sound. The result was the revamping of the home and family idea, the ad reading somewhat as follows:

For long Winter evenings at home—
No place to go and the cellar dry—
Tired of growling at the family and kicking the cat—
Parlor like a cage of tigers—
Something needed with "pep" and a "kick"—
Li'l ole talking machine mixed with a bunch of this month's records is the answer.
100 proof, and "stays with you."
Let SWIFT fill the prescription.
111 Main Street.
Office hours 8 a. m. to 6 p. m., daily.

The people that Swift wanted to reach got the idea promptly, and the advertising, with suitable variations at intervals, attracted plenty of attention and some real business. It's hard to sell jazz music to mourners, but Swift made them think it was stylish, and got away with it.

Old boys who had been home so seldom that they had forgotten their children's first names, and whose noses proved the fact, got enough excitement in battling with the family for the first week or so, but it takes some energy to fight all the time, and there was nothing to stimulate energy. These same old fellows began to turn to talking machines, for there are just as many sobs in a half dozen old-fashioned ballads as there are in an equal number of glasses of "red eye." Then again, the purchase of a new machine caused the family to lay off the new permanent member, temporarily at least.

Swift played the thing scientifically. When the ex-tank showed up the first number was a jazz record, simulating the tinkle of the first drink. As a rule a second jazz followed, after which came a pleasing waltz, one of these sentimental love songs, and finally the tear-producing mother ballad, taking the place of the fifth drink,

having about the same effect, with no hangover.

The system worked so well that Swift for a time was between two minds—whether to hire an ex-bartender, or wear a white coat and apron himself.

PARAMOUNT FOR PITTSBURGH HOUSE

Shipley-Massingham Co., Under W. H. Cross,
Made Distributors for Paramount Line

PITTSBURGH, PA., March 4.—The Shipley-Massingham Co., 949 Penn avenue, has arranged to take Western Pennsylvania and West Virginia as the territory in which to distribute Paramount products.

W. H. Cross, who has been with this exclusive wholesale company for eighteen years, will have charge of that branch of the business.

Fred Clark, whom the Paramount Talking Machine Co. has placed in this territory as factory representative, will co-operate with Shipley-Massingham Co. in rendering the most modern and efficient service to dealers.

The Shipley-Massingham Co. is an old-established house, having a wide reputation for its remarkable development and growth and for its fairness in dealing with the trade. The dealers in Western Pennsylvania and West Virginia will welcome this source of supply as they will realize it is another step forward in the development of the dignity of the talking machine industry, for this distributor handles nothing of doubtful quality and character and it bases its success on the ability to judge both the products it sells and the ability of the manufacturer to guarantee.

Paramount talking machines and records have an excellent name. The sales policy is based on that which has proven the most successful and every effort is being made by the manufacturer and distributors to assure success for the dealers.

The Stafford Phonograph Co., of Ashland, O., has been incorporated with a capital stock of \$1,000.

Yes you can—with the Kent

Can what? Make Customers for lateral-cut records out of all Edison owners in your community. That's worth while. You make a profit on the Kent Master Adapter and then many more profits on the records. Besides, they will all thank you for having multiplied the enjoyment of their machines

Playing
hill-and-dale
cut record



The
KENT
Master
Adapter

Ask us
about it



Registered in U S Pat Office

Playing
lateral-cut
record



MANUFACTURERS OF
Tone Arms, Sound Boxes, and Attachments
for Edison, Columbia and Victor machines.
KENT PRODUCTS "Win their way by
their play."

F. C. KENT COMPANY

Mulberry and Chestnut Sts.
Newark, N. J.

VITANOLA

The Phonograph of Marvelous Tone

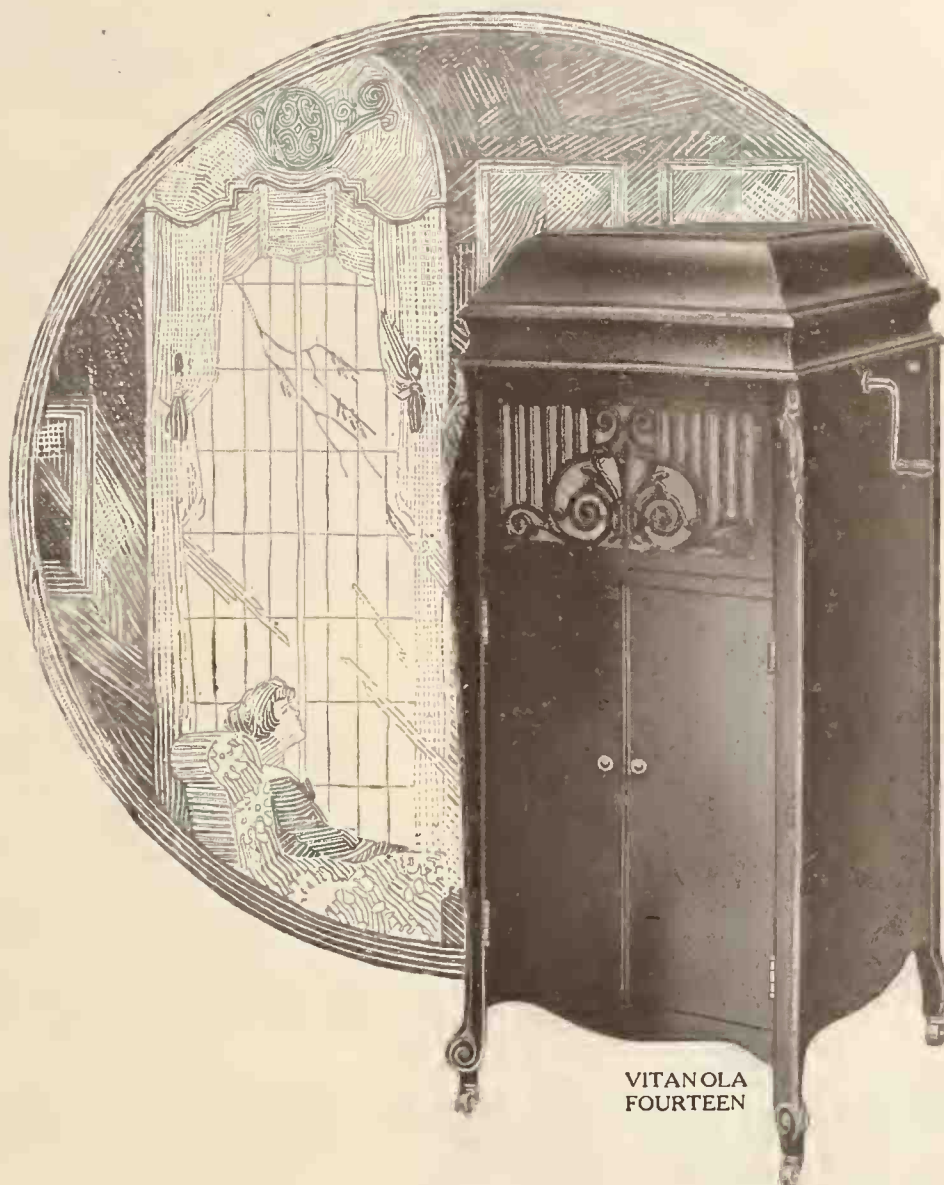

VITANO
LA
FOURTEEN

Advertising is good only to the extent that it produces results.

Our *Saturday Evening Post* publicity is creating hundreds of thousands new prospective purchasers which VITANO LA dealers are daily developing into buyers.

Our national advertising, as well as catalogs and other sales helps, are all developed with the view of helping the dealer sell his stock of VITANOLAS at the least possible expense to him and in the shortest period of time.

We have a real business - building, profit - making proposition for dealers who apply for it on their business stationery.

Write today for the much talked of booklet "Making a Phonograph Department Pay" and sample of attractive *vest pocket* catalog

Metropolitan Sales Representatives: **M. M. Roemer Sales Corp.** 400 WEST 23rd ST. NEW YORK, N. Y.

VITANO LA TALKING MACHINE COMPANY, 508 West 35th Street, CHICAGO, U. S. A.



The Best Talking Machine Needle on the Market

PACKED IN COUNTER SALESMEN

50 Needles to a box and they retail at 10 cents per box.
60 boxes to a package, \$6.00. This package costs you \$3.90 net.
Your profit is \$2.10 and your customer gets a needle that will give satisfaction.

THE FRED. GRETSCH MANUFACTURING COMPANY

60 Broadway

Manufacturers of Musical Instruments

BROOKLYN, N. Y.

Canadian Wholesale Agent, H. A. BEMISTER, 10 Victoria Street, Montreal, Can.
Western Distributor: WALTER S. GRAY, 530 Chronicle Building, San Francisco, Cal.

INTERNATIONAL BUREAU FOR TRADE-MARK PROTECTION

Established in Havana to Act for South American Countries and the United States—Bills Passed by Congress to Afford Protection to Trade-marks Used in Other Countries Over a Year

WASHINGTON, D. C., February 24.—President Wilson is expected to give prompt approval to the bill to give effect to certain provisions of

the convention for the protection of trade-marks and commercial names, made and signed in Buenos Aires, Argentine Republic, on August 20,

1910, which the Senate has just passed. The bill was passed by the House several weeks ago.

An international bureau to act for the countries of South America and the United States has been established in Havana, pursuant to this convention, but is unable to deal with the United States in the absence of specific statute giving the requisite authority to the Commissioner of Patents.

Senator Brandegee, in favoring the bill, stated that many manufacturers making trade-marked goods could not trade-mark any of the side lines they might desire to manufacture with the trade-mark they now own. "When they manufacture other articles and endeavor to give them their trade-marked name there is no way in which they can protect themselves in foreign countries," he added. "This bill provides that, if they continue to use that name in foreign countries for one year, they may file their trade-mark on that name, as well as on the other goods they manufacture.

"The situation now is this," continued Senator Brandegee. "Take, for instance, the case of popular makes of pianos and other musical instruments; a 'shark' in Cuba, say, or in some other country, files an application for a trade-mark on the name of '—', or '—', or other popular trade-marked names, and gets a trade-mark. The result is that none of our pianos, etc., of those names can be exported and landed in those countries under their laws without paying tribute to the shark who has trade-marked the names, although he has done so without the knowledge or consent of the manufacturers of the articles. This proposed legislation is designed to correct this evil, so that the manufacturer here may trade-mark the name of his own product if he has used it in foreign commerce for one year. The bill is designed to relieve the situation I have outlined. Both the House and Senate Committees on Patents were unanimously of the opinion that it was a meritorious measure."

"The situation is as Senator Brandegee has indicated, not with reference to Cuba, because there is an international bureau now established in Havana in pursuance of other legislation and other conventions," said Senator Fletcher. "But with reference to Argentina, I am told, as an actual occurrence, that a merchant of Buenos Aires ordered a lot of goods from the United States which are shipped under a trade-mark. Under the laws of Argentina the 'shark' to whom Senator Brandegee has referred can register that trade-mark even after the order is given and the goods are on the way, and when they arrive he can claim tribute. In one instance such an individual actually undertook to confiscate the American goods because they came under a trade-mark which he had registered and claimed as his own."

All worth while results are achieved by effort, usually by painstaking, persistent, unsparing effort. Thoroughness is not accompanied by hasty, careless methods.

"WHAT ARE YOU SHORT?"

Get in touch with us. We have everything in the phonograph line—Needles, Tone Arms, Motors, Cabinets, all kinds of accessories and repair parts. We specialize on Main Springs, Bettertone Phonographs. Let us do your repairs.

PLEASING SOUND PHONOGRAPH CO.,
204-206 East 113th St., New York.



A QUALITY RECORD—A FAST SELLER
A LIVE ORGANIZATION

Write At Once for
Dealer's Terms, Etc.

Immediate Deliveries

Lyrphone Co. of America

117 Mechanic Street

Newark, N. J.

NEW YORK

CHICAGO, ILL.

QUINCY, ILL.

DAYTON, OHIO

OTSEGO, MICH.

SONATA

TRADE MARK

THE PHONOGRAPH OF PERFECTION

KESNER & JERLAW

PRODUCERS OF

Exclusive Phonographs

FOR THE

Jobbers and Large Distributors

SCIENTIFICALLY CONSTRUCTED
 PIANO FINISHED
 WHOLESOME NATURAL TONE
 LOUDEST OF VOLUME
 LATEST AND BEST MODIFIER
 OUR OWN PATENTED HORN
 IMPROVED PERFECT SOUND BOX
 BALL-BEARING TONE ARM
 LATEST TYPE OF GUARANTEED
 MOTOR

NEW BEVEL EDGE TURNTABLES
SIX BEAUTIFUL MODELS
 OF ARTISTIC DESIGN

Every Phonograph is
GUARANTEED FOR ONE YEAR
 Against All Manufacturer's
 Imperfections

Write For All
 Information and Particulars
 To Either Address

M. L. KESNER
 47 West 34th St.
 NEW YORK

Telephone
 Greeley 6251

N. JERLAW
 316 So. Clark St.
 CHICAGO

Telephone
 Wabash 2646



ADVERTISING MATTER
 FURNISHED
 WITHOUT CHARGE



“Just Like the Rose” and “When You’re Alone,” fox-trots by the Paul Biese Trio, will sell fast. A-2864.

**Columbia Graphophone Co.
NEW YORK**



OHIO TO HAVE PARAMOUNT SERVICE

John Young of Cleveland Organizes Ohio Paramount Sales Co. to Distribute Paramount Machines and Records in the State of Ohio

CLEVELAND, O., March 5.—The Ohio Paramount Sales Co. has been organized by John Young, of the Young Furniture Co., 6101 Euclid avenue, to distribute Paramount talking machines and records to the dealers in the State of Ohio.

Mr. Young made a brilliant success in the talking machine business and, a few years ago, organized his own company to handle high-grade furniture and instruments, but waited until he could secure a line of unquestionable quality and merit.

This indicates another step forward in developing the dignity of the industry, as Mr. Young's organization is of exceedingly high character and will consider handling nothing but that of quality with which to supply the trade. Now merchants can secure a complete line of instruments and records of the same name and guarantee for their customers instead of risking a commercial black eye by selling merchandise of doubtful quality.

Theo. Zillier has been placed in this territory by the Paramount Talking Machine Co. as their factory representative for the purpose of co-operating with the Ohio Paramount Sales Co., and to render the most modern and efficient service to dealers.

With this new representation the Paramount Talking Machine Co. expects to do a large business in the Ohio territory. Mr. Young has made plans for an active campaign and is lining up dealers in all sections.

HEMPEL FLIES TO CONCERT

Famous Edison Artist Makes 200-mile Air Trip to Keep Texas Engagement

Frieda Hempel recently made an airplane flight from Fort Worth to Austin, Texas, a distance of about 200 miles, to keep a concert date. Her own telegram, sent immediately after she landed, tells the story:

“Fort Worth just wild with enthusiasm. Wouldn't depend on train down here. Hated to disappoint audience, so I engaged two airplanes, one for Bos (pianist) and one for me. We had most wonderful trip. Stopped for lunch at Waco. Made the whole trip in less than four hours with excellent pilots. This the only way of traveling. Please wire friend husband that I am alive. Oh, how we loved it.”

VISITORS AT COLUMBIA OFFICES

Among the recent visitors at the executive offices of the Columbia Graphophone Co. were the following Columbia dealers: Byron Mauzy, San Francisco, Cal.; Helen Plummer Howard, manager of the Hauschildt Music Co., Oakland, Cal.; A. Shemanski, Eastern Outfitting Co., Seattle, Wash.; J. Shemanski, Eastern Outfitting Co., San Francisco, Cal., and N. A. Melvin, Bangor, Me.

E. A. Geissler, of the George J. Birkel Co., Los Angeles, Cal., married recently Miss Louise Nixon Hill, of that city, the wedding being a most fashionable affair. Mr. and Mrs. Geissler plan to spend a portion of their honeymoon in the East.

DEATH OF WELL-KNOWN VICTOR MAN

Lucien D. Callahan, Representative of the Louis Buehn Co. of Philadelphia, Passes Away Following Short Illness at Wilkes-Barre

PHILADELPHIA, Pa., March 1.—Lucien D. Callahan, while engaged in his work as representative for the Louis Buehn Co., this city, was taken suddenly ill on February 17, passing away in the hospital at Wilkes-Barre on the following Saturday, February 21.



L. D. Callahan

This news came as a great shock to the Victor trade, both in the East and West, for Mr. Callahan, previous to his coming with the Louis Buehn Co., acted as representative for the Victor Talking Machine Co. in the Middle Western States and on the Pacific Coast.

He was a young man of recognized ability, and through his personality and character of work made many close friends in the talking machine industry. The remains were brought to his home in Philadelphia, where the funeral took place on Tuesday, February 24. It was largely attended.

The Albert Phonograph Co., 211 South Warren street, Trenton, N. J., has been incorporated with capital stock of \$100,000 to engage in the manufacture of phonographs, talking machines, etc.

**D
I
T
S
O
N**

Humanly Efficient

Best Describes the

DITSON VICTOR SERVICE

DITSON SERVICE does not confine itself to the work of forwarding goods from the factory to the dealer, but goes beyond and offers to the dealer that personal interest that helps him meet problems and make profits.

Ideal for New England Victor Dealers

Victor Exclusively

OLIVER DITSON COMPANY, Boston

CHAS. H. DITSON & CO., New York

**S
E
R
V
I
C
E**

AND WHILE THE MUSIC IS PLAYING

Farmer Habig Collects 115 Eggs From His Musically Uplifted Hens—Writer in New York Mail Tells the Temperamental Story

Fast on the heels of several important or important-if-true scientific discoveries that have gob-littered the columns of the public prints since the story of the interstitial gland saw the light, comes a significant announcement from Indiana, the literary center of the nation.

A farmer, having discovered a phonograph in his spare sock on Christmas morning, permitted his hens to listen to the music it produced. The results of the impromptu musical mornings have astonished and delighted him. His hens, only tolerable layers in the old musicless days, have begun to double their output.

This Indiana farmer—Habig is his euphonious stage name—now not only permits the hens to overhear the music as the phonograph grinds out its notes in the kitchen, as he used to do, but he has installed the phonograph right in

DIRECT FACTORY PRICE—JUST MENTION THE QUANTITY

<p>MOTORS CASTINGS REPRODUCERS</p>	<p>Grey Iron and Brass for</p>	<p>TURNTABLES MOTOR FRAMES STONE ARMS HORNS and THROATS</p>	<p>Stylus Bars Screw Machine Parts Talking Machine Hardware</p>
---	------------------------------------	---	--

Direct Quantity Importations On { **JEWEL and STEEL (Bulk or Packed)**
PHONOGRAPH NEEDLES
GENUINE RUBY BENGAL MICA

EASTERN REPRESENTATIVE
CHERRINGTON MFG. CO. **D. R. DOCTOROW**
IRONCLAD MOTORS *Vanderbilt Ave. Bldg.*
 51 East 42nd St., New York
 Tel. Vanderbilt 5462

the hen house, where 122 Orpingtons and Plymouth Rocks, Buff Cochins and Brahmas dwell together in peaceful industry. The result is that, whereas formerly he gathered 65 eggs in one day, he now collects 115.

It must be carefully noted, also, that the music furnished to the denizens of Habig's hen house is jazz—only jazz, to the entire exclusion of the higher forms of musical art. We

would suggest that Mr. Habig develop his remunerative experiments further by subjecting his hens to the elevating influences of such classic selections as Dvorak's Symphony No. 3 in M major, Opus 76; the Bruch Concerto in G minor, Opus 26; "Sounds of the Forest," from Wagner's "Siegfried," and Beethoven's Sonata, Opus 57.

We are confident that these works would impart to the fruit of Mr. Habig's spiritually stimulated hens arpeggio effects and pizzicato nuances that would open new worlds of emotional uplift to the ultimate consumers thereof.

We await from Mr. Habig interesting disclosures of the possibilities of the higher forms of music upon the languid hen that hesitates on the verge of being lost in the sterile region of paralytical unproductiveness.

E. G. BROWNE IN FLORIDA

Secretary of the Talking Machine Men, Inc., Enjoying Vacation in the South

E. G. Browne, secretary of the Talking Machine Men, Inc., the organization composed of talking machine dealers of New York, New Jersey and Connecticut, left last month for Palm Beach, Fla., accompanied by his family, where he will spend several weeks in an effort to get a much-needed rest.

Mr. Browne is very active in both the piano and talking machine trade associations, and recently much of his energies has been devoted to those channels.

GRUBSTEIN HELD FOR FORGERY

Samuel Grubstein, 32, of 91 Springfield avenue, Newark, N. J., who was taken to the Bellevue Hospital in New York recently, suffering from bichloride of mercury poisoning, was placed under arrest charged with forgery. He is said to have taken blank checks from Nathan Krasner of 54 West 115th street, and presented one of them for \$191 to the Fulton Phonograph Co., 640 Broadway.

Supplied to Builders of
Instruments of Music
not for
Squawking Machines

Square turn offers least resistance to passage of sound waves

No obstruction anywhere inside

Needle retains the same center and same correct angle in both playing positions of the Reproducer

Position of the reproducer for changing needle—turned up from either playing position does not interfere with lowering cabinet lid

The SCOTFORD Tonearm and Superior Universal Reproducer

"WE ATTRIBUTE a large part of our success to the improvement in our machine from the first Scotford Tonearm received from you. We are positively satisfied, and our only fear is that in the face of the multitude of competition temporarily on the market you may try in some way to cheapen to meet this. DON'T DO IT! The writer has been connected with "tone" all his life—and you have it"

Frank D. Perry—Hudson, New York

The Scotford Tonearm and Superior Universal Reproducer will not be cheapened. We know that the field is amply filled with Tonearms and Reproducers that sell on price. We are serving that better class of trade which is building on quality. They appreciate the fact that only those who build the Phonograph as an *Instrument of Music* will survive the tests of time.

	Nickel	Gold
Sample Set with Black Composition Diaphragm	\$8.50	\$10.50
Extra Reproducer with Mica Diaphragm	5.75	6.75

Prepaid anywhere, on receipt of price. Submitted on approval, subject to return within a reasonable time; in which event the full price will be refunded

Quantity Prices on Application

Barnhart Brothers & Spindler

Makers of Superior Specialties for Phonographs

Monroe and Throop Streets
Chicago, Illinois

NEEDLES

and

The Best in the World in Talking Machine Accessories

AND

United States Music Co. Player Rolls

The retail price of these rolls runs from fifty cents to one dollar each. Your discount 40% f. o. b. San Francisco.

942 Market St., San Francisco, California

Cleartone

PHONOGRAPH
SPEAKS FOR ITSELF



No. 150—\$85



No. 100—\$75



No. 135—Price \$135



Model 105—Price \$105



No. 200—\$100



Model 175—Price \$175

THE MOST WONDERFUL TALKING MACHINE OF THE PRESENT AGE
AT THE PRICE. AN INSTRUMENT OF SUPREME
VALUE, TONE AND QUALITY

The CLEARSTONE has become very popular because of its quality, splendid value and the advertising sales campaign that now stands in back of it. DEALERS! Watch us grow—write for our agency and grow with us.

LATEST 84-PAGE CATALOG NOW READY!

LUCKY 13 PHONOGRAPH CO., 46 East 12th Street, New York



**PHONOGRAPH
SPEAKS FOR ITSELF**

NEEDLES

SAPPHIRES

DIAMONDS

SPECIAL OPPORTUNITY

Sell Highest Grade Needles Packed in Envelopes.
We Are Getting 100 Million Per Month—All Live
Dealers Are with Us—Send for Samples and Particulars

Opera Needles

are made to our own specifications.

They are highly-polished, nickel-plated needles.

A glance at a sample will convince you that they are the finest finished needles on the market.

You can be assured of the quality by sending for free samples.

We are the largest jobbers of Steel Needles in the world

**Must sell one billion needles in 1920
2 customers 100 million each;
who's next?**

Prices as follows:

10,000 lots, 45c. per M
1,000,000 lots, 35c. per M

100,000 lots, 40c. per M
5,000,000 lots, 32c. per M

We are the largest jobbers of Sapphires and Diamonds in the world

We are the original headquarters for genuine Cleartone Sapphires and Diamonds

All our genuine Diamond and Sapphire Points are absolutely uniform, silver-plated and the highest quality jewels on the market

Prices subject to revision without notice

Sapphire Balls	Sapphire Points	Genuine Diamonds
Each	Each	Each
Dozen Lots..... 16c	Dozen Lots..... 18c	Sample..... \$1.75
Hundred Lots..... 13c	Hundred Lots..... 15c	Dozen Lots..... 1.50
Thousand Lots..... 12c	Thousand Lots..... 13½c	Hundred Lots..... 1.40
5-Thousand Lots..... 11c	5-Thousand Lots..... 12c	Thousand Lots..... 1.25
		5-Thousand Lots..... 1.15

SPECIAL PRICES ON LARGER QUANTITIES

1920 Catalog Listing Everything a Phonograph Man Needs

LUCKY 13 PHONOGRAPH CO., 46 East 12th Street, New York

Cleartone

PHONOGRAPH
SPEAKS FOR ITSELF

Motors, Sundries and Supplies

STOP! LOOK! READ!

Something new for Lucky 13!
We are now manufacturing our own motor, and can offer immediate deliveries in any quantity.

Send for samples—you can't go wrong.

This is the best buy on the motor market to-day.

Half Dozen, \$9.75 Each.
Dozen, \$9.00 Each.
100 Lots, \$8.50 Each.
1000 Lots, \$8.00 Each.

Bevel-gear wind; plays seven 10-inch records without re-winding. Complete with all parts including 12-inch turn table.

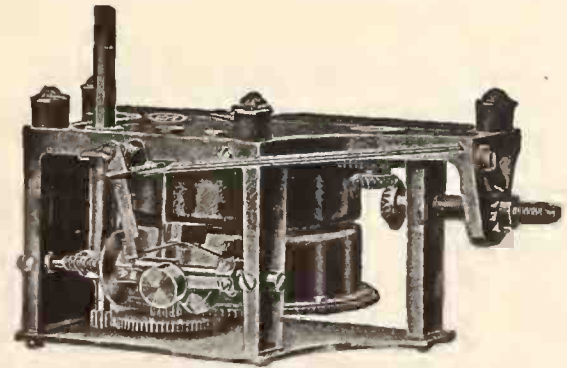

CLEARTONE MOTOR NO. 11

SPECIALS FOR MOTOR, TONEARM, REPRODUCER AND CABINET MANUFACTURERS

Cast-iron Turn Tables in any quantity at the right price. Felts in Discs or Squares, 10 and 12-inch, all-wool.
Mica, first and second quality, clear, in any size.

Main springs and governor springs to fit any motor
Tone modifier rods.
Continuous hinges.
Cover Supports.

Your inquiries will have our best attention.

SUNDRY DEPARTMENT

MOTORS

- No. 1, double-spring, 10-inch turntable, plays 2 10-inch records \$3.75
- No. 2, double-spring, 10-inch turntable, plays 3 10-inch records, \$4.00, with 12-inch turntable 4.25
- No. 9, double-spring, 12-inch turntable, plays 3 10-inch records, castiron frame 7.85
- No. 3, double-spring, 12-inch turntable, plays 4 10-inch records, castiron frame 9.85
- No. 11, double-spring, 12-inch turntable, plays 7 10-inch records, castiron frame, bevel gear wind..... 9.75

TONE ARMS AND REPRODUCERS

(Play All Records)

- No. 2 Per set \$1.75
- No. 3 Per set 1.95

- No. 4 Per set 4.00
- No. 6 Per set 3.75
- No. 7 Per set 3.75
- No. 9 Per set 2.95
- Sonora tone arm with a reproducer to fit

MAIN SPRINGS

- No. 00, 5/8 in., 9 ft. 29c
- No. 01, 3/4 in., 9 ft. 25c
- No. 02, 3/4 in., 7 ft. 25c
- No. 1 3/4 in., 10 ft. 39c
- No. 01A, 3/4 in., 10 ft. 49c
- No. 2, 13-16 in., 10 ft. 39c
- No. 3, 7/8 in., 11 ft. 49c
- No. 4, 1 in., 10 ft. 49c
- No. 5, 1 in., 11 ft., heavy 69c
- No. 6 1 1/4 in., 11 ft. 99c
- No. 7, 1 in., 25 gauge, 15 ft. 89c

We also carry other size main springs to fit Victor, Columbia and all other motors.

Special prices on springs in large quantities.

RECORDS—COLUMBIA

10-inch double disc records, 42c each; 12-in., 60c each.

We also manufacture special machine parts, such as worm gears, stampings, or any screw machine parts for motor; reproducer and part manufacturers.

Special quotations given to quantity buyers in Canada and other export points.

Write for our 84-page catalog, the only one of its kind in America, illustrating 33 different styles of talking machines and over 500 different phonographic parts.

LUCKY 13 PHONOGRAPH CO.

46 East Twelfth Street - - - - - New York



Oh, how you'll laugh when you hear Nora Bayes sing "Oh! How I Laugh When I Think That I Cried Over You" and "Snoops, the Lawyer." This record is worth lots of money to you. A-2852.

Columbia Graphophone Co.
NEW YORK

PIANOS AND PLAYERS IN THE TALKING MACHINE BUSINESS

Can Be Made to Work Out to Excellent Advantage Is the Experience of F. Clark Adsit, of the Edison Shop, Indianapolis—Training Talking Machine Men in Player Selling

INDIANAPOLIS, IND., March 4.—That the talking machine business can fit into the piano and player business has long been demonstrated. When F. Clark Adsit took charge of the Edison Shop he decided that there was no reason why the piano and player business could not be fitted into a former exclusive talking machine business without benefiting one line to the injury of the other.

For five years the Edison Shop was run by the Kipp Phonograph Co. as an exclusive phonograph shop, and it was not only one of the first in the local field, but it was equipped as only the modern talking machine shops are equipped. The Shop was recently acquired by the Adsit Music Co. Mr. Adsit has had years of experience in the piano business and he is well qualified to build up a piano and player

business in conjunction with the phonograph business.

In answer to the question as to whether he thought the piano and player business could be handled along with the talking machine business, Mr. Adsit said that it was being done by other music houses in the city.

"A man from Davenport, Ia., was in the store the other day and he said the piano and player business could not be added to a phonograph business without turning the business into a piano business chiefly or keeping it a phonograph business," said Mr. Adsit. "But I believe that it can be done."

"The piano business is already working into our business very nicely. The first day we had a piano on the floor we sold it a few hours after it had been there. And it was one of our phono-

graph salesmen who sold the piano." Mr. Adsit explained that he proposed to carry on his piano and player business through his present staff of phonograph salesmen.

"If a man has selling ability he can sell pianos," said Mr. Adsit. "If he can sell phonographs there is no reason why he should not be able to sell pianos and players." Mr. Adsit is giving his force pointers on piano selling.

"There is some difference in the way a phonograph is sold as compared to a piano," commented Mr. Adsit. "There is more inclination as a rule in the sale of phonographs for a salesman to go into details of construction, telling the customers about the tone arm, etc. A salesman does not have to contend with these details so much in piano salesmanship. A customer who is musically inclined is first interested in the tone of the instrument and also in the beauty of the thing as a whole. As regards tone, it is something like selling a violin to a musician. The violin may be black and smudgy in appearance, but what the musician is after is the tone."

"Of course, there are people who buy through their eyes more than through their ears. If the design of the case of piano or player appeals to them they are more likely to be pleased with the tone."

Mr. Adsit is working out plans to interest the phonograph customers of the Shop in the piano and player lines. Where it is found a



OPEN VIEW
PLAYS ALL RECORDS



CLOSED VIEW
MADE LIKE AN ELEGANT
TRAVELING CASE
13 1/2 X 13 1/2 X 10 INCHES

THE
Portrola
TRADE MARK REG.

The Phonograph of Value

Newest Type Motor Universal Tone-Arm
Record Compartment

For Home Use For Outings

Leatherette covered case made of resonant wood, with leather handle, complete nickel trimmings and needle carrier. Finished inside in maroon leather effect with silk grille.

TONE EQUAL TO ALL HIGH GRADE
PHONOGRAPHS

EVERY MACHINE GUARANTEED SATISFACTORY

DEALERS, ORDER FROM YOUR NEAREST
DISTRIBUTOR—A PROFITABLE
PROPOSITION FOR YOU:

- WADE TALKING MACHINE CO.
14 N. Michigan Avenue, Chicago, Ill.
- TIMES SQUARE AUTO & SUPPLY CO.
12th St. and Michigan Avenue, Chicago, Ill.
- S. J. STONE & CO., Beloit, Wis.
- A. G. KUNDE CO.
516 Grand Avenue, Milwaukee, Wis.
- TRI-STATE SALES CO.
218 East 10th Street, Kansas City, Mo.
- NATIONAL PHONOGRAPH SUPPLY CO.
411 Shukert Bldg., Kansas City, Mo.

Distributors, make connections now to handle this very popular machine in your district

PORTABLE PHONOGRAPH COMPANY
RESERVE BANK BUILDING, KANSAS CITY, MO.

What More Can You Ask

All the features that go to make a talking machine *Profitably Salable* you will find as regular equipment of *Magnola*: "Built by Tone Specialists."



Watching the Music Come Out

Complete description of all these features is to be found in our *handsome illustrated catalog*, which we should like to send you. May we? Ask us to tell you our plans for your benefit!

MAGNOLA TALKING MACHINE COMPANY
OTTO SCHULZ, President
General Offices Southern Wholesale Branch
711 MILWAUKEE AVENUE 1530 CANDLER BLDG.
CHICAGO ATLANTA, GA.

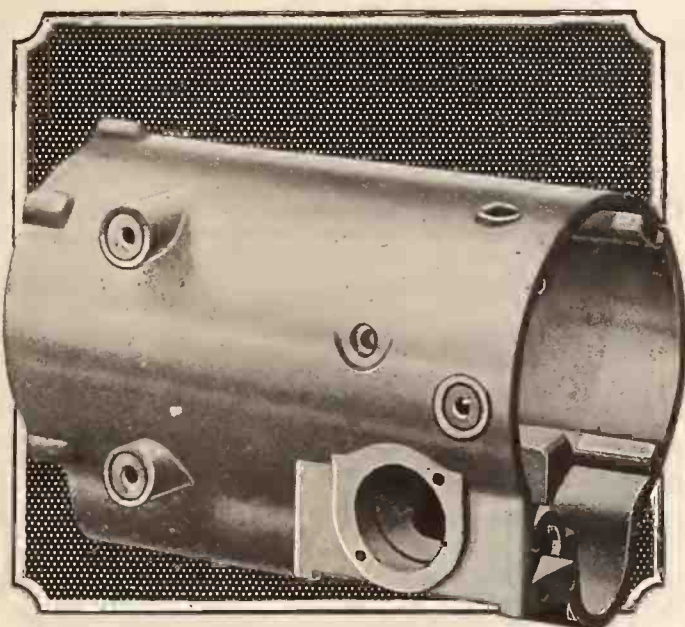

A talking machine motor casing—die-cast by Doehler

You cannot afford to take chances

Assuming that you have already been convinced of the economy of using die-cast parts there is still the matter of choosing the die-caster in whose hands you are willing to trust the reputation of your product.

If you make a choice on a purely price basis—that's one thing. But if you demand quality, uniformity and service the Doehler Company can supply your need. It produces only castings of that high grade on which you insist.

The Doehler Company places at your disposal a staff of engineer specialists whose recommendations are authoritative, manufacturing plants able to

execute your order, however large or small, within a specified time, and an organization of skilled workmen who are expert through years of experience.

You can do no better than put your die-casting up to Doehler

THE WORLD'S LARGEST MANUFACTURERS OF DIE CASTINGS
DOEHLER DIE-CASTING CO.

MAIN OFFICE AND EASTERN PLANT
BROOKLYN, N.Y.

CENTRAL PLANT
TOLEDO, OHIO.

WESTERN PLANT
CHICAGO, ILL.

SALES OFFICES IN ALL PRINCIPAL CITIES

D. D. C.-21

customer has a player, then his roll business will be sought. The Shop is now handling the Vocal-style and Q R S rolls.

"The reason the young man who bought the first player made the purchase was due to two things," Mr. Adsit remarked to his salesman. "He was stuck on the case and the tone pleased him." Mr. Adsit recalled that some of the greatest piano salesmen have not been able to play a note and said the fact that a salesman cannot play should not be permitted to handicap him.

Mr. Adsit is hoping to have his full line of pianos and players in the Shop by March 1. This line will include Packard pianos and players and the A. B. Chase reproducing pianos.

State Representatives Wanted

By established manufacturer of talking machines making an unusually high-grade line at moderate prices.

This is a big money proposition and only men who can show a successful record will be considered.

Kindly answer the following questions in your application.

All replies will be treated as strictly confidential.

1. Territory desired?
2. What territory have you been covering?
3. Experience, if any, in the talking machine business. (Experience is desirable but not essential.)
4. Give summary of your experience for the past five years.
5. Are you employed at present?
6. By whom?
7. In what capacity?
8. Why do you wish to make a change?
9. Have you sufficient financial strength to employ sub-salesmen for the purpose of thoroughly covering your territory?
10. Give references.

Address M. R., 17, care The Talking Machine World, 209 S. State St., Chicago, Ill.

BIG STRADIVARA SALES

Compton-Price Co. Finds New Factory Developments None Too Large to Take Care of Increasing Demand for Stradivara Phonograph

Compton-Price Co., of Coshocton, O., makers of the Stradivara phonograph, did the most successful business in January and February that this house has ever experienced. Louis V. Nippert, of the company, recently stated to a representative of The World: "Our dealers seem keenly alive to the situation in the phonograph market, and are protecting themselves against shortage and further raises in prices by sending in their requirements for many months ahead. We are glad that a foresighted policy on our own part enables us to accept and book these orders for shipment at a later date. We have bought well ahead on materials, and are in turn able to give our dealers the benefit of this saving."

"These dealers are not a bit slow in taking advantage of our service, seeing as they do the uncertainty of market conditions. In this connection, we have always tried to make it plain to our trade that it is the policy of this company to further protect them by not booking more orders than we are capable of handling. One hundred per cent. service in every department of our business is our motto, and our rapidly increasing list of enthusiastic Stradivara dealers is tangible proof that we are succeeding in making this idea a genuine reality."

NEW WEEKLY HOUSE ORGAN

Attractive Publication Issued by Columbia Co. Makes Its Initial Appearance

A new house organ named the Columbia Tone Arm Weekly made its appearance last month, and this publication, which is issued by the Columbia Graphophone Mfg. Co., at Bridgeport, Conn., promises to be one of the most valuable house organs issued by any factory organization

in the country. It is the intention of the company to continue the popular Tone Arm Monthly, but the weekly will try to give the news of the organization in a newsy way and by being published oftener will keep pace with the tremendous growth of the Columbia factory forces. The first issue is filled with interesting and timely chats regarding the various departments at the Columbia plant, together with articles of a semi-editorial nature and cartoon drawings that combine humor with pertinent messages.

The Columbia Tone Arm Weekly is a four-page newspaper and in size and make-up is similar to the Columbia Record, which is issued at the executive offices in New York and is recognized as one of the leading industrial house organs. An interesting feature of the new weekly is the use of photographs and short biographies of employes in the factory departments, and this section promises to be an important link in enhancing the spirit of good-fellowship and good-will that pervades the entire Columbia manufacturing organization.

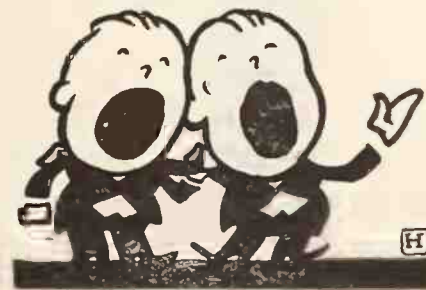

KEEPING IN TUNE

means harmony; co-operation means harmony. If you Victor dealers intend to co-operate with the Victor Management, keep in tune with Victor advertising policies. Advertise your Victor records inexpensively, yet effectively on your record delivery envelopes. For details, use coupon on page 45 or pin this ad to your letterhead and mail to

LU-FRANC SALES SERVICE
 1202 Dime Bank Bldg. Detroit, Mich.

GARFORD MFG. CO. NAME CHANGED

Elyria, O., Motor Manufacturing Concern Now to Be Known as the General Phonograph Mfg. Co.—Otto Heineman Chairman of Directors

It was formally announced last month that the name of the Garford Mfg. Co. had been changed to the General Phonograph Mfg. Co. A. G. Bean, president of the company, states that there is no other change in the organization, the officers remaining as they are now and the location of the factory continuing at Elyria, O.

The controlling interest in the Garford Mfg. Co. was purchased some time ago by Otto Heineman, president of the General Phonograph Corp., and at the present time the mammoth plant of the Garford Mfg. Co. is devoted almost in its entirety to the production of Heineman motors, tone arms and sound boxes. The factory is one of the most up-to-date and efficient manufacturing plants in the Middle West, and under the able direction of Mr. Bean has been a vital factor in the tremendous success of the Heineman product. Otto Heineman is chairman of the board of directors and an exceptionally capable factory organization has been developed during the past few years.

AEOLIANITES HAVE LEAP YEAR DANCE

Ladies of the Aeolian Employes' Association Act as Hosts to the Men at Interesting Party Held on Last Tuesday Night of February

The members of the Aeolian Employes' Association, at least the lady members, took advantage of the opportunity that occurs only once in four years to hold a Leap Year dance on the fourth floor of Aeolian Hall on February 24, following a buffet supper. The arrangements for the party were in charge of Miss C. E. Quinn, secretary of the Association, and there were a number of interesting surprises for the male guests. Being Leap Year, the ladies appeared in the role of hosts, asking the men to dance, to partake of refreshments, etc. The men enjoyed the unusual experience to the utmost and got on the floor in couples just in order that the members of the fair sex might "break" them for the dance. One bright mind

The Booth Felt Company, Inc.

Mechanical Felt Products

Turntable Felts **Motor Felt Washers**
Motor Brake Felts
Needle Rest Felts **Cabinet Strip Felt**

We carry a large stock of well assorted merchandise which insures prompt deliveries.

If interested in Velour or Velveten Discs we can supply them.

FACTORIES

BROOKLYN, N. Y. 463-473 Nineteenth Street	CHICAGO, ILL. 732 Sherman Street
--	---

went so far as to suggest that the ladies might appreciate the temporary change of position to the utmost by staging a theatre party, but the hint was not taken.

OSBORNE'S CLEVER ADVERTISING

During a recent lecture in Belfast, Ireland, on "Some Musical Facts, Fancies and Fads," Captain C. J. Brennan delivered quite a eulogy of the gramophone, which, he stated, had done much to popularize good music of late years. This lecture formed the basis of a very excellent advertisement carried by T. Edens Osborne, the enterprising talking machine factor of that city, in which he said: "Having been the first

to introduce the gramophone to Belfast (in 1898) twenty-two years ago, I naturally feel grateful for the Captain's praise of a marvelous musical entertainer the popularity of which is attested by the fact that thousands of these world-famous instruments and many thousands of records have been sold by me during the time mentioned."

TALKING MACHINE MEN MEET

Plans Progressing for Annual Banquet on April 14—Success in Combating Questionable Advertising—Other Features of the Session

The monthly meeting of the Talking Machine Men, Inc., the organization composed of talking machine dealers of New York, New Jersey and Connecticut, was held last month at the Hotel Pennsylvania. Of special importance was the report of the various committees on the plans and arrangements for the annual banquet and election to be held on April 14.

The committee on entertainment, composed of John E. Hunt, chairman; J. J. Davin, E. G. Browne, A. Galuchie, Irwin Kurtz, M. W. Gibbon and Cass B. Riddel, have arranged a very novel affair for the evening and among other things they announced that the affair was to be devoid of speeches. The tickets, including dancing, dinner, etc., are five dollars, and the present plans have been made to care for over six hundred people.

A nominating committee was appointed, composed of O. J. Rooney, M. Goransky, H. Bersin, G. Armstrong and I. Resenberg.

The meeting was addressed by representatives of the Harlow Insurance Plan and the Morris Plan of Industrial Finance Corp., who explained the workings of their businesses as applied to the talking machine trade.

The grievance committee reported on the results they had obtained in bringing to the attention of various advertisers misleading copy which had appeared in some New York papers since the first of the year. In every case the advertisers in question entered into agreements acceptable to the members, which proves that much can be accomplished by getting together with the house or houses who from time to time are charged with lowering the standards of their newspaper copy. Over forty members attended the session.

The Red Cross Decorating Co., of Centerville, Ia., have installed two booths and have placed a competent manager in charge.

BANG!

HERE IT IS!!

The "Hustylus"

THE little wonder-device that makes Pathé records playable on practically every instrument. The greatest thing that has yet happened for the Pathé dealer.

Sweeps all clumsy "adapters" into the discard. As simple to use as any steel needle. It adds many million instrument owners to the Pathé dealer's market.

Ask your jobber

Herbert & Huesgen Co.
Sole Sales Agents
18 East 42nd Street
New York

THE MYSTO NEEDLE—

CHANGED ONLY ONCE FOR PLAYING
TEN RECORDS — AND GUARANTEED



WE ARE GOING TO PUBLISH A BIG LIST OF MYSTO JOBBERS AND DISTRIBUTORS NEXT MONTH.

EVERY REAL JOBBER SHOULD BE LISTED.

WRITE TODAY FOR MONEY-MAKING JOBBERS' ARRANGEMENT.

NEEDLES FURNISHED IN COUNTER DISPLAY STAND JUST LIKE CUT SHOWN—50 NEEDLES IN EACH PACKAGE RETAILING FOR 10c.

"If it pertains to a phonograph we have it."

Amalgamated Phonograph Accessories Corporation

Dept. 2—12 E. 42nd St.

NEW YORK

The Trade in **BOSTON** *and* **NEW ENGLAND**
 JOHN H. WILSON, Manager
 324 WASHINGTON ST., BOSTON, MASS.

BOSTON, Mass., March 3.—Never in the history of the talking machine business has the trade suffered so much inclement weather. February will pass into history as a month that brought nothing good to business at large and the talking machine houses everywhere have shared in the difficulties due to unprecedentedly cold weather and heavy snows. While other parts of the country have suffered considerably, it has been New England that probably has been the hardest hit and from Connecticut to Maine business has been at times completely demoralized. That occupants of homes have been shut in for days at a time, thereby materially halting retail trade, was not the worst of the situation by any means, for the rigid embargo placed on shipments has seriously halted the receipt of goods from the factories. Machines have been very hard to get at times, but perhaps the most noticeably serious consequence has been in the late arrival of the March records, most of which did not come into the possession of the distributors until the eleventh hour. As the trade well knows there is an immense amount of work involved even then in getting the instalments ready for the retail shops. The result was that in many large Boston establishments the employes worked all night of the twenty-eighth and all day the following day (Sunday) supplying dealers' requirements.

Hope for Normal Conditions Soon

Meanwhile the demand for goods began heavy the first of February and continued right through the four weeks, so that if the goods could have been obtained—for the freight embargo went into force early in the month—business would have been splendid. Everybody is therefore hoping that March has something bet-

Steinert Service Serves

M. STEINERT & SONS CO.

35 ARCH ST.



BOSTON

WHOLESALE HEADQUARTERS

With our newly completed service department, a reality and a model for the good of the retailer, we are prepared to offer valuable ideas to our retailers to help resell such goods as are now obtainable.

ter in store for the trade. If only normal conditions can obtain from now on (one wonders how late this weather is to continue into the Spring, for the snow is four and five feet on

the level in most sections of suburban New England) there will be an opportunity to catch up. Fundamentally, conditions are excellent and it only needs favorable weather to open the Spring campaign.

Boston Men Liked Music Show

The Boston trade was well represented at the National Music Show in New York and everyone who went over appears to have had a delightful time in a social way as well as a profitable one from the business point of view. Talking machine men found much to interest them in some of the new types of standard makes, while there were many new products whose special claims to distinction were carefully inquired into. It is generally conceded that the show was quite worth while, as it gave the manufacturer, distributor, dealer, jobber, all of them, a new angle on trade developments.

Period Vocalions on Boylston Street

Under the local management of E. M. Wheatley the Vocalion Co. is making good headway. The Boylston street warerooms are now furnished with some new models, some of them period design, which are quite the handsomest designs seen in a long time. The two able young men whom Mr. Wheatley brought over from the New York warerooms, John Francis Leavy and Raymond Clarke, are proving themselves welcome additions to the retail staff.

Steinerts Beat Freight Embargo

The M. Steinert & Sons Co. was one of the local concerns that had to bravely face the freight embargo, especially as regards the March Victor records. Kenneth Reed, the wholesale manager, in discussing the situation with *The World*, made it plain that the Steinert organization aims to give its dealers the best possible service, which meant that it would be necessary for all hands to work all of Saturday night and all day Sunday. He said that the American Express had refused to handle any more freight and that there were even then (this was the eve of March) several hundred pieces of freight in which the Steinert house was interested awaiting disposition. It is of special interest, however, that in this case the March consignment of records was distributed

(Continued on page 86)

"New England Service for New England Dealers"

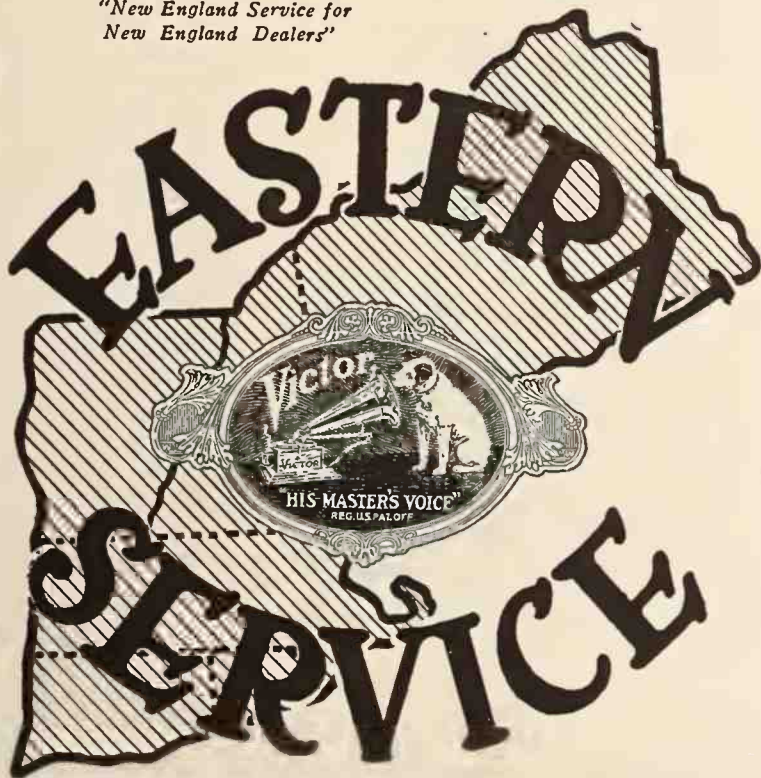

GOOD SERVICE is always characteristic of good business. Without one the other does not exist.

EASTERN Service specializes in New England and has one chief aim—to help Victor merchants put over the best year in 1920.

The Eastern Talking Machine Co.

VICTOR WHOLESALERS

85 Essex Street

BOSTON



C. H. BAGSHAW
President

THE present executives of the W. H. Bagshaw Co. are C. H. Bagshaw, President, and W. J. Bagshaw, Secretary, both of whom are men of business vision—able, progressive, and masters of the art of needle making. To grow steadily and quickly, at the same time constantly improving the quality of a product, is indeed an achievement. C. H. Bagshaw has the distinction of directing the world's greatest production of talking machine needles.

W. H. BAGSHAW
CORPORATION
LONDON, ENGLAND

1870
1920



W. J. BAGSHAW
Secretary

IN order to improve Bagshaw quality, it became necessary to organize a steel company. So the Hy-Carbo Steel Co. was formed to make the famous Hy-Carbo talking machine needle wire, which is used exclusively in Bagshaw needles. The president of this company is C. H. Bagshaw, and the treasurer is W. J. Bagshaw. C. H. Bagshaw has been making needles for 30 years, while the experience of W. J. Bagshaw totals 20 years.

W. J. BAGSHAW
COMPANY
LOWELL, MASS.

THE TRADE IN BOSTON AND NEW ENGLAND—(Continued from page 83)

to dealers and Manager Reed was able to get away the night of the first on a trip that is taking him to the factory at Camden, to Philadelphia, Baltimore, Washington, New York and Brooklyn. Speaking of general conditions outside of the weather Manager Reed said just before leaving town: "While conditions are not all that we would like to have them, the man is blind who cannot see an improvement. The record business is far better than it was a year ago and even machines are being received in more satisfactory quantities. All that can reasonably be asked for is a steady increase and this is what really is happening."

Eastern T. M. Officials Visit Camden

President George Dodge and Vice-President C. H. Farnsworth of the Eastern Talking Machine Co. were over at the Victor factory the middle of February. They returned to Boston convinced that the company is pushing ahead in its output to the limit of its capacity. Manager Shoemaker reports that the machine situation seems to be better than it was and he thinks the record situation will be about the same.

New Pathé Accounts for Hallet & Davis

Arthur J. Cullen, who came here from Chicago to associate himself with the Hallet & Davis Co. in handling the Pathé line, is at present devoting much of his time to training the road men in handling this line. Two concerns that have just signed up with Hallet & Davis to handle the Pathé are J. F. Quilty of Chatham, down on the Cape, and A. G. Wheeler of Winchendon. Pathé distribution is making surprising gains throughout the territory controlled by Hallet & Davis.

New Brunswick Records Popular

Kraft, Bates & Spencer, Inc., report that the records which the Brunswick put out for the first time a couple of months ago are coming along very well and that there is a marked demand for them by owners of Brunswick machines. The billboard campaign on which the house is about to embark by way of familiarizing all New England with the merits of the Brunswick will be got well under way as soon as Spring sets in, the weather up to this time having been prohibitive for outdoor work.

PERFECTION BALL-BEARING TONE ARMS

PERFECTION FLEXI-TONE REPRODUCERS

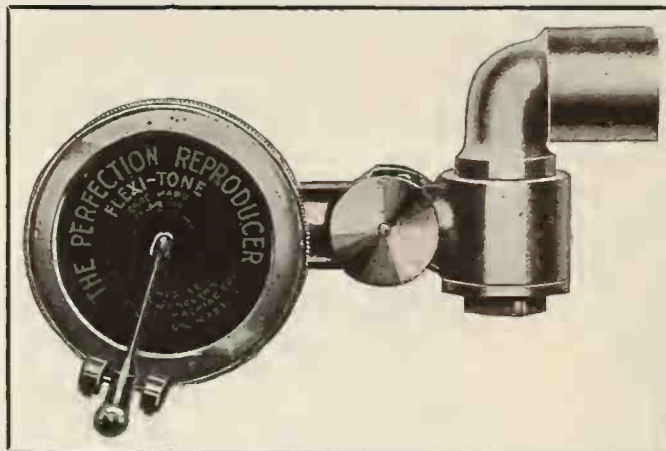

Manufacturers—
Jobbers—
Dealers—

The Perfection Flexitone reproducer No. 7 attached to the Perfection ball-bearing tone arm No. 4 plays all lateral cut records on all types of Edison Disc Machines. Made in nickel and 24 carat gold finish, extra fine quality disc.

These reproducers and tone arms are the very finest made, mechanically—reproducing as the records were recorded in the recording room—Clarity of sound with great volume.

WRITE FOR QUANTITY PRICES

Manufactured by

New England Talking Machine Co.

Largest Manufacturers of Phonograph Accessories

16-18 BEACH STREET BOSTON, MASS.

Pacific Coast Distributor: WALTER S. GRAY

942 Market St., San Francisco, Cal.

Phoenix Trading Co., 1265 Broadway, New York
Eastern and Export Office

Billy Fitzgerald Now "On His Own"

"Fitzgerald, the Victrola man," accompanied by his picture, is the way the advertisements

in the daily papers begin in telling of the opening of the new Victrola shop by Billy Fitzgerald, for eighteen years with the Eastern Talking Machine Co. The location is at 110 Tremont street, at the corner of Bromfield street, in what is known as the Studio building. The shop was opened the last Saturday in February. Few men in the trade know the talking machine business better than Fitzgerald and he should meet with success as he has many friends in the business.

J. O. Morris a Visitor

J. O. Morris, president of the Musical Supply & Equipment Co., was in town for a few days the latter part of February to confer with Manager Joseph Burke, who is meeting with great success in handling Sonora machines, Emerson records and other lines. Mr. Burke himself went over to New York the end of the month, but was away only a few days.

Tells of Empire Popularity

Charles G. Faux, head of the New England Piano & Talking Machine Co., makes a most encouraging report of the way the Empire and New England machines are going. The house is placing the machines in excellent hands throughout the New England field.

Edward Ginsberg Laying Plans

The products of Brown, McManus & Co. are rapidly finding their way around in Greater Boston and Manager Edward Ginsberg, who has supervision of the New England field, is carefully mapping out his program preparatory to a pushing campaign.

Mysto Agency for Sharmat & Son

S. W. Sharmat & Son, of Bromfield street,

CRESSEY & ALLEN

Portland
COVERS
New ENGLAND
CONN. MAINE

The SPIRIT of SERVICE
prevails throughout our
ORGANIZATION
CRESSEY & ALLEN
Victor Distributors
PORTLAND MAINE

Send for Descriptive Circular

Curry

DEMONSTRATION BOOTHS
AND RECORD CASES
IN STOCK OR TO ORDER

"SOUND PROOF"

FRANK B. CURRY
72-74 Dedham St. Boston, Mass.

New England Dealers!

We have a most unusual plan of financing your phonograph department

Write for Particulars

New England Phonographs

Empire Phonographs

New England Piano and Phonograph Co.

Largest Distributors of Phonographs in New England

405 Boylston St.

Boston, Mass.

who are making a success with the Vitanola, have taken on the agency for the Mysto needles and already the house is finding a good field for this additional line. It is Mr. Sharmat's idea to be constantly on the lookout for any talking machine accessory that will prove of value to his clientele.

Kenneth Reed Uses His Snowshoes

During the bad weather in February when the snow lay to the depth of several feet in the country districts, Kenneth Reed, wholesale manager of the M. Steinert's Victor department, made the distance between his home in Canton and the railroad station on snowshoes and he got to be quite proficient in their use.

March Records Cause Night Work

Manager Henry Winkelman, head of the Victor department of the Oliver Ditson Co., was another house that had to work hard to keep faith with its dealers apropos the delay in getting the March records through from the factory. But by dint of hard work all of Saturday

night and Sunday he and his faithful staff had a clean slate by Monday morning.

Wandering Shipment Reaches Port

Manager Arthur W. Chamberlain of the Iver Johnson Co. ordered a carload of Stegers that was supposed to have left Chicago January 6 which up to a few days ago had not arrived. This by way of hint as to the abominable weather and how it has affected transportation.

Steinerts Go North and South

Alexander Steinert, head of the M. Steinert Co., is enjoying a vacation at Pinehurst, N. C. Robert Steinert, his son, who makes his headquarters at the Arch street establishment of the house, spent several days at Hanover, N. H., where he took part in the winter sports of Dartmouth College, his alma mater.

Dockendorf Now an Edison Man

W. P. Dockendorf, who has been associated with several talking machine houses in this city, is now located with George Lincoln Parker in the distribution of the Edison line, over which

he has become most enthusiastic. Before Chickering & Sons disposed of their talking machine department Mr. Dockendorf was with that prominent establishment.

E. J. Dunham Entirely Recovered

E. J. Dunham, who has the Western Massachusetts territory for the Eastern Talking Machine Co., is back on the job after a siege of illness which included an attack of influenza.

John W. Canivan Recovering

John W. Canivan of the Oliver Ditson Co.'s Victor staff has been on the sick list, being a sufferer from an attack of influenza. Canivan, it will be recalled, is an overseas man, and suffered the experience of being gassed while at the front. His many friends will be glad to learn that he will soon be well enough to resume his duties.

The Achievements of the Bagshaws

It is rather unusual to find two men—brothers—who are associated in the same business and who get along harmoniously without even the slight small family scraps. In fact, so well do they chum together that they are frequently called the Bagshaw twins. The men referred to are C. H. Bagshaw, president, and W. J. Bagshaw, secretary, of the W. H. Bagshaw Co., Lowell, Mass., makers of talking machine needles.

C. H. Bagshaw has been with the concern for thirty years and W. J. Bagshaw twenty years, and it is a striking testimonial to not only the regard that the Bagshaw boys have for each other, but it is cited as a model for other brothers and other men, that it is easier to get along well together than on any other basis.

C. H. Bagshaw has directed the manufacture of more talking machine needles than any other man in the world, for not only was this organization the first makers of talking machine needles, but it enjoys the reputation of having to-day the largest output in trade history.

(Continued on page 88)

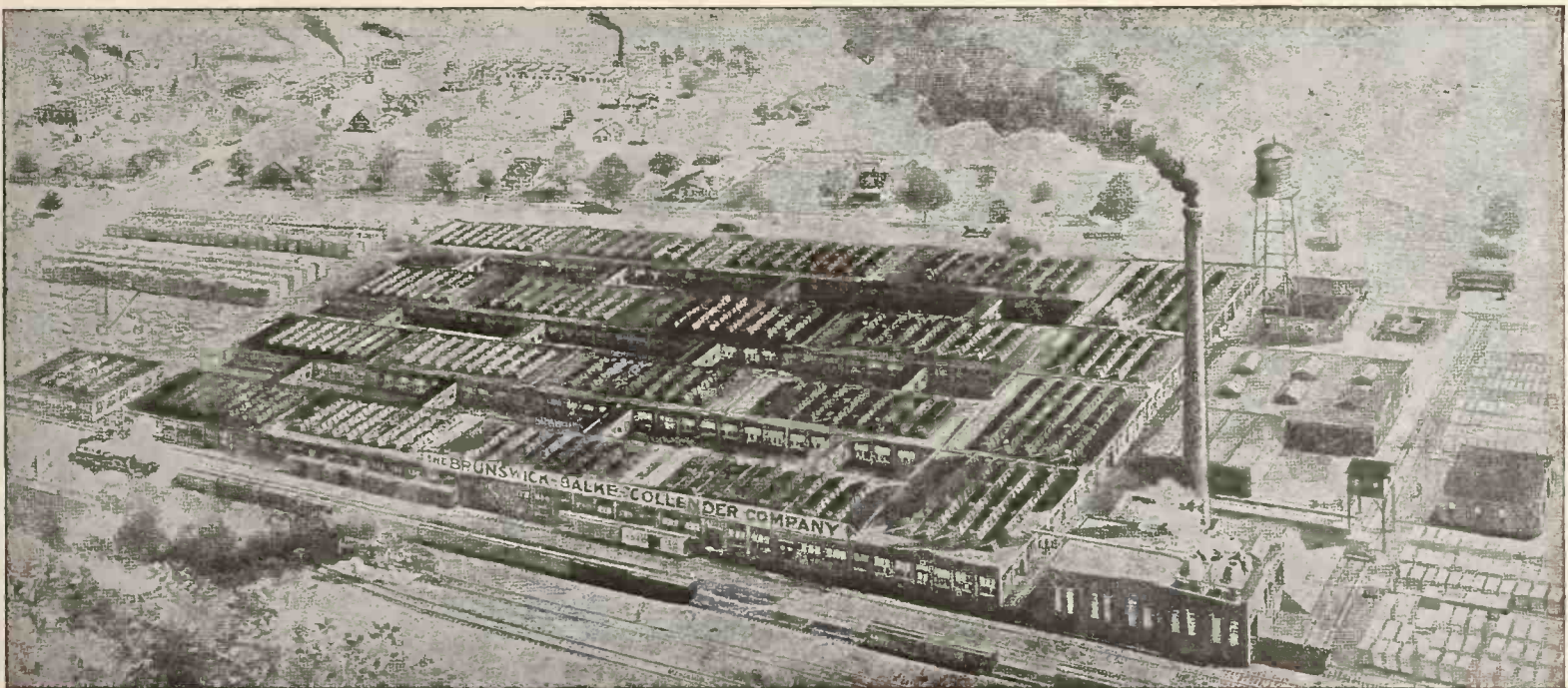

Above—Brunswick phonograph factory at Dubuque, Iowa
Other Brunswick phonograph factories—Muskegon, Mich.; Chicago, Ill.; Rockford, Ill.; Knoxville, Tenn.
Record factories—Long Island City, N. Y.; Jersey City, N. J.

All Brunswick

Brunswick Phonographs are Brunswick made—*completely*
All their features are our own

This advertisement is placed as an assurance to *Brunswick dealers* that Brunswick Phonographs are *not* assembled.

Every Brunswick is 100 per cent. Brunswick.

KRAFT, BATES & SPENCER, Inc., 156 Boylston St., BOSTON MASS.
NEW ENGLAND DISTRIBUTORS
Tonofone Victrolene Motrolas Steel Needles Jewel Points
Albums Record Brushes Khaki Covers



THE TRADE IN BOSTON AND NEW ENGLAND—(Continued from page 87)



Disc Record, Player Roll and Sheet Music Cabinets. The Best in the Market
See Display Ad in This Issue

Peerless Record Album

Standard of Quality to preserve the Records
See Display Ad in This Issue

Send your orders for both these lines to
L. W. HOUGH, 20 Sudbury St., Boston, Mass.
New England Representative

So that the supply of needle wire for making talking machine needles be developed to its highest degree of efficiency, it was necessary some time ago to incorporate the Hy-Carbo Steel Co., makers of the famous Hy-Carbo talking machine needle wire, this being used exclusively in needles made by the W. H. Bagshaw Co. Of this latter organization the president is C. H. Bagshaw and the treasurer is W. J. Bagshaw.

Nelson Goes to Chicago

Richard M. Nelson, vice-president and general manager of the Beacon Phonograph Co., made a flying trip to Chicago the latter part of February in order to arrange for the Western territory representation of his company.

Amos E. Russell a Visitor

Amos E. Russell, who is pleasantly remembered from the days of his association with the Vocalion Co., was in town the first of the month renewing old acquaintances. Mr. Russell, who was with the Vocalion in New York for a time, is now with Cluett & Sons, at Troy, N. Y., which concern also conducts stores at Albany and Schenectady, N. Y. As the manager of the phonograph department for this house he is making a distinct success.

Columbia Co. Wholesale in New Quarters

The Columbia Co., wholesale, has finally got

moved from its Federal street quarters to 1000 Washington street, where in a comparatively new fire-proof building it will soon be ready to greet its friends. The first instalment of removal was made on Washington's Birthday and thereafter so expeditiously was the removal accomplished that the house was out of service only one day. The contractors, however, will be at work in the new place for at least a couple of weeks yet. Manager Fred E. Mann states that when the freight embargo of the New Haven Railroad is finally lifted there will be an immense amount of goods released for the trade from Bridgeport; that at the present time there is at least \$2,500,000 worth of records awaiting shipment.

BEACON PHONO. CO. REORGANIZED

New Location at 19 Milk Street—Albert R. MacDonald Made President—Many New Beacon Distributors Appointed—Plan Big Campaign

BOSTON, MASS., March 1.—The Beacon Phonograph Co., Inc., which began business at 248 Boylston street, has been reorganized and is now located at 19 Milk street, down in the commercial section of the city. Albert R. MacDonald, who is now president and treasurer, according to a statement put out by the company, was formerly vice-president and assistant general manager of one of the largest efficiency concerns in the country. Richard M. Nelson, the vice-president and general sales manager, whose name has long been identified with the talking machine industry, was formerly general manager of the Musical Supply & Equipment Co. Alvah L. Falla, vice-president and factory manager, has been connected with one of the large woodworking plants in New England and is thoroughly familiar with cabinet making. John M. Falla, secretary and production manager, has been associated with his father for a number of years and is said to be an expert on

MICA DIAPHRAGMS

Watson Brothers, Inc.

170 PURCHASE ST.

BOSTON - - - MASS.

all matters pertaining to the production of talking machines. Chester W. Johnson is in charge of the research and experimental department. He has spent a number of years in experimental work pertaining to talking machines.

According to the statement in the hands of The World correspondent, Beacon distributors have been appointed for Maine, New Hampshire, Vermont, New York, part of Pennsylvania, Alabama, Mississippi, West Virginia, Kentucky, Ohio, a part of Indiana and a part of Michigan.

General Sales Manager Nelson, who is highly enthusiastic over the prospects, states that inside of sixty days the company will be prepared to take care of considerable additional business; that when the Beacon was exhibited at the Music Show it not only made a tremendous hit, but that a large volume of business was booked up. He says, also, that plans have been made for considerable export business, which will be begun during the summer months. The company is planning for a big billboard advertising campaign.

PLAN TO DOUBLE BUSINESS

BOSTON, MASS., March 5.—The Lenox Jewelry Co., of this city, states that the Pathé line is going fine and that it expects to double its business this year. This company is planning to open a new store in the near future.



TO TALKING MACHINE DEALERS!

All talking machine dealers who recognize the value of having a line of fast selling Records in connection with their business are asked to communicate with us at once. The exceptional facilities we enjoy in connection with the general distribution of Pathé Records make it possible for us to offer advantages and a character of service that are next to impossible to obtain at this time.

Hallet & Davis Piano Co.

146 BOYLSTON STREET, BOSTON, MASS.

New York Office: Hallet & Davis Bldg., 18 East 42d Street

Exclusive Distributors for New England States
and General Distributors for the United States
for *Pathé Phonographs and Pathé Records.*



VITANOLA

The Phonograph of Marvelous Tone



The Popularity of this Wonderful Talking Machine in New England has been unprecedented. If you are looking for

QUALITY SERVICE AND PROFIT

GET IN TOUCH WITH THE MOST PROGRESSIVE HOUSE IN THE EAST

Vitanola Phonographs

Records Mysterio Needles

S. W. SHARMAT & SON

Wholesale Distributors

5 Bromfield Street, Boston, Mass.

THE BRAIN A FILING CABINET

There was a time when men believed the size of a brain was an indication of its mentality. The brain is nothing but a filing cabinet for the thoughts born of our own feelings or gathered in from those generated by other people's feelings. In these filing cabinets the law of all nature prevails in that "everything goes to its own place"—every thought finding its place with every other thought of its own kind, and reacting in the generation of other thought and other feeling. Hence feeling generates thought, and thought becomes the mother of feeling.

C. C. MOIR GETS L'ARTISTE AGENCY

Closes Contract With Philadelphia House for Exclusive Distribution in New England—Line Includes Fourteen Period Models

BOSTON, MASS., March 1.—C. C. Moir, of 828 Massachusetts avenue, Cambridge, has just closed a contract with the Philadelphia Show Case Co., of Philadelphia, for the exclusive distribution of L'Artiste machines in New England. This prominent Philadelphia house has been handling L'Artiste machines for some time past and has placed very large orders with the Grand Rapids Phonograph Co., manufacturers of this machine, which will enable the company to give Mr. Moir excellent co-operation. New York and Philadelphia already have taken enthusiastically to this line during the past season and as it is an exceptionally high-grade one there is no question as to its reception in New England. The line includes fourteen period models, ten uprights and four consoles. The fine cabinet work and artistic designing come well up to the standard for which Grand Rapids is famous.

It is understood that R. H. Monroe, formerly with the Steger line, secured the contract for Mr. Moir and will have entire charge of the jobbing end. It is planned to open a Boston salesroom with a competent man in charge and an ample sales force to cover the New England territory.

METROPOLITAN OPERA IN ATLANTA

Record Sales Greatly Stimulated by Appearance of Metropolitan Opera Co.

ATLANTA, GA., March 3.—The talking machine business in this city, particularly the record branch of it, has been unusually active, owing to the appearance of the Metropolitan Grand Opera Co., of New York. The records of the celebrated artists making up this organization have been featured in window displays and advertising by the local dealers with splendid success. The public is not only interested at the present time, but when the company leaves the city the demand is certain to continue, because the thousands of people who heard these grand opera artists will want to get permanent records of their voices in their favorite arias.

Providence, R. I., has purchased several talking machines for the entertainment of the pupils in the public schools of that city.

Lansing Khaki Moving Covers

Despite the obstacles that have arisen during the past year have maintained their high standard of

QUALITY

The Quality of the LANSING cover has given it leadership in the field



No. 3 Carrying Strap Shown in Cut

These covers are made of Government Khaki, interlined with heavy felt in Grade A, or cotton in Grade B, fleece lined, quilted and properly manufactured under the personal supervision of E. H. Lansing, the originator of the Talking Machine Cover for protection in moving. Made in two grades.

Write for prices and descriptive catalogue

E. H. LANSING
611 Washington St., BOSTON

San Francisco Representative: WALTER S. GRAY
942 Market Street
PHOENIX TRADING COMPANY
1265-69 Broadway, New York

PLAZA

BUY YOUR ACCESSORIES

"All From One Source"



Sapphire Point



Sapphire Ball



Diamond Point

Genuine Diamond and Sapphire Needles

You should always carry a stock of these needles, because there is a steady sale for them.

It is important to know that the needles you handle are accurate and uniform. You are assured of this in our product.

Can be supplied as follows:

- Pathe Loud Tone
- Pathe Half Tone
- Edison Loud Tone
- Edison Half Tone

There is a big demand for genuine Diamond Point Needles also. You can buy them from us at very attractive prices.

Note to Manufacturers:

Your dealers will appreciate your including with each machine a set of Sapphire Needles. It makes a good talking point.

Write for Prices



PLAZA MUSIC CO.
18 WEST 20TH STREET
NEW YORK

Lundstrom CONVERTO

PATENTED DEC. II. 1917

Talking Machine CABINET

The proof of the high selling value of the Lundstrom "Converto" has been established at the hands of Victor dealers all over the country. At present their demand for Convertos exceeds the supply.

Profits from Converto sales have been greatest for those who were first to realize that the Converto does sell readily to present owners of Portable Victors, that it does arouse new interest in Records, and that it does offer in connection with a Portable Victor a more salable instrument to meet the competition of low-priced cabinet machines.

The C. J. Lundstrom Mfg. Co.
LITTLE FALLS, N. Y.

Lundstrom "Converto" Cabinets are broadly covered by patents. Infringements will be promptly prosecuted.



Converto Wholesale Distributors

Albany, N. Y..... Gately-Haire Co., Inc.
Atlanta, Ga..... Phillips & Crew Piano Co.
Baltimore, Md.... Cohen & Hughes
 E. F. Droop & Sons Co.
Birmingham, Ala. Talking Machine Co.
Boston, Mass..... The Eastern Talking Machine Co.
Buffalo, N. Y..... W. D. & C. N. Andrews
Burlington, Vt.... American Phonograph Co.
Chicago, Ill..... Lyon & Healy
Cincinnati, O..... The Rudolph Wurlitzer Co.
Cleveland, O..... Cleveland Talking Machine Co.
 The Collister & Sayle Co.
 The Eclipse Musical Co.
Columbus, O..... The Perry B. Whitsett Co.
Dallas, Tex..... Sanger Bros.
Denver, Colo..... The Knight-Campbell Music Co.

Des Moines, Ia... Mickel Bros.
Elmira, N. Y..... Elmira Arms Co.
El Paso, Tex..... W. G. Walz Co.
Houston, Tex.... The Talking Machine Co. of Texas.
Kansas City, Mo.. J. W. Jenkins' Sons Music Co.
 Schmeizer Arms Co.
Jacksonville, Fla. Florida Talking Machine Co.
Memphis, Tenn... O. K. Houck Piano Co.
Milwaukee, Wis... Badger Talking Machine Co.
Mobile, Ala..... Reynolds Music House
Newark, N. J.... Collings & Price Co.
New Orleans, La.. Phillip Werlein, Ltd.
New York, N. Y.. Emanuel Blout
 C. Bruno & Son, Inc.
 The Cabinet & Accessories Co., Inc.
 Kneckerbocker Talking Machine Co.

Omaha, Neb..... Mickel Bros. Co.
Peoria, Ill..... Putnam-Page Co., Inc.
Philadelphia, Pa.. C. J. Heppe & Son.
 The Geo. D. Ornstein Co.
 Penn Phonograph Co., Inc.
 H. A. Weymann & Son, Inc.
Pittsburgh, Pa.... W. F. Frederick Piano Co.
 Standard Talking Machine Co.
Portland, Me..... Cressey & Allen, Inc.
Providence, R. I.. J. Samuels & Bro., Inc.
Richmond, Va.... The Corley Co., Inc.
San Francisco, Cal. Walter S. Gray
Sioux Falls, S. D. Talking Machine Exchange
St. Paul, Minn.... W. J. Dyer & Bro.
Syracuse, N. Y.... W. D. Andrews Co.
Toledo, O..... The Toledo Talking Machine Co.
Washington, D. C. Cohen & Hughes
 E. F. Droop & Sons Co.

DEVELOPING TONE AMPLIFIER

Bureau of Standards Conducting Research Work in the Development of New Electron Tube

WASHINGTON, D. C., March 1.—Members of the talking machine and the musical instrument trade generally will doubtless be interested in the experiments which are now being made by the United States Bureau of Standards, Department of Commerce, in the development of the electrical song and speech amplifier known as the "electron tube."

In a bulletin just issued the bureau states that "this is such a recent development that as yet there are no standards of performance by which these devices are rated, and there are few of the generally recognized principles of electrical design by which an amplifier can be produced for a particular purpose without extensive and costly experimental work."

"With the idea of standardizing the construction of these devices the bureau is conducting an exhaustive experimental and theoretical investigation of all available types of amplifiers of both foreign and domestic design."

"It is expected that two important results will be secured: (1) The establishment of standards of operation for each type of amplifier according to which manufacturers can rate their product. (2) Principles of design will be formulated, data on constructional details will be assembled and all such information made available for the use of those interested in methods of electrical communication and the reproduction of sound."

"LARGEST SIGN IN THE WORLD"

Advertising Authorities Credit the Sonora Co. With Peekskill Sign Being Out of Ordinary

The advertising department of the Sonora Phonograph Co. has been advised by advertising authorities that the new Sonora painted sign near Peekskill, N. Y., alongside of the tracks of the New York Central Railroad, is one of the largest signs in the world, if not the largest. This enormous sign is 750 feet long and forty-three feet high. As aids in compelling attention, huge arrows are being put up, pointing it out in a way that no one can escape seeing it.

This gigantic sign has an area of 32,250 square feet, and it took forty men five weeks to erect the sign. Before it could be started, an entire orchard of apple and pear trees, covering two acres, had to be removed, the ground space clearing being 1,000 feet in length by 500 feet deep.

This tremendous sign is one of the leading factors in the Sonora outdoor publicity plans for the coming year. Other important locations have been secured and work is progressing on these sites.

WHO WILL GIVE SOME RECORDS?

The New Orleans division of the Red Cross is making a plea for used talking machine records to be distributed to army and naval posts on the Gulf Coast. Dealers might aid by offering to announce records brought to them would be turned over to the Red Cross, and then replace the old ones by selling the latest.

VISITS GRINNELL STORE

Frank Tinney, during his appearance in the city of Detroit in "Sometime," a musical show, paid a visit to the new store of Grinnell Bros. on Broadway. The event was given much advance publicity and the store was crowded during the afternoon.

PHONO-BRETTO
(PHONOGRAPH LIBRETTO)

As necessary to the phonograph-owner as is the opera-libretto to the opera-goer. The book you have been waiting for! It contains the words of over 800 favorite records of all makes. \$1.00 postpaid. THE PHONO-BRETTO CO. INC., 817 Faile St., NEW YORK CITY.

EUGENE A. WIDMANN OFF TO FRANCE

President of the Pathé Frères Co. to Spend a Month Abroad—Will Also Visit London

Eugene A. Widmann, president of the Pathé Frères Phonograph Co., Brooklyn, N. Y., sailed on Saturday, March 6, on the "Imperator" for Cherbourg, from whence he will proceed to Paris. Mr. Widmann expects to spend about



E. A. Widmann

a month in the French capital and on his way back will stop at the London offices of the Pathé Frères Phonograph Co. for a day or so. Maxime Pathé, who has been in this country since December, returned on the same steamer with Mr. Widmann. Mr. Pathé recuperated nicely from his trying experiences in the war and carried back with him many pleasant recollections of his stay on this side.

The demand for records continues to be unprecedentedly large.

NEW DISTRIBUTORS APPOINTED

Robinson-Pettit Co. in Kentucky and Lee-Coit-Andreesen Co. in Nebraska to Handle the Sonora Business in That Territory

Frank J. Coupe, director of sales of the Sonora Phonograph Co., New York, announced this week the appointment of the Robinson-Pettit Co., Louisville, Ky., a prominent wholesale drug house, as Sonora distributors in the State of Kentucky, and the Lee-Coit-Andreesen Co., Omaha, Neb., a wholesale hardware house, as Sonora distributors in the State of Nebraska. Both of these concerns are well equipped to handle Sonora business in their respective territories, and they are making plans for an energetic sales and service campaign.

Mr. Coupe returned recently from a two months' trip, which included a visit to every Sonora jobber as far west as San Francisco. He states that he found conditions wonderful, and that every jobber is making plans for a record-breaking year. A gratifying feature of the general Sonora business is the fact that the sales of the higher priced models are predominating in practically every trade center.

PUBLICITY OPENS WIDER SPHERE

The advertising by the Pathé Frères Phonograph Co. in foreign language newspapers of their foreign record lists has brought exceptionally good results, according to H. Leviton, a Pathé dealer of 551 E. 138th street, New York. In one instance Mr. Leviton reports it brought about the sale of three instruments and numerous records. Mr. Leviton has written the Pathé Frères Phonograph Co., congratulating them on the help they are giving to their dealers.

A new building is being constructed by the F. D. Rice Music Co., Victor dealers of Wellsville, N. Y., whose former store was burned to the ground. It will be equipped with every modern improvement.



UNIVERSAL PHONOGRAPH
LAWSON
EXACT TONE REPRODUCTION

LAWSON

UNIVERSAL

PHONOGRAPHS

Play All Disc Records
BEST
with the
Lawson Wood Tone Arm
(Patented)

Backed Up By
40 years' experience in manufacturing Musical Instruments and a "Gold Bond Guarantee."
LAWSON UNIVERSAL DEMAND
Is Increasing Faster than Production

Agents' Territory Allotments now being made as fast as new business can be handled. Your application should not be delayed.

SOLD DIRECT TO DEALER AT JOBBER'S PRICES

Lawson Piano and Phonograph Corp.
Executive Offices
2572-2574 Park Ave. **New York**



Unusual Opportunities For Live Wire Dealers



MODEL C-130
Height 46", Width 20", Depth 21"

T
H
E
W
A
D
E
R
O
L
A



THE PORTROLA
(Trade-Mark)

PLAYS ALL RECORDS
Size 13½x13½x10 Inches
Retail Price, \$35.00
Dealers Write for Discounts

T
H
E
W
A
D
E
R
O
L
A

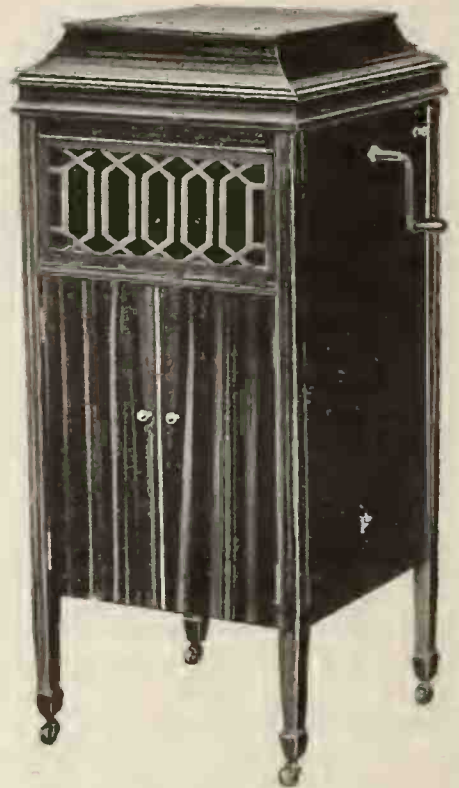

MODEL B-100
Height 44", Width 19", Depth 20"

PHONOGRAPHS
that appeal to the Eye and
Ear and are Sure Sellers.
Interested Dealers are re-
quested to Write for Prices
and Discounts.

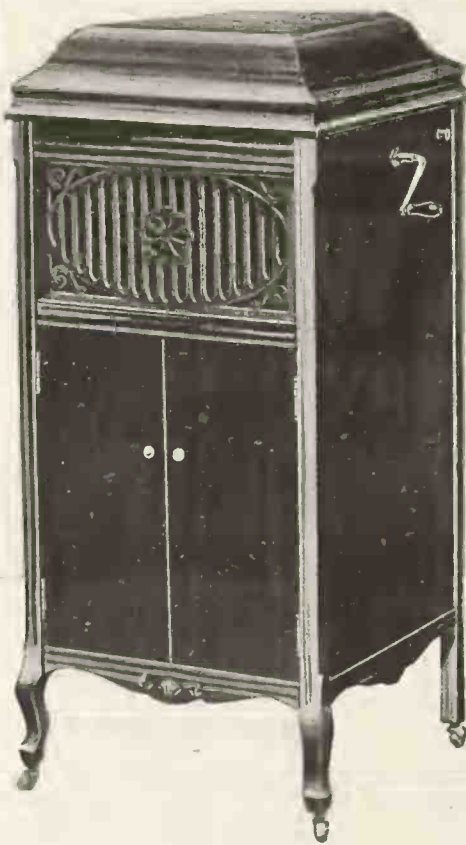

MODEL D-160
Height 48", Width 21", Depth 21"

T
H
E
W
A
D
E
R
O
L
A

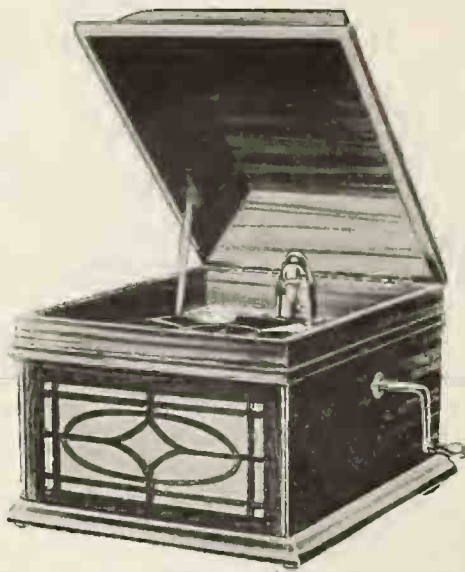

THE WADEROLA
Table Machine
Model A-70
Made in Oak and Mahogany
15x17x20½ Inches

T
H
E
W
A
D
E
R
O
L
A



MODEL G-250
Height 50", Width 23", Depth 23"

Wade Talking Machine Co

WHOLESALE DISTRIBUTORS.

12-20 NORTH MICHIGAN AVE., CHICAGO

THE TALKING MACHINE ACTS THE ROLE OF SPELLBINDER

Senator Harding and Wm. G. McAdoo Heard in Debate Through the Medium of the Columbia Records Made Under the Auspices of the Nation's Forum

Local newspapers have been devoting considerable publicity to the recent debate which was held in the club rooms of the Central Republican Club of the Nineteenth Assembly District, New York. At this debate the participants were William G. McAdoo, formerly sec-

known Columbia dealer, was in charge of this unique debate.

Referring to the general subject of talking machine debates during the Presidential campaign, the Evening Telegram on its editorial page viewed the subject in a way which met

political opinion? Suppose the Lincoln-Douglas debates were preserved on phonograph records—would they not take on wonderful significance to-day? We imagine the super-race that inherits this nation a century or two from now will be greatly interested in what we did and said right after the great war."

BUT MAYBE SHE LIVED IN JERSEY

Popular Columnist in Evening Sun Tells of Visit to Upper Broadway Music Store

The Woman was in an upper Broadway music store a few days ago when a smartly dressed, self-possessed young woman entered.

"Have you Citronella?" she asked in a high, clear voice. A look of blank amazement replaced the smile on the clerk's face. "I—I'm afraid you'll have to go to a drug store for that, Madam," he stammered.

"Why a drug store?" This coldly.

"Because citronella is a remedy for mosquito bites, Madam."

"The very idea! Haven't you heard of the latest fox-trot?"

"O—h! You mean 'Dardanella,' don't you?" And she did.

L. K. LINCOLN CONVALESCING

L. K. Lincoln, advertising manager of the Sonora Phonograph Co., New York, is now convalescing at the Midwood Hospital, Brooklyn, N. Y., after a serious operation. Mr. Lincoln has been away from his desk the past few weeks, but hopes to resume the active direction of Sonora publicity about the first of the month.

FEATURING THE PATHE LINE

The Pathé line of machines and records is meeting with much favor in Norwalk, O., and the A. B. Chase Co. has found the addition of the Pathé line to be very advantageous.



Partial View of Listeners to Debate at Central Republican Club

retary of the treasury, and Senator Warren G. Harding of Ohio. These prominent men carried their message to the club members through the medium of talking machine records, made under the auspices of the Nation's Forum, and played on a Columbia Grafonola. Irwin Kurtz, well-

with the general commendation of the trade and the public. In this article the editorial writer said in part:

"Would not modern audiences be glad to pay admission to hear Hamilton and Burr argue on the phonograph some of their differences of



Repair Department

VICTOR SERVICE

A repair department, completely equipped in every detail and conducted by expert repairmen; exclusively devoted to your interests. Another part of

Andrews Victor Service

W. D. & C. N. ANDREWS - Buffalo, N. Y.



*We have picked a
Winner for you in*

Okeh Records

OKEH RECORDS have met with phenomenal success —but it is a success that is well deserved, for this Record line is undoubtedly the fastest selling line on the market.

The latest song and dance hits are released *promptly* and the tone quality of

Okeh Records

is recognized everywhere. Our facilities for serving you are unsurpassed, and we know how to assist you in developing Record business.

Drop us a line for further details

PHILADELPHIA SHOW CASE COMPANY

127 North 13th Street

PHILADELPHIA, PENNSYLVANIA

Pittsburgh Branch: 2002 Jenkins Arcade Building

The Trade in PHILADELPHIA and LOCALITY

PHILADELPHIA, PA., March 3.—The talking machine business in this city during February showed little change from the business in January. Machines did not come through in very much better quantities and in some instances not as good. The Victor jobbers and retailers have been the greatest sufferers from the fact that the big plant in Camden was badly hit by influenza and other illnesses, so much so that several thousand men were out at one time, and it is estimated that these causes resulted in the Victor output being curtailed more than it was expected it would be in February.

Talking machine jobbers, however, were successful in getting a fair number of machines through, but those who depended on getting stock here from the West have been especially disappointed in the freight embargo that was placed on shipments from a considerable distance.

Conditions With the Louis Buehn Co.

The Louis Buehn Co., Inc., reports a satisfactory business in talking machines and records in February in spite of the fact that the receipt of Victor stock was not up to expectations. Meanwhile the company was able to shift what it received in such a way as to keep its trade fairly well satisfied. During the month Mr. Buehn lost one of his best-known salesmen by death. Lucien Drake Callahan, while on a trip for the firm, died at Wilkes-Barre, Pa., on February 21. He was buried in this city on the 24th and his funeral was attended by the entire Buehn force, with whom he was very popular. He had been sick only three days. He resided at 515 Arbutus avenue, Germantown, and is survived by his widow.

Among the Buehn visitors recently were S. H.

Hostetter, of the Hostetter-Keepers Co., of Parkesburg, Pa.; H. B. Mowers, representing the F. Hayes Harmon store, Waynesboro, Pa., and M. H. Housel, of M. H. Housel & Co., Williamsport, Pa.

Penn Phonograph Co. News

The Penn Phonograph Co. reports that things have been coming through a little better for the past few weeks. Mr. and Mrs. T. W. Barnhill, of the Penn Co., are at present on a trip South and West as far as Texas and the Pacific Coast. They left this city on February 18 and will not be back before April 1.

Harold Cregar, who has been in the Penn Co. office for a number of years, has been placed on the outside sales force to look after the firm's trade in Philadelphia and Camden. He recently graduated from the Victor Red Seal course. Mr. Pitts, of the O. K. Houck Piano Co., of Memphis, Tenn., was a recent visitor, and he also spent two weeks at the Victor factory taking the Red Seal course. F. S. Allen, of the Musical Record Co., Los Angeles, was also a recent visitor, as well as George Gewehr, of the Gewehr Piano Co., of Wilmington, Del. Mr. Gewehr was recently married to Miss Florence Goodley, and they are now in Florida on their honeymoon.

Meeting of Columbia Sales Force

About the middle of February J. D. Westervelt, the "Columbia Man," held a most interesting meeting of the new salesmen and salesladies employed by the Columbia dealers in his territory, at the Columbia headquarters, 40 North Sixth street. There were about seventy present. Manager N. J. Wilcox welcomed the assemblage; Assistant Manager Jennings spoke on "Service"; E. A. Manning on "Systems"; Mr.

Shriner on "The Model Shop," and Mr. Westervelt on "Grafonola Demonstration."

An Attractive Display Window

Starr Moss, 3631 Germantown avenue, recently had a very attractive Columbia window display, a large colored cardboard cut-out of Al Jolson listening at the telephone, advertising Columbia record No. 2836—"You Ain't Heard Nothin' Yet," one of Jolson's best. The Grafonola Shops, 1109 Chestnut street, are featuring at present Columbia record 2844, "Oh," by Ted Lewis. A group of small musicians in the window attracts the attention of all who pass.

New Quarters for A. J. Heath

A. J. Heath, the big Okeh record man here, says that his business in February was most satisfactory. He has taken new quarters in the Transportation Building three times as large as those formerly occupied, and now has room to handle the large stock of records which he intends carrying and which his trade, he believes, will demand.

Stock Coming in Greater Quantities

Harry Fox, of the Emerson Philadelphia Co., states: "Everything seems to be encouraging and we are getting lots of stock now. I just returned from a visit to New York, where I was promised close co-operation from the Emerson officials. Upon my arrival home I was greeted by one of the biggest shipments of records I ever received since I have been in business."

"We are progressing in a very satisfactory way," says Mr. Fox, "in the securing and holding of the best dealers in the industry in this city and territory. They are ordering in very large quantities and are very well pleased with

(Continued on page 96)

A BUSINESS ORGANIZATION EQUIPPED FOR BIG BUSINESS

Backed by a loyal clientele developed thru years of fair dealing and accurate business methods.

Progressive business program which serves both the higher interests of The Victor Company and our Victor Dealers.

THE LOUIS BUEHN COMPANY
OF PHILADELPHIA

Exclusive Wholesale Victor Distributors

Entertaining Camden

Popular entertainers sing the newest song hits for Camden people —through the medium of Emerson Standard 10-inch Gold Seal Records.

Camden toes trip lightly (and nightly) to the intriguing strains of Emerson dance music.

Camden folks like the way Emerson gets the big hits out on time

Also, we make bold to say, Camden dealers like the way we take care of their orders. Filling Emerson orders for dealers in Eastern Pennsylvania and Southern New Jersey is our hobby — and we ride it hard.

If it pays these dealers to handle Emerson Records, it may pay you. Ask us to prove it.



Emerson Philadelphia Co.

Parkway Building

BROAD and CHERRY Streets ··· PHILADELPHIA, PA.

Distributors of EMERSON RECORDS

THE TRADE IN PHILADELPHIA AND LOCALITY—(Continued from page 95)

the Emerson records. We have been unable to take on any new accounts. I have succeeded in building up a very substantial office and sales force and all are pulling together as a unit for the success of the Emerson. Compliments to the dealers' service department are in order, as it has succeeded in giving real service to our dealers. William D. Neff, the eastern Pennsylvania representative, is making a very good record on the road."

W. H. Shire, of the executive force of the New York Emerson, is expected in Philadelphia during this week to look over the work accomplished by the Emerson Philadelphia Co., and O. W. Ray will make his customary monthly visit in a few days.

Mr. and Mrs. Eames, of the Round Tree Corporation, Emerson distributors, at Richmond, Va., were in Philadelphia during the month; also Miss L. M. Guth, of the New York Emer-

son offices, and Julius Fox, of New York, a brother of the Emerson Philadelphia man, who was here on his honeymoon. He is an ex-captain in the aviation service of the Government and was wounded in France, as well as gassed.

Jobbers Meet in Harrisburg and Reading

On Thursday of last week the Columbia local jobbers were called to a meeting at the Penn-Harris Hotel, Harrisburg, and Messrs. Wilcox, Jennings, Shriner and Manning, of the local jobbers, went up and gave a talk to them on the Columbia system and service and sales plans for 1920. It was a general get-together meeting of Columbia dealers from Harrisburg, Lancaster, York and other points in the district. It was attended by about fifty dealers.

The same Big Four will hold a similar meeting to-morrow at the Hotel Berkshire, Reading, Pa., of dealers in that section and next

week on Thursday the same Big Four will go to Wilkes-Barre, to hold a meeting of dealers in that section. F. K. Pennington, assistant general sales manager of the Columbia Co., attended.

Assistant Manager Jennings, of the Columbia Co., says that production is coming through very good at present and that they expect March to be the biggest month in the history of their business.

Death of David E. Blake

Herbert E. Blake, of the firm of Blake & Burkart, is receiving the sympathy of the trade in the affliction of losing his youngest son last week, David E. Blake. Mr. Blake was also away from his office for more than a week on account of illness in February, and practically his entire family were victims of the "flu" epidemic. Sickness also struck his business family, Mrs. McIlvane, his head bookkeeper, be-



Superior Service in Vitanola Talking Machines

OUR TERRITORY COVERS

EASTERN PENNSYLVANIA, NEW JERSEY AND DELAWARE

If you are in this territory it will pay you to write for information regarding an agency for this progressive line

VITANOLA DISTRIBUTORS COMPANY

1025 ARCH ST.

E. V. MARTIN, President

PHILADELPHIA, PA.

BELL PHONE, WALNUT 1383

KEYSTONE PHONE, RACE 5913-D

The greatest combination in the Musical Industry for the dealer to acquire permanent prestige and success.

VICTROLAS AND VICTOR RECORDS

Q · R · S
PLAYER ROLLS

WEYMANN "KEYSTONE STATE" String Musical Instruments and specialties bearing the "W. & S." label.

Dealers in placing orders with us for their requirements have the advantage in obtaining from all three departments in one delivery goods that are unquestionably superior and best known to the entire industry.

If you have not received our special stock list and order blank, write us

Manufacturers and Wholesale Distributors

WEYMANN

Established 1864

1108 Chestnut Street Philadelphia, Pa.

ing out for more than a week, also Rocco Rich, of his sales force.

The business of Blake & Burkart is satisfactory, although they received very few Edison machines, but fairly good shipments of Sonoras and some Cheney's.

Edison Tone-test Concert

W. C. Stiver, phonograph dealer at 64 West Cheltenham avenue, Germantown, had an Edison tone-test at the Young Men's Christian Associa-

tion Building last Wednesday evening, in which Leola Lucy and Jacques Glockner engaged. Their voices and the reproductions on the Edison very greatly impressed the audiences.

Victory Music Stores Open

The Victory Music Stores Co. is a new Philadelphia enterprise just opened at 1035 Chestnut street, with Louis Lustman as manager. They have a chain of stores throughout the country and their factories are at Lansdale and Altoona,

Pa. They are the makers of the Victory music rolls, but eventually they will have Victory records, talking machines, etc. They will also handle pianos. At present they are featuring the Emerson records and Pathé records and the Okeh records.

Mr. Austen, proprietor of the Ediphone Co., reports that his February business was very good and that he has been compelled to considerably enlarge his branch office at Newark.

William R. Keech, the manager of the Sonora Shop at 1626 Chestnut street, says that they have been doing a satisfactory business, but that they are not getting nearly as many machines as they need.

Great Brunswick Activity

C. P. Chew, of the Brunswick jobbing department here, states that machines are coming through in a fairly satisfactory way, although shipments are being considerably delayed. Three carloads were just received, but none of them reached the department—all were distributed to the trade from the railroad station. Regarding the Brunswick records, Mr. Chew says: "Our records have met with a wonderful reception in this territory. All of our dealers have placed open orders to take them as fast as they are being received. We have a number of applications from leading houses in this territory to handle the Brunswick machines and records, but we are unable to accept any more dealers until we are able fully to care for our present ones."

Philadelphia Talking Machine Co.'s New Store

The finest individual talking machine house in this city has just been opened at 809-11 Chestnut street by S. Friedenburg, the head of the Philadelphia Talking Machine Co. This firm was started at 900 North Franklin street about eight years ago and from there it moved to 412 Market street and now to its present location. It handles the Victor, Sonora, Edison, Columbia and Cheney talking machines, and practically all makes of records. It also sells pianos, having

(Continued on page 98)

500 PENN-VICTOR-DOGS

(WITH YOUR NAME CAST IN PEDESTAL)

IN 500 HOMES
ARE 500 BOOSTERS for you
NOT FOR AN HOUR
NOT FOR A DAY
But PERMANENTLY
DO YOU GET THE VISION?

Order Penn Victor Dogs NOW for Your Easter Window

PENN PHONOGRAPH CO., Inc.
913 Arch Street, Wholesale Only—Victor Exclusively Philadelphia

PENN-VICTOR DOG DISTRIBUTORS

- Atlanta, Ga. Elyea Talking Machine Co.
Baltimore, Md. Cohen & Hughes.
Birmingham, Ala. E. F. Droop & Sons Co., Inc.
Boston, Mass. Talking Machine Co.
Burlington, Vt. Oliver Ditson Co.
Butte, Mont. Eastern Talking Machine Co.
Chicago, Ill. The M. Steinert & Sons Co.
Cleveland, Ohio. American Phonograph Co.
Denver, Colo. Orton Bros.
El Paso, Texas. Chicago Talking Machine Co.
Indianapolis, Ind. Cleveland Talking Machine Co.
Jacksonville, Fla. The Eclipse Music Co.
Kansas City, Mo. The Knight-Campbell Music Co.
Memphis, Tenn. W. G. Walz
Milwaukee, Wis. Stewart Talking Machine Co.
Atlanta, Ga. Beckwith-O'Neill Co.
Mobile, Ala. Wm. H. Reynolds.
New Haven, Conn. The Horton-Gallo-Creamer Co.
Newark, N. J. Collings & Co.
New Orleans, La. Phillip Werlein, Ltd.
New York City. C. Bruno & Son, Inc.
Philadelphia, Pa. Knickerbocker Talking Machine Co.
Pittsburgh, Pa. New York Talking Machine Co.
Portland, Me. H. A. Weymann & Sons
St. Louis, Mo. W. F. Frederick Piano Co.
Toledo, O. Cressey & Allen, Inc.
Washington, D. C. Koerber-Brenner Co.
E. F. Droop & Sons' Co.
Robt. C. Rogers Co.



Half Size

THE TRADE IN PHILADELPHIA AND LOCALITY—(Continued from page 97)

INCREASING CALL FOR VITANOLAS

LYRIC RECORDS

The Lyric records are lateral cut and will play on any machine. New issues March 1st, 1920. Write for catalogs and discounts

UNITED MUSIC STORES

1124 Walnut Street

Philadelphia, Pa.

Exclusive Philadelphia Jobbers of

LYRIC RECORDS

CONNORIZED MUSIC ROLLS

the agency for the Strich & Zeidler, the Chase & Baker and the Kohler & Campbell pianos. The firm plans to add six more nine-by-nine-foot booths to those constructed.

Weymann's "Faust" Window

The "Faust" display in the Victor window of H. A. Weymann & Son, Inc., drew much attention from the shoppers in that popular thoroughfare. In the center of the window was a stage set with the familiar garden scene,



An Operatic Window Display

including life figures of Marguerite, Faust and Mephistopheles. The window also contained the Red Seal records of this opera, the Victor opera book, and the famous Victor dog in large and miniature size. H. A. Weymann & Son have always given much attention to the appearance of their windows and the Faust window is one of the most attractive used.

T. W. Barnhill on Pacific Coast

T. W. Barnhill, president of the Penn Phonograph Co., Victor wholesalers, of this city, is en route to Los Angeles, where he will spend the windy month. Mr. Barnhill is evidently combining business with pleasure, as may be noted by the orders which mark his progress en route for the Penn-Victor dog in thousand lots.

Haag & Bissex Activity

Haag & Bissex, of this city, manufacturers of the Haag Record File, are bending every effort to fill the heavy orders they are receiving for their product. Although only incorporated last October, their business has reached very large proportions and Haag Record Files are now being sold in every State in the country. Orders on hand for March delivery constitute

an increase of 300 per cent over orders for February and all months previous.

J. A. Scott Getting Good Results

John A. Scott, the "Sunshine Man," also known by the more dignified title of "Maximus Optimo," is the local pusher of the Solotone and he is getting good results. The Wanamaker houses, both in New York City and Philadelphia, have been buying large quantities of these machines and are advertising them heavily.

The Solotone Co. now feels, with its new factory in Washington, N. J., as well as the plants in Lititz and in Philadelphia, that it will be able to build all the machines it will need. At the Washington factory machines of a high type of cabinet work, in mahogany and solid walnut, will be made.

Fulmer Joins Shewell Forces

G. Dunbar Shewell, the local Cheney jobber, has secured as an assistant David Fulmer, who had previously been connected with the Board of Education. Mr. Shewell brought to Philadelphia all the machines that were on exhibition by the Cheney Co. at the National Music Show in New York and he has since sold them to Lit Brothers, in this city, and to E. A. Barlow, a Trenton dealer. Prof. Forrest Cheney, the inventor of the Cheney, was recently in Philadelphia.

Many New Pathé Dealers

The business at the Pathé jobbing shop of Walter Eckhardt has been most excellent in February. Machines have been coming through of late with fairly good success, but early in the month shipments were much delayed by the weather. Alterations are under way and the placing of a partition dividing the rear office of the Pathé into a private room for Mr. Eckhardt and another for his assistant, Mr. Tay, has been completed. New Pathé representatives are R. M. Herron, of 3028 Ridge avenue; J. Conrad, Jr., of 2427 Lehigh avenue; the Logan Music Shop, 4511 North Broad street, and H. Saller, 929 North Thirtieth street.

Increase Line of Distribution

The Cirola Phonograph Co. of this city reports a remarkable increase in the distribution of its products. During the past month a large number of new dealers have taken on this non-conflicting line of portable machines, which they have added to the lines which they already carry.

Vitanola Distributors Co., of Philadelphia, Tell of Expansion in Eastern Pennsylvania, New Jersey and Delaware—Outlook Good

PHILADELPHIA, PA., March 4.—The Vitanola Distributors Co., of this city, report an increasing number of new dealers for Vitanola talking machines, of which they are distributors in Eastern Pennsylvania, New Jersey and Delaware. Six men are now on the road for this company and announcement is made of the appointment of C. P. Barilli as sales manager of the company. Mr. Barilli is well known in the talking machine trade, particularly in the territory in which he will operate. He was formerly connected with the Interstate Phonograph Co., Pathé distributors, and the Columbia Graphophone Co., both of this city.

The retail warerooms of the Estey Piano Co., at Seventeenth and Walnut streets, which have handled the Vitanola line since last November, report great success with the line and are backing up their reports by generous reorders for talking machines.

E. V. Martin, president of the Vitanola Distributors Co., has just returned from a few weeks' stay at Hot Springs and is planning great things for the Vitanola sales.

INSURES ENLARGED FACILITIES

PHILADELPHIA, PA., March 3.—The National Decalcomania Co. has purchased its factory building at 238-240 North Sixtieth street. The purchase includes its present building, an adjoining dwelling and four garages. Through this foresightedness it will be possible to provide for the necessary expansion of the company's business, which has had a remarkable growth and already needs larger facilities.

MAIN SPRINGS

3/4 inch 35c.; 7/8 inch 37c
1 inch for Victor 50c.
1 inch for Columbia 50c.
1 1/4 inch for Victor 65c.

Authorized distributors for Heineman and Meisselbach motors

EVERYBODY'S, 38 No. 8th St., PHILADELPHIA

DECALCOMANIA

Name Plates for Talking Machines, Pianos, etc.

High Class Workmanship

Write us for further information

National Decalcomania Co.
220-230 N. 60th St., Philadelphia, Pa.



WILL YOU PROFIT BY THIS OPPORTUNITY?

In our Philadelphia warehouse we have a limited number of Model A and B Solotones, current series.

NEW SERIES SOLOTONES from the Cornish Co., of Washington, N. J., will be shipped as soon as the weather permits and will require our entire available space.

For this reason we will sell our current series, Models A and B, at a considerable saving over present prices.

Our best terms are available for those who will order motor truck-load lots.

F. P. Alliman

SOLOTONE MANUFACTURING CO.

1727 CHESTNUT STREET

PHILADELPHIA, PA.

HAD NARROW ESCAPE IN BAD FIRE

PHILADELPHIA, Pa., March 1.—H. Power Weymann and Herbert Weymann, sons of H. W. Weymann, president of H. A. Weymann & Sons, Inc., of this city had a fortunate escape from the great fire which entirely destroyed Kugler's restaurant on Chestnut street last week. Both sons are connected with H. A. Weymann & Sons, Inc., in managerial positions and are graduates of the Philadelphia High School, class of 1908, which held an Alumnae banquet on the third floor of this fashionable restaurant on Thursday evening, February 26. The fire spread rapidly and all means of escape by stairway or elevator from the third floor were cut off. The only avenue of escape open was through a window and a drop of one story to the building below and thence by ladder to an adjoining office building. The only loss suffered by the Messrs. Weymann was that of their hats and overcoats.

The Harbour-Longmire Co., Pathé distributors, Dallas, Tex., report that the special

window displays that they have furnished to their dealers and the consistent advertising of records are bearing good fruit.



Operaphone RECORDS

PHILADELPHIA DISTRIBUTORS,
SUPPLEE - BIDDLE HARDWARE CO.
PHILADELPHIA, PA.

REED AGENCY WITH COLE & DUNAS

Efficiency Store Equipment in Demand at All Points—W. H. Reed's Recent Trip West

PITTSBURGH, Pa., March 6.—W. H. Reed, Jr., president of the Reed Co., Inc., returned recently from an extensive trip through the middle West. The visit to his factories at Saginaw, Mich., where the Reed efficiency store equipment is



W. H. Reed, Jr.

manufactured, was accomplished with extreme difficulty. The train arrived at Saginaw thirty-six hours late, being snowbound in the Western blizzards, the temperature at twenty-five degrees below zero. Mr. Reed found conditions at the factories ideal, with plenty of materials and a large stock to facilitate prompt deliveries of booths, racks and counters.

While in Chicago he appointed the Cole & Dunas Music Co. distributors for the State of Illinois for the Reed booths, record and player roll racks and efficiency counters. Mr. Reed called on Mr. Ruez, manager of the Badger Talking Machine Co., and the Yahr & Lange Drug Co., Milwaukee. Both of these enterprising houses reported excellent business conditions. Two days were spent with Mr. Spitz, manager of the talking machine department of the Carpenter Paper Co., Omaha, Neb., who stated that February sales were little short of phenomenal.

Cellarettes, of late untenanted, are being shipped back to the factory and some unkind creature who likes prohibition says they are being made into talking machine cabinets.



THE "CROSLEY" PHONOGRAPH—A real cabinet Phonograph at low cost Mahogany finish, Universal tone arm, double spring motor, wonderful tone quality. Stands 33½" high, 19" deep and 18" wide. Shipping weight approximately 80 lbs. Retail shipping price—\$60.00. Large manufacturing capacity; immediate deliveries. Ideal for premium house, agents, dealers, jobbers and distributors. Write today for full particulars and circular matter.

CROSLEY PHONOGRAPH CO.,
1 Vandalia Avenue Cincinnati, O.

The Franklin

A PHONOGRAPH OF DISTINCTION

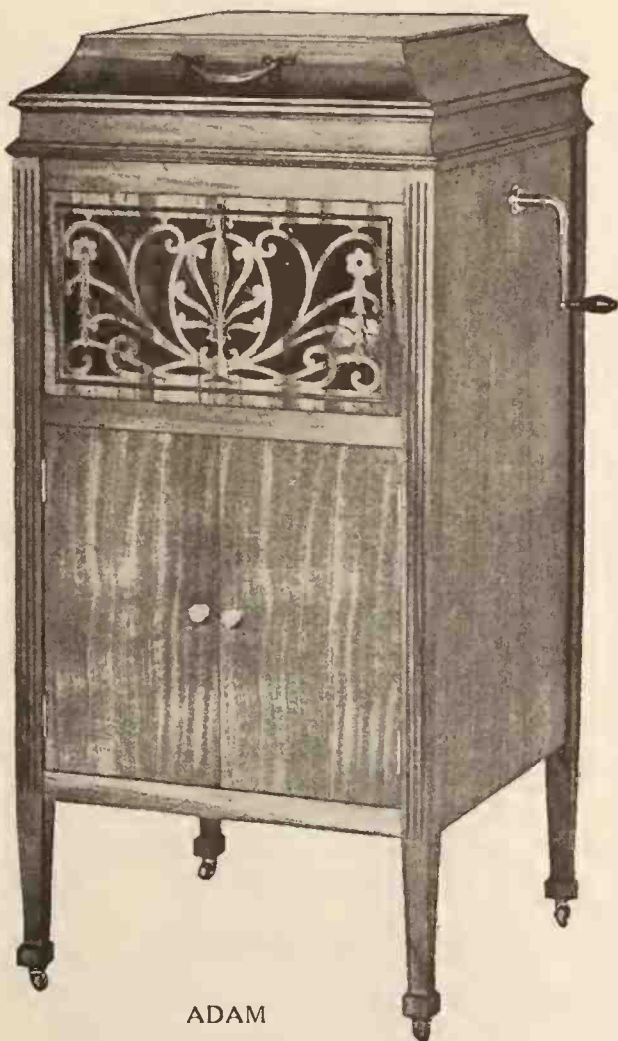

ADAM

The Franklin is already classed among the leaders in the phonograph field both as to musical worth, cabinet design and finish and is so priced as to be within the reach of all music lovers.

Order a sample and convince yourself.

The Franklin

Is Different

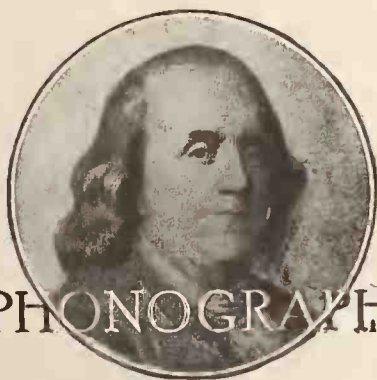

FRANKLIN PHONOGRAPH COMPANY

INCORPORATED

10th and Columbia Ave.

PHILADELPHIA, PA.

NEW YORK OFFICE — 253 West 42nd St., New York City

WM. RASHALL, Manager

The Emerson Phonograph Co., Inc.

Announce that they are now located in the

**Emerson Building
206 Fifth Ave., New York**

The phenomenal demand for Emerson Records, with the attendant rapid expansion of all departments, necessitated larger quarters.

Here in this splendid new building will be centered the executive activities of the Company as well as the Recording Laboratories.

In this new building with increased facilities the Emerson Company will continue to produce even more successfully the latest song and dance hits.

EMERSON PHONOGRAPH CO. INC.

Makers of Emerson Standard 10-inch Gold Seal Records

New York Office
206 Fifth Avenue

Chicago Office
7 E. Jackson Boulevard



"If It's a Hit, It's an Emerson"

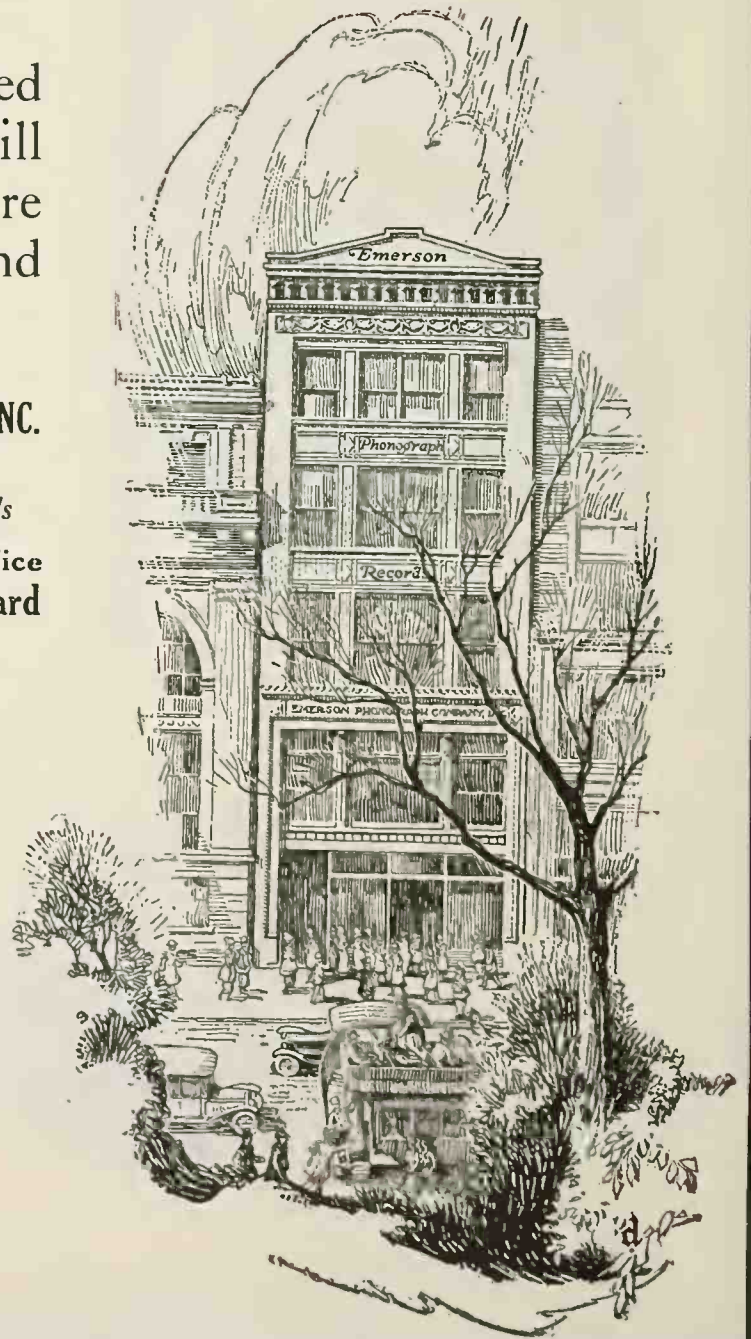

The Cincinnati Symphony Orchestra plays the overture from *Orpheus in Hades*. No real music lover can resist this record. A-6140.

**Columbia Graphophone Co.
NEW YORK**



REVISING THE MAILING LIST

Important That the Mailing List, to Be Effective, Should Be Checked Up to Avoid Duplication and Insure Correct Addresses—Some Hints From the Voice of the Victor

In a recent issue the Voice of the Victor makes a most appropriate comment upon the importance of the retailer keeping his mailing list strictly up to date in order that it may prove most productive of results. Special attention is paid to the danger of duplication, and in this connection The Voice says:

A Victrola owner writes us:

"Regularly, for months, I have been receiving six Victor monthly record bulletins from as many firms in this city, when one would be quite sufficient. It is logical to suppose that, this being the case in my family, the same condition prevails in many others."

We are willing to place a "side bet" with you that all six of these dealers have failed to go over their mailing lists within a year. And the letter has set us thinking in other ways.

What possible advertising value, for example, is there in a piece of literature that three or four other firms are sending to every customer? And what can such literature, duplicated and reduplicated, do for a customer except, possibly, irritate him?

Many Victor dealers have realized this and they have applied a swift and a common-sense remedy. It is to use, every three or four months, a return postal card. Three or four times a year they enclose one with their monthly supplement. If the customers write back that they already are receiving copies from other sources their names are made up into a special list, which is adroitly circularized with some attractive bit of advertising gotten up by the dealer himself. Good business? Rather.

We know of other dealers who revise their mailing lists every month and who send out

their supplements under two-cent postage. It costs more, they acknowledge, but they declare it cheaper in the long run. If you figure it out for yourself, you know how prone people are to run through their mail and first pick out their letters. Other matter is put by with the remark, "Oh, that's just an advertisement." You know yourself—aren't your letters the first things opened?

There is another consideration just here. If you put a two-cent stamp on an envelope and your letter isn't delivered, it is returned to you automatically by the postal authorities. A one-cent envelope won't come back unless you guarantee the postmaster his one-cent return postage, anyway. And to do this you've got to print a non-delivery notice on your envelope. This notice is all very well, but in the event of non-delivery it costs you two cents just the same.

There is no virtue in a big mailing list unless it is a thoroughly live one. Where names run into the thousands you may save a lot of money by weeding out the dead material. Send out a

return postal card with your next mailing and you will see for yourself.

Waste is bad business—for both you and ourselves. Think of the enormous cost of printing to-day. And for every supplement wasted, you waste a penny or two in postage. And the bigger your dead list the greater your loss. Your mailing list may develop into a liability instead of what it is—a live business asset.

You can easily understand why a man buys a morning newspaper—to learn what is going on. But he doesn't buy three or four, and he doesn't even care to have them left at his door as sample copies. In the same fashion, nobody will read three or four supplements when they all contain the same reading material.

Dealers realize this as well as we. But sometimes in the rush of business these things are overlooked. Make a resolution to-day, even though it's a few weeks late, to weed your mailing list out carefully and save useless postage. After all, if the pennies are saved, the dollars will look after themselves, and the pennies are only a part of your loss.

IMPORTANT MOVE BY JACOBUS

Louis Jacobus, formerly vice-president of the Hector Talking Machine Co., of Newark, N. J., and secretary of the Gilbert Mfg. Co., of the same city, has sold out his interest and severed his connections with both the above concerns and has purchased the machinery, quarters and all interests of the United Talking Machine Co., at 511 Mulberry street, Newark, N. J., for the Meritone Phonograph Co., of which he is head.

A new and enlarged Pathé department is nearing completion in Pittsburgh, Pa., at Pickering's. When the new department is opened it will be one of the best Pathé stores in the city and H. J. Brennan, of the Pittsburgh Talking Machine Co., Pathé distributors, predicts greatly increased sales for his line.

MUSIC DEPARTMENTS CONSOLIDATED

C. W. Fraleigh Heads New Department of the Outlet Co., Providence Victor Dealers

PROVIDENCE, R. I., March 5.—The appointment of C. W. Fraleigh as manager of the talking machine department of the Outlet Co., Victor dealers of this city, marks an important step in the expansion of this end of the business. For some years Mr. Fraleigh has been in charge of the piano department and has built up a large and active clientele by his efforts. With the consolidation of the two departments the Victor campaign will be carried on more actively than ever. Under Mr. Fraleigh is Harry Nye, son of a former manager of the Shepherd Co. piano department. Mr. Fraleigh is well known in both talking machine and piano circles here.



No. 100 Sound Box with No. 100 Tonearm Tension Spring with Exterior Adjustment



No. 100 Sound Box with No. 200 Tonearm Tension Spring Concealed

Assemble Your Own Equipment

WE OWN the Dies for producing the Die Cast parts of the above Sound Box and Tonearm designs, and furnish Die Castings to large users at no expense for Dies

SPECIAL Connections can be produced for adapting any make of Sound Box to these Tonearms. Prices on application. Samples sent prepaid upon deposit of \$1.50

Die Casting Department

Barnhart Brothers & Spindler

Monroe & Throop Streets CHICAGO



THE NEW VOCALION RECORD

Lateral Cut, Playable on All Standard Machines



THE importance of the new Vocalion lateral-cut Record may hardly be overestimated. To the public it means that the most perfect record ever put upon the market is now available for use with all standard phonographs. To the music-trade it means one more vital sales feature added to the many included in the representation of the Aeolian-Vocalion. The new Vocalion Record is a super record. In true musical quality, in durability, in content and timeliness of issue it is not equalled in the whole phonograph field.

Up-to-date merchants who are not in the phonograph business, and those who are, but are not handling the Aeolian-Vocalion, will see in this new record one more cogent reason for securing Vocalion representation before territory is all assigned.

The Fourfold Sales Appeal of the **AEOLIAN-VOCALION**

It is more and more coming to be recognized in the music-trade that the Aeolian-Vocalion has the most complete sales appeal of any phonograph on the market. The history of the Aeolian Company is one of extremely active development. It has almost unlimited resources here in the United States and abroad for the creation and development of musical instrument features. The Aeolian-Vocalion, though one of its younger, is one of its greatest and most successful enterprises.



The Aeolian-Vocalion possesses a number of distinctive advantages, among which are four that stand out particularly for their musical value and sales promotion. The primary appeal is that of *tone quality*. Added to this are its up-to-date and efficient mechanical features, such as a superior Automatic Stop, its artistic and fascinating Tone Control, the famous Graduola, and its uniquely beautiful outward appearance.

These four great points of advantage make the Vocalion by far the most attractive phonograph proposition today.

Among these features will be found an appeal to all classes of people, the highly trained musician, the wealthy connoisseur, the more modestly situated, the young and the old. People of discriminating taste, musical and artistic, are everywhere finding the Vocalion irresistible.

The character and quality of Vocalion advertising carried by the Saturday Evening Post and other mediums is admittedly superior to that done by any other manufacturer.

Aeolian service, which is being further strengthened by the establishment of convenient distributing points throughout the country and the breadth and fairness of Aeolian business dealings, added to the emphatic superiority of the Vocalion itself, make the representation of that instrument one of the most profitable, desirable and satisfactory business connections that can be made.

The AEOLIAN

NEW YORK LONDON PARIS

Distributors of the Aeolian-

- Nordheimer Piano & Music Company, Ltd., Toronto, Canada
- The Aeolian Company Chicago, Ill.
- The Aeolian Company Cincinnati, Ohio
- The Aeolian Company St. Louis, Mo.
- The Aeolian Company San Francisco, Cal.
- Consolidated Music Co. Salt Lake City, Utah
- B. Dreher's Sons Co. Cleveland, Ohio
- Emerald Co. Birmingham, Ala.



COMPANY

MELBOURNE SYDNEY MADRID

Vocalion and Vocalion Records

- Guest Piano Co. Burlington, Iowa
- D. H. Holmes Co., Ltd. New Orleans, La.
- O. J. DeMoll & Co. Washington, D. C.
- Stone Piano Co. { Fargo, N. D., and
Minneapolis, Minn.
- Titche-Goettinger Co. Dallas, Texas
- R. W. Tyler Co. Wheeling, W. Va.
- Vocalion Company of Boston, Boston, Mass.

CABINET FACTORY



*Hartzell Walnut—
Standard for 40 Years*

*Hartzell Mills—
Known for Efficiency*



HARTZELL, WALNUT LUMBER MILLS

WE are in a position to make the finest of Cabinets for houses who want to handle quality goods and whose business arrangements are based on facts and integrity.

In addition to figuring on Cabinet contracts we are able to deliver appreciable quantities of Cabinets all ready for installation of motors, etc. These are now available.

We cannot—we do not attempt to—show the quality of our goods in the accompanying photos. We will show it, however, to visitors to our plant.

We Are Walnut Experts

For 35 years we have specialized in Walnut from the log to the finished product and in that time the name "Hartzell" has come to be synonymous with the best in bringing out the beauties of that wood.

We, ourselves, make everything—Veneers, Cross-Bandings, Panels and all that goes into the finished product. Our plant is celebrated throughout the U. S. for its equipment and organization. We know exactly our costs and our capacities.

Correspondence Invited



GEO. W. HARTZELL
PIQUA OHIO

TALKING MACHINE DEALERS OF NORTHERN OHIO DINE

Association Enjoys Dinner and Installs Officers for Ensuing Year—Interesting Addresses Made by D. A. Delano and Several Members—Optimistic About Business Outlook

CLEVELAND, O., March 8.—The annual banquet of the members of the Talking Machine Dealers' Association of Northern Ohio in the ballroom of the Hotel Winton the evening of March 4 was turned into a good-natured social function, including a splendid dinner for more than 200 men and women, musical selections, a few short talks and a lively dance.

The departure from the ordinary long-drawn-out banquet with a set of lengthy, dry speeches on trade topics made a hit with the diners.

The dinner was informal. In fact, the whole function was a big house gathering of dealers from Cleveland and half a dozen surrounding cities, the members bringing their wives, sisters and sweethearts.

The following officers recently elected were installed: president, T. A. Davies, manager of the Victrola department of the William Taylor Son & Co.; first vice-president, Dan E. Bambaugh, of the Victrola department of the May Co.; second vice-president, Phil H. Dorn of the Collister & Sayle Co.; treasurer, W. E. Shay, Elyria; secretary, E. B. Lyons, sales manager of the Eclipse Musical Co.

The speeches included informal talks by the retiring president, Herman Wolfe, head of the

Wolfe Music Co.; the new president, Mr. Davies, who discussed "The 1920 Outlook"; and D. A. Delano, of the advertising department of the Victor Co., Camden, N. J., his subject being "The Voice of the Victor." Trade topics were generally sidetracked during these short informal talks, Mr. Davies pledging himself to do his utmost to make the organization "live up to its past" during the year.

The outlook for 1920 business, according to dealers, is splendid, the main drawback being shortage of machines and records.

The association now has a membership of forty-one dealers, all except nine of whom are doing business in Cleveland or its suburbs. Akron, Barberton, Kent, Elyria and Wadsworth, northern Ohio cities, are also represented. At a monthly meeting the third Thursday of the month Mr. Davies will announce his standing committees for 1920.

The dinner began at 7 p. m. and dancing at 9.30. A 12-piece orchestra furnished music during the dinner and for the dance, and a quartette sang several selections. During the dinner the diners were photographed. L. Meier and B. E. B. Lyons had charge of the banquet arrangements.

EMERSON BUILDING NOW OPEN

Emerson Phonograph Co. Now Established in Its New Home at 206 Fifth Avenue—Attractive Lay-out of Offices Pleases Visitors

The Emerson Phonograph Co. is now located in its new home, the Emerson Building, at 206 Fifth avenue, New York, between Twenty-fifth and Twenty-sixth streets. The company took possession of its new quarters on March 1, and the various departments of the organization are being afforded maximum convenience in the handling of their duties. The location of the new Emerson Building is ideal, for it is adjacent to all modes of travel, and runs clear through to Broadway. The building faces Madison Square Park, and visitors to the executive offices have been enthusiastic regarding the attractive and efficient lay-out of the various departments.

The executive offices of the company are

located on the second floor of the Emerson Building, and along the Fifth avenue side are the private offices of Victor H. Emerson, president of the company; H. T. Leeming, vice-president and general manager, and B. D. Colen, secretary. The various offices connected with the executive organization are also located on the second floor, and along Broadway are the private offices of Arthur H. Cushman, director of sales; J. I. Carroll, manager of sales, and Paul F. Wiggin, advertising manager. The upper floors of the building are occupied by the accounting and credit departments with an entire floor for the recording laboratories.

The phenomenal growth of Emerson business during the past few years is reflected in the rapid expansion of the floor space occupied by the company for their executive offices, recording laboratories and incidental departments. For over a year the company was handicapped by a lack of space in its former executive offices, and as the sales totals increased month by



Delivery Envelopes
Art Series—New Designs
NEW LIST OF RECORDS

Every 60 Days

A Selected List of Victor Records

We Will Be Pleased to Play Any of Them for You	
1888-18	Don't You Know I'm a Fool? <i>Small</i>
1889-19	When the Apple Blossoms Fall in Maryland <i>Small</i>
1890-20	Swing, Little Lady, Swing <i>Small</i>
1891-21	When the Apple Blossoms Fall in Maryland <i>Small</i>
1892-22	Swing, Little Lady, Swing <i>Small</i>
1893-23	When the Apple Blossoms Fall in Maryland <i>Small</i>
1894-24	Swing, Little Lady, Swing <i>Small</i>
1895-25	When the Apple Blossoms Fall in Maryland <i>Small</i>
1896-26	Swing, Little Lady, Swing <i>Small</i>
1897-27	When the Apple Blossoms Fall in Maryland <i>Small</i>
1898-28	Swing, Little Lady, Swing <i>Small</i>
1899-29	When the Apple Blossoms Fall in Maryland <i>Small</i>
1900-30	Swing, Little Lady, Swing <i>Small</i>
1901-31	When the Apple Blossoms Fall in Maryland <i>Small</i>
1902-32	Swing, Little Lady, Swing <i>Small</i>
1903-33	When the Apple Blossoms Fall in Maryland <i>Small</i>
1904-34	Swing, Little Lady, Swing <i>Small</i>
1905-35	When the Apple Blossoms Fall in Maryland <i>Small</i>
1906-36	Swing, Little Lady, Swing <i>Small</i>
1907-37	When the Apple Blossoms Fall in Maryland <i>Small</i>
1908-38	Swing, Little Lady, Swing <i>Small</i>
1909-39	When the Apple Blossoms Fall in Maryland <i>Small</i>
1910-40	Swing, Little Lady, Swing <i>Small</i>
1911-41	When the Apple Blossoms Fall in Maryland <i>Small</i>
1912-42	Swing, Little Lady, Swing <i>Small</i>
1913-43	When the Apple Blossoms Fall in Maryland <i>Small</i>
1914-44	Swing, Little Lady, Swing <i>Small</i>
1915-45	When the Apple Blossoms Fall in Maryland <i>Small</i>
1916-46	Swing, Little Lady, Swing <i>Small</i>
1917-47	When the Apple Blossoms Fall in Maryland <i>Small</i>
1918-48	Swing, Little Lady, Swing <i>Small</i>
1919-49	When the Apple Blossoms Fall in Maryland <i>Small</i>
1920-50	Swing, Little Lady, Swing <i>Small</i>

Very attractive proposition to Jobbers

Write for trial shipment

CLEMENT BEECROFT
309 W. Susquehanna Ave.
PHILADELPHIA

month it was found imperative to make arrangements for a new home in order to accommodate this growing business. The Emerson building at 206 Fifth avenue will afford the company plenty of room for expansion, which, judging from the sales figures for February, will be used to advantage in the very near future.

NOW OCCUPYING NEW QUARTERS

WASHINGTON, D. C., March 4.—Announcement is made by Cohen & Hughes, Inc., Victor distributors, that they are now located in their new warerooms, 1221-1223 East street, N. W., this city. These handsome new headquarters, which were illustrated and described in a previous issue of the World, are devoted to wholesale purposes exclusively.

Leo Hennessey, formerly with the Shepard Co., in Providence, R. I., and also with the Tilden-Thurber Corp., has returned to the Shepard Co. and has been added to the staff of the repair department.

AUTOMATIC COVER SUPPORT

No. 1287

LATEST IMPROVEMENTS MAKE THIS SUPPORT MORE DESIRABLE THAN EVER

Continuous Hinges
Automatic Stops
Needle Rests, Etc.

Finished in

- GOLD
- SILVER
- NICKEL
- COPPER
- BRASS

Write for Catalogue

WEBER-KNAPP CO.
JAMESTOWN, N. Y.





ANNOUNCING THE SPHINX GRAMOPHONE MOTOR

"The Standard by Which all Phonograph Motors are Judged and Valued"

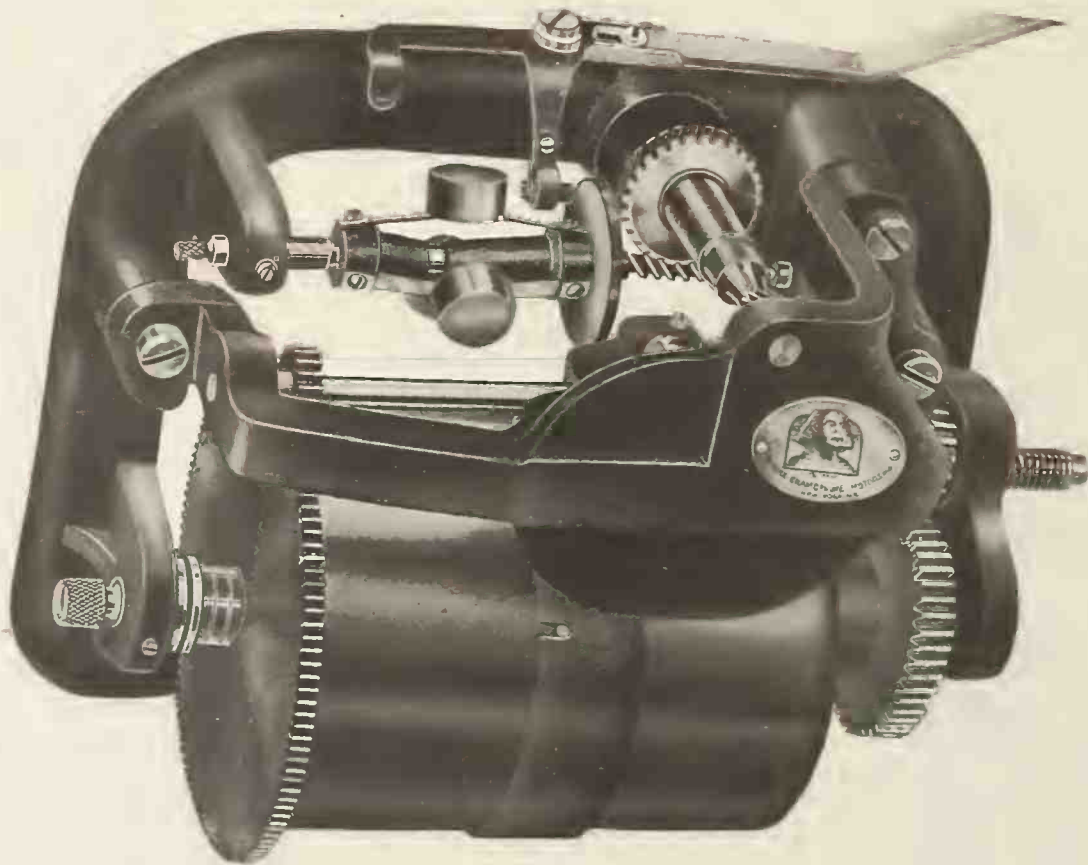

The Sphinx Motor is the successful result of the research and experiments of skilled and experienced motor engineers, who have successfully perfected a motor which positively meets these vital requirements

SILENCE
UNIFORMITY OF SPEED
PERMANENT SERVICE

This result is achieved by radical departures in both design and construction from other types of gramophone motors. These differences are those of principle and not of detail.

SPHINX GRAMOPHONE MOTOR

"The Standard by Which all Phonograph Motors are Judged and Valued".



THE SPHINX GRAMOPHONE MOTOR

is not merely another motor or an improvement on other motors, but a new motor, setting a new standard—"a standard by which all phonograph motors are judged and valued".

As the Sphinx Motor represents a complete departure, in every vital respect, from any other gramophone motor on the market, every manufacturer of high-grade talking machines positively owes it to himself, to his business and to his customers to take advantage of the earliest opportunity to examine this motor. Thorough investigation will prove that it not only sets a new standard, but will revolutionize the phonograph motor manufacturing industry.

A catalog, which pictures and describes this motor in all its details and gives the necessary assurances of manufacturing facilities and high standards of construction, is now on the press. Send for this book—it is the most interesting and important publication of its nature in the history of the phonograph.

The Sphinx Motor is now in process of commercial manufacture. It may be seen at our offices on April 1, and will be thereafter ready for quantity delivery.

SPHINX GRAMOPHONE MOTORS, Inc.
512 FIFTH AVENUE
NEW YORK

SPHINX GRAMOPHONE MOTOR

"The Standard by Which all Phonograph Motors are Judged and Valued".

We are now opening new accounts and making immediate deliveries on

VITANOLA TALKING MACHINES

The Phonograph of Marvelous Tone

Oké Records

These two splendid lines with Roemer Service will help to make nineteen twenty your banner year.

M. M. ROEMER SALES CORP., 400 West 23rd Street, NEW YORK

"TRY ROEMER SERVICE—IT SATISFIES"

Phone Chelsea 6323

ESTABLISHING NEW AGENCIES

Emerson International, Inc., Closing Important Deals for Tonofone Needles—Globe Music Rolls Also Meeting With a Ready Sale

Emerson International, Inc., 1780 Broadway, New York, domestic and foreign distributors of Tonofone needles, report a very active demand for these popular needles. The company has closed a number of important deals whereby the Tonofone needle will be handled by representative houses in leading trade centers, and full details regarding these deals will be announced within a few weeks. The officers of the company are enthusiastic regarding the distinctive qualities of the Tonofone needle, and an extensive sales campaign has been inaugurated to promote and develop the demand for the Tonofone product.

Emerson International, Inc., is also meeting with considerable success in the distribution of

Globe music rolls, for which the company is domestic and foreign distributor. Arrangements were recently made whereby a good sized catalog of Hebrew-Jewish and Italian rolls will form a part of this library, and judging from the orders already received for these rolls, the company will be in a position to establish important sales agencies. Emerson International, Inc., has recently been appointed distributor for Phono Movies, the Aerex player-piano motor and the Kleernote tracker bar vacuum cleaner.

LARGER QUARTERS FOR J. W. SELZ

ALLEGHENY, PA., March 3.—J. W. Selz, a Pathé dealer of this city, recently found it necessary to move to larger quarters to handle his greatly increasing business. The new building which he purchased has been attractively furnished for the convenience of the customer and through the medium of the local press an invitation was extended to visit the Pathé warerooms.

CARUSO SINGS DESPITE THE RAIN

Opera in Bull Ring at Mexico City Continued Despite Steady Downpour

Caruso, the great tenor and Victor artist, has received so many ovations during his artistic career that it is natural to assume that he has become hardened to the general tribute of the public. Nevertheless, he had a new experience in Mexico City recently when he appeared there for the first time. He had been engaged to sing in the big Iris Theatre in the City of Mexico, but the place proved entirely inadequate to handle the crowds who wanted to hear him, as high as \$20 being offered for standing room alone. He thereupon decided to give the opera performances in the bull ring, and even that spacious amphitheatre was crowded to capacity, the returns from one performance alone totaling \$45,000. It commenced to rain shortly after the first act started, and during the second act the rain came down in torrents, yet the audience stuck tight under their umbrellas and the artist finished the performance, although drenched to the skin.



REED EFFICIENCY COUNTER

What the Kitchen Cabinet is to the Modern Housewife, the Reed Efficiency Counter is to the Up-to-Date Music Dealer—A Place for Everything and Everything in its Place.

It provides in fifteen square feet of floor space ample room to store supplies which are too often found in all nooks and corners of the storeroom. Under one corner and readily accessible may be found Records, Needles, Envelopes and other articles most frequently called for. Truly—it is a real efficiency counter.



It is of beautiful design and well built of thoroughly seasoned lumber. It will not warp or swell. The Reed Efficiency Counter is 72 inches long, 30 inches high and 30 inches wide and is furnished only in natural finish.

We carry a large stock on hand at all times and are in a position to assure you prompt delivery. Wire or mail your order NOW.

Send for Descriptive Circular illustrating our attractive Record Demonstrating Booths and Record and Player Roll Racks.

THE REED COMPANY INC.

237 Fifth Avenue - - - Pittsburgh, Pa.

WINDOW DISPLAY ATTRACTS NOTICE

WATERTOWN, N. Y., March 3.—The attractive window display of Keegan, Mattern & Gaffney, Pathé dealers of this city, drew much favorable comment and was a decided selling aid. The two large windows on either side of the entrance were decorated with Pathé merchandise. Conspicuous in the center of the windows were period models of the Pathé phonograph, and radiating from the instruments were streamers of parti-colored ribbons. Pathé records were displayed in abundance and high over all was the famous red rooster.

SHEPARD DEPARTMENT ENLARGED

The talking machine department of the Shepard Co., Providence, R. I., is being enlarged and a system of self-service racks is being installed. When completed the department will be about three times its former size.

**TALKING-MACHINE
CABINETS
FOR THE TRADE**

GLENWOOD CABINET MFG. CO.
S. E. Cor. 22nd and Glenwood Ave.
PHILADELPHIA, PA.



PHONOGRAPHS AND RECORDS

"Supreme in Quality"

The Machine
that Plays
any Record

Created for the better grade of dealer who desires a phonograph of quality.

The Empire line shows value in every way—designs, workmanship, finish—every detail will stand your examination.

8 Models—Retail Prices \$40 to \$300

*Write for our
Catalog and Agency Proposition*



Model B
Mahogany, Oak or
Walnut

EMPIRE TALKING MACHINE CO.

John H. Steinmetz, President
429 South Wabash Avenue, Chicago, Ill.

BUSINESS CONTINUES TO BE ACTIVE IN SAN FRANCISCO

Phenomenal Demand Exists for Records, Particularly of the Latest Hits—Weather Conditions Interfere With Shipments of Machines and Records—Mercantile Finance Co. Increases Capital

SAN FRANCISCO, CAL., March 5.—Despite two holidays and the short month business in talking machines and records held up remarkably well in general volume in February. Machine business is very good. Instruments are coming out a little better. This is the era of "splendid hits" in music records, apparently the latest piece to hypnotize the public being "Dardanella," with all sorts of instrumental trimmings. There is springing up in San Francisco, where so many wonderful things spring up, a craze for dance medleys. The jazz orchestras change from the fox-trot to waltz, from the waltz to the one-step or vice versa, etc., and the versatile dancers do the rest. The fancy steppers want music which will give them a chance to "exhibit." There is at least one music roll for the player-piano which provides this sort of a medley and no doubt the talking machine record people will not be slow to adopt the idea if it continues to appeal to the metropolitan connoisseurs of popular music.

Receive Carload of Pathé Records

Frederick Stern, president of the Stern Talking Machine Co., has returned from his extended Eastern trip and is busy making the final arrangements for a number of new agencies in California which will handle the Rex, Jewel and Pathé products exclusively. The company has just received a carload of 35,000 pounds of Pathé records, so it may be imagined how well equipped the concern is to take care of the needs of its agencies. Two new rooms have been added to the executive offices of the company at 995 Market street.

Increase Capital Stock

The Mercantile Finance Co., which is incorporated to finance talking machine dealers throughout the country, has increased its capitalization from half a million dollars to one million, all of which is paid in. The company reports a profit of 12 per cent for last year. The offices are in the Hewes Building, San Francisco.

The California Phonograph Co. has several of the force on the sick list this week with "flu." but all are light cases. Mr. Levy reports that Victor goods are coming in more promptly.

Phonograph Studio to Open Soon

A fine new talking machine establishment, to be known as the Phonograph Studio, will be opened for business in San Francisco about the tenth of March. The shop is in an ideal location on Powell street and also has an entrance on O'Farrell street. This is in the heart of the

downtown retail district. William H. Quarg, the manager, is spending money lavishly in remodeling the store for the talking machine business and his idea of having all Chinese furnishings is a happy one. The prevailing tone of the finish will be French gray, but the furniture, the lighting fixtures and other accessories will be Chinese. There will be show windows on both streets, seven demonstration rooms on the main and mezzanine floors and a repair shop in the basement. The lines to be carried at the outset are the Columbia, Pathé and Starr. Mr. Quarg is a piano man of varied experience, who of late has been in the government service.

More Room for Kohler & Chase

Joseph M. Abrams, the new manager of the Kohler & Chase wholesale and retail talking machine business, says that business in Okeh records is so heavy that they have had to take over the entire seventh floor of the building for storing stock. Special success is reported on the "Amphona" talking machine handled by the company. The name of this machine was formerly "Symphona," but it had to be changed on account of a trade name complication.

George Q. Chase, president of Kohler & Chase, is in the East on an extended business trip.

Increasing Popularity of Okeh Records

L. Gruen, manager of the Pacific Coast office of the General Phonograph Corp., has just returned from a trip to Salt Lake City, where he found interest in Okeh records and his company's products becoming very keen. Many new manufacturing ventures are starting on the Coast and the demand for tone arms, motors and other products is lively. The success of the Okeh record of "Dardanella" is nothing short of phenomenal and the other lateral-cut numbers are going also as fast as supplies reach his territory. The San Francisco offices have been remodeled this month in order to provide for more convenient handling of business.

Selling Many Records

Ben Adkins, manager of the Remick Song Shop, on Market street, is selling a lot of Columbia and Emerson records these days, but he says it is impossible to keep stocked up on the popular pieces. The advanced prices on records have caused some inconvenience in merchandising, but the volume of sales has not decreased.

High Priced Victrolas in Demand

Billy Morton, of the talking machine department of Sherman, Clay & Co., says the sale of

CHAS. H. YATES

311 Laughlin Bldg. Los Angeles, Cal.

Manufacturers' Distributors of High Grade Phonograph Accessories and Supplies.

Send for my new catalogue and price list. It will interest you.

TELL ME WHAT YOU WANT

"If I haven't got it, I'll get it for you."

This is part of my service.

Exclusive Pacific Coast distributor for the

JONES-MOTROLA

the highest priced Victor machines during February was unexpectedly large. Andrew McCarthy and Fred Sherman are back from their Eastern trip. While East they visited the Victor plant at Camden, N. J.

O. F. Benz is Entertained

O. F. Benz, of the general sales department of the Columbia Co., has just been visiting the Columbia interests on the Coast. While in San Francisco he was the guest of honor at a luncheon given by the San Francisco office at Tait's. The trade of the Bay cities was well represented at this luncheon and they listened with interest to a very enlightening talk by Mr. Benz on modern methods of merchandising applicable to the talking machine business.

Some Interesting Personals

Proper Reiter has resigned as manager of the Emporium talking machine department. The post is now filled by Mr. Stretch, who has been in the employ of the Emporium for some years.

The new manager of the Hauschildt Music Co.'s San Francisco store is C. J. LaRoche, a music man of long experience in the East. He succeeds Mr. Valentine, who resigned earlier in the month.

Omer Kruschke, of the Western Phonograph Co., is on a trip throughout the State, making arrangements for new Pathé agencies. He recently returned from a trip to New York, where he visited the factories.

Walter S. Gray, of the Walter S. Gray Co., is back from a motor trip over the southern part of the State.

The department heads and others of the Wiley B. Allen Co. were entertained at a dinner at the Family Club this month. James J. Black and George Hughes both made little talks. This was a sort of "get-together" banquet.

The Victor department in the store of Joseph J. Campbell, Everett, Mass., has been completely remodeled and a new battery of sound-proof booths for the demonstration of records has been installed.



Can You Keep a Secret?

HERE it is! March is the heaviest record month of the first quarter. Your stockroom "reception committee" knows this—so begin now to dress up your record stock. "Full Dress" required and all the Victor Records needed can be secured thru Pearsall Service.



SILAS E. PEARSALL COMPANY

DISTRIBUTORS

WHOLESALE ONLY

Victrolas and Victor Records

10 East 39th Street, New York

“The Record Repeater with the Automatic Stop”

“The PHONOGRAPH OF TO-DAY—WITHOUT A—



Repeater-Stop

IS LIKE THE AUTOMOBILE OF YESTERDAY”—
WITHOUT AN ELECTRIC HORN OR SELF-STARTER

—“NOT FULLY EQUIPPED!”

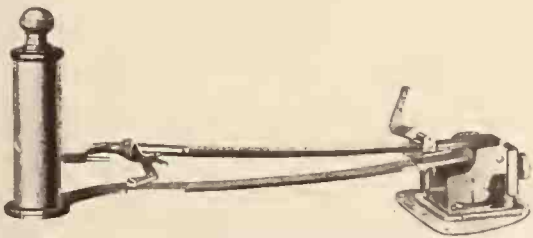

THIS SHOWS THE REPEATER-STOP
READY FOR ATTACHING

How often have you heard this remark, MR. DEALER,—
“The average dance record scarcely plays long enough to enjoy
a snappy fox trot—one step—or a dreamy waltz”?

“That the Repeater-Stop can be set to replay a record once—
twice—three times—or continuously—makes it indispensable for
repeating lessons in schools—or for descriptive dancing—its posi-
tive automatic stop feature and that it lifts the needle *off* the
record when it stops—adds safety and insurance against record
damage or breakage.” “It lifts the reproducer out of the last
groove and drops it in the first groove of a record more carefully
and gently than is possible with a human hand.” A child can
operate it.

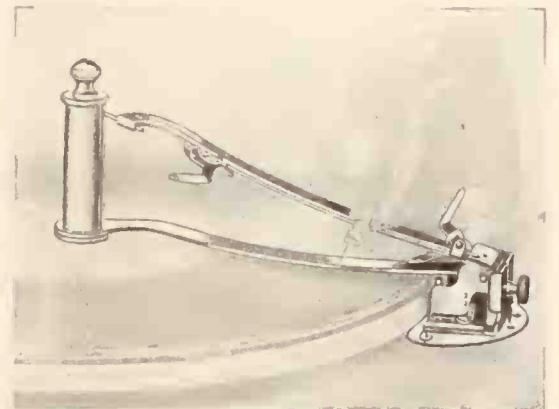

THIS SHOWS THE REPEATER-STOP ATTACHED

To the manufacturer: Give the consumer what he wants by including the Re-
peater-Stop as part of your equipment and thereby add another potent selling
factor to your product. You'll adopt it sooner or later—WHY NOT NOW?

BEWARE of Infringements and Infringers. BEWARE!

To the Dealer:—“Repeater-Stops sell like
hot cakes.” Nine of every ten prospects
buy upon a live demonstration. “A Re-
peater-Stop attached to a machine placed
in your window will prove the greatest
drawing card and the greatest advertising
medium obtainable. TRY IT!”

Price
\$9.00
(Nickel)
F. O. B.
Chicago

To the Jobber:—The Repeater-Stop is
not a makeshift nor a replica of any
“near right” device you may have seen
or heard about. It's the last word of per-
fection and we back it up with an iron
clad guarantee of satisfaction to you—the
dealer and the consumer—Line up with
us, NOW—our product is perfect—the
demand big and discounts attractive.

REPEATER-STOP CO.

115 South Dearborn St., Chicago, Ill.

“PROTECTED BY BASIC PATENTS THE WORLD OVER”

"BUFFALO MEANS BUSINESS"

IROQUOIS SALES CORPORATION

TALKING MACHINES, RECORDS AND ACCESSORIES

10-14 NORTH DIVISION ST. WHOLESALE DISTRIBUTORS BUFFALO, N. Y.

We present the

MASTERTONE

The Most Valuable Obtainable Agency!

To substantiate this statement we will not make extravagant claims, though we know we could well afford to. We content ourselves with presenting a plain, straight-forward business argument.

BECAUSE it really has genuine excellence, and beauty of *Tone*.

The big *VITAL POINT* necessary to *SUCCESS*.

Motor, quiet running, laboratory tested—

The Famous *STEPHENSON PRECISION* Enough Said!

AVOID REGRETS!

HEAR THE MASTER-TONE

Okéh Records

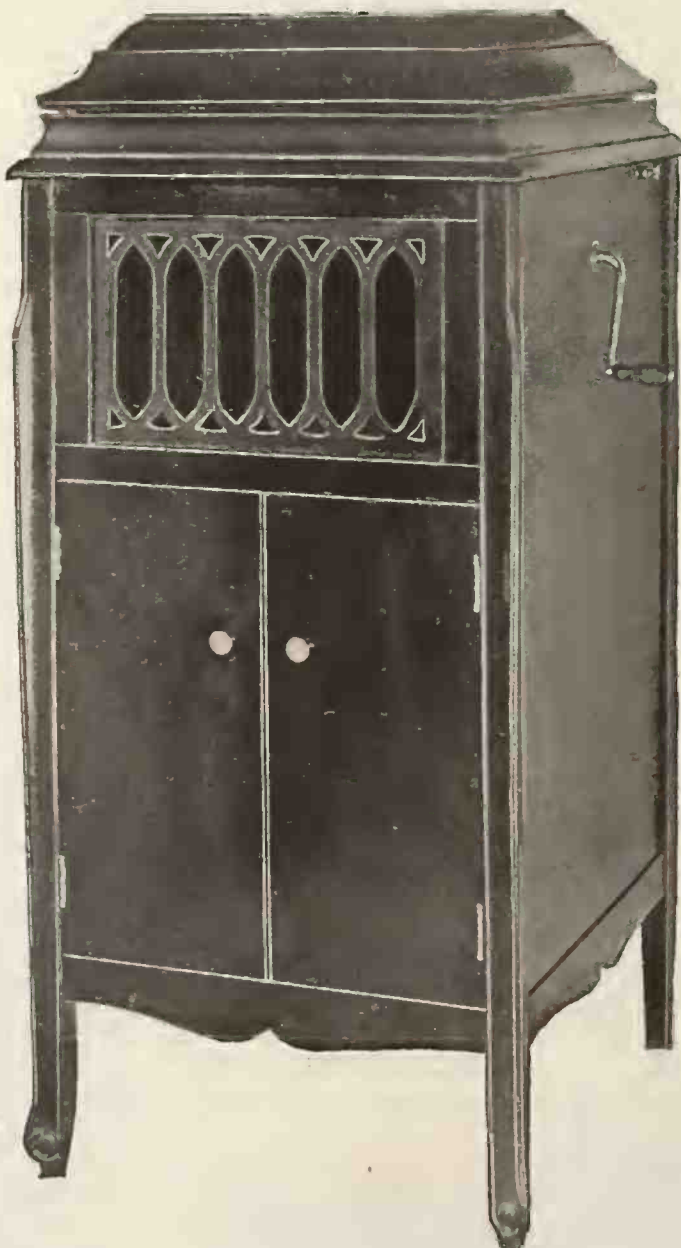

BECAUSE its uniform cabinet design is simple and clean-cut.

Pleasing and acceptable to all classes.

All wooden tone chamber. Tone arm universal of course. Sound box—

The New *HEINEMAN-MEISSELBACH* Enough Said!

MAKE COMPARISON

LET YOUR EAR DECIDE

Okéh Records

The fact that we can make IMMEDIATE DELIVERIES of four popular-priced sizes entitles this line to its accomplished establishment in the better-class stores where, in critical comparison with other standard lines, it is proving equally successful

DISCOUNTS AND TERMS TO DEALERS ON REQUEST
ORDER A SAMPLE NOW

Model 9, \$100
Model 11, \$125

Model 12, \$150
Model 15, \$175

Here's a new one — a Chinese one-step played by a Chinese orchestra. Can they dance to it? Will they? They can and will. E-4506.

**Columbia Graphophone Co.
NEW YORK**



SUPPORT NATIONAL ORGANIZATIONS, SAYS CLEVELANDER

Interesting Remarks on This Question by Wm. R. Graul—Dreher's Timely Comments on Misleading Advertising—Convention of Educational Association Pays Tribute to "Talker"—News of Month

CLEVELAND, O., March 8.—William R. Graul, president of the Piano Merchants' Association of Ohio, while in Cleveland attending the annual banquet of the Cleveland Music Trade Association, urged local dealers to back up their State and national organizations. "The Cleveland association of piano merchants and that of the talking machine dealers are probably the best known to the trade in the country," Mr. Graul said. "Both organizations have members who do things when they get together. While attending the big music show in New York recently I was impressed with the fact that the Ohio State organization of musical instrument merchants is really a live body of men who get busy when there is something to do."

T. A. Davies, the new president of the Talking Machine Dealers' Association of Northern Ohio and manager of the Victrola department of the William Taylor & Son Co., spent a few days last week in New York looking after business and buying new stock. The department which Mr. Davies manages made an unique display for Valentine Day. Talking machines were dressed up in white cheesecloth and decorated with colored ribbons. The machines were delivered to purchasers in the form of Valentines. Big red hearts also set off the machines. Records were put up in dainty boxes trimmed with hearts, ribbons and other ornaments. This plan of popularizing machines and

records for Valentine Day made a decided hit.

Henry Dreher, "Dean" of Cleveland's musical instrument dealers, recently took a broadside shot at certain musical dealers who have been featuring large newspaper advertisements offering high grade instruments at reduced prices and offering to accept \$5 cash down and \$5 a month.

Said Mr. Dreher: "It is a shame that some of our musical instrument dealers continue to fill half page newspaper advertisements with announcements of bargain sales of talking machines. This \$5.00 down and \$5.00 a month bait placed in these advertisements is misleading and we all know it. The dealers who make these statements ought to be ashamed of themselves."

Cleveland musical instrument dealers, particularly those selling talking machines, made much headway in behalf of popularizing machines during the annual convention of the National Educational Association, this city, the last week of February. More than 10,000 men and women delegates, who are teachers in public schools, colleges and universities and executive heads of educational institutions throughout the country, attended the convention, which included about forty sections.

Several of the city talking machine dealers made special demonstrations for the benefit of the visitors. Musical concerts were entertainment features of the week and a large pageant

put on by several hundred small children in the new Masonic Temple auditorium was another special attraction. Sheet music dealers and sellers of player rolls did a good business.

Prominent educators, representing almost every angle of educational work in the United States, including Philander P. Claxton, national superintendent of education, asserted that one of the most potential forces at work to-day in schools, colleges and universities is good music.

"There is nothing more uplifting, refining and beautiful than good music," Mr. Claxton said. "The musical instrument dealers, as well as the manufacturers, are doing a wonderful amount of good in pushing the propaganda to make music more popular."

The Caldwell Piano Co. closed its doors March 1. The closing of this store, at East Ninth street and Prospect avenue, marked the passing of a landmark in Cleveland's musical instrument trade. The firm has been a household word for several years. The conspicuous position of the big store at one of the busiest traffic centers in the heart of the city gave the management unusual opportunities for displaying talking machines, pianos and player-pianos in the ground floor sales rooms and in large show window space on two leading thoroughfares. A considerable quantity of merchandise was not sold. The business of the store will pass to the big new store of the Wurlitzer Co. in the Euclid Building, adjacent to the Stillman Theatre.

"I'm going to do all I can to make the Cleveland Music Trade Association a success in 1920," said Otto C. Muehlhauser, of the Muehlhauser Co. (Continued on page 114)

**Victor
Service
That
Knows
No
Limit**



**Victor
Co-operation
That
Will
Help
You**

WRITE FOR YOUR COPY OF THE "TOTAL ECLIPSE"

**ECLIPSE MUSICAL CO., Cleveland, Ohio
Victor Wholesale**



Operaphone

APRIL, 1920

POPULAR VOCAL SELECTIONS

21151	{ I'll See You in C-U-B-A (Berlin). Tenor, orch. accomp.....	Billy Murray
	{ Oh, Mother, I'm Wild (Johnson-Pease-Nelson). Tenor, orch. accomp.....	Bertram Smith
21152	{ You Said It (Kalmar-Cox-Santley). Baritone, orch. accomp.....	Ernest Hare
	{ Oh! How I Laugh When I Think How I Cried About You (Turk-Jessel-White). Tenor, orch. accomp.....	Bertram Smith
21153	{ Everyone Is Meant for Someone (Kalmar-Ruby-Santanello). Tenor duet, orch. accomp.....	Campbell-Burr
	{ Pickaninny Blues (Frost-Klickman). Tenor, orch. accomp.....	Lewis James
21154	{ Was There Ever a Pal Like You (Berlin). Tenor, orch. accomp.....	Henry Burr
	{ When the Harvest Moon Is Shining (Sterling-Von Tilzer). Tenor duet, orch. accomp.....	Lewis James-Charles Hart
21155	{ Mystery! (Johnson-Cirina). Soprano, orch. accomp.....	Jane O'Day
	{ I'm Always Falling in Love With the Other Fellow's Girl (Caesar-Meyer). Tenor, orch. accomp.....	Sam Ash

DANCE

31135	{ On the Streets of Cairo (Dance Egyptienne) (Hulten). Fox-trot, Operaphone Dance Orchestra	
	{ Alexandria, from "Aphrodite" (Goetzl). Fox-trot.....	Operaphone Dance Orchestra
31136	{ Little Girls, Good-bye, from "Apple Blossoms" (Jacobi). One-step, Farrell's Dance Orchestra	
	{ Ole Miss Blues (Handy). Fox-trot.....	Jones' Novelty Dance Orchestra
31137	{ Good-Night, Dearie (Henry-Onivas). Waltz.....	Farrell's Dance Orchestra
	{ Swanee (Gershwin). One-step.....	Farrell's Dance Orchestra

STANDARD VOCAL

41108	{ O Sole Mio! (Capurro-Di Capua). Tenor, Neapolitan orch. accomp.....	Marion Castello
	{ Sleep, Baby, Sleep (Hadley). Yodling, orch. accomp.....	William MacDonnell

INSTRUMENTAL

51128	{ Golden Sunset (Hall). Waltz. Accordion duet.....	Rosconi Bros.
	{ Faust Waltz (Gounod). Accordion duet.....	Rosconi Bros.
51129	{ Somewhere a Voice Is Calling (Tate). Violin, flute and piano.....	Mendelssohn Trio
	{ Cavalleria Rusticana "Intermezzo" (Mascagni). Violin solo.....	Alice Raymond
51130	{ Flags of Freedom (Sousa). March.....	Military Band
	{ Army Bugle Calls and the Star Spangled Banner (Key).....	Military Band

RECORDS

OPERAPHONE CO. INC., LONG ISLAND CITY, N. Y.

24 NEW TITLES EVERY MONTH

Operaphone Records Play on All Talking Machines Without Attachments

OPERAPHONE DISTRIBUTORS:

New York City
Philadelphia, Pa.
Pittsburgh, Pa.
Chicago, Ill.
Selma, Alabama

BROWN-McMANUS & CO.,
SUPPLEE-BIDDLE HARDWARE CO.
REED CO., Inc.
OPERAPHONE SALES CO.,
SOUTHERN SUPERTONE CO.,

51 East 42nd St.
237 5th Ave.
190 No. State St.

Write for Your Nearest Distributor

OPERAPHONE CO., Inc., Long Island City, N. Y.

hauser Bros. Piano Co., who accepted the vice-presidency of the organization when Charles K. Bennett, general manager of the Eclipse Musical Co., declined the honor.

Huron road will soon lose one of its talking machine firms. A deal has been made whereby the Columbia Graphophone Co. will occupy 24,000 square feet of floor space in the Neighbors' Realty Co. Building, 1812 East 30th street.

The rental will be \$25,000 annually during the first five years, the company having an option for an additional five years. The deal was made through J. W. Bowes, manager of the rental department of the Cleveland Trust Company, and John L. Du Breuil, general manager of the Columbia Co. Larger distribution stations are being provided. A section of the space of the new site in Cleveland will be set apart for a model shop affording prospective purchasers of instruments ideal surroundings in which to make selections of machines and records.

While the Columbia Co. is to desert Huron road the B. Dreher's Sons Co. are planning to occupy their new home in this thoroughfare as soon as the Winton auto concern gets out of the building recently purchased by the Dreher firm. Occupancy of the Huron road property by the Dreher's, however, is many months away, as the Winton lease has several months to run and the building, now used as a service station, will have to be remodeled for the Dreher's.

Carl A. Newton has been appointed office manager by Mr. Du Breuil. Mr. Newton is well known to the local trade and has a wide circle of friends in the industry.

Frank Chenny, of Detroit, was a visitor among talking machine dealers in this city last week.

NEW JOBBING HOUSE IN SPOKANE

Emil Simon and H. O. Kent Organize the Northwest Phonograph Jobbers, Inc., With Capital Stock of \$100,000 to Act as Distributors for Talking Machines, Records and Supplies

SPOKANE, WASH., March 6.—A new jobbing company, the Northwest Phonograph Jobbers, Inc., with a capital stock of \$100,000, has been formed by Emil Simon and H. O. Kent for the purpose of distributing to the dealers in the States of Washington, northern Idaho, western Montana and northern Oregon talking machines, records and a complete line of accessories.

This company is distributing the Brooks Automatic phonograph, the complete line of Paramount talking machines and Emerson records, together with such accessories as Brilliantone, Wall-Kane and B & H fibre needles, record albums, record cleaners, etc.

These men are the owners of the Simon Piano Co., the oldest retail piano organization in Spokane and that tributary section of the country known as the Inland Empire. The Simon Piano Co. has for over twenty-two years played a prominent part in the musical life of the community.

The new company is formed with a realization of the phenomenally rapid growth of the talking machine business, with sufficient capital to at all times carry a large enough stock to give its dealers immediate service in filling their orders. This is another evidence of the fact that Spokane is rapidly coming to the front as a logical center for jobbing in the Pacific Northwest.

The Northwest Phonograph Jobbers, Inc., is operating on a basis entirely separate from the Simon Piano Co., which is strictly a retail organization, but its policy will be the same one of fair dealing and service to the customer which has made the latter company so successful.

JOIN IN ADVERTISING CAMPAIGN

The Singer Music Store of Ritzville, Wash., reports that its entire Pathé stock was sold out and that \$2,000 worth more has been added. This concern has joined with the distributor in a series of newspaper advertising that is expected to make this year's record eclipse all others.

The MODERNOLA

A Home Delight to Ear and Eye

.....

A wonderful new musical instrument of the phonograph family, with all the tone, richness and evenness of the finest instruments you have ever heard play. It's unique and most artistic in designing, rightly constructed in its every part, and finished most exactly.

The silk lamp shade (detachable) enhances its beauty indescribably. As sweetest music pours from the instrument, the soft rays from the lamp multiply impression and add substantially to enjoyment.

.....

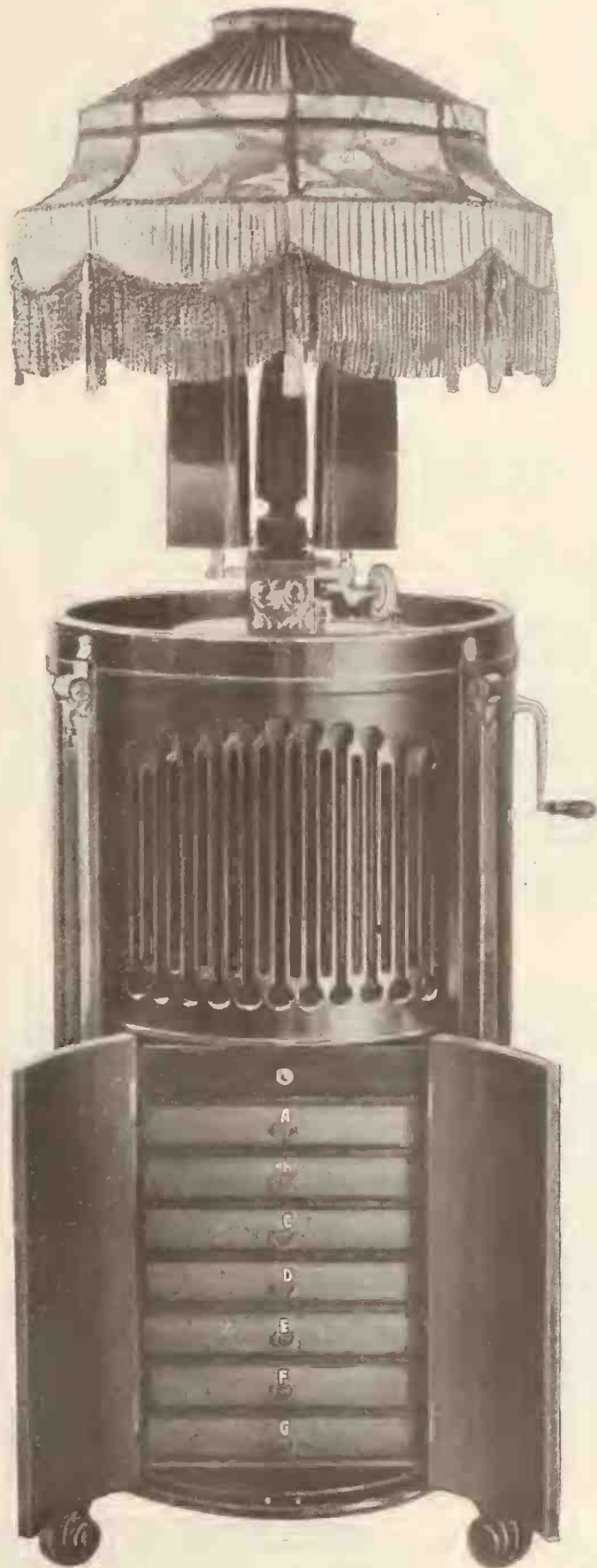

MODERNOLA COMPANY

JOHNSTOWN, PA.

Eastern Representative, Geo. Seiffert

Greeley 2978

45 West 34th St., New York

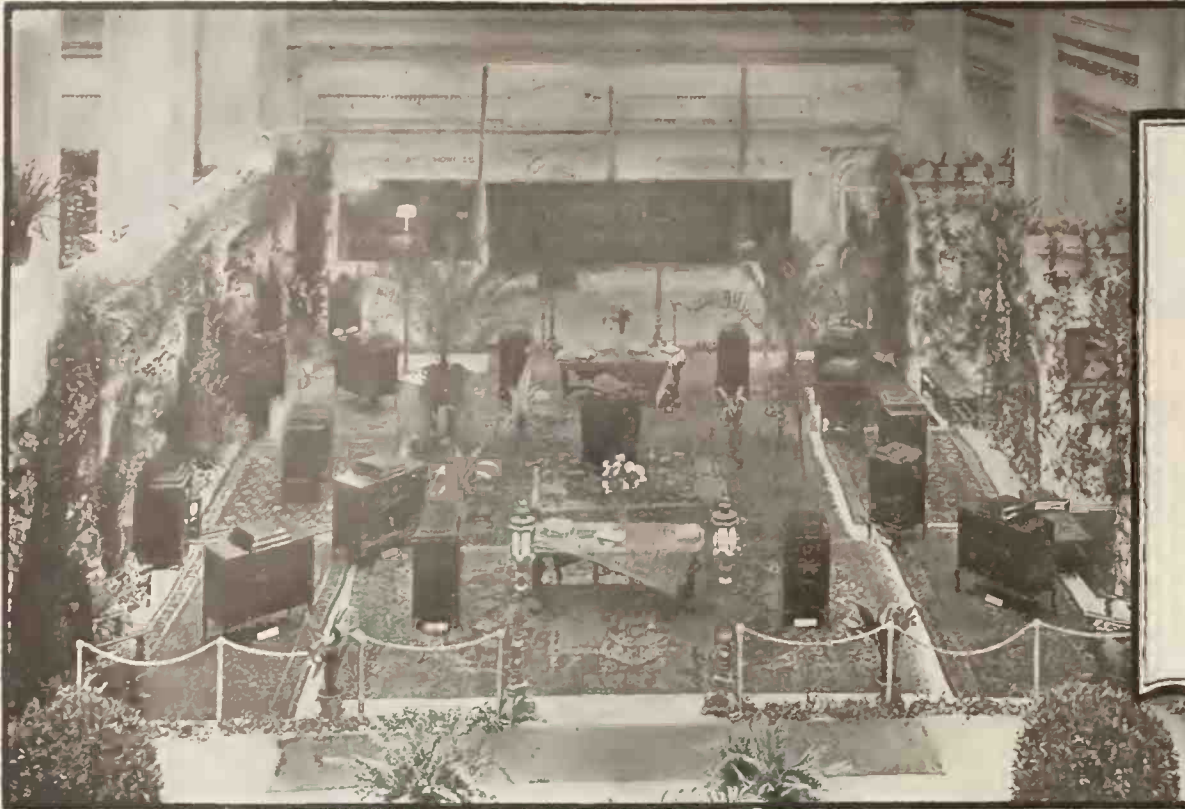

Some of the
TALKING MACHINE
EXHIBITORS
at the
NATIONAL MUSIC
SHOW
 New York, February 2-7
 1920

VICTOR TALKING MACHINE CO.



GENERAL PHONOGRAPH CORP.



COLUMBIA
GRAPHOPHONE
CO.



PATHE FRERES
PHONOGRAPH CO.



How
EFFICIENCY ELECTRIC
CORPORATION



KRASBERG ENGINEERING
& MFG. CORPORATION
PHILADELPHIA SHOW CASE CO.



AEOLIAN CO
VOCALION
EXHIBIT



MODERNOLA CO



SONORA PHONOGRAPH CO

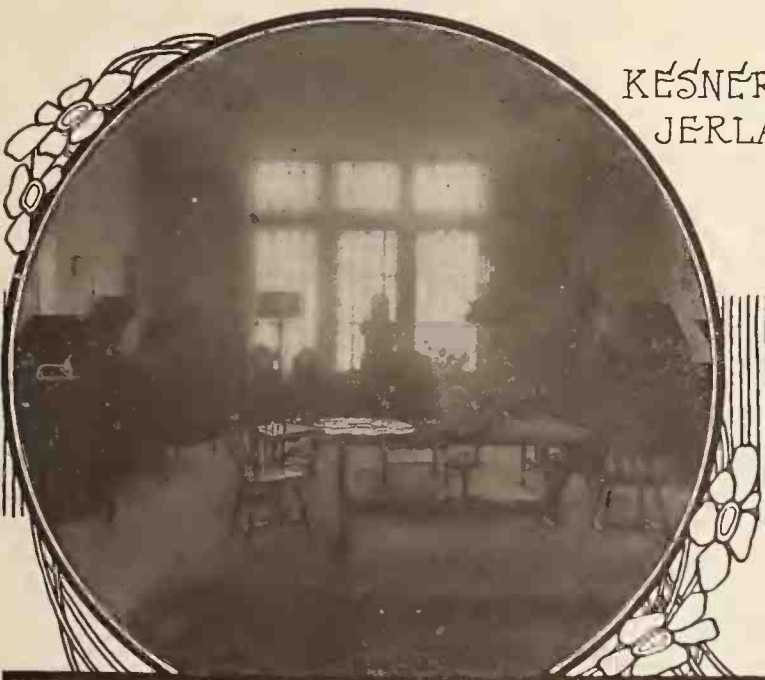

KESNER &
JERLAW



BRILLIANTONE STEEL NEEDLE CO.



At left
UNIVERSAL
FIXTURE CO



At right
INTERNATIONAL
MICA CO



Six Best Sellers

*Arrow Lateral
Records are made
under our own
new process.*

Patents allowed.

Our Second Supplement includes the following popular selections dedicated to sentiment and the dance:

- 513 { **If I Ever Get You** (Novelty Whistling Chorus), F. Bowers
 { **Now I Know**, Baritone, Elliot Shaw
- 514 { **I Might Be Your Once In a While**, Contralto, Louise Terrell
 { **When the Harvest Moon Is Shining**, Duet, Hart-Shaw
- 515 { **Bake Dat Chicken Pie**, Duet, Collins-Harlan
 { **The Preacher and the Bear**, Descriptive, A. Collins
- 516 { **Hawaiian Moonlight**, Duet, Terrell-Shaw
 { **I Never Knew**, Tenor, Henry Burr
- 517 { **Peggy**, Fox-Trot, La Salle Dance Orchestra
 { **You Know**, One Step, La Salle Dance Orchestra
- 518 { **Occidental March**, Arrow Military Band
 { **Washington Post March**, Arrow Military Band

May we send our dealer's proposition?

Arrow Phonograph Corporation

(Formerly Liberty Phonograph Company)

Laboratory
16-18 West 39th St.
New York

Executive Offices
1836 Euclid Avenue
Cleveland

MILWAUKEEANS HELP ADVANCEMENT OF MUSIC

Splendid Work Being Accomplished by the Milwaukee Association of Music Industries—Business Excellent Despite Bad Weather—Jobbers Tell of Expansion—News of Month

MILWAUKEE, Wis., March 8.—It is apparent that manufacturers are achieving more and more success in enlarging their output of machines and records, but local demands continue to be of such volume that even with improved deliveries the acute shortage of merchandise in the retail talking machine trade continues to be its most harassing factor. Trade during the last half of February and so far in March has been unusually active for this time of the year, and under a vigorous movement to keep interest in music at the highest point possible it is regarded as certain that no decline in demand is in sight for a long time to come. Wholesalers and retailers feel that they are about due to get some relief from the very bad traffic conditions obtaining throughout the Winter, now that the railroads are back in the hands of their owners and probably will be more rapidly brought to a state of efficient service than under Government control.

The Milwaukee Association of Music Industries continues to promote the advancement of music, which means the desire for music, among the people of this city and vicinity. It is becoming a more and more potent factor in making music popular and keeping it so. It is an organization with a broad vision and a courageous constituency, with splendid leadership. At the annual election the following officers were chosen: President, Paul F. Netzow; vice-president, Clarence C. Warner; secretary, Leslie C. Parker; treasurer, William R. Winter; directors, Edmund Gram, Henry M. Steussy and Richard H. Zinke.

President Netzow is a piano manufacturer and also engaged in the retail business where the Brunswick phonograph is featured. Mr. Warner is a Victor dealer, Mr. Parker is head of the Badger Victrola Shop, Mr. Winter is a State distributor of the Orola, a Milwaukee product; Mr. Gram is the Aeolian-Vocalion representative. Mr. Steussy is a Brunswick man, as general manager of the Milwaukee Piano Mfg. Co., and Mr. Zinke is now head of the Interstate Music Corp., distributor of Rythmodik player rolls, but formerly was manager of the Badger Victrola Shop, and affiliated with the Badger Talking Machine Co., Victor distributor.

Thus it will be seen that the Milwaukee Association is keenly alive to its responsibilities to the talking machine trade and gives it at least equal representation with the piano trade. Talking machine problems are given the same careful attention as those of piano men, and promotional efforts always have an equal bearing on both divisions of the music business.

The new administration played its first trump card on March 4, when Frank E. Morton, acoustic engineer of the American Steel & Wire Co., addressed a big meeting of representative manufacturers and other employers at a special noonday luncheon held by the Milwaukee Association of Commerce. Mr. Morton gave his wonderful talk on "An Inductive Force in Industry," in which he showed how employers may employ music to remarkable advantage in maintaining satisfaction among workers, increasing their efficiency and building up cordial relations.

The event was arranged in such manner that the music dealers did not appear in the foreground, lest their unusual interest might cause a psychological reaction by the suggestion of commercial motives. As a matter of fact, Mr. Morton's audience came with a most open mind.

A campaign of even greater possibilities which the Milwaukee Association of Music Industries is undertaking is to back to the limit the establishment of Community Service as the development of the War Camp Community Service, which grew out of the work of the American Playground and Recreation Association.



PERSONAL SERVICE

The members of our Company are always available and will gladly see you personally or write you at any time we can possibly serve you.

Why not communicate at once with us?

EXCLUSIVELY WHOLESALE

BADGER TALKING-MACHINE CO. 135 Second Street
MILWAUKEE, WIS.
VICTOR DISTRIBUTORS

It is encouraging George R. Eckert, director of the music division of Community Service, in raising a fund of \$60,000, of which the first \$10,000 has been set aside exclusively for music propaganda and material activities.

With these and many other conspicuous forms of music advancement work being undertaken by their association, the talking machine dealers feel optimistic over the prospects for an indefinite continuance of the present intense interest in music, which necessarily is reflected into the business of music merchants.

How substantially the local trade is attempting to fortify itself for the demand still to come is demonstrated by the report that the Yahr & Lange Drug Co. has placed orders for \$2,000,000 worth of Sonora instruments for 1920 delivery. This house, which is exclusive distributor of the Sonora in Wisconsin and upper Michigan, is launching a gigantic publicity campaign on billboards and through the usual advertising mediums. The first work has been to place a mammoth Sonora sign on the expansive south wall of the C. W. Fischer Furniture Co.'s eight-story building. It is done in brilliant colors and is visible for a great distance. The Fischer Company is one of the largest Sonora retailers in the territory, and Miss Helen Gunnis, manager of the department, expects to establish a new high record of sales this year, with the vigorous assistance the distributing house is giving her company.

The Badger Talking Machine Co., Victor jobber in Wisconsin and upper Michigan, reports improvements in deliveries from the East and more satisfactory conditions in its retail representation as the result. Instruments and records still remain far below the actual requirements of Victor dealers, however. Secretary Harry A. Goldsmith is confident that the situation may now be expected to grow better in regard to supply and demand.

Puritan business in Wisconsin and northern Michigan continues to make new records in comparison to the early part of 1919, according to Charles J. Orth, exclusive distributor of the Wisconsin-made instrument. Mr. Orth's dealer list is gaining new names selected from the best and most substantial merchants as rapidly as the apportionment of goods for his territory makes it possible to expand the distributing organization.

The Phonograph Co., Milwaukee, distributor of the New Edison, is highly pleased with the condition of business and says the only complaint it has to make is that the Edison factories cannot turn out instruments and records fast enough to keep the trade supplied to meet all requirements. Improvement, however, has been noted during the past month.

The new Paramount phonograph and Paramount records, manufactured in Wisconsin at Port Washington and distributed in the same territory by E. R. Godfrey & Sons Co., are

(Continued on page 121)

The
Fundamental
Factor of a
Successful
Service
is
Personal
Co-operation



C. BRUNO & SON

INCORPORATED

Victor Distributors to the Dealer Only

351-353 Fourth Avenue

NEW YORK

WE DO NOT RETAIL

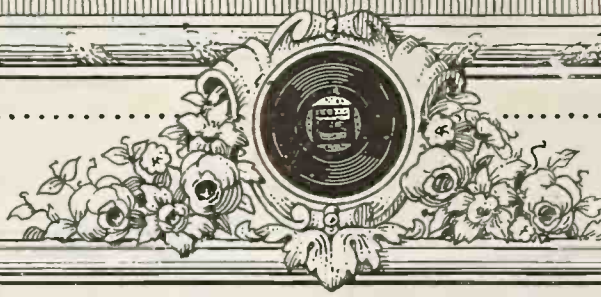

The
AEOLIAN-VOCALION
and
AEOLIAN LATERAL-CUT RECORDS

Vocalion Features

TONE-QUALITY of extraordinary richness and depth; Tone-Control by means of the Wonderful Graduola; Cases of distinctive design and perfect finish; Plays all records perfectly, without extra attachments.

Inquiries solicited from our territory comprising Tennessee, Alabama, Mississippi, and Florida

Write, wire or 'phone Main 586 for full particulars, and one of our representatives will give personal demonstration

THE EMERALD COMPANY

Farley Building
 BIRMINGHAM, ALABAMA

Exclusive Aeolian Distributors



MUSIC ADVANCE IN MILWAUKEE
(Continued from page 119)

meeting with a most enthusiastic reception that is particularly pleasing in view of the newness of the name. The company's big organization is reaching into every corner of the State with the message of the Paramount line.

The growth of Brunswick business in Wisconsin and adjacent territory is a favorite topic of discussion in the local trade. Under the able direction of Thomas I. Kidd, manager of the Milwaukee branch of the Brunswick-Balke-Collender Co., the line has become one of the most popular and best known of all. Retail Brunswick dealers in Milwaukee embrace some of the largest music stores, furnishing an exceptionally active representation.

Pathé retailers in Milwaukee say the demand for instruments is considerably better than a year ago, while the sale of Pathé records is the most active that they have ever known.

Gimbel Bros. announced recently the addition of the Brunswick to their talking machine line, as a companion to the Victor. The New York and Philadelphia stores added the Brunswick a year ago and the experience was so successful that the same action has been taken in Milwaukee.

The Kesselman-O'Driscoll Co., which retails the Victor and Edison, recently increased its capital stock from \$100,000 to \$250,000. Its North avenue branch, a Victrola shop, has been sold to William E. Vollmer, so that all attention may be concentrated on the main store at Grand avenue and West Water street.

The Smith Piano Co., which retails the Columbia and the Elbertone, will move May 1 to a new two-story building at 274 West Water street, doubling its floor space.

Aeolian-Vocalion service at the Edmund Gram Music House has been greatly facilitated by the removal of the record department to the front end of the store, with new cabinet and file equipment. The changes carry out some original and praiseworthy ideas of Miss Julia Wolf, manager of the department.

Oscar A. Bronson has been appointed manager of the retail store of the Jackson Piano Co., at 425 Milwaukee street, succeeding F. J. Pokorney. The Jackson store represents the Columbia and the Brunswick.

The Playonola Talking Machine, Inc., is the style of a new Wisconsin corporation, organized with \$60,000 capital to deal in talking machines, records, etc., at Milwaukee.

SIGNS LONG-TIME CONTRACT

Walter Scanlan Is Now an Exclusive Emerson Artist—Well Known to Theatregoers

The Emerson Phonograph Co., New York, announced this week that arrangements have been consummated whereby Walter Scanlan, popular Irish tenor, becomes an exclusive Emerson artist on a long-time contract. Mr. Scanlan has been recording for the Emerson library since last Summer, and his records have been heartily commended by the dealers and the public, meeting with a ready sale everywhere.

Walter Scanlan is well known to the music-loving public and to theatregoers as the leading man in Victor Herbert's popular light opera, "Eileen," in which he achieved signal success. At the present time he is one of the co-stars of the musical comedy "Always You," and musical critics predict that his popularity will steadily increase as he becomes better known to music lovers throughout the country.

PARKER BUYS W. E. FOX MUSIC CO.

Fond du Lac, Wis., Music House Supplanted by Badger Music Shop, a \$25,000 Corporation

The W. E. Fox Music Co., 109 South Main street, Fond du Lac, Wis., has been purchased by L. C. Parker and associates in the Badger Victrola Shop, 425 Grand avenue, Milwaukee. A new corporation, styled the Badger Music Shop, has been incorporated with \$25,000 capital. Edward R. Sweeney, widely known as a Victor and Puritan traveler in Wisconsin, and a native of Fond du Lac, has been appointed general manager. Mr. Parker is president; Mr. Sweeney, vice-president, and G. A. Einbecker, secretary-treasurer. The Badger Music Shop will retail the Victor exclusively and also deal in pianos.

PROVIDENCE LIKES NEW RECORDS

Brunswick and Aeolian-Vocalion Laterals Reach High Sales Levels

The Tilden-Thurber Corp., Providence, R. I., Aeolian-Vocalion and Brunswick representative, has found the sale of records in that city very large during the past month. The new Brunswick records were eagerly taken up both by Brunswick owners and owners of other makes of machines. The Aeolian-Vocalion lateral cut records have noticeably increased the sales.

The Melodia



STYLE F

Size 20½ x 22 inches; height 48½ inches; automatic stop; tone modifier; floating horn; powerful silent double spring motor.

Record shelves are spacious—accommodating 150 records.

Retail Price

\$160.00

Surprisingly Liberal Discounts

We have been developing our line of machines for the past six years. Our output has not been large and has been absorbed by Dealers near home. This year we have made arrangements to double our capacity, and desire more Dealers.

The "MELODIA" line is one of quality throughout.

Agencies for the complete line are going fast.

Write

THE MELODIA CO.
Troy - - Ohio

A REAL SALES FEATURE

The Universal Tone Arm we offer manufacturers adds a distinctive selling feature to their campaign because our tone arm is distinctive and surpassing in appearance.



Patent Applied For
Presto Universal All-Brass Ballbearing Base Tone Arm No. 11

The all-brass construction insures supreme tone qualities; a patented ball-bearing base provides the ideal record tackage; the non-blasting, superbly-constructed reproducer has a perfected universal adjustment for playing all makes of disc records.

Why not investigate these distinctive features and have an arm that is different and better?

Presto Phono Parts Corporation

124-132 Pearl Street

BROOKLYN, N. Y.

PLAZA

BUY YOUR ACCESSORIES
"All From One Source"

PHONOGRAPH
RECORD CLEANER

RECORD CLEANERS

Great Advertising Medium

A good serviceable Record Cleaner with your imprint is the greatest means of keeping your name constantly before your customers.

These Cleaners are made of velvet and the backs of grained leather on which your advertisement or address is embossed in gold.

These Cleaners are always left in a prominent place—consequently, your customers will always remember you.

Besides, they are a source of profit that you can easily obtain.

Three Styles
Write for Prices

ALL FROM ONE SOURCE

REPAIR PARTS
NEEDLES
CLEANERS
ENVELOPES
SAPPHIRES
ALBUMS
RECORDS

PLAZA MUSIC CO.
18 WEST 20TH STREET
NEW YORK

COLUMBIA DEALERS IN HARRISBURG

Retailers in That Section of Pennsylvania Attend Interesting Meeting Held Under Auspices of Columbia Co.'s Philadelphia Branch

HARRISBURG, PA., March 5.—The Philadelphia branch of the Columbia Graphophone Co., through its executives and salesmen, has begun to hold dealers' meetings in each salesman's territory and on Thursday, February 26, the first of the series was held in Harrisburg, Pa., for the purpose of bringing together the dealer and the management of the branch.

O. F. Jester, salesman of the territory, acted as chairman of the meeting and spoke on co-operation between the dealer and the branch and told the dealers of the purpose of the series of meetings to be held in Harrisburg throughout the year 1920.

B. W. Jennings, assistant manager, gave a very interesting talk on the value of service and assured the dealers that the service extended them in the coming year would be as near 100 per cent. perfect as it was possible. He also outlined the record situation for 1920, telling the dealers what they could expect in the way of larger and better deliveries on their record orders.

E. A. Manning, office manager, told how the dealers could obtain the most service from the branch by playing the "Columbia way" and abiding by the Columbia system as outlined by him. He also gave the dealers an idea of establishing a definite collection system for installment sales which had been tried out by him in the past and proved exceedingly effective in his collection efforts.

W. A. Schreiner, manager of the Dealer Service department, gave a brief history of the establishment of the Dealer Service idea, and what the department has done and plans to do for the dealer in 1920.

Last, but not least, speaker N. J. Wilcox, manager of the branch, gave a brief résumé of the preceding talks and explained that he wanted the dealers to like the ways the Columbia Graphophone Co. did business with them, and to feel that the branch in its entirety was working 100 per cent with the dealer. He next touched on the question of quotas and stated that the branch had been assured 100 per cent increase in product in 1920, over 1919, and that if the company was to increase its sales 100 per cent the dealer would have to get behind the Columbia proposition in a way that has never been attempted before.

Mr. Wilcox outlined the Columbia Graphophone Co.'s advertising campaign for the year of 1920, which was received very enthusiastically by the dealers. All those who attended the meeting expressed their enjoyment and complete satisfaction with same and are anxiously awaiting the meeting of all the dealers in the Philadelphia territory to be held in Philadelphia very shortly.

At the close of the meeting the dealers were allowed to ask any questions they desired and a number of good ideas were exchanged between them and the management. The success of the Harrisburg meeting indicates that the plan is filling a long felt want of both the dealer and the Columbia sales organization.

BURGLARS WORK AS MUSIC PLAYS

Close Comfortable Evening by Carrying Off a Baby Grand Piano

Burglars smoked cigarettes and played jazz music while they pilfered the office of the Standard Phonograph Co., 14 Duane street, New York, last month.

When Jacob Bass, manager, went to the office Monday he found a baby grand piano and materials valued at \$400 gone. The floor was littered with cigarettes and candle stubs, and jazz records were found on several of the phonographs.

J. I. CARROLL RETURNS TO DESK

J. I. Carroll, manager of sales of the Emerson Phonograph Co., returned to his desk last week, after being confined to his home for over a month with a serious attack of the grippe. Upon his return to active work Mr. Carroll received a hearty welcome from his associates, and Emerson jobbers from all parts of the country have expressed their pleasure upon learning that J. I. is again "on the job."

WINS ATTENTION WITH DOG TEAM

The Tremont Talking Machine Co., Boston, recently attracted much attention from the crowds in the neighborhood of Tremont and Boylston streets by sending out a team of four Boston terriers, hitched to a little car on which was a large Victor dog. The propensity of the terriers to sit down to rest at the most congested points on Tremont street gave the traffic police much extra work although the spectators enjoyed it immensely.

Perfect Uniformity and Uniform Perfection in

Turntable Felts

You get just that in Turntable Felts made by the American Felt Company. That's why they are the choice of leading manufacturers in the Talking Machine trade.

Send us your specifications for felts for any mechanical purpose. They will have the attention of technical experts with laboratory facilities at their disposal

American Felt Company

TRADE MARK

100 Summer Street
BOSTON

114 East 13th Street
NEW YORK

325 So. Market Street
CHICAGO

CINCINNATI REPORTS ACTIVE TRADE

**Aeolian Co. Plans to Broaden Jobbing Field—
Many Portable Victrolas Sold—Huss Bros.
Factory Output to be Materially Increased**

CINCINNATI, O., March 5.—February, though a small month, produced quite a volume of business in the Victrola line, but nothing to what it would have been, however, had goods been available in larger quantities. Many out-of-town dealers visited local stores in quest of records which are so hard to get at the present time. In some instances, though, they were successful in purchasing records that were only fair sellers in this district, but good sellers in their locality.

Portable Victrolas were received and sold in large quantities at the Rudolph Wurlitzer Co. store, which helped considerably in increasing the sales for the month. This is an excellent idea on the dealer's part in purchasing the small type instruments now, for it will place him in an ideal position to prepare for the sale of this type of machine for the early Spring and Summer trade.

As announced in the February issue of The World, the Aeolian Co., on account of the increased inquiries and demands from dealers and prospective dealers throughout the Middle States, has decided to broaden out in the jobbing field. The Cincinnati store has been receiving requests and inquiries from prospective dealers in all parts of its territory. The facilities for handling both old and new accounts will be greatly enhanced, for Cincinnati is in a direct shipping route from the Grand Rapids factory.

Howard C. Shillito, formerly of the Werner Industries Co., and a thoroughly competent talking machine man, will take Chas. A. Byars' position as manager of the retail department. Dan Stephens, connected with the retail department for the past eighteen months, has been transferred to the wholesale department and will take charge of the details of handling this department.

There will be an increased drive made this year in the Vocalion line, and this, along with the acquisition of the lateral cut records, should result in an increase in business.

The Huss Bros. Phonograph & Piano Co. has under way at the present time a deal whereby the output of the factory will be considerably increased. This move was found to be necessary to take care of the increased demand for "Re-Call" phonographs.

After an absence of three weeks, during which he was confined to his bed with pneumonia, C. C. Coppin, president of the Huss Bros. Phonograph & Piano Co., is again able to be about.

INCREASES CAPITAL TO \$75,000

COHOES, N. Y., March 5.—J. C. Oleson, secretary and general manager of the Master-Tone Phonograph Co., Inc., of this city, announced recently that the company had increased its capital stock from \$20,000 to \$75,000. A considerable portion of the additional capital will be used to purchase the N. T. Mfg. Co., which now becomes associated with the Master-Tone Phonograph Co. The N. T. Mfg. Co. has been manufacturing cabinets for several years and its entire production will now be utilized by the Master-Tone Phonograph Co. The following officers were elected at a recent meeting of the stockholders of the Master-Tone Phonograph Co.: J. H. Madson, president; Wm. D. Buchanan, vice-president; P. C. Rasmussen, treasurer, and J. C. Oleson, secretary and general manager. The officers and Roy M. Peltier compose the board of directors.

ENLARGE THEIR STORE

Spring Bros., talking machine dealers, of Eaton, O., have just enlarged their store, taking in the second floor of the building and installing an elevator.



International Talks

Every one of our Dealers make money when they sell our Emerson Foreign Records in

- Polish
- Italian
- Hebrew-Jewish
- Bohemian
- Russian
- Scandinavian
- Spanish

Every Music Dealer in the country has a public that buys only the Best—and the "best" lies right in our

Premier Catalogue
of
Grand Opera
Violin
Orchestral
Band
Nobelty

selections by exclusive INTERNATIONAL artists—
by artists who sing and play in your locality— by
the Best

We are also

Domestic & Foreign
Distributors
of
Tonofone Needles

The Needle you will always use
when you use it ONCE

and

Globe Music Rolls

Both Word and Instrumental.
"HITS WHEN THEY ARE HITS"

Emerson
International
Inc.

1780
Broadway
New York

An ELECTRIC DRIVE PHONOGRAPH MOTOR

Guaranteed—To maintain constant turntable speed on
110 volt alternating current
60 cycles and under
110 volt direct current
and through all variations in voltage occurring on commercial lighting circuits.

Guaranteed "To run cold"—cannot overheat

Guaranteed To operate in silence.

Guaranteed To produce perfect tone at the exact speed which the record was intended to play, at 78 or 80 turntable revolutions per minute.

Guaranteed To need no adjustment, oiling, or any attention whatever for at least two years from date of delivery.

Guaranteed To function satisfactorily under all proper usage on either alternating or direct current (110 volts unless otherwise specified). The motor is shipped in dust proof ("fool proof") case, sealed.

All Guarantees Are subject to the original seals of the dust proof case remaining intact.

Guaranteed Deliveries You may absolutely depend on any delivery agreements we may make with you.

YOUR STANDARD EQUIPMENT

The Talking Machine manufacturer, dealer and consumer have demanded the perfect self-starting talking machine. You can safely install the Efficiency Electric Drive Talking

Machine Motor and justify any claim which you may make for it as a unit in your standard equipment.

Write to-day for further information

EFFICIENCY ELECTRIC CORP.

Experimental Laboratories,
124 WHITEST., NEW YORK

Factory,
LOWELL, MASS.



AN UNPRECEDENTED DEMAND FOR RECORDS IN DETROIT

Temporary Dullness Disappears—Brisk Demand for High-priced Machines and Records of all Kinds—Wallace-Brown's Third Brunswick Store—Menace From "Storage Houses"

DETROIT, MICH., March 6.—Apparently dull days are over in the talking machine business. At least that's the impression one gets from talking with dealers and visiting their stores. Sales people in the machine and record departments seem to have no time to sit around as there is always somebody in the stores shopping. The majority of dealers are frank to admit that things in the industry have changed from what they used to be and that it has developed into a big business.

There is still a brisk demand for machines and particularly the higher priced ones at \$150 and up to \$275. Inasmuch as most machines are sold on time payments, people seem to prefer the best and are willing to take a little longer to pay for it. Of course, dealers are asking larger down payments than formerly and also larger monthly payments and the public accepts the new terms just as readily as it did when everybody advertised "\$1 per week." Wages continue high in Detroit—there is a crying need for more skilled and unskilled workmen—and indications point to the best year industrially the motor city has ever had.

As for records, every dealer is doing a big record business, no matter whose line is handled. We say this sincerely because dealers handling the newer makes of records say their sales are increasing right along. The public takes the attitude that a hit is a hit and this is proven in the case of Dardanella. Most of the record companies have this and all dealers are selling piles and piles of them. We can safely make a comparison right here with the motion picture industry. It used to be that the "star" was the thing and now it's down to a basis where it's the "production" that counts. In records it is not so much any more as to "who" makes them but "how good" are they made?

Victor records apparently hold the lead for popularity in Detroit. There is no telling how many more records Victor dealers might sell here if they could fill all their orders or would appoint new dealers in accordance with the requests that come in for a Victor agency. Grinnell Bros. are the Victor jobbers in Michigan, and in addition they operate twenty-six retail stores in the territory.

Ed Andrew, manager of the J. L. Hudson talking machine department, was among those who attended the music show in New York recently. He also visited many of the leading retail stores in the East for new ideas. Ed reports a splendid business in Victrolas, Sonoras

and the Cheney line, as well as in Victor and Emerson records.

Dealers have had a big year on operatic selections. The reason for this is due no doubt to the number of famous artists who have appeared in Detroit for recitals. The last artist of the season to appear will be Caruso sometime in April and already dealers are making window displays and advertising his records. This applies to Victor dealers.

Nothing can take the place of the syncopated songs and dance numbers for popularity. They are by far in the lead not only with Victor records but all the others as well. People are "crazy" over syncopation and the various one-steps and fox-trots. There are more restaurants in Detroit than ever that permit dancing—there are more dance halls than ever—and more dancing than ever. Every dance given stimulates the sale of dance records because "somebody" is going to "fall" for some hit and a visit to the talking machine store next day follows.

Wallace Brown is now giving his entire attention to the Wallace Brown Brunswick shop having given up his position as sales manager in Michigan for Brunswick. He says the arrival of the first shipment of Brunswick records created quite a stir around the place—and that they are meeting with popular favor among Brunswick customers.

Buhl & Sons, hardware dealers in Detroit, are now Michigan distributors for the Vitrola line of phonographs.

The Adora Phonograph Co. has opened a seventh store on Michigan avenue, No. 1646, and will soon announce several other east and west side locations. The Adora stores all handle Emerson records. They have all been established within the past 18 months, and all seem to be enjoying prosperity.

Sam Lind, manager of the local Columbia wholesale branch, says he is not anticipating how much business he will do this year because the quota he set the first day of January will be reached around midsummer and he will apparently double and possibly triple his anticipated quota. The various accessories for display purposes being put out by the Columbia people are helping the dealers a great deal to exploit the late hits. We are hearing a lot of fine compliments for these Columbia accessories. We have yet to find a dealer who is not using them advantageously.

Wallace Brown, Brunswick dealer, has opened a third store on the west side, and may open

several more stores before the year is out. He has several good locations in view.

A menace to the business right now is the number of "storage houses" which advertise talking machine "bargains," making the public believe that the machines have been left by persons who did not pay the storage charges and that as a consequence they can offer them at special bargains. We do not say that all of the storage ads are "fake," but a great many of them are and legitimate retailers should do something to put a stop to the misrepresentations which are set forth therein.

SECURE QUALITY ATMOSPHERE

Advertising of Channell Chemical Co. Utilizes Sonora Phonograph in Its Displays

Readers of national magazines have undoubtedly noticed in recent issues the attractive advertising of the Channell Chemical Co., manu-



How the Sonora Gives Tone to an Ad

facturers of O-Cedar polish. In this advertising, in order to secure a quality atmosphere, the artist has placed in a panel at the top a fashionable drawing-room scene. A grand piano appears at the right hand side of the illustration, and in another part of the room is presented a handsome Sonora "Invincible" model, easily distinguishable because of its "bulge" design.

This advertisement is reproduced herewith, although the black and white illustration hardly does justice to the original, which appears in the magazines in many colors.

A Motor of Superior Quality—No. 10

Silent Running

Silent Winding

Immediate Deliveries in Large and Small Quantities

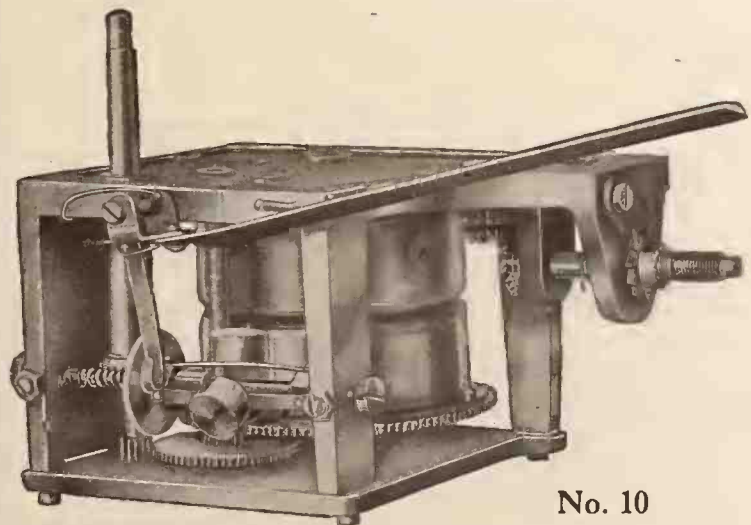

No. 10

Read the Specifications and Order—NOW

- Beveled gear noiseless winding.
- New ratchet device that prevents clicking.
- Bakelite intermediate gear—absolutely silent.
- Plays five 10-inch or three 12-inch records at one winding.
- Cast iron nicked frame.

- Powerful, durable, compact, accessible.
- Built especially for the highest-grade machines.
- Guaranteed in every minutest detail.
- The perfection of mechanical genius as applied to the phonograph motor.

Ask for Specifications on No. 12 and 22

BUTTERFLY PHONOGRAPH MOTOR CORP.

243 W. 17th St., New York



BE FAIR

Mr. Victor Dealer

Victor factory production during the past few years has appeared as nothing compared with the demand. Still most dealers' Victor sales were larger than ever. It was the relation of the supply to the demand which hurt.

It was the opportunity for "so-called" manufacturers to enter the field and cash in on the surplus Victor demand. Any merchant, it seems, can get dealer's discounts and a supply of almost any talking machine or record on the market, except the Victor.

Victor distributors however, generally speaking, have been loyal to Victor dealers. New accounts have been refused by the thousands to ensure first supply to Victor dealers already established. And this, regardless of the fact that many Victor dealers were taking in and pushing, in preference to the Victor, many varieties of "new-born" machines and records.

I wonder if these dealers believe that "competition is the life of trade." If so, will they be as liberal minded toward new competition in their immediate neighborhood? I mean real competition—new Victor dealers.

Greatly increased Victor production is at hand. Be fair, Mr. Victor dealer. Who is most entitled to increased production? You want your share and we want to give it to you. The only question is, what is your share? What have you earned?

Think it over and talk it over with us. We want to co-operate with all our Victor dealers who are willing to reciprocate for a "square deal" for all.

Stewart Blackman,



Blackman

TALKING MACHINE CO.

81 READE ST. NEAR CHURCH ST. NEW YORK
VICTOR DISTRIBUTORS EXCLUSIVELY WHOLESALE



BUFFALO HAVING A BANNER TRADE THESE SPRING DAYS

Trade Enjoying Large Measure of Prosperity Despite Severest Weather in History—Talking Machine Music by Wireless—Hoffman Display at Food Show—New Wurlitzer Officers

BUFFALO, March 8.—February was a banner month in Buffalo's talking machine trade. This prosperity was enjoyed in spite of a long period of severe weather throughout almost the whole month. For several days many of the stores had insufficient heat and clerks and customers alike were subjected to many discomforts resulting from a tobogganing mercury. The "flu" also handicapped trade, but all these setbacks were surmounted by the talking machine men, who found that they had made a fine showing when they had totaled up their receipts at the end of the month.

A. W. Fiscus, traveling representative of W. D. & C. N. Andrews, has resumed his trips throughout western New York and northern Pennsylvania. He was on the sick list for a few days. H. N. Noyes, who was a major in the U. S. motor transport corps in France, was a recent caller at the Andrews store. At one time he was traveling representative for that firm.

Occasionally stories of what are termed "new uses of the talking machine" go the rounds in this city. The latest report along this line describes the surprise which local wireless operators experienced recently when they heard a series of musical numbers varying from the latest jazz music to selections from grand opera. This music, of course, is said to have taken the place of the customary series of dots and dashes familiar to the wireless operators. The music was produced by the use of a new device said to have been operated by Charles Klinck, of 38 West Parade avenue, an instructor in the Nichols School for Boys in this city. The contrivance transmits the tones of a regular talking machine with surprising distinctness of tone. John Rieger, of 15 Fairview avenue, instructor in radio at the Seneca Street Vocational School, this city, was able, by means of an amplifying device, to hear the music distinctly all over his home. It is said that those listening could also hear the person sending talking to the man winding up the phonograph and to other people in the room. Mr. Rieger says he will attach a large horn to his device so that his neighbors may hear the music as they sit on their verandas this Summer.

It is rumored that a talking machine department will be one of the features of a large department store to be erected in Chippewa street by W. A. Morgan & Babcock Co.

Albert Stettenbenz of the Utley Piano Co., which handles the Brunswick and New Edison lines, placed a number of orders while attending the music show in New York.

F. E. Russell, manager of J. N. Adam & Co.'s Victrola department, is praising highly the benefits to be derived from the salesmanship class of the Victor Talking Machine Co. Mr. Russell recently completed his course in this school.

Near the entrance of J. N. Adam & Co.'s talking machine department one of the three original Titians in the United States was recently exhibited. The masterpiece is entitled, "Raising Lazarus from the Dead." The exhibit was visited by local art lovers, many of whom also inspected the company's stock of talking machines. A resident of Salt Lake City owns the painting.

According to a report from North Tonawanda the Rudolph Wurlitzer Co. has elected the following officers for the coming year: Chairman of the board of directors, Howard E. Wurlitzer, Cincinnati; president, Farny Wurlitzer, North Tonawanda; vice-president and general superintendent, Walter F. Wendell, North Tonawanda; secretary, W. S. Little, Cincinnati; treasurer, R. H. Wurlitzer, Cincinnati; assistant secretary, Thomas E. Gray, North Tonawanda.

The upward trend of prices of everything—from talking machines to silk hosiery—is the subject of frequent articles appearing in local newspapers. The human interest features are not overlooked in the stories, which show only one side of trade conditions, and readers are inclined to gain the wrong impression that they are being imposed upon by the retailers.

"Simple justice and their own self-interest should prompt the dailies to state all the facts, not just one side of the case," remarked a local talking machine man. "An occasional editorial could be written about the skyward trend of the cost of labor and materials used in the making of machines and the unusual increase in our overhead expenses. The editorial writers, how-

ever, say little about these subjects. The newspapers are persistent in soliciting our advertising, but when it comes to telling the simple truth about the higher cost of production, they are too often silent. It is quite noticeable, however, how much space they devote to picayune politics and 'high-price sensations,' which are often used as material for the agitators."

In line with their policy of expansion, C. Kurtzmann & Co., piano manufacturers, have bought four acres at Genesee street and the New York Central tracks and will erect a modern factory on the site. This plant will be in addition to the firm's other two extensive factories in this city. The expansion will represent an investment of more than \$300,000 and will bring upward of 700 more skilled workmen to Buffalo.

The Koenig Piano Co., piano and talking machine dealer, has secured a lease at 668 Main street, one of the most desirable locations on Piano Row.

Sonora and Brunswick talking machines were among the merchandise displayed by the Hoffman Piano Co. at its booth at the recent Buffalo Food Show at the Broadway Auditorium. In connection with the exhibition the Hoffman Co. said: "Our display was a great success. There was a total attendance of upward of 100,000 persons. Besides the advertising benefits we received we made a number of direct sales at the show." The Hoffman booth was in charge of R. E. Smith. Five hundred dollars' worth of Sonora needles were also distributed. The talking machine music at the booth attracted the crowds. Considerable ingenuity was shown by the Hoffman Co. in selecting a slogan that would be in keeping with a food show. The concern hit upon the happy motto—used atop their booth—"Food for the Soul."

REMARKABLE SONORA SIGN AT THE BROOKLYN BRIDGE

Travelers crossing the Brooklyn Bridge are bound to see the handsome Sonora sign at the

Equitable Bldg., the largest office building in the world, and the Bankers' Trust Tower, which form a striking background. This sign is seen by hundreds of thousands of people daily, and it forms a valuable addition to the mammoth Sonora outdoor publicity campaign. According to the company's present plans, new signs will be erected in the most important advertising locations in the country.

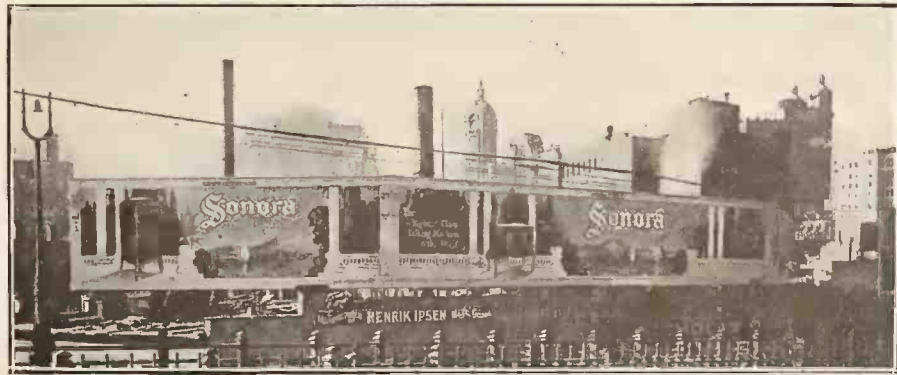

This Illustration Will Give an Idea of Size of Sonora Sign

south side of the bridge. The Sonora instruments are shown against the sky line of lower New York. This sign is very attractive and is a three-panel affair, its total length being 177 feet.

In the picture there will be seen in the distance, behind the sign, the Singer Bldg., the

A new Kimball piano and phonograph store has been established at Blanchardville, Wis., by Garfield Johnson, who has leased the Noble building on Main street and is stocking it with a full line of instruments, records, music rolls and kindred merchandise.

"Victor Exclusively"



Victor Dealers:

The above slogan raises you above the common level and is your supreme mark of distinction. Now is the time to show your colors.

THINK IT OVER!

THE TOLEDO TALKING MACHINE CO.

VICTOR WHOLESALERS EXCLUSIVELY

TOLEDO, OHIO

Universal Displayors—Talking Machine and Music Trade



No. 551. Universal Floor Self-Service Record Displayor. Can be moved about from place to place. Has 6 leaves, giving 12 sides for display of records. Constructed of heavy cast-iron base, equipped with roller casters and upright tubing. Size of leaves, 13x38 inches. Filler of heavy green cardboard and pockets of flexible green denim cloth. Displayor holds 30 10-inch records and 24 12-inch. All titles clearly visible. Guaranteed to hold full weight of records. Fillers can be changed when desired. Height over all, 67 inches; wings when open spread 28 inches. Crated, 32 pounds.

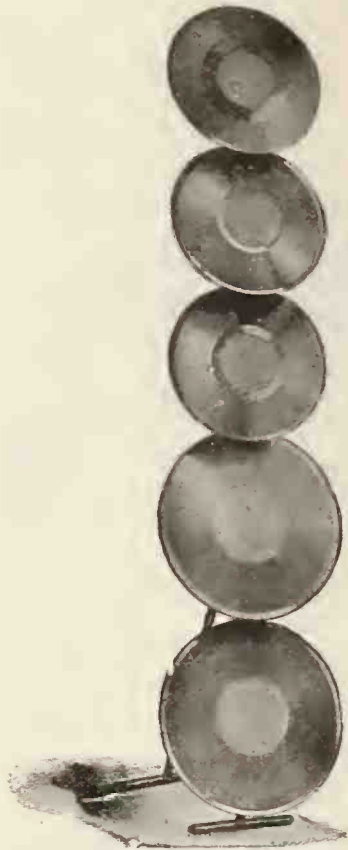

No. 553. Vertical Record Displayor. Holds two 12-inch records and three 10-inch. Constructed of 3/8-inch steel tubing, properly braced in the back, electrically welded, and sheet steel discs preventing records from warping. Entire Displayor finished in double baked ebony enamel. Weight, crated, 12 lbs. Height 52 1/2 inches, width 12 1/2 inches.

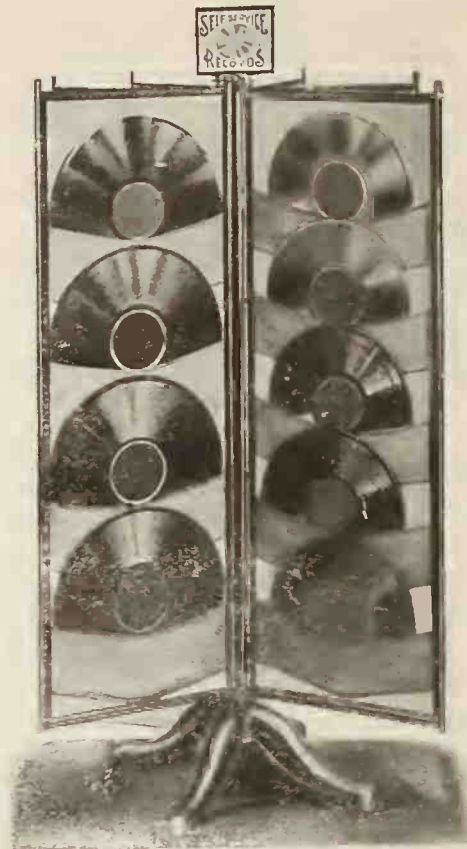

No. 552. Universal Revolving Counter Self-Service Record Displayor. Has 6 leaves, giving 12 sides for display of records. Constructed of heavy cast-iron base, equipped with upright tubing. Size of leaves 13x38 inches. Filler of heavy green cardboard and pockets of flexible green denim cloth. Displayor holds 30 10-inch records and 24 12-inch. All titles clearly visible. Guaranteed to hold full weight of records. Fillers can be changed when desired. Height 42 inches, wings when open spread 27 inches. Crated, 32 pounds.

Ask for Catalogue Order Through Your Distributer

Distributers Handling Our Complete Line



No. 500A. Universal Upright Catalogue Displayor. Furnished with six pockets, one above the other, each measuring 5x4 inches. Constructed of sheet steel, electric welded, finished in double baked ebony enamel. Will hold six large catalogues or seventy-two monthly booklets. No less than 2 sold to a customer.

- BIRMINGHAM, ALA.**
Birmingham Talking Machine Company
The Emerald Company
- BOSTON, MASS.**
Brown, McManus Company
Eastern Talking Machine Company
Kraft, Bates & Spencer, Inc.
Oliver Ditson Company
Henderson, F. C.
Phonograph Supply Company
Stewart & Sons Company, M.
- BUFFALO, N. Y.**
Andrews, W. D. & C. N.
Buffalo Talking Machine Company
Buffalo Wholesale Hdwe. Co.
- BURLINGTON, VT.**
American Phonograph Company
- CAMDEN, N. J.**
Victor Talking Machine Company
- CEGAR RAPIDS, IOWA.**
The Churchill Drug Co.
- CELINA, OHIO.**
Harmonia Company
- CHICAGO, ILL.**
Butler Bros.
Chicago Talking Machine Company
Cole & Ludas Music Co.
Empire Talking Machine Company
Noble Supply Co.
Rudolph Wurlitzer Company
- CINCINNATI, OHIO.**
Phonograph Company
Rudolph Wurlitzer Company
- CLEVELAND, OHIO**
Cleveland Talking Machine Company
The Fischer Company
- COLUMBUS, OHIO.**
Perry B. Whitist Company
- DALLAS, TEXAS.**
Harbour, Longstre Company
Sanger Bros.
Sons-a-Distributing Company
- ELMIRA, N. Y.**
Elmira Arms Company
- HOUSTON, TEXAS.**
Southern Drug Company
The Talking Machine Company of Texas
- INDIANAPOLIS, IND.**
Stewart Talking Machine Company
- KANSAS CITY, MO.**
Jenkins Sons' Music Co., J. W.
Richards & Conover Hdwe. Co.
Schmelzer Arms Company
The Phonograph Company
Wm. Volker Co.
- LANSING, MICH.**
Lansing Phonograph Co.
- MILWAUKEE, WIS.**
Badger Talking Machine Company
E. R. Godfrey & Sons Co.
Yahr & Lange Drug Company
- MINNEAPOLIS, MINN.**
Berkwith, O'Neill Company
Stone Piano Co.
- NEWARK, N. J.**
Collings & Price Company
- NEW HAVEN, CONN.**
Horton, Gailo Creamer Company
Plaza Music Company
- NEW ORLEANS, LA.**
Werlein, Ltd., Phillip
Diamond Phonograph Company
- NEW YORK CITY, N. Y.**
Brown, McManus Company
Cabinet & Accessories Company
Century Music Publishing Company
Crown Music Company
Columbia Graphophone Company
Ditson & Company, Chas. H.
Emerson Company
Enterprise Music Supply Company
Knickerbocker Talking Machine Company
Plaza Music Co.
The Aeolian Company
New York Talking Machine Company
- OGDEN, UTAH**
Proudfit Sporting Goods Company
- OKLAHOMA CITY, OKLA.**
Alexander Drug Company
Harbour, Longstre Phonograph Company
- OMAHA, NEBR.**
Hospe Company, A.
Mickel Bros. Company
- PHILADELPHIA, PA.**
Emerson Company
Girard Phonograph Company
Grafonola Shop, Inc.
Heath & Gorman
Interstate Phonograph Co.
Penn Phonograph Company
Smith, Kilno & French Co.
- PITTSBURGH, PA.**
Buehn Phonograph Company
Emerson Company
Frederick Plano Company, W. F.
National Phonograph Co.
Beed Company, Inc.
Standard Talking Machine Company
- PORTLAND, ME.**
Cressey & Allen
- PORTLAND, ORE.**
Sherman, Clay & Company
- RICHMONO, INO.**
Starr Piano Company
- RICHMONO, VA.**
The Corley Company
Crafts Starr Phonograph Company
Haynes & Company, C. B.
Roundtree Cherry Corporation
- SALT LAKE CITY, UTAH**
Columbia Stores Company
The John Elliott Clark Company
- SAN FRANCISCO, CAL.**
Sherman, Clay & Company
- SEATTLE, WASH.**
Sherman, Clay & Company

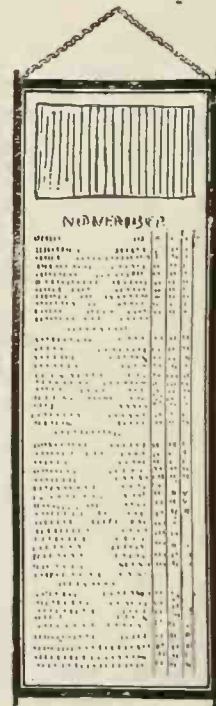

No. 504. Universal Hanger Frame for one monthly record sheet. Constructed of steel channel frame, electric welded, with pulp board filler. Double baked ebony finish. Chain at top. Weight, crated, 5 lbs. each.

- SIoux CITY, IOWA.**
Harger & Blish.
- ST. LOUIS, MO.**
Associated Furniture Manufacturers
- ST. PAUL, MINN.**
Dyer & Bro., W. J.
- SYRACUSE, N. Y.**
Andrews Company, W. D.
- TORONTO, CANADA**
His Master's Voice, Ltd.
- WASHINGTON, D. C.**
Cohen & Hughes, Inc.
Droop & Sons, E. F.
Rogers Company, Robert C.
- WHEELING, W. VA.**
Hillman Phonograph Company
H. W. Tyler Company
- WINNIPEG, CANADA**
Western Gramophone Company

Universal Fixture Corporation

133 WEST 23rd STREET
NEW YORK

TALKING MACHINE BUSINESS AT HIGH TIDE IN ST. LOUIS

Trade Cannot Get Enough Machines and Records—Tri-State Victor Dealers to Meet—Aeolian Expansion—Vitanola Publicity—Edison Dealers Gather—Victor Concerts at Vandervoort's

ST. LOUIS, Mo., March 5.—Spring opens with the talking machine business in St. Louis at high tide. The tide would be higher if dealers could get more machines and records, for the scarcity continues in the leading makes, although shipments are coming better, with Edison and Columbia dealers getting a fair supply. The Victor situation cannot be said to have improved. More machines and records are coming through, but the supply continues about six months behind the orders. Dealers who have been compelled to take on other makes in order to have something to sell are accordingly continuing to feature the new makes in their advertising. Great numbers of these machines are being sold.

The talking machine business is in pleasing contrast to the piano business. Pianos have not been selling strongly since several weeks before Christmas. But there has never been a let-up in the demand for the talking machines. And the demand for records is insatiable. Thousands of "Dardanellas" were bought as soon as they were placed on sale.

The Tri-State Victor Dealers' Association is going to have a meeting. It has been so long since the Association held a meeting that pessimistic persons were beginning to think that it would never meet again. But it is going to meet March 10 at the American Annex. There will be a dinner at which Harry A. Beach, manager of the traveling branch of the Victor Co., will speak. Members of the Association are indulging a hope that he will tell them that the supply of Victor machines and records is to be increased. New officers will be elected.

E. C. Rauth, manager of the Koerber-Brenner Music Co., Victor distributors for the St. Louis territory, says stock is coming through better, but the demand grows as fast as the supply and six months is about as near as the supply comes

to catching up with the now universal demand.

Mark Silverstone, president of the Silverstone Music Co., is completing the arrangements for the annual Edison dealers' conference, for the St. Louis zone, which will be held March 11 at the Hotel Statler. William Maxwell, vice-president of Thomas A. Edison, Inc., will make a special trip to St. Louis to speak. Other speakers will be J. W. Scott, Amberola supervisor, and J. W. Kuhn, disc supervisor. It is expected that there will be an attendance of about 200 dealers from Missouri, Southern Illinois, Arkansas and Tennessee. There will be a dinner and cabaret entertainment. The third floor of the Silverstone Music Co.'s store on Olive street is being redecorated.

Ciccolini of the Chicago Opera Co. sang all last week at the Orpheum in comparison with his own recreations on the New Edison. The newspaper critics did not dwell upon the tonest feature of his performance, but the Silverstone Music Co. and other dealers took advantage of the tenor's visit to do some liberal advertising. The management of the theatre says that 28,784 people attended the fourteen performances at which he appeared. The instrument used was the laboratory model, taken from regular stock. Dealers say that the sale of Ciccolini records was noticeably stimulated.

The Vitanola has taken rather a prominent place in the newspaper advertising of the latter part of the month. The advertising is general in character, sent out from the executive offices of the Vitanola Talking Machine Co., Chicago. The wholesale distributors in St. Louis are the Associated Furniture Manufacturers, the Rice-Stix Dry Goods Co. and the Witt Hardware Co. A list of nineteen retail dealers is given. The advertising features the "tone-filter."

A. E. Whitaker, who moved recently from the Holland Building to Rooms 317 to 323 in

the new Arcade Building, Eighth and Olive streets, has added talking machines to his piano stock. He handles the Brunswick, Lindell and Kimball.

Aeolian-Vocalions are coming in such numbers now that the wholesale Vocalion branch of the Aeolian Co. here has felt justified in speeding up materially. R. V. Johnson and B. S. Tucker, formerly of the Famous & Barr Co., and A. S. Engleman, formerly with the Brunswick-Balke-Collender Co., have been added to the sales force. They are working out of town, opening new accounts. In the past month they have opened up twenty-five new accounts in parts of seven States. It has been some time since the department has been qualifying new accounts. W. H. Alfring, general manager of the Aeolian Co., was in St. Louis two or three days last week, accompanied by Mrs. Alfring. They were on their way to the Pacific Coast.

C. F. Lippman, manager of the Victrola department of the Field-Lippman Piano Co., has recovered from an attack of tonsillitis which confined him to his home for a week.

The Artophone Co., 1113 Olive street, will soon have to move. The Baldwin Piano Co., its next-door neighbor on the east, has leased the Artophone building and will spread over into it as soon as the Artophone Co. can find another place to go to. The latter does not have to move, however, until August, as its lease then expires. R. H. Cone, manager of the company, says options have been taken on two locations, both on Olive street. Both are still occupied, so it will probably be August before all the changes are effected. The Artophone Co. has had a rapid rise. It started in a small way two or three years ago. During the past holiday season it was one of the biggest advertisers. The mail order department has been especially developed. It was forced upon the company rather than planned. So many mail inquiries were evoked by the regular advertising that it was found necessary to have such a department. It is now in charge of J. Stub.

(Continued on page 130)

NOTE THE CONSTRUCTION!

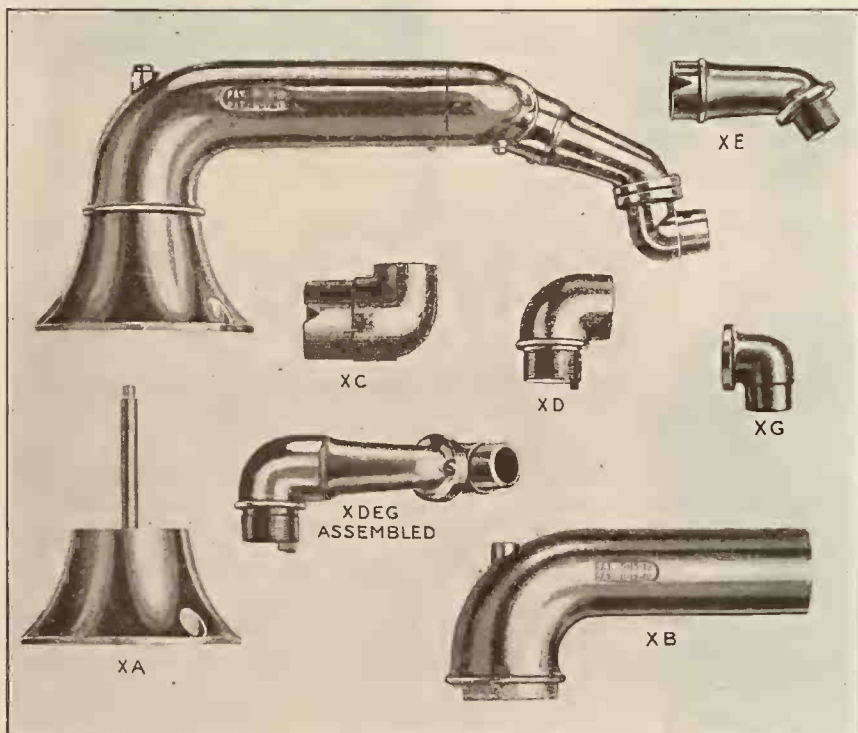

UNIVERSAL TONE ARM AND REPRODUCER

Do You Realize That One of the Most Important Items of Equipment on Any Phonograph Is the Sound Reproducing Mechanism?

The saving of a few cents on the first cost of this important item of equipment is very poor policy, especially for any firm desiring to build up a profitable and permanent phonograph business.

The EMPIRE TONE ARM AND SOUND BOX is more nearly PERFECT mechanically than any other. On performance it will reproduce all makes of disc records at their best and bring out all the beautiful overtones that are usually lost. On appearance it will appeal to your dealer customer and help him interest the best of trade.

Write for our prices and give us an outline of the quantities you will require

Address All Inquiries to Chicago Office
THE EMPIRE PHONO PARTS CO.
 Sales Office—429 S. Wabash Ave.—CHICAGO, ILL.
 Factory—1108 W. 9th St. — CLEVELAND, OHIO

Crystal Edge MICA Diaphragms

THE STANDARD OF QUALITY AND SERVICE

PHONOGRAPH APPLIANCE CO.

109-113 West Broadway, New York

BUSINESS ACTIVE IN ST. LOUIS

(Continued from page 129)

John McKenna, manager of the Columbia Graphophone Co.'s wholesale department, has returned from a week's stay at the Chicago offices. He says that the company is now able to fill 90 per cent of its orders and goods are coming through in fine shape. A conference of Columbia dealers is being planned, to be held the latter part of March at the Statler. Sales of Columbia records have been helped by the visits of Nora Bayes, Bert Williams and Van and Schenck. John Schnell and William Heim, auditors of the Columbia Co., were in St. Louis during the past week.

The Scruggs, Vandervoort & Barney talking machine department continues to derive advantage from the Victor concerts which are given in the new auditorium. For the new records at the first of the month Miss L. Merritt, manager of the department, was able to get three days of auditorium demonstrations. Her force of salespeople had all they could do selling the records demonstrated. Miss Merritt says the few Victors she gets are sold before they get on the floor. Brunswicks are coming through better. With the remodeling of the piano and talking machine departments, the latter has been allotted a third more floor space and eight additional demonstration rooms, making twenty-eight in all.

Manager J. F. Ditzell, of the Famous & Barr Co. music department, is getting ready to occupy the greatly increased space which is to be allotted to his department under a general re-adjustment in connection with the taking over of two additional floors of the Railway Exchange Building. Manager Ditzell is running another Cheney campaign. He has a large stock of the large Cheney's on hand and the advertising campaign is bringing a good number of sales.

Welch & Co., dealers in furniture, pianos and talking machines, occupying the former Wurlitzer building on Olive street, have been incorporated for \$50,000.

The Victrola department of the Scruggs, Vandervoort & Barney Dry Goods Co. has received a telegram of congratulation from H. A. Beach, manager of the traveling department of the Victor Talking Machine Co., extending cordial congratulations on the opening of the new Vandervoort auditorium.

H. Spencer Grover, formerly traveler for the Victor Co. in western Pennsylvania and Illinois, is now traveling for the Koerber-Brenner Music Co., Victor distributors in the St. Louis district.

B. H. Kirby, of Greensbury, Ind., has been appointed the representative in that town for the Pathé line of phonographs and records.

TELLS OF PROGRESS IN CHARLOTTE

CHARLOTTE, N. C., March 3.—The Banner Furniture Co., Pathé dealer, reports that record sales have greatly increased. This progressive concern has built up a large business in this city in Pathé machines and records. It reports that the Pathé advertising in the Saturday Evening Post has undoubtedly contributed to the remarkable increase attained and believes firmly in the power of advertising.

A. J. Cooke of the Stranburg Music House of Bradford, Pa., has returned from a six-weeks' vacation in Florida and has again taken up his duties in that city.

Natural Voice Phonograph Co.

ONEIDA, N. Y.



Style 175



Style 125

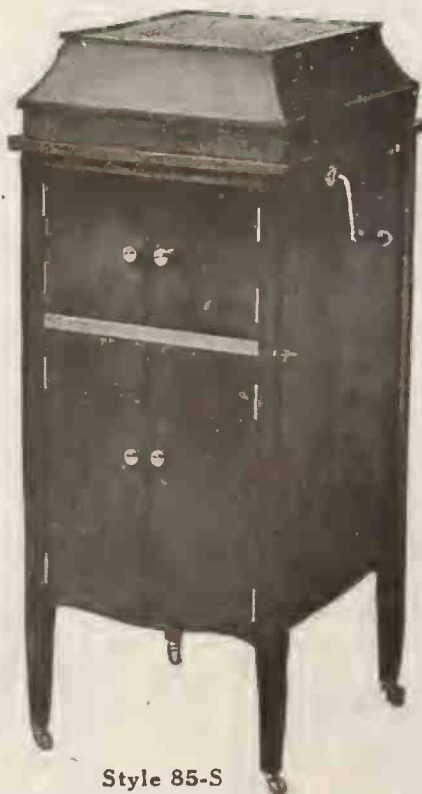

Style 85-S

Natural Voice is a splendid line of Talking Machines which will appeal instantly to your patrons. In fact, Natural Voice is as perfect as money can make it, and is worthy of its name and guarantee.

Natural Voice is the most remarkable musical instrument now before the public. For a full line of machines and price list, inquire

Natural Voice Phonograph Co.
ONEIDA, N. Y.

"Does It Play All Records?"

Certainly MAGNOLA does; and without any extra attachments, too. This is only one feature, albeit a most important one, in the thoroughly up-to-date equipment of the MARVELOUS MAGNOLA.

"MAGNOLA "Built by Tone Specialists"



Watching the Music Come Out

May we send you our handsome illustrated catalog chock full of information concerning the wonderful construction system of Magnola and the beauties of its musical results, its artistic appearance and its moderate price?

Send your name and let us tell you more!

MAGNOLA TALKING MACHINE COMPANY

OTTO SCHULZ, President

General Offices
711 MILWAUKEE AVENUE
CHICAGO

Southern Wholesale Branch
1530 CANDLER BLDG.
ATLANTA, GA.

Steinburn



Supreme Quality and a most successful policy of giving dealers exceptional advantages

Quality acknowledged, you must consider the *practical point of profit*.

This old-established organization extends unusual financial co-operation, giving exclusive dealers unique advantages of business growth.

The Steinburn range of designs, twelve popular models, meets every demand with lists lower than other high-grade lines. Retail \$60 to \$300, including upright, period, console and table models.

Our 5-year guarantee bond with each instrument reflects the Steinburn predominating character.

The Steinburn Agency is a Franchise of Great Value

Every dealer should have our catalog and terms. **WRITE US NOW.**
The agency may yet be available in your territory.

STEIN-BURN CORPORATION
Heyworth Building Madison and Wabash
CHICAGO

Eastern Distributors.
A. M. DRUCKMAN
140 West 23d Street
NEW YORK



THE MID-WEST

WESTERN DIVISION OF THE WORLD, CHICAGO, MARCH 8, 1920.

THERE may have been those who have supposed that the great middle empire of the North American continent, that empire which the innocent Manhattanite calls "Western" and the indignant Coaster "Eastern," and which is neither and both, has a sense of retiring modesty which would prevent it from blowing its own trumpet. Candidly we do not think that any such person exists; but, if he does, the appearance of the present Mid-Western remarks are calculated, we hope and believe, to convert him.

A Voice
From the
Mid-Plain

For reasons best known to themselves, but not entirely unconnected with geography, the Fates have decided that the role of the Mid-West in matters musical shall be almost decisive. We out here believe, with some reason, that we are doing more in a musical way than all the rest of the country put together. And when it comes to the business end of the game we bow to none. Annoying as it may be to the effete, we of Chicago and environs have an abiding faith in the verbo-mechanical future of our parts. We are quite sure in fact that, from the point of view of the talking machine business, we are bound to wake up some day soon and find ourselves the real bosses of the industry. At any rate, it does no harm to any one else if we talk thus cockily; and, if it should later turn out that we are wholly mistaken, the laugh will be on us.

This may all sound serio-comic, but the readers of the Talking Machine World will not fail to notice that we are beginning here a real editorial page devoted to the needs of the Mid-West, intended, in a sense, to express the ideas and sound abroad the thought of the great middle empire, for the benefit of all concerned. The sheer expansion of the talking machine industry during the last two years has, in this territory, been so very great that such a course has become necessary. The Talking Machine World believes that it serves not unsuccessfully and not unworthily the great industry from which it takes its name. Its world-wide circulation, its great bulk, the authoritative tone of its news and editorial pages, and the volume and diversity of its advertising columns have combined to make it what may fairly be called an encyclopaedia of the industry; in fact, that unusual phenomenon, a monthly encyclopaedia. As such, and considering that a position like this carries responsibilities as well as privileges, it has for some months past been in the minds of the Western Division to erect within the paper a Forum of Mid-West Opinion, wherein the first-hand, immediate point of view of the men who make the industry in our section of the land may be plainly set forth. We have earned, we think out here, the right to our own Pylon of Publicity, as B. L. T. would say; and so here goes:

THERE is just one really large topic to-day in the true sense of that elastic term. Speaking relatively, there is just one overshadowing topic, and that is production. How to fill orders when production lags has been the standard puzzle in our circles for these many months. We have out here some of the best magicians in that sort of wonder-working, but so far none of them has been able to work a spell worth calling by that name. It simply cannot be done. Seriously, what was at first a sort of a joke, and for still longer an occasion for congratulation, is rapidly becoming something very like a tragedy. The causes for shortage in production are various enough and include the questions of labor, transportation and raw material supply. But, above all, they have their roots in the human question. It is labor that is at the root of the matter, and that means something more than at first appears. The trouble with labor has nothing to do with money or hours. It refers wholly and entirely to what may be called morale. The trouble is with the inclination to work, not with the ability or the opportunity. Let our business men get down to brass tacks and find out why there should be that disinclination to work. Then they will be doing something worthwhile. Otherwise they are simply wasting their time. We have

Wanted:
Puzzle
Solvers

our own answer, and that has something in it about social and industrial thinking which might astonish some of our ultra-conservative friends. But of that more anon, as the novelists say. For the moment it is enough to present the factors of the problem and let some one else do the brain-work of solving individual cases.

You might not know it, but we are a literary, a romantic and even a humorous trade. There is, therefore, nothing at all difficult in turning out as many quips, wheezes and japes from this editorial desk as one can ask for, with naught to guide the editorial mind save the snacks and flotsam of trade news and information of all sorts that drift in. Take the very first example that comes to mind. Give us a poser and see what we can make of it. Just to show what we can do at a moment's notice, suppose we undertake to dash off something brilliant about, well, about, say, Sam Schiff! No sooner said than done, *aussitôt dit, aussitôt fait*, as we say in la belle Patee! Sam Schiff, name in full Sam S. Schiff, S.S.S.! Not quite S.O.S., but something near enough. S.O.S. means "hurry up; someone has kicked over the apple cart." It also means Service of Supply. Now every Vitanola dealer knows that Sam's name ought to have been Sam O. Schiff, otherwise S.O.S., because he has been one great little responder to every call for help they have sent out, as well as a never-failing Service of Supply in the darkest days of under-production. But if that is too strained, remember that S.S.S. is a pretty good initial monicker, too. Vitanolists call the bearer of it "Double-S Schiff," which means Double Service. Service in the factory and then Service towards the selling. Long ago, in the primitive days, he set his standard in the factory; and from that standard he has never once receded. When he went to help his dealers put Vitanola on the map he went in the right way, too, and he has never come out the wrong way. If there is anything in the way of newspaper, billboard, mailing matter, or anything else of the sort which Vitanola dealers have not received, to their own great comfort and prosperity, it is because that thing has not been invented yet. Do the Vitanola folks like Sam? They do!

Visiting
Vitanola
Sam!

THE descendant of the ancient Kings of Eirann who so ably cares for the immediate interests of the Western Division's manufacturing friends (in a word, our own Monsieur Caré) came in a few days ago from a visit with Kendrick of Brunswick. One does not venture to inquire what deep mysteries were laid bare during the confab, but our portly friend brought back one souvenir anyway. Here it is: A. J. swears he has given us a fair and accurate typographically faithful copy of a letter he had the same day received. The writers have evidently heard of the new Brunswick records.

"We Take
Chances
With You!"

"February 15th, 1920.

"Dear Sir: I take chances to let you know that me and my friend are good singers. My friend is also a fine piano player. Our duets are fine would be sure to make hits with them. If you are looking for something good try to get us for your company. We both studied vocal and sing from notes, we can learn any song at all.

"Heres one good chance for it might be to late we never have taken stage. We want to get started somewhere. We would give ourselves to a phonograph company, classical or popular, Polish or English Is of no different to us we are in love with what we can and very proud of it. Our voices are good soprano. But my friend is fine in low parts of duets. You will be surprised to hear us. Answer to Miss Cecilie K——."

We have not the felicity of knowing the doubtless charming Miss Cecilie and her doubtless winsome friend. But we agree with her that she is taking chances, all right. We should opine that she is taking desperate chances. To be in love with what you can is indeed an admirable achievement and to be proud of it equally laudable. Nor are we inclined to doubt that the Brunswicks, one

POINT OF VIEW

and all, would be surprised to hear them. We only are concerned lest some of the same, Harry Bibb, for example, should never get over their surprise. Well, it is a sad world, brethren, and such experiences should give us pause and teach us to avoid the flowing bowl. . . . [or is it, rather, the fermenting raisin?]

ONE of the joys of being a jobber is to have nothing to job. Now it is of course plain that the less the jobber has to job, the bigger job he has; that is, of course, the bigger is the job the more one has the job of explaining to irate merchants that the last job of records you ordered has not come, and so you have no records to job. That is some job. Anyhow, everybody understands what we mean; but what we started out to say was that during the late holiday season some of our big local jobbers went through one of the toughest experiences this business has ever known. The shortage of records hit everybody, but among the worst off were the three big Victor houses, Lyon & Healy, Wurlitzer's and the Chicago Talking Machine Co. There were weeks at a stretch during which they simply had no records at all. How they managed to pacify their dealers, deponent knoweth not, and they won't tell. But the same dealers are with them stronger than ever to-day, so they must have worked a *coup d'état*. Lest we forget, the names of L. C. Wiswell, Dan Creed, Griffith P. Ellis and Max Schlossinger are herewith nominated for the Hall of Fame. They were the boys who ran the gauntlet in the strenuous days of last Yuletide. Here's to them!

"Jokes You Are Making It, Mawruss"

Magna est Veritas!

AMONG the wonders of the world which the talking machine industry so steadily continues to produce, observe, ladies and gentlemen, as we pass to the right, the benign features of our friend Silverman, M. B., himself, the one and only Silverman of the big Mandel organization. Our friend is known far and wide as the only stationary traveling salesman now in captivity. He is, in a word, the only traveling salesman in any business we know of who never travels. He never travels because he never has to. No, Eugenie, it is not because he has not the price. He does not have to. He can sit at a desk and send out nice little letters which get the business from all over the land. The fact is that M. B. has the trick, the magic trick, of telling the truth only. Some folks brazen out their ruptures of diplomatic relations with truth by the statement that "truth is stranger than fiction." To which the trite reply of course is: "So it evidently is . . . to you!" But that is not the Silverman way. Our friend has a simple story to tell, and he tells it in a simple way. He tells the truth and the business rolls in. Simple, is it not? But very, very effective. Bismarck once said in his old age that he attributed much of his diplomatic success to the fact that he had usually, when he wished to fool his opponents, announced exactly what he was actually intending to do. Nobody believed him and so he always had the advantage of surprise. Maybe a certain sales manager we know of studied the old master's secrets a bit himself and has been keen enough to apply them!

WELL, that is one way of making an editorial page for the Mid-Westerns. Here is another. Edward Lyman Bill, Inc., publish the weekly Music Trade Review, which has for forty years been the organ of the piano trade. In that paper, this same Western Division publishes a weekly editorial page under the title "Western Comment." It happened that some weeks ago one of our associate editors, visiting the President of the Steger & Sons Piano Mfg. Co., of Chicago, the great institution which makes the Steger line of pianos and the Steger talking machines, noticed a sign which has for a long time been hanging in the retail warerooms on Wabash avenue. That sign simply reads: "An expression of opinion by our salesmen concerning our competitors or their goods is positively forbidden." The idea struck our Western Commentator so forcibly

Two Boosts and a Moral

that he sat down and wrote a paragraph or two about it for his next week's "Comment." Whereupon our Steger friends took that expression of opinion, without telling us anything about it, fashioned it into an advertisement and published it in all the evening and Sunday papers of Chicago. Now the point of all this is that the very idea set forth in the original notice, and in the comment on it, is an idea which the talking machine retail trade very much needs to read, mark, learn, and inwardly digest. Therefore we reprint the body of the ad, without its border adornment, just as it appeared in the Chicago newspapers. It is to be hoped that it reflects a new spirit in our music trade affairs:

An expression of opinion by our salesmen concerning our competitors or their goods is positively forbidden.
STEGER & SONS
PIANO MFG. CO.

CURIOUS it is that no one has noticed it before, but the visitor who chances to glance around at the elevator in the retail offices of the Steger & Sons Piano Mfg. Co. in this burg of ours will, if he or she looks carefully enough, perceive a statement or legend which sets forth that salesmen employed by the company are strictly forbidden to use the names of competing goods for purpose of comparison. The little notice is not very conspicuous in looks, but it is very significant of the spirit which governs the industry these days. When the present Commentator came into the industry it was considered to be impossible to sell a piano at all save by telling lies about it and its competitors. In those days the public rather expected to be cheated and, not unnaturally, often realized its expectations. Where the purchase of a piece of goods rests on a name or on a reputation expressed in a name, the temptation to use the comparative method of selling is almost overwhelming. If the salesman does not want to use it, the prospective purchaser is almost certain to introduce it. It is, therefore, really self-sacrificing to forbid this method and to insist that salesmen shall refuse to draw comparisons and shall even say that they are so forbidden. Yet, of course, no sounder policy could be devised. To insist that the talk be all about the goods which the prospective purchaser is considering at the moment is to imply that these goods are what the French call *hors concours*, beyond competition. The effect may be perhaps to astonish, and even to annoy occasionally; but the sort of person who would be annoyed at the assumption of this high attitude is not the sort of person wanted as a purchaser of pianos. The Stegers are right about this, exactly right. It is good to see this sort of sound affirmation in our merchandising methods. One is tempted to wonder when the entire trade will pursue the same course.—MUSIC TRADE REVIEW.

At this point, if we were real editors instead of just trade paper men, we should write a solemn paragraph about the business situation. We should, in the language of the solemn ones, "analyze business conditions." We wish we could do it. But we simply cannot. We don't know enough. All we do know is that the talking machine trade is founded on one of the deepest of human needs; that so long as that trade sticks to fair practices and gives good values it will merit and enjoy prosperity. What will happen if the profiteering gang does not mend its ways is another matter. What will happen if our politicians continue to exhibit their present driveling imbecilities is something else again; is, in the words of the immortal Abe Potash, "a dawg of another color, Mawruss." Apart from this, one can see only clear skies. May they long continue in their present relatively cloudless state so far as this industry of ours is concerned.

The Analyst of Biz!

Our Desire Is to Be of Service

JUST a serious word at the close. It is our desire to do for the Western and Middle States trade some real service. If we can in any way interpret their thought and give expression to their opinions, that will be what we want to do. If we can make known the personalities of the men who are doing things, and present them served up with a dash of humor, so much the better. If we can lightly skim over the surface of the news and give a reader here and there something to chuckle over, we shall be content. But, principally, we want to serve, and how far we succeed our readers will have to discover for themselves, as succeeding months go by—we hope it will be in full measure.

*Here's another
Dollar Making
idea for Dealers!*

The Silent Salesman

Every dealer has records in stock that he would like to move. Place a dozen or more of the numbers on a table or rack in the front of your store, where customers can look them over and select one or more to be played.

A slow moving record may have more music value than those records around which popular demand is centered. Remember, that the Victor Company passed on the desirability of the record before it was pressed for sale.

So give your customers a chance to sell records to themselves.

This plan is not experimental. Stores that have tried it, report good results.



NEW YORK TALKING MACHINE COMPANY
119 West 40th Street, New York City
CHICAGO TALKING MACHINE COMPANY
12 North Michigan Avenue, Chicago

From our **CHICAGO** HEADQUARTERS
 REPUBLIC BLDG., 209 SOUTH STATE ST TELEPHONE WABASH 5774

EDWARD VAN HARLINGEN

WILLIAM BRAID WHITE

EUGENE F. CAREY

ARTHUR E. NEALY

A. SNYDER

CHICAGO, ILL., March 8.—The wholesale trade during the past month has gone on at a very satisfactory rate. There has been no curtailment in production. On the contrary, there have been appreciable gains and it begins to look as though a few more months would see the output equaling the demand. For this time of year there has been an unusually large number of dealers calling upon the local trade. Undoubtedly much of this has been due to the trade conventions in New York and to the National Music Show, which attracted many talking machine merchants to the East who stopped off in Chicago en route. Another reason has probably been that retailers have had much difficulty in securing merchandise and so have desired to see what they could do by direct personal contact with their manufacturing headquarters.

The material and labor situations remain practically the same as they were a month ago. Panels are still very scarce and hard to get, and this fact seems to furnish the greatest drawback to a large production. Phonograph hardware is in a more plentiful supply than at any time in the past. Manufacturers are not having as much trouble securing motors and tone arms as they did a couple of months ago. Probably this is due to the increased production of motors and tone arms in the Middle West, which thing the trade has been led to expect by recent announcements of expansion by concerns manufacturing these essentials.

Regarding the retail business, there have been some curtailments in advertising of talking machines proper, but records seem to have been given more publicity than ever during the past thirty days. There has been some slight falling off in the demand for talking machines; but there has been no falling off in the sales. This of course is easily explained by the fact that the demand has constantly been in excess of the supply, and sales have corresponded to the number of machines available. Although records seem to have been advertised very strongly, it is undoubtedly true that there has not been enough of these to supply the demand; that is, in so far as the best sellers are concerned. A canvass of retail music establishments in Chicago's Loop brings out the fact that player rolls and talking machine records have both

been in very great demand for this time of the year. Right here let us pause to remark that when talking machine records are enjoying such excellent demand the manufacturer of instruments need have no fear of a big drop in demand, for record sales are always a sure harbinger of prosperity or depression in the sale of talking machines proper. The retailer has plenty of cause to rejoice. Of course he has plenty of cause to rejoice anyway nowadays, but, basing our belief on present indications, there is assured prosperity ahead of us for at least a year to come.

It is our sincere belief that talking machines and talking machine music are increasing in popularity in this city to a greater degree than most of us appreciate. There is a better understanding of the infinite possibilities contained in this instrument, both as regards music and along educational lines. Much of this is probably due to advertising, particularly co-operative advertising. A recent good example of co-operative advertising by G. Schirmer, New York music publishers, is that of advertising placed in Chicago newspapers featuring the hit "Patches." At the top of the ad in the most prominent position appeared the words, "Ask Your Talking Machine Man, Ask Your Player Roll Man," thus bringing before the retailer directly the suggestion of a purchase. We might say that such copy as this is co-operative in more than one way. The man or woman reading it cannot "ask his talking machine man" if he hasn't got a talking machine to play the record on. The moral is: Get one.

There has been a noticeable increase in the sale of accessories in the Loop during the month. This probably comes as a result of the inability of retailers to get a sufficiency of other goods. Finding, in so many places, that they cannot supply the wants of their customers in records they are taking the opportunity of suggesting the idea of a purchase of the many little conveniences which are accessory to the talking machine. Window displays of automatic stops, repeating devices, record albums and so forth have appeared profusely on Wabash avenue.

300,000 Visitors

About July 5 Chicago talking machine men may wonder at the great numbers of dealers who will probably be calling upon them. Start-

ing on this date the Elks will hold their convention in this city. 300,000 strong they will invade Chicago, swamping the Loop and outlying hostelrys and probably being housed even in such places as armories. There will undoubtedly be great numbers of phonograph merchants in the 300,000, but even if there were not a single one, the fact that 300,000 prosperous business men are coming to Chicago will mean much to the phonograph industry along with others. Plans are being made for tours throughout the factory districts of Chicago, and it is very probable that these will extend to certain talking machine concerns. \$50,000 will be spent in decorating the Loop streets. There will be a night parade in which floats from forty-eight States will participate. To give an idea of the immensity of this proposition the city of Detroit alone is spending \$15,000 on its float. It is estimated by statistical experts that the 300,000 people will spend over \$35,000,000 while in Chicago. Can it be doubted that phonograph men will get their share of this?

On July 5 Chicago will take on the appearance of Mardi Gras, second only to the famous festivities of New Orleans. It is expected that the city will request all offices to close on the 5th of July, which is the opening date, and that the entire city will appear in the downtown section dressed up in gala array, making a holiday in honor of the Elks. The music trade of Chicago will be asked to contribute its share of the amount to be raised to cover entertainment expenses.

Okeh Window Service

The Western office of the Okeh Record Co. of late has been receiving numerous requests from Okeh dealers in this territory for the Okeh window trimming service, supplied by the General Phonograph Corporation. The service seems to have aroused considerable favorable comment on the part of dealers and is in great demand. There are issued each month from six to ten pieces for use in window display, including show cards, cardboard cut-outs, colored illustrations and so forth. These are supplied to Okeh dealers at cost. "The live music merchant is distinguished by his show window," says H. L. Coombs, director of Okeh

(Continued on page 137)

Use Your Own Judgment!

Here is a fact:—

The Wade Fibre Needle Cutter was on the market long before any other Cutter was ever advertised. Almost everybody knows that *The Wade Fibre Needle Cutter* is not alone the ORIGINAL, but after all the most dependable Cutter on the market.

Obviously, "The Wade" gives better and longer service, as we use only the very best of materials and workmanship that money can procure.

When you buy *Fibre Needle Cutters*—just use your own unbiased judgment, buy the original and the best—and you will have no occasion to be sorry about it in the long run.

"THE WADE"—A CUTTER WITHOUT A RIVAL IN APPEARANCE AND CONSTRUCTION, TRIED, TESTED AND PROVEN TO BE THE ORIGINAL AND THE BEST.

OUR MOTTO:

"Not how Cheap but how Good"

WADE & WADE, 3807 Lake Park Ave., Chicago, Ill.



The New Lyon & Healy Wholesale Warehouse

717-725 South Desplaines Street
CHICAGO

Our enlarged facilities enable us to carry, at all times, an extensive stock of Victrolas, Victrola Records, Fibre Needles, Fibre Needle Cutters, and Victrola Supplies of all kinds. Prompt shipments are assured.

*Only ten minutes from
freight terminals*



Victrola Distributors
CHICAGO

FROM OUR CHICAGO HEADQUARTERS—(Continued from page 135)

sales in the West, "and the cut-outs supplied by us should be made the most of by every retail merchant."

1,000 Hear Cheney Phonograph

On Washington's birthday the doors of Marshall Field & Co.'s retail store were thrown open to school children of Chicago for a program in honor of the country's first President. There was a musical program in which the Cheney talking machine played a prominent part, over one thousand visitors hearing the instrument.

Mrs. Anne Oberndorfer gave a talk on "Music in the Time of George Washington," and there was distributed to each child a copy of the song, "Beneath the Weeping Willow Lane" by Frances Hopkinson.

World Phonograph Co.'s Annual Meeting

The annual stockholders' meeting of the World Phonograph Co. was held February 26, at which time a number of matters of considerable importance came up for discussion. Most important of all was the action taken by the stockholders in increasing the capital stock from \$100,000 to \$500,000. This increase was taken up entirely by the present stockholders and is in accord with the World Phonograph Co.'s policy of expansion.

The remarkable growth of this concern during the past two years, combined with the certainty of continuance of the present market conditions for some time to come, induced the stockholders to make this move.

Ernest C. Cook, general manager of the World Phonograph Co., states that as soon as possible they will move into their new factory on the South Side of the city, where they have secured over 150,000 square feet of floor space in a four-story building. "I see nothing ahead but a continuance of the present remarkable business for some time to come," said this gentleman. "During the past Fall the demand for talking machines increased to such an enormous extent that practically none of the manufacturers have

been able to keep up with it. This has been so with us. However, after a few more months this concern expects to be able to take care of all their dealers in excellent shape."

The stockholders of the World Phonograph Co. comprise the following names: Frank Baackes, vice-president and general manager of sales American Steel & Wire Co.; Paul Dillon, secretary Northwestern Barbed Wire Co.; A. J. Harris, president Janesville Barbed Wire Co.; J. P. Sherlock, president Illinois Nail Co.; James Brown, president Brown Wire Fence Co.; A. H. Lance, treasurer Simmons Bed Co.; Z. G. Simmons, president Simmons Bed Co.; W. W. Cooke, president Adrian Wire Fence Co.; P. L. Carter, president Jackson Fence Co.; W. P. Heron, treasurer Crawfordsville Wire & Nail Co.; Frank E. Morton, manager acoustic department American Steel & Wire Co.; Ernest C. Cook, secretary and general manager World Phonograph Co.; Karl Baackes, treasurer World Phonograph Co.

New Wade & Wade Distributors

Wade & Wade, manufacturers of the Wade fibre needle cutter, announce the following new jobbers: Kraft, Bates & Spencer, Boston, Mass.; Hoeffler Mfg. Co., Milwaukee, Wis.; E. R. Godfrey & Sons, Milwaukee, Wis.; Michigan Phonograph Co., Grand Rapids, Mich., and Cole & Dunas Music Co., Chicago, Ill. The business of this concern has been increasing right along the past few months and the Wade & Wade cutter is now more in demand than ever before.

Buying a Phonograph

The little booklet published by the Brunswick-Balke-Collender Co., entitled "What to Look for When Buying a Phonograph," written by Henry Purmort Eames, the famous concert pianist, lecturer and director of the Cosmopolitan School of Music, has been attracting considerable attention in the trade as a guide for prospective purchasers of talking machines and contains some very helpful and pertinent information. Says Mr. Eames in the foreword: "Selecting the

proper phonograph is an easy matter for one who knows definitely what to look for when investigating the various makes. The following pages outline in brief the vital points to be taken into consideration in the purchase of such an instrument." The first of the "vital points" taken up by Mr. Eames is the matter of tone reproduction. He explains the functions of the record, the needle, the reproducer and the tone amplifier, and tells prospective customers what they should look for in each of these points. Following this comes the motor, cabinet work and finishes; then conveniences, such as the automatic stop, the automatically balanced top or lid, record filing systems and compartments for the accessories. The matter of up-to-date-ness is embraced at length, and, last and most important of all, the manufacturer's reliability and reputation is dealt with.

Inasmuch as the average talking machine purchaser knows almost nothing about these instruments it will readily be seen that there is a definite need for such a comprehensive little booklet, and the fact that a concern publishes such a booklet is an excellent sales argument and confidence-inspiring point in its favor. A pencil portrait of Mr. Eames at the piano closes the talk.

An Interesting Ad

A recent advertisement by Lyon & Healy in the Chicago newspapers, radically different from the conventional ads and of great constructive power, is headed "Here Is a Very Interesting Statement." It is an excerpt from an article which appeared in the Chicago Daily News and deserves consideration:

"I would not willingly give up my own talking machine, which came to me as a birthday present from my wife five years ago. Half an hour of listening to Homer, Caruso or Paderewski on the records rests me so thoroughly after a day's work that I am ready to set to work again—and often do. It matters not how tired I

(Continued on page 138)

Your Account With Us

Lateral
Cut

Okeh

Records

Lateral
Cut

Will Be an Insurance Policy Against

EMPTY RECORD SHELVES

LOSS OF CUSTOMERS

LOSS OF PROFITS

Record Dealers Reach the Acme of Wisdom

WHEN THEY STOCK UP WITH POPULAR HITS ON



OKEH RECORDS

No Waiting for Delayed Shipments When You Order From Us

MAGNOLA TALKING MACHINE COMPANY

711 Milwaukee Avenue

OTTO SCHULZ, President

CHICAGO, ILL.



NEWMAN BROS. PHONOGRAPHS

No. 2

Unusually pleasing in tonal qualities as well as in appearance.

Finish: Walnut, Mahogany, Oak Height: 50 inches.

Plays five 10-inch records. Noiseless in winding. Plays all records. Automatic stop.

Tone Modifier. Other special features we shall be pleased to point out.

You will be pleasantly satisfied with our line of phonographs.

For your convenience and because of increased business, we have opened an office and display rooms in the FINE ARTS BUILDING, CHICAGO.

Newman Bros. Co.

Makers of Newman Bros. Pianos, Players and Phonographs

ESTABLISHED 1871

OFFICES AND DISPLAY ROOMS: THE FINE ARTS BUILDING

410 SOUTH MICHIGAN BOULEVARD

CHICAGO

FROM OUR CHICAGO HEADQUARTERS—(Continued from page 137)

am, the elixir of music puts new life into me. My hearty wish is that everybody might similarly benefit from music, and everybody would if everybody but gave music a chance to exercise its magnetic influence. Music in the homes of all would mean a broader, happier life for all. Of that I am convinced. Signed H. Addington Bruce."

Following the above appeared the question in bold-faced type, "Is Your Home Supplied With Good Music?"

Another ad by Lyon & Healy occupying full pages in the Chicago daily newspapers has been productive of excellent results. It is entitled "The Uses of a Victrola," and it lists all of the possibilities of this instrument from dancing to the learning of wireless telegraphy. Line drawings illustrating some of the infinite possibilities of this twentieth century instrument appear around the borders of the page.

Victor Jobbers Coming

There will be a meeting of Victor jobbers in Chicago on March 22 at the Sherman House. The purpose of the gathering is for educational work and there will be discussion of various important matters now before Victor retailers. Another similar gathering will be held at the Knickerbocker Hotel in New York on March 25. Both of these meetings will be for jobbers only and it is expected that there will be a strong attendance at both.

F. W. Clement Visits New York

F. W. Clement, manager of the Chicago Emerson office, returned to this city last week after a ten days' visit to the Eastern headquarters of this concern. Mr. Clement was in New York in connection with the bringing out of the new Emerson talking machine. He was highly enthusiastic over the result of his observations and predicted immediate success for the line in the West. He expects to begin receiving shipments of the new Emerson talk-

ing machines in time for the Fall campaign.

A visitor to the Emerson office during the week was Peter G. Spitz, of the Carpenter Paper Co. of Omaha, Neb. This concern is jobber for Emerson records in the State of Nebraska. There has been great demand in this State for records during the past four months, according to Mr. Spitz, and from present indications it looks as though the demand would continue for a month or more at least.

New Vitrola Signs

The Vitrola Talking Machine Co. has prepared two very attractive electric signs for the use of Vitrola dealers. The sign features the name "Vitrola" prominently, as well as the Vitrola slogan, "Natural as Life." The sign in the daytime makes up an easily read attractive display and at night, when illuminated, flashes its message in brilliant lights, as though it were composed of numerous tiny bulbs. As a matter of fact only two 25-watt lamps are required to produce this effect, making the maintenance relatively insignificant.

In a notice sent out to dealers regarding it, the company says: "This sign is sold to dealers at the cost price of \$100, and it may be returned to us for refund any time within four months after receipt. Should you desire to avail yourself of this opportunity to secure such excellent advertising at so low a cost, the sign will be shipped to you from the factory at Springfield, Ohio."

Speaking of Difficulties

Regarding the difficulties of travel during the past Winter an excerpt from a letter of H. H. Michael, of the Chicago Talking Machine Co., to the Chicago office on January 28, 1920, contains an interesting story:

"I was just fourteen hours going from the Muskegon junction to Muskegon, Mich. About midway between Fruitport and Muskegon Heights our car, which was headed by a snow

plow, was unable to travel through a drift approximately five feet high. After waiting in the car for a little over five hours, without food, several others and myself attempted to walk to Muskegon Heights. Another gentleman and myself floundered around in cornfields and the woods for about three hours before we could get our bearings. In the meantime I lost my folio bag with samples; however, I was able to recover this the next day.

"This was the most unusual experience I have had for some time, and after losing one night's sleep, and having to work the entire next day, I turned in boots and saddles last night and slumbered for about twelve hours. You no doubt will be glad to know that I suffered no ill effects from being in the cold and wet all night. However, it cost me just six bucks to induce a farmer to get up in the middle of the night and haul me into the Occidental Hotel at Muskegon."

\$10,000 Shipment of Bamboo

The B & H Fibre Mfg. Co. have recently received a \$10,000 shipment of bamboo from the Orient, containing some of the finest wood for the manufacture of talking machine needles ever secured by this concern. During the war it was exceedingly difficult to get sufficient suitable bamboo as this was being utilized by the Allies for tent poles, etc. Now, however, even better material is being received than previous to 1914.

The visitor to the manufacturing plant of the B & H Fibre Mfg. Co. who happens to see the stockrooms in which this bamboo is stored is astonished at the number, length and diameter of the poles. All are from full-grown bamboo trees, the type so difficult to obtain and the kind which makes the hardest and best fibre needles. Only full-grown stalks can be used for this purpose, as it is age that hardens

(Continued on page 141)

TRANSFER NAME-PLATES

We make the Transfer Name-Plates and Trade-Marks for the largest talking machine manufacturers in this country and for dealers in every state.

YOUR NAME, Mr. Dealer, on every machine brings the owner back to you or records and his friends to you for a machine.

Samples, Suggestions and Sketches Furnished Free

THE MEYERCORD COMPANY, CHICAGO

Largest Manufacturers of

DECALCOMANIA

Transfer Name-Plates

One of the 250 Machines Turned Out DAILY by the
WORLD PHONOGRAPH CO.

Manufactured by this Company Under Exclusive Patents

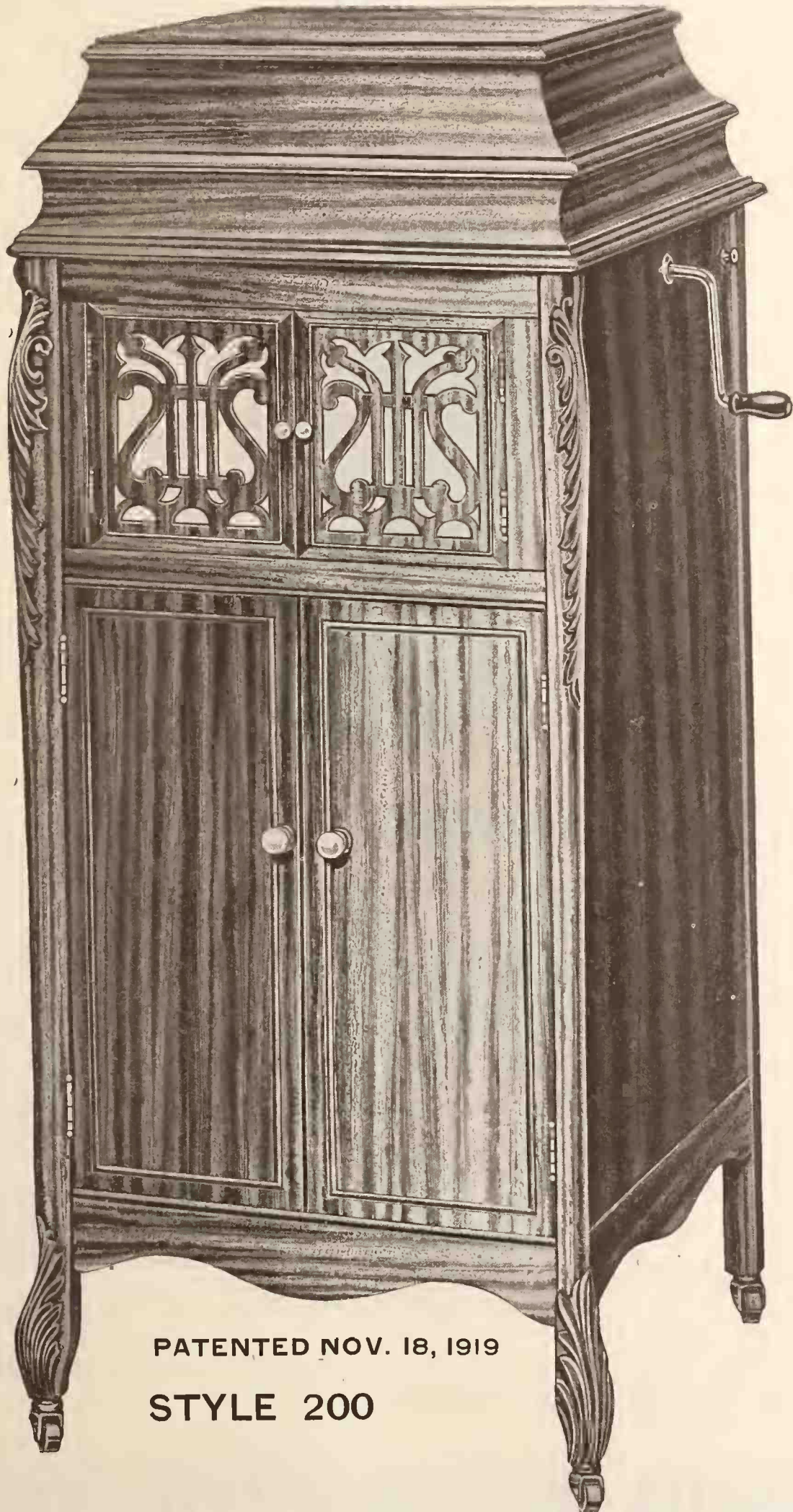

PATENTED NOV. 18, 1919

STYLE 200

“FROM THE LUMBER TO THE COMPLETE INSTRUMENT”

The World Phonograph Company is one of the few manufacturers making their own product in their own factories throughout, thus insuring to their dealers consistent high quality

WORLD PHONOGRAPH CO.

736 TILDEN ST., CHICAGO

HIAWATHA



HIAWATHA, STYLE AA

THE Models we shall put out during 1920 will in no essential differ from the very successful Hiawathas of 1919. The 1920 line comprises five models. They are built and sold on the one basis of Quality; the basis on which Hiawatha prestige and commercial success have been founded.

HIAWATHA PHONOGRAPH COMPANY

Offices 209 South State Street, CHICAGO

Blood

TONE ARM & REPRODUCER

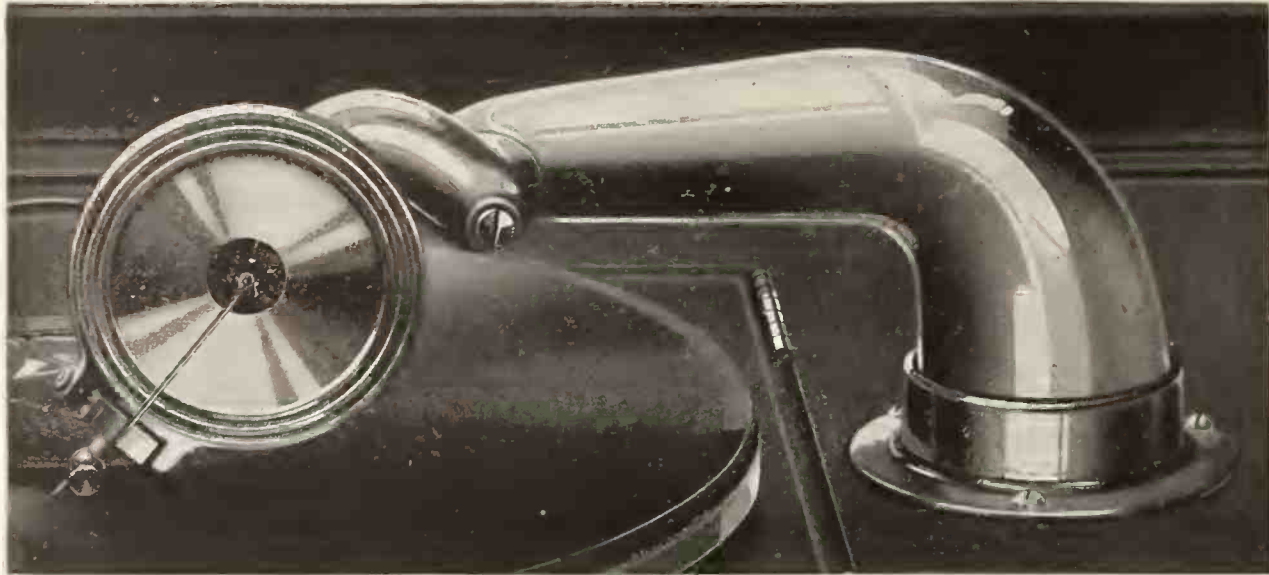

CRITICS SAY:

“Most important improvement in Phonographs during recent years”

PHONOGRAPH manufacturers have long realized the utter inadequacy and deficiency of the present so-called tone modifier, which merely muffles or chokes the sound at entrance to tone chamber. Tonal vibrations are retained within limits of arm, causing excessive vibrations, with their resultant distortion of sound waves, harsh and indistinct tones.

NOW THE BLOOD MUTE ELIMINATES all the objectionable features of the “choker” device, and makes possible perfect sound reproduction, which can be modified to a softness and clearness that are really remarkable. Retains high tonal quality of BLOOD reproducer.

HERE'S WHAT THE “BLOOD” ACCOMPLISHES:

Perfect regulation of volume while the record is being played, without in any way changing character of tone.

Enables you to build tone chamber flush with motor board and makes possible air-tight tone chamber construction.

Eliminates “choker” device and reduces manufacturing costs.

Gives you a phonograph of unexcelled tonal quality.

NO OTHER REPRODUCER HAS IT



SHOWING BLOOD MUTE

*Designed and patented by Burr Blood and used exclusively in the
BLOOD TONE ARM AND REPRODUCER*

JEWEL PHONOPARTS CO.

59 E. VAN BUREN STREET

CHICAGO, ILL.

WE WISH TO ANNOUNCE A COMPLETE LINE OF STRICTLY HIGH GRADE
UPRIGHT AND CONSOLE
TALKING MACHINES

WHICH ARE NOW AVAILABLE FOR

Immediate Delivery

The acquisition of increased manufacturing space permits us taking on additional representation in localities where dealers are not already handling our machines.

These instruments are built up to a standard designed to meet the keenest competition and to win the approval of the most discriminating customers. They are masterpieces of the cabinet-maker's art and in tonal qualities are second to none.

Write for Our Proposition

Federal Phonograph Co.

CHICAGO, ILL.

FACTORY ADDRESS

1458-1464 W. KINZIE ST.

Tel. Haymarket 168

OFFICE ADDRESS

8 S. DEARBORN ST.

Tel. Central 2025

FROM OUR CHICAGO HEADQUARTERS—(Continued from page 141)

"Patches" and "Swanee"; "Romance" and "Karavan"; "Where the Lanterns Glow" and "Lucille"; "You'll Be Sorry" and "Fluffy Ruffles."

Empire: "On the Trail to Santa Fe" and "Ting Ling Toy"; "Wait Till You Get Them Up in the Air, Boys" and "You Ain't Heard Nothin' Yet"; "In Your Arms" and "Dreamy Amazon Waltz"; "Nobody Knows and Nobody Seems to Care" and "My Baby's Arms"; "Dardanella" and "You'd Be Surprised"; "Pee Gee Blues" and "Sensation."

New Empire Model

The Empire Talking Machine Co. announces that its model XC, retailing at \$110, has been superseded by another model, retailing at the same price, but of a much more artistic and elaborate cabinet design. The XC is one of the most popular Empire models, selling second only to the model B. A sixteen-page folder has been prepared, listing all of the models, including the new XC type.

The trade will be interested to know that J. H. Stiff, Southern traveling representative, whose headquarters are at Atlanta, Ga., is again out visiting the Empire trade. Mr. Stiff was ill for a month and a half, confined to his home, but is now entirely recovered.

The Empire Talking Machine Co. announces a new Coast jobber. Louis Merke, prominent retailer of San Francisco, is the concern. Mr. Merke has been retailing for the Empire for quite some time and has built up an excellent business in San Francisco.

Tono-Graf Expands

The Tono-Graf Corp., following upon its attainment of increased production in its Rockford plants, has secured jobbers for Tono-Graf instruments in the Far West, Meyers & Swartz Co. being appointed to this position. They will handle the Tono-Graf in the States of California, Washington and Oregon. This concern is manufacturers' agent for a number of products on the Coast.

Side Lines for Dealers

The Cole & Dunas Music Co., of Chicago, is adding a line of ukuleles and Hawaiian guitars and other stringed instruments to its monthly bargain bulletin. "It is our belief," said Mr. Dunas, "that the majority of dealers are neglecting a wonderful opportunity for additional profits in side lines. The talking machine dealer can very appropriately handle small musical merchandise just as well as the

piano merchant proper. There is quite a demand for ukuleles and other small goods at the present time, and there is no reason at all why the talking machine man cannot supply this demand. Particularly is this true for the Spring. The Spring trade tends very much along these lines and right now there is a big opportunity for the sale of Spring instruments."

Recently changes were effected in the Cole
 (Continued on page 145)

Repair Parts

For All and Every Motor That Was Ever Manufactured

We can supply any part. The largest and most complete assortment of repair parts—in the United States—on hand, for old, obsolete and present-day motors. If your order cannot be filled from stock, we will make it up special.

Special prices on main springs, governor springs, micras, repair parts, motors, tone arms, steel needles, etc., in quantity lots.

Expert repairing on all makes of phonographs and motors.

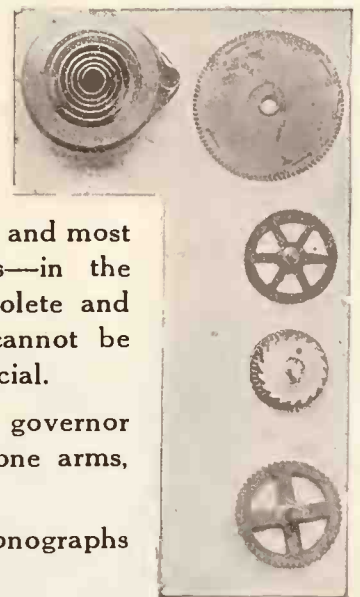

INCORPORATED UNDER THE LAWS OF ILLINOIS



SUCCESSORS TO
 Standard Talking Machine Co.
 United Talking Machine Co.
 Harmony Talking Machine Co.
 O'Neill-James Co.
 Arctine Co.

High Grade Talking Machines, Disc Records, Talking Machine Supplies, Etc.

227-229 W. Washington St., Chicago, Ill.



TRADE MARK
 "CONSOLA"

CABLE ADDRESS
 "CONSOLA"



WILSONIAN III



WILSONIAN IV



WILSONIAN V

WILSONIAN Phonographs

Jobbers! Read This

Announcement

The WILSONIAN PHONOGRAPH SALES CO., 501 Orear-Leslie Bldg., Kansas City, Mo., has been appointed Western Representative of the WILSONIAN for the states of Missouri, Kansas, Oklahoma, Iowa and Nebraska.

For the South, the sales of the WILSONIAN will be handled by the SOUTHERN TALKING MACHINE DISTRIBUTORS, Birmingham, Ala.

We have worked out a new sales plan under which WILSONIAN Jobbers will find themselves in a distinct class by themselves.

It has so many advantages that even the veteran jobber will read our offer with the smile that won't come off.

We know you, Mr. Jobber, and we'll prove it by telling you that there are THREE things which you must absolutely have before your business in phonographs can reach the point where you will be satisfied with progress. They are—

First: A phonograph of proved and admitted physical quality, tonal excellence, in short, one with the "class" people associate with machines which are old-timers in the market and which have been boosted into their present prominence by tremendous advertising campaigns costing millions of dollars.

Second: You must get *deliveries* to enable you to satisfy red-hot demand and make quick turnovers.

Third: You must get a range of profit which will make every sale count heavily in your favor—a really worth while profit.

It will take you one minute, actual time, to fill out the COUPON below. Mail it in to us at once for this new plan which we know will get to you because you won't be prepared for what we have to propose. Do it NOW.

We want to assure you, in all seriousness, that this is a rare opportunity which well merits your immediate follow-up for this special information it contains, *whether you accept the plan or not.* Fill out the COUPON and MAIL TO-DAY.



WILSONIAN VI



701-709 North Sangamon St., Chicago

COUPON

THOS. E. WILSON & CO., Chicago.

Gentlemen:—Please mail me at once your unique WILSONIAN plan for Jobbers referred to in the March issue of Talking Machine World.

Name

Address

.....

Immediate Deliveries of All Orders

YES, THIS IS

The Oro-Tone
QUALITY FIRST

THE PERFECT EDISON ATTACHMENT
WE CAN PROVE IT—IF YOU WILL SAY—
“Send sample on approval” or ask your jobber

Retail Price, Nickel Plated, \$8.50 Highest Grade Gold Plating \$12.50

The New ORO-TONE Safety Point Steel Needle Now Ready
Sample Thousand 60 Cents

Mfrs. of highest grade tone arms, reproducers, attachments for phonographs for playing all records. Diamond and jewel point needles, motors, supplies, etc.

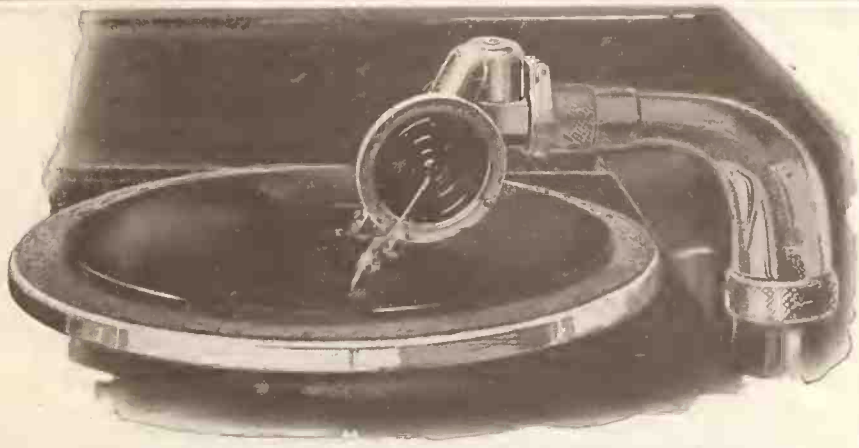

ILLUSTRATION SHOWS THE ORO-TONE ATTACHED

The Oro-Tone Co.
QUALITY FIRST

Successors to COMBINATION ATTACHMENT CO.

1808-10 IRVING PARK BOULEVARD, CHICAGO, ILL.

FROM OUR CHICAGO HEADQUARTERS—(Continued from page 143)

& Dunas offices whereby they have secured much-needed room for the clerical force. The latter has been increased slightly and it is the intention to render more immediate service to their many dealers. Cole & Dunas' most recent and conspicuous addition to their catalog has been a console phonograph of the Queen Anne type, which is described at length in the new bulletin which will be issued on the 15th.

A New Type of Instrument

An instrument designed to meet an entirely new trade demand is that recently placed on the market by the Vit Talking Machine Co. Feeling confident that in the past there has been definite need of a machine of the cabinet type, slightly smaller and less expensive than the conventional, yet more desirable than the table models, this concern has produced the "Vit," standing 32 inches high and equipped similarly to the regular cabinet talking ma-

chines. Although this instrument is sufficiently different from the usual types to be in the nature of an innovation, sales tests in retail establishments have already indicated that it is destined to no inconsiderable success. The machine has been placed on exhibition in a number of retail store windows and has been found to be quite an attraction if only by reason of its novelty. Buyers of two special kinds seem to make up the majority of its customers: those who cannot afford the more expensive types and a wealthier class who already own talking machines but want another instrument which can easily be moved about from one part of the house to another. Strangely enough, one of the first sales of this machine was to one of Chicago's wealthy residents on the Lake Shore drive, who desired it for just this purpose.

C. B. Emmert is president of the concern

and the other officers are: A. J. Carter, vice-president; W. I. Spitler, secretary. The "Vit" factory is located on the northwest side of the city, and production is already well under way. The company is also manufacturing a line of record filing cabinets for dealers, constructed sectionally to permit of additions from time to time.

Sales Increase 50 Per Cent

E. D. Sanford of the W. W. Kimball Co., Pathé dealers of this city, reports that record sales have increased fifty per cent. Mr. Sanford attributes this remarkable increase largely to the use of the special Pathé window displays each month. The Kimball Co. is a consistent weekly advertiser on the music pages of the Chicago dailies.

Nearly Million Dollar Trade in January

That the talking machine industry is taking
(Continued on page 147)

SEND US YOUR ORDERS

for the new lateral cut Okeh Records

Okeh
Records

feature the latest and best vocal and dance hits and they are a quality record in every way.

Write for Complete Catalog

New Releases Ready Now

Wade Talking Machine Co.
WHOLESALE DISTRIBUTORS.

12-20 NORTH MICHIGAN AVENUE, CHICAGO

Our Record Sales Plan

is designed to give you service and cooperation and *help you sell records*. This plan is unique with us and represents a sincere effort on our part not only to sell the dealer records, but to sell him the *best* records and also to help him turn them into profits.

OKeh Records

are of such a high quality that we feel justified in giving them this backing and we believe you will be justified in pushing the sales of this record because it will make money for you.

Complete Catalog Now Ready—New Releases

CONSOLIDATED TALKING MACHINE CO.

227-229 WEST WASHINGTON STREET, CHICAGO, ILL.

Manufacturers, Assemblers, Jobbers and Big Dealers, let me help you solve your problems of buying and selling phonographs. My selling cost is the lowest of any agency in America.

Cabinets only will be furnished to big users at a guaranteed saving of 10%.

Line No. One: A line of cabinets 48" high, ranging in price from \$25.00 to \$35.00.

Line No. Two: 50" cabinets in Golden Oak and Mahogany, ranging in price from \$35.00 to \$37.50.

Will furnish you Cabinets at the lowest cost of production and install your motors and tone arms for you at a very small cost; furnish you motors and tone arms at factory cost. Samples will be sent to well-rated jobbers and assemblers on request.

I have a selling plan which has been tried and is as nearly 100% as we can make it. My selling plan is furnished free to my clients.

A WORD TO MANUFACTURERS OF CABINETS: If you are now spending 10% to 25% on your sales, let me do it for you—and I will guarantee to sell your cabinets at 5%, or less. I will carry the accounts; finance the sales and can refer you to the leading bankers and manufacturers as to my financial standing and ability. Address

NAT KAWIN, The Phonograph Man
 316 South Wabash Avenue - Chicago, Ill.
 Director of Sales, Great Eastern M'frs' Co. and Associate Factories

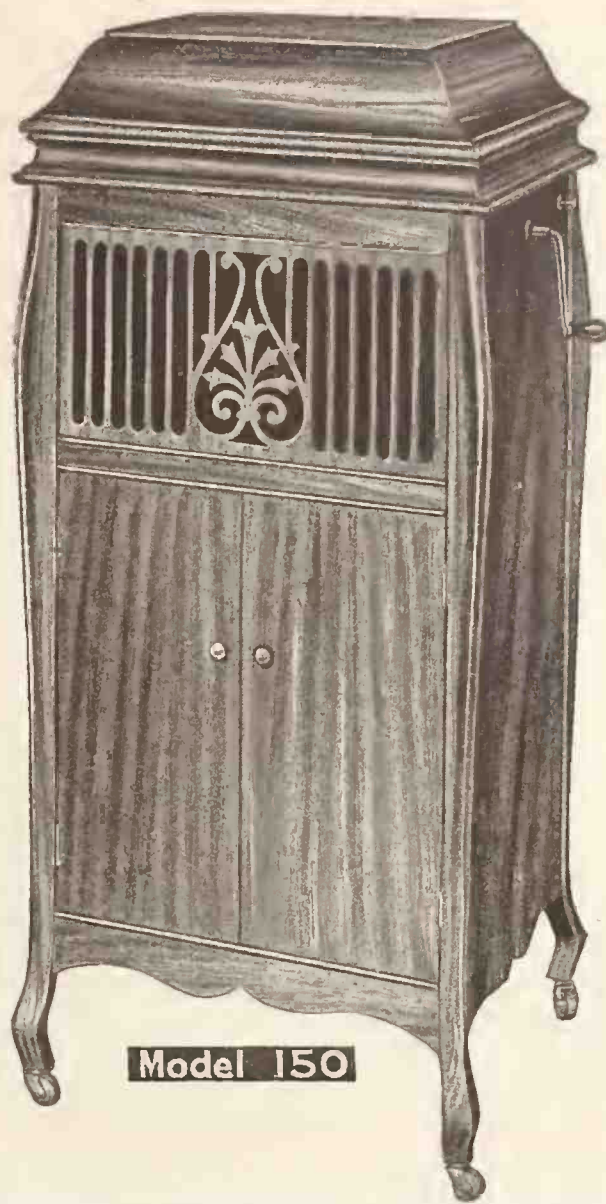

Model 150

FROM OUR CHICAGO HEADQUARTERS—(Continued from page 145)

a new stride is evidenced by the business that was booked in January by the Krasberg Engineering & Mfg. Corp., whose output consists of motors, tone arms and reproducers. W. Magill, sales manager, has good reason to be enthusiastic, for the January orders come close to a million dollars.

Mr. Magill attributes this remarkable showing to the greater stability in the talking machine industry and the realization on the part of manufacturers that motors and other phonograph equipment must be of the very highest quality in order to place their machines in the quality class. On the other hand the public is more discriminating and is beginning to inquire into the mechanism of talking machines. The heavy advertising carried on by the record manufacturers particularly is directing much attention to the phonograph and the public is buying as never before.

The new enclosed Krasco motor, which was the sensation of the New York show, and the Sterling reproducer and tone arm afford the opportunity to the manufacturer of a high-class machine to install mechanical equipment commensurate with the beautiful cabinets which are now being offered the buyer of talking machines.

Piano Club Dinner

The annual dinner of the Chicago Piano Club was held on the evening of March 3 at the Hotel Morrison in the Cameo Room. There was quite a strong representation of talking machine men present, in fact, more than in any year previous, a number of phonograph men having joined during the past twelve months. The Piano Club is more or less of a social organization where men interested in the music industries can get acquainted with each other. The annual dinner is the principal affair, but regular noonday luncheons are held in the Stratford Hotel during the week. Some very important business and excellent entertainment were on the program at the dinner. There were dancers and an Hawaiian troupe to amuse the diners, as well as a humorous sketch of a mock retail sale. This was staged by Eugene Whelan, retail manager of the Kimball Co., acting the part of salesman, and George M. Hall, a prominent booking agent, the customer. Madame Sturkow-Ryder took part as the artist demonstrator.

By far the most important feature of the evening was a talk by Frank E. Morton, of the American Steel & Wire Co., on plans of the
 (Continued on page 151)

"Guesswork Won't Do"

The ACME allows a test with the drag of the needle throughout the length of the record.

**A
C
M
E**

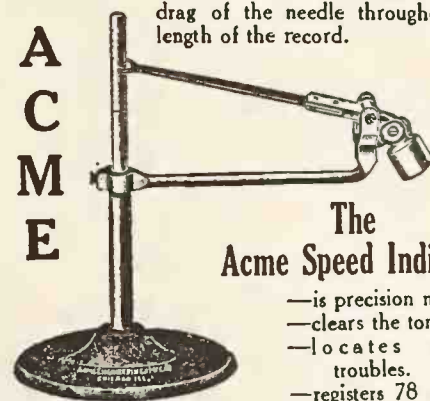

The Acme Speed Indicator

- is precision made.
- clears the tone arm.
- locates motor troubles.
- registers 78 and 80 revolutions.

"The repairman's stethoscope."

Made by

Acme Engineering & Mfg. Co.
 1622 Fulton Street CHICAGO

AMBEROLA SERVICE

As the Edison Cylinder products are not controlled by zone system, dealers anywhere can take advantage of **LYONS' SERVICE**, which is efficient, skilled, and up-to-date.

Contrary to the general impression, the cylinder line **IS NOT A THING OF THE PAST**. It is absolutely the best value offered the public today.



J. I. LYONS

17 W. Lake St.

Chicago

WE ILLUSTRATE THE

"Handy" Dome Clamp

Quick action for clamping domes and frames on Talking Machine Cabinets
 Write for Catalogue of clamping machines for Cases and for all purposes.

VENEER PRESSES AND CLAMPS

HANDY MFG. CO.

27 E. Madison St., Chicago, Ill.

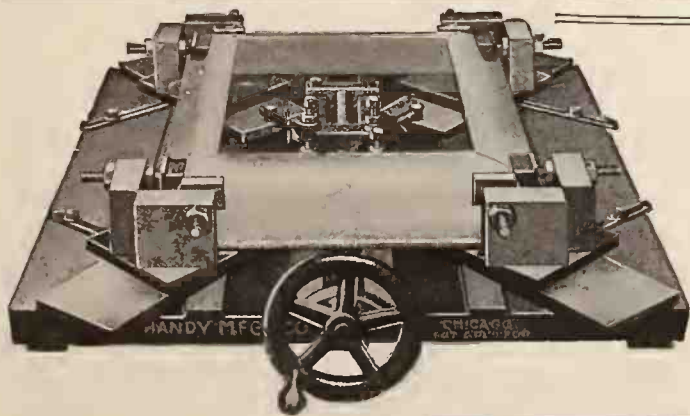

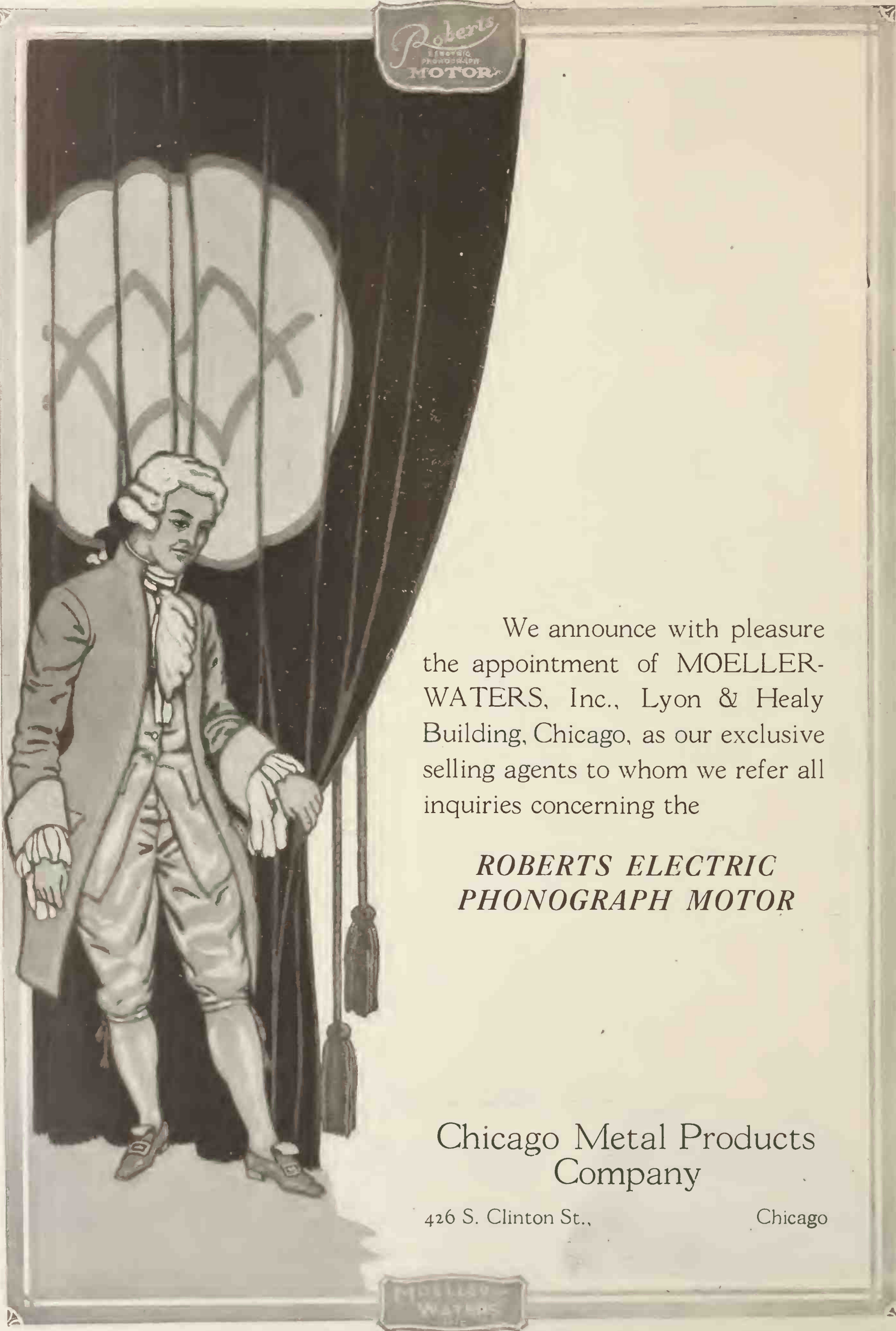

Roberts
ELECTRIC
PHONOGRAPH
MOTOR

We announce with pleasure the appointment of MOELLER-WATERS, Inc., Lyon & Healy Building, Chicago, as our exclusive selling agents to whom we refer all inquiries concerning the

**ROBERTS ELECTRIC
PHONOGRAPH MOTOR**

Chicago Metal Products
Company

426 S. Clinton St.,

Chicago

MOELLER
WATERS



The "PROVEN WORTH" of the
**ROBERTS ELECTRIC
 PHONOGRAPH MOTOR**

is clearly evidenced by its satisfactory performance in the higher grade phonographs during the past three and one-half years.

Because of increased production, it is now possible to offer to other manufacturers this highly efficient and dependable motor.

A request for a **ROBERTS ELECTRIC PHONOGRAPH MOTOR** to test in your own laboratories will meet with an immediate response.

"Beyond the experimental stage"

Moeller-Waters, Inc.
 (Sole Selling Agents)

Lyon & Healy Building,

Chicago, Illinois



THE ONLY COMPLETE LINE

Selling U. S. Music Rolls Through Talking Machine Jobbers and Dealers

Practical and Profitable Because—

1. Small Investment Required.
2. Established Market.
3. Large Volume of Business.
4. Small Variety Carried.
5. No Selling Expense.
6. Quick Turnover.



Music Rolls Become Staple.

Some conspicuous successes have been won in a short time, in the distribution of player piano rolls, by wholesalers of phonographs and supplies. Last week a new department of this character showed for its Eastern owner several hundred retail accounts exclusively granted to his line and he said he would be asleep if he did not push it over a thousand before the new year. A Middle Western supply house that employs a man to call upon many dealers in the rural district with records alone added music rolls to his stock in trade with a gain of over \$900 weekly to the business from that source, without a cent additional investment to get it. For some months a single brand of rolls has sold phenomenally in all the Eastern wholesale houses of a record line.

The jobber's margin in player rolls is very substantial, particularly in view of the fact that he is almost certain to be subjected to no missionary expense in the bargain. A definite consumer demand has been created both by the national sale of player pianos and the national advertising and the store-display services of the music roll houses. Player rolls are universal; any player piano plays all the parchment on the market.

The staple character that these influences have given to the music roll sells it by name on demand, without demonstration. This is the reason why talking machine dealers, who are daily getting farther and farther away from even unnecessary record demonstrations, buy and sell player piano music.

Reprint of editorial in Oct. 8th issue of the Phonograph and Talking Machine Weekly

Why It Will Pay Jobbers and Dealers To Sell U. S. Music Rolls

1. Intensively and Extensively Advertised.
2. Service—48 Hour Shipments of All Goods Ordered.
3. Intelligent Co-operation.
4. More Than 15 Years' Exclusive Player-Music Roll Manufacturing Experience.

Focus your sales efforts on a line that is 100% salable and 100% available.

U. S. MUSIC COMPANY
CHICAGO Manufacturers U. S. A.

DISTRIBUTED BY

G. SOMMERS & CO.
PARK SQUARE, ST. PAUL, MINN.

COLE & DUNAS MUSIC CO.
54 W. LAKE STREET, CHICAGO, ILL.

IRWIN PAPER COMPANY
MAINE AND THIRD STREETS, QUINCY, ILL.

WALTER S. GRAY CO.
942 MARKET STREET SAN FRANCISCO, CAL.



???

**WHY
Mr. Dealer**

Are Your Competitors Selling
So Many

Phono-Grands

???

Simply Because They
Know That



PHONO-GRAND

Fills a Long Felt Want

This little compact combination of a splendid Phonograph and an electrically controlled Reproducing Piano is just the thing for ice cream parlors, restaurants, cafes, etc. It fits in nicely and takes up no more room than an ordinary talking machine.

Want particulars? Write today

J. P. Seeburg Piano Co.
419 W. Erie St. Chicago, Ill.

FROM OUR CHICAGO HEADQUARTERS

(Continued from page 147)

club for salesmen's conferences. Retail phonograph and piano salesmen of Chicago are to have the opportunity of attending a series of educational meetings, which will be found of great value to all. To put the matter in the words of Mr. Morton, "Every retail salesman has a closing argument which he believes to be the crowning argument in making a sale. It will be found that all salesmen or at least most of them have a different viewpoint upon what constitutes their best closing argument. Now, when we get the salesmen together in a conference, and hear the different best arguments of each salesman, why, then, every salesman present is bound to benefit thereby." It will readily be seen that such a series of gatherings will be of intense interest to phonograph salesmen. Mr. Morton announced that it was not necessary that a salesman be a member of the Piano Club in order to attend the conferences, the first of which was held on Friday evening, March 12, in the Continental Bank Building.

To Be Married

A little romance all of its own has been developing over at the Talking Machine Shop, and now we hear that Frank Johnson, manager of the record department, is to be married to Helen Steging, cashier. Mr. Johnson started working with the Talking Machine Co. nine years ago and has been with this concern ever since with the exception of the period during the war, when he was in the army and overseas.

Wiswell at Atlantic City

L. C. Wiswell, manager of the talking machine department of Lyon & Healy, spent about ten days in the East during the early part of the month. While at Atlantic City he was so unfortunate as to contract a slight touch of influenza.

Mr. Wiswell, in addition to managing one of the biggest retail and wholesale Victor businesses in the country, has added to his many duties the general managership of the Lyon & Healy player roll department. He has begun by securing Kirby Tallmadge, the well-known composer and former manager of the player roll department of the Baldwin Piano Co., as retail manager of Lyon & Healy player roll department.

Dance by Wireless

A recent folder issued by the Brunswick-Balke-Collender Co. tells of dance music transmitted by wireless over a distance of 400 miles. A quotation was given from Chicago daily papers from which we excerpt as follows:

"Experiments now being conducted by Lieut. Elias, officer in charge of the navy wireless station in the Transportation Building, showed that phonograph music can be sent 400 miles without losing a perceptible amount of strength. The trials are conducted in conjunction with the Brunswick Phonograph Co., who are furnishing the records, and are said to be a success, the sounds being clearly heard at all the stations within a radius of several hundred miles of the city."

Returns from Florida

F. S. Spofford, Chicago retail representative of the Sonora phonograph, returned to Chicago early in March, after a five weeks' stay in Florida. Mr. Spofford has a Winter home at Sarasota, Fla., where he enjoys himself annually.

Make Only Phonographs

J. Addison Warren, Jr., of the Manophone Corp., Adrian, Mich., was in the city recently and reported that this concern had eliminated the manufacture of pianos entirely to give over all of their facilities to the making of talking machines. It is expected that an increased output of 50 to 100 per cent of these instruments will result.

New Smith & Barnes Manager

Fred Firestone, formerly manager of the city
(Continued on page 152)

Announcing the

New 1920

Playerphone

MANUFACTURED BY

PLAYERPHONE TALKING MACHINE CO.
D.W. MCKENZIE, CHICAGO, ILL. W.D. CALDWELL, TREASURER

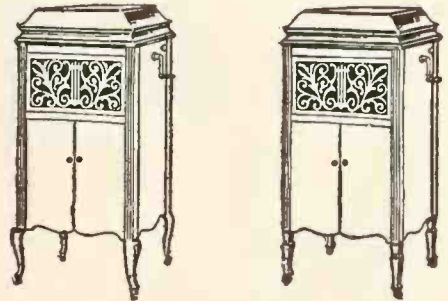
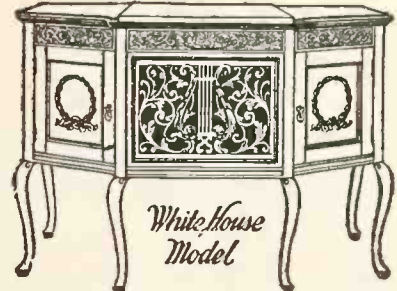
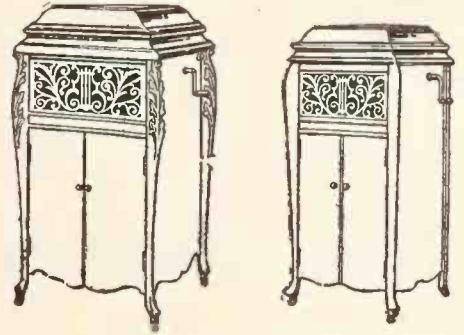

To
Playerphone's

Dealers and Friends!

Watch our big national advertising campaign beginning in the Literary Digest during April.

Other national magazines, to be announced later, will be included in our campaign for your benefit from May 1920 onwards.

For tone, quality and beauty, Playerphone stands in a class by itself. Eleven models of original and beautiful design. Plays all makes of records perfectly.

Merchants who are looking for a thoroughly high-grade phonograph with original and exclusive features at the right price will do well to communicate with us directly or with any of our jobbers.

SOME DESIRABLE JOBBING
TERRITORY STILL OPEN

Manufactured by
**PLAYERPHONE TALKING MACHINE
COMPANY**

338-352 N. Kedzie Ave.,
Chicago, Ill.



UNIVERSAL

The Motor You Will Eventually Adopt

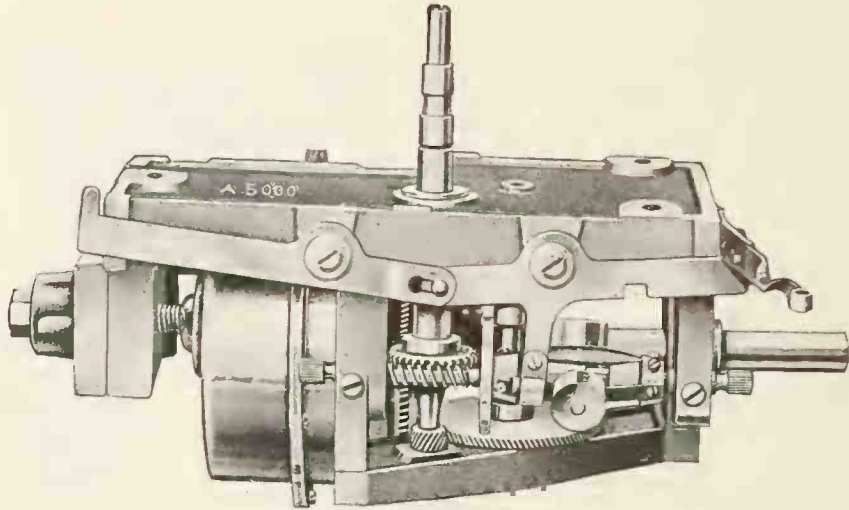

Universal Motor "A-5"

Investigate the Universal.
 See today's motor.
 Study its past history.
 Be guided by fundamental facts in
 your selection of a motor.
 Leave sentiment to other purposes.
 Let this be your attitude when you
 consider the Universal.

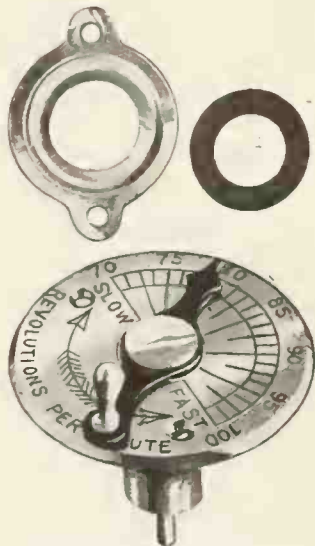

The Universal Speed Regulator

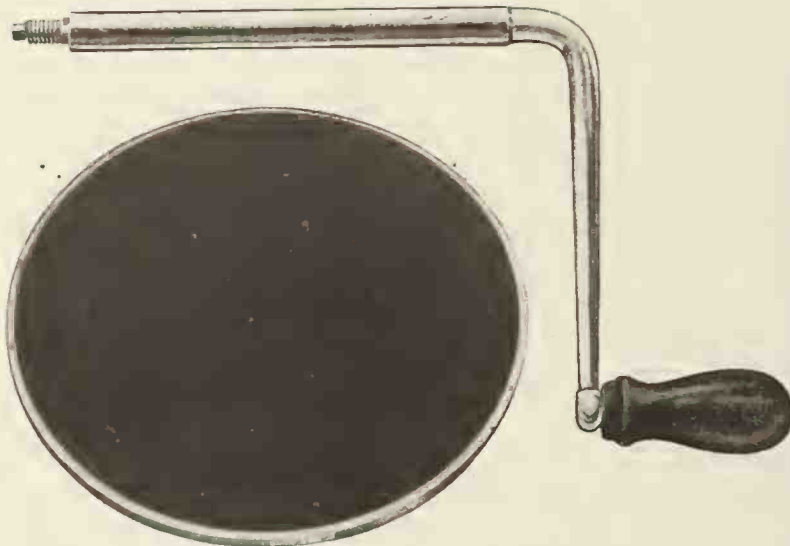

The Universal Turn Table

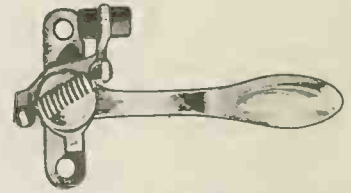

The Universal Stop

Manufacturers of
 MOTORS
 TONE ARMS
 AUTOMATIC STOPS
 NEEDLE CUPS
 NEEDLE CUP COVERS
 NEEDLE RESTS
Samples and Prices on Request

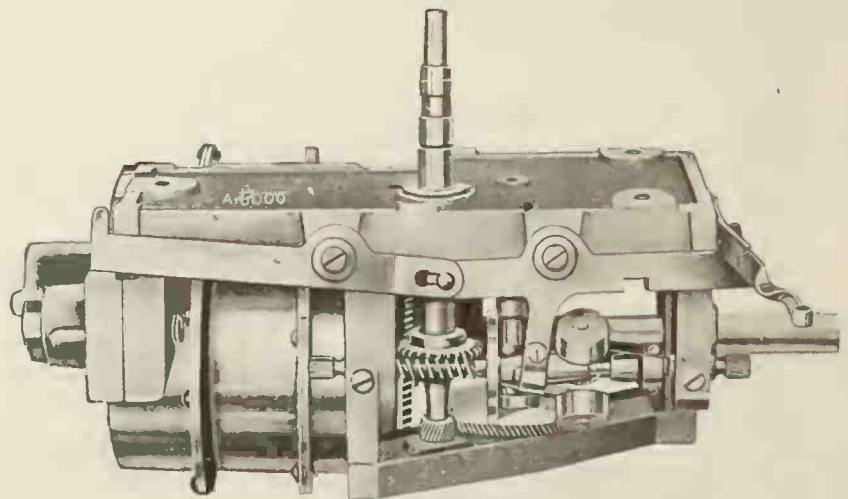

Universal Motor "A-6"

Universal Stamping and Manufacturing Co.

Main Offices and Factory

1917 to 1925 So. Western Avenue - Chicago, Ill.

NOTE: The Universal Stamping and Manufacturing Co. has established an
 EASTERN DIVISION AT WILLIAMSPORT, PA.



THE IRONCLAD ENCLOSED MOTOR



A large and favorably known phonograph manufacturer — one that has tried and used every known make of motors — has just completed a test of the IRONCLAD Enclosed Motor. His mechanical experts have pronounced it

- The quietest running motor—
- The motor without vibrations—
- The smoothest releasing of springs—eliminating all spring kick—
- The easiest taken apart and reassembled—
- The only motor which played its rated capacity.

They wanted the best

They have adopted the IRONCLAD

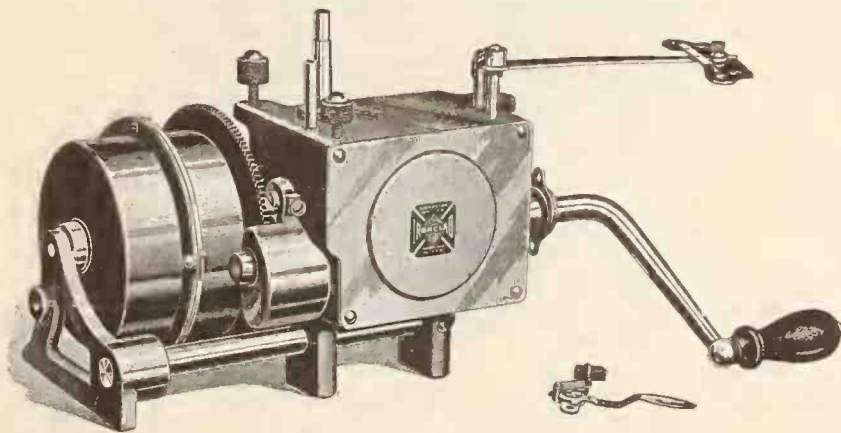

Similar tests will convince you

ESTABLISHED 1884

Cherington Mfg. Co.

Main Office and Factory

Waukegan - Illinois

NEW YORK OFFICE
51 EAST 42nd STREET
D. R. Doctorow

CANADA
ARTHUR K KEMPTON
MONTREAL

CHICAGO OFFICE
108 W. LAKE STREET

SAN FRANCISCO OFFICE
320 MARKET STREET
Arthur C. Ioas

FROM OUR CHICAGO HEADQUARTERS—(Continued from page 151)

sales department of Lyon & Healy, has resigned his position to accept the managership of the Smith Piano Co., retailers on Wabash avenue. This concern handles the Columbia talking machine and records, and has recently considerably extended this department.

Mr. Firestone has had extensive experience in the music business, starting as a piano salesman with the Cable Company, in whose employ he remained for a period of three years. He then made connections with the F. J. Smith Piano Co., where he remained for eleven years, after which he went to the Coast and joined the sales department of the Eilers Music Co. After this he was with Grinnell Bros., Detroit, and later, in 1915, he took charge of the city sales department of Lyon & Healy. Mr. Firestone's many friends wish him success in his new position.

Now Exclusive Victor Store
The piano stock of the Geo. P. Bent Co., consisting of uprights, players and grands of Bent make, together with some instruments of the J. & C. Fischer line, has been sold and Charles and Harry Bent have arranged to conduct an exclusive Victor retail store at the old stand. The new store will be known as the Music Shop.

Success With Record Albums
Probably many of the Western trade have met Miss B. Rogers, who is the traveling representative for the Boston Book Co., manufacturers of talking machine record albums. Miss Rogers bears the distinction of being one of the most capable sales persons in the record album line, she having closed five of the largest contracts with the five largest talking machine concerns.

Miss Rogers' sister, Mrs. Lily Gelbspan, is vice-president, secretary and treasurer of the



Miss B. Rogers

Boston Book Co. and one of the chief workers of this organization. The capacity of the two plants of the Boston Book Co. is soon to be ten thousand albums per day. Quite some record, n'est-ce pas? But this is not surprising in view of the merits of this product, which has won the favor of a host of talking machine dealers and talking machine record users throughout the United States.

Business in all lines of supplies for talking machines is very active in the Chicago territory, and the prospects are excellent.

The Superior Lid Support

A Spring Balance that Does Not Warp the Lid—
No Pull on the Lid when Down

A mere touch of the finger lifts or closes the lid,
which stops at any point desired

Sample—Nickel 75c—Gold \$1.00

Prepaid anywhere upon receipt of price. Submitted on approval, subject to return within a reasonable time, in which event the full price will be refunded

Quantity Prices Quoted on Application

Barnhart Brothers & Spindler

Monroe and Throop Streets, Chicago, Illinois



Patented
December 1919



Style 540



Period Style 1495



Style 620

Distribution and Service for the
NEW VOCALION RECORD

(Lateral cut for all Standard Machines)

and the

AEOLIAN-VOCALION

The Aeolian Company of Chicago
529 South Wabash Avenue

(wholesale only) is equipped to supply the trade with instruments and records and to furnish complete advertising and other branches of service

THE establishment in Chicago is a branch of The Aeolian Company in New York. Dealers will appreciate the advantage of direct contact with the manufacturers which this gives them.

The production of the new lateral-cut Vocalion Record is one of the most important events of recent years in the phonograph industry. This record may be

played on all standard phonographs and possesses the marked musical superiority that distinguished the original hill and dale Vocalion Record.

Aeolian Service is famous in the music trade. Coupled with the recognized supremacy of the Aeolian-Vocalion and Vocalion Record it makes representation of these goods the most valuable franchise in the phonograph industry.

Address all communications to

THE AEOLIAN COMPANY

529 South Wabash Avenue, Chicago, Ill.

FROM OUR CHICAGO HEADQUARTERS—(Continued from page 150)

PIONEER IN THE "TALKER" FIELD

The Achievements of L. P. Valiquet Constitute a Veritable History of the Industry—Now Associated With the Krasberg Engineering & Manufacturing Corp.—New Enclosed Motor

CHICAGO, ILL., March 4.—A birthday was celebrated by a pioneer in the talking machine industry early last month, to be exact, February 6. On that day L. P. Valiquet, consulting engineer and talking machine expert of the Krasberg Engineering & Manufacturing Corp., recorded his sixty-fourth anniversary and received the congratulations of his many friends.

Few men connected with the talking machine industry to-day have had such an extensive and varied acquaintance through so long a period of time as has Mr. Valiquet. He started his experiments as early as 1896 with a disc talking machine. Throughout twenty-five years of research and invention he has studied and improved the various appurtenances to a talking machine and as his latest achievement, being the result of two years' experimentation, he has produced the new Krasco enclosed motor. He looks upon this motor as the culminating product of his years of work and takes a pardonable pride in this latest of his accomplishments.

The history of L. P. Valiquet is one of intense interest to everyone connected with the talking machine industry, and particularly so to those who can trace back their knowledge of the trade ten or fifteen years. Previous to his work on the disc talking machine he carried on experiments with music boxes operated with slot devices, and is said to have made the first American music box.

A brief outline of Mr. Valiquet's experience follows: In 1886 he associated himself with the American Music Box Co., of Hoboken, N. J., the first concern to manufacture music boxes in America. In 1889 Mr. Valiquet visited Robert H. Ingersoll, which resulted in his designing and building the first five Ingersoll watches. In

1897 Mr. Ingersoll called Mr. Valiquet's attention to a small disc talking machine invented and manufactured by Emile Berliner (of telephone fame) and sold as a toy. Mr. Valiquet saw the immense possibilities of development in the line of disc talking machines, so started to experiment on these machines in an independent way.

In the Fall of 1898 he completed a disc talking machine and record that was practical and commercial and organized a company for the



L. P. Valiquet

manufacture of same known as the Universal Talking Machine Co., which manufactured the well-known Zon-O-Phone, the first talking machine having a worm screw governor.

In 1903, the Universal Talking Machine Co. was purchased by the Victor Talking Machine Co., and from that time on Mr. Valiquet was the consulting engineer for the Victor Co. until 1906. While in that capacity he designed and built several motors for the Victor people.

In 1906 he resigned and devoted his time to the design and construction of spring motors for automatically operating illustrated song and picture machines, also vending machines. In

1908, 1909 and 1910 penny parlors ceased to be a novelty, so Mr. Valiquet turned his attention to the design and construction of combination talking and moving picture machines. During the years 1911 and 1912, on account of ill health, Mr. Valiquet retired.

Following this retirement he connected himself with the Boston Talking Machine Co. as consulting engineer and designer and during this time designed the little Vanaphone made now by the Garford Co. During 1915, Mr. Valiquet was with the Aeolian Co. of New York and designed two very successful motors which they are making to-day. In 1916 he joined the Otto Heineman forces.

It was in 1919 that he associated himself with the Krasberg Engineering & Manufacturing Corp. as its consulting engineer and talking machine expert. Since joining this organization he has spent his time perfecting the various Krasberg motors and in developing the enclosed type. He commenced experiments on this motor as early as 1917 and completed it a number of months ago. Although it has been on the market for some time it was not until recently that quantity production was attained on the Krasco enclosed type motor.

L. P. Valiquet, when discussing this favorite subject of his—the enclosed motor—is as enthusiastic as a small boy with a new toy. He believes that the enclosed type is a distinct step forward in the industry, something radically different from anything produced before. He believes it to be a logical development, just as it has been the logical development in the automobile field with automobile motors. "The public demands the utmost in refinements of construction," he says. "Those who are able to supply these refinements are the ones favored. That a refinement, such as an enclosed motor, cannot be seen, matters nothing. It is there and can be pointed out by salesmen and later by the owner to his admiring friends. That it is a refinement is a guarantee that the entire

(Continued on page 157)

The April Bulletin from Phonograph Headquarters



OUR SET NO. 79C, CONTAINING 79 SALABLE ACCESSORY ITEMS LISTED IN OUR BARGAIN BULLETIN

48-Hour Delivery. We aim to ship all orders within 48 hours. Every item listed in our bulletin is carried in stock and ready for immediate delivery. To serve you is our endeavor, for "Service" is our Motto.

FREE

Write for the April issue now. It is bigger and better than ever. Filled with many items new to phonographdom, it fills a long-felt dealer need. It is bristling with right-up-to-the-minute sales ideas and sales plans for the phonograph dealer.

Our Line

- Albums
- Automatic Stops
- Bell-Hood Needles
- Brilliantone Needles
- Cabinet Hardware
- Demonstrating Booths
- Delivery Envelopes
- Efficiency Counters
- Fibre Needles
- Fibre Needle Cutters
- Gennett Records
- Genuine Diamond Points
- Main Springs
- Motors
- Moving Covers
- Mysto Needles
- Olympian Phonographs
- Okeh Records
- Record Lites
- String Instruments
- Record Racks
- Repeatographs
- Sapphire Needles
- Ten-M Needles
- Tone-Arms
- Tonofone Needles
- U. S. Player Rolls
- Universal Fixtures
- Violins and Bows
- Wall-Kane Needles

Write for Bulletin Today!

Take advantage of our help and co-operation. We are in a position to be of assistance to you. Send us your name, so that you may receive this bulletin regularly as it is issued.

Cole & Dunas Music Co., Inc., PHONOGRAPH HEADQUARTERS 56 W. Lake Street, Chicago

NEW PROFITABLE STURDY ARTISTIC LIGHT RIGHT

SOMETHING ABSOLUTELY NEW IN PHONOGRAPHS

- New Design
- New Finishes
- New Size
- New Construction
- New Price
- New Market
- New Profits



RETAIL PRICE

\$50

WHOLESALE PRICE

Satisfactory to
Retailers

The "VIT"

Motor, tone-arm and reproducer of standard make, fully guaranteed. Plays all records.

Finishes, Ivory Satin Enamel, panels decorated with colonial figures in dainty coloring.

French Blue Enamel, panels decorated with richly colored designs.

Oriental Black, panels decorated with Japanese designs in colors.

Mahogany Finish, without panel decorations.

Design, Sheraton Period, 32 inches high, 15 inches square. The ideal instrument for the greatest number of different uses, for sun porches, summer and winter cottages, small apartments, rooms, nursery. Easily carried from room to room, up and down stairs, and meets with many other purposes that other types do not.

Window Display, these four richly finished floor cabinet machines make such an attractive show that compels attention and sales to be had in no other manner.

Exclusive Sales Agency for live dealers. Quick deliveries. Be the first and only dealer in your town to offer the public something new.

Sectional Record Cabinets for stores. Capacity for over 200 10 and 12 inch records per section. Dimensions of cabinet 12 inch high, 36 inch long and 12 inch deep. Price per section, \$10.00

VIT TALKING MACHINE COMPANY

123 West Madison St., Suite 412

CHICAGO - - - - - ILL.

FROM OUR CHICAGO HEADQUARTERS—(Continued from page 155)

instrument is made and equipped throughout in the same way. It is very often such things as this decide the sale."

L. P. Valiquet, having spent twenty-five years in the talking machine business, naturally has a very extended acquaintance in the trade. At

the recent convention and music show which he attended in New York he found his time so occupied by the many old friends who had not seen him in years that he said "I had no opportunity to sell motors," to which he added: "But the other boys did that."

A UNIQUE MANDEL EXHIBIT AT THE FURNITURE MARKET

CHICAGO, ILL., March 5.—The Mandel exhibit at the furniture market has not only attracted

on one of the panels a perfectly balanced owl was plainly visible—one of those oddities in



Display of 1920 Models of Mandel Phonographs at Furniture Market

the attention of all visitors on account of the unique display, but a large volume of orders was booked. The display itself proved to be quite an attraction. Instead of demonstrating the machines in the regulation style booths, a miniature red brick house was built in the exhibition space. This house was divided into two sections, showing two separate miniature stores. The interior of each little store was appropriately decorated, with heavy plate glass windows adorning the front. Visitors and casual observers couldn't help being attracted by this unusual display and commented favorably on the details which were so carefully worked out by the Mandel Mfg. Co.

The brick cottage was used only for demonstrating the tone of the Mandel phonograph and was set back at the rear end of the exhibition space. In the fore part the 1920 line of Mandel phonographs were profusely displayed in all finishes. Two very unusual cabinets were shown, one, in walnut, being a real freak of nature, as

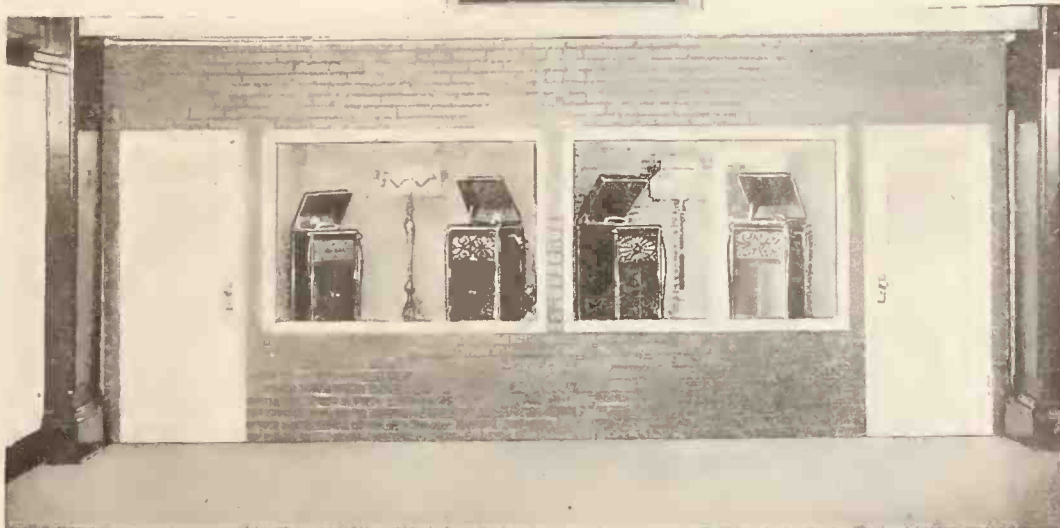

The Miniature Red Brick House in Which the Mandel Display Was Made wood that happen once in a generation. All made by the Mandel organization in turning out who examined it were amazed at the accuracy (Continued on page 159)

Equip Your Phonographs With Perfect Automatic Brakes

Samples \$1.00 Each Cash with order State make of tone arm used



Also made with long brake shoe for 1 inch offset

Patented Aug. 28, '17

Simple construction and easily attached. Made in four styles to fit any make of tone arm.

Write for attractive quantity price

PERFECT AUTOMATIC BRAKE CO. Room 400, 425 S. Wabash Ave., Chicago

of the likeness of the justly celebrated bird.

The other cabinet was referred to as the "Crazy Quilt," since it was made up of all the different woods and finishes—no two parts being alike, and yet the cabinet was an exact duplicate in size, shape and design of one of the Mandel models.

A large volume of business was booked from old and new dealers and jobbers of Mandel phonographs, who expressed themselves as being extremely pleased at the splendid strides

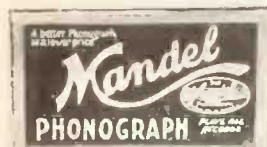

MELODIA Phonograph Company

400 N Sangamon St. Chicago Ill.

Now that the MELODIA has been properly introduced read other side for a few of its performances

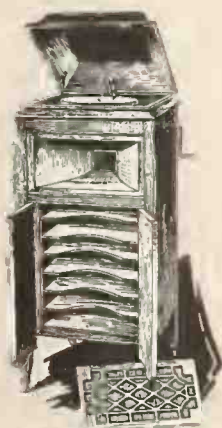

An instrument built of heavy five-ply material, given an exquisite finish into which are placed the best of motors, tone arms and reproducers. The specially designed tone chamber far surpasses the ordinary machine on the market. Indorsed by Marinuzzi, Musical Director of the Chicago Grand Opera Co. Live agents wanted. Send for Bulletin.

THE MELODIA PHONOGRAPH COMPANY 400 No. Sangamon St. Chicago, Ill. Phone, Haymarket 3833

“A Phonograph is no better than its Motor”

R O E M E R

RED
SEAL

M O T O R S

Worthy of any high-class Manufacturer's consideration is the
ROEMER RED SEAL MOTOR

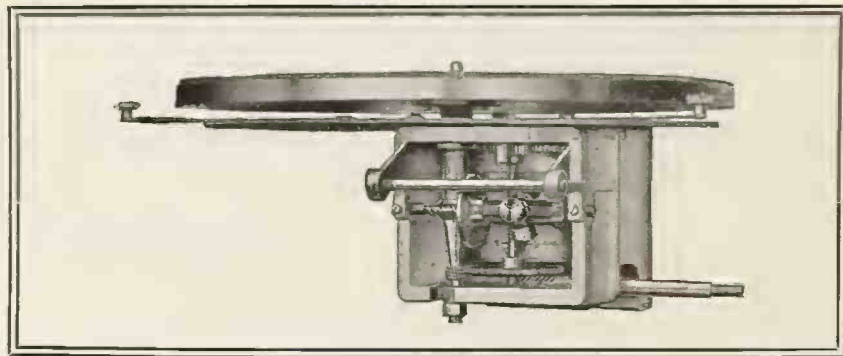

AN Exclusive Feature of the ROEMER RED SEAL MOTOR, assuring Strength and Durability, is the One-piece Die-cast Frame, the only one of its kind on the market today. This, together with its other Exclusive Features, such as the tapered Jeweler's Rod, Adjustable, Ball-bearing, Perfectly Rigid Turntable Shaft; Bindless Hollow Spindle, True-cut Die-cast Phosphor-bronze Intermediate Gear; Swedish Steel Springs; Steel Motor Plate; One-piece Cam-stop and Regulator; makes the ROEMER RED SEAL MOTORS, as we said before, worthy of any High-class Talking Machine Manufacturer's consideration. Will play 4 ten-inch Records on one winding—NOISELESSLY!!

Write Today for Further Information

ROEMER MANUFACTURING CO.

1916-1920 West Lake Street - - - Chicago, Illinois

FROM OUR CHICAGO HEADQUARTERS—(Continued from page 157)

so many new and beautiful machines to enhance its line.

Another feature of the Mandel exhibit was the new Mandel triple spring motor, which was suitably mounted on a high metal frame, and was run continuously, about eight hours a day, during the exhibit. Visitors were invited to give this motor a most rigid inspection and test. All who did so testified to its easy winding and quiet running qualities. Large orders were booked.

Those who listened to the tone demonstrations of the new Mandel sound box, which was patented as recently as November 25, 1919, were unanimous in their praise. This is of the convertible type, playing all makes of disc records, and the reproductions of both instrumental and vocal music were true to life.

It is worthy of note that the tendency on the part of dealers was to buy the higher priced instruments, which leads to the belief that dealers have been successful in creating a demand for the better products. Sales Manager M. B. Silverman and a large corps of his salesmen were in charge of the exhibit. When interviewed concerning the success of the exhibit, Mr. Silverman said:

"Results speak for themselves. Dealers and jobbers have come, have seen, have heard, and are satisfied. In my opinion, the Mandel line answers every requirement in talking machines. It is complete in embodying a full line of what we consider to be among the most popular-priced machines, quality considered, on the market to-day. We have gone through all of the experimental stages, and in this, our fifth year of phonograph manufacturing, we are producing a line of instruments that marks an epoch in our career. We have increased our production by adding a new cabinet plant to our present factories. Our instruments are in great demand, and we are preparing for a record-breaking year."

STARTED AD CAMPAIGN IN ST. LOUIS

St. Louis, Mo., March 8.—The campaign of the Emerson Phonograph Co. on records by Eddie Cantor started in St. Louis yesterday, March 7. Numerous prominent newspaper advertisements are featuring the records sung by the star of the "Follies" all during the week that the show is in progress.

BIG BROOKS SHIPMENT TO SIMON

One Shipment Totaled 177 Machines—Business Active—New Catalog Issued

SAGINAW, MICH., March 5.—In a recent chat with The World, A. W. Norris, vice-president and general manager of the Brooks Mfg. Co., manufacturers of the Brooks Automatic repeating phonograph, stated that the company had



Brooks' Shipment to Simon Piano Co.

closed a very successful year in its talking machine production and sales. In fact, 1919 business quadrupled 1918, and the present scale of manufacture so far this year indicates that the company will double 1919 production. Plans are under way for new building extensions, including a building 60x250 feet and additions to the power plant.

The company recently shipped a carload of Brooks automatic repeating phonographs to the Simon Piano Co., Spokane, Wash., distributor of the Brooks talking machine. This shipment, which totaled 177 machines, is partially illustrated in the accompanying photograph. Mr. Norris states that quite a number of Brooks distributors are getting their shipments in carload lots in order to afford their dealers efficient service and co-operation.

The company recently issued a very attractive catalog showing illustrations of the popular models of the Brooks automatic repeating phonograph. This instrument is now manufactured in three models, all of which are fur-

nished with either spring motors or electric motor equipment. The automatic repeater, which is an exclusive Brooks feature, has attracted wide attention throughout the country and has won enthusiastic praise from the trade.

BUYS SITE IN WEST ALLIS, WIS.

The Dalin Jewelry Co., West Allis, Wis., which is now a leading Victor dealer in that territory, has purchased a business block at 6217 Greenfield avenue, which it will occupy after May 1, instead of erecting a new building of its own. The purchase will make it possible for Samuel Dalin, proprietor of the business, to carry out his plan of developing his Victor department into a real music house, carrying pianos and musical merchandise.

The Bangor Optical Co., Inc., Bangor, Me., has taken the exclusive agency for the Aeolian-Vocalion machines and records.

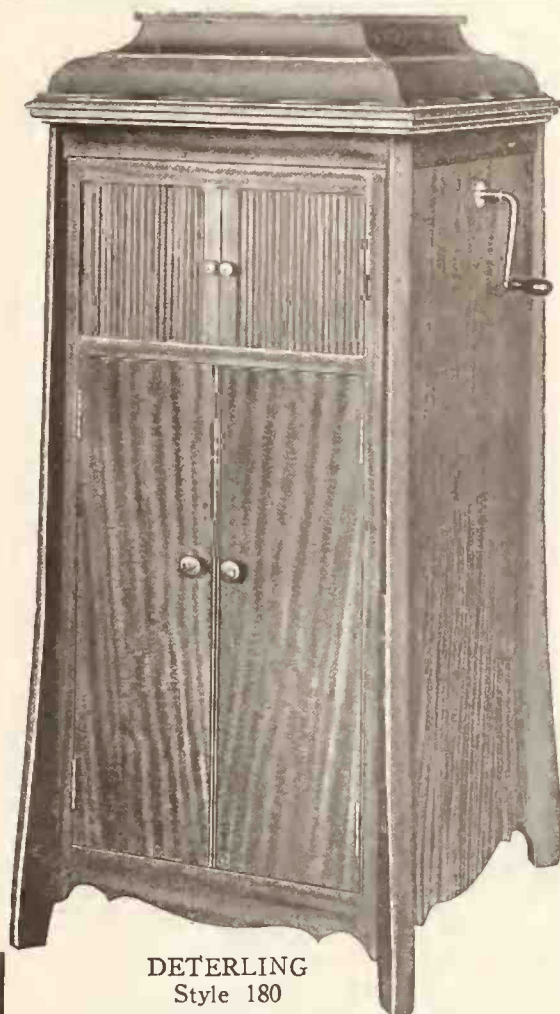

DETERLING Style 180

DETERLING TALKING MACHINES

Are selling big BECAUSE
THEIR DESIGNS attract and hold the eye.
THEIR CABINETS are built to stay built—not to sell and fall apart and cause endless trouble.
THEIR SLIDING DOORS are unique and attractive, and modify the volume WITHOUT MUFFLING.
THEIR FILING SYSTEM is very effective and is a quality point that is easy to demonstrate.
THEIR MERITS—and MOTORS keep them sold.

Send for Our Story

DETERLING MFG. CO.
 TIPTON INDIANA

Prepare for Safe Handling

Insure Perfect Delivery

Khaki Moving Cover, Padded Fleeced Lined

Price \$8.50

Mention Style of Machine when ordering



No. 804

Heavily Padded and Quilted

Jobbers: Write for Special Offer

LYON & HEALY

CHICAGO



New York Telephone Co. Installs Mandels in Rest Rooms

In the telephone exchanges of the States of New York and New Jersey, MANDEL Phonographs are being installed as rapidly as deliveries can be made. The MANDEL was chosen after rigid tests were made, in which some of the best known brands competed. As proof of quality, we can offer no greater testimonial.

The 1920 MANDEL line embodies bigger talking machine values than any other phonograph on the market to-day. The new MANDEL triple spring motor is the last word in phonograph motors. Runs and winds noiselessly. The new MANDEL patented reproducer plays records with a tone volume that is unexcelled.

Low retail selling prices, liberal discounts and terms to dealers, and guarantee of satisfaction to every ultimate purchaser, are three reasons why you should investigate our proposition without delay.

The new art portfolio illustrating the complete MANDEL line for 1920 is now ready for distribution. Write for your copy to-day. With it we will include our confidential proposition to dealers.

More than 3,500 dealers are now selling MANDEL Phonographs. Your territory may be available.

MANDEL MANUFACTURING CO., Inc.

General Offices, 501-511 So. Laflin Street
CHICAGO, ILLINOIS

F. S. HARMON & CO., Northwestern Distributors, Seattle, Tacoma, Spokane, Portland.
HARLE HAAS COMPANY, Distributors for Nebraska, address Council Bluffs, Iowa.
WICHITA WHOLESALE FURNITURE CO., Distributors for Kansas, Wichita, Kan.

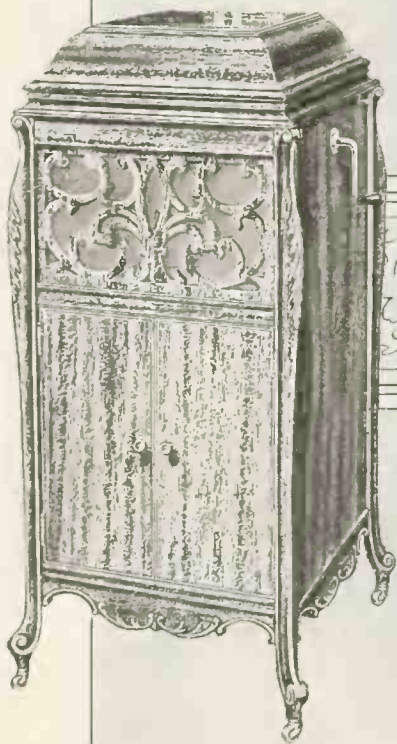

VICTOR DEPARTMENT HEADS ADDRESS SELLING CLASSES

Mrs. Frances E. Clark, John G. Paine and F. A. Delano Offer Interesting Information to Students in Cleveland Talking Machine Co.'s Classes in Salesmanship

CLEVELAND, O., March 6.—Several of the department heads of the Victor Talking Machine Co. have visited Cleveland recently and addressed the classes in salesmanship being conducted by the Cleveland Talking Machine Co. One of the prominent visitors was Mrs. Frances E. Clark, head of the educational department of the Victor Co., who addressed the classes on February 26.

Mrs. Clark spoke first of her pleasure in the establishment of a service department by the Cleveland Talking Machine Co., since it is the realization of a long-cherished dream that wholesalers would some day take up the work of the Victor Co. in this direction. She feels the work will have a sympathetic and solid backing, because during his long association with the Victor Co., Mr. Shartle was at all times a strong believer in the worth of her department. She then spoke of the founding and carrying out of the educational department of the Victor Co., and the ideals which had actuated it.

The Victor Co. founded the department, foreseeing that to instil a sense of musical discrimination in little children would insure a permanent and growing musical market in the adult. Believing this, they obtained the services of Mrs. Clark, who was at that time the director of music in Milwaukee. Mrs. Clark, seeing as an educator the enormous future of music if proper records could be placed in every home, eagerly grasped the opportunity to help the Victor Co. in this added service.

Now, after ten years, the two ideals have justified themselves. Financially, the educational department is a good investment; as to its standing in the educational world, it is sufficient to say that any member of the department would be welcomed in any music school, or college, or university in the country as an honored member of the faculty.

It was not of the schools, however, that Mrs. Clark spoke most, but of the service of the educational department to the homes. She said: "Every mother is a prospective buyer; every child lover is a prospective buyer, and which of us does not belong to one class or the other?"

The homes to-day are eager for children's records; the schools are eager for them; the

factory is pushing them, and it remains for the sales girls and the retail stores to become interested in the possibilities of these records from a financial as well as from a constructive standpoint. There are hundreds of children's songs; dozens of little games, marches, skipping and running records which are utterly unknown to the selling public.

Speaking of the worth and variety of the Victor catalog, Mrs. Clark used several Tuskegee and Princess Watahwaso records to illustrate the native music of America.

The classes were convinced of the real merit and breadth of the educational idea—and Mrs. Clark's talk will undoubtedly be followed by fresh interest in the sale of the better class of records.

John G. Paine, of the copyright department of the Victor Co., also addressed the sales classes, and said in part:

"The keynote of the success of the Victor Co. has been the faithfulness with which it has lived up to its ideal—quality. The crying question of to-day is that of production. You want goods; we want to give you Victor goods. To give you goods in the quantities you want would mean to sacrifice quality, and disregarding all the impatience of Victor enthusiasts at the necessary delay, the company has steadfastly maintained the same high standard of production—the same high standard of quality."

Mr. Paine pointed out the great care with which the wood is seasoned and the cabinet fitted together. As an illustration, he called attention to the screw-heads, all of the slots in which run with the grain of the wood. Even to such minute details has the company extended its ideal.

He assured the classes that in a short length of time there would be a reasonable amount

of Victor goods of the same high standard on the market.

F. A. Delano, who conducts the Red Seal course at the Victor factory, also addressed the classes and brought to the girls a fresh realization of the value of a thorough knowledge of the catalog and their own responsibility in demonstrating the right record for each customer. His anecdotes concerning Victor artists and the early trials of the company were full of humor and human interest, and his remarks on selling pointed and convincing. Every visit from a factory representative adds to the zest of those in direct touch with the public.

TEXAS MUSIC DEALERS TO CONVE

First Annual Gathering of State Body to Be Held in Waco on May 11 and 12

DALLAS, TEX., March 6.—The first annual convention of the Texas Music Dealers' Association will be held in Waco on May 11 and 12, according to an announcement made this week by B. Heyer, the president of the Association. It is stated that plans are being prepared for an educational program, along constructive lines, that will serve to make the sessions of real interest and benefit to the visiting dealers from all sections of the State.

The Texas Music Dealers' Association has been one of the most active bodies in the country in forwarding the cause of music generally and has been responsible for a great mass of propaganda for music advancement. Plans for continuing this great work on a larger scale, for the ultimate benefit of the trade as a whole, will be discussed and decided upon at the forthcoming convention.

The new Reflexo needle, the blue needle in the blue package, has met with much success in the trade. The Reflexo Products Co., New York, state that orders for the product have already reached large figures.

Why Break Records? Just File Them!

That is if you have the wonderful Record filing system which is a feature of

The Marvelous MAGNOLA



Watching the Music Come Out

This is only one feature of many that will command your interest and attention. Let us send you handsome illustrated catalog and information as to our plans for helping you to make money with MAGNOLA.

MAGNOLA TALKING MACHINE COMPANY
OTTO SCHULZ, President
General Offices Southern Wholesale Branch
711 MILWAUKEE AVENUE 1530 CANDLER BLDG.
CHICAGO ATLANTA, GA.

ATTENTION

VICTOR and EDISON DEALERS

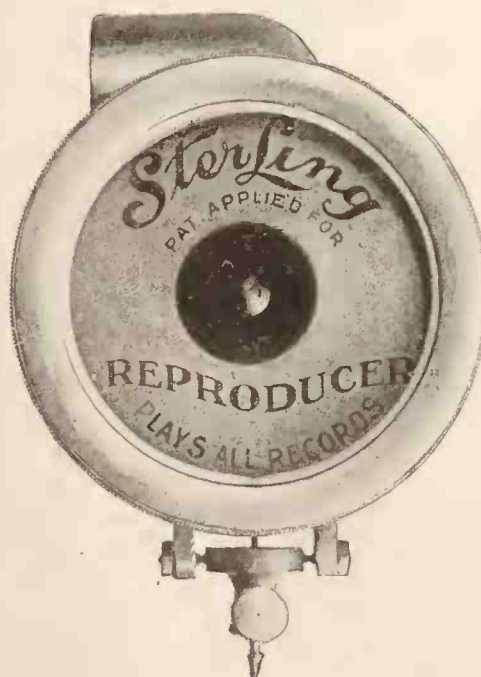

STERLING REPRODUCER WITH ATTACHMENT

Plays all Records—Wonderfully improves the tone—Attached to your machine in a second—No tools required.



Send for circular and prices

To adjust for the playing of different records, means just a quick, easy turn of the reproducer. No extra elbows. You ought to see and HEAR the Sterling. You will be surprised at its convenience, its beauty and wonderful improvement of tone.

Krasberg Engineering & Manufacturing Corporation

536 Lake Shore Drive

Chicago Illinois U.S.A.



“Do it Electrically,”
and

“Why Crank your Phonograph”

Are two phrases that will be seen and heard everywhere within the next year.

National Advertising—newspaper Advertising — and Billboards will carry the “Electrical Idea” direct to millions of receptive people;
AND THE ELECTRIC TALKING MACHINE WILL HAVE ARRIVED

Progressive manufacturers are aware of this and are taking advantage of it.

So when you, Mr. Manufacturer, decide to equip your instrument with electrically driven motors—remember that

**THE JOHNSON
ELECTRIC MOTOR**

is the most satisfactory driving power ever devised for Talking Machines.
THE MOTOR OF CONTINUOUS EFFICIENCY

You, Mr. Dealer, can profitably replace spring motors with the
JOHNSON ELECTRIC

The installation is simple, requiring no mechanical skill. Ask us for significant facts.

Phonograph Motors Corp.

SUCCESSOR TO
JOHNSON MOTOR CO.

341 N. Crawford Avenue
Chicago Ill

ATTEND EDUCATIONAL CONVENTION

Columbia Executives in Attendance at Superintendents' Convention—J. M. Dorey Makes Address—Interesting Exhibit at Cleveland

W. H. Gould, sales manager of the educational department of the Columbia Graphophone Co., accompanied by six members of the department's sales staff, attended the annual meeting of the department of superintendents of the National Education Association held at Cleveland the week of February 22. Over 7,000 superintendents were registered at this convention, constituting about 95 per cent of all the superintendents in the country. The majority of the meetings were held at Keith's Theatre, and an attractive display of various products of interest to educational authorities was held in the Bolivar-Ninth Building. Under Mr. Gould's direction an attractive Columbia display was featured, comprising popular Columbia school equipment that is being used in schools throughout the country.

In a chat with The World, Mr. Gould stated that the most important phase of the convention from the viewpoint of the talking machine industry was the fact that the superintendents gave the phonograph semi-official recognition as a part of the regular and necessary paraphernalia for school use. They conceded that the phonograph and the motion picture are entitled to an important place in the school curriculum, and individually the superintendents manifested a keen interest in the Columbia exhibit.

J. M. Dorey, of the Columbia educational department, addressed 1,200 superintendents at Keith's Theatre on the subject of the Seashore tests for musical measurement and the superintendents listened to this address with keen appreciation.

In addition to Messrs. Gould and Dorey the representatives of the Columbia educational department in attendance at this meeting were: Miss Nina Legge, Cleveland representative; Miss G. Quelay, of the Chicago branch; Miss Florence Hazlett, of St. Louis, and Miss W. E. Skilley, of Toronto.

MORE SPACE IN SALT LAKE CITY

SALT LAKE CITY, UTAH, March 5.—The John Elliott Clark Co., Victor wholesalers of this city, are now comfortably settled in their remodeled quarters, having found it necessary to practically double former floor space in order to take care of customers' demands. The additions include three new demonstrating rooms, comfortably furnished, as well as a large stockroom for storage and shipping purposes. The increasing regularity of shipments from the Victor factory is proving most welcome to the Clark Co. in handling current business.

B. H. Kirby, of Greensbury, Ind., has received his appointment as a retailer for Pathé phonographs and records.

Victor Dealers—



will find in our new wholesale store every facility for the marketing of

VICTROLAS and RECORDS

Our New Location at

Penn Avenue and 12th Street

brings our wholesale department to within one block of the Pennsylvania Station.

Be Sure to visit the Model Victor Sales Room on the first floor.

Mellor's
PITTSBURGH, PA.

GODOWSKY ON BRUNSWICK RECORDS

World-famous Pianist and Composer Joins Staff of Brunswick Record Artists

The latest addition to the list of Brunswick record artists is the famous pianist and com-



Leopold Godowsky

poser Leopold Godowsky, whose records will appear on early releases from the Brunswick laboratories. Godowsky has a reputation which is world-wide and through his work here in America has won a large following. The announcement that he will now be heard on Brunswick records is a welcome one to dealers and

music lovers generally with whom the new records have proved very popular. The Brunswick company of artists already includes many famous names and the addition of Godowsky adds a pianist whose reputation is such that it lends considerable prestige to any product with which he is connected.

LARGER QUARTERS FOR H. G. NEU

New York Envelope and Accessories Manufacturer Also Increases Sales Force

H. G. Neu & Co., 108 Worth street, New York, manufacturers of record envelopes and other paper necessities used by talking machine dealers, have recently enlarged their quarters and added to their sales force. They now occupy space more than double the size of their previous location. R. G. Adrian, of the Commercial Exchange Bank, New York City, and A. J. Dommergue, formerly of the Phoenix Hermetic Co., of Brooklyn, have become associated with the company. Mr. Dommergue is an ex-soldier, having served for several months overseas with the 105th Hospital Unit.

H. A. Copeland of South Connellsville, Pa., is now manager of sales for H. G. Neu & Co. throughout southern Pennsylvania and West Virginia.

Emerson records are now carried in Detroit by six stores of the Adora Phonograph Co.

THE PHONOSTOP---No Machine Is Complete Without It

- ☐ This stop is now tested and adjusted in actual use at our factory before shipping, and is *guaranteed to do the work. It stops on the line.*
- ☐ More PHONOSTOPS in use than all other makes put together.
- ☐ Adjustability is one of our features, and it is an exclusive one.

Made Right Stays Right Acts Right

Order early—we will ship

Immediate Delivery up to 10,000.

500,000
IS OUR 1920
OUTPUT
FIGURE

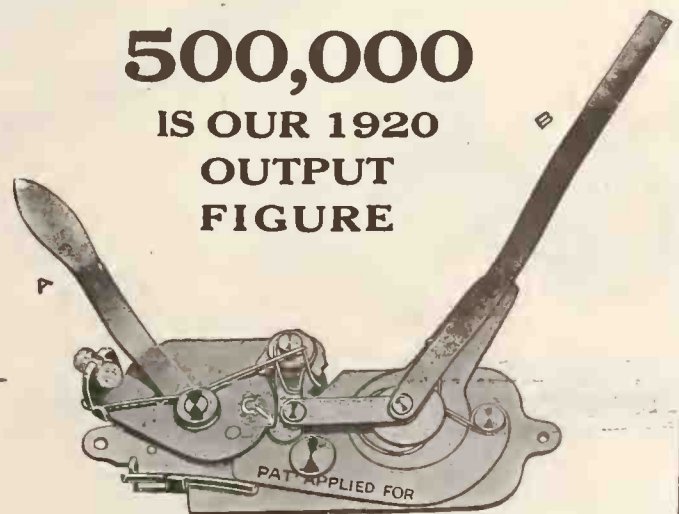

THE PHONOMOTOR CO. - 121 WEST AVENUE ROCHESTER, N. Y.

Phonographs Come, Phonographs Go—
But—**PATHE RECORDS**—go ON Forever



Every Phonograph has a Turntable

For EVERY turntable on EVERY Phonograph is a place for you to put Pathé Records at a profit. We say Pathé Records—We MEAN Pathé Records—because:

Every day the demand for Pathé Records increases.

Every day more people recognize the exquisite tone quality of Pathé Records.

Every day more people discover that Pathé is first with the hits that make Broadway famous.

Every day people find out that they get the widest possible choice in Pathé Records—everything in music—operatic, orchestral, band and vocal—from the classical favorites and the “songs that never grow old” to the raggy, jazzy popular melodies of the day.

How are they making their discoveries so fast? The answer. Pathé national advertising: It is effectively telling the public about Pathé Records day by day, week by week, month by month. And every time every 24 hours go by, ten times that many people right in YOUR neighborhood have discovered that Pathé Records give them the music they want—and surpassing tone.

There is no question as to Pathe Record Superiority

PATHE FRÈRES PHONOGRAPH CO.

EUGENE A. WIDMANN, Pres.

10 to 56 Grand Ave., Brooklyn, N. Y., U. S. A.

and London, Eng.

The Pathé Frères Phonograph Co.
of Canada, Ltd.,
Toronto

The Genuine

Pathé
REG. U. S. PAT. OFF.

COSTS NO
MORE
THAN THE
ORDINARY
PHONO-
GRAPH

PHONOGRAPH

New Pathé Distributing Points



DISTRIBUTORS

- | | | |
|---|--|--|
| Hallet & Davis Piano Co.
146 Boylston St.,
Boston, Mass. | John A. Futch Co.
630 Washington St.,
Jacksonville, Fla. | W. W. Kimball Co.
Jackson & Wabash Aves.,
Chicago, Ill. |
| Bistol & Barber
111 East 14th St.,
New York | John A. Futch Co.
35 Auburn Ave.,
Atlanta, Ga. | Mooney, Mueller & Ward Co.
101 S. Meridian St.,
Indianapolis, Ind. |
| Inteistate Phonograph Co.
1026 Chestnut St.,
Philadelphia, Pa. | John A. Futch Co.
1500 S. Boulevard
Charlotte, N. C. | Salt Lake Hardware Co.
Salt Lake City, Utah |
| Pittsburgh Talking Machine Co.
963 Liberty Ave.,
Pittsburgh, Pa. | Gray & Dudley Co.
Nashville, Tenn. | G. Sommers & Co.
Park Square,
St. Paul, Minn. |
| Rochester Phonograph Co., Inc.
44 Clinton Ave., North
Rochester, N. Y. | Harbour-Longmire Phonograph Co.
1001 Elm St.,
Dallas, Tex. | Williams, Davis, Brooks &
Hinchman Sons
26 Congress St.,
Detroit, Mich. |
| Buffalo Wholesale Hardware Co.
317 Washington St.,
Buffalo, N. Y. | Harbour-Longmire Phonograph Co.
311 W. Main St.,
Oklahoma City, Okla. | Wright & Wilhelmy Co.
Tenth & Jackson Sts.,
Omaha, Neb. |
| Weaver Piano Co.
York, Pa. | The Fischer Co.
940 Chestnut Ave.,
Cleveland, O. | Western Phonograph Co.
985 Market St.,
San Francisco, Cal. |
| M. Seller & Co.
Fifth and Pine Streets,
Portland, Ore. | The Fischer Co.
44-46 Vine St.,
Cincinnati, O. | Western Phonograph Co.
820 S. Broadway
Los Angeles, Cal. |
| Wm. Volker & Co.
Main, 2d & 3d Sts.,
Kansas City, Mo. | Churchill Drug Co.
Burlington, Ia. | Morley Murphy Hardware Co.
Green Bay, Wis. |
| Wm. Volker & Co.
Houston, Tex. | Churchill Drug Co.
Peoria, Ill. | Rice-Stix Dry Goods Co.
St. Louis, Mo. |
| Wm. Volker & Co.
Denver, Col. | Churchill Drug Co.
Cedar Rapids, Ia. | Rice-Stix Dry Goods Co.
New Orleans, La. |
| Armstrong Furniture Co.
59 N. Main St.,
Memphis, Tenn. | Fuller-Morrison Co.
540 W. Randolph St.,
Chicago, Ill. | F. P. May Hardware Co.
469 C St., N. W.,
Washington, D. C. |

The dealer who hitches on to Pathe Products is in with the fastest distribution service and the most aggressive association of distributors that the Phonograph Trade has yet produced. If you are not selling Pathe Products *write or wire* for the "Other 20%." *It's Free.*

PATHÉ FRÈRES PHONOGRAPH CO.

EUGENE A. WIDMANN, Pres.

10-56 Grand Avenue

Brooklyn, N. Y., U. S. A.

and London, England.

The Pathé Frères Phonograph Co. of Canada, Ltd., Toronto

THE REPEATOGRAPH

AUTOMATICALLY REPEATS YOUR RECORD WHILE YOU DANCE OR DINE.



Mr. Live Dealer:

Here is the most profitable accessory you can handle; one for which there is a great demand and of such simple and perfect construction as to overcome all objections.

The Repeatograph plays entire records or any part of them, over and over, as desired. Anyone can attach it permanently in place. Simply pressing on the motor spindle sets it in operation. Swings aside out of the way when not in use. No delicate parts or intricate mechanism.

Appeals to every phonograph owner and can be sold to almost every person who comes in to buy records. Ideal for Dancing, Dinner Parties, Card Parties and private receptions.

Send for prices, discounts and sample.

The Repeatograph works with the utmost efficiency on most all phonographs made.

THE REPEATOGRAPH CO.

NEW YORK 311 Hudson St. CHICAGO 664 W. Randolph St. MONTREAL 511 St. Catherine St. W.



WARNING!

To All Jobbers and Dealers in Talking Machines and Accessories:

In view of the fact that the enormous success of the Repeatograph, for automatically repeating talking machine records, has stirred up some unfair competition, we hereby give notice to all concerned that we are the sole manufacturers of all automatic repeating devices made, advertised or distributed under the original Eskil H. Josephson patent, No. 1218408, dated March 6, 1917, for a repeating attachment for sound reproducing instruments, and that we are the sole owners of the name Repeatograph as used in connection with sound reproducing devices.

Notice is further given that on February 17th, 1919, the Honorable Charles M. Foell, Judge of the Superior Court of Cook County, Illinois, sitting in chancery, issued an injunction in our suit against the Webster Novelty Company, of Chicago, C. H. J. Marr, and others, as defendants, General No. 341405, restraining and prohibiting said defendants, and all of them, from manufacturing, advertising, selling and otherwise disposing of any record repeaters or repeating devices manufactured in accordance with the Eskil H. Josephson patent, No. 1218408, dated March 6, 1917; that said injunction now remains in full force and effect; that on May 2, 1919, the Repeatograph Co. filed with the Commissioner of Patents application, Serial No. 294153, for an improved record repeating device, upon which application a number of claims have already been granted by the Patent Office and other claims are pending.

The trade is hereby given fair and reasonable warning that any advertisement or sale of mechanical record repeating devices in violation of the aforesaid injunction or infringing the above described patent and application for patent will be prosecuted to the full extent of the law.

THE REPEATOGRAPH CO.

TALKING MACHINE CO.'S NEW HOME

New Retail Store Made Headquarters for Chain of Establishments in Philadelphia

PHILADELPHIA, PA., March 6.—The Talking Machine Co. has opened a new store at 1225 Chestnut street, which is the headquarters store, where Harry Ellis, the general manager, has his offices, and from which is directed all the business of this successful company.

Several months ago the Talking Machine Co. found it necessary to look for a new home and they secured a long lease on the 1225 Chestnut street property. At an expense of close to \$30,000 they remodeled the place and brought all their equipment from the former Broad street store. Many new features were added and now the store has twenty booths, ten on either side of a long passageway, all lighted with "daylight lights." On the second floor is a handsome reception room, in which there will be a special display of period type of Victor machines—for this company handles the Victor exclusively. At the rear of the store, on the balcony, General Manager Ellis has his private office. Each one of the six stores has its own manager, the manager of the 1225 Chestnut street store being John A. Snyder. The new retail store is entirely separated from the other stores, with ample storage facilities, repair departments, stock rooms, etc.

KAUFIELDS OPEN AT THE "PALACE"

The "Kaufields," an exclusive Emerson combination, opened their vaudeville act at the Palace Theatre on Monday, March 8, and scored one of the hits of the bill in this well-known playhouse. Their act is unique in many respects and they feature several songs that they have recorded for the Emerson record library. The "Kaufields" have been appearing at several of the leading "big time" vaudeville houses in Greater New York, but their booking for the Palace emphasizes the quality and merit of their production. The "Kaufields" consist of Arthur Fields, Irving and Jack Kaufman.

OPENS NEW VICTOR STORE

Clement Beecroft Opens Exclusive Victor Store in Philadelphia—Now Decorating Warerooms

PHILADELPHIA, PA., March 5.—Clement Beecroft, one of the most popular members of the talking machine trade, has purchased the prop-



Clement Beecroft

erty at 5546 North Fifth street, and has spent the last three weeks in making this store larger and installing a new show window. Mr. Beecroft will handle Victrolas and Victor records exclusively in his store, and will also continue to merchandise envelopes, cabinets, etc.

When alterations are completed, Mr. Beecroft's store will have six booths, the interior of the store, including the booths and fixtures, being finished in French grey. The store is located in the business section of northern Philadelphia known as Olney, and is in the

midst of a very rapidly increasing population. Mr. Beecroft is thoroughly familiar with all phases of Victor merchandising, and his many years' experience in the trade will enable him to give the public efficient and valuable service.

A. J. BALCOMBE ARRIVES HERE

Great Britain Representative of General Phono. Corp. Arrives in New York for Flying Visit—Gives Encouraging Résumé of Conditions

A. J. Balcombe, London representative of the General Phonograph Corp., arrived in New York Tuesday, March 2, on the "Imperator" for a brief stay at the executive offices, returning to London on the same ship on March 8. While in New York Mr. Balcombe spent his time in conference with Otto Heineman, president of the company, regarding plans and developments for the coming year, and a number of important ideas were discussed which will materialize in the very near future.

Mr. Balcombe gave a very interesting résumé of European conditions, stating that the business situation in England is excellent and that the outlook for the future is very encouraging. In every line of industry there is a tremendous boom and as soon as sufficient merchandise is received, Great Britain is destined to enjoy exceptional prosperity. Mr. Balcombe commented upon the hearty reception being accorded the products of the General Phonograph Corp. throughout Great Britain and the colonies. There is a gratifying demand for the motors manufactured by the General Phonograph Corp., and this demand is increasing steadily.

ADDS ENTIRE NEW STORE

Hickey's Lyceum Music Store in Ithaca, N. Y., has been enlarged by the addition of an entire new store on the ground floor, which has been devoted exclusively to the Victor department. The new store is equipped in modern style and contains three sound-proof demonstrating booths. Fred T. Wilcox has returned to his old position as manager.

**"Easier to sell
than any other
phonograph in the world"**

That's the way salesmen talk about

The **Aeolian-VOCALION**

The new and greater phonograph

VOCALION RECORDS Two distinct styles of records. A lateral cut and a hill and dale. You can therefore sell EVERY phonograph owner in your community.

— Ask for our Dealers' Proposition —
We are Western Distributors, prepared to give you the goods you want **WHEN YOU WANT THEM.**



13 to 19 East 1st, South - - - - - Salt Lake, Utah

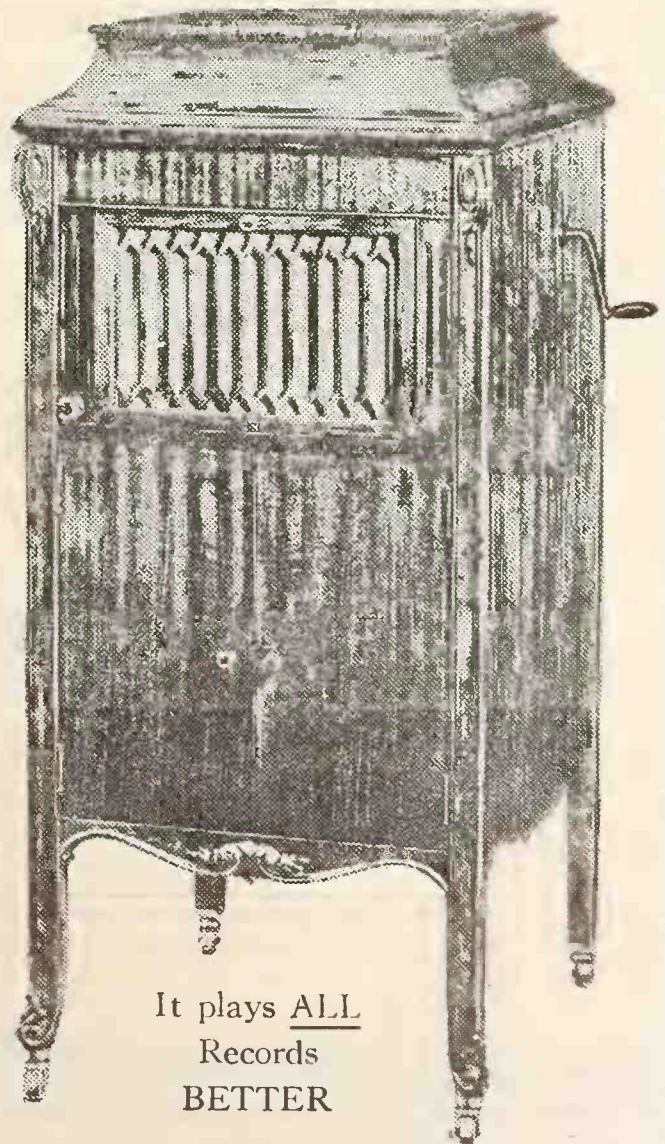

It plays ALL
Records
BETTER

Edison Amberola Message No. 4

From twenty-five to thirty Blue Amberol Records are issued on the 25th of each month. Each supplement is chock-full of the very latest song hits, dance hits, popular ballads, comic records, etc., etc.

This is the kind of up-to-the-minute service a live Phonograph merchant appreciates, and Amberola dealers everywhere are cashing in on it.

THOMAS A. EDISON, Inc.

AMBEROLA DEPARTMENT

ORANGE, N. J.

AEOLIAN CO. ESTABLISH WHOLESALE BRANCH ON COAST

Aeolian Vocalion Records and Melodee Music Rolls to Be Distributed by Wholesale Branch, to Be Located in San Francisco—Horace M. Hull to Be in Charge of New Branch

An Aeolian Co. announcement of unusual importance and significance is to the effect that arrangements have been completed for the establishment of a wholesale distributing branch in San Francisco for the handling of the Aeolian Vocalion, Vocalion records and Melodee music rolls. The final details connected with the opening of the new branch have been taken care of by W. H. Alfring, manager of the wholesale department of the Aeolian Co., on his visit to the coast, and it is expected to have the new branch in full operation on or about April 1.

The move has been in contemplation for a long time, but action was delayed until such time as the production of Vocalions made it possible to free sufficient stock to take care of the demands on the Pacific Coast. The en-



Horace M. Hull

largement of the Vocalion plant in New York and the establishment of a large assembling plant in Grand Rapids have served to increase production materially and the Aeolian Co. plans to develop its Pacific Coast business in Vocalions, records and rolls on a big scale.

Horace M. Hull, who has been connected with the wholesale departments of the Aeolian Co. since 1907, will be in charge of the new branch, to be known as the Aeolian Co., San Francisco. Mr. Hull is well qualified by experience for the important post, inasmuch as he acted as wholesale traveler for the Universal Music Co. for four years and during the past six years has traveled for the wholesale Vocalion department. He is thus familiar with both the Vocalion and Melodee music roll lines and methods of distribution and his advice should prove of distinct value to new dealers in those lines.

In the San Francisco branch a complete stock of Vocalions, regular and period models, to-

gether with complete stocks of records and Melodee music rolls, will be carried at all times, an entire building being provided for the purpose. All orders from dealers in the Pacific Coast region will be filled direct from the San Francisco warehouse, which will mean that orders will be filled promptly and that, in an emergency, a specially desired machine or record

LIVELY TRADE IN CANTON DISTRICT

Talking Machine Dealers Manage to Increase Sales Totals Despite Continued Shortage of Goods—Record Sales Show Big Gains

CANTON, O., March 2.—Talking machine sales in February more than doubled those of January, according to P. Q. Shrake, manager of the talking machine department of the Klein & Heffelman Co., one of Canton's largest music stores. "Business in this department during the month of February has been phenomenal, and has been a surprise to even the oldest of music store men," said Shrake. "Considering the shortage in production, which is the biggest problem that confronts us to-day, business has held up exceptionally well generally in Canton." Regarding record sales Mr. Shrake says his store is unable to get enough of them. A shipment when received contains about 25 per cent of the original order and it is impossible to get the latest records in large quantities. The Klein & Heffelman Co. are agents for the Victor and Edison machines.

Business, generally speaking, is reported to be unusual for the month of February by heads of talking machine departments of all Canton's leading music stores. Prosperous Canton wants the very best in the talking machine line and merchants here are catering to the best trade in years. The high wages paid in Canton factories have given an added incentive to talking machine buying and it is only with difficulty that merchants keep a few machines on their floors for display purposes.

Canton talking machine department managers, interviewed on the situation in general and prospects for the coming Spring months, commented as follows:

D. W. Lerch, manager D. W. Lerch Music Co., dealers in Grafonolas and Vocalions: "Business has been above the average for us. We are selling all the machines we can get and record sales are holding their own with other makes."

Al H. Waltamath, talking machine department manager for the Brown Piano Co., exclusive agent of the Sonora Piano Co.: "Business the past two months has been the biggest in the history of the store. Sale of records keeps up amazingly well and the only trouble is getting the machines. We seldom have a machine on the floor a day after it is unpacked."

can be secured by the dealer without any delay.

In addition to the establishment of the branch the company's plans call for other important developments in the Pacific Coast region which will be announced in due time. With the new branch the entire country is now well covered by Aeolian Co. distributing factors, which provide unusually prompt service for the dealers. This rule applies to both the matter of Vocalions and Melodee music rolls, a number of new Melodee roll distributors in various sections of the country having been announced only recently.

E. H. Woomer, manager Woomer Phonograph Co., agents for the Stradivara machine: "February business thus far is in excess of January. We are arranging to establish a record department in addition to store now being equipped."

C. M. Alford, manager Alford & Fryar Piano Co., handling the Cheney and Starr makes, said: "We are just beginning to be able to halfway meet the demand for records and machines. From observation, I believe the production situation is commencing to ease up and in the course of a few weeks conditions will assume normal. This company is so optimistic as to the future that we are planning to expand our phonograph department so the floor space will be almost double."

EMERSON FIELD MANAGER ON TRIP

W. H. Shire, field manager of the Emerson Phonograph Co., and well known in talking machine circles throughout the country, left on Monday, March 8, for an extended trip, which will keep him out of town until July 1. Mr. Shire will visit every Emerson jobber in the country, as far West as the Pacific Coast, according to his present plans, and will spend some time with every representative, discussing practical merchandise problems.

M. O. Giles, Southern representative of the Emerson Phonograph Co., has been visiting Emerson jobbers in the South, and he reports that business conditions in this section of the country are very encouraging.

PATHE SUPPLIES ENTERTAINMENT

COLUMBUS, O., March 4.—At a recent meeting of the Lancaster Camp Meeting and Assembly Association in this city entertainment was furnished by a recital of Pathé records, under the auspices of the Bope Furniture Co., Pathé dealer. The Bope Furniture Co. later received an enthusiastic letter of commendation from the Association on the entertainment furnished by the Pathé records and which paid a high compliment to the charming voice of Grace Hoffman, lyric soprano and Pathé star.

Edward Caldwell, Victor dealer, of Stoneham, Mass., has installed a new battery of three Unico booths, together with a series of Unico record racks.

—We are now fully equipped to give unequalled service—



The Phonograph with the Singing Throat

STARR PHONOGRAPHS

EMERSON RECORDS
(Western Iowa and Nebraska)

TONOFONE NEEDLES

REED DEMONSTRATING BOOTHS

COMPLETE STOCKS :: PROMPT SERVICE



Write Today for our Dealers' Emerson Proposition

Carpenter Paper Company
Omaha Western Selling Agents Nebraska

FERRO TALKING

A HIGH STANDARD

Introducing the New

FERRO MOTOR

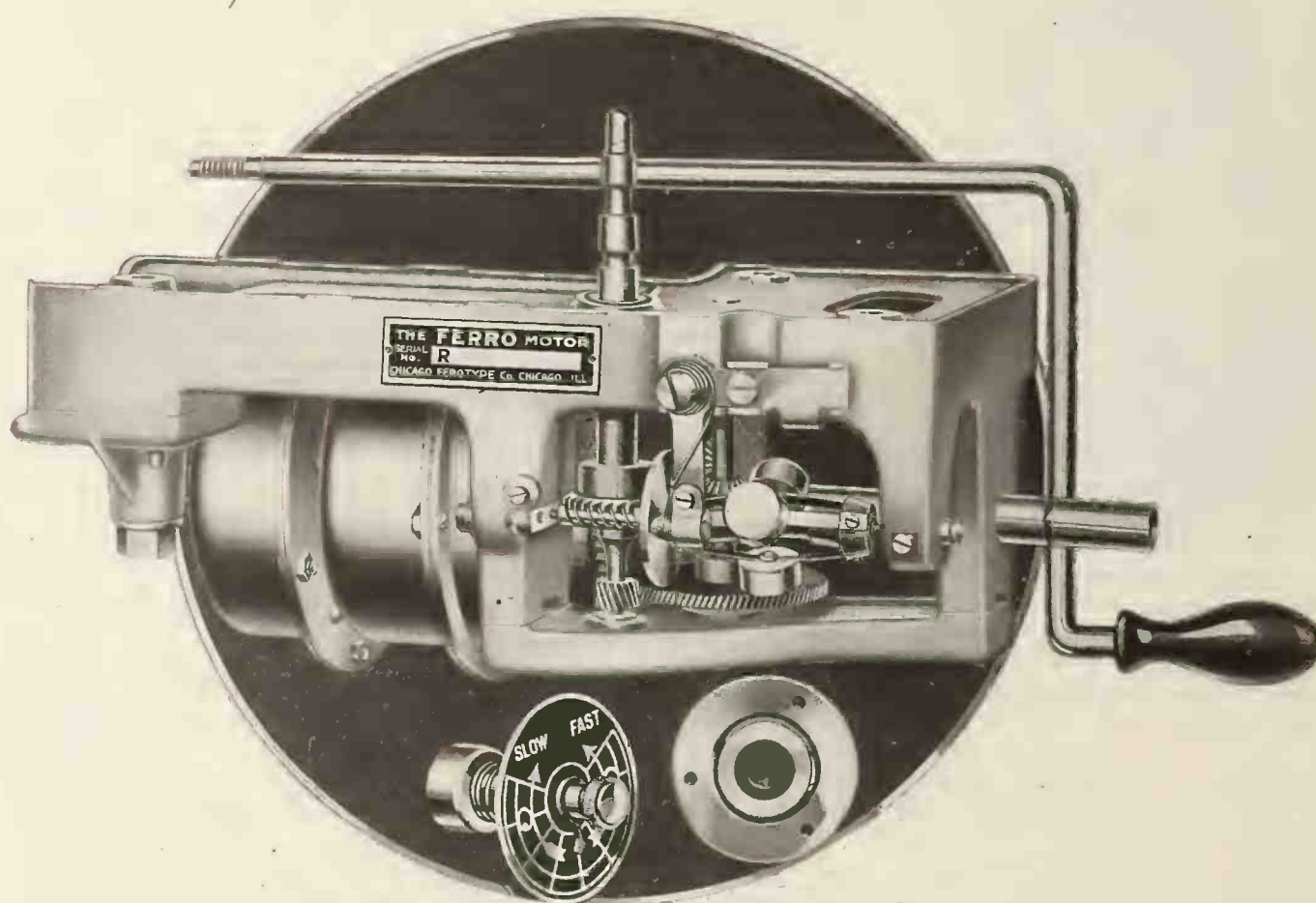

The Last Word in Phonograph Motordom

**MASSIVE
DURABLE**

**POWERFUL
NOISELESS**

The new FERRO MOTOR is made with three or two springs. The three-spring motor runs twenty-one minutes—plays eight 10-inch records—with one winding. The two-spring motor runs sixteen minutes—plays six ten-inch records—with one winding.

Eliminate your motor troubles by adopting the wonderful FERRO MOTOR. Built by master phonograph motor makers.

The Chicago Ferrottype Company is one of the oldest independent manufacturers of talking machine motors, etc., in the United States.

Write for sample.

CHICAGO FERROTYPE COMPANY

1455 West Congress St.,

MACHINE PRODUCTS

OF QUALITY

The FERRO AUTOMATIC STOP

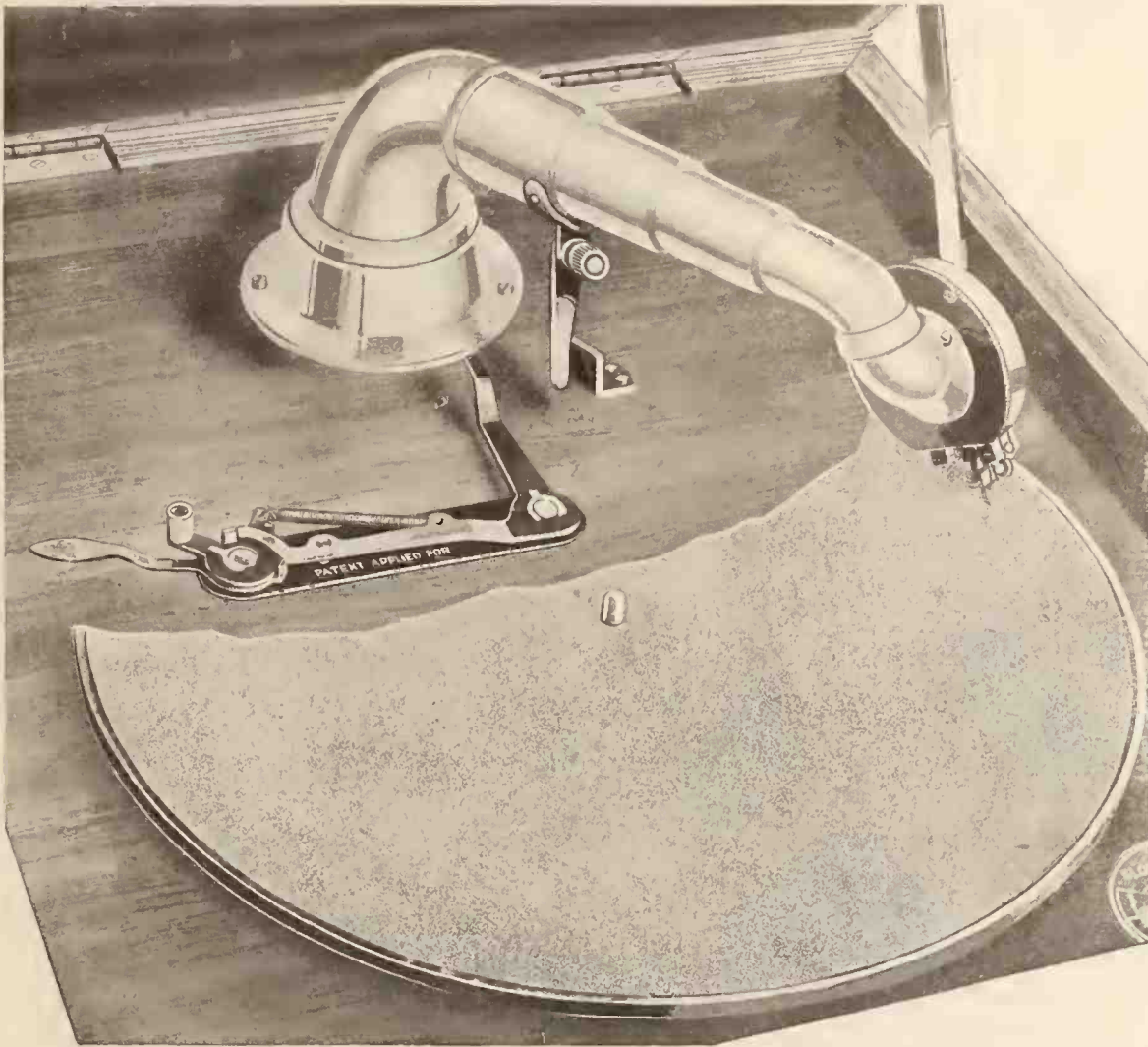

The 100% efficient automatic stop—
Guaranteed for five years

Read what others say about it. Note the following testimonials.

"The FERRO STOP surely is a marvel. Perfect workmanship, durability. Certain in action."

"Your FERRO STOP is all you claim for it. We will make a contract with you for five thousand."

"You certainly have the best automatic stop we have tried. There is no guesswork about its stopping on all records at the right time."

The FERRO STOP can be used with any tone arm. It can also be used as a hand brake.

The FERRO STOP is positive, accurate, in its action. It actually stops the motor where you want it to stop.

The FERRO STOP will enhance the value of any phonograph. It is a great asset in selling a talking machine. It is just the automatic stop phonograph manufacturers and assemblers have been looking for.

The FERRO TONE ARM and REPRODUCER—Patented Nov. 25, 1919

Beautiful in appearance.

Wonderful in sound producing qualities.

In the FERRO TONE ARM and REPRODUCER we have a sound producing unit second to none. Built for **Your** high grade talking machines.

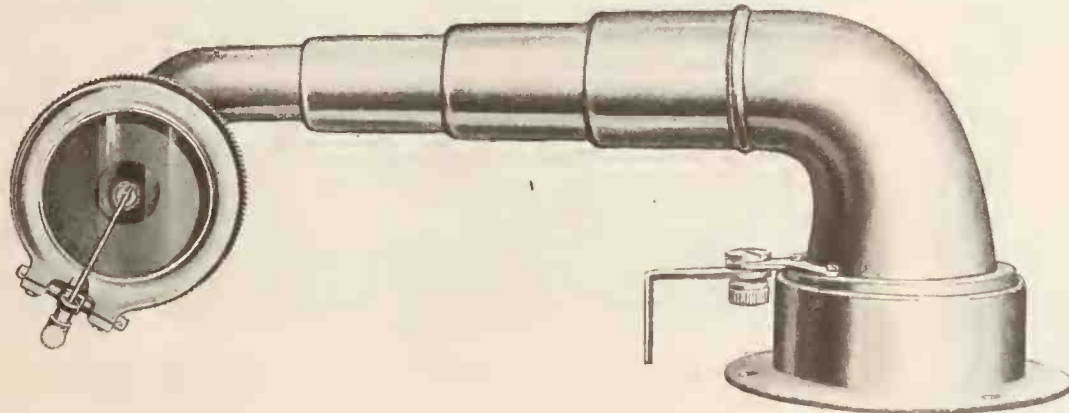

The FERRO sound box plays ALL records—both lateral and vertical cut—adjusted by a simple turn.

If YOU want something better—something distinctive—something well worth talking about—DON'T FAIL to take advantage of the opportunity NOW to write for a sample of the FERRO SOUND PRODUCING UNIT. SEE it—HEAR it—and you will be convinced.

PHONOGRAPH PARTS DIVISION

Chicago, Illinois

This Record Won't Sell

Look at the small amount of music on it!
People want their money's worth now, as
always,.....

.....which accounts for the truly revolutionizing success of long-playing Grey Gull Records. Send coupon below for samples and full particulars.

Every customer that buys a Grey Gull Record, Two-In-One style, in your store, gets approximately twice more music than he is used to getting, without any advance in price. This will tie him to you *permanently*, because he will be getting something from you that is *not available anywhere else in town*.



Grey Gull Records, Two-In-One Style, are *entirely different* from all other records. They *look* the same, and *play* the same; yet in the ten inch size they run from 4½ to 5½ minutes, and in the twelve inch size, from 5½ to 7½ minutes. We often put *four entire pieces* on the two sides of one disc. For example, Number H4003, retailing at 85 cents, gives you on one side, Second Regiment March and Boston Commandery March, and on the other side Up the Street March and Cruiser Harvard March—all four marches *complete*. We pursue the same policy with popular dance and song hits of the day.

Grey Gull Records, Two-In-One Style, sell *best* when they are compared with other kinds of records. Their merits are then and at once *enthusiastically* recognized. When you have established a trade in them, no other dealer can get it away from you, because he has no records anything like them.

You can satisfy yourself as to the accuracy of our statements by using the coupon below. Your money back at once if you don't like the records.



INCORPORATED

295 HUNTINGTON AVE., BOSTON

FILL OUT THIS COUPON AND MAIL

GREY GULL RECORDS, 295 Huntington Ave., Boston, Mass.

Please send to address below, an easy-selling assortment of ten Grey Gull Records, for which remittance of \$6.00 is enclosed. Privilege of returning these records within ten days, at your expense, and obtaining a refund of the remittance is reserved. Also send your two leaflets, "Distributor Proposition" and "Dealer Proposition," and list of your records.

Name _____

Address _____

Bert Williams preaches two sermons on this record. You'll offer up a prayer of thanks if you order a big supply. A-6141.

**Columbia Graphophone Co.
NEW YORK**



ROCHESTER TRADE IS ACTIVE

Demand for Machines and Records Shows No Abatement and Retailers Are Expanding Facilities—E. J. Chapman in Florida—New Lines Appearing in the Local Field

ROCHESTER, N. Y., March 5.—Rochester dealers are all smiles. The demand for talking machines and records apparently has no limit and dealers in this vicinity are having difficulty in securing goods in large enough quantities to meet the demand. "Dardanella" made a tremendous hit, and while shipments on this record have been greater than on any recent hit, the demand is far from satisfied.

Brunswick records have made their appearance in Rochester and according to Miss Kathleen Whalen, of E. W. Edwards & Son, local Brunswick dealers their reception by the public exceeded by far the highest hopes entertained for them.

Chester Davenport, formerly of the Pelham Bay Naval Reserve Band, has been placed in charge of the musical merchandise department of the Music Lovers Shoppe.

John Clark, formerly manager of the Victrola department of the B. J. Fryatt department store, in East Rochester, has entered the wholesale field, having taken the exclusive distributing rights for the Waddell talking machine in New York State. Mr. Clark has also opened a retail department in the MacAlpine-Bullock Co., and says that the Waddell is making fast friends.

E. J. Chapman, Victor wholesaler, is spending several months in Florida and at present is in Florence Villa. M. L. Welsh, manager for Mr. Chapman, reports the demand for Victor goods as great as ever and that factory shipments to date have done very little to overtake the demand. Mr. L. A. Randall, traveling representative for Mr. Chapman, is in Camden taking the Salesmanship Course at the Victor factory. Among recent visitors at Chapman's were A. C. Clother, of Avon; I. D. Bramer, of Fairport; Frank Reilly, of Penn Yan; C. N. Andrews, of Buffalo; T. D. Davies, of Wm. Taylor & Sons, Cleveland; Mr. Scott of The Hengerer Store, Buffalo. and Mr. Allen, of Los Angeles, Cal.

The remodeling of stores is still going on in Rochester; Arthur W. Oster, at 168 Clinton avenue, South, recently completed alterations in his store, making it a model home for the Columbia line. His new show windows are receiving much favorable comment. The large increase in his business has caused S. J. Hoffman, of Joseph avenue, to expand and he is turning the store next to his present location into a new talking machine show room to be used in connection with his old store, thus giving him twice the space for his Columbia and Victor lines.

Mr. Young, of Young's Music Store, Ames street, has been losing sleep lately by people getting him out of bed for a record of "Dardanella." Mr. Young claims he is an early riser, but that doesn't seem early enough for those who want to be sure of getting the record.

The Reilly Brothers, of Penn Yan, are each planning to attend the Salesmanship School

at the Victor factory and Edward Reilly will attend the class starting March 8.

The Buchanan Hardware Co., of Richfield Springs, has a very nice talking machine department in a new addition to the old building. It is under the able direction of Joe Famular

and he handles the Victor and Sonora lines.

B. S. Morgan, of Cooperstown, has moved from his old store into larger and newer quarters across the street, where he can give better service to those who desire Victor or Sonora products.

C. J. POTT CHRISTENS AN HEIR

C. J. Pott, general sales manager of the Canadian interests of the General Phonograph Corp., was a visitor to New York the early part of the month, and, in addition to taking care of important business matters, celebrated the christening of a baby son. Mr. Pott solemnly promised Otto Heineman, president of the company, that this baby son may be safely counted upon as a new recruit to the company's sales organization. Mr. Pott was most enthusiastic regarding Canadian business conditions and commented particularly upon the tremendous growth in popularity of Heineman and Meisselbach motors among dealers in all parts of the Dominion.

MUSIC PAGE FOR STOCKTON RECORD

Peffer Music Co., Columbia and Pathé Dealers, Encouraging Music News in Daily Press

In the music section of the Stockton (Cal.) Daily Evening Record the Peffer Music Co., large music dealers of that city, occupied the greater part of two pages in a double spread featuring all kinds of musical instruments and accessories. Pathé phonographs and Columbia Grafonolas, as well as Pathé and Columbia records, are carried. The new music section carried interesting news regarding happenings in the musical world. It is worthy of note that musical news filled the section completely and no extraneous matter was used.



This superior product is a necessary part of the superior quality machine

The "Crip-N-Ejex" File is a high quality product that will add **SELLING POWER** for the machine in which it is featured.

It not only improves the appearance and attractiveness of any talking machine, but will also provide **A RECORD SYSTEM** that is a positive necessity for all talking machines.

Manufacturers who make it a standard part of their finer quality models will render prospective purchasers of phonographs a **REAL SERVICE** which will be everlastingly appreciated. Increased business will result from an increased demand. This desirable device is easy to install in all makes of cabinets. It is substantially built to last a lifetime, permanently protects the records from becoming scratched, marred or broken, and instantly produces **THE DESIRED SELECTION**. It will, therefore, increase the pleasure of the owner many hundredfold.

MAKE US PROVE IT

Crippen Record File Corporation
39 North Water Street Rochester, N. Y.



Illustration above shows Special **MADE TO ORDER** Mahogany Sectional Cabinet, consisting of base, two 100 section units and top. **TOTAL CAPACITY: 200** Records.

The Puritan

An Opportunity for Dealers

The PURITAN Phonograph literally "speaks for itself."

There is a richness and purity in the reproduction, quite different from other instruments, that invariably pleases the listener.

The most critical music-lovers declare that such smoothness, clearness and volume of tone have never been produced by ordinary phonographs.



THE REPRODUCER

A new type of sound-box and tone arm give absolutely free horizontal and vertical movement, enabling the needle to receive ALL THE IMPULSES from the corrugations of the record. The faintest recorded sounds are faithfully transmitted to the ear. The mechanism is very sensitive to record vibrations, and is the result of long experiment.

The great clearness of tone in the PURITAN is produced by the

LONG WOOD HORN

This is an exclusive, patented feature, and CANNOT BE USED BY ANY OTHER MANUFACTURER.

PURITAN LATERAL-CUT RECORDS ARE BRILLIANT AND CONTAIN THE LATEST POPULAR NUMBERS

The Puritan Phonograph plays all makes of Disc Records, with all the distinctness and volume of which the record is capable

EIGHT BEAUTIFUL MODELS NOW READY FOR IMMEDIATE SHIPMENT
WRITE FOR CATALOG AND DEALERSHIP PROPOSITION

United Phonographs Corporation

Factory and General Offices: Sheboygan, Wisconsin

The PURITAN HORN is a rectangular channel representing an organ-pipe, extending from the tone arm to the bottom of cabinet. It has only one bend (see illustration).

THIS IS THE MOST EFFECTIVE AMPLIFIER EVER PRODUCED

The PURITAN HORN magnifies and mellows the vibrations from the diaphragm. At the same time it absorbs all hissing and grinding sounds, delivering the MUSIC ONLY in a wonderfully realistic way.

The entire instrument, including motor, sound-box and cabinet, is made in our own factory, and we guarantee every part.

NEWARK WORKS IN OPERATION

General Phonograph Corp. Occupies Mammoth Plant at Newark—Production of Meisselbach Motors Rapidly Increasing to Meet Demand

In a chat this week with *The World*, Otto Heineman, president of the General Phonograph Corp., stated that the company's new Newark plant is now being equipped with the necessary machinery and that the removal from the old plant to this mammoth factory has practically been completed. This moving was accomplished under unusual handicaps, as weather conditions were abnormal and it was necessary to use a day and night shift in order to make any progress.

By the end of this month the new Newark factory will be working under "full steam," and the production of Meisselbach motors will be accomplished on a scale far beyond comparison with the output of the old plant. Manufacturing facilities in the new factory are ideal, for, instead of turning out Meisselbach motors in a plant of fifty small rooms, which comprised the old factory, every modern convenience is afforded the factory staff in the new Newark works. Mr. Heineman has been spending quite some time in the Newark plant during the past few weeks, taking personal charge of the many important details incidental to the removal to and the equipment of the new Newark factory.

MANAGER OF THE LUCKY 13 CO.

Max Bartelstone, a cousin of David Bartelstone, head of the Lucky 13 Phonograph Co., who for many years has held some very important positions in the plate glass industry, has recently severed his connections with that field and has been appointed general manager of the Lucky 13 Phonograph Co.

Max Bartelstone, although a comparatively young man, has demonstrated his ability as a business executive in many ways, and his qualifications to assume his new duties are excellent. The ever-growing business of the above company has forced it to enlarge its organization considerably, and plans to handle a greatly increased business are well under way.

FORCEFUL NEWSPAPER PUBLICITY

An attractive advertisement was used by the Vitanola Talking Machine Co., of Chicago, in last Sunday's *Times*, featuring a reproduction of the artistic Vitanola publicity now appearing in the leading national magazines. At the bottom of this advertising was a list of Vitanola dealers in metropolitan territory, this list appearing over the signature of the M. M. Roemer Sales Corp., New York, local Vitanola distributor.

The length of the list and the standing of the dealers handling the Vitanola machine in this territory emphasize the remarkable popularity achieved by this line in Greater New York during the past year or two.

IMPORTANT CHANGES IN VICTOR CO. EXECUTIVE BODY

Leon F. Douglass and A. C. Middleton Join Advisory Committee—Succeeded as Directors by C. G. Child and E. E. Shumaker—Walter J. Staats Is Treasurer and Edward K. MacEwan Secretary

A number of interesting and important changes in the executive organization of the Victor Talking Machine Co. have recently been completed.

Leon F. Douglass and Albert C. Middleton, two of the original incorporators and directors, resigned as directors and accepted appointment on the newly organized Advisory Committee, by whom important matters of policy and operation are discussed before consideration and decision by the Board of Directors.

It will be recalled that Mr. Douglass, who for several years past has been chairman of the board and will continue as chairman of the Advisory Committee, was the Victor Co.'s first vice-president and general manager and that, working in close co-operation with Eldridge R. Johnson, the founder and president, he developed and carried on the company's marketing system during the formative stage of the industry. During the past ten years or more Mr. Douglass has not enjoyed good health and has necessarily been less active in the company's affairs.

Mr. Middleton was also one of the incorporators and original directors of the Victor Co. For a period of thirteen years, from 1901, he held the office of secretary, relinquishing the duties of that office in 1914 because of a desire to be less active in business and to have more time for his private interests.

To fill the vacancies in the board Calvin G. Child and Edward E. Shumaker were elected directors.

Mr. Child is, of course, well known to the trade through his long connection with the Victor Co. as director of the Recording Laboratory. The development of the Victor Co.'s magnificent record catalog has been his particular work.

Mr. Shumaker has spent his entire business life in the service of the Victor Co., having been purchasing agent during the past nine years. This promotion will call attention to the tremendous problems which a manufacturer on such a large scale has to contend with in the procurement of raw materials and supplies. The volume of business transacted by the Victor Co.'s purchasing department, under Mr. Shumaker's direction, is very large indeed and the importance of the department's work is attested by the election of its head to membership in the Board of Directors.

Walter J. Staats has been elected treasurer, succeeding Charles K. Haddon, who will devote his entire time to the duties of his office as vice-president. Eugene F. Haines, Frank B. Middleton, Jr., and George W. Jagers have been elected assistant treasurers. It is interesting to note that all of these gentlemen have long years of service with the Victor Co. to their credit, this fact also indicating the belief of the Victor Board in the sound theory of promotion within the organization.

Edward K. MacEwan, another veteran of the Victor organization, has been elected as secretary of the company, succeeding Ralph L. Freeman, who resigned that office in order to devote his entire time to the problems connected with the distribution of the Victor Co.'s vast output.

STRATFORD CO. ENTERS TRADE

New \$1,000,000 Concern Erecting Plant in Ashland, O., to Manufacture Period Models of Machines—Prominent Men Interested

The Stratford Phonograph Co., a new organization capitalized at \$1,000,000, has purchased a large plot of ground in Ashland, O., and is erecting a modern up-to-date daylight factory in that city. The plans are said to call for equipment capable of turning out 100,000 machines a year in period models only. It is expected that the firm will be ready to ship within ninety days. The president of the new concern is F. P. Amreihn, who was for a number of years Detroit manager of the P. T. Stark Piano Co. J. P. Kearney is the auditor of the company, and Seth Gongwer is the treasurer. The latter, by the way, is also the treasurer of Ashland County, O. A. B. Cornell, president of the A. B. Cornell Co., New York, is secretary of the new organization. One of the directors of the new company is C. H. Yahrling of the Yahrling & Raynor Piano Co., Youngstown, O., who is also director and president of the Ohio State Music Trades Association.

Equipment is rapidly being installed in the new quarters of the company, and it is expected that samples of the instruments can be forwarded to the trade within a very short time.

B. R. FORSTER ON WAY TO COAST

B. R. Forster, president of the Brilliantone Steel Needle Co., was reported, just before going to press, at Omaha, Neb. He has met with great success so far on his trip and will continue on to the Pacific Coast. The Brilliantone Steel Needle Co. has established a remarkable record in its sales thus far this year. The volume of sales for the first two months in 1920 has already exceeded the entire business done during 1919.

CRESSEY & ALLEN EXPANDING

PORTLAND, ME., March 6.—Due to the rapid growth of the Victor business of Cressey & Allen, the directors of the company are planning to remodel and enlarge this department. This enlargement will apply to both the wholesale and retail branches and the most modern equipment will be installed. Work will be begun soon on the comprehensive plans and will be rushed to completion.



Size: 6" x 6" x 12"

"Take Your Music With You"

"CIROLA," the only PORTABLE Phonograph without sound chamber; has twin spring motor; highly nicked metal parts; is finished like a Piano; built like a Battleship; folds like a suitcase; weighs 16 lbs.; plays all records better because the good fresh air is its sound amplifier; and we will give \$10,000.00 for any Cabinet Phonograph at \$100.00 that will produce a larger volume of tone. Write for our proposition quickly. Enterprising dealers everywhere are rapidly stocking these Spring and Summer Whirlwinds.

CIROLA DISTRIBUTING CO., Inc.
Distributors of the
CIROLA PHONOGRAPH

PROMPT DELIVERIES

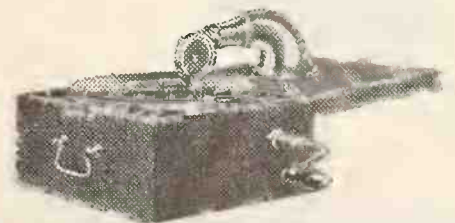

203-04 Colonial Trust Bldg.
Phone Spruce 6340
PHILADELPHIA, PA.
U. S. A.

SOUVENIRS RECEIVED BY T. A. EDISON ON BIRTHDAY

Among the unusual souvenirs received by Thomas A. Edison upon his seventy-third birthday anniversary recently were a number of scrapbooks, including two from an Edison jobber, containing clippings concerning nearly 800

Creation during the year. The campaign is declared to be one of the most elaborate ever attempted in the trade and Mr. Edison was much interested in the various features as set forth in the book. The accompanying photo-



Thomas A. Edison Inspecting Birthday Scrapbooks

tone tests held in the jobber's territory. Of particular interest was the volume outlining in detail the elaborate sales and advertising campaign prepared by Thomas A. Edison, Inc., for the purpose of exploiting the new Edison and Re-

graph shows Mr. Edison with William Maxwell, vice-president of the company, and his son, Charles Edison, inspecting the sales campaign. This is an excellent "human document" of the great inventor.

PLAZA
**BUY YOUR
 ACCESSORIES**
"All From One Source"



BUBBLE BOOKS

*Music, Book
 and Songs*

All In One

Very few other toys or novelties have had the wide publicity of BUBBLE BOOKS.

Because of this extensive advertising campaign, the sales last year amounted to over 1,000,000 copies. Are you getting your share of this Million Dollars?

BUBBLE BOOKS are not merely playthings of an hour. They are of real educational value.

They sell on Sight.

Eight Titles.

Write for descriptive circular and liberal discount proposition.

Retail Price \$1.25



PLAZA MUSIC CO.
 18 WEST 20TH STREET
 NEW YORK

PHONOGRAPH CASES

Reinforced 3 ply veneer
THE STANDARD CASE
 for Talking Machine and Records

and
**Plywood
 Cases**

ARE SYNONYMOUS

For 10 years phonographs have traveled in plywood cases and have reached destination in perfect condition.

Our capacity and experience in manufacturing insure your getting good service and well made cases.

Let us figure on your requirements.



Made by

PLYWOOD CORPORATION

GOLDSBORO, N. C.
 Mills in Va., N. C., and S. C.
 Chicago Office, 111 Monroe St.



The **STONE PIANO COMPANY**

Northwest Distributors for

The **AEOLIAN-VOCALION**

and the

NEW VOCALION RECORD

THE AEOLIAN-VOCALION has made a success—a phenomenal success. The public—that great jury of award—has passed upon the Aeolian-Vocalion and accorded it the premiership of the phonograph world.

The same jury is now passing upon

the new lateral cut VOCALION RECORD—that wonderful companion of the Vocalion. Even now the verdict is rendered—for the Vocalion Record is already taking the position to which it is rightfully entitled, as the most musical, most perfect, most satisfactory phonograph record ever produced.

STONE PIANO COMPANY

Distributors

MINNEAPOLIS
MINNESOTA



F A R G O
NORTH DAKOTA



MODEL "AA"—OPEN
Mahogany or Oak
14½" high; 16½" wide; 20¾" deep
Like the more expensive Models,
"AA" will play all makes of Disc
Records.

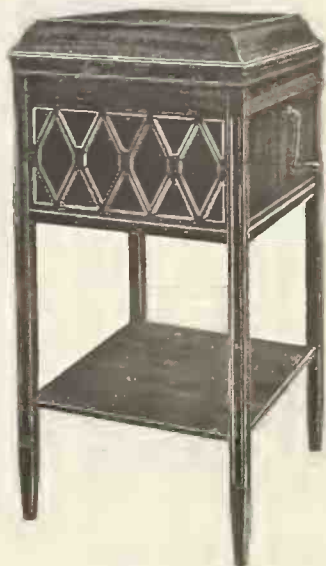

MODEL "A"
Mahogany or Oak
17" wide; 19" deep; 42" high
This is an exceedingly artistic
model, built to meet a popular de-
mand. Nickel-Plated Hardware is
used throughout, and the shelf for
Albums is made of five-ply veneer.



MODEL "B"—CLOSED
Mahogany, Walnut or Oak
18" wide; 20" deep; 43¾" high



Crafts

Superiority

is being recognized far and near. Not only has the CRAFTS Phonograph had a cordial reception in America, but England is interested in the CRAFTS line. A substantial Music House there seeks the representation of CRAFTS Phonographs. Christiania, Norway, too, is calling for the CRAFTS Phonograph. Inquiries likewise have come from Japan and other foreign countries. This, coupled with the fact that heavy demands are being made upon us by dealers already appointed, should convince the trade that CRAFTS superiority is established.

The CRAFTS Phonograph is truly an artistic musical instrument, as well as an excellent mercantile commodity—hence attractive either from an artistic or a commercial point of view. The CRAFTS line opens up avenues of increased profit for dealers.

Each and every CRAFTS Phonograph is carefully constructed by painstaking workmen, guided by a master mind. From the moment the lumber is placed in the dry kilns until the finished product is delivered to the carrier, it is handled by those who take a personal pride in it. Our achievement is the result of mechanical ingenuity, the application of scientific principles, plus an efficient organization and the unified interest of happy, contented workers. Each hand in the mill, each cabinetmaker, each assembler, each packer, each chauffeur seems to be proud of the part he plays in building the success and the reputation of The House of CRAFTS.

Much territory is still open—and it is better to offer the CRAFTS Phonograph in competition than to meet it that way!

Does not good business dictate that you at once

"Talk with CRAFTS"

?

A. J. CRAFTS PIANO CO.

Manufacturers

RICHMOND

VIRGINIA



MODEL "C"—CLOSED
Mahogany, Walnut or Oak
22¾" wide; 24½" deep; 46¾" high

Featuring the **MUSICAL** POSSIBILITIES of the **TALKING MACHINE**

[Note:—This is the 44th of a series of articles on the general subject of the musical possibilities of the talking machine by William Braid White. The aim of the series is to develop these possibilities from all angles, thus opening up fields for sales expansion neglected wholly or in part.—EDITOR.]

WHAT SHALL WE SELL?

Not so long ago, the representative of one of the greatest weekly publications in the world, judged by circulation and influence, was discussing with me the probable tendencies of the music industry of this country. His ideas were both candid and disconcerting. Generally speaking, the music trade was to him a small and rather obscure luxury trade, not at all comparable with the larger and more basic industries, and certain to sway back and forth with every passing breath of industrial change. In the course of conversation, I was, of course, able to point out to our friend that there was another side to the shield. The music industries are not indeed as large as we, at least, should like to see them. But why is this? Obviously it is because the people of this country are not thoroughly awake to the possibilities of music. The very moment any one tries seriously and sincerely to organize musical activities, on the right scale and with due regard to the ideas of his community or of the group within which he works, it is found that the public takes to music like the proverbial duck to water. The musical desires of the American people have never yet been brought out. The incoming foreigner has often brought with him a wealth of native musical talent, a wealth of musical tradition; but it has almost uniformly been crushed out of him by the intolerable pressure of industrial life. Yet the desire is there, and it is common to the masses of the people everywhere. The people are hungry for music and hungry as never before.

The Great Need

The most serious defect in the spirit of the music industries is to be found in their failure to detect these facts and in their consequent lack of understanding of the wonderful future which awaits them. They have failed hitherto to grasp the fundamental fact that the people want music almost more than they want anything else save food and clothing, and that any apparent hesitation on their part in putting this desire into expression is mainly due to the cold and narrow attitude of music merchants. The

point I want to make is simply that the future of the music industries will have been assured, no matter what may be the coming economic or social events, just as soon as the industries recognize that they have never yet attained to anything like the possible and legitimate national distribution of musical instruments. Once it is recognized that the number of pianos, of player-pianos and of talking machines, so far distributed in our best year, is far below the natural normal consumption of the American people, there will be an understanding also that the reason for this is to be found in our faulty method of merchandising. When we can clearly see that we have sold, and are selling, all musical instruments on the wrong basis, we shall be in a fair way to finding the right one in due course.

There may be some merchants who feel that the present trend of events in the economic world portends a reaction towards harder times. This may or may not be a correct idea; but I insist that, whether it be correct or not, the music industries have no cause for uneasiness. Let us devote ourselves to considering the specific case of the talking machine industry, from the retailer's point of view, and then we shall be able to focus our ideas effectively.

The Great Truth

No one knows, of course, how many talking machines have already been made and sold; but the census figures, when they are available, will probably confirm my belief that about three millions of talking machines have so far found their way on to the market and are now in use. At the present moment it is, I think, not improbable that ten thousand machines a day are being made. Allowing for an average of twenty-one working days per month, one may suppose that nearly two and a half million machines will be turned out this year. Now the present population of the United States is about one hundred and ten millions, divided into more than twenty millions of families. It is plain that the absorptive capacities of the contemporary population will not be reached for some years at this rate, not mentioning the annual population-increase, which may be set down as between two and a half and three millions.

This refers to machines only and does not take account of the already enormous aggregate demand for records; a demand which, as we

shall see in a moment, is just as far below normal as the demand for machines. It should seem plain to the most frightened mind that the future of the talking machine merchant is sure.

Yes, it is; but not so long as the present narrow ideals prevail. I mean simply that, if the talking machine retailers are to make their future secure, despite of any and every possible future difficulty and danger, they must wake up to the supreme truth that when they sell a talking machine or a bunch of records they are not filling a demand for a thing of wood and clock-work, but for the idea of music in the home; not for a bundle of shellac discs but for the idea that to hear the voice or the strings of a great artist is something joyful and to be desired as a pearl of great price.

The Horrible Example

The piano men have had the same difficulty and have fallen into the same error. For years pianos have been sold on the plea that a piano is a necessary piece of furniture which any one can buy on very easy terms. The idea of the piano as something to buy because it is the music-giver which brings the greatest amount of musical happiness in the easiest way, has but lately been thought of in the general practice of the trade. That is to say it had not been a practical thought until the competition of the talking machine came along. Now every one knows that it was the record which floated the talking machine; and consequently the entry of that machine into the music industry field inaugurated a real campaign to sell the idea of music, not the idea of a box of machinery, to the people. This idea the player-piano folks started; but they let it get away from them. The talking machine men started it also, and it begins to look as if they were in danger of losing it in turn.

The One Sound Basis

Yet the only possible sound basis for the future of the talking machine lies in regarding and treating it purely and simply as "music" in the concrete, as the means for bringing music into the home. To take up any other sort of position is to invite all the uncertainties which in due course will visit and plague every non-staple industry in this country. The Music Industries Chamber of Commerce realizes this

(Continued on page 181)



HERE IT IS

The

**FLETCHER UNIVERSAL
TONE ARM and REPRODUCER**

Gives Proper Playing Weights for all Records. No Adjustment Screws or Springs.

SAMPLES \$8.00

Specify 8½" or 9½" arm

FLETCHER-WICKES CO., 6 East Lake Street, Chicago, Illinois

THE GEORGE McLAGAN FURNITURE CO., STRATFORD, ONTARIO, EXCLUSIVE CANADIAN AGENTS

The Fern-O-Grand Co.

Announces the completion of its removal into its new and enlarged factory building and with the addition of new equipment will before long be able to make deliveries more rapidly

The Reception Offered the Fern-O-Grand

"The Phonograph with the Grand Piano Tone"

has been beyond our fondest expectations, and re-orders, particularly, have been most flattering.

The FERN-O-GRAND is built under the direction of men whose life work has been that of expert piano builders.

Its accurate reproductions of the finest tone shadings make it the master musical instrument.

Its Construction lends itself to volume and tonal quality without the least restriction.

Electrically Illuminated and equipped with an easily adjusted automatic stop, it offers the latest attractions to the discerning buyer.

The Cabinet Work is of the finest and all our models are made in Mahogany, Ebony, Walnut and Oak.



THE FERN-O-GRAND
"The Phonograph with the Grand Piano Tone"
Equipped with Fern-O-Grand Reproducer (Ellis Patent),
Automatic Electric Light and Stop and
Lorimer Heavy-duty Motor

AGENCIES FOR THIS HIGH-GRADE AND POPULAR MACHINE
ARE BEING ALLOTTED TO RESPONSIBLE DEALERS AND JOBBERS

CORRESPOND WITH THE

FERN-O-GRAND COMPANY

212-220 W. Central Parkway

Cincinnati, Ohio

POSSIBILITIES OF THE TALKER
(Continued from page 179)

fact and is beginning to organize nation-wide propaganda for stimulating the natural love of music among the people. Once make that desire and stir it into active life and there will be nothing to worry about in the future of the trade. This is the one great principle, in fact, which must now be grasped by every merchant who would prosper; namely, that the talking machine and record must henceforth be understood as "means to music." Thus understood and thus advertised, they will not need to be sold by the retailer. He will sell "music." Materially of course he will be dealing in machines of wood and clock-work, discs of shellac and paper; but in fact he will be selling "music." His sole business will be to stimulate the love of music in his community and then to show how the talking machine and its records are the music-means supreme. If he will work along these lines he will find for himself a future which no winds or storms of adversity can destroy.

These thoughts may seem to some to be radical; but the whole tendency of the most advanced merchandising thought is in this direction. Never forget that the talking machine market is not, and for many years can not, be normally supplied by the present manufacturers, even after we add those who will enter the industry in the course of time. But it can be killed by stupidity. Stupidity and not guile has furnished usually the cause of all the disasters which from time to time have overwhelmed the commercial as well as the political and social worlds.

SCHMOLLER & MUELLER BURNED OUT

Prominent Omaha Music House Suffers Loss of \$315,000 As a Result of Blaze Which Guts Building—Resume Business Immediately

OMAHA, NEBR., February 28.—Fire which swept through one of the principal blocks in the business district of the city yesterday morning completely destroyed the building and stock of the Schmoller & Mueller Music Co., at 1311-13 Farnam street, causing a loss to the company estimated at about \$315,000, \$240,000 on the stock and \$75,000 on the building. The loss is well covered by insurance.

The fire broke out at about 1 o'clock in the morning from some undetermined cause and the building was a mass of flames before the fire department could get into action. The flames spread to the upper floors of the Brunswick-Balke-Collender Co. building next door, causing a loss of \$50,000 to that company's stock, and resulting in the ruining of a large number of phonographs as well as of other products manufactured by that company.

The Schmoller & Mueller Co. arranged immediately to resume business and secured temporary quarters in the Omaha Printing Co. building, at 15th and Dodge streets. The com-



SOSS
INVISIBLE HINGES

preserve beauty. The fine cabinet work which is required in many instances to preserve the disguise of talking machine cabinets requires that hinges be as inconspicuous as possible. Soss Hinges are *invisible*.

Write for Catalogue T.

SOSS MANUFACTURING COMPANY
Grand Avenue and Bergen Street
Brooklyn, New York

pany fortunately had in the railroad yards waiting to be unloaded three carloads of pianos and two carloads of talking machines, and the manufacturers in the East were immediately advised to rush new stock. W. H. Schmoller, president of the company, announced that the employes laid off as a result of the fire would receive their salaries regularly until such time as their services should again be required.

COLUMBIA ADVERTISING FOR MARCH

The advertising department of the Columbia Graphophone Co., New York, has prepared for the use of its dealers in March a splendid batch of advertising that can be used by the dealers to excellent advantage. This advertising features the various artists who are represented in the March list, and there is a diversity to this publicity that makes the advertising adaptable for use in any section of the country.

Among the artists who will be featured in the mammoth advertising campaign of the Columbia Co. this month are Rosa and Carmella Ponselle, Riccardo Stracciari, Oscar Seagle, Al. Jolson and the Ted Lewis Jazz Band. There are also several advertisements featuring the various classes of Columbia records, such as the latest dance and popular hits, while another group of advertisements is devoted exclusively to presenting some of the distinctive merits of the Columbia Grafonola.

NEW SONORA PERIOD PRICE-LIST

Sonora Phonograph Co. Introduces Some New De Luxe Period Designs and Also a Series of Moderately Priced Period Models

The Sonora Phonograph Co. has announced a new price list for its period models. Coincident with the inauguration of this price list, the company also announced a new series of moderate-priced period models, which attracted general attention at the Music Show. These models will retail at \$325, and comprise the following cabinet designs: Italian Renaissance, Queen Anne, Adam, Louis XV, Louis XVI.

The price list for the other Sonora period models is as follows: Colonial, \$425; Sheraton, \$525; Louis XVI de luxe, \$575; William and Mary, \$575; Duncan Phyfe, \$725; Adam de luxe, \$775; Chippendale, \$775; Louis XV de luxe, \$1,250.

The company also announces a series of new de luxe designs in period models which represent exceptionally artistic cabinet work and are exact replicas of the periods they follow. This new series comprises the Jacobean, antique walnut, \$1,650; Polychrome, \$1,900; Gothic, antique walnut, \$1,750; Polychrome, \$2,000; English Renaissance, antique walnut, \$2,250; Polychrome, \$2,500; Italian Renaissance de luxe, antique walnut, \$2,250; Polychrome, \$2,500.



HAAG RECORD FILES

Give your customers an opportunity to buy a real record file. A slight pressure on the key hands you the record from non-binding compartments.

PRICES NET TO DEALERS

Model "A" (As shown in cut).....	\$11.25
" " "B" (Same, without ejector keys).....	10.25
" " "C" (Made especially for Edison Model A-100).....	19.00
" " "D" (Same, without ejector keys).....	18.00
" " "E" (Fits into drawers of Edison Laboratory Models).....	6.50
" " "F-100" (Upright Cabinet. Holds 100 of any record. With ejecting keys).....	48.00
" " "G" (Made in Rouge or Natural for Edison Chalet Model).....	26.50

Write for Complete Catalogue

Manufactured Exclusively by
HAAG & BISSEX
PHILADELPHIA, PA.

Distributed Exclusively by
BLAKE & BURKART
Herbert E. Blake, Successor
1100-1102 Walnut Street
PHILADELPHIA, PA.

The
BEACON
 PHONOGRAPH

This instrument is created for the better grade of dealer who desires to handle a phonograph that is distinctive and of unquestionable superiority to those now on the market.

The Beacon tone is marvelously sweet, the cabinets of an exclusive design, and the motor and tonearm of the finest possible construction and workmanship.

There are five models, retailing at \$70, \$110, \$150, \$225 and \$350.

PERIOD MODELS from \$375 up

Dealers or jobbers, considering franchises for 1920, should send in their applications as soon as possible.



Patents Pending
 Model No. 6, Price \$110.00
 Mahogany, Oak and Walnut

Beacon Phonograph Company

19 Milk Street

Boston, Mass.

Factories at Somerville and Waltham, Mass.

Western Representatives: Moeller-Waters, Inc., Lyon & Healy Bldg., Chicago, Ill.

Beacon
Phonograph

The Value of a **BEACON** FRANCHISE

There is incalculable value to the dealer in holding a franchise for a high-grade phonograph which has laid its permanent foundation for success.

In a very short time the BEACON franchise will be as valuable as any now existing: because it conforms to all established merchandising principles.

We offer the

Beacon Phonograph

"made as well as a phonograph can be made"
rich in tonal properties, unique in design, supreme in comparative value.



Very liberal discounts are offered. Moreover, BEACON dealers enjoy the advantage of the BEACON Cooperative Advertising Campaign in their own home town. These features make the BEACON Franchise irresistibly attractive.

We shall be happy to answer your inquiries.

Moeller-Waters, Inc.

Western Representatives

LYON & HEALY BLDG.

CHICAGO

MOELLER
WATERS
INC.



NEW CLAYOLA DISTRIBUTOR

F. Altschul Sells Interest in Schilling Piano Co. and Plans Progressive Campaign in the Furthering of the Interests of the Clayola

Announcement was made this week of an important deal which was consummated a few days ago, whereby Frederick P. Altschul has acquired the Eastern distribution of the Clayola phonograph, manufactured by the Clayola Phono. Co.



Frederick P. Altschul

Mr. Altschul has been identified with the music industry for over ten years, having established at that time the Schilling Piano Co., 112 West Twenty-third street, who in recent years have been distributors of the Stradivara phonograph. At the first of the year Mr. Altschul sold his half interest in the Schilling Piano Co., and has made arrangements to give the Clayola phonograph a strong representation throughout the East, having already acquired the services of four well-known and popular salesmen, who are

at the present time covering the Eastern trade. Mr. Altschul has leased the former headquarters of the Schilling Piano Co., and will be located there after May 1. In the meantime, extensive alterations will be made, the result of which will be one of the most attractive wholesale phonograph establishments in New York.

In speaking of the Clayola phonograph, Mr. Altschul stated to a representative of The World this week: "I feel that I have secured a splendid proposition. The Clayola phonograph comes in five models, including a beautiful Console model. Besides this, it is the only machine that has a tone chamber made of the same excellent quality of spruce which is used in the sounding boards of the world-famous Steinway pianos. The cases are also manufactured of the very finest veneers, and great care has been displayed in the artistic finish of them. In the new warerooms we will have a complete line of instruments on display at all times, and dealers who are visiting New York will be welcome there after May 1."

MUSICAL APPEAL IN ADVERTISING

Boys' Magazine Uses Talking Machine Illustration to Put Its Own Argument Across

Recognizing the fact that the talking machine has to-day become a universal instrument with which everyone is thoroughly familiar, the American Boy in its advertisement in Printers' Ink in the issue of March 4 used at the top of the page a picture showing a group of boys enjoying themselves at home with the latest records. An insert recalls to mind the days of childhood long ago when the boy's chief delight was to make weird melodies on instruments of his own invention. The text of the ad said: "When father was a boy a tissue paper and comb horn furnished melody sweet to his soul, and a mouth organ an ecstasy of musical delight. Real music in the home was about as frequent as when mother had a minute from her duties and wasn't too tired to sit down at

You Talk Quantity

ON
Gram. Brakes, Needle Cups, Needle Rests, Cover Supports, Crank Handle Escutcheons (with fibre washer), Modifier Rod Escutcheons, Stylus Arms and on any Special Parts.

We Will Talk Price

Immediate Deliveries



Phonograph Hardware Specialties Manufacturers
GRAND STREET & WEST BROADWAY
NEW YORK CITY

the old square. Nowadays the boy operates the player-piano or phonograph and gives his mother a rest. He begins early to develop through them a love for good music and a desire to take up an instrument of his own."

Some very good points which dealers might well make use of in their own advertising.

EMERSON EMPLOYEES HOLD DANCE

The Emerson-Graphic Savings Club, consisting of employes of the manufacturing plant of the Emerson Phonograph Co., held a full dress and civic ball at the Yorkville Casino, New York, on Wednesday evening, March 3. The affair was a decided success, one of the features of the evening being the music, which was rendered by the Emerson Dance Orchestra. Among those present at the ball were several of the executives of the Emerson Phonograph Co.

J. W. Milligan, of Carbondale, Ill., has purchased the entire interest of the Milligan & Fly Music Co., of that city.

REAL MERIT WINS

HIGHEST QUALITY MOTORS
Universal Tone Arms



RECORDIONS make friends easily by their wonderful tone and stay sold on account of the unchallenged quality.



PLAYS ALL RECORDS PERFECTLY



RECORDIONS are selling fast. We have but recently enlarged our factory floor space and shall do so again. There's a Good Reason.

OUR MOTOR TRUCK DELIVERY

is QUICK and SAFE and has many other advantages. We therefore especially invite Dealers from GREATER NEW YORK and adjacent territories to write for the Latest Booklet and Prices or to call and see the

1920 MODELS now on Exhibition

at the newly-renovated office of the

Columbia Mantel Co., Inc.
Leonard and Devoe Sts., Brooklyn, N. Y.

Within walking Distance from Williamsburg Bridge Plaza
Also at the Industrial Exhibit at the 23rd Reg. Armory, Brooklyn, April 10 to 17

BE A LIVE WIRE—BE THE FIRST RECORDION DEALER IN YOUR VICINITY

HAPPENINGS IN THE DOMINION OF CANADA

TORONTO REPORTS ACTIVE TALKING MACHINE BUSINESS

Trade Keenly Interested in Fate of the Moratorium Act—Nordheimer Introduces Vocalion Lateral-cut Record to Canadian Trade—John Raper Co. Enlarges—New Concerns Open in Ottawa

TORONTO, ONT., March 4.—Musical activities in this city continue and the sale of talking machines and records keeps both manufacturers and dealers busy. New ventures are being undertaken by numerous individuals, showing that the field offers attractive opportunities. Just at this time the trade is interested in the fate of the Moratorium Act, technically known as the Mortgageors' and Purchasers' Relief Act. The attorney-general's department of the Ontario Government is now considering what action is wisest and will cause the least disturbance in business circles in dealing with this act. In a recent interview with those in a position to know The World was informed that no definite decision had yet been arrived at with regard to the action that would be taken, but was assured that it was the desire of the Government to take whatever action would least disturb business.

Three suggestions have been made and are being considered by the members of the Government and officials of the several departments. One is that the moratorium be allowed to lapse automatically. The second suggestion is that it be continued for another year. The third suggestion, and the one that, at present, meets with the approval of members of the Government, is that legislation be passed which will put things as they were before the act was passed. In other words, if a mortgage fell due six months after the act was passed, it will now fall due six months after it is called to lapse.

The Nordheimer Piano & Music Co., Ltd., Canadian distributors of the Aeolian-Vocalion line, have announced the introduction of the new Vocalion lateral-cut record to the Canadian trade. T. C. Wright, manager of the Nordheimer wholesale Vocalion department, is most enthusiastic over the quality of the new product and considers the immediate active demand for Vocalion lateral records a good omen for their future in Canada.

The Phonola Co. of Canada, Ltd., Elmira, Ont., has opened a branch in this city under the management of R. C. Willis. A full and complete stock of the various models of the company is being carried in stock, also records, which will now give dealers a system of immediate deliveries.

The John Raper Piano Co., Ltd., Ottawa, Ont., is enlarging its Victrola departments and will spend \$20,000 in alterations to its store, which, when completed, will supply much more room for the enlargement of the phonograph end of the business, which is growing at a rapid rate.

The Musical Merchandise Sales Co. of this city has been appointed Canadian distributor for the wholesaling of Brilliantone Steel Needles.

H. A. Fricker and Healey Willan, both of whom spoke at the inaugural dinner of the Canadian Phonograph Manufacturers' Association, are giving a series of lectures at the University of Toronto in connection with the course leading to Bachelor of Music.

Charles Clarke, who has been advertising manager of the Christian Guardian for the past year, has resigned his position to become the representative of the Columbia Graphophone Co. in the West.

W. C. Strong, one of the senior officers of the General Phonograph Corporation, New York, has just returned from a call at the Kitchener factory of his firm. Mr. Strong expects to leave shortly for England to visit the London and Paris branches.

W. B. Puckett, John E. White and F. A. Trest-

rail, of the Musical Merchandise Sales Co., were recent visitors to Chicago and all three returned bubbling over with enthusiasm over the new Brunswick period phonographs to be announced shortly.

Leach, Clegge & Leach is the name of a new firm to be organized shortly in Ottawa. They will open up phonograph and piano show rooms at the corner of Bank street and Laurier avenue.

Carl Pelton, formerly with the John Raper Piano Co., Ltd., Ottawa, has formed a partner-

PLEASING CONDITIONS IN MONTREAL

Musical Appreciation Growing, Due to Spread of Talking Machine—Victor Records Increase in Price—Twilight Recitals Draw Crowds

MONTREAL, CAN., March 5.—Conditions in the talking machine and record trade continue to be excellent in the Dominion, with many gratifying evidences of a growing and widespread appreciation of music among all classes. The talking machine has done much to aid this movement, as the several prominent artists, among them Paul Dufault, the well-known Canadian tenor and Victor artist, have testified to The World. One of the features of the trade is the increase in price of the Victor records, the ten-inch record now selling for \$1 and the twelve-inch record for \$1.65.

Considerable interest is being manifested in the appearance in Montreal this month of the eight star Victor artists. This novel concert is one which will not only attract lovers of the popular grade of music alone, but is one with a strong appeal to all devotees of music.

Layton Bros., Edison and Columbia dealers, recently tendered their staff and employes a dinner and dance which was largely attended and was a most unqualified success from every angle.

Twilight recitals featuring the new Edison, given by N. H. Phinney, Ltd., Halifax, N. S., are still an immense drawing card with capacity houses every week, bad weather having no ill effects on the size of the audiences.

H. H. Duchesne, Canadian distributor of National Vitaphone products, has opened an office here under the management of E. J. Cerre. Vitaphone tone arms are now being produced in Canada and Mr. Duchesne stated to The World that in a short time deliveries of the motor would also be an accomplished fact.

A wholesale warehouse has been opened in Halifax, N. S., by His Master's Voice, Ltd. R. H. Murray, who has been connected with this company for several years past, has been placed in charge.

New firm registered recently include La Cie. de Piano et de Phonographe, of St. Angele de Laval, Que.; Regent Piano Phonograph Co.; Bayeur Frères; Mozart Talking Machine Co.;

ship with Arthur Pellerin. The new firm will be known as Pellerin-Pelton Co., Ltd., and business will be carried on at 187-89 Rideau street, where a stock of phonographs of various makes will be handled.

B. F. Stewart, Rock Island, Que., has taken on the local representation of His Master's Voice records.

Lucy Gates, the exclusive Columbia artiste, recently visited Montreal in concert recital. Dealers report increased sales through her visit.

Torontoans are eagerly looking forward to the concert to take place shortly in Massey Hall of the eight Victor artists who will appear in person not only in this city but other cities in Ontario.

Caron Piano & Phonograph Co.; La Cie. de Phonographe de St. Hyacinthe, Que.

A project for a soldiers' memorial and music temple is being seriously considered by the citizens of Montreal and may take definite shape shortly.

PRAISE FOR THE TALKING MACHINE

Canadian Writer Points Out Position of Music Teacher Toward Modern Machine

WINNIPEG, CAN., March 3.—A writer in the Manitoba Free Press says:

"Not many years ago the average music teacher felt entitled to regard the talking machine with some scorn. It seemed impossible to believe that an instrument producing such monstrous sounds could ever emerge from the slums of the Empire of Art. Yet, to-day, the talking machine is a worthy member of the musical fraternity, having definite accomplishments in the world very much to its credit.

"One of the most significant of its accomplishments is the increased respect it has brought to the music teacher. It has brought the subject of music before so wide a section of the public that it has immeasurably strengthened the standing of the music teacher in his community. Where music is honored, the music teacher also is counted among the prophets. Yet if the music teacher only knew it, the talking machine can be of even more direct aid to him. It can be of the greatest possible assistance in his own studio."

A report from Edmonton, Alta., says that Heintzman & Co., Ltd., have announced the purchase of the Cristall block on Jasper avenue, close to their present premises. In the new store there will be several soundproof rooms for demonstrating Victrolas, Sonora and Brunswick phonographs and His Master's Voice records, the present accommodation being altogether too inadequate for demonstration purposes.

D. D. Gordon has opened a talking machine store in Ottawa on Sparks street. The new store, which handles both Edison and Columbia machines, is attractively fitted up.

Talking Machine Supplies and Repair Parts

SPRINGS, SOUND BOX PARTS, NEEDLES

THE RENÉ MANUFACTURING CO.
MONTVALE, NEW JERSEY

THE NEW BUSINESS ALIGNMENT

following the excesses of the war-period, is upon us. Its predominant quality will be Conservatism. In the great phonograph industry, the conservative merchant, representing only lines of quality and established prestige, will inevitably win over all competition less soundly based.



WIDDICOMB No. 12

THE WIDDICOMB REPRESENTATION

opens the door to
the

QUALITY

TRADE

in each merchant's
community.

The name WIDDICOMB, for half a century associated with the best in furniture craftsmanship, takes on even higher significance when applied to a Phonograph. It then implies "*A Finished Product*," in every sense of that term, made for the quality trade which cares only for the very best.

Interested merchants are invited to correspond with

PHONOGRAPH DIVISION

THE WIDDICOMB FURNITURE CO.

Grand Rapids, Mich.

O. K. HOUCK CO.'S NEW PURCHASE

Buy New Building on South Front Street, Memphis, to House Wholesale Victor Department After September 1—To Remodel Present Main Street Store at the Same Time

MEMPHIS, TENN., March 8.—The O. K. Houck Piano Co. has recently purchased the building at 100-102 South Front street, now occupied by Stewart-Gwynne & Co., and will take possession of the premises on September 1, for its wholesale Victor department. The building has a frontage of forty-seven feet on Front street and extends back 148 feet, cost \$42,500, and the O. K. Houck Co. plans to expend several thousand dollars more in remodeling the structure to meet the special requirements of its business.

Upon taking over the Front street property in September, the Houck Co. will start immediately to remodel the building at present occupied by the company at 103 South Main street. New elevators, a sprinkling system, and a new heating plant will be installed, the entire front on the ground floor will be remodeled, and the interior will be re-equipped in a modern manner. The changes include the equipment of the first floor as exclusive retail Victor salesrooms, fitted with booths and other essentials. September 1 will mark the twenty-fifth anniversary of the Houck Co.'s opening at their present address on Main street.

OUTSIDE SIGN FOR PATHE DEALERS

A novel outdoor advertising sign has been prepared for Pathé distributors and dealers. This novel road sign measures ten by twenty-eight inches and is made of thirty gauge Bessemer steel, with an artistic design printed in red and black on a light yellow background. The sign contains the famous Pathé red rooster and the words, "We sell the genuine," followed by "Pathé Phonographs and Records." Space is left for the dealer's name and local address.

ENTER GENERAL EXPORT FIELD

Lucky 13 Phonograph Co. Arranges to Handle General Merchandise for Foreign Trade

The Lucky 13 Phonograph Co., of New York, has recently taken quite a position in the import and export field of general merchandise. This is due to the connections it controls in every country on the globe, to which it has for some years been shipping large quantities of talking machines. This company was practically forced to handle general merchandise through its various agents, who often forwarded samples, etc., and who desired service from the Lucky 13 Phonograph Co.

The Lucky 13 Co. will shortly make a special department of this division of its business and will arrange a display room for goods. It is intended to handle the complete output of manufacturers and perform valuable service to buyers.

In recent circulars sent to the trade, the commodities listed with the import and export departments of the Lucky 13 Co. comprise products from practically every industry.

David Bartelstone, head of the above company, recently stated he expects this department of his business to assume large proportions, and all indications since its opening point in that direction.

DEMAND IS PERSISTENT

CLARENDON, TEX., March 3.—Goldson Bros., who are exclusive dealers in Pathé phonographs and records, state that this line has scored a big hit in their city. The steady, persistent demand has far exceeded the supply. They predict that the exceptional business of the past will continue right through the year and are making their plans for a large business.

The Markenola phonograph has appeared on the market in Minneapolis and St. Paul. Next!

WORKING ON NEW WHITSIT BUILDING

New Structure in Columbus to Be Devoted Entirely to Wholesale Victor Business

COLUMBUS, O., March 8.—Work has started on the new building being erected by the Perry B. Whitsit Co., the well-known Victor distributors, to house their wholesale Victor business. The new building is located at Fifth and McKee streets, near the Pennsylvania freight depot. It will contain three floors and a basement, 62x120 feet, and will be built entirely of reinforced concrete. The first floor will be devoted to general offices and display rooms, together with the shipping department, equipped with interior loading platforms. The second floor will be devoted to records and accessories, and the third floor to machines and cabinets.

The building will be equipped throughout in the most modern manner and will provide unusual facilities for handling Victor wholesale business promptly and efficiently, the long experience of the Whitsit Co. enabling them to arrange matters most satisfactorily.

DOUGLAS SOMLYO GOES ABROAD

Douglas Somlyo, son of Arnold Somlyo, New York, export manager of the Baldwin Piano Co., sails for Europe this Saturday on the 'Imperator.' Mr. Somlyo will enter the import business, with headquarters in Madrid, Spain. Among other lines that he will handle will be the Wonder talking machine, manufactured by the Wonder Talking Machine Co., New York City.

DEMAND FOR NEEDLES GROWING

David Bartelstone, of the Lucky 13 Phonograph Co., in speaking of the steel needle situation recently, stated that despite the fact that he is constantly receiving and shipping needles in million lots he finds the demand for his products is steadily increasing.

Of Vast Importance to Edison Disc Instrument Dealers



Showing No. 95-A

A Queen Anne Creation. Designed expressly for use with the Chalet Model Edison Instrument equipped with the famous Eject-O-File Record Filing System. Produced in natural figured Red Gum and rouge Red. Dimensions: 20" wide, 22" deep, 32" high.

"The Eject-O-File"

The Eject-O-File is manufactured and owned exclusively by the Eject-O-File Co. Manufactured under U. S. mechanical and design patents.

The Eject-O-File is a most simple and efficient method of "Filing & Finding" disc Records at the desired time. Mechanism controlled entirely by gravity. Has no springs to get out of order and if you do not have an Eject-O-File in your home you do not realize what is best in Record Filing efficiency.



Showing No. 95

A straight line effect conforming with the Chalet Model Edison Instrument for which it is designed and produced. Equipped with the Eject-O-File Record Filing System. Dimensions and Finish same as No. 95-A.

Manufactured by

THE EJECT-O-FILE CO., Inc. HIGH POINT, NORTH CAROLINA

FACTORY AND GENERAL OFFICES

!!! Attention!!!

RECORD AND
WORD ROLL **Dealers**

Here are the season's five new big song hits. Numbers that you cannot afford to be without. Look over your stock and be prepared for calls. We have launched a big publicity campaign on each and every one of them.

STOCK UP NOW

"ROSE OF WASHINGTON SQUARE"

FANNY BRICE'S HIT IN THE "ZIEGFELD FROLIC"

"ALL THAT I WANT IS YOU"

THE NEW BALLAD BEAUTIFUL—OUR NEXT SONG HIT

"JAZZ BABIES' BALL"

A WONDERFUL RAG SENSATION—INTRODUCED BY FRISCO, "KING OF JAZZ"

"WILD FLOWER WALTZ"

MARY EARL'S SUCCESSOR TO "BEAUTIFUL OHIO" AND "DREAMY ALABAMA"

"ORIENTAL STARS"

A NOVELTY ONE-STEP SONG BY JAMES V. MONACO

These numbers are recorded on all talking machine records and player-piano rolls

PUBLISHED BY
SHAPIRO, BERNSTEIN & COMPANY, Inc.
Music Publishers

Cor. Broadway and 47th St.

New York

GLEANINGS *from the* WORLD *of* MUSIC

INSTRUMENTAL NUMBERS BEST POPULARIZED BY RECORDS

Due to Present Vogue of Orchestra Music for Dancing and Other Purposes This Class of Music Far Outshines the Ordinary Songs So Far as Records Go

From time to time there is discussion in music publishing circles as to the merits of the different channels used for popularizing and exploiting musical numbers. Invariably in some part of these talks the value of talking machine records in assisting in the popularizing of music is brought to the forefront.

Most of those who have given this matter close consideration can show examples where the talking machine has taken a prominent part in giving certain numbers popularity. With few exceptions, where such credit is given, it is found that the number is an instrumental one, or was presented on the records in instrumental form rather than as a song.

Several years ago the professional departments of the various publishing houses, in order to popularize certain works, made the vaudeville and concert stage the most important field for their endeavors. In the last two years, however, the vaudeville stage has lost much of its importance as a medium for song popularization. It is still important, but the results accomplished in the orchestra field have far overshadowed those from the singing profession in recent months.

The most successful numbers of the past eighteen months, those selling around two million copies or more, have won their early popularity to a great extent through the medium of the orchestra. It is hard to tell just why this is so, as we have always had orchestras, and what is termed the dance craze has been with

us well over five years. However, it is an admitted fact that the orchestras have performed great work. Such numbers as "Missouri Waltz," "Hindustan," "Beautiful Ohio," "Vamp," "Arabian Nights," "I'm Forever Blowing Bubbles," "Tell Me," "Ja Da," "Alcoholic Blues," "Dardanella," "Kentucky Dream," "Chong," "Tents of Arabs" and numerous others—all received much of their original popularity from the orchestra field, and this goes too for all "Blue" numbers, which generally receive their initial success from the orchestras and sometimes from the records.

That it is possible for the talking machine records to popularize a number has been proved with dance selections, and with what are termed "Blues." There have been occasions where dance and novelty numbers got much of their original popularity in the record field. This is true in the case of "Livery Stable Blues," and only last season the records did much to give popularity to a published blue number which was only a mediocre seller prior to its being recorded.

In the song field, the talking machine record, although probably doing its share in popularizing a work, has never demonstrated its value in that direction as strongly as in the cases above. The data regarding songs seem to show that these must first get their publicity from the concert and vaudeville stage. Of course this does not hold true where a number is as big a success instrumentally as it is in vocal

form, because from the instrumental angle the orchestras and records would serve to good purpose.

From the record maker's viewpoint, of course, there is no reason why he should go out of his way to record an instrumental number before it has attained popularity. However, they often do so. Especially is this true regarding novelties which they feel a need of in their catalog, and their various combinations of trios, quintets and orchestra often have in their repertoire an instrumental number which they do most cleverly and on the strength of which it is recorded. In this manner, numbers have been recorded and have won success with practically no aid from any other than the record field, thus demonstrating beyond dispute the power of the record to exploit a work.

That does not mean to say that a publisher would not use all the other avenues at hand to assist in a number's popularity, but it does say that the possibilities of the number were brought out through the medium of the record and gave the publisher the encouragement, and possibly the wherewithal to feature the number in a way that its discovered merit justified.

LACK OF INTEREST IN ONE-STEP

During the past season the one-step, so far as popularity was concerned, was more or less conspicuous by its absence. Probably this was due to the fact that there had not been any especially successful numbers produced of the one-step variety. Of late, however, the song writers and publishers seem to have taken more interest in works of that kind, and we may again see the one-step in the limelight.

Another PHENOMENAL and SENSATIONAL "HIT" from the pen of JOHNNY (S.) BLACK, writer of "DARDANELLA," with lyrics by FRED FISHER:

(WHEN THE SUN GOES DOWN IN) "CAIRO TOWN"

The same leaders who predicted that "DARDANELLA" would be a national "hit" say that "CAIRO TOWN" is its equal. Orchestrations now ready.

FRED FISHER'S BALLAD

"Daddy, You've Been a MOTHER to Me"

IS THE TALK OF NEW YORK and will be the ballad "hit" of the country

McCARTHY & FISHER, Inc.

224 WEST 46th STREET

FRED FISHER, Pres.

NEW YORK CITY

J. MITTENTHAL, Gen. Mgr.

Men Who Make Popular Songs

No. 10—Lee David

Lee David, who is well known to the talking machine trade as the writer of "Romance," "Wond'ring," "Tents of Arabs," and more recently "Clouds" (That Pass in the Night), is, although quite young, considered among the best of our present-day composers who make it a point to write popular works of the better class.

Lee David is a graduate of Columbia College, a thorough musician and has had much experience in orchestra work, which latter he pur-



Lee David

sued as a vocation while a student at college.

Before signing up exclusively with B. D. Nice & Co., Inc., his present publishers, he had placed songs with at least six of the recognized publishing firms. He was one of the first of the popular writers in New York territory to seriously consider the thirty-cent field, and with some minor exceptions all his works have been of the standard type.

Like all other ambitious popular composers of the present day, he has taken a fling at writing musical comedies, original musical sketches for vaudeville performers, and at the present time he is engaged in writing two productions.

The fact that Mr. David's works are recognized as having much merit, and his connection with a firm of publishers who are most enterprising and fast taking a position of prominence

in the field, should assure him and his works popularity for several years to come.

The Music Publishers' Protective Association recently took action whereby it is hoped in the future to avoid any conflict of song titles. A case, this season, of two publishers both issuing works with similar titles brought the question forward.

Q.R.S. BENNETT & WHITE PIANOSTYLE
 VOCALSTYLE UNITED STATES MUSIC CO.
 WURLITZER RYTHMODIK
 NATIONAL FILMUSIC CO.
 LINK PIANO CO. MILLS NOVELTY CO.
 COLUMBIA CONNORIZED MUSIC CO.
 REPUBLIC PLAYER IMPERIAL PLAYER ROLL CO. ORIENT
MIAMI WALTZ
 General Phonograph Corp. SHORE
 Victor Columbia Emerson
 Pathe
 STANDARD

EMERSON ARTISTS IN CONCERT

Employes' Welfare Association of Emerson Phonograph Co. Stages Successful Concert—Popular Artists on Program

A very interesting benefit concert was given by the Welfare Association of the Emerson Phonograph Co. at the Brooklyn Academy of Music on Sunday evening, February 29. This Welfare Association comprises principally the employes of the plating and graphic departments in the Emerson manufacturing plants, and the success of the concert is a tribute to the untiring efforts of the association members in behalf of this event.

The program for the concert featured Emerson artists, many of whom record for the Emerson library exclusively, and from a musical standpoint the concert was one of the important events of the season. The Brooklyn Academy of Music is one of the largest auditoriums in Greater New York, but standing room only was available when the program opened with "Eileen Selections" from Victor Herbert's popular light opera, played by the Emerson Concert Orchestra under the direction of Harold Sanford, musical director of the com-

**The Question Properly Answered
 A Customer Asks: "HAVE YOU?"**

- " BLUE DIAMONDS "
- " OLD MAN JAZZ "
- " WHISTLE A SONG "
- " ABADELE "
- " MADRIGAL OF MAY "
- " NOW I KNOW "
- " GIBRALTAR, ROCK OF MY LOVE "
- " IF YOU'RE ONLY FOOLING 'ROUND ME, WHY DON'T YOU PUT ME WISE? "

Then say: "Certainly, here you are," and collect your Profits
 "You Can Sell More Than You Order"

RECORDS—MUSIC ROLLS—SHEET MUSIC
JOS. W. STERN & CO., 102 W. 38th St., N.Y.

ACME-DIE
CASTINGS
 ALUMINUM-ZINC-TIN & LEAD ALL'YS
 Acme Die-Casting Corp.
 Boston Rochester Brooklyn N.Y. Detroit Chicago

Hinds, Hayden & Eldredge, Inc.

11 UNION SQUARE, NEW YORK CITY

PUBLISHERS OF

"SOUTHERN LULLABY"

ANNOUNCE

"IN THE AFTER GLOW"

By

J. WILL CALLAHAN

Author of

"Smiles" and "Tell Me"

FRANK H. GREY

Composer of

"Think, Love, of Me" and other successes

Programmed by America's Foremost Concert Artists

pany. The other artists on the program were the Plantation Jazz Orchestra, Arthur Fields, Kalmar and Ruby, Charles Hart and Elliot Shaw, All Star Trio, Perry and Peppino, Dolly Connolly (Percy Wenrich at the piano), Rudy Wiedoeft, Irving and Jack Kaufman, Walter Scanlan and the Three Kaufelds. Every artist on this program records for the Emerson library with the exception of Kalmar and Ruby, who are well-known composers and song writers, and who are keenly interested in the Emerson record library.

The diversity of the program and the enthusiastic reception accorded every artist emphasized the popularity of the Emerson record library, and each artist was obliged to render

several encores in response to the applause of the audience. Many of these artists are vaudeville headliners and, although they gave their services to the Welfare Association free of charge, their performances had the stamp of the Palace Theatre, vaudeville's leading theatre in New York.

This benefit concert was such a phenomenal success that concerts along similar lines will probably be given in the near future. The executives of the Emerson Phonograph Co. were all present at the concert and evinced a keen interest in the various details connected with the event. An interesting sixteen-page booklet containing the program was one of the unique features of the concert.

BRUNSWICK RECORDS ACCLAIMED

First Releases Bring Many Repeat Orders From All Dealers—Production Rapidly Assuming Larger Proportions—New Home for Recording Laboratories Somewhat Delayed

The ready response which the new Brunswick records have met with all over the country, both from Brunswick owners and the general public as well, shows that the latest product of the Brunswick-Balke-Collender Co. has won favor. William A. Brophy, general manager of the record department, in a chat with The World, declared that from every part of the country came reports from dealers of the hearty reception accorded the first release of records. Repeat orders bore concrete evidence to this testimony and the pressing plants, which are rapidly getting into better shape as new machinery and presses come through from the manufacturers, are hard put to keep up with the insistent demand. Mr. Brophy outlined the plans for the future manufacture of records and declared that his company has undertaken to accomplish in six months what the majority of other companies have done in two or three years. The hearty co-operation of all the men in charge of the various departments of the record division has made it possible to push the work with such rapidity that remarkable results have been obtained without sacrificing quality to quantity.

"In a few years," remarked Mr. Brophy, "there will undoubtedly be a general over-production of records due to the great scale on which many companies are now making them. It will then be a case of the survival of the fittest. In the working out of the plans for the Brunswick record production this fact has always been borne in mind. In spite of the fact that other manufacturers have increased prices the Brunswick record will not be increased according to present plans."

As was announced in The World last month, the scope of the record catalog embraces both popular and high class selections. Effort has been concentrated on the standard or high class numbers and dealers say that both classes of records are selling equally well. The recording laboratories are still located at 19 East Twenty-first street, New York, due to the delay of the builders in completing the building at 16 West Thirty-sixth street, which will be the larger and permanent home of the Brunswick recording laboratories.

BROADENS OUT ITS LINE

Shapiro's Song Shop, San Francisco, Cal., has recently engaged in the music business, taking on a large line of Emerson phonographs and records as well as player rolls, sheet music and accessories. The new store is located at 1461 Polk street.

Watch It Grow



WORDS BY WILLIAM LE BARON

MUSIC BY VICTOR JACOMI

CHAPPELL & CO., Ltd., New York, Toronto and Melbourne

WARNING!

WALL-KANE steel needles made in America of American steel, and by American workmen are to-day the standard trade mark needles of the phonograph industry. Like any article that is a proven success, WALL-KANE steel needles are being imitated.

The highest grade steel needle of domestic manufacture, is subjected to chemical processes by which the point of the needle is greatly improved. Three different coatings of certain chemical solutions are placed on the point of the needle, softening the point so much so that the needle will positively play ten records before the friction with the grooves will wear off the three coatings and reach the original grain of the point.

The solutions placed on the point are of such character that their distribution is beneficial to the grooves of the record, thereby greatly prolonging the life of the record. The softness of the point of the WALL-KANE NEEDLES minimizes the scraping sound of the ordinary steel needle, thereby greatly improving the clearness and tone of reproduction.



BEWARE OF IMITATIONS

This handsome metal enamel display stand holds 60 packages, 2 doz. extra loud, 1 doz. medium and 2 doz. loud; each package containing 50 WALL-KANE NEEDLES, retailing for 15c. Price of Stand to dealers, \$4.60. Single packages, 7½c.

Jobbing Territory Open

Progressive
Phonographic Supply Co., Inc.

145 WEST 45th STREET

NEW YORK



"Hear Dem Bells" and "Keemo Kimo" by Harry C. Browne and the Peerless Quartette are two negro songs that are sure-fire hits. A-2853.

**Columbia Graphophone Co.
NEW YORK**

EXCELLENT FEBRUARY BUSINESS TOTAL IN LOS ANGELES

Majority of Stocks Depleted, but Volume of Sales Keeps Up—Local Association Holds Meeting—New Brunswick Manager Appointed—Many New Talking Machine Stores Opened

LOS ANGELES, CAL., March 5.—February has gone on record for 1920 as another bumper month, sales far exceeding those for February, 1919. Stocks are still very short but considerable shipments reached Los Angeles during the month and enabled dealers to make promised deliveries and swell their totals. This applies to machines, of course. The record business has been immense in spite of the fact that the number of shorts almost exceeds the number of selections in stock. Customers journey from one store to another vainly asking for certain numbers which they particularly crave. The great hit among the popular numbers has been "Dardanella"; a few thousand of these arrive one day and are out of stock the next. However, as mentioned above, the total sales have been good and on many days the crowds looked like Christmas shoppers in numbers.

Los Angeles Schools to Hold Music Contest

Miss Kathryn Stone, supervisor of music, is already busy arranging for this year's school music contest and is picking the various selections accordingly. These selections are being chosen with a view to their being obtainable on records and to avoid the disappointment which was so common last year through many being out of stock. The task is somewhat difficult owing to the fact that records of

famous overtures, classical numbers and standard pieces have long been and continue to be practically unobtainable.

Columbia Traveler Shows Increase

Newton I. Hancock, traveling representative of the Columbia Graphophone Co. for the northern portion of southern California, is very enthusiastic over the splendid increase of business from his territory for January and February over the corresponding period of last year.

E. Bonnell in Los Angeles

E. Bonnell, western representative of the Sonora Phonograph Co. has arrived in Los Angeles. He reports extensive sales of the "Magnavox," which is an exclusive patented device for amplifying and increasing the volume of sound reproduction for phonographs. The Magnavox can also be used for public speaking and announcements.

Music Trades Association Meets

The regular monthly meeting of the Music Trades Association of southern California took place recently at the Brack shops. About fifty members sat down to a dinner and the principal speakers of the evening were Fred W. Blanchard and F. L. Grannis of the Filmusic Co. Mr. Blanchard spoke of the development and advancement of music during the last thirty-four years, during which time he had identified him-

self with the trade and profession in all its branches. Mr. Grannis gave an interesting talk on the cutting of player rolls. President Marygold made a witty speech on sales methods of thirty years ago. Talking machine members, claiming that piano subjects had monopolized the evening called upon Secretary Farquharson for a speech for their benefit; accordingly he responded with a brief and interesting history and review of the talking machine from the time of its invention.

Seventh Street Store Moves

Richardson's, Inc. are moving from 607 W. 7th street to 727 W. 7th. Very elaborate fixtures and unique arrangements are being installed and it is anticipated that the new store will be even more attractive and sought after than the "old stand." President Richardson expects to move about March 10th.

New Brunswick Phonograph Manager

The increase of sales of the Brunswick phonograph from the Los Angeles branch has grown to such an extent that local manager Simpson of the Brunswick-Balke-Collender Co. has found it necessary to obtain the services of a manager for the department who has had extensive experience in the phonograph business. Howard L. Brown, manager of the phonograph department of Lyon-McKinney-Smith, has accepted this position and will take up his new duties on March 15th. Mr. Brown is the second son of the late J. B. Brown who founded the well-known house which bore his name and was one of the first piano stores in Los Angeles. He has the very best wishes and congratulations of all members of the music trades, of which he has long been a popular member.

Organizes Sales Force

E. R. Darvill, of the firm of Fuller & Sunderland, Broadway department store, is in charge of the outside sales force. Five experienced talking machine men are under his sales management and are producing gratifying results. Weekly recitals are held in the Broadway Auditorium when new records are demonstrated and local artists and singers engaged.

E. A. Geissler Married

The marriage of Louise Nixon Hill and E. A. Geissler was solemnized at St. John's Episcopal Church, Los Angeles, on February 12th before a fashionable gathering. The bride was given away by her brother-in-law, Dr. Josiah Evans Cowles and George J. Birkel acted as best man. After the wedding breakfast the happy pair left for San Francisco by auto.

Out-of-Town Items of Interest

J. M. Barnum, of Long Beach, reports big business for the first two months of the year. He carries Starr phonographs and Gennett records.

Manager Salvcier has engaged Mrs. R. Labarr to take charge of the talking machine department of Renick's Song and Gift Shop.

H. Saladin of Saladin Music Co. of Santa Marie was a recent visitor in Los Angeles. Both he and "Flick" Felger, his partner, report exceptionally good sales during the first two months of 1920.

DO YOU KNOW



RECALL
Style No. 11
Height 46½ inches
Depth 22½ inches
Width 20¼ inches

that the "RE-CALL" combines **QUALITY, BEAUTY and RICHNESS OF TONE** to make it the real surprise of the Phonograph World during the 1920 season?

It has workmanship that is above reproach, due to many years' experience in the manufacture of high grade cabinet work.

Its finish is of the highest type while its equipment is of the very best.

It sells at a price which makes it attractive to the purchaser, at the same time giving the dealer a much larger margin of profit than can be obtained from most other lines.

Four Styles — Catalog and Prices on Application.
Communicate direct with the Manufacturer.

The Huss Bros. Phonograph and Piano Co.
6-8-10 W. Canal Blvd., Cincinnati, Ohio



MARVELON
TRADE MARK
 "THE SOUL OF MUSIC"



IN EVERY SENSE AND
 FROM EVERY VIEWPOINT
 A MUSICAL INSTRUMENT
 FOR THE
 DISCRIMINATING BUYER

Acoustically Perfect

The final word in mechanical simplicity and craftsmanship
 meeting the most exacting musical, mechanical and artistic requirements

Four models \$125 to \$225

UNUSUAL
 SERVICE
 TO THE
 CUSTOMER

WHEN the MARVELON Phonograph was introduced in 1917, we were showered with compliments—on its wonderful tonal qualities, its efficient and silent running motor, its superlatively finished and artistically designed cabinet work—and many orders were received. The initial orders were trial orders. The subsequent repeat orders resulted because MARVELON when sold STAYED SOLD. The customer was a satisfied customer and satisfied customers help the dealer to grow and prosper.

MARVELON plays all records and plays them perfectly. The FIVE-YEAR Guarantee covers it thoroughly—even spring breakage.

ADEQUATE
 PROFIT
 TO THE
 DEALER

If we have no representative in your city and you have a trade that demands "Something Better" you will find it profitable to write us. You owe it to yourself to investigate.

MARVELON PHONOGRAPH CO.

DIVISION OF SALES
 508 - 510 ARCADE BLDG.
 ST. LOUIS, MO.

A Line of Toy Phonographs That Will Sell

GARFORD "BABY" PHONOGRAPHS

MODEL X
RETAILS AT \$10

This new Model "X" Garford Baby Phonograph is a toy — nothing more — nothing less.

BUT

It is meeting with a ready sale.

It will develop sales for larger machines.

It will stimulate the sale of larger records.



CLOSED



OPEN

Plays Little Wonder records and also 7 inch records. Cabinet finished in Mahogany.

Height - - 17¼ inches Depth - - 9½ inches
Width - - 8⅝ inches

Provided with one spring worm gear motor. 5¼ inch turntable. High grade sound box, with wonderfully clear reproduction. Speed regulator.

GARFORD "BABY" PHONOGRAPH

Retails at
\$6.00



This standard model of Garford "Baby" toy phonograph is being merchandised by progressive retailers everywhere. It stimulates the demand for larger machines and records; develops the child's love of music, and provides a constant source of entertainment.

Plays Little Wonder or 7 inch records
Metal Cabinet finished in high grade Ebony
Enamel with nickel trimmings.

Length 8¼ inches Height 7½ inches
Width 5½ inches Weight 3½ lbs.

Provided with one spring worm gear motor. 5¼ inch turntable. High grade sound box, with wonderfully clear reproduction. Speed regulator.

WRITE FOR DEALER PROPOSITION

GENERAL PHONOGRAPH MFG. CO. Elyria, Ohio

FORMERLY NAMED THE GARFORD MFG. CO.

C. M. GOLDSTEIN
Consulting Engineer

20 Years' European and U. S. Experience
5 Years with Columbia Graphophone Co.

Room 1621
111 Broadway
New York

Raw Materials
Recording
Record Manufacture
Talking Machines and Parts
Patent Information

Strictly confidential advice. A-1 references.

BIRMINGHAM VICTOR DEALERS' ENJOYABLE BANQUET

Many Dealers and Employes Meet at Hotel Tutwiler and Hear Talks by Leading Victor Men—
Record Shortage Grows in South—McDavid Joins Clark & Jones Co.—Other News

BIRMINGHAM, ALA., March 8.—All talking machine houses throughout this section report a very brisk business for February, but add

Earl Silliman, for the past few years with the Columbia Graphophone Co. in its offices in Boston, has returned to Birmingham and has taken charge of the talking machine department of Messrs. Bromberg & Co., who handle the Aeolian Vocalion, Columbia and Edison lines.

The J. E. Cain Furniture Co. has announced that it will close out the furniture lines and devote all space and energies to the sale of talking machines. This house handles the Brunswick and Aeolian lines.

Robert Matthews, formerly distributor for the American line of phonographs in this territory, has resigned from that position and joined forces with the Cable-Shelby-Burton Piano Co. This house handles the Victor and Sonora lines.

The store of the Rhodes-Carroll Furniture Co., dealer in Vocalions and other phonographs, was destroyed by fire during the past week. Plans are now under way for a new building in which a beautiful talking machine department will be installed. "King" Doty recently resigned from the Emerald Co., Aeolian distributors for the State of Alabama, to accept a position with the Aeolian Co. in its offices in Cincinnati.

John M. Goudelock, of the Clark & Jones staff, left recently for Camden, N. J., to attend one of the classes of the Victor salesmanship course.

A. R. Boone, general manager of the Talking Machine Co., Victor distributors, was East on a business trip early in February and was compelled to return home on account of contracting influenza during his stay in New York City. He is improving in health and, without any setback, will attend to his duties in a few days.

ENTHUSIASTIC OVER CONDITIONS

PITTSBURGH, PA., March 3.—I. Goldsmith, president of the Player-Tone Talking Machine Co., Pittsburgh, Pa., returned recently from an Eastern trip which included a visit to the Music Show at New York. Mr. Goldsmith spoke enthusiastically on general business conditions, stating that the dealers who visited the show placed good-sized orders for immediate delivery.

According to his present plans, the Player-Tone Talking Machine Co. will be in a position to give the company's dealers maximum service and co-operation during the coming year. Mr. Goldsmith is making a specialty of attractive and high-grade cabinet designs, and the cabinet work of the Player-Tone phonograph has been the subject of general praise by the dealers.

MCCUNE OPENS IN EL CENTRO

F. L. McCune placed a very large order for a complete stock of Columbia goods with traveling representative Charles Mack, and has opened an up-to-date phonograph store in El Centro, Cal.



Banquet of the Birmingham Victor Association

that many thousands of dollars in business was lost because of the shortage of records, which is becoming acute. One of the interesting events of the month was the banquet of the Birmingham Victor Association, held at the Tutwiler Hotel. All dealers of the Birmingham district, including their employes, were present and many interesting talks were given. Among the most enjoyable was a talk given by B. F. Bibighaus on "Development of the Victor Industry." A. R. Boone, president of the Association, acted as toastmaster and during the evening each member of the Association was called on for a word regarding the Victor business. The accompanying photograph will give some idea of the interest manifested in this Association by its members.

The Clark & Jones Piano Co., Victor dealers, has announced the election of Robert P. McDavid to the secretaryship of the company. Mr. McDavid is particularly well qualified for the position by reason of his previous business training. He has been for years vice-president of the McDavid Realty Co. and secretary of the Birmingham Real Estate Exchange. For the past five years he has devoted a great portion of his time to writing and has established himself as an authority on sports through his connection with the Birmingham Age Herald as sporting editor. He also held the chair of associate editor of the same daily. Mr. McDavid will devote most of his time to the talking machine department in his new connection, as his branch of the Clark & Jones business has assumed very large proportions during the last few years.

We Manufacture a Fine Line of
Low Priced Table and Floor
Model Talking Machines

WE STAND GOOD FOR THEM

A full supply of "parts" for all makes of
machines in our "PARTS" department

Write for Illustrations and Prices

WOLLMAN TALKING MACHINE MFG. CO.

560-562 Grand St., Brooklyn, N. Y.

Established 1889

A Max L. Goldberg Special

FOR
IMMEDIATE
DELIVERY

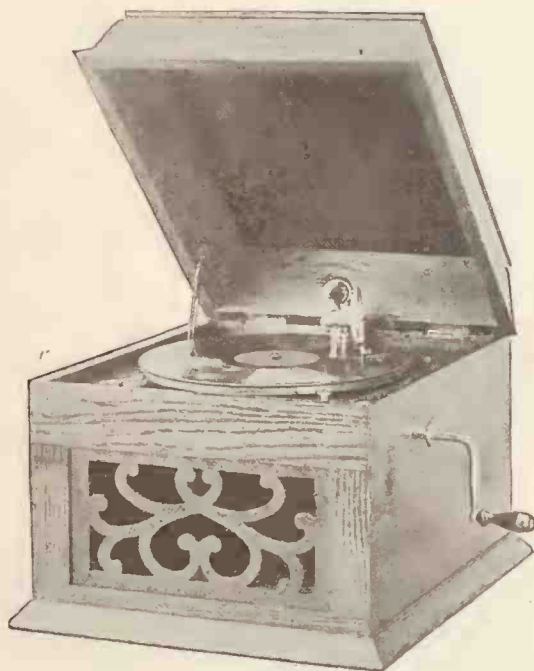

14 1/4" High
17 1/4" Wide
19 1/2" Deep

The woodwork, finish, construction and assembling of these machines are of the highest grade.

A scientifically constructed Tone-Chamber, in connection with Universal Tone-Arm and Sound Box (playing all records) truthfully reproducing all records, as to tone-quality and volume.

The highest grade nicked Swiss Motor made. Double spring—worm drive—exceptionally even and silent running. Plays over three 10" records with one winding; 12" Turn-table. All metal parts heavily nickel-plated.

Samples in Golden Oak \$22.50 WAR TAX PAID

Fumed Oak 22.50

Mission 22.50 TERMS, NET

Birch Mahogany 22.50 F. O. B. NEW YORK CITY

WRITE FOR SPECIAL QUANTITY QUOTATIONS

MAX L. GOLDBERT 3 and 5 WAVERLY PLACE, NEW YORK CITY

STEGER
The Finest Reproducing Phonograph in the World

The world's greatest artists, singers and musicians are at their best when they entertain you with a Steger Phonograph. It plays all disc records *correctly*, with no change of parts.

Steger Phonographs are sold at universal prices. The Steger Phonograph factories make every part of the Steger Phonograph complete.

Steger Wholesalers

EMERSON RECORD SALES CO., Inc.
6 W. 48th St. New York, N. Y.

IVER JOHNSON SPORTING GOODS CO.
155 Washington St. Boston, Mass.

STEGER & SONS PIANO MFG. CO.
867 Broad St. Newark, N. J.

JONES BROTHERS CO.
317 Main St. Jacksonville, Fla.

SMITH & NIXON CO.
306 Walnut St. Louisville, Ky.

HALL MUSIC CO.
246 Pine Street Abilene, Texas

WARFIELD PRATT HOWELL CO.
Des Moines, Ia.

COLORADO BEDDING CO.
2nd St. and Grand Ave. Pueblo, Colo.

CAMPBELL PHONOGRAPH SALES CO.
60 East S. Temple St. Salt Lake City, Utah

STEGER & SONS PIANO MFG. CO.
Steger Building, Chicago, Ill.

MODEL 606 \$280

MODEL 605 \$210

MODEL 604 \$190

MODEL 603 \$155

MODEL 602 \$140

MODEL 601 \$110

MODEL 607 \$360

MODEL 608 \$410

MODEL 600 \$90

COLUMBIA CO. FORCES MEET AND DINE IN NEW ORLEANS

Over Two Score Dealers, Salesmen and Employes Enjoyed First Monthly Meeting at the St. Charles Hotel Recently—Selling Demonstration Proves of Interest—Other News Items

NEW ORLEANS, La., March 3.—Forty-three Columbia dealers, salesmen and employes of dealers and the branch house in the New Orleans territory had their first monthly meeting Friday night, February 27, at the St. Charles Hotel in New Orleans. A demonstration of a

and Miss N. Solonas, New Orleans branch of Columbia Co.; G. E. Tcmplet, Bay Jewelry Co.; Bay St. Louis, Miss.; Miss Abie Iron and Mrs. G. S. Brittan, Maison Blanche; R. E. Ching, manager of talking machine department D. H. Holmes Co.; S. Seidler, Poplarville, Miss.; Carl

with Max Barnett Furniture Co.; H. B. Lawrence, H. P. Wise, assistant manager New Orleans branch.

Mr. Whitted, proprietor Whitted Furniture Co., Chipley, Fla., Sol. Holtzman, 1409 Annunciation street, New Orleans; W. W. Twigg, Jackson, Miss.; J. H. Perkins, Brookhaven, Miss.; A. L. Dunlap, Jackson, Miss.; D. Bienn, Bogalusa, La.; Hugh J. Bourdeaus, Franklin, La.; H. F. Gambal, Greenville, Miss.; C. H. Jewell, Crowley, Miss.; Louis Mandel, Port Arthur, Texas; L. L. Parker, Tylertown, Miss.; W. Q. Smith, A. Burglass Furniture Co., New Orleans.

J. H. Lillibridge, former manager of the talking machine department of Thomas Goggan & Bros., Dallas, Texas, has joined the staff of the local Columbia wholesale branch. Mr. Lillibridge will represent Columbia in Northern Louisiana and Arkansas territory. The Dealer Service department of the New Orleans branch has been opened with A. W. Clapperton in charge.

A. B. Creal, manager of the house, and E. L. Estes, salesmen in the Beaumont, Tex., and Lake Charles and Lafayette, La., territory, have just returned from a trip through Mr. Estes' section. Mr. Creal says the Beaumont talking machine business is as great as that of any city of its size in the country. The Phoenix Furniture Co. and Jones O'Neal Furniture Co. are Columbia retailers in Beaumont.

New representatives of Columbia in the New Orleans territory are: Soniat Music store, Donaldsonville, La.; Greenville Music Shop, Greenville, Miss.; J. A. Abrams, Biloxi, Miss.; J. D. Lanham, Greenwood, Miss.; and the Lacour Mercantile Co., Lacour, La.

Kerr-Smalley Co. of Phoenix, Arizona, have opened a branch Columbia Grafonola shop in Mesa. The store is under the management of J. E. Bryant.

F. J. Ehlers has opened the Pomona, Cal., Music Co. A complete stock of Columbia Grafonolas and records has been installed.



Gathering of Columbia Men at St. Charles Hotel, New Orleans

sale was given by W. W. Twigg, of Jackson, Miss., as the salesman, and E. L. Estes, sales representative of the branch house, acted as the customer. The entire range of argument was given and some of the unusual questions were asked by the "customer." H. P. Wise, the new assistant manager of the branch, was present.

Those present were: E. Berwin, manager L. Grunewald Music Co., Inc.; Miss Kate J. Codar, D. H. Holmes Co.; Miss Helen Porter, A. P. Taliffero's music store, Mansfield, La.; Mrs. M. F. Holmes, D. H. Holmes Co.; Mrs. E. L. Estes, 4502 Carrollton avenue; D. A. Barre

D. Barnes, representing J. D. Henington, Crystal Springs, Miss.; D. B. Powell, manager of talking machine department, and Miss Frances Johnson, Maison Blanche; J. M. Menger, representing W. Q. Menger, Vicksburg, Miss.; Mrs. S. Seidler, Poplarville, Miss.; S. Davis, 319 Sequin street, and H. Perloff, 1635 Tulane avenue; P. W. Boudreaus, Boudreaus Furniture Co., Franklin, La.; Miss W. Lemley, with local Columbia branch; L. Trolle, L. Grunewald Music Co.; Mrs. J. Purnell, D. H. Holmes Co.; J. B. Lillibridge, sales representative of local branch; O. P. Arrow, local branch; Miss H. Cameron,

STODART

PHONOGRAPH

The sign of a quality phonograph

**Made by the makers of one of America's oldest pianos
Unexcelled for Beauty of Case Design, Tone and Equipment**

Style AA



Five handsome models in mahogany veneer, covers and cover mouldings solid mahogany.

Stephenson Precision-made motor with velour turntable. Universal Tone Arm.

A wonderful reproducing device, furnishing beautiful tone in great volume—Tone modifying rod.

The Stodart Phonograph is famous for quality which cannot be surpassed

Get details of our proposition and *make money* with this leader

STODART PHONOGRAPH CO., Inc.

GEORGE H. BEVERLY, General Manager

119 West 42nd Street

NEW YORK

Style C



PERMANENT EXHIBITION, BUSH TERMINAL BUILDING, NEW YORK

Operollos are "Quick Turnovers"

They Make Good. High Grade Quality; Reliable Product; Popular Price

Our concentration on making and marketing a line of strictly high grade instruments which give everlasting satisfaction, has met with a tremendous success. It seems no dealer can secure enough of our machines, as orders are multiplied continually.

Operollos will help dealers build up a permanent and prosperous business. Apply for exclusive agency at once.

We do not bind dealers on a contract, but protect agents in territory. Our products are of such quality, represent such unusual value and are so easily sold that we do not need to bind a dealer on a contract.



Style No. 135

Height 50 in., Depth 23 in., Width 21 in.
Finish: Mahogany, Golden or Fumed Oak.
Krasco Motor. Universal Tone Arm. All
Wood Amplifier.

Permanent and Profitable Business with Operollos Assured

Why try so many inferior products? It is an established fact that Operollo dealers are doing a fine and prosperous business. There are big possibilities with Operollos everywhere. One large retail concern tested out our products during the last six months and bought so far over \$40,000. Now we are figuring on a contract for 2,500 machines for 1920 for this same concern.

Our products—covering 90% of the actual demand of the trade—have proven to be "Quick Sellers" and Operollo Quality and our popular prices have done the balance to cause a big demand for our instruments.



STYLE NO. 95

Height 45 in., Width 19 in., Depth 21 in.
Mahogany, Fumed or Golden Oak Finish.
Has our Special Double Spring Motor.
Universal Tone Arm.

Every Operollo is a Wonderful Value

There is no substitute for our machines possible. We have been fighting high prices for inferior goods. We believe in a square deal. WHAT THE TRADE WANTS IS NOT A "GOOD LOOKING PICTURE" BUT "REAL GOODS"—CLEAN MERCHANDISE, GOOD RELIABLE PRODUCTS—which sell fast and do not cause "come-backs." Operollos fulfill all your expectations. They make good.

Highest Grade Equipment used Throughout

KRASCO SILENT MOTORS; latest style of Operollo Universal Tone-arms; all wood amplifier. Cabinets are of excellent workmanship, and beautifully finished. Every instrument is sold under a positive guarantee to be as represented. Prompt service. Liberal trade discounts.

Write Today for Attractive Agency Proposition

OPEROLLO PHONOGRAPH COMPANY

54 WEST LAFAYETTE BOULEVARD—DETROIT, MICH.

NEW LAWSON CO. FORMED

Lawson Piano & Phonograph Corp. Replaces Lawson Piano Co.—To Make Phonographs—New Sales Force Organized—Retail Business Taken Over by A. F. Kraus

The Lawson Piano & Phonograph Corp. has been incorporated under the laws of the State of New York, with executive offices and factory



Wm. W. Lawson, Pres. A. M. Lawson, Treas. at 572 Park avenue, New York. The officials of the company are William W. Lawson, president; Henry W. Harvest, vice-president and sales manager; Arthur M. Lawson, treasurer, and George A. Griffin, secretary.

The company has acquired the extensive factory of the former Lawson Piano Co., and will



H. W. Harvest, Vice-Pres. G. A. Griffin, Sec'y. manufacture from now on both pianos and phonographs. In connection with the latter the company will be in a position to do all the

varnishing and finishing of the cabinets of the Lawson Universal Phonograph. They will also manufacture here the Diamond-L, Hub back reproducer and tapered bore tone arm.

In connection with the formation of this new corporation, an extensive sales staff has been organized. G. M. Soule, well known in the piano industry and musical circles, and one of the most popular traveling men, will act as general representative for the company. Mr. Soule expects to start on a long trip within a few days. In the Middle West the company is represented by C. E. Scott of Mansfield, O., as well known throughout other sections of the country as he is in his territory. The Southern territory, including Virginia, West Virginia and the Carolinas, will be covered by H. A. Copeland

of Connellsville, Pa.; in New York State the company will be represented by P. H. Vaughan. Arrangements have also been made with C. H. Mackay to give adequate wholesale representation in Cuba.

The retail warerooms, which have been conducted at 372 East 149th street, New York, for many years by the Lawson Piano Co., have been purchased by Albert F. Kraus and will hereafter be conducted under the name of the Lawson Piano Warerooms, where there will be retailed the Lawson pianos and player-pianos, Victrolas, Victor records and the Lawson phonograph, as well as a complete line of music rolls and other accessories.

W. Ernest Robinson is manager of this retail establishment.

SOME PATHE BRIEFLETS

New Store-front Sign for Dealers—Mason Takes on Pathé Line—Muratore Coming Next Season—Scheduled to Arrive in September

The Pathé Frères Phonograph Co., Brooklyn, N. Y., have prepared for the use of their dealers a brightly colored ten-foot muslin sign. This sign is waterproof and is designed to make the store-front of the dealer conspicuous. It can also be used to excellent advantage at State fairs and other exhibits.

Mason's furniture house in Brooklyn is among the latest additions to the list of Pathé dealers. This large house is featuring the entire line in a large way and with very gratifying results.

Word has been received from Lucien Muratore, famous Pathé star, that he will be in America for the next opera season and expects to arrive in this country in September. This will greatly please his many friends.

RECITALS BY BRUNSWICK ARTISTS

Max Rosen and Elias Breeskin Appear in Many Cities During March—Detailed Schedule

Max Rosen and Elias Breeskin, the celebrated violinists and exclusive Brunswick record artists, have been appearing in concerts and recitals in many cities throughout the country during the past month. Breeskin's appearances were scheduled as follows: March 2, Cleveland, O.; March 5, Pittsburgh, Pa.; March 8, New York City; March 9, King, N. H.; March 13, Waterbury, Conn.; March 15, Wilkes-Barre, Pa. On April 5 he will appear in Scranton, Pa.

In his dates for March Max Rosen covered a great deal of ground from Canada to the South. His program called for the following recitals: March 4, Massy Hall, Toronto, Can.; March 9, Kentucky College for Women, Danville, Ky.; March 11, Elks' Hall, Chillicothe, O.; March 12, Memorial Hall, Columbus, O.; March 19 and 20, St. Louis, Mo.; March 23, Sioux City, Ia.

THE DEMAND OF A NATION

The Player-Tone Phonographs

"It's Simply Great"

The superior quality embraced in our line insures unequaled and permanent satisfaction. The beautiful designs, together with the wonderful tone volume, afford you complete selections. The immense output and specializing in the manufacturing of the **PLAYER-TONE** exclusively mean the **Greatest Phonograph Value** for all progressive dealers who are desirous of offering their customers the best that skilled labor and money can produce.

"When Sold They Stay Sold."

We have the lowest price, considering beauty, cabinet work and tone quality, after all.

Dealers, write us for our booklet and special discount, on our six models in all finishes.

Desirable territory open for live representatives. Write us today.

The Player Tone Talking Machine Co.

Executive Office, 967 Liberty Avenue

PITTSBURGH, PA.



Model 316



Model 314



Model 311



Model 310

Van Veen

"BED SET"

Booths
Sectional
Record Racks
Record
Sales Counters

Dealers:—

Van Veen "Bed Set"
Hearing Rooms are an
absolute necessity to you

If you are without them you are not
properly equipped for business

Install a Van Veen "Bed Set" outfit and see it pay for itself

The Hearing Rooms Sell the Goods—an unsalaried Selling
Force

ARTHUR L. VAN VEEN & CO., 47 West 34th Street, New York

Telephone Greeley 4749



Model Store Front and Interior at Collings & Co.,
Victor Distributors, Newark, N. J.

GOOD WEATHER STIMULATES BUSINESS IN KANSAS CITY

Noticeable Increase in the Demand for Records of All Kinds—Much Improvement Reported in the Stock Situation—Son Secures Records Made by Late Jessie Bartlett Davis

KANSAS CITY, Mo., March 8.—Unusually pleasant weather during the past month has had a noticeably favorable effect on business and talking machine dealers have been placing orders to replenish their depleted stocks. The demand for records has been especially strong and sentiment among the general public is that records are about the only products that have not been affected very much by the general high cost of everything. Perhaps the great sale of machines during the holidays is responsible in some measure for the increased demand for records. This was the view of W. F. Standke of the Columbia Grafonola Shop.

The Edison Shop reports that the business during the past month has been exceedingly good. The local store has been advertising the New Edison extensively. This has been particularly attractive in the retail store and a volume of business has been the direct result of this one factor.

The Brunswick Shop has been doing an unusually brisk business. Will Chestnut, manager of the company, declares that the business has been a great deal heavier than he had anticipated.

C. V. Bissell, manager of the Starr Piano Co., recently said: "Business during the Spring and Summer seasons is going to be better than it has ever been before, which is due to the fact that the demand for talking machines and records has remained so consistent in proportion to

all other businesses in this territory. However, it seems that there is little or no demand being experienced for small machines. Stocks are better, having almost completely recovered, and deliveries are being jacked up to schedule, which makes it possible for the dealers to do a larger and better business."

J. L. Repogle, general field manager of the Vitanola Co., recently visited Kansas City after a most successful trip throughout the Southwest, where he opened up a remarkable Vitanola business. The Abernathy Furniture Co., which recently placed a tremendous order for machines, has been doing an especially good jobbing business. A number of new agencies have been opened in Kansas City, among which is the Walter Solt Furniture Co.

The Architects & Engineers Supply Co. continues to handle several makes of machines and recently placed the Modernola in its stock. According to E. L. Clenny this line has been meeting with general favor.

C. L. Dodson, general manager of the Portable Talking Machine Co., recently announced that the first product of his company would appear within the week. Mr. Dodson is assembling and placing on the market a new machine, which is built in a carrying case and is particularly designed for camping and outing parties.

When Will J. Davis, of Chicago, published the advertisement in a newspaper for talking

machine records made by his late mother, Jessie Bartlett Davis, many years ago, he secured two records from Kansas Citians who happened to see the advertisement. Mr. Davis's home burned and his records were destroyed. His mother had made several of the first recordings. Seemingly the records were not credited to the singer at that time, and it was up to the ears of Mr. Davis to select the ones his mother sang. Among the records, and the one particularly sought, was "Sweet Genevieve." Mrs. George Williams discovered one in her catalog, on the reverse side of which was recorded "Bonnie, Sweet Bessie."

MARKED GROWTH OF BUSINESS

ELLWOOD CITY, PA., March 3.—The Ellwood Music Shop, Pathé dealer of this city, has increased its business forty per cent in the last two months. Ben G. Swick, proprietor of the store, has made good use of the attractive window display material furnished by the Pathé Frères Phonograph Co.

W. S. MEFFORD IN NEW VENTURE

The Colonial Music Co., Toledo, O., has been organized with a capital of \$52,500 to take over the W. S. Mefford store, which handles the Pathé. W. S. Mefford is one of the incorporators of the new company.

The F. G. K. Talking Machine Co., Brooklyn, N. Y., has been incorporated with a capital of \$10,000 by E. Harris, P. Duryee and H. O. Falk, 141 West Forty-fifth street.

Represents BEAUTY and TONE Combined

The "VICSONIA" Reproducer

(MODEL A)

Designed to PERFECTLY play Edison Disc Records on "Victrolas" or "Grafonolas." Easy to attach—slips on—a child can do it. The Vicsonia is recognized as the BEST reproducer for its particular purpose. ORDER NOW.

ATTENTION!!!

Model B Vicsonia now ready. Plays all hill and dale records—Pathé, Edison, Okeh, Lyric, Aeolian, Vocalion, etc.
A sample reproducer Model A or B will be sent on receipt of \$4.50 Retail price \$7.50.



VICSONIA MFG. CO., Inc., :: 313 E. 134th St., New York, N. Y.

The Goal

WE in this organization have a definite goal toward which we are working. And it is not a goal of big production, of great volume; it is not our ambition to see processed through our shops huge tonnage of iron and steel. It is not a goal of cubical factory space, nor of great sales volume as measured by dollars and cents. It is not a goal, either, toward which we are hurrying with such speed that we have not time for the finer things of life.

It is a goal, rather, where merit sets stern limit upon production and where volume must be measured by service. We believe with Emerson that, "the greatest success is confidence or perfect understanding between people." And the goal toward which we are working is to make our business a bigger, better business, to grow, always, but to grow only so fast as we can keep faith and confidence with all.

STEPHENSON
INCORPORATED
One West Thirty-fourth Street
New York City

MAKERS OF THE STEPHENSON PRECISION MADE PHONOGRAPH MOTOR



THE AEOLIAN-VOCALION
Art Style 1516
Queen Anne, 1702-1714
\$295



THE
AEOLIAN-VOCALION
Style 430
\$165
with Graduoala



THE AEOLIAN-VOCALION
Art Style 1496
Duncan-Pfyfe—Early American
\$325

THE

AEOLIAN-VOCALION

The Phonograph that has made the Talking Machine a Real Musical Instrument.
Manufactured by The Aeolian Company—Largest Manufacturers of Musical
Instruments in the World

THE Aeolian-Vocalion has risen to its position of world-supremacy on the strength of its marvelous tone. No other features of interest or convenience have been required to make it great. Its reproduction—particularly when playing

the new and revolutionary Vocalion Record—possesses a richness, depth, purity and beauty that has brought the music world to a new appreciation of the value and meaning of the phonograph.

VOCALION LATERAL CUT RECORDS

For March and April

			Number	Size	Price				Number	Size	Price
Le Prophete—Ah, mon fils (Ah, my son!)	Marguerite D'Alvarez	}	45000	12	\$1.50	Venetian Moon	Sterling Trio	}	14029	10	\$.85
Aubade—Le Roi d'Ys	Colin O'More		24002	10	1.00	Jazz Babies' Ball	Peerless Quartet		14030	10	.85
Reviens (Return)	Nevada Van der Veer	}	14016	10	.85	You're a Million Miles from Nowhere. Waltz	Paul Biese and His Novelty Orchestra	}	14031	10	.85
I Love You Truly	Reed Miller		14017	10	.85	Dream—Amazon—Waltz	Yerkes' Orchestra		14033	10	.85
A Perfect Day	Sybil Fagan	}	14023	10	.85	When My Baby Smiles—Fox-Trot	Wedding and Shimmie and Jazz	}	14034	10	.85
My Lindy Lou	Harry A. Yerkes' Dance Orchestra		14024	10	.85	Wedding and Shimmie and Jazz	Dabney's Band		24003	10	1.00
The Want of You	Sybil Fagan	}	14026	10	.85	The Kiss	Nellie & Sara Kouns	}	14035	10	.85
A Day in Florida (Parts 1 and 2)	Harry A. Yerkes' Dance Orchestra		14027	10	.85	A May Morning	Nellie Kouns		14036	10	.85
Swanee—One-Step	Samuel Ash	}	14028	10	.85	A Madrigal of May	Adler's Trio	}	14037	10	.85
Mystery—Fox-Trot	Elliott Shaw		14029	10	.85	When My Baby Smiles at Me	Billy Murray & Rachel Grant		14038	10	.85
Underneath the Southern Skies	Ernest Hare	}	14030	10	.85	I'll See You in C-U-B-A	Billy Murray	}	14039	10	.85
Castle of Dreams	Al Bernard & Ernest Hare		14031	10	.85	Cohen Talks About the Ladies	Monroe Silver		14040	10	.85
Saxophone Blues	Billy Murray	}	14032	10	.85	Abraham	All Star Trio	}	14041	10	.85
You're My Gal	Ernest Hare		14033	10	.85	Afghanistan—Asiatic Fox-Trot	Harry A. Yerkes' Dance Orchestra		14042	10	.85
He Went In Like a Lion						Hold Me—Fox-Trot					
I Gave Her That						Oh, By Jinzo!—One-Step					
						Shake Your Little Shoulder					

Handsome catalogue of VOCALIONS and RECORDS sent upon request

SOUTHERN DISTRIBUTORS

O. J. De Moll

O. J. DE MOLL & COMPANY

Emmons S. Smith

WASHINGTON, D. C.

Aeolian-Vocalions

Vocalion Records

MELODEE Player-Piano Rolls

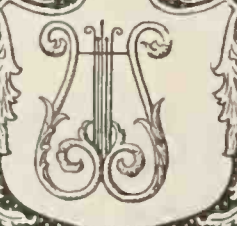

AN ACTIVE VICTOR WHOLESALER

Wm. H. Reynolds, of Mobile, Ala., Has Had an Interesting and Successful Business Career—Is Prominent in Civic and Industrial Affairs

MOBILE, ALA., March 1.—This thriving city of about 75,000 population boasts one of the most aggressive Victor distributors in the South. His name, as everybody in the trade knows, is William H. Reynolds and the story of his business career reads like a commercial romance of the first order.

Back in 1891, Mr. Reynolds was a mandolin teacher in Vincennes, Ind., the town of his birth. After teaching the young how to thrum for some five years, he went to Colorado Springs, Col., where he continued teaching. When the Spanish-American war broke out he was seized with a big yearning to get into the fray and came South and joined the regulars in order to get as quick a sailing as possible to Cuba. He came to Mobile, as this was the port of embarkation. Here he met some young men belonging to the Mobile rifle company and enlisted with them. During the war he, of course, made a large number of Mobile friends and, after it was all over, came back to this city and resumed here his former occupation of teaching the mandolin.

The opportunity soon presented itself to buy out the small goods department of the Bayley-Arnold Music Co., at 167 Dauphin street, and, on February 24, 1902, he consummated the deal, gave notes for the stock and good will and borrowed five dollars in change for his cash register for the first day. The Bayley-Arnold Co. kept the balance of the store until the end of the year, when Mr. Reynolds took over the lease of the entire store. In a few months he decided to add talking machines and placed his first order with Eldridge R. Johnson, then making gramophones on his own hook. In 1904 he commenced jobbing the Edison cylinder line and in 1905 signed up as a Victor jobber. When the Edison disc machine was introduced, Mr.



Wm. H. Reynolds

Reynolds dropped the Edison line and has since devoted his entire attention to the Victor. His



W. D. Miller



Miss Ruth Heorig

jobbing operations cover a radius of 300 miles around Mobile, including important sections of Alabama, Florida, Georgia, Mississippi and

Louisiana. The business of W. H. Reynolds, Victor distributor, now occupies a large two-story building, superbly equipped for the purpose for which it was built.

Fifteen years ago business so increased as to make the securing of a competent sales manager thoroughly necessary. Mr. Reynolds found him in W. D. Miller, who has developed into one of the best known sales managers in the Victor line. Mr. Miller makes frequent trips among Victor dealers throughout the Southern territory and he has a very competent assistant, who takes charge of affairs at the office while he is on these journeys, in Miss Ruth Heorig.

While attending to Victor business, Mr. Reynolds has also been an active factor in Mobile. After various activities in the Mobile Chamber of Commerce, he was made president a year ago and only just declined re-election on account of pressing business duties. He is still a member of the board of directors. Among other civic activities, it might be mentioned that he was president of the Mobile Rotary Club, chairman of the committee of the Four-Minute Organization during the war and chairman of the committee which conducted the Victory Loan drive. He is vice-president of the Gulf Coast Citrus Exchange and a former president and vice-president of the Gulf Coast Horticultural Society. He has been a national figure in talking machine circles and has served on the board of directors of the National Association of Talking Machine Jobbers for seven years and has been treasurer of this organization for several years.

DONLON BUYS RIDGEWOOD T. M. CO.

George A. Stanley, who has conducted the Ridgewood Talking Machine Co., Ridgewood, N. J., has sold his business to Joseph Donlon, who will continue in the same line. Mr. Donlon has many friends in the talking machine trade who will wish him the greatest measure of success in his new venture.

Just What You Have Been Waiting For

The GATELY Carrying Case

for VICTROLA VI's

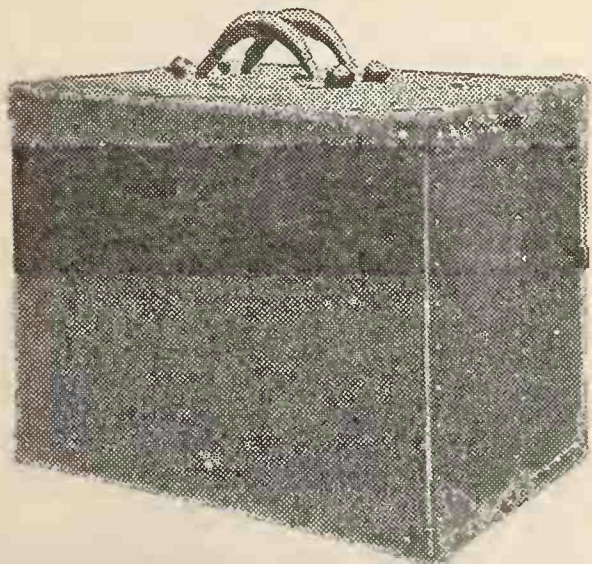

This handsome carrying case will help increase your VICTROLA VI sales.

The Gately Carrying Case is constructed of wood, covered with black waterproof fibre and substantially made so that it can be carried by one man or as baggage.

Each case is arranged to hold thirty 10-in. or 12-in. records, and has a separate place for a sound box, winding key and needles.

Price, \$8.50 Wholesale

Write for Descriptive Circulars

GATELY-HAIRE CO., Inc. - - Albany, N. Y.

CO-OPERATES WITH DEALERS

N. S. Reeves Gives Valuable Assistance to Pathé Dealers—Pathé Sales Increasing

OMAHA, NEB., March 5.—N. S. Reeves, manager of the Pathé department of the Wright & Wilhelmy Co., of this city, Pathé jobbers, has been co-operating with the various Pathé dealers in Omaha, in the consummation of distinctive and practical sales ideas. These plans have worked out very satisfactorily and the Pathé dealers in this territory report a constantly increasing demand for Pathé phonographs and records.

The Phonograph Sales Co. in Omaha, a successful Pathé dealer, has been doing some original advertising and Mr. Reeves has been assisting the company in taking care of its various plans. In one of this dealer's publicity "stunts"



N. S. Reeves

a big Rhode Island Red rooster was placed in the show window and strutted around before the admiring eyes of passersby. Of course, the red rooster was a replica of the famous Pathé trademark, and constituted splendid publicity for this live-wire dealer. Mr. Reeves acquainted the visitors to the store with the features of the Pathé product, and also gave the first public demonstration in Omaha of the Pathé Actuelle.

T. T. Stricklin, formerly with the Southern California Music Co. has been appointed talking machine manager of the Bledsoe Co., San Diego.

YAZOO RIVER RED GUM

For high-grade cabinet work. Of soft texture and rich, dark color. Sawed from mature, thrifty trees. Specially manufactured and air seasoned.

Adapted to a variety of finishes—Satin Walnut to Dark Mahogany. Can furnish either in Plain or Quarter sawed stock.

- 10 cars 3" No. 1 Common and Better Qrtd. Red Gum.
- 10 cars 2½" No. 1 Common and Better Qrtd. Red Gum.
- 10 cars 2" No. 1 Common and Better Qrtd. Red Gum.
- 10 cars 1¼" No. 1 Common and Better Qrtd. Red Gum.
- 2 cars 1" No. 2 Common Red Gum.
- 2 cars 1¼" No. 2 Common Red Gum.
- 2 cars 2" No. 2 Common Red Gum.
- 5 cars 1" No. 1 Common and Better Qrtd. Red Gum.
- 5 cars 1" 1st and 2nds Qrtd. White Oak.
- 5 cars 1" 1st and 2nds Qrtd. Red Oak.
- 5 cars 1" No. 1 Common Qrtd. Red Oak.

Send us your inquiries for all cabinet woods.

THOMAS & PROETZ LUMBER CO.

15 Angelrodt St., St. Louis, Mo.

TO EXPLOIT NEW COPPER PROCESS

Condon & Co., Inc., to Act as Sales Representatives for Copper Process Co. in Marketing Talking Machine Parts Made From Copper

Announcement has recently been made by William A. Condon, president of Condon & Co., Inc., of the consummation of arrangements whereby his company will be sales representatives for the Copper Process Co., inventors of a new secret process of fabricating copper for the manufacture of tone arms and other talking machine parts.

Mr. Condon, whose many years of experience in the trade have made him numberless friends from coast to coast among jobbers and dealers, will make as active a selling campaign on this product as he has so successfully done with Torrington Uniform Needles, "Gliss" and "Groovite."

Describing his new proposition to a World

representative, Mr. Condon said, "Merely explaining to you what this secret process of fabricating copper does is really a very poor substitute for seeing the article made and then examining and testing the finished product. I find it very hard to try to make words do full justice to this process and its result.

"Copper tone arms and other talking machine parts of surprising beauty of line and tone and also remarkable practical utility and adaptability of design and assembly are thus produced through this amazing process, in the only plant of its kind in America.

"After testing copper parts made by this process in every conceivable way (even beneath the repeated blows of heavy hammers) I am so convinced of its merit that I intend to bring it before the trade in a 'seeing is believing' attitude. My method in bringing out the various salient points of copper process tone arms and other parts made by this process will be in naming specifically just what its points of superiority are and in letting the product itself do most of the talking, which I believe it is well capable of doing.

"The Copper Process tone arm, for example, has eleven distinct features which I believe will interest every talking machine manufacturer. It is also of importance to know that the necessary production of Copper Process tone arms and other parts can be speedily obtained and that manufacture is not limited to any of the standard designs now in use, but that through this process any design the manufacturer desires can effectively be produced.

"It surely is a real pleasure for me to say that the merits and benefits of this secret process of fabricating copper are now to be put to use for the general advancement of the talking machine present and future."

Be of good cheer—Spring is here!

H. J. SMITH LABORATORIES

Jewel Manufacturer

EXECUTIVE OFFICES,
FINISHING and
RECORDING
LABORATORY JEWELS

Plant No. 1
833 Broad Street
Telephone 2896 Market
NEWARK, N. J.

SAWING
GRINDING
ROUGHING
ROLLING and
EXPERIMENTAL
LABORATORY

Plant No. 2
54½ Franklin St.
NEWARK, N. J.

Manufacturer of

Phonograph Diamond and Sapphire Reproducing Points—Recording Laboratory Jewels—Rough Diamond—Diamond Powder—Experimental Work. Jewels manufactured for all talking machine records. Consulting Specialist on all experiments relating to any new recording grooves. Recording problems satisfactorily worked out.

NEEDLES

WE MANUFACTURE

Diamond needles for Edison
Sapphire needles for Edison
Sapphire needles for Pathe

in stock ready for delivery

MERMOD & CO., 874 Broadway, N. Y.

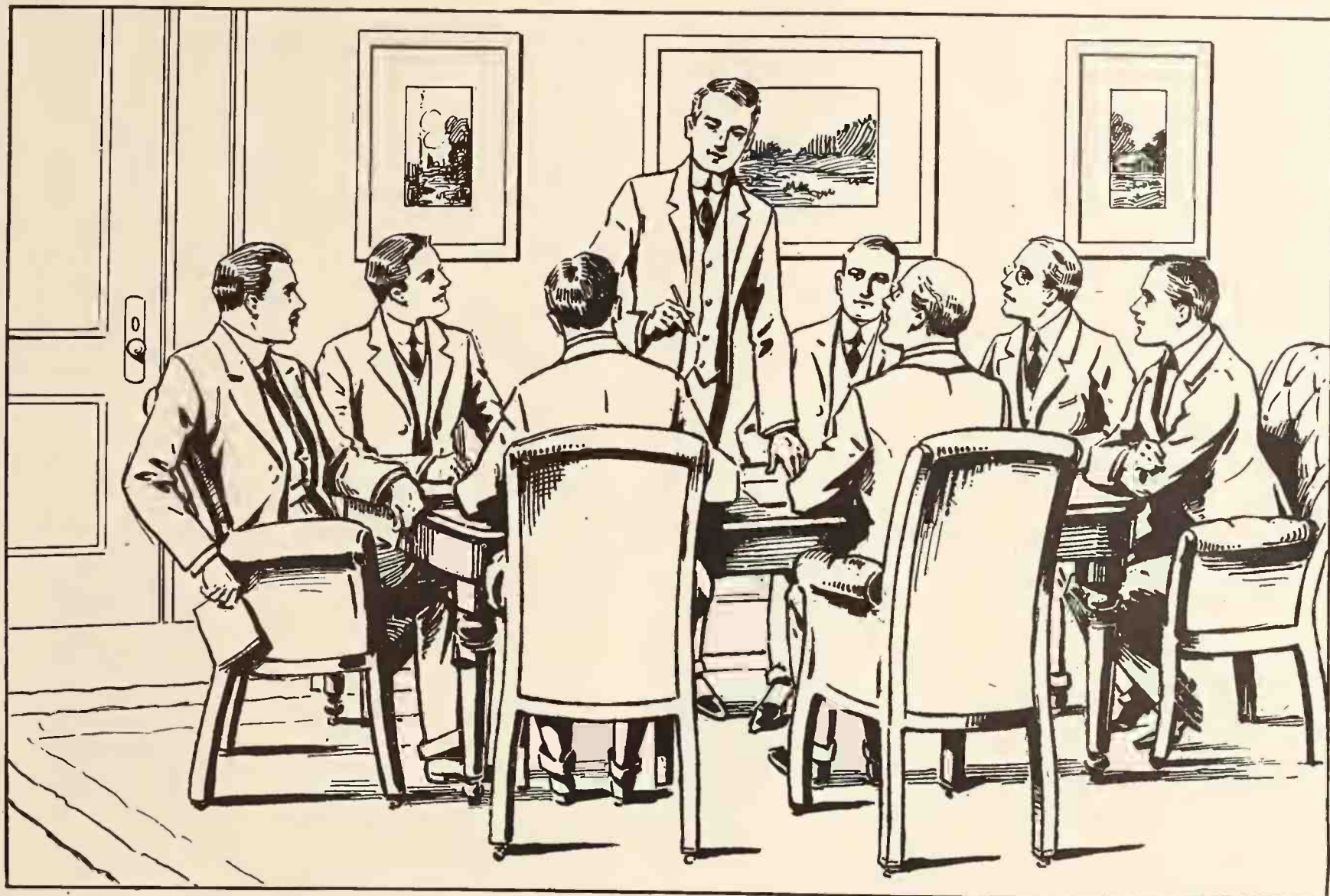

Make These Experts Work for You

If you want to build your retail business along lines which will positively guarantee a healthy profit over a period of a great many years, you want the benefit of expert help on all the

merchandising problems of your business. You can get consulting advice of great dollar value based upon over forty years' experience in the music business in

THE TALKING MACHINE WORLD SERVICE

Here is what will come to you every month if you are fortunate enough to secure this Service exclusively in your territory.

Three original Merchandising Plans—practical methods of getting business, finding new prospects, handling your customers, earning more money out of your store.

Three timely, catchy Window Display Plans—practical schemes that draw the crowds to your windows through their clever appeal to human psychology—yet do not require elaborate and costly "stage scenery."

Two Form Letters that have human interest, selling punch and "pep," prepared by a specialist nationally known for the business-getting power of his letters, whose fee is \$100 or better per letter. One is about machines, the other is on the new records, to be mailed out with your monthly bulletin.

Seventeen complete ads for your newspapers, featuring your store, your name and your service. The reading matter is

bright, original, timely and brimful of money-making ideas. Strictly local, retail personal advertising for you—the kind that sells goods and builds good will.

Seventeen cuts for these ads, drawn by the cleverest and most expensive advertising artists in the country today, such as Ethel Plummer of "Vanity Fair"; Olga Thomas of "Vogue"; Frederick T. Chapman, who illustrates the Franklin automobile and many other ads; W. Fletcher White, famous commercial artist of New York; Charles Baskerville, Jr., of "Scribner's"; Will Graven, whose clever drawings are bought by the leading advertising agencies of New York; Royce Cody, late art director of "Motor Life," and other artists of the same class.

Mats or electros of these cuts are sent you each month as part of the Service—without extra charge.

A yearly total of more than 200 ads, 200 cuts, 36 window display plans, 36 merchandising ideas and 24 form letters—also special ads written to your order, when necessary, for particular events in your store, and consulting advice on all your business problems.

The Cost is about one-quarter as much as the salary of an office boy—because we are selling it to dealers all over the United States and in foreign countries as well, thereby dividing the cost into small fractions. The money you have been losing on one or two ads that failed to bring results would pay the cost of this complete Service for the entire year.

But remember—only one dealer in each territory, and first come, first served! If somebody else in your city orders first, you can't buy the Talking Machine World Service at any price.

We are steadily receiving letters from our clients located throughout the United States and in many foreign countries, wherein they are frank to tell us that The Talking Machine World Service has already caused a material growth in their business.

We will place facts and material before you and will quickly convince you that The Talking Machine World Service is a very vital yet extremely economical adjunct to any retail talking machine business.

OVER 175 DEALERS HAVE PROVED THIS SERVICE IS A SURE THING

Talking Machine World Service,
373 Fourth Avenue, New York City.

If other dealers in big cities as well as small towns are getting results and making a big profit on the Talking Machine World Service, I'd like to know all about it. Without obligation, send me sample copies of ads, form letters, ideas, etc. Tell me what it will cost per month for exclusive use in my territory.

The population of my city is.....
I handle these machines.....
My firm name is.....
By
My address

3-15-20

Mail the above coupon today.

BALTIMORE DEALERS FORM ASSOCIATION

Victor Talking Machine Dealers' Association Organized With William Mueller as President—Wholesalers Lend Their Support—Columbia Dealers Have Successful Monthly Meeting—News and Changes in the Local Trade

BALTIMORE, Md., March 5.—A slight increase in the receipt of records and machines was noted by all of the dealers and distributors during February, but the increase did not help very much to satisfy the demand of the public. Heavy selling of machines, and particularly of records, was noted by many of the dealers.

One of the most noteworthy incidents of the month to the talking machine dealers was the organization of the Victor Talking Machine Dealers' Association of Baltimore. Several preliminary gatherings were held before the dealers finally adopted a working plan, which includes the holding of a meeting on the third Wednesday of the month. The officers chosen include: William Mueller, president; Robert Ansell, vice-president; M. J. Rogers, secretary, and C. D. Messenger, treasurer. The purpose of the dealers coming together was to promote better business, better service to the public, and, finally, better profits to the dealers themselves. The plan includes a general advertising plan of a co-operative nature setting forth a plea for home patronage, home service, loyalty and other points of a nature by which it is hoped to draw especial attention to the merits of the product they handle.

The three Victor distributors of Baltimore—Cohen & Hughes, represented by Elmer J. Walz; H. R. Eisenbrandt Sons, represented by W. A. Eisenbrandt, and E. F. Droop & Sons Co., represented by W. C. Roberts—were presented and gave assurance of their hearty co-operation to the dealers and the association in all of its plans for the betterment of business. The representatives of the distributors made addresses in which they expressed their faith in the success of the plans and forecast a better feeling between dealers. One of the surprising incidents of the occasion was the introduction of the various dealers to each other, for it soon developed that many dealers were unacquainted with one another. It is planned to eventually extend the scope of the organization to dealers throughout the State.

A plan, which will prove attractive to dealers in times when there is a shortage of machines, has been put into practice. The distributors will announce a certain model of a machine for the current meeting. The members all have a number on their dinner check and a drawing is made which gives the names of the three dealers hav-



FULTON (Model 35)

Mahogany, 16x16x10 in., double spring motor, universal tone arm. Back casting and metal horn. Price, \$15.00.

(Model 50) With Cover

Mahogany, 17x19x13 in., double spring motor, Universal Tone-arm. Price, \$16.00.

True-tone and Clear-tone Needles, in metal boxes or packages at lowest prices.

Universal double and triple spring Motors, Tone-arm, Auto Stops, etc. Phono parts and accessories, as Motors, Tone-arms, Sound Boxes, Cabinets and Cabinet hardware. Repair parts for all makes.

Records—Standard make, lateral cut, at \$40.00 per 100.

Cash with order

FULTON TALKING MACHINE CO.
640 Broadway New York, N. Y.

Do You Throw Money Away?

It is not a popular pastime—but still it is unconsciously done by many who just don't know that *Repair Parts* can be bought for less

**RENE MADE SPRINGS AND PARTS LAST LONGER
COST LESS**

RENE MFG. CO.

Montvale, N. J.

ing the privilege of obtaining one extra machine over the regular allotment for the month. Of course, the successful dealer pays for the machine just as though it was sold to him direct, but it thus gives him one additional machine for selling purposes during the month. Two committees have been appointed—one to look after plans for advertising service and the other

an entertainment committee to provide speakers and other forms of amusement that will be helpful in business.

The February meeting of the Columbia dealers at the Southern Hotel was successful and was largely attended. W. S. Parks, manager of the branch, presided and from time to time outlined generally some of the plans of the company.

AMERICAN

THE AMERICAN success has been gained through merit. It is a truly musical machine, and, owing to its excellent equipment, will enable your trade to enjoy every record to its full extent.

Seven models, mahogany, golden oak and fumed oak finishes. The AMERICAN remains sold when delivered. Grand Rapids made and guaranteed throughout. Meisselbach equipment. Are in position to make prompt deliveries and place but one dealer in a town.

Write for our 1920 catalog. Handle a line that it is a pleasure to sell and which carries with it a good profit.

American Phonograph Co.
17 N. Ionia Ave., Grand Rapids, Mich.

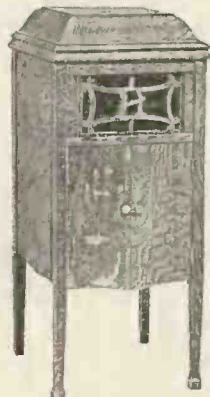

No. 5
Height—40 in.
Width—17½ in.
Depth—18½ in.



No. 8
Height—43 in.
Width—19 in.
Depth—20 in.



No. 9
Height—45 in.
Width—20 in.
Depth—21 in.



No. 10
Height—48 in.
Width—20½ in.
Depth—22 in.



No. 11
Height—51 in.
Width—23 in.
Depth—24 in.



No. 14
Height—46½ in.
Width—19½ in.
Depth—20½ in.



No. 22
Height—50 in.
Width—22 in.
Depth—23½ in.

The April records were demonstrated and dealers made acquainted with other plans. A novel feature of the occasion was the introduction of a selling plan by which William Heinekamp, a Baltimore Columbia dealer, sold a Grafonola to Dan Green, of H. C. Grove, Inc., Washington, in the presence of the dealers from various sections of the territory. William H. Swartz, son of Professor Swartz, of the Johns Hopkins University, and who served Uncle Sam in the World War, was introduced to the dealers as the new head of the dealers' service department at the Baltimore Columbia headquarters. He made a brief address outlining his purpose of helping the dealers and called particular attention to the Nation's Forum series, which contains the records of the speeches of the leaders in affairs of America. Mr. Swartz succeeds Dan DeFoldes, who has become one of the partners and will be the manager of the Grafonola Shop, Norfolk.

W. T. Sibbetts, who until a short time ago was a member of the sales staff of the Columbia headquarters here, has entered business for himself and will have a chain of stores through various sections of the Eastern shore of Maryland. His company opens its first store in Cambridge next week, to be followed immediately by a temporary headquarters in Salisbury, pending the completion of a permanent headquarters. The concern will be known as the Eastern Shore Music Co., will handle the Columbia line exclusively and plans to have at least a dozen stores within a short period.

H. A. Syring, who has been the bookkeeper at the Columbia branch, will have charge of developing the international record department. H. J. McDorman has resigned as credit man and is succeeded by L. H. Evans. During the month Mr. Parks made a hurried trip to Martinsburg and Cumberland and stopped off at various points in the Western Maryland territory. He was pleased that in the branch, despite the lack of records and machines to equal the demand, the business went ahead of the quota set. One of the obstacles to business

was the freight embargo, which held up not alone receipt of goods for the branch, but delayed as well as prevented shipments of goods from the Baltimore headquarters to various dealers in the territory. Motor truck service in some instances made delivery possible and this helped to hold up the quota.

The improvements have been completed at the Cohen & Hughes headquarters. The first of a series of monthly meetings of C. & H. dealers was held in these quarters during the month, when the coming records were demonstrated. A light luncheon was served. An address was made by Manager Walz, in which he placed strong stress on service and better business methods. The firm has also fitted up a special reception room for visiting dealers.

The Rosenstein Piano Co., which is directed by Sol. Rosenstein, through several up-to-date

and especially attractive show windows, have brought themselves prominently before the public and thereby made the venture profitable. Two successes are noteworthy of discussing. One was the display featuring "Dardanella," which had as the central figure a woman in the native garb of the Sultan's land looking down from the cliff at a ship riding in the harbor, while in the offing the scene depicted some of the Constantinople buildings. The other big feature was "The Moon Shine on the Moonshine," with Bert Williams shown on a card design with an empty jug and empty bottles. The words of the chorus were set out on a cardboard. The store is located between the big theatrical houses downtown and the retail section, where are also located some of the principal movie houses of quality, and the display drew the attention of thousands.

EXPAND RECORD PRESSING PLANT

Lyrphone Co. of America Adding Much Equipment to Increase Its Production

The Lyrphone Co. of America, 117 Mechanic street, Newark, N. J., manufacturer of the well-known Lyric lateral record, is adding much new equipment in its record pressing department. Its Newark, N. J., plant is now in full operation, and all the various departments are working overtime in an effort to cope with the present demands for its products.

Its factory is most efficiently laid out and the numerous processes that go into the making of a record are carried out with the speed and certainty that are only found in plants where precision is valued most highly.

The Lyrphone Company is represented by progressive distributors in all parts of the country. Its plans for giving co-operation to its jobbers and to the trade in general are most elaborate, and its sales department takes special pains in devising means of giving service along both sales and advertising lines. The output of the company is being steadily increased.

HANDS DOWN RESTRAINING ORDER

In the Court of Chancery of New Jersey there was recently handed down a restraining order by James F. Fielder, the Vice Chancellor, against the Hector Talking Machine Co., 55 Commercial street, Newark, N. J., enjoining the said corporation from contracting any debts and from collecting and receiving any money owing the corporation.

NEW OPERAPHONE DISTRIBUTOR

The Universal Talking Machine Co., 5 Governor street, Richmond, Va., was recently appointed distributor for the Operaphone records by the Operaphone Co., Inc., Long Island City, N. Y. The Operaphone Co. has in recent months been constantly adding to its jobbers, and is now ably represented in all the larger trade centers.

The New Music Store, Mount Vernon, N. Y., which handles the Pathé Actuelle, has done such a good business the past year that the floor immediately above the present store will be added to the establishment.

ACME

Stands for Highest Quality and Prompt Service

WE MANUFACTURE

ACME MICA DIAPHRAGMS

WE SUPPLY AFRICAN AND INDIA RUBY EXCLUSIVELY

Any Size and Any Thickness and Quantity

LET US HAVE YOUR INQUIRY

ACME MICA COMPANY, Incorporated
Importers and Manufacturers

56 BLEECKER ST.,

Phone, Spring 7197 and 7198

NEW YORK

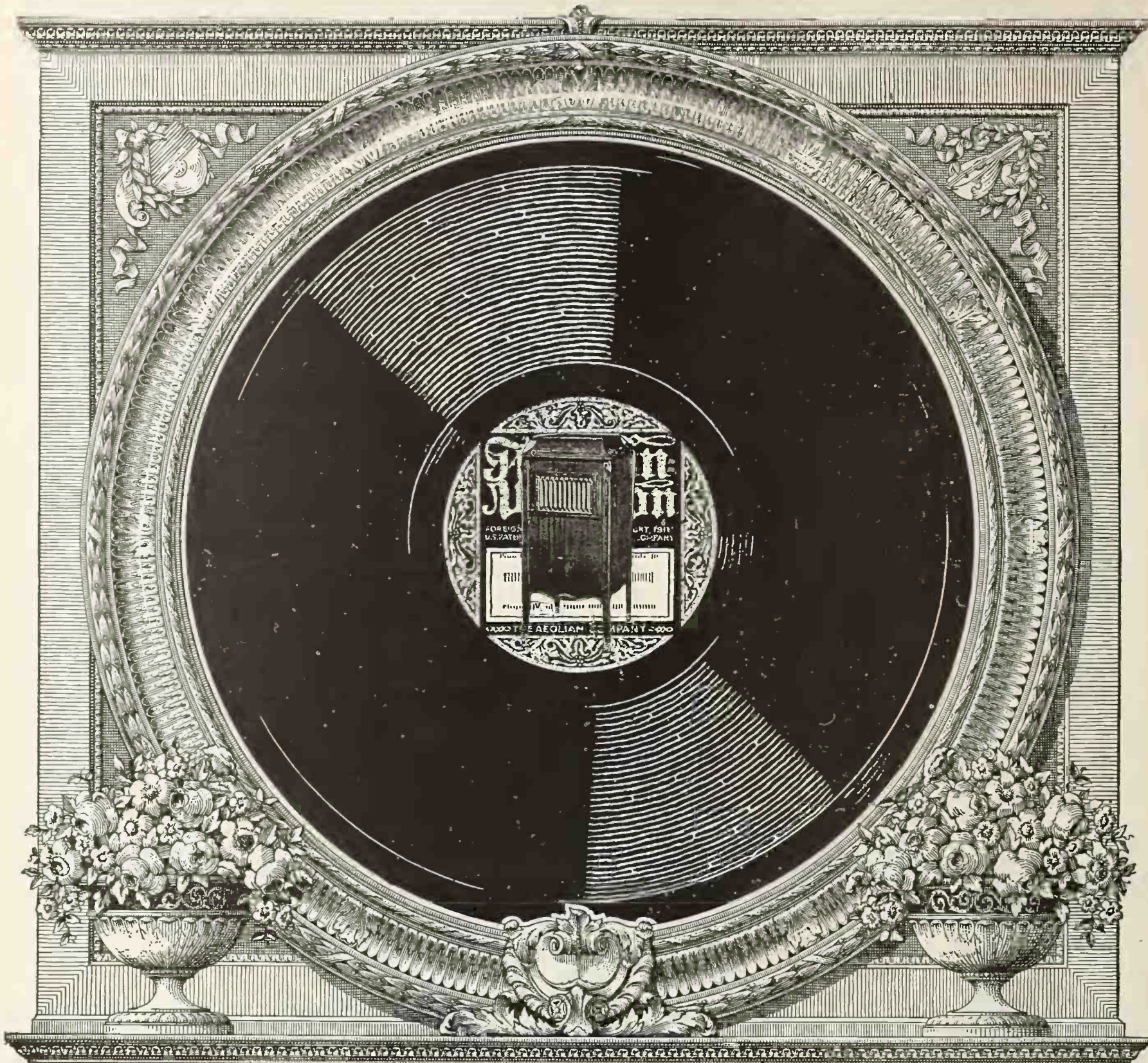

THE AEOLIAN COMPANY OF CINCINNATI

*Wholesale distributors for Cincinnati and adjacent territory
of the celebrated*

AEOLIAN-VOCALION

and the new lateral cut

VOCALION RECORD

Playable on All Standard Makes of Phonographs

COMPLETE dealer service in all branches including newspaper advertisements, window cards, store hangers, etc. The newspaper advertisements are prepared to enable the dealer to tie up his local publicity with the impressive campaign of Vocalion advertising now being run in the Saturday Evening Post and other mediums.

Address Communications to

THE AEOLIAN COMPANY

25 West Fourth St., Cincinnati, Ohio



PITTSBURGH ENTHUSES OVER APPEARANCE OF CARUSO

Victor Dealers Benefit by Successful Concert by Noted Tenor—Educational Department of Mellor Co. Doing Good Work—Change in Columbia Managers—General Trade News

PITTSBURGH, PA., March 3.—The leading event in talking machine circles here the past month and one which caused considerable discussion among the devotees of good singing was the appearance in Syria Mosque on Saturday evening, February 28 of Enrico Caruso, the noted tenor and brilliant Victor artist. The demand for tickets was most pronounced and every seat was occupied long before the hour of starting the concert. In addition there were quite a number of persons seated on the stage, and standing room was at a premium. It is understood that Caruso received \$10,000 for his Pittsburgh appearance. The big musical event was made possible through the enterprise of the Standard Talking Machine Co., Victor distributors, who arranged for the coming of the pleasing Italian singer, who was given a warm and very enthusiastic welcome here. Elias Breeskin, the talented violinist, delighted the audience with his numbers which showed a pleasing sureness of execution and distinct ideas of interpretation.

Pittsburgh Victor dealers took advantage of the visit of Caruso both before and since to keep before the public the varied Caruso records. The window displays the week prior to the concert were lavish in their showing of large cutouts, photographs, signs and placards all extremely Carusoesque and all tending to promote the sales of the Red Seal records. Hundreds were disposed of during the week and thus far sales on part of those who heard Caruso the first time were reported brisk. The Standard Talking Machine Co. utilized its service bureau very satisfactorily to the advantage of the Victor dealers and this aided in a marked manner in promoting sales.

The Victor educational department of the C. C. Mellor Co., which is under the able supervision of Miss Lillian M. Wood, has been very active during the past month, Miss Wood hav-

ing had a number of engagements at a school and also before teachers' institutes. Recently Miss Wood gave a very satisfactory demonstration of the use of the school room Victrola before a teachers' institute at Glassport. Miss Wood also gave a concert interspersed with folk songs and dances at the welfare department of Spang, Chalfant & Co., one of the big steel concerns of the Pittsburgh district. In speaking to The World representative, Miss Wood stated that she had a number of engagements for demonstrating the school room work of the Victor Victrola before schools and educators. She said that the field in the Pittsburgh district was an exceedingly fertile one, especially in view of the good that could be accomplished by the Victrola and Victor records in the Americanization movements here that are being sponsored by the large industrial establishments in their campaign for securing the more general use of the English language. Motion pictures, aided by singing of patriotic, popular and sentimental songs as demonstrated by use of Victor records, are factors that have made the Americanization work here very successful.

Charles B. Hewitt, for some years manager of the Columbia department of Campbell's, one of the leading department stores of this city, has resigned to accept the position of general manager of the Columbia Music Co. A number of years ago Mr. Hewitt entered the employ of the Columbia as a collector. Later he became a salesman and proved so proficient that his promotion to a managership quickly followed. He built up a large and profitable trade at Campbell's and his window displays always attracted more than ordinary attention.

A. B. Smith, assistant manager of the Pittsburgh office of the Columbia Co., has assumed the management of the talking machine

Pretty Messengers with Record News

Painted by famous artists of child subjects and lithographed in full colors on

Nursery Rhyme Blotters

Splendid means of featuring educational records and very attractive inserts for supplements and the regular mail.

Price Lower Than Factory Prices

Sets of 100—12 different subjects—\$8.10, without printing, postage prepaid.

In writing for samples, address Department "C."

Stewart Talking Machine Company

Victor Distributors
INDIANAPOLIS, IND.

department of the National Cloak & Suit Co. of New York this week. Mr. Smith was a very popular Columbia man and his going was much regretted by the office staff. He was given an informal farewell reception and a number of useful gifts were bestowed on him. He has the best wishes of the entire staff from Manager S. H. Nichols down to the office boy.

T. B. Niles, formerly assistant manager at the Indianapolis offices of the Columbia Co., has been selected to fill the vacancy made by the departure of Mr. Smith. He has entered upon his duties.

S. H. Nichols, manager of the local Columbia offices, stated that "sales for February were far in excess of the same month a year ago and marked a new step forward in the 1920 sales." He anticipates a very large spring demand for Grafonolas and records.

Oscar Willard Ray, of the Emerson Phonograph Co.'s New York offices, was a recent visitor to the Emerson Sales Co. offices in the Jenkins Arcade, which is presided over so ably by Mr. and Mrs. Jacob Hirsh. So extensive have the sales of Emerson records become in

(Continued on page 210)

MUSIC AND RECORD CARRYING CASES

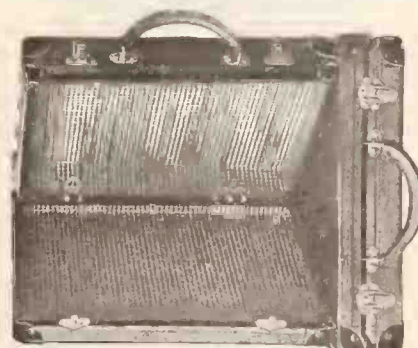

Made of embossed fiber, reinforced with metal and hard fiber. Brass nicker catches and loops, metal covered handle. Record size... 3 x 12 1/2 x 12 1/2", No. 204 Sheet Music Size 3 x 11 x 15", No. 203

Write for Prices and latest catalogue

J. D. HUNT MFG. CO.

Mass. & Davidson Sts. Indianapolis, Indiana
Manufacturers of all kinds of Musical Instrument Cases and Covers



MODEL B, VENUS BELLE

Showing Record Compartment holding 70 records.
Equipped with Modulator.
Height 35 inches. Width 2 feet 7 inches. Length 3 feet

THE VENUS BELLE

(SHAPED LIKE A BELL)

is a remarkable instrument in **Tone and Volume Design and Finish**

Because of its bell-shaped construction it is acoustically correct. Its long and tapering horn of TEMPERED wood affords a clarity and resonance that are so marked that one demonstration results in

Instant Sales

Three models in mahogany, walnut, oak and ebony.

Dealers who desire exclusive territory should make application at once.

The VENUS CO.

Also Makers of The VENUS Phonograph Needle

Factory and General Offices: Liberty & Western Aves. Cincinnati, Ohio, U.S.A.

Chicago Sales Office: 717 South Wells Street

CARUSO APPEARS IN PITTSBURGH

(Continued from page 209)

the territory covered by Mr. Hirsh that larger quarters are needed and will be secured when the new Emerson phonographs make their appearance here.

One of the most elaborate talking machine department in the city is that devoted to Pathé phonographs at Pickering's which has just been thrown open to the public. It is located on the main floor and is admirably adapted for demonstration purposes. There are fifteen large booths all equipped with electric lights and so arranged as to give quick service. In the rear of the department is the record stock room, where space for 10,000 records is to be had. The front part of the department will be utilized for display purposes and a full line of Pathé art models, as well as the regular styles, will be on exhibition.

Newton B. Heims, distributor of the Brooks automatic repeating phonograph and the Cardinal phonograph and Okeh records, as well as trade accessories, with offices in the Jenkins Arcade, was bereaved recently by the death of his eleven months old son, Newton B. Heims, Jr. Both Mr. and Mrs. Heims have the sincere sympathy of the trade in their sorrow.

P. W. Kline, manager of the talking machine department of The Rosenbaum Co., announces that a full line of Emerson records will hereafter be on sale in the department. He also carries the Victor, Columbia and Pathé lines.

J. J. Murray, manager of the Victrola department of Spear & Co., reports trade as exceptionally good, especially in the record line.

A. R. Meyer, manager of the Joseph Horne Co. talking machine department, stated that February sales showed a marked increase over the same month a year back. He is much interested in the development of the plan of using talking machine records to instil a love for good music. He believes that a wide expansion of this plan is bound to come soon.

At the headquarters of Smith, Kline & French Co., Sonora distributors, H. M. Miller stated that every indication pointed to an unprecedented demand for Sonoras, which he will try very hard to satisfy. He stated that local Sonora dealers all reported that they could dispose of Sonoras about as fast as they could be delivered to them.

At the Pittsburgh offices of the Brunswick phonograph it was stated that every effort was being made to satisfy the demands of the dealers for Brunswick machines and records. Manager

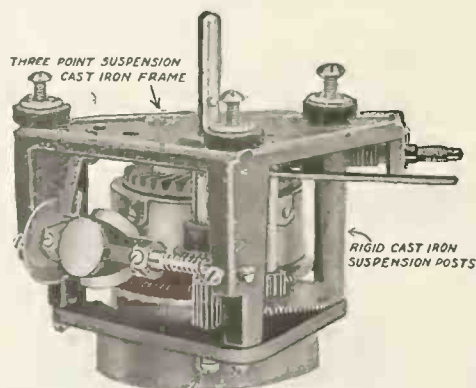

WONDER D. S. MOTOR NO. W2

Motor Building is a science which is mastered only by patient effort and experience. That is the reason it pays to buy motors of an established talking machine manufacturer rather than of mere "motor builders" who set aside, maybe, a part of a plant and produce motors solely for profit without realization of the service requirements. That is the reason it will pay you to buy Wonder Motors.

Our No. W2 illustrated above is a service giving, tested and tried product. It has been designed by our organization to overcome the defects which were found to be in everything previously bought by us from others. It has been regularly assembled into our own talking machines without a single complaint ever having been received. It is a thoroughly high-grade mechanism at a very fair price. It will save you money and reduce your motor troubles. It is not built FOR us but BY us at our own factory at South Norwalk, Conn. We guarantee it and stand back of it. It is a sensible, practical, high grade, Yankee product. Write for detailed information and sample.

Prompt Deliveries on Contracts.

WONDER TALKING MACHINE CO., Inc.

109 East 12th St., Cor. Fourth Ave. Phone Stuyvesant 1666
NEW YORK CITY

Distinctive Hardware Requisites

for

Phonographs—Furniture—Refrigerators

Lid Supports
Automatic Stops
Tone Rods
Needle Cups
Escutcheons
Sockets
Knobs, etc.

A complete line in all the periods. Also commercial furniture hardware.

All sized locks and hinges that answer every requirement.

Smart, durable, practical Trimmings and Parts.

Samples cheerfully furnished manufacturers on request.

Grand Rapids Brass Company

Grand Rapids

NEW YORK: 7 EAST 42d STREET

Michigan

George J. Meyer said that the prospects were never brighter and he is looking forward to a very active Spring trade.

At Gray & Martin's talking machine shop a fine display of Cheney and Sonora phonographs was observed. The firm reports brisk sales of the two instruments and also Emerson records. The firm also handles the Modernola.

H. F. Andre, manager of the retail talking machine department of the W. F. Frederick Co., who spent two weeks taking the Victor salesmanship course at Camden, N. J., is delighted with the methods used and stated that it was a revelation to him. Mr. Andre is utilizing the knowledge he gained of Victor salesmanship in instructing the sales force of the retail department at frequent intervals.

A. A. Buehn, president of the Buehn Phonograph Co., Edison distributors, reports trade conditions in the Edison line as very brisk both in the wholesale and retail departments. Mr. Buehn and his traveling salesmen have arranged

to attend the conference of Edison salesmen in New York on March 15. All of the Buehn roadmen are very enthusiastic over the contest that has been launched by the Edison Co. and they intend to be among the winners when the prizes are awarded.

Established in the forties, the Willson Co., of Sharon, Columbia distributors, recently tendered a dinner to their employes at the Shenango House, Sharon, at which covers were placed for twenty-one persons. Following the dinner the party adjourned to the store, where Mr. Willson gave a brief address to the staff and told of the growth of the Willson store from the date of its inception to the present day. He also referred to the fact that in the Fall the seventy-fifth anniversary of the founding of the Willson store would be fittingly celebrated. The Columbia department of the Willson store is to be much enlarged with the addition of new demonstration booths and other improvements for the betterment of the service for the Columbia patrons.

The Reed Co., Inc., distributor of the Regina phonograph and Operaphone records, reports sales of records unprecedented, seeming never to be able to keep up with the demand for the Operaphone records which are exceedingly popular in the Reed territory. It was also stated that the Reed Co. is very busily engaged in installing the Reed sectional record demonstrating booths and record racks.

B. N. DeFrance, of Ellwood City, Pa., has installed in his pharmacy a complete line of Regina phonographs and Operaphone records. He has also equipped his store with the Reed record demonstrating booths and record racks.

After April 1 the Reed Co., Inc., will be located in its new and commodious building at the corner of Ellsworth and Maryland avenues, East End, Pittsburgh. The present location at 237 Fifth avenue has long since been too small for the expanding business of the company.

A new talking machine motor increases the speed of rotation as the needle nears the center of the record, so that the needle is always moving at the same speed, producing a uniform range of vibration values.

Our Pictures Talk Music

We have the greatest advertising proposition on the market. For window display or wall decoration. Low in price, but high in results. Write for particulars.

Music Advertisers Club, 741 ALDINE AVE.
CHICAGO, ILL.

MORE PHONOGRAPH SALES IN 1920

IF YOU HANDLE THE
CHORISTER

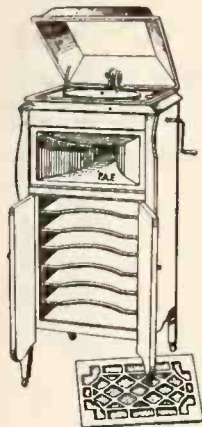

"LEADER OF THEM ALL"

Have we told you about our new amplifying chamber?

PERFECT
TONE
AND
MECHANISM

WRITE NOW FOR
PRICES AND ILLUSTRATIONS

CHORISTER PHONOGRAPH CO.

336-38 WEST 63rd STREET
CHICAGO

TELEPHONE ENGLEWOOD 1979

SUPERB
CABINET
WORKMANSHIP

NEW MOTOR MANUFACTURERS READY TO ENTER FIELD

Sphinx Gramophone Motors, Inc., Has New Plant Ready for Production of Talking Machine Motors of New Type on Large Scale—Shipments to Begin on or About April 1

The Sphinx Gramophone Motors, Inc., of New York City, has just announced to the trade a new talking machine motor, with many special patented features. The motor is the invention of Maximilian Weil, an engineer well known in the talking machine field, who was ably assisted by a staff of motor engineers of prominence in creating the product.

Although patents were granted on the motor over a year ago, the manufacturers have delayed making an announcement until all preparations for quantity production had been completed. Deliveries are to be made on April 1.

The Sphinx Gramophone Motors, Inc., is a subsidiary of the Nathan Mfg. Co., 512 Fifth avenue, New York, a firm who, it is understood, is allied with a prominent associate company of the American Locomotive Works, the Nathan firm owning locomotive parts manufacturing plants in Flushing, L. I., and 106th street and East River, New York. The Nathan Mfg. Co. was established nearly sixty years ago by Max Nathan, a mechanical engineer of international prominence and father of Alfred Nathan, its present head.

Howard De S. Hodson, formerly of the American Motor Car Co., and of late years in sales and engineering work in the United States and foreign countries, is president of the Sphinx Gramophone Motors, Inc. Edward S. Toothe, is vice-president, and Alfred Nathan is secretary and treasurer. LeRoy Fairman, well-known in advertising circles, is in charge of the publicity.

Initial production of the motor is planned to commence at the Flushing plant, where exhaus-

tive research into the problems of talking machine motor power generation and transmission has been made by a corps of engineers. It is at present planned to manufacture 500 motors daily, and the facilities of the company will allow this to be increased to 1,000 as needed.

The plant in which the motors will be turned out is most efficient from every angle, and all work is done according to charts and sketches. It is understood that negotiations now well under way will practically take care of all the initial production of the company.

Mr. Toothe, vice-president of the company, will be in direct charge of the manufacturing of the motors, and he is well qualified for this work, having established a record for efficient production of intricate and delicate mechanisms. During the war, a plant under his charge turned out 28,000 high explosive fuses a day. His work brought him very prominently before war department heads and he was given the rank of major in the U. S. Army, and placed in charge of all engineering depots from debarkation ports to the firing line in France. Mr. Weil, who will supervise the work of design, construction and research, was one of the engineers engaged in the original electrification of the New York Central Railroad. He is a well-known authority on sound reproduction and has many talking machine inventions to his credit. Among his other inventions is the Weil harmonic train control system, operated on a principle of harmonics. He is a member of the American Institute of Engineers, Aeronautical Society of America and other scientific organizations.

George Perrenet, formerly of the Standard Oil Co. of New York, and controller of the Nathan company, is controller of the Sphinx Gramophone Motors, Inc. The Flushing plant of the firm is a most modern one, especially designed for metal work. It is equipped from draughting room to pattern making, foundry casting and machine tooling. It is a concrete structure, having hundreds of thousands of feet of floor space, with a private railway siding. For local delivery and other shipping purposes a fleet of motor trucks is at hand.

Both Dennis Bros. and the Jensen Music Co., Clinton, Ind., have retired from business, leaving H. D. Bradshaw as the only music store in that city.

Improve Your 1920 Production WITH **PARR PRODUCTS**

**The Solution
of True
Reproduction
of Tone
Qualities**



OUR MAGNETIC REPRODUCER: Produces pure tone qualities and wonderful volume. The method of constructing the reproducer and the pivotal arrangement of the stylus bar allow the vibrations to pass without interruption from the needle to the diaphragm. The magnetic attraction of the needle arm gives an outward strain on the diaphragm, making it more sensitive to vibration influences.

THE UNIVERSAL TONE ARM: The only arm on the market with an automatic change of weight. The weight to play either vertical or lateral cut records is automatically and accurately changed. It centers in either position. Our new and improved arm is made entirely of brass, producing a rich, mellow tone and presenting a neater and more beautiful appearance. Can be furnished in any length desired.

OUR VIBRATONE DIAPHRAGM: Eliminates the troubles encountered with mica; is light, elastic and flexible; will not crack, blister or develop inequalities. Produces a more beautiful tone and greater volume. Not affected by atmospheric changes.

Parr Manufacturing Corporation

Factories
New York City.
Latrobe, Pa.
Newark, N. J.

MAIN OFFICES:

100-108 WEST 23rd STREET

NEW YORK CITY

REPAIRS

All Makes of Talking Machines
Repaired Promptly and Efficiently

ANDREW H. DODIN

176 Sixth Avenue

New York

TELEPHONE, CHELSEA 8437

QUALITY LEADERS IN THE CABINET FIELD



Style 71.—Mahogany, Golden Oak, Fumed Oak, Weathered Oak. Height 33 1/4 in. Top 17 1/2 x 17 1/2 in. Holds 168 12-in. Records. For Victrolas IV-A and VI-A; Columbia No 25 and No. 35.



Style 24.—Mahogany, Golden Oak, Fumed Oak, Weathered Oak. Mahogany has Mahogany front door; Oak has Quartered Oak front door. Height 33 in. Top 17 x 17 in. Holds 168 12-inch Records. For Victrolas IV-A and VI-A; Columbia No. 15, No. 25, No. 35.



Style 72.—Golden Oak, Fumed Oak, Weathered Oak. Height 34 in. Top 16 1/2 x 20 in. Holds 180 12-in. Records. Made specially for Victrola VIII-A. Top has countersunk holes to accommodate rubber bumpers on machine.



Style 86.—Mahogany, Golden Oak, Fumed Oak, Weathered Oak. Height 30 in. Top 19 1/4 x 22 1/4 in. Holds 96 12-in. Records. For Victrola IX-A; Columbia No. 50; Pathé No. 50.



Style 79.—Mahogany, Golden Oak, Fumed Oak, Weathered Oak. Height 34 in. Top 19 1/4 x 22 1/4 in. Holds 96 12-in. and 96 14-in. Records. For Victrola IX-A; Columbia No. 50; Pathé No. 50.



Style 32.—Mahogany, Golden Oak, Fumed Oak, Weathered Oak. Height 30 in. Top 24 x 20 in. Holds 126 12-in. Records. For Victrolas VIII-A and IX-A; Columbia No. 50; Pathé No. 50, and smaller machines.

Prompt deliveries on all orders. Write for Illustrated Catalog of complete line

**The Geo. A. Long
Cabinet Company**
HANOVER, PA.



Style 76.—Mahogany, Golden Oak, Fumed Oak, Weathered Oak. Mahogany has Mahogany front door; Oak has Quartered Oak front door. Height 34 in. Top 19 1/4 x 22 1/4 in. Holds 96 12-in. and 96 14-in. Records. For Victrola IX-A; Columbia No. 50; Pathé No. 50.



Style 77.—Mahogany, Golden Oak, Fumed Oak, Weathered Oak. Height 34 in. Top 19 1/4 x 22 1/4 in. Holds 96 12-in. and 96 14-in. Records. For Victrola IX-A; Columbia No. 50; Pathé No. 50.

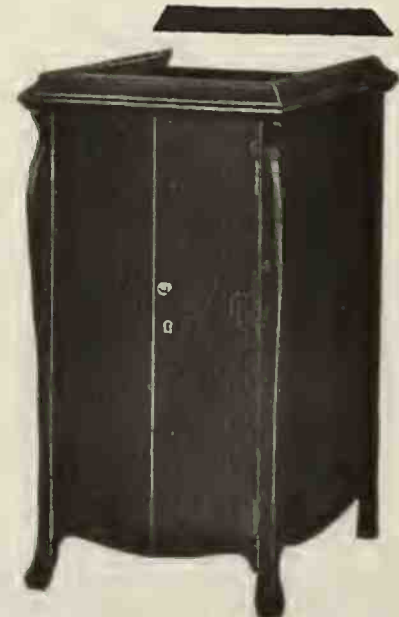

Style 77.—Shows cabinet equipped with top moulding to be used only in connection with Victrola IX-A.

ORVILLE HARROLD FOR VICTOR

Popular American Tenor Signs Up to Record Exclusively for Victor Co.

The latest addition to the Victor Talking Machine Co.'s list of famous recording artists is the name of Orville Harrold, the noted American tenor, who has created a sensation with the



Orville Harrold

Metropolitan Grand Opera Co. in New York this season. Mr. Harrold has been prominently before the public for several seasons through his appearances on the concert and operatic stage and musical critics concede that he is one of the foremost tenors of the day. He has a voice of great range, power and beauty and his first recordings indicate that it is particularly well adapted for record making. The first of the Harrold records will be released to the trade and the public at an early date.

SALES CONDITIONS IN THE SOUTH

Interesting Letter Received by the Sonora Phonograph Co. From Brace Bennett, Which Gives Pleasing Evidence of the Activity in That Section of the Country

An interesting letter regarding sales conditions in the Southwest was received recently by the sales department of the Sonora Phonograph Co., New York, from Brace Bennett, of the Southwestern Drug Co., Wichita, Kan., Sonora jobbers. In his letter, Mr. Bennett states in part:

"Even though you triple your production this year, we do not believe we will have enough Sonoras—especially the 'bulge' designs and any design in the oak finish.

"It may be of interest to you to know about the very effective business-getting plan used this past season by our progressive dealers of Sapulpa, Okla.—Cowman's Pharmacy. They organized a Christmas phonograph club, worked out on the same basis as a bank's Christmas savings club. Weekly payments were begun by its members in the Fall, and by Christmas a substantial amount had been paid and the machines delivered on time. A real sales volume was developed in this plan and invaluable advertising resulted from this effort.

"Highest honors for the past season are shared equally between J. C. Bredelhoff, of Buhler, Kan., and the Stinson Confectionery, of Durant, Okla. Mr. Stinson started out rather conservatively last Summer, and since then has gone from C to A contract. His specialty is the 'Nocturne' model, and it seems almost daily that we get a telegram, special delivery, or some other form of hurry call for machines from him.

"J. P. Blevins, live-wire dealer of Lyons, Kan., phoned in the other day and wanted everything we had and would have in models from \$200 up. His system of scouring farm country keeps him and two other salesmen always on the jump.

DETERLING CO. TO MAKE "TALKERS"

Organization Perfected and Plant Secured to Manufacture Talking Machines Which Will Contain Special Deterling Features

TIPTON, IND., March 5.—Phil. A. Deterling, of the Deterling Manufacturing Co., has just completed plans and the purchase of machinery which will soon result in the production by the Deterling Manufacturing Co. of close to 5,000 talking machines per year.

The growth of the Deterling Manufacturing Co. has been a rapid one since its inception less than two years ago. At that time the company was organized by some of the principal business men of Tipton, who felt that their community offered exceptional advantages for a talking machine factory. They secured the services of Mr. Deterling, who has been engaged in the manufacture of musical instruments practically all his life, and soon had the plan on a working basis. Mr. Deterling had been one of the officials of the Bell Brothers Piano Co., at Muncie, for a number of years, but, seeing the opportunities, decided to go with the Tipton organization.

The officers of the corporation are: George P. Bower, president; Walter Carter, vice-president; I. H. Woodruff, secretary and treasurer. Mr. Deterling is general manager.

One of the features of the Deterling product has been its zig-zag felt filing system, which is highly spoken of. Although somewhat difficult to build and costly, it nevertheless was decided to equip all Deterling machines with this system.

T. B. NILES' NEW APPOINTMENT

Thomas B. Niles Becomes Assistant Manager of the Pittsburgh Columbia Branch

The general sales department of the Columbia Graphophone Co. announced this week the appointment of Thomas B. Niles as assistant manager of the Pittsburgh branch, of which S. H. Nichols is manager. Mr. Niles was formerly assistant manager of the Indianapolis branch and prior to that was associated with the general sales department. He attained signal success at Indianapolis and well deserves his promotion to the post of assistant manager of the Pittsburgh branch.

RECEIVER FOR BLISS APPOINTED

A petition in bankruptcy has been filed against the Bliss Reproducer, Inc., manufacturer of the Bliss reproducers, 80 Fifth avenue, New York. Judge Hand has appointed Bertha Rembaugh receiver with a \$5,000 bond. The liabilities are said to be about \$50,000 and the assets \$10,000.



S

one

SHEER beauty of tone has given the Bush & Lane Phonograph its high rank in the world of music. There may be phonographs which are higher in price, but none which excel the Bush & Lane in faithful reproduction of music. Made in the same factory that produces Bush & Lane Pianos and Cecilian Player-Pianos, this phonograph is a worthy member of a "family" of perfect musical instruments. BUSH & LANE PIANO COMPANY, HOLLAND, MICH.

BUSH & LANE

THE LATEST Okeh Records ARE HERE

*Get your orders in early for these wonderful records.
Timely release of quick selling titles.*

4057	{ Dardanella—Oriental Fox-trot "O" (Oh!)—Fox-trot	Rega Dance Orchestra Rega Dance Orchestra	} \$1.00
4058	{ A La Carte—One-step Ching-A-Ling—One-step	Conway's Band Conway's Band	} \$1.00
4059	{ I Am Climbing Mountains—One-step Dreamy Alabama—Waltz	Conway's Band Conway's Band	} \$1.00
4060	{ When You're Alone—Fox-trot Bo-La-Bo—One-step	Green Bros. Xylophone Orch. Paul Biese Novelty Orchestra	} \$1.00
4061	{ Fast Asleep in Poppy Land—One-step Yellow Dog Blues—Fox-trot	Paul Biese Novelty Orchestra Paul Biese Novelty Orchestra	} \$1.00
4062	{ Floatin' Down To Cotton Town—Tenor and Baritone Duet Lucy, (Dancing Around the Cabin Door)—Tenor and Baritone Duet	Kaufman-Hall Kaufman-Hall	} \$1.00
4063	{ Cairo Land—Vocal Trio We Must Have a Song to Remember—Tenor	Sterling Trio Harvey Hindermeyer	} \$1.00
4064	{ Baby Love—Vocal Duet Sunny Weather Friends—Tenor	Campbell-Burr Harvey Hindermeyer	} \$1.00
4065	{ When It Comes To Lovin' The Girls—Tenor I Don't Want A Doctor—Baritone	Emerson Westervelt Jack Kaufman	} \$1.00
4066	{ Little Girls, Good-Bye!—Tenor and Vocal Quartet Just Like The Rose—Baritone	Lewis James Arthur Burdin	} \$1.00
4067	{ Pickaninny Blues—Vocal Trio When Two Hearts Discover—Vocal Duet	Crescent Trio Marion Evelyn Cox-Phillips	} \$1.00
4068	{ Linger Longer Letty—Vocal Duet Climbing The Ladder of Love—Baritone	Helen Clark-Joseph Phillips Joseph Phillips	} \$1.00

Remember that you gain by placing your orders early. Offer your patrons the latest and best in vocal and instrumental selections and they will patronize you regularly. Ordering early is one way to avoid disappointing them as we are sure to fill orders in the order they are received.

Our Service Department will help you sell these records. We have a number of sales helps that you can adapt to your window and store trim.

Yahr & Lange Drug Co.

Okeh Jobbers

MILWAUKEE, WIS.

THE VISION

Devoted to the Interest of the Educational Work Being Conducted by the Talking Machine Dealers and Jobbers

New uses for talking machines are being discovered every day. The latest plan for use by physicians and specialists in neurology is to stimulate nerve control-centers of the body by loud crashy music, such as the Rachmaninoff Prelude or Wagner's "Ride of the Valkyries," and to use as a sedative, quieting, tinkly compositions like Rubinstein's Melody in F and MacDowell's "To a Wild Rose" or any other of his "Woodland Sketches." The talking machine is taken into the patient's room and the music played with gradual increase in volume. Dr. Simon Weil, of the New York County Medical Society, is chairman of a special committee on this research and is using a Victrola in his work.

Several inquiries have been made recently regarding the supervisor of the course in music appreciation given at Columbia University, New York City, last Summer. This course was given by Miss Edith M. Rhett, of the Victor educational department, and was attended by interested students, who keenly appreciated its practical value.

The revised edition of the Columbia educational catalog, "The Grafonola in the Class Room," is issued and now ready for distribution. It contains all the new and up-to-date records suitable for school purposes. The catalog is graded from kindergarten to high school with classification of musical selections for each and every grade.

Since January 1 of this year M. L. Mohler, of Teachers' College, Columbia University, New York, who is affiliated with the educational de-

partment of the Columbia Graphophone Co., has been supervising the teaching of "Music Appreciation" in the Oak Lane Country Day School, of Philadelphia. Mr. Mohler works in this school on Thursday of each week. It is said that the Oak Lane school is on a par with the Horace Mann School, of Teachers' College, New York, but it is not an experimental school. It accepts and puts into practice the principles of those working in the field of educational psychology. The fact that Mr. Mohler's work is put into practice in both Horace Mann School and Oak Lane School shows that his work is rightly based and has the balance and poise that men and women in education commend.

Landay Bros., New York, N. Y. (Victor jobbers), have announced their new series of concerts with Grace Leigh Scott, American soprano, a pupil of Oscar Saenger, singing the songs of the Music Memory Contest, New York City. The compositions required for the contest are of considerable interest to educational directors and jobbers and dealers. All the compositions are recorded by the Victor Co. and are distributed in New York City schools by the Landay department, in charge of Franklin S. Dunham. The list is an extensive one.

One of the most important subjects discussed at the superintendents' convention of the National Educational Association in Cleveland, February 23-28, was the subject of educational measurements. The leading experts of the country were present to explain the values of establishing measures of ability in pupils and standards by which to record growth. Numerous charts were shown to indicate the work accomplished to date in the schools.

J. Milnor Dorey, educational representative of the Columbia Graphophone Co., was given the opportunity to explain the records they have issued, making serviceable to the schools the great work of Professor C. E. Seashore, head of the department of psychology in the University

of Iowa, in establishing tests for measuring capacities in music. The scientific character of these five tests—pitch, intensity, time, consonance and memory—was thoroughly explained, the methods of giving the tests, the uses to which the results may be put, and some of the results already attained in the schools.

This effort to establish forms in music as in the other subjects was favorably commented upon by the 1,500 educators present, in view of the wide use the music supervisors are making of them all over the country.

C. W. WODDROP RETURNS FROM VISIT

C. W. Woddrop, vice-president, secretary and treasurer of the Columbia Graphophone Co., returned to New York a few days ago after a flying visit to the Pacific Coast. Mr. Woddrop visited Los Angeles for the purpose of meeting his daughter, who had been visiting Mrs. E. D. Easton, widow of the late president of the Columbia Co.

While in Los Angeles Mr. Woddrop called at the Columbia branch in that city, and congratulated Manager Stidham and his organization upon the splendid sales totals attained during the first two months of the year. The Los Angeles branch recently moved into a handsome new home, and Mr. Woddrop was delighted with the facilities and conveniences afforded the Los Angeles force in its present quarters. Mr. Stidham stated that the business outlook was excellent and that March figures would undoubtedly show a substantial gain over February, which was the best month in the history of the branch. Prosperity seems to be universal throughout the Pacific Coast.

INCORPORATED

The F. G. K. Talking Machine Co., Brooklyn, N. Y., has been incorporated with a capital of \$10,000 by E. Harris, P. Duryee and H. O. Falk, 141 West Forty-fifth street.

GUARANTEED

Model No. 2150 D.D.
2 Units Illustrated.

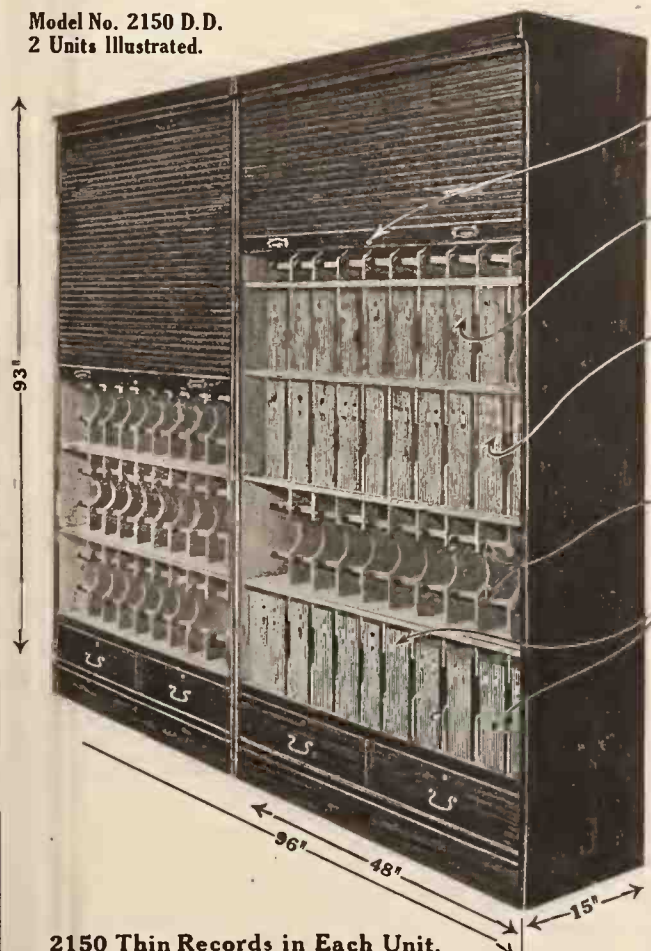

Locking Roll Top Prevents Dust and Theft, also supplied with Spanish Leather Curtain.

350 10" or 10 1/2" Records on each shelf. Filed in Sales System Covers and with Index Guides.

350 10" or 10 1/2" Records on this shelf, also 3 shelves above.

Soft Flat Supporting Springs Prevent Warping (Patented). Holds 350 10" or 12" records.

10 and 12" Records Filed on same shelf. Held Flush at the front by Patented Adjuster.

Sectional Models Fit Any Size Stock and Help You Grow.



File Your Records so you can find them and it's easy to sell them.

This System pays for itself by increasing Sales through better service and Automatic ordering of "Sold Out" Records.

Secure These From Your Jobber:

COLUMBIA DISTRIBUTORS

Columbia Co., All Branches.
Tampa Hardware Co.

EDISON DISTRIBUTORS

Harger & Blish.
C. B. Haynes Co., Inc.
Laurence H. Lucker.
Phonographs, Inc.
The Phono Co. of Chicago.
The Phono Co. of Cincinnati.
The Phono Co. of Detroit.
The Phono Co. of Kansas City.
The Phono Co. of Milwaukee.

VICTOR DISTRIBUTORS

W. D. & C. N. Andrews
Badger Talking Machine Co.
Blackman Talking Machine Co.
C. Bruno & Son, Inc.
Louis Buehn Co., Inc.
The Cleveland Talking Machine Co.
The John Elliott Clark Co.
Cohen & Hughes.
W. J. Dyer & Bro.
Elmira Arms Co.
Eclipse Musical Co.
Elyea Talking Machine Co.
J. W. Jenkins' Sons Music Co.
Mickel Bros. Co., Des Moines.
Mickel Bros. Co., Omaha.
Putnam-Page Co.
Stewart Talking Machine Co.
The Toledo Talking Machine Co.
Talking Machine Co., Birmingham.
The Perry B. Whitsit Co.

OTHER DISTRIBUTORS

Buffalo Wholesale Hardware Co.
Interstate Phonograph Co.
C. M. McClurg & Co.
Cabinet & Accessories Co.
Sonora Dist. Co. of Texas.
Yahr & Lange Co.
Crafts-Starr Phono. Co.
W. H. Caldwell.

SALESMEN

H. A. Copeland.
W. O. Harris.

Ogden Sectional Cabinet Co., Inc.
LYNCHBURG, VA.

The Ogden Sales System Is Equivalent to an Extra Clerk and Increases Sales.

INDEPENDENT

POPULAR MODEL FOR 1920

RIGHT
IN
EVERY
PARTICULAR:

Design
Finish
Workmanship
Tone
Quality

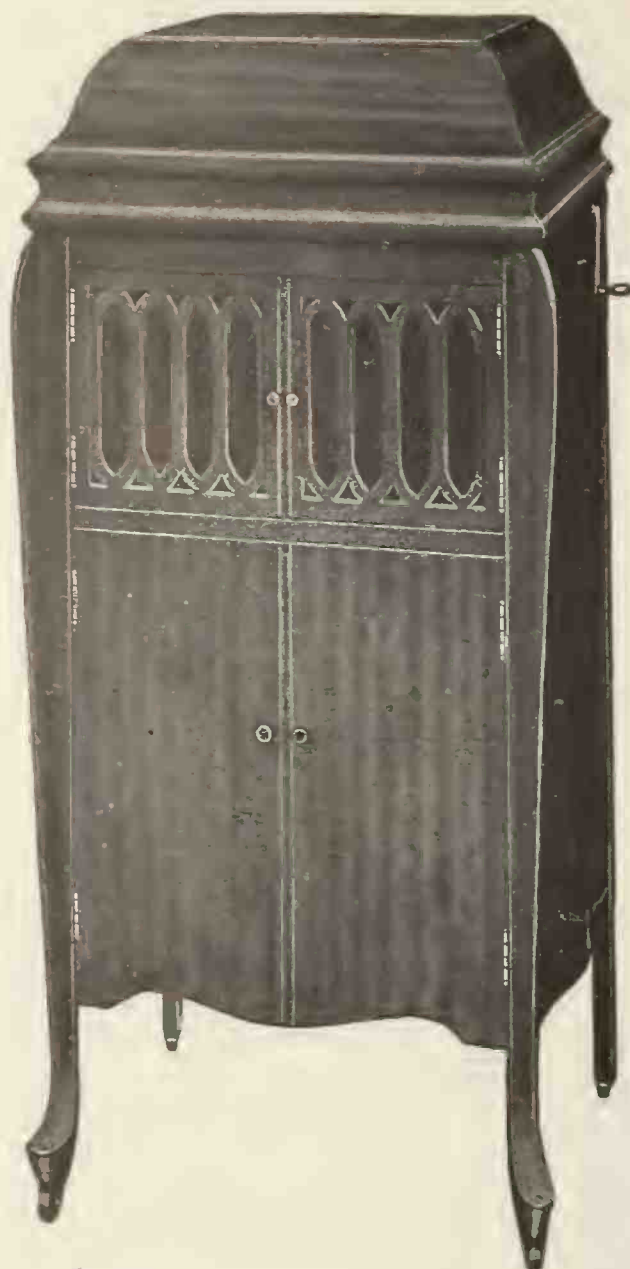

Manufactured
Entirely
In
Our
Own
Factories
By
People
Who
Know

MODEL 12—Retailing at \$110.00
46 inches high—20 inches wide—20½ inches deep

In our own factory at Canton, Pa., we will manufacture 40,000 Model 12 in 1920.

In our factory at Elizabethport, N. J., we will manufacture 15,000 of our Models 15 and 20, retailing at \$150.00 and \$200.00.

These Remarkable Values Must Be Seen—Description Is Inadequate.

We desire distributors in several important territories, and to substantial concerns with a real following we will offer an attractive contract—Circulars on request

INDEPENDENT TALKING MACHINE CO., Inc.
12 East 42nd St., NEW YORK CITY 105 Washington St., BOSTON, MASS.

A. T. EMERSON'S IMPORTANT MOVE

Incorporates With Capital of \$1,500,000 to Manufacture Talking Machines on a Large Scale

A. T. Emerson, purchasing agent of the Pathé Frères Phonograph Co., Brooklyn, N. Y., for the past five years, resigned from this position recently, and is now head of the firm of A. T. Emerson, which was incorporated this week with a capital stock of \$1,500,000 to manufacture on a very large scale. The company is manufacturing complete talking machines and Mr. Emerson states that at the present time orders have been placed for raw material costing \$3,500,000 and that these orders specify immediate delivery. Mr. Emerson, who is one of the best known members of the talking machine industry, will be ready to announce detailed plans regarding his manufacturing activities within a few weeks, and judging from all indications his company will be an important factor in the field.

LARGER QUARTERS IN CANTON, O.

CANTON, O., March 9.—To meet the constantly increasing demand for talking machines the Livingston Furniture Co. has started alterations to its main floor which, when completed, will give this company an additional 1,000 square feet of floor space, to be devoted exclusively to the display and sale of talking machines. The new addition will be in the form of a balcony and will comprise nine sound proof booths. D. B. Livingston, the manager, expects to have the enlarged department open by April 1. The Livingston Co. handles the Columbia Grafonola.

NEW RETAIL VOCALION MANAGER

R. M. Kempton has been appointed manager of the retail Vocalion department of the Aeolian Co. with headquarters at Aeolian Hall, succeeding E. M. Wheatley, who recently went to Boston as manager of the Vocalion Co.

VICTOR CO.'S WINDOW DISPLAY SUGGESTION FOR EASTER

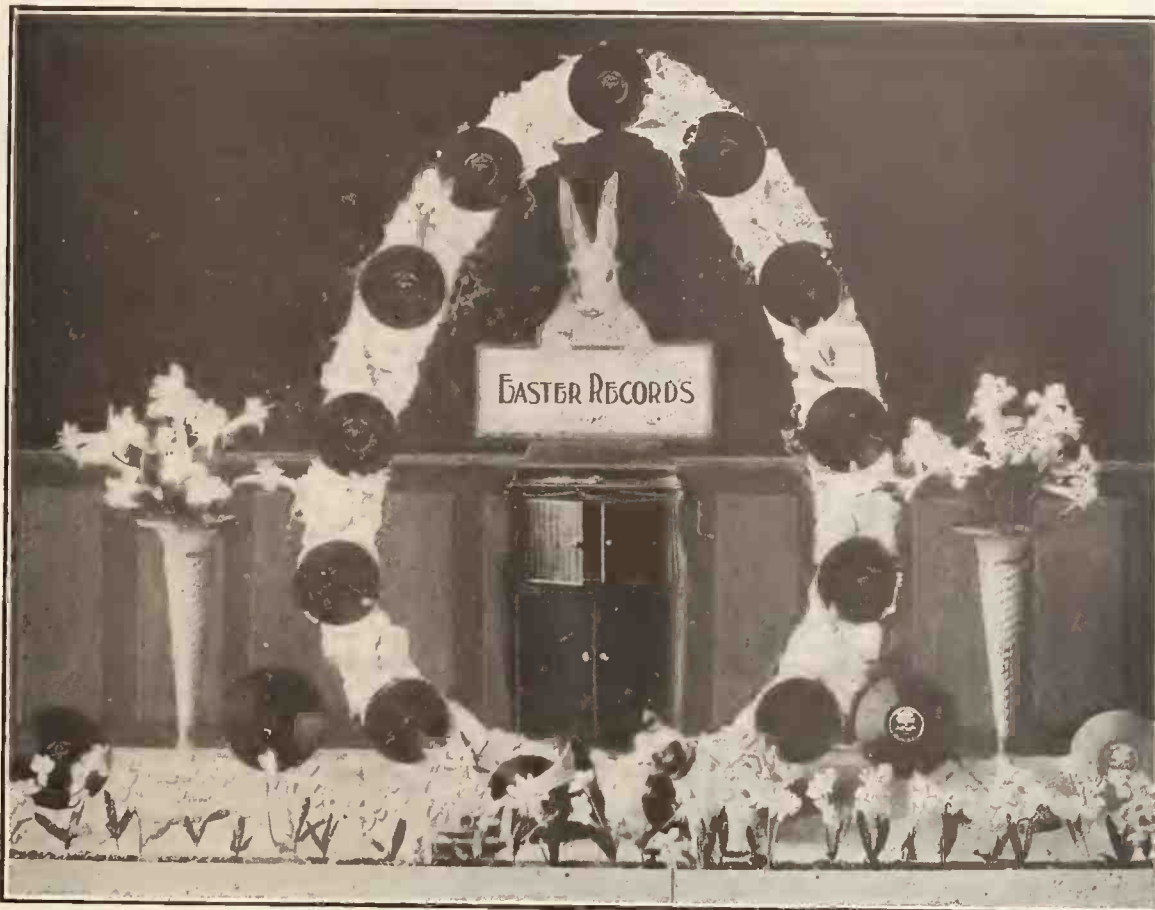

This Simple but Effective Window Arrangement Should Make a Wide Appeal to Dealers

COLUMBIA MANAGERIAL CHANGES

W. H. Lawton Now Manager of Columbia Branch in Buffalo—E. M. Shute Appointed Assistant Manager in Cincinnati

The general sales department of the Columbia Graphophone Co., New York, announced this week the appointment of W. H. Lawton as manager of the company's Buffalo branch. Mr.

Lawton, who was formerly a salesman at the Cleveland branch, succeeds Fred A. Denison, who resigned the post of manager of the Buffalo branch to become a Columbia retailer on the Pacific Coast.

E. M. Shute has been appointed assistant manager of the Columbia Co.'s Cincinnati branch, succeeding N. B. Smith, who last month was promoted to the post of assistant manager of the Chicago branch.

JEWEL NEEDLES

FOR

PHONOGRAPHS

HIGH-GRADE QUALITY

STOCK ON HAND FOR IMMEDIATE DELIVERY

OLDEST ESTABLISHED MANUFACTURERS

Jobbers:

Ask for samples, price list and full information. Our prices will surprise you. We will make special agreements for import orders.

MOSER & CO., Bienne, Switzerland

NEW YORK OFFICE

A. Willemin, *Resident Partner*
291-295 Broadway, New York

WESTERN OFFICE

E. C. Howard
Grand Rapids - - Michigan

NEED MORE SALES PEOPLE TO HANDLE PORTLAND TRADE

Business of the Various Talking Machine Departments Increasing Steadily—Brunswick Phonograph on the Stage—Local Departments Being Enlarged—General News

PORTLAND, ORE., March 5.—More salespeople are needed very much by the Wiley B. Allen Co. in its talking machine department. Business there has grown to such an extent that it is quite impossible for the present force to attend to all the customers. The spacious rooms, the fine assortment of machines and records, and excellent service, all tend to make the Wiley B. Allen department one of the most popular places of the kind on the Coast. Frank M. Case is manager. While there is no difficulty in securing help, there is considerable difficulty in securing the right kind of help, and it has been the policy of this house to employ only those who are specially fitted to look after the high class of trade which the Wiley B. Allen Co. has always catered to.

Business volume in the talking machine department of Lipman, Wolfe & Co. shows a

gratifying increase since the alterations have been completed and more space given to that important part of the music floor. L. A. Willard, who is in charge of the department, has everything in fine condition. An unusually good supply of stock is on hand, most attractively arranged. The Widdicomb phonograph is very much admired, and a new shipment of these beautiful machines has just been received. The Bluebird talking machine is now also carried by this house. It is manufactured in Los Angeles.

At the performance of "Head Over Heels" at the Heilig Theatre last month, in which Mitzi Hajos stars, a handsome Brunswick phonograph was on the stage. The machine was furnished by the Wiley B. Allen Co. The following letter was received by Frank M. Case, manager of the local branch, who complied with the request of Miss Hajos' manager: "Will you be so kind as to send a Brunswick phonograph to be used on the stage during the engagement of Mitzi Hajos in 'Head Over Heels' at the Heilig Theatre, beginning Thursday, February 5? The Brunswick phonograph was selected for this important musical production on account of its clearness and purity of tone and the excellence of its sound-projecting qualities, as well as its universal ability to play all records."

Three new record rooms have been added to the talking machine department of the local branch of the Bush & Lane Co. These rooms are handsomely furnished in keeping with all the rest of the Bush & Lane establishments. E. C. Johnson, the new manager of the department, finds business very good, with stock below normal. C. A. Speer is a new salesman in the department.

W. G. Gaston, Northwest sales representative of the Victor Talking Machine Co., was a Portland visitor last month. He has been in this territory since early in January and finds conditions booming. Mr. Gaston will be out here about seven months, looking after the interests of the dealers.

Eiler's talking machine department has added several to its sales force. J. K. Bain and W. B. Bundy are in the machine department and Miss Laura Dobbert is in the record department.

Mrs. Z. Baker is no longer connected with Meier & Frank's talking machine department, having resigned and gone to Seattle. Her position has been given to Miss Madeline Krebs, who has just returned from Tacoma, where she was engaged in the talking machine business.

Miss Charlotte Kramer is now in the Seiberling-Lucas record department. Miss Kramer is a member of the Monday Musical Club, Symphony Orchestra, and a member of Spitzner's Philharmonic Society, and her knowledge of music makes her a valuable addition to the Seiberling-Lucas talking machine force.

"The biggest talking machine sale ever known in the history of the city" is what Martin C. Collins says of the business done at Reed, French Co. last month. E. B. Hunt, manager of Sherman, Clay & Co.'s wholesale Victor department, reports very encouraging news from the Victor Co. Indications are, he says, that it will not be long before Victor goods will be available in very satisfactory proportions. This is very pleasing news.

Mr. and Mrs. T. Bullock, of Nampa, Idaho, have been on a pleasure trip through California and called on Sherman, Clay & Co. while passing through Portland. Mr. Bullock is a Victor dealer in Nampa and was as enthusiastic as ever over their Victor account.

Miss Meighen, of the Reed, French Co., sold a \$35 talking machine to a man who at the same time bought \$37 worth of records.

W. B. Maxwell is again in charge of the talking machine department of Powers Furniture Store. He says that business was quiet last month, but was as good as could be expected

under present conditions on account of the scarcity of records.

The business in the record department of the Wiley B. Allen Co. is very good. Victor records are now being received, and, while the shipments are small, they are much more frequent.

E. B. Hyatt, manager of the Hyatt Talking Machine Co., says that the increase of business in the record department has necessitated the employment of additional help. Mr. Hyatt says the demand for electrically operated machines is greater than ever before. Mr. Hyatt has purchased a handsome residence for himself in Laurelhurst, one of Portland's most exclusive residential sections.

LAKE SIDE PHONOGRAPH PRODUCTS



CABINETS

Motors	-	{ LAKESIDE SAAL KRASBERG LORIMER HEINEMAN
Tone Arms		{ LAKESIDE OROTONE SUPREME MUTUAL FEDERAL FULTON
Electric Motors		{ ARNOLD JOHNSON EFFICIENCY
Hardware		{ FULL LINE AT ALL TIMES
Accessories		{ NEEDLES NEEDLE CUTTERS ALBUMS, ETC.

YES, WE CAN SUPPLY YOU COMPLETED PHONOGRAPHS

Write for Our New Catalogue

Lakeside Supply Co., Inc.
Telephone Harrison 3840
416 So. Dearborn St. Chicago, Ill.

Hoffay Talking Machine Co., Inc.

14 Thomas St. New York City

Manufacturers of the Famous

Resurrectone Reproducers Airtight Tone Arm and Hoffay Talking Machine



METZLER & CO. (1909) Ltd.

ESTABLISHED 1788

40, 41, 42 and 43 Great Marlborough Street and
33, 35, 37 and 37 and 39 Foubert's Place
LONDON, W., ENGLAND

SOLE DISTRIBUTORS FOR
GREAT BRITAIN AND IRELAND
**HOFFAY AIRTIGHT MACHINES
and ACCESSORIES**

Sole Distributors of the

Hoffay Airtight

—a really wonderful machine—

for the States of Utah, Idaho,
Nevada, Montana, Wyoming,
and Colorado.

Geo. A. Lowe Co.

Ogden, Utah



We Assure the Trade Best Service

Send Your Orders for

HOFFAY PRODUCTS

WILLS & PATON, Pty., Ltd.

Sole Agents for Australia

265 Collins Street
MELBOURNE, AUSTRALIA
also
7 Quadrant
LAUNCESTON, TASMANIA

DISTRIBUTORS OF

HOFFAY PRODUCTS



Southern California Music Company

Established 1880

332-334 S. Broadway, Los Angeles, Cal.
Other Stores Pasadena, Riverside, San Diego

ORDER *Okeh* Records FROM US

You should not delay your order for these superior records for they are quick sellers and therefore profitable merchandise for you to handle.

Come in and hear these superior records. New release samples will be here in a few days.

CHARLES W. KALDER, Inc.,

Grand Rapids, Mich.

(Successors to The Okeh Record Distributing Co.)

The Columbia Graphophone dealers of Portland were recently favored by a visit of O. F. Benz, of the general sales department of the Columbia Graphophone Co., of New York. Mr. Benz was accompanied by his wife, and Frank Dorian, manager of the Seattle branch, came down to meet him. Mr. Benz is making a tour and holding meetings with the dealers of the Columbia machines in the various cities which he visits. While in Portland the dealers were assembled at a luncheon, which was held at the Benson Hotel, and was attended by between thirty and forty Columbia dealers and their assistants. Mr. Benz outlined what the Columbia Co. had accomplished during the past year and gave the dealers an outline of what was planned for 1920. Among other things Mr. Benz said was that the company contemplated an extensive advertising campaign during 1920, practi-

cally doubling the advertising of last year. He also told of the plans of the company for increasing the products of the factory, giving the dealers an insight into the large vision the company has of the talking machine business in general. The statements made the dealers very enthusiastic and they were greatly pleased when he announced that the company would send a representative to the coast every three months in order to look after the interests of the coast dealers and put them in closer touch with the New York office.

Mr. and Mrs. Benz, before they left for Seattle, where they will hold another meeting at a luncheon to be given at the Hotel Washington, were taken over the Columbia River Highway by L. D. Heater, the Oregon representative of the company. Mr. Heater accompanied them to Seattle.

VICTROLA PRICES INCREASED

New List Price Schedule, Effective March 16th, Announced By Victor Co.

The Victor Talking Machine Co. has announced an increase in the list prices of the several styles of Victrolas to become effective on March 16th. The new price schedule follows:

Victrola IX., \$75; Victrola X., \$125; Victrola XI., \$150; Victrola XIV., \$225; Victrola XVI., mahogany or oak, \$275, electric, mahogany or oak, \$337.50; Victrola XVII., mahogany or oak, \$350, walnut, \$415, electric, mahogany or oak, \$415, and electric, walnut, \$480. The increases range from \$5 to \$40 above current prices.

TO RECORD FOR THE VOCALION

Collins Sisters, of Musical Comedy Fame, to Record Exclusively for the Vocalion

Among the prominent artists who have recently signed up with the Aeolian Co. to record exclusively for the Vocalion records are included the Collins Sisters, who are at present among the successful stars in the "Frivolities of 1919." The Collins Sisters, who will shortly end their American tour to fill an engagement in London, have already finished their first recordings for the Vocalion, which will be released at an early date. Arrangements with other prominent singers to record for the Vocalion will be announced shortly.

EDISON JOBBERS IN CONFERENCE

Regional Conferences of Jobbers Being Held in Several Sections of the Country to Discuss Business Plans—Dealers Also Meet

Dealers who have had the opportunity to inspect the 1920 sales and advertising plans of Thomas A. Edison, Inc., are enthusiastic in their approval of their great scope. William Maxwell, who originated and perfected the plans, has recently been West, conferring with C. E. Goodwin, manager of the Phonograph Co., Chicago jobber for the New Edison. He attended dealers' conventions on March 9th and 10th in Kansas City, on March 11th at St. Louis and on March 12th and 13th at Indianapolis. The dealers' convention at Indianapolis will be followed on March 15th by a regional conference of jobbers at Indianapolis. Jobbers and jobbers' travelers from Indianapolis, Chicago, Cleveland, Cincinnati, Detroit, Milwaukee, Minneapolis, Winnipeg and Calgary will attend this conference.

T. J. Leonard, general sales manager of Thomas A. Edison, Inc., took part in the regional conference of Southern jobbers and travelers at Atlanta on March 12th and 13th, which was attended by representatives from Cincinnati, Richmond, Atlanta and New Orleans jobbing points. On his way back North he will attend a convention of dealers at Richmond, Va.

Apropos of these sales plans, a regional conference will also be held on March 15th at the Fifth Avenue Edison Shop, New York. Jobbers and travelers from New York, Boston, New Haven, Williamport, Albany, Syracuse, Pittsburgh, Philadelphia, Toronto, Montreal and St. John, N. B., will be present to discuss points and particulars. Joseph B. Gregg, advertising manager, and J. A. Shearman, assistant general sales manager, of Thomas A. Edison, Inc., will attend this meeting.

The new prospectus and portfolio promised for the use of jobbers' travelers by the first week of March were ready for delivery according to schedule. Those who have had the op-

portunity to examine the 1920 Edison prospectus pronounce it to be a "winner" so far as sales-getting possibilities are concerned.

VETERANS LEARN TO MAKE RECORDS

Former soldiers, sailors and marines will have an opportunity to learn the manufacture of records under a plan established by the Knights of Columbus in co-operation with the manufacturers. One set of forty men has already begun the first course and other classes are being formed as rapidly as possible.

Room No. 321

New York City

130 Fulton Street

Phone, 2812 Cortlandt

Clifford A. Wolf
MANUFACTURER OF
Diamond and Sapphire
Phonograph Points

DEALERS IMPROVING THEIR STORES

Great Demand on All Sides for Unit Construction Booths and Other Equipment

PHILADELPHIA, PA., March 8.—The rapid growth of talking machine trade in all sections of the country is visualized in the orders being received by the Unit Construction Co. of this city for Unico demonstrating rooms, record racks, record counters and other equipment. This demand was fully anticipated by the Unit Construction Co. and large stocks of material are reported already stored in the factory, and the plant has been operating to capacity for some time past. Rayburn Clark Smith, president of the company, in a statement, reports that over two hundred and fifty contracts for Unico departments have been placed with them during the past ninety days. The activity is country-wide, as may be seen from the following partial list of concerns who have placed contracts for Unico installations since the first of the years: McCoys', Inc., Hartford, Conn.; Norwalk Piano Co., Norwalk, O.; W. A. Mason, Bellevue, O.; Meir & Sons Co., Cleveland, O.; Mickel Bros., Des Moines, Ia.; Starr & Laird, Camden, N. J.; Metropolitan Furniture Co., Waterbury, Conn.; Phillips & Crewe Piano Co., Atlanta, Ga.; G. W. Jones Music Co., Washington, Pa.; Sonora Shop, Philadelphia; Talking Machine Co., of Texas, Houston, Texas; The Music Shop, Huntingdon, W. Va.; Reisinger-Siehler Co., Baltimore, Md.; Gulf Furniture Co., Orange, Tex.; Rowe Furniture Co., Port Arthur, Tex.; Burkhart Co., Covington, Ky.; Columbia Graphophone Co., stores in New York, Cincinnati, Pittsburgh, St. Louis, Kansas City, Baltimore, Dallas, New Orleans, San Francisco, Indianapolis; S. B. Davega, New York; D. Krasik, Monessen, Pa.; Urken & Kohn, Trenton, N. J.; Sohmer & Co., New York City; Penn Traffic Co., Johnstown, Pa.; Wallace Brown, Detroit, Mich.; Jas. Donnelly, S. Norwalk, Conn.; Sam Solar Music House, Chicago, Ill.; Southern Photo Material Co., Atlanta, Ga.; C. M. Sigler, Inc., Harrisburg, Pa.; Block & Kuhl, Peoria, Ill.; Aaron Co., Connellsville, Pa.; Lester Gunst, Dallas, Tex.; Emmet Thompson, Warsaw, Va.; Ed. Caldwell, Wakefield, Mass.; Chamberlain Co., Superior, Wis.; J. H. Fleetwood, Laurel Springs, N. J.; H. J. Turnell, Jackson, Mich.; E. J. Meyerholtz, Sidney, O.; O. Steele & Co., Ononah, Mich.; Gorman Realty Co., Collingswood, N. J.; J. O. Baxter, New Berne, N. C.; Cleveland Talking Machine Co., Cleveland, O.; F. G. & A. Howald Co., Columbus, O.; A. Lupinacci, Philadelphia, Pa.; Horton Furniture Co., Hanford, Cal.; Martin Brothers, Springfield, Mo.; M. M. Palminteri, Port Washington, L. I.; M. B. Bol-

**THE
CABINET & ACCESSORIES
COMPANY**

145 E. 34th STREET . . . NEW YORK



**LIST
PRICE
\$40**

*Regular Trade
Discount*



THE PORTOPHONE

The talking machine with
a double surprise

Write for Catalogue

'IN THE HEART OF NEW YORK'

**GET ALL
YOUR ACCESSORIES
FROM ONE SOURCE**

Standard Phonographs
Lundstrom Converto Cabinets
Record Albums
Record Delivery Envelopes
Motrolas
Record-Lites
Fibre Needle Cutters
Phonograph Cabinets
Table Cabinets, All Kinds
Talking Machine Toys
Brilliantone Needles
Velvetone Needles
Red, White & Blue Needles
Polishes and Oils
Repeaters and Rotometers
Wall-Kane Needles
Record Cleaners
Dust and Moving Covers

All from One Source

=====
OTTO GOLDSMITH
President

linger, Oskaloosa, Ia.; Cohen Brothers, Jacksonville, Fla.; J. A. Russel, Del Rio, Tex.; The Fair, Chicago, Ill.; Woodlawn Phonograph Co., Chicago, Ill.; Carlin Music Co., Indianapolis, Ind.; B. Ginsberg, Chicago, Ill.; Kessellman-O'Driscoll, Milwaukee, Wis.; F. W. Trory, Kent, O.; Griggs Music House, Keewanee, Ill.; Jos. Meszaros, Cleveland, O.; Ember Co., Baltimore, Md.; Soward Anderson Co., Dayton, O.; A. J. Heim, Barberton, O.; J. T. Morris, Portsmouth, Va.; Burley & Beisinger, Buffalo, N. Y.; P. J. Mann, Worcester, Mass.; Pearson Piano Co., Kokomo, Ind.; Gregg Music Co., Menomonie, Wis.; F. Mullen & Co., Fall River, Mass.; Cline's Drug Store, Herrin, Ill.; J. C. Welton, Lancaster, O.; Hayden Sporting Goods Co., McAlester, Okla.; J. T. Hinton Co., Paris, Ky.; Forbes & Wallace, Springfield, Mass.; R. Montalvo, New Brunswick, N. J.; B. B. Todd, Philadelphia, Pa.; Frank Haimbach, Philadelphia, Pa.; Findt Music Co., Steubenville, O.; Sol Levit, Shenandoah, Pa.; J. P. Lyons, Chicago, Ill.; C. W. Fisher, Milwaukee, Wis.; M. S. Allen, Jamaica, L. I.;

W. J. Convery & Sons, Trenton, N. J.; Armstrong Furniture Co., Memphis, Tenn.; Phillips & Crew, Savannah, Ga.; J. E. Teat, Dover, Del.; E. J. Mayle, Norwalk, O.; Bethea Carmichal, Dillon, S. C.; Anthonia Co., Stamford, Conn.; Sunbury Sporting Goods Co., Sunbury, Pa.; Ed. Caldwell, Stoneham, Mass.; Glass Block Co., St. Mary's, O.; Jas. McCreery, New York; Geo. Krebs Sons, Hamilton, O.; Jos. F. Dudirk, Chicago, Ill.; Nunn Electric Co., Dallas, Tex.; Fineman Music House, Tarboro, N. C.; D. J. Brown, Bayonne, N. J.; Foord Furniture Co., Wilmington, Del.; A. Lessor, New York; Tyler Haswell, Bryan, Tex.; Elyea Co., Atlanta, Ga.; Ballinger & Perrot, Philadelphia, Pa.; A. J. Eberhard, Camden, N. J.; Baldauf Rosenblatt, Oskaloosa, Ia.; M. Steinert & Sons, Springfield, Mass.; Marcellus Roper, Worcester, Mass.; C. C. Harvey, Brockton, Mass.; Hill & Welsh, Lynn, Mass.; Chase & West, Des Moines, Ia.; Wolf Furniture Co., Chicago, Ill.; Watkins Brothers, S. Manchester, Conn.; D. E. Odom, Bennettsville, S. C.; Ferdinan Co., Chicago.



Model 137

Sona-Tone

Plays every make of record without extra attachments! An achievement in tone perfection. Wonderfully built. Moderately priced. And yielding a margin of profit beyond the average.

Ready for immediate delivery. For better music, better entertainment, you can provide no finer instrument for your customers than *Sona-Tone*—the proven phonograph. Write for details.

MODEL 137 (as illustrated)—Solid mahogany. Needle cup indicator. No. 16 Meisselbach motor. Universal sound box. Supreme tone arm. List, \$137. Complete specifications on request.

**Sona-Tone Phonograph Division
of American Business Corporation**

Executive Offices and Demonstration Rooms
1780 BROADWAY NEW YORK

THE TALKING MACHINE WORLD SERVICE



Robert Gordon's Page -



A DEPARTMENT DEVOTED TO PROMOTING RETAIL SALES

FIGURES are interesting, and when cleverly used on signs, catch the eye. Next time you show a small portable model in your window, put over it a sign with this lettering at the top:

"The Model IV. (name of machine) at \$35."
The rest of the card displays the following:

5 minutes to pick it out.
dollars to send it home.
decades to enjoy it.

Do it now!

VARIETY is the life of advertising. It's hard to get out of the rut—but costly to stay in it, costly in the lack of results from your advertising.

After you have been advertising your merchandise for a long while, change the diet by advertising your sales force. Personal advertising, with lots of human interest in it, has made the success of more than one concern. Get a photograph of each member of your sales force, from the head salesman down to the office boy. Pen and ink drawings should be made from these photographs in order to print well in the newspapers. Lay out your ad with these illustrations as a basis. Let every member of the staff write his own messages to go opposite his picture, or, if you prefer, you can prepare this material yourself. The ad may take a form somewhat as follows:

Here are the people who know how to give you SERVICE.

Their whole object in life is to dispense musical good cheer and efficient service to you whenever you pay us a visit. Just for a change, we asked each member of our "family" to send a personal greeting to you to-day. So here we go!

JAMES W. SMITH

He can tell you all about the merits of the Talking Machine and he will do it on the slightest provocation. Jim began when he was fourteen years old and he has been going strong ever since. He carries the numbers of about 2,000 records in his head all the time. Come in and ask him for any record you want, and it's a sure thing that he will say "18791," or whatever it is, and pick it out of the file without looking at the catalog at all. Last year he sold 421 machines and so many records that he lost count. His favorite amusement is listening to record No. 98976 (title). Next to that, he likes to play the guitar or a game of cards with his three fine young children.

MARGARET McKEE

Come into the record department any morning about 8:45 and you will see a young lady moving about busy as a bee, straightening things up for the day. Come back an hour or two later and you will see her with half a dozen records in each hand, moving in and out from booth to booth. We asked Miss McKee to write something about herself, to go with her picture, and she gave us this:

"We now have the records of 'Dardanella' and 'I Gave Her That,' which everybody has been asking for."

And that's all we could get out of her about herself. Maybe you can do better. Try it!

(Continue in the same way, through your sales force. When you get to the office boy, put in something along this line:)

OSWALD W. (RED) KENNEDY

Mr. Kennedy is seventh assistant manager. In other words, office boy. We caught him young to see whether he could be tamed, and so far we have succeeded fairly well while he is in the store. But watch "Red" at the ball game some Saturday! "Red" seals the letters, carries them to the P. O., fills the ink wells, files carbon copies, dusts off the machines, holds down the switchboard during lunch hour and wraps up packages with perfect technique. Give him a trial with your next package. Guaranteed to be satisfactory or money refunded.

At the bottom of your ad, put a general talk something like this:

This is our cast of characters and they're all stars, too! Whenever they take part, the play always has a happy ending, and your transaction here will likewise have a happy ending when you entrust it to them!

Follow with name or names of machines you carry and lines of records, and sign with your store name. This ad will require either 3 or 4 columns x 14 to 18 inches, according to the number of people listed in the ad. Since your "biographies" are about real people, you will be able to say something interesting and to the point. This ad

will have a lot of human interest and make a hit for your store. In each "biography" keep harping on the superiority of the machines and records you sell, so that all the time the reader of the ad is taking in the message you want to put across.

YOUR store window is an asset. It is also a liability. It is an asset, if you keep it live, up-to-date and interesting. It is a liability if it looks drab, dull, dusty and doleful.

It says to the public, "I am a live one! I've got pep, push and ideas and so has everybody inside the store!"

Or it says, "I am old-fashioned and slow. The dust has settled down over my enthusiasm and buried it. My curtains haven't been cleaned for eleven years. The boss gives me a new dress once in six months. He's lazy."

A poet once wrote "The eyes are the windows of the soul." Paraphrasing the poet, your window betrays the soul of your store.

Your window is a salesman who is always on the job—never late in the morning—never in a hurry to quit at night. Pay it a salesman's wage. Invest enough in trims to keep it from starving to death and looking like a corpse preserved under glass.

Take out those old signs and put in new ones—shift your machines around—put in your newest record hit, with a searchlight focussed on it—get up a brand new trim for Easter, April 4th—do something, do anything, so long as you do it to your window, and do it now!

KEEP your eye on the want ad as a business-getter. While display advertising is the source of most of your sales and the keystone of your business arch, bear in mind also that certain classes of buyers read the want ads for bargains in talking machines, and that considerable business is done in that way.

Meet this competition by putting a little ad in the want columns yourself now and then. Sometimes you have a used machine or a trade-in that you can offer as a special bargain. Other times, to offset the real or spurious bargains offered, talk about the quality, reliability and value of your standard machines. Keep your name under the eyes of the person who is planning to buy. Here are a few suggestions:

Talking Machine, handsome cabinet model, in matched mahogany; world-famous make; received in part payment for a period model; perfect condition; \$68 takes it, if you get here in time. Blank Phonograph Co., 1000 Main Street; 'phone Main 1000.

You're looking through these ads to find a bargain; here it is; a brand new; the greatest value on the market to-day; extra large cabinet, beautifully made; plays all makes of records; tone is unsurpassed; very special terms, including 15 records, your choice; elip out this ad and bring it with you. Blank Phonograph Co., 1000 Main Street; 'phone Main 1000.

There's no "come-back" when you buy your phonograph at Blank's; we guarantee your instrument, and we take care of it after you've bought it; choose a new....., or; a few dollars sends it home now with your choice of records. Blank Phonograph Co., 1000 Main Street; 'phone Main 1000.

..... Talking Machine, cabinet model, with records. 'Phone Main 1000.

Do not buy a price, buy a talking machine—the best one in the world—a (insert name), from a house that gives you genuine service while you're buying and after you've bought. It's a bargain at the regular price, because it gives you the satisfaction you're seeking. Blank Phonograph Co., 1000 Main Street.

IF you're shopping for slogans, here are a few at the bargain price of nothing each:

- Oldest and Largest Music Store in the City.
- The Little Shop with the Big Record Stock.
- The World's Greatest Artists PREFER the Victrola.
- Your Choice of the Five Finest Phonographs at Blank's.
- The Meeting Place for Music Lovers.
- At It Since 1879 (insert correct date).
- Spend an Idle Hour at Blank's.
- Headquarters for SERVICE.
- Service Station for Talking Machine Tourists.
- If It's Musical, We Have It.
- A Talking Machine from Blank's in Every Home.
- Everything in Music.
- The Talking Machine Headquarters of Blanktown.

EDITOR'S NOTE—Mr. Gordon, who writes this monthly page, is also director of "The Talking Machine World Service." Mr. Gordon will publish on this page any good ideas submitted by you for the benefit of the trade, and also answer any questions you ask him concerning merchandising problems. Use this department as much as you like. It is intended to serve you.

IMPORTANT NOTICE

TO THE AMERICAN TRADE

The Sterno Manufacturing Company
19 CITY ROAD LONDON, E. C. ENGLAND

Manufacturers of the world known COMPACTOPHONE—the most complete portable gramophone extant—beg to announce the conclusion of arrangements for the EXCLUSIVE SELLING RIGHTS IN THE UNITED STATES OF THE

High Grade Motors ^{Manufactured} **By** **Mermod Freres** ^{St. Croix} ^{Switzerland}

WONDERFUL MECHANISM

These motors represent the acme of workmanship and quality. Each part is made to the finest gauge limits and assembled to run with the precision of a watch—silent and true. Messrs. Mermod Freres is an old established Swiss manufacturer. Back of their motors are years of hard practical experience. The experimental stage was left behind a decade or more ago. Reliability and quality are therefore assured.

DIFFERENT MODELS

Mermod Freres motors comprise several types—single and double spring worm and pinion-gear drive, the very latest and scientific method of construction.

CONSULT US

Before placing your orders elsewhere consult us as to prices and terms of trading. We are out for quick shipments and prompt delivery direct from the factory to the buyer.

SPECIAL TERMS TO JOBBERS

Within the near future it is proposed to establish
A CENTRAL DISTRIBUTING DEPOT IN NEW YORK
Meanwhile trade inquiries should be directed to

THE STERNO MANUFACTURING CO.
19 CITY ROAD LONDON, E. C., ENGLAND

EDISON EXECUTIVE CHANGES

Phonograph Business Separated Into Several Divisions—Wm. Maxwell's New Title—Chas. Edison Responsible for Reorganization Work

A brief announcement made recently to the effect that William Maxwell, vice-president of Thomas A. Edison, Inc., and manager of the Musical Phonograph Division, had also been elected vice-president of the Edison Phonograph Works, and would in future be known as "Vice-President in Charge of Phonograph Industry," made public the fact that the reorganization of the Edison executive staff, which has been quietly in process for the past five years, has finally been accomplished. In addition to his new duties Mr. Maxwell will continue as president of Edison Phonographs, Ltd., the Phonograph Corporation of Manhattan and Phonographs, Ltd.

Inasmuch as Mr. Maxwell has long been desirous of giving the major part of his time to sales problems, he has appointed George E. Clark, long associated with Edison factory operations, to relieve him of much of the general responsibility concerning manufacturing problems.

The work of reorganization was carried on under the personal direction of Charles Edison, whose object has been to separate the various branches of the phonograph business into their logical divisions, and to establish in each division a manager upon whom is placed personal responsibility.

Thus, the Edison Phonograph Works constituted one unit of operation and in Thomas A. Edison, Inc., there were created several units, such as the Disc Re-Creation Manufacturing Division, the Amberol Record Manufacturing Division, the Printing and Paper Products Division and the Musical Phonograph Division, which markets all Edison phonograph products.

The W. S. Vowels Music Co., 511 Main street, Vincennes, Ind., has been dissolved.

H. P. WISE IN NEW ORLEANS

Becomes Assistant Manager of Columbia Co. Branch in That City

NEW ORLEANS, LA., March 2.—H. P. Wise, formerly with the Baltimore branch of the Columbia Graphophone Co., has just reached New



H. P. Wise

Orleans and is taking up the reins of the office of assistant manager of this branch. In addition to his familiarity with branch affairs, Mr. Wise has been associated with Harry C. Grove Co., Inc., of Washington, D. C., which is a large retailer of Columbia products.

INCORPORATED IN ROCHESTER

The Unity Industrial & Commercial Corp., Rochester, N. Y., has been incorporated with a capital of \$100,000, to do a general business in talking machines and general merchandise.

The Jordan Cabinet Works, Brooklyn, N. Y., has increased its capital stock from \$25,000 to \$400,000.

JOBBER PLAN TWO MEETINGS

Open Executive Meeting to Be Held in Chicago on March 22 and 23 and in New York on March 24 for Convenience of Members

President George E. Mickel, of the National Association of Talking Machine Jobbers, has issued a call for two executive meetings of the Association, to be open to the membership at large, the first meeting to be held at the Hotel Sherman, Chicago, on Monday and Tuesday, March 22 and 23, and the second meeting at the Hotel Knickerbocker, New York, on Wednesday, March 24. The Chicago meeting will be called at 1.30 p. m. Monday, and the New York meeting at 11 a. m. Wednesday.

The object of the two meetings is to make it possible for all members of the Association to attend conveniently one of the sessions.

Gilbert H. Montague, counsel for the Association, together with Victor factory officials, will attend both meetings, and many matters of importance to jobbers will be discussed.

L. C. Wiswell, of Lyon & Healy, is in charge of the details of the Chicago meeting, and C. L. Price, of Ormes, Inc., 25 East 125th street, New York, is looking after details in this city.

TO REPRESENT MOSER & CO.

E. C. Howard, who needs no introduction to the talking machine trade, has been appointed Western representative, with headquarters in Grand Rapids, Mich., of Moser & Co., Bienne, Switzerland. This concern has been established for over twenty-two years and enjoys a world-wide reputation for the quality of the jewel points which it produces. Its facilities for production of jewel needles are very large and 350 workmen are employed in the factory. A Willemin, resident partner of the company, will handle the Eastern territory, with offices in New York City. Mr. Howard's many years of experience in selling jewel points fit him admirably for the position which he now occupies.



VICTOR DISTRIBUTORS

Wholesale Exclusively

Our Policy

To assure our dealers of the best service possible, we are concentrating our efforts solely on northern New Jersey and northeastern Pennsylvania territory.

Newark, N.J.

We Want Every Dealer to Know
"Ten-M" Means 10,000!!!

Ten-M-Needle

PLAYS 10,000 RECORDS

→ **Retails at \$1.50** ←

No More Worry—Simple and Scientific

Enter the Ten-M Supreme
Exit! Needle Annoyance
No Change—No Bother

Ten-M is Ever Pointed
Ten-M is Ever Ready
Ten-M is Mellow as Moonlight

The Non-Change Needle

Ten-M means freedom from all annoyance of changing phonograph needles. It means five years' needle service at one-tenth the cost of old-style needles. And it means

!! BIG PROFITS FOR DEALERS !!

Plays On All
Phonographs
Ends Needle
Trouble

Jobbers:
Write for
Sample and
prices



Ten-M-Needle under Magnifying Glass

Patent Applied for

Dealers:
If your
Jobber can-
not supply
you, write us

The Cream is Waiting—Get your Share
Millions Will Be Sold—Sell What the People Want

BAKER-SMITH COMPANY

SALES MANAGERS

Rialto Building, San Francisco

Republic Building, Chicago

GEORGE MITTLEMAN, 487 Broadway, New York, Eastern Representative

SEND YOUR ORDER NOW

A WINDOW DISPLAY NOTABLE FOR ITS TIMELINESS

Seldom has a more timely or interesting window display come to our attention than that arranged by the J. C. Schmidt Co., Victor dealers of Tiffin, O. Some time ago, when the world series baseball games held the attention

grandstand. A small scoreboard at one corner of the field kept the public advised as to the progress of the game. The Victor dogs, of course, were those manufactured for and marketed by the Penn Phonograph Co. of Phila-



Victor Dogs as Baseball Players and "Fans" in Window of C. J. Schmidt Piano Co. of the country, the floor of the window was laid out to represent a baseball diamond, with Victor dogs properly beribboned representing the opposing players, and other Victor dogs ranged around to represent the fans in the

delphia, Pa. The display attracted an unusual amount of attention, and was commented upon favorably in several of the local papers. We are indebted for the cut to The Total Eclipse of Cleveland.

NEW EDISON SCORES BIG IN NEW YORK RECITAL

Anna Case Delights New York Audience With Her Songs and Their Re-Creation—Crowded House Recalls Artist Many Times—The New Edison Applauded—A. L. Walsh Speaks

On Wednesday afternoon, March 10, the New Edison demonstrated its power to re-create the human voice and the music of every instrument to the entire satisfaction of a representative New York audience which packed Carnegie Hall from the floor to the highest balcony. The principal artist of the afternoon was the talented American soprano and Edison artist, Anna Case, whose songs and their re-creations both delighted and charmed her audience, which showed their appreciation of her art by repeated applause. At times singing in unison with the instrument and now and then pausing to allow the record to take up the melody alone, Miss Case showed the audience that they could not distinguish between the re-creation of the voice and the original. Assisting her on the

program were Victor Young, pianist; Willard Osborne, violinist, and William Reed, flutist.

Shortly after 3 o'clock, when every available seat had been filled and everyone was looking with interest at the New Edison which occupied the center of the softly lighted stage, Arthur L. Walsh, of Thomas A. Edison, Inc., explained the purposes of the tone-test, outlining briefly the history of sound reproduction and the experiments carried on by Mr. Edison over a period of many years.

Miss Case opened her program by singing "Depuis le Jour," followed by "Mon Coeur ne Peut pas Changer." Singing in unison with the New Edison, stopping from time to time to allow the instrument to take up the song itself, Miss Case charmed her audience with her art. The re-creation of her voice on the instrument was so life-like that a murmur of astonishment swept over the house at the conclusion of the first number.

Following Miss Case, Willard Osborne gave an excellent rendering of "Meditation," from "Thais," to the re-creation of a violin solo by Albert Spalding.

It is seldom that an artist sings a duet with

WORLD BOUND VOLUMES

Should like to procure a complete file of The Talking Machine World. If you have a complete file to offer or one nearly complete, please let me know right away the price at which you will sell same. Address Box 772, care The Talking Machine World, 373 Fourth Ave., New York City.

herself, but this was accomplished when Miss Case sang Thayer's popular "My Laddie," letting the record carry the melody while she sang a pleasing harmony. "Mighty Lak' a Rose" and "Will o' the Wisp" followed and brought forth enthusiastic applause from the audience. Her next number furnished the climax to the drama of the afternoon, when, during the singing of "Quando m'en vo" (Boheme), the house was suddenly darkened while the song continued, everyone believing that Miss Case was still singing. The burst of applause which greeted the New Edison when the lights flashed on again and found the instrument in sole possession of the stage showed that the audience was entirely convinced of the value of the New Edison in re-creating the human voice. Other songs on Miss Case's program were "Charmant Oiseau," in which the flute obbligato was played by William Reed; "Coming Home," and "Home, Sweet Home."

In order to show the improvements made in the recording of piano music, which has always been a difficult task, Victor Young, of the Edison laboratories, rendered the "Second Mazurka" by Godard, with the re-creation of a piano solo by André Benoit. Mr. Osborne's second number was the playing of "Ave Maria," with the re-creation of a violin solo by Carl Flesch.

From every standpoint the tone-test was a marked success, and the many words of praise heard on all sides as the audience filed out of Carnegie Hall would have shown those in charge of the affair that the New Edison had made a profound impression on the music-loving public of New York, an impression which will be felt by all Edison men in this section of the country in the future.

AIR CONCERT FROM NAVY "BLIMP"

Crowds in New York were entertained on Wednesday, March 10, by an air concert from the United States naval "blimp" C-4, which flew over the city, and by means of the wireless telephone transmitted the music from a talking machine to the Air Service truck below. The flight was arranged in connection with the Second Aeronautical Show at the Seventy-first Regiment Armory. It was with great interest that the assembled crowds watched the "blimp" overhead and it was a novel sensation to hear music coming from many thousand feet in the air.

A new music department is being added to the stores of the Craycraft Dry Goods Co., Noblesville, Ind.

BIG STOCK OF GENUINE MAHOGANY FLOOR CABINETS

Equipped and unequipped at very low prices. Size 49" high, 23" wide, 24 3/4" deep. Eight different Models. Write us to-day.

We also offer—

- Best steel needles, loud and soft, 100 in a package..... 30c per 1000
- Mahogany complete table machines..... \$4.50 up
- Genuine mahogany piano finish cover machines, 17" x 18" x 14". Double-spring motor, 12-inch turntable, universal tone-arm..... \$15.00
- Motors, single and double spring, with 10 and 12-inch turntable,..... \$2.00 up.
- Six different styles of universal tone-arms..... \$1.50 up
- 10-inch turntables with green felt to fit any motor..... 30c

We also carry a large stock of all makes of parts, such as springs, felts, thumb screws, governor springs, etc. Cash with order.

UNITED PHONOGRAPH CO.

107 East 10th Street

New York City

TO ENTER TALKING MACHINE FIELD EDISON EXHIBIT AND ARTISTS AT RECENT MUSIC SHOW

Remington Phonograph Corp. Chartered in Delaware and Will Have Factory in Iliou, N. Y.—Those Interested in the New Venture

One of the centers of interest at the National Music Show, held in New York during the week of February 2nd, was the Edison Theatre

cital with the Edison instrument were: Marie Tiffany, soprano of the Metropolitan Opera Co.; Hardy Williamson, the English tenor;

The Remington Phonograph Corp., chartered under the laws of Delaware, with a capital stock of \$1,000,000, has opened offices in the Finance Building, Philadelphia, and has secured a plant at Iliou, N. Y., for the manufacture of talking machines and records, according to one of the officers of the company. It is stated that the company's products will be on the market some time in the Fall.

Among those interested in the company are Eliphalet Remington, son of the founder of the Remington Arms Co., and P. E. Remington, formerly connected with the Remington Typewriter Co., the latter being president of the new corporation. The vice-president is James S. Holmes, for a number of years connected with the piano trade, and the secretary is M. B. Thomas. Several prominent Philadelphians are said to be interested in the venture.



Edison Theatre and Exhibit at Music Show and Artists Who Gave Tone-tests and accompanying exhibit, which were visited by probably more people than any other display at the show. The tone-test recitals especially aroused enthusiasm. The prominent artists who appeared in recital with the Edison instrument were: Marie Tiffany, soprano of the Metropolitan Opera Co.; Hardy Williamson, the English tenor; Jacques Glockner, 'cellist, and William Reddick and Victor Young, pianists. Mr. Reddick conducted the recitals, and Arthur Walsh, director of the tone-test recital department, was in charge.

CHAMBER OF COMMERCE MANAGER

Alfred L. Smith Assumes Control of Music Industries Chamber of Commerce

Alfred L. Smith, appointed general manager of the Music Industries Chamber of Commerce at the annual convention of that body last month, assumed his new duties on March 1st, making his headquarters at the Chamber of Commerce offices, 105 West 40th street.

At a meeting of the Board of Directors of the Chamber held on March 3rd, a budget of \$50,000 was voted for the National Bureau for the Advancement of Music, a move was made to collect accurate data regarding the financial status of the music industry to present to bankers in order that they might have a proper con-

ception of the importance of the industry, and the general manager was authorized to organize an export department, as well as a statistical department. All these moves were in keeping with the program laid down at the convention.

The Chamber of Commerce has gone on record as urging the early repeal of the War Excise Taxes, and as opposed to the excess profits tax, favoring the proposed gross wholesale tax as a substitute.

LOOKING AFTER THE PURCHASING

James Watters, secretary of the Pathé Frères Phonograph Co., Brooklyn, N. Y., is at the present time, it is announced, looking after the affairs of the purchasing department of that company in addition to his many other duties.

Announcing the New "Supreme Phonograph"



Three upright models and three consoles \$100 — \$130 — \$160

Beautiful in appearance, faultless in design, real piano finish, tone quality unexcelled. Liberal discounts, immediate deliveries, guaranteed co-operation.

Rights open to responsible dealers and distributors. Be sure and investigate this wonderful phonograph. We also are the largest distributors in the West for Motors, Tone Arms, Lyric Lateral Cut Records and Phonograph Accessories. Satisfaction guaranteed.

Superior Phonograph Co.

320 So. Wabash Ave. Chicago, Ill.

"MAGNET" DECALCOMANIE NAMEPLATES

FOR TALKING MACHINE CABINETS ETC.



Pamphlets with fac-simile illustrations and prices mailed on request.

SMITH-SCHIFFLIN CO.

126 Liberty Street New York City



SOLD BY WALTER D. MOSES & CO. Oldest Music House in VA and N.C. 102 E. BROAD STREET RICHMOND, VA.

SOLD BY J.E. STRATFORD AUGUSTA, GA.

GOLD PLATING

Tone Arms, Sound Boxes and Phonograph Parts OUR SPECIALTY

PRICES QUOTED ON REQUEST

Cliff Manufacturing Works, Inc.

20-22 JACOB STREET NEW YORK CITY

ANENT PLANNING OF DEALERS' ADVERTISING

Pertinent Questions Answered When Laying Out an Advertising Campaign for the Retail Store as Outlined in Voice of the Victor

The average manager of a Victor store is a salesman first of all. A salesman, as a rule, is a man with a "Do-it-now" disposition. He wants results immediately, and as a rule he gets them; but it is open to question whether the results he gets are as numerous as possible, or the best kind. A man with his eye constantly on the present has no chance to peer into the future, says the Voice of the Victor.

That is where advertising comes in. A good advertising man is always looking to the future, while, of course, not neglecting the present. It would certainly be a good thing for the salesmanager to get in touch with the advertising man, and the two to work in co-operation.

Advertising is looked upon by the outsider as unduly mysterious. Everybody agrees that advertising is a good thing, but many who have tried their hand at it have found that a good deal of money can be spent on advertising without producing results. Those who have had this unfortunate experience usually blame advertising, whereas they should blame their own bad planning.

An advertising man—a real advertising man—never aims into the dark. He always has a definite campaign mapped out, the expense of which is in proportion to the end to be gained. Like the salesman, he is "out for results" that are tangible, but the results he is after may be a long time in maturing—and this is where the outsider fails to get his point of view.

Advertising is of two kinds: Instantaneous Advertising, and Long-Time Advertising. The first is the one most appreciated by the salesmanager kind of advertiser. It consists of taking immediate advantage of immediate hap-

"A Million A Year"
WHAT'S YOUR SHARE OF

MICA DIAPHRAGMS OF BEAUTY

—Phonographically Speaking—They Talk for Themselves—
Manufactured for over ten years for the larger consumers by the

INTERNATIONAL MICA COMPANY

Factory and Sales Dept. { 37th & Brandywine Sts. W. Philadelphia, Pa.	Mines, Amelia Co., Va.	Executive Dept. { 1228 Filbert St., Philadelphia, Pa.
--	------------------------	--

Send for samples and quotations now and eliminate your diaphragm difficulties

Immediate delivery of small quantities can be made in the following districts.
SAN FRANCISCO, CALIF.—WALTER S. GRAY
CHICAGO, ILL.—LAKESIDE SUPPLY COMPANY
MONTREAL, CAN.—ARTHUR K. KEMPTON

penings. If Galli-Curci is coming to town, anybody can see the advantage of advertising her records in the local newspapers; a good salesman would do that instinctively. In the same way most sales organizations see the force of advertising special lists for Christmas, Easter, Summer vacation use, etc. Such advertising is, of course, extremely valuable, but it should be accompanied by "Long-Time Advertising"—that is, a steady current of advertising, carefully mapped out to build up a steady trade. This is the kind that costs money—and brains of a special order.

The first thing in planning a Long-Time Advertising Campaign is to consider conditions. What class of customers have you? Where are they located (is your store in a market town where people come in from outside, or is it metropolitan or suburban)? How much can you afford to spend as a regular thing? What means have you for reaching your customers? What class of customers is your store best adapted to serve? What new line of Victor business (foreign records for instance), can be developed with reasonable assurance of success? What is your local standing as a retailer and how can it be improved?

Only by careful consideration of these questions and many others of a like nature can you

plan an economical and really effective campaign. When you have answered them it is time to consider the material placed at your disposal by the Victor Talking Machine Co. Probably no country in the world is so lavish in supplying advertising matter to meet all needs. It is up to the retailer to select and reject, using the material best adapted to local conditions, and using this matter systematically.

Long-time advertising is cumulative in effect. A single explosion won't drive an automobile far, however violent it may be; but a series of explosions, properly timed, and of the right degree of power, will send it anywhere you want, at any speed you desire. It is so with advertising, and every retail store manager should have a definite advertising campaign designed to his own special needs, based on actual knowledge of local conditions.

VICTOR CO. SUES CHENEY CO.

The Victor Talking Machine Co. on March 3 filed a bill of complaint against the Cheney Talking Machine Co. in the U. S. District Court, Grand Rapids, Mich., charging infringement of the Johnson tone arm patents Nos. 814,786 and 814,848. Efforts are being made to expedite the trial of the case.

THE PHONOMOTOR

Trade Mark Registered U. S. Pat. Office

The first and most perfect electrical equipment for the

Phonograph

(Patented 1918)

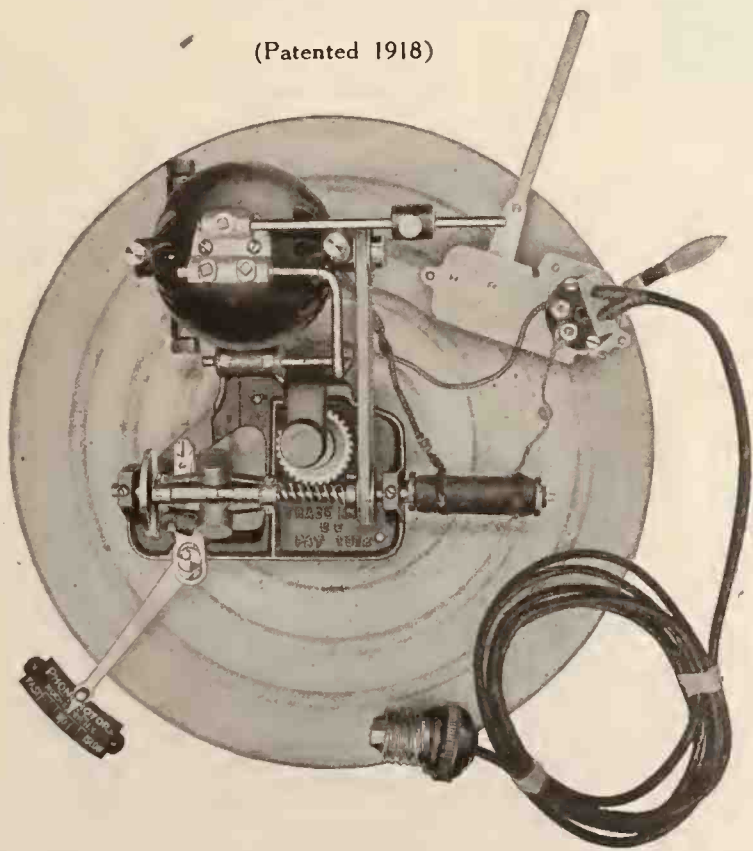

INTERCHANGEABLE

STANDARD

SIMPLE

UNIVERSAL

110-20 A. C. or D. C.: also adapted for 220 V.

Silent Absolutely

Regulation Perfect

Everlasting

Guaranteed

Patented in United States and Canada

AUTOMATIC STOPS

supplied on all Phonomotors and Spring Motors, an approved, reliable stop,

THE PHONOSTOP

Supplied the Trade

Write for Quantity Prices Now

Discard your old Spring Motor. Have our representative install a Phonomotor in your Phonograph

G. CLAY COX

73 State Street, Rochester, N. Y.

WHAT THE STEGER TRADE PAPER CAMPAIGN ACHIEVED

In an Interview in Advertising and Selling Chas. E. Byrne, Director of Advertising of Steger & Sons Piano Mfg. Co., Offers Facts and Figures of Great Interest

Convincing proof of the value of trade paper advertising, properly handled, in the selling of pianos and talking machines, based on actual and successful experience, is offered by Charles E. Byrne, director of advertising of the Steger & Sons Piano Mfg. Co., who in an interview in a recent issue of Advertising and Selling told how a trade paper campaign had sold 5,000 pianos and 10,000 phonographs for his company. Mr. Byrne also offered valuable information regarding the selection and use of trade paper space that should prove of distinct value to members of the industry.

He discussed particularly the results of the 1919 trade journal advertising campaign of the Steger institution and regarding this campaign he said:

The results were, to say the least, surprising. So remarkable were the returns that they proved conclusively how unlimited are the possibilities of publicity in trade publications. It was found upon investigation that over 155 high-grade piano merchants and 280 responsible phonograph dealers were attracted by the confidence-inspiring Steger prestige announcements and induced to apply for appointments as Steger representatives. By tabulating the orders, it was discovered that over 5,000 pianos and 10,000 phonographs were sold for cash. Of course, the annual output of the Steger institution is much greater than those figures would indicate—covering 18,000 player-pianos, 12,000 pianos and 30,000 phonographs—and is at present heavily oversold. It is quite likely that the sales produced by this campaign were far more than 5,000 pianos and 10,000 phonographs, but as only directly traceable returns are to be considered that decisive record is the answer, including as it does only those dealers who became interested in the great Steger lines primarily through the trade journal announcements.

It is true that the trade magazine publicity was accentuated and augmented in various ways. Reproductions of the beautiful display pages—in many instances veritable works of art, pictorial, typographical and otherwise—were mailed to dealers to be framed and displayed in their store windows and warerooms, in order to interest music-lovers. Furthermore, these displays were reproduced by progressive dealers in their local newspaper advertising, programs and other media.

In conjunction with this campaign a system of efficient dealer service was maintained by Steger & Sons, comprising national magazine and local newspaper advertising, electrotypes, catalogs, instruction booklets, folders, leaflets, form letters, moving picture slides, window cards, outdoor and electric signs, house organ literature, bulletins to salesmen, financial co-operation and personal counsel in merchandising and selling.

Power of Industrial Magazine Publicity

A young man recently decided to engage in the manufacture of a certain product. His capital was limited. He wanted to bring his proposition to the attention of 10,000 dealers in his

industry in the quickest, most effective and most economical way. Somebody had suggested that he use a striking folder and had prevailed upon him to obtain a dummy and quotations. The entire cost of paper stock, printing, engravings, folding, addressing, stamping and mailing amounted to \$450.00, not including the postage.

As a certain excellent trade journal covered the 10,000 dealers like a blanket, it was suggested that he hold the folder in reserve for a while and publish a page announcement in the magazine at the cost of \$100.00. He liked the idea.

Some time later he submitted the proof of the advertisement. It was as interesting as a tombstone, as unattractive as a red flannel shirt



Charles E. Byrne

and as anaemic as are many trade journal announcements that are hurriedly dashed off to fill space.

The copy was the familiar story about quality unexcelled. It was set in old-fashioned job printer style with a stock border and antique decorations that Noah undoubtedly used. No illustrations were visible. He did not regard them as necessary. When he asked for an opinion regarding the announcement he was told that it would not prove profitable.

Then it was suggested that he consult an experienced advertising man, as he would a specialist in any other line, and secure the benefit of a selling idea, well presented in clear, concise, forceful, brief copy, dressed up in artistic form with appropriate type and a suitable, beautiful illustration of his product.

He followed directions, and when his announcement appeared in the trade magazine it made 10,000 dealers take notice.

Results the Test

Whenever business men inquire as to what

REPAIRING AND REPAIR PARTS for all makes of Talking Machines

BOND'S GRAPHOPHONE SHOP
38 Arcade :: Nashville, Tenn.

kind of advertising is the most satisfactory and therefore preferable—whether magazine, newspaper, trade journal, direct-by-mail, billboard, catalog, moving picture or any other medium—the statement of a man who made a great success applies very effectively: "I do not employ men because I like their looks," he said, "but solely because of their ability to produce results." In other words, that form of advertising which has been found to be the most reliable medium for building up a particular business should be favored, because it represents a straight line between the man who is spending the money and results.

Some kinds of business can employ many forms of advertising with success. Advertising is certain to be profitable if the logical media to fit a specific business are used and supported with carefully thought out, tested selling-ideas, properly presented from the standpoint of space, copy, type and illustrations. Billions of dollars are made through well-directed publicity. Millions of dollars are wasted by men who do not understand it. They fail to avail themselves of its sales-producing power, by neglecting to secure the counsel and co-operation of advertising experts.

It is to the interest of the magazine publisher and his readers, as well as of the advertiser, to have high-class advertising that is carefully planned to attract attention and to sell. How often have you read an announcement that looked as if it were prepared in about five minutes by some busy executive, who never studied even the first principles of salesmanship on paper? Did it impress you favorably? That is the kind of trade journal advertising that does not pay. Compare it with the advertisements that gripped your attention and forced you to respond favorably.

News Value of Announcements

Advertising is news—vital, important information that offers the reader some necessary benefits or service. Therefore it should be presented as news—in the most appealing, impressive and vivid style—so that it will burn its message indelibly into the mind of the reader like the powerful electric flash of lightning.

The widespread realization of the possibilities of well-directed publicity is reflected by the wonderful advertising pages that frequently appear in the trade magazines. These journals are read by progressive business men, alert for information of value to them—who realize that the spirit or character of a commercial institution usually is indicated by its public announcements.

Much trade journal publicity is not planned for immediate results, but rather to build prestige—and after all, what is more profitable or brings greater dividends than high-grade institutional advertising, properly backed up by a real business organization?

If the publishers of trade magazines would encourage and urge their advertisers to use attractive, sales-producing announcements instead of shoddy displays they would inspire greater faith in the pulling power of their publications by producing better results and at the same time adding to the appearance of their pages.

Experience proves that when various forms of advertising are found profitable for a business—for example, trade journal, direct-by-mail, magazine, newspaper and poster publicity—they

NEW ENGLAND MUSICAL INSTRUMENT TRADING CO.

WORLD AGENTS FOR

The Bell Hood Semi-permanent Needle

(Plays 50 to 100 Records)

Retail one package of 3 needles 25 cts.

Dealer's Price, \$15.00 for 100 pkgs. Jobber's Special Prices.

Now booking orders for Violin, Cello and Bass Rosin, a product from our new factory. Made up in boxes for jobber and dealer with your own imprint.

ALSO JOBBERS OF

UKULELES, BANJOS, VIOLINS, MANDOLINS, DRUMS, HARMONICAS
Strings of all kinds and the famous "Nemitco" Brand. All Small Goods and Music Books

NEW CATALOG NOW READY. SEND FOR IT

NEW ENGLAND MUSICAL INSTRUMENT TRADING COMPANY

127 East 23rd Street, New York

FOR SALE PANELS—for Immediate Delivery

1700 Sets first-class MAHOGANY PANELS
for two sizes of Phonograph Cabinets.

Also Cabinet Hardware.

FLOTTORP MFG. CO., 213 Lyon St., Grand Rapids, Mich.

increase the effectiveness of each other immeasurably and their power, as a combination, is all the greater.

To obtain success in trade journal advertising the reliability of the advertiser must be unquestioned, the merchandise must be right, the sales proposition must be fair and reasonable and the publicity must be consistently maintained, in order to keep the name before the trade. Institutional advertising, without constant repetition, is not institutional advertising.

Every newspaper, trade journal or magazine has a personality that either possesses or lacks character—and the pulling power of every publication depends upon the degree of confidence its readers place in its reliability and integrity. A self-respecting magazine that enjoys the confidence of 10,000 readers, who place implicit faith in its utterances, is more valuable from an advertising standpoint than an irresponsible journal with 100,000 circulation.

Methods Adopted in Trade Paper Campaign

Trade journal—as well as all other forms of well-directed advertising—can be made to produce profitable results. Experience covering many years of steady use, month after month, in all the trade papers of the music industry establishes the truth of that statement.

In the Steger campaign all of the Steger lines have been featured at different times. The method of illustration has been varied, so as to make all announcements original, different in artistic presentation, but harmonious to the extent that they always have projected the quality appeal—namely, musical and constructive excellence, service to dealers and financial strength. The co-operation of the best artists has been secured to present the sales ideas in the most striking manner. A distinct style of copy has been employed in each announcement to bring out some definite thought. Page space always has been used. There has been no "splurging" in space. The advertisements have been conservative, consistent and carefully thought out months in advance of publication. No "last minute" announcements have been published.

The Steger institution—with over forty years of experience in piano making—long ago foresaw the great demand for phonographs and promptly decided to manufacture them. Con-

siderable preliminary study was given to the plan of publicity presentation. The phonograph was developed and perfected. It was determined that the advertising should be original, self-

EMERSON JOBBER IS ENTHUSIASTIC

Peter G. Spitz, of Carpenter Paper Co., Describes Growth of Emerson Business

P. G. Spitz, manager of the phonograph department of the Carpenter Paper Co., Omaha, Neb., who are distributors for Emerson Gold



P. G. Spitz

Seal Records, in Nebraska and Western Iowa, has written a very interesting letter regarding Emerson records to Jos. I. Carroll, manager of sales of the Emerson Phonograph Co. This letter reads in part as follows:

"I wish to give you a little outline as to what we are doing with the Emerson record proposition. First of all I wish to say that the writer

respecting and constructive, to represent worthily the artistic and musical supremacy of the phonograph. The vast number of high-grade representatives appointed and the great volume of sales indicate how satisfactorily the merchandise, the sales proposition and the advertising were united.

When a campaign in business magazines of a particular industry brings to the surface directly traceable cash sales of over 5,000 pianos and 10,000 phonographs the returns afford an opportunity for reflection. Furthermore, if advertising is news, calculated to create prestige, the influence of this series of announcements should produce thousands and thousands of sales in years to come.

This Steger campaign is another proof that advertising, properly directed, helps to make it easier and more satisfactory for the consumer to buy, simplifies distribution, lowers costs and tends to standardize quality.

has had extensive experience with the talking machine industry, having started some fifteen years ago in Philadelphia with the Victor Talking Machine Co., prior to the time when they went to Camden. After a couple of years I left the talking machine business and did not return to the industry until about nine years ago, having been actively engaged in the business ever since, handling the Victor, Edison, Columbia and Brunswick lines of machines, until coming with the Carpenter Paper Co.

"I want to say that in all my experience I never realized that a proposition such as the Emerson record line could become so big a proposition in such a comparatively short time. On June 11 we placed with your Mr. Shire a blanket order for general stock records to the extent of what we believed was a very substantial quantity. We also placed what we considered a heavy standing order for all new releases. Just six months have elapsed, and our stock of records here is five times what it was at the time of starting, and our standing order is eight times what it was originally. Our number of sound and satisfactory dealers is well up in the hundreds.

"Due to the kind of territory that we have, it has been necessary for us to turn down a number of applications because we could not see our way clear, for the benefit of our business, to establish any more than one dealer in a town. This, of course, is due to the fact that there are so many small towns in western Iowa and the State of Nebraska.

"It is an impossibility, at the present time, for us to keep ahead of our orders, and I feel that our business is going to be limited only by the number of records that we will receive from the Emerson factory.

"As to the outlook for the future, with the publicity that the Emerson factory is giving us, together with the active way in which we intend to go after business, I can see no reason why we should not easily increase our business to a point many times larger than it is to-day."



THIS SALESMAN

WILL
DISPLAY SUGGEST REMIND SELL
FOR YOU

Dulciphone Needles

"The Highest Quality Needle in America"

MADE SCIENTIFICALLY OF THE HIGHEST GRADE CARBON STEEL. GUARANTEED TO PLAY THE LONGEST RECORD WITHOUT VARIATION AND WITH PUREST REPRODUCTION.

DEALERS' PRICE **6 1/2c.** Per Package | Your Initial Order for 200 Packages Brings the Handsome Display Case **Free**

Jobbers and Sales Agents write for our proposition to you

GRAND TALKING MACHINE CO., Inc.

Manufacturers of Dulciphone Phonographs
Dulciphone Needles
Distributors of QRS Player Rolls
Emerson Records
366 Adams St., Brooklyn, N. Y.

WORLD'S CLASSIFIED ADVERTISING

Any member of the trade may forward to this office a "Situation" advertisement intended for this Department to occupy a space of four lines, agate measure, and it will be inserted free. Replies will also be forwarded without cost. Additional space will be at the rate of 25c. per line. If bold faced type is desired the cost of same will be 25c. per line. Rates for all other classes of advertising on application.

PROGRESSIVE SALESMAN WANTED—To represent us throughout the Middle West. We have a complete line of phonographs, records, player rolls and accessories. Side line or full-time men wanted. M. R. 5, care The Talking Machine World, 209 So. State St., Chicago, Ill.

POSITION WANTED—Managership of retail store by experienced salesman. Manager, with ten years' experience in the field, six years' retail managing experience. Desires change because of retirement from business of present connection. Pleasing personality. Best of references can be furnished. Address "Box 763," care The Talking Machine World, 373 Fourth Ave., New York City.

WANTED—Several good salesmen to carry our high grade line of talking machines through all States west of the Mississippi except California. Also want salesmen for all States east of the Mississippi except New England, Michigan and New York State. Also want good men for New York City. Very liberal commissions. Prompt shipments and advances on accepted orders. Excel Cabinet Co., 136 West 23rd St., New York City.

WANTED—Seven men to sell a popular priced line of phonographs as a side line. Furniture salesmen preferred. Address "Box 766," care The Talking Machine World, 373 Fourth Ave., New York City.

WHOLESALE MAN WANTED—Familiar with the needs and requirements of talking machine and music dealers to take charge of small, rapidly growing wholesale department in Chicago. Must have had previous experience buying, selling, corresponding, catalog work, circulars and circular letters, handling stock record systems, customers' purchases and a general all around jobbing experience. In answering state age and full particulars of length of experience and service, salary expected, etc. Address "Box 768," care The Talking Machine World, 373 Fourth Ave., New York City.

POSITION WANTED—Superintendent or Production man with phonograph company making sixty or more machines per day. Can furnish the best of references. Address E. R. L., 4526 N. Lowell Ave., Chicago, Ill.

WANTED—Playerphone salesman to work on road. Orchard & Wilhelm Co., 414 S. 16th St., Omaha, Neb.

WANTED—Several good salesmen to carry our high grade line of Stein-Burn Machines and Lyric Lateral Cut Records for the following territories: Metropolitan District, New York State, New Jersey, Virginia, North Carolina, Maryland and Washington, D. C. Liberal commissions and advances on sales. Only first-class men need apply. Address A. M. Druckman, 140 West 23rd St., New York City.

MAN, seven years' experience selling two leading makes of phonographs, possessing college education, wishes position to take charge of retail store or in similar capacity in New York City. Address "Box 773," care Talking Machine World, 373 Fourth Ave., New York City.

RECORDING laboratory expert, fully conversant with processes of the leading manufacturers, will engage to completely, or partly, equip establishments to produce lateral cut records of quality and surface equal to the best. Address "Box 760," care Talking Machine World, 373 Fourth Ave., New York City.

POSITION WANTED—Young man, 29 years old, five years' phonograph sales experience, wishes position with firm in New York City handling high-grade line of instruments. Capable of taking charge of a department. At present employed in like capacity in a large city nearby. Can come for interview. Address "Box 759," care Talking Machine World, 373 Fourth Ave., New York City.

EXPERIENCED salesman wants position, wholesale phonographs or accessories. Well informed in all phases of business. Address M. R., 6, care Talking Machine World, 209 South State St., Chicago, Ill.

POSITION wanted by A-1 talking machine man, West Coast preferred, can take full charge, seven years' experience. Understand Columbia instruments and records thoroughly. Can repair and assemble all makes of motors, reproducers, automatic stops, etc. Address "Box 774," care Talking Machine World, 373 Fourth Ave., New York City.

POSITION WANTED—Experienced phonograph salesman wishes to connect with reliable phonograph manufacturer as wholesale representative. Now holding responsible position. Address M. R., 4, care Talking Machine World, 209 South State St., Chicago, Ill.

REPAIRMAN would like to make a change. Several years' experience on all makes of motors, also capable to take charge, assembling, shipping or receiving. Address "Box 764," care Talking Machine World, 373 Fourth Ave., New York City.

I AM now manager of a plant making talking machine cases and would like to get in touch with some one in the South who would need the services of a practical man who can buy machinery and start a plant for the manufacture of talking machine cases. Address "Box 761," care The Talking Machine World, 373 Fourth Ave., New York City.

OPPORTUNITY

An excellent phonograph department in a large department store in the East is available for responsible party who has capital to invest in as excellent a paying proposition as there is in the business. Very best of references will be required and party must be prepared to take over the proposition clear. Address Box 767, care The Talking Machine World, 373 Fourth Ave., New York City.

WANTED

To purchase a talking machine store in New England. One that has a Victor franchise preferred. Address Box 762, care The Talking Machine World, 373 Fourth Ave., New York City.

Cabinet Contracts

A prominent phonograph manufacturer in the East is prepared to place large contracts with furniture factories equipped to produce

Thousands of Cabinets

on a quality basis and of quality construction. Give full details.

Address Box 769,
care of
The Talking Machine
World,
373 Fourth Avenue,
New York City.

PHONOGRAPH CABINETS

50" x 22½" x 22½" in white or finished in oak, mahogany, walnut, also consoles. Cabinets built to order. Write for particulars to Arcade Phonograph Co., 1758 North Rockwell St., Chicago, Ill.

MOTORS

Perfect single spring motors complete, \$3 each. Cast-iron, strong, double-spring motors, bevel winding. 12-inch table, complete, \$7.25 each.

Let us know what you can use.

WOLLMAN TALKING MACHINE MFG. CO.
560-562 Grand St., Brooklyn, N. Y.
Established 1889

WANTED

100,000 Edison Blue Amberol Records, also Victor, Columbia, Edison Disc, Emerson, Pathé, or any make, new or second hand. Give details. Pay cash. Address Benjamin Weil, 20 South Second St., Philadelphia, Pa.

Main Springs

- 2 in. x 0.22 x 16 ft., MeisselbachEach \$1.25
- 1½ in. x 0.22 x 17 ft. reg. VictorEach 0.75
- 1¼ in. x 0.22 x 17 ft., Victor new style ..Each 0.75
- 1 in. x 0.28 x 10 ft., for ColumbiaEach 0.50
- 1 in. x 0.20 x 13 ft., VictorEach 0.50
- 1 in. x 0.20 x 13 ft., Victor new style ..Each 0.50
- 7/8 in. x 0.23 x 10 ft., for Blick mtr.Each 0.38
- ¾ in. x 0.23 x 10 ft., oval holeEach 0.35
- ¾ in. x 0.22 x 8 ft., for Swiss mtr.Each 0.27
- ¾ in. x 0.25 x 11 ft., for EdisonEach 0.27

MICA DIAPHRAGMS

- 1 23/32 in. Victor Ex. Box, first grade, Each 0.15
- 1 7/8 in., new Victor No. 2, very best..Each 0.18
- 1 31/32 in., for SonoraEach 0.20
- 2 3/16 in., for Columbia No. 6Each 0.25
- 2 9/16 in., for Pathe or Brunswick ...Each 0.45

SAPPHIRES

- Pathe, very best loud tone, genuine, Each 0.27
- Pathe, soft toneEach 0.27
- Edison, very best, medium toneEach 0.27
- Edison, very best, loud toneEach 0.27
- Edison, genuine diamondEach 2.50

STEEL NEEDLES

- AMERICAN MADE extra loud, loud, medium and soft needlesPer 1,000 0.60

ATTACHMENTS

- Kent attachments for Victor Arm.....Each 0.25
- Kent attachments for Columbia Arm..Each 0.25
- Edison attachments with C boxEach 2.50
- Kent attachments for EdisonEach 1.60

MOTORS

Distributors for Heineman and Meisselbach Motors. Best Prices. Immediate Deliveries.

TONE ARMS

- No. K with sound boxEach \$3.25
- No. E with sound box, very loud and clear,Each \$6.00

LID SUPPORTS

- AutomaticEach 0.30

NEEDLE CUPS

- Highly nickel platedPer 100 \$2.00
- Covers for cupsPer 100 \$1.00

REPAIR PARTS

- Columbia driving shaft, No. 11778.....Each 0.70
- Columbia bevel pinion, No. 12333.....Each 0.90
- Columbia cranksEach 0.45
- Columbia governor weightsEach 0.08
- Columbia governor shaft, No. 3004.....Each 0.40
- Columbia gov'r bearing, No. 11923.....Each 0.25
- Columbia governor springsPer 100 1.00
- Columbia governor screwsEach 0.01
- Columbia barrel screws, No. 2621, Per 100 1.00
- Columbia so'dbox thumb screwsPer 100 1.50
- Victor cranks, short or longEach 0.45
- Victor soundbox thumb screwsPer 100 1.00
- Victor Stylus bar (needle arm).....Each 0.35
- Victor governor springsPer 100 1.00
- Victor governor screwsEach 0.01
- Turn-table felts, 10 in., roundEach 0.15
- Turn-table felts, 12 in., roundEach 0.20
- Victor governor balls, new styleEach 0.10

FAVORITE MFG. CO.

1506 DeKalb Ave., Brooklyn, N. Y.

Phonograph CABINETS

For Immediate Delivery



WE have on hand several thousand cabinets in 46" and 48" size in Solid Mahogany, Walnut and Oak, all ready for motors and tone arms. There are several beautiful new designs with hand carved legs and handsome finish.

Sold in

Large or Small Lots

Order what you need. We also have a lot of SPECIAL 48" Gum Cabinets, finished in Mahogany and Walnut.

Cabinets in the White

This is our Specialty. We shall be glad to send photographs and prices on request—will make individual grills in lots of 25 or more.

We have installed new machinery and greatly increased our facilities, and now have a

First Class Finishing Dept.

in every detail, which enables us to turn out work second to none in appearance and genuine merit. Our Cabinets will please the highest class of trade, and will build a permanent business for the man who sells them.

Everett Hunter Mfg. Co.

McHenry, Ill. U. S. A.

[1140]

WOOD SCREWS

First quality, nickel-plated, 1 1/4-inch-6, oval head 48 cents per gross.

WOLLMAN TALKING MACHINE MFG. CO.
560-562 Grand St., Brooklyn, N. Y.
Established 1889.

WANTED

Victor and Columbia records. Job lots any quantity. Spot cash paid for them. Address

DENINGER CYCLE CO.,
Rochester, N. Y.

WILL SELL

Talking machines and cabinets to the trade; any style made to order. Best possible grade at lowest prices. Address: Delaware Talking Machine Co., Elsmere, Del., Main Office, 2616 N. 11th St., Philadelphia, Pa.

FOR SALE

A going concern, located in New York City, manufacturing phonograph motors, tone arms and reproducers of merit for which the demand greatly exceeds the supply. Will sell the entire business consisting of raw material, finished and unfinished parts, machinery, tools and dies. Accounts receivable, etc. No indebtedness; wonderful opportunity for the right party to make a big fortune; easy terms to responsible party. Good reason for selling. Principals only. Address Box 771, care The Talking Machine World, 373 Fourth Ave., New York City.

FOR SALE

Well established music store in good territory in the Middle West, handling old established lines of pianos, phonographs and small instruments, population over 7,000, can do from \$3,000 to \$5,000 a month. Stock including fixtures and delivery car in all invoice from \$7,000 to \$8,000. Reason for selling, other business demanding all of my attention. Full particulars to interested party. Address Box 765, care The Talking Machine World, 373 Fourth Ave., New York City.

WANTED

We want to buy job lots of *Needles, Motors, Turntables, Springs, Cabinets*, equipped or unequipped; in fact, all parts for Talking Machines.

Tell us what you have

United Phonograph Company
107 East 10th St. New York City

An Exceptional Opportunity

The tone that keeps Milwaukee famous! Grace, beauty, elegance, wonderful tone, acoustic and mechanical perfection. BUILD PHONOGRAPHS! Sell Outingphones! Plans, knockdowns, guaranteed accessories. Records, 70 cents on approval. Catalog, 10c stamps. Address Riviera, 335 Riverside Place, Milwaukee, Wis.

FOR SALE

Phonograph records, Victor, Columbia, Emerson (brand new). A very fine assortment of vocal and instrumental selections. Particulars given upon request.

I. DECKINGER
3064 Albany-Crescent Ave.
New York, N. Y.

WANTED

Recording Machine, Shaving Machine or Complete Recording Laboratory. Address Box 776, care of Talking Machine World, 373 Fourth Ave., New York.

CABINETS

At Prices That Are Right

STYLE 200
48x21x23

Our best seller. Finished in mahogany, walnut or oak, ready for installation of motor and tone arm.

Prompt deliveries. Send \$37.50 for sample.



BADGER STATE CABINET CO.
MILWAUKEE, WIS.

WORKS MANAGER

open for engagement

Five years' service as such in one of the largest phonograph plants in the country.

Well known in the patent field and have secured very important patents under development now that will go with my service.

Permanent connection desired with a large company. Principals only.

Thoroughly experienced in the design and manufacture of all classes of phonograph equipment and records. Address Box 770, care The Talking Machine World, 373 Fourth Ave., New York City.

Will Make Masters

I have access to a completely equipped laboratory and will make lateral or vertical masters and mothers at a flat rate, plus artists' fees. Will prove work to be of highest grade. Quick action needed. Give requirements in reply. Will not accept small contracts from irresponsible parties. Address Box 775, care The Talking Machine World, 373 Fourth Ave., New York City.

WANTED

Several experienced salesmen to carry our high-grade line of talking machines and records. Excellent opportunity for the right man. Liberal proposition. Address with full details the Superior Phonograph Co., 320 So. Wabash Ave., Chicago, Ill.

FOR SALE

Talking machine demonstration booths, sound proof, plate glass and mahogany. Four in all, size 6'x9', together with other fixtures of a talking machine department. Address

SEAVER BROS.,
5216 Third Ave., Brooklyn, N. Y.

FOR SALE

500 complete machines 46" high, equipped with highest class motors, tone arms, etc. Immediate deliveries. An exceptional bargain. Address Box 757, care The Talking Machine World, 373 Fourth Ave., New York City.

FLEMISH MOTOR PARTS

and others on hand, send for prices.
WOLLMAN TALKING MACHINE MFG. CO.
560-562 Grand St., Brooklyn, N. Y.
Established 1889.



EUROPEAN HEADQUARTERS

2 GRESHAM BLDG., BASINGHALL ST., E.C. LONDON

W. LIONEL STURDY, MANAGER

Gramophone and Record Sales Continue at Very High Level—Trade Running Beyond Normal, But Shortage of Supplies Still Exists—Trend of Prices Continues Upward in All Lines—Mica and Shellac Are Scarce and Expensive—General Phonograph Co. Incorporated in England—German Records Appear on the Market—Leipzig Messe to be Visited by British Gramophone Men—Exhibitors at Ideal Homes Display—Federated Board of Music Industries Dine—News of Month

LONDON, E. C., ENGLAND, February 27.—Though remarkable, it is a pleasant fact that British gramophone and record sales continue to maintain a very high level. Trade is really beyond the normal for this particular period of the year. It rather goes to prove the progressive expansion of our industry. Indeed, notwithstanding good supplies of machines and records, production still lags behind demand. Record factories are pressing discs continuously, day and night, and in many cases building extensions to provide room for additional presses have reached the limit. Record output is restricted not by lack of labor or presses so much as inability to find sufficient space for their installation, and factory accommodation is so scarce to-day that applicants are offering big premiums (apart from high rent) whenever any suitable building becomes vacant. This is general. But I can count half a dozen or more gramophone firms who have been waiting months for the right place. The building trade has been stagnant (in the ordinary way of building) for five years. Now its energies

are concentrated on bricks and mortar and wooden shanties for house accommodation. New factory construction is much less than is really necessary, partly owing to the enormous cost of building to-day. It is a drag on the rapidly advancing progress of the gramophone trade.

Supplies of machine parts and accessories are good, but still—not good enough. The principal shortage is motors, as usual. Every gramophone manufacturer, factor, or assembler is hampered by the inadequate supplies of mechanisms. The adverse money exchange rate seriously affects supplies from your side. British firms cannot place orders with American motor manufacturers until the pound sterling reaches a more normal value. At 3.34 (quotation at time of writing) the difference between the normal value—4.87, of our pound sterling, would bring imports of American motors to a prohibitive selling figure, freight, insurance and duty charges considered.

Unfortunately, imports of motors from Switzerland are susceptible to little or no possibility of increase, because there also production is of less amount since the introduction of an eight-hour day in the Swiss factories. According to David Sternberg, who recently visited St. Croix, deliveries of motors from Switzerland are far short of the actual requirements of British gramophone firms. While there is good labor available, it cannot be utilized to the extent desired, owing to absence of house accommodations within reasonable distance of the factory. Accordingly, my informant is of opinion that we cannot hope for increased

supplies of Swiss mechanism for some time.

From Germany a few consignments of motors are now coming through, but in small quantities. Sentiment prevents many firms from buying German goods, but others quite eagerly buy up all they can get.

Price of British Records Again Increased

Notwithstanding strong opposition and protests from all quarters the selling price of most articles and commodities continues upward all the time. Productivity throughout the world has been stagnant for so many years as to dislocate the whole machinery of labor and commerce. An equal length of time is required to make good the ravages of war and its stagnating effect upon industry. The world and men are working mighty hard to-day in an endeavor to satisfy the seemingly insatiable demand for every known article of luxury and essential need. Necessity—it is nothing less—recognizes no standard of price. Buyers of raw material—of everything, outbid each other in the supply markets of the world. Other than this, there is no competition in trade as we ordinarily measure it. And without the steadying influence of competition, materials and manufactured articles soar in cost and selling price automatically.

It is no wonder that gramophone record prices are very unsteady. There is no firm rate for labor and materials. The cost is upward. And so upward goes the selling price of records and machines. The position to-day is as hereunder:

The "His Master's Voice" Co. announce an increase of one shilling in the price of ten and



"His Master's Voice"

Copyright

This intensely human picture stands for all that is best in music

—it is the "His Master's Voice" trade-mark, and it brings to you, no matter where you are, the very best music of every kind, sung and played by the world's greatest artists—the greatest singers, pianists, violinists, orchestras and bands—all enshrined

in the unequalled "His Master's Voice"

records

'His Master's Voice'

—the trade-mark that is recognized throughout the world as the

HALL-MARK OF QUALITY

Branches

DENMARK: Skandinavisk Grammophon-Aktielselskab, Frihavnen, Copenhagen.

FRANCE: Cie. Française du Gramophone, 115 Boulevard Richard Lenoir, Place de la République, Paris.

SPAIN: Compañía del Gramófono, 56-58 Balmes, Barcelona.

SWEDEN: Skandinaviska Grammophon-Aktiebolaget, Drottning Gatan No. 47, Stockholm.

RUSSIA: The Gramophone Co., Ltd., 45, Nevsky Prospect, Petrograd (Petersburg); No. 1 Solyanka, Solyanov Dvor, Moscow; 9, Golovinsky Prospect, Tiflis; Nowy-Swiat 30, Warsaw; 11 Michailovskaya Ulitsa, Baku.

INDIA: The Gramophone Co., Ltd., 139, Balghatta Road, Calcutta; 7, Bell Lane, Fort, Bombay.

Great Britain:

The Gramophone Company, Ltd.

HAYES - MIDDLESEX - ENGLAND

Agencies

AUSTRALIA: S. Hoffnung & Co., Ltd., Sole Concessionaries of The Gramophone Company, Limited, 163, Pitt Street, Sydney.

NEW ZEALAND: Gramophonum, Ltd., 118-120 Victoria Street, Wellington.

SOUTH AFRICA: Darter & Sous, Post Box 174, Capetown; Mackay Bros., Post Box 251, Johannesburg; Mackay Bros. & McMahon, Post Box 419, Durban; Ivan H. Haarburger, Post Box 105, Bloemfontein; Franz Moeller, Post Box 108, East London; B. J. Ewins & Co., Post Box 86, Queenstown; Handel House, Kimberley; Laurence & Cope, Post Box 132, Bulawayo; The Argus Co., Salisbury.

EAST AFRICA: Bayley & Co., Loureuso Marques.

HOLLAND: American Import Co., 22a, Amsterd Veerkade, The Hague.

ITALY: A. Bossi & Co., Via Orefici 2, Milan.

EGYPT (Also for the Soudan, Greece and the Ottoman Empire): K. Fr. Vogel, Post Box 414, Alexandria.

The VULCAN MAIN SPRINGS

J. STEAD & CO LTD

SEND to-day for SAMPLES & PRICES MANOR WORKS SHEFFIELD.

FROM OUR LONDON HEADQUARTERS—(Continued from page 233)

Cheapside, circulars have been dispatched to the trade offering "the famous HomoKord records" in all languages, at reasonable prices . . . if . . . you are not biased by recent events." Gramophones and sound boxes are also offered.

An informal chat with Mr. Knight proved of interest. He informed us that as regards trading policy there would be no question of dumping or undercutting . . . the ten-inch double-sided records were to retail at 3s., or according to market price. His company proposes erecting a factory here within the next two years; meantime up-to-date British music scores are regularly dispatched to Berlin. Mr. Knight also claimed for his company a new discovery in recording sound, and in reproducing it, though with the use of an ordinary sound box superior tonal results would be obtained.

The foregoing represents the substance of Mr. Knight's remarks, but in the absence of supplies of Homophone products, we are unable to make comment.

British Department of Overseas Trade

A definite advance has been made in the development of trade overseas by the good offices of the Department of Overseas Trade, 35 Old Queen street, Westminster, London, S. W. 1. Besides providing information in trade matters, facilities are also provided for examining samples of foreign production.

A French World's Market

A scheme to create an extensive market in Paris to be called the "Paris Marché du Monde," where producers and buyers of the world may do business all the year round, is exciting commercial circles. An extremely big palace is aimed at, which will accommodate 5,000 firms. The estimate is that it will take two years to build and that the cost will be £6,500,000. The company has been formed by private enterprise and all the directors are Frenchmen.

With the backing of one of the most important French banking firms and also the fact that the directors are wealthy enough to subscribe the capital ten times over and are determined to make it a success, this wonderful enterprise seems certain to become a valuable factor in commerce. The scheme may be put on an international footing eventually.

German Protest Against Limitation of Exports

Measures to limit exports by the German Government have called for an objection and protest by the German Trade Press. The *Vogtlandische Anzeiger* objects to the steps taken on the ground that the principal market is not at home, but abroad. The case is very strongly stated, in that musical instruments as articles of export, being of relatively cheap raw material but of a high price as a finished article, are just the class of goods to increase the value of the mark. The central bureau for the music industry to sanction exports, will also control prices according to which the export duty should be gauged. Caution is being urged in fixing prices in fear of competitive measures being adopted by "French" makers. The italics are mine.

Brief Trade News Items of General Interest

It is generally conceded that the Association of Gramophone and Musical Instrument Manufacturers and Wholesale Dealers has justified its existence over and over again. During the war period particularly, much good work has been done of real benefit to the trade. But I will not anticipate. The first annual dinner of the Association is due March 8 at the Frascati Restaurant, London, when doubtless of its work we shall hear much of interest.

The "His Master's Voice" Co. advises me of an increase in the allowance for old and worn records, as follows: Ten-inch, from 6d. to 8d.; twelve-inch, from 9d. to 1s. This arrangement operates as from February 11 and until fur-

ther notice is sent out by this company.

A London firm has just introduced two good selling novelties, i. e., albums (on the loose leaf principle) for ten and twelve-inch records, and a liquid for cleaning and reviving old records. Both have been received favorably in trade circles and big orders are the order of the day.

Another novelty recently introduced is a gramophone automatic stop. Very simple in construction and operation, it is the first of its kind on the British market, which, by the way, is very much neglected by gramophone novelty and accessory manufacturers.

The Zonophone Co. advises a new exchange scheme. An allowance of 6d. for ten-inch and 8d. for twelve-inch old or worn Zonophone records is made, providing an order is given for new records equal in quantity to those returned. This works out at approximately 1s per pound.

Messrs. J. E. Hough have advised dealers of their willingness to pay in cash 8d. per pound for all old gramophone record material. This applies to all records other than Columbia, Regal and Phoenix.

For the first time since 1914 the Leipsig Messe will be visited by British gramophone men. The number is small. Sentiment keeps many away, apart altogether from the rival attraction of the British Industries Fair. The latter is in being from February 23 to March 5, inclusive, while the Leipsig show runs from March 1 to 7, as far as the business side is concerned. There will be the usual gramophone exhibits, but lack of material and industrial chaos is likely to preclude Germany from exporting gramophone goods in quantity for many a day to come. Only very small parcels are coming through to London.

Considerable doubt must exist regarding the veracity of a report published by one of the daily press scribes to the effect that Germany is

(Continued on page 235)

GRAMOPHONES

Complete—Fittings—Sundries—Repair
Parts—Needles

Special Lines and Quotations for Export Trade

THE BRITISH POLYPHON CO.

Glasgow, Scotland
27 Jamaica St.

1, 2 and 3 NEWMAN STREET
LONDON, W. 1, ENGLAND



YE "POPULAR" RECORDS

Double-Sided Superb Needle Cut "Lateral"

LONDON'S LEADING VALUE!!!

"OUR POINTS" SET OUT BELOW

Have Attracted Keen-Overseas Houses

from SCANDINAVIA to PATAGONIA AND THE PRINCIPAL EAST and WEST MARKETS of the WORLD

IMPORTANT We can give customers their own design Labels for LARGE Parcels.

REMEMBER You Can Have CLOSE QUOTATIONS For 5,000 Lots and up "Your Selection" or a Sample 1,000, made up with "One Example" of Every Catalogued Pairing.

Address: **SOUND RECORDING CO., Ltd.** CABLES "Grammavox" London EXPORT DEPT., 18-19 Swallow Street Piccadilly, London, England **"QUOTATIONS CABLED FREE"**

POINTS

- ➔ Repertoire Approx 2,000 Titles—Covering
- ➔ Superb Selection, Bands and Orchestras
- ➔ Lightning Shipments
- ➔ Packing by Experts
- ➔ Rock Quotations "Always"
- ➔ F. O. B. London
- ➔ We attend to all Insurances "if Requested" to Buyers A/c
- ➔ Our Shipping Services, this Side FREE

FROM OUR LONDON HEADQUARTERS—(Continued from page 234)

endeavoring to get records from this country and the States, as their own stocks are low and cannot be replenished because the copper matrices were commandeered for munitions during the war. As an offset to this, it may be stated that the Germans are even offering to sell us records.

And so we are to have an "unwearable" needle. There is the usual qualification. It is only good for a couple of hundred playings. Well, that's good enough. Herman Darewski is, however, in the field with an actuality—the famous Tonofone fifty-tune needle. That suits us better than a myth.

At the Ideal Homes Exhibition, Olympia

Open during the best part of February, this exhibition was mainly devoted to furniture, domestic utensils, electric apparatus, besides which there were to be seen a varied range of articles that go to make the home ideal. In conformity with the nature of the exhibition, one would expect to find the musical instrument of primary importance among the exhibits. Instead of which there were but half a dozen firms represented. Thousands visited the show daily, and this fine opportunity to bring home to the masses the value of musical enjoyment by modern contrivances was unfortunately neglected. The pitch of perfection to which the gramophone and the player-piano have attained to-day is a matter for publicity. Here was the best form of direct publicity—the people came to listen and to buy. What a pity that so few firms advantaged the trade at this exhibition. Such a golden chance for propaganda work of an educational nature! That policy entirely smothers the plea one so often hears concerning inability to supply. At least one firm—the "His Master's Voice," was represented by a good display of instruments, not because they wanted orders—they do not, but it is sufficient to say they believe in publicity all the time.

Tribute must be paid to the Aeolian Co., Ltd.,

for their truly magnificent stand, with its several "period" audition rooms. The exhibits, covering a complete range of their musical goods, included models of the Vocalion in cabinet and period styles, the Weber piano, the Pianola player, the self-governed pneumatic action Duo-Art player, pipe organs, etc. W. Paget Smythe told your representative that excellent orders were being booked for near future delivery and that the "prospective" work was really great. Period Vocalions in Adam, Sheraton and Chipendale, etc., were much in demand. There was an increasing call for players, particularly for the electric, and the foot-power Duo-Art Pianola.

The Triumph-Auto Co. reported very satisfactory business at their well arranged booth. They were exhibiting the popular Triumph-Auto player, with its unique control devices, and Columbia graphophones.

Some fine examples of British piano and player instruments were to be seen at the stand of John Strohmenger & Sons, Ltd.

The well-known publishing house of Ascherberg, Hopwood & Crew, Ltd., built their stand in the form of a cottage and christened it "The Cottage Where Your Dreams Come True," after the title of one of their many popular songs. In the introduction of new numbers—songs, waltzes and operatic selections, etc., the stand was of good advantage, said J. W. Figg.

In a tastefully furnished glass-fronted salon, Keith Prowse & Co. presented a fine range of Sonora models. At the time of my visit a goodly audience, comfortably seated, was being regaled with various records which evoked much favorable comment, and, as I afterwards learned from Julian Millest, many orders.

At the Bellaphone stand were to be seen a good range of table-grands, cabinet, hornless and portable models. In this case, too, I was glad to learn that good orders had been booked.

And, last but not least, I had a chat with Mr. Woolland at the stand of the Disque Cabinet Co. Said he: "People are appreciating our unique record filing cabinets to such an extent that our entire output for 1920 is almost booked up." This is pleasing information.

The Federated Board Dinner

The inaugural dinner of the Federated Board of the Music Industries of Great Britain and Ireland, which took place on Friday, January 20, was a gigantic success. Between four and five hundred members of the music trades and profession, truly representative of the British Isles, were gathered together and demonstrated in no mean manner the progressive spirit of the age. Alexander Dow, to whom may be accorded praise for his energies making possible this Federation, was the chairman. As the president of the Federated Board he said he would do his best to carry the scheme of the Federation through to a successful issue. There are in the Federation at the present moment six of the leading trade organizations of the music industry of Great Britain, and the Federation of Organ Builders has decided to join. The only outstanding people were the publishers and he hoped they would be in ere long. One of the aims of the Board was to support the musical efforts of municipal enterprise and to foster musical culture in the elementary schools. The Board did not wish to interfere with individual effort, but to be the friends and servants of all in the industry and profession. Lord Howard de Walden, Viscount Burnham, L. Paish (of the Board of Trade Overseas Department), Sir Henry Foster (president of the Pianoforte Manufacturers' Association), Dr. Allen (principal of the Royal College of Music), Percy Scholes, Sir Frederick Bridge, Sir Charles V. Stanford, Sir Samuel Waring and H. Gordon Selfridge all spoke in glowing terms

(Continued on page 236)

The Sound Box That Has Beaten the Band

An All British Production of the Highest Grade; Marketed at Popular Prices

4—Models Only—4

Export Quotations for Quantities at Extraordinarily Low Prices.

LARGEST OUTPUT IN UNITED KINGDOM

HOME TRADE OUTPUT BOOKED UP FOR SEASON 1919-1920. WILL MAIL SAMPLE SET 4 MODELS B.C.E.F. (one only) TO ANY RECOGNIZED JOBBER ON RECEIPT DRAFT, \$5 (DOLLARS)



Vernon Lockwood Manufacturing Co., Ltd.

76-78 CITY ROAD LONDON, E. C. I.

FROM OUR LONDON HEADQUARTERS
(Continued from page 235)

of the work being undertaken, and it can be felt that this function marks the stepping-stone to great results.

The British Industries Fair

There are many sure signs of a larger measure being considered necessary for the adequate development of trade, and not the least is the reorganization of the British Board of Trade. The British Industries Fair, this year organized as three fairs in one, is to be held from February 23 to March 5, as already announced in my previous notes, in London, Birmingham and Glasgow. The Crystal Palace, as one of the largest exhibition buildings in the world, is quite properly the place for the London Fair and here are to be found all the musical exhibits for the United Kingdom. There is no doubt but that the accumulation of interests centered at the Crystal Palace will do much to foster the rapid growth of the talking machine industry. The enterprise of firms in our business will be fully appreciated when I mention that two-thirds of the exhibitors in the music section of the fair are those engaged in the gramophone industry. Taking them in alphabetical order the exhibitors are as follows: Aston Cabinet Co., Bellaphone Co., Ltd., British Gramophone Motors, Ltd., Cooper Bros., Ltd., Columbia Graphophone Co., Ltd., Crairs & Stavridi, Curwen, J. & Sons, Ltd., Disque Cabinet Co., Evans, George & Co., Eccles, J. R., Hough, J. E., Ltd., Invicta Record Co., Ltd., L. E. Jaccard, Pathé Frères, Pathéphone, Ltd., Perophone, Ltd., (Lockwoods), Remoplec Trading Corp., Rowhill Engineering Co., Samuel Bennett & Co., Sterno Manufacturing Co., Stroud, R. & Son, Ltd.

HOLIDAYS THROUGHOUT THE WORLD

The Guaranty Trust Co., New York, has recently issued a convenient cloth bound volume listing all the bank and public holidays throughout the world. The listings are made under two divisions, first in chronological order, and then according to countries. The volume should prove of distinct value, to those engaged in export trade, in the handling of contracts and financial matters.

George W. Hopkins, general sales manager of the Columbia Graphophone Co., left New York recently for a vacation at Palm Beach, Fla.

Horn, Hornless and Table-Grand
GRAMOPHONES

FOR
EXPORT

Please State Your Requirements

REX GRAMOPHONE CO. 2 Elizabeth Place
Rivington Street, LONDON, E.C. 2, England
Cable Address "Lyrecodisc, London"



**BRITAIN'S BEST
Gramophone Needle**
(Guaranteed made from High Carbon Steel)

IS MADE BY
W. R. STEEL, of REDDITCH,
Head Office and Works—QUEEN ST.

Scientifically pointed, Hardened and Tempered on the latest up-to-date machinery and plant by skilled craftsmen only.

RESULT:
A FIRST QUALITY NEEDLE far ahead of anything of pre-war quality
INQUIRIES SOLICITED
Special Quotations for Quantities

Manufacturer of all Kinds of Sewing Needles

THE PATHE FOR HARDWARE MEN

Buffalo Wholesale Hardware Co., Pathé Wholesalers, Reprint Article on Timely Subject—Exhibit at Convention of Hardware Men

BUFFALO, N. Y., March 4.—"The Talking Ma-



Pathé Exhibit at Hardware Dealers' Convention, Syracuse

chine in the Hardware Store" is the subject of a very interesting booklet issued by the Buffalo Wholesale Hardware Co., wholesale distributors

for the Pathé Frères Phonograph Co. in this city. The article, written by Courtney Harrison originally for the Hardware Dealer's Magazine, describes very forcefully the advantages of the hardware dealer carrying a line of phonographs as well. The article is not theoretical, as it gives numerous actual experiences of hardware dealers

who have been very successful with phonographs as part of their merchandise. Earl B. Dryden, manager of the Pathé department of the Buffalo Wholesale Hardware Co., planned a very interesting exhibit of the Pathé line for the Hardware Dealers' Convention, which was held recently at Syracuse and which is shown herewith. The entire line of Pathé phonographs was exhibited, including the new period models of the Actuelle. The exhibit proved very popular at the convention and was entirely profitable from the standpoint of the Buffalo Wholesale Hardware Co. as well as instructive to Pathé dealers.

AUSTRALIA.

Herbert G. Polyblank,
SYDNEY,
N.S.W.

BELGIUM.

F. Carton,
Rue Karel Ooms, 11,
ANVERS.

ITALY.

G. Menaboni,
Via S. Sebastiano 2,
LIVORNO.

SPAIN.

Ernesto Verdu,
ALICANTE.

ENGLAND.

A. Waite & Co., Ltd.,
15-17 Flitree Lane,
SHEFFIELD.

*Songster
Talking
Needles*

Manufactured by J. STEAD & CO. LTD.
MANOR WORKS. SHEFFIELD ENGLAND.



LATEST PATENTS RELATING TO TALKING MACHINES AND RECORDS

WASHINGTON, D. C., March 7.—Talking Machine. Anton D. Anderson, Harrison, N. Y. Patent No. 1,327,516.

The present invention relates to new and useful improvements in talking machines, and pertains more particularly to that type of machine in which the talking machine per se is combined with an article of furniture, as, for example, a table.

In the accompanying drawings Figure 1 is a top plan view showing the position of the parts during the operation of removing and replacing

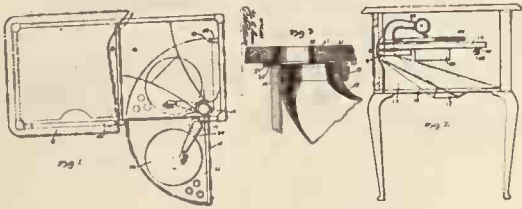

record tablets; Fig. 2 is an end elevation partly broken away of the complete device; Fig. 3 is a detail sectional view.

Talking Machine. Frank L. Dyer, Montclair, N. J. Patent No. 1,326,920.

This invention relates to various new and useful improvements in talking machines, and the object is to provide a talking machine in the form of a table or stand lamp whereby its identity will be concealed, without detracting from its efficiency as a reproducer of sound. The effect produced is that of a reasonably large electric lamp having a substantial base and a suitably ornamented translucent or semitransparent shade.

With the improved phonograph the standard of the lamp comprises the horn, or amplifier, or at least a portion of the same, and the horn or amplifier opens into the base of the lamp, the walls of which are suitably perforated to allow the sounds to escape. The perforations are preferably in the form of some ornamental open work pattern or design so as to make the lamp artistically attractive. If desired the lamp may be provided with supporting feet so as to provide a space between the base and the table upon which the lamp is supported, and when these supporting feet are used the base may be open at the bottom so that the sounds may come out through the space between the base and the table. When the latter expedient is adopted the perforations in the walls of the base may be omitted, or both suggestions may be used—that is to say, the sounds from the horn or amplifier may reach the auditor through the perforations in the walls of the base and through the space between the base and the table.

If it is desired to deflect the sounds from the horn or amplifier in any particular direction, a deflector may be used connected with the horn or amplifier and mounted within the base

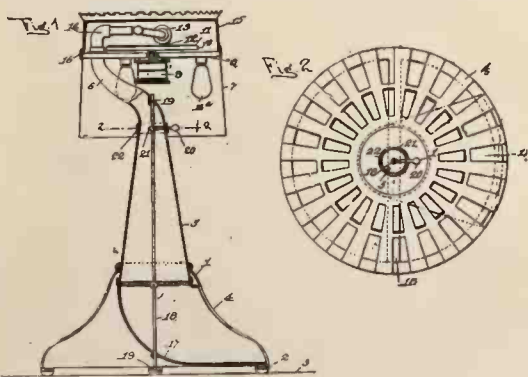

so as to deflect the sounds toward any desired point, and this deflector when used may be adjustable so as to vary the direction in which the sound will be deflected.

The upper part of the lamp is provided with a suitably ornamented shade made of some translucent or semi-transparent material, such as silk, paper or glass, and the lamp is illumi-

nated with one or more electric lights supported within the shade. The upper part of the shade incloses a chamber or receptacle in which the turntable, sound box and tone arm are mounted. Preferably the shade is divided so that its upper part constitutes a lid which may be raised to permit a new record to be placed on the turntable, and lowered when the record commences to play. The turntable is operated in any suitable way, such as by a spring motor or electric motor.

Figure 1 shows a vertical sectional view of a talking machine, illustrating the present improvements in a very simple way, no attempt being made to illustrate artistic details, but only the barest outline of its mechanical construction. Fig. 2 is a sectional view looking downward, taken on the line 2—2' of Fig. 1.

Gramophone, Phonograph and the Like. Jose Hoffay, New York and South Kensington, London, Eng. Patent No. 1,326,932.

This invention relates to improvements in or connected with sound boxes for talking machines and comprises mounting a stylus lever on a single rigid pivot in such manner as to permit the stylus holder to partake of universal rocking movement on the pivot point, apex or head (hereinafter referred to as the pivot point.)

Figure 1 shows a front elevation partly in section of a sound box having a stylus lever mounted according to one form of the invention, and, for example, in a position suitable for playing zig-zag records. Fig. 2 is a central elevation at right angles to Fig. 1, parts being

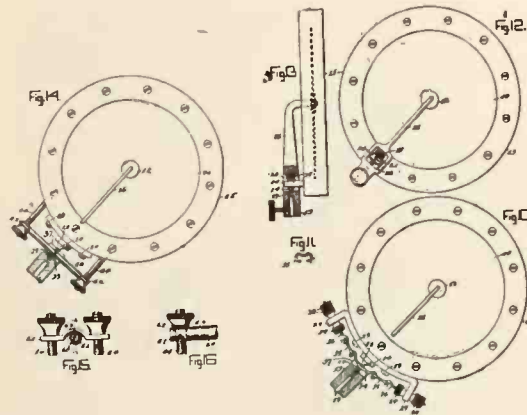

omitted for the sake of clearness; Fig 3 is a back elevation; Fig 4 is a sectional plan on the line 4—4, Fig. 1; Fig 5 is a sectional elevation; Fig 6 a sectional plan; Fig 7 a sectional elevation; Fig 8 an elevation of the right hand lug of the bracket 21, Fig. 1; Fig 9 a part sectional elevation of the left hand lug of the bracket 21, Fig. 1; of details on enlarged scales; Fig 10 is a front elevation partly in section of a modification; Fig 11 is a plan of a detail; Fig 12

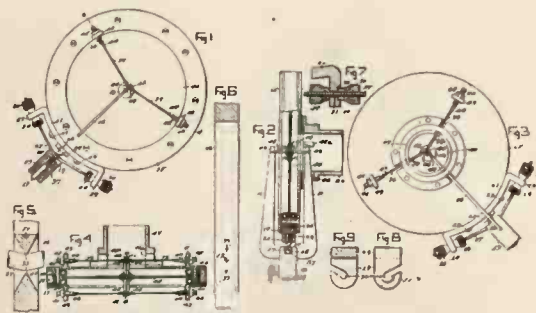

is a front elevation; Fig 13 is a sectional elevation at right angles to Fig 12; of another modification; Fig 14 is a front elevation; Fig 15 is a section on the line 15—15 of Fig 14; and Fig 16 is a section on the line 16—16 of Fig 15; of another modification.

Cabinet Phonograph. Seward W. Hecox, Zeeland, Mich. Patent No. 1,324,311.

This invention relates to improvements in cabinet phonographs. The main objects of this invention are: First, to provide an improved cabinet phonograph, in which the horn is disposed above the reproducer so that the sound

from the tone arm travels upwardly to the horn. Second, to provide an improved cabinet phonograph in which the turn table is mounted on a supporting member to be adapted to be extended or withdrawn from the cabinet, to facilitate the operation of the machine.

Figure 1 is a front perspective view of a structure embodying the features of the invention. Fig. 2 is a detail front perspective view with the cabinet open and the supporting member for the turn table, tone arm and motor in its extended position. Fig. 3 is a detail side elevation of the cabinet in vertical section, the parts being broken away to better show the structural details, the supporting member being shown in its inner or retracted position. Fig. 4 is a detail side elevation of the parts shown in Fig. 1, with the supporting member in its extended or outer position, parts being broken

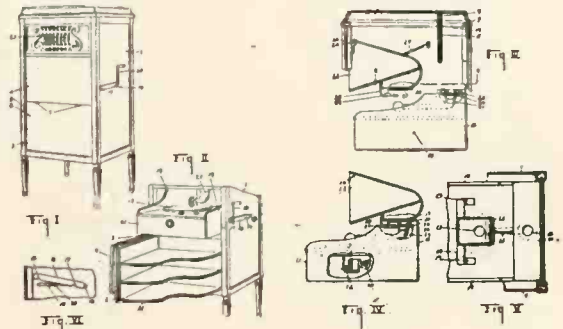

away to show the structural details. Fig 5 is a detail horizontal section on a line corresponding to line 5—5 of Fig. 3. Fig. 6 is a detail side elevation showing a latch, or detent, for the crank in its disengaged position.

Sound Reproducing Machine. Francesco Cirilli, Philadelphia, Pa. Patent No. 1,324,306.

One object of this invention is to provide a sound reproducing machine which will give an accurate and natural reproduction of sound. Another object is to so construct the invention that it can be made without the usual sound amplifying horns or chambers and can be applied to any form of cabinet or supporting structure.

Figure 1 is a side elevation of this improved talking machine, a part of the cover and sup-

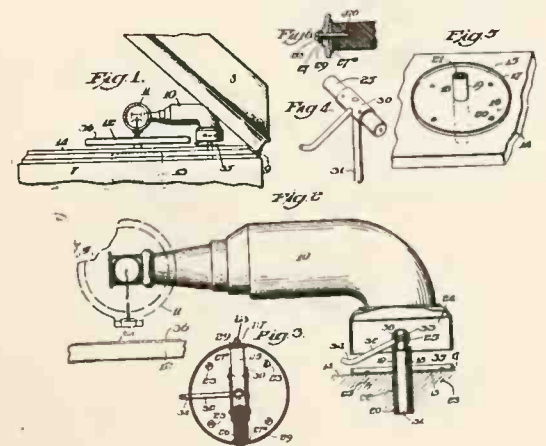

porting structure being broken away. Fig 2 is a fragmentary elevation on a larger scale than shown in Fig. 1, certain of the features being illustrated in central vertical section. Fig. 3 is a sectional plan view taken on the line 3—3 of Fig. 2. Fig. 4 is a perspective view of certain of the elements of the invention. Fig. 5 is a perspective view of a bearing member which forms the pivotal support for the tone arm. Fig. 6 is an enlarged fragmentary section taken on the line 6—6 of Fig. 1.

Tone Control Device for Talking Machines. William H. Davis, Bronxville, and Frederick E. Joss, Brooklyn, N. Y., assignors to the Lekto- phone Co., Delaware. Patent No. 1,316,536.

This invention relates to tone control devices for talking machines, and in particular for talking machines of the so-called Hopkins type.

(Continued on page 238)

LATEST PATENTS RELATING TO TALKING MACHINES AND RECORDS—(Continued from page 237)

wherein the vibrations of the stylus are transmitted by a connecting device to a conical diaphragm of large area, the connecting device comprising a rod or analogous element and a stylus holder. The diaphragm referred to is freely exposed to unconfined air and is so constructed and arranged as to take the place of the usual sound box and of its associated horn or similar amplifier.

The present invention aims, therefore, to provide an effective means or device for acting upon the transmission connection in the manner indicated, such action being obtained, according to the illustrated embodiment of the invention, by disposing a pair of jaws on opposite sides of the said connection so as to grip the latter when moved toward each other, the operation of the jaws being produced by a device which is rotably mounted upon the support.

Figures 1 and 2 are, respectively, a vertical and a horizontal fragmental longitudinal sec-

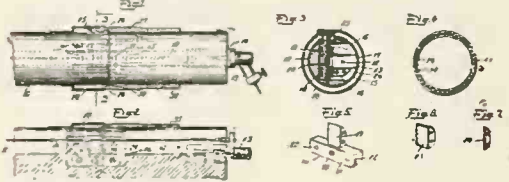

tional view showing the application of the invention to the supporting bar of a Hopkins-type machine. Fig. 3 is a transverse section, taken on line 3—3, Fig. 1. Fig. 4 is an end view of the main operating element. Fig. 5 is a perspective view of one of the jaws, and Figs. 6 and 7 are detail views of certain adjuncts of the clamping jaws.

Patent No. 1,316,537 has also been granted to above parties for expansion of tone control principle.

Sound Controller. Wm. A. Sommerhof, Erie, Pa. Patent No. 1,327,118.

One of the objects of this invention is to provide a sound controller that can be applied to all makes of phonographs and which, though made of straight panels, will conceal the interior of the sound chamber or amplifier and, at the same time, allow a uniform dispersment of the sound waves thereby to thoroughly blend the loud and the feeble sounds and produce a volume of sound that is uniform throughout the

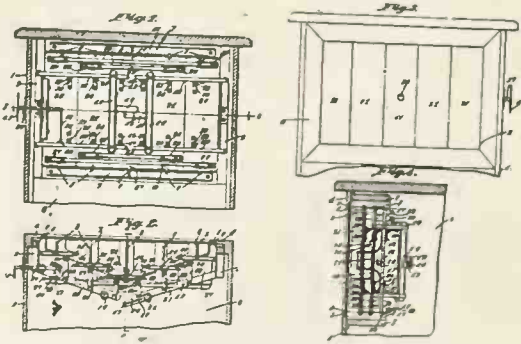

area of the outlet. Another object is to provide a dust proof closure void of ledges or the like on which dust can accumulate.

Figure 1 is a transverse section through a portion of a phonograph cabinet and showing the sound controller in rear elevation. Fig. 2 is a section on line 2—2, Fig. 1. Fig. 3 is a front elevation of the controller. Fig. 4 is a section on line 4—4, Fig. 2.

Repeating Device for Talking Machines. Alexander Fraser, Rrenfrew, Ontario, Canada. Patent No. 1,327,816.

This invention relates to improvements in a repeating device for talking machines, particu-

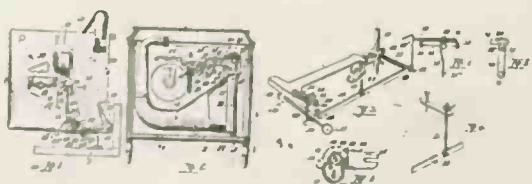

larly machines of the so-called Edison type, in which the tone horn extends below the records and swings about a pivot at its forward end, and the objects of the invention are to provide a

simple and effective device by which a record may be caused to repeat, or cause to be automatically repeated any given number of times.

In the drawings Figure 1 is a plan portion of a talking machine embodying the present invention. Fig. 2 is a sectional elevation. Fig. 3 is a perspective detail of the repeating mechanism. Fig. 4 is a side elevation showing a detail of the end of the swinging rack. Fig. 5 is an end elevation of the device shown in Fig. 4. Fig. 6 is a perspective detail of one of the repeating levers. Fig. 7 is a plan view, showing a detail of the device for stopping the machine after the record has been repeated a given number of times.

Talking Machine. Francois J. A. Pratte, Montreal, Quebec. Patent No. 1,327,776.

The present invention relates to improvements in talking machines and consists particularly in the provision of two sound amplifiers arranged substantially at right angles to each other, one opening through the front of the casing of the machine in the usual way, while the other projects downward and opens through the bottom of the casing. Means are also provided to alternate from one sound amplifier to the other.

The invention further consists in the addition of a sound board adjacent said sound amplifiers and so connected thereto as to increase or amplify the resonance of the instrument.

The object of the invention is to provide a talking machine in which the vibrations may be

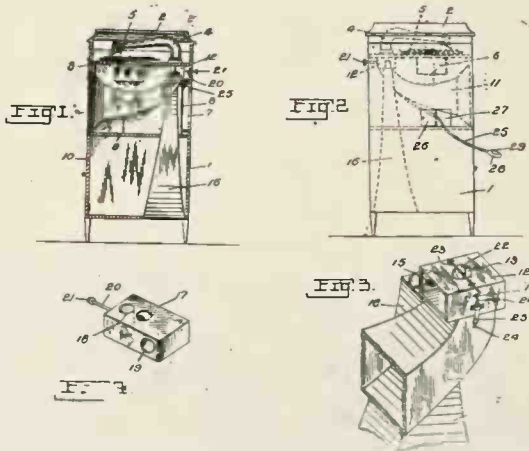

heard directly from the sound amplifier through the usual opening in the front of the machine, or indirectly from the downwardly projecting sound amplifier. It may be noted that there will be a considerable difference in the intensity of the tone. The vibrations coming indirectly will naturally strike the floor, and the consequence will be that of modulating or diminishing the tone, as if it was heard from a distance, without, of course, altering the clearness or limpidity of the tone.

A further object of the invention is to provide a resonant or vibrating member, commonly called "sound board," to increase the resonance as well as to prevent the vibrations from being abruptly interrupted, as often happens in high notes, particularly vocal notes.

In the drawings Figure 1 is a vertical section of the improved talking machine. Fig. 2 is a side elevation of the talking machine, illustrating the device for manipulating the tone controlling means. Fig. 3 is an enlarged perspective view of a portion of the two sound amplifiers and their connecting means. Fig. 4 is an enlarged perspective view of the movable block provided for directing the vibrations from one sound amplifier to the other.

Cover Support. Burr B. Blood, Chicago, Ill., assignor of one-half to Geo. Heidman and one-half to Norman A. Street, same place. Patent No. 1,327,978.

This invention relates more particularly to a support for the cover of a talking machine cabinet and has for its object the provision of a construction which will automatically assume a supporting position when the cover or lid of the cabinet has been raised or tilted.

A further object is to provide a construction which will readily yield to a predetermined amount of pressure on the cover or lid when

it is desired to lower or return the latter to a closed position; the support thereby being moved into a non-supporting position which will not interfere with the cover or lid remaining properly closed.

Another object is to provide a construction whereby the movement or return of the cover or lid to closed position may be caused without the sudden dropping of the cover or lid from a point prior to a complete closing.

Figure 1 is a vertical sectional view of the upper part and lid or cover of a phonograph cabinet with improved cover support shown in elevation and the cover or lid and support shown in full lines in closed position and in dotted lines in raised or open position. Fig.

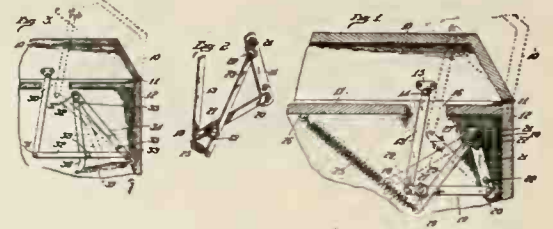

2 is a detail view, in perspective, of the cover support shown in Fig. 1. Fig. 3 is a vertical sectional view of a portion of the upper part of a phonograph cabinet and portion of the lid or cover, provided with a modified form of the cover support, which is shown in side elevation, the cover or lid and support being shown in closed position in full lines and in raised or opened position in dotted lines.

Support. Adolph A. Schaefer, College Point, N. Y. Patent No. 1,329,552.

The present invention has reference to a means for supporting a swinging member angularly with respect to a stationary member to which the said swinging member is hinged, and the object of the invention is to produce an automatic device of this character.

Figure 1 is a view showing the cover of a phonograph supported in accordance with this invention. Fig. 2 is a perspective view of the lever and the elements connected therewith. Fig. 3 is a perspective view of the latch plate. Fig. 4 is a detail view, partly in elevation and partly in section, showing the arrangement of parts when the cover is closed. Fig. 5 is a similar view, showing the arrangement of parts when the lever is passed through the slot in the guide element to bring the directing element on the said lever in contacting engagement with the under face of the latch plate. Fig. 6 is a similar view, showing the arrangement of parts when the lever has been moved by engagement of the guide element thereon to bring the hook on the said lever into the notch in the latch plate. Fig. 7 is a similar view, showing the arrangement of parts when the lever has been

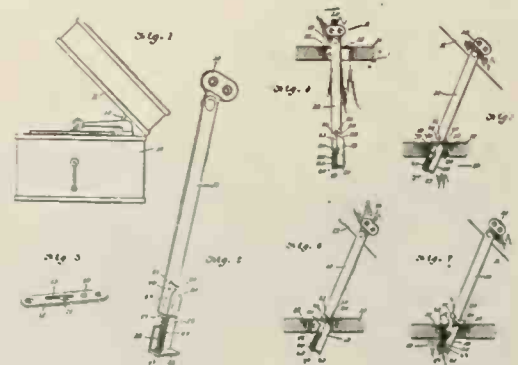

moved to engage with the latch plate to bring the spring dog carried by the lever in alignment with the transverse notch that communicates with the slot in the latch plate, to permit of the cover being brought to closed position.

LESLEY'S PATCHING VARNISH

Dries in 10 seconds, flows without showing the lap. With it damaged varnish can be repaired invisibly. Price now 1 pint \$1; 1 quart \$1.90. Complete repair outfit, \$3.50. F. O. B. Indianapolis, Ind.

LESLEY'S CHEMICAL COMPANY
Indianapolis, Indiana

Advance RECORD BULLETINS for April, 1920

VICTOR TALKING MACHINE CO.

- VOCAL RECORDS
45174 Sweet and Low... Elsie Baker
A Southern Lullaby... Elsie Baker
FIRST RECORD BY A NEW VICTOR ARTIST
45176 Irene (from the Musical Comedy, "Irene")... Edith Day
Alice Blue Gown (from the Musical Comedy, "Irene")... Edith Day
45175 Christ in Flanders... Lambert Murphy
There Is No Death... Lambert Murphy
18652 I'll See You in C-U-B-A... Billy Murray
That's Worth Waiting For... Billy Murray
18653 Buddha... Peerless Quartet
Let Me Dream... Sterling Trio
DANCE RECORDS
18650 In Your Arms—Medley Fox-trot... Selvi's Novelty Orchestra
That Naughty Waltz... Joseph C. Smith's Orchestra
18651 Venetian Moon—Fox-trot (Saxophone, Xylophone, Piano)... All Star Trio
Swanee—One-step... All Star Trio
18654 Bo-La-Bo—Fox-trot... Paul Biese and His Novelty Orchestra
Harem Life—Fox-trot... Paul Biese and His Novelty Orchestra
RED SEAL RECORDS
FRANCES ALDA, Soprano
64859 If You Could Care (from "As You Were")... Wimperis-Darewski
ENRICO CARUSO, Tenor—In Italian
88615 Campana a sera (Ave Maria)... Billi-Malfetti
GERALDINE FARRAR, Soprano—GIUSEPPE DE LUCA, Baritone—In Italian
87568 Zaza—Il Baccio (The Kiss)... Leoncavallo
FLONZALEY QUARTET
(Adolfo Betti, First Violin; Alfred Pochon, Second Violin; Louis Bailly, Viola; Iwan d'Archembeau, Cello.)
74611 Quartet in F Major—Lento ("American" Quartet)... Dvorak
JASCHA HEIFETZ, Violinist
(Pianoforte by André Benoist)
64856 Minuet... Porpora-Kreisler
FRITZ KREISLER, Violinist
64857 Gypsy Serenade (Serenade du Tsigane)... Valdez
JOHN McCORMACK, Tenor
64860 Your Eyes Have Told Me So... Kahn-Van Alstyne-Blaufuss
ERNESTINE SCHUMANN-HEINK, Contralto
87307 In the Sweet Bye and Bye... Bennett-Webster
REINALD WERRENATH, Baritone—In French
74610 Hérodiane—Vision Fugitive (Fleeting Vision)... Massenet
RENATO ZANELLI, Baritone—In Spanish
64858 Los Ojos Negros (Black Eyes)... F. M. Alvarez

COLUMBIA GRAPHOPHONE CO.

- 78846 Barcarolle from "Tales of Hoffmann"—Soprano and Contralto Duet... Rosa and Carmela Ponselle
49611 Rigoletto. Tutte le Feste Al Tempio (As On Festal Days I Went)—Soprano and Baritone Duet... Barrientos and Stracciari
A6140 Orpheus in Hades (Orfee Aux Enfers)—Overture. Part I... Cincinnati Symphony Orchestra
Orpheus in Hades (Orfee Aux Enfers)—Overture. Part II... Cincinnati Symphony Orchestra
A2875 Mah Lindy Lou—Baritone Solo... Oscar Seagle
Sorter Miss You—Baritone Solo... Oscar Seagle
POPULAR SONGS
(See Mid-month List for Other Popular Hits)
A2852 Oh! How I Laugh When I Think That I Cried Over You—Comedienne... Nora Bayes
Snoops, the Lawyer—Comedienne... Nora Bayes
A6142—Vocal Gems From "Buddies"... Columbia Light Opera Company
Intro.: 1. My Buddies. 2. Please Learn to Love. 3. Darling I. 4. To Be Together Is the Thing. 5. Twilight. 6. Hullo, Home! Vocal Gems From "Irene"... Columbia Light Opera Company
Intro.: 1. The Last Part of Ev'ry Party. 2. Alice Blue Gown. 3. Irene. 4. Castle of Dreams. 5. Sky Rocket.
A2865 Why Did You Do It?—Tenor Solo, Jack Kaufman
Oh! Mother, I'm Wild—Tenor Solo, Jack Kaufman
A2867 Some Day You'll Know—Tenor Solo, Henry Burr
Down In My Heart—Tenor Solo, Chas. Harrison
A2866 Comrades—Tenor Duet... Campbell and Burr
Sweethearts—Soprano and Tenor Duet, Gladys Rice and Chas. Harrison
NOVELTY RECORDS
E4506 Chinese One-step. Part 1... Chinese Orchestra
Chinese One-step. Part 2... Chinese Orchestra
A2860 Bird Calls—An Evening in Birdland. Bird imitations by Edward Avis (Robin, Veery, Wood Thrush, Cricket, Whip-poor-will.) Bird Calls—Birdland Melodies. Bird imitations by Edward Avis (Baltimore Oriole, Cardinal Grossbeak, Rose-breasted Grossbeak, Robin, Brown Thrasher, Carolina Wren.)
A2856 Hawaiian Hours With You—Waltz—Hawaiian Guitar Duet... Carl Seville and Jack Geddes
Cinderella—Fox-trot—Hawaiian Guitar Duet, Carl Seville and Jack Geddes
FAVORITE REVIVAL HYMNS
A2873 When the Roll Is Called Up Yonder, Earl F. Wilde, Evangelist
Softly and Tenderly... Earl F. Wilde, Evangelist
A2854 Uncle Josh in a Cafeteria, Cal Stewart (Uncle Josh) Comedian
Uncle Josh and the Sailor, Cal Stewart (Uncle Josh) Comedian
A2859 Back Home on the Farm—Recitation, Golden and Hughes
Fishing and Drinking... Golden and Hughes
A2855 A Cat-Astrophe... Columbia Orchestra
Slim Trombone... Columbia Band

- A2853 Hear Dem Bells, Harry C. Browne and Peerless Quartet 10
Baritone Solo and Male Quartet. Orchestra
Banjo Accompaniment.
Keemo Kimo,
Harry C. Browne and Peerless Quartet 10
Baritone Solo and Male Quartet. Orchestra
Banjo Accompaniment.
DANCE RECORDS
(See Mid-month List for Other Dances.)
A6139 My Isle of Golden Dreams—Medley Waltz, Columbia Orchestra 12
Intro.: Your Eyes Have Told Me So.
The Naughty Waltz—Medley Waltz, Columbia Orchestra 12
Intro.: Golden Hours. Incidental Chorus by Campbell and Burr.
A2858 Cairo—One-Step... Art Hickman's Orchestra 10
Rose Room—Fox-trot... Art Hickman's Orchestra 10
A2874 Apple Blossoms, Waltz, Prince's Dance Orchestra 10
Intro.: 1. You Are Free. 2. Brothers. Old Fashioned Garden—Medley One-step, Prince's Dance Orchestra 10
Intro.: Peter Piper from "Hitchy-Koo 1919."
The Mid-Month Records
A2861 Chloe... Al Jolson 10
Was There Ever a Pal Like You... Henry Burr 10
A6141 Elder Eatmore's Sermon on Throwing Stones, Bert Williams, Comedian 12
Elder Eatmore's Sermon on Generosity, Bert Williams, Comedian 12
POPULAR SONGS
A2862 You're a Million Miles From Nowhere When You're One Little Mile From Home, Fred Hughes, Tenor 10
Once Upon A Time from "The Magic Melody," Fred Hughes, Tenor 10
A2863 All That I Want Is You... Henry Burr, Tenor 10
When the Harvest Moon Is Shining, Lewis James, Tenor 10
78686 Dear Little Boy of Mine, Riccardo Stracciari, Baritone 10
DANCE RECORDS
A2857 Wond'ring—Fox-trot... Ted Lewis Jazz Band 10
You Can't Get Lovin' Where There Ain't Any Love—Medley Fox-trot, Louisiana Five Jazz Orchestra 10
Intro.: Tip-Tip Tippy Canoe. Incidental Chorus by Billy Murray.
A2864 Just Like the Rose—Fox-trot... Paul Biese Trio 10
Intro.: In Siam. Saxophone, Banjo and Piano Trio.
When You're Alone—Fox-trot... Paul Biese Trio 10
Intro.: The Great American. Saxophone, Banjo and Piano Trio.

AEOLIAN CO.

- STANDARD SELECTIONS
30100 Values (Vanderpool). Soprano, Vocalion orch. accomp... Florence Easton 10
24003 Annie Laurie (Scott). Duet, Vocalion orch. accomp... Sara and Nellie Kouns 10
The Kiss (Arditi). Soprano, Vocalion orch. accomp... Nellie Kouns 10
14032 Ma Little Sunflower, Good-night (Vanderpool). Baritone, Vocalion orch. accomp... James Stanley 10
Sunrise and You (Penn). Baritone, Vocalion orch. accomp... James Stanley 10
SACRED SELECTIONS
14033 Brighten the Corner Where You Are (Gabriel). Baritone, Vocalion orch. accomp... Homer Rodeheaver 10
I'm Coming Home, Mother's Prayers Have Followed Me (deArmond-Ackley). Baritone, Vocalion orch. accomp... Homer Rodeheaver 10
INSTRUMENTAL SELECTIONS
14034 A May Morning (Denza). Violin, Cello and Piano... Played by Adler's Trio 10
A Madrigal of May—from "The Jest" (Maurice Mitke). Violin, Cello and Piano, Played by Adler's Trio 10
POPULAR SELECTIONS
14035 When My Baby Smiles at Me (Munro-Klapholz). Orch. accomp... Billy Murray and Rachel Grant 10
I'll See You in C-U-B-A (Berlin). Orch. accomp... Billy Murray 10
14036 I'm Always Falling in Love With the Other Fellow's Girl (Myer & Millinger). Orch. accomp... Samuel Ash 10
By the Honeysuckle Vine (deSilva-Jolson). Orch. accomp... Ernest Hare 10
14037 Daddy You've Been a Mother to Me (Fisher). Orch. accomp... Henry Burr 10
14037 Rose of Virginia (Caddigan & Storey). Orch. accomp... Burr and Meyers 10
14038 All the Boys Love Mary (Gus Van and Joe Schenck). Orch. accomp... Billy Murray 10
Oh Mother, I'm Wild (Jones). Orch. accomp... Billy Jones 10
NOVELTY SELECTIONS
14039 Cohen Talks About the Ladies (Silver). Monroe Silver 10
Abraham (Gottler). Orch. accomp... Monroe Silver 10
14040 Afghanistan—Asiatic Fox-trot (Willander & Donnelly)... Played by All Star Trio 10
Hold Me—Fox-trot (Hickman-Black). Played by All Star Trio 10
14041 Oh By Jingo—One-step (Von Tilzer). Played by Harry A. Kerkes' Dance Orchestra 10
Shake Your Little Shoulder—Intro. Dixieland is Happyland—Fox-trot (Rosemont). Played by Harry A. Yerkes' Dance Orchestra 10
April Mid-Month List
POPULAR SELECTIONS
14042 Alice Blue Gown, from "Irene O'Dare" (Tierney). Orch. accomp... Marion Evelyn Cox 10
Someone Like You, from "Angel Face" (Herbert). Orch. accomp... Nanette Flack 10
14043 What a Day That'll Be (Jess Feiber). Orch. accomp... Ernest Hare 10
Oh How I Laugh When I Think How I Cried About You (Turk-Jessel and White). Orch. accomp... Billy Jones 10
14044 Ching-a-ling Jazz Bazaar (Bridges). Orch. accomp... Shannon Four 10
Hawaiian Love (Terriss & Bridges). Orch. accomp... Charles Hart and Elliot Shaw 10

- 14054 She's Just Like Sal (Schuster). Orch. accomp... Sterling Trio 10
Oh My Lady (Perkins). Orch. accomp... Sterling Trio 10
DANCE SELECTIONS
14046 Somebody (Little-Stanley-Delton)—One-step, Murray's Melody Men 10
I Like to Do It—Fox-trot (Byron Gay), Murray's Melody Men 10
14047 Railroad Blues (Roberts)—Fox-trot Novelty Five 10
14047 Good-Night Boat, from "The Night Boat" (Kerr), Fox-trot... Novelty Five 10

EDISON RE-CREATIONS

- 83076 Last Rose of Summer—Martha (Von Flotow). Soprano... Marie Rappold
O, Divine Redeemer! (Gounod). Soprano, Marie Rappold
83086 Jean (Spross) and Robin, Robin Sing Me a Song (Spross). Soprano... Anna Case
Lithuanian Song (Chopin). Soprano... Anna Case
82180 O mio Fernando (Oh! My Fernando)—La Favorita (Donizetti). Contralto, in Italian, Cyrena Van Gordon
Stride la vampa (Fierce Flames Are Soaring)—Il Trovatore (Verdi). Contralto, in Italian, Cyrena Van Gordon
82183 Funiculi-Funiculà (Denza). Tenor and Chorus, in Italian... Guido Ciccolini and Chorus
In questo suolo (In This Bower of Roses)—La Favorita (Donizetti). Contralto and Baritone, in Italian, Carolina Lazzari and Mario Laurenti
82184 Drink to Me Only With Thine Eyes (Old English Air, Arr. by Quilter). Violin, Albert Spalding
Sérénade (Pierné). Violin... Albert Spalding
82185 He Giveth His Beloved Sleep (Abt). Bass-Baritone... Arthur Middleton
Tell Me the Old, Old Story (Doane). Bass-Baritone... Arthur Middleton
80400 Blackbird's Song (Scott); and Songs My Mother Taught Me (Dvorak). Soprano... Stella Power
Una voce poco fá (A Little Voice I Hear)—Il Barbiere di Siviglia (Rossini). Soprano, in Italian... Stella Power
80429 Anitra's Dance—Peer Gynt Suite, No. 1 (Grieg); and At the Brook (De Boisdeffre). Violin, Violoncello and Piano... Cherniavsky Trio
Spring Song (Mendelssohn). Violin, Violoncello and Piano... Cherniavsky Trio
80516 Echo (Köhler). Flute and Cornet, Weyert A. Moor and Pietro Capodiferro
Nocturne (Tschaikowsky). Violoncello, Vladimir Dubinsky
80517 Beyond the Smiling and the Weeping (Stebbins). Tenor and Baritone... Charles Hart and Elliott Shaw
Favorite Hymns of Fanny Crosby, No. 1, Mixed Voices... Calvary Choir
80518 Saul Overture, Part 1 (Bazzini), American Symphony Orchestra
Saul Overture, Part 2 (Bazzini), American Symphony Orchestra
50417 Three Bears (Brooks). A Bed-Time Story, Edna Bailey
Three Billy Goats "Gruff." A Bed-Time Story, Edna Bailey
50630 Blacksmith and the Bird (Belmont). Whistling, Joe Belmont
I'm Dreaming of You (Barton). Yodel, Ward Barton
50631 I Love to Be a Sailor (H. Lauder)... Glen Ellison
We'll All Go Home the Same Way (H. Lauder), Glen Ellison
50632 Rainy Day Blues—Fox-trot (Wassauer), Yerkes Saxophone Sextet
Who Wants a Baby?—Fox-trot (Introducing "I'm Waiting For Ships That Never Come In") (Olman)... Lenzberg's Riverside Orchestra
50633 Home That's In My Memory (Stonaker). Tenor, Lewis James
In the Shadow of the Pines (Lang). Tenor and Baritone... Charles Hart and Elliott Shaw
50634 A Bullfrog Am No Nightingale (Ethiopian Oddity) (Schleiffarth). Bass, Ernest Hare and Male Chorus
He Went in Like a Lion and Came Out Like a Lamb (H. Von Tilzer)... Al Bernard
"DARDANELLA" SPECIAL RE-CREATIONS
50626 Molly Malone (My Own)—Passing Show of 1919 (Schonberg). Tenor... Charles Hart
Nobody Knows (And Nobody Seems to Care) (Berlin). Contralto... Louise Terrell
50637 Dardanella—Fox-trot (Bernard-Black) for Dancing... Harry Raderman's Jazz Orchestra
Make That Trombone Laugh—Fox-trot (Scharf), for Dancing... Harry Raderman's Jazz Orchestra
50638 Sahara (We'll Soon Be Dry Like You) (Schwartz)... Billy Murray
You'd Be Surprised (Berlin)... Billy Murray
50639 Little Girls, Good-Bye—Apple Blossoms (Jacobi). Tenor... Lewis James and Chorus of Men
You Are Free—Apple Blossoms (Jacobi). Soprano and Tenor, Betsy Lane Shepherd and Lewis James

EDISON AMBEROL RECORDS

- ROYAL PURPLE RECORDS
29048 O, Divine Redeemer! (Gounod). Soprano, Marie Rappold
29049 Vien Leonora (Leonora, Spurn Not My Love)—La Favorita (Donizetti). Baritone, in Italian... Taurino Parvis
REGULAR LIST
3944 Who Wants a Baby? Fox-trot (Intro. "I'm Waiting for Ships That Never Come In") (Olman)... Lenzberg's Riverside Orchestra
3945 Molly Malone (My Own), Passing Show of 1919 (Schonberg). Tenor, orb. accomp... Charles Hart
3946 Backyard Conversation Between Mrs. Reilly and Mrs. Finnegan... Ada Jones and Steve Porter
3947 Lisztiana March (Chiaffarelli)... Conway's Band
3948 Shall We Meet? (Rice). Baritone and tenor, Vernon Archibald and Lewis James
3949 Chasin' the Blues (Piantadosi)... Al Bernard
3950 Sweet and Low. Waltz (Intro. "Lonesome—That's All")... Tuxedo Dance Orchestra
3951 Nightingale Song (Wilson). Yodel song, Frank M. Kamplain
(Continued on page 240)

ADVANCE RECORD BULLETINS FOR APRIL—(Continued from page 239)

- 3952 Lucille. Fox-trot (Wadsworth-Arden). Saxophone, xylophone and piano, for dancing. All Star Trio
3953 Sahara (We'll Soon Be Dry Like You) (Schwartz) Billy Murray
3954 Pretty Little Rainbow. Waltz (Plunkett). Lenzberg's Riverside Orchestra
3955 Let the Rest of the World Go By (Ball). Contralto and tenor. Marion Evelyn Cox and Harvey Hindermeyer
3956 Leaf By Leaf the Roses Fall (Bishop). Baritone and tenor. Vernon Archibald and Lewis James
3957 A Matrimonial Mixup. Negro sketch. Billy Golden and Joe Hughes
3958 Little Girls, Good Bye—Apple Blossoms (Jacobi). Tenor. Lewis James and Chorus of Men
3959 The Mighty Deep (Jude). Bass. Wilfred Glenn
3960 Linger Longer, Letty (Goodman). Contralto and baritone. Helen Clark and Joseph Phillips
3961 It's the Smart Little Feller Who Stocked Up His Cellar That's Getting the Beautiful Girls (Ager). Maurice Burkhardt
3962 Dixie Lullaby (Dixon). Soprano, mezzo-soprano and contralto. Homestead Trio
3963 Sunny Weather Friends (Kendis-Brockman). Tenor. Harvey Hindermeyer
3964 You'd Be Surprised (Berlin). Billy Murray
3965 Dardanella. Fox-trot (Bernard-Black) for dancing. Harry Raderman's Jazz Orchestra
3966 Make That Trombone Laugh. Fox-trot (Scharf) for dancing. Harry Raderman's Jazz Orchestra
FRENCH RECORDS
27190 Demain qui n'est jamais venu (To-morrow Never Comes) (Popy-Piccolini). Baritone. Hector Pellerin
27191 J'aime une Brune (Christine). Baritone. Hector Pellerin

PATHE FRERES PHONOGRAPH CO.

POPULAR SUPPLEMENT NO. 31

- VOCAL
22301 Pickaninny Blues (Frost-Klickman). Tenor. Lewis James
Brazilian Chimes (Kendis-Brockman-Hager). Orpheus Trio
22302 When My Baby Smiles (Berlin). Baritone. Ernest Hare
The Irish Were Egyptians Long Ago (Bryan-Smith). Tenor. Billy Murray
22303 Was There Ever A Pal Like You (Berlin). Tenor. Henry Burr
Alice Blue Gown. from "Irene" (McCarthy-Tierney). Contralto. Marion Evelyn Cox
22304 That Wonderful Kid From Madrid (MacDonald-Osborn). Soprano. Patricola
I'll Dance My Way Back To Dixieland (Clarke-Baskette). Soprano. Patricola
22305 You're A Million Miles From Nowhere (Lewis-Young-Donaldson). Tenor. Sam Ash
When The Harvest Moon Is Shining (Sterling-Von Tilzer). Tenor Duet. Lewis James and Charles Hart
22307 I Am Waiting For To-morrow To Come (Davis-Hawelka-Privat). Tenor. Edward Kane
Everyone Is Meant For Someone (Kalmar-Ruby-Rubini-Santaella). Tenor Duet. Campbell and Burr
22318 I Never Knew I Had A Wonderful Wife (Until The Town Went Dry) (Brown-Von Tilzer). Tenor. Eddie Cantor
When It Comes To Loving The Girls I'm Ahead Ahead Of The Times (Kissen-Burns-Glogau). Tenor. Eddie Cantor
22319 You Said It (Kalmar-Cox-Santley). Baritone. Ernest Hare
Oh, Mother, I'm Wild (Johnson-Pease-Nelson). Tenor. Billy Jones
22322 I'll See You In C-U-B-A (Berlin). Tenor. Billy Murray
Oh! How I Laugh When I Think How I Cried About You (Turk-Jessel-White). Tenor. Billy Jones
DANCE
22308 Linger Longer Letty, from "Linger Longer Letty" (Goodman). Medley Fox-trot, introducing "Climbing The Ladder Of Love." Tuxedo Syncopaters
In And Out (Samuels). One-step. Tuxedo Syncopaters
22309 Irene O'Dare, from "Irene" (Tierney). Medley Fox-trot, introducing "The Last Part Of The Party." Joseph Samuels' Orchestra
That Naughty Waltz (Levy). Waltz. Joseph Samuels' Orchestra
22310 Little Girls, Good-Bye, from "Apple Blossoms" (Jacobi). One-step. Jacobs' Dance Orchestra
What a Day That'll Be (Ferber). Medley Fox-trot, introducing "You Cannot Make Your Shimmy Shake On Tea." Jacobs' Dance Orchestra
22299 Who Wants A Baby (Yellen-Olman). Medley Fox-trot, introducing "I'm Waiting For Ships That Never Come In." Rudy Wiedoeft's Californians
Blues My Naughty Sweetie Gives To Me (McCarron-Morgan). Medley. Rudy Wiedoeft's Californians.
22320 Afghanistan (Wilander-Donnelly). Fox-trot. Tuxedo Syncopaters
When My Baby Smiles At Me (Munro). Fox-trot. Tuxedo Syncopaters
22323 Alexandria, from "Aphrodite" (Goetzl). Fox-trot. Nicholas Orlando's Orchestra
When You're Alone (Spencer-West). Fox-trot. Nicholas Orlando's Orchestra
22300 Under The Honeymoon (Hanley-King-Pinkard). Medley Fox-trot, introducing "Wonderful Pal." The Saxo-Piano Phields
In The Land of Rice and Tea (Straight-Biese). Fox-trot. The Saxo-Piano Phields
HAWAIIAN
22293 In Shadowland (Stanley Bros.) (H. J. Clarke-Steele Guitar). Royal Waikiki Hawaiian Orchestra
Rings (Sullivan-Handman). (H. J. Clarke-Steele Guitar). Royal Waikiki Hawaiian Orchestra
REGULAR APRIL PATHE LIST
OPERATIC VOCAL RECORDS
5402 Gianni Schicchi (Forzano-Puccini) "O Mio Babino Caro" (Oh My Beloved Baby). In Italian. Soprano. Claudia Muzio
60082 La Procession (Franck) In French. Soprano. Yvonne Gall
Manon (Massenet) "Gavotte." Soprano and Chorus. Yvonne Gall
60083 The Pearl Fishers (Bizet) "Del Tempio al limiar" (In The Depths Of The Temple). Charles Fontaine, Tenor; Jean Note, Baritone
William Tell (Rossini) "Ah, Mathilde io t'amo e amore" (I Love Thee, Mathilde). Charles Fontaine, Tenor; Jean Note, Baritone

- NEW BAND AND ORCHESTRA RECORDS
40195 Dance Macabre (St. Saens). Pathé Military Band of France
Pomp And Circumstance (Elgar). Pathé Military Band of France
40196 Lohengrin (Wagner) "Introduction To Act III." Versailles Military Band
Lohengrin (Wagner) "Bridal Chorus." Versailles Military Band
22274 The Merry Wives Of Windsor (Nicolai) Overture, Part 1. National Symphony Orchestra
The Merry Wives Of Windsor (Nicolai) Overture, Part 2. National Symphony Orchestra
22275 La Gitana (Bucalossi) Waltz. Native Brazilian Orchestra
Estudiantina (Waldteufel) Waltz. Native Brazilian Orchestra
STANDARD SONGS SUNG IN ENGLISH
59085 Home To You Ireland (Hewitt). Mezzo-Soprano. Eleonora de Cisneros
Kathleen Mavourneen (Crouch). Mezzo-Soprano. Eleonora de Cisneros
25038 Macushla (Rowe-MacMurrough). Tenor. Ernest Davis
My Wild Irish Rose (Olcott). Tenor. Ernest Davis
22251 Carry Me Back To Old Virginny (J. Bland). Rosalie Miller, Soprano and Shannon Four Male Quartet
Ben Bolt (Kneass). Soprano. Rosalie Miller
Life's Paradise (Mary Brown). Contralto. Alma Beck
Night Is For Loving And Dreaming (Tate). Contralto. Alma Beck
22272 Little Tommy Went Fishing (Macy). Victory Four, Male Quartet
A Catastrophe (Sheldon-Sprague). Victory Four, Male Quartet
NEW INSTRUMENTAL RECORDS
59086 Etude In F Sharp Major (Arensky) and Shadow Dance (MacDowell). Piano Solo. Mme. Ethel Leginska
Winter Wind Etude, Op. 25 (Chopin). Piano Solo. Mme. Ethel Leginska
22276 Chromatic Fox-trot (Green). Nylophone Solo. George H. Green
Stop Time (Green). Nylophone Solo. George H. Green
22277 Mighty Lak' a Rose (Nevin). Violin, Flute and Piano. The Longo Trio
Somewhere a Voice Is Calling (Tate). Violin, Flute and Piano. The Longo Trio
27516 Smilin' Through (Penn). Violin Solo. Jacques Thibaud
Roses of Picardy (Weatherly-Wood). Violin Solo. Jacques Thibaud
22278 I Left My Door Open And My Daddy Walked Out (Irving Berlin). Intro. "Nobody Knows and Nobody Seems to Care." Medley Fox-trot, Piano Duet and Saxophone. Saxo-Piano Phields
Oh! (Gay-Johnson-Bridges). Intro. "Just Like the Rose." Piano Duet and Saxophone. Saxo-Piano Phields
ENCHANTING MUSIC BY THE HAWAIIANS
22271 Rainbow Land (Frost-Klickman). Royal Waikiki Hawaiian Orchestra
Just Like the Rose (Cool-Terriss-Bridges). Vocal Refrain by Robert Bruce). Royal Waikiki Hawaiian Orchestra

OKEH RECORDS

- 4069 Freckles (Cliff Hess-Milton Ager)—Fox-trot, inst. Paul Biese and His Novelty Orch.
Please (Lee S. Roberts)—Fox-trot, inst. Paul Biese and His Novelty Orch.
4070 Mystery (Joseph Cirina)—Fox-trot, inst. Paul Biese and His Novelty Orch.
Meet Me in Bubble Land (Isham Jones)—Waltz, inst. Paul Biese and His Novelty Orch.
4071 Tents of Arabs (Lee David)—One-step, inst. Conway's Band
Nobody Ever (Hugo Frey)—Fox-trot, inst. Conway's Band
4072 Hot Foot (M. L. Lake)—One-step, inst. Nylophone solo with Conway's Band. George H. Green
Don't You Remember Those School Days? (Raymond Hubbel)—One-step, inst. All Star Trio
4073 Only (I. Caesar-Harry L. Akst). Tenor, with Orch. accomp. Sam Ash
Sweet and Low (James S. Royce-Charles I. Johnson). Vocal Trio with Orch. accomp. Crescent Trio
4074 For Ev'ry Door That Closes (Another Will Open for You) (Kendis-Brockman). Tenor with Orch. accomp. Reed Miller
I Love You Just the Same (Sweet Adeline) (Gaskill-Armstrong). Vocal Quartet with Orch. accomp. Peerless Quartet
4075 Lend Me Jim (Watson Sisters). Contralto duet, with Orch. accomp. Watson Sisters
Never Let No One Man Worry Your Mind (Will E. Skidmore-Jack Baxley). Contralto with Orch. accomp. Fannie Watson
4076 Lullaby Blues (In the Evening) (M. M. Kendall-J. R. Robinson-T. Morse). Vocal Trio, with Orch. accomp. Crescent Trio
Just for Me and Mary ("Twas a Beautiful Wedding Day) (Clarke-Rogers-Edwards). Vocal Trio, with Orch. accomp. Sterling Trio
4077 Mother Machree (Young-Olcott-Ball). Tenor, with Orch. accomp. William Robyn
Bells of St. Mary's (Furber-Adams). Baritone, with Orch. accomp. Joseph Phillips
4078 Swanee (Geo. Gershwin)—One-step, inst. Green Bros.' Nylophone' Orch.
Blues (My Naughty Sweetie Gives To Me) (Swanstone-McCarron-Morgan). Fox-trot, inst. Harry Raderman's Jazz Orch.

EMERSON PHONOGRAPH CO.

- MARCH-APRIL
STANDARD 10-INCH GOLD SEAL
LATEST DANCE HITS
10121 Dardanella (Bernard-Black). Fox-trot. Sanford's Famous Dance Orchestra
O (Oh!) (Gay-Johnson-Bridges). Intro. "Just Like the Rose." Medley Fox-trot. The Imperial Three
10131 Dardanella (Bernard-Black). Fox-trot. Plantation Jazz Orchestra
Make the Trombone Laugh (Henry Scharf). Fox-trot. Plantation Jazz Orchestra
10120 Nobody Knows (Irving Berlin). Intro. "I Left My Door Open and My Daddy Walked Out." Medley Fox-trot. The Imperial Three
You'd Be Surprised (Irving Berlin). Fox-trot. Emerson Military Band

- 10117 That Naughty Waltz (Sol. B. Levy). Waltz. G. H. Greene's Novelty Orchestra
Little Blue Devil (Harry Carroll). Intro. "I'm So Sympathetic" and "Peter Pan." Medley Fox-trot. G. H. Greene's Novelty Orchestra
10128 Tumble In (Schwartz-Byers-Schonberg). Intro. "Molly Malone" from "Passing Show of 1919." Medley Fox-trot. Emerson Military Band
Irene (Tierney-McCarthy). Intro. "Skyrocket" from musical production "Irene." Medley Fox-trot. Emerson Military Band
10122 Chromatic Fox-trot (Geo. H. Green). Fox-trot, xylophone solo, orch. accomp. G. H. Green
Mid the Pyramids (Clarence M. Jones). Fox-trot. The Imperial Five
10116 Weary Blues (Artie Matthews). Fox-trot. Louisiana Five
Down Where the Rajahs Dwell (Lada-Skidmore). Fox-trot. Louisiana Five
10118 The Vamp (Byron Gay). Fox-trot with words. Emerson Military Band
Oh! What a Pal Was Mary (Pete Wendling). Waltz with words. Emerson Dance Orchestra
POPULAR SONG HITS
10130 Dardanella (Fisher-Bernard-Black). Oriental hallad, orch. accomp. Artbur Fields
I Never Knew (Irving Berlin-Elsie Janis). Baritone solo, orch. accomp. Arthur Fields
10119 Come On and Play Wiz Me, My Sweet Babe (Ruby-Kalmar-Leslie). Comedy solo, orch. accomp. Eddie Cantor
All the Boys Love Mary (Sterling-Van-Schenck). Comedy Song, orch. accomp. Eddie Cantor
10126 Patches (Callahan-Roberts). Baritone solo, orch. accomp. Artbur Fields
Why Did You Do It To Me, Babe? (Sterling-Von Tilzer). Comedy song, orch. accomp. Jack Kaufman
10115 Just Like the Rose (Cook-Terriss-Bridges). Tenor solo, orch. accomp. Edward Hamilton
Let the Rest of the World Go By (Brennan-Ball). Tenor and baritone duet, orch. accomp. Charles Hart and Elliott Shaw
10113 Bye-Lo (Ray Perkins). Male Trio, Orch. accomp. Sterling Trio
I Sing of You (Walker-Lamont). Tenor solo, orch. accomp. Edward Hamilton
10129 I've Found the Nesting Place of the Blue Bird (Yellen-Olman). Male Trio, orch. accomp. Sterling Trio
It's a Small World After All (Sterling-Von Tilzer). Tenor solo, orch. accomp. Walter Scanlan
10114 Bless My Swanee River Home (Lewis-Young-Donaldson). Baritone solo, Orch. accomp. Arthur Fields
Good Night, Dearie (Warren-Henry-Onivas). Tenor solo, orch. accomp. Walter Scanlan
10132 My Isle of Golden Dreams" (Kahn-Blaufuss). Male Trio, Orch. accomp. Sterling Trio
Bubbling Over (Life Is Bubbling Over All the Time) (John William Kelleter). Tenor solo, orch. accomp. Reed Miller

OPERAPHONE CO., INC.

POPULAR VOCAL

- 21151 I'll See You In C-U-B-A (Berlin). Tenor, orch. accomp. Billy Murray
Oh, Mother, I'm Wild (Johnson-Pease-Nelson). Tenor, orch. accomp. Bertram Smith
21152 You Said It (Kalmar-Cox-Stanley). Baritone, orch. accomp. Ernest Hare
Oh! How I Laugh When I Think How I Cried About You (Turk-Jessel-White). Tenor, orch. accomp. Bertram Smith
21153 Everyone Is Meant For Someone (Kalmar-Ruby-Rubini-Santaella). Tenor Duet, orch. accomp. Campbell and Burr
Pickaninny Blues (Frost-Klickman). Tenor, orch. accomp. Lewis James
21154 Was There Ever a Pal Like You? (Berlin). Tenor, orch. accomp. Henry Burr
When The Harvest Moon Is Shining (Sterling-Von Tilzer). Tenor Duet, orch. accomp. Lewis James and Charles Hart
21155 Mystery! (Johnson-Cirina). Soprano, orch. accomp. Jane O'Day
I'm Always Falling In Love With the Other Fellow's Girl (Caesar-Meyer). Tenor, orch. accomp. Sam Ash

DANCE

- 31135 On the Streets of Cairo (Dance Egyptienne) (Hulten). Fox-trot. Operaphone Dance Orchestra
Alexandria, from "Aphrodite" (Goetzl). Fox-trot. Operaphone Dance Orchestra
31136 Little Girls, Goodbye, from "Apple Blossoms" (Jacobi). One-step. Farrell's Dance Orchestra
Ole Miss Blues (Handy). Fox-trot. Jones's Novelty Dance Orchestra
31137 Good-Night Dearie (Henry-Onivas). Waltz. Farrell's Dance Orchestra
Swanee (Gershwin). One-step. Farrell's Dance Orchestra

STANDARD VOCAL

- 41108 O Sole Mio! (Capurro-Di Capua). Tenor, Neapolitan Orchestra accomp. Marion Castello
Sleep Baby, Sleep (Hadley). Yodling, orch. accomp. William MacDonnell

INSTRUMENTAL

- 51128 Golden Sunset (Hall). Waltz, accordion duet. Rosconi Brothers
Faust Waltz (Gounod). Accordion duet. Rosconi Brothers
51129 Somewhere a Voice Is Calling (Tate). Violin, flute and piano. Mendelssohn Trio
Cavalleria Rusticana "Intermezzo" (Mascagni). Violin solo. Alice Raymond
51130 Flags of Freedom (Souza). March. Military Band
Army Bugle Calls and the Star-Spangled Banner (Key). With Military Band

EMPIRE TALKING MACHINE CO.

POPULAR SONGS

- 407 Wonderful Pal. (Tracey-Pinkard)—Tenor, Orch. accomp. Lewis James
Just For Me and Mary (Clark-Rogers-Edwards)—Tenor duet, Orch. accomp. Lewis James and Charles Hart
408 Fast Asleep in Poppyland (Gay)—Orch. accomp. Peerless Quartet
Swanee Shore (Mitchell-Fields-Kaufman)—Tenor, Orch. accomp. Henry Burr
409 I Might Be Your Once-in-a-While (Smith-Herbert)—Baritone, Orch. accomp. Arthur Fields
A Pretty Girl Is Like a Melody (Irving Berlin)—Tenor, Orch. accomp. Sam Ash
412 Dardanella (Fisher-Bernard-Black)—Tenor duet, Orch. accomp. Campbell and Burr
I Never Knew (Janis-Berlin)—Tenor, Orch. accomp. Harry McClaskey

Some Leading Jobbers of Talking Machines in America

1856 **WURLITZER** 1916

VICTOR
DISTRIBUTORS
VICTORS EXCLUSIVELY

We make a specialty of getting the order out on time—every time.

The Rudolph Wurlitzer Co.
CINCINNATI AND CHICAGO

Two points of supply; order from the nearer

TEST IT. 

OUR VICTOR

Record Service

has a reputation for efficiency.
Suppose you try it.

E. F. DROOP & SONS CO.
1300 G. STREET, WASHINGTON, D. C.
231 N. HOWARD STREET, BALTIMORE, MD.



WM. H. REYNALDS
DISTRIBUTORS OF
Victrolas and Victor Records
MOBILE, ALA.



Where Dealers May Secure

COLUMBIA

Product

Ready, Full Stocks, and Prompt Deliveries
from Convenient Shipping Centers
all over the United States.

Distributors

Atlanta, Ga., Columbla Graphophone Co., 63 N Pryor St.
Baltimore, Md., Columbla Graphophone Co., 16 South Howard St.
Boston, Columbla Graphophone Co., 137 Federal St.
Buffalo, N. Y., Columbia Graphophone Co., 733-35-37 Main St.
Chicago, Ill., Columbla Graphophone Co., 14 N Michigan Ave.
Cincinnati, O., Columbla Graphophone Co., 427-429 W. Fourth Ave.
Cleveland, O., Columbla Graphophone Co., 1378 Euclid Ave.
Dallas, Tex., Columbla Graphophone Co., 1011 Elm St.
Denver, Colo., Columbla Stores Co., 1608 Glenarm Place.
Detroit, Mich., Columbla Graphophone Co., 401 Woodward Ave.
Indianapolis, Ind., Columbla Graphophone Co., 207-217 W. Washington St.
Kansas City, Mo., Columbla Graphophone Co., 1017 McGee St.
Los Angeles, Cal., Columbla Graphophone Co., 745 S. Broadway.
Minneapolis, Minn., Columbla Graphophone Co., 412-414 Nicollet Ave.
New Haven, Conn., Columbla Graphophone Co., 206 Meadow St.
New Orleans, La., Columbla Graphophone Co., 517-525 Canal St.
New York City, Columbla Graphophone Co., 55 Warren St.
Omaha, Neb., Schmoller & Mueller Piano Co., 1311 Farnum St.
Philadelphia, Pa., Columbla Graphophone Co., 210 N. Broad St.
Pittsburgh, Columbla Graphophone Co., 632-640 Duquesne Way.
Portland, Me., Columbla Graphophone Co., 43 Exchange St.
Salt Lake City, Utah, Columbla Stores Co., 221 South West Temple.
San Francisco, Cal., Columbla Graphophone Co., 130-150 Sutter St.
Seattle, Wash., Columbla Graphophone Co., 911 Western Ave.
Spokane, Wash., Columbla Stores Co., 161 South St.
St. Louis, Mo., Columbla Graphophone Co., 1127 Pine St.
Tampa, Fla., Tampa Hardware Co.

Headquarters for Canada:
Columbia Graphophone Co., 54-56 Wellington St., West, Toronto Ont.

Executive Office
COLUMBIA GRAPHOPHONE CO.
Woolworth Building New York

W. J. DYER & BRO.
DYER B'LD'G, ST. PAUL, MINN.
NORTHWESTERN DISTRIBUTORS
OF THE

VICTOR
Machines, Records and Supplies

Shipped Promptly to all
Points in the Northwest

RECORD BULLETINS FOR APRIL
(Continued from page 240)

413 Hand in Hand Again (Egan-Whiting)—Tenor duct, Orch. accomp. Lewis James and Charles Hart
We Must Have a Song to Remember (Green-Stept). Orch. accomp. Peerless Quartet

414 I Love You Just the Same, Sweet Adeline (Armstrong-Gaskill)—Tenor duct, Orch. accomp. Campbell and Burr
Let the Rest of the World Go By (Brennan-Ball)—Tenor duct, Orch accomp. Lewis James and Charles Hart

HUMOROUS VOCAL SELECTIONS

410 Freckles (Hess-Johnson-Ager)—Tenor, Orch. accomp. Billy Murray
Slow and Easy (Williams-Spencer)—Baritone, Orch. accomp. Ernest Hare

411 When My Baby Smiles (Berlin)—Baritone, Orch. accomp. Ernest Hare
Oh! (Gay-Johnson)—Baritone, Orch. accomp. Ernest Hare

DANCE SELECTIONS

503 Dardanella (Bernard-Black)—Fox-trot, Empire Dance Orch.
You'd Be Surprised (Irving Berlin), Intro. "I Never Knew"—Fox-trot. Novelty Dance Orch.

504 Pee Gee Blues (Clark)—Fox-trot, Novelty Dance Orch.
Sensation (Dixieland Jazz Band)—One-step, Novelty Dance Orchestra

505 My Isle of Golden Dreams (Kahn-Blaufuss)—Waltz. Conlin's Society Orch.
See Saw (Hirsch) Intro.: 1—When Two Hearts Discover; 2—Good-bye—Hello.—Medley One-step. Conlin's Society Orch.

506 Valse Classique (Dabney) (Adapted from "Humoresque")—Waltz. Xylophone solo, Orch. accomp. George Green
Stop Time (Green)—One-step. Xylophone solo, Orch. accomp. George Green

Mickel Bros. Co.

Omaha, Nebraska
Des Moines, Iowa

Victor Distributors

BRUNSWICK RECORDS

2028 The Drum Criterion Quartet
Jerusalem Mornin' and Little Tommy, Criterion Quartet

2030 Hearts and Flowers Concert Orchestra
Spring, Beautiful Spring Concert Orchestra

2031 I'm So Sympathetic Biese Novelty Orchestra
Bow Wow Rodemich Orchestra

2032 Venetian Moon Biese Novelty Orchestra
Mystery Biese Novelty Orchestra

2033 Hold Me All Star Trio
Last Part of Every Party All Star Trio

2034 Desert Dreams Rudy Wiedoeft's Palace Trio
Missy Rudy Wiedoeft's Palace Trio

2035 Swanee Al Bernard
You're My Gal Bernard-Hare

2036 Little Alice Blue Gown Irene Williams
Alexandria William Robyn

5000 Oh, Dry Those Tears Elizabeth Lennox
Whispering Hope Lennox-Heydt

13001 Little Mother of Mine Theo. Karle
I'll Sing Thee Songs of Araby Theo. Karle

13002 Christ in Flanders Theo. Karle
The Lord Is My Light Theo. Karle

13003 Love's Old Sweet Song Irene Pavloska
Just a'Wearin' for You Irene Pavloska

13004 Habanera—Carmen Irene Pavloska
Musetta Waltz—La Boheme Irene Pavloska

13005 Souvenir Poetique Elias Breeskin
Minuet in G Elias Breeskin

30001 Una voce poco fa—Barbiere Seville Virginia Rea
30002 Old Folks at Home Virginia Rea

Sherman, Clay & Co.

San Francisco, Los Angeles, Portland, Seattle, Spokane
PACIFIC COAST DISTRIBUTORS OF
VICTOR PRODUCTS

The PERRY B. WHITSIT CO.
Distributors of
Victrolas and Victor Records
COLUMBUS, OHIO

William Volker & Co. Kansas City, Mo.; Houston, Tex., and Denver, Col.

Pathe 

DISTRIBUTORS

Complete Pathephone and Pathe Record Stocks.
The best proposition for the progressive dealer.

WM. A. CONDON IN THE WEST

Wm. A. Condon, head of Condon & Co., New York, well-known distributors of "Torrington" needles, "Gliss," "Groovite" and other products, left New York late in February on a four weeks' trip to the Pacific Coast. He visited some of the larger trade centers in the Middle West, where he closed satisfactory deals with several large jobbers and dealers for his goods. It is expected that Mr. Condon will return to his home office shortly before the end of March.

Victor Exclusively
EASTERN TALKING MACHINE CO.
177 Tremont Street, Boston
VICTOR DISTRIBUTORS

A C B L A C O F H I K L N P Q S U A X V B D F G I J L N P Q S U V X Z V C E F H J K W O P R T A C E M O N
 E B L V
 G J K W
 H I J K W
 M N O P Q R S T U V W X Y Z
 P Q R S T U V W X Y Z
 S R P O M K J I H F E C V B C E F H I J K W O P R T U N Y L B D E G I K M J O Q S T V M Y A B D

INDEX TO ADVERTISERS

A		Grand Rapids Brass Co. 210	Philadelphia Show Case Co. 38, 94
Acme Die Casting Corp. 190	Grand Rapids Phonograph Co. 68	Phillips, Wm. 70	
Acme Engineering & Mfg. Co. 147	Grand T. M. Co., Inc. 229	Phono-Bretto Co. 91	
Acme Mica Co. 207	Gray Co., Walter S. 76	Phonograph Appliance Co. 130	
Aeolian Co. 102, 103	Great Eastern Manufacturers Ass'n. 147	Phonograph Motors Corp. 162	
Aeolian Co., Chicago 154	Green, J. 63	Phonomotor Co. 163	
Aeolian Co., Cincinnati. 208	Gretsch Mfg. Co., Fred. 74	Player Phone T. M. Co. 151	
Amalgamated Phonograph Accessories Corp., Insert following page 82	Grey Gull Records. 172	Playertone T. M. Co. 199	
American Felt Co. 122	Griffith Piano Co. 147	Plaza Music Co. 41, 51, 67, 89, 122, 176	
American Phonograph Co. 206	H		
Andrews, W. D., & C. N. 93	Haag & Bissex. 181	Reed Co. 108	
Arrow Phono. Corp. 118	Hallet & Davis Piano Co. 88	Regina Co. 18	
Astoria Mahogany Co. 42	Handy Mfg. Co. 147	Rene Manufacturing Co. 185, 206	
Automatic Cover Support & Mfg. Co. 35	Harponola Co. 65	Repeater Stop Co. 111	
B		Hartzell, Geo. W. 104	
B & H Fibre Mfg. Co. 62	Herbert & Huesgen Co. 82	Repeato-Graph Co. 166	
Badger State Cab. Co. 230	Hessig-Ellis Drug Co. 47	Rex Gramophone Co. 236	
Badger Talking Machine Co. 119	Heywood Bros. & Wakefield Co. 12	Reynolds, Wm. H. 241	
Bagshaw Co., W. H. 84, 85	Hiawatha Phono. Co. 140	Robinson, The Plater. 141	
Baker-Smith Co. 224	Hillman & Son Phonograph Co. 191	Robinson-Pettit Co. 47	
Barnhardt Bros. & Spindler. 76, 101, 153	Hinds, Hayden & Eldredge, Inc. 218	Roemer Mfg. Corp. 158	
Beacon Phono. Co. 182	Hoffay Talking Machine Co. 233	Roemer Sales Corp., M. M. 108	
Beecroft, Clement 105	Hough, J. E., Ltd. 88		
Blackman Talking Machine Co. 126	Hough, L. W. 209	R	
Bond's Graphophone Shop. 228	Hunt, J. D., Mfg. Co. 192	Schmelzer Arms Co. 23	
Booth Felt Co., Inc. 82	Huss Bros. Phonograph & Piano Co. 192	Seeburg, J. P., Piano Co. 151	
Boston Book Co. 49	I		
British Polyphon Co. 234	Isley, Doubleday & Co. 26	Shapiro, Bernstein & Co. 188	
Brooks Mfg. Co. 69	Independent T. M. Co. 227	Sharnat & Son, S. W. 89	
Bruno & Son, Inc., C. 119	International Mica Co. 112	Sherman, Clay & Co. 241	
Brunswick-Balke-Collender Co. Insert following page 34	Iroquois Sales Co. 112	Smith Drug Co., C. D. 47	
Buehn Co., Louis. 95	J		
Buffalo T. M. Co. 213	Jewel Phonographs Co. 142	Smith, Kline & French Co. 204	
Bush & Lane Piano Co. 125	Jones-Motrola, Inc. 29	Smith Laboratories, H. J. 226	
Butterfly Phonograph Motor Corp. 125	Jones Piano Co., E. H. 51	Smith-Schiffin Co. 98	
C		K	
Cabinet & Accessories Sales Co. 220	Kalder, Inc., Chas. W. 219	Sona-Tone Phonograph, Inc. 220	
Cardinal Phonograph Co. 57	Kent Co., F. C. 72	Sonora Phonograph Sales Co., Inc., Inside Front Cover, 39, 46, 47	
Carpenter Paper Co. 169	Kesner & Jerlaw, Insert following page 74	Soss Mfg. Co. 181	
Chappell's 190, 191	Keystone Minerals Co. 47	Sound Recording Co., Ltd. 235	
Cheney Talking Machine Co. 55	Kiefer-Stewart Co. 47	Southern Cal. Music Co. 218	
Cherington Mfg. Co. 153	Kirkman Engineering Corp. 18	Southern Drug Co. 218	
Chicago Ferrotyp Co. 170, 171	Kraft, Bates & Spencer, Inc. 87	Southern Sonora 47	
Chicago Hinged Cover-Support & Balance Co. 141	Krasberg Engineering & Manufacturing Corp. 37, 161	Southwestern Drug Co. 107	
Chicago Metal Products Co. 148	L		
Chicago Talking Machine Co. 134	Lakeside Supply Co., Inc. 218	Sphinx Gramophone Motors. 106, 107	
Chorister Phono. Co. 211	Lansing, E. H. 89	Standard Accessory Corp. 33	
Cirola Distr. Co. 175	Lawson Piano & Phono. Co. 91	Standard Talking Machine Co. 44	
Classified Want Ads. 14	Lee-Cort-Andreesen Co. 238	Starr Piano Co. 234, 236	
Cleveland T. M. Co. 220	Lesley's 235	Stead & Co., J. 236	
Cliff Manufacturing Works, Inc. 155	Lockwood, Vernon 212	Steel, W. R. 196	
Cole & Dunas. 223	Long Cabinet Co., Geo. 184	Steger & Sons Piano Mfg. Co. 131	
Collings & Co. 18, 20, 21, 27, 34, 43, 50, 54, 75, 80, 101, 113, 173, 192	Lorentzen, H. K. 218	Stein-Burn Corp. 83	
Columbia Graphophone Co. 184	Lowe Co., Geo. A. 77, 78, 79	Steinert, M., & Sons Co. 58	
Columbia Mantel Co. 50	Lucky 13 Phonograph Co. 45, 63, 81	Steinola Co. 201	
Compton-Price Co., Insert following page 75, 16, 17	Lu-Franc Sales Service. 90	Stephenson, Inc. 190	
Condon & Co., Inc. 167	Lundstrom Mfg. Co., C. J. 136, 159	Stern & Co., Jos. W. 222	
Consolidated Music Co. 143, 146	Lyon & Healy. 147	Sterno Manufacturing Co. 209	
Consolidated Talking Machine Co. 227	Lyons, J. I. 74	Stewart T. M. Co. 197	
Cox, Geo. Clay. 178	M		
Crafts Piano Co., A. J. 86	Magnavox Co. 47	Stodart Phono. Co. 36	
Cressey & Allen. 52, 53	Magnola Talking Machine Co. 19, 80, 130, 137, 161	Stoffer & Stackhouse. 177	
Crippen Co., Inc. 173	Mandel Mfg. Co., Inc. 70	Stone Piano Co. 47	
Crippen Record File Co. 99	Manhattan Phono. Parts Co. 47	Strevell-Paterson Hardware Co. 226	
Crosley Phono. Co. 86	Marshall & Co., C. L. 193	Superior Phono. Co. 99	
Curry, Frank B. 86	Marvelon Co. 189	Supplee-Biddle Hdw. Co. 70	
D		McCarthy & Fisher. 163	
Delpheon Co. 43	Mellor's 121	T	
DeMoll & Co., O. J. 202	Melodia Co. 157	Talking Machine World Dealer Service. 205	
Deterling Mfg. Co. 159	Melodia Phonograph Co. 204	Thomas & Proetz Lumber Co. 204	
Ditson Co., Oliver. 75	Mermod & Co. 218	Toledo Talking Machine Co. 127	
Doctorow, D. R. 76	Metzler & Co. 138	U	
Dodin, Andrew H. 211	Meyercoed Co. 241	Udell Works 19	
Doehler Die-Casting Co. 81	Mickel Bros. Co. 47	Unit Construction Co. 48	
Droop & Sons Co., E. F. 241	Minneapolis Drug Co. 115	United Mfrs. & Dist. Co. 98	
Drying Systems, Inc. 39	Modenola Co. 149, 183	United Music Stores 174	
Dulcitone Phonograph Co. 56	Moeller-Waters Co. 47	United Phonographs Corp. 225	
Duo-Tone Co. 241	Montagnes, I., & Co. 217	United Phono. Co. 150	
Dyer & Bro., W. J. 241	Moser & Co. 210	United States Music Co. 128	
E		Music Adv. Club. 47	Universal Fixture Corp. 152
Eastern Talking Machine Co. 83, 241	Musical Supply & Equipment Co. 70	V	
Eclipse Musical Co. 113	Mutual T. M. Co. 24	Vacuum Record Lifter, Ltd. 61	
Edison, Inc., Thos. A. Back Cover, 30, 31, 168	Myers Replayer Co. 47	Van Houten, C. J., & Zoon. 47	
Efficiency Electric Co. 124	N		Van Veen & Co., Arthur L. 200
Einson Litho., Inc. 27	National Decalcomania Co. 98	Venus Co. 200	
Eject-O-File Co., Inc. 187	National Publishing Co. 6	Vicsonia Mfg. Co., Inc. 5, 7	
Emerald Co. 120	Natural Voice Phonograph Co. 130	Victor Talking Machine Co. From Cover, 5, 73	
Emerson International, Inc. 123	Neu & Co., H. G. 63	Vitanola Talking Machine Co. 96	
Emerson Philadelphia Co. 100	New England Mus. I. T. Co. 87	Vitanola Distributors Co. 156	
Emerson Phonograph Co. 10	New England Piano & Phono Co. 86	Vit Talking Machine Co. 241	
Emerson Record Sales Co. 32	New England Talking Machine Co. 138	W	
Emerson Sales Co., Pittsburgh. 219	Newman Bros. Co. 4	Wade Co., R. C. 59	
Empire Phono. Parts Co. 109	New York Album & Card Co. 134	Wade & Wade. 92, 145	
Empire Talking Machine Co. 231	New York Talking Machine Co. 36	Wade Talking Machine Co. 54	
Everett Mellenry Co. 98	O		Wagner Phono. Co. 50
Everybody's Talking Machine Co. 40	Ogden Sectional Cabinet Co., Inc. 215	Ward Co., C. E. 47	
Excel Cabinet Co. 40	Ohio Sales Co. 47	Wathall Music Co. 88	
F		Onken Co., Oscar. 114	Watson Bros. & Co. 105
Faultless Caster Co. 26	Operaphone Co., Inc. 198	Weber-Knapp Co. 66	
Favorite Mfg. Co. 35	Operollo Co. 9	Werlein, Ltd., Philip. 97	
Federal Electric Co. 143	Ormes, Inc. 145	Weymann & Son, H. A. 241	
Federal Phono. Parts Co. 180	P		Whitsit Co., Perry B. 186
Fern-O-Grand Co. 229	Paramount Talking Machine Co. Inside Back Cover	Widdicomb Furniture Co. 218	
Flottorp Mfg. Co. 179	Parks & Parks. 60	Wills & Paton. 144	
Fletcher-Wickes Co. 99	Parr Mfg. Co. 211	Wilson & Co., Thos. 25	
Franklin Phonograph Co. 206	Pathé Frères Phonograph Co. 164, 165	Windsor Furniture Co. 219	
Fulton Talking Machine Co. 206	Peabody, Henry W., & Co. 22	Wolf, Clifford A. 195	
G		Pearshall Co., Silas E. 110	Wollman T. M. Co. 210
Gately-Haire Co., Inc. 203	Peckham Mfg. Co. 5	Wonder T. M. Co. 139	
General Phonograph Corps., Inserts following pages 18, 28, 194	Peerless Album Co. 45	World Phono. Co. 241	
General Phonograph Mfg. Co. 11	Peerless Record Makers. 97	Y	
General Sales Corp. 47	Penn Phonograph Co. 233	Yahr & Lange Drug Co. 47, 214	
Gibson-Snow Co. 108	Perephone Co., Ltd. 157	Yates, Chas. H. 110	
Glenwood Cabinet Co. 36	Perfect Automatic Brake Co. 157	Z	
Globe Decalcomanie Co. 47			Ziegler, Baker & Johnson. 34
Glynn, W. B., Distributing Co. 195			
Goldbert, Max L. 195			
Goldstein, C. M. 242			
Gramophone Co., Ltd. 242			

REG. U.S. PAT. OFF.

Paramount

Talking Machines & Records

Think this over: Here you are offered a complete line of TALKING MACHINES, RECORDS, NEEDLES and ACCESSORIES under one name and guarantee. An instrument which truly represents a big step forward in the progress of the industry; a machine which has exclusive features of powerful selling force. And back of the complete line a big, complete plan of dealer co-operation to build prestige and sales for the PARAMOUNT line right in your community.

Write for full details of this profitable proposition

MARCH RELEASES

Paramount Lateral Cut Records A DOUBLE HIT to Every Record

Big Sellers—Just Out

- 20001 { Dardanolla (Felix Bernard & Johnny S. Black)—Fox-trot, for Dancing, Benny Selvin's Novelty Orch.
\$1.25 { In Your Arms, Intro.: "I Know Why" (Elmer Floyd & Al. Glaser)—
Fox-trot, for Dancing.....Benny Selvin's Novelty Orch.
- 20002 { Isle of Golden Dreams—Waltz, for Dancing..... Benny Selvin's Novelty Orch.
\$1.25 { Peggy (Harry Williams & Neil Moret)—For Dancing, Benny Selvin's Novelty Orch.
- 33058 { Just Like a Rose—Male Trio, Orch. accomp..... Sterling Trio
\$1.00 { Bye Lo (Ray Perkins)—Duet, with orch..... Hall & Kaufman
- 33059 { Floatin' Down to Cotton Town (Jack Frost & F. Henri Klickmann)—Male
Duet, with Orch..... Hall & Kaufman
\$1.00 { When the Preacher Makes You Mine—Duet with Orch..... Hall & Kaufman
- 20003 { Turkey in the Straw—Solo with Orch..... Billy Golden
\$1.25 { Life Is a Merry-Go-Round, Comic Song (Golden-Burt)..... Dan Quinn
- 20004 { Morning, Noon and Night Overture—Part 1 (Von Suppe)..... Rogers Symphony Orch.
\$1.25 { Morning, Noon and Night Overture—Part 2 (Von Suppe)..... Rogers Symphony Orch.
- 20005 { Baltimore Centennial March (Herbert)—Military Band..... Roger's Band
\$1.25 { American Patrol (Meachman)—Military Band..... Roger's Band
- 20006 { Love's Dream After the Ball (Czibylka)—Cello, Violin and Piano... Taylor Trio
\$1.25 { Minuet In "G" (Beethoven)—Violin solo, Piano accomp..... Samuel Gardner

LIST OF DISTRIBUTORS

- SHIPLEY-MASSINGHAM HOWE, CO., THE OHIO PARAMOUNT CO.,
Pittsburgh, Pa. 6101 Euclid Ave., Cleveland, O.
For Western Penn. and West Virginia. For Ohio
- E. R. GODFREY & SONS CO., NORTHWEST PHONOGRAPH JOBBERS,
Milwaukee, Wis. INC.,
For Iowa, Illinois, Michigan, Indiana and Wisconsin. 915 Riverside Ave., Spokane, Wash.
For Washington, Northern Oregon, Northern Idaho, Western Montana

The Paramount Talking Machine Co.
Port Washington, Wis.



Style XXX
Price \$250
Mahogany and oak



Style XX
Price \$185
Mahogany and oak



Style X
Price \$115
Mahogany and oak



Style XXV
Price \$200
Mahogany and oak



Style XV
Price \$140
Mahogany and oak



Style V
Price \$70
Mahogany and oak

ORDER BLANK

For March Lateral Cut Paramount Records

Quantity	Record Number	Quantity	Record Number	Quantity	Record Number	Advertising
.....	20001	33059	20005Supplements
.....	20002	20003	20006Hangers
.....	33058	20004Envelope Circulars
					Window Announcement

Check here Write us about available territory for Paramount Co-ordinated Products

Date..... Ship to

Order No. City & State.....

Laboratories
1140 Broadway,
New York
City



Factories
Port Washington,
Wisconsin
Grafton, Wis.

For our March magazine advertising, a famous artist has harmonized the musical and furniture art of the New Edison.

By unusual impressionistic painting he makes you *feel* the New Edison is playing. The artist adds to this a subtle impression of beautiful furniture.

When you receive your copy of this advertisement, display it in your window. It is the most beautiful phonograph advertisement ever published.

THOMAS A. EDISON, Inc.

Orange, New Jersey

JOBBER OF THE NEW EDISON, EDISON RE-CREATIONS, THE NEW EDISON DIAMOND AMBEROLA AND BLUE AMBEROL RECORDS

CALIFORNIA
Los Angeles—Edison Phonographs, Ltd.
San Francisco—Edison Phonographs, Ltd.

COLORADO
Denver—Denver Dry Goods Co.

CONNECTICUT
New Haven—Pardee-Ellenberger Co., Inc.

GEORGIA
Atlanta—Phonographs, Inc.

ILLINOIS
Chicago—The Phonograph Co. James I. Lyons (Amberola only).

INDIANA
Indianapolis—Kipp Phonograph Co.

IOWA
Des Moines—Harger & Blish.
Sioux City—Harger & Blish.

LOUISIANA
New Orleans—Diamond Music Co., Inc.

MASSACHUSETTS
Boston—Pardee-Ellenberger Co.
Iver Johnson Sporting Goods Co. (Amberola only).

MICHIGAN
Detroit—Phonograph Co. of Detroit

MINNESOTA
Minneapolis—Laurence H. Lucker

MISSOURI
Kansas City—The Phonograph Co. of Kansas City.
St. Louis—Silverstone Music Co.

MONTANA
Helena—Montana Phonograph Co.

NEBRASKA
Omaha—Schultz Bros.

NEW YORK
Albany—American Phonograph Co.
New York—The Phonograph Corp. of Manhattan.
Syracuse—Frank E. Bolway & Son, Inc. W. D. Andrews Co. (Amberola only).

OHIO
Cincinnati—The Phonograph Co.
Cleveland—The Phonograph Co.

OREGON
Portland—Edison Phonograph Ltd.

PENNSYLVANIA
Philadelphia—Girard Phonograph Co.
Pittsburgh—Buchu Phonograph Co.

Williamsport—W. A. Myers.
RHODE ISLAND
Providence—J. A. Foster Co. (Amberola only).

TEXAS
Dallas—Texas-Oklahoma Phonograph Co.

UTAH
Ogden—Proudfit Sporting Goods Co.

VIRGINIA
Richmond—The C. B. Haynes Co., Inc.

WISCONSIN
Milwaukee—The Phonograph Co. of Milwaukee.

CANADA
Montreal—R. S. Williams & Sons Co., Ltd.
St. John—W. H. Thorne & Co., Ltd.
Toronto—R. S. Williams & Sons Co., Ltd.
Vancouver—Kent Piano Co., Ltd.
Winnipeg—R. S. Williams & Sons Co., Ltd.
Babson Bros. (Amberola only).
Calgary—R. S. Williams & Sons Co., Ltd.