

The TALKING MACHINE WORLD

AND
NOVELTY
NEWS

Published Each Month by Edward Lyman Bill at 373 Fourth Avenue, New York, January 15, 1915



Victrola XVI, \$200
Mahogany or oak

The instrument by which the value of
all musical instruments is measured



DEALERS IN THE SALTER LINE

MADE MANY THOUSANDS OF
DOLLARS DURING THE HOLIDAY
SEASON SELLING THESE CABINETS

THEY ARE SELLING THEM THIS MONTH, TOO,
AND WILL BE NEXT MONTH TO BUYERS OF
MACHINES WHO ARE JUST BEGINNING TO FEEL
THE NEED OF A PLACE TO PUT THEIR
RECORDS.

↓ SALTER CABINETS

Standard of Industry



CABINET No. 19
AND VICTROLA IX.



CABINET No. 112 WITH
COLUMBIA "FAVORITE."

OF COURSE, YOU HAVE GOT TO CALL
THE ATTENTION OF YOUR TRADE TO
THEM AND SHOW THEM. IT IS THE
ONLY WAY TO ILLUSTRATE HOW
PERFECTLY THE CABINETS COMBINE
WITH THE MACHINES.

WE HAVE STORAGE CABINETS FOR
THOSE WHO HAVE A LARGE COLLEC-
TION AND OTHER CABINETS THAT
WILL MEET ANY CONDITION THAT
CONFRONTS YOU.

SALTER MFG. CO.

337-39 Oakley Boulevard

CHICAGO

The Talking Machine World

Vol. 11. No. 1.

New York, January 15, 1915.

Price Ten Cents

HEAVY FIRE LOSS IN ATLANTA.

All of Talking Machine and Record Stock of Elyea-Austell Co. Destroyed by Fire with Loss of \$100,000—Able to Supply January Records to Dealers—Will Have Old Quarters in Right Good Shape Again This Month.

(Special to The Talking Machine World.)

ATLANTA, GA., January 7.—The Elyea-Austell Co., the prominent Victor talking machine distributors and bicycle and supply dealers of this city, are making rapid progress in having their quarters remodeled and refurbished, following the fire which destroyed practically the entire stock of talking machines, records and supplies, bicycle and automobile supplies and bicycles on December 15.

Although employes managed to save some of the bicycle and supply stock, the talking machine stock was burned up completely, the entire loss amounting to about \$100,000 and being well covered by insurance.

In discussing the fire and its consequences, E. N. Upshaw, manager of the Victor department of the company, said: "When the fire occurred we had not, fortunately, received our shipment of the January records and these we were able to ship promptly on December 24 to our dealers. We were also able to secure temporary quarters which we are now occupying and this enabled us to handle the machines that the Victor Co. could furnish us with, which helped to relieve the situation among our dealers to a certain extent.

"Our plans now are not exactly perfected, but we expect to be firmly re-established in business by the 15th of January, and we believe that we are going to be in a position to give our dealers in all of our lines much better service than ever before. We shall adhere very strictly to our exclusively wholesale policy throughout our entire business.

"Fortunately, practically all of our office records were saved and this greatly facilitates our resuming business."

PREPARES WINDOW DISPLAY PUZZLE.

Thomas Devine Uses Odd Signs to Arouse Curiosity of Kansas City Citizens and Gets Results That Please Him in Highest Degree.

(Special to The Talking Machine World.)

KANSAS CITY, Mo., January 9.—Thomas Devine, a traveling representative for the Columbia Graphophone Co. working out of the Kansas City office, came into the office the other day and offered to trim the window. His offer was very promptly accepted, and so he accordingly set about his work. After several hours' work he showed the office force the result of his labors. There was nothing particularly unique about the window except a couple of signs that he had made. One read:

Grafonolas Shorten the Way to Tipperary.

The other sign proved to excite more interest. It read:

Terms
To Suit Jack and His
Master.

When asked what terms "To suit Jack and his master" were, Mr. Devine said that he didn't know. But he advised the force to keep a close watch on the pedestrians and see how many stopped and puzzled over the sign. The result was that many people were seen to stop and ponder over the sign. Some more curious than others came in and asked what its meaning was. The salesmen were naturally at a loss to explain the meaning. However, the difficulty was overcome by saying that the sign meant terms that were suitable to everyone.

During the week after Columbia University had given Walter Damrosch the degree of Mus. Doc., the noted conductor received a note from Alexander Lambert in which the piano pedagogue remarked: "I am so glad that you are a 'doctor of music.' Now when I get sick of music I shall know where to go."

H. C. BROWN AS A BIG GAME HUNTER

Advertising Manager of Victor Co. Gets Recreation by Hunting in the Great North Woods and Gets His Share of Big Game.

Henry C. Brown, the ever active advertising manager of the Victor Talking Machine Co., is one of those red-blooded men who believe that the greatest relief from the cares of business is to get deep into the North Woods for big game, and whenever the opportunity offers Mr. Brown wires his guide, packs up his hunting clothes and his rifles and is off for Canada.

Mr. Brown, who is a member of the Campfire Club, when he took a hunting trip two years ago wrote an interesting story of his adventures for the Field and Stream magazine under the alluring caption of "The Moose That Charged." Last fall the advertising man took another trip into the wilds and although he did not have to dodge wounded moose, found game so thick that he soon had his



Henry C. Brown and His Caribou.

lawful limit of moose and caribou securely tagged. He tells of his latest trip in Field and Stream for January under the caption of "Getting Your Moose and Caribou Within Two Days of Broadway." The story is plentifully illustrated with snapshots of the author and his guides, and serves to create in the reader the desire to get after the big game on his own account. Such recreation between times serves to augment Mr. Brown's great abundance of energy—for he is a wonder, judging from the amount of work he manages to dispose of.

LOUIS BUEHN INCORPORATES.

Faithful Employes Made Officials in Louis Buehn Co., Inc.—To Handle Victor Goods Exclusively—Excellent Business Record.

(Special to The Talking Machine World.)

PHILADELPHIA, PA., January 7.—The business of Louis Buehn, the well-known talking machine jobber at 825 Arch street, this city, has been incorporated with capital stock of \$75,000, under the title of the Louis Buehn Co., Inc., the change being effected on January 1. The officers of the new company are Louis Buehn, president and treasurer; Charles W. Miller, vice-president, and Frank B. Reineck, secretary. Mr. Miller has been connected with Mr. Buehn for the past thirteen years, and Mr. Reineck for over six years, and their election to office in the new corporation is a tribute to their ability and persistent efforts.

The Louis Buehn Co., Inc., will in future handle the Victor talking machines, records and supplies exclusively.

Mr. Buehn states that the year just closed has been the most successful in the matter of business volume that he has ever experienced, and he is making preparations for an even increased demand for Victor goods, which he feels sure will come during 1915.

Nowadays business is made to grow by using plenty of good advertising to cultivate new trade,

GET-TOGETHER MEET IN BUFFALO.

Talking Machine Dealers' Association in That City Working to Create a Better Understanding Between Dealers and Agents in Buffalo and Neighboring Towns—Live Campaigns Following Annual Meeting This Week.

(Special to The Talking Machine World.)

BUFFALO, N. Y., January 8.—In a well-directed effort to establish a talking machine of some sort in every home in northern New York, the Talking Machine Dealers' Association of Buffalo, one of the liveliest organizations of its kind in the eastern section, has decided to create a better understanding and greater co-operation among city, town and village agents and dealers through get-together meetings. The first defined step in this direction will be taken on the night of January 13 in the banquet hall of the Hotel Statler when the annual meeting will be held, with the out-of-town dealers as guests.

Advertising campaigns, sales schemes along with other new trade-getting wrinkles that have worked out well in Buffalo, will be divulged by the local leaders in the talking machine world, while the visitors will be called upon to enter into the discussions. President W. H. Poling, of the association, who is the head of the J. N. Adam talking machine department here, is bending every effort to obtain good speakers and plenty of entertainment.

Invitations are now being sent out to dealers living within a radius of fifty miles of Buffalo, and up to date many acceptances have been received. Several perplexing problems will be finally determined at the affair, which is being awaited with considerable interest.

SOUND WAVES ON SCREEN.

Interesting Lecture by Dr. Dayton C. Miller, Noted Physicist, Who Says the Musical Critic of the Future Need Not Leave Home.

The musical critic in the year 1960 should be able to sit at home and report accurately the work of an operatic singer or an orchestra in a hall miles away from him, said Dr. Dayton C. Miller, the noted physicist of Cleveland, O., in the course of a lecture on "The Science of Musical Sounds" last week at the Asbury Methodist Episcopal Church, Thirty-third and Chestnut streets. The address was delivered in connection with the convention of the American Association for the Advancement of Science.

Upon an instrument of his own invention, called a "phonodeik," Dr. Miller projected sound waves upon a screen, so that his audience was able to "see" each sound as it was made. The human voice, a flute, a cornet and operatic and orchestral selections upon a phonograph were used to show the various sorts of sound waves, the spectators being able to see upon the screen the slightest changes in the pitch, quality or complexity of the music. The waves sent out by the simple tones of a tuning fork gave long, even curves, while the delicate variations in the human voice sputtered upon the screen like fireworks. "The telephone transmitter already reproduces the 'color' of the voice at long distances," said Dr. Miller, "and fifty years hence we shall have perfected apparatus which will enable the musical critic to judge an opera or a concert intelligently without leaving his own fireside."

ELECTRIC SIGN FOR BLACKMAN CO.

The Blackman Talking Machine Co., 97 Chambers street, New York, Victor distributor, installed recently an expensive and attractive electric sign that is visible from quite a distance. This sign features the famous Victor trade-mark, with the word Victor in large letters. An electric clock arrangement adds to the practicability of the sign. The background of the sign is multi-colored, with red and white lights for the flasher effect.

DETROITERS MAKE SUGGESTION AS TO STYLE CHANGES.

Suggest That New Models of Machines Be Placed on Market During the First Half of the Year to Facilitate Holiday Preparation—Holiday Demands Clean Out Local Stocks—Tendency Toward the Better Class of Trade—J. H. Ling Pleased with Department.

(Special to The Talking Machine World.)

DETROIT, MICH., January 5.—The talking machine dealers of Detroit lost probably \$10,000 worth of business in December owing to inability to get the goods. They thought last year that such experiences were a thing of the past, the enlargements of the factories having enabled the manufacturers to fill orders promptly, even in the rush days. But apparently the growth of the retail trade has been such that the manufacturers are again outstripped.

January 1 the stores of Detroit are almost clear of goods, except records. The few machines scattered about the spacious floors look awfully lonesome in their effort to carry the impression that there is stock on hand. The Columbia wholesale store has just one model in stock, a \$50 machine, and only a few of that. The Max Strasburg Co. has about one machine to a demonstration room and one in the reception room. The new talking department of J. Henry Ling, in its first holiday trade, was almost denuded of machines. In the two or three days before Christmas it sent out no less than three wagon loads of Columbias. Grinnell Bros., Victrola jobbers, had such a big retail trade that they were unable to fill orders from local dealers, to say nothing of turning down orders from other cities. One day shortly before Christmas they sold so many machines that the delivery and shipping departments were compelled to work until daylight the following morning removing the sold machines from the salesrooms, getting them ready for delivery and replacing them with new machines from the stockrooms.

The dealers have a suggestion to make to the manufacturers that will help a lot in solving this holiday shortage problem. It is that the styles be changed in the first half of the year instead of in the last half. The large downtown houses have ample storage facilities and would like to buy large quantities of stock in advance. But with the styles changing in the autumn machines bought in the summer are out of date when the holidays arrive. So they are not readily salable. It is necessary to get a special dispensation from the home office to dispose of them at a discount, and this makes a bad impression. If the new styles were brought out in the spring or early summer the dealers could then go ahead and buy all they expect to handle, and would not lose business in December for lack of stock.

The J. L. Hudson Co. was the first in Detroit to advertise the new \$250 electric Victrola. It sold

all of that style that it could get hold of. This company sold from forty to fifty machines per day in the last two weeks of the Christmas trade. Having absorbed all that the local jobbers could supply one week before Christmas, it wired to Cleveland, Columbus, Chicago, Buffalo and New York jobbers for more. An inventory of the machines on the floor showed 296. There were nine more in the windows, making 305. Yet with the aid of such reinforcements as could be obtained from other cities, it just barely survived the rush. These figures do not take into consideration the small box machines. Only the cabinets are counted as the real goods.

The class of trade throughout Detroit was higher this year than ever. This is ascribed to the fact that the cabinet machines are now put up in styles fit for anybody's fine home. The demand for mahogany, undoubtedly to match mahogany furniture, was tremendous. There is not one of the downtown stores but has from ten to twenty-five unfilled orders for mahogany styles, most of which were tided over Christmas by the delivery of some special design to be exchanged when mahoganies arrive in stock. This process is undesirable from several points of view. It makes the used machines slightly second hand, it creates a shortage of stock in those styles, it makes it necessary to sell them over again and it costs the price of two deliveries. As mahogany furniture is found only in the best of homes, this experience is a good indication of the class of trade.

The shortage of Columbias is attributed largely to the recent and unforeseen opening of two very large accounts in New York and Chicago, those of the Aeolian Co. and Marshall Field. Both of these big institutions absorbed so many machines that they created a shortage elsewhere.

J. Henry Ling is so well satisfied with his short experience with a talking machine department that he has arranged to have Robert B. Barclay, of the Columbia Co., remain all winter as manager of the department. Originally it was the plan to have Mr. Barclay pilot the house through the holiday season and then retire in favor of the regular ship's captain. But Mr. Barclay has made a huge success of the department, and Mr. Ling wants him to remain as long as possible, figuring him a profitable addition to his business force.

Max Strasburg estimates the increase of December business this year over that of 1913 at 30 per cent. F. A. Denison, manager of the Grafonola

wholesale house, estimates an increase of from 25 to 30 per cent. The business of December was more than double that of the average of the preceding three months. S. E. Lind, city sales manager, sold more machines in December than he ever sold in any three previous months of his career, and his career has been an active and successful one. All the Grafonola dealers in the city have sold out nearly all their stock and have orders waiting; orders for machines actually sold and money paid on them. So they must be delivered, and the Columbia store itself can get no machines to put on its floors.

The Columbia store is to be remodeled in January to make room for enlarged general business and a Dictaphone department. The Dictaphone department has been for some time on Lafayette Boulevard, but is to be moved to the main store. H. Q. Duple, formerly Dictaphone manager in Baltimore and Washington, will come to Detroit to take charge of it. A mezzanine floor is to be built in the front part of the store, probably extending back over the demonstrating rooms. The record cases will be rearranged. This will make room for the Dictaphone department upstairs, and also take care of part if not all of the offices, thus making more room for general business on the first floor.

The personnel of the store made the first Christmas of the new manager, F. A. Denison, in Detroit, a memorable one by presenting him with a fine library lamp.

The four principal Edison stores, the "Edison Shop," Story & Clark, Frank J. Bayley and the American Phonograph Co., all had good sized stocks laid up in advance, so were not seriously bothered by the destruction of the Edison factories by fire. They did not have all the machines they could have sold, but were in no worse condition than their competitors.

There is one cheering feature in the loss of this \$10,000 worth of business by Detroit dealers. The business probably will come back. The people evidently were "sold" before they called for the goods. Their purchases simply are just a little delayed. The several stores may not get the exact business they lost in December, but probably they will get equal amounts. Business in records is steady and continually increasing. There seems to be a demand for almost everything in the catalogs.

SECURE PATHEPHONE AGENCY.

(Special to The Talking Machine World.)

MILWAUKEE, Wis., January 9.—The Milwaukee agency for the Pathephone talking machine line, manufactured by the Pathé Frères Phonograph Co., has been taken up by the Billings & Sons, Piano Co., 504 Grand avenue. The line is being featured in the window displays at the store. Good sales of Mehlín, Holland, Cable-Nelson and Billings & Sons pianos and players are reported.

Service Is the Paramount Asset of a Victor Distributor

The factory controls the Prices and Terms.

The distributor controls his Service

This is the reason we have endeavored to make

EASTERN SERVICE THE BEST EVER

And we believe we have succeeded, and will convince you if you will give us the opportunity. A trial order will do.

Will you do it?

Thank you.

When may we expect it?

EASTERN TALKING MACHINE COMPANY

177 TREMONT STREET, BOSTON, MASS.

EDISON

FOR NINETEEN YEARS TALKING MACHINES EXCLUSIVELY

VICTOR



Victrola IV, \$15
Oak

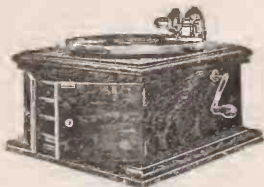

Victrola VI, \$25
Oak



Victrola VIII, \$40
Oak



Victrola IX, \$50
Mahogany or oak.



The prosperity of the music trade centers around the Victrola.

It is the biggest single factor in the success of every music dealer.

Victor Talking Machine Co., Camden, N. J., U. S. A.

Berliner Gramophone Co., Montreal, Canadian Distributors

Always use Victor Machines with Victor Records and Victor Needles—the combination. There is no other way to get the unequalled Victor tone.



Victrola X, \$75
Mahogany or oak



Victrola XI, \$100
Mahogany or oak



Victrola XIV, \$150
Mahogany or oak



Victrola XVI, \$200
Mahogany or oak

FAMOUS RECORD ALBUMS

AT VERY LOW PRICES TO MEET COMPETITION

These Record Albums will Pay for Themselves in a short Time by Preserving Records. When Full the Albums are Flat and Even Like Books. They will Fit in a Library Cabinet or Book Case, or They will Lie Flat on One Another.

We manufacture Disc Record Albums containing 12 pockets to fit the new Victrola Cabinets No. X. and XI.

We also make Albums containing 17 pockets, and with the indexes these Albums make a complete system for filing all disc Records.

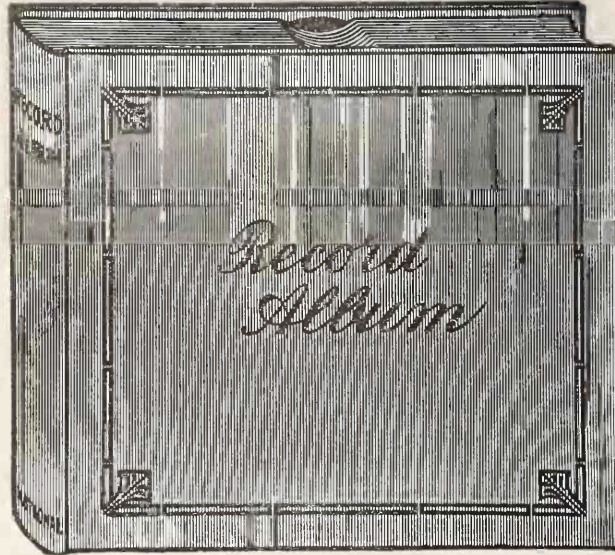

For Durability, Artistic Design and Finish, our Albums have no equal. They are made in the most substantial manner by skilled workman. We sell our Superb Albums at big discounts to meet competition. Shall we send samples and quote our very low prices?

THESE ALBUMS ARE THE BEST FOR VICTOR, EDISON, COLUMBIA AND ALL OTHER DISC RECORDS

Write for samples of our Albums, which are superior to all others

Address NATIONAL PUBLISHING CO., 235 South American St., Philadelphia, Pa.

KANSAS CITY TALKING MACHINE MEN IN CROWING MOOD.

Scarcity of Machines and Records the Only Cloud on the 1915 Horizon—December Proves a Record Month with the Majority of the Dealers and Jobbers—How Young Lady Demonstrator Uses Prospect-Picking Ability—Fine Window Displays—Other News.

(Special to The Talking Machine World.)

KANSAS CITY, Mo., January 9.—Those talking machine dealers that let their spirits have leeway on occasion are very apt to be heard crowing. And they have a right to crow; and why shouldn't they? Never before have the talking machine men done such a business as they have done during the holidays. There is not a single dealer that does not complain of the scarcity of machines. Every dealer sold down to the "very dregs" as one man said. This condition is not only unusual, but it is unprecedented as well. The prospects for 1915 were never brighter than at the present time. Business instead of showing a decided relapse after Christmas has shown a remarkable steadiness, and at the present time there is more buying going on than at any time since the first of August.

Joe Mullin is one of the jubilant talking machine men. He is manager of the Victrola department of the Carl Hoffman Music Co. When he came down the morning after Christmas and surveyed the debris he found that he was "entirely cleaned out," to use his own words. This fact was not nearly so surprising as it was gratifying. "And the best of it is," he adds, "that business didn't slump afterwards as it usually does."

R. S. Peer, assistant manager of the Kansas City office of the Columbia Graphophone Co. says that the sale of the new push button Grafonolas exceeded all expectations. Every machine of that type that was in the house was sold before the Christmas rush had fairly begun.

J. H. Best, manager of Dictaphone sales in Kansas City, says that he had the best business during the month of December that he has had for years. The record business was unusually heavy, due no

doubt to the destruction of the Edison plant by fire. He reports that he has installed several machines in the geology department of the Kansas University during the past month.

E. A. McMurty, manager of the Columbia Phonograph Co. in Kansas City, spent several days in Chicago during the latter part of December conferring with W. C. Fuhri, district manager.

Arthur A. Trostler, manager of the talking machine department of Schmelzer Arms Co., jobbers for the Victrola, reports that his sales for the month of December ran way ahead of last year and that the total for the year would do the same. "Practically everything that we had was sold," says Mr. Trostler. "That includes electric and all other styles of machines." As to the prospects for the 1915 trade Mr. Trostler expressed himself as being satisfied that it would show the increased volume that the past year's business has.

The Means & Pearson Music Co. boast of the distinction of having the largest variety of talking machines of any store in the city. This firm handles the Victrola, the Grafonola and the Edison. During the holidays the major portion of the business was in talking machines. Mr. U. L. Means says that during the month of December the firm took in more money than in any month of any year since he has been in business.

"Just come right back here," says Mr. Harry Wunderlich, manager of the F. G. Smith Piano Co., "I want to show you the number of Victrolas that I have left after the rush." Dragging us ruthlessly by the arm, he displayed his remaining half dozen instruments. "If that factory doesn't get me some more in a hurry I'll have to commence selling them from the window."

M. M. Blackman, manager of the Phonograph Company of Kansas City, presents the picture of satisfaction when the Christmas trade is mentioned. Although handicapped in some lines by the fire that occurred at the Edison factory, he said that it in no way injured business. The company spent considerable money previous to the holidays advertising its concerts and instruments. This, according to Manager Blackman, helped.

Miss Yula Cutler, who has been added to the force of the Phonograph Co. of Kansas City as concert demonstrator, has a remarkable faculty for picking prospects. Nobody has ever tried to account for this ability. However, around the office she is generally said to use "remarkable originality in picking prospects." As to the methods used, these are her secrets and stock in trade. It is noticeable that she stands at the front of the concert hall and scrutinizes the faces of the listeners. It is presumed that when she sees a person look particularly well pleased or satisfied she decides that that person is in the market for a machine. Or if he isn't he ought to be. However, this pertinent fact remains: Miss Cutler has made a name for herself in the number of prospects that she has turned over to the salesmen.

A distinctive Christmas display of Victrolas in the window of the J. W. Jenkins Sons' Music Co. proved to be notably successful in catching the attention of the Christmas crowds in the shopping district of Kansas City. The company called attention to its Victrola department each day in its newspaper advertisement also.

In the window were seven instruments, four of the smaller Victrola cabinet models, one of the medium size and two of the largest style. The four smaller machines were mounted on a revolving table which was built on a level with the floor in the window space. The table and floor were carpeted with green felt. Tasteful placards were placed on top of each machine, describing the combination offer of ten double records with each Victrola, the cost, and the monthly payment plan.

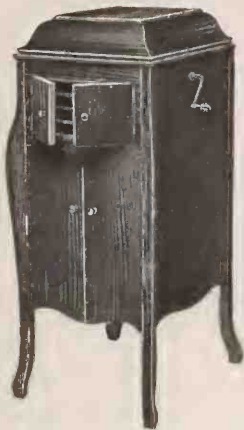

Victrola X, \$75
Mahogany or oak



Victrola IV, \$15
Oak



Victrola VIII, \$40
Oak



Victrola XVI, \$200
Mahogany or oak

Success in the music trade is measured by the Victrola.

The dealers who are the most successful are those who make the most of the opportunities the Victrola offers them.

Victor Talking Machine Co., Camden, N. J., U. S. A.

Berliner Gramophone Co., Montreal, Canadian Distributors.

Always use Victor Machines with Victor Records and Victor Needles—
the combination. There is no other way to get the unequalled Victor tone.



Victor Distributors

- | | | |
|---|--|--|
| Albany, N. Y..... Finch & Hahn. | Detroit, Mich..... Grinnell Bros. | Omaha, Neb..... Nebraska Cycle Co. |
| Altoona, Pa..... W. F. Frederick Piano Co. | Elmira, N. Y..... Elmira Arms Co. | A. Hospe Company. |
| Atlanta, Ga..... Elyea-Austell Co. | El Paso, Tex..... W. G. Walz Co. | Peoria, Ill..... Putnam-Page Co., Inc. |
| Phillips & Crew Co. | Galveston, Tex..... Thos. Goggan & Bro. | Philadelphia, Pa..... Louis Buehn Co., Inc. |
| Austin, Tex..... The Talking Machine Co., of Texas. | Honolulu, T. H.... Bergstrom Music Co., Ltd. | C. J. Heppé & Son. |
| Baltimore, Md..... Cohen & Hughes, Inc. | Indianapolis, Ind... Stewart Talking Machine Co. | Penn Phonograph Co., Inc. |
| E. F. Droop & Sons Co. | Jacksonville, Fla... Florida Talking Machine Co. | The Talking Machine Co. |
| H. R. Eisenbrandt Sons. | Kansas City, Mo.... J. W. Jenkins Sons Music Co. | H. A. Weymann & Son, Inc. |
| Bangor, Me..... Andrews Music House Co. | Schmelzer Arms Co. | Pittsburgh, Pa..... C. C. Mellor Co., Ltd. |
| Birmingham, Ala. Talking Machine Co. | Lincoln, Neb..... Ross P. Curtice Co. | Standard Talking Machine Co. |
| Boston, Mass..... Oliver Ditson Co. | Little Rock, Ark... O. K. Houck Piano Co. | Portland, Me..... Cressy & Allen, Inc. |
| The Eastern Talking Machine Co. | Los Angeles, Cal... Sherman, Clay & Co. | Portland, Ore..... Sherman, Clay & Co. |
| M. Steinert & Sons Co. | Louisville, Ky..... Montenegro-Riehm Music Co. | Richmond, Va..... The Corley Co., Inc. |
| Brooklyn, N. Y... American Talking Machine Co. | Memphis, Tenn.... O. K. Houck Piano Co. | W. D. Moses & Co. |
| Buffalo, N. Y..... W. D. Andrews. | Milwaukee, Wis... Badger Talking Machine Co. | Rochester, N. Y.... E. J. Chapman. |
| Neal, Clark & Neal Co. | Mobile, Ala..... Wm. H. Reynolds. | The Talking Machine Co. |
| Burlington, Vt.... American Phonograph Co. | Montreal, Can..... Berliner Gramophone Co., Ltd. | Salt Lake City, U.. Consolidated Music Co. |
| Butte, Mont..... Orton Brothers. | Nashville, Tenn.... O. K. Houck Piano Co. | San Antonio, Tex... Thos. Goggan & Bros. |
| Chicago, Ill..... Lyon & Healy. | Newark, N. J..... Price Talking Machine Co. | San Francisco, Cal. Sherman, Clay & Co. |
| The Talking Machine Co. | New Haven, Conn. Henry Horton. | Savannah, Ga..... Phillips & Crew Co. |
| The Rudolph Wurlitzer Co. | New Orleans, La.. Philip Werlein, Ltd. | Seattle, Wash..... Sherman, Clay & Co. |
| Cincinnati, O.... The Rudolph Wurlitzer Co. | New York, N. Y.... Blackman Talking Machine Co. | Sioux Falls, S. D... Talking Machine Exchange. |
| Cleveland, O..... The W. H. Buescher & Sons Co. | Emanuel Blout. | Spokane, Wash... Sherman, Clay & Co. |
| The Collister & Sayle Co. | C. Bruno & Son, Inc. | St. Louis, Mo..... Koerber-Brenner Music Co. |
| The Eclipse Musical Co. | I. Davega, Jr., Inc. | St. Paul, Minn.... W. J. Dyer & Bro. |
| Columbus, O..... Perry B. Whitsit Co. | S. B. Davega Co. | Syracuse, N. Y.... W. D. Andrews Co. |
| Dallas, Tex..... Sanger Bros. | Chas. H. Ditson & Co. | Toledo, O..... The Whitney & Currier Co. |
| Denver, Colo..... The Hext Music Co. | Landay Brothers, Inc. | Washington, D. C. Robert C. Rogers Co. |
| The Knight-Campbell Music Co. | New York Talking Machine Co. | The E. F. Droop & Sons Co. |
| Des Moines, Ia... Chase & West Talking-Mach. Co | Ormes, Inc. | |
| Mickel Bros. Co. | Silas E. Pearsall Co. | |
| | Ben. Switky. | |



Right now is a remarkably appropriate time for you to write us for particulars.



(Write for "Music Money," a book "full of meat" for those dealers interested in quick and frequent turnover of capital.)

**Columbia Graphophone Company
Woolworth Building, New York**

"TALKERS" TEACH MUSIC IN KANSAS.

State Back of Campaign Being Carried on by Prof. Frank A. Beach. Head of the Music Department of the Kansas State Normal School—100,000 in Music Courses Last Year—250,000 Students Expected in 1915.

(Special to The Talking Machine World.)

TOPEKA, KAN., January 5.—The talking machine, backed by the State of Kansas, is teaching Kansans how to understand and appreciate good music. Last year nearly 100,000 persons studied the courses in music appreciation prepared by Prof. Frank A. Beach, head of the music department of the Kansas State Normal School, and made available to the general public by printed lectures and phonograph records.

This year at least 250,000 are expected to enroll in this unique music school, which will open its season in a short time.

The idea was first tried out by Prof. Beach on the students at the normal school in an effort to arouse the teachers in the grade and high schools to the need of teaching music to the children in the common schools.

A considerable number were found to be unable to teach music. The first move was to insist upon all students attending the recitals of the students and faculty of the normal school, but these lacked regularity and gradation and could not be formed into a successful music appreciation course.

Then Prof. Beach asked the State to buy his department a phonograph and the necessary records to form a complete music appreciation course, starting with the simplest melodies and gradually extending into the classics.

But the State school authorities refused to purchase the instrument. So Prof. Beach bought it

out of his own pocket and began giving regular graded lessons in music by the phonograph to the teachers. In a few weeks the value of the course was seen and the State purchased the instrument and also a player-piano for the school, and has purchased additional phonographs for the use of the movable music appreciation courses that are traveling throughout the State.

When the teachers went home and began teaching music or told their friends how they had learned enough about music to sit through a concert, vocal or instrumental, and really enjoy it, the folk who couldn't go to school began asking about it. So Prof. Beach compiled a series of lectures on music. He started with many of the beautiful and simple folk songs of Ireland, England and Germany and gradually took the student through a full course of music lessons, including Mendelssohn's "Spring Song," the "Hallelujah Chorus," the overture from "William Tell," and many other compositions coming under the designation of the lighter classics. Many of the phonograph records were prepared especially for the music appreciation movable school in Kansas.

Circles Pay Shipping Expense.

It is a circle proposition. A group of persons in any community ask for the course and contribute enough to pay the expense of shipping the records. The circles meet regularly, one series of songs or instrumental numbers being given each evening. One of the group reads the lecture prepared on each number by Prof. Beach and then the selection is played. The members of the circle discuss the selection, the manner of construction, the relation of the various parts of the composition, the characteristics of different voices and instruments, the different forms or molds in which

music is cast, and other interesting features of the music that would give the listener an understanding of the music. The ability to recognize and recall melodies is made a prominent part of the work. This phonograph music appreciation course was taken before more than 2,000 groups of Kansans during its first year. The demand this year is much heavier than ever before. The course is entirely free, except the expense of shipping the records. A result of the music appreciation course is a great interest in music throughout the State, and the lyceum and music bureaus cannot get enough artists to fill the calls for concerts in the Kansas towns, big and little.

The people have learned to understand and enjoy the concerts which once bored them, and which they attended only because they were fashionable, and hereafter, it is predicted, that musicians who tour the State will have no reason to find fault with "rural coldness."

DEATH OF LEN SPENCER.

Well-Known Recording Artist of Other Days Dies Suddenly in New York.

Len. G. Spencer, who in the early days of the phonograph was one of the most popular of the recording artists, died suddenly in his office in New York December 18. At the funeral services there were played several records made years ago by Mr. Spencer for that particular purpose, and which contained the Lord's Prayer and several Psalms. The remains were cremated.

After several years spent as a recording artist for the Edison, Columbia and other concerns, Mr. Spencer branched out as a manager of a lyceum bureau in New York, providing entertainment for various occasions, and was fairly successful.

DITSON *Victor* SERVICE

WE know every condition involving all Victor retail sales and we know that having the goods is an important factor towards getting the big profits. For your benefit, we maintain the largest stock in the East of Victor machines, records and supplies, and you can feel sure that your orders receive quick attention. The Ditson organization is trained to render the leading service and you can link up your store to our warehouse and feel safe.

Ask us to explain the value of Ditson co-operation. It means much to your business.

OLIVER DITSON CO., Boston, Mass.

UNPARALLELED DECEMBER TRADE IN CINCINNATI.

Factories Apparently Unable to Fathom Out the Extent of the Pocketbook of the Cincinnati Buying Public, Judging from the Inability to Supply Instruments — Close to \$20,000 in Orders Unfilled When the Holiday Rush Ended in Cincinnati.

(Special to The Talking Machine World.)

CINCINNATI, O., January 5.—Even though the talking machine business was scattered over a larger territory through new retailers coming into the field since last Christmas, reports from all sources indicate a phenomenal business. The factories apparently were unable to fathom out the extent of the public's pocketbook. From confidential sources it is learned that close to \$20,000 in orders remained unfilled when the holiday rush was over.

The situation is clearly outlined in the following interview with Manager Dittrich, of the wholesale Victor department of The Rudolph Wurzlitzer Co., whose retail section is to be enlarged more than a third this month on account of last month's development:

"The month of December was a big surprise to all concerned in the talking machine business, for while extensive trade was naturally looked for, neither dealers nor the factory were in a position to even begin to meet the tremendous demand for Victrolas and Victor records. The Christmas trade started exceptionally early in the season and continued with daily increase until it reached its climax on Monday, December 21, which was undoubtedly the biggest day that the talking machine trade ever experienced, and in fact was probably double that of the largest previous day on record.

"The feature of the holiday season was the almost universal demand for the cabinet style Victrolas, and the average price of the Victrolas sold during the holidays was over \$100. Dealers, in spite of large reserved stock, were absolutely unable to cope with the situation, and from reports gathered from various sources throughout the Central States we estimate that there must be many thousand dollars worth of business as yet unsupplied because of the shortage, which should very materially increase the sales during January and February.

"We have just announced to our retail trade that we are installing a new set of eight record booths on the main floor of our establishment in order to meet the increased demand which the heavy machine sales are causing. The record business is growing very rapidly, not only on account of Victrola sales, but also because of the fact that the Victor record is in demand universally.

"Conditions, in spite of the financial stringency, are exceptionally good and there is no question but what the remainder of the winter and the spring months will show an increase in proportion as great as the holiday season."

Throughout December and up into January business at the local headquarters of the Columbia Co. was characterized by strenuous hustle and bustle throughout the day and, let it be said, far into the night.

"Our holiday business was very gratifying," said Manager Whelen of the local Columbia store, "and we closed with a large increase over the same period last year. We were practically cleaned out and had we been able to secure all the stock necessary to supply the unprecedented demand and more room to accommodate the customers, results would have been far in advance of what they were. The factory, on account of the financial condition of the country, did not anticipate such a demand, that knocked all previous records in the head, and consequently were not prepared to fill all orders. The new \$85 Leader with the individual record ejector proved to be a winner and had we been able to get enough machines of this type could have more than tripled our sales on this machine alone. The higher priced machines seemed to be in the lead, although the smaller types held their own."

Mr. Whelen further said: "Business throughout the wholesale territory during the month was extremely satisfactory and all the dealers report a good holiday business. The year on a whole has been very gratifying and we are ready to pitch in with

renewed vigor to make last year's figures loom up small in the distance when the next glad New Year rolls around."

A Victrola as an aid to firemen fighting a fire is the proper thing. Owners should please take notice. Several days ago in the home of Miss Lillian Ludlow, 2446 Highland avenue, Mount Auburn, the Christmas tree caught fire, due to crossed wires. An SOS signal was sent out for firemen. They responded and started to work. While busy confining the spread of the fire the laddies were much surprised to hear the strains of "Nearer, My God, to Thee." Miss Ludlow had simply placed the record on her new machine and released the music. She believes the firemen used more energy after the music was started than upon the initial stages of the blaze.

An assortment of old machines, picked up in

Cleveland, it is said, were offered here during the holidays by Charles M. Robinson, who opened an office in the Glenn Building for the purpose. Robinson promised to donate half of his profits to any charitable institution.

The Cable Company had wonderful success with its Victrola department. But four machines were left on the floor Saturday, all the remainder of the stock having been sold out. The same is true of the Otto Grau Piano Co., which buys its goods from Chicago.

The Phonograph Company has lined up George Gross as an Edison disc deal. Gross used up considerable space in the newspapers during the holiday season.

While nothing official is available at this time, it is believed some of the piano houses, particularly those controlled by factories, will take up the handling of talking machines during the coming year. The officers find that their competitors, with phonograph supplies, are doing business every day of the year in addition to their piano lines, and this condition is said to have brought about a desire for a little more activity on their part as well as the profits which go with the business.

The New Idea Attachments

For

Victor, Edison, Columbia and Pathé Machines

gives YOU, Mr. Dealer, the opportunity of pleasing your customers, and incidentally increasing your own business. Why not order a sample of each of the following, and be convinced that WE always LEAD, and others follow.

Our New No. 1 Attachment to play Victor and Columbia Records on Edison Machine.

Our New No. 2 Attachment to play Edison Disc Records on Victor Machine.

Our New No. 3 Attachment to play Edison Disc Records on Columbia Machine.

Our New No. 4 Attachment to play Victor and Columbia Records on Pathé Machine.

Our New No. 5 Attachment to play Edison Records on Pathé Machine.

Our New No. 6 Attachment to play Pathé Records on Victor Machine.

Our New No. 7 Attachment to play Pathé Records on Columbia Machine.

Our New No. 8 Attachment to play Pathé Records on Edison Machine.

Write us for information and prices.

The Union Specialty & Plating Co.

409 Prospect Ave. N. W.

Cleveland, Ohio

The TALKING MACHINE WORLD

For the makers & sellers of talking machines

EDWARD LYMAN BILL, - - - Editor and Proprietor.

J. B. SPILLANE, Managing Editor.

Trade Representatives: GLAD HENDERSON, C. CRACE, L. E. BOWERS, B. BRITAIN WILSON, A. J. NICKLIN, AUGUST J. TIMPE, L. M. ROBINSON.

Boston: JOHN H. WILSON, 324 Washington Street.
 Chicago Office: E. P. VAN HARLINGEN, Consumers' Building, 220 South State Street.
 HENRY S. KINGWILL, Associate, Telephone, Wabash 3774.
 London, Eng., Office: 2 Gresham Buildings, Basinghall St. W. LIONEL STURDY, Manager.
 Representatives for Germany and Austria: VERLAG NEC SINIT, Berlin C. 19, Ross-Strasse 6, Germany. GEO. ROTHGIESER, Director.
 The Talking Machine World has regular correspondents located in all of the principal cities throughout America.

Published the 15th of every month at 373 Fourth Ave., New York.

SUBSCRIPTION (including postage), United States, Mexico, \$1.00 per Year; Canada, \$1.25; all other countries, \$1.75.

ADVERTISEMENTS: \$3.50 per inch, single column, per insertion. On quarterly or yearly contracts a special discount is allowed. Advertising pages, \$120.00.

REMITTANCES: should be made payable to Edward Lyman Bill by check or Post Office Money Order.

NOTICE TO ADVERTISERS.—Advertising copy should reach this office by the first of each month. By following this rule clients will greatly facilitate work at the publication headquarters.

Long Distance Telephones—Numbers 5982-5983 Madison Sq.
 Cable Address: "Elbill," New York.

NEW YORK, JANUARY 15, 1915.

A HAPPY NEW YEAR to talking machine men everywhere!
 May 1915 add to the prosperity records of this trade.

It is off with the old love and on with the new.

Gone is the Old Year, with its shadows and its sunshine—its triumphs and its sorrows.

Gone is 1914, a year unlike any other in all history—a year in which the whole world has been saddened by the greatest war of all the ages—a year in which, as a natural sequence, there has been disturbances of various kinds.

And yet, in casting a retrospective glance over 1914 it must be admitted that we have much to be thankful for. It must be conceded that much of our trouble is mental; that, after all, we have no real troubles, such as those destroying the warring European countries.

While we understand, to some slight extent, the magnitude and awfulness of this war, we should realize, to a greater degree perhaps, the blessings which are ours—the blessings which come from living in a country free from war and famine, and blessed with an agricultural yield which has added from eight to ten billions to its national wealth. That is something to think about—something to cheer the heart, as we face the future. For, after all, the world spends but very little time in contemplation of the past. We are not built on the yesterday plan.

If we turn toward yesterday—that is, the old year—we will perhaps see much to fill our minds with sadness and clog our mental machinery somewhat with despair and doubt. But why yesterday when we face to-morrow? Let us wisely improve the present.

Our greatest asset is the present time, and it is the only thing that we can truly call our own, and when we face the future let us face it in a sunshiny mood, and the sun always shines for the to-morrow mind!

Nineteen fourteen is dead—it is but a memory; but 1915—that is now with us—is large with promise and rich in the elements which make for human advance.

Of course, we cannot all be victors; some of us will be defeated in the New Year, and what is life but one defeat after another.

When some men meet with reverses it only seems to encourage them to bigger things.

The more energy you have, the more hard knocks you can receive and come up under them.

One type of man receives a sudden blow amounting to great reverses, and he sits down and howls with all the ginger departed from him. The other type wipes the blood from his face and strikes out, vitalized with a new force.

It is hard work to down a true fighting spirit, but no triumph can long stiffen the backbone of a whiner.

The men with chocolate éclair backbones have no place in the modern ranks of business fighters. They are simply cumbering up the earth, and are bound to be pushed aside by the triumphant army of producers—men who are trade builders in the truest sense.

The cruelty of fate cannot check the men with an unconquerable spirit. Those men to whom 1914 was a failure come up fresh on the threshold of 1915 with a smile on their lips and with an undaunted spirit. In other words, they strike out manfully for newer and bigger things. They are the kind of men who do not think of yesterday, because that is dead; but with them it is today—the New Year. It is to the scrap heap with failures of the past, no matter what they are, and it should be to the scrap heap with antiquated systems and a lot of suicidal policies which have hampered the business of the country in the past. Why stick to a method when its failure has been clearly proven by past events?

We have men in the talking machine trade of large vision—business builders—and we have others of the type who are always thinking of yesterday, and whose whole view of life is narrow and contracted. They are the road blockers, nothing else.

When we stand on the threshold of the New Year it seems to be quite time to figure out definite plans for the new twelve months, and if we have found by results that anything is radically wrong in our program of yesterday, why stick to it to-morrow?

The New Year can be a good one for talking machine men if they will do their part.

We cannot expect to have a good reaping unless there is planting of the right seed.

No use to sit back and theorize—work is the thing—and faith in our ability to win out.

EDISON jobbers were delighted to receive the following telegram dated from Orange on the last night of the Old Year: "At 8:30 p. m., December 31, 1914, we turned out finished Blue Amberol Records at the old stand, which was practically wiped out by fire on the night of December 9. Getting back to the ring in twenty-two days is going some. A Happy and Prosperous Year to you all."

Indeed it is going some, and it emphasizes that the Edison forces have improved every minute since the flames devastated the great Orange plant. The ashes were not cooled before preparations had been made for its immediate rehabilitation. Undaunted by the cold of winter and the fearful shock to the great enterprise by its destruction by fire, the Edison forces faced the situation resolutely, and in twenty-two days are "back in the ring." Such accomplishments are the results of concentrated and loyal effort on the part of every man in the organization. Edison enterprise again breaks all records regarding time accomplishments after a total destruction by fire.

May 1915 be a bright and prosperous year for this great American corporation, which, undaunted by a fire-swept plant in the midst of winter, has again scored a tremendous victory.

DURING the first part of 1914 the country, with nervousness and apprehension, faced a change in the whole economic structure brought about by a complete and almost revolutionary change in our tariff program. Naturally business would not adjust itself instantly to conditions which affected so many industries.

Then there was the fear of other legislation more or less disturbing, and this condition created nervousness among financial and industrial chiefs.

Surrounded by these influences, business moved along the first half of last year in a very unsatisfactory manner, and when the great European war came naturally the bad state existing was materially accentuated; but it should be remembered that business was of a most unsatisfactory nature before the war broke out.

While we may attribute a good many things to the war which is raising havoc in so many countries, yet, as a matter of fact, we should not forget that conditions in this country, financially, industrially and commercially, had reached a low point, if not the lowest point for years before the great struggle commenced in foreign lands. However, a new state of affairs has now been forced upon us and we are resolutely adjusting ourselves to them.

January will probably be a quiet month. It usually is, and there is no reason to expect that things will be changed materially for the better during the first month of the year. However, we

face the future with the fixed belief that the building-up process has arrived, and having been way down in the sub-cellar of doubt and uncertainty, we are now climbing to the upper stories.

The granting of the increased rates to the railroads has been a factor which is bound to make for business advance in hundreds of different ways. It gives the roads backing which will enable them to make purchases on a scale which will mean demands upon various lines of trade. Furthermore, it gives confidence to scores of industries and will give a foundation of the right kind for plans in the industrial world.

Now we know what we have to face, for a while at least, in tariff conditions, and the war in Europe has created a deficit in manufactures which we must make good, because we are the only great producing nation left, outside of the line of belligerents. We must make good and we will.

The American spirit never falters, and we are going ahead to bigger and better things during 1915.

Trade may reach a boom in many lines before the year is very old.

Many well-posted men feel assured of this and predict this happy state, but we are rather inclined to a more temperate view of the situation. We believe that the return to prosperity will be gradual, but that the move is in the right direction cannot be denied by those who are in touch with the fundamentals. Let us help the move with a boost rather than a knock.

There is every reason why we should face the future with a firm belief in the business prospects of the new year.

If business men sit around waiting for prosperity to come thundering at their doors they will wait a long time and they will have failed to do their part in bringing about the desired improvement.

There is no better way in which we can aid the general prosperity of the country than to show by our own acts that we ourselves have confidence in the business future of America.

Let us all be a nation of boosters rather than a nation of knockers. It is said in some cases that every knock is a boost, but in this case every knock helps to retard the wheels of prosperity to a certain extent. It is sand in the bearings.

If business men go ahead and make their arrangements for the

new year along systematic, regular lines, without hanging back to see what the other fellow is going to do, they certainly will have played a useful part in helping the onward march of prosperity.

There is much which this nation has to be thankful for. It is rich in every kind of resources—in fact, the richest nation in the world.

We are at peace with all nations and the country is peopled by the most progressive men on earth; but if we hold back in doubt we are not playing just the part we should in the nation's prosperity. Do not let us be holdbackers.

WHILE a large number of Aeolian Vocalion sales had been made from Aeolian Hall before the beginning of the year, the formal introduction of this product to the public did not take place until the beginning of 1915.

Striking announcements were then made in the daily papers of this new claimant for musical patronage. An unusual compliment was paid this new creation by complimentary notices which appeared in all of the leading dailies, emphasizing some of its distinctive features.

An introductory announcement was also made to Aeolian patrons through artistically prepared brochures in which some of the distinctive features of the Aeolian Vocalion were interestingly featured.

As previously stated in *The Talking Machine World*, the distinctive features of the Vocalion are the symphonetic horn, a new sound box, and, perhaps, the most important feature is a device termed the Graduola, which enables the operator to personally control the tone and power in the playing of a record.

The interest thus far created in the Vocalion has been at once a tribute to the strength of the producing company in musical New York.

The Aeolian Co., through its various American and European factories and branches in the principal cities throughout this country, is conceded to be the largest music trade organization in the world, and when such a corporation enters the talking machine field, it must be at once conceded that it has definite and clean-cut plans regarding the creation and distribution of this special product.

TRY SWITKY SERVICE

You can refer to any of our regular dealers. Ask them about our holiday service to them.

Speed, Accuracy, Fairness to All

The reason? **WHOLESALE ONLY**

Do not say that you can't get it until after you have tried us.

'PHONES, 7531-7532 MADISON SQUARE

BENJ. SWITKY

NEW YORK CITY

Thomas A. Edison Manufacture of Edison

It is with much gratification that we are able to announce the resumption of manufacture of Edison Diamond Disc and Blue Amberol Records. Both kinds of records were made in the fire swept buildings on December 31st (22 days after the fire). Shipment of Blue Amberol Records were made to Jobbers on January 10th and arrangements now made assure the beginning of shipments to Jobbers of Diamond Disc Records on February 1st.

So rapid has been the recovery from the fire that there will be no interruption in the Blue Amberol Supplements. The February supplement will be issued as usual. The weekly supplements of Disc Records will be resumed with the com-

n, Inc., Resumes Phonographs and Records

pletion of No. 20 (which was being shipped on December 9th) and the beginning of No. 21.

B-80 Disc Phonographs are now being brought through and shipments will probably begin on January 18th.

Shipments of \$30.00 Amberola Phonographs will begin about February 5th.

Then will follow shipments of Disc Phonographs, \$150, \$200 and \$250, and other types of Amberolas.

During February we expect to begin making shipments of all popular types in constantly increasing quantities.

THOMAS A. EDISON, Inc.

ORANGE, N. J.

THE TRADE IN BOSTON AND NEW ENGLAND

JOHN H. WILSON, MANAGER, 324 WASHINGTON STREET, BOSTON, MASS.

(Special to The Talking Machine World.)

BOSTON, MASS., January 9.—As the local talking machine houses review the business, of December, and the whole year of 1914 for that matter, there is a general feeling that the business certainly took a leading place among the most prosperous of the commercial lines. Scarcely a house but reports a good holiday business, and the great trouble seemed to be that the scarcity of goods badly handicapped most of the houses. This applied equally to machines and to many records, and there were some of the latter of which dealers seemed continually to be without. There were several cases where local managers went over to the home offices to try and get goods, but to no purpose, for it is reported that the cry from all over the country was the same; from the Victor, the Edison and the Columbia alike.

Helped in Demonstrating Work.

A group of men from the headquarters of Thos. A. Edison, Inc., who had been visiting various points in New England, have been visiting the Boston establishment of the Pardee-Ellenberger Co., Inc., at 26 Oliver street, where they helped greatly in demonstrating work. These men were Mr. Shearman, the manager of the department; H. R. Moses, H. A. Brennan, M. F. Jolliff, F. Bellidelli and F. G. Gilmore. They were thus brought into close touch with Mr. Pardee, head of the company, who has been making frequent trips over to Boston, and with Manager Silliman. These men have been able to fit into valuable places in the business and they have found much to do throughout New England.

Exultant Over Business Showing.

Manager Erisman, who has been over in New York conferring with the head officers of the Columbia Graphophone Co., is quite exultant over the business which his department has been able to show not only for December, but for the whole of last year, the increase over the preceding twelve months having been something unbelievable. Mr. Erisman says that the business building club of his house is arranging for a busy season, and in a fortnight there will be a gathering of the office staff at the Hotel Thorndike. It is hoped that with hearty co-operation and with the help of the factory to double the business during the coming year.

Joins Columbia Forces.

H. Tosi, formerly with the Tosi Music Co., of Boston, and later the representative of the Thomas

A. Edison Co. in Italy, with headquarters at Milan, is back in Boston and will associate himself with the Columbia Graphophone Co. He will take charge of the foreign record department for the Boston offices of the Columbia. As he is well acquainted with the talking machine business, Manager Erisman has made a good selection in him.

Pleased with Season's Business.

When The World correspondent called at the Eastern Talking Machine Co.'s Tremont street quarters a few days ago the season of stock taking had arrived and everyone was busy making out inventories. Thanks to a very busy season, the company did not have much stock on hand, and Manager Taft is well pleased over the holiday business, for toward the close of the year it was practically impossible to get goods.

A Visitor from Canada.

Harry Brown, pleasantly remembered a few years ago as one of the valued attachés of the Eastern Talking Machine Co., but who now is in Montreal, Can., with the Berliner Gramophone Co., was a caller in Boston a week ago and was cordially greeted by his many friends.

Honors for Arthur Erisman.

Manager Arthur Erisman, of the Columbia Graphophone Co., has been elected a member of the Boston Chamber of Commerce, and attended his first meeting of that body a few days ago. Mr. Erisman also has been elected a member of the product committee of the Columbia Co. and he will be called over to New York once a month to confer with the committee.

Did a Great Victor Business.

Business at the Victor department of the Henry F. Miller Co. in Boylston street made a good showing during the holidays, and Manager Batchelder reports that since the advent of the new year there has been a very good business in Victor outfits.

To Visit Friends in New York.

Chester J. Sylvester, manager of the talking machine department of the C. E. Osgood Co., and his brother, R. C. Sylvester, of the Columbia Graphophone Co., are planning to go over to New York for a week-end trip shortly. Both have many good friends in the talking machine business.

Visited the Trade in Maine.

Manager Royer, of the Arch street Victor quarters of the M. Steinert & Sons Co., was up in Maine for a few days looking over the field, and returning he said that the Maine dealers had

a good holiday trade, and the prospects were good for a busy winter and spring.

Some Distinguished Visitors.

Two of the featured people of "The Midnight Girl," playing at the Shubert Theater, are Miss Margaret Romaine and George MacFarlane, and during the week they have made several visits to the Tremont street quarters of the Eastern Talking Machine Co., where their records have been good sellers, especially by those who patronized the musical comedy.

A visitor to the Victor department of the Henry F. Miller Co. has been George Waters Douglas, who has lately returned from Europe, where before the war he had been studying grand opera. Some of his teachers have been Mme. Eames, Plancon and Tomagno.

Plans of the Talk Club.

The Talk Club of the Eastern Talking Machine Co. is making its plans for a busy season, and some interesting sessions are likely to be held during the winter, which will prove of profit and enjoyment for the members.

Developing Good Edison Business.

The Edison business of the Furbush-Davis Piano Co. in Boylston street has been developing at a rapid rate since the warerooms were opened about two months, and a number of sales of Edison diamond disc outfits have been made to some of the leading people of Greater Boston. John A. Davis, one of the partners in the combination and who devotes his attention largely to the Edison line, has returned from a visit to East Orange, where he went to confer with some of Thomas A. Edison's lieutenants regarding business details.

Demand for Gerville-Reache Records.

It is interesting that quickly following the announcement of the death of Mme. Gerville-Reache, the opera singer, who had been one of the Columbia artists, there was a surprising demand for her records at the Boston quarters of the Columbia. Her work as Delilah in "Samson and Delilah" had brought her into considerable prominence, and the particular aria of the opera was always a favorite.

Billy Fitzgerald Remembered.

Billy Fitzgerald, manager of the wholesale department of the Eastern Talking Machine Co., received as a Christmas gift a fine photograph of Fred J. Hager, at one time connected with the Boston Talking Machine Co. in Boston and a man whose friends are legion in the business. At pres-

PARDEE-ELLENBERGER CO., Inc.
BOSTON, MASS. NEW HAVEN, CONN.

ENO NEEDLES

Real Music
At Last

EDISON DIAMOND-DISC PHONOGRAPHS

THE TRADE IN BOSTON AND NEW ENGLAND

JOHN H. WILSON, MANAGER, 324 WASHINGTON STREET, BOSTON, MASS.

ent Mr. Hager is with the Rex Talking Machine Co., of Philadelphia. Mr. Fitzgerald also heard from George Cheney, also pleasantly remembered in the trade, who now is in Japan, where he is experimenting to find the most primitive language and is working under the auspices of a leading college.

One of Boston's Landmarks.

Those traversing the territory in the neighborhood of Washington and School streets in the downtown district are regaled every day now with the martial airs of some stirring band number, including "Tipperary." Upon looking about for the source of the music they find that it comes from the third story of the building occupied by Rosen's Talking Machine Shops. The stand is one of the famous landmarks of Boston, familiarly known as the Old Corner Bookstore; and with the additions lately made by Mr. Rosen to his suite, he now

has one of the largest retail talking machine shops anywhere about. His rooms occupy parts of two floors and number many rooms, including demonstration booths. Mr. Rosen always has on hand a large stock of Victor, Columbia and Edison outfits, language equipments and business Dictaphones and dictographs. Mr. Rosen's holiday business was very large and he expresses the greatest appreciation at the way he has been treated by the trade and the public.

Captivates Mayor of Boston.

An interested individual stood watching the dancing of Rastus in the Columbia Co.'s windows the other day and then he went inside and made a purchase of one, giving voice to his belief that it was one of the funniest things he ever had seen. He gave orders where it should be sent, and the astonished saleswoman discovered that her customer was Mayor Curley, of Boston.

warerooms for stock needed to supply demands. Early in the evening Manager Silliman received a wire from Thomas A. Edison sent from Orange, N. J., which read as follows:

"Have just heard your building is burning. I know how to sympathize with people who have fires. Hope loss is small. I know it will take more than a fire to stop you.—Edison."

"TOO MUCH CONTROL OF TRADE."

President Humphreys of Stevens Says Commissions Very Often Err.

(Special to The Talking Machine World.)

PROVIDENCE, R. I., January 4.—The tendency of the Interstate Commerce Commission and of the State Public Utilities Commission has been to extend their powers from regulation to general control of business enterprises, said President Alexander C. Humphreys, of the Stevens Institute of Technology, in an address to-night at Brown University, given in connection with its 150th anniversary celebration.

"While the Federal and State commissions have instituted some much needed reforms," he said, "they have done much which has been injurious.

"I am of the opinion that the great majority of those who are conducting our public service corporations are more ready honestly to co-operate for real progress and efficiency than are the representatives of the people, the politicians, amateur reformers, professional reformers and know-it-all cranks."

VISITS NEW ENGLAND TRADE.

H. A. Yerkes, manager of the wholesale department of the Columbia Co., and New England district manager, is expected back to-day from a trip through the South, on which he visited the prominent Southern cities of Atlanta and Birmingham, which are included in his territory. Mr. Yerkes' report of conditions in these cities indicate that business in the South is steadily approaching a normal status, with the people adjusting their affairs to the new conditions which confront them.

RUSKIN IS RIGHT.

No man ever got nervous prostration pushing his business; you get it only when the business pushes you. The *doing* that makes commerce is born of the *thinking* that makes scholars.—Ruskin.

PARDEE-ELLENBERGER CO.'S BUILDING DAMAGED BY FIRE.

Fire Originating on Second Floor of Building Causes Serious Loss to Company—Could Use Stock in New Haven Store to Meet Demands—Sympathy from Mr. Edison.

(Special to The Talking Machine World.)

BOSTON, MASS., January 8.—The Pardee-Ellenberger Co.'s building was badly damaged as a result of fire yesterday noon, but the extent of the damage, which is entirely from smoke and water, mainly the latter, has not yet been estimated. The fire originated in a paper stock warehouse on the second floor of the building, 26 Oliver street, into which the Pardee-Ellenberger Co. only moved about a year ago. It started in the rear, and the first thing that Miss Young, the office secretary, knew of any trouble was when the engines stopped short in front of the building, the first of the apparatus having been summoned by an automatic alarm. Manager Silliman was out at lunch at the time, and the only ones beside Miss Young about the Pardee-Ellenberger premises were Mr. Boyd, one of the salesmen; Mr. Carpenter, one of the shippers, and Billy Gibbs. At first no one thought there was anything serious, though they realized that there was considerable excitement overhead, but when the fireman ordered Miss Young and the others out they knew that it was something serious. The automatic was soon followed by a regular box alarm, and shortly after a third alarm was rung in, the second being skipped.

The firemen battled with a very smoky fire for three hours, but the protective corps was early on

hand and covered over all the Edison machines and cases of records, doing a pretty good job, too. All the windows in the floors above were smashed, but the large plate glass ones of the Pardee-Ellenberger Co. were saved. Manager Silliman early 'phoned to Mr. Pardee at New Haven and he came right up to Boston, arriving early in the evening. In the meantime the water began to pour onto the ground floor and run out into the streets in torrents, and the metal ceiling in the stock room at the rear was burst in several places due to a hot air explosion.

The heating apparatus in the basement and the electric lights were put out of commission, so that no one was able to work in the Pardee establishment to-day. The floors were covered with sawdust so as to absorb the moisture, and there were several pails about the place to catch the water that still continued to drip down. Mr. Pardee, in a conversation to-day, said that the house escaped well from a more disastrous loss, and it was fortunate, especially that no fire got into the company's quarters. By to-morrow it is expected that the heating plant will be in operation and the lights on by Monday. After the floors have been dried and cleaned up, the staff will be able to resume work. Mr. Pardee said that had the loss been any greater the house could fall back upon the New Haven

"MADE IN AMERICA"

63,000,000

IN 10 CONSECUTIVE DAYS

Still stands as the world's record for volume of output in talking machine needles.

Even with this remarkable volume, arrangements are under way to triple our capacity, due to the growing demand at home and abroad for Bagshaw-made Needles.

W. H. BAGSHAW,

Lowell, Mass.

Oldest and Largest Manufacturer—Established 1870.



Joan Sawyer, originator of the Fox Trot, teaches how to dance it in a free Columbia booklet just issued. See your distributor about getting a supply. The complete line of Columbia dance records is also featured in this book.



(Write for "Music Money," a book "full of meat" for those dealers interested in quick and frequent turnover of capital.)

Columbia Graphophone Company
Woolworth Building, New York

COLUMBIA CO. AT THE EXPOSITION.

Marion Dorian Tells of Visit to San Francisco and Arrangements Made for Columbia Exhibit at the Panama-Pacific Exposition—An Interesting Review of an Interesting Trip.

Marion Dorian, treasurer of the Columbia Graphophone Co., who recently returned from an extensive trip to the Coast, where he attended to the important details incidental to the Columbia Co.'s booths at the Panama-Pacific Exposition gives a very interesting account of conditions on the coast at the Exposition grounds. In addition to spending some time at San Francisco Mr. Dorian visited the various Columbia stores in this territory, where he found excellent business conditions prevailing in every case.

"At every point I visited I found a gratifying business situation," said Mr. Dorian in a chat with The World. "There was a noticeable improvement in all the large cities, and the Columbia dealers at every point I visited reported a brisk demand for Columbia goods. I received a number of compliments on our company's foresight in producing records of song hits, especially the records of 'Tipperary,' 'I Love You California,' 'Hawaiian Songs,' and '1915 San Francisco.' This last named song is a composition which won the prize offered by the San Francisco Bulletin for the best musical selection based on the Panama-Pacific Exposition in 1915. The composition is the work of two young men of San Francisco, brothers, Jacoby, by name, and their work was awarded the prize over

a number of competitors in popular competition.

"Walter S. Gray, our Pacific Coast manager, was prominent in this matter, and as soon as the award was made secured the necessary license from the composers, and the Columbia Co. made the records and shipped them out to the Coast, where they have had an enormous sale. The sales of 'Tipperary' ran into many thousands in the first month it was put out and is still going very strong. The same is true of the Hawaiian Songs, and 'I Love You California' is being sold to every person who owns a talking-machine on the Pacific Coast.

"The principal purpose of my visit to the Coast was to complete arrangements for the construction of our booth for the Panama-Pacific Exposition, and while I was in San Francisco a contract for its erection was concluded with the house of D. N. and E. Walter & Co., probably the largest furniture, carpet and decoration concern on the Pacific Coast. This firm has organized a very complete Panama-Pacific Exposition department for the erection of booths and the decoration of same. Mr. Gray was especially desirous of awarding the contract to a local concern if it was possible, but Walter & Co. would have secured the contract anyhow because of the superior merit of the plan they offered. The designs and plans for the booth were executed by Walter H. Coggan, who is an architect of long experience and has already distinguished himself by the work he has executed for the Exposition, having planned the magnificent Panama Canal exhibit.

"The construction of the Columbia Exposition booth will be under Mr. Coggan's immediate supervision and he declares it will be one of the gems of the Exposition. The Columbia Co. has secured desirable and ample space in the Palace of Liberal Arts. At the rear of this space will be erected the booth proper which will take the form of a beautiful building modelled along the lines of the Trianon at Versailles, with its graceful French windows opening upon the terrace which constitutes the fore part of the Columbia site.

The decorations of the rooms are being carried out in delicate shades of old rose, ivory and French gray, aided by a subtle lighting scheme of semi-indirect rays harmonizing perfectly with the exquisite tints of the decorations.

"The Exposition officials declare most emphatically that the Exposition will open on schedule time, February 20, and that it will be 80 per cent. finished on that date. It would have been entirely finished but for the interruption caused by the war. The officials and all the people on the Pacific Coast are confident that the Exposition will prove the greatest event of this nature ever presented and that it will be a permanent benefit to the entire country."

ADVERTISING AND SUCCESS.

The Policy Pursued by the Aeolian Co. and the Victor Co. Praised by Printers' Ink.

In an editorial entitled, "Advertising Which Is Bigger Than the Goods," Printers' Ink referred to the advertising of two prominent musical concerns as follows:

"The success of concerns like the Victor Talking Machine Co. and the Aeolian Co. is due in no small degree to the fact that they were wise enough to advertise 'music in the home,' instead of merely harping upon the superlative merits of their own goods. In short, the advertising of such concerns has been 'bigger than the goods.' It has concerned itself not alone with the advertiser's business, but has gone much further in adapting itself to real needs of the public. The proof that advertising is an economic and social benefit is to be found in campaigns such as these."

THE VINTAGE OF WISDOM.

The mintage of wisdom is known that rest is rust, and that real life is in love, laughter and work.—*Elbert Hubbard.*

It sometimes costs more to neglect a duty than it does to perform it.



Marion Dorian.



**DO YOU WISH
TO PLAY
EDISON DISCS?**

Attachment Complete with Permanent
Sapphire Needle

Price \$2.00

(Sample Mailed to Dealers Upon Receipt
of \$1.00)

LEXTON SPECIALTY CO., 216 West 99th St., N. Y.

Pathé Frères Phonograph Co.

Cable Address:
Pathephone, New York
 Telephones 1989 Greeley

29-31-33 West 38th St.

Pathephone
Pathegraph
Pathe Discs

New York, January 15, 1915

TO THE TALKING MACHINE TRADE

Gentlemen:

That great genius, Thomas A. Edison, knows the phonograph business if anybody knows it. He has been in it and at it since its inception, and when he realized that the cylinder record was a thing of the past, and therefore took up the disc, what did he do?

He recorded and put out his discs with the up and down cut. He could have produced the lateral or needle cut if he wanted to, but he chose the up and down cut because it is better and truer.

When Pathé changed from the cylinder record to the disc, he also chose the up and down cut because he, too, found it better and truer.

But Pathé has something which no one else has. Pathé has a sapphire ball, which rides the discs like a boat on the waves. It is not thrown from side to side like the needle on the lateral cut records, which is bound to wear the records, break down the walls, and then impair the tones.

The explanation of the Pathé sapphire ball principle is easily understood: it is the difference between running a blunt pencil across the back of the hand without injury to the skin, and doing the same thing with a sharp steel point, with a weight behind it equal to the weight of a soundbox, and run at the speed at which the disc travels under the needle. Do it half a dozen times, and you will scratch in under the skin. The blunt point does not wear the records and shows practically no wear itself. It can be run transversely across the record, without injuring it. The blunt point does something else. It catches the tone waves on the side of the cut as well as those tone waves which lie at the bottom, and therefore reproduces tones which are lost by any other method.

The time is coming when the blunt point and the up and down cut will dominate the phonograph field.

Now is the time to get in with the Company that has the blunt point, that has the up and down cut, and that has the repertoire.

Yours truly,

PATHE FRERES PHONOGRAPH CO.

CLEVER STUNT WITH THE VICTROLA.

Manager of the Regent Theater in Buffalo Pays Tribute to the Wonderful Perfection of the Modern Talking Machine by Replacing Human Singers with the Victrola and Agreeably Fooling the Audience.

(Special to The Talking Machine World.)

BUFFALO, N. Y., January 7.—Just how much of an element of perfection in the creation of the sounds of the human voice has been attained in the latest high price models of talking machines was forcibly and clearly demonstrated last week, when a brand new and startling innovation into the local theatrical world was born by Manager Gus Schlesinger, of the Regent Theater, an amusement palace located in Buffalo's most fashionable residential section at Main and West Utica streets.

Manager Schlesinger used a Victrola in such clever fashion, that many left the theater wondering where the opera singers had been secreted, inasmuch as a troupe of trained soloists had appeared on the stage but a short time before the Victrola was set in action.

The Victrola was introduced as part of the performance scheduled for "Grand Opera Week." High class singers known as the "Milano Quintette" offered operatic numbers, and as soon as they withdrew from the stage the music from a Victrola floated into the big auditorium from the wistaria covered crest in the rear of the house. The machine was completely hidden, and the audience craned necks long in an effort to locate the singers.

With the completion of the Victrola offering, the operatic singers appeared. Applause in large measure came as a finale to each Victrola number. Every night throughout the week the big Victrola was used with success. With the opening of the number on the Victrola the lights were dimmed and more of a surprise created when the audience, upon brightening of the lights, saw that the singers were not on the stage. When the plan was discovered the Victrola selections were applauded generously, all of which tends to show that the talking machine has considerable of a grip on the Buffalo taste for music.

DICTAPHONE PROMOTIONS.

N. F. Milnor, for the past two years New York sales manager of the Dictaphone division of the Columbia Graphophone Co., has been appointed sales manager of the general Dictaphone business, with headquarters at the executive offices in the Woolworth building. John C. Button, principal assistant for several years to General Manager Frank Dorian, of the Dictaphone division, has been appointed New York sales manager to succeed Mr.

Milnor. John S. Baker, assistant New York sales manager, has been promoted to the executive offices to assist Mr. Dorian in various capacities. These men are all "live wire" Dictaphone promoters.

NEW STRUCTURE IN SPOKANE, WASH.

Sherman, Clay & Co., Now Settled in Handsome New Building in That City.

(Special to The Talking Machine World.)

SPOKANE, WASH., January 9.—Sherman, Clay & Co., who moved into their new building in this city on December 1, are now well settled in the new quarters and have found that the additional space available has come in very handy in taking care of the holiday business. As will be seen by



Sherman, Clay & Co. Building in Spokane.

the accompanying illustration the new building is handsome in appearance and strictly up-to-date in arrangement. The new building is of modern slow burning construction, and in every way ideal.

Sherman, Clay & Co., some time ago decided to remodel or reconstruct several of their important branch stores, and the Spokane building is the first fruit of this resolve. The next store to be taken in hand will be the branch located in San Jose, Cal.

SPECIAL RED SEAL PAMPHLET.

The Victor Talking Machine Co. advised its trade last week that it has in preparation a special Red Seal pamphlet listing records by a number of prominent Victor Red Seal artists. The company states that it was impossible to present these records in the regular monthly bulletins owing to the

reduction in size of these bulletins during the summer months. It is suggested that these records should be presented to the public during the present opera season.

This special Red Seal list as announced in this preliminary folder includes recordings by such famous artists as Caruso, Bori, Amato, Emmy Destinn, Fritz Kreisler, Melba, Schumann-Heink and many others.

VICTOR CO. TO SPEND \$1,000,000.

Big Talking Machine Company to Extend Plant in Camden—A \$30,000 Restaurant Building and a Hospital for Employees Among the Features Planned by the Company.

(Special to The Talking Machine World.)

PHILADELPHIA, PA., January 6.—The Victor Talking Machine Co., according to Louis F. Geissler, its general manager, is about to let contracts for a \$1,000,000 extension to its plant in Camden, N. J. A \$30,000 restaurant and a hospital building, representing part of \$1,000,000 already placed under contract this year, are nearing completion.

The restaurant will be for the convenience of the officials of the company and heads of departments. The hospital is to be thoroughly equipped for the treatment and care of any of the 6,200 employees.

The big plant is now operating twenty-four hours daily. To increase its capacity one of the new contracts provides for a power house and additional machinery which will add 2,000 horsepower, at an estimated cost of about \$150,000.

TO OCCUPY LARGER QUARTERS.

Wholesale Branch of the Columbia Graphophone Co. Will Move on February 1 from No. 89 to No. 83 Chambers Street, New York.

The local wholesale branch of the Columbia Graphophone Co. will move on February 1 from 89 Chambers street, where it is now located, to 83 Chambers street. Arrangements to this end were completed last week, and Manager Bolton is now busily engaged in making plans for the furnishing and decorations of the new store.

The company will have twice as much room in its new store as it now has, as it will occupy the store, basement, sub-basement and first floor. On the first day of May the local division of the Dictaphone department will also remove from 261 Broadway, where it is now located, to the building at 83 Chambers street, occupying a part of the first floor. In its new home the Columbia Co. will have ample facilities for expansion and will not be handicapped for any lack of space, which has hindered it in its growth the past year.

Pearsall Victor Service New York

WHAT the Victor dealer wants to-day is more of a "friendly service"—a service which not only involves the quick and complete furnishing of Victor machines and records, but includes co-operative consulting with regard to business management in general. This is the character of Pearsall service, and this is why a large number of new dealers have been enrolled as Pearsall boosters.

Test our service! It will prove profitable to you.

Silas E. Pearsall Co.

Victor Distributors

18 W. 46th St. (near Fifth Ave.), NEW YORK

THE AEOLIAN VOCALION FORMALLY LAUNCHED.

New Musical Creation of the Aeolian Co., New York, Arouses the Enthusiasm of Critical Music Lovers—Wins Much Favorable Comment—Its Special Features—Ambitious Plans for Its Exploitation Will Result in General Interest Throughout the Country.

For a long time past it has been current trade knowledge that the Aeolian Co., through its mechanical experts, was making a close study of the talking machine field in its various phases of development. As a result, in the latter days of 1914 a new Aeolian product was created. This has been referred to in a previous issue of *The Talking Machine World*, but it was not until the first of the year that the new product of this great music

registers and varying timbre are amplified with uniformity.

Artists and others who have listened to the tones of this new creation have been enthusiastically outspoken in their admiration of its musical accomplishments.

Naturally, everything which the Aeolian Co. does is planned on a vast scale, and it is understood that the Aeolian Vocalion within the near future will



Aeolian Vocalion, Style K.

arations to sail for home. Just before leaving, however, he called to say "good-bye" to H. S. Spottiswoode, chairman of the famous old English firm of piano manufacturers, Broadwood & Sons, with whom he was acquainted. Mr. Spottiswoode earnestly advised him to show his model to the Aeolian Co.'s London house, assuring him of consideration and courteous treatment if nothing else.

This advice he followed, and A. J. Mason, head of the Aeolian Co.'s European business, was so impressed that he secured an option on the patents and sent Mr. Empson to the home office in New York.

The features of the Empson invention appeared so obviously valuable to the officials in New York that exclusive rights for the entire world were secured, and Mr. Empson returned to Australia not only enriched financially, but highly pleased with the recognition and courteous treatment he had received.

In the two years that have elapsed Aeolian experts have been intensively at work developing the mechanical principles of phonographic construction, bringing to the task the wide knowledge of
(Continued on page 22.)



The Vocalion Salon on Third Floor of Aeolian Hall.

trade organization, designated the Aeolian Vocalion, was formally presented to the public.

Naturally, when a great organization, with ramifications extending throughout the globe, enters the talking machine domain as manufacturers, it creates a good deal of comment. Hence a brief

description of the Aeolian Vocalion will be interesting to World readers. The illustrations which accompany this article are views of two models of the Aeolian Vocalion, of which, we may remark, there are many, and it is the intention of the officials to specialize in designs which will conform with period furniture.

The history of the product will be interesting: In the latter part of 1912 F. J. Empson, of Sydney, Australia, appeared in London, England, with an invention for controlling phonographic tone. He expected that English manufacturers would jump at the chance to buy his patents. Instead he met with a series of rebuffs which so discouraged him that he purchased his return ticket and made prep-



Aeolian Vocalion, Style L.

description of the Aeolian Vocalion will be interesting to World readers.

The illustrations which accompany this article are views of two models of the Aeolian Vocalion, of which, we may remark, there are many, and it is the intention of the officials to specialize in designs which will conform with period furniture.

The tonal effects of the new Aeolian Vocalion are in many respects remarkable and strikingly original. It may be said that one of the distinctive features of this product is the Graduola, a device which enables the user to modify tone volume. The Graduola affords an outlet for the individual's tone modulation or control.

There is also a new improved sound box and a horn, termed the Symphonetic, which is made up of a series of wood sound boards under tension—in effect they are quite similar to the sounding board of the piano—arranged above the metal composition horn. By this arrangement tones of all



The Aeolian Vocalion Quarters on Second Floor, Aeolian Hall.

The New Master-Phone Red Needle

The Long-Looked-For, Long-Hoped-For
Improvement in Talking Machine Needles Realized

PLAYS FIVE TO TEN RECORDS WITHOUT CHANGE

IN the prodigious growth and development of the talking machine business, improvements have been coming thick and fast, and they will continue to come until the PERFECT talking machine has been presented.

There have been improvements in sound-boxes, improvements in records, improvements in cabinets. But in the matter of NEEDLES there have been few genuine improvements.

Now comes the ONE BIG IMPROVEMENT IN NEEDLES—as far ahead of anything else that has been offered as the present record is ahead of the old wax record.

*The
First Real
Composition
Needle*

The trouble with the ordinary steel needle has been that IT IS HARDER THAN THE RECORD. In playing a composition record, the walls of the sound-waves are inevitably worn away or crushed by the metal of the needle.

Wood fibre has proved a poor substitute because the wooden point, no matter how hard, must splinter and mushroom.

The MASTER-PHONE RED NEEDLE, which is just making its appearance, is a COMPOSITION NEEDLE—a new substance softer than the record itself, and yet taking the firm, sharp point of ivory.

Manifestly, composition against composition will not scratch and wear away like steel against composition.

You will agree that, if it gives as smooth and natural a tone as a steel needle, and IF THE POINT DOES NOT WEAR OFF, the composition needle is the LOGICAL NEEDLE.

*Velvety
Smoothness
and Fullness
of Tone*

Repeated tests show that the new Master-Phone Red Needle will play FROM FIVE TO TEN RECORDS WITHOUT BEING CHANGED.

In its private "try-outs" it has won the admiration of the best judges of needle quality in this country and in Europe.

In making the Master-Phone Needle, these were the aims of its inventor:

To provide the needle that would play the greatest number of records without change.

To get ALL THE VOLUME and ALL THE SWEETNESS out of each record, with the minimum wear and tear.

To minimize the "scratch," or murmur, inevitably produced as part of the reproduced sound when steel is dragged over composition records.

To avoid all the objectionable features of the "fibre" needles, such as the muffled, or guttural, effect; and the splintering of the point before a single record is finished, which sometimes happens.

It was not an easy job—because no composition was known which POSSESSED ALL OF THESE QUALITIES.

*A NEW
SUBSTANCE
WAS
PRODUCED*

After more than a year's experiments the proper ingredients were brought together, to make what is at once the softest and the toughest of needles.

It is unlike any other needle ever produced. It seems incredible that this new needle, when it is in the needle-socket of the sound-box, may be dragged ACROSS THE SOUND WAVES without the slightest injury to the record. It will not score the record—will leave no visible mark.

*The Aim
of the
New Needle's
Inventor*

Send for Samples! Get in Early!

THE MASTER-PHONE CORPORATION

286 Fifth Avenue, New York

The New Master-Phone Red Needle

Softer Than The Record Itself—Made of a
New Composition Substance—More Durable Than Steel

PRODUCES FULL, RICH VOLUME AND SWEET TONE

THE point of the Master-Phone Red Needle is MORE PERMANENT than the point OF ANY NEEDLE EVER BEFORE PRODUCED.

If that were its only superiority over other needles, it would be sufficient to make it THE MOST POPULAR TALKING MACHINE NEEDLE MANUFACTURED.

*Will Save
Thousands of
Dollars in
Records*

But while the needle wears longer, by its use the record is ALSO made to wear longer.

When you consider the millions of dollars invested in talking machine records, the value of this feature of the new needle is apparent.

In the heaviest operatic records, in which the sound-waves are most acute, actual tests show that SOMETHING MUST GIVE WAY every time they are played with a non-elastic needle.

The steel needle CAN'T give way. The walls of the record must give way. They do not collapse, but the "overtones" are so injured with thirty to fifty playings with a steel needle that it is very noticeable.

This Master-Phone composition needle CAN NOT injure the overtones. It leaves every record in the condition in which it found it.

With the heaviest records only, like the Sextette from Lucia and the Caruso-Ruffo records, it should be used but once.

With ordinary records it may be used to the limit of five or ten times, AVOIDING THE BOTHERSOME CHANGE OF NEEDLES.

As soon as the character of this needle is made known—which will be done immediately by advertising—the demand for it will be universal.

*The Demand
For This Needle
Will Be
Universal*

It produces an indescribably smooth, sweet tone with both voice and instrument records—totally unlike the fibre needle, and without the staccato impact of the steel needle.

*Send for
Samples and
Try It
Yourself*

The very novelty of the needle—its total dissimilarity from all other needles, and the sweetness of the tone produced, mean an unusual initial demand.

The dealer who does not prepare himself for this demand will be overlooking an unusual opportunity to prove his progressiveness.

There is a good profit in this needle for the dealer. HIS INTERESTS HAVE BEEN FULLY PROTECTED IN THIS RESPECT.

Do not delay. Leading dealers in New York have placed big initial orders.

Within a few weeks the MASTER-PHONE RED NEEDLE will be the SENSATION OF THE TALKING MACHINE WORLD.

*We Urge All Dealers
to Send in Their Names
for Samples with the
Least Possible Delay, In
Order That They May
Be Prepared for the
Demand.*

The Demand For This Needle Will Be Unprecedented!

THE MASTER-PHONE CORPORATION

286 Fifth Avenue, New York



The Columbia line is beautifully complete—a full line of disc instruments from \$17.50 to \$500, an unmatched record product—and a rapidly growing popularity and good-will in the name “Columbia” which gives the dealer something to look forward to.



(Write for “Music Money,” a book “full of meat” for those dealers interested in quick and frequent turnover of capital.)

Columbia Graphophone Company
Woolworth Building, New York

AEOLIAN VOCALION LAUNCHED.

(Continued from page 19.)

the science of sound which has enabled these men to build world-famous pipe organs and pianos.

Great changes have been made at Aeolian Hall, New York, so that a vastly enlarged and beautified department, devoted to the sale of talking machines, has been the result. The illustrations which accompany this article will show two of the interior views of what are termed the magnificent new Vocalion Salons. These were opened just before the holidays and have handled a surprisingly large volume of business.

LARGER QUARTERS FOR PATHÉ.

Lease Large Warehouse on 31st Street, New York, to Meet Demands of Growing Business—Policy of Expansion Continues.

The Pathé Frères Phonograph Co., 29 West Thirty-eighth street, New York, manufacturer of the Pathéphone and Pathé records, has been obliged to lease additional quarters on Thirty-first street to take care of the rapidly increasing demands of its business. These new quarters will be used as a warehouse and as a medium for supplying extra shipping facilities, which the company has needed for some time. Carrying out its general plans for expansion, the Pathé Frères Phonograph Co. this month engaged a number of successful travelers, who will visit all parts of the country in the interests of the Pathé Frères products. These new road men thoroughly understand the requirements of the

phonograph dealer, and will be equipped to extend to the Pathé Frères dealer valuable co-operation from many standpoints.

“We have been working nights and Sundays to keep pace with the demands of our trade,” said an officer of the company in a chat with The World. “Our progress has been country-wide, and in the East particularly we have been fortunate in securing the accounts of a large number of dealers who are enthusiastic regarding the merits of our goods.

“We have had absolutely no trouble in receiving goods from abroad, and as a matter of fact some of our recent shipments have been among the largest received at this port since the war started. Our advices from abroad indicate that excellent and uninterrupted shipping facilities will continue.

SHIPMENT OF LEXTON NEEDLES.

Just Received by the Lexton Specialty Co. Will Enable Company to Fill Pending and Future Orders for Attachments Promptly.

The Lexton Specialty Co., 216 West Ninety-ninth street, New York, manufacturer of the Lexton attachment for playing disc records of the hill-and-dale, or Edison type on Victor machines, has just received a liberal shipment of Lexton sapphire pointed needles which will enable the company to fill all pending orders and place it in a position to take care of future demands promptly. The Lexton needles are specially designed to withstand constant usage without damaging the record, and in connection with the Lexton attachment have given general satisfaction.

“REK-REP” WILL INTEREST TRADE.

Devotees of the Dance Using the Talking Machine Will Rejoice at the Appearance of This Invention That Has Recently Been Put on the Market by the Record Repeater Co.

The Record Repeater Co., 432 Fourth avenue, New York, has just placed on the market a new device termed the “Rek-Rep,” which can be used on Victor, Columbia and Aeolian Vocalion machines to repeat a record any number of times without requiring the attention or touch of any operator. Plans for marketing this device through trade channels have been carefully perfected, and in this issue of The World the company sets forth the sales arguments on behalf of the “Rek-Rep” and other important details.

Since the advent of the dance craze the complaint has often been expressed by dance devotees that the dance records, while perfect in tempo and rhythm, did not last long enough to bring out the true beauty of the dance music, and that the interruption caused by putting on a new record or even preparing the machine for a repetition of the same record seriously annoyed the dancers. It is this interruption that the Rek-Rep eliminates.

The Rek-Rep, which can easily be attached to the machine by slipping it through the center of the turntable, is essentially simple in every feature, and weighs only 1½ ounces. It is finished in brass or nickelplated, and its retail price of \$2 places it within the reach of all dance enthusiasts. A feature of the Rek-Rep is the embodiment of a small attachment which will stop the record after it has been played once or twice, or will permit the record to be played indefinitely.

E. H. Presbrey, inventor of the Rek-Rep, who is well known in local manufacturing and commercial circles, states that the Record Repeater Co. has carefully investigated the requirements of the dancing public, and that the production of the Rek-Rep should prove a boon to dancers and a boom to the dance record trade. Mr. Presbrey has received an enthusiastic letter of praise in connection with the Rek-Rep from Mr. and Mrs. Vernon Castle, the prominent dancers who are using the Rek-Rep continuously in Castle House. The Record Repeater Co. includes among its directors the names of well-known financiers and members of the commercial world.

GRANTED “NYACCO” TRADE-MARK.

The New York Album & Card Co., 23 Lispenard street, New York, well-known manufacturer of disc record and photograph albums, has just been granted the trade-mark rights to the term “Nyacco,” which will hereafter be placed on all albums turned out in its factory. This trade-mark is featured in a neat design which is both dignified and attractive.

Philip Ravis, vice-president of the company, states that the new year had started in very satisfactorily, and that within the past fortnight a number of new accounts for the “Nyacco” record and photograph albums have been added to the company's books.

Two Greatest Musical Comedy Hits of Broadway

“TO-NIGHT'S THE NIGHT”

Music by Paul A. Rubens

The Only Way.....	\$0.60
I'm a Millionaire.....	.60
Please Don't Flirt with Me...	.60
Pink and White.....	.60
Stars.....	.60
Around the Corner.....	.60
I Could Love You If I Tried...	.60
Vocal Score.....	2.00
Selection.....	1.00
Waltz.....	.60

TWO BIG DANCE HITS

LOVE IN A GARDEN, VALSE.

By Reginald Benyon.

MIDNIGHT VALSE.

By Theodore Holland.

“CHIN-CHIN”

Music by Ivan Caryll

Good-bye Girls, I'm Through..	\$0.60
Love Moon.....	.60
Ragtime Temple Bells.....	.60
Violet.....	.60
The Grey Dove.....	.60
The Mulberry Tree.....	.60
Vocal Score.....	2.00
Fox-Trot.....	.60
Waltz.....	.60
Selection.....	1.00

LATEST SONG SUCCESSES

Little Grey Home in the West.

By Hermann Lohr.

Wonderful Garden of Dreams.

By Dorothy Forster.

In Keys to Suit All Voices

Write at Once for Rates to Dealers

CHAPPELL & CO., Ltd.

41 East 34th Street, New York

LONDON

347 Yonge Street, Toronto

MELBOURNE

MANUFACTURING IN FULL SWING AT EDISON FACTORIES.

Remarkable Achievement Since the Fire in Getting Plants Ready for Manufacturing Records and Phonographs—Chats with General Manager Wilson and President Thos. A. Edison.

A visit to the Edison plant will show that astonishing, almost miraculous, results have been achieved since the plant was fire swept on December 9.

Thos. A. Edison's fund of physical and mental energy is astounding. Early and late he is superintending the rejuvenation of his plant, and he maintains the closest personal interest in every phase of development, and with the enthusiastic co-operation of all the officials and departmental heads.

To say that Mr. Edison is enthusiastic over the rebuilding of his plant is to use a mild term. He is bubbling with energy, and has spent no time in counting his losses. Mr. Edison is not built on the yesterday plan. He predicts for 1915 a most prosperous year. Discussing business conditions, he remarked:

"Now is the time for the United States to go ahead. We can manufacture cheaper to-day than in many years to come. However, many of our best business men seem to be penny wise and pound foolish. I am surprised that commercial and industrial America has been affected with a form of paralysis, evidently as the result of the war in Europe. This is all due, however, to unnecessary alarm.

"The railroad rate decision," Mr. Edison continued, "was a good thing. The railroad business is our commercial barometer. When you cripple the arteries of trade there is always trouble. I am satisfied with the increased rate and it will cost me thousands of dollars, but I am going to get it all back in increased trade. I think that public opinion is in favor of the increase. The Federal reserve act has proved its worth already."

C. H. Wilson, vice-president and general manager of the Edison interests, as might be imagined, is a mighty busy man these days. There is, too, a well accentuated air of satisfaction in Mr. Wilson's attitude toward Edison accomplishments since the fire.

When asked by The Talking Machine World for some specific statement for the Edison jobbers and dealers throughout the country, concerning the ability of the Edison factories to supply stock, he remarked:

"Edison jobbers and dealers are probably more interested in knowing how soon we shall begin the manufacture and shipment of goods than in knowing what we have done since the fire. Yet a few facts about the past month may be worth stating. They will show how hard we have worked to resume business and thereby reduce to a minimum the inconvenience to the trade caused by the fire.

"The task that confronted us on the morning of December 10 was twofold: To clean up and arrange to resume business. The cleaning up work was comparatively simple, for it was all in sight and a small army of men completed it in ten days. The waste was carted away and machinery, parts, etc., were salvaged.

"Plans for resuming business divided themselves into two parts, one providing for record manufacture and the other for phonograph manufacture.

"To make records we have put in workable shape three-fourths of the floors in building 24 (always used for record making), and have erected two one-story corrugated iron structures, each about 60x150 feet in size, one for making disc blanks and the other for record stock, storage and shipping. These facilities enabled us to actually make both disc and cylinder records on December 31 and to begin shipments to the trade of blue amberol records on January 10, with a reasonable assurance that we may begin shipments of disc records on February 1. Another corrugated iron building will be begun at once, and the work of completing No. 24 will be pushed unremittingly. By February 1 our record making facilities will be nearly as large as they ever were. We should then be in a position to fill all orders for weekly or monthly records and a considerable number of catalog selections.

"Since our entire stocks of records issued prior to December 9 were destroyed we must now re-

place them with new products. There were some 340 different disc records listed prior to December 9, and about 1,000 different blue amberol records. We shall handle this replacement by advising the trade of our intention to make a given number of selections at a time, say, fifty disc records and 100 cylinders, and asking for orders accordingly. As our facilities increase these blocks will be enlarged until we are able to fill orders for all records cataloged. This should not be later than April 1.

"The manufacture of phonographs was a much larger task and involved much more in the way of buildings. Because of its magnitude and the cold weather we decided not to attempt to resume this manufacture in our own buildings. Fortunately, several floors of the large, new concrete extension of the buildings of the Edison Storage Battery Co. on Lakeside avenue, opposite our own plant, were not yet occupied. We at once arranged for the use of these floors, installing large numbers of machines of various kinds salvaged from our own buildings and buying others. We were also able to begin the manufacture of many parts on the machines of the Edison Storage Battery Co. So quickly was the equipment of this building accomplished that we were actually able to make a B-80 disc phonograph on December 31, and are now planning to begin shipments of this type to the trade on January 18. Located in this building are the following departments: Punch press, screw machine, jewel, reproducer, gear and lathe, drill, press, japanning, japan cleaning, sheet metal, grinding, finished parts, phonograph assembly, packing and shipping. Two large buildings on the north side of Alden street escaped the fire and other departments were at once quartered in them.

"Then we leased complete the large five-story factory of the Ellis Typewriter & Adding Machine Co. in Newark. This plant is fully equipped with up-to-date machinery and tools. We put a large force of our own workmen in the plant, and within a week they were making parts. We also took over the factory of the Bulkley Manufacturing Co. at High and Alden streets, a plant especially equipped for heavy work.

"While these plants were being manned and equipped we put into the hands of a dozen or more outside companies all of our work that each could handle, and each is working overtime to take care of it.

"From all of this it will be seen that we have acquired large facilities for manufacturing phonographs. From now on our only trouble will be to get started with assembled machines and to increase the output. By February 5 we expect to begin shipments of the \$30 Amberola. There will shortly follow disc types 150, 200 and 250, and other types of Amberolas. During February all popular types will be going through in constantly increased quantities."

The statement of Mr. Wilson is full of interest to Edison representatives everywhere, and it places in a comprehensive manner before the trade the exact situation of the Edison physical properties up to the time of The World going to press.

LINDSTROM OPENS IN NEW YORK.

Otto Heinemann Opens Office at 45 Broadway, Where Company's Motor Trade Will Be Developed—An Extensive Organization.

Otto Heinemann, of Berlin, Germany, has opened an office in New York City, where he will manage the American distribution of the products of the Carl Lindström Co. The Lindström organization is one of the largest of its kind in Europe. Its production of motors and machines run over half a million every year. This immense number of motors is distributed throughout all parts of the world and has earned for itself a very high reputation. This concern also is the parent company of numerous record manufacturing concerns, such as the Beka, Odeon, Favorite and Fonotopia. The New York office is located at 45 Broadway, where sample lines are carried.

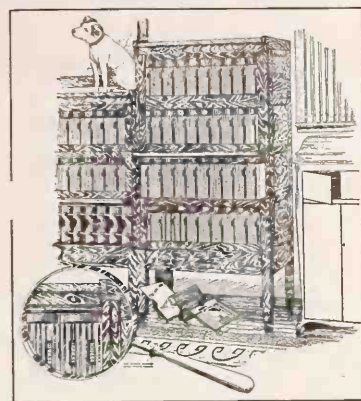

"Double Our Order"

We recently shipped an order of the

OGDEN SECTIONAL RECORD AND FILING SYSTEM

to a large dealer. Upon receipt of the goods he wired:

"Duplicate finish, double our order, ship quick."

Another dealer says:

"Sectional cabinet is clever and filing system is the best yet."

If you want to make more money, save time and cut out your dead stock of records, investigate the OGDEN SECTIONAL RECORD and FILING SYSTEM—and do it quick!

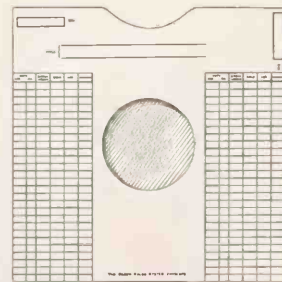

This sales system envelope keeps track of what you sell and what you need—a perfect and automatic inventory, showing profitable and slow sellers. Envelopes arranged for upright and flat filing and will fit any system.

Write for catalog and sample envelope.

J. B. OGDEN
LYNCHBURG, VA.

THE TRADE IN NEW YORK CITY AND VICINITY

December of 1914 proved to be one of the most remarkable periods that the local talking-machine trade ever experienced. Starting in with every indication of being a generally satisfactory month, and possibly showing some gain over December of the preceding year, the month ended in an unprecedented boom, and, according to the reports received from jobbers and dealers, was in a great many instances the best month they ever experienced in the history of their business. What makes this record more remarkable is the fact that business in other mercantile lines suffered from the depression that seized the business world last summer, and there were very few lines which were able to close the month with figures which could even stand favorable comparison with the totals of December, 1913. The prime and fundamental reason for this phenomenal success of the talking-machine business must be attributed to its steady growth in popu-

larity as a means of musical entertainment. This growth has been free and natural, there being no sign of any artificial or forced measures in the steady march onward. The stability of the industry as a whole, in view of its youth, is wonderful, and there is every reason to believe that the progress of the talking machine will steadily increase, as its possibilities are unlimited, with its field and scope ever broadening.

Great Shortage in Machines and Records.

The shortage of machines and records during the few weeks prior to the Christmas holidays was the most serious that the trade has ever encountered, but there was an undercurrent of optimism noticeable in this trying time that imbued the dealer with the necessary stimulus to sell a \$150 machine when a \$100 machine was out of stock, and dispose of three records that were in stock to replace three which were short. The shortage

was general, leaning more decidedly towards the \$75, \$100 and \$150 machines, and extending in many cases to the \$200 models. The record shortage was not confined to any particular class of selections, including the operatic and classic, as well as an unusual holiday shortage in popular and dance records. The jobbers extended every possible co-operation to their dealers in this period when the shortage was most marked, and several of the jobbers have remarked that not one of their dealers lost a single machine sale. Machines and records were apportioned with due regard to the necessity of their being shipped immediately or deferred until a future date, with the preference being given to the more urgent order. Those dealers who had not made provisions to secure adequate stock from their regular jobbers were somewhat handicapped by their lack of foresight, as the jobber naturally gave their regular dealers the benefit of their service organization rather than scatter their efforts among the dealers who had neglected to take care of their stocks earlier in the year.

How Advertising Co-operation Helped.

Any consideration of December talking-machine business should include some reference to the constructive and far-reaching co-operation extended by the Victor Talking Machine Co. to its dealers and jobbers. Beginning the first week in December and continuing until Christmas Eve, the Victor Co. used a full page in two or more of the local daily newspapers, and on several days practically every newspaper in the city carried a full page Victor advertisement. Included in this series were a number of pieces of copy featuring the name and address of every Victor dealer in Greater New York. Needless to say, the direct results from this advertising were tremendous. The advertisements also served to emphasize the musical prestige of the Victor products, as the copy used was dignified and high class, being typical of Victor national publicity and the high plane it has occupied for many years.

January Starts Off Satisfactorily.

January business has started in very encouragingly, and as this month is recognized as one of the best record months of the year, this phase of the business is attracting the dealer's attention at the present time. As a machine month January is usually a comparatively light one, but this month seems to be an exception, as machine business up to the tenth of the month showed quite a gain over last year. The dealers are using considerable publicity to advertise their products, and the replenishing of stocks after the holiday trade is occupying a considerable portion of their activities.

J. N. Blackman on Business.

J. Newcomb Blackman, president of the Blackman Talking Machine Co., 97 Chambers street, New York, Victor and Edison cylinder jobber, referring to December business, said: "December showed a very satisfactory increase over the corresponding month of last year. This has been the status of our business every month since the closing of our fiscal year, April 30th, with the exception of September. One of the features of this year's business, which in view of other business conditions seems somewhat remarkable, is the greatly increased demand for the higher priced instruments and records. It seems as though the public was beginning to realize the advantages of getting the full value of reproduction from their Victor records and are therefore selecting better instruments. The public is also getting more critical and calling for the best artists and certain classes of selections which would hardly be expected. This demonstrates without a doubt that our business, as a whole, is constantly being elevated and the public, quite unconscious in many cases, is day by day being better educated in music. The belief seems to prevail on all sides that the talking machine business has been remarkable, and in my opinion the permanency of the business is beyond question, as there is nothing about it at the present

(Continued on page 28.)

Substantial Service To Victor Dealers WHOLESALE ONLY

A Support Which Builds Your Business
A Service to Which You Are Entitled
This Is What We Offer You

A GOOD MANY DEALERS welcome the Opportunity to MAKE MORE PROFIT by adding Musical Instruments and Musical Instrument Strings to their Talking Machine line. The Investment is small, the Profit Large.

Cabinet Assortment No. 2-T.—A complete line of Musical Instrument Strings and Trimmings.

Retail prices plainly marked.

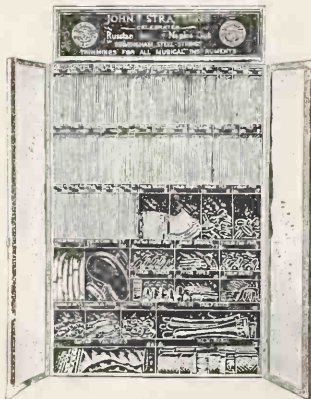

No. 2-T Size 12 1/4 x 18 1/2

Total Retail Value ... \$44.10
Cost to the Dealer ... 15.80

Profit \$28.30

180% Net Profit, plus a handsome cabinet.

C. Bruno & Son, Inc.

ESTABLISHED 1834

Victor Talking Machines Musical Instruments
351-353 Fourth Avenue New York

Be a *Plunger*

Victrolas and standard records are staples same as sugar in a grocery store, or nails in a hardware store.



Buy a Six Months Stock
—Plunge a Bit,
but have the goods no
matter where you are.

SEND US THAT ORDER

NEW YORK TALKING MACHINE CO.
81 Chambers Street : : : : New York

The Most Wonderful for Dance

FIRST ANNOUNCEMENT TO DEALERS

A new device has just been invented for use with disc records on the Victrola, Columbia and Aeolian machines. By means of this device—the REK-REP (Record Repeater)—any record can be repeated any number of times without a touch from the operator.

So simple in construction and easy in manipulation is the REK-REP that a child can adjust it in a second.

The REK-REP (Record Repeater) is a simple device made of steel,—brass or nickel plated. It weighs only 1½ ounces.

Easily attached to any needle-point machine by slipping it over the center pin, which holds the record itself.

Can be used on both double- and single-faced records.

Cannot scratch or injure the record in any way. No part of the REK-REP touches the playing part of the machine. Has but two bearing points.

The REK-REP is equipped with a simple device which can be adjusted in a second to automatically stop the phonograph after the record has been played through once or twice, or will allow it to repeat continuously.

Send for the Rek-Rep, you make 85% on every one that you sell.

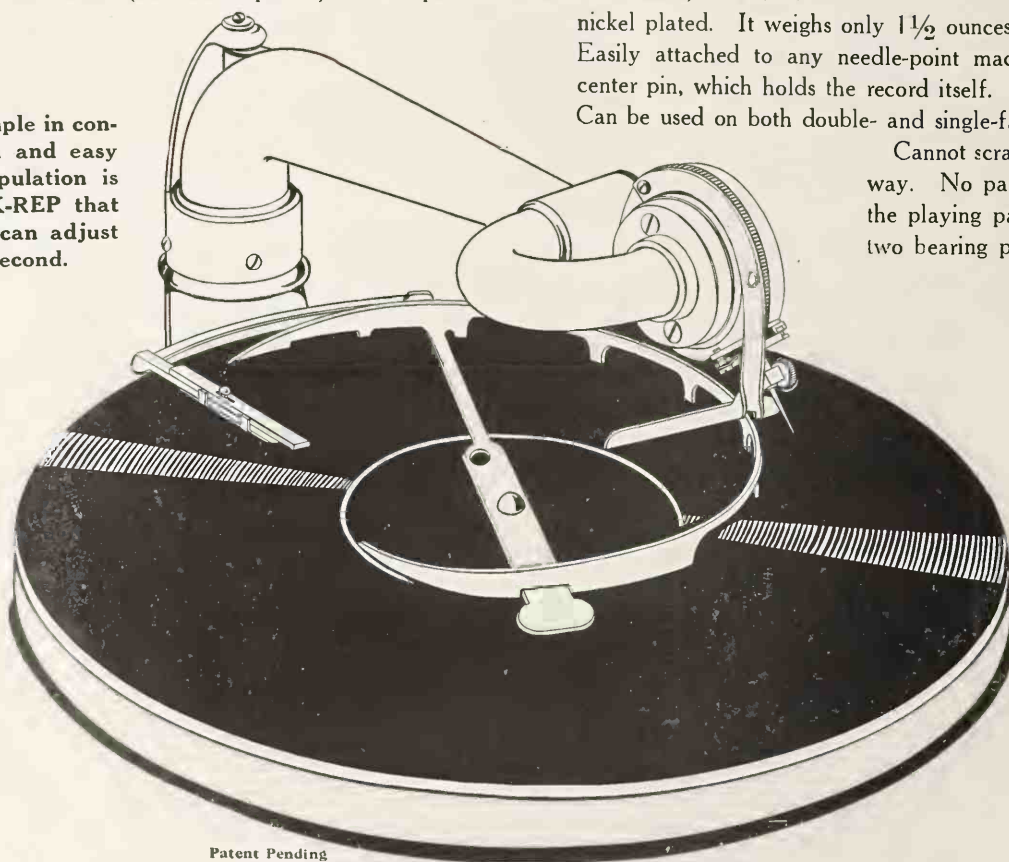

Patent Pending



Thing Ever Invented Records

REK-REP REPEATER

Terms to Dealers—Discounts 40% & 10%

SELL THE REK-REP WHEN YOU SELL DANCE RECORDS

The dance is the thing!

An immense boom in your business has been brought about by the universal dance craze.

There is a greater call for dance records than the factories can supply.

The average dance record is played out in three minutes. The dancers have to stop and wait while machine is being readjusted. Until the invention of the REK-REP (Record Repeater) there was no escape from this annoyance.

Now, with the REK-REP, the dancers can enjoy their fun uninterrupted by the sudden stopping of the music.

Every buyer of dance records is a prospective customer for the REK-REP. Every time you sell a dance record for the Victrola, Columbia or Aeolian show your customer the REK-REP and make an extra sale.

Dancing teachers know the tremendous value of the REK-REP. You can work up a big business among them.

Our national advertising starts in February. Be sure to stock the REK-REP in time, so that your customers will not be disappointed. Be prepared to meet the great demand that exists for this device.

We guarantee the REK-REP to do all that we claim—or money refunded. Send us your order today. Terms to dealers: \$2.00 each, less 40% and 10%. State whether for Victrola, Columbia or Aeolian machine.

The REK-REP will be ready for delivery on or about February 15th.

RECORD REPEATER CO., INC.,

432 4th Ave. NEW YORK CITY



January 9, '15.

CASTLES IN THE AIR
ATOP THE 44TH ST. TEL. BRYANT 1
THE MR. AND MRS. VEE
BUSINESS MANAGEMENT
105 WEST 107th STREET
TEL. BRYANT 1

The Record Repeater Inc.
432 Fourth Avenue,
New York City

Attention of Mr. E. H. Presbrey:

Dear Sir:-

We beg to inform you that we have installed on our talking machines in use at CASTLE HOUSE, your Rek-Rep Repeaters, and use same in connection with our instruction work.

We consider the Repeater to be one of the most valuable accessories to the talking machine that has ever been invented, and that it is of the greatest value to dancing instructors. We feel sure that it will be a source of great pleasure to all owners of talking machines, especially to those who buy dancing records, and who appreciate the annoyance of being obliged to stop dancing to re-adjust the machine.

Very truly yours,
Kennon Castle
June Castle





The quality of the Columbia *tone* to-day is really beyond serious competition. When it comes to *tone-control*, however, a Columbia dealer is not merely beyond competition, he is almost beyond argument.



(Write for "Music Money," a book "full of meat" for those dealers interested in quick and frequent turnover of capital.)

Columbia Graphophone Company
Woolworth Building, New York

THE TRADE IN NEW YORK CITY.

(Continued from page 24.)

time that would indicate a success based on any craze."

"We closed the biggest December in the history of the company," said R. F. Bolton, manager of the Chambers street wholesale headquarters of the Columbia Co., "and incidentally the biggest single month since we have been in business. Notwithstanding the heavy shortage of goods we showed an increase of something like 40 per cent. over last December. There never was a time in the history of our company when there was such a tremendous demand for goods. While the shortage was in the higher-priced types of machines, selling at \$75 and \$100, we also ran out of the smaller machines in the three or four days preceding Christmas, and on Christmas Day there was practically not a single machine on the floor. It is gratifying to note that the cancellations of our unfilled orders placed before Christmas has totaled only 3 per cent., which would indicate that the dealers' stocks are very low, and they need all the stock ordered for the new year."

High-Priced Designs in Demand.

L. S. McCormick, manager of the Edison Shop, 473 Fifth avenue, New York, conducted by the Phonograph Corporation of Manhattan, in a chat with *The World*, said: "The majority of the instruments we have been selling are the \$250 models. Our warerooms are crowded daily with visitors and the average number of callers has been in the neighborhood of 600. Our business is growing so rapidly that we have found it necessary to change a number of our rooms up stairs from auxiliary stock rooms to record and phonograph demonstration rooms. On Dec. 24th we were entirely sold out of machines in the \$80, \$150 and \$200 styles, and were fortunate in having some \$250 machines which were also disposed of quickly. Business has really been phenomenal, and we are looking forward to a prosperous year from every standpoint."

Many New Representatives.

The Pathé Frères Phonograph Co. has been making steady progress in local territory, and the dealers whom they have established report the closing of an excellent business. These representatives include Hardman, Peck & Co., the prominent piano house which is making an effective display of Pathéphones throughout their handsome establishment. Other local Pathé Frères dealers are Ludwig Baumann & Co., 125th street; B. G. Warner, Brooklyn, N. Y.; Altai Sales Co., Newark, N. J., and a number of others closed in the past fortnight.

Talking Machine Co.'s Big Trade.

In answer to the question as to whether or not the past month was the best December the company ever had, V. W. Moody, sales manager of the New York Talking Machine Co., 81 Chambers street, Victor distributor, said: "The amount by which the business closed this December exceeds that of last December is greater than the total business closed in the month of December only four years ago. While of course we feel that our increase can at least be accounted for in part by the far-reaching campaigns we con-

ducted during the year, the major portion of the increase is nevertheless due to the natural increased demand for Victor goods, and that increase is "tremendous"—the only word in my vocabulary which can at all describe it. The gains over general, and our Red Seal and high class record business increased in such proportions that it easily overtook the demand for popular records which had been so greatly stimulated through the call for dance selections. The demand for the latter class of records remains unabated, and we are selling some dance numbers by the thousands monthly, even though they were issued a full year ago. We sold more of the small machines than we ever sold before and all of the larger machines that we could obtain from the factory. Our system of allotment of machines received from the factory was such that no dealer who depends on us for his Victor service really lost a sale of a machine. Of course we were not able to fill all orders offered us, but these orders amounted to thousands of machines from outside sources or from dealers who did not call upon us except in the case of such emergencies."

Great Columbia Holiday Business.

The many Columbia dealers in local territory report the closing of a splendid holiday business, traceable they state to the enhanced prestige of Columbia products throughout the Greater New York territory. One of the recently established Columbia representatives who is doing a very fine business with Columbia machines and records is A. J. Hamblen, who conducts the Grafonola Shop at 156th street and Broadway, in the heart of the high grade residential district. Mr. Hamblen, through the use of energetic and progressive sales methods, has succeeded in building up a profitable clientele in the short while his store has been open.

Good News from City Across the Hudson.

The Eclipse Phonograph Co., 203 Washington street, Hoboken, N. J., exclusive Edison jobbers, reports the closing of a wonderful business in Edison disc products during the month of December. A. W. Toennies, Jr., is enthusiastic in discussing the future for the Edison disc phonograph, as he

states that its sales are only limited by the factory output, which will be greater than ever when alterations at the Orange plant are completed.

INFORMAL DINNER TO SALES STAFF.

The New York sales district of the Columbia Graphophone Co. on Tuesday night gave an informal dinner to the members of the sales staff and a number of the company's executive officers. The main purpose of the dinner was in the nature of a get-acquainted and get-together affair, and the spirit which prevailed was typical of Columbia harmony and co-operation.

R. F. Bolton, district manager of the local territory, who arranged for the holding of the dinner which was given at the Arkwright Club, 320 Broadway, New York, was delighted with its success and the enthusiasm it evoked. W. L. Sprague, manager of the Buffalo headquarters of the Columbia Co., was an out-of-town guest at the dinner.

Among the Columbia officials who made short and impromptu addresses were John A. B. Cromelin, general manager; Edward N. Burns, vice-president; James T. Bradt, sales manager; H. L. Willson, assistant general manager; Louis S. Sterling, general European manager; Frank Dorian, Dictaphone manager; R. F. Bolton, New York district manager; H. A. Yerkes, wholesale manager, and Nathan Milnor, Dictaphone sales manager.

NEW COLUMBIA ACCOUNTS OPENED.

Among the many new accounts opened by the Columbia Graphophone Co. in local territory are the Goldburg Furniture Co., Yonkers, N. Y., and the Frank Cordts Furniture Co., Hoboken, N. J. The first named concern handles the Columbia lines in both of its local stores, and the success of these departments prompted the opening of the Yonkers department.

This sounds like a paradox, but it isn't. The man who always has a skate on never cuts much ice.

"Standard" Record Cleaner

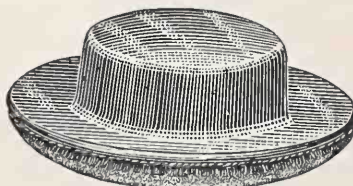

Price, 50 Cents, List
Patented June 2, 1914.

Send 10 cents in stamps for a sample cleaner. Write on your business letter head only. Place regular orders through your jobber.

STANDARD GRAMAPHONE APPLIANCE CO.
173 LAFAYETTE STREET NEW YORK

We also manufacture the Simplex Record Cleaner, Price 15 cents, list.

ARTISTIC AND ATTRACTIVE

Grips the record surface and clings as if on rails.

Extended brush area cleans record with one sweeping circuit.

SOUTHERN CALIFORNIA NEWS ITEMS.

The Biggest Holiday Trade in the Talking Machine Business for Southern California—A New Pathephone Agency with Colyear Co.

(Special to The Talking Machine World.)

LOS ANGELES, CAL., January 6.—Southern California has just finished a most prosperous holiday business in both talking machines and records. Never before have so many machines been sold in and around Los Angeles, and this in spite of the fact of the general depression in business throughout the country.

A scarcity in both machines and records has been felt both by the jobbing houses and retailers, and from the present outlook in the East it will be several weeks before we can promise a

full supply of machines and records. It was very gratifying to note that the larger models of all makes of machines were the most in demand. The great number of machines recently sold will, without doubt, create an enormous demand for records in the next few months, as many of the purchasers of machines were unable to get a complete list of records most desired.

Curtis Colyear, a Los Angeles business man and capitalist, has recently acquired the Pacific Coast agency for the Pathephone machine. Mr. Colyear has obtained the services of Harry Club as manager. Mr. Club is a talking machine man of fifteen years' experience, and is well known all over the Pacific Coast. The Colyear Co. has already established six agencies and has disposed of the entire output of the first shipment. One of Mr. Colyear's numerous warehouses is being remodeled and refitted as jobbing headquarters for the Pathephone.

The first agency established was with the Barnes Music Co., 131 South Broadway. Mr. Barnes is remodeling his talking machine department, and now has six sound proof rooms, in which to display his Columbia and Pathephone machines. Mr. Barnes claims the distinction of being the first Pathephone dealer of the Rocky Mountains.

The Wiley B. Allen Co. reports fine business for December, and says that its business exceeded that of last year. Manager Wolfinger says Victrolas XI and XIV were the best sellers.

Chas. S. Ruggles, of Sherman, Clay & Co., Victor jobbers, reports a 25 per cent. increase in business. His record stock is very much depleted at the present time, but he expects some heavy shipments in the near future. P. T. Clay, of the same company, passed through the city recently on his way from the Hot Springs in Arizona.

The Geo. J. Birkel Music Co., "The Exclusive Victor Dealers," also report a fine holiday trade, especially in the larger model Victrolas.

The talking machine department of the Southern California Music Co. broke all records in the history of that department during the holidays. The large talking machine quarters were taxed to the utmost in accommodating the crowds. They did an especially fine business in the Edison Diamond Disc phonographs. C. A. Lovejoy, manager of the wholesale Edison department of this company, believes he will be able to supply the enormous demand for machines and records despite the great fire at the Edison factory. Telegrams from the factory state they have the situation well in hand by this time.

Joseph Carter and Earl Dible, of the Southern California Music Co., made a flying trip to San Diego over New Year's to attend the opening of the Great Fair.

Irving Andrews, one of the hustling proprietors of the Andrews Talking Machine Co., says business was never so good.

The Columbia Phonograph Co., wholesale, has had an exceedingly prosperous season, and there has been a large demand for their new model Grafonola, equipped with the automatic record ejector. This is an exceedingly simple and effective way of keeping records, and is proving very popular. They also report the sale of several grands during the holidays.

Barker Bros. report a phenomenal business during the past month. This enterprising house, under the able management of C. A. Booth, have in a short space of time thoroughly established themselves in the talking machine business, and in time bids fair to rival the business of the largest houses on the Pacific coast. Mr. Booth bewails the shortage of the Edison Diamond Disc goods.

Miss Brown, with the Baxter-Northrup Music Co., is pleased with business in the Columbia line during the holidays.

The Broadway Department Store, which has just recently entered the field, with a complete line of Edison Diamond Disc machines and records, are doing a splendid business, and the manager, Mr. Guyot, looks for a steady increase.

L. E. Newton, manager of the talking machine department of the Southern California Music Co., in San Diego, accompanied by his charming wife, spent Christmas in this city.

FOR SALE

The services of a thoroughly trained talking machine man. Twelve years' practical experience in all branches. Collegian—good appearance. If you want new blood on your staff and willing to invest a few dollars weekly which will pay good interest, drop a line for interview to "Energetic," care The Talking Machine World, 373 Fourth Ave., New York.

TALKING MACHINE MANAGER

Young man, 30 years of age, with a broad business experience, four years in the talking machine business with one of the biggest houses; knows and has held positions all the way up to and including manager, and am holding this successfully; am desirous of making change for better position and possibilities; knows wholesale end as well; first-class appearance and personality and capable of handling the best trade. Address "Manager," care The Talking Machine World, 373 Fourth Ave., New York City.

WANTED FOR CASH

Want to buy big job lot of talking machines and records, any make; also flower horns and parts for any make. Will pay spot cash for same. Address "Cash," care The Talking Machine World, New York.

POSITION WANTED

I would like to correspond with a Columbia or Victor dealer who has a proposition to offer a good talking machine man; I am capable of taking charge of a department, or I will accept a position as salesman. I am 24 years old, married. I will give reference to my ability as a talking machine man also as to my character. E. Taylor, 304 Spearing St., Jacksonville, Fla.

FOR SALE

1,000 high-class Polish and Russian double face 10 in. records; 1,000 English song and dance selections, double face, 10 in. records. Must be sold at once. 20c. each. Berliner Phonograph Co., 140 East Fourth St., New York.

WANTED

Wideawake salesman who is good in getting orders—not promises—to represent a prominent talking machine accessory concern and handle its products as a side line. Big proposition for a "business getter." Address "Salesman," care The Talking Machine World, 373 Fourth avenue, New York.

For Sale, Sacrifice

For sale entire stock or in lots to suit, consisting of
 30 EDISON FIRESIDE PHONOGRAPHS - AT \$8 EACH
 15 TRITON DISC MACHINES - - - AT \$6 EACH
 85 SMALL COLUMBIA CYLINDER MACH'S AT \$2 EACH
 6000 2 MIN. INDESTRUCTIBLE RECORDS \$4 PER 100
 3500 BRAND NEW SPANISH ZONOPHONE
 DOUBLE FACED RECORDS \$30 PER 100
 Loose Leaf record albums (10 & 12 INCH) \$6 per doz.
 Also large stock of Edison and Columbia business phonographs new and slightly used at BIG SAVINGS.
 SINGLE SAMPLES supplied upon receipt of check at the RATE OF PRICES QUOTED. Correspondence invited.
 Address
 ROSEN'S TALKING MACHINE SHOP, 3 SCHOOL ST., BOSTON, MASS.

At Your Service
Landay
 BROS INC

VICTOR DISTRIBUTORS EXCLUSIVELY
563 5th Avenue
NEW YORK

"A limited number of dealers served well is a very good policy as our dealers can tell."

At Your Service
Landay
 BROS INC

VICTOR DISTRIBUTORS EXCLUSIVELY
563 5th Avenue
NEW YORK

THE AUTOPHONE

FOR HOME USE

Purely Automatic Thoroughly Fool-Proof
Mechanically Perfect

Plays over half an hour with one winding of motor. All you have to do is to put 12 records on the wheel; the Autophone reproduces one record after another automatically, requiring no attention, no handling, no starting and stopping, no needles, no nursing.

Uses Blue Amberol or any other hard cylinder records. Non-breakable, don't deteriorate with use.

The quality of music is a revelation. The Autophone is the first to get diffused music—no megaphone tone—incomparably superior in tone quality, naturalness, real music, to any phonograph yet produced, whether cylinder or disc—with *no* exceptions.

The Autophone is not a half-baked experiment, but is the result of constant improvements suggested by ten years of the hardest kind of usage of similar mechanical principle on slot machines. The Autophone was the first—ten years ago—to use concealed horn cabinet; the first—seven years ago—to use diamond point in reproducer; *the first—NOW—to give perfect tone quality.*



The Autophone.

Plays 12 records automatically, one after the other, without touching the instrument, except to wind motor once.



Model No. 200. Price \$200.
Height, 47 in. Width, 24 in. Depth, 23 in.

DEALERS

The Autophone has *proved* itself a *big seller*. Until the present time the entire factory output has been taken by agencies established. Orders are running right now up to five hundred \$200 Autophones at one delivery.

Enormously increased capacity makes it possible now to supply more dealers and distributing agencies. Only one live dealer—and that, the best—wanted in each medium-sized city. Plenty of elbow room given dealers in large cities. The dealer gets the full benefit of his hustle, push and advertising.

Trade discounts are right. The choicest territory is still open. Be the first to get in your application as dealer in your section. See and hear the Autophone. It will convince you. Immediate delivery of all orders, large or small. Autophones sent out COMPLETELY FINISHED. You have nothing to do but remove the instrument from the shipping box and cut the strings. It's ready to play.

Proposition for exclusive distributing agencies will be entertained on liberal terms from those qualified to do the line full justice.

AMERICAN PHONOGRAPH CO.
102 West 101st Street : : New York City

MILWAUKEE TRADE ONLY LIMITED BY SIZE OF STOCKS.

Jobbers and Dealers, in Some Cases, Completely Cleaned Out of Popular Types of Machines and Certain Records—Some Excellent Reports Made Regarding the Business During December—All Lines Enjoy Favor with Purchasing Public—News of Month.

(Special to The Talking Machine World.)

MILWAUKEE, Wis., January 8.—Despite the shortage of machines in the Victor, Edison and Columbia lines, Milwaukee and Wisconsin dealers secured a record-breaking holiday business. It had been anticipated earlier in the season that because of a depression in many lines of business, only a fair talking machine trade could be expected this year. The results, while surprising, were most gratifying, and the best part of it is that every dealer in the State seems to have shared in the prosperity. Most of the Milwaukee houses made gains of from 15 to 50 per cent. in the total volume of business received during the month of December.

Milwaukee jobbers, as a rule, found themselves hard pressed to secure enough goods to meet only a part of the orders rushed in from dealers all over their territory. The trouble was that so many dealers ordered conservatively early in the fall and then when business exceeded their expectations rush orders were placed with jobbers for hurry-up shipments. As the jobbers in turn were held down on the size of their orders from the factories, the result was that dealers lost some business. One good result will be that all surplus stocks in whatever style will be cleaned out and dealers will be in the market for the next few months for all the machines they can get.

"If we could have secured the goods from the factory we could have done several hundred per cent. more business in the month of December," said H. A. Goldsmith, secretary of the Badger Talking Machine Co., jobber in this territory for the Victor goods. "Dealers all over the State simply clamored for machines throughout the month. We had twenty-two long distance calls in one day from dealers who asked to have goods rushed to them for their holiday trade. We asked these same dealers to anticipate this demand in September, but they ordered conservatively and so they were compelled to forego the sale of many machines."

"I believe that much of the talk of hard times is a fancied condition, rather than fact," said Mr. Goldsmith. "For instance, a dealer from Kiel, Wis., who was in here to buy machines, said he was not doing a very big business and was buying stocks of merchandise rather carefully. When I questioned him closely he admitted that he was doing a better business than during the same month a year ago. Many other dealers have complained and later admitted that they were doing as good or better a business than for the corresponding month in 1913.

"During October and November we sold 40 per cent. more machines than last year, while the December business exceeded all bounds. Collections were backward in November, but they have shown great improvement since the banks have loosened up on credit.

"The people of Milwaukee and elsewhere have plenty of money. The wealthy already have machines, but the people with average incomes are buying machines for \$100 or more. The demand for this type of machine is much greater than for the \$50 machines. Heads of families do not skimp in buying these machines, because they give pleasure to the entire family. The outlook for the coming year is bright, as we see it at the present time."

The Smith Piano Co., 90 Wisconsin street, handling the Bradbury, Webster, Henning, Strohler, Hoffman and Willard pianos, has taken on the agency for the entire Columbia line of machines and records. Manager F. D. D. Holmes has arranged special quarters for the new talking machine line on the second floor and is enthusiastic regarding the big business which has been experienced. During the first week after the agency had been secured the house sold twenty Columbia machines, the total number included in the first shipment. All the salesmen in the piano department

are being given the opportunity of selling the Columbia machines and the plan is working out most successfully. The salesmen of the Smith house were banqueted at the Weber & Stuber restaurant on December 30 by Manager Holmes and were highly complimented for the manner in which they have been pushing the Columbia business.

A. G. Kunde, 516 Grand avenue, Columbia, jobber and retailer, experienced the largest holiday trade in the history of the store. Mr. Kunde has figures to prove that the total retail business showed an increase of 50 per cent. during the month of December, as compared with the corresponding period a year ago. The Kunde establishment sold two of the \$500 Grafonola grands during the month of December.

Milwaukee department stores met with an unusually fine holiday business in their talking machine departments this season. L. C. Parker, manager of the Victor and piano departments at Gimbel Bros., experienced the heaviest holiday business in the history of the department. Carl W. Abbott, manager of the Victor department at the Boston Store, nearly doubled his sales over 1913. Mr. Abbott experienced an unusually strong demand for some of the moderate priced machines. He now has four people in his sales department. Edward Schuster & Co. met with a fine business in the Victor departments at their three stores.

The Billings & Sons Piano Co., 504 Grand avenue, one of Milwaukee's newest piano houses, has taken on the agency of the Pathephone line of talking machines, manufactured by the Pathé Frères Phonograph Co. Special quarters have been provided for the new line and the machines sold well during the holiday period.

There is probably not a house in Milwaukee that reached the sales record attained by the Victor department of the Edmund Gram Piano House during the month of December. Paul A. Seeger, manager of the department, has figures to prove that business during the month showed a gain of 95 per cent., as compared with the corresponding month a year ago. Sales were rather evenly distributed among the various styles of Victrolas. Several of the new electrically operated Victrolas were sold by the house during the month. The first of these instruments to be disposed of in Milwaukee was sold by the Gram house to George

Clayton, a merchandise broker in this city.

The Phonograph Co. of Milwaukee, a jobber in this territory for the Edison line, was especially fortunate in that it had received four carloads of Edison machines just before the disastrous fire at the Edison plant. The result was that Edison dealers in Wisconsin were fairly well supplied in most lines, although more of the \$150 and \$200 machines could have been disposed of. The company's stock is getting low in some lines and orders from dealers are naturally being cut down at the present time. The Edison Shop, the retail branch of the business, met with a big holiday trade, a result of the daily concerts given at the store and because of the consistent campaign of advertising on a large scale.

C. Niss & Son, Inc., operating one of the largest furniture houses in Milwaukee, which took on the Edison line last fall, met with a holiday business that exceeded by several thousand dollars the amount anticipated earlier in the season. The house carried on an extensive advertising campaign in all the Milwaukee papers. The Edison department at the store will be enlarged by adding quarters in one of the largest balconies at the store.

J. H. Becker, Jr., manager of the Victor department at the Hoeffler Piano Manufacturing Co., secured the biggest holiday business in the history of the store. Mr. Becker had put forth special efforts in circularizing the trade and in advertising in the local papers.

The Gensch-Smith Co., 730 Grand avenue, handling the Victor line as well as pianos, has increased its sales force. Holiday sales attained a new high mark at this store.

AEOLIAN VS. VICTOR IN U. S. COURT.

The Aeolian Co. has brought suit against the Victor Talking Machine Co. in the United States District Court for the State of New Jersey, filing its Bill of Complaint on Wednesday, January 6, which alleges a breach of contract on the part of the Victor Co. and asks for damages approximating \$70,000. These damages, it is alleged, were created by the Victor Co.'s acceptance of certain orders for talking machines which it neglected and refused to deliver in accordance with the acceptance of the orders.

BUYS OUT TALKING MACHINE STOCK.

C. E. Wyeth, a dealer in talking machines, bicycles and other goods in Newark, N. J., has purchased the entire talking machine stock of the American Machine Co., that city, and will move it to his present store on West Main street, that city.

THE BEST

Record and photo albums can be obtained for price of inferior goods by just specifying NYACCO when ordering.



"THE STAMP OF QUALITY"

stands for the best there is in albums, because they are made of the finest materials, by experienced men who know, for people who want the best—maximum quality at minimum prices.



There's one way in making NYACCO Albums—**THE BEST WAY**

Look for the stamp



New York Album & Card Co., Inc.
23-25 Lispenard St., New York

Here we go on

WE believe this is a peculiarly appropriate time to remind you of certain features in the Columbia policy—fully established and in entirely successful operation.

This is really only by way of reasserting our stand that there is and shall be no change in the Columbia principle of manufacturing the product that the people want and selling it to dealers with a liberal and standard margin of profit between the wholesale and the fixed, invariable retail price: in other words, as manufacturer to merchant—subject to that one inflexible protective feature of absolute price maintenance.

*Glance through these paragraphs
once more in one-two-three order:*

COLU

Graphophone Company

Woolworth Building, New York



Record once more

1—PRODUCT

Model by model—dollar for dollar, part by part, Columbia machines are safe in competitive comparisons. And records the same—quality, durability, volume, repertoire, timeliness.

2—DEMAND

As evident as the face on the town clock.

3—INTERCHANGEABLE

The more owners of Columbia machines who come to know that those machines will play other makes of records, the better we like it, for it's a good thing for the industry. The more owners of other makes of machines who find out that Columbia records will play on their machines, the better we like it, for it is a good thing for *our share* of the industry.

4—LIBERTY

Dealers in Columbia product have complete freedom to handle competitive product if they wish. If a Columbia owner wants a competitive record to play on his Columbia instrument he can go and buy it—he can buy it of *you*, too, as far as we are concerned. If the owner of any other make of instrument wants a Columbia record he can come to you and buy it.

COLUMBIA



Creators of the talking machine industry. Pioneers and leaders in the talking machine art. Owners of the fundamental patents. DEALERS AND PROSPECTIVE DEALERS, WRITE FOR A CONFIDENTIAL LETTER AND A FREE COPY OF OUR BOOK "MUSIC MONEY."

HANDSOMELY EQUIPPED QUARTERS

Are Those of the Pardee-Ellenberger, Inc., New Haven, Conn., Where Edison Phonographs and Records Are Handled.

(Special to The Talking Machine World.)

NEW HAVEN, CONN., January 9.—Among the handsome and well-appointed talking machine houses of southern New England is that of the

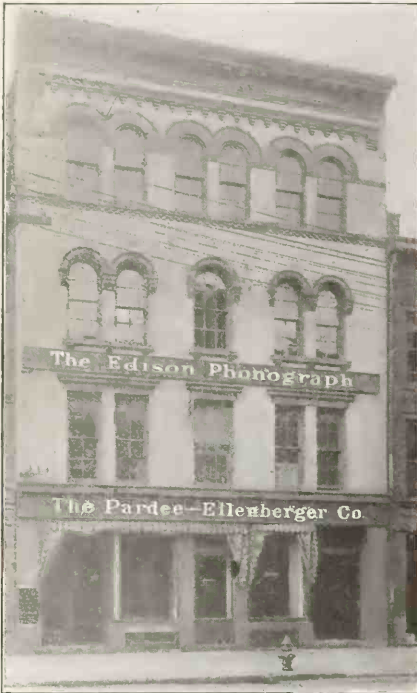

Front View of Pardee-Ellenberger Store.

Pardee-Ellenberger Co., Inc. of this city, whose large offices and warerooms are located at 94-104 State street. The company is a jobber of Edison phonographs and records and talking machine supplies, and enjoy a large following among dealers who have had business associations with the house for a long time. Because of the growth of the business it was decided during the summer to make some improvements and enlargements, and these for the most part were confined to the office and



One of Pardee-Ellenberger Co.'s Handsome Display Rooms.

show rooms. The improvements were completed a short time ago, and to-day the house is better able than ever before to properly handle all the wants of its customers. In the office all the latest devices for the furtherance of business has been installed and the staff of a dozen employes are kept constantly busy. W. O. Pardee is president and treasurer of the concern, and H. L. Ellenberger is the secretary. Besides this large house which supplies southern New England, the company has another large house at 26 Oliver street, Boston, in charge of F. H. Silliman, as manager.

GREAT IMPROVEMENT DURING 1914.

Every Month Shows Gain Over Preceding Month of 1913—December Trade with American Talking Machine Co. Limited by Available Stocks—Deliveries a Feature.

R. H. Morris, head of the American Talking Machine Co., the active and successful Victor distributors of Brooklyn, N. Y., makes a most satisfactory report for business during 1914 and declares that every month showed a substantial increase over the business for the corresponding month of the previous year. "Despite the general conditions our business forged ahead steadily," said Mr. Morris, "until the crest was reached in December, and the business that month was limited only by the amount of stock we were able to secure from the factory. Through the fact that most of our dealers had confidence in the prospects for the holiday trade, and made their wants known in time which served in some measure to encourage us to order early and liberally. The chief shortage was, of course, with Victrolas X and XI, but many sales that would have been lost to our dealers on those styles were saved through the fact that Victrola IX was made to fill the gap. Better a few dollars less profit than none."

A feature of the development of the jobbing business of the American Talking Machine Co. during 1914 was the demands made upon the company, not only from Long Island cities, but from Manhattan and even New Jersey. The location of the company's headquarters practically in the traffic center of Brooklyn, places it in a position to make quick deliveries by messenger, freight or express, and it is the quick deliveries that count in the talking machine trade these days.

"MASTER-PHONE RED NEEDLE"

Just Introduced by the Master Phone Corporation Will Be Extensively Advertised in Order to Aid the Dealer.

The Master Phone Corporation, 286 Fifth avenue, New York, has just placed on the market a new composition needle termed the "Master-Phone Red Needle," which the company has perfected after more than a year's experimentation. This new needle, which is composed of various ingredients, has been thoroughly tested and tried out by prominent musicians and music lovers, who are enthusiastic in referring to its distinctive merits and qualities.

The Master Phone Corporation has already perfected plans for a national advertising campaign on behalf of the "Master-Phone Red Needle" which will be far-reaching in its scope and aid the dealer materially in developing a profitable market for this latest addition to the needle family. One of the main points or sales arguments developed in this advertising will be based on the company's tests of the new needle, which demonstrated that it will play from five to ten records without any necessity of change. Other claims and arguments to be advanced in this advertising, as set forth in the preliminary advertising, are the minimizing of the scratch or "murmur" and the fact that the "Master-Phone Red Needle" is a new substance softer than the record itself and yet takes the firm, sharp point of ivory.

Don't think that a man is ready to take the advice of every fool he meets just because he takes yours.

JAS. T. BRADT NOW SALES MANAGER

Of the Columbia Graphophone Co. for the United States and Canada—Brings Large Ability to a Large Position.

James T. Bradt has been appointed sales manager of the Columbia Graphophone Co. for the United States and Canada. His return to the Columbia fold a few weeks ago at the time John Cromelin became general manager was a pleasing announcement to his many friends in the trade.

Mr. Bradt has been connected with the Columbia Co. in various important capacities for many



James T. Bradt.

years. His long and wide experience will be of great value in getting results as sales manager.

Mr. Bradt gave up newspaper work seventeen years ago to join the Columbia Co. He was assistant manager in Philadelphia before being appointed manager for the Southern States, with headquarters at Baltimore. After three years of very successful administration in the South Mr. Bradt was sent to Berlin as director of the Columbia operations in Germany, Austria-Hungary and Russia. England next claimed him, and for three years he was manager of the Columbia business in Great Britain.

When the Canadian business began to assume proportions, Mr. Bradt was put in charge, with headquarters in Toronto. His thorough knowledge of Columbia product, his long business experience and strong personality soon won for him a splendid reputation among the Canadians. Under his regime a factory was opened in Toronto and the sales of Columbia goods increased wonderfully.

His talking machine experience in different parts of the world has been successful far beyond the commonplace. The executive offices of the Columbia Graphophone Co. are strongly reinforced by Mr. Bradt's appointment. He brings large abilities to a large position.

FOR CANNED ART LECTURES.

(Special to The Talking Machine World.)

Boston, Mass., January 10.—Municipal nickel-in-the-slot art lectures were advocated by Henry Turner Bailey, prominent art authority and former supervisor of drawing in the public schools, at the Twentieth Century Club's discussion of "The Significance of Chinese Art."

"I would like to see installed in the Boston Museum of Fine Arts," said Mr. Bailey, "a slot machine where, upon the dropping of a coin, by phonographic reproduction I could get an explanation of the particular subject I wanted to understand and appreciate."

The Pittsburgh Rex Agency Co., has been incorporated under the laws of Delaware for the purpose of dealing in talking machines, records and accessories of all kinds.

The Rex Talking Machine Co., of Philadelphia, has leased quarters in the new Stanwick building, Pittsburgh, Pa. The store will be operated under the management of J. S. McIlvaine.

FRONTING THE NEW YEAR.

Interesting Views Presented by Arthur. D. Geissler, Vice-President and Managing Director, New York Talking Machine Co., New York, and Talking Machine Co., Chicago.

"Experience"—if we could only know it—appreciate it and learn by it—if we could only stand together with eager eyes facing our problems, knowing that old man "Experience" would open his mouth and speak to us and we ourselves would profit by it, what a happy New Year it would be for us all.

As Benjamin Franklin said: "Experience keeps a dear school, but fools will learn in no other,



Arthur D. Geissler.

and scarcely in them, for it is true we may give advice but we cannot give conduct. Remember this—they that will not be counseled cannot be helped. If you do not hear Reason, she will rap your knuckles."

My experience in the Victor business has been one of wholesaling exclusively. Victor goods can be bought from all distributors at the same discount; the merchandise is the same, and the only way that a distributor can hope to maintain this established trade and add to it is by maintaining his service to the dealers and adding to it.

Fortunately, the writer's experience administering the affairs of the Talking Machine Co., of Chicago, and the New York Talking Machine Co. has given him many loyal dealers, who, each year, are disposed more and more to profit by their experience and each year more and more are willing to accept our advice, and at certain opportune times place large advance orders for machines and for standard sellers in records.

Owing to this increased confidence which the dealers have shown in our judgment, we can safely say those regular dealers have come through the past year without losing a sale of a Victrola.

We are dealing in a standard article—Victrolas and the popular Victor records should be carried in stock just as the grocer carries sugar and the hardware man carries nails—the chance for being overstocked has been reduced to a minimum.

Our business has shown a wonderful increase in 1914. At one time we were worried for fear

the goods were not moving with the dealers. Our travelers were instructed to send in detailed reports from their territory covering a two weeks' period. These reports, without exception, showed a shortage of machines and a clamoring for more records, and in a great many cases disclosed the fact that machines were sold before being delivered by us.

The most gratifying part of this increase was shown by the fact that several of our most representative dealers claimed that their instalment business was just on a par with last year, and that their entire increase was in the cash and charge sales.

If our dealers would now only profit by the experience of these other dealers and, when a prospect walked into his store, instead of immediately talking terms, they would wait for that prospect to bring up that subject and then answer with the statement:

"Certainly, Mr. Prospect, we are willing to quote you terms. What would be satisfactory to you? Two, three, four or five months in which to pay for this outfit? If so, let us charge it to you. You take your time to pay for it, so long as it is paid for in several months' time—that is satisfactory to us."

The dealer will find in a majority of cases the rendering of a statement each month for an outfit sold will collect the money for that outfit in one-third the time than if that customer had been put on a contract basis.

It is a fact that the retail customer in a good many cases is a bit flattered in being offered a charge account, and the looking up of that man's credentials for a charge account is no more work or expense than looking him up for a contract, and, even though the man does not prove a safe charge account, nothing is lost, as the contract can easily be substituted should the dealer still want to take that risk on a lease proposition.

We merchants in the Victor line should be deeply grateful that it has been our good fortune to be engaged in this business. We cannot overlook the tangible fact that nearly every other line of merchandise in our country has suffered. When we tell other merchants that we are showing an increase, a wonderful increase, they look at us aghast, and wonder how we do it. They say: "Here we are handling a line we thought a necessity and you handling a line we thought a luxury." All right, that's a fact, this line is a luxury, but luxuries to this country are becoming necessities. The American people must be entertained, and instrumental music and songs have been God-given methods of entertainment since this old world began.

No doubt the future of 1915 is brighter than 1914. General business conditions are brightening up. If, in face of all the adversity of 1914, merchants carrying the Victor line have been able to put over a wonderfully prosperous year, what may we expect in 1915? Here again let us profit by experience. Let us appreciate the fact we have the most profitable line of merchandise in the country to-day. Let us be imbued with that spirit of optimism and begin now preparing for 1915—the biggest of them all.

The final meeting of the creditors of the Atwood Phonograph Co., of Memphis, Tenn., will be held January 23 at the office of the referee, A. A. Hornsey, in the Bank of Commerce building, that city.

THE MAN WHO PICKED "TIPPERARY."

Bert Feldman, the Prominent London Music Publisher, Saw Merit in the Song That Others Had Rejected and the Sale of Millions of Copies of the Song Has Proven the Value of His Judgment as to Its Merit.

To those who have marveled at the wonderful success in this country of "It's a Long, Long Way to Tipperary," the marching song of the British soldiers fighting on the Continent, the accompanying portrait of Bert Feldman, head of the British music publishing house of B. Feldman & Co., who are the publishers of the number, should prove interesting.

The success of "Tipperary" is particularly re-



Bert Feldman.

markable at this time owing to the fact that it is not in any sense a war song, but a plain Irish ditty without any attempt at the injection of poor brogue or other features supposed to be popular with the masses. It is simply the plaintive hankering of an Irishman marooned in London to get back to his own Tipperary, and especially to "the sweetest girl he knows." The sentiment is "Home, Sweet Home" and "The Girl I Left Behind Me" combined.

Jack Judge and Harry Williams collaborated to write the words and music, but the former well known music hall artist is the chief author and composer. "Tipperary" was ready for publication in 1911, but it was not until 1912 that Messrs. Feldman accepted it for publication after it had been rejected in several other quarters. Even after publication it was found that copies were not selling, and on Mr. Judge expressing his disappointment, B. Feldman replied, "Take my word for it, that not only Edinburgh but all the world will one day ring with your song." An acute prophecy! The sales have now passed the second million.

In holding to his faith in the ultimate success of "Tipperary," Mr. Feldman has given startling proof of his ability as a publisher of great discernment. In addition to the millions of copies of "Tipperary" sold in England and her possessions, there are to be counted the million or more copies that have been sold in the United States where ChapPELL & Co., Ltd., New York, have the exclusive sale rights.

DICTAPHONE MANAGERIAL CHANGES.

T. K. Lyle, a nephew of Vice-President Lyle and formerly a member of the New York Dictaphone sales staff, has been appointed manager of the Dictaphone business of the Baltimore Columbia headquarters. Mr. Lyle succeeds Harold Duple, who has been placed in charge of the Dictaphone business at Detroit.

Paul Hayden, formerly a member of the Columbia Graphophone Co.'s advertising department, who resigned some time ago to enter the advertising agency business, has rejoined the Columbia advertising staff. Mr. Hayden is very popular, and his return to the Columbia fold was very pleasing.

Lawrence McGreal has re-entered the talking machine field in Milwaukee, Wis.

"MAGNET" DECALCOMANIE NAMEPLATES

FOR TALKING MACHINE CABINETS ETC

EASILY AND PERMANENTLY APPLIED. BE THE FIRST DEALER IN YOUR CITY TO USE THIS POPULAR METHOD OF ADVERTISING.

500 MINIMUM QUANTITY MANUFACTURED. SEND FOR SAMPLES AND PRICES.

GEO. A. SMITH & CO. INC.
74 CORTLANDT ST., NEW YORK

FROM THE **DORAN CO.**
45 MICHIGAN AVE.
DETROIT

FROM THE **THE PHONOGRAPH CO.**
1240 HURON ROAD (Structure House)
PHONES - PROSPECT 2-10 - CLEVELAND

SOLE BY **WALTER D. MOSES & CO.**
103 E. BROAD STREET
RICHMOND, VA.

SOLE BY **J. E. STRATFORD**
AUGUSTA, GA.

SOLE BY **MURTEAU WILLIAMS & CO.**
MONTREAL - OTTAWA

Kunkel Piano Co.
BALTIMORE

YOUR VERY GOOD HEALTH, NINETEEN-FIFTEEN.

Here's to Your Happiness and Prosperity Through Life, Master New Year—May Your Feet Touch Only the Soft Places, and Your Purse Be Full to Overflowing Always—May This Be the Good Fortune, Also, of Talking Machine Men Everywhere.

The mile-stones which mark the years flit past with ever-increasing rapidity, taking with them things which are good and evil. The highway of time is strewn with fragrant blossoms for some while others totter under a burden of deepest sorrow; such is the way of the world, which to most of us is past all understanding.

However, I imagine we are all quite pleased to greet old Father Time's new baby, 1915. We should at least welcome him in a spirit of good fellowship, for probably no nation upon the entire earth to-day is enjoying just the sense of security together with the self-satisfied feeling that goes with deeds well performed as is The United States of America, God bless her!

While we tremble at the dire calamity which has befallen our neighbors across the father of waters, and stand aghast at the thought of eighteen million men plunged into the bloody maw of battle for reasons that are difficult to sanction, we, thank heaven that we can at least aid in appeasing the suffering which this war has caused.

The fact that we are at peace with the whole world and that business is undergoing a rapid change for the better should make every American citizen play "The Star-Spangled Banner" upon his talking machine at every concert. Speaking again of the improvement in trade, the month of December, 1914, showed a very substantial increase, the holiday business of the Philadelphia department stores being the greatest in their history. Far more parcel post and express packages were shipped than ever before, and—here's something interesting—Gimbel Bros. sent home seventy-two talking machine outfits in one day. Never were the crops of our country so valuable as in the year just ended, the magnificent sum of \$10,000,000 being paid for them, and now, to-day, Europe is calling impatiently for our products.

Still another thing to be thankful for is the fact that importations—the articles that Europe alone can produce—are coming along in satisfactory quantities. Cities in the various war-torn countries are rapidly adjusting themselves to present conditions and are endeavoring with bravery and tact to make the best of a bad situation from which, of course, we shall profit.

Therefore, gentlemen of the talking machine

fraternity, let us all be optimistic for 1915. What could we gain by doing otherwise, living in the greatest country and under the most glorious flag, peace and abundance everywhere, liberty with all that the name implies? What more, pray, could we wish?

Made any new plans for 1915, Mr. Dealer? Have you thought of any accessories which might be added to your business machine in order that it may run a little more smoothly in the future? In other words, have you indulged in a confidential



Your Very Good Health, 1915.

chat with yourself upon the subject of better business and more of it? If you have not done this, I would suggest that at the first opportunity you take an hour or so to think this thing out. Lock yourself in your private sanctum with a note book and a good cigar, place a "No Admittance" sign on the door, and concentrate. When your note book is bulging with the new ideas that have come to you through the quiet and tobacco smoke, unlock the door, take down the sign and call in the boys. Read them your ideas and ask for suggestions and improvements. Believe me, Mr. Dealer, this is a great New Year scheme. The people who toil for you are both brainy and faithful or they would not be in your employ—the age of the brainless and the shirker is past. Therefore they too have ideas which they will be only too glad to share with you for your mutual benefit, and their plans for bigger business annexed to the ones you have already formed can have but one result—the uplifting of your entire establishment.

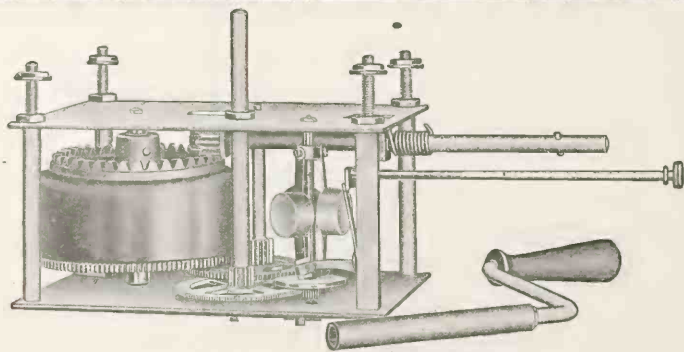

TRITON MOTORS

can be wound while playing. Perfectly made and simply constructed. Will play 12-in. records. Noiseless.

Also makers of Triton Sound Boxes and Tone Arms

These products sold only in quantities to Manufacturers and Jobbers

TRITON PHONOGRAPH CO.

41 UNION SQUARE :: :: NEW YORK

Why not start the young year upon its way by giving a little banquet to the faithful? Make it an occasion where all boundaries, both business and social, are thrown down, and let heart to heart, man to man, talk be the headliner upon the program. There can be no better method employed than this for getting upon a perfect basis of harmony and good will with the people who work for you and with you. There may be misunderstandings existing in your establishment, through no fault of yours, which may go on and on, expanding as they go, and eventually breaking out into a conflagration of unpleasantness unless extinguished by some such means as described above. It works out this way: If a fellow has anything on his chest regarding the bum treatment he thinks he is receiving from the man higher up, an affair like a social banquet, where he meets the big boss on an equal footing, is just the place to air his grievances without the fear of getting fired and also with the certainty of being heard. Also he has the surety of being mollified if the other chap is wrong, which is not, by any manner of means, always the case.

It is imperative, Mr. Dealer, that you consider your subordinates as partners and treat them as such, for it is also through their efforts and ability as well as your own that you are able to maintain yourself in business. The sooner a merchant realizes that by making confidants of his employes he will increase their enthusiasm, and along with it the business building capacity of the institution they represent, the better it will be for him and his pocketbook.

If your profits are not as large as they should be—if there is a drag or a binding somewhere in the trade machinery, ask yourself the question: "Do I stand upon the proper footing with my employes?" If you find yourself compelled to answer in the negative, proceed to rectify this fatal error without loss of time.

How do you feel regarding side lines, Mr. Dealer? Do you not think that, provided the line suggested would blend nicely with the talking machine and increase the sale of the same, it would be well to take it on?

"If this is so, unquestionably yes," I hear you answer.

Then comes the skeptical query: "What is this wonderful side line which sells not only itself, but everything with which it comes in contact?"

I answer you with enthusiasm and candor: "The moving picture machine for the home."

You will remember, if you were considerate and patient enough to read my December story, that Santa Claus paid a brief but glowing tribute to this instrument, and I wish to follow up his statement with a short one of my own, to wit: Every talking machine dealer should sell the Pathoscope, for by doing so he will not only add greatly to his own profits, but send into the homes of his customers a wealth of entertainment, and at the same time, distribute among the young folks of the household splendid facilities for advanced geographical education. The moderately priced films, bearing wonderful action pictures depicting life in other lands, can have but one effect, and that is for the greatest possible good. I have investigated this machine thoroughly, and the results have been most gratifying. My hat is off to the Pathoscope.

Lack of space prohibits further details at this time, but take my advice, Mr. Dealer, and when you communicate with Pathé Frères regarding their wonderful talking machine, the Pathephone, ask about the Pathoscope also. I feel sure that if you do this, you will become as enthused and delighted as was the writer.

If when you think of the old year,
You get a little blue;
As you compare the things you've done
With things you'd like to do,
And good resolves seem hard to keep,
No matter how you try;
Just grit your teeth and plug away,
For that will get you by.

HOWARD TAYLOR MIDDLETON.

The Stewart Talking Machine Co., Victor jobbers, Indianapolis, Ind., had a large holiday business. W. S. Barringer, manager of the company, said the December business surpassed all expectations. George E. Stewart, son of Alexander M. Stewart, owner of the Stewart Co., is now in full charge of the large wholesale department.

REUNION OF ROBT. L. LOUD FORCES.

Members of Buffalo and Niagara Falls Stores Entertained by Mr. Loud at the Hotel Statler—The Year's Sales Campaign Discussed—Most Enjoyable Gathering.

(Special to The Talking Machine World.)

BUFFALO, N. Y., January 6.—Optimism that heralds a record-smashing 1915 glowed at the complimentary banquet tendered the entire working force of Robert L. Loud's piano and Victrola stores in Buffalo and Niagara Falls on the night of December 31. Robert L. Loud, head of the big institutions, acted as host to his employes at the enjoyable affair featured in the Dutch room of the Hotel Statler, and instilled a new spirit of enthusiasm into the workers, who sell hundreds of musical instruments in Buffalo and the Power City each year. A year's successful sales campaign was discussed, and it became known that despite business depression, 1914 was well to the fore insofar as business was concerned. At the conclusion of the banquet Mr. Loud was toasted royally, and all those in attendance pledged themselves to set a new mark for sales during the year to come.

Mr. Loud, as proprietor, was called upon to act as toastmaster, while his son, Lingard Loud, formerly actively connected with the firm, was the guest of honor. Mr. Loud is in his last year at Harvard. Young Mr. Loud contributed to the entertainment during and after the dinner.

Although many of the sixty business associates of Mr. Loud were called upon to speak, there was hardly time for a bare majority to respond, as a bowling match was featured in the Smith alleys at the conclusion of the "spread." R. C. Schermerhorn, manager of the Loud Buffalo store, rolled the highest score in the matches between the local and the Niagara Falls forces. The Buffalo team won a hotly contested match.

Richard Neville, one of the oldest employes in period of service for the Loud interests, was given an ovation when he was called upon to review the events of the piano business in Buffalo for the past twenty years. Clifford E. Ford, in charge of the Loud player department, spoke on "Customers I Have Met," while C. C. Schumacher enlarged upon "Player Construction," as his topic. Other shop-talk was indulged in, until the gathering repaired to the bowling alleys.

From the Buffalo store these live-wires were in attendance: Robert L. Loud, Lingard Loud, A. J. Boland, R. C. Schermerhorn, Richard Neville, C. C. Schumacher, Edwin Hayes, C. E. Ford, H. G. Butler, E. M. Stroud, Edward Hock, Edward Heintz, Harry Towne, Emil Fischer, Alvin Strohecker, John Dreyer and Anthony Weise.

The guests from Niagara Falls were: Gordon W. Cattley, Carl Doerflin, R. J. Mitchell, Don Sutherland, William Chambers, Frank Finley and M. D. Trumbull.

LATEST VICTOR PUBLICITY.

Some Superb Advertising Matter Prepared for Dealers to Boom January Trade.

The Victor Talking Machine Co. sent out to its dealers recently a large amount of advertising matter to assist them in securing a record-breaking January business. January is considered by a large proportion of the trade as the best record selling month in the year, owing to the fact that so many machines have been purchased for Christmas presents that a vast amount of new record business has naturally been created.

One of the most important features of this January advertising literature was a window poster of John McCormack to present the new Victor record of "Tipperary" which this eminent artist recently recorded. This window poster represents the highest development of the printing and engraving arts, and its design, coloring and general make-up equal in dignity and attractiveness the most artistic publicity ever issued by the Victor Co., whose efforts in this particular field have won the praise of advertising and sales experts throughout the country.

Included in the general advertising matter for the month were two hangers devoted to the Victor educational division, featuring American history

series and Shakespearean records. This usual batch of monthly literature included for the first time a sheet of foreign and domestic numerical pasters, which were introduced a short while since by the New York Talking Machine Co., Victor distributor, with signal success.

MORTIMER D. EASTON HONORED.

Elected a Member of the Board of Directors of the Columbia Graphophone Co.

Mortimer D. Easton, son of Edward D. Easton, president of the American Graphophone Co., will take a seat on the board of directors of that company at its January meeting in New York City. The new director was graduated from Princeton in 1910 and has already served a substantial apprenticeship in the business.



M. D. Easton.

He started his Columbia career in the export department, for which his special study of languages had suited him. He then went into the Bridgeport factory and learned how graphophones were made. For several years past he has been specializing on the Dictaphone. As a Dictaphone salesman in New York City he made a successful record. He then went to the City of Mexico and had charge of the Dictaphone throughout Mexico, being aided by an excellent knowledge of Spanish. On his return from Mexico he traveled extensively in the interests of the Dictaphone both in the United States and in the West Indies. For a short time he served as private secretary to his father. At the present time he holds the position of advertising manager of the Dictaphone. In the latter part of January he will start with his wife for the Pacific Coast and will have charge of the great exhibit of the company at the Panama Exposition.

An interesting fact in this connection is that Mortimer Easton was born at about the time of the birth of the graphophone and is one of the second generation to become prominent in the business created by his father; a conspicuous instance being John Cromelin, now general manager of the Columbia Graphophone Co. and the son of the late R. F. Cromelin, one of the pioneers who was associated with Edward D. Easton from the beginning; another being Mervin E. Lyle, now the manager of the great Bridgeport factory of the company, the son of the late Mervin E. Lyle, Sr., who was also a pioneer.

The Pearson Piano Co., 128-130 North Pennsylvania street, Indianapolis, Ind., handling the Victor and Edison disc machines, had an attractive holiday Edison window. With a background of white and large palms, a picture of Mr. Edison, a number of Edison machines were placed in one of the main windows. The display attracted the attention of the holiday buyers and, in the opinion of the Pearson Co.'s window decorator, was responsible for a number of the Edison sales at Christmas time.

OPPOSITION TO NEW PATENT BILL.

American Inventors Claim That So-called Emergency Measure Favors Foreigners to the Detriment of Citizens of This Country—An Outgrowth of the War.

Considerable opposition has developed against a bill drawn up for presentation to Congress by the American Patent Law Association providing for the temporary extension of the time of filing applications for letters patent and registration in the Patent Office and fees therefor. This bill is broadly drawn, in order to cover all possible contingencies growing out of the war, and purports to follow closely a law passed in Germany since the outbreak of hostilities for approximately the same purpose.

The present wording of the bill, however, affords to the Germans, as well as other foreigners, more definite advantages than are given to American inventors, or other interested persons, by the German act. In addition to this, the wording of the bill is said to discriminate in favor of foreigners in that it offers them the chance of pleading that owing to their financial condition on account of the war, they were unable to file their applications in good time, whereas citizens of this country, who are also adversely affected in a financial way by the war, are not granted similar privileges.

The bill specifically provides that "whenever an applicant for letters patent or registration of a trade-mark or label is unable on account of the existing state of war to file an application or pay any official fee within the period now limited by law, then the commissioner of patents will upon petition accept such application or fee within an additional period of nine months." It also says that the act shall be deemed effective from August 1.

The German law in question, while it makes specific mention of an extension not exceeding nine months in which an overdue annual patent tax may be paid without the penalty of an additional fee, does not provide for the acceptance of delayed applications for patents during that period.

COMMITTEE OF JOBBERS TO MEET.

(Special to The Talking Machine World.)

CHICAGO, ILL., January 12.—The executive and advisory committees of the National Talking Machine Jobbers Association to meet at the Chicago Athletic Club on Sunday, January 24, when plans for the next convention to be held in San Francisco, will be discussed and perfected and other important matters taken up for consideration.

"HELP" AND "POSITION WANTED" ADS.

Beginning with the current issue of The Talking Machine World "Help Wanted" and "Position Wanted" advertisements will be accepted at the rate of 25 cents per line. Minimum advertisement, four lines. To all other classes of advertisements the card rates will apply as in the past.

Pluck is bound to end with luck. If you don't believe it, just spell the word out. It's there!

Your Opportunity

50 cents stamps brings you a sample of our highly perfected Standard Fibre Needle Cutter.
25 cents stamps brings you a sample of our simple and accurate Standard Automatic Stop.

Samples sent only to bona fide dealers writing on their business letterhead. Place regular orders through your jobber.

STANDARD GRAMAPHONE APPLIANCE CO.

173 LAFAYETTE STREET

NEW YORK

LANDAY BROS.' HANDSOME NEW ESTABLISHMENT.

Opened Recently at 23 West Forty-second Street Proving One of the Most Popular of the Various Establishments Controlled by Landay Bros. in New York.

The new Victor store of Landay Bros. at 23 West Forty-second street, New York, is proving to be one of the most successful establishments that this enterprising and successful Victor firm has yet opened. Situated in the heart of the high-

herewith. This sign is visible from a comparatively great distance, and sends the Victor message of Landay Bros. broadcast.

Benj. Landay, who has been associated with his brothers in the conduct of the Landay Bros.' stores for several years, is manager of the new store, assisted by a capable and efficient sales force. To Max and James Landay should be credited the splendid success of the house of Landay Bros. and the detailed perfection of the new store. Their many years of experience in the Victor business and their intimate knowledge of the requirements of high-grade merchandising is reflected in the steadily increasing prestige of the Victor establishments of Landay Bros.

A feature of Landay methods in the new store and the other Landay establishments is the detailed perfection which characterizes the store's record service. Landay Bros. since the first day they entered the Victor business have maintained that the success of any Victor business depends primarily on completeness of stock and a



Demonstration and Record Stock Rooms with Concert Hall in Extreme Rear.

true understanding of the term "service." With the end in view of making every transient customer in their stores a permanent one, Landay Bros. have spared no effort or expense to keep their record and machine stocks as complete as conditions and circumstances will permit. A Landay customer is made to feel that his desires will be accommodated at all times, and the success of this far-reaching policy is well evidenced by the prominence of the Landay Bros. stores in local talking-machine circles.

PHONOGRAPHS FOR INSTITUTIONS.

One of the Real Needs of the City, Says Charities Worker—Contributions Solicited.

The need of phonographs and records in our public institutions of New York is urged by Mary G. Potter, a member of the New York City Visiting Committee of the State Charities Aid Association.

"A pleasant and familiar tune frequently quiets the patient and turns his mind from his own distress, while for the cripple or defective it is both a source of good cheer and a stimulus," says the appeal.

This committee visits twenty-five public hospitals and almshouses, each of which has many wards in which music would be welcome. Phonographs and records may be sent to room 701, Charities building, 105 East 22d street, New York.



Entrance to Landay Bros.' New Establishment, on West Forty-second Street, New York, Showing Great Electric Sign.

grade shopping district and easily accessible to all modes of transit, this new member of the Landay chain has closed a remarkable business in the few weeks it has been open. There are now five Landay stores in New York, all of which are situated in the most desirable high-class business districts of New York. They represent clearly and convincingly the progress that the products of the Victor Talking Machine Co. has achieved in recent years, in addition to being a tribute to the business success of Landay Bros. The addresses of these five stores are 563 Fifth avenue, 427 Fifth avenue, 27 West Thirty-fourth street, 153 West Forty-second street and 23 West Forty-second street.

The new Landay store is a model of refined furnishing and decoration. Gaudiness and show were forbidden in the instructions given the decorators, and the result is a store which even surpasses in many respects the other Landay establishments which have been opened in recent years. In the new store there are eight Victor record demonstration rooms, finished in white mahogany after the Louis XV. period of furnishing and design. In the rear of the store is a beautiful recital hall which is favored at all times with natural lighting facilities, there being no need for artificial lighting during the day. The display of Victrolas in this room is comprehensive and adequate, affording the prospective purchaser the privilege of hearing the machines under ideal conditions.

A feature of the new store is an immense electric sign, which is shown in one of the illustrations



Main Display Room of Landay Bros.' New Store Viewed from the Entrance.

LIBERAL ADVERTISING AIDS ST. LOUIS TRADE.

The Great Factor in Enabling the Talking Machine Dealers of That City to Surpass All Former Records in the Matter of Holiday Sales—Where the Demand for the Higher-Priced and Cheaper Machines Is Divided—Dealers Pleased and Optimistic for 1915.

(Special to The Talking Machine World.)

St. Louis, Mo., January 8.—The talking machine dealers here are more than elated with their year-end showing of sales, both as to machines and records. The trade was practically limited by the available supply of Victor and Columbia machines, ranging from \$75 to \$110 in price, and the \$250 Edison disc styles. There is not a store that handles talking machines but that asserts that the business for December far eclipses the mark fixed in October, when the Christmas stock orders were given or revised.

There is a plain line of divergence between the price of machines sold by the downtown musical instrument houses and those handling talking machines as a side line to house furnishings and the sale of the machines at a lower price than \$75 was practically limited to the latter houses. It is whispered that the Piano Row houses and those of the same standard in other parts of the city, bring pressure to bear so stiffly for the higher priced sales that they either gain their end or the prospects go to the house furnishing houses to make a cheaper purchase.

Another feature of the trade this Christmas was the exceptional amount of cash. The percentage of ready money paid on talking machine sales far exceeds that of former years. One sales manager said that this had two explanations; the stiffer terms put onto the trade by the Talking Machine Dealers' Association and the consequent stimulation toward cash on the salesmen, and the fact that so many people had been out of work. The latter fact has turned to the benefit of the talking machine trade in rather a peculiar way. When shops began to shut down and stores to decrease their forces, many wage earners took warning and began to lay aside a fund for an emergency. When Christmas came, with a practical assurance that the hard times are passing, a part of this rainy day fund went into a Christmas present for the family.

Several talking machine houses beat even last year's record of sales. This is true of the Field-Lippman Piano Stores, where the last year's December sales record was equaled on the afternoon of December 21, and some very good sales were recorded after that period. The Concordia Music House (Barthel & Dusenberg) also went ahead of previous records. The local jobbers of all three lines report increased sales over a year ago. There is a decided increase in the number of houses handling all three lines in this city and trade territory, yet retailers all are congratulating themselves on the showing, as compared with other lines of merchandise, which goes to show the strength of the talking machine trade and its steady growth in this section.

C. R. Salmon, of the Columbia jobbing department, reported excellent trade for that company and remarked that the Favorite model was most in demand for the country trade.

The advertising campaign conducted this year on behalf of the talking machine caused much talk. This feature, more than ever, has made the piano men take notice of this invasion of their field of musical instruments for the home. While exact totals are not at hand for the advertising for the month, it is admitted on all sides that the talking machines ran the pianos a very close race for supremacy, if indeed, they did not win. The piano houses that handle both talking machines and pianos have expressed amazement at the rapid strides of the talking machine, and this very fact has put some of the piano men on their mettle as to the line that they regarded as the leader.

The advertising campaign by the Silverstone Music Co. on behalf of the Edison disc machines has caused more talk, perhaps, than any one feature of the holiday musical instrument trade. At the time of the Edison factory fire Mr Silverstone had in one of the newspaper offices here a two-page spread, largely art work of a Santa Claus, ready for publication in \$1,000 worth of space the next

Sunday. Mr. Silverstone showed his gameness by permitting this ad to be printed despite the fact that every newspaper was printing reports that the Edison factory was in ruins and that the trade generally expected the Edison machine to be out of the market as soon as the stocks then in the jobbers' warerooms were sold.

"We have had an excellent trade during December," said Mr. Silverstone. "Fortunately, we had plenty of machines, unless it was that a few more of the \$250 model, which all of our retail dealers are pushing, were needed. We thought we had plenty of these, but we were very glad the day after Christmas to receive an additional shipment from the stored stock at Silver Lake. Several of this later shipment were held in our warerooms only long enough to assure that the packing was in good order and to change the addresses to our customers."

The Aeolian Vocalion still is a mystery to the local trade, and at Aeolian Hall no predictions are made as to when the machine will be displayed here, nor is any comment made except, "We hear from New York that the instrument is meeting with unqualified approval of all who hear it."

Harry Levy, manager of the Aeolian Hall talking machine department, was well pleased with the outcome of the holiday trade at that store. "The big thing to me," he said, "is the general record made by the talking machine trade this year as compared with other lines of trade. From what I hear of mercantile lines, there is no other line that will show the excellent comparison that the talking machine trade will."

The record business this Christmas probably exceeded by large amounts that of any former years. Retail Manager Duffy, of the Columbia warerooms, tried out the plan of making up selected packages for the holiday trade, and to quote him: "They were a whirlwind success." The packages, artistically wrapped and with the numbers and names listed, were displayed in the show windows. There was natural sequence in the lists and many persons seeking Christmas presents rejoiced to find their work done for them. The dance package beat the others, except the purely Christmas selections, by several laps.

A notable change in the trade during 1914 was the cutting down of the exclusive model dealers.

Where in former years few dealers handled more than one model, now almost every downtown dealer handles two, if not all three lines. The comparison of the machines is made a strong point in the advertising. A pioneer in this line of advertising was the Thiebes Piano Co., and this year this company used newspaper space very liberally with well-displayed, special art advertisements which presented the three lines impartially and invited the customers to come to the store and decide.

INCREASES FACTORY FACILITIES.

American Phonograph Co. Now in a Position to Go After Trade in an Extensive Way—Some Interesting Features of the Autophone Manufactured by That Company—Now Appointing Agents in Various Localities.

The American Phonograph Co., 101st street and Columbus avenue, New York, which is making the Autophone, has greatly increased its manufacturing facilities and is now in a position to go after the market of this country in an extensive way. In the Autophone is represented a phonograph that automatically plays twelve records, going through the entire list one after the other or stopping at any one desired. Any or all of the records may be removed and others substituted quickly.

Two particular features of the Autophone that the company desires to impress upon the trade are that the company has been making mechanism for slot machines in many ways similar to that used in the Autophone for nine years, thus emphasizing the fact that the instrument has been subjected to hard usage by the public and the test of time, and is no new experiment in any sense of the word; and the other is the simplicity of the Autophone. In the latter connection it is claimed that it is absolutely fool-proof; that any child can operate it; that every useless part has been eliminated, and that the Autophone represents the last work in phonographs of any type.

A diamond-point reproducer is used, this diamond having been used since 1907, while it was back in 1904 that the company first used the concealed-horn feature in machines of its make. The cabinet is genuine mahogany, high-class finish both inside and out, the inside mechanism being beautifully nickel-plated. The motor runs from one-half to three-quarters of an hour of playing, and without the slightest attention it is possible to hear twelve different selections of music.

With the increasing of manufacturing facilities the company is adding to its territory, and is now prepared to appoint representatives in various localities where it is not represented.

LONG CABINETS



D 70

Mahogany, Golden Oak, F. O. and W. O.
Finished all around.
Sliding Record Shelf.
For IX Victrolas.
Capacity, 196 12-inch Records.

Follow up your
machine sales
for Cabinet
business

The George A. Long Cabinet Co
Hanover, Pa.

Address Clement Beecroft, Sales Manager
309 W. Susquehanna Avenue, Philadelphia



The announcement in the February list of exclusive Columbia recordings by Eleonora de Cisneros, the famous American mezzo-soprano, is what a great many Columbia customers have been waiting for.



(Write for "Music Money," a book "full of meat" for those dealers interested in quick and frequent turnover of capital.)

Columbia Graphophone Company
Woolworth Building, New York

MANY CASH SALES PLEASE THE TRADE IN BALTIMORE

High Grade Machines and Records and Ready Money Features of an Unusually Brisk Holiday Business in Monumental City—Victrola Used for Minstrel Show of Polytechnic Institute—Talking Machines in Demand by Dancing Academies—Other News.

(Special to The Talking Machine World.)

BALTIMORE, Md., January 9.—Truly marvelous was the talking machine business done in Baltimore during December by the thirty odd talking machine dealers in this city. Everywhere the business went forward by leaps and bounds; in some instances it doubled the sales of December, 1913, and as to the year's business 1913 went over 1912 and last year left 1913 far in the rear. The most sanguine optimists never looked forward to the business that was done in talking machines previous and during the holidays. Many of the talking machine sales people appear to be bordering on nervous prostration as a result of their hard work. A conservative estimate placed 4,000 as the number of machines sold during the month in Baltimore.

One of the big features of the Christmas rush was the amount of ready cash that was forthcoming. It was the large cash business that was really pleasing, in addition to the volume. Along with the rush of business the sales of records also went forward by leaps and bounds.

Higher priced machines had the call, and had it been possible to obtain more of the higher grade talkers more would have been sold. But at the same time no sales were missed, and when purchasers were unable to obtain the higher grade article they contented themselves by taking lower priced machines than was their original intentions.

The rush is still going on and all the dealers are still on the jump. Many of them say that they are selling many more machines than they expected during the days immediately following the Christmas rush.

E. F. Droop & Sons Co., one of the Victor distributors here, through W. C. Roberts, its manager, report a wonderful business that exceeded all

expectations for both December of 1914 and the entire year. Continuing, he said: "We never expected to do the business in December that came to us. It was truly wonderful. High priced machines had the call, and the only reason we sold a good many lower priced machines was the fact that our supply of the higher priced machines was out.

"A big surprise was the volume of cash business done in our retail department. The cash retail business for December of 1914 was greater than the wholesale business done in December of 1913."

During the rush four extra men were added to Droop's sales force, and two of these will be permanently retained.

At the headquarters of the Columbia Graphophone Co. in this city the greatest December business in the history of the local office was reported. This office, which is the distributing point for a great part of the South, was hard pressed to keep up with the demand made upon it. Clifford Cooke declared that the business had exceeded all expectations and preparations, for care had been taken to lay in an extra large supply of machines and records, but even the precaution failed to meet the demand. Continuing, he said: "With the high price goods holding the lead, cash sales were better than ever before. Among the sales were three \$500 grand Grafonolas. There has been no lull in the business since Christmas, and we are still waiting to fill some orders."

"The Victrola season was the greatest we ever had," said Henry Eisenbrandt, of H. R. Eisenbrandt Sons, Inc., a local distributor of the Victrola. The Eisenbrandt firm has represented the Victrola ever since the company was organized, and the statement coming from Mr. Eisenbrandt, who is thoroughly familiar with the work in all its

branches, having full charge of the talking machine department of the house, means much.

I. S. Cohen, of Cohen & Hughes, Inc., stated that the December business was the best they had ever done in Victor machines. "A better class of trade buying higher grade machines," said Mr. Cohen, "was one of the features of the holiday rush. The big question was to get sufficient machines to meet the demand, not alone for the retail trade, but for the dealers. In two days we received and answered 310 telegrams from all parts of the country for machines. These came from Chicago, Boston, Philadelphia, Florida and many other points. It was without doubt the best December we ever had."

It was with the greatest difficulty that Stewart & Co. succeeded in filling all its orders for higher priced Victrolas. But J. L. Gibbons, the manager of the Victrola department, who came here recently from the Stewart Dry Goods Co., of Louisville, foresaw the rush and made preparations for it. When it came Mr. Gibbons had eighteen machines stored away to fall back upon, and he found it necessary to use them.

A \$200 Victrola was furnished by the Stewart firm for the minstrel show given by the students of the Baltimore Polytechnic Institute. Mr. Gibbons selected the machine and was on hand when it was used. He said that he went to all parts of the large hall and was greatly pleased with the performance of the machine. The result was the sale of a \$200 Victrola to the institution.

Two dancing academies in this city have added the Victrola to their establishments as one of the things necessary in the instruction of the latest dances. One of the machines—a \$150 model—was furnished by the Stewart firm to Prof. Albert V. Tuttle, who conducts one of the most select dancing academies in this city. The same firm furnished a Victrola to the Easy Method Dancing School.

The rush for records has struck Stewart & Co. hard and a big sales force is being kept on the move to handle this business. For three weeks this store, Mr. Gibbons says, was the only one in Baltimore that had Cecile in stock.

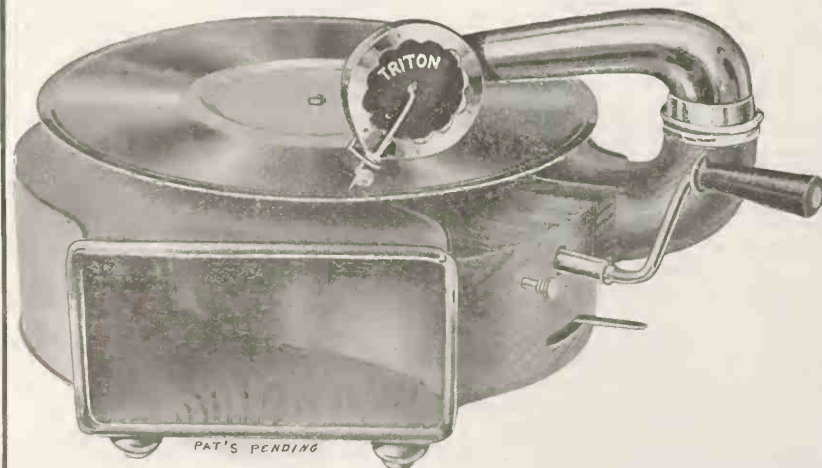

The Triton Phonograph

Retails at \$10

Wonderful value for the money, it being possible to play any lateral-cut disc, getting music of excellent power.

Solidly built and guaranteed.

Samples \$10

Write for territory and wholesale prices

TRITON PHONOGRAPH CO.

41 Union Square

NEW YORK

Joseph Fink, of the Fink Talking Machine Co., like all other talking machine dealers, was in a very optimistic humor, both over December business and the outlook. He said: "The 1914 business was 50 per cent. better than 1913, and December of 1914 more than double the business of the same month a year ago. Higher priced machines had the call and I was hard pressed to fill all the orders for Style XI, Victrola, which was really the best seller. The new electric machines were sold with a rush. I couldn't possibly wish for better trade, and since Christmas there has been no letup. Between Christmas and New Year's we did as much business as we could handle."

Hochschild, Kohn & Co., one of the largest department stores in the city, and which has a large Victrola department, did a good holiday business. Mr. Lorfink, the manager, says he is devoting most of his attention to regular customers of the house with excellent results. He said he had no complaint to make as to the amount of business done.

Hammann-Levin Co., through Mr. Levin, reports a phenomenal run on Victrolas, and it was well pleased with the business. "The higher priced machines, that is, those from \$50 up," said Mr. Levin, "sold as fast as we could get them."

The Hub Piano Co., which handles Columbia machines, did a very satisfactory business. It reports as much business as it could handle.

Sol Rosenstein, of the Rosenstein Piano Co., which handles both Edison and Columbia machines, said he believed his firm sold more talking machines in the last two weeks in December than any two agencies in Baltimore. Its specialty was low priced machines, \$17.50, \$25, \$35 and \$50. The fire that destroyed the Edison plant made things look bad for us for a little while because we could not get as many models as we needed.

The business done by William C. White, where the Victrola is handled, was one grand rush during the holidays, and it is still keeping up. In addition to the many higher priced machines sold before Christmas, several others have been disposed of within the last few days.

Sanders & Stayman Co. did an exceptionally fine business in both Victor and Columbia goods. In fact, it sold completely out of machines. It handles only machines from \$40 upwards, and did the best business for December since this department has been added to its establishment.

A high tribute to the record albums of the New York Album & Card Co. was paid by J. L. Gibbons, of the Victrola department of Stewart & Co. Mr. Gibbons says that the albums are the best he has ever seen, and the big feature of them is that they are sold cheaper than albums manufactured by any other concern.

Phil Ravis, vice-president of the New York Album & Card Co., and Charles Hill, of the Herzog Art Furniture Co., recently visited the trade in this city.

The big selling records for the month were John McCormack singing "It's a Long, Long Way to Tipperary," "Cecile" and dance records.

An interesting talk on the educational value of the talking machine was given by Mrs. Henrietta Baker Low, of New York, for many years the supervisor of music in the public schools of Baltimore, before the porch class of the Women's Club of Roland Park. Mrs. Low spoke of the necessity of teaching the young children to appreciate good music and keep from them a superabundance of ragtime. She discussed the value of training the child's voice to sing in accompaniment to good music played on the Victrola, and outlined the means by which children can be taught to differentiate between good and bad music.

One hundred and fifty inmates of St. Vincent's Male Orphan Asylum were given a treat in the form of a Victrola concert Christmas Day. This was made possible through the kindness of Adam Deupert, who for almost a quarter of a century has been president of the board of directors, bringing his handsome Victrola from his home to the institution.

A little balance on the right side of the ledger will do more to put stamina into a man than most any other human agency.

PROMOTION FOR F. R. ANGLEMIER.

Appointed Local Manager of the Columbia California Store Thus Relieving Walter S. Gray, Whose Duties as District Manager of the Pacific Coast Trade Have Considerably Broadened Out—Both Entertained at Banquet.

(Special to The Talking Machine World.)

SAN FRANCISCO, CAL., January 4.—Fred R. Anglemier has been appointed local manager of the Columbia Graphophone Co.'s store in this city, thus taking off the shoulders of Walter S. Gray, district manager, some of the responsibility of looking after local affairs. Mr. Gray for the past three years has looked after the company's interests in San Francisco in addition to the duties incumbent upon his position as district manager. His district is a large one, extending into Montana and south to the Mexican border, and his resignation as local manager will give him more time to develop it. Mr. Anglemier has been with the Columbia Company for five years, spending two years at one of the retail stores and the last three years he has acted as wholesale manager at the San Francisco headquarters. In that capacity he has become thoroughly familiar with the local situation and his appointment as local manager is in the nature of a well-earned promotion.

In view of the change, the annual banquet of the San Francisco force, held on the evening of Dec. 30 at Paoletti's restaurant, took the form of a greeting to Mr. Gray and a reception to Mr. Anglemier. Those present were: W. S. Gray, Fred R. Anglemier, James Ferguson, E. L. Gray, G. L. Mauritius, R. W. Gade, M. L. Mefret, E. G. Batchelor, H. M. Coghlan, O. Boerner, M. Valentine, P. B. Morris, M. Sittenfeld, H. Norstman, C. J. Moore, G. M. Bastian, C. P. Le Roy, T. A. Devine. The

1914 get-together meeting was pronounced by those present the most enjoyable affair of the kind ever attended, the entertainment being excellent and the spirit of good fellowship at its height. All expressed the desire of making 1915 a banner year at the local branch.

SAN DIEGO EXPOSITION OPENS.

Dedication of the Mammoth Organ Precedes Formal Opening of the Fair by President Wilson—Some Interesting Ceremonies.

(Special to The Talking Machine World.)

SAN DIEGO, CAL., January 1.—The Panama-California Exposition, San Diego's twelve months' celebration of the completion of the Panama Canal, opened at midnight when President Wilson in Washington pressed an electric button that turned on the lights in the buildings and grounds.

Preceding the formal opening was the dedication of a music pavilion and mammoth organ, presented to the exposition and the city by John D. Spreckels.

William McAdoo, Secretary of the Treasury, represented President Wilson in the dedication.

Fireworks and illuminations signaled the opening of the gates early in the evening, and for three hours there was opportunity to explore the new city of Old Spain, which has risen on the mesa above the Harbor of the Sun.

At 11.30 p. m. the formal ceremony of throwing wide the gates to the world began. Lyman J. Gage, of San Diego, former Secretary of the Treasury, introduced Col. D. C. Collier, former president of the exposition. After describing the inception of the exposition, Col. Collier made way for President G. Aubrey Davidson, to whom were delivered the plans, the keys, and finally the exposition itself.

At midnight the exercises ended, and the flash of an electric spark in the White House carried over the wires President Wilson's announcement.

WHAT WOULD YOU DO?

IF YOU FOUND YOUR COMPETITOR

was able to give **BETTER SERVICE** than you? "**YOU SHOULD WORRY.**"

Worry until you found out WHY. If you found, as many dealers do, that the "REASON" was "BLACKMAN SERVICE" would you be satisfied with the reason only, or would you become a "BLACKMAN DEALER"?

If this fits your case or if you are not getting SATISFACTORY SERVICE on Victor Machines or Records will you get in touch with Blackman AT ONCE?

"Satisfaction at Blackman's COSTS LESS than dissatisfaction elsewhere."—Blackman.

WILL YOU DO IT NOW?

DISTRIBUTORS



Blackman
TALKING MACHINE CO.
97 CHAMBERS ST. NEAR CHURCH ST. NEW YORK

JOBBERS





EVERY PROPHECY FULFILLED

NOT A PROMISE BROKEN

THOSE of our dealers who threw the responsibility of furnishing them with a Victor stock entirely upon us—who accepted our suggestions as to when and how to stock up—finished the season's business without the loss of a single sale.

We guaranteed no future deliveries—but we filled our orders.

1915 Will Be Your Biggest Year

Our Stocks are the most complete in the country—throw the responsibility of being prepared for this business on us—you'll be taken care of.

THE TALKING MACHINE COMPANY
12 North Michigan Avenue : : : Chicago

FROM OUR CHICAGO HEADQUARTERS

E. P. VAN HARLINGEN, Manager
HENRY S. KINGWILL, Associate

World Office
Consumers' Bldg. 220 South State St., Chicago
Telephone: Wabash 5774

(Special to The Talking Machine World.)

CHICAGO, ILL., January 9.—The holiday season of 1914 has undoubtedly broken all records, and members of the trade can congratulate themselves that in the midst of the general depression that has affected most every other industry their business has witnessed a tremendous advance. Furthermore, the new year has started off right, and reports from numerous cities of the Middle West indicate that there will be a most satisfying sale of records within the next couple of months. An interesting feature of the holiday trade was that the demand was for machines of the larger and more expensive type. There has been, of course, a large demand for foreign records, which is one good that the ill wind of war has blown to the talking machine trade. Cash has been more plentiful than was expected, and collections at the present time are likewise good.

Generous Call for Accessories.

Accessories are enjoying a generous call also, as witnessed in the statement of two of Chicago's leading manufacturers. S. O. Wade says that the demand for the Wade fibre needle cutter during the last month of the old year was just double that of the preceding December and that at the present time the call is holding up very well.

John F. Mortensen, manager of the Salter Manufacturing Co., says that its business also has been a record breaker. "We impressed it upon our customers," said Mr. Mortensen, "that it was absolutely necessary that they place their orders early, and this worked out very happily. Of course, there were the usual number of latecomers, but very few as compared with last year. The volume of business was much greater and there was an unusual call for record cabinets, and there continues to be a demand for that style of cabinet at the present time."

Interest in Pathé Growing.

A. J. O'Neill, of the O'Neill-James Co., local Pathé distributors, says that the Pathé machines and records have been given an excellent reception and that the number of dealers handling the line is increasing rapidly. "We are receiving inquiries concerning the Pathé from all over the Middle West," said Mr. O'Neill, "and have established a number of dealers in the line. Our immense library of records has received particular favor, and our dance records, too, have made a most favorable impression."

Plans New Machines.

George M. Willson, of the Premier Cabinet Co., of Montoursville, Pa., announces that his company is at work upon some new and very unique styles of cabinet machines that will be presented to the trade within a couple of months. Mr. Willson says that despite some troublesome delays good progress has been made in the marketing of the present styles, and says that business favored the company all through the holiday season.

European Manufacturer a Visitor.

A notable visitor in Chicago at the present time is Otto Heinemann, a director of the Carl Lindström Co., of Berlin, one of the largest of European manufacturers of talking machines and records, controlling a number of different companies. While in Chicago he is the guest of his brother, Oscar Heinemann, head of the large silk house of the Oscar Heinemann Co.

Mr. Heinemann came to America in December after having been detained in London for three months on account of the war. He was finally lucky enough to get a permit to leave England for the United States and will probably remain here until the war is over. He is making a general investigation of conditions in this country, and is now on a trip which will take him to San Francisco, visiting leading centers both on his way out and on his return to New York.

"We are not attempting to do much in America right now," said Mr. Heinemann. "The high wages, high prices of materials and the great difficulty of shipping goods from Germany, all due to the war, militates against our doing an export trade at present. However, there is a field, I am certain, for our lower priced machines in America, and we hope to do considerable business with you after the war is over. The various interests controlled by our company have had some tragic experiences since the war began. Our French factory, that of the Compagnie Francais Odeon, was burned on August 2 by the Paris mob. Our Russian factory at Warsaw was closed, and the two civil engineers in charge sent to Siberia as prisoners of war."

"As may be readily understood, the talking machine business in the belligerent countries is very much depressed. The sole exception being England. There the factories are quite busy, owing to the fact that business is less demoralized than in the Continental countries, and also because of the practical elimination of Continental competi-

tion both in their own country and in the overseas trade. The factory of the Carl Lindström Co., at Hertford was very busy when I left England both on records and to a lesser degree on machines. The sales of records in England have not felt the effect of the war as much as machines. The sale of patriotic records is, in fact, immense."

Mr. Heinemann spoke very highly of the talking machine business of the United States, the wonderful organizations of the big companies, their marvelously effective selling and advertising plans and the price maintenance system also eliciting his sincere admiration.

Remarkable Holiday Business.

The business done by the Talking Machine Co., local Victor jobber, during the month of December, has broken all records, running ahead of the corresponding month of last year by 60 per cent. R. J. Keith, sales manager of the company, said: "This wonderful showing would indicate that the talking machine business is one of the very few industries that came unscathed through the depression that has existed generally. Machines from \$75 up seem to have enjoyed the greatest demand, although as far as our company went, we were absolutely cleaned out of every machine that we had by the time Christmas Eve rolled around. There was considerable difficulty, of course, in supplying the great demands made upon us, but those dealers who counted on us for their supply of Victor goods during the year—who would accept our suggestions concerning stocks—were all well taken care of. We were also able, further, to help out some of the dealers who ordered at the last minute, and some of the trade from distant parts of the country, but those who depended on us and had given us sufficient notice were not disappointed. We were kept under considerable of a strain right through the holiday season, and every man and woman in the organization worked hard and long in the effort to give service. Of course, this was much appreciated, and every employe was given a five dollar gold piece and a glove certificate. During Christmas we called all our travelers in and set them to work filling orders and waiting on city trade."

Big Holiday Sale of Columbias.

"Business showed an increase of 15 per cent. over December of last year," said Charles F. Baer, Chicago manager of the Columbia Co., to The World. "And if we had been in possession of sufficient stock we could have shown further increase of 40 per cent. The holiday business was

(Continued on page 45.)

THE WADE—THE PRACTICAL—THE WADE Fibre Needle Cutter

The WADE embodies the right principle, worked out through long experience. It is simple, durable and accurate. It trims the needle at an angle resulting in the best tone. The WADE cutters are made of the best steel and are absolutely guaranteed.



The Wade
Fibre
Needle
Cutter No. 2

The WADE has a self-acting stop, which prevents waste and enables one to get from 12 to 15 perfect playing points from one fibre needle. No. 2 has a double action, making it especially easy to operate. No. 1 is a very popular cutter which has given excellent service. You save more than double the price of the Wade in the re-pointing of the first 50c. worth of needles.

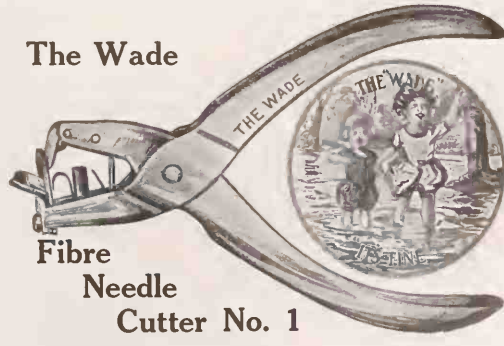

The Wade
Fibre
Needle
Cutter No. 1

RETAIL PRICES—No. 1, \$1.50; No. 2, \$2.00

Order from your regular Distributor—we sell to Jobbers only

WADE & WADE,

3807 Lake Park Ave.
CHICAGO, ILL.

BEGIN 1915 RIGHT

Resolve to take advantage in your Victrola purchases of:

1. **An Enormous Stock;**
2. **A Great Experience;**
3. **An Ideal System;**
4. **A Unique Service.**

You owe it to yourself to have the best possible source of supply for Victrolas, Records and Accessories.

You owe it to yourself to get in touch with

Lyon & Healy

CHICAGO

FROM OUR CHICAGO HEADQUARTERS—(Continued from page 43).

something remarkable, and I think a good indication of further prosperity is found in the fact that of all the goods that we were obliged to deliver after Christmas because of insufficient notice there have been practically no cancellations. The rush was something immense and Christmas dawned without a machine left in the stock room. Our record business was doubled and the present time is holding up in wonderful shape. We have just received a sample of one of the new 'Favorites,' which is equipped with an electric motor and retails for \$75. It is a very handsome thing and runs perfectly. I am going to take a rest for a few days about the middle of January and go on a little shooting trip in southern Illinois."

District Manager W. C. Fuhri is at present on a trip through the South. He will stop for some time at St. Louis and New Orleans.

O. H. Radix, who for some time has been in charge at the order desk, has been transferred to the Dictaphone department and will confine his attention to that branch of the company's activities permanently. He is succeeded by C. H. Kennedy, who was formerly connected with Robert Fulton, well-known music dealer of Waukegan, Ill.

Move Rothschild's Department.

D. V. Dvorak, manager of the talking machine department of Rothschild & Co., announces that his section will be removed from the seventh to the sixth floor, south end, and will be combined with the piano department. The new department will enjoy a greatly enlarged space and the mutual advantages which seem to attend the combination of the piano department with talking machines. Several commodious booths are to be constructed, and when all the work is finished Mr. Dvorak will have excellent facilities at his command. George Israel is buyer of Rothschild & Co.

Asks for Cash—Gets It.

"Ask for cash and you will get it," says T. J. Cullen, manager of the talking machine department of the W. W. Kimball Co. "This has been my experience during the past month. It was the greatest month I ever saw for business, and we received by far a greater percentage of cash. This idea of quoting terms first and cash last is all wrong. I think it is wise to keep in mind, 'Ask and ye shall receive.'"

Mr. Cullen was unable to make any statement concerning the talking machine department that is to be a part of the handsome new sixteen-story Kimball building, which is to be erected probably this spring on the site of the present building.

Five Popular Records.

Five popular records that are being sold by Victor dealers in Chicago are: "It's a Long, Long Way to Tipperary" (McCormack), "Down on the Farm," "When You Wore a Tulip," "Diane of the Green Van," "When It's Night Time Down in Burgundy."

Five Edison records that are selling well are: "It's a Long, Long Way to Tipperary," "Rouli-Rouli," "Die Wacht Am Rhein," "Aba Daba Honeymoon," "Dixie Medley" (banjo).

Some Columbia records that are enjoying a big call are: "It's a Long, Long Way to Tipperary," "He's a Rag Picker," "Destiny Waltz," "Poor Pauline," "Chinatown, My Chinatown."

Wiswell on Eastern Trip.

L. C. Wiswell, manager of the talking machine department of Lyon & Healy, has left for a two weeks' trip to Florida. He will be accompanied by Mrs. Wiswell and will endeavor at St. Augustine to get a good rest from the heavy work of the holiday season. In this connection Mr. Wiswell said: "December was positively the biggest month in both the wholesale and retail way that we have ever had. We were practically sold out and toward the last were deluged with requests for stock that we did not have. Our wholesale patrons for the most part had been stocked up fairly well, but there were, of course, the usual number of those who postponed their orders until the last couple of weeks and then demanded by telegraph and telephone that we ship them goods immediately. This month of December taught many a dilatory dealer the futility of placing holiday orders so late. At

the present time we are doing a big business in records and are also busy with the work of renewing our concerts. This department will contain some special features of unusual interest during the coming season."

New Talker Store.

The Reichardt Piano Co., whose main store is at Milwaukee and Carpenter streets, has opened a new north side branch at 5356 North Clark street. The company is handling both Victor and Columbia lines, as well as a line of pianos.

Blackman Home for the Holidays.

M. M. Blackman, formerly connected with the Chicago trade, returned with his family for a visit to Chicago during the holiday season. Mr. Blackman now directs the distribution of the Edison machine in the territory surrounding Kansas City, Mo., and is very enthusiastic over the possibility for building up a tremendous business.

Big Holiday Business for Edison.

C. E. Goodwin, manager of the Phonograph Co., local Edison distributor, is at present on a short trip to the East, where he is helping in the work of re-establishing the Edison factory and business. In his absence R. L. Du Bois reports that the holiday business in the Edison machine ran into startling figures. "We ran out of almost all the

different styles of machines," said Mr. Du Bois, "and had only one or two machines in odd finishes left when Christmas week came to a close. We were obliged to turn down numerous orders and also took a large number of orders for future delivery. All this was despite the large stock that we received prior to the fire."

Personals and Visitors.

Roy Sonneborn, of Sonneborn & Sons, La Porte, Ind.; E. D. Allington, Freeport, Ill., and M. M. Merrin, of Grand Rapids, Mich., were recent talking machine dealers visiting the local trade.

A. M. Lockridge, the new traveler for the Talking Machine Co., is now upon the road taking care of the Wisconsin trade. Mr. Lockridge succeeds Don C. Preston, who is now located in Minneapolis.

Among other recent visiting dealers there have been in Chicago Mr. Frederickson, of the Frederickson Music Co., of Oshkosh, Wis.; D. L. Hogan, Kankakee, Ill.; E. Brueckner, of Diresville, Ia.; H. G. Power, of the Taylor Carpet Co., of Indianapolis; E. Larson, of Rockford, Ill.; B. H. Hughes, of Oshkosh, Wis.; Messrs. Pronger, of Pronger Bros., Blue Island, Ill.

E. W. Richardson, well-known to the talking machine trade of St. Louis, is now a part of the retail Columbia organization.

DEPARTMENT STORE PRICE BAITERS

Says Brandeis, Cut Rates to Induce Customers to Buy Other Things—Price Maintenance the Sheet Anchor of Trade.

(Special to The Talking Machine World.)

WASHINGTON, D. C., January 11.—Every talking machine merchant in America is interested in price maintenance, and naturally will be interested in certain matters which are now before Congress.

Louis D. Brandeis, of Boston, appeared before the House Committee on Interstate and Foreign Commerce last week in advocacy of the bill introduced by Representative Stevens, of New Hampshire, which has for its object the correction of evils of merchandising based on misleading advertising, sham "bargain" pricing and substitution of inferior articles in place of standard goods.

The legislation is advocated by the American Fair Trade League and by the National Association of Retail Merchants throughout the country. The bill would permit uniform price fixing by manufacturers.

Mr. Brandeis stated that unfair and oppressive competition prevents natural development and gives success to those who use crooked methods to destroy competitive business. He said the aim of the Clayton law was to prevent the destruction of competitors.

He denied the right of the department stores to cut prices of standard articles.

"They lose money every time they do it," he explained. "They have an ulterior purpose in so doing. While they may cut the price upon one or two articles, they will raise the price on others. They do this as an inducement to the purchaser to buy other things.

"A woman who goes into a department store to buy a certain article at two cents cheaper than the average retailer can sell it passes through a series of temptations before she reaches the floor on which this particular article is sold. She will probably spend ten times as much money as she had intended before she leaves this store."

He contended that the people of the country wanted a known value and they did not mind paying the price for it as long as they got that value. He said that to undersell a staple article was not only ruinous to the manufacturer of the article but exceedingly hurtful to the reputation of the retailer as well.

"The minute one store or one man cuts the price on an article," he said, "that very minute the consumer will begin to think that he has been cheated by paying more for such articles at the individual stores. It creates distrust in his mind and he will hesitate before going back to his regular merchant or storekeeper."

Mr. Brandeis contended that the practise of price cutting was used as a "bait" by the department

stores in order to sell other goods to the consumers not on the bargain counter.

"The cut sale," he stated, "blackens the reputation of the manufacturer and the reputation of the retail dealer. Every standard article is a competitive article, and the idea that anyone is benefited through the underselling is erroneous."

These arguments are in line with those which have been previously made in the columns of The World, and we contend that a fixed price for the manufacturers protects the retail purchaser and insures a standard of values. Destroy that, and the solidity of the business edifice tumbles.

Department stores which offer standard articles at cut-rate prices invariably use them as bait to encourage the belief that if they sell standard articles at cut rates all purchases may be made in like proportion at their establishments.

INCORPORATED.

The Atlantic Talking Machine Co., Boston, Mass., has been incorporated with capital stock of \$25,000. The incorporators are: O. S. Wyman and A. A. Wyman, of Boston.

VALUE OF AN ENVELOPE.

If manufacturers would make a practice of saving envelopes in which financial statements and orders are received, according to a man in charge of the collection bureau of an association, they would be able to prove with little trouble, when the occasion might arise, that a statement or order had actually been received. While credit men envelope containing the statement was filed away and could be used to prove misuse of the mails if fraud were practiced in compiling figures. One conviction has already been obtained in this State, he said, for sending a false statement through the mails, and other cases are pending. In bankruptcy cases, he added, the attorney for the bankrupt is often able to discredit the mere word of a witness who testified that a statement was received on such a date, but if the envelope is produced with the date of receipt and nature of the inclosure written on the face of it and signed, the evidence given

O'NEILL-JAMES CO.

337 W. Madison St.

CHICAGO

DISTRIBUTORS OF

PATHÉ
MACHINES AND RECORDS
and ARETINO RECORDS

THE TRADE IN PHILADELPHIA AND LOCALITY

(Special to The Talking Machine World.)

PHILADELPHIA, PA., January 11.—The year 1914 was another conundrum to the talking machine dealers. It was a year of great results and most satisfactory returns. In spite of any business depression it has gone way ahead of any previous year, and in some instances in this city dealers note that their December business increased by close to 100 per cent. over a year ago. The war has had no effect on the talking machine and neither has any other condition.

It might be argued that but for the war the business would have been much greater, but this argument is laid aside, for the reason that the business done was only limited by the capacity of goods that the dealers and jobbers were able to receive, and in neither machines nor records did the supply hold out. What a wonderful business this

is, and who ten years ago would have thought such a thing possible?

As a general rule all the firms were able to take very good care of their regular dealers and such dealers who looked out for themselves in time. It was the pessimists who got left and lost out, and therefore it should be a good lesson to such to turn optimists as soon as possible so that it will not happen again.

There is no striking news developed the past month in Philadelphia. Everybody was too busy making money. So far as I can learn there will be no changes whatever in Philadelphia with the New Year. There will be no new dealers either in Victor, Columbia or Edison; I have not heard of one change at any of the houses, and the only progress that is to be made will be the enlargement of several of the departments, which will be started at once.

C. J. Hepe & Son report that their talking machine business in 1914 was phenomenal, and especially during December. On Christmas day alone they delivered forty-four Victor machines which should have gone out a few days before. The Heppes had been well supplied, and while they ran short on two of the biggest sellers, yet they feel that they did not lose very much business.

Blake & Berkart, the dealers in the Edison line at Eleventh and Walnut streets, say that they have no kick coming whatever. They are short of the eighty machine, but otherwise the factory kept them well supplied and the fire had little effect upon them, and they were able to keep their record stock up to all demands. They are going to do a great amount of circularizing during January and will go back to their recitals about the 10th of the month. They had been very successful in the fall and they were compelled to cut them out owing to the rush of holiday business. The good work that the Edison men did in this city has told with all the dealers, and N. Stetson & Co. tell me that they had an extraordinary business with the Edison. Mr. Von Bernuth, the Stetson local manager, has grown to be quite an Edison enthusiast. The entire December list of records, Blake & Berkart tell me, went so well that they had none left by Christmas. Two of the most popular selections were the "Chin-Chin" music and music from "The Girl from Utah." They ran out of Harry Van Eps banjo records.

Harry Weymann, of H. A. Weymann & Sons, says: "The Victor business closed one of the largest years we have ever had with that machine. Had it not been for the shortage and inability to supply certain types for which we had such a great demand, we would have been able to have completed all orders placed with us by our dealers, which we were so anxious to do. In placing our advance orders we had made all preparations for an extraordinary quantity in anticipation of orders sent out the last minute by our dealers, but unfortunately even with this the demand exceeded the supply by a considerable per cent., the Victor Co. being unable to let us have the goods."

As to the future Mr. Weymann says: "All indications, so far as we can see, point to the fact that 1915 will be an exceptionally good year, and we shall make every preparation accordingly in anticipation of the wans of our dealers. I base this optimism on reports I receive at the Manufacturer's Club, of which I am a member, and from conversations held with large manufacturers who speak of the large advance orders they have taken to be filled in 1915, which will necessitate their putting on full force, many of them having, during the past six months, been only working about 20 per cent."

Manager Eckhart of the Pennsylvania Talking Machine Co. is one of the most optimistic men in the local trade. When I asked him how his business was with the Columbia he replied that "I cannot say anything but 'wonderful.' That sums up my December. My astonishment is absolute in the

extreme. I was ready to close my books on Christmas Day and call quits, but business continued up to the very first of the year and gave us no let up. We were able to satisfy practically all demands, but we only had goods from mouth to mouth, from one day to the next. All our dealers have been highly prosperous."

"The new Columbia goods," continued Mr. Eckhart, "were received this year as I never thought they would be received anywhere, and the most agreeable part of the business was the high class of machines and records that were taken."

December was an exceptionally good month for the Pennsylvania Co. in Dictaphones. They placed these instruments in a number of new places, placing a new equipment with the Dupont High Explosive Co., the Hercules Powder Co., both Wilmington firms; N. & G. Taylor Co., tin plate; the George Bush Co., Taylor Bros., Camden; Curtin & Bockie, of this city.

Last year," Mr. Eckhart says, "I said that if 1914 was as good as 1913 I would be tickled to death. I want to make the same statement with a 'double-barrel' regarding 1915 as compared with 1914. We were so far ahead of 1913 in 1914 that I hate to recollect the previous year, and it looks to me as if we were going to run way ahead of 1914 this year."

John De Angeles, manager of the Cunningham Edison business, has added to his force three new men. They had a splendid business.

The New York men here making a campaign for the Edison will continue the work at least until the first of April.

Harry S. Ziegler, head of the retail department at Hepe's, reports that they had a very fine business and he is quite optimistic as to the future. Mr. Ziegler had such a strenuous time of it that he was compelled to take off a day and rest up when it was over. Fred C. Ferris, one of the salesmen, was also knocked out for a few days. The boys of the talking machine department presented Miss L. Smith, of the same department, with a very handsome leather hand-bag the day before Christmas.

Louise Buehn has incorporated his business into the Louis Buehn Co., for which he has just received a charter. The other members of the firm are Charles W. Miller and Frank B. Reineke, both old employes of the firm, the former having been with Mr. Buehn thirteen years and the latter six years. The firm will hereafter handle the Victor product exclusively. Mr. Buehn disposed of his entire stock of cylinder goods.

Mr. Buehn says that his firm has started the year with real business with very bright hopes as to the future. "We had a remarkable December," he says, "with an increase over last December of 30 per cent., and we had a splendid increase during the entire year of at least 25 per cent."

The company will make a number of changes about their wareroms, since they have disposed of the cylinder business, which gives them considerably more room, which will be utilized for the building of additional record racks. They will also change their offices and will build an additional demonstrating room, besides repapering and redecorating the entire place—in fact, they are preparing for a busy year.

**PENN
PHONOGRAPH CO.
PHILADELPHIA**

**Largest
Stock of
Victor Records
and Victrolas
in
Pennsylvania**

**Orders Filled
Immediately
Upon Receipt**

**Give us a trial and be
convinced**

**PENN PHONOGRAPH CO.
17 South 9th Street
Opposite Post Office, Philadelphia**

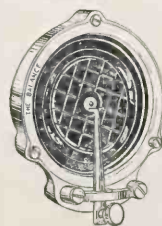

THE "BALANCE" SOUND BOX

The metal diaphragm produces the true tenor notes.

Retail Prices:

Nickel \$3.00

Oxidized 3.00

Gold plated 4.00

For samples, send to any jobber of Edison Disc machines.

TRADE IN SAN FRANCISCO UP TO EXPECTATIONS.

Talking Machine Dealers Enjoy Big December Business—Columbia Exhibit at the Panama-Pacific Exposition Well Under Way—Victor Co. Will Also Be Represented—Sherman, Clay & Co.'s Big Trade Gains—Columbia Agency with Emporium.

(Special to The Talking Machine World)

SAN FRANCISCO, CAL., January 4.—Holiday business in talking machines was well up to expectations in this city, and reports from other sections of the Pacific Coast indicate that Western dealers generally enjoyed a big December business. Trade was a little slow in starting here on account of the stormy weather the first half of the month, but the last few days before Xmas were sufficiently busy to more than offset the late start in holiday shopping. A gratifying feature of the month's demand was the large percentage of high priced machines sold, and the large first payments received. Many of the sales were for cash. Another source of great satisfaction to the trade was its ability to supply the demand in talking machines to better advantage than in former years. There was little complaint of shortage in any of the makes this season, the distributors having anticipated their needs by securing all the stock they could from the factories at an early date. The first of the year finds many departments practically cleaned up, but it does not appear that many sales were lost on account of shortage of goods, as has been the case heretofore. Emphasis is now being placed on the record end of the business in view of the large number of new machines put out during the holiday season.

Sherman, Clay & Co. Gains.

Sherman, Clay & Co. report an increase in their Victor business for 1914 over 1913, which gives them an unbroken series of gains each year over the preceding one since they took on the line. The first part of 1914 did not quite hold its own with the corresponding months of 1913, but there has been no room for complaint since the first of October, according to Andrew G. McCarthy, who gives particular attention to this part of the business. "Both wholesale and retail holiday business was excellent," said Mr. McCarthy. He looks for a good year in 1915 and to this end the company has just completed improvements in some of its branch stores. The store in Spokane, Wash., was practically rebuilt in the last few months, the company occupying temporary quarters while the work was in progress. The new four-story and basement steel and concrete structure was ready for occupancy just before the holidays and no part of the business profits more by the improvements than the talking machine department. The ground floor is devoted to the retail talking machine department and the offices, and the basement has been fitted to accommodate the wholesale stock. In finish and equipment the Spokane store compares very favorably with any of the company's other stores, even the main establishment in San Francisco. The interior is finished throughout in mahogany and the partitions are of thick hollow tiling and plate glass. The heating, ventilating and lighting systems are the best known at the present time.

The branch store of Sherman, Clay & Co. in San Jose, Cal., has been done over also, five new talking machine demonstration rooms having been installed on the ground floor. These are rendered sound-proof by the use of double glass and panel partitions.

Planning the Columbia Exhibit.

Walter S. Gray, district manager of the Columbia Graphophone Co., accompanied M. Dorian, treasurer of the company, to the southern part of the State when he left for the East within the past month, after spending some little time on the Pacific Coast. The principal object of his trip was in connection with the Columbia exhibit at the Panama-Pacific Exposition, and the booth in the Liberal Arts Building was well under way when he left. D. N. and E. Walter & Co., a San Francisco concern, has the contract. Mr. Gray reports the closing of the best holiday business this office has ever had.

Victor Co. at Panama-Pacific Exposition.

Work on the exhibit of the Victor Talking Ma-

chine Co. in the Liberal Arts Building is progressing nicely also. It is understood a special feature will be made of educational work. Mrs. Clark, who has devoted attention to that part of the work, having charge of that phase of the exhibit.

Gathering of Travelers.

Travelers for the Pacific Phonograph Co. were at headquarters over the holidays, but will be leaving again for their respective territories within a few days. A. J. Pommer, head of this company, reports a big increase over last year's holiday business. He does not anticipate serious interruption in Edison business on account of the recent burning of the Edison factory.

Handle the Columbia Line.

New quarters have been fitted up on the third floor of the Emporium for the talking machine department. Six sound-proof demonstration rooms, well ventilated and lighted, have been installed, besides two record rooms. The demonstration rooms are 6 by 12 feet, and the record rooms are 9 by 12. The woodwork is finished a light gray, and the hangings and carpet are royal blue. Columbia graphophones are handled exclusively in this department, which is under the management of William Hoffman.

Plan to Feature the Sonora Phonograph.

Frank M. Steers, president of the Sonora Phonograph Co., has just returned from New York, where he had been in consultation with officials of the Sonora Phonograph Corporation in reference to inaugurating an extensive campaign for the wholesaling of Sonora products on the Pacific Coast during the ensuing year. The local company has jurisdiction over the eight States of California, Oregon, Washington, Utah, Nevada, Arizona, Idaho and Colorado. All that territory

will be covered from the San Francisco headquarters according to Manager F. B. Travers. He says local retail holiday business was fully up to expectations.

Boiled Down Paragraphs.

H. P. Rothermel, manager of the talking machine department of Eilers' Music House, says their first holiday season will set a high standard for following years. Sales Manager W. R. McArthur left for the East late in December, visiting a number of important centers.

The Mission Phonograph & Piano Co. has put in a stock of Edison phonographs at its store on Mission street.

P. H. Beek, manager of the Kohler & Chase department, reports a very satisfactory holiday business, with a gratifying percentage of cash sales and substantial first payments.

George R. Hughes, assistant manager of the Wiley B. Allen Co., says their talking machine business ran way ahead of last year at all their stores.

J. J. Morgan, formerly manager of the Emporium talking machine department in this city, is now with Sherman, Clay & Co. as manager of the talking machine department at their Fresno store.

Byron Mauzy says holiday business was better in his talking machine department than in his other music lines.

LOOKS FOR BIG BUSINESS IN 1915.

Discussing the business situation and the outlook for the new year, George E. Brightson, president of the Sonora Phonograph Corporation, 57 Reade street, New York, said to The World early this month: "I am pleased to say that we are enjoying a very fine business, and we believe that the new year will be a big one for all in the phonograph business."

Take notice! You cannot beat the man who works all the time by the man who works only part of the time, that is, when he feels like it.

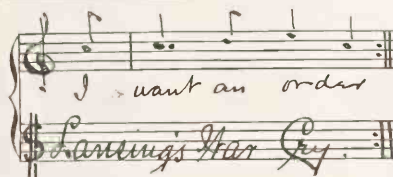

Begin the New Year Right
by Keeping Down the Overhead Expense

The Lansing Khaki Moving Cover

WILL HELP A LOT

MADE IN TWO GRADES

I have them and don't need them.

You need them and haven't got them.

WRITE FOR BOOKLET OF PARTICULARS

E. H. LANSING, 611 Washington Street, Boston, Mass.



**The Columbia Grafonola "Jewel"—\$35—
meets a distinct demand and sells itself
every time you give it anything that
looks like a "prospect."**



*(Write for "Music Money," a book "full of meat" for those
dealers interested in quick and frequent turnover of capital.)*

**Columbia Graphophone Company
Woolworth Building, New York**

HIGH WATER MARK OF TRADE.

Established in Indianapolis and Throughout the State of Indiana in the Closing Week of the Old Year—All the Leading Concerns Make Splendid Reports—News of the Month.

(Special to The Talking Machine World.)

INDIANAPOLIS, IND., January 4.—A high water mark in the talking machine trade was established in Indianapolis and Indiana in the last few weeks before Christmas Eve. Managers of the Indianapolis talking machine retail stores assert business was better than in the same period of last year and the wholesale dealers say business throughout the State kept up with the local trade.

A. W. Roos, of the Columbia Graphophone Co., said the December business of the store at 27 North Pennsylvania street was nearly twice as large as the December record of any year in the history of the store. The retail department showed the largest percentage of gain. Cash collections during December, Mr. Roos said, were the best of the year and the year's total business was approximately 50 per cent. better than that in 1913, which was the best previous sales year for the Indianapolis store.

On the optimistic side of the "business depression argument" for several months, Mr. Roos attributes the large increase in his sales to that frame of mind. He asserted the depression was really "psychological," but that the added business and profits were not.

The usual monthly inventory of the Columbia store was a small job compared with other months because so many types of Grafonolas were sold. The stockroom of the Columbia store never looked so large. Mr. Roos, however, said not a sale was lost through inability to keep up with the demand because stock orders came in December at opportune times.

H. M. Wright, floor manager of the retail store, says that enough Christmas and sacred records were sold just before the holidays to reform the entire city. The month's sale on records of this class outranked the sale of dance records. This is the first time, according to Mr. Wright, that the dance records have not held first place in the total sales for any month in the last year.

The Columbia branch store at Terre Haute reported a good volume of business for the month. L. A. Moeller, in charge of this store, is expecting business to keep up in the next few months. The attractive new store there is proving to be a business getter.

Mr. Roos has been won over by the dance craze and is learning to do the new ones, his instructor, Mr. F. Graham Miller, recently of New York, and teacher of the J. Hepburn Wilson system of instruction, says Mr. Roos is an apt pupil and that he is getting on remarkably well. As does Mr.

**NEW JERSEY
PRICE TALKING MACHINE CO.
VICTOR DISTRIBUTOR
(Exclusively)
We can supply ALL your wants on time.
NEWARK**

BEAUTIFULLY ARRANGED EDISON SHOP IN SAN FRANCISCO.

(Special to The Talking Machine World.)

SAN FRANCISCO, CAL., January 4.—One of the centers of activity during the month of December, and particularly during the holiday season, was the new Edison Shop, which was opened on Geary street this fall for the purpose of taking care of the retail demand for the new Edison diamond disc phonograph. One of the interesting features of

the new Edison Shop, which is under the management of James S. Baley, is the elaborate but harmonious and pleasing character of the interior arrangements and decoration, all of which are in thorough keeping with the manner in which the Edison products are being featured.

The accompanying illustration affords an excellent idea of the general appearance of the main or street floor of the Edison Shop, which is devoted chiefly to the purposes of a reception room. There is also shown the stairways leading up to the mezzanine floor, upon which is located a commodious recital hall where daily concerts have been held since the opening and which is very popular.

During the holidays the stock of the Edison Shop was sadly depleted as a result of the demands made upon it, particularly for medium-priced machines, and the reserve stocks in the city were found very welcome.



Interior View of the Edison Shop, San Francisco, Cal.

Hepburn, Mr. Miller uses the Columbia Graphophone while teaching the various steps.

Although retarded to a certain extent by the fire which almost destroyed the Edison factory, December 9, the Kipp-Link Phonograph Co., distributors of the Edison talking machines, experienced the greatest volume of holiday business in the history of the house.

Walter Kipp, president of the company, visited with Mr. Edison the latter part of December. He said the manner in which the factory was re-establishing itself was marvelous. Twenty-one days after the fire, Mr. Kipp said, talking machine records were being turned out.

December proved to be the biggest month in the history of the house, Mr. Kipp said. The Kipp-Link Co. not only supplied the dealers throughout Indiana and neighboring States with machines, but also three large downtown stores in Indianapolis—the Pearson Piano Co., the Carlin Music Co., and the E. L. Lennox Piano Co., all of which have attractive Edison talking machine departments. Mr. Kipp said toward the last few days before Christmas he began wondering what these houses were doing with the machines they demanded.

the Victor Talking Machine Co., presided, and announced the results of the letter ballots on the suggested new advertising building. A total of 137 votes were sent in, of these 133 were affirmative and four opposed. Eighty-one members wrote that they would work actively to help fill the building with tenants.

NEW STORE IN BETHLEHEM, PA.

**The Bethlehem Talking Machine Co. Opens
on Main Street—Will Handle Four Lines of
Talking Machines—Optimistic Over Outlook.**

E. J. Delfraisse, formerly local manager of the Melville Clark Piano Co. and now head of the Delfraisse Music House, Hackettstown, N. J., has opened another store in Bethlehem, Pa., under the name of the Bethlehem Talking Machine Co. The lines to be handled in this new store include the following makes of machines and records: Edison, Columbia, Sonora and Pathé Frères. Mr. Delfraisse states that he will also handle the Apollo player-piano in his new store, which is located on Main street, the leading business street in Bethlehem.

Mr. Delfraisse, who visited New York this week to place orders for stock for his new store, states that he has been very successful with his store at Hackettstown, having closed an excellent piano, player and talking machine business.

VOTE FOR ADVERTISING BUILDING.

At the recent dinner of the Sphinx Club, held in New York, H. C. Brown, president of the association, and by the way, advertising manager of

FROM OUR EUROPEAN HEADQUARTERS

2 GRESHAM BUILDING, BASINGHALL STREET E. C., LONDON, W. LIONEL STURDY, MANAGER.

Lively Final Spurt of Business During Holiday Season Encourages Trade—Optimistic Feeling Regarding New Year—Resume of 1914 Business—Big Talking Machine Factory for Japan—Sympathy for Thos. A. Edison—The Talking Machine's Part in the War—Patriotic Records in Great Demand—Recent Record Lists—Hoffay to Visit U. S.

(Special to The Talking Machine World.)

LONDON, E. C., ENG., January 5.—Before passing to the usual report I would take this opportunity of extending to all my readers a very hearty wish that the New Year may herald renewed prosperity and, above all, the blessings of good health!

With the dawn of another year one's thoughts—be the times normal or abnormal—usually travel in an optimistic direction, ever hopeful of brighter things to come, even though the old year may have been associated with progress in all one's particular interests.

A healthy optimism is at all times justified. Perhaps at this troublous period some of us need to call upon our reserves of cheerfulness, but all said and done, we in the gramophone trade are by no means downhearted. No! Xmas trade was good—much beyond expectation. In August the outlook for the season was very cloudy, and such was the state of depression that some firms wisely or unwisely made immediate cancellations of business-stimulating plans which had cost a deal in preparing. Experience has taught us that trade can be just as bad as we like to make it. We know now that gramophone sales may be maintained substantially by continuous effort on the part of each trade section. How then shall we pre-deney the trading possibilities of the New Year? In some quarters there appears to exist a little nervousness as to the future. Let us be frank and admit that sales may not be over great. But we must also admit that the unexpected volume of trade this last four or five months has changed the perspective. No one, therefore, is justified in giving vent to gloomy forebodings. Practical optimism must forever hold the field. It is the more difficult path, true, but that's just why British gramophone firms will take it. Let us all continue to be animated with the determination to "carry on," for just as the persistent drip, drip of water will wear away the hardest stone, so each individual effort will consolidate into a gigantic force that will again lift trade—all things considered—into a satisfactory channel. For the new year keep the war motto flying, "Business as usual," and direct all your efforts to that ideal.

Passed Through a Trying Time.

During 1914 the gramophone industry has passed through a very trying time, and a brief resume of events may be of interest to those who follow our doings on this side of the water.

It will be remembered that the 1913-14 season witnessed the issue of 10-inch double records at the retail price of one shilling. This caused a great upheaval in the trade, and several firms unable to meet such cutting competition were forced to liquidate. The effect was to unsettle the half crown record trade, and generally disorganize the whole business to such an extent that certain big dealers threatened to close down their gramophone departments unless these cheap discs were withdrawn. Without going into the whole case again, the records were not withdrawn—beyond some little restriction of output, and things had about reached a climax when the dread news of a European war was announced. Under the circumstances it can easily be imagined the trade was some little time recovering from this staggering blow. The occasion demanded special efforts on the part of manufacturers, factors and dealers. Taking the bit between their teeth, so to speak, they have turned what looked like disaster into a veritable triumph of concentrated effort, overcoming all difficulties in a praiseworthy and successful attempt to keep the gramophone trade flag aloft. That, to my mind, is the outstanding feature of the 1914 gramophone situation. Faced with a shortage of supplies, scarcely able to meet the small demand that then existed for machines; hedged all round with apparently insuperable difficulties. Insuperable? No! To-day we can offer you several designs in motors, tone arms, sound boxes, etc.—all British made by British capital and labor! Is not that an achievement of which to be proud? I might interpolate here that when the war is over, even if the German merchant can find anyone to deal with him, his one-time monopoly of the gramophone trade is gone—gone forever! Apart from present productions, there are a number of other British firms who have planned to manufacture all parts of gramophones in time for delivery next season.

In other directions there is little of importance to chronicle. The continued development of the so-called hornless type of machine may be remarked upon. It is of greater popularity each year, and 1914 witnessed a marked advance of sales, proportionately, over the exterior horn type. Prior the outbreak of war prices were on the downward grade, but there has been a slight tendency the other way since. Broadly speaking, there is no particular progress in a technical sense to record. The method or style of construction has been varied, but the principle remains. One exception is worthy of special mention. And that is, "the world's musical instrument," the invention of J. Hoffay. Full details of its ingenious construction were published in the November issue of this journal, a perusal of which would well repay the reader.

On the record side progress is noticeable with regard to quality of tone, due to improved recording apparatus and methods of manufacture. As an example, the value obtainable for eighteen pence is really surprising. Two first-class selections, played or sung, as the case may be, by artists of high repute, on a 10-inch double disc is exceptionally good value, especially when one considers that not so very many years ago a single-sided record of inferior quality cost almost double the price.

Space forbids further remarks beyond the fact that in expressing an earnest hope that 1915 will witness the termination of this terrible war, I feel that I am but echoing the cry of civilization and humanity—the wish of all who have at heart the ideals of humanitarianism!

A Novel Gift Scheme.

A week or so before Xmas the Gramophone Co. publicity expert evolved a very novel gift scheme, which, of course, was supported by some excellently designed advertising matter and press advertising. The plan took the form of a gift coupon which Mr. A., desirous of making a Xmas or New Year remembrance to Mr. B., would fill in to any amount desired. This gift coupon the dealer would then send to Mr. B., and he would choose records to value. The merit of the scheme is obvious; that it proved highly successful was only to be expected.

The Talking Machine Trade in Japan.

A consular report tells of the establishment in Japan of a large talking machine factory, the output of which it is expected will very adversely affect imports of records and machines from foreign countries in general, and Germany in particular. Of late years, it appears, the gramophone has become highly popular in Japan, and there is a big field, unlimited in scope, for development.

The Mellow Tone Stroh Violin.

For recording purposes, for large orchestras and for solo work the beautiful, mellow tone of the Stroh violin enraptures all who hear it played. Its rocking bridge and sensitive diaphragm, in conjunction with a medium sized amplifying horn, are features which lift the Stroh above the ordinary instrument and make it at once the violin par excellence. Inquiries should be addressed to the American agents, Oliver Ditson Co., Tremont street, Boston.

New Companies Incorporated.

Wholesale Manufacturing Co., Ltd., musical instrument manufacturer; capital, £1,000; office, 2 Thane Works, Thane Villas, Finsbury Park, London, N.

G. A. Bryan, Ltd., talking machine suppliers; capital, £2,000; office, 3-5 Frith Road, Croydon.

(Continued on page 52.)

"RENO, THE MAN OF MANY PARTS"

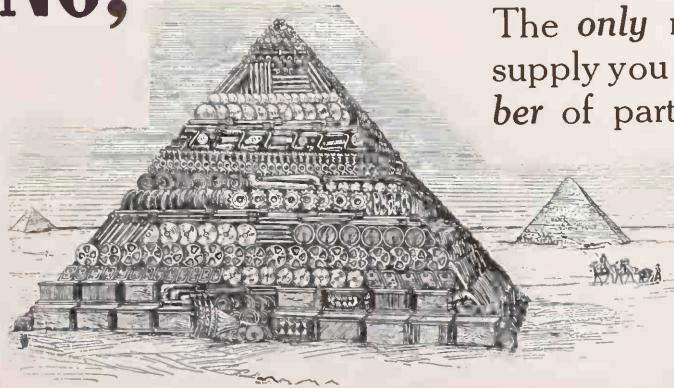

The only man in the world who can supply you with one part—or any number of parts for any Talking machine ever made from Adam to Edison-Roosevelt.

64 Page Catalogue Yours for Asking

W. H. REYNOLDS, Ltd.
"KNOTASLEPE"
London, England

SALES POLICY.
DISTRIBUTORS,
JOBBER
AND DEALERS.



EXCLUSIVE
PROPOSITIONS
(FOR DISTRIBUTORS
AND JOBBER)
ENTERTAINED.

Hoffay's Gramophone is Bound to be a Success WHY?

Your record stock will move more rapidly if you sell your records by means of this MUSICAL Instrument.

You can fill every flat of a house—every home—with one of these UNIVERSAL Instruments, thus establishing a UNIVERSAL buyer of ALL makes of records in every flat; all Instruments can be played at the same time, the soft, clear, natural reproduction does not go through the walls and floors, no matter how "loud" it is inside the flat.

The reproduction is free from any metallic tinge.

SELL RECORDS OF ALL MAKES

Increase your profits and those of all record manufacturers.

DESCRIPTION OF OPPOSITE PAGE

Fig. 1. Shows in section the Hoffay Sound-Box. Notice therein that the diaphragm is vibrated by a strong THREAD, which is kept stretched by the forks of the lever, the latter being in this way strengthened, thus making a fully braced structure. This accounts for the wonderful faithfulness of the reproduction. The same degree of braced structure is obtained in every Hoffay Sound-Box by means of a special tool (for which a patent has been applied), thus ensuring a standard of tonal efficiency. Also notice in Fig. 1 that the lever is rigidly supported by a ring carrier, which is free from metallic contact with the casing of the Sound-Box, insulated by a rubber ring, which is under lateral compression; in this manner the ring carrier is solidly supported without affecting in the least the vibratory action of the lever. The combined action of this rubber mounting at one end of the lever and the THREAD vibrating the diaphragm at the other end is so *sensitive* and balancing to one another that the sounds are reproduced as if in "relief" and "separated" from each other; the reproduction is *full, round, natural* and loud enough to be heard in a Theater if desired; at the same time it is of such a quality as to make it a pleasure to listen to it in the smallest of rooms.

Fig. 5. Shows the same Sound-Box with the difference that the diaphragm is connected to the forks of the lever by a screw, the result being to obtain a reproduction of great quality and as "loud" as you may wish.

Fig. 2. Shows the Hoffay Sound-Box Mounting in a

"closed" condition proper for playing records of the zig-zag type (Victor, Columbia, Odeon, etc.). Light in weight, small in size, and efficient in every respect.

Fig. 3. Shows the Hoffay Sound-Box Mounting in the "transition" condition, before swinging the block which holds the Sound-Box to position shown in Fig. 4 without having to detach the Sound-Box.

Fig. 4. Shows the Hoffay Sound-Box Mounting in an "open" condition, proper for playing records of the "hill and dale" type (Edison, Marathon, Pathe, etc.). In every case (Figs. 2 and 4) the structure is very rigid, so that no "rattling or vibration" takes place.

Fig. 6. Shows what the Hoffay Sound-Box Mounting does. Either whilst playing "zig-zag" records or "hill and dale" the stylus (26) touches the *same point* on the record without any further alteration. Also notice that the angle of the stylus, in comparison with the record, remains the same in both cases; this means that AT LAST the successful use of a DIAMOND for playing the zig-zag (Victor [His Master's Voice], Columbia) is TO HAND, thus utilizing one point for playing *every* record ever made.

Fig. 7. Shows the Hoffay Tone-Arm Mounting and Weight Counterbalancing Tone-Arm. The tone-arm moves "horizontally" round the "upper" carrier and "vertically" round the "lower" carrier, shown in dotted lines, in alignment with the counter-weight. The tone-arm is straight, the weight is just "right," and the scratching of the needle is practically done away with.

J. HOFFAY

P. O. Box No. 1249

New York City, U. S. A.

Address in England: 67 Egerton Gardens, South Kensington, London, S. W.

For comparison of sizes: "His Master's Voice Goose Neck" and the "Hoffay's Sound-Box Mounting" fitting a gramophone of that or similar type.

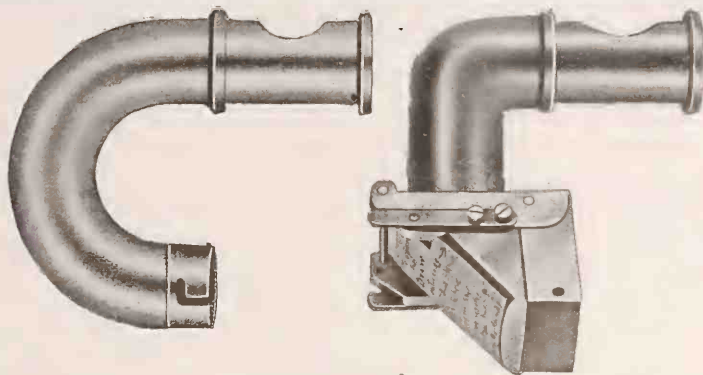

Retail Price
\$6.50

Place orders at once, stating "make" of re-producer to hold.

AN "INSIDE" GLIMPSE INTO
HOFFAY'S
"The World's Musical Instrument"
GRAMOPHONE

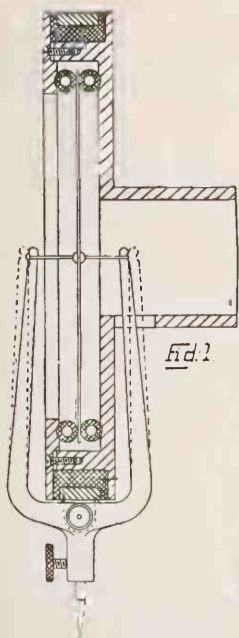

Fig. 1.



Fig. 2.

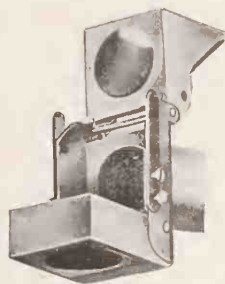

Fig. 3.

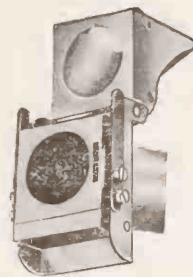

Fig. 4.

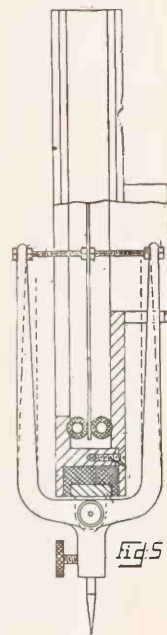

Fig. 5.

RETAIL PRICES: Sound-Box (Fig. 1) with Sound-Box Mounting (Fig. 2) Nickeled, \$18.50; Oxydized, \$20.00; Gold-Plated, \$22.50. Made to fit machines of ANY make. Sound-Box Mounting, sold separately, \$6.50. Sound-Box sold separately, deduct \$6.50 from prices as above.

Usual Trade Discounts.

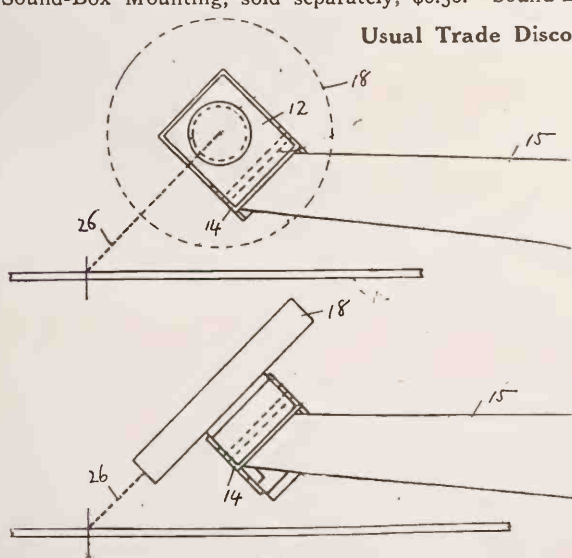

Fig. 6.

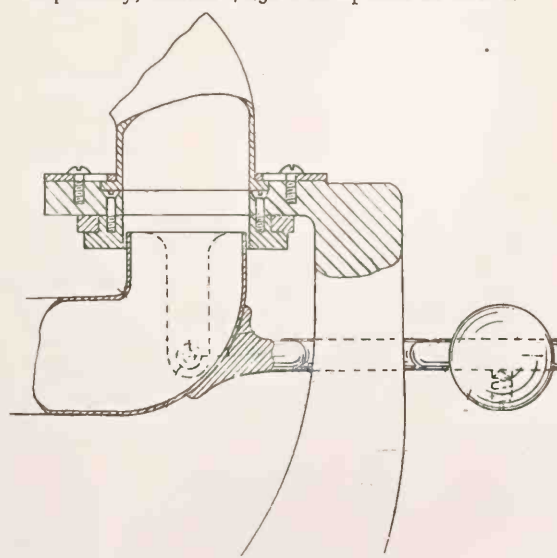

Fig. 7.

Ready to entertain propositions for Distribution and Manufacture in all countries of the World. Patents granted or pending the World over. Expect to be in New York to begin manufacture at the end of November. Send orders soon; make appointment soon. Dealings direct only; no nominees.

J. HOFFAY

P. O. Box No. 1249

New York City, U. S. A.

BEKA DOUBLE-SIDED RECORDS

BRITISH MADE THROUGHOUT.

SOME RECENT EXAMPLES.

A SELECTION FROM OUR
LATEST PATRIOTIC AND
NEW YEAR SUPPLEMENT
—NOW READY—
All hot sellers!!

- | | | | |
|-----|---|-----|---|
| 933 | 35716 Billy Whitlock—Special Constable | 930 | 35742 The Union Jack Forever <i>C. Williams</i> |
| | 35719 Billy Whitlock's Pantomime | | 35763 Cheer Up, Molly <i>David & Wright</i> |
| 904 | 25640 Fall In <i>Harold Begbie & Sir F. Cowen</i> | 931 | 35744 When the Angelus Is Ringing <i>Bert Grant</i> |
| | Sung by ROBERT ENGLISH | | 35741 You've Got Me and I've Got You |
| | 35654 The Eye Beneath the Busby <i>Eric Kemble</i> | | <i>Scott & Godfrey</i> |
| | Sung by VICTOR CONWAY | | |
| | 35758 Hail! King Christmas, Part 1. | 903 | 35659 Your King & Country Want You |
| | Containing:—"Here We Are, Here We Are, | | Sung by ROBERT ENGLISH |
| | Here We Are Again" | | 35654 England! Thy Name <i>Lewis Barnes</i> |
| | "Sunshine of Your Smile" | | Sung by VICTOR CONWAY |
| | "I Will Wear Your Rosary, Mavourneen" | | |
| | "He'd Have to Get Under" | 769 | 35299 Star of Bethlehem (Cornet Solo) <i>Adams</i> |
| 924 | 35759 Hail! King Christmas, Part 2. | | 35230 Nazareth (Cornet Solo) <i>Gounod</i> |
| | Containing:—"Now, Are We all Here? Yes!" | | |
| | "Make Me the King of Your Heart" | 870 | 35522 British Imperial Chimes <i>Partridge</i> |
| | "Sister Susie's Sewing Shirts for Soldiers" | | 35523 Russian Church Parade |
| | "Bravo Territorials" | | |

Complete catalogue and trading terms on application.

O. RUHL, Ltd., 77 CITY ROAD, LONDON, E. C., ENGLAND.

FROM OUR LONDON HEADQUARTERS—(Continued from page 49).

Much Sympathy for Thos. A. Edison.

The news of the destruction by fire of the Edison phonograph works at Orange, N. J., excited general sympathy in British gramophone trade circles, and the hope is expressed that the damage is not so irreparable as was at first reported. Mr. Edison is regarded on this side as representing the Alpha and Omega of phonographic invention, and it is not therefore surprising to find that his loss has evoked sympathetic comment in the columns of our trade and other newspapers. His optimistic remarks, which have been quoted this side, are just what one would expect from the great wizard, and but confirm his reputation that no difficulty is too great to be overcome!

The Gramophone in the War.

"Eye Witness," the official war correspondent, tells an amusing story in which the gramophone played a prominent part. He writes: "At one point not far from our own line, where the French and German trenches are sufficiently close together for the occupants to converse, the French recently asked the 'Bosches' where the Emperor was. The answer was that the Germans did not know, whereupon the French replied that their President was actually going to visit them in the trenches. 'When?' was the eager inquiry. 'Oh! to-morrow, somewhere about midday,' was the equally innocent answer. About the appointed time, to the strains of the 'Marseillaise' played on a gramophone, a top hat on a stick was slowly marched down the trench so as occasionally to show above the parapet. The waste of German ammunition which took place is described as colossal."

Imagination in Business.

A recent lecture delivered in London by W. Teignmouth Shore on "Imagination in Business" is of interest. The Germans, he said, had shown themselves a more imaginative, and therefore a more practical race than ourselves; at any rate, in business affairs during the last forty or fifty years.

COLONIAL and FOREIGN BUYERS

of gramophones and records may obtain valuable information from English firms who are desirous of opening up trading relations with oversea markets upon application, stating requirements, etc., to our European representative,

W. LIONEL STURDY

2 Gresham Buildings,
Basinghall St., London, E. C.

For example, they made their goods to fit their market; we were too fond of trying to make the market fit the goods. Lack of imagination had led to our neglecting many splendid opportunities for consolidating and increasing our trade. Mr. Shore touched on the deadly routine of daily work, which could be much lightened if employers could and would use their imagination to bring them into more sympathetic touch with those whom they employ. The man of imagination was usually exempt from the blight of staleness; the gift of imagination kept a man fresh and young, enabled him to see the advantages of new methods and to avail himself of them; enabled him to grasp the bearings of the new conditions which constantly face the business man.

New "H. M. V." Catalogs.

A batch of new publicity literature is to hand from the Gramophone Co., Ltd., which in style, printing and general arrangement conforms to the high standard maintained by this firm. A magnificent production is the complete record catalog itemizing all issues up to and inclusive of November. Of the indexing and sectional plans one can only say it is simplicity itself, in that immediate reference to any desired title is thereby insured. Such a valuable encyclopedic guide should be at hand in every dealer's shop.

The 1914-15 new instrument catalog provides all the information needed concerning the "H. M. V." models, of which there is illustrated many varieties of the hornless, horn and cabinet type. In addition we have a little homily on the choice of needles, the right kind to use, and so forth. Also included in this instrument catalog are particulars of "H. M. V." trumpets, albums, record-carrying cases and other accessories indispensable to every good owner of a gramophone. A selection of the more popular models occupies a separate folder, and this will be found of extreme importance to all agents located in middle class localities.

Supplemental to the record catalog the company has issued for trade use only all the record titles in a separate book, which is indexed according to the record numbers.

"The Man of Many Parts."

During my rounds of the trade Xmas week I visited W. H. Reynolds at 45 City Road, London, where I found things as busy as in pre-war times,

In the course of a brief chat Mr. Reynolds said: "We have been and are now inundated with orders to such an extent that I have been compelled to refuse acceptance of orders for certain lines this side of Xmas. My staff has been working until very late each night in an endeavor to satisfy all wants, but I fear some customers may have been disappointed. As you know, I am now equipped with the necessary machinery for the building of all-British motors, tone arms, sound boxes, etc., and other lines incidental to talking machines of British manufacture will shortly be available. We are going ahead very quickly and shall in the future be able to dispense with foreign goods altogether."

That this enterprising firm will soon be in a position to style itself "The All-British House of Many Parts" is a foregone conclusion.

Winner Records and the War.

Under the above caption the Winner Record Co. estimates its contributions in money and value of goods to total over £1,000 to date. This covers cash subscriptions to the Prince of Wales' and several other relief funds, and 12,000 records free to H. M.'s North Sea fleet, distributed in cases to 600 ships to the special order of Admiral Sir John Jellicoe. And further, records, gramophones and needles are being sent. Magnificent!

Latest List of Beka Records.

In addition to a batch of new seasonal titles, the Beka record people announce a fine list of good things in their supplement for January. A happy couple—on 925—is "In the Clouds" and "Land of Hope and Glory," played by the Empire Military Band. The Beka Bijou Orchestra contributes two

The Patent Silver-Sheath Needles



NEEDLE

SECTION

They come between steel and fibre needles and wear your records less than any metallic needle whatever. Each S/Sheath will play 400 to 500 records, with occasional resharpening.

Medium loud tone—clearest results possible—scratch almost done away with.

Prices } 1 S/Sheath Needle.....\$0.25
Post Free: } 6 Needles with sharpener 1.65
Aluminum Sharpener, separately50

Ask for particulars of the FLEX loud speaking diaphragm, etc.

DAWS CLARKE, 14 Lorne Grove
FALLOWFIELD MANCHESTER, ENG.
WANTED AGENTS. Good Trade Discount.

STROH VIOLS

VIOLIN, VIOLA, ETC.

The mellow and matured tone of these instruments, which are constructed largely of aluminum, yet possess none of the characteristics of the gramophone or wind instrument, is only one of its many points which are fully set out in an illustrated booklet which will be mailed free on request to the sole makers.



String Fiddle

GEO. EVANS
& CO. 94 Albany St.
London, Eng.

OR

in U. S. A. to their sole representatives

OLIVER DITSON CO.

150 Tremont Street
BOSTON
NEW YORK and PHILADELPHIA



Violin

pleasing items, "Mon Amie" and "Lady Betty Gavotte," which are bound to be in good demand. Two very old favorites, "Good-Bye, Dolly Grey" and "Good-Bye, Little Girl, Good-Bye," are sure of a welcome, especially as rendered by Victor Conway. Those of a humorous turn of mind should not fail to hear the descriptive numbers by Billy Whitlock and party.

Royalties from Columbia Records.

A copy of a letter from St. James' Palace, S. W., recently found its way into print in one of the leading Belfast newspapers. It consisted of an acknowledgment of £1,000 subscribed to the Prince of Wales' fund, this amount representing royalties on the sale of the Columbia Co.'s records. Under the letter appears a little eulogy of the company's efforts, this large subscription being "a forcible indication of the phenomenal popularity of the Columbia and Regal discs. . . ." Needless to say, we must attribute this smart piece of advertising—for such it is—to our old friend, Thos. Edens Osborne, who describes himself as the largest importer (presumably in Ireland) of Columbia goods.

J. Hoffay on Way to the United States.

On account of work connected with further improvements in the world's musical instrument, Mr. Hoffay's promised visit to New York last month had reluctantly to be abandoned. He now plans to arrive about the 20th of this month without fail, and will be glad to make appointments with all who may be open to treat for an exclusive territory proposition. His address, I understand, is Box 1,249, New York City. This new instrument is likely to create a furore in American trade circles on account of its many original features. The average quality of present day records is undoubtedly good in reproduction, but as delivered by Mr. Hoffay's gramophone very much improved. For purity of general tone and marvelous detail, it is most unusual, as I think all will agree after a demonstration. In the reproduction of orchestral and band records, the clear notes of every instrument is easily distinguishable. Surface scratch, too, by Mr. Hoffay's method of delivery, is almost entirely eliminated in the great majority of records.

TEACHING LANGUAGES BY MEANS OF THE GRAMOPHONE.

(Special to The Talking Machine World.)

BELFAST, IRELAND, January 4.—If my memory serves me I believe I communicated to you during last winter some jottings with regard to The French Society of the Queen's University, Belfast, over which the clever, popular and pains-taking D. L. Savory, Esq., M. A., Professor of French and Romance Philology, presides with such ability.

The numerous lectures delivered by this gentleman to colleges, technical schools, etc., have invariably indicated his enthusiasm for the gramophone and phonograph as valuable adjuncts to the teaching of languages.

During season 1913-14 Corneille's celebrated tragedy "Le Cid" (in five acts) was rendered verbatim to large audiences in the French lecture room of the university by means of a "Monarch Senior" H. M. V. Gramophone to which a Pathéphone sound-box was attached. The fact that the seventeen double-sided 14-inch Pathé discs used were recorded by twelve actors and actresses of the National Theatre of France—La Comédie-Française—was a sufficient guarantee that the orthoepy of the language could not have been excelled. The society accordingly congratulated itself upon having heard the tragedy reproduced so clearly, naturally and above all with that purity of diction which is such a desideratum for students anxious to acquire correct pronunciation.

With characteristic thoughtfulness Professor Savory always arranges a musical program for the entr'actes, during which choice collections of French songs are played on the gramophone by celebrated artists, much to the enjoyment of all present.

With regard to the last meeting of the society, which was held on first currt., and for which I was privileged with an invitation, I cannot do better than ask you to peruse the excellent report which appears in The Northern Whig, mailed you to-day, from which you will observe that the distinguished President epitomized—in his in-

structive introductory address—Molière's mirth-provoking comedy, "Le Malade Imaginaire," the first act and portion of the second act of which were afterward rendered to a large and enthusiastic gathering by the gramophone. During the entr'acte songs by Caruso, Plançon, Renaud and Journet were rendered by the instrument loudly and distinctly to the immense satisfaction of the audience, who joined with great éclat in singing "La Marseillaise" at the close of the proceedings.

I should have mentioned that Professor Savory has personally recorded several recitations on the gramophone, one of which was reproduced at last-mentioned meeting, namely, the well-known patriotic song, "Rule Britannia," which was well received and was most appropriate and opportune on account of the disastrous war now in progress.

I may here mention that Molière's entire comedy of "Le Malade Imaginaire" is recorded on fourteen double-sided Pathé discs and Corneille's tragedy, "Le Cid," on seventeen similar discs.

The French Society look forward with pleasurable anticipation to the forthcoming meetings, for not only the remaining acts of "Le Malade Imaginaire" will be rendered, but Gounod's complete opera of "Faust" will be reproduced from twenty-eight Pathé discs (14-inch, ordered from Thomas Edens Osborne), which have been recorded by artists of the Opéra Comique, Paris.

Mr. Osborne reports a phenomenal demand for war and patriotic records, of which he has sold some thousands since the commencement of the war. In this connection he informs us that the proprietors of a local newspaper, the Belfast News-Letter, with commendable patriotism, appealed to gramophone users for records to present to the British navy. This appeal has met with a hearty response and one of Mr. Osborne's staff was intrusted with the packing of over a thousand records in thirty cases, which have been handed over to the Admiralty for distribution to war-ships now on the North Sea. In each case a suitable "Good luck" card was enclosed.



"His Master's Voice"

Copyright

This intensely human picture stands for all that is best in music

—it is the "His Master's Voice" trade-mark, and it brings to you, no matter where you are, the very best music of every kind, sung and played by the world's greatest artists — the greatest singers, pianists, violinists, orchestras and bands—all enshrined in the unequalled "His Master's Voice" records.

'His Master's Voice'

—the trade-mark that is recognized throughout the world as the

HALL-MARK OF QUALITY

Branches

AUSTRIA: Oesterr. Grammophon - Gesellschaft, m.b.H., Graben 29, Trattnerhof 1, Vienna I, Austria.

BELGIUM: Cie. Française du Gramophone, 51, Avenue de la Porte de Hal, Brussels.

DENMARK: Skandinavisk Grammophon-Aktiesselskab, Frihavnen, Copenhagen.

FRANCE: Cie. Française du Gramophone, 115 Boulevard Richard Lenoir, Place de la République, Paris.

GERMANY: Deutsche Grammophon - Aktiengesellschaft, 35, Ritterstrasse, Berlin.

HUNGARY: The Gramophone Co., Ltd., Kosuth Lajos-Utcza 8, Budapest.

SPAIN: Cia. Francesca del Gramophone, 56, Balmes, Barcelona.

SWEDEN: Skandinaviska Grammophon - Aktiebolaget, Drottning Gatan No. 47, Stockholm.

RUSSIA: The Gramophone Co., Ltd., 45, Nevsky Prospect, Petrosgrad (Petersburg); 9, Golovinsky Prospect, Tiflis; Nowy-Swiat 30, Warsaw.

INDIA: The Gramophone Co., Ltd., 139, Ballaghatta Road, Calcutta; 7, Bell Lane, Fort, Bombay.

Agencies

AUSTRALIA: S. Hoffnung & Co., Ltd., Sole Concessionaires of The Gramophone Company, Limited, 163, Pitt Street, Sydney.

NEW ZEALAND: E. J. Hyams & Co., Post Box 45, Wellington.

SOUTH AFRICA: Darter & Sons, Post Box 174, Capetown; Mackay Bros., Post Box 251, Johannesburg; Mackay Bros. & McMahon, Post Box 419, Durban; Ivan H. Haarburger, Post Box 105, Bloemfontein; Franz Moeller, Post Box 108, East London; B. J. Ewins & Co., Post Box 86, Queenstown; Handel House, Kimberley; Laurence & Cope, Post Box 132, Buluwayo; The Argus Co., Salisbury.

EAST AFRICA: Bayley & Co., Lourenzo Marques.

HOLLAND: American Import Co., 22a, Amsterdam Veerkade, The Hague.

ITALY: A. Bossi & Co., Via Orefici 2, Milan.

EGYPT (Also for the Sudan, Greece and the Ottoman Empire): K. Fr. Vogel, Post Box 414, Alexandria.

Great Britain:

The Gramophone Company, Ltd.

HAYES - MIDDLESEX - ENGLAND

EDWARD D. EASTON AN OPTIMIST.

Interesting Talk with the President of the Columbia Graphophone Co., New York, on Business Conditions—Reasons for the Faith That's in Him Revealed in His Conversation.

Edward D. Easton, president of the Columbia Graphophone Co. and one of the best informed members of the talking machine industry, in an interview this week with a representative of the Talking Machine World commented as follows regarding Columbia business for the past year and the outlook for 1915:

"It seems rather remarkable that when conditions in so much of the civilized world are so shocking and so distressing and when so many business men are complaining of general business depression we should find this comparatively young enterprise, only now in its twenty-eighth year, at absolutely high water mark. Although so many factories are operating on only a part time basis our great Bridgeport factory and our London factory are running all night.

"We account for our good business in the United States because of the fact that the talking machine enterprise here is more prosperous than ever. We account for conditions in Europe in a different way, however. Our company is the only American owned talking machine enterprise in Europe, and therefore the only perfectly sound element in the business. All the other concerns in that country have been seriously affected by the war, and ours is the only company so completely undisturbed that it can go forward in the usual way. Therefore, in Europe our prosperity is the result of obtaining more than our share of the business, which, as a whole, is by no means as good as usual.

"The outlook for the coming year, from our point of view, is for a greater demand and a better showing than ever in the history of the business. We find a constantly-enlarging market for higher priced machines and for better goods of every description. While a good deal has been said regarding unsatisfactory financial conditions



Edward D. Easton Snapped at His Desk in His Office by the World Photographer.

in the United States, nothing of that sort is reflected in our experience, as our collections have been, and are satisfactory.

"It is only fair to add that the excellent conditions now appearing were not so clearly shown in the early part of the year and that the first shock of the European war had a tendency to disturb even our business. This tendency, however, was happily of short duration and was followed by a forward movement so marked as to be unmistakable in its significance for the future."

A WORLD ADMIRER IN JAPAN.

Kingoro Ezawa, a well-known merchant of Tokio, Japan, has been an interested reader of The World since its first publication. He writes: "We have subscribed to The Talking Machine World since the first year it was published, and we have enjoyed the up-to-the-minute notices in this publication."

Boyle's Broken Dollar Store at Warrensburg, Mo., has opened a talking machine department.

CARL LINDSTRÖM A-G.

BERLIN, GERMANY

MOTORS FOR TALKING MACHINES

One, two and three-spring motors
with one or two worm gears

Output: 500,000 motors annually

NEW YORK OFFICE: A. Heinemann, 45 Broadway

THE PROBLEMS OF SUCCESSFUL RECORD ORDERING.

Gifts of a Seer Necessary to the Jobber Who Would Pick the Winners Each Month Without Fail, Says Benj. Switky, the Well-Known Victor Distributer, in an Unusually Interesting Article—Pertinent Questions of the Dealers Answered in Detail.

It was New Year's Eve. I was busy in my office playing over the February advance sample records. The night was cold and clear. Outside the occasional tooting of horns, intermingled with the reverberating clang of cow bells, told of mirth and revelry that seemed to gather momentum with each fleeting minute. Broadway's rising tide of humanity flowed northward from Twenty-third street in currents swift and strong, increasing as the cross streets emptied their streams of gay ones into the surging mass, like tributaries that drain into the parent stream.

The year 1914 was retreating with its mingled memories of joy and sorrow, of success for some and failure for others. It resembled a warring host that had passed through a strenuous campaign in which victories, drawn battles and defeats had alternated. Having fought for 365 days in the battle of life, the year 1914 was to make way for a fresh and hopeful, albeit untried, army.

Hence the vociferous greeting accorded the New Year of 1915. To all alike it brings fresh courage and vigor. It is a time at which most of us take mental inventory of the past year's work and worth and, having cast the balance for the fiscal year, we open a new ledger and turn to a fresh, clean, spotless page, a page that encourages even by its blankness.

Although I have always preached and practiced freedom from superstition, and have chaffed at the weak mortals who wait for the New Year to make their good resolutions—usually broken—yet there seemed to be something awe-inspiring, almost hallowed, in the feeling that I stood upon the threshold of a new year.

"Why not make a New Year resolution?" a mysterious little voice from somewhere seemed to whisper in my ear.

"Don't know. Never did," I replied.

"Why not offer up a prayer?" the voice persisted.

"Can't," I answered. "I'm not of the praying kind."

"But there's no harm in trying, is there? Most everyone else does," urged the irrepressible spirit. Then, after a moment's deliberation, I raised my hands to heaven and cried:

"O Lord, flood my mind with light and guide my pen in ordering Victor records, that I may pick the winners each month from among the samples. Vouchsafe unto me the prophetic power to foretell the big sellers, and preserve me from accumulation of surplus stock!"

As the echo of the last word died away in the silent night I was conscious of having bared my soul to that which troubled me most sorely.

There is no task assigned the distributor in his duties in behalf of his dealers that is so onerous, so irksome, as that of ordering records from the factory. There is no other work that is so difficult or so unsatisfactory in its performance. In ordering records, particularly the monthly records, there is never that feeling that the task is well and accurately done.

Unlike all other departments of the business, there is never the satisfaction of knowing that time and experience bring knowledge and perfection.

After nine years of record ordering I to-day feel that I would like to thrust the job upon someone else—someone whom I could rail at for his incompetence, or even discharge as a penalty for colossal blundering.

But to assign to someone else the task of ordering seems almost equivalent to handing that individual my purse and saying to him: "There, go and spend my money like a drunken sailor."

Prestige vs. Profit.

Every distributor aspires to rank first in the estimation and the preference of his dealers. If successful in his aspiration, it means a maximum of both prestige and profit.

But, unfortunately, prestige and profit, although they may run in parallel lines, seldom travel at uniform speed. Quite the contrary. One is bound to outdistance the other.

To simplify this statement I must ask you to follow an extreme illustration: If a jobber were to lay in a tremendous supply of every selection in the catalog (presuming that capital and manufacturing conditions permitted), and likewise ordered heavily of every number on the monthly advance sheets, he would be sure of attaining the maximum of prestige. That jobber would unquestionably "put it over" on all the other fellows. But he could not at the same time expect to realize the maximum of profit. By no means. The profit would not travel as fast as the prestige.

While the jobber would make big profits on the big quantities sold, yet these profits would be whittled down and greatly offset by the losses tied up in excessive surplus stock.

The average profit in a record sold is equal to one-quarter of the money tied up in one unsalable record. In other words if I sell 100 records I make \$10, and if I get stuck with 100 records I tie up \$40 capital. To carry the figuring just one step further, one must sell 400 records to make enough profit to enable him to cover the loss of capital tied up in 100 unsalable records.

If a jobber's record business were to be carried on in this four to one ratio for any considerable length of time, it would require all his machine profits to cover running expenses.

The prestige would be big—but, where's the profit?

Yet one or two blunders in picking the winners from a monthly list has often caused me to waste the profit on the sale of that list. And I dare say that others can say the same.

Answering the Dealers' Question.

At this season of the year, when dealers are obliged to turn from one jobber to another in a vain effort to gather the records that they need, it is but logical that they should feel that the jobber is somehow to blame for lost sales.

"Why didn't you stock in earlier and heavier?" is a question frequently put by the dealer to his

jobber. "If you see a good seller on the new list why don't you plunge on it?"

Yes, why? The answer is, Because.

1. Because we are in business for profit first and prestige second.

2. Because of manufacturing limitations. Ordering is not producing.

3. Because a newer and better and possibly cheaper rendition of the same selection may be issued next month or the month after, which would supersede or curtail the sale of the earlier one.

4. Because the catalog is so superfluously big that it would be shameful extravagance of capital to invest in a six months' supply. We must look to the manufacturer to make quicker and more complete shipments, so as to enable more frequent turnover of record stock.

5. Because no man can predict the life of a popular song. One may order 1,500 of a certain selection, dispose of 800 the first two weeks, sell 400 more within the next two months, and the remaining 300 may last the balance of the year.

6. Because public taste is an uncertain quantity. The veriest trash may unexpectedly become the rage within two weeks and a clever song or a beautiful sentimental ballad may fall flat as a pancake.

7. Because a song that is in popular demand for three or four months may fail to sell when finally issued because it comes too late.

8. Because a selection may prove a tremendous hit on the stage, due to the personality of the artist, together with the background and environment, yet it may prove a failure on the record. I heard "The International Rag" at Hammerstein's when it had its première. The public took it mildly—still it was one of last year's big sellers. When record No. 60,059 (the "Melody of Love" from "Gypsy Love") was announced by the Victor laboratory as a special I rushed to the show to get a line on it. The production was superb, the music masterful, and the "Melody of Love" was the hit of the operetta. Everybody sang or hummed or whistled the tune on the way out. We had calls for it. The record was issued. It was a keen disappointment. The verse, which occupied two-thirds of the record, was tame, whereas the catchy melody, the refrain, came at the end—just a snatch of it. Besides, the show after the first few weeks was sent on the road. I think this was three years ago, but I still have a lot of this selection in stock.

9. Because the music publishers and theatrical managers fail to let us into their plans. If they would only tell us how much money and time they propose spending to develop a demand we might be better able to pick the winners.

10. Because the monthly lists are so lengthy that the jobber feels the burden of the monthly investment and figures on a reorder (the delivery of which is very undependable).

11. Because the dealer shirks his share of the burden. Most dealers either leave it to their jobber to make up the monthly order for them, or at most give a sample order so meaningless that it fails to serve as a guide for the jobber in making up his own order to the factory. It is quite customary for the dealer to order two each of the best sellers on his monthly advance orders and then call for twenty-five of a selection a day or two after the records go on sale. In other words, with a

(Continued on page 56.)

READY REFERENCE OF GENERAL SUPPLIES

DEALERS

Send for our "Trial Proposition" on the Regina Hexaphone—the latest and best paying popular priced coin-operated instrument for use in public places.

THE REGINA CO.

311 Marbridge Bldg., 34th St. and Broadway, New York City
Manufacturers of Regina Music Boxes; Reginaphones;
Coin-operated Mandolin Orchestrons; Vacuum
Cleaners and other specialties.

Mermod & Co.

505 Fifth Avenue New York

Manufacturers of

Talking Machine Supplies

Motors—Sapphire Points

Diamond Points a Specialty

Keep Your Record Stock with

THE
Heise
SYSTEM
TRADE MARK

Costs about \$2.00 for 250 records for 50 years
Send for 20-page catalog

THE SYRACUSE WIRE WORKS,
SYRACUSE NEW YORK



It ought to be clear to you right now that the selling rights for Columbia product in your locality are just about ripe enough for somebody to pick. And it can't do any harm to make inquiries, at least.



(Write for "Music Money," a book "full of meat" for those dealers interested in quick and frequent turnover of capital.)

**Columbia Graphophone Company
Woolworth Building, New York**

SUCCESSFUL RECORD ORDERING.

(Continued from page 55.)

possible aggregate demand of 200 records of a certain selection, as judged by the advance lists, the distributor is expected to be able to fill orders for perhaps 2,000 within forty-eight hours after the selection is put on sale. With nothing tangible as a guide in making up his factory order, the jobber must either plunge on several selections so as to hit the right one, or the dealer's orders must be filled short until a duplicate shipment can be secured from the factory. Quite often the demand for a selection does not go much beyond the first sample orders.

12. Because sometimes there is lack of co-operation between the advertising department and the pressing plant at the factory. For example, it is a rule that an increased demand beyond the normal is always created by the advertising department when it features on the back of the supplement a new list of "ten best sellers." Yet it is not unusual for the jobber to be unable to get a supply of these selections notwithstanding the fact that his order was entered thirty days before the supplement appears. Why feature something that cannot be supplied? Another illustration: In the December supplement (which we consider the holiday list) a record of two beautiful Christmas hymns was listed as an "Educational Series" record. It received just a little bit better treatment at the hands of dealers than is usually accorded the educational records. The jobber was in a quandary when making up his advance order. Should he treat it as a Christmas number or as an educational record? The jobber who treated it as an educational record lost a moderate number of sales. On the other hand, the jobber who sized it up as a big holiday number will carry a lot of them over for next Christmas.

13. Because and because and because. There is no end to the becausees.

However.

There is relief in sight for us all. When the Victor Co. shall have completed its new additions to the record factory, whether this season or in

time for next year, most of our troubles—if not all—will swiftly vanish.
Hurrah for 1915!

IN CHARGE OF COLUMBIA EXHIBIT.

Mortimer E. Easton, son of President Easton of the Columbia Graphophone Co. and manager of the company's Dictaphone advertising, will leave on February 1 for the Coast to take charge of the Columbia Co.'s exhibit at the Panama-Pacific Exposition. Mr. Easton, who will be accompanied on this trip by Mrs. Easton, will remain on the Coast during the course of the exposition, and the keen interest being manifested by the Columbia Co. in the forthcoming Panama-Pacific celebration is well evidenced in this decision to have Mr. Easton make a special trip from New York to take charge of the company's display.

GOOD NEWS FROM ENGLAND.

Louis S. Sterling, the recently appointed European general manager of the Columbia Co., who arrived here a few weeks ago for a conference with the company's executive officers, received a number of letters recently from his headquarters in London referring to the satisfactory status of Columbia business in that country. These letters state that there is a record shortage in England of more than 100,000 Columbia records, with the shortage steadily increasing. The record manufacturing plant in England was considerably enlarged a short while since, but even this extra space has proved insufficient to take care of the remarkable demand, which the war has augmented rather than diminished.

ISSUES ATTRACTIVE POSTER.

The advertising department of the Columbia Co. has just issued an attractive poster featuring Pavlova, the prominent danseuse. It is designed in several colors and calls attention to a Pavlova dance article in the Ladies' Home Journal.

1914 WAS A GREAT VICTOR YEAR.

Holiday Business Exceeded Expectations—
Factory Busy Looking After Trade Needs.

(Special to The Talking Machine World.)

PHILADELPHIA, PA., January 9.—The Victor Talking Machine Co. last week closed one of the greatest business years in the history of the institution. The sales of Victor Victrolas in all parts of the country were phenomenal, and December in particular broke all previous records.

The great advertising campaign carried on by the Victor Co. in the daily papers in New York, Chicago and other points was undoubtedly a great stimulus in developing business, demonstrating afresh that advertising, when backed by the right products, pays.

In order to supply the demands for January's business, owing to cleaned-out shelves of jobbers in many sections of the country, the Victor Co. on Christmas eve shipped ninety-eight truckloads of talking machines by express and sixty-nine truckloads by freight. All departments of the great Victor institution have performed wonders in meeting the great demands made upon them, particularly during December.

The officers of the Victor Co. are most optimistic regarding the outlook for the new year, and expect an even greater volume of trade than that closed in 1914.

"How to Dance the Fox Trox," written by Joan Sawyer, originator of this season's popular dance and one of the best-known dancers in this country, has just been issued by the Columbia Co. to aid its dealers in securing maximum results in developing their trade in fox trot records. This new publication is concisely and informatively written, and its contents are so presented that the mysteries of the new dance are easily solved by the merest novice.

Often the disagreeable but necessary duties would be done in half the time we take wishing we didn't have to do them.

BUSINESS IS GOOD—THERE'S A REASON

A TRIAL ORDER WILL SHOW YOU

WHY

THE GOODS AND THE SERVICE IS THE ANSWER

The DOME RECORD CASE



should be in your stock. Holds 20 records. Made in 10" and 12" sizes. Equipped with lock and key. Order samples to-day, with the list of records and that particular style or finish of Victrola you are unable to get elsewhere.

The completeness in filling and promptness in shipping your order will convince you we have both goods and service.

Edison and Victor Distributer

W. D. ANDREWS, Buffalo, N. Y.

ATTRACTIVE STORE IN LAKEWOOD.

George Hurlburt Has Handsome Quarters in Popular New Jersey Resort.

The accompanying illustration affords an excellent view of the new quarters of George Hurlburt, the successful talking machine and piano dealer of Second street, Lakewood, N. J. The store oc-

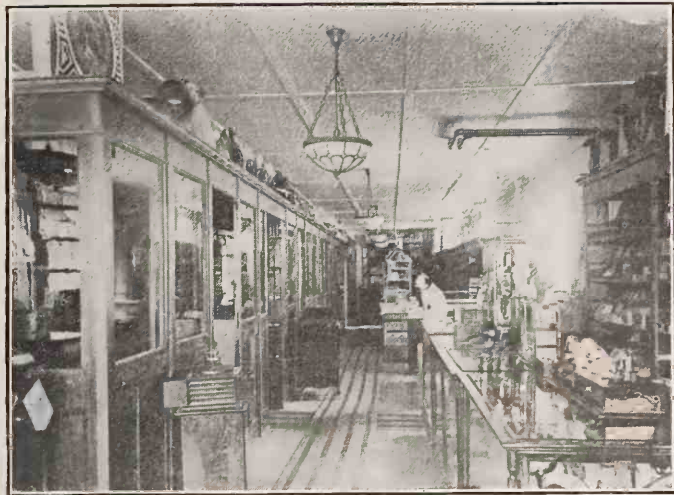

The Warerooms of George Hurlburt, Lakewood, N. J.

cupied the ground floor of a building erected especially for Mr. Hurlburt and on the site of his old store.

The equipment of the store includes a modern, indirect lighting system, three attractive soundproof demonstrating booths with plate glass panels, an improved record filing system and other features in keeping with the character of the business handled.

Lakewood, located in the pines, is one of the most popular winter resorts near New York, and Mr. Hurlburt does a considerable trade in high grade records with transients.

Elbert Hubbard says that "Business consists in getting an order for the goods, filling the order to the satisfaction of the customer, getting the money and completing the transaction to the profit and pleasure of all parties concerned."

We can forgive a man for kicking if he limits it to kicking goals.

GREAT ACTIVITY IN BUFFALO.

Neal, Clark & Neal Did Large Holiday Business and Closed a Most Satisfactory Year.

(Special to The Talking Machine World.)

BUFFALO, N. Y., January 6.—W. J. Bruhl, chief of the Neal, Clark & Neal talking machine forces here, reports that the holiday trade was more than

satisfactory, and harbingers a year that will go down in history as being the most successful since the induction of the popular instruments into the big store's policy. Neal, Clark & Neal have one of the largest lines in Buffalo, and especially during Christmas were the big showrooms crowded. All records for sales were shattered, and the racks were left looking unusually slim.

"We never have done such a cash business," declared Mr. Bruhl. "Despite conditions, the trade here has kept far above the average, especially in the high-priced machines. The new year opened up well; in fact, the sales are phenomenal. Neal, Clark & Neal know that they will experience the biggest year in history."

Consistent newspaper, magazine and window display advertising is doing much to push sales in Buffalo. Dealers find advertising of their own along with that of the various manufacturing companies of much worth.

PRESENT VICTOR TO ALMSHOUSE.

Alumni of Carthage Collegiate Institute Considered Such a Gift Most Suitable for Entertainment Purposes.

(Special to The Talking Machine World.)

KANSAS CITY, Mo., January 9.—The alumni of the Carthage (Mo.) Collegiate Institute recently presented the almshouse of Carthage, Mo., with a handsome Victor talking machine. The reason for giving the machine to the institution was that the alumni wished to use a fund that had been accumu-

lating for several years. The members unanimously agreed that since there was nothing to provide entertainment for the inmates of the home, a talking machine would be the most suitable gift that could be made. The almshouse is advertising in the Carthage papers asking for the old records of people living in Carthage. In this way it is hoped that a large and varied collection of music can be secured for the unfortunate inmates of the home.

E. P. H. ALLEN WITH EDISON STAFF.

E. P. Huyler Allen has recently been added to the sales force of the Thomas A. Edison, Inc. Mr. Allen's association in the musical business has been of such an extensive nature that he is well qualified to fill the position he now holds. He is the former general sales manager of the Keen-O-Phone Co., of Philadelphia. Mr. Allen has been connected with piano concerns for a number of years—among them the Aeolian Co., Lauter Co., and Schubert Piano Co. Mr. Allen's success with the new Edison diamond disc has already been very marked, and he is greatly encouraged with the reception that the Edison disc is being given by the trade.

**John
M.
Dean
Corp.**

PUTNAM, CONN.

TALKING MACHINE
Needle
MANUFACTURERS

Quality
and Quantity
—the ideal combination
for good needles at the
right prices.

FLEXIBLE The **FLEXIBLE**

Flexible Four Pointed Steel Needles

PATENTED IN U. S.—FOREIGN PATENTS PENDING

Four Pointed Flexible Needle

FLEXIBLE

PATENTED
FOUR TUNES ON ONE NEEDLE

In Attractive Packages of 200 Points.
Increase Your Profit.
Send for Samples and Prices today.
Two Sources of Supply.

WRITE TO
JOHN M. DEAN, Inc.
PUTNAM, CONN.

FLEXIBLE **FLEXIBLE**

Flexible Needles are guaranteed to play the Longest Records Perfectly.

Flexible Needles are guaranteed to save the record from wear.

Flexible Needles are guaranteed to eliminate the scratch.

Flexible Needles make old records sound like new.

Flexible Needles are better because they do more.

Flexible Needles are made from the best steel obtainable.

Flexible Needles are the best for any record because they bring out all that is in the record.

"SCHOOL ROOM MUSIC."

Second Edition of This Interesting Volume
Just Issued by the Columbia Co.—Admirably
Illustrated and Beautifully Printed.

The Columbia Graphophone Co. has just issued a second edition of "School Room Music," which attained country-wide popularity when introduced by the company's educational department some two



Studying Cultural Music with Aid of Grafonola.

years ago. The new book resembles the first edition in name only, as in contents the publication is entirely new and up-to-date and infinitely more valuable than the former edition.



Pledging Allegiance to the Flag.

When it was decided a few months ago to issue a new book to illustrate the educational prestige of Columbia products, Frederic Goodwin, director of the Columbia educational department, determined to spare no efforts to make the new book truly representative of the remarkable progress that the Grafonola has achieved the past year in educational circles. To this end Mr. Goodwin

decided to include in the new publication every phase of school life to which the Grafonola is adapted and has proven its worth, thereby furnishing Columbia dealers with invaluable information to assist them in properly developing the possibilities of the school field.

"School Room Music" is profusely illustrated with pertinent photographs (two of which are shown herewith) from all parts of the country, and every picture serves to emphasize the value of the Grafonola in the schoolroom and playground. The various phases of schoolroom work to which the Grafonola is adapted are treated in detail in the new book under such headings as "Patriotism," "Discipline," "Rhythmic Music for Calisthenics," "The Folk Dance," "The Playground," "Mental Training," etc. Under these titles are listed the various Columbia records which are specially intended for each class of educational work.

"School Room Music" is not only intended to present the practical uses of the Grafonola in schools, but to furnish the dealer with an intimate knowledge of the educational prestige of the talking machine, and the success it has won from coast to coast. This book treats the important subjects it covers in a thorough, comprehensive way that is worthy of careful thought and consideration, and Mr. Goodwin and the Columbia Co. are receiving well-deserved praise for the detailed perfection of this most interesting and educational publication, which is destined to win a new popularity throughout the country. It should prove a decidedly strong factor in the school campaigns.

TAKE A LESSON.

Take a lesson from the molecule. It's a little thing. But take the biggest thing you know—what is it but molecules compiled? Big things in business are but little things moulded together. Don't overlook 'em.



NYOIL
For polishing
varnished woodwork it is
extremely satisfactory. No oil is so clean.

Ask your watch repairer whose
oil he uses on your watch.

TALKING PICTURE INJUNCTION.

Commercial Biograph Co., Inc., Secures Temporary Restraining Order Against the Renfax Co., Inc., Charging Patent Infringements on Method of Synchronizing Talking Machines and Films—Controls the Messter Biophone.

Judge Hough, in the United States District Court, New York, on December 24 granted a temporary injunction to the Commercial Biophone Co., Inc., restraining the Renfax Co., Inc., from "further construction, sale or use of new and useful improvements of sound producing machines in connection with films in order to synchronize both for the purpose of producing singing and talking moving pictures."

The Commercial Co. controls in the United States the Messter Biophone, a German device patented in this country. It has pending infringement suits against all the other American makers of talking moving pictures.

Judge Hough gave the Renfax Co. leave to cause the suit to be set for final hearing Jan. 11, by entering an order to that effect before Dec. 30.

The Columbia Co.'s foreign record department has announced the recording of two acts of the popular opera "Aida" by a prominent group of Italian artists. These records will be issued at the very moderate price of seventy-five cents apiece (double disc), and the complete opera will be ready in a short while.

The Columbia Co. sent out to its dealers recently a complete list of the cut-out records announced from time to time during the year 1914. This list of records is returnable to the company under certain conditions mentioned in the letter that accompanied the list.

TO VICTOR AND COLUMBIA DEALERS

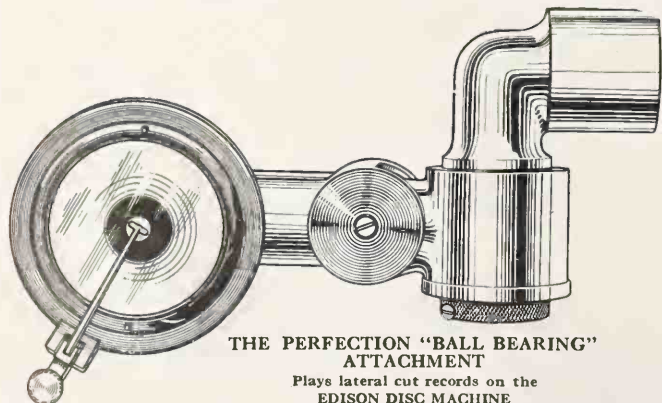

THE PERFECTION "BALL BEARING"
ATTACHMENT
Plays lateral cut records on the
EDISON DISC MACHINE

Do you want to sell records to owners of EDISON DIAMOND DISC MACHINES? If you do, carry our "PERFECTION" attachment in stock.

EDISON DISC MACHINE owners will be coming to you every day asking you if the records you sell can be played on their machines. If you carry our attachments in stock you not only have a chance to sell them, but you also have a chance to make record sales and add a new name to your record mailing list.

We can also furnish you with a reproducer which is fitted to our attachment. Price of sample attachment, \$2.50 in gold, nickel, or bronze finish. With reproducer any finish \$4.75. Cash or check must accompany each order for sample. We will quote you quantity price on cash or credit basis on request.

EVERY PHONOGRAPH DEALER IN THE UNITED STATES AND CANADA SHOULD STOCK THIS ATTACHMENT.

If you are interested write to us and we shall be pleased to give you our view of its present and future value.

NEW ENGLAND TALKING MACHINE CO.
132 Boylston Street
BOSTON, MASS.



It looks like a big Columbia year coming. The new Columbia Grafonola "Nonpareil" at \$150 looks like one of the biggest winners in it. Are you *on*, or just *looking on*?



(Write for "Music Money," a book "full of meat" for those dealers interested in quick and frequent turnover of capital.)

**Columbia Graphophone Company
Woolworth Building, New York**

MOST ARTISTIC DISPLAY ROOMS.

Are Those Opened Recently at 118 Washington Street, Hoboken, by Herman Jaffee—Handling a Full Line of Victor Talking Machines—"Opening" an Important Affair.

One of the handsomest talking machine stores in northern New Jersey is that opened on December 1 at 118 Washington street, Hoboken, by Herman Jaffee, who for a number of years has sold Victor machines and records as well as sporting and photographic goods at 122 Washington street, that city.

At the formal opening of the new store several thousand people were entertained by Mr. Jaffee and his staff in a thoroughly pleasing manner. An orchestra had been engaged for the occasion, refreshments were served to all comers and the evening ended up with dancing. An interesting feature of the program was the dancing of Miss Jaffee and her partner. Al Edelstein, the well-known salesman connected with Benjamin Switky.

As will be seen from the accompanying photograph, which was taken immediately after the opening and with the many floral tributes still in



Herman Jaffee's Neatly Arranged Showrooms.

place, the arrangement and decoration of the new quarters is of a most elaborate character. The demonstration booths are finished in French ivory effect and are set off with dainty carvings, and that finish predominates throughout the store. Facing the booths is the main showroom with up-to-date record files close at hand. The indirect lighting system and rich furniture, rugs and other fittings give the store a decidedly cozy appearance.

Above the show-windows Mr. Jaffee's name and the words Victrolas and Kodaks are set in large panels of stained glass. A 500-light working sign will also be put into position over the door and the effect at night will serve to attract much attention.

ranged now will include Victrola numbers; in fact, the major part of the affair will be given over to the talking machine department.

TALKING MACHINE OF CONCRETE?

A writer in the Philadelphia Post draws somewhat on his imagination when he tells the following story:

"So many different uses have been discovered for cement that one is not surprised at anything announced in this line, but one would hardly expect to hear of musical instruments made of cement. This, however, has been accomplished by an inventor who has resorted to the use of this material in order to produce a low-priced instrument. The revolving table which holds the record is a disc of cement concrete, which offers a flat bed and has sufficient weight to impart a desired momentum. The record is placed on the disc and is revolved on a wire support by means of a crank handle. The wire support also carries the sound box with its needle. The sound box is also of concrete with the diaphragm imbedded in it, the latter having been put in place while the material is in a plastic condition. With the exception of the horn and diaphragm, this instrument is entirely of concrete, supported by a piece of wire."

BIG HOLIDAY TRADE IN NORTHWEST.

Reports from Minneapolis and St. Paul Tell of Satisfactory December Business, with Dealers Optimistic Regarding New Year.

(Special to The Talking Machine World.)

MINNEAPOLIS and ST. PAUL, MINN., January 8.—Victrolas, amberolas, Grafonolas and all the other olas went like hot cross buns in the Twin Cities in the pre-holiday times. There was only one complaint—all the dealers kicked because they could not get enough goods. The crest of the wave came through at Christmas, which was to be expected, but the flood was going very high up to New Year and since then, while it has subsided somewhat, trade has been fully satisfactory.

W. J. Dyer & Bro., distributors for the Victor lines and the Edison cylinder line, never did such talking machine business in their history and doubtless will be satisfied if they can repeat in the same scale in the years to come. They were hampered somewhat in their Edison business by the inability to get stock on account of the fire. It should be remarked here that the interior towns of northern Minnesota and Dakota still have a penchant for the cylinder machines and the volume of their purchases is no inconsiderable item even for a house like the Dyers.

"We practically doubled the business of December, 1913," declared Lawrence H. Lucker, manager of the Minnesota Phonograph Co. "We had prepared for big trade by stocking up and the fire did not affect us in the least. The Edison's are growing in favor and as they are being shown in the two finest stores in the Twin Cities, we feel certain that there is a big future for them in the Northwest. This section of the United States is taking hold of the new style of music production in earnest and it is not only the Edison lines that are doing well, but I understand that the other makes of machines are being sold on a larger scale than ever. It's the music of the future without much doubt."

Samuel Esser has opened an exclusive Edison store at 416 Central avenue. This is on the East Side and will be the only Edison store in that section.

Archie Matheis, of the Talking Machine Co., handling both Victor and Edison instruments, pronounces the holiday trade the best he ever has had. The aftermath also has been excellent. He resumed the weekly recitals Thursday evening, January 8. For several weeks before the holidays ended the recitals perforce were abandoned. The annual dinner and theater party to the employes of the company is set for the latter part of the month. They well have earned the entertainment.

Just one thing bothered the Columbia managers in Minneapolis and St. Paul, their failure to get the instruments that were wanted. Scores of fine machines were sent out with the express understanding that they would be exchanged after New Year, when the new shipments from the East would arrive.

The prospects are all that one could ask and there are no dark faces among the talking machine men and women of the Northwest,

VICTROLA CONCERT FOR ORPHANS.

Denton, Cottier & Daniels Act as Hosts at Entertainment for Benefit of Youngsters in Buffalo—Appreciated Good Music.

(Special to The Talking Machine World.)

BUFFALO, N. Y., January 6.—A musical program composed in the main of Victrola selections from the latest model instruments, more than delighted a fashionable audience Thursday night in Elmwood Music Hall. The concert, arranged by the well-known firm of Denton, Cottier & Daniels, was carried out for the benefit of the youngsters of the Buffalo Orphan Asylum, and although many of the city's most prominent musicians appeared in numbers, the Victrola selections were applauded as enthusiastically as were the original offerings.

There were twelve musical numbers, along with the Victrola creations, which were selections from the operas. The children were unusually pleased with the band numbers, several hundred hands applauding vigorously each selection played upon the Victor Victrola.

Several similar entertainments will be held during the winter by Denton, Cottier & Daniels, whose talking machine department is one of the most complete in the country. The concerts being at-

LATEST PATENTS RELATING TO TALKING MACHINES AND RECORDS

WASHINGTON, D. C., January 8.—SOUND BOX.—Eldridge R. Johnson, Philadelphia, Pa., assignor to the Victor Talking Machine Co., Camden, N. J. Patent No. 1,118,348.

The main objects of this invention are to provide in a sound box an improved casing; an improved mounting for a diaphragm.

In the accompanying drawings Fig. 1 is a longitudinal central section of a sound box constructed in accordance with this invention; Fig. 2 an en-

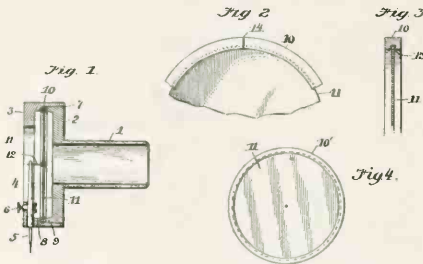

larged fragmentary front elevation of the diaphragm and its mounting; Fig. 3 a transverse section on a radial line of Fig. 2 and Fig. 4 a front elevation of a diaphragm mounted in a continuous ring.

SOUND BOX FOR TALKING MACHINES.—Harry W. Hess, New York. Patent No. 1,18,345.

The present invention relates to a form of reproducer for talking machines by the use of which the tone arm and horn hitherto used may be dispensed with, while at the same time greater accuracy of reproduction is attained.

One object of the invention is the provision of an improved diaphragm having a peculiar conformation permitting a single disc to accommodate itself to sounds of all qualities within any reasonable degree of pitch, without imposing upon the particular changing forms of vibration imparted to it any material coercion due to its own natural tone. Another object of the invention is the provision of means whereby one or more thin layers of air are made active, each conforming as nearly as possible to the ideal form of the diaphragm.

Fig. 1 is a front elevation of the combined apparatus as employed with a disc record seen in edge view; Fig. 2 is an enlarged sectional view of the same on the line 2—2 in Fig. 1; Fig. 3 is an enlarged

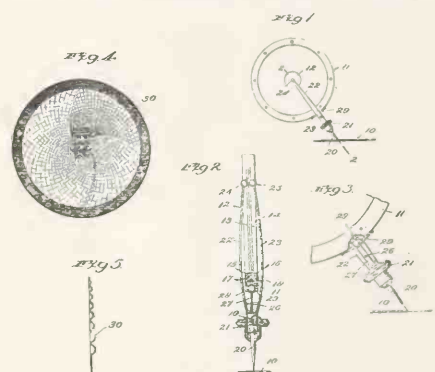

sectional view of the mounting for the needle arm looking at right angles to Fig. 2; Fig. 4 is a face view of the preferred improved diaphragm, one quadrant only being shown completed, and Fig. 5 is a sectional view of a small portion of the diaphragm.

DISC TALKING MACHINE.—Max Marcus, Pankow, near Berlin, Germany. Patent No. 1,115,707.

This invention relates to disc talking machines such as gramophones and the like and has for its object to provide an apparatus whereby the needle or like member carried by the sound box is automatically brought into operation instead of being moved by hand or by some separate mechanism as heretofore.

A further object of this invention is to insure the needle always engaging the record smoothly

without employing any additional mechanism and to effect disengagement between the needle and the record as soon as the main driving spindle ceases to rotate.

According to this invention the turn-table is so mounted on its spindle that the starting or stopping of the latter automatically moves the turn-table into or out of its operative position and also causes the rotation of the turn-table to be started or stopped gradually. To this end the turn-table is mounted on its spindle so as to rotate relatively thereto within certain limits and the driving engagement between the spindle and the turn-table is effected through a cam surface. When the spindle is at rest the turn-table occupies a plane below that in which it rotates during operation of the machine, the inertia of the turn-table relatively to the spindle and the cam surface causing the turn-table to be gradually rotated to the same speed as the spindle and simultaneously raised into engagement with the sound reproducing needle. When the record is completed and the driving mechanism is stopped, the turn-table and the record it carries descend vertically relatively to the spindle and thus are moved out of engagement with the needle owing to the

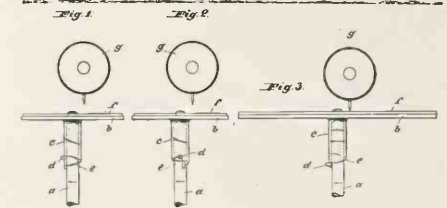

momentum of the turn-table. In this way the turn-table is automatically returned to its initial position without any danger to the surface of the record which remains intact.

In the accompanying drawings, Fig. 1 shows in front elevation diagrammatically the turn-table and spindle in their inoperative position. Fig. 2 is a side elevation also in the position of rest, and Fig. 3 shows the turn-table in operation.

DISC-RECORD HOLDER.—Julius M. Alter, president Boston Book Co., Brooklyn, N. Y. Patent No. 1,121,446.

This invention relates to means for holding in a safe and convenient manner disc records for talking machines or the like.

Among the objects of the invention is to produce an album-like structure having a series of pockets or envelopes for retaining individual records, the envelopes being made in a peculiar, simple and strong manner, and all held securely in the album book whereby the danger of tearing of the envelopes or their slipping from the album will be prevented.

Fig. 1 is perspective view of a record holder made in accordance with this invention, the view

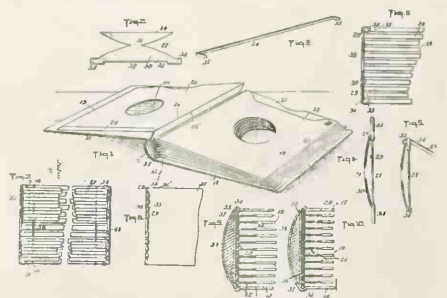

showing the holder lying open and empty; Fig. 2 is a plan view of one of the anchor members before it is folded; Fig. 3 is a perspective view of one of the tie strips; Figs. 4 and 5 are perspective views showing progressive steps in the assembling of the anchor members and tie strips; Fig. 6 is a plan view of one end of the binding strips showing the relation between one of the anchor members and the tie strips when the operation of securing

the parts together is almost finished; Fig. 7 is a view indicating the same parts as Fig. 6 but with most of the envelopes and tie rods in position; Fig. 8 is a view of one end of the binding device after the fastening of the parts is finished; and Fig. 8 is a view of one end of the binding device the lines 9—9 and 10—10, respectively, of Fig. 7, these views also indicating the binding complete.

MANDREL FOR SOUND RECORDS.—Frank L. Capps, Bridgeport, Conn., assignor to the American Graphophone Co., same place. Patent No. 1,119,064.

One of the objects of this invention is to provide a mandrel for a talking machine on which the sound records may be readily placed and securely held in position, but from which they can

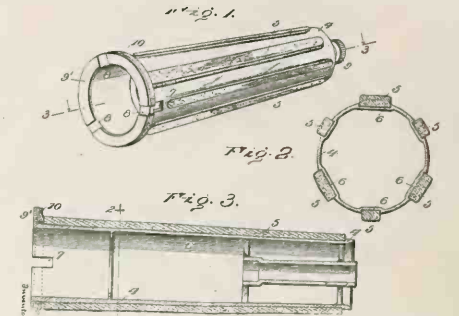

be more readily removed than heretofore. A further object is to provide a mandrel of this character which means for acoustically insulating the record from the mandrel.

The invention will be best understood by reference to the accompanying drawings, which illustrate one expression of the inventive idea, and in which Fig. 1 is a perspective view; Fig. 2 is a cross-section on the line 2—2 of Fig. 3, and Fig. 3 is a longitudinal section on the line 3—3 of Fig. 1.

EJECTOR MECHANISM FOR CYLINDRICAL RECORDS.—Frank L. Capps, Bridgeport, Conn., assignor to the American Graphophone Co., same place. Patent No. 1,119,065.

The present invention relates to talking machines, and particularly to ejector mechanism for removing the cylindrical records and blanks from the mandrel.

The object of the present invention is to provide a simple device which may be readily manipulated and which will be durable and effective in operation, the parts of which are compact and out of the way, said parts being readily assembled and disassembled.

In talking machines employing a cylindrical form of records or tablets, the mandrel of the machine and the interior of said records or tablets have a slight taper. When the record or tablet is in operative position it fits tightly upon the mandrel and revolves therewith, but a slight longitudinal movement of the tablet tends to free it from frictional contact with the mandrel, and it may then be readily removed by hand. The tablet must fit firmly on the mandrel when in operative position, and being of wax or wax-like material, is liable to be broken or injured in imparting the initial longitudinal movement thereto to remove it from the mandrel. It has heretofore been proposed to effect this initial or loosening longitudinal movement by means of lever mechanism which is open to several objections. It is liable to damage the tablet, is more or less inefficient, and is in an exposed position where it is in the way of the operator in manipulating the machine.

The object of the present invention is to provide an efficient means for imparting the initial or starting movement to the tablet, which means shall be free from the objections above indicated, and with this object in view, the invention consists, generally stated, of a member placed preferably within the interior of the mandrel revolving therewith, but capable, under certain conditions, of longitudinal movement with relation to the mandrel and provided with an outwardly projecting member or members for engaging the record during said longitudinal movement and imparting the initial or starting movement thereto.

Fig. 1 is an elevation, partly in section, of the

LATEST PATENTS RELATING TO TALKING MACHINES—(Continued from page 60).

mandrel, the record mounted thereon, and the means for ejecting the record from the mandrel, the parts being in the position which they occupy during the normal operation of the machine, that is to say, when a record is being made or reproduced; Fig. 2 is a view similar to Fig. 1, except that the parts are shown in the position which they occupy after the ejector mechanism has been op-

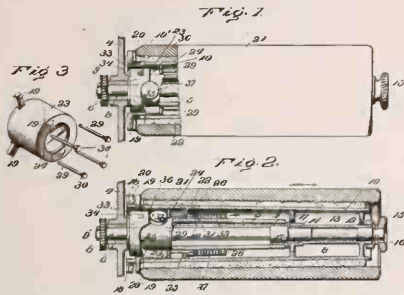

erated, and when the cylinder may be readily removed by introducing the hand in the end thereof which projects off of the mandrel; and Fig. 3 is a detail perspective showing the record-engaging members and associated parts.

PHONOGRAPH REPRODUCER.—Alexander N. Pierman, Newark, N. J., assignor by mesne assignments to New Jersey Patent Co., West Orange, N. J. Patent No. 1,119,113.

The present invention relates to phonograph reproducers and has for its object the provision of an improved mounting for the stylus lever, wherein all looseness in the connections of parts is obviated, which renders the reproducer capable of withstanding jarring without causing the stylus to skip from one thread of a record to another, and thus insures the exact tracking and reproduction of a record.

It is customary in reproducers, as now constructed, to pivotally mount the floating weight on the sound-box, to provide a member, pivotally connected to the weight for carrying the stylus lever, and to provide separate means, such as a spring, for normally holding the member in central position while allowing lateral movements thereof. This construction is objectionable owing to the impossibility of making a sufficiently tight fit in the pivotal connection of the floating weight and member, the looseness existing therein, and which increases with use, frequently resulting in the jumping or skipping of the stylus from one thread of a record to another when the reproducer is jarred, giving a faulty reproduction and producing foreign and objectionable sounds.

In overcoming the objections indicated, the reproducer is constructed as follows: A floating weight is pivotally mounted on a reproducer sound-box of usual construction, a member of small in-

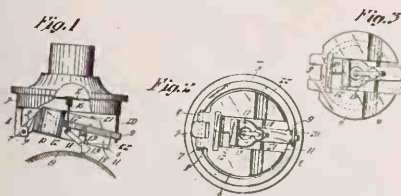

ertia compared with that of the weight is employed for carrying the stylus lever, which is connected to the diaphragm mounted in the sound-box in any suitable manner, and the member is mounted on the weight by means of a resilient member rigidly connected at its ends to the weight and member respectively. This resilient connection between the weight and member may be of any suitable construction, but as shown is a very thin flat sensitive spring of any suitable material, such as spring steel, which normally maintains the member carrying the stylus lever in central position while allowing lateral movement of the member with respect to the weight so as to permit the stylus to faithfully follow all irregularities in the record

threads. In a reproducer constructed in accordance with this invention the stylus will not skip from one thread to another when the reproducer is jarred, for all looseness in the connection between the floating weight and member carrying the stylus lever is obviated.

Figure 1 is an elevation partly broken away, and partly in section, showing a reproducer constructed in accordance with the invention; Fig. 2 is a bottom view of Fig. 1; and Fig. 3 is a view similar to Fig. 2, showing different positions of the member carrying the stylus lever, the sound-box body being omitted.

SOUND REPRODUCER.—Thomas A. Edison, Llewellyn Park, West Orange, N. J., assignor to New Jersey Patent Co., same place. Patent No. 1,119,141.

This invention relates to sound reproducers, and the object is to provide a reproducer in which the stylus lever is so mounted that the stylus will always track the record faithfully under all circumstances. The stylus lever is so mounted as to be moved with the greatest freedom in conformity with the engagement of the stylus in the record groove. The stylus lever and its mounting are of small mass or inertia and are movable laterally with respect to the floating weight supporting the same, the stylus lever also preferably being bodily movable with respect to the weight in a plane at right angles to the plane of the latter. The provisions of means permitting lateral movement of the stylus with respect to the floating weight is intended to permit the stylus to track the record groove without having to overcome the inertia of the floating weight when a lateral movement is necessary, and the provision of means permitting the stylus lever to move bodily toward and away

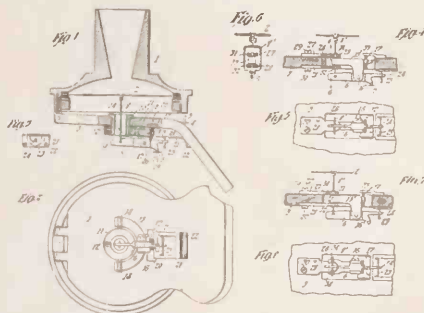

from the floating weight prevents binding of the mounting in the weight and increases the sensitiveness and efficiency of the device.

Another object of the invention is the provision of a roller upon the stylus lever mounting, this roller contracting the under side or other surface of the floating weight during the lateral movements of the lever with respect to the weight, whereby friction is reduced.

Figure 1 represents in side elevation and in vertical cross-section a reproducer embodying one form of the invention. Fig. 2 is a bottom plan view of the same. Fig. 3 is a cross-section on line 3-3 of Fig. 1 looking to the right. Fig. 4 is a partial side elevation and vertical cross-section through a modified form of this device. Fig. 5 is a bottom plan view of the same. Fig. 6 is a cross-section taken on line 6-6 in Fig. 4, and Figs. 7 and 8 are views similar to Figs. 4 and 5 of another modified form of this device.

SOUND-RECORD.—Thomas A. Edison, Llewellyn Park, West Orange, N. J., assignor to the New Jersey Patent Co., same place. Patent No. 1,119,142.

This invention relates to an improved sound-record, preferably of that type which consists of a base or backing of one material, usually a molded material, and an outer surface or covering of another material which receives the sound-record.

The main object of the invention is to produce a record which can be cheaply and readily produced, which will be strong and durable, have very little surface noise on reproduction, the record itself permitting a large number of reproductions without sensible wear, and which will be effective in

every way for the purpose of recording and reproducing sounds.

Another object of this invention is to construct the parts of the record—that is, to say, the base or backing and the outer covering of sound-recording material—of substances which have the same or practically the same coefficient of expansion under changes of temperature, whereby both parts of the phonogram blank are made to expand and contract equally and the cracking of the outer surface material does not occur.

In the drawing A represents the outer recording layer or surface formed of a hard, tough composition such as the shellac and tetra-chloronaphtha-

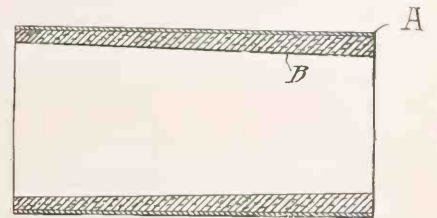

lene mentioned above, and B the base of cheaper material such as montan wax and cotton flock, and if desirable inert powders, such as chalk. While the inventor has shown a cylindrical record, the invention is evidently applicable to disc records.

PHONOGRAPH.—Adolph F. Gall, West Orange, N. J., assignor by mesne assignments to the New Jersey Patent Co., same place. Patent No. 1,119,269.

This invention relates to phonographs, and more particularly to an improved connection between the reproducer and sound-conveying or reproducer arm of a phonograph.

The principal object of this invention is to provide an improved connection particularly adapted for use with a mechanically fed sound-conveying arm whereby the reproducer is capable of adjusting itself to irregularities in the record groove and of being readily lifted from the record surface.

Another object of this invention is to provide an improved means for lifting the reproducer and positioning the same on the record surface.

Fig. 1 is a side elevation of the improved device applied to a reproducer and reproducer arm; Fig. 2 is a central vertical section of the repro-



ducer arm and the improved connection, the reproducer being shown in side elevation; Fig. 3 is a plan view of the reproducer and the connection for securing the same to the reproducer arm; Fig. 4 is a section taken on line 4-4 of Fig. 3, and Fig. 5 is a fragmentary elevation of the improved positioning means.

H. H. Swanson has opened a talking machine store in Grand Rapids, Mich.

60 YEARS' EXPERIENCE

PATENTS

TRADE MARKS
DESIGNS
COPYRIGHTS & C.

Anyone sending a sketch and description may quickly ascertain our opinion free whether an invention is probably patentable. Communications strictly confidential. HANDBOOK on Patents sent free. Oldest agency for securing patents.

Patents taken through Munn & Co. receive special notice, without charge, in the

Scientific American.

A handsomely illustrated weekly. Largest circulation of any scientific journal. Terms, \$3 a year; four months, \$1. Sold by all newswriters.

MUNN & Co. 361 Broadway, New York
Branch Office, 625 F St., Washington, D. C.

RECORD BULLETINS FOR FEBRUARY, 1915.

EDISON BLUE AMBEROL RECORDS.

- REGULAR LIST. 2518 Amazonia—Polka Bresilienne (P. J. de O. Pinto) (For dancing) National Promenade Band

- A1661 Chin-Chin (Caryl). "Love Moon." Soprano and Tenor duet, Orch. accomp. Miriam Clark

COLUMBIA GRAPHOPHONE CO.

SYMPHONY DOUBLE-DISC RECORDS.

- No. A5626 Don Carlos (Verdi) "O Don Fatale" (O Fatal Gift) Mezzo-soprano, in Italian, with orch. accompaniment. Eleonora De Cisneros

BLUE LABEL DOUBLE-DISC RECORDS.

- A1653 "Neath the Oaks (Sawyer). Unaccompanied. Wellesley College Glee Club

RECORDS BY MANOLITO FUNES, THE WONDERFUL BOY PIANIST.

- A1660 Arlequine (Chamnade). Piano Solo. Manolito Funes

SACRED NUMBERS OF UNUSUAL CHARM.

- A1668 Softly floating on the Air (Root). Orch. accomp. Columbia Mixed Quartet

DOUBLE-DISC RECORDS.

- A5625 The Only Girl (Herbert). "When You're Away." Soprano Solo, orch. accomp. Grace Kerns

- 17672 The Victors March (Louis Elbel). Victor Military Band

VICTOR TALKING MACHINE CO.

THE FEBRUARY DANCE RECORDS.

- No. 17680 Le Rouli Rouli (The New Castle Dance) (Jean Schwartz). Victor Military Band

POPULAR SONG HITS OF THE MONTH.

- 17541 The Rose of My Dreams (Ruth L. Stoddard). Edna Brown-James F. Harrison

TWO NEW CELESTA DOUBLES.

- 17674 Old Folks at Home (Transcription) (Stephen C. Foster) (Celesta Solo). Felix Arndt

TALKING MACHINE EXPORTS.

The Figures for October Presented—Exports Show Falling Off for the Month.

(Special to The Talking Machine World.) WASHINGTON, D. C., December 30.—In the summary of the exports and imports of the commerce of the United States for the month of October (the latest period for which it has been compiled), which has just been issued by the Bureau of Statistics of the Department of Commerce and Labor, the following interesting figures relating to talking machines and supplies are set forth: The total exports of talking machines for October, 1914, amounted in value to \$50,644, while records and supplies for October, 1914, amounted in value to \$81,032.

SEES HIS FINISH.

The man who keeps thinking "ishkabibble" soon puts the "ish" in his "finish."

"Here is Your Answer" in WEBSTER'S NEW INTERNATIONAL THE MERRIAM WEBSTER. It answers with final authority all kinds of questions in Language, History, Biography, Fiction, Trades, Arts, and Sciences. 400,000 Words and Phrases Defined. 2700 Illustrations. 6700 Pages. Write for specimen pages, etc. FREE. G. & C. Merriam Co., Springfield, Mass.

CHEMISCHE FABRIK E. SAUERLANDT FLURSTEDT del Apolda i. Th., Germany. The largest manufacturing plant in the world devoted exclusively to the manufacture of Master-Waxes and Master-Blanks for Gramophone and Phonograph Recording. Sole Manufacturer of Wax "P." the best recording material for Berliner-cut.

Leading Jobbers of Talking Machines in America

1856 **WURLITZER** 1914

VICTOR
DISTRIBUTORS
VICTORS EXCLUSIVELY

We make a specialty of getting the order out on time—every time.

The Rudolph Wurlitzer Co.
CINCINNATI and CHICAGO

Two points of supply; order from the nearer.

Edison Phonograph Distributors
for the **SOUTHWEST**
All Foreign Records in Stock.

Houston Phonograph Co., HOUSTON, TEXAS

NEW ENGLAND
JOBBER HEADQUARTERS
EDISON AND VICTOR
Machines, Records and Supplies.

THE EASTERN TALKING MACHINE CO.
177 Tremont Street BOSTON, MASS.

PACIFIC COAST DISTRIBUTORS OF
Victor Talking Machines and RECORDS

STEINWAY PIANOS—LYON & HEALY
"OWN MAKE" BAND INSTRUMENTS

Sherman, Clay & Co. San Francisco Portland
Oakland Los Angeles

The Chicago Edison Jobber

The perfection of Musical Instruments—THE EDISON diamond disc PHONOGRAPH—with EDISON double disc records.

THE PERFECTION OF SERVICE—Our Service.

The Perfection of advertising for the dealer—Our plan.

The Phonograph Company
229 So. Wabash Ave. CHICAGO

CHASE & WEST DES MOINES IOWA

Machines **Victor** Everything
Records in stock all
Cabinets the time.

WHOLESALE TO IOWA TRADE

Send us your name and address and we will mail you postpaid complete illustrated catalogues, giving detailed information concerning all Victor products. Showing the various styles of Victor Machines, list of all Victor Records, the entire line of Victor Cabinets, Repair Parts and all Accessories. Dealers, let us help you build a Victor Business.



Where Dealers May Secure

COLUMBIA

Product

Ready, Full Stocks, and Prompt Deliveries from Convenient Shipping Centers all over the United States.

- Distributors**
- Atlanta, Ga., Columbia Graphophone Co., 132 Peachtree St.
 - Baltimore, Md., Columbia Graphophone Co., 305-307 North Howard St.
 - Birmingham, Ala., Columbia Graphophone Co., 1818 Third Ave.
 - Boston, Mass., Columbia Graphophone Co., 174 Tremont St.
 - Buffalo, N. Y., Columbia Graphophone Co., 622 Main St.
 - Chicago, Ill., Columbia Graphophone Co., 14 N. Michigan Ave.
 - Cincinnati, O., Columbia Graphophone Co., 117-119 W. Fourth Ave.
 - Cleveland, O., Columbia Graphophone Co., 1376 Euclid Ave.
 - Dallas, Tex., Southwestern Talking Machine Co., 1101 Elm St. Columbia Building.
 - Denver, Colo., Columbia Stores Co., 605-507 Sixteenth St.
 - Detroit, Mich., Columbia Graphophone Co., 114 Broadway.
 - Hartford, Conn., Columbia Graphophone Co., 719 Main St.
 - Indianapolis, Ind., Columbia Graphophone Co., 27 N. Pennsylvania St.
 - Kansas City, Mo., Columbia Graphophone Co., 1112 Grand Ave.
 - Lincoln, Nebr., The Grafonola Company, 1036 O St.
 - Livingston, Mont., Schenber Drug Co.
 - Los Angeles, Cal., Columbia Graphophone Co., 420-422 S. Broadway.
 - Louisville, Ky., Columbia Graphophone Co., 403 South Fourth St.
 - Milwaukee, Wis., Albert G. Kunde, 815 Grand Ave.
 - Minneapolis, Minn., Columbia Graphophone Co., 424 Nicollet Ave.
 - New Haven, Conn., Columbia Graphophone Co., 25 Church St.
 - New Orleans, La., Columbia Graphophone Co., 933 Canal St.
 - New York City, Columbia Graphophone Co., 89 Chambers St.
 - Philadelphia, Pa., Pennsylvania Talking Mach. Co., 1100 Chestnut St.
 - Pittsburgh, Pa., Columbia Graphophone Co., 101 Federal St.
 - Portland, Me., Columbia Graphophone Co., 550 Congress St.
 - Portland, Ore., Columbia Graphophone Co., 371 Washington St.; Eilers Music House.
 - Providence, R. I., Columbia Graphophone Co., 119 Westminster St.
 - Rochester, N. Y., The Grafonola Company, 23 Clinton Ave., South.
 - Sacramento, Cal., Ktrk, Geary & Co.
 - Salt Lake City, Utah, Daynes-Beebe Music Co., 40 Main St.
 - San Francisco, Cal., Columbia Graphophone Co., 384 Sutter St.
 - Seattle, Wash., Columbia Graphophone Co., 1311 First Ave.; Eilers Music House, 3d and University Sts.
 - Spokane, Wash., Columbia Graphophone Co., 813 Sprague Ave.
 - Springfield, Mass., Columbia Graphophone Co., 174 Worthington St.
 - St. Louis, Mo., Columbia Graphophone Co., 1008 Olive St.
 - St. Paul, Minn., Columbia Graphophone Co., 17 East Sixth St.
 - Tampa, Fla., Tampa Hardware Co.
 - Terre Haute, Ind., 640 Wabash Ave.
 - Toledo, O., Columbia Graphophone Co., 229 Superior St.
 - Washington, D. C., Columbia Graphophone Co., 1210 G St., N. W.

DEALERS WANTED—Exclusive selling rights given where we are not actively represented.

Write for particulars to the Columbia Graphophone Co., Wholesale Department, Woolworth Building, New York.

Headquarters for Canada:
Columbia Graphophone Co., 363-5-7 Borauren Ave.
Toronto, Ont.

Southern Victor Dealers
Largest Stock VICTROLAS and RECORDS.
Prompt Shipment and Low Freight Rates.

WALTER D. MOSES & CO.
Oldest Music House in Virginia or North Carolina.
RICHMOND, VA.

SERVICE FIRST

EXCLUSIVE VICTOR JOBBERS
WHOLESALE ONLY

Standard Talking Machine Co.
PITTSBURGH, PA.

PERRY B. WHITSIT L. M. WELLER
PERRY B. WHITSIT CO.,
213 South High Street, Columbus, Ohio.

Edison Phonographs and Records **JOBBERS** Victor Talking Machines and Records

OLIVER DITSON COMPANY
BOSTON

Largest VICTOR Talking Machine Distributors East of Chicago.

Creators of "The Fastest Victor Service." Let us tell you more about our service.

W. J. DYER & BRO.
Saint Paul, Minn.

VICTOR & EDISON
Distributors

Quick Service for all points in the Northwest. Machines, Records, Supplies.

Do you belong with—"the quick or the dead"

Every talking machine jobber in America should be represented in The World of January 15th.

If you are keenly alive to your business interests you will be with the live ones and occupy space in the issue of The World of that date.

The time to secure space is now, and get your copy in at once. Don't be a "dead one."

OUR POLICY OF EXCLUSIVE REPRESENTATION TO LIVE DEALERS

Is but One of the many strong reasons why you should become a Sonora dealer. It is an inviting proposition to be the only Sonora dealer in your section. You get direct benefit from your own efforts without assisting your competitors. Every Sonora sold is the first of a series. Satisfied customers talk about their Sonora. Be first in your field. Do not wait for somebody else to show you how good a proposition the Sonora is to handle. Territories are being closed very fast, and your own interests demand that you investigate the Sonora line now.

The SONORA

is the Acme of Perfection in
Tone Quality
Universal Playing
Motors of Power and Precision
Individuality

It is the only phonograph that
Plays Perfectly all makes of Disc Records
and can be called

"THE HIGHEST CLASS TALKING MACHINE IN THE WORLD"

The Sonora line is the most complete line on the market with styles at \$35, \$40, \$50, \$75, \$100, \$135, \$150, \$200. All styles from \$75 to \$200 equipped with electrical apparatus, \$75 list additional.



Price, \$135.00
Style "Baby Grand."

12" Turntable. Extra Strong Double-Spring Motor, Nickel-plated. Tone Modifier. Multi-Playing Needle. Sapphire Needle. Diamond Needle. Automatic Starter and Stopper. Equipment for playing all makes of disc records in the world. Trimmings Nickel-plated. Envelope Filing System, with capacity for holding 70 records. Compartment at bottom of cabinet for accessories. Dimensions: Width 21 1/4", height 42 1/2", depth 21 1/4".

The SONORA Multi-Playing Jewel Needle

Offers the dealer a new opportunity to get back the profit which he has lost on steel needles by the reduction in price. No sale is for less than one dollar and quite often more. Your profit is large and you establish a new line of trade. Your list of customers increases together with your record sales, because the Sonora Multi-Playing Jewel Needle is a decided improvement over the steel needle, and it gives greater satisfaction. It adds to the life of new records and gives new life to old records. Price \$1.00.



Price, \$200.00
Style "Grand."

12" Turntable. Extra Heavy Double-spring Motor, playing half an hour, or ten 10" records, in one winding. Tone Modifier. Sapphire Needle. Diamond Needle. Automatic Starter and Stopper. Multi-Playing Needle. Equipment for playing all makes of disc records in the world. Trimmings Gold-plated. Envelope Filing System, with capacity for holding 160 records.

Sonora Phonograph Corporation

57 Reade St.

New York City

GEO. E. BRIGHTSON, Pres.