

The TALKING MACHINE WORLD

AND
NOVELTY
NEWS

Published Each Month by Edward Lyman Bill at 1 Madison Avenue, New York, April 15, 1907



YES, I've got several other makes of Talking Machine Horns in the place, but this is the best Horn that comes. It's name? Why, it's a  Horn. Beautiful! you say. Yes, it is beautiful. But every one of their Horns is a work of art. Will the colors last? Yes, they're bound to. Why? Well, the colors on a  Horn are "Baked-on" by a special process which makes them practically indestructible. They won't fade, or crack, or flake off. They can't. That's why a  Horn stands in a class by itself. I myself have proven that.

Send for Handsome Booklet on Horns and Cranes

**THE TEA TRAY COMPANY
OF NEWARK, N. J.**

(FOUNDED 1867.)

HB

ZON-O-PHONE QUALITY

Have you heard the latest product?—the new Zon-o-phone 12 inch records?

They are the best we ever made, and that is saying a good deal, because Zon-o-phone records have taken high rank in the trade.

It has been our aim in presenting our monthly list of records, to offer to the trade the latest and best that money and brains can produce. Every Zon-o-phone record issued creates a demand for more of the same character.

If you have not handled Zon-o-phone records, you have missed a business opportunity. You will be convinced as others have been that there is a charm and fascination about the Zon-o-phone products which will win you business.

The Zon-o-phone twelve-inch records are retailed at one dollar each. The dealer's price is sixty cents.

The Zon-o-phone ten-inch records are retailed at sixty cents, and to the dealer forty cents. Complete catalogue ready for the asking. If you send an order for the Zon-o-phone, you will be convinced that our statement is not merely an idle one, regarding record quality, but one which conveys facts only.

We have never been content to rest on laurels won, but we are always striving to make betterments wherever possible.

The Zon-o-phone Tapering Arm instruments retail from \$30.00 to \$75.00 and are winning their full share of trade commendation. The motors are interchangeable, all parts are alike, and will fit single spring, two spring and three spring. A comparison of these instruments with others on the market will immediately make you a Zon-o-phone convert. You can increase your Spring trade materially through a business alliance with us. Let us take up the subject with you.

Universal Talking Machine Manufacturing Co.

Camp and Mulberry Streets, NEWARK, N. J.

The Talking Machine World

Vol. 3. No. 4.

New York, April 15, 1907.

Price Ten Cents

THE POWER OF SUGGESTION.

One of the Great Essentials in the Art of Salesmanship—How the Customer's Mind Can be Moulded and Business Materially Helped—An Illustration Points Out the Possibilities in This Connection When Properly Utilized.

Have you ever considered the power of suggestion as relating to salesmanship? It is as important to be able to present an article in harmony with the customer's ideas as it is to prove that the quality is suitable and price right. Where a customer is confined to a number of selected items a choice is made much more readily than if the confused contents of the whole shop are thrust upon him at once.

The power of suggestion in salesmanship was well illustrated recently in the wall paper field. Two women, one of whom had purchased a house with nearly a score of rooms which she desired repapered, went into one store, where the salesman was polite, but far from diplomatic. The parlors came first on the list. He simply placed two or three sample books of parlor papers on the rack and turned them over rapidly without comment. The array of a hundred or more papers so confused the ladies that they had to postpone immediate choice, and the same plan on the part of the salesman in relation to other rooms had a similar result, and the possible customer walked out of the store without any clear idea of what had been shown.

Strolling down the street the ladies were attracted by the window exhibit of another company. Going inside, "just to look around," they were approached by an affable young man who persuaded them to be seated, and was not long in getting the plans of the rooms. When it came to the parlor papers he took one book and began by showing heavy bronze papers. The ladies were not very enthusiastic, but when the heavy flowered patterns turned up they became interested, and at sight of a series of light and dainty French patterns they expressed their delight quite audibly. That was the salesman's cue. He had suggested various styles until he found what was wanted and confined himself to that. Instead of showing several hundred patterns for different rooms he confined himself to perhaps fifty of the light flowered order. The ladies were delighted, and when they were undecided between the shades he simply contrasted them with the papers picked for other rooms, when the one most in harmony was quickly chosen. The salesman did not force his superior knowledge and wider experience upon the customers, just studied their tastes and suggested only such things as he knew would most likely suit them. A few clever words in favor of or sometimes against a paper made the task of the ladies comparatively easy, and he took the order for paper for the entire house before they left the store.

What that wall-paper salesman did should interest many "talker" salesmen, even if the lines are totally different. When a customer drops in, don't hand him or her a catalogue and play the Sphinx. Better find out what style of music is preferred, a very simple matter, if the same party has purchased records before at your store, and then pick out a few desirable selections along that line from the latest lists. Instead of becoming weary of listening to records of his own unguided choice—perhaps only one out of three of which will appeal to him to the slightest extent—he listens to records, every one of which has some interest for him. If he likes light opera of the better sort he is bored with either extreme, "ragtime" or grand opera. If he likes vocal selections, don't make him listen to a band or vice versa. When he has picked out a number from which his final choice is to be made, suggest reasons why he needs every one; this because it is the hit of a popular opera; that be-

cause it is the work of a popular composer, and he will be thus prevailed upon to purchase several records at least beyond the number he originally intended to order. Learn to mould your customer's mind to the extent that it helps your business; don't appear insistent, simply suggestive, and you have another grip upon the art of salesmanship.

OPPORTUNITIES IN PHILIPPINES.

Rare Chance to Develop a Good Talking Machine Business—A Musical People Who Are Prospering—Interesting Chat on Conditions by a Recent Visitor to the Far East.

Talking the other day with a United States army officer who had just returned from the Philippines, he stated to *The World* that there were a great many opportunities for a live talking machine jobber in the city of Manila. "Any bright young American, after a six months' study of the country, could work up a business in talking machines and records that would be simply astonishing. The Filipinos are intensely musical. In the larger cities they are refined and cultured in their tastes and are rapidly accumulating money. Among these people grand opera records and high-priced machines could be easily sold in large numbers. Among the poorer classes there is also a good market, and in this connection the instalment plan may be tried with success. It is difficult to go to any large town throughout the islands and not find a band that plays far better than any to be found in a town in the United States of the same population. Moreover, there is a great anxiety prevalent to get the latest and best music, instrumental and vocal, from the United States. Wherever a talking machine is heard it is the center of a crowd large enough to cause a riot.

"On my last visit to the Philippines I took over a talking machine and a large number of records, and it would be impossible to describe the commotion they caused. One peculiar trait of the Filipino is his ability to memorize. I heard one of them whistling a song which he had heard two days before through the medium of my talking machine. It is a mistaken idea to believe that the Filipinos are savage, uneducated or unprogressive. The country is making splendid headway, and while the people have not lost their aspiration for independent government yet they are becoming greater admirers of American ways and American ideas, and it looks as if the Filipinos are in for a good long period of prosperity."

There is meat in this for the talking machine manufacturer and dealer. Are we covering the talking machine market in that country as we should? If not, the matter is worth remedying.

HOW HE HEARS FROM HIS FAMILY.

New York Traveling Man Is Up-to-Date and Receives Records from Home.

A man went into a music store in Kansas City recently with a phonograph record, which he asked the clerk to place in a machine and reproduce it for him. When the machine was started the sound of a baby's words and laughter came from the horn.

"Hello, papa! 'Ere's a tiss fum me en little Bob. I wusht ood tum home."

For a full minute the baby's voice talked. Then came a few words in a woman's voice.

The man dabbed at his eyes with a handkerchief and said:

"That's my wife and baby talking."

He was a traveling salesman. His home was in New York.

"I wouldn't have missed that for a twenty dollar bill," he said to the clerk. "I've been away

from home six weeks now, and every Saturday evening I have received a record from home. I tell you, there's nothing so good as the sound of their voices. It beats a letter 200 city blocks. An' that's goin' some, too."

"How did he work that scheme?" the clerk was asked.

"Easily. In his home in New York is a talking machine. His wife simply puts a blank record into it and she and the baby talk into it. Then she mails it to him, and he has simply to put the record into another machine to have it reproduced."

The clerk said that it was becoming quite a fad for parents to have their babies talk into a phonograph record. Then the record was carefully put away to be kept until baby grew up.

"There'll be lots of fun with those records," the clerk said. "Imagine an old man listening to the prattle of his own baby voice!"

INDIA A FERTILE COUNTRY

For Talking Machine Trade—Great Interest Being Manifested in American Machines and Supplies—Class of Records Best Liked.

India is a great country for the talking machine, and every month thousands are being shipped to that point. That the dealers in these instruments are also growing in number, and that they can read English, is evident from the rapidly growing clientele of Talking Machine World subscribers in India. Every mail brings either inquiries about advertised specialties or subscriptions. All this is a healthy sign and shows how the American machine and supplies stand abroad. Indeed, it is a matter of common knowledge that the talking machine trade with India is more extended and more profitable than with many other countries. The native who can command the price wants a talking machine, and the records he delights in are those which reproduce the native songs. A correspondent of the "Zeitschrift für Instrumentenbau" points out that records in the four or five different Indian languages command a ready and permanent sale; he also advises record companies to record the songs of the Indian dancing girls. In support of his advice he explains that the sales to the European population are very much more limited than to the indigenous peoples; and even if the western nations refuse to class the screams and cries which pass for Indian songs as music, it must be remembered that they gratify the taste of the majority of record buyers in India.

MUSIC IN THE CHURCH.

Talking Machine Rapidly Taking the Place of Choirs in Churches—Moving Pictures Next.

The Rev. L. G. Leggett, pastor of the First Presbyterian Church, in Nebraska City, Neb., who has become famous as the first minister to substitute the talking machine for a church choir, has had hundreds of communications from churches all over the country, asking particulars regarding this move. It is not improbable that within the next year hundreds of churches, particularly those in the smaller towns, will enjoy first-class singing through the medium of the talking machine. In Ohio, Indiana, Missouri, parts of California, and in a number of the eastern States the ministers are putting in talking machines with a full equipment of hymns, while several Catholic churches have secured the music of entire masses by several eminent composers. We notice that the Rev. Byron G. Olatt, pastor of the Central Christian Church, of Marion, O., has now gone further than having an automatic choir—he has been illustrating his sermons with stereopticon pictures thrown on the screen exemplifying the teachings of Christ.

THE TALKER AND DIVORCE.

Some Humorous Comments Made on the Employment of the Talking Machine in the Taking of Depositions in Divorce and Other Law Suits and What Ideas It Suggests.

The employment of the phonograph in the taking of depositions, in divorce and other law-suits, suggests an idea which might, perhaps, be adopted by the widower or the widow, the divorcer or the divorcee, who marries again.

It has happened so often that it has begun to assume the dignity of an established rule, so it is said, that a man or a woman who has been previously married can hardly help telling his second wife or her second husband how good his first wife or her first husband was about a great many things.

There is nothing particularly harmful in this in itself. Harm comes out of it, however, when the second wife or the second husband, who has heard it a great many times—perhaps too many times—declares that she or he does not believe it. From this moment there must necessarily be strained relations in the once happy home.

When the wife, who up to this time has been willing to believe almost everything, after being informed by her husband, who was a widower, that his first wife was always ready for church just on the minute, says:

"William, I don't believe a word of it, so there!"

Or the husband, who has married a woman who was a widow, or who had, at least, a former husband, after being told by her that her first husband never thought of giving her less than \$40 to buy an Easter hat, declares, impulsively:

"Mary Ann, don't tell me that; Tom Wilson never had \$40 at one time in his life!"

Then is the time that there is need of something which will serve to heal the wounds that have been started and which, if allowed to fester, may eat into the very heart of conjugal love.

Why would it not be a good thing for all mar-

ried people to preserve phonographic records, in duplicate, of the nice things they say to each other before they become separated, naturally or by the courts? Then when they marry again and talk about their former wives or husbands, and tell how good their former wives or husbands were to them, and their present wives or husbands question the statements made, the husband or the wife, as the case may be, need only find the particular record desired, and, by winding up the phonograph, present a happy marital scene to the man or the woman, his wife or her husband, who was becoming doubtful, discontented, and disagreeable, with the result that she or he becomes trustful, reasonable, and reconciled.

So far as we are able to see at present, the matrimonial phonograph record thought is one that deserves serious consideration, particularly in Pittsburg.

WHAT COURAGE MEANS.

Mr. Talking Machine Man, to make your business a thing of throbbing life, a slave to your will, who shall do your bidding faithfully and well, you must infuse into the heart of that slave the most sought-after of accomplishments among tradesmen, namely: Courage.

This is what Courage means, Mr. Dealer, and to have it, and the success that accompanies it, you must be

Constant in your efforts to please,
Obedient to the call of your business,
Unblemished in reputation,
Right there with the goods,
After more trade,
Gallant toward the ladies, and
Enveloped with new ideas.

HOWARD TAYLOR MIDDLETON.

The Spokane Phonograph Co., Spokane, Wash., recently received a very large shipment of Mega horns made by E. A. & A. G. Schoettel, of Maspeh, N. Y.

SENDING MUSIC BY WIRE.

Successful Experiments Between Wilmington and Philadelphia in Which Talking Machines Were Employed.

The Delaware & Atlantic Telegraph & Telephone Co., one of the companies in the Bell system, recently conducted successful experiments in the sending of music through their underground cables between Wilmington and Philadelphia, a distance of twenty-eight miles.

A phonograph was placed in a hotel in Wilmington, in such a position that it faced the telephone. The other end of the cable was attached to a receiver placed in a special booth in the store of Strawbridge & Clothier, in Philadelphia, and later on transferred to a booth at the Business Men's Exposition. At both places the tones proceeding from the receiver were as clear as though the music was produced in the next room. At the Business Men's Exposition the receivers were attached to a Victor Auxetophone with wonderful results.

USED PHONOGRAPH AS WITNESS.

According to a recent dispatch from Paris the talking machine has again played a very useful and novel role. The landlord of a residential house let his ground floor to a coppersmith, the noise from whose workshop greatly disturbed the other tenants. One of them, instead of resorting to the complicated procedure of calling in experts, simply had the noise registered by a phonograph and brought action for damages against the landlord and coppersmith. By means of the machine he gave the court a correct idea of the nuisance complained of. Judgment was given in his favor.

Kohler & Chase, the well known Edison jobbers at Oakland, Cal., who have opened a jobbing branch at 1305 Second avenue, Seattle, Wash., are sending out some very handsome cards to dealers, notifying them of this move.

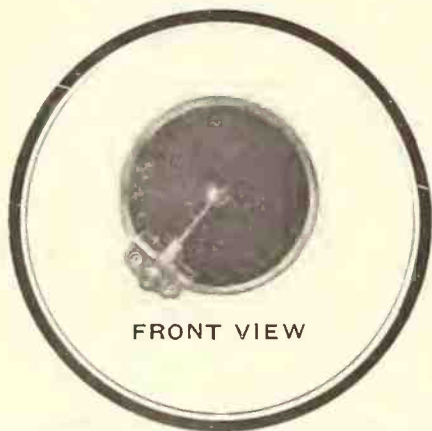

FRONT VIEW



SIDE VIEW

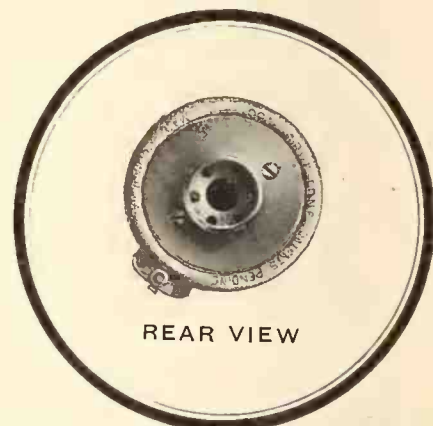

REAR VIEW

TRUE-

-TONE

YOU WANT THE BEST REPRODUCTION YOU CAN OBTAIN.

The **True Tone Box** will, as its name implies, give you a most perfect reproduction. The Best way to prove this is to try it for yourself.

We are so confident that a trial will please you and that you will desire to push the sale of the True Tone, that **we will send to any responsible dealer or jobber in the U. S. A. a box on trial.** If you like it, pay us the price and order more. If you do not like it, return at our expense.

This Box is the result of long and careful experiments and we are confident you will decide it is the best you have ever heard.

PRICE \$5.00

REGULAR VICTOR DISCOUNTS TO DEALERS AND JOBBERS
MADE FOR STRAIGHT OR TAPER ARM VICTOR, ZONOPHONE OR COLUMBIA MACHINES. SPECIFY TYPE WANTED WHEN ORDERING.

AMERICAN TALKING MACHINE COMPANY
586 FULTON STREET, - - - BROOKLYN—N. Y. CITY

Largest Talking Machine House in the City



Every month all the purchasing people of the United States see a full-page advertisement of the Victor in the leading magazines.

Victor Talking Machines and Records

These customers are looking to you to supply their wants. It doesn't matter where you are located, you can't get away from this demand. There is just one way to meet it, if you are wide-awake and business-like in any sense of the word.

Show *every* Victor, from the Junior Gramophone up to Victor VI. Show the Victrola and the Aux-e-to-phone—they attract great attention and help sell the whole line while they sell themselves.

Keep all the Records, especially all the New Records, every month, and play them freely for any person who comes near your store.

Above all, keep everybody talking about you and the Victor; advertise in your local paper; give your window display close attention, and go out after trade with good circulars and free concerts.—Then Watch Your Sales Grow.

Victor Talking Machine Company Camden, N. J.

Better try this method, if you haven't begun already:—Place your standing monthly orders for the new records with your distributor, and push this feature. (It keeps your customers calling at least monthly—they look for them.) Artistic Monthly Supplements furnished free for this purpose.

Full information and prices can be obtained of any of the Victor Distributors as follows:

- | | | | | | |
|-------------------------|------------------------------|------------------------|----------------------------------|-------------------------|-------------------------------------|
| Albany, N. Y..... | Price Phonograph Co. | Honolulu, T. H..... | Bergstrom Music Co. | Philadelphia, Pa ... | C. J. Heppe & Son. |
| Altoona, Pa..... | W. H. & L. C. Wolfe. | Indianapolis, Ind..... | Carlin & Lenox. | | Musical Echo Company. |
| Atlanta, Ga..... | Alexander-Elyea Co. | | C. Koehring & Bro. | | Penn Phonograph Co., Inc. |
| | Phillips & Crew Co. | Jacksonville, Fla..... | Metropolitan Talking Machine Co. | | Louis Buehn & Brother. |
| Baltimore, Md..... | Cohen & Hughes. | Kansas City, Mo..... | J. W. Jenkins Sons Music Co. | | Western Talking Machine Co. |
| | E. F. Droop & Sons Co. | | J. F. Schmelzer Sons Arms Co. | | H. A. Weymann & Son. |
| | H. R. Eisenbrandt Sons. | Little Rock, Ark..... | O. K. Houck Piano Co. | Pittsburg, Pa | Pittsburg Phonograph Co. |
| | Wm. McCallister. | Los Angeles, Cal..... | Sherman, Clay & Co. | | Powers & Henry Co. |
| Birmingham, Ala..... | E. E. Forbes Piano Co. | Memphis, Tenn..... | O. K. Houck Piano Co. | | Standard Talking Machine Co. |
| Boston, Mass..... | Oliver Ditson Co. | | E. E. Forbes Piano Co. | Portland, Me..... | Cressey & Allen. |
| | Eastern Talking Machine Co. | Milwaukee, Wis..... | McGreal Bros. | | Portland Talking Machine Co. |
| | M. Steinert & Sons Co. | Minneapolis, Minn ... | Minnesota Phonograph Co. | Portland, Ore..... | Sherman, Clay & Co. |
| Bridgeport, Conn..... | F. E. Beach Co. | Mobile, Ala..... | Wm. H. Reynolds. | Providence, R. I..... | J. Samuels & Bro. |
| Brooklyn, N. Y..... | American Talking Machine Co. | Montreal, Canada..... | Berliner Gramophone Co., Ltd. | Rahway, N. J..... | Regina Company. |
| Buffalo, N. Y..... | Robt. L. Loud. | Moorhead, Minn..... | H. Backenheimer. | Richmond, Va..... | The Cable Co. |
| Canton, O..... | The Klein & Heffelman Co. | Nashville, Tenn..... | O. K. Houck Piano Co. | | W. D. Moses & Co. |
| Charlotte, N. C..... | Stone & Barringer Co. | Newark, O..... | Ball-Fintze Co. | Rochester, N. Y. | The Talking Machine Co. |
| Chicago, Ill..... | Lyon & Healy. | New Haven, Conn..... | Henry Horton. | Rock Island, Ill..... | Totten's Music House. |
| | The Talking Machine Co. | New Orleans, La..... | Nat'l Auto. Fire Alarm Co. | San Antonio, Tex..... | Thos. Goggan & Bro. |
| | The Rudolph Wurlitzer Co. | | Philip Werlein, Ltd. | San Francisco, Cal..... | Sherman, Clay & Co. |
| Cincinnati, O..... | The Rudolph Wurlitzer Co. | New York, N. Y..... | Bettini Phonograph Co., Ltd. | Salt Lake City, Utah... | Carstensen & Anson Music Co. |
| Cleveland, O..... | W. H. Buescher & Sons. | | Blackman Talking Machine Co. | Savannah, Ga..... | Youmans & Leete. |
| | Collister & Sayle. | | Sol. Bloom | Seattle, Wash..... | Sherman, Clay & Co. |
| | The May Company. | | C. Bruno & Son. | Sioux Falls, S. D..... | Sioux Falls Talking Mach. Exchange. |
| | Eclipse Musical Co. | | I. Davega, Jr. | Spokane, Wash..... | Eiler's Piano House. |
| Columbus, O..... | The Perry B. Whitsit Co. | | S. B. Davega. | St. Louis, Mo..... | O. K. Houck Piano Co. |
| Dallas, Tex..... | Thos. Goggan & Bro. | | Tbe Jacot Music Box Co. | | Koerber-Brenner Music Co. |
| Dayton, O..... | The Fetterly Piano Mfg. Co. | | Landay Brothers. | St. Paul, Minn..... | St. Louis Talking Machine Co. |
| Denver, Colo..... | Knight-Campbell Music Co. | | Stanley & Pearsall. | | W. I. Dyer & Bro. |
| Des Moines, Iowa..... | Edward H. Jones & Son. | | Benj. Switky. | Syracuse, N. Y..... | Koehler & Hinrichs. |
| Detroit, Mich..... | Grinnell Bros. | | Victor Distributing & Export Co. | Toledo, O..... | W. D. Andrews. |
| Dubuque, Iowa..... | Harger & Blish. | | Tbe Regina Co. | | The Hayes Music Co. |
| Duluth, Minn..... | French & Bassett. | Omaha, Neb..... | A. Hesse Co. | | A. J. Rummel Arms Co. |
| El Paso, Texas..... | W. G. Walz Co. | | Nebraska Cycle Co. | | Whitney & Currier Co. |
| Galveston, Tex..... | Thos. Goggan & Bro. | | Piano Player Co. | Washington, D. C..... | John F. Ellis & Co. |
| Grand Rapids, Mich..... | J. A. J. Friedrich. | | Chas. C. Adams & Co. | | S. Kann & Sons Co. |
| Harrisburg, Pa..... | S. A. Floyd. | | | | |

INDIANAPOLIS TRADE DOINGS.

Jay's New Repeater Praised—Columbia Co.'s St. Patrick's Window—Big Call for 20th Centuries—Wahl's Good Trade in Edison's—Covering Trade With Wagon—Trade 40 Per Cent. Better Than Last Year—People Becoming Better Educated as to Talker Possibilities.

(Special to The Talking Machine World.)

Indianapolis, Ind., April 8, 1907.

A. E. Jay, manager of the Kipp-Link Co., which sell all kinds of talking machines, has a new patent on a repeater, which he thinks will prove to be a decided success. This repeater is arranged so that the cylinder record slides back instantly as soon as the selection has been played and it is given again. It may be adjusted while the machine is running. It has other advantages which Mr. Jay believes will make it a success. The Kipp-Link Co. are enjoying an excellent trade just now, turning practically all of their attention to the jobbing business. "We would rather get an order out to a jobber on time than to sell a \$50 machine at retail," said Mr. Jay.

Thomas Devine, manager of the Columbia Phonograph Co., made an unusual "hit" with a front display window on St. Patrick's day. The display attracted more attention than any similar window ever decorated in Indianapolis. Mr. Devine made a huge bank of nickel flowered horns in the window with an unusually large horn in the center. In this large horn he placed a bunch of shamrocks, and in the other horns roses of various colors. The St. Patrick's day parade passed the Columbia store, and the marchers were not so engrossed but that they saw the window. Later after the exercises of the day they came back to view it more critically and there was plenty of praise.

The Columbia Phonograph Co. are having an unusual demand for the large Twentieth Century machine. When it was first placed on the market here dealers were a little afraid of it because it seemed to be complicated in its machinery. This has passed away, however, and the company now are enjoying a good jobbing business in this line. The dealers all seem to be satisfied with it, and there is hardly a time when the Columbia Co. are not behind in filling orders for this machine. This company are also having a demand for their new model cylinder machines of regular types. The machines are so constructed that practically nothing can jar them when they are playing, and this seems to appeal to every one and makes a good talking point for the salesmen. No matter in what position the machine is placed the music is the same.

The Jersey Lillies Co., which appeared here at the Gayety Theatre last week, included in the show a scene representing an office of the Columbia Phonograph Co. All of the various departments were represented, and pretty girls posed as salesmen. A little burlesque was given in which a Twentieth Century Columbia machine was used to advantage.

A. B. Wahl, who is closing out his disc talk-ophones and turning his attention to Edison's, says that he is enjoying a good trade. His disc machines are going rapidly at reduced rates, and soon will have been disposed of.

George W. Maze, who handles Edison machines, says that his talking machine wagon "is doing only just fairly well now." This wagon was started out six or eight weeks ago in the charge of W. G. Power. Mr. Power is canvassing thoroughly the rural districts in this and adjoining counties. He is meeting with excellent weather, which makes traveling easy, but just now farmers are thinking about paying taxes and business is not quite as good as it might be. However, he believes there are better times ahead.

"Our business is not as good this month as it was last," said Charles Craig, who does an extensive jobbing business in Edison machines. "However, trade is 40 per cent. better than it was at this time last year. This good weather

means that the farmers are busy at work, and therefore it is hard to attract their attention to talking machines.

"I believe, though, that the people generally are getting educated to talking machines, and that the prejudice against these instruments is being removed. Recently I went to call on a woman in the aristocratic section of the city. At first she said she would not allow me to play the talking machine in the house. Finally I persuaded her to let me try it, and knowing that she was religiously inclined, I put on a sacred record. I sent a machine up to her house that afternoon and got the money for it."

WILL IT BE "SOUNDERS."

Suggesting New Names for the Talking Machine—"Lyrphone" and "Sounders" Mentioned—Some Canadian Opinions.

Joseph M. Tees, of Winnipeg, recently took exception to the name "talking machine," claiming that nine out of ten people wanted those instruments for the music they reproduced so well, and not for their talking proclivities. He suggested as a substitute the word "Lyrphone." To this a correspondent of the Canadian Music Trades Journal takes exception and writes as follows concerning Mr. Tees' suggestion:

"Taken literally, the word 'Lyrphone' would about mean 'a harp which gives sound,' and in this sense is not suggestive, as the machines are by no means harps. The 'lyre' is an obsolete instrument, but the 'liar' we always have with us, and in the latter sense the name is probably suggestive enough, for we in the musical business (especially the salesman) are noted for our strict adherence to the truth—when it pays.

"We've been told that 'all men are liars,' but one does not like to be continually reminded of this (as might be the case if this suggested title were to come into general use), for we must remember that the truth is not always palatable.

"The English language contains idiosyncrasies enough without inflicting any more upon us, and in coining words for future use in 'English as she is spoke' we should endeavor to make them fit. 'Talking machiue' is a loug name; 'Lyrphone' is nearly as long, and in the general tendency of the age toward economy in business transactions we (or rather a good many of us) endeavor to save breath. The machines cannot well be described in one syllable, but may be, perhaps, in two. Let us see:

"The machines are 'soudn reproducers,' and this name covers all the requirements, but is, of course, too long. Now, on the principle of

Bret Harte's 'Sevenoaks, and then S'enoaks, and lastly Snoak,' let up, cut out the intervening syllables and we arrive at the word 'Sounders,' an appropriate enough title—odd, perhaps, until one gets accustomed to it, but both convenient and suggestive."

"3-IN-ONE" MOVES.

G. W. Cole Co. Take Fine New Offices in 42 Broadway Bldg., New York.

The sales of that famous oil, "3-in-One," have moved up at such a lively rate that the manufacturers, G. W. Cole Co., have found it necessary to move to more commodious quarters. Hence the New York offices have been changed from the Washington Life Building to the new 42 Broadway Building.

The new offices occupy the major part of the third floor of a wing of the building. Here they have large, light, commodious offices for the transaction of business and for the officers of the company.

The history of "3 in One" oil has been one of expansion. Starting with a one-room factory in Asbury Park eleven years ago the business rapidly outgrew the manufacturing facilities at that location, and the factory was moved to Rahway, N. J., into a fine new building of their own construction. Within the past year the factory capacities have been doubled by brick building additions. The executive offices in New York expanded from one office to a suite of offices, and now to almost the entire floor of a wing of the new 42 Broadway Building. The expansion of the offices and the factory is significant only in that it is a substantial evidence of the greatly increased sale of "3-in-One" in every corner of the United States and in many foreign countries.

In a chat with a member of the company the other day, he said: "'3-in-One,' which is the original and only oil compound for lubricating, cleaning, polishing and preventing rust, was first discovered in a semi-accidental way by the G. W. Cole Co., who are and have been the sole manufacturers of the same since it was first put on the market."

An English paper tells of a young lady in Australia, who, desiring to compete for a scholarship in vocal instruction, sang into a talking machine and sent the record to a well-known teacher, with a request that he offer his judgment upon the quality of it. The opinion of the teacher was favorable, the young lady entered the contest, and was successful in winning one of the scholarships.

To All Talking Machine Dealers

YOU buy Screws, Studs,
etc., for repair work.

Why Not Try Us for Prices

Remember, we make only to Specifications or Samples, which you must send in

THE WALLACE BARNES COMPANY
BRISTOL, CONN.

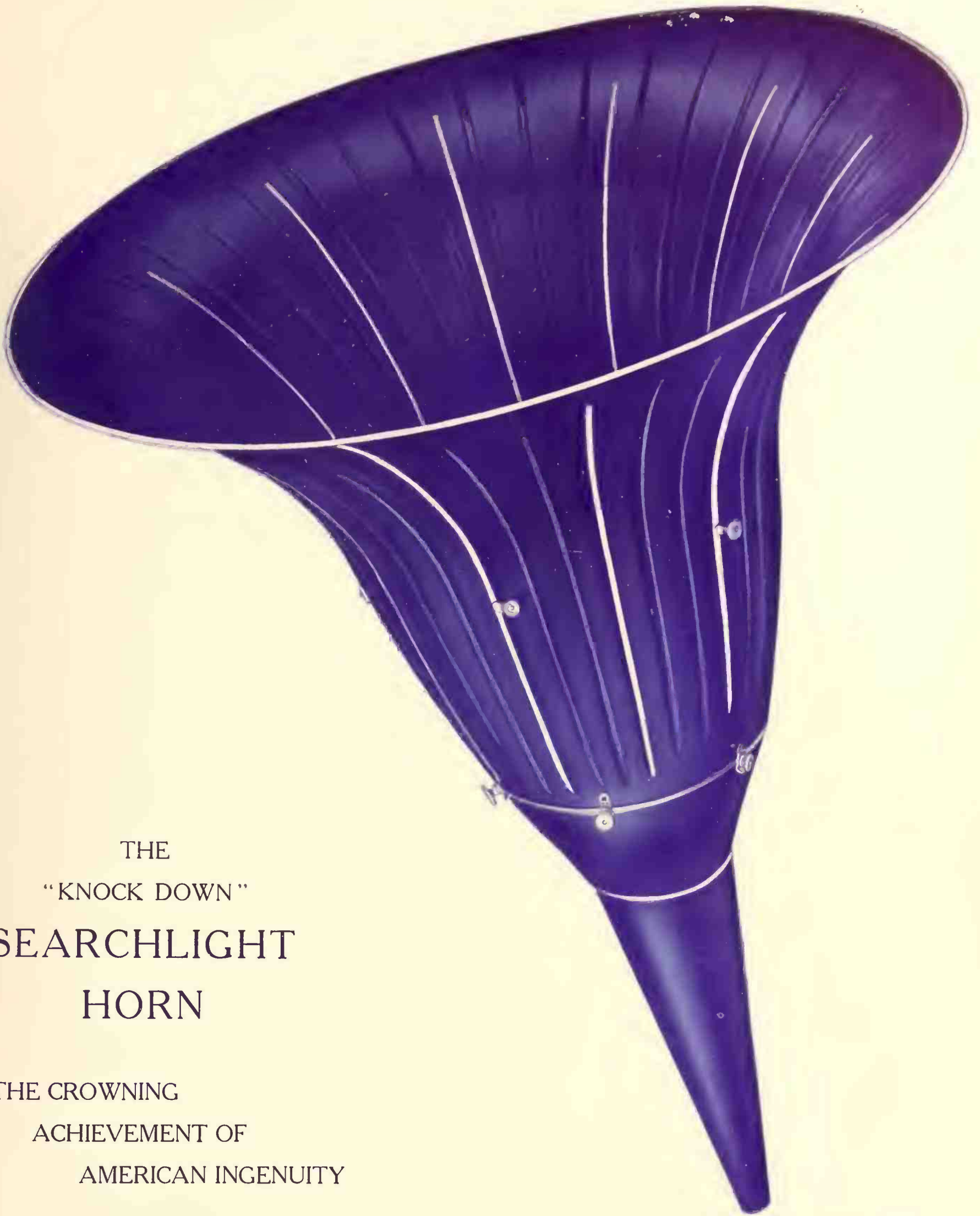

THE
"KNOCK DOWN"
SEARCHLIGHT
HORN

THE CROWNING
ACHIEVEMENT OF
AMERICAN INGENUITY

Style—Blue Gold Striped.

For all Edison and Victor Machines except Victor 1st.

The MARVELOUS REPRODUCTIVE POWER
OF THE

Searchlight Horn

IS PRODUCED BY THE PARABOLIC SHAPE WHICH
REFLECTS THE SOUND IN PARALLEL DIRECTION

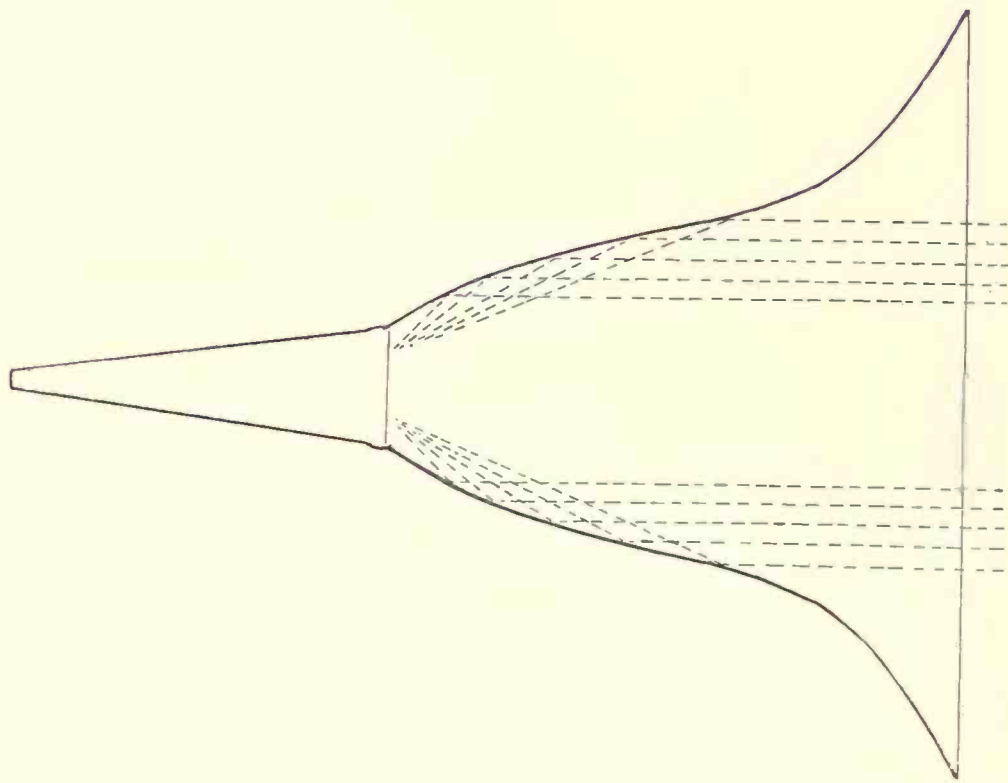

THE SEARCHLIGHT HORN IS THE ONLY
HORN CONSTRUCTED ON SCIENTIFIC PRINCIPLES AS
SHOWN IN ABOVE DIAGRAM.

REPRODUCES THE FULL STRENGTH OF THE RECORD

Sold only through Jobbers

Send to your Jobber for Samples

MANUFACTURED BY THE
SEARCHLIGHT HORN COMPANY

753-755 Lexington Avenue

Borough of Brooklyn, New York

DISTRIBUTED BY

Every Recognized Edison and Victor
Jobber in the United States

CHILDREN AS A BUYING FORCE.

Their Cultivation by the Dealer Helps, as They Are a Great Persuasive Power in Getting the Older People Into Line as "Talker" Enthusiasts and Steady Customers.

How many talking machine dealers think of catering to the children in their locality? How many, if a group of childish faces appear in the doorway during a demonstration, assume an annoyed expression and run them off? And yet catering to the same children to a certain extent would undoubtedly mean increased business.

The dealer says: "Well, they only have a few pennies to spend, and it is a waste of time to show them a machine and records on which the monthly instalments alone would almost equal their yearly allowance of spending money." True enough; but think of the persuasive powers of children, especially the younger ones. They see something they want and set out to get it. No delay is tolerated. They want it and want it at once, and the father, no matter how little he cares for that special article, will in nine cases out of ten capitulate and dig into his "jeans," if the price is anywhere within his means. If the dealer has children of his own he will readily realize the effectiveness of children's teasing and coaxing, and why not have the teasing in the interests of a talking machine? An excellent plan is to devote Saturday mornings to recitals to which all children in the neighborhood, of the better class especially, should be invited. Play records of interest to them, band selections, laughable monologues and minstrel numbers, and the popular airs of the day, with perhaps some well-known patriotic melody thrown in. One company has produced a double-sided record, one side containing a personal address to a boy and the other to a girl. The idea of having the talker "speak for itself," as it were, makes an especially strong impression on the youthful minds and pleases them immensely. Answer all questions if possible, especially those relating to price, and impress upon their minds the musical advantages to be derived from the talking machine in the home. When the children return home the talking machine will be the sole subject of their conversation. All the dealer's arguments will be repeated, together with those convincing arguments that can be brought up by the young people when occasion requires. They will do more for the dealer's cause in five minutes than a first-class salesman could accomplish in a week.

After they have attended a few recitals, even the most headstrong parent will reason seriously whether it would not be advisable, after all, to buy a talking machine outfit if only to keep peace in the family. Possibly he will buy only a low-priced machine at first, but in nine cases out of ten he will become so impressed with the instrument as an entertainer that he will be back to buy a first-class outfit in a remarkably short time.

Cater to the children. Remember, you expect to stay in business some time; they are growing up rapidly, and when they arrive at the income-producing age, you want to get some of it, so make yourself "strong" now.

NEW WIRELESS MUSIC.

Why the Wireless Telegraph Experts Around Have Been Charmed With the Strains of Sweet Music This Last Month.

Strange sounds that broke in on the dot and dash messages being received at the Brooklyn Navy Yard this last week by the operator sent him hot-foot in search of G. S. Davis, chief electrician of the wireless station.

"Come, quick," he said, breathlessly, "there's all kinds of music breaking in on us."

Davis put the receiver at his ears and listened. At first he heard only the Morse symbols of the message from the vessel at sea. Then came a burst of music. Chords and harmonies, coming evidently from out of the heavens, filled him

with amazement. Then he recognized the overture from "William Tell." This was followed by Mendelssohn's "Spring Song," parts of "Il Trovatore" and "The Rosary." Ten minutes later Davis was on his way to Manhattan in search of Lee De Forest, of the Wireless Telegraph Co.

"What do you mean?" he exclaimed when he found Mr. De Forest at an uptown hotel. "For half an hour this afternoon grand opera and other music broke up Uncle Sam's conversation and frightened our operator half out of his wits. He thought he was listening to the singing of angels."

He congratulated De Forest when the latter explained that the music was the result of a successful public test of the latest De Forest invention given on a recent afternoon at the Normandie Hotel, Thirty-seventh street and Broadway. For months Mr. De Forrest had been at work on apparatus capable of transmitting music through the air. By the means of high frequency pulsations and a transformer the music is sent out as waves of electricity, varying intensity in the waves reproducing the different notes.

The music was played into the transformer at Telharmonic Hall, Thirty-ninth street and Broadway. Wires connected the instrument with a discharging pole erected on the top of the building. The receiving pole was placed on the top of the Normandie Hotel. Wires ran from this to the receiving apparatus in a room on one of the upper floors. The receiver is identical with the apparatus used in taking all wireless messages.

The test proved not only that the age of wireless music had been reached and the dream of Edward Bellamy realized, but that of the wireless telephone as well. During the intervals while music was not being played the voice of the man operating the transformer could be distinctly heard. He inquired if the music sounded well and asked what other airs he should play.

Mr. De Forest, speaking of the latest achievement of science, said that while the present apparatus was capable of throwing the music waves only a few miles he hoped to improve it so that soon passengers on ocean liners a hundred miles at sea could enjoy grand opera airs.

It is the plan of Mr. De Forest to utilize the invention in supplying the public with music to order at their homes. With a central station equipped with a transformer of sufficient size music can be furnished at a trivial cost. All that would be required would be a receiving pole on the roof and a simple receiving apparatus. By adding to the voltage and enlarging the transformer it would be possible to amplify the sound so that it could be heard through a megaphone in all parts of a room.

THE VALUE OF ACCURACY.

In No Business Is It So Important and Necessary as in That Devoted to Talking Machines.

Accuracy is synonymous with success, because without it a talking machine dealer cannot achieve greatness in the world of trade.

Accuracy means the careful inspection of records before they are shipped; the impossibility of a "come back" owing to carelessness in making up a patron's order.

It means careful bookkeeping that will always show exactly how the business stands as to profit and loss, etc., and it also means the ability on the part of the "talker" man to satisfy his customers, because if he makes accuracy his hobby he will be able to tell them off-hand just what they want to know. If they ask for a record, he can give it to them at once, or if it is not in stock, he can inform them to that effect, thus avoiding a lough and perhaps fruitless search.

Accuracy is a time saver, because it embraces the careful and systematic distribution of records upon the shelves, a complete and alphabetical list of the names of customers, and a general state of affairs that is very refreshing on account of the absence of confusion and disorder.

Accuracy is a word that every dealer who is climbing toward the rosy heights of glory and hopes to some day arrive at the summit, should have printed in big, glaring black letters upon a white card and hung upon the wall or on his desk, where it will stare him in the face at every turn, for

Accuracy is something

That will help him to success;

Something he should strive for;

A friend when in distress.

If taken as a motto,

It will boost him up to fame.

You try it, Mr. Dealer;

It may help you do the same.

HOWARD TAYLOR MIDDLETON.

C. B. HAYNES & CO. EXPANSION.

W. V. Youmans, son of G. E. Youmans, connected with the National Phonograph Co., at Orange, has purchased an interest in the talking machine business of C. B. Haynes, 602 East Main street, Richmond, Va., and the firm title will hereafter be C. B. Haynes & Co. The store adjoining the present quarters has been leased by the company, which will about double their floor space, and when alterations are completed they will carry one of the largest talking machine stocks in the South.

ATTENTION!

NEW ENGLAND DEALERS

If you handle both EDISON and VICTOR, we can offer you an advantage no other New England jobbing house can—One Source of Supply for both

EDISON PHONOGRAPHS AND VICTOR MACHINES

ONE SHIPMENT—ONE EXPRESSAGE

THERE'S AN ADVANTAGE! Try the Eastern's Policy of Service.

THE EASTERN TALKING MACHINE CO.

177 TREMONT ST., BOSTON, MASS.

Distributors of EDISON and VICTOR
MACHINES, Records and all Supplies

Eastern Agents for HERZOG DISK and
CYLINDER RECORD CABINETS

The Biggest Return from the Smallest Investment

YOUR profits depend upon the number of talking machines you sell and the time it takes to sell them. Machines that find no takers tie up money and money tied up is a losing proposition.

It's business, therefore, to devote your energies to an instrument that commands the approval of all who hear it:

THE EDISON PHONOGRAPH

The Edison sells without argument and always brings its price. Its superior construction and wonderful reproducing powers—its clear records, produced by the country's best artists and the powerful advertising in its behalf—make it the best proposition in the talking machine field. A small investment secures a representative stock. A little well directed energy means big returns.

Write us for the Edison proposition and the name of a nearby Edison jobber.

National Phonograph Co.

59 Lakeside Ave., Orange, N. J.

New York Office, 31 Union Square.

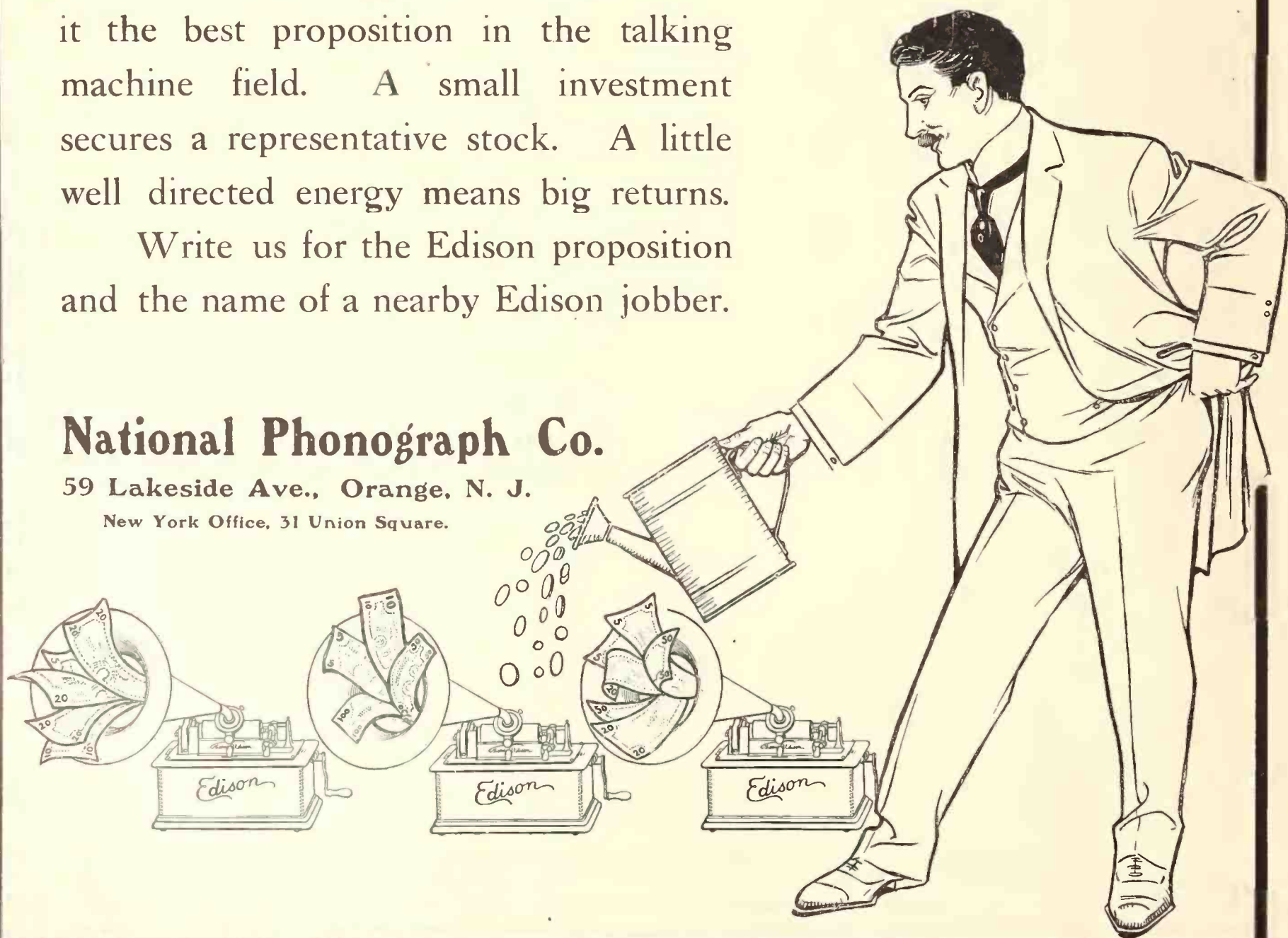

TONS OF CATALOGUES DESTROYED

By the Australian Authorities Through Failure of Exporters to Pay the Required Duty on Them—Shippers Should Note This Pointer.

Tons of American catalogues are destroyed every year by the customs authorities of Australia for the reason that business men to whom they are addressed by manufacturers and exporters of the United States decline to pay the duty of 3d., or 6 cents in American money, per pound assessed on them as advertising matter imported for distribution. This is a loss which cannot be estimated in dollars and cents. Because of negligence or unfamiliarity with the tariff provisions of Australia, these descriptive circulars, catalogues and price lists generally fail to reach their destination, and consequently all opportunity for trade which might be obtained through their perusal is lost.

This condition of affairs can be prevented if the following suggestions are followed: If the American exporter has his Australian mailing list in the home office he should carefully address the catalogues, and then by the same mail he should send to the comptroller-general of customs, or the postmaster-general, or the comptroller of customs at Sydney, Melbourne, Brisbane, Adelaide, Fremantle, or Hobart (Tasmania), as the case may be, a notification to the effect that he is sending to ——— by parcels post, via San Francisco or via London, ——— catalogues weighing ——— pounds, and enclosing ——— (dollars and cents, or pounds, shillings and pence) in payment of duty.

The official receiving this communication, with preferably an international money order enclosed, will immediately notify the postoffice authorities, and the catalogues will be forwarded to their destination without delay. The printed matter should be carefully weighed before it leaves the home office, and the money order, draft or check sent to the Australian customs or post office official should amount to 6 cents a pound full weight. This is the English method, and it has given uniform satisfaction.

MUSIC WITH EVERY SHAVE.

Brooklyn Barber Discovers Way to Win Customers.

Shaving men to music is the latest novelty in Brooklyn. An Italian barber, who recently opened a shop in upper Broadway, in the Bushwick district, is attracting customers to his place by means of music from an expensive talking machine, and his business rivals in the neighborhood are preparing to adopt similar methods to win back the trade they are losing.

When the new barber opened his shop he found that the field was already so well occupied that there was scarcely any business to be picked up. He was beginning to get discouraged at the end of the first week, when one day, upon returning from an errand in the neighborhood, he found a customer in the chair and his young assistant busy lathering the man.

The barber was the owner of a talking machine, and like all sons of sunny Italy, he had a lot of grand opera records, and while waiting for his assistant to get the customer's face in condition for him, commenced to play to relieve his feelings as to the lack of business.

"Ready," said the lather boy suddenly, and the barber came out of his dreaming.

The customer turned in the chair and looked impatiently at the boy.

"Play on, man; play on," he urged, addressing the barber. "Never mind the shaving; just play that over again."

STEWART

You can handle banjos easily and add to your income. Talking machine men will find them big sellers.



THE BAUER CO., 726-730 Girard Avenue Philadelphia, Pa.

The barber, pleased, played the air again. Then he shaved the customer.

"I'm very fond of music," said the man as he was leaving, "and if I could hear some more like that I'd come here oftener."

That gave the barber an idea. When the next customer came in, after a long interval, he played for him, too. That man, like the first, seemed to enjoy his visit to the shop immensely and became a regular patron. More and more customers were won in this way. Now the other barbers in the neighborhood, learning the secret of the newcomer's success, are installing automatic music-making instruments.

BEN REYNOLDS CO. ORGANIZED.

Ben Reynolds, a music dealer of Washington, Pa., has formed a company under the firm name of Ben Reynolds & Co., to take over his business. Charles Kochendarfer is president of the new company; James E. Mathews, treasurer, and secretary, and Ben Reynolds, general manager. The company have leased the old quarters for a period of ten years and are having the building entirely remodeled. One of the leading departments of the business is that devoted to talking machines, which is located in the rear of the main floor. A complete line of both machines and records is carried in stock, and the department is experiencing a rapid and steady growth.

T. EDENS OSBORNE'S "OUTING."

T. Edens Osborne, the enterprising talking machine factor of Belfast, Ireland, writes The Talking Machine World from Spalato (Dalmatia): "I am enjoying a delightful cruise around the eastern seaboard of the Adriatic. On my way here I spent some time in Paris, Lucerne (Switzerland), Verona and Venice (Italy). We have now left Abbazia, Fiume, and are proceeding to Gravosa and Ragusa and Cattaro in this wonderfully interesting country. Then on to one of the Ionian Islands—Corfu. Afterward we visit Syracuse, Messina and Palermo in Sicily; then for Naples, Genoa, Milan and the Italian and Swiss Lakes. Expect to reach home about the 4th of April. Kindest regards."

Mr. Osborne is one of the wise men of his generation, who recognizes that all work and no play makes Jack a dull boy. He adopts the plan annually of laying in a stock of energy by such trips as the above to meet all demands made upon his physique.

USED HORN AS FIRE TRUMPET.

A prominent New York railroad magnate is chief of a fire department in one of the suburban villages adjoining New York, and was recently awakened by hearing the midnight alarm pounded out on a locomotive tire that did duty as a fire bell. His suit duly donned, he looked about for his silver-mounted trumpet, but it could not be found. In a fit of desperation he seized the horn from the talking machine, and hurrying to the scene of the conflagration, bellowed his orders through it, to the satisfaction of the department and the amusement of the spectators.

STANDARD MUSIC CO. EXPANSION.

The Standard Music Co., of Chattanooga, Tenn., have been carrying on a lively advertising campaign in the interests of the Victor line which they handle. They used half-page space in the local dailies and made a feature of the dollar down and dollar a week proposition. They also published a list of fifty Chattanoogaans to whom they had sold Victor outfits and who had expressed themselves as well pleased with their purchases. Such an argument is hard to beat.

D. W. Wile, Ashland, O., has purchased the stock of talking machines of Charles Smith, that city, and in future will handle that line of goods in connection with his stock of pianos, organs, music, etc., at his store on Orange street.

PETMECKY SPECIAL:

Some Statements and Some Replies

In a recent copy of a publication issued by one of the great talking machine concerns are to be found some statements to which we reply:

Statement: "Influenced by the advertising of these so-called marvelous (?) needles, some . . . distributors and dealers have allowed themselves to imagine that they were really getting something better than was being supplied by the . . . company."

Reply: The PETMECKY COMPANY has in its files thousands of unsolicited testimonials from these very . . . distributors and dealers testifying to every single claim we make for the PETMECKY Multi-tone needle. In placing an order for One Million PETMECKY needles, one of these . . . distributors writes us: "I surely gave them a very trying test both as to sound and durability. All I can say is this: I am unable to subtract anything from your broad assertions that you make for the needle in question. Therefore, they are all you claim for them. Most assuredly they are here to stay, and that is saying a heap in these days of rapid improvements and inventions."

Statement: "It is unreasonable to think that after playing a record you can turn the needle and use it again without detriment to the record. Persistent use of such needles will result in the destruction of every record played within a few months' time, and, of course, the record will be blamed, while the fault lies entirely with the needle."

Reply: The PETMECKY Multi-tone Self Sharpening needles are the only truly scientific needles on the market. They are sold with the absolute guarantee that each and every needle will play ten or more of the largest and finest records through with less harm than any other metal needle on the market to-day. One of the largest . . . dealers in America writes: "We use them ourselves in exhibiting records, especially our best class records. You may be sure we would not use anything but the best needles on records running in price from \$3.00 to \$5.00 each." Another large dealer writes: "The writer took 16 twelve-inch red seal records and played them all with one PETMECKY needle. There was hardly any wear noticed at the point of the needle, and the records are all right yet."

Statement: "It is a well-known fact that when two moving substances meet, the weakest must give way; therefore it is far better that the needle be used but once than the more valuable record should fail in its functions."

Reply: Tell us, if you please, good sirs, the difference between using one ordinary needle once and 100 or 1,000 ordinary needles 100 or 1,000 different times. Especially when the ordinary needle is so constructed that the extreme sharp point cuts out the sound wave groove. The PETMECKY is so made that it sharpens itself just enough to give the smooth mellow tone without the rasping and "bellow" (the one positive proof of wear) prevalent in the ordinary needle, thus reducing the wear of the finest records to practically nothing.

Caught With the Goods

Let us all be fair—let us all be just—let us all be honest. On your word of honor, Mr. Dealer, in the use of the ordinary needle, do not your records show the most wear at the beginning, when all or nearly all of them are fairly good, during the last half after the first half is completely gone? Let us be honest—is this not proof absolute that the ordinary needles are too sharp and being of inferior case hardened steel wear very quickly?

In Conclusion

If necessary, the PETMECKY COMPANY offers herewith a handsome apology for not keeping a "great corps of scientists and experts" to know just what it is talking about. There was but one scientist ever connected with this company, and that was Mr. Petmecky, the clever inventor of the marvelous PETMECKY Multi-tone Self Sharpening Needle, as well as many other practical and useful articles which have had a world-wide sale for a generation.

The PETMECKY Multi-tone Self Sharpening Needle is guaranteed to be the most universally endorsed needle to-day. There is none better than the best. If ever the time does come that some clever genius perfects a better needle, then Good-by Petmecky.

PETMECKY—the Needle of Quality
The ONE and ONLY Needle Every Dealer Can SAFELY Guarantee.

Samples of PETMECKY needles, interesting needle lore booklet, testimonials and prices on request.

PETMECKY COMPANY

506a New York Life Bldg.

KANSAS CITY, MO., U. S. A.

100,000 RECORDS ALWAYS IN STOCK

JOBBER'S

EDISON

PHONOGRAPHS
RECORDS, ETC.

GENERAL SUPPLIES
FOR
CYLINDER MACHINES

Douglas Phonograph Company

MANUFACTURERS "PERFECTION" SUPPLIES, ETC.
RETAIL—WHOLESALE—EXPORT

Salesroom, 89 Chambers Street

Cable Address, Doughphone, N. Y.

New York

Largest Exclusive Talking Machine Jobbers in the World.

DISTRIBUTORS

VICTOR

TALKING MACHINES
RECORDS, ETC.

GENERAL SUPPLIES
FOR
DISC MACHINES

Mr. Dealer

How 1c. May Realize \$100.00

Invest _____ in a Postal Card
address it to the

Douglas Phonograph Company

89 Chambers Street, New York City

put your name and address on the other side, and we will
mail you as issued our Snap List. It only costs you

.01c.

Realize _____ that we are the

**Largest Exclusive Talking Machine
Concern in the World**

and continually have to offer New and Original
Accessories that stimulate business.

Also every once in awhile we offer something
at Bargain Prices. These offerings are new, fresh
goods, and are mainly articles we discontinue to
catalogue.

You can make _____
or more by keeping in touch with us.

\$100.00

We carry
the largest stock of **EDISON PHONOGRAPHS** and **RECORDS** in the U. S.

Ask for samples of our Imported German Disc Machine Needles. Compare our quality and prices and we will get your orders.

TRADE HAPPENINGS IN CLEVELAND.

Steady Betterment in Trade the Past Month—High Priced Machines in Favor—Bailey Co. Handling the Victor and Edison Lines—Harry Markle's Latest Invention—The National Phonograph Co. Open Commercial Department—The Selling of Commercial Machines Discussed by H. E. Jones—Leasing Chronophones—The Arcades and the Church—Other Items.

(Special to The Talking Machine World.)

Cleveland, O., April 10, 1907.

Conditions generally during the past month have been favorable to the talking machine trade and dealers have all been doing a satisfactory business. There has been a regular steady demand for machines, while the call for records and supplies is constantly increasing, which is evidenced by the continued extensions and improvements forced upon the dealers, who, however ample the initiative arrangements, soon find themselves cramped for room in which to make a proper display and for demonstrating purposes.

Throughout this section of the State the talking machine business is flourishing, and the music is growing in popularity to an extent hardly appreciated by the dealers.

The Columbia Phonograph Co. are busy as usual. Mr. Probeck, manager, said: "Considering the season of the year, business is very satisfactory. We are expecting a lot of surprises to come along soon, which will boom the summer trade and make us all happy."

W. J. Roberts, Jr., was delighted over the recent sales of several of the high-priced machines. He stated business was unusually good, and the outlook one of great promise.

Messrs. Robbins & Emerson started in the talking machine business nearly two years ago at 256 The Arcade, and have just moved to the floor below, No. 145, the Euclid avenue entrance, where they have a larger room and altogether better facilities for conducting the business. It is really one of the most attractive talking machine stores in the city. Mr. Robbins' experience in the business dates back to 1894, when he engaged with the Ohio Phonograph Co., supervising the various electrical machines then in use. He remained with the above company during their existence, and with their successors until August, 1905, when the present company was organized. They handle the Victor and Edison machines and records, and are doing a very successful and growing business.

All the evidences of prosperity prevail at the store of W. H. Buescher & Son. Mr. Buescher stated that throughout March business with them was very brisk, and was keeping up in the most satisfactory manner, and that from the present outlook it means a busy summer.

The Baily Co., department store, have opened a new talking machine department, handling the Edison and Victor machines. They have fitted up demonstrating rooms on the sixth floor, which by reason of offering easy payment terms is generally crowded with purchasers. They carry a large stock of machines and a full line of disc and cylinder records. The company are advertising and pushing the business, and the manager stated they would have to take in four times the present space to accommodate customers.

"The March business was excellent," said Mr. H. Gulley, No. 924 Prospect avenue. "During the month we tripled our orders for red seal records. If not handicapped by manufacturers in getting goods, April will prove to be better than March. There seems to be no let up in business, and I am making preparations for a large summer trade. Prospects are very bright."

The Hallet & Davis Piano Co. have got their talking machine department in running order, in rooms 126 and 128, The Arcade, over their main piano store. Trade was reported very satisfactory.

The special Victor red seal records are taking well, especially the Rigoletto quartet by Caruso, Abott, Homer and Scotti. Collister & Sayle have sold a large number, and are having fine sales of the entire April list. They state business is keeping up fully equal to the winter trade, and that the past month was the best in several

months. They disposed of a number of machines, and could have sold several Victrolas could they have been procured.

The Gottdiner & Wicht Co., No. 2084 West 25th street, claim to be the largest talking machine dealers in Cleveland. They are enterprising men, and are pushing for their share of business with energy, and are securing it.

Walter L. Eckhardt, general manager of the wholesale department of the Columbia Phonograph Co., New York, was in the city a few hours March 29, en route home from the West. He talked very enthusiastically of conditions in the talking machine line.

Harry Markle, of H. E. & Harry Markle, dealers in Edison phonographs, No. 403 Public Square, Nashville, Tenn., left for home April 1. Mr. Markle is the inventor of a multiplex phonograph intended for cylinder records, and had been in the city for the past two months perfecting and completing a working model of his machine. Dealers and others who have witnessed its operation, declare it is constructed on correct principles, and are profuse in expressions of admiration. Mr. Markle said it would probably be six months before it would be placed on the market.

The National Phonograph Co. have opened a commercial department in the Schofield Building, this city, with J. O. Hanna in charge. Their system, it is claimed, is considered perfect and the company will no doubt prove a keen competitor in this field.

P. A. Powers, the talking machine man of Buffalo, was in Cleveland, March 30. He expressed himself highly elated with business prospects.

H. E. Jones, manager of the commercial department of the Columbia Phonograph Co., believes that in business matters in these hurrying, skurrying days one should always take the short cut to results, and should be sufficiently informed to know how to. "It is remarkable," said he, "when one comes to think of it, that business men of to-day who are generally so thoroughly up to date in most things, should be so ignorant as they often seem to be, as to the practicability and convenience of the talking machine commercially applied.

"An experience recently had, with one of the largest business houses in this vicinity was almost amusing in this direction. The head of the house was approached, and said very urbanely, 'Kindly be seated. What can I do for you?' At this a general outline of the commercial graphophone's possibilities was launched into at the end of which the gentleman said with great earnestness. 'But these machines are not practicable, because how do I know that the man whom I am writing to has got a machine himself to read my letters from?' This may seem like pure romance to the average person who is not a commercial talking machine man, but it is nevertheless cold truth. Another misconception which almost invariably is encountered, when the machines have never been actually in use, is that the speed of the machine for transcribing can be so reduced as to make the record talk slow enough to enable the operator to keep up with it on the typewriter, and it is sometimes more difficult to get a man who is going to do the dictating to realize that the proper method is to cut the matter up into phrases of four or five words, than it is to get the typewriter operator to see that such is the proper method.

"It is really remarkable, though, the widespread use, which is increasing every day, which the commercial graphophone enjoys. From the most unexpected sources inquiries come, and even people who have before tried the machines and have been discouraged, are to-day again tak-

ing up the use of them eagerly.

"The principal difficulty which the commercial graphophone user finds in practice is the securing of capable operators of the machines who are at the same time good typists. Here there is an excellent field for the commercial school that is sufficiently enterprising and abreast of the times to comprehend this new and daily increasing need, and take advantage of it.

"The opportunities for the company selling the machines to educate operators are very limited, because of the difficulty, in the first place, of getting operators to realize that this is an additional qualification for a position nowadays. The commercial school's position in this direction would be different, dealing with entirely inexperienced pupils and having the opportunity to educate them along all lines as well as merely in the direction of handling the graphophones. This difficulty, however, has not been so serious, but that a large number of large and small business houses in this district have seen fit to install the machines in their offices during the past month. Some of the largest concerns in the outlying district and cities have also either installed the machines or displayed sufficient interest in them to have trial outfits placed in their offices. Altogether it would look as if the often-talked-of day, when shorthand would be a back number in the average business office were close at hand."

The "Family Theater" Co., a new local organization, have leased from the Gaumont Chronophone Co. one of their chronomegaphones, and are remodeling a building originally constructed for a vaudeville theater, at No. 1876 East Ninth street, where they will give exhibitions. The interior is being fitted up in the finest style, and will have a seating capacity of 600, furnished with up-to-date opera chairs. It will be an ideal moving picture theater.

The Catholic bishop of Cleveland, indorsing a crusade against Sunday dancing, in a public manifesto, takes occasion to also condemn the moving picture shows and penny arcades as being "mischievous as they are vile." He concludes: "I am in favor of Sunday baseball. God almighty never intended that the Sabbath should be a Puritanical one." The bishop may have reached his conclusions by reason of the fact that baseball is prohibited by statute, while the moving picture business is not.

Notwithstanding the large number of moving picture shows in town, most of them are doing well. "We aren't doing so badly here, said the proprietor of one of the 5-cent theaters. "We are clearing on the average about \$1,800 a month, and I expect to do considerably better than that before the business wears out." "I didn't suppose you made that much in a year out of so small an establishment," said his acquaintance. "Why," said the man on the high tide of



THIS CABINET

can be used for any make Talking Machine with or without head. If used with head the sound can be brought through mouth, if without, sound can be brought through column; records can be kept in column when head is used.

Write for price and information

CHAS. RUPPEL, Mr.
2611 N. 5th Street
PHILADELPHIA, PA.

prosperity, "I know a fellow who gave up a \$75 a month job and started one of these places in a location that you can hardly see, and although he has been there only a short time, he is clearing about \$600 a month."

The Akron City ordinance under which Mr. Charles Decker was arrested, charged with operating a phonograph on the street, advertising a picture show, was declared illegal in habeas corpus proceedings, March 25.

REPEATING PHONOGRAPH CLOCK.

A Novel and Useful Creation Worked Out by a Clockmaker Downtown—Some Possibilities in Getting Lazy Men Out of Bed.

A downtown clockmaker has worked out a repeating phonograph clock, which in his belief will in a large measure supplant the old style of bell repeaters. His mechanical arrangement consists of a pair of cylinder records on which have been recorded the hours and each five minutes of the day. These are moved along a bar by clock work, and when it is desired to know the time, the pressure of a button throws the diaphragm into place, the record revolves and announces the time after this fashion—"two thirty-five." He says it is only a matter of mechanics to produce a clock that at the proper time in the morning will release a weight that will lift the clothes off of a bed and at the same time call out, "John, it's time to get up. Hurry on now, the breakfast is on the table and all getting cold. Come on, get a move on you, etc.," with such repetitions and variations as will be most pleasing and effective in assisting the slumberer in throwing off his torpidity.

AN ELECTRIC MOTOR HORN.

The electric horn for automobiles, an English device, is an electric buzzer, fitted to a common automobile "toot" horn. A brass cylindrical case contains a steel vibrating disc, held at its periphery by two flanges and two electro-magnets,

and the rapid vibration of the disc caused by the magnetization and demagnetization of the magnets yields a sound which is magnified in volume and effectiveness by the horn. The current is provided by an eight-volt accumulator. The signal can be maintained as long as is necessary or desired, the blast being louder and more continuous than that of the ordinary wind horn, and with the switch on the steering wheel the driver can give his warning without removing his hand from the wheel.

A CLEVER COLUMBIA WINDOW.

The Skill of Harold Godwin Again Displayed at 353 Broadway Where He Conceived Something Entirely Original and Attractive—The New Marconi Records Featured in a Most Effective Environment.

The windows of the Columbia Phonograph Co., at 353 Broadway, under the able decorative ability of Harold Godwin, continue to attract crowds that at times almost block the sidewalk, and has become a model for many of the merchants along that thoroughfare. A recent display called attention to the new English song, "Riding in the New Electric Car." A diminutive trolley car ran around the window with a full complement of passengers, motorman and conductor. A dangerous crossing bore the sign, "Beware of Imitations," and "Stop-Look-Listen-Columbia Records."

The display of this week was wholly given up to the new Marconi records, of which a sample shipment has reached New York. The object lessons plainly show the remarkable qualities of these new products. A scale beam suspended from a beam stand has a Marconi record at one end and a feather at the other—a sign that aptly illustrates the fact that they are as light as a feather. Another corner has a record in an envelope, which has been through the post office, plainly illustrating that these records may be mailed with perfect safety without any packing. The two center displays are worthy of a careful

study. Two records placed on edge have a continuous electric spark playing between them. An enormous spark coil capable of generating 300,000 volts is hidden under the window, and is used for this display.

The exhibit is to suggest the Marconi wireless telegraph, and as the record label bears a picture of Mr. Marconi, the effect is extremely pleasing. Another object lesson is the fact that the records are flexible. A small stand has been erected, underneath which is an electric motor with a specially designed shaft. This reaches up through the floor of the platform, and working up and down continually bends a Marconi record back and forth, while a sign asks: "How can you break a record like this?"—Music Trade Review.

TALKING MACHINE IN EAST AFRICA.

The Governor of British East Africa, while upon a recent visit to the wild trans-Tana districts, took along a talking machine, and the effect of its music upon the natives, a very primitive race, is said to have been wonderful to witness. In the Kenia forest, for instance, the natives could not be induced to come out of their retreats and meet the governor until the talker was started, when their curiosity overcame their fear and backwardness. Even then any unfamiliar sound proceeding from the machine, such as a bugle call, would cause the gallant warriors to retreat on the run.

A little more than a year ago the wife of an organist in Kansas City while visiting in Minneapolis, sang "My Rosary" for a talking machine record. Not long afterward she died. The phonographic record was sent to her husband. Occasionally he listens to the sacred song as sung by her, and it is a great comfort to him.

The Columbia will move their Yonkers store to 116 New Main street on May 1, where they will have much larger quarters in which to handle their increasing business. W. J. Hance is the manager.

The KOMPAKT HORN

A Practical Sheet-Metal Collapsible Flower Horn which anybody can put into use inside of one minute

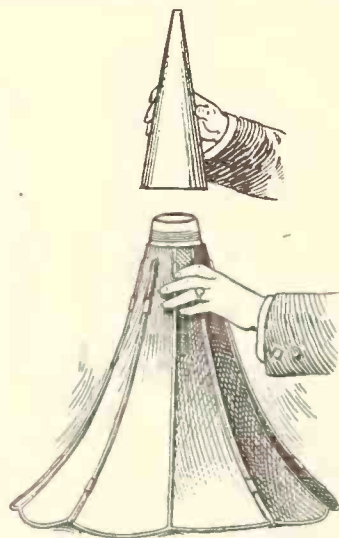
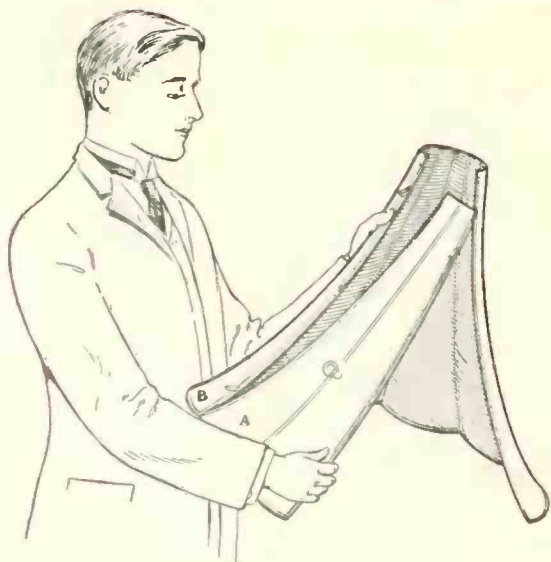

Screw Tube

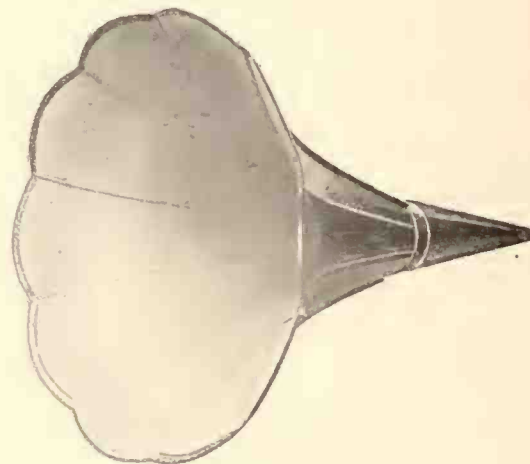

A new feature on the Kompakt Horn is the Screw Nozzle, which does away with ThumbScrews.

Worth Handling—Pays Large Profits

We manufacture a complete line of Brass and Sheet Steel Nickel-Plated Flower Horns finished in artistic designs and decorations. For catalogue and prices, address

The New Jersey Sheet Metal Company

9-11 Crawford Street, Newark, N. J., U. S. A.

GOOD REPORTS FROM ST. LOUIS.

Business Thirty Per Cent. Ahead of the Same Period Last Year—Walthall With Columbia Co.—Long Succeeds Ramsdell—Conroy Chats of Talking Machine Growth—Clancey's Good Columbia Report—Other Items.

(Special to The Talking Machine World.)

St. Louis, Mo., April 10, 1907.

The talking machine business still continues to boom, and trade for the month of March and the opening week of April is reported to be about 30 per cent over that for the same month a year ago. For the first quarter of the year business has maintained about this average, and the demand is for the best of goods. The record business is very heavy, and dealers are still suffering from a shortage of goods, and inability to get them as fast as needed.

E. B. Walthall, formerly manager of the talking machine department of the O. K. Houck Piano Co., left on April 1 to accept the position of manager of the retail sales department of the Columbia Phonograph Co. in Chicago. He left many friends here who wish him the greatest of success in his new field.

C. W. Long, formerly manager of the wholesale and retail talking machine department of the Cable Company, Chicago, has succeeded D. S. Ramsdell, formerly manager of the St. Louis Talking Machine Co., who has resigned to enter other business in Chicago. The departure of Mr. Ramsdell will be greatly regretted by all who knew him here, and his employes will remember him as a very kind and considerate employer. On the evening of March 21 Mr. Ramsdell gave a farewell reception to his former employes at his home, and during the evening they made him a very handsome present.

Charles P. Ramsdell, brother of D. S. Ramsdell, formerly stock clerk for the St. Louis Talking Machine Co., has resigned to go to Sioux Falls, S. D., where he will become a partner in the Sioux Falls Talking Machine Exchange, which his brother, F. C. Ramsdell, conducts.

Mr. Ramsdell will be succeeded by L. A. Cummins, formerly connected with the talking machine department of the O. K. Houck Piano Co.

P. E. Conroy, president of the Conroy Piano Co., in speaking of their talking machine business, states: "I have been in the talking machine business twelve years, and the trade that we have had the first quarter of this year beats all records by a very large margin. Our trade throughout Kansas, Oklahoma and Texas, as well as other tributary States, has showed a phenomenal increase, and it is constantly growing, and the demand is for the best line of goods we carry." He added, "I consider this a remarkable showing in view of the fact that we are exclusively Edison dealers." Mr. Conroy will sail for a three months' tour of Europe in July, joining his wife and son, who are now in Berlin.

T. P. Clancey, manager of the Columbia Phonograph Co., reports a very fine trade for the month of March, and that their trade for the first quarter of the year will show nearly 30 per cent. increase over that of a year ago. The highest priced instruments are the best sellers, and the outlook is of the best. May Irwin, the actress, who recently played here, sang for some Columbia records, which will soon be on the market.

Marks Silverstone, president of the Silverstone Talking Machine Co., was called to Roanoke, Va., on March 26, by the death of his father. The funeral took place at Baltimore, Md., two days later. Mr. Silverstone returned the first week in April.

The Koerber-Brenner Music Co., report a fine talking machine trade for the month of April, and that everything is booming with them. A. Haas, one of their travelers, has left on a two months' Western trip.

The Balmer & Weber Music House Co. report a nice trade in their new talking machine department.

Manager Brewer, of the talking machine department of the Thiebes-Stierlin Music Co., reports an excellent business for the month of March, and that they sold a number of their highest priced instruments.

J. F. George Gunter, formerly with the St. Louis Talking Machine Co., has accepted a position as assistant to Manager Brewer, of the talking machine department of the Thiebes-Stierlin Music Co.

TO MAKE ELECTRIC SOUND DEVICES.

(Special to The Talking Machine World.)

Macon, Ga., April 8, 1907.

Citizens of the city of New York and of Macon made application in the Superior Court of Bibb last week for a charter for the American Callaphone Co. The application for charter recites that the capital stock is a million dollars and that half the amount has been paid in. The principal places of business will be Macon and New York. The applicants desire the privilege of increasing their capital to ten millions. The incorporators are A. G. Kaufman, L. J. Lippman and L. J. Waxlebaum, of New York City, and J. J. Waxlebaum and T. J. Carling, of Macon. The concern wished the right to manufacture and sell everything musical that reproduces sound by electricity or mechanical devices.

CRESSEY & ALLEN'S SHOW WINDOW.

(Special to The Talking Machine World.)

Portland, Me., April 9, 1907.

Cressey & Allen, the music dealers, recently had a window that attracted much attention. In the window was a turntable, seven feet across, and devoted exclusively to the display of Victor talking machines and appliances, the whole arranged in an artistic manner and making a very attractive display. The turntable was operated by electricity, and as it revolved, showing the many different machines, records, horns, etc., it gave the public a good idea of the class of goods to be found in the Victor parlors of this well-known concern.

Many a clerk has made customers for the store by being possessed of patience unlimited. Patience is to salesmanship what oil is to an axle.

THE AJAX—The Strongest Horn

Constructed in seventeen pieces of carefully selected, rust-proof sheet steel, thus giving the **AJAX** surprising strength, and eliminates all danger in shipping and handling.

ARTISTICALLY FINISHED HORN

Finished in light Enamel and Japan Colors. Baked in ovens built for the purpose. A positive proof against fading.

ATTRACTIVE HORN

THE AJAX is a horn of a very decided artistic appearance. A horn which you **will sell**, not keep.

We manufacture a complete line of Brass and Sheet Steel, Nickel Plated Flower Horns. Send for our new catalogue and prices—they will interest you. For further particulars, address

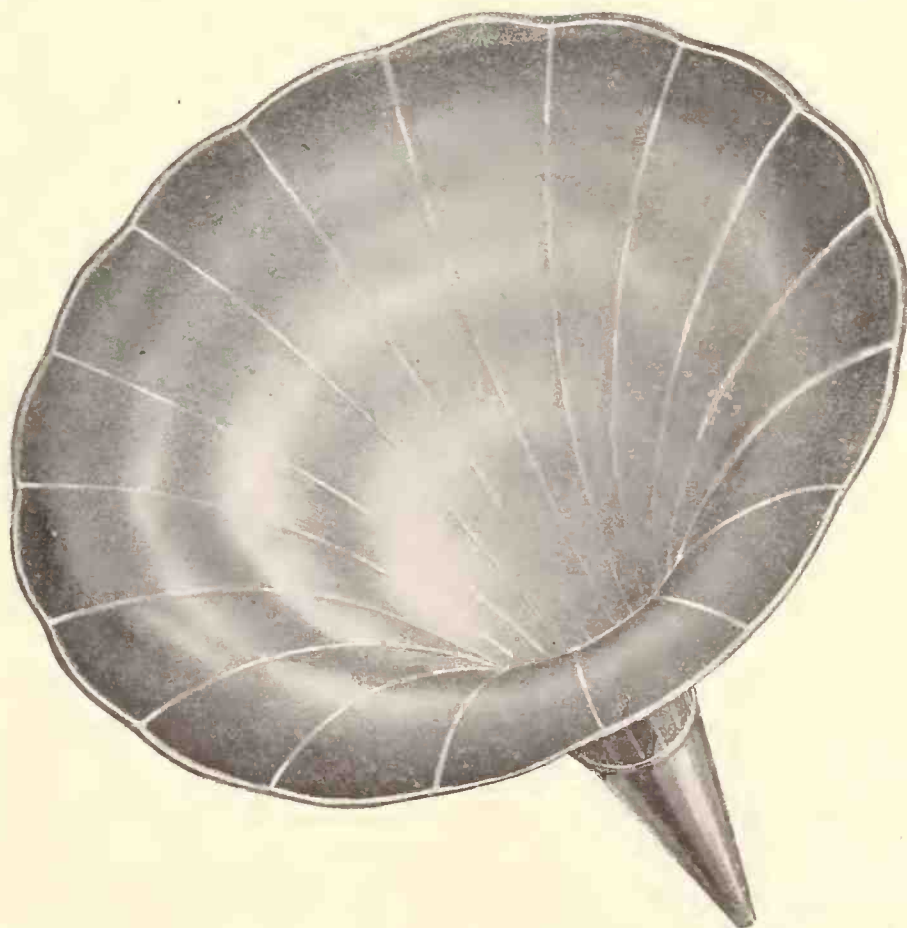

The New Jersey Sheet Metal Company

9-11 Crawford Street, Newark, N. J., U. S. A.

MUSIC OF THE JUNGLE

Reproduced by Prof. Starr Through the Medium of the Phonograph and Moving Picture Machine at His Interesting Lectures.

Prof. Frederick Starr, who returned some time ago from an extended visit to the African jungles, has been delivering a course of lectures at several of the leading universities on the lives and habits of the African cannibals, which have been interspersed with a number of love and war songs. Professor Starr did not waft the strains to the audience, but presented them by means of a talking machine, which he carried with him to the savage tribes on his 24,000-mile trip. He has recorded, he declares, all of the latest melodies of the pigmies, cannibals and barbarians of the Congo Free State.

Grand opera, he asserts, thrives among certain tribes—or at least something on the order of grand opera. Many of the cannibals were musically inclined—some with Caruso voices—and on certain festivities he was able to record the musical ceremonies.

The professor carried with him also a moving picture machine, and is therefore able to present a double bill to his classes. While the phonograph is reeling off the music the anthropologist throws the singer on a screen and sends him through his antics, which generally are quite varied.

THE TALKING MACHINE.

A Poetical Tribute by a Member of the Trade Which Is Worth Reading.

We are indebted to V. M. Hatfield, of the Hatfield Music House, Ossian, Ind., for the following tribute to the talking machine, which will be read with pleasure by our readers:

I have many home comforts and luxuries rare;
Diversions unnumbered that drive away care.—
Such as horses, and carriages, pictures and books;
Easy rockers, cigars, newspapers, and cooks.
I am fond of lawn tennis, and checkers, and cards.
To jovial companions I pay my regards.
But nothing affords me a pleasure so keen
As that musical wonder, my talking machine.

At the close of the day, when business is o'er,
I gladly escape from the cares of the store;
And flee to that hearthstone, where sunshine and cheer
Shed a radiance of welcome the whole of the year.
With the worries and cares of the day left behind,
A wealth of domestic enjoyment I find.
But the joys of the evening are heightened, I ween,
By that richest of treasures, my talking machine.

Some like the piano, while others insist
The organ stands first in the musical list.
The fiddle has friends, and so has the drum;
And even a bag pipe is music to some.
A cornet is pleasing; a dulcimer grand;
There's a ravishing charm in the village brass band.
I like all of these, and I have them. I mean
They're combined in my versatile talking machine.

Of heaven's rich gifts the most sensible choice
Is that envied possession, an exquisite voice.
A charming soprano, an orator bold,
Can quickly convert simple phrases to gold.
The well-rounded tones of a speaker has power
To hold an assembly through many an hour.
The world famous speakers I never have seen,
But I hear them at home, in my talking machine.

It sings like a bird, it cries like a child;
It scolds like a woman whose temper is "riled."
It puffs like a steamboat, it laughs like a clown;
It prays like a preacher when Satan's in town.
It swears like a parrot, it barks like a dog;
Declaims like a school boy, and grunts like a hog.
Its clever, its witty, its slangy, its green,
Its whatever you ask for, this talking machine.

There's one thing I recently happened to learn,
That a talking machine can serve a good turn.
There's an old-time adage you often have heard,
That a woman invariably has the last word.
I'm not much on argument, never could preach;
Like the ancient lawgiver, I'm tardy of speech.
So when the old woman gives vent to her spleen
I simply wind up my talking machine.

PETITIONING GERMAN GOVERNMENT.

The talking machine and record manufacturers of Germany are petitioning their government to prevent the revision of the Berne Convention so far as the free use of published music goes. They maintain that the compulsory payment of

royalties to composers, or publishers would cripple their industry, which, after many losses and unexampled hard effort, is only just beginning to show returns.

BURKE CO. MAKE ASSIGNMENT.

Assets of the Brooklyn Co. Placed at \$6,500 With Liabilities at \$4,200—Business Is Being Continued—Thomas Burke Also Goes Into Bankruptcy.

On March 11 the Burke Talking Machine & Novelty Co., successors to Burke & Rous, 334 Fifth avenue, Brooklyn, N. Y., made an assignment to Leo Greenlinger. Their assets, face value, are placed at \$6,500, with liabilities of \$4,200. The business is being continued by the assignee, and it is probable the financial embarrassment is temporary; at least this is what the four leading creditors, whose claims aggregate over \$3,000, are hoping. About the same time Thomas Burke, who was supposed to be the head and front of the company, went into voluntary bankruptcy on his individual account. It is claimed Mr. Burke had no financial interest in the company. The creditors are perplexed over the mixed situation.

LOVED WHAT HE ONCE DISLIKED.

Prof. Barilli, the Well Known Musician a Great Admirer of the Talking Machine—Formerly Had No Use for One—Reason for Transformation.

Prof. Alfredo Barilli, the well known Atlanta, Ga., musician, is the owner of a talking machine which he greatly prizes and regarding which there is quite a story. For a number of years, in fact, ever since talking machines were put on the market, they were Professor Barilli's pet aversion. He registered an oath that he would never have one, and it only took the sound of a talking machine to set his teeth on edge. Last summer, however, fate conspired to make him the possessor of one, and, worse than all in his eyes, he actually played into one.

Professor Barilli, as is well known, is a nephew of Adelina Patti, the famous singer. While visiting her last summer the agents of a talking machine company often induced her to sing into their machine. For years she had been importuned by various companies to sing for them, but the most flattering offers failed to tempt her. However, the particular talking machine company had made certain improvements which did away with her objections. She sang several

songs to Professor Barilli's accompaniment, and a short time ago she sent him a splendid machine with the records of her songs.

Professor Barilli, in a chat with a writer in an Atlanta paper, says the occasion of her singing was an interesting one. Madame Patti was placed a certain distance from the talking machine, with a man behind her. As the range of the song was high or low she was moved rapidly forward or backward until it seemed that the breath would be jostled out of her; but, strange to say, her rather violent gymnastic exercise had no apparent effect on her and the records were well-nigh perfect. Considering Madame Patti's advanced age of sixty-three, the records show her to possess a voice that is remarkable.

HENRY A. BISHOP ELECTED DIRECTOR.

On March 14, at a meeting of the American Graphophone Co.'s board of directors, Henry A. Bishop, of Bridgeport, Conn., was elected a member of the directory. The new director is a capitalist of note, widely known from his railroad connections, and at the present time is on the board of the following corporations: Western Union Telegraph Co., Connecticut National Bank, of Bridgeport; American District Telegraph Co.; also president of the Bridgeport Public Library and vice-president of that city's Board of Trade, besides being a director of every hospital, humane society and club in Bridgeport. Mr. Bishop is a graduate of Yale, and for many years was purchasing agent of the New York, New Haven & Hartford Railroad, and subsequently vice-president of the Western Maryland Railroad.

SALE OF USED TALKING MACHINES.

Upon the opening of their handsome talking machine parlors on the second floor of their building at Seventh and Main streets, Little Rock, Ark., the Hollenberg Music Co. held a sale of used "talkers," thus enabling people to possess a machine who would not pay the price of a new machine. This is said to be the first public sale of "used" machines.

The new prices on horn cranes manufactured by the Hawthorne & Sheble Manufacturing Co. have made such a hit that this company now have nearly one hundred hands working on cranes alone, and still they find it difficult to keep pace with the trade requirements. It is the old story—a good article sold at a popular price.

LOUIS BUEHN & BROTHER

FORMERLY

WELLS PHONOGRAPH COMPANY

offer to the dealers within several hundred miles of Philadelphia the largest stock of

Edison and Victor Goods

for their selection. Also a complete line of supplies and all the leading lines of

Horns, Cranes and Cabinets.

We make a specialty of supplying the needs of the dealer and promise the best possible service. If not already dealing with us it will pay you to get in touch with us. Prices on Horns, Cranes, Cabinets and all supplies for the asking.

Write for Catalogue.

45 North 9th Street, Philadelphia.

HARMFUL LEGISLATION.

Proposed Changes in the Conditional Bill of Sale in the Connecticut Legislature Have Been Brought to the Attention of the Talking Machine Trade in a Forceful Manner by the Pardee-Ellenberger Co. of New Haven.

(Special to The Talking Machine World.)

New Haven, Conn., April 4, 1907.

The various legislatures, including that of Connecticut, have been giving much attention this year to changes in the conditional bill of sale, used so generally in the musical instrument business. The bill recently introduced in the Legislature of this State, and which later was transferred to the judiciary committee, has been the subject of much concern to talking machine dealers. Among the first to recognize how unfavorably this measure would act on the talking machine interests were the Pardee-Ellenberger Co., the enterprising jobbers of Edison phonographs and records, in this city, who at once issued the following illuminative circular to the trade:

"A matter of vital interest to every phonograph dealer in the State of Connecticut is the presentation of a bill before the present session of the Legislature relative to goods sold on conditional bill of sale, or lease, as it is more generally called. The present law on this subject is, to quote from Chapter 113, Public Acts of 1905, as follows:

"Section 4684 of the Grand Statutes is hereby amended by inserting after the word 'instruments' in the seventh line of said section the word 'phonographs and phonograph supplies.' so that said section as amended shall read as follows: all contracts for the sale of personal property, conditioned that the title thereto shall remain in the vendor after delivery, shall be in writing, describing the property and all conditions of said sale, and shall be acknowledged before some competent authority and recorded within a reasonable time in the town clerk's office in the town where the vendee resides: but the provisions of this section shall not apply to household furniture, musical instruments, phonographs and phonograph supplies, bicycles or to property exempt from attachment and execution. Approved June 6th, 1905."

"The bill as presented at this time was to elim-

nate the words 'musical instruments' from the present statutes, and at the hearing before the Judiciary Committee, the author of the bill gave notice that he intended to introduce a substitute bill which would cut out the words 'Phonographs and phonograph supplies' as well.

"Relieved of all its legal verbiage it would mean that if this was enacted, the sale of every phonograph or phonograph accessory sold on lease would have to be acknowledged before a notary or other magistrate, and would then have to be recorded in the office of the town clerk in the town where the vendee, or customer, resides; otherwise the protection afforded the vendor, or dealer, by the conditional bill of sale or lease would be legally forfeited in case of an attachment by a third party. The inconvenience and expense of such a course, to say nothing of the objections of purchasers to have the details of such sales made public is so apparent that no comment by us is necessary.

"We were represented by counsel at the hearing and vigorously opposed any change in the law and also claimed the right for a hearing for the phonograph dealers at some later date should the substitute bill be presented.

"Should the author of the bill persist in his purpose to present a substitute bill or should any other attempt be made at any time to take away the present rights of phonograph dealers through change in the existing law, we hope every dealer in the State will request his Senator and Representatives to oppose such substitute bill. We, on our part, shall follow this matter, and by every legitimate effort protect, to the extent of our powers, our dealers from annoying, expensive and useless legal requirements.

"It may not be generally known that it was due to our initiative and efforts that in 1905 the words 'phonographs and phonograph supplies' were inserted in this statute, relieving the dealer beyond any question, from the necessity of recording conditional sales of these articles.

"The welfare and interest of our dealers is ours as well, and they can rest assured that, as in the past, we shall look after their interests and aid them in every way possible in the safe, secure and profitable carrying on of their business."

Thanks to the immediate action taken by the Pardee-Ellenberger Co., the dealers throughout the State have been petitioning their representatives in the Legislature at Hartford to fight hard against the passage of this measure and the probabilities are that it will not be reported favorably by the Judiciary Committee.

THAT MYSTERIOUS MACHINE.

Who tampered with the correspondence talking machine? is a question just now agitating many minds, and a still hunt is in progress for the mischievous person responsible for the unaccountable antics of a hitherto staid and sober talking machine, says the Washington (D. C.) Times. It had never behaved that way before, but the clerks in the bookkeeping division were treated to a rather spicy and entertaining vaudeville performance the other day before the thing was squelched. The enunciation of the talking machine is particularly loud and distinct, and when it said, "Oh, fudge! I'm tired of this," everybody in the room, including several ladies, immediately whirled about in their seats and gazed with astonishment at the spectacle of a talking machine going on a rampage. And a rampage it surely was. The voice was rich and melodious. After it relieved its mind of the way things should be run at the printery, it changed tactics and whistled a bar from "Hiawatha." Then the mournful strains of "Wait Till the Sun Shines, Nellie" were beginning to issue forth, when one of the clerks recovered her presence of mind sufficiently to turn the stop lever and choke it off.

Mrs. Whitson, proprietor of the Whitson Music Co., Albuquerque, N. M., is one of the women music dealers who have made a success of selling talking machines. She handles the Victor and Edison lines.

Some Facts Worth Considering

THE talking machine man frequently asks, "How can I increase my business?" The answer is easy. Place on a side line which takes but little space, which is attractive, and a standard in its particular line. Take the **Black Diamond Strings**, for instance. Steel and wound. New process. They are the finest manufactured. They are used by all of the prominent artists, and you will have a trade coming your way when it is known that you handle the "Black Diamond." Music dealers all over America, and all over the world for that matter, know full well the value of this product.

National Musical String Co.
New Brunswick, N. J.

Promptness

That's a word to conjure with! To build up a larger business; to draw your old customers closer to you; to make a good impression on new customers; to add a pile of dollars to your bank account.

How are you fixed to take care of your customers' wants? Is there anything in the talking-machine line that you haven't in stock—that some customer is liable to ask for and catch you napping? Would you be able to tell him or her exactly when you would have it? Could you be sure of keeping your promise?

That's when promptness counts—and it's largely up to your jobber. He must be prompt or you can't be. How does he size up when a similar line of questions is pointed at him? Reason out for yourself what his answers would be, and what they would mean to your business.

Our service is always right and particularly valuable when you get in a pinch. That is the time when you are sure to appreciate our promptness—the fact that we ship all goods the same day the orders are received.

Try us on anything you want in Victor talking machines and records, English needles, fibre cases, trumpet horns and other accessories.

Write today for our latest catalogue and see what a complete line of goods we handle.

The Victor Distributing
and Export Company

77 Chambers Street New York



Artistic Flower Horns=

Beauty—Quality—Satisfied Customers

Imitations=

Gaudy—Quality—Repeat Orders

Which will you handle?

**ARTISTIC
FLOWER HORNS**

*are now recognized as the best and most
salable product on the market.*

HAWTHORNE & SHEBLE MFG. CO.

PHILADELPHIA, PENNA.

THE MONTHLY RECORD

OF THE

“STAR”



- No. 1—First Seen by the Talking Machine World in March
- No. 2—First Order Received in March
- No. 3—First Shipment in March
- No. 4—Sales Are Doubling Every Five Days

CHALLENGE

We challenge any Talking Machine or Record Company to show the same amount of initial business in the same length of time. We have received orders in the past forty-five days for more than 300,000 records.

The “STAR” is Growing into a PLANET

HAWTHORNE & SHEBLE MFG. CO.

Howard and Jefferson Sts., PHILADELPHIA, PA.

STATION O

PRACTICAL SUGGESTIONS AND COMMENTS.

CONCERT HALL TRANSFORMATION.

In talking with a Western dealer the other day he stated that in the several stores which he controls he has so arranged the establishments that he can turn them into regular concert halls for talking machine recitals whenever desired. On one side the demonstrating booths are so arranged that they can fold up, forming an ornamental background, while on the other side the counter is portable and folds up right under the shelving. At the rear is a handsome little stage arrangement which virtually falls into place without any apparent effort. This, with a fair equipment of camp stools, or other furnishings, turn the place into a handsome concert hall that holds a goodly number of people. As compared with the expense involved in fitting out the place, the results in increased business are amazing. Here is a tip worth noting.

IMPORTANT TO USE NEW NEEDLES

Dealers should make it a point to impress on their customers the advisability of not using a cheap needle more than once. Very many good records are spoiled by using a poor needle over again, and oftentimes the disc is actually damaged. Needles are inexpensive enough, while records, particularly those of grand opera, cost too much to experiment with. The needle, when worn, becomes broad and blunt, and if used over wears off not only the impressions made by the recorder, but is liable to spread or break the thread, in which case the disc is absolutely useless, inasmuch as the needle will not feed past the break. This damage is impossible when the Petmecky needle is used.

HOW NEEDLES ARE MADE.

And this brings to mind that our readers will doubtless be interested in how needles for high-grade talking machines are made. In making them a carbon steel rod about 3-16 inch in diameter is generally used. The first process consists in reducing this rod to wire about 1-16 inch in diameter, that of the finished needle. The operations are as follows: The rods are first heated in an annealing oven, and then slowly cooled in order to soften them. In this heating and cooling process they become oxidized or coated with scales. To remove these they are tapped with hammers, after which they are "pickled" in a solution of acid and water, and again heated in another oven much cooler than the first to remove the effects of pickling. They are then taken to the wire-drawing machine, where the 3-16 inch soft rod being drawn through a die plate about 1/8 inch in diameter, is reduced

to No. 8 wire. Drawing compresses and hardens the metal, making it necessary to repeat the annealing process before another reduction in diameter is possible. Therefore, these operations must be repeated about five times before the requisite reduction to 1-16 inch, or No. 16 wire is obtained.

PASSES TO THE FORMING MACHINE.

The long coil of small wire is now passed to a forming machine, in appearance like a lathe, which in spinning around the wire, as fed through it, straightens and cuts it into rods about 18 inches in length. These rods are gathered up and taken to a grinding machine, an ingenious special mechanism which points the ends of about 150 of them at a time. They are fed to it sideways, and are held in exact position, fed through and turned as they grind against the stone by means of rubber tired wheels or rollers. One set of ends being pointed, the rods are reversed and again fed to the grinder to point the opposite ends. The now double-pointed rods pass to the cutting machine. Its operator seizes a handful (about 100) pushes the ends against a plate to even them, places them in the cutting machine against a gauge plate set 1/8 inch from the shear, and touching a lever cuts off 100 rough needles at a stroke. Turning the bunch of rods end for end 100 more needles drop into the hopper. The shortened rods pass to the next grinder and thence to the next cutter, and so on until the rod is about used up.

HARDENING THE NEEDLES

The now rough needles are spread evenly to the depth of an inch over the surface of a heavy iron plate or tray, and while on this tray are heated cherry red in a special furnace, on being removed from which they are at once thrown into large double cans containing whale oil to harden them. These cans are kept in a water tank for cooling purposes. The inner cans have strainers at the bottom, so that when removed with needles in them the oil drains back into the outer cans, which always remain in the water. The needles, perfectly shaped and hardened, but still in the rough and gummy with oil, are placed in a huge pan or trough, which slides back and forth with jerking motion (somewhat like that of an ordinary ash sifter) on the top of what may be called a "washing machine." Here they are treated to a bath of soft soap or soda and water, as they roll about in the bottom of the pan. After a thorough shaking up in this soapy mixture they are drained, and while still damp are placed in a tumbling barrel, or,

in other words, a slowly revolving barrel, pivoted at an angle of about 45 degrees. About double their bulk in dry sawdust is mixed with them, and in a short time dries them thoroughly. They are then separated from their sawdust towel by a rather ingenious contrivance, which sucks off the dust and leaves the needles.

PREPARED FOR FINAL POLISH.

It is now necessary to prepare their surfaces for the final polish, and to do this they are scoured. A batch numbering several thousand is mixed with a pasty looking compound, and the mass is wrapped into a cylindrical canvas packet about 5 inches in diameter and 2 feet in length. Several packets, tightly bound around with strong rope, are placed in a machine called a "mangler," in which they are rolled back and forth between two slabs as one would make a roll of butter. After this careful rolling or massage treatment is continued for some time, the needles, by rubbing against each other in the scouring compound, are thoroughly cleansed and smoothly surfaced, and are taken from the packets. They are then given a rinsing in clear water, and another turn in the sawdust barrel, after which they are for the last time packed into sausage-like canvas casings and rolled this time with a fine polishing compound. From this last mauling they emerge as finished product, and are sent to the stockroom, to be weighed (not counted) into packets of 100 or more, as required.

FORTY-TWO HANDLINGS IN ALL.

There are about 16 processes between the steel rod and the finished needle, or, if we count the number of operations necessarily repeated in the wire drawing, annealing process, pickling, hammering, etc., there are about 42 handlings in all, and yet in no case is a needle handled singly as such.

NOISES IN OPERATION.

J. H. Wilson, of Salt Lake City, Utah, writes to The World that some customers to whom he recently sold machines complain that when they put on a record there is a grinding noise like a buzz-saw in the machine, and asks for a remedy. With such a lack of detail, it is almost impossible to answer fully, but the reason for this grinding noise is generally found in the governing shaft. If the noise is so great as to be noticeable when the machine is playing, it would be best to give the instrument a thorough overhauling. It may be well also to put in new motor suspension springs, which, if properly adjusted, make the machine practically noiseless.

HANDY OUTFIT FOR REPAIRING.

The same correspondent inquires where he could procure a convenient outfit for repairing machines. In this connection we may say that

Michigan Dealers Should Send Their Orders to

GRINNELL BROS., DETROIT

Authorized VICTOR and EDISON Distributors

ENLARGED and excellently equipped quarters, devoted exclusively to the wholesale Talking Machine business, enable us to give service unexcelled for promptness and accuracy. Orders invariably filled same day received, and none but absolutely new goods sent out under any circumstances.

**PERFECT
GOODS
PERFECT
SERVICE
PERFECT
SATISFACTION**

WE carry an immense stock of everything in VICTOR and EDISON goods—Machines, Records, Horns of every description, Cranes, Record Cabinets, Needles, etc. No matter where located it will pay you to open an account with us. Write for our Catalogues and prices, and DO IT TO-DAY!

Try Us on Your Next Order!

We Guarantee to Please You!

one of the best we know of is Kaiser's Handy Pack. It contains thirty small bottles, which are labeled blank for contents. They hold all needful supplies for repair parts for the reproducer and recorder, and will be found invaluable to dealer or repairer. The pack occupies a comparatively small space, being 12 by 14 inches, and can be secured through L. Kaiser, the inventor, 32 East 14th street, New York.

TROUBLES WITH SOUND BOXES.

"Many customers come in with their sound boxes and claim they are imperfect," said the repair man in a city talking machine store. "When I take them in hand I almost invariably discover that the screws that act as the tension on the rubber gasket that holds the diaphragm in place has become loosened or that a thick coating of dust has become attached to the edges of the diaphragm. The result of the former is a disagreeable rasp, which is often attributed to the record. The matter of tightening them up is simple, and every dealer should carefully examine the sound boxes on the machines he sells to make sure that they have been properly tightened up or have not become loose in use in the warerooms. If the dealers would instruct the users of talking machines to cover up sound boxes when not in use, and to dust them out occasionally with a fine camel's-hair brush, they will find their patrons receiving much greater satisfaction from their purchases. An accumulation of dust prevents the proper vibration of the diaphragm, and in consequence the tone is lacking in resonance, the same as that of a violin when a mute is placed on the bridge."

THE RUSTING OF NEEDLES.

"I have recently discovered that much of the wear on disc records come from the fact that the fine points on the needles now in use is extremely liable to rust," said a dealer to The World, "and I am now treating all of the needles used by me so as to prevent that difficulty, and am advising my patrons to buy in small packages. I think if the points could be treated to a thin bath of copper, much of this trouble would be obviated. When the point of a needle is attacked by rust the friction against the disc wears it away much more rapidly than is intended, and as a result, it is widened out to an extent that seriously damages the thin walls, particularly when it is used on a 12-inch record. I make it a point to keep all needles in stock in the driest place I can find, and even then I have opened new boxes and found the points imperfect. Were it not for the cost, I believe tempered manganese bronze would make an ideal material for needles, and I have made a few out of that metal and have found them to wear much better than steel, and practically free from ordinary oxidization. They can be made harder and given a higher polish than anything except nickel steel, which also might prove a good needle material."

SPECIAL SERVICE OF SONG

For Easter Heard Through the Talking Machine —How Good Music Was Enjoyed.

In a nearby suburban church, where the choir is composed of the rawest kind of raw material, it was decided to have a special service of song for Easter, but the progress was slow and very painful to the hearers. Finally a gentleman of the congregation, who possessed a good disc talking machine, took it to the rehearsal. The tenor was struggling with "The Palms." The record of that song by one of the best tenors was placed on the machine, and he was instructed to sing in unison with it. The first few attempts resulted in a dire failure, but eventually he won out. "Come All Ye Faithful," by a quartet, was used to drill the full choir with equal success. The result was a surprise to the congregation when Easter morning came. The timing of the records to the organ was accomplished by regulating the speed of the machine. The choir is now regularly practicing by the use of the talking machine as a leader, and the list of sacred songs published by the various companies is being carefully searched for all that can be used on the various occasions.

PIANO DEALERS MUST WAKE UP.

Will Have to Regard the Talking Machine as a part of the Legitimate Music Trade Business —An Interesting Chat on This Subject.

One of the leading piano dealers in a large Pennsylvania city, who carries a full line of talking machines, recently said to The World: "I believe the time is at hand when the piano dealer will have to regard the talking machine as a part of the legitimate music trade business, and take steps to handle it as such. Since taking it up I have found it not only profitable from the sale of machines and records, but from the sale of pianos and music to the owners of the machines. I know that they have assisted in the sale of pianos by making the owners realize that the manual production of music is even a greater pleasure than the automatic reproduction of the machine. I have also found that the sale of music has been increased through their agency, the publishers to the contrary. Many of those who buy a record come back in a few days and ask for the published song, and I am now trying to keep copies of the words and music of the popular records in stock. In my store the talking machine department receives the same attention as does the one devoted to pianos and organs, and the public will naturally prefer to go into a reputable piano store to buy machines and records than to a place where the talking machine is the only article of musical merchandise, the combination being bicycles, caudy or some other wares foreign to that class of business. Of course, stores devoted strictly to the talking machine business are another thing, and they are tending to elevate the business wherever established if conducted properly. I find in many of the large cities the leading piano houses are doing the best talking machine business, and have a class of customers that will not go to variety or department stores."

An excellent talking machine business is done in Margaretville, N. Y., by Charles Gorsch, who handles the Victor line.

RECENT INCORPORATIONS.

The Standard Talking Machine Co., Chicago, have incorporated with a capital of \$2,500 for the purpose of manufacturing talking machines. Directors: W. B. Walrath, Clinton S. Woolfolk, Robert L. Lane.

* * * *

The American Film Service, Chicago, have incorporated with a capital of \$2,500 for the purpose of manufacturing moving picture machines and parts. Directors: Leo Schoenbrim, Joseph Burke, Charles Lederer.

* * * *

The National Cameraphone Co., New York, have been incorporated to manufacture moving picture machines, sound machines, give exhibitions, etc. Capital, \$150,000. Incorporators: James A. Whitman, Francis Fitch, Arnold F. Wainwright, 42 Broadway, New York, and others.

* * * *

The Solon Vendophone Co., Armour, S. D., a foreign corporation, has filed a certificate of incorporation with the Secretary of the State of Wisconsin. Capital, \$25,000. The principal place of business, Superior, with W. F. Albright as agent.

* * * *

La Compania Edison Hispano-Americano (phonographs), Newark, was incorporated last week with the Secretary of State of New Jersey, with a capital of \$25,000. Incorporators: John E. Heim, Hugo Boepple, Jr., John G. Van Blarcom.

* * * *

The Van Phonograph Co., Cincinnati, O., have incorporated, with a capital of \$10,000. Directors, Herbert Van Cleve and others.

NEW LINE OF MACHINES.

We hear rumors about a new line of disc talking machines shortly to be offered to the public by a well-known and established firm. New mechanical features of high merit distinguish the models. We expect to have more to say on this subject in the next issue of The World.

BLACKMAN'S SPECIAL OFFER.

FREE

WE ARE GIVING AWAY SAMPLES OF GOODS YOU NEED AND SELL AT A BIG PROFIT

DON'T LOSE YOUR CHANCE

WE have a number of Talking Machine Specialties that we manufacture and sell to JOBBERS and DEALERS. We KNOW they are the BEST but we want YOU to know it. We will stand the expense.

WE TAKE ALL THE RISK

If you are a QUALIFIED Jobber or Dealer and fill in coupon below we will send you samples of our specialties ABSOLUTELY FREE. DO IT NOW.

If you find our specialties are all we claim, we win your confidence in them, but we don't stop there.

Orders will be filled on the "MONEY BACK" plan to insure ABSOLUTE SATISFACTION. Fill in coupon now.

BLACKMAN TALKING MACHINE CO., 97 Chambers St., New York.

Date,190....

Gentlemen:

As per your "Special Offer," please send FREE SAMPLES. I am a handling Fill in Jobber or Dealer.

EDISON, VICTOR, ZON-O-PHONE, COLUMBIA.

Cross out machines you don't handle.

Yours truly,

NAME..... ADDRESS.....

BEKA RECORD

THE BEST and CHEAPEST DISC

IN THE WORLD

*The largest and most Comprehensive Repertoire which has
ever been compiled, in*

GERMAN**ENGLISH****FRENCH****ITALIAN****PORTUGUESE****RUSSIAN****AUSTRIAN****HUNGARIAN****DANISH****SWISS****DUTCH****SPANISH****CHINESE:**

SWATOW

GUAKAU

PEKINESE

SHANGHAI

KIANGNANESE

CANTONESE

ARABIAN**TURKISH****HINDUSTANEE:**

URDU

MARATHI

GUJARATHI

HINDI

TARSI

TAMIL**MALAYIAN****INTERNATIONAL CATALOGUE****(224 Pages)****GRATIS***(See description in pages 23 and 24 this issue)***UP-TO-DATE ADVERTISING****CORRESPONDENCE INVITED****Beka Record, G. m. b. H. Berlin, Heidelberger Str. 75-76****SOLE AGENT FOR GREAT BRITAIN AND COLONIES****O. RUHL, KIMBERLEY HOUSE, 6 and 7 REDCROSS ST., LONDON, E. C.**

FROM OUR EUROPEAN HEADQUARTERS

69 BASINGHALL STREET, LONDON, E. C., W. LIONEL STURDY, MANAGER.

TRADE HAPPENINGS IN ENGLAND.

Review of the Trade Situation—Cycle Dealers Not Doing Their Duty to the Industry—British Sonogram Co. to Make Double Sided Records—Popularity of the White Record—Russell Hunting Co. Branching Out—Seymour Specialties—Decision in Edison Bell vs. National Phonograph Co. Litigation—Columbia Staff Changes—Visitors to Leipsic Fair—Plan for Permanent Talking Machine Exposition—Battistini Latest Gramophone Recruit—Other News of Interest.

(Special to The Talking Machine World.)

World Office, 69 Basinghall Street,
London, E. C., England, April 5, 1907.

The London talking machine trade is not in a very flourishing condition, the majority of dealers and factors reporting business as quiet during March. This is apparently not attributable to anything in particular, yet be it recognized that the cycle dealer knows more about it than any one. He will tell you that there is no demand for records, the season is over and so forth. It must be so—it is so, he has spoke! And all we can do is to take up the pen in corroboration—more or less. I prefer the "less." Unfortunately the talking machine trade cannot at present be independent of cycle dealers collectively, but there will come a time—and in the not far distant future, too—when this class of shopkeeper shall be cut off the books as unfit to handle musical goods. "Unfit" in more senses than one. They are in the first place bad payers, cause a lot of trouble to the factors, while, as a rule, they are not too well educated, and in the majority of cases lack the essential elementary musical knowledge to sell records, however good a salesman they may be of cycles. And is it to be supposed that the record enthusiast could tolerate being served by such tradesmen who often wait upon a customer in their dirty greasy overalls straight from the workshop? No, he demands to be served by a man decently clad, who is au fait with all the latest selections listed by the various companies; in fact, the talking machine salesman of the future must of necessity be associated in more appropriate surroundings than that usually obtaining in cycle shops.

At the American Talking Machine Co., I was recently discussing this matter with Mr. Nottingham, who advanced some pertinent views along

the above lines. At the same time objection is taken to the man who mixes up tar, soap, shaving, etc., with the sale of talking machine goods. With the object of eliminating these jugglers in ordinary to all and sundry trades, Mr. Nottingham is shortly convening a meeting of factors to decide upon the best means of protecting the genuine dealer from such and other shopkeepers who stock a few records and obtain to order only. Said my informant: "To have to pay carriage on and supply a dozen or so records, not only entails loss of valuable time, with small financial benefit to us, but is grossly unfair to the dealer who makes a good show and sends large orders, and who, in a great number of instances, occupies premises a few doors off the man in question, who very often cuts prices as well. The chief firms have been approached upon this subject, and it is to be hoped that an agreement will be come to, to supply not less than a fixed quantity and at fixed prices. The effect of such reforms means the saving of considerable trouble and office expenditure, and the trade all round will attain a much more satisfactory condition by giving encouragement and protection to legitimate and enterprising dealers."

A New Double-Sided Disc.

The British Sonogram Co., Ltd., are the pioneers of yet another disc double-sided record, priced at 2 shillings. It is flexible and unbreakable, and can be sent through the post in just an ordinary envelope without any risk whatever. A good and varied repertoire by the best talent obtainable will be provided. The directors of this company include many well-known men, among whom may be mentioned Paul Mellerio as managing director, late of the British Zonophone and Gramophone companies; Mr. Hans Knudsen, of liquid air fame, will act as consulting engineer, while G. H. Burt will manage the works. The latter gentleman is perhaps better known in America, where he founded the Burt Co. some years ago. Others associated are D. J. Rees; secretary, Mr. J. Dempsey; sales manager, Mr. Sidney Smith; musical director, whose reputation as a composer and conductor is well known. The company have a fully equipped and up-to-date factory at Stockport, and it is their intention to secure London offices in City Road.

Edison-Bell Co.'s Latest Productions.

The Edison-Bell Co. announce that they will have ready shortly four new types of phono-

graphs, which will be manufactured in their own premises. No. 1 will run two records, No. 2 four, No. 3 six and No. 4 ten records at one winding. The retail prices are £1 15s., £2 10s., £3 15s. and £4 15s., respectively. The "Gem" and "Standard" makes will be continued.

Novel Development of the Recording Art.

There is an action pending affecting a large motor bus company who have refused to accept a number of new buses from the manufacturers on the ground that they would not be licensed to run on the streets, owing to the very excessive noise made in running. In order to judge of the noise difference between these and other buses, Mr. C. R. Johnstone, chief of the Edison-Bell recording staff, recently took records both in and outside of a number of buses at midnight on the high road not ten miles from London. The results were eminently successful, and the records will be put in as evidence at the trial.

The "White" Record for Canadian Dealers.

In conversation recently with James H. White, of the General Phonograph Co., he said: "In the last issue of The Talking Machine World you gave currency to the fact that we are receiving large orders from Australia for the 'White' record, I may say the extent of the order was far in excess of the number mentioned, which is significant of the fact that our special bid for the foreign and colonial trade has brought us much business. It may interest your readers to know that we have closed a contract with a large German firm to supply no less than one million records at the rate of 20,000 per week. This agreement will entitle the firm in question to supply the demand in both Germany and Austria. We shall ourselves supply direct to all other countries, and we especially invite application from Canadian dealers who do not handle the 'White' record. The preferential tariff allows of export, and we can supply to any extent. I am confident there is a good field in Canada for cylinder record trade, and if necessary we shall send a representative to break ground in all the provinces, as the 'White' record provides a fair margin of profit to the trade." Apart from the cylinder record, the General Phonograph Co. will shortly have their "Phono Disc" ready, and have also started manufacturing a disc machine, which, from personal test, proved itself most reliable. The motor is well made, and will run two 7-inch or one 12-inch record at one wind.

THE NEW REX RECORD CO., LONDON

Offer a British made Record at a price which will command trade. It secures preferential tariff in all British Colonies. Get into touch with this line for future trade.

PARTICULARS FROM

THE NEW REX CO., 261 Liverpool Road, LONDON, ENGLAND

GEO. DYER, Sec.

PATHÉ FRÈRES—LONDON
PATHÉ FRÈRES—LONDON

PATHÉ'S DISC

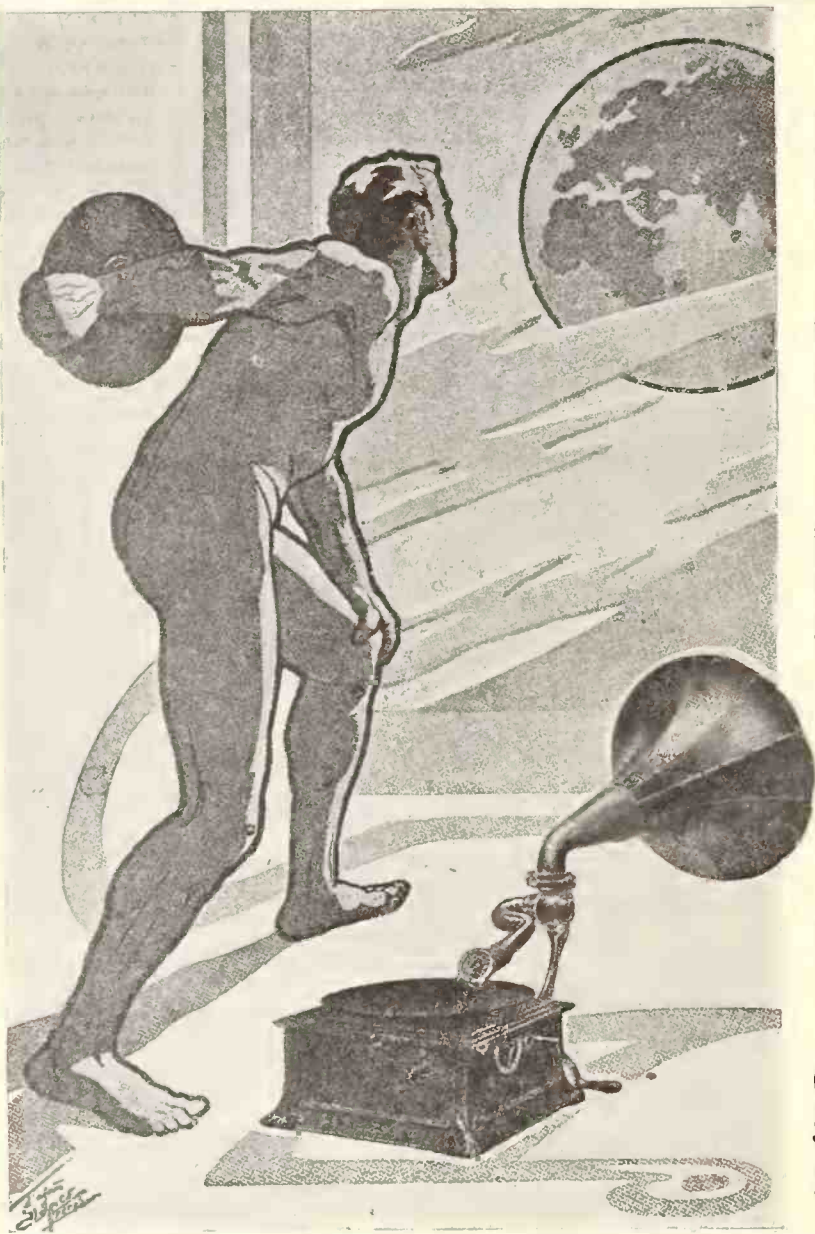

ONCE YOU HAVE HEARD
PATHÉ'S DISC YOU WILL
 NEVER BUY OTHERS.

PATHÉ'S DISCS ARE PLAYED
 WITHOUT A NEEDLE, HENCE THEIR
 GREAT SUPERIORITY.

THE TIME FOR FANCY PRICES
 FOR DISCS IS PAST WE GIVE YOU THE
 GREATEST STAR ARTISTES AT ONE
 UNIFORM PRICE, 3/- PER DISC.

THE GREAT SUPERIORITY OF THE
PATHÉ DISC IS OBTAINED BY
 USING A SAPHIRE POINT, THERE
 IS NO CHANGING THE NEEDLE,
 GIVES THE NATURAL VOICE.

PATHÉ'S RÉPERTOIRE
 CONTAINS OVER 20.000
 SELECTIONS DRAWN FROM
 ALL PARTS OF THE WORLD.

PATHÉ'S PHONOS

LONDON WAREHOUSE, 14, 16, 18, LAMBS CONDUIT STREET (W.C.)
 LONDON RETAIL SHOWROOMS, 64, REGENT STREET, LONDON (W.)

PATHÉ FRÈRES—LONDON
PATHÉ FRÈRES—LONDON

FROM OUR LONDON HEADQUARTERS—(Continued.)

The case is round and made of metal, the sound-box, fitted with a permanent sapphire pointed needle, reproduces a full and rich tone, and a special attachment is provided to play gramophone and other needle cut records, while the tone arm is surmounted by a prettily shaped flower horn of an exclusive pattern. The whole outfit retails at the extraordinary low price of £2, and shows a good profit for the dealer.

Russians Enjoy the Gramophone.

A Russian cruiser squadron recently paid a two days' visit to these shores. At the invitation of the King a select party of sailors journeyed to London sightseeing. In the afternoon a visit was paid to the Hippodrome, and what most interested the sons of the sea was the animated pictures and gramophone, so said a sailor visitor in conversation with a Daily Mail representative.

New Talking Machine Novelties.

Fr. Rauth's announcement (elsewhere) contains particulars of some fine talking machine novelties and accessories. He is also advertising cheap disc machines for export and genuine recording and reproducing sapphires. The Lyra-phone double-sided disc record, which Mr. Rauth is handling in this country, is well supported by up-to-date dealers, who appreciate the advantages of these full-toned records, which provide a repertoire of an international character.

Russell Hunting Co.'s New Building.

By the time this is in print the Russell Hunting Record Co. will be housed in their new building at 13, 15 and 17 City Road, some particulars of which I shall give in our next issue. For the present the company announced a very special Welsh list of records, which are considered the best ever made. "Lilley," for titles, the well-known Cardiff (Welsh) factor, has placed the largest order received from the English factors. He writes in regard to these Welsh records: "Sales booming, everybody delighted and enthusiastic." Ted and Mary Hopkins and Tom Owen—three very successful and popular Welsh

comedians—are at their best in these records, while Mr. David Brazell, baritone, records three of the popular Welsh selections in the native vernacular. There are also Welsh airs by Hunting's concert, and the Imperial Infantry bands. All fine sellers.

Seymour Phonograph Specialties.

F. M. Russell & Co. have issued a very neat and comprehensive catalogue of the "Henry Seymour" phonograph specialties, covering reproducers with various diaphragms, recorders, amplifying horns, tone analyzers, sound-tight joints, machine sundries, etc. The difference between the trade and retail prices show a fair margin of profit to the dealer. Anent the "Seymour Indestructible Record," I am authorized to say that the many difficulties which arose in equipping their temporary factory in Clerkenwell have been successfully overcome, but that the trade must not expect to be fully catered for until more plant has been laid down at the company's larger works in Willesden. We are now engaged in fitting up these works," said Mr. Palliard, "but until they are completely equipped we shall not possibly be able to meet the demand. This, judging from the enormous number of inquiries which we received even prior to the issue of our samples to the trade. The price of this indestructible record is fixed at 1s. 6d. In our next issue further particulars will be given.

Referee to Assess Damages in Edison-Bell Suit.

The case of the Edison-Bell Consolidated Phonograph Co., Ltd., plaintiffs, versus the National Phonograph Co., Ltd., defendants, in the High Court of Justice, Chancery Division, has created quite some attention in the trade. The cause of this action arose in consequence of a circular issued by the defendants on the 13th of September, 1905, of which the following is a copy:

"TO ALL FACTORS—MISUSE OF NAME 'EDISON.'

"In consequence of the misunderstanding that has arisen in the confusion of trade names The National

Phonograph Company, Limited, who are the sole owners of Mr. T. A. Edison's autograph trade mark and the sole distributors in this country of his genuine phonographs and records, hereby give notice that they cannot supply their goods to any dealer who is handling or continues to purchase goods made in imitation of genuine Edison manufactures. To prevent misconception it is necessary to announce that this Company has no connection whatever, directly or indirectly with any other company in this country, and that no other firm has any right to the use of Mr. Edison's name, trade mark and present manufactures.

"THE NATIONAL PHONOGRAPH CO., LTD.,

"JAS. H. WHITE, Managing Director.

A writ was issued by the plaintiffs on the 21st of the same month, the claim being (1) a declaration that the plaintiffs are entitled to use the name 'Edison' in connection with their phonographic goods, subject only to the restrictions on such user imposed by clause 2 of an agreement dated May 6, 1904; (2) an injunction to restrain the defendants from publishing, issuing or circulating any circular, or other advertisement, calculated or intended to induce the belief, and from otherwise representing that the plaintiffs are not entitled to use the name 'Edison' subject to the said restrictions; (3) damages; (4) costs.

This action came for trial before Mr. Justice Neville on Friday, the 22d of March, and lasted until Monday, the 25th, on which day his lordship gave judgment in the terms stated below:

Counsel for plaintiffs stated that both they and their predecessors had, since 1892, used the name of Edison-Bell, under an agreement with Mr. Edison. Mr. Edison was a shareholder in the defendant company, which was registered with a capital of £100, and was an American company.

For the plaintiffs, Mr. J. E. Hough, manager, gave evidence as to the right of the company to use the name, and the consideration paid for such right by the predecessors of the present company, namely, £40,000, and also as to the injury to the plaintiffs' business caused by the

HAVE THE BEST

Canadian dealers and jobbers should bear in mind,

The "White" Record

IS

BRITISH MADE

and by purchasing this record they benefit by the preferential tariff.

Stock this record and increase your sales.

The "White" Record has merit, and the large sales are the best evidence of this.

JAS. ANDERSON

**255-257-259 Clarendon Street
SO. MELBOURNE**

SOLE SELLING AGENT FOR AUSTRALIA



Retail Price 1/- Each

LATEST TITLES

ALL GOOD SELLERS

- 162 John, go put your trousers on
WILL DANBY
- 163 Cheyenne
PETER DAWSON
- 164 Two dirty little Hands
MARIE BLYTHE
- 165 I Love a Lassie
HECTOR GRANT
- 166 In dear old Georgia
PETER DAWSON
- 167 Funny Tales
JOHNNY WAKEFIELD
- 168 The Bellman
ARTHUR GILBERT
- 169 Home again, my Cherry Blossom
WALTER WEBSTER
- 170 Au Revoir, my little Hyacinth
WALTER WEBSTER
- 171 Women get the best of it
JOHNNY WAKEFIELD
- 172 Where, Oh Where
WILL DANBY
- 173 Galloping Major
WILL DANBY
- 174 Whispering of the Flowers
EMPIRE MILITARY BAND
- 175 The First Quarrel
YOLA NOBLE & WILL DANBY
- 176 I wish I had someone to love me
HECTOR GRANT

Send your name and address for prices and terms and all particulars.

THE GENERAL PHONOGRAPH COMPANY, Ltd., 26 Euston Building, Euston Road LONDON, N. W., ENGLAND

FROM OUR LONDON HEADQUARTERS—(Continued).

issue of the said circular. Several of the plaintiffs' factors also gave evidence to the effect that they understood and fully believed that the circular referred to, and was aimed at, the Edison Bell Co. and their products, and indeed referred to them and no other. A number of witnesses who were called stated that they had been induced by the circular to withhold orders from the plaintiff company, but admitted that the real Edison goods were sold by the defendants.

For the defense Mr. Croydon Marks, who is a director of the defendant company, and the attorney in Great Britain of Mr. T. A. Edison, alleged that the circular was not intended to, and did not, in fact, refer to the Edison-Bell Co., but was intended to be applied to various wrongdoers who duplicated records, and who used the name "Edison" as applied to their commodities, electric rings, bicycles and the like.

Mr. Marks also stated that the circular was drawn by himself in conjunction with Mr. White, the then managing director of the company, but was issued by Mr. White during his, the witnesses' absence from London; in fact, three or four days after he had left England for America, and upon receiving a copy of the same while in New York, and after consultation with Mr. W. E. Gilmore, it was decided to cable to England to withdraw the circular, which was accordingly done, the circular being withdrawn on the 22d of the same month.

The learned judge, after having heard the counsel for defendant in reply, intimated to the plaintiffs' counsel that he did not require him to reply on the case, and proceeded to deliver judgment, in which he stated that the plaintiffs were entitled to judgment on all issues, and were entitled to an injunction against the defendants, who, although they had withdrawn the circular, had not withdrawn the innendo, or definite statement that the plaintiffs were not entitled to the use of the name "Edison."

He also found that the circular was libellous and malicious, and that the plaintiffs were entitled to substantial damages, irrespective of the absolute proof of such damage, but that he would not assess damages, it being a matter which should and must come before an official referee for assessment. He also directed that the defendants must pay the costs and refused the application of the defendants' counsel that the payment of costs must depend upon the assessment of damages, as he found that whatever amount should be assessed the plaintiffs had in fact sustained damage and the costs must be paid by the defendants.

Various rumors have been floating about as to the amount of damages claimed by the plaintiff company. Having made inquiries I find that no specific amount for damages was claimed, that being a matter which must be left for the assessment of the official referee, who will be duly appointed.

Some Columbia Staff Changes.

The Columbia people have enlisted the services of H. T. Bristow, who has hitherto represented

the Neophone Co. in the Eastern counties. The late export manager of the Neophone people, T. F. Bragg, is another recruit to the Columbia Co., who have given him the superintendence of their shipping department.

The position of assistant manager of the London branch of the Columbia Phonograph Co., vacated by C. J. Hopkins, whose removal to Buenos Ayres, we announced last month, has been filled by the appointment of W. E. Hanshue.

The managership of the office graphophone department of the Columbia Phonograph Co. has been put into the hands of W. Pike, lately with the F. E. Potter Advertising Agency. The extensive acquaintance with London business houses gained by Mr. Pike while with his old firm will stand him in good service in his new position.

A Remarkable Record.

A leaflet, which the Columbia Phonograph Co. are issuing to users of their records, calls attention to a most attractive composition by Francis Popy, entitled "Whistling Pierrettes Polka." This is recorded in splendid style by the London Military Band on Columbia cylinder and disc records Nos. 201,440 and 25,958, respectively. The piece is quite exhilarating, and has all the charm of novelty, some original effects being secured by very pretty whistling passages. It evokes such admiration wherever performed that the Columbia Co. are publishing this special leaflet lest any users of Columbia records should overlook the number.

The Leipzig Fair.

According to reports which I have received, the annual fair at Leipzig was a complete success in every way. Business during the week maintained a good average in comparison with previous seasons, but there were not so many talking machine novelties in evidence as has hitherto been the case. Among the important buyers who attended the fair were: George Murdoch and Ronald Fulton (J. G. Murdoch & Co.), Louis Sterling (Russell Hunting Record Co.), F. W. Nottingham (American Talking Machine Co.), Max Samuel and Mr. Balcombe (Barnett, Samuel & Sons), Mr. W. Herzog (New Polyphon Supply Co.), Swaine Stoddart (Parker Phone Co., Bradford), Mr. and Mrs. Charles Duwe; Mr. Ross (J. J. Stockall & Sons, Ltd.), O. Ruhl (Beka Record Co.), Mr. Harris (Harris & Co., Dublin), E. C. Paskell (Colmore Depot, Birmingham), and I. Lyon (Lyon & Co., City Road, E. C.).

Columbia at the University Races.

The Oxford and Cambridge University boat race presented an opportunity of forceful advertising which the Columbia Phonograph Co. did not allow to pass. The thousands of persons who had gathered to watch the fortunes of the rival blues were regaled for an hour and a half before the race by a lively graphophonic entertainment. The Columbia people had secured a launch, on which they carried some of their

We have

taken this space to tell you that we are specialists in all and everything appertaining to the TALKING MACHINE INDUSTRY, from a complete outfit to the smallest accessory.

Our 72-Page Catalogue

(sent free on receipt of trade card) is conceded to be a complete cyclo-pædia of the trade.

OUR PRICES WILL SURPRISE YOU!

We want

a responsible firm in each country to carry samples and represent us on commission. Applications should cover references. We are the largest and oldest exclusive talking machine house in Europe.

American Talking Machine Co.

**31 Tabernacle Street,
LONDON, ENGLAND**

typical models and a supply of records. Flags and streamers were gaily displayed, announcing to the vast assembly the name of the firm and its specialities. Two graphophones were kept playing on the launch, the sound-magnifying "Premier" and the "Regal," the one at the stern, the other at the bow, confusion being avoided and two audiences reached simultaneously by turning the horns in different directions. Up and down the Thames, first on the Surrey side, than on the Middlesex, the Columbia craft made its way to the accompaniment of expressions of approval shouted from the banks. All the arrangements were in charge of W. E. Hanshue, the new assistant manager of the London branch, who is to be congratulated on the very successful carrying out of an impressive bit of advertising.

Proposed Talking Machine Exhibition.

The other day we met J. Lewis Young, who is well known on this side of the water as one of the pioneers of the talking machine business, and whose ready pen is so frequently used to help along the talking machine industry. He informed me that he had been endeavoring for a considerable time to so arrange his affairs as would give him time to develop a scheme which he has had in mind for the last three years, namely, the installation of a permanent talking machine exhibition in London, and he has just got an option on some large premises in Pholand, otherwise City Road, with a floor space of nearly 30,000 feet. The building is eminently adapted for the purpose, is being lighted by electricity, a passengers' lift is being put in, together with heating apparatus. The total cost of this alone being \$10,000, while the rental of the building is \$7,500 per annum, but as the exhibition will be held under Board of Trade regulations it is believed that there will be only the local taxation in addition to the rent.

It is well known that in nearly all the German towns there is a building controlled by the gov-

No Fakes**SAPPHIRES**

Guaranteed Genuine

Recording and Reproducing
Shaving Knives, Etc.Edison and Columbia Types
Needles

All Accessories Made to Order

**CHEAP DISC MACHINES
FOR EXPORT**Lyrophone Disc Record, only
double-sided International
Repertoire

Specialty: Hebrew Records

Apply
to**FR. RAUTH, 9 Christopher St., LONDON, E. C.**

MANUFACTURER OF DISC RECORD ALBUMS

12x10 inch Flower Horns, Shaded; 13 x 11 inch, etc., also in Brass; and all the other articles advertised in last copy.

FROM OUR LONDON HEADQUARTERS—(Continued.)

ernment, which is called a Muster Lager, in which is to be found the manufacturing products of that particular town, and it occurred to J. Lewis Young that as there is not among the trade such confidence in the business as the capital invested in it should command, such an exhibition as he proposes would go far to impress all concerned of the wide scope and importance of the industry.

He says that very frequently when he meets a man whom he has not seen for some years, and he is asked what he is doing, and he replies, "Still doing something in talking machines," he generally hears a remark to this effect, "Oh, I thought that had all petered out long ago." This is not as it should be.

Further, the exhibition will be for the trade only, and it will be of an international character. Lewis Young, who will shortly be able to take the matter up, will act as curator or president, and will afford to inquirers every information necessary.

The exhibition will be controlled by a council of manufacturers and factors, and others interested in the trade, and it is intended that only firms who are actual manufacturers will be able to exhibit as such, and any firm who is found duplicating or stealing other firms' records will not be permitted to exhibit or to have a location in the building.

Information of interest to the industry will be sent to all manufacturers, factors, dealers, shipping houses, etc., and efforts will be made to interest a better class of dealers than now exists in this country. Also to induce the dealer to pay more attention to his stock and provide himself with goods in a business-like way, and not as is now done by thousands of dealers who just stock a few records and procure goods to order only. Nothing will be sold at the exhibition, and it will be the aim of the council to make the exhibition of such a benefit to the trade, that any manufacturer producing a new article will only be too anxious to have it exhibited in the councils exhibition.

Lewis Young rightly says that London is the Mecca of the world, that the talking machine is an international article, and derives its charm from the fact that it is not confined to any particular language or music, therefore, there cannot possibly be any sentimental objection to an exhibition of the character he proposes. He says he has devoted 20 years of his life to free trade in talking machines, and it was not until such free trade came about that the business became anything worth talking about.

He also says that he, like a great many other men who are pioneers, has been in the past, greatly misunderstood, because when he says

"free trade" in talkers he does not mean that an inventor shall not have the benefit of his invention, but he says that he objects most strongly to an inventor getting the monopoly of an article and then refusing to supply it to the public or to act in a reasonable and business-like way in connection with his invention. Twenty-one years ago he dedicated his life and his money to the talking machine, as he believed in it, and he does believe in it now, but he has had a very hard road to travel and has several times fallen, as it were, by the way, but he is optimistic, and all he has striven for has come about, and he further believes that this exhibition idea is the best scheme of his life, as it will benefit the manufacturer, the factor, the dealer and the buying public.

In fact, he says, that having regard to the support he has already received, that if he opened the exhibition to-morrow there would be such an immense press boom that it alone would be worth all the money that has been expended in promoting the affair. As before stated, it is understood that nothing will be sold at the exhibition, and no orders taken. It is to be purely a standing advertisement of the industry, and is intended to create a great impression and introduce the goods.

The building is being prepared and unless some unforeseen circumstances occur it will be licked into shape in the course of a few months, and as the talking machine business here is a season's one, he hopes to have everything prepared by September next, and then to work the press for all it is worth, and so make the running for the talking machine trade for the season. Mr. Young's address is 69 Fore street, London, E. C., where any communications on this subject will find him. He rightly says that the affair cannot be organized without trouble and expense, and provided the latter is not too great for his pocket, there is every prospect of the success of the scheme.

A Pathetic Communication.

There are many homes where the talking machine is held in peculiarly tender regard because of its ability "to reproduce the sound of a voice that is still," just as the photograph recalls the vanished face and form. An affecting instance is furnished in a letter recently received from a Welsh miner by the manager of the Columbia Phonograph Co.'s Cardiff branch. The communication proceeds: "I suppose you read about the disaster that occurred here, in which six men were killed. My stepson was one of them, and a fortnight ago my brother-in-law died. I wish to have a cylinder machine because my son and brother-in-law have sung on records, and I can hear their voices again at home by having your

Columbia Jewel graphophone in my home."

To Use for Lectures.

An office graphophone has recently been sold by the Columbia Co. to a Birmingham gentleman for use for lecturing purposes in conjunction with a limelight lantern.

Gramophone Progress.

Signor Battistini, the famous baritone, is the latest gramophone recruit. His records have proved a great success, and are said to be only equaled by Caruso. The marvelous range of voice and dramatic power displayed by this wonderful singer were greatly applauded at Covent Garden recently. The recording is all that one could wish, and the series of thirteen records give the public an opportunity of hearing Signor Battistini in some of his finest moments. We will print later a portrait of the great singer in his picturesque native costume. The whole thirteen records are 12 inch, and price at fifteen shillings each.

Reminder of Hook of Holland Disaster.

The sad disaster by the Hook of Holland has been reflected in several communications received by the Columbia Phonograph Co. in this city. Some few of the passengers and crew of the ill-fated "Berlin" apparently were users of the graphophone or interested inquirers, and letters addressed to them have been returned indorsed with the brief yet pregnant phrase, "Lost at sea," or notes have been received from other members of the victims' families, conveying the somber news at greater length.

Russians Afraid of the Columbia Record.

The talking machine is the latest suspect of the Russian Government. Newspaper reports have familiarized us with the arbitrariness of police methods in the Czar's dominions—the forcible entry into private premises in search of incriminating evidence against political progressives and similar behavior. And now the Columbia Phonograph Co. have had an unwelcome experience of official espionage at their Warsaw branch. Through some misapprehension, it was reported that revolutionary songs were being published on Columbia records, and the other Sunday, without any warning, the police pounced down on the establishment, took the manager into custody, and ransacked the stock of records. The search revealed no grounds for suspicion, yet the manager was held under arrest the whole day.

Exhibition of Office Devices.

At the exhibition of office devices and business aids to be held at Olympia from the 4th to the 13th of July next, the Columbia commercial graphophone is sure to attract its full share of attention.

CARL LINDSTRÖM, G. m. b. H.

BERLIN

LARGEST Continental Manufacturer of All Kinds of

TALKING MACHINES

Best Quality

Best Workmanship

Best Value

Agent for England and Colonies:

O. RÜHL, 6 and 7 Red Cross St. London, E. C., England

To whom all inquiries should be addressed

FROM OUR LONDON HEADQUARTERS—(Continued.)

PRICE CUTTING DISCUSSED.

Some Important Contributions on This Subject from Mr. Manson of the Russell Hunting Co. and Lewis Young—Both Advocate a Firm Attitude Against Price Cutters—Co-operation Also Essential—The Prices of Supplies.

(Special to The Talking Machine World.)

World Office, 69 Basinghall Street,
London, Eng., April 3, 1907.

The crusade against price cutting started in our last issue has attracted widespread interest throughout the trade. Leading members of the trade expressed some very pertinent opinions, and—hereunder we present some more. If the stability of this industry is to be preserved, fixed prices must be adhered to. All are agreed upon this vital matter, and it but remains for two or three of the prominent manufacturers to take the initiative in the formation of a better means of protecting trade than now existing, to put the industry on a firmer basis to the benefit of all.

Mr. Manson's Views.

W. Manson, the genial assistant manager of the Russell Hunting Record Co., writes as follows concerning the very prevalent practice of cutting fixed prices:

"The attitude of my company toward price cutters is most conclusively shown by the legal actions which we have so successfully taken against many of these pests. I see that some of the other manufacturing companies are also taking steps to stamp out a practice, which, if allowed to continue, would make it impossible for the honest dealer to get a living. In view of the success which individual companies have met with in their endeavor to insure dealers getting a good working profit out of talking machine records, I should be glad to see a combination of manufacturers formed, specially to deal with this question. It would then be possible to devise such a course of action as would effectively nip in the bud any attempt of pettifogging shopkeepers to indulge in such an unscrupulous method of attracting trade from their competitors. Talking machines and records have become so deservedly popular that it would be a thousand pities if the trade were to be upset by a handful of men who cannot build up a business by legitimate means. The Russell Hunting Record Co., Ltd., is determined to uphold its rights, and at the same time to protect those dealers who maintain the proper selling price of 'Sterling' records. Our efforts have created that feeling of confidence

which is absolutely necessary for the development of trade, and we have received letters from numbers of dealers throughout the kingdom, congratulating us upon the firm stand we have assumed, and upon the success which has attended us in the actions we have undertaken, and they further state that it has given them heart to keep large stocks of 'Sterling' records, and to work all they know to bring the merits of our product under the notice of the public."

Some Interesting Views by Mr. Lewis Young.

"England is a country by itself, its laws and its people have all been bred, born and nurtured in freedom and in all transactions, whether it be in private life or in business, which has any resemblance to restraint, it is resented, and it has often been said by foreigners that they in business would just as soon take an Englishman's word as his bond, and this is no more strongly exemplified than the conduct of the British in India, where the confidence in the Englishman is so great that there was instituted a system of 'chits,' which is a great convenience to everybody. The system of checks again exemplifies the confidence which one business man has in the other.

"I remember when I was in business in Amsterdam some years ago not one firm in fifty that I did business with had a check book, whereas in England the smallest firm would never dream of paying actual specie when they could do so with a check. I mention these facts to show the inherent love of the Englishman for what they rightly or wrongly call freedom.

"The Englishman's idea of business is this: 'If I buy, say, a record for 16 cents I have got a perfect right to sell it for 17 cents, and if I am clever enough to run my business so that the one cent profit is sufficient to cover my expenses, it is purely a matter for myself, and not for the manufacturer to dictate to me what I shall do.' It is this view of the case which the dealer takes. He wants to be free and does not believe in the American system of price agreement which savors of a trust scheme which he won't have at any price. He thinks the obligation is on the part of the seller and in all our ordinary business transactions this is so.

"The British shopkeeper, be he ever so big and ever so wealthy, will be found frequently serving customers in his own store, and he does not think it beneath his dignity. He does not also forget to offer his thanks to his customers for their kind patronage. On the other hand the Americans, when they come to London, do

not at all care for the manner in which we conduct our shops.

"The 'floorwalker' and obsequious salesman is all foreign to them, accustomed as they are to roam through their department stores at their own free will, and to practically serve themselves. This latter system largely prevails on the Continent. Certainly all attempts to restrict the man who pays for the goods has failed, and it has been held that the labeling of conditions on goods does not bind the purchaser unless he has actually signed a contract. An eminent judge during the trial of a talking machine case the other day called the labeling practice 'all stuff and nonsense.'

"But I am quite sure that if the dealer were made to realize all the harm he does to the trade when he cuts prices he will generally be willing to act in a reasonable way, but unfortunately the manufacturers have not in the past approached the dealer with a smile and a big stick, but they have generally gone with two big sticks and a few bulldogs, and this to an Englishman and probably to any other man of any nationality, means fight.

"Take the case of one very large sportshouse here which for years stuck out, and is to-day cutting prices of many articles which I feel sure if they were reasoned with they would not do. I feel that the policy of writs and litigation in trade is not a good one. You may succeed with one, but immediately some one else, out of sheer devilment, comes up.

"Another point is this: The lack of harmony between the manufacturers themselves. This is very deplorable, because the remedy for the confirmed price cutter is for all the manufacturers to notify their factors not to supply any price cutter with any goods whatsoever. Of course, the price cutter will try to get them through his friends, but he will soon get tired of this, and will either go out of the business or come into line.

"Further, if we examine the list of price cutters we shall find that they are, as a rule, small people possessed of the peculiar characteristics of the narrow-minded, and who are of the class that we could very well dispense with in our trade, or they are those who make a capital advertisement out of it. I believe that as time goes on there will come into the trade serious people with more capital at command, and who will take a keen interest in the talker from a dilettanti as well as the profit point of view, and these small disturbers of our peace will drop out.

"I have but very rarely heard of price cutting in gramophone goods, and this comes about by the fact that the Gramophone Co. pick and choose their dealers, and if they find any of those dealers doing something which is against the best interest of all concerned they, to my own knowledge, send a representative to talk the matter over and try to arrive at a modus vivendi. In my opinion, price cutting can only be stopped by the co-operation of the manufacturers and the co-operation of factors, and by introducing into the business a better class of dealer altogether.

"It is, I suppose, generally known that in January, 1901, I introduced here the Edison goods, and spent a great deal of time and money in the work. Some little time ago a gentleman connected with the business informed me that he thought I was greatly to blame in the matter of the undesirable handlers—the cycle trade—because I had assisted at the commencement, or, rather, at the renaissance of the business, to bring them into it. My reply was one which can be confirmed by every one in the trade here, that when I started in the business there was not a single firm in Great Britain who bought 300 records at a time. There were no factors or

THE BRITISH BOOM OF THE YEAR!

THE RECORD
THAT'S
HALF AN INCH
LONGER!

"STERLING" RECORDS

The Best Cylinder Record and the Best Selling Record on the British Market. Every record made under the supervision of Mr. Russell Hunting, the original "Michael Casey." Every record a masterpiece of its kind. Send for our list. It is full of novelties.

PRICE 1s.

Liberal Discount for Export

25 CENTS

MANUFACTURED By

THE RUSSELL HUNTING RECORD CO., Ltd.

13, 15, 17 City Road

LONDON, E. C., ENGLAND

Australasian Representative: H. A. PARKER, 19 Hunter Street, SYDNEY

PHILIP NEALE,

PHONO. EXPERT,
5 Chalk Farm Rd. LONDON, N. W.

Talking Machines of every description repaired. Special terms to the trade. City address and price list on receipt of postal. No job too small—no job too large.

dealers in phonographs. The Edison-Bell Co., which had had the monopoly of the business here, supplied, as a rule, direct to the public, and the music trade which ought to have been the natural channel of distribution would not look at phonographs, and I call to mind the many times that even a firm like George Murdock & Co., who now devote a whole building to talking machines, showed Mr. Sinclair, who was then my partner, and myself the door.

"It was at that time heart-breaking work, and when at last we hit upon the idea of selling the goods to the cycle factors we thought we had done the best thing that human beings would do. But what has happened is this, the Gramophone Co. have gone on improving their products, they have been able to show to the music trade that the bicycle man has been doing good business in talkers, and that they have lost the sale of small goods such as flutes and violins through it, and further the music trade, after taking up gramophones, have found out that they can also sell cylinder records, and so to-day there is slowly but surely coming into the business a more reliable, gentlemanly and adaptable man than the cycle dealer. It will be seen at the same time that if the cycle dealer had not taken up the talker the music dealer would not have done so, for the reason that I have before given.

"Perhaps I am getting away from the question of price cutting, but I believe that these remarks taken as a whole have a good bearing upon the subject, and I hope that the day will not be long before manufacturers, both American and Continental, will meet in all friendliness, and make common cause against the price cutter. The talking machine industry has, in my opinion, not commenced, it is only in its infancy. Both the records and machines we have to-day, in my opinion, have not advanced very much, we have the same old wax records that we had in early days, except that the manufacturers have learned that by moulding it it becomes case hardened and gives a better result.

"The same people are making the same discs as they did 10 years ago. It is all old, and that being the case, there must be some room for invention, for improvement, for perfection, and when these attributes of the talker comes about a new era will dawn and machines that we have thought best to-day will be scrapped as were the old 'Bone Shakers' high bicycles and early motor cars. I myself am very pleased to think that

we have not perfected them, because if they were so the business might soon come to an end. But I think it is good enough to go along with as you, Mr. Sturdy, say you are going to send my remarks to your ever interesting paper, permit me to wish to my old friends in what they proudly call God's own country, my hearty good wishes."

Mr. Tobin on Price Maintenance.

"On the question of price maintenance," said Mr. Tobin, "what is wanted is a protective association, formed mainly to look after the interest of legitimate dealers. As it is, the cutters are having a good time at our expense. It will be remembered that last year Mr. Tobin made a determined effort to secure co-operation in forming a retail protective association, but, unfortunately, his trouble met with little response from those best able to help. Nothing daunted he will, in the near future, make a personal canvass of prominent London dealers, from whom he will secure such a demand for redress as will compel manufacturers and factors to provide whole-hearted protection of their interests; and, why not? They can do it in the cycle industry, and, if a little more complicated, the same facilities for protection are offered in the talking machine trade."

TEXAS PHONOGRAPH CO.'S REPORT.

(Special to The Talking Machine World.)
Houston, Tex., April 9, 1907.

At a stockholders' meeting of the Texas Phonograph Co., held last week, a dividend of 3 per cent. was declared for last quarter, payable April 1. The March report of Treasurer Parrish showed an increase of \$4,000 over business of February, over that of the corresponding month of last year, 300 per cent. increase in volume of business. This company has declared quarterly dividends of 3 per cent. for the past three years.

EDISON'S FISHING EXPERIENCE.

While Thomas A. Edison and his wife were fishing in Florida recently Mrs. Edison hooked a shark nearly six feet long. At the first bite the shark nearly pulled Mrs. Edison out of the boat, but upon Mr. Edison coming to her assistance the shark ran with the tackle, towing the boat after him, for some distance until exhausted, when it was dragged into shallow water, where Mrs. Edison's brother killed it with a harpoon.

A NEW DIAFRAM

which combines all the qualities required of the perfect one without the objectionable features.

NO { Blast Rattle Wear Squeak } MORE { Volume Range Natural Sweetness } EMBODYING { Depth of Tone Indestructibility Clearness Uniformity }

An ideal diaphragm which improves any reproducer; adds Volume and Sweetness to a remarkable degree.

Adaptable to any make of Sound Box, whether Disc or Cylinder. State kind of reproducer, Diaphragm is required for. Sample sent upon receipt of 25 cents, or one dozen of one kind or assorted for One Dollar.

ACME PHONOGRAPH SUPPLY CO., Box 682 LINCOLN, NEBRASKA

To SOUTHWESTERN DEALERS

We carry the Largest Stock of EDISON MACHINES and RECORDS and General Talking Machine Supplies west of New York.

CONROY PIANO CO. COR. 11th AND OLIVE STS., ST. LOUIS

FIBRE FIBRE

The "MEGA"

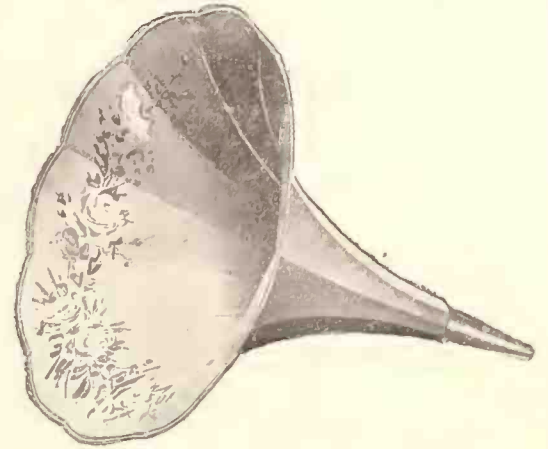

A Distinctive Product for a Discriminating Trade



PERFECT IN TIMBRE

Built on the Principle of the Sounding Board

For general all around satisfaction, the "Mega" is without a peer. Any one of our regular models will convince you our argument is sound. If your jobber cannot supply you write to us direct. We shall be pleased to send you our literature. It will pay you to become acquainted with our product.

THE "MEGA" SCHEDULES

TRUMPET SHAPE

For Cylinder Machines

	Length.	Bell.
Junior "MEGA"	22 in.	13 1/2 in.
Medium "MEGA"	27 "	17 "
Senior "MEGA"	30 "	23 "

Colors

Inside	Outside
Road Cart Red	Tuscan Red
Twilight Blue	Royal Blue
Lavender	Moss Green
Apple Green	Moss Green
Moss Pink	Moss Green

Gold neck—Gold hoop.

RECORDING "MEGA"

Length.....	25 in.	Bell.....	6 1/2 in.
-------------	--------	-----------	-----------

Colors

Tuscan Red.	Royal Blue.
-------------	-------------

Gold-neck—Gold hoop.

FLOWER TYPE

For Cylinder Machines

	Length.	Bell.
Junior Flower "MEGA"	26 in.	16 1/2 in.
Senior Flower "MEGA"	32 "	23 "

FLOWER TYPE

For Victor Machines

	Length.	Bell.
Senior Victor Flower "MEGA"	26 1/2 in.	23 in.

Colors

Crimson	Magenta	Violet
Royal Blue	Old Rose	

Blended inside and outside.

Green neck—Gold stripes—Gold edge.

FLOWER SHAPE, DECORATED

For Cylinder Machines

	Length.	Bell.
Junior Flower Decratd "MEGA"	26 in.	16 1/2 in.
Senior Flower Decratd "MEGA"	32 "	23 "

FLOWER SHAPE, DECORATED

For Victor Machines

	Length.	Bell.
Senior Victor Flower Decorated	26 1/2 in.	23 in.

Colors

Colors	Studies
Carmine	Poppies
Royal Blue	Roses
Violet	Pansies
Ivory Black	Chrysanthemums

(Black in Senior types only)

Gold neck—Gold edge—Gold stripes.

A Type, Style and Price for Every Requirement.



Trade Mark. Registered.

E. A. & A. G. SCHOETTEL MAKERS Broad St., Maspeth, Queens Co., N. Y.



EDWARD LYMAN BILL, - Editor and Proprietor

J. B. SPILLANE, Managing Editor.

Trade Representatives: GEO. B. KELLER, F. H. THOMPSON,
W. N. TYLER, B. BRITAIN WILSON, A. J. NICKLIN.

Boston Office: ERNEST L. WAITT, 278A Tremont St.

Chicago Office: E. P. VAN HARLINGEN, 195-197 Wabash Ave.

TELEPHONES: Central, 414; Automatic, 8643.

Philadelphia Office: Minneapolis and St. Paul:
W. H. PRESCOTT. A. W. SHAW.

St. Louis Office: San Francisco Office:
CHAS. N. VAN BUREN. S. H. GRAY, 240 Sacramento St.

Cleveland Office: G. F. PRESCOTT.

London, England, Office:

69 Basinghall St., E. C. W. LIONEL STURDY, Manager.

Berlin, Germany, CHAS. ROBINSON, Breitestr. 5.

Published the 15th of every month at 1 Madison Ave. N. Y.

SUBSCRIPTION (including postage), United States, Mexico and Canada, One Dollar per year; all other countries, \$1.25. England and her colonies, five shillings.

ADVERTISEMENTS, \$2.00 per inch, single column, per insertion. On quarterly or yearly contracts a special discount is allowed. Advertising Pages, \$60.00; special position, \$75.00.

REMITTANCES, in other than currency form, should be made payable to Edward Lyman Bill.

IMPORTANT.—Advertisements or changes should reach this office by the first of each month. Advertisements arriving too late for insertion in the current issue will, in the absence of instructions, be inserted in the succeeding issue.

Long Distance Telephone—Number 1745 Gramercy.
Cable Address: "Elbill," New York.

NEW YORK, APRIL 15, 1907.

OUR reports for the month past indicate a very satisfactory condition existing in the talking machine industry, and it is believed that if there should come a lull in the general business of the country that this particular trade would not suffer as much as many of the others which we could enumerate. Talking machine men may feel that they rest on about as secure a business platform as any of the trades. The sales of high priced machines would probably drop off materially, but it will be a long time before a business depression would seriously affect the talking machine business. The talkers have a strong hold upon the people.

THERE is in some departments of the trade much difficulty experienced in filling orders promptly. It is impossible to get materials readily, and several of the largest concerns, when discussing these matters with The World this week, remarked that they have been hampered seriously in their factory output through their inability to secure raw materials as promptly as they desired. This is a serious matter, and ultra good times sometimes work out almost as much unhappiness as slow times. The most happiness in conducting a business is really found when times are moderately good. Everyone then is not rushing and crowding to the extent which they are in these busy days. Manufacturers find it difficult to keep up with their orders, and they are constantly compelled to write apologies and explain to their factors the reasons why they cannot send their orders along more promptly.

SPRING business may be said now to be fairly under way with the coming of seasonable weather, and both manufacturers and jobbers are fully occupied in supplying the demands of the trade. It would seem, if the price of metals continues to advance, that substantial raises in the wholesale price of talking machines must be

made. It should be understood that there have been substantial raises in prices of brass, copper and various metals and woods which are used in the construction of machines. Thus far, the manufacturers have refrained from advancing prices, giving their jobbers and dealers the fullest advantage. Whether this condition will continue to remain as at present is rather problematical.

SHIPPERS have experienced considerable delay in the delivery of freight, and the result is not a little inconvenience to manufacturers primarily, and to the distributors and public ultimately. Notwithstanding efforts to overcome this troublesome condition of things, the delays in delivering materials to the factories and goods to the merchant is perhaps as serious as at any time, as the roads seem unable to cope with the great volume of business which is forced upon them. The disposition to control, not always along reasonable lines, and with grave danger of checking their enterprise, together with the intimate relation they bear to financial matters, have united in developing a condition of things which, notwithstanding the existing prosperity, is regarded as a possible menace to the continued commercial and industrial well-being of the country. A hope, however, is entertained that these disturbing influences may not go too far, and the confidence may not be unreasonably shaken.

FORTUNATELY the crops of the country are excellent and the agricultural prospects are more than brilliant. The divorcement between the great West and Wall street has been clearly established, and business outside of those districts directly affected by the financial fluctuations is sure to enjoy good commercial conditions. The consumption of goods of all kinds goes on apace, and the complaint among merchants of all lines, including talking machine men, is still of the difficulty of keeping their stocks full. While in some lines there is unquestionably more promptness in supplying goods, the many back orders placed long ago evidence the unrelaxed demands which are being made upon the factories. Sluggishness in collections is reported in some sections, but there is little serious danger experienced on this account.

A WESTERN dealer writing to The World says: "I am amazed to see the position of the talking machine industry, as evidenced by your splendid publication. To my mind, no talking machine dealer can afford to be without your journal, which gives so much of interest and of value to those whose interests lie along talking machine lines. The development of the industry has been phenomenal, and I believe that it must have been aided very materially by your publication, to which the trade certainly are under deep obligations." We have received a number of communications along similar lines, and it is surprising to those unacquainted with the actual developments of this industry how it has thrived and prospered during the past few years.

IT is of the most vital importance that every man who has invested dollars either in the jobbing or retail trade should keep himself thoroughly posted on all changes and improvements that are constantly being brought out by the manufacturers in these lines. There are brainy, intelligent men, hard at work, developing the talking machine to higher and better things, and

that they have accomplished much is evidenced when we contrast the splendid product of to-day with the crude production of years ago. Then again, there are so many by-products, shall we say, that is, talking machine accessories, which are indispensable to those retailing the product.

EVERY talking machine man should have the latest and best devices which are put forth always in his store. He should be ready to give the customer at any time information along lines which are interesting to his caller, and the only way to do this is to keep in constant touch with trade developments. As one prominent manufacturer remarked: "There is no better way, nor can one gain greater knowledge from any one source, than from The World. It is the only paper in America devoted to the interests of the talking machine men, and it is broadening and increasing its influence with each issue."

THE men who succeed in all business lines today are those who keep in the closest possible touch with improvements and inventions in their line, and if there is a special field which is more productive than the talking machine industry in patented inventions just at the present time, we do not know where to locate it. Look over our record of patents and inventions each month. There is no other special industry outside of the electrical lines that can compare with it. Of course, there are a lot of inventions which are impracticable, which have not been developed up to the correct standpoint, but it is well to know of the bad inventions as well as the good, in other words, to know what everyone is doing in the talking machine industry. Keep in touch with it; keep posted. It will pay.

IT was only recently on a Western trip that a well-known jobber, while looking around for a copy of The World, asked his manager where it had been placed. He replied by saying: "I am never able to keep that paper for more than an hour: some of the boys will always pounce upon it, and when I wish to see it I am never able to locate it." The proprietor remarked: "That condition is a decided compliment to the paper, and if it is so useful to us I think we had better subscribe for half a dozen more copies." So this particular jobber has a number of copies coming to his establishment each month, and the educational force among his salesmen amounts to considerably more than the annual cost to him.

SALESMEN who read and who keep posted on conditions in their own industry are the ones who invariably increase their own income. It is the bright, up-to-date salesman who will win out, and the talking machine industry is aided materially by the influence of an army of young, bright fellows who are engaged in selling talking machines. Most of them know that it pays to watch developments, and to make themselves more valuable to their employers, learn more about the talking machine so that they can represent it in a more intelligent manner and interest their customers in a greater degree. There is no point too small to be overlooked in modern business, because it is a number of these small points when properly presented that make an unsurmountable argument. It is the little things in life that accumulate into the larger ones, and it is the small things in the life of a salesman which, if overlooked, will send him down the hill instead of up to greater prosperity.

NEWS FROM HERE AND THERE.

The Douglas Phonograph Co., 89 Chambers street, New York, have repainted the front of their store and all the signs a brilliant red, picked out in gold, making it one of the most conspicuous places on the street. Prismatic glass has displaced the former plate in the upper part of the display window, throwing a flood of bright light into the interior, and rendering the use of the electric incandescents entirely unnecessary. The company have recently acquired the sole agency in the Greater New York territory for the "Many-Use" oil.

M. B. Romaine, who recently returned from a two weeks' trip West on special business for the National Phonograph Co., calling upon the jobbing trade, will visit the New England States on the same errand at an early date. Subsequently he will probably go South.

As musical director for the International Record Co., Auburn, N. Y., G. Peluso has recorded a large number of fine instrumentals at their New York laboratory. Mr. P. is a well-known musician of many years' standing in the profession, and has been connected with several famous musical organizations. He is also regarded as an expert in instrumental sound reproduction.

At a session of the Grand Consistory of Scottish Rite Masons, recently held in the Scottish Rite Cathedral, New Orleans, La., the National Automatic Fire Alarm Co., of that city, loaned a Victor Auxetophone for the three days' convention. The machine was used during the musical ceremonies, and one of the old members of the order, who had never listened to anything of the kind, made a strong protest when he heard the Auxetophone singing one of Miss C. Morgan's sacred selections, believing there was a woman in the lodge room. The reproduction was so perfect that the majority of the lodge, being from St. Joe, Mo., had to be shown the machine. E. H. McFall, president and general manager of

the National Automatic Fire Alarm Co., believes this to be the best unsolicited recommendation the Victor Talking Machine Co. ever received, and the incident was the general talk of New Orleans at the time, and to which was credited the sale of several Auxetophones that followed on its happening.

John P. Kelsey, the new manager of the Bettini Phonograph Co., New York City, assuming the position March 11, has inaugurated an entire new system of conducting the business, the complete change being effected on the first of the current month. Mr. Kelsey, lately secretary of the Eastern Talking Machine Jobbers' Association, is one of the best-known men in the Eastern trade, his connection beginning with the old North American Phonograph Co., the pioneer concern in the line, and which marketed the first machine invented by Thomas A. Edison, namely, the tinfoil record device. In short, Mr. Kelsey is one of the "old guard," though still reckoned as a man considerably on the sunny side of forty.

A. P. Petit, general manager of the Talking Machine Supply Co., after calling on the trade in the Pacific Coast territory, has started East, and will probably be in New York by the end of the month. He has touched all the principal intermediate points on his way West, and booked a splendid line of orders, goods to go forward immediately. Mr. Petit is greatly enamored with the manner in which the Western talking machine houses do business. Mayhap "A. P." will deliver a course of lectures on this interesting subject some day.

The New Jersey Sheet Metal Co., Newark, N. J., have just issued a handsomely printed catalogue containing illustrations and descriptions of the various styles of horns which they manufacture, as well as other specialties. The volume is destined to interest the trade. The New Jersey Sheet Metal Co. are having a big call for their sheet metal collapsible horn, which

embodies many recent improvements. They report export trade good.

R. H. Morris, secretary and general manager of the American Talking Machine Co., Brooklyn, N. Y., who has been on the sick list for several months, returned to business a fortnight ago. His absence was keenly felt by his associates who cordially welcomed him back to his post of duty, and warmly congratulated him on his recovery, in which The World heartily joins.

The Victor H. Rapke Co., with the redoubtable Victor H., president, has equipped a new factory at 530-538 East 72d street, New York City, for the manufacture of the Rapke collapsible horn, crane and other specialties. They will also have installed a repair department, complete in every detail, for the "diagnosis and cure of sick talking machines." Mr. Rapke has purchased an automobile to gather up his patients in and about New York, guaranteeing to return them in sound condition. John Born, for thirty-two years superintendent of the Western Co., will occupy the same position with the V. H. R. & Co. The main office will remain at 225 East 86th street, the wholesale and retail departments at 1661 Second avenue.

F. M. Prescott, who recently retired from the International Talking Machine Co., Berlin, arrives on April 19 to reside permanently in this country.

At a meeting of the creditors of Sol Bloom held on Wednesday last, a settlement of his affairs was agreed upon. Payment of all indebtedness in full is to be made within twelve months in quarterly payments. As soon as possible the receiver will vacate and Mr. Bloom again assume management of the business.

A taper tone arm and horn has been brought out by a Cleveland, O., inventor for the Edison machines. An effort is being made to have the National Phonograph Co. adopt it officially.

You will find it Profitable

To handle our line of Musical Instruments and Musical Merchandise in connection with your Talking Machine business. Our large 500-page catalogue is free for the asking—send for it at once and get in touch with us. A small investment will put in a good stock. At any rate write, it will prove profitable to both.

THE RUDOLPH WURLITZER CO.

MANUFACTURERS AND IMPORTERS OF MUSICAL
INSTRUMENTS AND MUSICAL MERCHANDISE

Cincinnati and Chicago



Concerning Perfect Records

MR. DEALER:—

A customer may ask you, "What make of record is the best?"

If you are a "Columbia man" you can reply with the incontestable fact that the best records are the

COLUMBIA RECORDS

The reasons are these:

EXPERIENCE in manufacture is as indispensable as genius in invention. The Columbia Company are the originators of the record industry, and consequently **LEAD** in experience.

The **GREATEST** and **MOST ENTERPRISING INVENTORS** in the field are Columbia men, whose genius has produced exclusively for the Columbia, **ALL THAT IS NEW AND UP-TO-DATE**.

OUR FACILITIES ARE GREATEST: the largest talking machine and record factory in existence, and we are the only company operating laboratories in all the great musical centres of the world, resulting in the **BEST** and **GREATEST VARIETY OF MUSIC**.

Through our superior knowledge of the best record material, as well as the art of recording, the **SMOOTH** and **STAY PERFECT QUALITY** of Columbia Records is supreme.

As Columbia Records always receive **HIGHEST AWARDS** when exhibited in competition with all other makes, the superiority of Columbia Records is beyond question.

These arguments are convincing because based on indisputable facts, such as the recent U. S. Circuit Court decision as to the superiority of the Columbia Record-making process.

You can lead the Record business when you deal in Columbia Records.

COLUMBIA PHONOGRAPH COMPANY, Gen'l

Tribune Building, New York

GRAND PRIX, PARIS, 1900

DOUBLE GRAND PRIZE, ST. LOUIS, 1904

GRAND PRIZE, MILAN, 1906

STORES IN ALL PRINCIPAL CITIES

DEALERS EVERYWHERE

IMMENSE STOCK FOR BABSON BROS. HANDSOME NEW BUILDING.

(Special to The Talking Machine World.)

World Office, 195 Wabash avenue,

Chicago, Ill., April 10, 1907.

We present herewith a photograph of the fine new building which Babson Bros. are just com-

ment is the shipping room. The offices will be on the first floor, and the second, third and fourth floors will be given up entirely to stock-rooms. The wholesale record stock will occupy the entire fifth floor. This floor has been de-

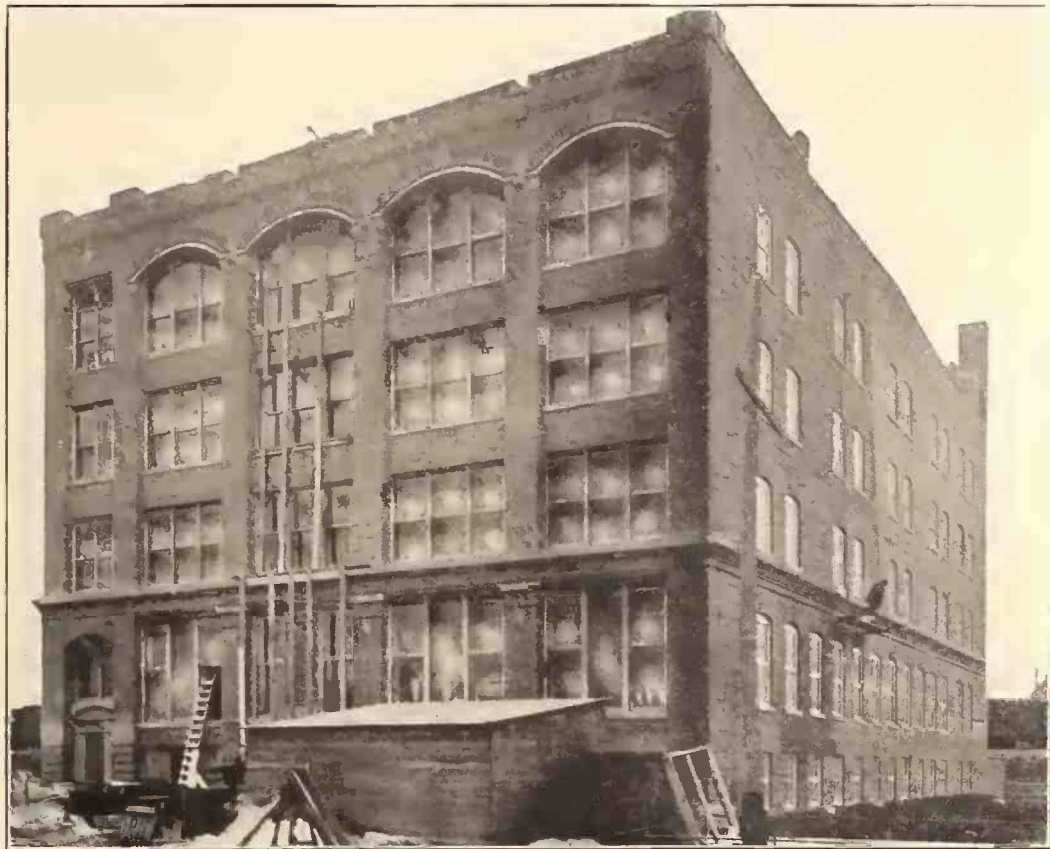

BABSON BROS. GREAT BUILDING, NOW COMPLETED.

pleting at the corner of 19th street and Marshall Boulevard, on the west side, and which is a monument to the enterprise and remarkable progress of the firm who have built and will occupy it. The structure is five stories, pressed brick and stone, 150 by 80 feet in size. In the base-

signed especially for records, and has immense skylights running the entire length of the building. The firm has unobstructed light on all four sides of the building. They also own 400 feet of additional frontage on 19th street, and thus have plenty of room for expansion. The rear of the

building is right on the C., B. & Q. tracks, and the firm have their own private switches in their own yard. The building was put up in less than sixty days by the employment of an immense force of mechanics working overtime. It is of the best and most durable construction throughout, and is one of the largest buildings in the world devoted exclusively to the sale of Edison phonographs and records, something which speaks volumes for the popularity of these goods and for the progressiveness and aggressiveness of Babson Bros., who, in the short period of eighteen months, have built up a business of over a million dollars per annum. The new building will be occupied by the time this paper goes to press, and within one week will be stocked with what they assure me will be the largest stock of Edison phonographs and records ever assembled under one roof.

A special train of twenty cars will leave the Edison factories at Orange, N. J., to-day, April 15, loaded exclusively with over 8,000 phonographs and over a quarter of a million records, in addition to several carloads of horns and cranes, duly placarded with legends describing the character of the cargo, its origin and destination, and will arrive in Chicago the following Friday, going through to Babson Bros. direct. These goods will be placed in stock in the new building before they move in, and thus delay will be prevented in the filling of orders. When all the stock is in place they will carry more than a half million records. The bins for the wholesale stock will be on the fifth floor, and constructed after special designs of G. M. Nisbett, wholesale manager. The bins will have a total capacity of 2,000,000 records. In our next issue we hope to present interior views of this wonderful establishment together with portraits of its proprietors.

The Columbia Phonograph Co. have opened a new store at 421 South Front street, Mankato, Minn., where a large and complete stock of both machines and records will be kept in stock.

Mr. Talking Machine Dealer

If you are located in New England—

We Can Save You Money.

Our facilities permit us to ship goods on first Express after order is received. We **wholesale exclusively**—consequently everything is shipped in original packages as received from the factory—no played-out records, no second-hand machines.

We **manufacture** a number of talking machine accessories among which are our famous Tray Outfits. (If you are not using this system for carrying records in stock it will pay you to write us.)

The **Lynn Record Cases and Peg Boxes** are another of our products.

We also manufacture the **Wentworth and No. 10 Horn Stands.**

Special Lines and Special Prices on Flower Horns.

==== We solicit a trial order. ====

Boston Cycle & Sundry Co.,

J. M. Linscott, Manager

48 Hanover Street, Boston, Mass.

TRADE NOTES FROM CINCINNATI.

Business Satisfactory—Smith & Nixon Growth—Rudolph Wurlitzer Co. Doing a Magnificent Victor Business—Their Methods of Holding Trade—Automatic Department Has Become One of the Most Important in Their Vast Business—Columbia Co. Well Pleased.

(Special to The Talking Machine World.)

Cincinnati, O., April 8, 1907.

The talking machine business in this section is reported as being most satisfactory. Getting stock seems to be a harder problem than disposing of it, and higher priced outfits have the call. The Smith & Nixon Co. report that although somewhat hampered by weather conditions early in the year, the March and early April business bids fair to make a good showing.

The talking machine department of the Rudolph Wurlitzer Co., in charge of Mr. Strief, is having a record breaking trade especially in jobbing the Victor line. Joseph Dittrich, special representative of that department, who covers a broad territory in a thorough manner, is making a splendid record. The plan of the Wurlitzer Co. in placing each Victor record in a separate envelope, thus minimizing the danger of the records being scratched or otherwise damaged, has met with the hearty indorsement of both dealers and customers, especially the former. When a dealer can offer an enveloped record to a customer, the latter feels sure it has not been played over for demonstrating purposes or otherwise abused, and is likely to confine his purchases to the store offering such assurance. It also means that the dealer will have a smaller accumulation of damaged or unsalable stock.

The automatic coin-operated musical instrument department of the Rudolph Wurlitzer Co. also shares in the general prosperity of the house. The several styles of electric pianos ranging from forty-four notes to eighty-three, the Wurlitzer harp, mandolin quartet, the monster military band organ, as well as a smaller style,

and the pianorchestra offer an assortment of money-making devices that should appeal to proprietors of hotels, cafes, stores, roller rinks and resorts of all kinds. The increasing demand for all the above styles well illustrates the growing appreciation of their money-making qualities.

The Columbia Phonograph Co.'s store always presents a busy scene. The popularity of the Columbia line never wanes, and so often do the owners of machines call for new records that almost every customer is known personally to the staff. The heavy selling is in medium and high-priced outfits. The various window decorations and stock arrangements at this store call forth unstinted praise.

HAPPENINGS IN WHEELING, W. VA.

(Special to The Talking Machine World.)

Wheeling, W. Va., April 8, 1907.

The past month is one that will be long remembered by the inhabitants of this valley. We had a flood, not of the proportions we read of in connection with old Brother Noah, but had enough, thank you. It did demonstrate, however, how highly valued are talking machines, as many families lost all their personal property, excepting these entertainers.

Your correspondent visited many parts of the flooded district, and on several occasions was attracted by machines being played from second-story windows. The people were using this method of keeping up their own spirits and those around them. And well they might, for in several instances you could see their pianos floating around in what had been their parlors.

Of course, a visitation of this kind put a decided crimp in business, and collections are particularly slow. The first two weeks of March was marked by particularly good business, so the total business for the month was quite satisfactory.

Bard Bros. have recently closed their Market street store. Since getting their Main street building completely remodeled they found that

the trade could be handled there to a better advantage than to have two stores so close together. The F. W. Baumer Co. were in the flooded district, but their loss amounted to nothing. They had ample warning, and removed their stock to the upper floors. The Peak-Friedel Piano Co. have moved to South Market street, where they have much more room. They are making many improvements, with a view to enlarging their talking machine department. The Columbia Phonograph Co.'s store has been enlarged to accommodate their growing business. Mr. Shortell, the local manager, is well pleased with the growth of same.

VICTOR VS. LEEDS & CATLIN CO. SUIT.

In the case of the Victor Talking Machine Co., Camden, N. J., against the Leeds & Catlin Co., New York, argument was heard in the United States Circuit Court of Appeals, second district, April 9. This is an appeal from the opinion of Judge Lacombe, Circuit Court, rendered January 5. Decision was reserved.

A marked increase in the business of the Columbia Phonograph Co.'s Holyoke, Mass., branch is noticed since they have been in the new quarters on High street. It is much better located for business than was the old store. R. E. Demarest is the local manager.

The Hawthorne & Sheble Manufacturing Co. report their sales of artistic flower horns in March have exceeded any former record. Popular fancy has certainly been captivated by this attractive line.

The Douglas Phonograph Co. recently shipped a full line of Perfection talking machine cabinets to South America, all of them being intended for one style of American machine.

Eugene Reed, of Reed & Reed, Boston, Mass., was in New York Thursday to see Manager Macnabb, general manager of the Universal Talking Machine Manufacturing Co.

TRADE STANDARD MARK	TRADE STANDARD MARK	TRADE STANDARD MARK	TRADE STANDARD MARK	TRADE STANDARD MARK
<h1>NEW STANDARD GOODS</h1> <h2>Mahogany, Golden Oak, Flemish Oak</h2>				
TRADE STANDARD MARK	<p>Largest variety in the market.</p> <p>Best of workmanship to produce the best made horns in the country.</p> <p>No fading in color, no rattle in seams.</p>		<p>Jobbers should handle our line. You are protected.</p> <p>Dealers should write us, and we will write you where to get our goods.</p>	TRADE STANDARD MARK
<p>We Make the Full Line—ALL COLORS, SHAPES AND SIZES</p> <h1>STANDARD METAL MFG. CO.</h1> <p>FACTORY—Jefferson, Chestnut and Malvern Sts., Newark, N. J. OFFICE AND SALESROOM—10 WARREN STREET, NEW YORK</p>				
TRADE STANDARD MARK	TRADE STANDARD MARK	TRADE STANDARD MARK	TRADE STANDARD MARK	TRADE STANDARD MARK

JOBBER MEET IN PHILADELPHIA.

Sixth Quarterly Meeting Well Attended—Many Matters of Importance Transacted—Local Dealers as Well as the Victor Talking Machine Co. Entertain Visitors in Handsome Fashion—The Proceedings in Detail.

(Special to The Talking Machine World.)

Philadelphia, Pa., April 11, 1907.

The sixth quarterly meeting of the Eastern Talking Machine Jobbers' Association—and the first to be held in Philadelphia—convened this afternoon at the committee rooms of the Bellevue-Stratford Hotel. There was a large attendance of members and a number of important trade matters came up for discussion and action. Among them were the following subjects: Opinions as to the number of records catalogs should contain and the proportion of different priced records; where listed; the question as to the number of new records advisable to be issued each month; the question as to how many records it is advisable to cut from the catalog each year and upon what basis; how often an exchange proposition is desirable, and upon what basis. These subjects were discussed, it should be stated, by the jobbers, with the object of effecting amicable arrangements with the manufacturers to the end that both parties would be mutually benefited. Other subjects up for discussion were: The advisability of setting apart one or two discount days per month, days when the dealers can settle accounts and receive discounts. The instalment against cash payment proposition. In the past many dealers have sold talking machines on the deferred payment plan at the same price as they charged cash payment customers. It is believed customers should pay more when buying on the instalment plan.

The following jobbers and representatives of the firms named were in attendance at the business session: W. D. Andrews, Syracuse, N. Y.; Louis Buehn, of Louis Buehn & Bro., Philadel-

phia; J. Newcomb Blackman, of the Blackman Talking Machine Co., New York; Theo. F. Bentel, of the Standard Talking Machine Co., Pittsburg; John P. Kelsey, with the Bettini Phonograph Co., New York; A. J. Denninger, Rochester, N. Y.; E. F. Droop, of E. F. Droop & Sons Co., Washington, D. C.; C. V. Henkel, of the Douglas Phonograph Co., New York; E. F. Taft, of the Eastern Talking Machine Co., Boston; A. W. Toennies, Jr., of the Eclipse Phonograph Co., Hoboken, N. J.; C. Forsyth, of Forsyth & Davis, Kingston, N. Y.; Louis J. Gerson and H. E. Marschalk, of the Musical Echo Co., Philadelphia; A. H. Jacot, of the Jacot Music Box Co., New York; Victor H. Rapke, of the Victor H. Rapke Co., New York; G. A. Stanley, of Stanley & Pearsall; I. Davega, Jr., Benj. Switky, New York; Albert C. Harry W. and William C. Weymann, of H. A. Weymann & Co., Philadelphia; William Warner, Easton, Pa.; Adolph Weiss, of the Western Talking Machine Co., Philadelphia; J. T. Williams, of the Victor Distributing & Export Co., New York; Max Landay, of Landay Bros., New York; John B. and H. F. Miller and T. W. Barnhill, of the Penn Phonograph Co.; Herbert T. Lewis, of the Lewis Talking Machine Co., Philadelphia; James K. O'Dea, Paterson, N. J., and H. L. Ellenberger, of the Pardee-Ellenberger Company, New Haven, Conn.

Oliver Jones, as representative of the Victor Talking Machine Co., Camden, N. J., assisted the Philadelphia jobbers in looking after the comfort of the visitors and carrying out the program of entertainment.

The business session was strictly executive, only members being permitted to attend. Little or no news as to the action taken at the business session was given out, it being the impression that as the matters concerned the parties interested and not the trade generally, it was best to say nothing at present.

From various sources it was gleaned that the jobbers decided the matters named as follows, although it should be understood this account is

not official and may be subject to correction: On the subject of the number of records manufacturers' catalogs should contain opinions varied, although the general belief was expressed that manufacturers and jobbers would be benefited by having many less records issued, at least for a while. New records issued each month should be less hereafter than has been the rule, in order to "catch up," so to speak, with the amount of business already being called for. On the exchange of records question it was generally agreed that two or more exchanges per year would be desirable; but this question, as well as the others, depends upon an amicable arrangement with the manufacturers. The manufacturers are naturally desirous of learning what the jobbers, from experience, believe to be the best plan to pursue. For all hands interested, and at future conferences most likely a settled plan will be adopted and put into effect. It was deemed advisable to set aside one day in the month as discount day, when dealers settling accounts would be given the usual discount allowed in general commercial circles. Goods sold on the instalment plan should be charged more for, to the end that cash customers would be benefited and cash purchases encouraged. What per cent. additional the "deferred payment" customers will pay is a "trade matter" for obvious reasons, but the percentage will be the same with all jobbers.

The committee which will have conferences with the manufacturers to determine the plan to be followed regarding the points, etc., named, consists, it is stated, of Messrs. Blackman, Marschalk and Taft.

It is probable the next quarterly meeting—in July—and which is also the first annual meeting (at which officers will be elected for the ensuing year) will be held in New York City.

President W. D. Andrews occupied the chair at the business session, and was ably assisted as usual by Secretary Jacot. The treasury is reported in good condition, and the affairs of the association generally are in satisfactory shape.



W. D. Andrews

We are Jobbers
in Edison Phonographs
Victor Talking Machines
Records and Supplies.

Our big stock is Complete
Covers everything! Machines records horns
cabinets repair parts and sundries.

Quick Shipments

"I want what I want when I want it!"
Don't you? If so, order from

Musical Echo Company

1217 Chestnut St., Philadelphia Pa.



Louis J. Gerson

The social side of the jobbers' meeting was thoroughly pleasing, and the visiting talking machine men were dined and entertained until all were satisfied of the hospitality of their hosts and the Quaker City generally.

The visiting jobbers while here were the guests of the Philadelphia Talking Machine jobbers and the Victor Talking Machine Co., of Camden, N. J., and the program of entertainment was varied and interesting. First, the visiting jobbers were domiciled from Thursday until Friday night at the Bellevue-Stratford and given to understand that they must feel perfectly at home, which they did. After the business session, a fine dinner was served the jobbers and invited guests in the Red Room of the hotel, and this pleasant function promoted sociability and friendship. Impromptu speeches were made, of course, and a general flow of wit and wisdom made Thursday evening one long to be remembered.

And it should be noted right here that the Eastern jobbers keenly enjoyed themselves and passed due resolutions of thanks to the City of Brotherly Love jobbers and the Victor Talking Machine Co. for hospitality received.

Later—Friday's Program.

Friday was devoted entirely to pleasure. The trip to the Victor Co.'s plant in Camden, N. J., was made in the morning, and was enjoyable throughout. The members of the association were taken in charge by officers and representatives of the Victor Co., and shown all over the extensive premises. The new laboratory building, in course of construction, opposite the main plant, was greatly admired. Subsequently an informal luncheon was given at the cosy quarters of the Down Town Club in the Bullitt Building.

In the afternoon the visitors were taken in "Seeing Philadelphia" automobiles for a tour of the city, the itinerary including brief visits to the many historical buildings and places as well as a rather extended spin in Fairmount Park, along its famous drives and boulevards. After dinner at the Bellevue-Stratford the jobbers were escorted to the Broad Street Theater,

where fifty seats had been reserved for them to enjoy George M. Cohan in "Fifty Miles from Boston."

While a majority of the visitors started for home late Friday night, a number remained over until Saturday and looked after business.

ZONOPHONE RECORD EXCHANGE PLAN.

The Universal Talking Machine Co., Newark, N. J., have notified their trade to the following effect:

"We have decided to make an exchange proposition for Zonophone records only. On the three for one basis, that is, allow you to return one record, order three and pay for two. Records to be returned from April 15 to 25, 1907, under the following terms and conditions: We will take back Zonophone records only, black or brown material, allowing you to return 2 7-inch records and call them 1 10-inch; 1 9-inch record and call it 1 10-inch; 1 10-inch record and call it 1 10-inch; 1 11-inch and call it 1 10-inch. We will not accept any broken records or any other make and you must order three times the number of records you are returning. Freight and express charges must be prepaid or records will not be received.

"Records will be counted as soon as possible and certificate sent to the dealer; then he must order three times the number of records he returns through the jobber or factory. Until you have ordered three times the number of records through your jobber or the factory, credit bill will not be sent to you. No bill of lading or express receipt for records returned dated later than April 25, 1907, will be accepted. As soon as the dealer receives the certificate from our office, he must order the records at once from the jobber. Dealers must not offer this exchange proposition to consumers."

W. D. Schultz, of Stanley, Wis., announces that hereafter he will handle the Edison phonographs and records, in addition to the Victor.

MARKS A PROGRESSIVE STEP

In Amplifying Devices—The Rapke Collapsible Horn Wins High Praise from Experts.

After being critically tested a well-known expert in the art of sound reproduction has freely and frankly expressed the opinion that the Rapke collapsible horn is a distinct improvement and marks a progressive step in amplifying devices.

It is agreed that the less interference of vibrating sounds with the quality of the record tone is the sine quo non or indispensable condition of a horn. In this respect the Rapke collapsible horn is held to be unique; the manner of its construction being such that foreign vibrations are eliminated, and the sound issues forth in true, natural tones, from which muffling and rattle are conspicuous by their absence. The horn is made in segments, or rings, and as the sound enters at the small end and proceeds toward the bell or enlarged part, the foreign vibrations are not carried forward, but become a negligible factor, and the tendency to "blast" on the high notes is obviated.

As Victor H. Rapke, the inventor, himself says of it: "I have now overcome all obstacles and can reproduce the human voice correctly. My new horn carries the quality, gives the reproduction perfectly clear and without any vibratory influence. The natural sound enters the narrow end, is conducted there through and emitted in magnified volume at the large end unchanged in quality. The secret of the success of this horn lies in the fact that it is built upon scientifically correct acoustical principles."

The Rapke horn is impossible to get out of order. Any person can set it up, and it can be put together or taken apart in a minute. It can be packed in small compass, and sent through the mails. Locked or unlocked, the horn will sustain the weight of any man standing upon it, and it can be used on any known make of machine.

The MYSTIC REFLECTOR

A POST CARD PROJECTOR

Retails at
\$5.00
Liberal discount



NEW YORK, March 30, 1907.

The Mystic Reflector is so remarkable in its results that nothing but a trial can make a person realize its extraordinary merit. It is, indeed, a pleasure to commend it.

W. IRVING DAVIS, 32 Waverly Place.

NORTH AMERICAN EXPORT CO., Inc.

31-33 Broadway, New York, March 30, 1907.

CHURCH SUPPLY CO., 10 Barclay Street, City.

Gentlemen:—In answer to your valued communication of March 29th, relative to the merits of the Mystic Reflector, we can only say that when same was recently demonstrated, we were greatly surprised at the results attained. It gives us pleasure to endorse same and from the opinions that we have had in the premises, we cannot help but appreciate that it is an article that will meet with great sale, and we are in hopes to place further orders with you in the near future. Wishing you every success, we beg to remain,

Yours very truly,

NORTH AMERICAN EXPORT CO., Inc.,

By J. E. SITTERLEY, Pres.

This wonderful machine projects upon a sheet SOUVENIR POST CARDS, PHOTOGRAPHS, MAGAZINE PICTURES, Etc., Etc., in Original Colors. No glass slides required. Can be used for ILLUSTRATING SONGS in connection with a PHONOGRAPH. A QUICK-SELLING SIDE LINE for the TALKING MACHINE TRADE. Dealers must order through their jobber.

**CHURCH SUPPLY CO. 10 BARCLAY STREET
NEW YORK**

MAKE INDESTRUCTIBLE RECORDS.

The Indestructible Phonographic Record Co. Equip Laboratory in Brooklyn and Manufacturing Plant in Albany, N. Y.—Will be Ready for Market in August.

The Indestructible Phonographic Record Co., which, as reported in The World some time ago, have been incorporated in the State of Maine, with a capital of \$1,000,000, expect to have their first catalog and sample records on the market early in August. They have secured a spacious factory at Albany, N. Y., which is splendidly equipped, with a capacity for turning out more than three million records a year. Their laboratory, which is in charge of a staff of competent men, is located at 352 Livingston street, Brooklyn, N. Y. Here all the "Master" records will be made and tested. They will make only cylinder records which will be sold at standard prices.

Professor Starr, who returned some time ago from the African jungles, where he secured a number of valuable records of the various races he came in contact with, has given his originals to the Indestructible Phonographic Record Co., and it is not improbable that these will be accessible for public use as well as preservation.

LEASE NEW QUARTERS.

The St. Louis Talking Machine Co., St. Louis, Mo., recently closed a lease for the ninth floor of the new Mills building at Seventh and Catherine streets, one of the most modern loft buildings in the city.

McGREAL BROS. OPEN IN CINCINNATI.

Secure Central Quarters for Their Wholesale and Retail Business in That City.

(Special to The Talking Machine World.)
Cincinnati, O., April 10, 1907.

L. E. McGreal, of McGreal Bros., Edison jobbers and Victor distributors, Milwaukee, Wis., spent several days here recently arranging for the opening of Cincinnati wholesale and retail quarters. Mr. McGreal secured a lease of store now occupied by Florsheim & Co., 29 East Fifth street, for retail business, and large loft, Sixth and Main streets, for wholesale department. McGreal Bros. will carry a big line of Edison and Victor goods, and, it is presumed, try to equal, if not excel, their great success as talking machine merchants in Milwaukee, where they now are located and recognized as among the largest wholesale and retail concerns in the West. It is understood that they will job the Edison goods only here, but carry both Edison and Victor goods complete at their retail place. They will open on or about May 15.

"THE MYSTIC MIRROR"

Certain to be a Big Winner as Side Line With Talking Machine Dealers.

There is a new novelty on the market which will prove a great seller in the talking machine trade. It is called the "Mystic Mirror," and is an illustrated post card projector which throws any picture, or, in fact, any article on a sheet in all of its original colors. When one stops to consider the countless thousands who have the post-card craze, all of whom will be interested in this wonderful little machine, it is not hard to see that its possibilities are enormous. The Church Supply Co., who control the "Mystic Mirror," are offering them to this trade in the right way—namely, selling only through legitimate jobbers and giving both jobber and dealer a good margin of profit. For further particulars, see their advertisement which appears in this issue.

SOME BRIGHT THINGS IN "CHAT."

That always interesting little volume, "Chat," published by the Tea Tray Co., of Newark, N. J., is full of bright sentiments for April. We quote just a few to show the spirit of the text, and to whet the reader's appetite:

- "There's something wrong with the man who slips down twice on the same banana peel."
- "It's a sad mistake to treat the public like a country cousin. The customer is examining into things on his own hook while you're sitting inside a glass case at a desk."
- "Don't expect any man to have faith in your judgment if you call him a fool."
- "Don't make the mistake of grumbling about your competitor. Make a noise like a winner."
- "There's a good market for every good thing—but you must have the good thing. We make a number of 'good things' every one of which is a big selling success."
- "It may look black on your side of the fence, but the

MANAGER WANTED

We want a young man of experience to take charge of a retail talking machine store in Montreal. He must be competent and up-to-date and understand the business thoroughly. Give age, experience, salary expected and references. Berliner Gramophone Co. of Canada, Ltd.

MANAGER WANTED

One who understands the Edison business both wholesale and retail from A to Z, and wants to better his position. Address, "Confidential," care The Talking Machine World, 1 Madison Avenue, New York.

MANAGER WANTED

WANTED—Manager for wholesale and retail Talking Machine Jobber. Familiar with both Victor and Edison Lines. State experience, reference and full particulars. Good salary to right party. Address, "S," care The Talking Machine World, 1 Madison Ave., New York.

chapel on the other side may see a white fence. It all depends on the side you're on. Get on the white side. Keep the best lines of goods you can and then let the people know you've got them. You'll be gratified at the results."

"If all prayers were answered there would be no room in the streets for the automobiles and the wheel-barrow factories would have to close up."

BURKE TALKING MACHINE CO. AFFAIRS.

Leo Greenberger, assignee of the Burke Talking Machine & Novelty Co. (bankrupts), advise us that by virtue of assignments, dated, respectively, March 11, 1907, and April 6, 1907, all the outstanding accounts of the Burke Talking Machine & Novelty Co. have been assigned to the Mechanics' Bank, of Brooklyn, the same to collect all the accounts due and apply it, after reimbursing itself for all the outlays made, toward the payment of their claim, as well as all other creditors. This terminates the assigneeship.

THE NEEDLE QUESTION DISCUSSED.

Some very interesting facts are to be found in the advertisement of the Petmecky Co., which appears elsewhere in this issue of The World. Some misleading ideas about the functions of the needle which they manufacture are set before the public in a correct and important light. This needle question is an all-important one, and no dealer can afford to overlook it, because a good needle is as valuable as a good record. In this connection the especial merits of the Petmecky needle must enter into consideration.

The True Tone sound box, manufactured by the American Talking Machine Co., Brooklyn, N. Y., for all types of horns and tone arms, in spoken of as giving the most perfect reproductions. This box is the result of long and careful experiments, and is the invention of one of the best-known experts in the country in this line of development.

NEW IMPERIAL PHOTOGRAPHS OF THE TALKING MACHINE ARTISTS

Wide-awake dealers are now supplying the demand for these photographs. They are attractively finished, each bearing the facsimile signature of the artist. The demand for these is very large among the users of the talking machine. It remains for you or your competitor to supply this. All orders must be placed through your regular Jobber.

THE CHANNELL STUDIO FOR PHOTOGRAPHY

483-485 Main Street

ORANGE, N. J.



NYOIL FOR PHONOGRAPHS

We have for 40 years been producers of Delicate Oils for Watches, Clocks and Chronometers, and we offer NYOIL as the most delicate and effective article ever produced for the use of Phonographs.

W. F. NYE
New Bedford, Mass., U. S. A.



Mr. Dealer!

To laugh and grow fat "is an old saying" but to laugh and grow prosperous is a version made possible only by the possessor of a

Victory Cash Register

Our own success and those of our representatives is our best argument. Not being able to cope with the ever increasing demand of our product and keep pace with orders received, we have secured the greatly enlarged and handsome quarters of

1933 Broadway

where with a fourfold enlarged stock, we shall be able to fill orders promptly.

Booklet on application. Few more representatives wanted.

VICTORY, \$65.00 VICTORY, Jr., \$40.00

H. C. MEHDEN 'Phone 3445 New York
Columbus

TIMELY TALKS ON TIMELY TOPICS.

The complaint that inferior parts are being used and substituted for the original articles, when machines are under repair, is not only a serious charge, but has a foundation in fact. In this indictment is included the practices of jobbers whose methods are far from honorable. For example, no matter whose make of machine may suffer in consequence, the ultimate result is bound to injure the guilty parties also. If a machine fails to give satisfaction after being overhauled simply because some conscienceless concerner, instead of using genuine goods, employs "something just as good," when, in fact, the substituted parts are known to be inferior, the owner soon despairs of ever again enjoying records as they should be rendered, and finally throws it aside more in sorrow than in anger. At the same time a customer may be irretrievably lost, and one less source of business cut off.

Perhaps the short-sighted dealer may be acting in good faith in buying springs, belts, handles, sapphires, needles, balls, feed nuts, etc., from jobbers or concerns who have imposed upon him. As a fact also a great many—too many, unfortunately—dealers regard price as the controlling consideration in buying goods, and when spurious articles are put in place of reliable parts in the repairing of machines, they commit a trade crime that never should be condoned. The machine manufacturers are justifiably jealous of the reputation of their product, and when complaints reach them that they are not working satisfactorily, and an investigation reveals the dastardly practice above alluded to, they should adopt any means, no matter how drastic, to protect and perpetuate the high esteem with which their goods were regarded as they first came, "pure and undefiled," from the factory.

While Ricordi & Co. and Sonzogno, the music

publishers of Milan, Italy, were successful in having the decision of the High Court against gratuitous reproduction of music on records sustained on review by the Court of Appeal, the latest decree came as no surprise. The Gramophone & Typewriter, Ltd., London, England, were the defendants, and hereafter tribute must be paid, not to the composers, but the several publishers who control the music in every stage of its employment. Naturally each country seeks to protect its interests as against the world, and the production of music being a great Italian industry, so to speak, Italy would naturally throw every safeguard around the so-called property of its citizens, international agreement or equity to the contrary notwithstanding.

When an exchange of records is announced by the manufacturer, an undertaking ensues the magnitude of which only those handling the returned goods realize. Notwithstanding the explicit instructions given for shipping "dead" stock to the factories, it turns up in every imaginable shape, and the labor of straightening out, checking up and crediting the accounts of dealers and jobbers involves an amount of work and the exercise of patience little dreamed of. A case in point is that of the Victor Talking Machine Co., who have been literally overwhelmed by returns, receiving on an average of 187,000 records back daily. The National Phonograph Co. had the same experience, and now the Zonophone people have offered a like privilege to their trade, with doubtless the same proportional result before them. As yet the manufacturers here have not determined upon any fixed time for the housecleaning process, though abroad it is a regular yearly affair, with the clean-up in the spring. Perhaps this custom may be adopted in the United States, and then doubtless a permanent department will be established for that express purpose. In that event

the embarrassment and annoyance of being "all balled up" during the exchange period will be entirely eliminated.

Among the inventions in course of development for commercial or practical purposes is that of the Telegraphone. From time to time reports of progress have been made, and its evolution from a scientific wonder to a plane where its marvelous properties can be converted to the everyday uses of the work-a-day world is being closely watched. The latest advices regarding the Telegraphone is that the new model disc machine will be on the market inside of ninety days, and then startling progress will be shown in the mystic art of sound reproduction. The discs first used will be twelve inch, duplex or a continuous record, if need be, on both sides, but it is not necessary to stop the machine to turn the disc, the reverse record being operated by simply pressing a button when the obverse or face has finished. Larger records—15, 20 and 30 inch—may follow, the enthusiastic advocates of the Telegraphone say, and as for duplicating, it is claimed, by a magnetized strip of metal as a connecting link 10,000 records may be made at once. Truly wonderful! If these dazzling promises are actually realized in practice the acme of perfection would seem to have been reached.

In a recent informal chat with The World, B. G. Royal, president of the Universal Talking Machine Manufacturing Co., who has had years of experience here and in Europe, said that the small dealer was the actual distributor or backbone of the trade. Therefore manufacturers should aim to put out only the best possible records, goods that were sellers, and not load him up with dead stock. To attain this object the best talent, the most improved processes and the highest art should be exercised in maintaining the best standard of excellence reachable. Mr. Royal was also of the belief that twenty-five records monthly were enough, and more than sufficient to meet every demand for variety and quantity. In comparing the trade abroad with

BEST SELLERS OF THE YEAR!

ALWAYS IN FRONT!

RAPKE'S COLLAPSIBLE HORN IMPROVED CRANE

To illustrate the compactness of the horn when collapsed or nested, 100 can be shipped in same size box used for sending an ordinary single horn.



We do not sell to dealers direct. All orders handled through jobbers. Orders filled strictly in rotation. Ask your jobber about **Rapke Specialties**. They will increase your business.

VICTOR H. RAPKE CO., MANUFACTURERS, 255 E. 86th St. **New York City**

American conditions, he was inclined to favor an opinion of the former's greater advancement for more reasons than one. As the gentleman is regarded in the inner circles as one of the best equipped men in the business, on broad grounds, he is likely to be heard from in no uncertain way.

The sale of the commercial or business talking—rather, writing—machine is increasing at a rate simply astonishing. Both the Edison business phonograph and the Columbia commercial graphophone are making great strides in the esteem of the mercantile world; and the energy, versatility and resourcefulness displayed by the management of this special department in the respective companies is of a high order of merit. It is believed this branch of the business is destined to assume great proportions, and the machines come into general use the world over. As with the entertainment sound-reproducing devices, foreign countries are again indebted to American inventive genius for this system.

On account of its high notes, all Edison horns are said to be tested by record No. 9400, "Love and the Bird." If a horn does not "blast" under this severe ordeal it will pass muster.

A sapphire reproducing point is used on the Pathé Freres disc records, and instead of using the lateral or zig-zag sound line, the vertical or undulating wave is employed. The results attained are a revelation, according to experienced talking machine men who have had the privilege of hearing these records.

An organization has been formed in Germany under the appalling name of "Bund der Sprechmaschinenhandler Deutschland," or, as interpreted, Talking Machine Dealers Association of Germany. Its success is assured, as it is organized for mutual benefit and protection.

The holiday season in Germany developed a strong demand for cheap machines, with which the factories were unable to cope. It is reported extensive additions will be made to the plants so as to have a supply of this class of goods in the future; or, as an esteemed contemporary, "Die Sprechmaschine," expressed it, "so that such calamities will not reoccur." We fail to see the "calamity" point, however distressful may be the other conditions.

The Universal Talking Machine Manufacturing Co., Newark, N. J., within the last few weeks, have adopted a new trade-mark, which will be used on all their products, literature, printing, etc.

WHY CUT PRICES?

The Attitude Assumed by Some Talking Machine People Contrary to Good Business Rules—Prices Should be Maintained and Fair Profits Returned.

The talking machine manufacturers, in regulating their contracts with their agents, have inaugurated a plan which could be followed with pleasure and profit by the members of the auxiliary trade, who supply various talking machine accessories.

The system under which talking machines are sold prevents the cutting and slashing of prices, thus securing to a dealer a fair margin of profit and saving the reputation of the instrument which he handles from slaughter. Why should not this same plan apply equally as well to talking machine accessories? Every business should pay a legitimate profit, and from some of the prices which we have learned have been quoted recently by some of the talking machine supply manufacturers, we are convinced that the profit is something which they have cut out entirely from their business. In fact, there are some horns sold at prices which afford no profits to the makers.

Now, a business which does not show a profit is not worth securing. No business man should fool himself with the belief that it pays to replace one dollar with another. It does not, for he is wasting his time and his energy, and with the talking machine industry in a healthy buoyant state there is no reason why every line of goods should not be sold at profitable rates. The additional cost would not be thought of by the retail purchaser as being any impediment to the sale.

Talking machines and accessories are not like staples bought by the same parties daily and therefore should return a fair percentage of profit.

BOSTONIANS IN GOOD HUMOR.

The Talking Machine Fraternity in the City of Culture Have No Complaints to Make—They Are All Doing Well With an Increasing Demand for the Better Grade of Goods.

(Special to The Talking Machine World.)

Boston, Mass., April 9, 1907.

The advent of spring finds the dealers in talking machines feeling in very good humor. Trade has been more than good for two months, and the prospects for the summer are much brighter even than last year, which was a record breaker

in every store. Now that the dealers are able to get their orders filled a little more promptly than they have been able to before, the situation is relieved a great deal.

The M. Steinert & Sons Co. are giving more window space to the display of talking machines than they have been in the habit of doing, with the result that trade has increased quite a little. They have had a very attractive display during the past week. At the wholesale office trade is reported as being remarkably good, especially on the higher priced Victors.

The Eastern Talking Machine Co. are making great headway with the I. C. S. lesson idea, and already one or two of the Boston public schools are using the series for the teaching of German. The wholesale department here, under the management of Mr. Chamberlin, has been rushed with orders for several months.

At the Columbia Phonograph Co. the recently enlarged record rooms have been taxed to their utmost this spring. A fine demand for the better grade of goods is noted here, especially on the Columbia phonographs. The window display

You Want
What You Want
When You
Want It

That is just what
we are prepared
to furnish—Try
us.

THE PARDEE-
ELLENBERGER
COMPANY

NEW HAVEN, CONN.

The only Edison job-
bers, EXCLUSIVELY
Wholesalers, in New
England :: ::

Racks for Homes and Cafes

ARE YOU SELLING YOUR SHARE OF THIS TRADE?

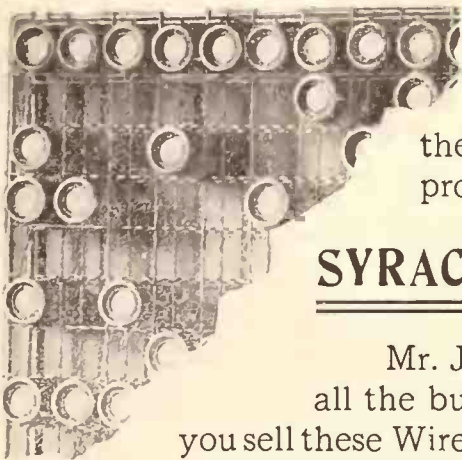

There's a demand for Racks in homes where many records are kept; the proper storing of records after the number reaches fifty becomes a problem which is quickly solved by

SYRACUSE WIRE RECORD RACKS

Mr. Jobber and Mr. Dealer are you getting all the business you should along these lines? If you sell these Wire Record Racks you provide room which will speedily be filled with records—to your advantage.

You need our No. 123 Rack for this trade. Read descriptions of 100 and 200 Space Racks, Catalog page 2. If you have no Catalog, write for one to-day. Liberal discount to jobbers.

Syracuse Wire Works East Water Street
SYRACUSE, N. Y.

is changed here several times a week, which adds to the attractiveness of the store.

Business at the Boston Cycle & Sundry Co. is reported as "better than ever, and growing better every day." Manager Andrews is pushing the sales of his new tray system which has "caught on" in the trade immensely. This company does a wholesale business that is enormous, and it covers every branch of the talking machine business. The new style carrying case which is made by this company is one of the best things ever invented for the comfort and convenience of users of the talking machine.

The new rooms given over to the talking machine department at Houghton & Dutton's department store are proving their worth every day. Business here is reported remarkably good and rapidly increasing.

THE OUTLOOK IN CUBA

For Talking Machines and Supplies Has Steadily Improved—An Interesting Chat on This Subject With J. H. Dorian Who Has Just Returned from a Trip to That Island—Columbia Branch Opened in Havana.

John H. Dorian, manager of the department of New York of the Columbia Phonograph Co., arrived home in this city last Saturday after a very pleasant trip to Cuba. While rest and pleasure were the chief objects in view, at the same time he could not resist the temptation to make a study of the conditions of that island with a view to future business. In regard to them, he said to *The World*: "With the improved conditions in Cuba, the scope for the talking machine has developed in a simply wonderful manner, and the cultivation of the field has not as yet commenced. While on the island I was one of a party that took a ride inland of 250 miles on an automobile, and everywhere we found talking machines or traces of them. They have become extremely popular with the native population, and to meet the demand for records in their native tongue, we will have a large list made specially for the Spanish-American trade, and to that end have arranged for some of the best Spanish singers to come to this country and make records at the Columbia laboratory. While in Havana we established a Columbia store and headquarters in that city, and have secured a manager that is thoroughly wideawake, and who will make the name "Columbia" known throughout the island. The Columbia graphophones at the present time have a large following among the Cubans, and they are daily growing more

partial to the disc machines, although the demand for the cylinder variety is excellent. Civic conditions on the island have tended to bring business down to a much better basis, and under the present rule there is no reason why it should not become one of the most prosperous of the Spanish-American countries."

PITTSBURG'S RECORD BREAKING FLOOD.

(Special to *The Talking Machine World*.)

Pittsburg, Pa., April 3, 1907.

The scene herewith shows Penn avenue, from Seventh street to Water street, covered with six

EFFECTIVE ADVERTISING.

It is very difficult to introduce a good article to-day without distributing samples. The public seem to class all articles alike until they can put the goods to the test. It is very easy to sell goods of known value, and the distributing of free samples, although in most cases quite expensive, has proven to be the most effective way to quickly introduce an article of merit.

Mr. Blackman, proprietor of the Blackman Talking Machine Co., 97 Chambers street, New York, in discussing this subject, says that he makes it a point to give away samples of any-



THIS IS PITTSBURG, NOT VENICE, IN FLOOD TIMES.

feet of water at the deepest part. In the square in the foreground are the stores of the Columbia Phonograph Co., and the Penn avenue store of Messrs. Powers & Henry. These stores were in the very heart of the flood. The boat to the left of the picture made a voyage on the first floor of the Columbia store. On this floor there was nearly four feet of water. The enterprising assistant manager, A. W. Ross, had painted and displayed a neat sign which read: "Flood your homes with good music." "Flood sales" have been conducted by all of the talking machine stores whose stocks were damaged by the unprecedented high waters.

thing he manufactures, which does not cost so much that it would be practically impossible. In this connection it would be well for dealers and jobbers to refer to the Blackman Co.'s advertisement in this issue, in which they offer to furnish free samples of their specialties.

Fred C. MacLean, who had been traveling through the Southwest and in Mexico for the Sterling Debenture Co. nearly three months, looking after the commercial end of the Telegraphone, the wonderful sound recorder by means of electro-magnetism, returned to New York March 28.

FROM
53 N. J. R. R. AVE.
NEWARK, N. J.

WE'VE MOVED

TO
28-30-32 Division Pl.
NEWARK, N. J.

Outgrowth of the former premises compelled us to seek more spacious quarters.

Our rapid growing business demanded space; now we're prepared to handle any amount of business with disregard to size.

This change is simply the result of strenuous efforts in the direction of turning out goods that appealed to the trade.

Proper dealing—with *proper goods* at *proper prices* and deliveries at the *proper time* are the four essentials with which we built up a magnificent enterprise.

Our remarkable wood color horns, together with the famous morning glory and decorated horns are the products which won for us the distinction we're so justly proud of, and every possible means will be employed to further claim it.

Demands for these goods came from many points—in fact, various parts of the country—*North, South, East, West* and in consequence of this we branched out to Chicago.

The *Western Talking Machine & Supply Co.* will take care of our tremendous western business. Doesn't that give evidence of growth?

Expansion is the order of the day and we're still expanding.

Small decorated and plain horns 20 x 25 are our present leaders. They've proved very popular and we sold many—many more to be had. Get interested.

WRITE US—PHONE US—OR CALL ON US. However, let us know your wants.

NEWARK TINWARE & METAL WORKS
28-30-32 DIVISION PLACE, NEWARK, N. J.

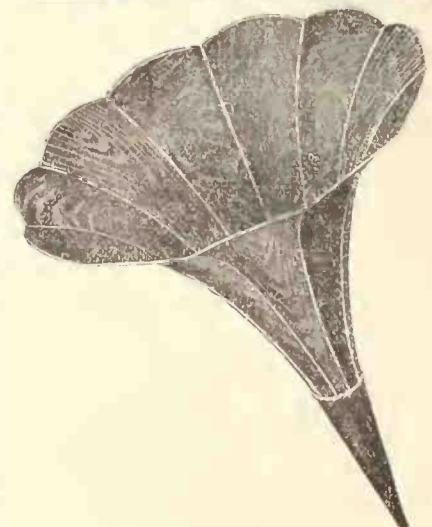

VALUE OF WINDOW DRESSING.

One of the Most Important Departments of Publicity With the Pushing Talking Machine Man Is the Well Dressed Window.

Window dressing has come to be regarded as one of the essential features of store advertising, and at the present time the man who can arrange an attractive display is an almost indispensable factor in any place of business. It is only recently that the talking machine trade have recognized the fact that their store windows can be so arranged that they prove a magnet to every passerby. A jumble of machines, horns and records cannot be said to constitute a display; in fact, many of the windows seen would be greatly improved by being vacant. It is not required to have any elaborate mechanical contrivance to attract attention, although if

unique they add to the appearance. One of the most attractive windows seen during the Easter season was a model of simplicity, combined with richness. In the center was a large sized disc machine mounted on an attractive cabinet. Across the horn and twined around the cabinet was a broad purple ribbon. The floor and background was covered with a deep yellow cheese-cloth and a few artificial Easter lilies were scattered carelessly on the floor. It was the acme of rich simplicity, but attracted the attention of thousands. Another window on a side street was a mass of small machines, without a single feature to attract the eye, and it was passed by without a glance from the pedestrians that thronged the thoroughfare. The proprietor of the store told The World that he did not have the time to fix his windows, and furthermore that he did not believe that it made any difference, anyway. But one thing was certain, he had few callers compared to his competitors who were progressive.

parently in a trance until the music stopped. Mr. Grady considers the matter so unusual that he will exhibit both machine and chickens at the next State fair held in the fall if the chickens do not recover from their enraptured state before that time.

The Hawthorne & Sheble Manufacturing Co. report a phenomenal demand for their Star records. Within forty-five days they have received orders for over 300,000 records. This is certainly going some, and speaks well for records and the reputation of the firm making them.

The Columbia Phonograph Co. have opened a new branch store at 941 Main street, Hartford, Conn. It is said to be one of the handsomest talking machine stores in New England.

**AT A BARGAIN
50 Disc Machines**

We guarantee them to be absolutely new, latest Model with powerful clock spring Motor, 10 inch Turntable, Concert Sound Box, large Solid Oak Cabinet, 23-inch Black and Brass Horn with supporting arm. Cut sent on application.

These are not Talk-o-phones and no offer accepted for less than fifty. Address, **OUTLET CO., Providence, R. I.**

**FREE SAMPLES
of Needles That Prove.**

Playrite
TRADE MARK

NEEDLES

"THE NAME TELLS WHAT THEY DO"

Best for VOLUME, TONE and LASTING QUALITY. PLAY RIGHT from START to FINISH. PRESERVE RECORDS and can be used on ANY DISK MACHINE OR RECORD. Packed in RUST PROOF packages of 100. RETAIL, 10c. per 100; 25c. 300, 75c. 1,000.

Melotone
TRADE MARK

"GIVE A MELLOW TONE"

REDUCE VOLUME and DON'T SCRATCH. Each needle can be used SIX TIMES. No special attachments needed. Packed in RUST PROOF packages of 200. Price, 25c. Package.

NOTE—We furnish Jobbers and Dealers with ADVERTISING MATTER FREE. Big profit. We will send FREE sample packages to Jobbers or Dealers. Write now.

Manufactured by

**BLACKMAN TALKING MACHINE CO.
97 Chambers Street, New York**

THE ILLUSTRAPHONE

A Combination Talking and Picture Machine Which Is Destined to Become a Big Winner.

(Special to The Talking Machine World.)

Philadelphia, Pa., April 11, 1907.

When the Talking Machine World representative called at the factory of the Hawthorne & Sheble Manufacturing Co. the other day he had

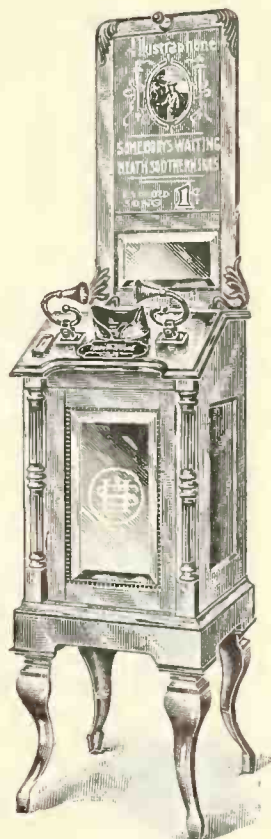

THE ILLUSTRAPHONE.

the privilege of seeing their latest production, which is called the Illustraphone. As its name implies, it is a combination talking and picture, coin slot machine. The pictures are simply wonderful and the way they come into view and harmonize with the sentiment of the song shows great care and artistic taste in getting them up. The cabinet is solid mahogany with beveled plate glass mirror in the front and is mounted on nickel-plated legs. All details conceivable to make a perfect machine are covered. As soon as a person drops a coin in the slot, there is a little Pilot lamp lights up to indicate the machine is running O. K. The hearing tubes are superseded by their new Auditrumpets. The first machines placed in public locations average over \$10 each per week. An illustration of the machine is presented herewith.

STILL ANOTHER USE FOR "TALKER."

Henry Grady, of Atlanta, Ga., has discovered a new use for a Victor talking machine. One day, while playing the machine in his home on Peachtree street, he noticed all the chickens on the place congregated under the windows, seemingly hypnotized by the music, and they remained ap-

DEALERS AND JOBBERS

Get in line and write for prices and samples of the wonderful

**Petmecky Multi-Tone
Needles**

Can be used ten times and give loud or soft tone.

Lewis Talking Machine Co.

DISTRIBUTORS

No. 15 South 9th St.

PHILADELPHIA, PA.

**HOW TO PRESERVE
YOUR
Talking Machine
Worlds**

For some time past we have received numerous requests from subscribers for binders to hold the files of the paper, so that they would be convenient for reference purposes.

To supply this demand we have had a number of "Common Sense Binders" made, which will accommodate the Talking Machine World readers.

If you wish your Worlds filed always within reach, order a binder.

These binders are full cloth, with the title of the publication on the front in gold.

These will be supplied to subscribers, delivered to any part of the country for \$1.25.

BUSINESS DEPARTMENT

**The Talking Machine World
1 Madison Avenue
NEW YORK**

**Phonograph Record Cabinet with
Hornholder Attachment (Patented.)**

Convenient—
Saves time and space.

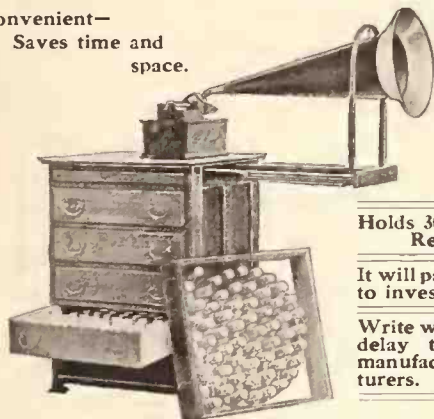

Holds 305
Records.

It will pay you
to investigate.

Write without
delay to the
manufac-
turers.

Syracuse Cabinet Co., Syracuse, N. Y.

**HENRY P. ROBERTS
Commercial
TALKING MACHINES**

**320 BROADWAY
NEW YORK**

Correspondence Solicited

KEEP YOUR CUSTOMERS PLEASSED

It is the Secret of Commercial Success
It Makes Good Business

THEY COME BACK.

60% of all persons who own PHONOGRAPHS, hardly use them at all. Their enthusiasm soon dies after they have bought a machine. Why? Because their RECORDS soon become scratchy and unmusical. Most people are not wealthy enough to keep constantly buying new records, and so they shove their PHONOGRAPHS aside. This is the worst thing that can occur, for the DEALER. It means the shutting off the purchase of many thousands records annually. The common cry is heard everywhere "I've got a PHONOGRAPH, but I never use it." This is caused simply by worn records and it is the purpose of RECORDOL to prevent this. By its use CYLINDER RECORDS are kept in perfect playing condition, which of course makes the owner use them, and that's WHAT YOU WANT. It keeps his interest up. He keeps using his PHONOGRAPH. He doesn't lay it aside and forget its existence. RESULT, he is anxious to hear new and more good music, and where under regular circumstances he may spontaneously buy 25 or 30 records a year, he will, when his interest is always up, steadily keep adding, which will average 100% more for the dealer in the long run.

RECORDOL, is a DRY POWDER. It comes put up in fine boxes which RETAIL for \$1.00 each. We want you to try it, and be satisfied before you put it in stock. If you will fill out the attached coupon, inclose it with a 2-cent stamp and one of your cards, to show you are a dealer, we will mail you prepaid a sample of "RECORDOL." Write to-day. WE WANT AGENTS EVERYWHERE.

KEEP ALL YOUR RECORDS LIKE
New Records Always BY USING
RECORDOL

RECORDOL COMPANY
108-110 East 125th Street
NEW YORK CITY

CUT HERE AND MAIL TO-DAY:
Enclosed find 2-cent stamp for which send to party below a sample of RECORDOL, together with enclosure and DEALER'S price.

NAME.....
ADDRESS.....
P. O.
STATE.....

THE STANDARD TALKING MACHINE CO.

Of Pittsburg Who Took Over the Business of the Theo. F. Bentel Co. Are Building Up a Fine Business.

(Special to The Talking Machine World.)

Pittsburg, Pa., April 6, 1907.

The Standard Talking Machine Co., who recently took over the business and secured the good will of the Theodore F. Bentel Co., incorporated, are now in a position to take care of the trade in the same prompt and satisfactory manner that was the policy of the Bentel concern.

The Standard Talking Machine Co., incorporated, for the past two years were exclusive Victor distributors in this territory, but since the acquiring of the Bentel concern they are now Edison, Victor and Columbia jobbers and will conduct the business largely on the same lines as their predecessor. The personnel of the Standard Talking Machine Co. is as follows: George E. Grotenpond, president; M. S. Roceto, vice-president; J. C. Roush, treasurer and manager, and D. O. Jones, secretary. The company, which was incorporated under the laws of Pennsylvania, has a capital of \$25,000.

INVITES EDISON TO GERMANY.

Representative of Exhibition of Inventions Comes to America.

A cable to The New York Times from Berlin says: "A notable exhibition will be opened here in June under the patronage of the Emperor and the auspices of the Technical Society. It will consist of the newest inventions, and among the exhibits will be Lilienthal's airship, the latest inventions in wireless telephony, and Korn's photo-telegraph. A representative of the management is now in the United States for the purpose of trying to induce Thomas A. Edison to come here for the opening of the exhibition."

SELLING OF SCHEME GOODS.

National Phonograph Co. Issue Warning to the Trade on This Subject.

The National Phonograph Co. have notified their jobbers and dealers regarding the exchange of premium goods of whatever origin for Edison machines and records in connection with newspaper or magazine advertising schemes, as follows:

"All schemes involving the giving away or the disposal at less than current prices of any article whatever, or, for which advertising is considered a part payment, and which article is taken in exchange in whole or part payment for goods manufactured or sold by this company, is a violation of the conditions of sale governing the sale of goods manufactured and sold by this company; and any advertising or premium scheme which directly or indirectly involves the exchange or sale of goods manufactured and sold by this company, is a violation of such conditions of sale. All jobbers and dealers are hereby warned that after this date, all goods manufactured and sold by this company, must not in any way be coupled with advertising or premium schemes, or exchanged for goods of other make or nature involved in such schemes. Jobbers or dealers who hereafter dispose of goods of our manufacture in this way, will be immediately suspended from the advantages and privileges of our jobbers' and dealers' agreements."

Policeman Charles A. Jones, of Portland, Me., one of the oldest officers in point of service in that city, owned one of the first Edison phonographs in that city and at one time owned one thousand records, although he has since disposed of many of them.

Edmond F. Sause has been appointed assistant manager of the export department of the Columbia Phonograph Co., in recognition of his efficient services while connected with the company in other capacities.

MORE MELBA RECORDS.

The Famous Operatic Soprano Was Paid an Enormous Sum to Make Records for the Victor Talking Machine Co.

Some important additions to the beautiful records made by Mme. Melba for the Victor Talking Machine Co. will doubtless soon make their appearance owing to the fact that the great prima donna was prevailed upon to postpone her de-



MME. NELLIE MELBA.

parture for Europe and spend a week making records exclusively for this company. This made the third time Mme. Melba delayed her sailing for home. Of course, the offer was extremely tempting to persuade one of the world's greatest operatic stars to extend her season, but—well, this is America.

Mme. Melba was booked to sail on the "Kron Prinz Wilhelm" on March 26, immediately after

the ending of her season at the Manhattan Opera House, but the Victor contract caused her to wait until April 2, spending the entire week in making a series of records. In consideration of the immense advance payment and a liberal royalty on every one of her records sold, Mme. Melba binds herself not to sing for the purpose of making records of her voice for any person or party other than the Victor Co. and an associated corporation. No record is to be placed on the market without her approval, and orchestral or piano accompaniment as desired by the prima donna, and all other facilities are to be placed at her disposal by the Victor Talking Machine Co.

In connection with the making of her records, Mme. Melba paid a handsome compliment to Walter B. Rogers, conductor of the Victor Orchestra. She had originally intended to bring her own personal orchestra leader over from Europe, had, in fact, cabled for him, but upon witnessing the able manner in which Mr. Rogers handled the baton, cancelled her orders to her own conductor and placed herself under his direction entirely while making the records.

DUPLEX PHONOGRAPH CO.'S PLANT CLOSED.

The plant of the Duplex Phonograph Co., Kalamazoo, Mich., was closed on April 2, and all employees laid off in obedience to the injunction issued in favor of the Victor Co. by the Federal Court forbidding the former concern to manufacture machines pending the decision of the court in the suit of the Victor Co. for alleged infringement of patent.

Colonel F. D. Eager, manager of the Duplex Phonograph Co., informed the employees that while the shutdown would be of indefinite duration; should the suit go in favor of the Duplex Company operations would be resumed upon a much larger scale than heretofore.

Cressey & Allen, the talking machine dealers of Portland, Me., recently received a ton of Victor records in one shipment. Looks like business.

**In the Words of Others
"Sell I. C. S. Language Outfits"**

The best proof that it will pay you to sell I. C. S. Language Outfits comes from the statement of dealers that have tried them. We have published several of these letters before; here is another one from the Denver Dry Goods Co. This is piling up evidence that you are losing profits of from 10 to 30 per cent. on your business if you are not handling these Outfits. The phonograph system is fast becoming recognized as the most perfect way in the world to teach foreign languages.

As a commercial enterprise, the I. C. S. System has always paid dealers well in the past, and it is growing very rapidly. Wouldn't it be a good idea for you to write us today for full particulars of what we can do for you? Let us put our advertising to work for you. It will not only bring you customers for language work, but will increase your regular business. Send us a postal card NOW

**International
Correspondence
Schools**

SCRANTON, PA.

International Correspondence Schools,
Scranton, Pa.

Gentlemen:

In reply to your letter of the 17th inst., will say we considered the demonstration of Mr. Mistrand very successful and while he was here we sold several Language Outfits. We have also sold some since he left us. We expect to advertise these Language Outfits during December as gifts as you may rest assured we will communicate with the parties to whom demonstration was given and who have not as yet made a purchase. We think the plan of advertising or demonstrating these Outfits is successful and leads to sales which could not be obtained otherwise.

We have placed several orders with you since the demonstration and would like to know if we could make arrangements to purchase whatever we need in this line through your Denver office as we have had to do several times recently; same can be billed to us by you. This would be quite an accommodation to us.

We will keep you advised from time to time of the results of sales on I. C. S. Language Outfits.

Yours very truly,
THE DENVER DRY GOODS CO.,
per *A. Schuller*

FROM OUR CHICAGO HEADQUARTERS

195-197 WABASH AVENUE, E. P. VAN HARLINGEN, MANAGER.

Trade Conditions Healthy—Babson Bros. New Building Near Completion—Big Regina Trade—Cable Company Developing Their Retail Trade—Talking Machine Co. Remove to Larger and More Central Quarters—Columbia Twelve Inch Records Please—Handsome Exhibit Made by the Columbia Co., and the National Phonograph Co. at the Recent Business Show—Wurlitzer Co. Expansion in Chicago—C. W. Noyes Back from the Coast—Some Babson Surprises Soon—Other Happenings of Interest to World Readers.

(Special to The Talking Machine World.)

World Office, 195 Wabash Avenue,
Chicago, Ill., April 10, 1907.

The Western trade is in a decidedly healthy condition, thank you. Jobbers, as a rule, state that business during the first quarter of 1907 has shown a most gratifying increase over the same period of 1906. Collections are good and the trade generally is in a very contented frame of mind. Local retail trade is of very fair proportions.

That new building of Babson Bros., on the West side, is under roof. It has been put up in a remarkably short space of time, but nothing has been slighted. It is a splendid building in every way, and constructed to stay. That such a building should be erected for a concern in this business for distributive purposes alone is a magnificent comment on the permanency and immensity of the trade. Wholesale Manager Nisbett bought the Edison stock of the Cable Company, who are retiring from the wholesale business. The record stock amounted to something like 40,000.

C. E. Goodwin, manager of the talking machine department of Lyon & Healy, has gone East. While there he will pay a visit to both

the Victor and Edison factories. He reports business as excellent.

Mr. Blumberg, Western manager for the Regina Co., says that his only trouble is to get goods enough to supply the demand. His business so far this year has been nearly double what it was in the same period of 1906.

At the Rudolph Wurlitzer Co., Manager Uhl was highly elated over the way business is swinging along. "Away ahead of last year," was his brief but comprehensive report. In the retail department Manager John Otto has secured a valued head assistant in Lewis Kean Cameron, one of the best-known salesmen in the city, for some years with Lyon & Healy, and later with the Cable Company. An aggressive and systematic advertising campaign has been started by the retail department.

The Cable Company are down to a retail basis now, but superficial indications would go to indicate that their department will speedily become one of the most important in the city. At the head, under Manager Joseph T. Leimert, who has general supervision of all the local retail interests of the Cable Company, is a most capable man, C. M. Le Roux, who has around him a competent force of assistants. They are going to cater to the very best trade handling the Victor line, and as soon as they are out the Columbia Marconi records. The department is going after things in the way that wins, and will have the distinction of being the only large retail concern in town outside of the Columbia Co.'s office devoting itself entirely to the disc product. Manager Le Roux says they are going after the Red Seal and Victor Victrola trade, and go after it hard.

The Talking Machine Co. are making another milestone in its progress by removing to larger

and more centrally located quarters so far as the talking machine trade is concerned. The new quarters occupy an entire floor of the big building at 72-74 Wabash avenue. They will have more room than formerly, and will have the additional advantage of having everything on the one floor—a big advantage in the case of an immense jobbing business of this kind. Manager Arthur D. Geissler deserves the congratulations of the trade for the remarkable progress made by the company since his incumbency of the managerial chair.

The Western Talking Machine & Supply Co. are certainly a concern which must be reckoned with in a large way in the future. Messrs. Dillbahrner and Feinberg are two young men, hustlers both of them, who are the kind of men who do things. As previously announced in these columns they are prepared to make shipments of horns, O. K. cranes and "Standard" needles, f. o. b. Chicago at factory prices, and are now in a position to ship goods from Chicago the day ordered, a big advantage to the Western jobbing trade. While Mr. Feinberg was away Mr. Dillbahrner found things swinging in a manner which gave him something suspiciously like a case of nervous prostration, and he is now in his native State, Michigan, exercising his prowess as a mighty Nimrod and expert disciple of Isaak Walton.

The Salter Manufacturing Co.'s big factory on the West Side is busy taking care of the steadily growing demand for Salter cabinets.

Some of the recent 12-inch dollar record issues of the Columbia records are of the character calculated to increase and strengthen the Columbia prestige. Among them may be mentioned notably "I'll Sing the Songs of Araby," by Henry Burr; "Calm Breathes the Night," from one of

PROMPT SHIPMENT

WE CAN GIVE YOU
"WHAT YOU WANT"

IN

Edison Phonographs and Records

WHEN YOU WANT IT

"THE PEOPLE WITH THE GOODS"

BABSON BROTHERS

G. M. NISBETT, Manager.

304 Wabash Avenue,

CHICAGO, ILL.

the Verdi operas, sung in magnificent fashion by the robust Italian tenor, Romeo Berti; "In a Chimney Corner," by Collins and Harlin, a couple of stirring military patrols and a delightfully sung duet, the famous serenade by Schubert.

exhibit in charge of Nelson C. Durand, general manager of the company's business phonograph department, assisted by C. L. Hibbard, manager of the Western commercial department; E. C. Barnes, local representative, J. O. Hanna and others. Miss Rose Fritz, who carried off the



EXHIBIT OF EDISON BUSINESS PHONOGRAPHS AT BUSINESS SHOW, CHICAGO.

Decidedly interesting exhibits of commercial dictation machines were made at the National Business Show held recently at the Coliseum. The National Phonograph Co. had a fine large

typewriting honors at the New York show, demonstrated for the National. An interesting feature of the exhibit and carefully protected in a glass case is the first crude model brought out



EXHIBIT OF COMMERCIAL GRAPHOPHONES MADE BY COLUMBIA CO. AT BUSINESS SHOW.

~~Opportunity to Quality for Jobbers' Discounts~~

FOR

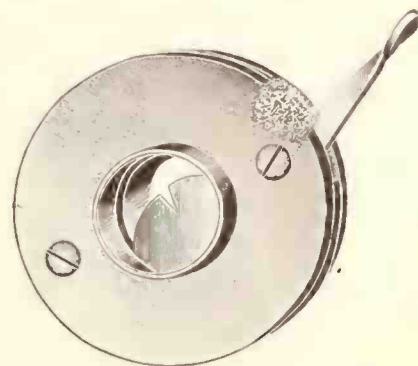

The Crescent Tone Regulator

—List \$1.00—

The Most **Successful** Tone Regulator ever placed on the market. We have taken the factory output.

No Need to Place Large Initial Order. Order a Sample.

We will send you free samples of **Exhibition Needles** and the famous **Petmecky Needles**.

Our Line of **Cabinets** are the greatest values in the country to-day.

Our Expert Repair Department

is amply equipped to handle both dealers' and jobbers' work in the most up-to-date and prompt manner.

REMEMBER WE WHOLESALE EXCLUSIVELY



72-74 Wabash Avenue, CHICAGO, ILL.

THE TALKING MACHINE CO.

Exclusive Wholesalers



HAVE MOVED TO NEW AND LARGER QUARTERS

72-74 Wabash Avenue

CHICAGO, ILL.

by Mr. Edison. Numerous samples of the company's latest improved direct current and alternating current machines were also exhibited. In connection with this exhibit was that of the Bates Manufacturing Co., another Edison institution, showing the Bates numbering machine. It was in charge of Frederick A. Burnham, of New York, manager of sales.

The Columbia Phonograph Co. had a fine exhibit to the right of the entrance as you pass into the building. They displayed the new model 1907 commercial dictation graphophone, of which the recording device is an especial feature. The type C. A. alternating current machine attracted much attention as it is available by concerns in comparatively small places, who have heretofore been compelled to use the spring motor graphophone. W. W. Parsons, who is the manager of the commercial dictation department of the Chicago office, was in charge, assisted by Paul M. Wood, C. A. Burgsten and Miss M. Ruckenbach and C. P. McDonald, a champion typewritist, as demonstrators. The exhibit proved to be a very big success, and Mr. Parsons has already had the pleasure of demonstrating to representatives of big local companies who have not yet come into the fold, but who give strong symptoms of warming up.

A set of the Bonci records has been received by E. C. Plume, wholesale manager for the Columbia Co., in this neck of the woods. He treated your representative to a recital. The records are superb.

J. A. Warren, formerly head of the collection department at the Chicago office of the Columbia Phonograph Co., has gone to Peoria to take charge of the Columbia office at that point. He is a young man who, while with the Columbia Co. only a few months, has had several impor-

tant promotions. The Columbia Co. are quick to appreciate ability on the part of their employes. Mr. Warren is just the kind of a man to make a superexcellent branch office manager. Watch him climb.

C. W. Noyes, secretary of the Hawthorne & Sheble Manufacturing Co., is now on his way back from the Coast. He has with him an imposing outfit, consisting of three of the company's excellent new talking machines, together with samples of the new Star records. He is meeting with splendid success, and if reports are true, has taken enough orders to keep the factories running for quite some time.

The demand for Victor Victrolas continues unabated. It is still purely a question of supply.

Some of the talking machine stores in the outlying districts, not all by any manner of means, are doing some wonderfully effective window trimming. Topical windows and windows illustrative of specific conceptions are occasionally seen which do distinct credit to the creators thereof.

Babson Bros., it is reported, have some surprises to spring on the trade in the very near future.

E. C. Plume, Western wholesale manager of the Columbia Co., is on a trip to the Twin Cities.

Another case of the talking machine occupying an important place in a funeral service comes from Muskegon, Mich. At a funeral in Pentwater, a nearby town, after the last rites had been conducted by the preacher, a talking machine was placed on the casket and the mourners heard the voice of the dead man singing his favorite hymn.

Looks like a busy spring and summer in all sections of the West.

BANQUET OF COLUMBIA FORCES.

Members of the Chicago Office as Well as Many Guests Held Their Annual Banquet at Vogel-sang's on March 20th—A Most Enjoyable Occasion—Many Impromptu Addresses Made by the Members of the Staff—Affair Will Go Down in History as the Most Successful Ever Held by This Company.

(Special to The Talking Machine World.)
World Office, 195 Wabash Avenue,
Chicago, Ill., April 8, 1907.

The Chicago office of the Columbia Phonograph Co. gave their annual banquet at Vogel-sang's on Wednesday evening, March 20. The event was a most thoroughly enjoyable one, and more than that was deeply significant to the man disposed to look beneath the surface. The affair, it should be said, was largely the work of O. W. Eckland, the manager of the instalment department, although he had very able assistance from the other department heads and the members of the working force. The World representative was honored with a place at the speaker's table and was glad of it, as it enabled him to study the faces of the 125 animated talking machines (beg pardon, gentlemen, graphophones) who filled the cosy little banquet hall at Vogelsang's. There were the managers of the departments, prominent members of the office and collection force, all men of evident ability, and then the salesmen. The remarks made in these columns last month applied generally to store salesmen. While all the instalment solicitors are on a commission basis, there were men there who make on an average of \$500 a month on a house to house canvass. A brighter, more intelligent lot of men you never saw, but, gentlemen, to the banquet. Toastmaster O. W. Eckland's introductions were very happy, full of intimate personalities and decidedly talkable. Toward the close of the evening, and after he had partaken of a demitasse of Vogelsang's coffee (there was no wine served), he burst forth into a rhapsody on the graphophone which cleared the smoke from the atmosphere and made every mother's son in the audience determine to be a better, truer man in the future. Your representative had an inkling of what was coming and had three court stenographers there to try to "take" Eckland. They got taken in. The immense philosophy and overpowering eloquence of Eckland's remarks palsied the brain, stilled the pen and made the stenographers in despair quit the hall and the business. While your representative is not sure he is right, he will try to the best of his ability to tell what Eckland was at. He informed the audience that according to the latest archaeological discoveries the Columbia graphophone dates back to a period long before the Christian era. He presented a theory to the effect that Moses used a Twentieth Century graphophone in transmitting his decrees to the Children of Israel. He has it on good authority that Mark Anthony entertained Cleopatra with the strains of "Won't You Let Me Put My Arms Around You?" wafted from an XP record on a type AP graphophone. The wonderful oracles at Delphi and the other places were made possible, he said, only by disc graphophones concealed within the shrine. He also called attention to that new cabinet of Parsons as a modern development of this idea. All that civilization can give us, all the consolations of religion, and all the inspiration of poetry can be traced to the graphophone.

Western Jobbers!

MORNING GLORY HORNS

Plain and Decorated

O. K. Cranes, Standard Needles, etc.

Shipped f. o. b. Chicago at factory prices, and shipped from Chicago the day order received.

Western Talking Machine and Supply Co.

DILLBAHNER & FEINBERG, Props.

6 E. Madison Street

CHICAGO



"Tiz-It" sells on sight—Retailers at 50 cents—Worth much more.
"Tiz-It" fits all Edison Phonographs and cylinder Graphophones.

IMPROVES ANY MACHINE 100 PER CENT.

Send for Descriptive Circulars and Discounts to the Trade

SPECIAL INTRODUCTORY OFFER TO DEALERS—Write for it To-Day



THE NEW ALL METAL

HORN CONNECTION

KREILING & COMPANY

INVENTORS AND SOLE MANUFACTURERS
855 North 40th Avenue, CHICAGO

RECORD DISC and CYLINDER CABINETS

Complete Line

Attractive Designs

Popular Prices

YOU WILL BE PLEASED

Write for Catalog "by return Mail"

O. D. WEAVER & CO.

Cor. Adams and Wabash Ave., CHICAGO

Brunnhilde could never have made her voice carry to the gods if she had not used the Twentieth Century. The small, still voice which Elijah heard in the mountain cave was undoubtedly from a type AU. He also has it on direct authority that the factories are now working on an order for a special machine for Gabriel, to be used in delivering the final trumpet toots.

Well, to go back. After the very bountiful repast had been discussed to the accompaniment of a magnificent type BD on one of the tables, Eckland started the flow of soul going by introducing W. C. Fuhri, district manager, who acquitted himself nobly.

Right here I would like to say that it is impossible to follow the law of proportions in referring to these speakers, as many of them, while very interesting and greeted with the greatest enthusiasm by the guests, yet treated the private business affairs of the company, and therefore only passing mention can in justice be made of them. Mr. Fuhri devoted himself largely to explaining the congestion in the company's factory and the reason why there has been delays in getting deliveries on certain types of machines. He said, however, that the company was getting in shape to fill all demands promptly, and went considerably into details. He thanked the men for the hearty co-operation and encouraged them heartily in their labor. A telegram of regret at not being present was received from A. D. Herriman, manager of the Davenport branch.

C. F. Baer, manager of the Chicago office, made a fine little talk, having to do mostly with the company's business. He was applauded to the echo.

E. C. Plume, western wholesale manager, made a talk which, unlike many of the others, it would be proper to report almost in full. Mr. Plume spoke in substance as follows:

"Mr. Chairman and Gentlemen—It is with a great deal of pleasure that I look around me and see the many enthusiastic and intelligent faces of the many Chicago office employes present here this evening, and I want to say that I have never before so much regretted the severance of my nominal connection with such a force of men. Many of you have worked for me, and with me, during my regime in charge of the retail departments of the Chicago office, and since that time many of you have become managers of the various stores under Chicago's jurisdiction. I want to say that there is room for all of you in responsible positions with this great concern, and that almost every man now in a position of responsibility and trust in our service has risen from the ranks. Some of you perhaps know something of my start in the service, but for those who do not know I want to say that I started with the Columbia Phonograph Co. in San Francisco quite a few years ago at a salary of \$10 per week. Since that time I have filled positions in every branch of the service, and while the end of the business now represented by me in this territory (that of the wholesale department) naturally makes us work along different lines, I want to assure one and all of you of my hearty co-operation at all times, and desire to thank you for the co-operation which I have received from the various employes of the Chicago office and its branches. You have at your head a man who has also risen from the ranks, as has been the case with such men as your former chief, John H. Dorian. I might add before closing that Mr. Dorian also started in the company's service at \$10 per week, and I hope to see every man who is present here this evening, and who is worthy of the trust, in a responsible position. You can do it, gentlemen; all it needs is sticktoitiveness and strict attention to business and the interests of the company. It is needless to say that I believe one and all of you will give Mr. Fuhri, Mr. Baer, and the department heads the co-operation which they will need to keep Chicago in its present position among the offices—that of first—and I think you are all with them in attaining this end; aren't you? (Cries of yes.) I thank you one and all for your forbearance



First Row (from left to right)—O. M. Kless, W. W. Parsons, A. E. Thomas, W. C. Fuhri, E. C. Plume, C. F. Baer, O. W. Eckland, F. A. Cass, E. A. Parsons. Second Row (from left to right)—W. A. Ashleman, W. A. Everly, J. H. Patker, Geo. Cass, Geo. Remelmschneider, T. D. Waiss, O. Radix, V. E. Green, J. W. Bentley, A. Mortenson, G. H. Ingalls, J. J. Murphy.

ANNUAL BANQUET OF THE CHICAGO OFFICE OF THE COLUMBIA PHONOGRAPH CO.

in listening to one who is essentially not a speaker, but I assure you that I am with you, heart and soul."

About this time the Columbia Junior Quartet, made up of members of the Ashland avenue branch, began to get in their innings. The quartet consisted of Messrs. Libben, Allen, Brown and Levy, with Prof. Chas. W. Hawley at the piano. Mr. Libben sang several solos, accompanied by the quartet, and one or two alone. He has a rich basso cantate voice. His upper tones are especially beautiful: he sings with great dramatic feeling. We also heard Mr. Grimes in a couple of ringing baritone solos. Mr. Shatz gave us some very clever German impersonations. One of the most enjoyable events of the evening was Mr. Levy's topical song, "Having to do with Columbia Personalities," with the chorus sung by the quartet. Mr. Levy wrote the skits himself.

Three good salesmen, lots of luck
Get a store rid of the truck
Columbia Graphos always sell
If you push 'em hard as h—
We do like h—.

Work from early morn till late
Bring ten leases in we'll say
Six are cancelled, three rejected
One delivered, but defective—
No cash.

Mr. Baer he sits downtown
Calls up Ashland with a frown
Boys get busy, get the his
So that Eckland will get his
May be.

When he does tell us this parable
We think Baer is quite unbearable
Pushing us like a Teddy Bear
Then we get business from everywhere—
Sometimes.

Then comes second Mr. Cass
What he says it sounds like brass
Boys get less business but more cash
It takes money to buy hash
A la boarding house.

Now such talk should spur us on
To work hard from morn till dawn
But if these two can't make us go
Then comes last not least you know
Oh Fuhri.

Him we tell our troubles all
That sometimes our orders fall
Because A1 is short on supply.
Then old Fuhri makes him fly.
Nothing but red tickets.

Now then this great aggregation
Of names is the combination
Mixed with energy and zest
Makes Columbia outsell the rest.
That's no joke.

We bear the cash right through old Fuhri
To Columbia just for glory
Take the banner lead us on
Hail Columbia Graphophone
Hurrah.

Mr. Green gave some talk on the practical problems and told something about his crew

management and also of his training methods.

J. A. Corday made an interesting talk, and C. L. Cassidy also spoke, exalting the calling of the salesman. Frank Cass, manager of the credit and collection department, gave a decidedly interesting talk and tried to clear up misconceptions on the part of the salesman regarding the credit department. He showed clearly that a sale was never turned down without thorough investigation, and described the woes of the collector and of the credit man in a decidedly interesting and often humorous fashion. Mr. Libben, manager of the Ashland branch, urged the necessity of co-operation in every branch, and showed why, in his opinion, the graphophone instalment solicitor had a lead pipe cinch as compared with salesmen in other lines. Mr. Johns, manager of the Detroit office, was greeted enthusiastically and spoke gracefully.

E. A. Parsons, who has again joined his brother, W. W. Parsons, in the commercial department, after an absence of two and a half years, brought the speech-making to an end in a strong and helpful address.

Among those who attended the banquet, or to whom invitations were sent, were the following: G. Abler, Mr. Allen, Benj. Arnold, W. A. Ashleman, Milwaukee, Wis.; L. Altenut, J. W. Bentley, Aurora, Ill.; J. F. Beattie, H. H. Brown, Maywood, Ill.; H. Braveman, Oak Park, Ill.; Wm. M. Breckinridge, Rockford, Ill.; Oscar Baer, G. Brown, L. Block, A. Busch, Chas. A. Bergsten, Edw. Blimke, Chas. F. Baer, J. L. Brouse, Tony Bertucci, R. Bowes, T. J. Blight, San Francisco, Cal.; Jos. Bentz, South Bend, Ind.; J. H. Bowling, F. J. Brogan, C. Balash, Mr. Blake, Davenport, Ia.; Mathew Conrad, F. L. Corcoran, Maywood, Ill.; C. C. Cassidy, Mr. Carlton, F. J. Connelly, Frank Coleman, Frank Cavanaugh, Geo. C. Cass, W. C. Clare, Harry A. Carlson, W. A. Conant, Morgan Park, Ill.; L. Core, B. J. Conway, Jas. H. Cordary, Oak Park, Ill.; F. W. Chamberlain, Rockford, Ill.; E. Conuoly, Mr. Cook, J. C. Cook, M. Connoly, F. A. Cass, A. Calason, A. L. Chouinard, Milwaukee, Wis.; J. P. Dryer, F. W. Davis, Crystal Lake, Minn.; J. H. Dorian, W. L. Eckhardt, E. D. Easton, New York, N. Y.; A. J. Ecklund, Walter R. Eckert, Rockford, Ill.; W. A. Everly, Otto F. Engel, A. F. Forrest, Wm. Forest, M. Feckles, W. C. Fuhri, C. W. Fuller, Wm. H. Finley, Edw. Frederickson, St. Paul, Minn.; W. S. Gray, San Francisco, Cal.; J. J. Grimsey, Seattle, Wash.; L. A. Gardner, A. Goldschmidt, Milwaukee, Wis.; H. H. Goul, Sali Gerst, J. Griffine, Harlem, Ill.; G. P. Green, Highlaud Park, Ill.; E. R. Gaskill, D. W. Handlin, Rockford, Ill.;

L. D. Heatre, Spokane, Wash.; Chas. Hermann, Wm. Hambly, Palos Park, Ill.; Chas. Hughes, J. Horton, W. H. Hammond, J. C. Hamilton, Riverside, Ill.; David Halperin, Rockford, Ill.; A. D. Heriman, Davenport, Ia.; J. S. Hollis, Cincinnati, O.; T. Herbst, M. Hamilton, G. H. Ingalls, W. Jones, Davenport, Ia.; Louis S. Johnson, Chas. W. Johnson, Oscar Johl, E. T. Jackman, H. M. Kane, M. J. Kirkpatrick, A. H. Karsten, Oak Park, Ill.; F. Kirscher, Oscar Kiess, J. Krieger, Alex. Kozlow, Indian Harbor, Ind.; A. Lubben, Geo. W. Lyle, New York; Ned Law, J. H. Lott, Jas. Larson, J. M. Little, E. Lipke, O. Lowry, A. J. Morrissey, New York; A. Miller, Jos. Matejka, M. Myers, H. H. Moses, John M. Means, Louis M. Miller, Alex. Milne, Thomas J. Murray, E. J. Melich, Charles Melisher, P. Myers, William Moylan, A. Mortenson, E. Marvill, T. F. McCarthy, R. Naughton, J. E. Naughton, C. A. Norlin, C. A. Nosker, J. H. Parker, R. F. Proctor, Evansville, Ind.; J. W. Paulson, Ed. D. Pugh, A. L. Peterson, John J. Palmgren, Indiana Harbor, Ind.; W. W. Parsons, E. A. Parsons, E. C. Perkins, Geo. Remeinschneider, O. Radix, C. O. Rathey, E. C. Rumble, L. S. Rausnitz, W. E. Remont, J. Runtz, Ralph Rose, A. W. Schultz, Rockford, Ill.; Geo. Sagar, South Bend, Ind.; J. H. Scoemann, St. Paul, Minn.; F. J. Steinback, Wm. Strand, A. C. Schultz, Sturgeon Bay, Wis.; Geo. Summer, Harry Stingley, L. M. Snell, Geo. Sidlan, Hedgewisch, Ill.; Frank Shanahan, Aug. Sims, Rockford, Ill.; N. Scheuben, Chas. Stone, Jas. H. Skelly, R. Saider, Philip Serida, D. Secord, W. R. Sumner, Edw. Siebert, Edw. Selbman, A. Swan, J. Schantz, H. Schmeltz, Chas. Schatz, A. Schatz, Wheaton, Ill.; D. E. St. Jean, A. W. Stewart, J. G. Tinsdale, A. E. Thomas, Milwaukee, Wis.; J. R. Templeton, F. J. Thompson, Pullman, Ill.; J. E. Tahl, John Uhlir, Mr. Vincent, Davenport, Ia.; E. T. Van De Mark, T. D. Weiss, J. R. Wilson, D. E. Waswick, Oak Park, Ill.; Wm. Werner, W. A. Weinberg, Davenport, Ia.; W. E. Whiteman, T. H. Williams, E. A. Wacaser, Harry L. Wilcox, G. M. Wedge, R. White, St. Paul, Minn.; E. H. Wheeler, St. Paul, Minn.; J. P. Whiteman, P. M. Wood, Leo Wolterding, J. G. Zoller, John Palmer, E. P. Van Harlingen, Richard Saunders, A. Miller, Chas. Wurst, W. T. Schueider, Leonard Ptang, David Dooley, C. G. Cook, J. A. Waring, Peoria, Ill.; Chas. Murphy, M. Gewolb, M. Kahn, A. Snyder, C. Smith, Mr. Kaplitzki, O. W. Eckland, T. H. Williams, E. C. Plume, J. McDonald, E. Levy, L. Grant, J. O'Donnell, F. Severa, A. Kane, V. E. Green, M. Skelly, K. Kalman, D. A. Halperin, J. Hausworth, E. P. Crafton, W. B. Clark, G. Bach.



"The White Blackman"

Fills Dealers' Orders
FOR
EDISON or VICTOR

goods in a way that makes other jobbers wonder how he does it.

TAKE NOTE, MR. DEALER

"Satisfaction" at Blackman's costs no more than "Dissatisfaction" elsewhere.

Write for our New Price List

Yours to make good

BLACKMAN TALKING MACHINE CO.
J. NEWCOMB BLACKMAN, Prop'r
"The White Blackman"
97 Chambers Street NEW YORK
"THE PLACE WITH THE GOODS"

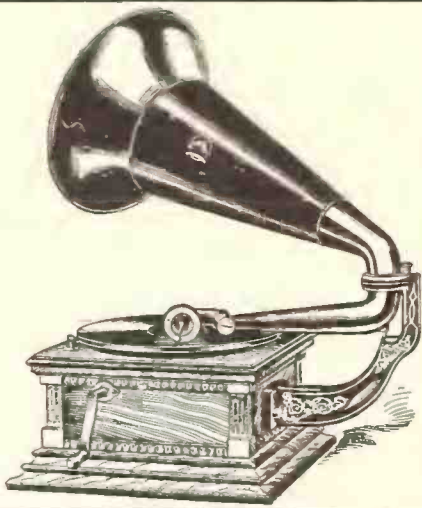

Mr. Dealer:

If you want always to get
the goods, send your orders to
a house of exclusive
Victor Jobbers.

STANLEY & PEARSALL,

541 Fifth Avenue, N. Y.

DEALERS — Be Up to Date

Stop clinging to traditions and buying inferior **RECORDS** because they have a name.

Order the **IMPERIAL** and get the latest and best on the market at most advantageous prices to yourself.

SEND FOR LISTS AND PRICES

LEEDS & CATLIN COMPANY

New York

THE MONTH'S HAPPENINGS IN PHILADELPHIA.

Satisfactory Trade Reports Both in Wholesale and Retail—Meeting of the Jobbers' Association—Continued Victor Company Expansion—Mme. Melba Visits the Victor Plant—The National Phonograph Co. Enlarge Commercial Department—Manager Gouldrup's Good Report—Russell Baum Takes Charge—What the Penn Co. Report—Opera Records Discussed—The Philadelphia Talking Machine Co. and the Keene Co. Consolidate—Louis J. Gerson, of the Musical Echo Co. Enthusiastic Over Demand for High Priced Machines and Records—Eagen Joins Bellak Forces—H. H. Gibson's New Sound Box—Mr. Weiss' Report—Louis Buehn & Bro. Very Busy—Some Important Trade Happenings of the Month Presented.

(Special to The Talking Machine World.)

Philadelphia, Pa., April 8, 1907.

Cheerful news as to good trade conditions in Philadelphia talking machine circles is heard on all sides. Business in wholesale departments is especially good, and while Easter buying of new hats and frocks tended to make retail sales a little quiet, the depression was only temporary and the trade anticipates good near future business in retail selling.

Much interest has been taken in jobbing circles, the past month in the first meeting in this city of the Eastern Talking Machine Jobbers' Association—an account of which appears in another page. Credit is due H. E. Marschalk, of the Musical Echo Co., chairman of the local committee of arrangements, and the Victor Talking Machine Co., of Camden, N. J., for the thorough success of the "meet" and the pleasure given the large number of visiting jobbers and their friends. All the Philadelphia jobbers did their share to make the gathering a happy success.

"Always busy" is a fit description of affairs at the ever-growing plant of the Victor Talking Machine Co. across the river. In all departments orders are being turned out as rapidly as facilities will allow and care and good workmanship will permit. As to demand: it is for everything the company makes from modest-priced talkers to the really remarkable machine, the auxetophone. On April 4 the Victor Co. took title to additional land on N. Front street, extending through to Delaware avenue. The property is 180 feet on N. Front. They also secured title to 40 feet front land on Market street. Buildings used by manufacturing companies now occupy some of the premises, but in time they will probably make way for new Victor plant additions. Kaighn & Draper, contractors, of Camden, N. J., are making alterations to the boiler-house of the company. Plans are being prepared for still another addition to the warehouse plant on N. Front street. It will be a five-story concrete building. Work on the new laboratory building at the southeast corner of Front and Cooper streets is progressing rapidly.

Mme. Melba, prima donna, and attendants, visited the Victor plant the past month and were shown all that was to be seen, much to their pleasure and interest.

A steam whistle on the Victor warehouse at Front and Linden streets, is a new improvement and calls the many employes to work. They have dubbed the voluminous calliope "His Master's Voice." The large electric sign which was on the main rear tower has been removed.

Edward B. Bostwick, manager of the Philadelphia district of the National Phonograph Co.'s commercial talking machine department, has enlarged his office staff of employes in the North American Building, in order to take care of increasing business. Mr. Bostwick is having excellent success in introducing phonographs in commercial circles here, and is an energetic and tireless worker.

Referring to trade conditions, Manager John A. Gouldrup, of the Columbia Phonograph Co.'s main Philadelphia office, said: "Business has exceeded our expectations; it is far ahead of a year ago at a similar period—and it was very good then. I ascribe brisk trade to good business conditions and the fact that our Columbia employes have been hustling—activity and push has much to do with securing business, you know. Personally, I favor the proposed plan of the manufacturers to not issue so many new records every month. Matters have been at

rather high pressure and business under the new plan will better adjust itself all around."

Maxwell Carrington, who has been an efficient assistant to Mr. Gouldrup here, was appointed manager of the Columbia Co.'s office at Lancaster, Pa., the past month, and has taken hold of matters with a vim that presages success.

Russell Baum, formerly connected with a prominent New York advertising house, has been appointed manager of the commercial graphophone department of the Columbia Co. "He has had a phenomenal month," said Mr. Gouldrup, referring to Mr. Baum's hustling abilities, "and runs in orders so fast we hardly know what to do with them. Mr. Baum is certainly 'making good.'"

William Morse, jobbing house salesman of the Columbia Co.'s headquarters, stopped over here three days on his way South. He reports excellent business and is stirring things up lively.

Said the Penn Phonograph Co., 19 S. Ninth street: "Business with us is going along very nicely—not quite up to a year ago, which was unusually good—but very satisfactory on the whole. The prospects are for good steady business." The Penn Co. have just received a carload shipment of record cabinets of various designs and finish, from the Herzog Furniture Co., Saginaw, Mich. They are giving considerable attention to the cabinet end of the business, and as a result buyers are looking to them for the latest and best in cabinets and accessories.

E. G. Friedel has joined the salesmen's staff of the Penn Co. and will travel Eastern Pennsylvania. He is experienced and, as orders already sent in prove, energetic.

Speaking of "opera records," one large jobber said: "I find that the opera records are a pretty big proposition for the average buyer on account of the cost. The sales of complete opera records must be somewhat limited, it seems to me, as there are not many people who care to invest so much money at once, and buying an opera on the plan of a record at a time is hardly satisfactory.

However, sales already made of the opera records prove the getting out of them was a success, artistically and financially, and I hope more will be put on the market in due time."

The Philadelphia Talking Machine Co., Benjamin Futernick, proprietor, and the Keen Co., jobbers and retailers, have consolidated and the Keen Co. have reorganized, with David Keen, president, and Mr. Futernick, secretary and treasurer. Application has been made to the Governor to increase the capital stock of the Keen Co. from \$5,000 to \$10,000. The large stock of phonograph goods formerly sold by Mr. Futernick, at 156 N. Eighth street, has been removed to the Keen Co.'s large warerooms at 132 N. Eighth street, and here the consolidated companies will conduct a retail and jobbing business under the firm name of the Keen Co. Speaking of trade conditions, Mr. Futernick said: "In retail lines it is a little quiet on account of Easter aftermath, but it is very good in jobbing lines. We now have such an enormous stock of Victor, Edison and Columbia records we scarcely know where to place it; we ought to have more room and will probably rent an annex for stock purposes. The Talking Machine World deserves credit for its lasting work in building up the talking machine business." A new state salesman will be added to the company's sales' forces.

In a trade chat, Assistant Manager Louis Jay Gerson, of the Musical Echo Co., 1217 Chestnut street, expressed decidedly optimistic views of the talking machine business, present and future. "Of our own business," said Mr. Gerson, "I can say that we are extremely busy in all departments. We have increased our force of employes to forty persons—in office, stock, shipping and retail sales departments—and that is outside of employes we retain in other ways. Our wholesale business is increasing very much and it is because we have the goods and can fill orders promptly—two things which count. We put in an order early for two hundred Victor Victrolas and we have been putting them out as fast as we can get them. We ascribe much of the success we have had in our retail department to the grand opera season. We had twenty grand opera nights in Philadelphia—from Conried; if we have Hammerstein and Conried both next season our business will be doubled. We sent circulars to patrons of the opera—setting forth the merits of our opera records, and then, using a follow-up system, secured most successful results. The 'Rigoletto' quartette and the other special red seal records of the Victor Co. have sold immensely well and to them we ascribe much of our success in sales the past season.

Mr. Dealer.

Have you ever been caught short on your Edison Records and found that your Jobber could not help you out?

Have you ever lost a sale in consequence? Then you can appreciate the value of doing business with a Jobber who can fill your orders promptly.

We are the largest exclusive Edison Jobbers in the East, and carry the most extensive line of Edison Machines, Records and Supplies.

We guarantee immediate shipment of all orders.

ECLIPSE PHONOGRAPH CO.
203 Washington Street
HOBOKEN, N. J.

Said Manager H. T. Lewis, of the Lewis Talking Machine Co., 15 S. Ninth street: "New millinery and Easter suits had an adverse effect upon retail talking machine trade—but a temporary depression only, and I look to see business pick up again soon. In wholesale lines trade is very good and the outlook is bright. We are putting out a large quantity of records and supplies.

Trade being so good in the player piano department of James Bellak's Sons, 1129-1131 Chestnut street, H. B. Rouillet has been appointed exclusive manager of that department, relinquishing the talking machine department to James Egan. Mr. Egan was formerly with the North-Eastern Phonograph Co. and has both experience and vim. The Bellak firm have removed the phonograph department to the fourth floor of its large establishment and there Mr. Egan is putting in some excellent sales' work. It has been pointed out that the Bellak Co., with such a large and complete stock, seemed to be hiding its phonograph light under a bushel measure—but that plan now seems to be a thing of the past.

At the office of the Disk Talking Machine Co., 13 N. Ninth street, The World was informed that Howard H. Gibson was again with the company as retail office salesman and is having excellent success in pushing sales of Zonophones. He said of trade: "Easter festivities had some effect on sales, but it won't be quiet long and business is very satisfactory." William L. Ziegler is visiting state points and pushing sales with success. Robert Gibson and family are in Florida. Mr. Gibson has perfected a new taper arm and sound box which will be on the market shortly. We are putting out the goods, all right. So long—come in again."

Proprietor Adolph Weiss, of the Western Talking Machine Co., 41-43 N. Ninth street, said: "Trade is a little quiet, as it usually is Easter time, but I look to see it pick up shortly. Talking machines are luxuries—not necessities like shoes and clothing, and hence, we must look for sales to fall away when hats and Easter clothes have the upper hand. I look for improvements in talking machine lines and they will tend to make business good. Then, too, we will probably have an adjustment of talking machine affairs. It is only a question of time when a lot of small dealers will drop out—or be dropped—dead dealers will go, and it will result in benefit for the live men in the business. To be successful in the phonograph business now a house must carry a full and complete line. A few sales here and there by small dealers does not constitute

THE EDISONIA CO.'S HANDSOME NEW QUARTERS.



(Special to The Talking Machine World.)

Newark, N. J., April 11, 1907.

The Edisonia Co., who recently took possession of their new building at 57 Halsey street, have found that even with three floors and basement packed with stock, more room was needed to handle their growing business, and therefore they have signed a lease, good until 1915, for the entire building in which their branch store occupies the ground floor. The branch is devoted entirely to the retail trade, and extensive alterations already begun will

success and spoils the trade of legitimate dealers."

J. N. Blackman, vice-president of the Blackman Talking Machine Co., New York, was a recent trade visitor and stated business was very good all along the line.

Louis Buehn & Bro., 45 N. Ninth street, reported the jobbing end of business to be brisk, while Easter had made the retail end a little quiet. It will quickly recover, however, and the outlook is promising.

Among new retail talking machine dealers stocked up by Philadelphia jobbing houses the past month are: Moore Bros. & Co., Plymouth,

greatly facilitate the handling of the many customers. In connection herewith is shown a view of the interior of the main store on Halsey street, with the handsome gold-plated Edison phonograph presented by Mr. Edison to A. O. Petit, president of the Edisonia Co., placed in the center of the floor, and which he greatly prizes. The Edisonia Co. are among the representative talking machine houses, not only in Jersey, but in the whole United States, and the future is full of promise for their further success.

Pa.; W. M. Koch, Tamaqua, Pa.; William Kulp, Leadrockville, Pa. (Schwencksville P. O.), and Oswald & Schlang, York Road and Tioga street, Philadelphia.

M. La Homadieu, a successful retailer of Stroudsburg, Pa., was a recent trade visitor and left a number of good orders for phonograph goods.

Embassador Hugg, of the Edison Co.'s headquarters, was a recent visitor and carried a large, well filled order book.

News notes in a minor key are the failures of J. P. Jones, retailer at Sunbury, Pa., and the failure of Felix R. Bayley. Mr. Bayley was formerly in the phonograph business with John F. Ruane. The partnership was dissolved and Mr. Bayley opened a store at 5004 Baltimore avenue. Mr. Bayley, individually, and trading as F. R. Bayley & Co., and as partner of the late firm of Ruane & Bayley, was adjudged a voluntary bankrupt. Liabilities, \$14,501.28; assets, \$10,976.54. Referee, T. M. Etting.

New amusements arcades have been opened here as follows: Mark M. Dintenfass, 1319 Market street; W. Saunders, 6300 Woodland avenue, and at 4028-4030 Lancaster avenue; name of owner not given.

The department stores have been giving Easter entertainments galore—as one manager put it, "from variety stage knockabout stunts to sacred cantatas," and the crowds attracted by the free shows have boomed trade in the talking machine departments. Good sales have been the rule for several weeks.

COLUMBIA AT JAMESTOWN EXPOSITION.

Elaborate preparations for the exhibit by the commercial department of the Columbia Phonograph Co. at the Jamestown, Va., Tercentennial are under way. One of the features will be a booth fitted up like a model office, showing how the commercial graphophones may be used to the best advantage.

The Columbia Phonograph Co. have opened warerooms at 30 Plume St., Norfolk, Va., where concerts are being given every Saturday evening.



(Patented March 12, 1907.)

For Edison and Columbia Machines
Ask Your Jobber

**THE IDEAL FASTENER CO., 143 Liberty Street
NEW YORK CITY**

TRADE NOTES FROM TWIN CITIES.

Minnesota Phonograph Co. Transfer Wholesale Department to Minneapolis—Their New Retail Store Splendidly Equipped—H. C. Hough Optimistic Over Outlook—The New England Furniture Co. Now Handle Edison as Well as Victor Lines—Big Call for Scandinavian Records—Other Items.

(Special to The Talking Machine World.)

Minneapolis and St. Paul, April 8, 1907.

The Minnesota Phonograph Co. have transferred their wholesale department from St. Paul to Minneapolis, and that end of the business will be carried on from quarters which have been opened at Fifth avenue south and Washington. The retail business in St. Paul will be continued at the old location.

This company's new retail store on Nicollet avenue in Minneapolis is not completed as yet, though it was occupied this week. It will be the best equipped talking machine store in the Twin Cities when the finishing touches are on. There will be eight separate parlors, so that eight machines can be running at the same time without one interfering with the other. It is located in the center of the best retail district of the city, where rents are the highest, and the experiment will be watched with much interest by other dealers who predict dire things for the company. L. H. Luckner, the president of the company, is very optimistic, however, of the outlook in the talking machine trade, and believes the growth of the business warrants such a move as he has made.

T. C. Hough, who operates four stores in these two towns, exploiting Edison and Zonophone machines, reports a steady trade, with a considerable increase over last year's business. He regards the outlook for the spring business as very encouraging.

J. W. Wheeler, manager of the Columbia Phonograph Co., reports the retail trade at stores in both cities as showing up well with a year ago. The new \$28 disc machine has met with considerable favor, and is having a good sale, with excellent prospects for the spring and summer.

At the talking machine department of the New England Furniture Co., A. M. Magoon, who has charge, said: "We are not rushed, but we are doing business right along, and trade keeps pretty steady. The demand for records is good." The New England people have added the Edison machine to their list. They handled the Victor exclusively heretofore.

The Columbia Phonograph Co. have decided to put a number of Scandinavian records on the market, with a view to supplying the great Scandinavian element in the Northwest, according to Manager Jay H. Wheeler, of the Minneapolis store. The experiment has been tried of introducing records made by local talent, but was not successful. The company now intends to send representatives to Sweden, Norway and Denmark, who will make records of the folk songs and ballads of those countries as originally sung—a move that should prove successful.

UDELL CABINETS ABROAD.

The Products of the Famous Indianapolis Manufacturers Find Favor in South America—Valuable Addition to Dealers Stock.

The Udell Works, Indianapolis, manufacturers of fine record cabinets both for discs and cylinders, have experienced a most encouraging increase in their business, including their export trade. Only very recently a large order was received for disc record cabinets to be shipped to Buenos Ayres, and it is the intention of the firm to push their export business in a very energetic manner. The line of cabinets made by the Udell Co. is one that tends to promote trade for both manufacturer and dealer, being handsomely finished and built especially for holding records. They lend attraction to any parlor, and increase the attraction of the whole talking machine outfit.

MORE KICKS FROM THE KICKER.

Five New "Kicks" Covering a Variety of Subjects Which Cannot Fail to Interest the Many Kickers in the Trade.

Biloxi, Miss., March 23, 1907.

Editor The Talking Machine World:

Thank you for publishing my "kicks," and yet, while that which you have published has "afforded considerable relief to my mind," I feel as if there were some more kicks coming, and that my reputation as a kicker will not be fully established until I have registered them.

Kick 1. Why do not dealers organize so they can kick to some purpose?

Kick 2. Why do record manufacturers, when they get a good singer, work them to death, and on songs their voices are unfitted for? Take Miss Ada Jones—simply "great" in "Keep a Cosy Corner in Your Heart for Me," and plenty of others. She is almost non-understandable in "Virginia Song," "If the Man in the Moon Were a Coon," "Waiting at the Church," and others, and these records are "dead ones," and the makers will not take them back—except as I shall tell in another kick. I have tried various poor records in several makes, thinking the first ones I received was the fault of recording in that particular brand of record, but I found that poor records in one manufacture were the same in all. What right has the manufacturer to foist on the dealer a record made by a singer whose voice does not suit the song, and then lecture us on "how to sell records, and keep sweet, and please our patrons," etc., ad nauseum? We cannot please our patrons with any such records, and unless we force them on customers in some questionable manner, they are dead stock to us, and so a dead loss, as we are under contract not to cut the price, and that, by the way, brings me to

Kick 3. Why, only once in a long time are we allowed to exchange records with the manufacturer, who gives us just ten days, and is five days getting the news to us, and unless we can get the records—all nicely prepaid—to a given point to the minute in the other five days, we are out not only the records, but our express charges? By organization we could change all this, and every unsalable record would go back to the man who made it, for a record that would sell. Then the maker would devote his attention more to quality and less to quantity. We little dealers are "dead eases," and we don't know we have any rights that the manufacturers are bound to respect.

Kick 4. The manufacturers, smiling, tell us

that the more agents they have in each town the more machines each agent will sell! "Yep!" that is perfectly clear! I have never seen any claim that needed so little explanation to prove it. But, Lord bless you! the manufacturers themselves refuse to take their own dose of castor oil. They are lawing the daylights out of each other over "infringements," in order to limit the number of factories, and, bless you, how one crows when he shuts up the other! That which is sauce for the goose seems to be gall and wormwood for the gander!

Kick 5. I have rebelled on the advice issued in wheelbarrow loads to always "smile and smile" to our customers. I have smiled so much my face aches, and my customers—a few of them—worked me to a frazzle; so I have faced about. A man a few days ago had me play cylinder records nearly an hour. He took three, then later brought a lady back with him. The lady carried two of the records which she wanted new records for, claiming I had sold the man two cracked records. I took the records, laid the money for them on the counter, and said to the lady, "That gentleman picked those records from the machine; when he left here they were in perfect order. I will not exchange them, but here is your money. I don't want any more of that gentleman's trade!" That "gentleman" never opened his pie aperture, but slunk away. I have soaked six customers this way, and didn't give them a "smile" of any sort, and I count myself ahead. There are times when a little manly self-assertion is needed in presence of those who conspire to beat you. Their "patronage" is the kind it pays you to get along without.

But this is enough kicks, as space with you is valuable. There are a lot more that might be made but which will do no good until dealers make them in an organized way. Fraternally,
SUMNER W. ROSE.

ENTERPRISING BUFFALO HOUSE.

The Buffalo Talking Machine Co., Buffalo, N. Y., is certainly "all there" with up-to-date ideas when it comes to advertising their business, especially locally. Not long ago they hired the well-known Hawaiian orchestra to render selections for recording while seated in the show window in full view from the street. The recorder was placed in front of the orchestra and customers desiring a certain selection could have the orchestra play it and take the master record away immediately. The scheme proved highly successful in every way and attracted record breaking crowds.

No Jobber in the United States can or will take better care of your

Victor, Edison and Columbia

RECORD AND MACHINE

orders than we will. If you are getting entire satisfaction where you now trade—stick! If not, and you have the cash—try us.

POWERS & HENRY CO.

101 Sixth Street

PITTSBURG, PENN.

OUR FOREIGN CUSTOMERS.

Amount and Value of Talking Machines Shipped Abroad from the Port of New York.

(Special to The Talking Machine World.)

Washington, D. C., April 5, 1907.

Manufacturers and dealers in talking machines will doubtless be interested in the figures showing the exports of talking machines for the past four weeks from the port of New York:

MARCH 11.

Alexandria, 4 pkgs., \$273; Antwerp, 7 pkgs., \$350; Berlin, 113 pkgs., \$1,860; Bombay, 9 pkgs., \$212; Buenos Ayres, 30 pkgs., \$3,439; Calcutta, 4 pkgs., \$100; Corinto, 1 pkg., \$110; Hamburg, 3 pkgs., \$100; Havana, 7 pkgs., \$268; Havre, 95 pkgs., \$320; 3 pkgs., \$122; London, 36 pkgs., \$1,767; Montevideo, 15 pkgs., \$1,799; Neuevitas, 21 pkgs., \$140; Para, 4 pkgs., \$342; St. Petersburg, 44 pkgs., \$1,729; Sydney, 163 pkgs., \$6,656; 141 pkgs., \$3,000; Vienna, 7 pkgs., \$235.

MARCH 18.

Berlin, 125 pkgs., \$1,908; Calcutta, 50 pkgs., \$558; Cardiff, 20 pkgs., \$1,175; Genoa, 27 pkgs., \$1,119; Georgetown, 6 pkgs., \$121; Hamburg, 3 pkgs., \$235; Havana, 6 pkgs., \$586; 6 pkgs., \$254; Havre, 58 pkgs., \$1,120; London, 291 pkgs., \$3,485; 2 pkgs., \$132; Manchester, 20 pkgs., \$1,075; Melbourne, 25 pkgs., \$560; Natal, 4 pkgs., \$197; Santos, 16 pkgs., \$946; Santiago, 14 pkgs., \$423; Singapore, 13 pkgs., \$878; St. Petersburg, 8 pkgs., \$349; 4 pkgs., \$117; Vienna, 14 pkgs., \$290; 11 pkgs., \$487; Warsaw, 15 pkgs., \$483; 9 pkgs., \$184; Yokohama, 28 pkgs., \$2,360.

MARCH 25.

Buenos Ayres, 156 pkgs., \$10,747; 32 pkgs., \$456; Cardiff, 4 pkgs., \$200; Corinto, 5 pkgs., \$150; 3 pkgs., \$240; Hamburg, 1 pkg., \$100; 30 pkgs., \$6,000; Havana, 22 pkgs., \$735; Havre, 3 pkgs., \$160; London, 276 pkgs., \$7,481; Para, 13 pkgs., \$646; Rio, 20 pkgs., \$1,472; Vera Cruz, 8 pkgs., \$125.

APRIL 2.

Berlin, 27 pkgs., \$836; Brussels, 126 pkgs., \$326; Buenos Ayres, 58 pkgs., \$2,401; Calcutta, 4 pkgs., \$150; Colon, 8 pkgs., \$258; Glasgow, 6 pkgs., \$102; Lodz, 9 pkgs., \$335; London, 82 pkgs., \$3,408; St. Petersburg, 11 pkgs., \$292; Vienna, 11 pkgs., \$304; Warsaw, 14 pkgs., \$363.

S. R. Leland & Son have opened a large talking machine department in their store in Worcester, Mass., and will devote much effort to it in order to make it the leading department of their business. A full line of Victor machines and records is carried in stock.

EDISON MEN PLEASED.

The Heads of Departments and Employes of the Various Edison Companies at the New York Office Report Progress of Edison Mutual Savings and Loan Association.

The Edison Mutual Savings and Loan Association, composed of the heads of departments and employes of the various Edison companies at their New York offices, 31 Union Square, declared its regular semi-annual dividend, the twelfth of the series of twenty-five weeks, March 20, and everybody was happy. The neat sum of \$3,724 was handed out, with a smiling countenance, by Frank K. Dolbeer, the secretary-treasurer. In speaking of the association, Mr. Dolbeer said: "This is one of the most profitable and successful associations of its kind I have ever been connected with. For six years—since its organization—I have been treasurer, and handled \$38,652, and every 25 weeks we divide up the proceeds, the result of loans among ourselves. As you see, we have the regulation constitution and by-laws, and the affairs of the association are looked after by a board of directors. None of the officers are paid for their services." The officers, besides Mr. Dolbeer, are: President, C. H. Wilson, sales manager; Walter Stevens, manager of the export department, vice-president.

PRELIMINARY INJUNCTION REFUSED.

Judge Lacombe Hands Down His Long Expected Decision March 25, in Favor of the Leeds & Catlin Co.

The long-looked-for decision in the suit of the American Graphophone Co. against the Leeds & Catlin Co., New York, involving the disc duplicating process of the Jones patent, was handed down by Judge Lacombe, United States Circuit Court, southern district of New York, March 25. It is brief, as follows:

"Irrespective of any other point presented on this motion, there is too much dispute as to the process by which defendants' discs were produced to warrant the granting of a preliminary injunction on affidavits. Motion denied."

A NEW DIAPHRAGM.

A. C. Mestraud, formerly of this city, and one of the best-known inventors in this field, has just perfected a new diaphragm, which is spoken very highly of by all who have heard it in use. For some time past his friends have been trying to induce him to place it on the market, therefore many will be glad to know he has taken the

step and it is being introduced in an advertisement of the Acme Supply Co., Lincoln, Neb., which appears in another part of this paper.

BOON TO OVERWORKED FATHERS.

According to a New Jersey paper, a new and practical use has been found for the talking machine by a busy housewife of that busy state: "Mrs. Franklin, living in the east part of Atlantic City, N. J., has discovered a new use for the talking machine. She uses it to lull the baby to sleep while she goes about her household work as usual. She simply puts a lullaby song on the machine and starts it going and the baby drops off to sleep. The little one has developed a talent for music and objects seriously when the wrong kind of music is played for it."

GROWTH OF DOUGLAS CO.'S BUSINESS.

Since John Kaiser has become sales manager of the Douglas Phonograph Co., New York, its business has greatly increased. President Henkel and John are practically invincible when it comes to laying out a selling campaign and adding new and irresistible lines.

J. W. Binder, manager of the Columbia Commercial graphophone department, made an interesting address upon salesmanship recently at a dinner given to their employes by Koenig & Schurtz, wholesale grocers and importers. Mr. Binder spoke from wide experience and made some excellent points.

SPECIAL TO THE TRADE!

FOR 30 DAYS ONLY—These 1907 Song Hits at 10c. per copy, or \$10.00 per hundred:

"Every One Is In Slumberland But You and Me"

"Twinkling Star"

"Sweethearts May Come and Sweethearts May Go"

"Where The Jessamine Is Blooming, Far Away"

Instrumental—Paula Valse Caprice

It will pay you to keep in touch with us. Write to-day!

THIEBES-STIERLIN MUSIC CO.
ST. LOUIS, MO.

Increase Your Income!

YOU CAN DO IT EASILY
WITH THE

YORK BAND INSTRUMENTS

These instruments are used by leading bands, and will form a special feature of attraction in any store. The name of York on a band instrument is a guarantee of the highest quality.

J. W. YORK & SONS
GRAND RAPIDS, MICH.

Sell Them The Best Oil— It Pays



The best oil that's made (that's "3-in-One") is none too good for your talking machines. No other oil is good enough. Any less-than-best oil is liable to make trouble between you and your customers. Why take chances? Why not take the good easy profit (50 and 100 per cent.) you would make selling "3-in-One?"

"3-in-One" is the one right and safe lubricant for phonographs, graphophones, gram-o-phones and all other disc machines. It makes the action points work perfectly. Prevents rust and tarnish on the metal surfaces. Polishes the wood cases. Keeps the records clean—just wipe them with soft cloth moistened with "3-in-One."

Suppose you just get a trial supply of "3-in-One" from your jobber and see what happens. Or prove its value to yourself by writing to-day for a FREE sample bottle and the "3-in-One" Book. Address:

G. W. COLE COMPANY, Sole Makers
of "3-in-One"

42 Broadway,

New York City.

60 YEARS'
EXPERIENCE

PATENTS

TRADE MARKS
DESIGNS
COPYRIGHTS & C.

Anyone sending a sketch and description may quickly ascertain our opinion free whether an invention is probably patentable. Communications strictly confidential. HANDBOOK on Patents sent free. Oldest agency for securing patents. Patents taken through Munn & Co. receive special notice, without charge, in the

Scientific American.

A handsomely illustrated weekly. Largest circulation of any scientific journal. Terms, \$3 a year; four months, \$1. Sold by all newsdealers.
MUNN & Co., 361 Broadway, New York
Branch Office, 625 F St., Washington, D. C.

Leading Jobbers of Talking Machines in America

OLIVER DITSON COMPANY

Are the largest Eastern Distributors of
Victor Talking Machines and Records

Orders from Dealers are filled more promptly, are packed better, are delivered in better condition, and filled more completely by this house than any other house in the Talking Machine business, so our customers tell us.
150 Tremont St., BOSTON, MASS.

EDISON VICTOR JOBBERS DISTRIBUTORS

You Can Get Goods Here
Our wholesale depot is a mile from our retail store. Records are not mauled over for retail customers and then shipped out to dealers. Dealers buying from us get brand new goods just as they come from the factory.
McGREAL BROS., Milwaukee, Wis.

Have you a meritorious article you want "pushed" in Mexico? We are Edison jobbers; twenty years' experience in the country. Address
The WARNER DRUG CO.
Torreon, Coah., Mex.
Apartado 163

BENJ. SWITKY

Victor and Zonophone Distributor
Phone 665 Gramercy 27 E. 14th St., New York City

NEW ENGLAND
JOBBER HEADQUARTERS
EDISON AND VICTOR
Machines, Records and Supplies.
THE EASTERN TALKING MACHINE CO.
177 Tremont Street BOSTON, MASS.

Eclipse Phonograph Co.,
Hoboken, N. J.
Jobbers of Edison Phonographs and Records.
Best deliveries and largest stock in New Jersey

JOHN F. ELLIS & CO.
WASHINGTON, D. C.
Distributor
VICTOR Talking Machines and RECORDS Wholesale and Retail
Largest Stock in the South

PERRY B. WHITSIT L. M. WELLER
PERRY B. WHITSIT CO.,
213 South High Street, Columbus, Ohio.
Edison Phonographs and Records **JOBBERS** Victor Talking Machines and Records

S. B. DAVEGA,
EDISON JOBBER
VICTOR DISTRIBUTOR
Kaiser's Illuminated Signs for Edison, Victor and Columbia Records.
32 East 14th St. New York City.

NEAL, CLARK & NEAL CO.,
BUFFALO, N. Y.
Jobbers of Edison, Columbia, Zonophone and American machines and records.
Largest Talking Machine house between New York and Chicago.

SAINT LOUIS TALKING MACHINE CO.

Southwestern Headquarters for
Victor Machines and Records
We are Specialists of long experience and guarantee satisfactory service
SAINT LOUIS, MO.

KNIGHT MERCANTILE CO.

211 North 12th St., ST. LOUIS, MO.
ZON-O-PHONE JOBBERS
AND YOU GET every record same day; also NEEDLES, HORNS, CRANES, CABINETS, CASES.

HARGER & BLISH

Western Distributors for the
VICTOR COMPANY.
It's worth while knowing, we never substitute a record.
If it's in the catalog we've got it.
DUBUQUE, IOWA.

PITTSBURG PHONOGRAPH CO.

VICTOR JOBBERS and EDISON JOBBERS
Largest and most complete stock of Talking Machines and Records in Western Pennsylvania.

Minnesota Phonograph Co.

ST. PAUL MINNEAPOLIS
37 E. 7th Street 518 Nicollet Avenue
Edison Phonographs and Records
ALL MACHINES, RECORDS AND SUPPLIES
Write for Prices on Supplies.
Orders filled same day as received.

THE ECLIPSE MUSICAL COMPANY

T. H. TOWELL, Pres. & Treas.
JOBBER OF **EDISON PHONOGRAPHS, VICTOR TALKING MACHINES, RECORDS AND SUPPLIES.**
LARGEST STOCK, QUICKEST SERVICE. 714 Prospect Ave., Cleveland, O.

E. F. DROOP & SONS CO.

925 Pa. Avenue 109 N. Charles St.
WASHINGTON, D. C. BALTIMORE, Md.
Wholesale and Retail Distributors

Edison Phonographs Victor Talking Machines

Southern Representatives for
Topham's Carrying Cases; Herzog's Record Cabinets; Searchlight, H. & S. Tea Tray and Standard Metal Co.'s Horns and Supplies.

WEYMANN & SON

WHOLESALE DISTRIBUTORS
EDISON Talking Machines RECORDS & SUPPLIES VICTOR

Place your name on our mailing list. We can interest you.
923 Market St., Philadelphia, Pa.

Peter Bacigalupi & Sons

SAN FRANCISCO, CAL.
WHOLESALE 1021-23 Golden Gate Ave. RETAIL 1113-15 Fillmore St.

JOBBERS Edison, Zonophone
DEALER Victor
All Kinds of Automatic Musical Instruments and Slot Machines.

BABSON BROS.

304 WABASH AVENUE
CHICAGO, ILL.
Special attention given DEALERS only, by G. M. NISBETT, Manager, Wholesale Department.

LARGEST STOCK OF EDISON PHONOGRAPHS AND RECORDS in the U. S.

Southern California Music Co.

EVERYTHING FOR TALKING MACHINES
Edison and Zon-o-Phone Jobbers
LOS ANGELES, CAL.

KLEIN & HEFFELMAN CO.

Canton, OHIO.
Edison & Victor
MACHINES, RECORDS AND SUPPLIES
Quickest service and most complete stock in Ohio

Jacot Music Box Co.,

39 Union Sq., New York.
Mira and Stella Music Boxes.
Edison and Victor Machines and Records.

Victor Talking Machines and Records

SELF-PLAYING PIANOS.
Catalogs and Prices on Application.
Pacific Coast Distributors
Sherman, Clay & Co., San Francisco, Los Angeles, Seattle.

SOL BLOOM

SOL BLOOM BUILDING
3 E. 42d Street, New York
VICTOR DISTRIBUTOR
EDISON JOBBERS

All the Latest Novelties in Talking Machines, Attachments, Supplies, Etc.

IF YOU'RE IN WESTERN MICHIGAN it will be money in your pocket to order
Victor Machines and Records
... of ...
JULIUS A. J. FRIEDRICH
30-32 Canal Street, Grand Rapids, Michigan
Our Motto: { Quick Service and a Saving in Transportation Charges

Every Jobber in this country should be represented in this department. The cost is slight and the advantage is great. Be sure and have your firm in the May list.

Leading Jobbers of Talking Machines in America

Business Developers

SOLE IMPORTERS OF
**Low-Priced Cylinder
Phonographs**

IMMEDIATE DELIVERIES FROM
NEW YORK STOCK

THE EDWIN A. DENHAM COMPANY, Inc.
31 Barclay Street
LONDON NEW YORK BERLIN

FINCH & HAHN,
Albany, Troy, Schenectady.
Jobbers of Edison
Phonographs and Records
100,000 Records
Complete Stock Quick Service

THE OLDEST TALKING MACHINE HOUSE
IN PENNSYLVANIA
C. J. HEPPE & SON
1115-1117 Chestnut St.
PHILADELPHIA, PA.
EDISON and VICTOR A Stock that
GOODS and ALL ACCESSORIES is always Complete

Lewis Talking Machine Co.
15 South 9th Street, Philadelphia, Pa.

Columbia Jobbers
SUPPLIES OF EVERY DESCRIPTION
Give us a trial on your next month's Record
order.

C. B. Haynes W. V. Youmans
C. B. HAYNES & CO.
Wholesale Distributors
Edison Phonographs and Records
All Supplies
602-604 E. Main St. RICHMOND, VA.

Paste This Where You Can Always See It!

MR. DEALER:

We refer all Talking Machine inquiries coming from towns where we are represented by dealers to the dealer or dealers in that town.

VICTOR and EDISON JOBBERS

Lyon & Healy
CHICAGO

KOHLER & CHASE

OAKLAND, - - CAL.

JOBBERS OF ZONOPHONES
—AND—
EDISON PHONOGRAPHS

WE claim Largest Stock and Best
Service, and are willing to
"SHOW YOU."

Every Jobber in this country should be represented in this department. The cost is slight and the advantage is great. Be sure and have your firm in the May list.

THE NEW TWENTIETH CENTURY TALKING
MACHINE CO.
L. MAZOR, Proprietor
Baltimore Headquarters Zonophone Jobber
Talking Machines and Records. The Biggest
Assortment of Hebrew Records.
1423-25 E. Pratt Street, BALTIMORE, MD.

SPALDING & CO.
109-113 W. Jefferson St., Syracuse, N. Y.
JOBBERS
COLUMBIA MACHINES and RECORDS
Also Athletic Goods, Fishing Tackle and Cutlery

THE "TALKER'S" SENTIMENTAL SIDE.

Will Appeal to Patrons When the More Practical Side Will Fail Utterly—A Fact Worth Noting and Acting on Accordingly.

Did you ever lose a customer, Mr. Dealer, because, although he admitted the mechanical accuracy and even the musical merit of the machine demonstrated, he claimed there was a lack of the human quality he had expected to find after reading the many advertisements lauding the talking machine? Of course, you have, and in such a case it is "up to you" to prove to this gentleman's satisfaction that he is all wrong, and "that the human or sentimental side of the "talker" is very much in evidence. In order to do this well you must turn sentimentalist yourself, and be able to paint an amorous or pathetic picture of every vocal record on your shelves which deals with the subject of affection or tears. In other words, you must back up the assertion set forth in the back pages of the magazines that the talking machine is an instrument with a soul capable of producing thoughts of love or sorrow at the will of the operator. This is a strong assertion to make, I admit, but it is true, and, therefore, the proving is an easy matter.

When Mr. Doleful, or Mr. Sentimentalist, or even Mr. Skeptic calls and admits with the hesitancy, which, by the way, usually means no sale, that the "graph" or "phone" in question is no doubt a very nice machine, but that it does not

have the certain something needed to stir one's thoughts to the higher things of life, to remind one of neglected duties, etc.; that is, the soulful influence felt only when listening to instruments played by human hands, it is time for you to paint a picture, Mr. Dealer, and in as bright colors as possible. Such pessimistic critics who call at your store, and there are a great many of them, I am sure, must be confronted with a weapon powerful enough to shatter their arguments against the "talker" with strenuous dispatch. One way to do this is to have an artist draw for you an attractive cartoon which should be reproduced in an appropriate size to harmonize nicely with the printed matter already on your table. This sketch should tell in a striking manner the story of the sentimental side of the talking machine. That one good cartoon will express more than columns of type is demonstrated in our daily newspapers every day, and I see no reason why the same rule should not apply to the "talker" trade.

The following is suggested for such a cartoon. As you will notice, it depicts a young girl listening to the strains of a talking machine, and as it pours out in sweet melody a song of the country, it paints a picture of her native village in such a realistic manner that she can see the snow-covered church wrapped in the pale moonlight, the little cottage once so dear to her—the place her childhood knew as home—and even the white waste of the fields. There are two old people out yonder in that little village who

are waiting and praying that their only daughter may return to them. They have sent her many a quaintly worded appeal without effect, but at last, through the medium of the talking machine (through its sentimental side) she hears



their call and realizes for the very first time its true significance. Yes, she will go home tomorrow.

When you hand Mr. Doleful or Mr. Sentimentalist or even Mr. Skeptic a copy of the above illustration, or one drawn along the same lines, and have an appropriate selection played for him as a sequel, "Ain't You Coming Back to Old New Hampshire, Molly?" for instance, you will see his pessimistic, critical or skeptical ideas evaporate as the morning mist before the sun, and his respect and patronage will both be yours.

HOWARD TAYLOR MIDDLETON.

W. H. Schnltz, a talking machine dealer of Stanley, Wis., will in future handle Edison machines and records in addition to his Victor line.

OPENS AND SHUTS

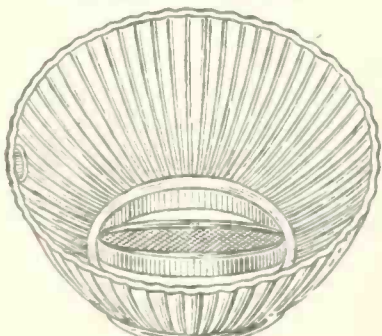

GOES IN THE HORN

The Mello-Tone Attachment

Makes a Musical Instrument of a Talking Machine or Phonograph and is adapted to either the Cylinder or Disc Machine. ☐ Can be regulated while record is being played—from full volume with shuttle open to mellow tone when closed. ☐ Does away with the scratch and blast of the record and eliminates the metallic sound of the metal horn. ☐ Sample, with terms and prices to dealers. **Retail, \$1.00 Each.**

MELLO-TONE CO., - Springfield, Mass.

RECORD BULLETINS FOR MAY, 1907.

NEW VICTOR RECORDS.

No.	ARTHUR FRYOR'S BAND.	Size.
5074	Carmen Selection.....Bizet	10
5075	American Beauties March.....St. Clair	10
5076	La Gitana Waltz.....Buccalossi	10
SOUSA'S BAND.		
31621	Siegfried Fantasie.....Wagner	12
31622	Bamboula(Negro Dance of Trinidad).....Ulrich	12
VICTOR ORCHESTRA.		
5047	For Freedom and Honor March.....	10
31623	Belle of Mayfair Selection.....Stuart	12
VICTOR DANCE ORCHESTRA.		
31624	The Call to Arms—Two-Step.....Rolfe	12
31625	Paquita Waltzes.....Lewis	12
VICTOR CONCERT ORCHESTRA.		
5079	Coppella Valse.....Delibes	10
31620	Egmont Overture.....Beethoven	12
AMERICAN PIPE, BUGLE AND DRUM CORPS.		
5094	Semper Fidelis March.....Sousa	10
BANJO SOLO BY VESS L. OSSMAN, WITH ORCH.		
5077	Patrol of the Scouts.....Boccalaire	10
VIOLIN AND FLUTE DUET BY D'ALMAINE AND LYONS, WITH ORCH.		
5096	Sweet Spirit, Hear My Prayer.....Wallace	10
FLUTE SOLO BY DARIUS LYONS, WITH ORCH.		
31623	Le Carnaval Russe.....Ciardi	12
TENOR SOLO BY FREDERIC C. FREEMANTEL, WITH ORCH.		
31627	Then You'll Remember Me (from "The Bohemian Girl").....Balfe	12
COMIC SONG BY ARTHUR COLLINS, WITH ORCH.		
5093	Ta, Ta, Au Revoir, Good Bye!.....Lowitz	10
LAUGHING SONG BY CAL STEWART, WITH ORCH.		
5101	And Then I Laughed.....	10
DUET BY COLLINS AND HARLAN, WITH ORCH.		
5092	That Welcome on the Mat Ain't Meant for Me.....Edwards	10
DUET BY MISS JONES AND MR. MURRAY, WITH ORCH.		
5081	Some One Looks Good to Some One.....Weaver	10
DUET BY MISS MORGAN AND MISS STEVENSON, WITH ORCH.		
31628	Holy Mother, Guide His Footsteps (from "Maritana").....Wallace	12
DESCRIPTIVE SPECIALTY BY MISS JONES AND MR. SPENCER, WITH ORCH.		
5034	Becky and Izzy—A Yiddish Courtship.....	10
YANKEE SPECIALTY BY MR. AND MRS. CAL STEWART AND HAYDN QUARTETTE.		
5082	Uncle Josh and Aunt Nancy Go to House-keeping.....	10
BILLY MURRAY AND HAYDN QUARTETTE, WITH ORCH.		
5095	The Homesick Yankee (from "The Rich Mr. Hoggenheimer").....Clark	10
MINSTREL RECORDS.		
5097	The Christy Minstrels—No. 1 (introducing "College Life" and "My Kickapoo Queen").....	10
5098	The Christy Minstrels—No. 2 (introducing "Yankee Doodle Negroes" and "San Antonio").....	10
TENOR SOLO BY HARRY MACDONOUGH, WITH ORCH.		
5080	I'll Do Anything in the World for You.....Cobb-Edwards	10
TENOR SOLO BY HARRY TALLY, WITH ORCH.		
5078	The Girl Who Was Meant for You.....Hochana	10
TENOR SOLO BY BYRON G. HARLAN, WITH ORCH.		
5085	Cheer Up, Mary.....Kendis-Paley	10
5086	School Days (When We Were a Couple of Kids).....Edwards	10
COMIC SONG BY BILLY MURRAY, WITH ORCH.		
5083	Man Without a Woman.....Rogers	10
TENOR SOLOS IN GERMAN BY EMIL MÜNCH, WITH ORCH.		
5088	Wer nicht liebt Wein, Weib und Gesang.....Waldmann	10
5089	Wer hat euch been getraut.....Strauss	10
5090	Ach Konnt ich Noch so Lieben.....Aletter	10
5091	Du verstehst mich nicht.....Brandt	10
VICTOR ORCHESTRA.		
5031	The Cakewalk in the Sky (Ethiopian Two-Step).....Harney	8
5032	The Midnight Club (Descriptive Two-Step).....Barker	8
SONGS BY BILLY MURRAY, WITH ORCH.		
5099	San Antonio (Cowboy Song).....Van Alstyne	8
5100	In Washington (Topical Hit).....Bryan-Hoffman	8
DUET BY COLLINS AND HARLAN, WITH ORCH.		
2754	Down on the Brandywine.....Mullen	8
BILLY MURRAY AND HAYDN QUARTETTE, WITH ORCH.		
5095	The Homesick Yankee (from "The Rich Mr. Hoggenheimer").....Clark	8
DESCRIPTIVE SPECIALTY BY MISS JONES AND MR. SPENCER, WITH ORCH.		
5033	Hans and Gretchen.....Spencer	8
YANKEE TALKS BY CAL STEWART.		
665	Uncle Josh in a Department Store.....Stewart	8
2542	Uncle Josh on a Fifth Avenue Bus.....Stewart	8

NEW EDISON GOLD MOULDED RECORDS.

Edison Gold Moulded Records are made only in Standard Sizes. Both Standard and Concert Records may be ordered from this list. Order by number, not title. If Concert Records are wanted, give the number and letter C.

9530	The Mill in the Forest (Eilenberg).....Edison Concert Band
9531	Poor John (Pether).....Ada Jones
9532	While I Have You (Seamans).....Irving Gillette
9533	Good-a-Bye John—Medley (Original).....Albert Benzler
9534	I've Told His Missus All About Him (Tate).....Helen Trix
9535	Oh! Mister Brown (Von Tilzer).....Arthur Collins
9536	Something for Jesus (Lowry)—A sacred selection.....Anthony and Harrison
9537	The Thunderer March (Sousa).....Edison Military Band
9538	No Wedding Bells for Me (Furth).....Bob Roberts
9539	Nobody's Little Girl (Morse).....Byron G. Harlan
9540	Flanagan On a Farm (Original).....Steve Porter
9541	Dixie (Emmett-Ecke).....Edison Symphony Orchestra
9542	'Neath the Old Acorn Tree, Sweet Estelle (Helf).....Harry Anthony
9543	That Welcome on the Mat Ain't Meant for Me (Edwards).....Collins and Harlan
9544	When You Know You're Not Forgotten by the Girl You Can't Forget (Helf).....Frank C. Stanley
9545	Fanella—Intermezzo (Keiser).....Edison Concert Band
9546	The Last Rose of Summer (Flotow).....Edith Helena
9547	San Antonio (Van Alstyne).....Billy Murray and Chorus
9548	Let Me Hear the Band Play "The Girl I Left Behind" (Casey).....Frederick H. Potter

9549	Love's Serenade (F. V. Blon).....Edison Venetian Trio
9550	Stand Up for Jesus (Webb).....Edison Mixed Quartette
9551	Ask Me Not (Cobb and Edwards).....Will F. Denny
9552	Meet Me Down at the Corner (Original).....Ada Jones and Len Spencer
9553	Georgia Sunset (Brown).....Edison Military Band

NEW COLUMBIA 10-INCH DISC RECORDS.

SOPRANO SOLO, ORCH. ACCOMP.	
3604	Poor John (Leigh and Pether).....Ada Jones
BANJO SOLO, ORCH. ACCOMP.	
3605	Policy King March (C.B. Brown).....Vess L. Ossman
CELLO SOLO, PIANO ACCOMP.	
3606	The Rosary (Ethelbert Nevin).....Victor Sorlin
PICCOLO SOLO, ORCH. ACCOMP.	
3607	Dance California (G. W. Gregory).....Marshall Lufsky
MINSTREL, ORCH. ACCOMP.	
3608	Sau Antonio—Solo by Billy Murray.....The Rambler Minstrel Company
VOCAL QUARTETTE, MALE VOICES.	
3609	A Meeting of the Hen Roost Club—Descriptive (Cal Stewart).....Columbia Quartette
BARITONE AND TENOR DUET, ORCH. ACCOMP.	
3610	Bake Dat Chicken Pie (Frank DuMont).....Collins and Harlan
BARITONE AND TENOR DUET, ORCH. ACCOMP.	
3611	Lovin' Time—Coon song (Drislane and Morse).....Collins and Harlan
SOPRANO AND TENOR DUET, ORCH. ACCOMP.	
3612	I'd Like to See a Little More of You; or, The Game of Peek-a-boo (Gus Edwards).....Ada Jones and Billy Murray
BARITONE SOLO, ORGAN ACCOMP.	
3613	Jesus, Saviour, Pilot Me—Sacred (J. E. Gould).....George Alexander
BARITONE SOLO, ORCH. ACCOMP.	
3614	Ephraim Johnson—Don't Live Here No More (Green and Werner).....Arthur Collins
BARITONE SOLO, ORCH. ACCOMP.	
3615	My Irish Rosie (Jerome and Schwartz).....J. W. Myers
BARITONE SOLO, ORCH. ACCOMP.	
3616	If You Want to Pick a Fuss, Wait Till the Sun Shines (Moran and Furth).....Bob Roberts
TENOR SOLO, ORCH. ACCOMP.	
3617	When You Know You're Not Forgotten by the Girl You Can't Forget (Gardenier and Helf).....Albert Campbell
TENOR SOLO, ORCH. ACCOMP.	
3618	Captain Baby Bunting (J. Fred Helf).....Byron G. Harlan
COMEDY SKETCH, ORCH. ACCOMP.	
3619	How Mat Got the Mitten—A Down East Courtship (Len Spencer).....Ada Jones and Len Spencer
TALKING RECORD, DESCRIPTIVE.	
3620	Pedro, the Hand Organ Man (Len Spencer).....Len Spencer and Steve Porter
TALKING RECORD, DESCRIPTIVE, WITH INCIDENTAL ORCHESTRA MUSIC.	
3621	Flanagan on a Broadway Car (Steve Porter).....Steve Porter
5476	Thy Eyes Waltz (Lus Ojos Valse) (Emiliano Correa).....Banda Espanola
5613	The Destroyer March (El Tala Marcha).....Banda Espanola

NEW COLUMBIA 12-INCH DISC RECORDS.

30061	Introduction to 3d Act "Lohengrin" (R. Wagner).....Prince Military Band
30062	My Kickapoo Queen—Solo by Arthur Collins.....The Rambler Minstrel Company
30063	In Time of Trouble He Shall Hide Me—Sacred (Ralph G. Kilmer).....Frank C. Stanley

NEW COLUMBIA X.P. (CYL.) RECORDS.

VOCAL SOLO IN FRENCH, ORCH. ACCOMP.	
9101	La Marseillaise—Chant National (Roget De L'Isle).....
TENOR SOLO, ORCH. ACCOMP.	
33117	Won't You Come Over to My House (Egbert Van Alstyne).....Henry Burr
33118	The Mouse and the Clock—Descriptive (Howard Whitney).....Prince's Military Band
BANJO SOLO, ORCH. ACCOMP.	
33119	Policy King March (Chas. B. Brown).....Vess L. Ossman
BARITONE AND TENOR DUET, ORCH. ACCOMP.	
33120	Lovin' Time (Drislane and Morse).....Collins and Harlan
BARITONE AND TENOR DUET, ORCH. ACCOMP.	
33121	Owatomma (Williams and Van Alstyne).....Stanley and Burr
SOPRANO AND TENOR DUET, ORCH. ACCOMP.	
33122	I'd Like to See a Little More of You; or, The Game of Peek-a-boo (Gus Edwards).....Ada Jones and Billy Murray
BARITONE SOLO, ORCH. ACCOMP.	
33123	My Irish Rosie (Jerome and Schwartz).....J. W. Myers
BARITONE SOLO, ORCH. ACCOMP.	
33124	If You Want to Pick a Fuss, Wait Till the Sun Shines (Moran and Furth).....Bob Roberts
TENOR SOLO, ORGAN ACCOMP.	
33125	Peace, Perfect Peace—Sacred (G. T. Caldwell).....Henry Burr
TENOR SOLO, ORCH. ACCOMP.	
33126	When You Know You're Not Forgotten by the Girl You Can't Forget (Gardenier and Helf).....Albert Campbell
TENOR SOLO, ORCH. ACCOMP.	
33127	Captain Baby Bunting (J. Fred Helf).....Byron G. Harlan
TENOR SOLO, ORCH. ACCOMP.	
33128	School Days (Gus Edwards).....Byron G. Harlan
TALKING RECORD, DESCRIPTIVE, WITH INCIDENTAL ORCHESTRA MUSIC.	
33129	Flanagan on a Broadway Car (Steve Porter).....Steve Porter
UNCLE JOSH WEATHERSBY'S LAUGHING STORY.	
33130	Uncle Josh at the Dentist's (Cal Stewart).....Cal Stewart and Len Spencer
45101	Der Zigeunerbaron—Potpourri (Strauss).....Columbia Orchestra
55031	Hipp, Hipp, Hurrah!.....Band of the "Kaiser Franz" Garde Grenadier Regiment
57190	Ein Prosit der Gemutlichkeit.....Metropole Theatre Orchestra, Berlin
60642	Tutti in Baldoria Galop (C. Rovere).....Banda

NEW COLUMBIA B. C. (CYL.) RECORDS.

VOCAL QUARTETTE, MALE VOICES.	
85116	The New Parson at the Darktown Church (Cal Stewart).....Columbia Quartette
BARITONE AND TENOR DUET, ORGAN ACCOMP.	
85117	Sometime We'll Understand—Sacred (James McGranahan).....Anthony and Harrison
BARITONE AND TENOR DUET, ORCH. ACCOMP.	
85118	Crucifix (J. Faure).....Stanley and Burr
TENOR SOLO, ORCH. ACCOMP.	
85119	O Dry Those Tears! (Theresa Del Riego).....Henry Burr
UNCLE JOSH WEATHERSBY'S LAUGHING STORY.	
85120	Ground Hog Day at Pumpkin Center (Cal Stewart).....Cal Stewart

ZON-O-PHONE 10-INCH RECORDS.

ZON-O-PHONE CONCERT BAND.	
748	Dreams of Childhood Waltz.....
726	Popular Songs—Medley Two-Step.....
749	Second Regiment Connecticut N. G. March.....
727	United Empire March.....
HAGER'S ORCHESTRA.	
734	Arrah Wanna—Medley Two-Step.....
728	Jamestown Rag—Patriotic March and Two-Step.....
729	Military Hip Waltz.....
730	Pipe of Peace—A Characteristic Episode.....
731	Teddy Bears' Picnic—Characteristic Novelty.....
ACCORDEON SOLO BY J. J. KIMMEL.	
750	Irish Jigs.....

Disc and Cylinder Record Cabinets



No. 505 Cabinet.

Holds 125 Cylinder Records made in Golden, Weathered, Fumed or Early English Oak. Also Mahogany finish.

Write

The Udell Works
INDIANAPOLIS, IND.

for booklets
and quotations.

You and your trade
want only the best
cabinets. We cer-
tainly have them.

- VOCAL SELECTIONS, WITH ORCH. ACCOMP.
- 735 Because You're You. Miss Alice Stevenson and Mr. Frank C. Stanley
- 736 Don't You Think It's Time to Marry? Miss Ada Jones and Mr. Wm. Murray
- 737 Farewell Mavourneen. Frank Howard
- 746 Find Another Tree to Build Your Nest. Arthur Collins
- 782 Giving Mat the Mitten. Miss Ada Jones and Mr. Len Spencer
- 738 In Washington. Billy Murray
- 739 It's Great to be a Soldier Man. Billy Murray
- 733 I've Told His Missus All About Him. Miss Ada Jones
- 740 My Dear. Frank C. Stauley
- 742 No Wedding Bells for Me. Billy Murray
- 741 Rambler Minstrels No. 2. Collins, Murray, Harlan and Porter
- 743 Jesus, Lover of My Soul—Refuge. Mendelssohn Mixed Quartette
- 747 Ta Ta, Au Revoir, Choo Choo, I'm Going to Go. Arthur Collins
- 745 Uncle Josh's Visit to New York. Cal Stewart
- 744 Whistle It. Miss Ada Jones, Mr. William Murray and Mr. Steve Porter

NEW BONCI DOUBLE DISC RECORDS.

SOLD BY THE COLUMBIA PHONOGRAPH CO.
10% INCHES.

- 39079 Mignon (Thomas)—Addio, Mignon, fa core. Farewell, Mignon. Romance.
- 39111 La Favorita (Donizetti)—Una vergin, un angiol di Dio. (A fair Maiden, an Angel of goodness.)
- 39080 Menstofele (Boito)—Giunto sul passo estremo. (I have arrived at the last step.) Faust's Romance.
- 39084 I Puritana (Bellini)—A te, o cara. (Once I sought thee.)
- 39081 Rigoletto (Verdi)—La donna e mobile. (The woman is changeable.)
- 39082 Tosca (Puccini)—Recondita armonia. (Hidden Harmony.) Mario's Monologue (Act 1).
- 39083 L'Elisir d'amore (Donizetti)—Una furtiva lacrima. (One secret tear.)
- 39128 Caro Mio Ben (Giordani)—Romanza. (Air, O My Dear.)
- 39127 Eleua e Paride (Gluk)—Spiagge amate. (Beloved Shores.)
- 39129 Il Flauto Magico (Mozart)—Ah, cara imagine. (Oh, wondrous beauty, fast compare.)
- 39239 Rigoletto (Verdi)—Questa o quella. (In my heart all.)
- 39241 O del Mio Dolce Ardor (Gluk)—Romanza. (O My Sweet Ardour.) Romance.
- 39240 Carmen (Bizet)—Il fior, che avevi a me tu dato. (The flower thou hast given to me.) Flower Song.
- 39242 La Violetta (Mozart)—Romanza. (The Violet.)
- 39248 Song—I'll sing thee songs of Araby (Fr. Cloy). Romanza in Inglese.
- 39292 Tre giorni son che Nina (Pergolesi)—Celebre Siciliana. (Three days have passed since Nina.)
- 39338 La Favorita (Donizetti)—Spirito gentil. (Spirit so fair.)
- 39339 L'Africa (Meyerbeer)—O Paradiso. (O paradise to earth awarded.)
- 39673 Lucrezia Borgia (Donizetti)—Di pescatore ignobile. (Lovers in a lowly fisher's hut.)
- 39674 Marta (Flotow)—M'appari. (Like a beam from above.)
- 39685 Don Pasquale (Donizetti)—Cerchero lontana terra (In a distant world I'll seek)
- 39686 I Pescatori di Perle (Bizet)—Mi par d'udir ancor. (I seem to hear once more.) Fishermen of pearl.
- 39691 Luisa Miller (Verdi)—Romanza di Rodolfo.
- 39692 Recitativo—O fede negar potessi. (If I could deny faith!)
- 39692 Romanza—Quando le sere al placido. (When calm the evening.)
- Lucia di Lammermoor (Donizetti)—Atto IV.—Aria di Edgardo.
- 39693 Recitativo—Tombe degli avi miei. (Tombs of my ancestors.)
- 39694 Aria—Fra poco a me ricovero. (Shortly I will be myself again.)
- 39695 Aida (Verdi)—Romanza—Celeste Aida.

- 39696 Fedora (Giordano)—Amor ti vieta. (Your love distant.)
- 39697 Lucia di Lammermoor (Donizetti)—Tu che a Dio spiegasti l'ali. (Thou hast spread thy wings to Heaven.) The melody gem of Donizetti's masterpiece heard in perfection.
- 39698 Werther (Massenet)—Ah, non mi ridestar. (Do not awaken me.) Werther's Romance.
- 39299 Faust (Gounod)—Terzetto Finale. (Prison Trio—Act V.) Sung with G. Russ and O. Luppi.
- 37149 Der Freischütz (Weber)—Coro, Vittoria, Vittoria. (Chorus, Victory, Victory.)
- 39331 La Favorita (Donizetti)—E' Fia Vero? (Duetto con O. Luppi.) (And be it true.) Duet sung with O. Luppi.
- 37169 La Favorita (Donizetti)—Coro, Bell'alba foriera. (Beautiful Dawn.)
- Il Barbiere di Siviglia (Rossini)—Duetto Atto I fra Almaviva e Figaro. (Con F. Corradetti.)
- 39336 Ia parte—Voi dovrete travestirvi. (You will have to disguise yourselves.)
- 39337 Ia parte—Numero quindici. (Number Fifteen.)
- 39340 I Pescatori di Perle (Bizet)—Del tempio al limitar. (From the Temple.) Duet with A. Magini-Coletti.
- 37163 Der Freischütz (Weber)—Coro, Che supera. (Chorus, You are first.)
- 39341 Don l'asquale (Donizetti)—Tornami a dir. (Duetto con R. Pinkert.) Tell me once more.) Duet sung with Regina Pinkert.
- 37120 Nabucco (Verdi)—Coro, Va pensiero. (Chorus, Go, O Thought.)
- 74000 La Boheme (Puccini)—Che gelida manina. (How frozen your fingers are.)
- 74006 Faust (Gounod)—Salve dimora. (All hail thy dwelling.)

SINGLE DISC RECORDS, APPROXIMATELY 14 INCHES.

- 69007 Mignon (Thomas)—Ab, non credevi tu. (Never the maiden dreamed.)
- 69008 Don Giovanni (Mozart)—Dalla sua pace. (On her my treasure.)
- 69017 La Gioconda (Ponchielli)—Cielo e mar. (Heaven and Sea.) Euzo's Romance.
- 69018 Se, tu Mami (Pergolesi)—Romanza. (If you love me.) Romance.

NEW YORK PHONOGRAPH CO. SUIT.

Decision Handed Down by Judge Keogh in Favor of This Company—Counsel for the National Phonograph Co. Say It Bears Not on Merits of Case, But on Jurisdiction.

March 15 Justice Keogh, New York Supreme Court, Special Term, at New Rochelle, handed down a decision adversely to the defendants in the case of the New York Phonograph Co. against S. B. Davega, and 293 other Edison jobbers and dealers in the State. This is another move in this celebrated suit, which, in reality, is the outcome of an action previously brought against the National Phonograph Co., the Edison Phonograph Works and others for alleged breach of a territorial selling contract, dating back to the old North American Phonograph Co., the first company formed to market Edison's original invention. The defense, in the argument heard February 16, raised the point of jurisdiction and other reasons why the case should be dismissed, but the court, though not writing an opinion, filed the following brief memorandum: "The application to dismiss the complaint denied." The case will now be tried on its merits in the same

court at an early day, according to Samuel F. Heyman, counsel for the New York Phonograph Co.

Relative to this decision the National Phonograph Co., when seen, made the following statement: "The decision by Justice Keogh in cases of the New York Phonograph Co. against various jobbers and dealers handling Edison phonographs, was not on the merits of the case, but merely on a motion as to jurisdiction; that is, as to whether the cases should be tried in the State or Federal courts. Justice Keogh holds that the cases should be tried in the State courts."

The New York Tribune, it appears, published the most absurd and misleading story in connection with the foregoing action of Judge Keogh. The National Phonograph Co. defended the suit, and S. B. Davega, the New York jobber, was the nominal defendant only in a test case which, of course, would apply to his co-defendants. The statement that the profits of Mr. Davega's sale of Edison goods for ten months were \$100,000, is so ridiculous as to be scarcely worth mentioning, excepting that the trade is greatly injured in the eyes of the public, while the animus of its inspiration is only too evident. The case is a long way from adjudication, despite the silly tale from the same source, "that the defendants must account for their profits for six years, which, it is believed, will amount to about \$31,000,000!"

COLUMBIA WHOLESALE QUARTERS

Will be Removed from 353 Broadway to 111 Chambers Street, New York, on May 1st.

The wholesale department of the Columbia Phonograph Co., at present located at 353 Broadway, will be moved to 111 Chambers street, near Church street, on May 1. In this store a sufficient stock to supply all the dealers embraced in the New York territory will at all times be carried. A retail department will also be opened in connection with the wholesale end. The wholesale department will be under the supervision of R. F. Bolton. This store, as well as the new one on West 23d street, will be under J. H. Dorian, of the New York office.

TALKER CONCERTS IN GERMANY.

In Berlin, recently, at the Tiergarten, an immense talking machine concert was heard, with over a thousand people present, who manifested their interest in this popular instrument. That such an assemblage was in attendance, notwithstanding the entrance fee asked, afforded much satisfaction to all interested. A week or so later a similar concert was given in the Crystal Palace, Leipsic. The attendance here was even larger and much more interest was manifested.

DIFFICULT TO PRONOUNCE WORDS.

Few people know how difficult it is to pronounce some words to a talking machine so that they will be plainly heard in the reproduction, says The Sound Wave. One leading article declares that the word "thrice" is his shibboleth. That which reached the ear in the reproduction unless the greatest care was taken, was the word "ice," which, of course, was not the one desired. The "th" sound is very difficult and never loud. The "r" is also hard to record clearly unless it be rolled.

DOUGLAS & CO.'S NEW SOUND MODIFIER.

In the near future the Douglas Phonograph Co., 89 Chambers street, New York, will place on the market a new and marvelous sound modifier that is claimed to outrank any similar device known. The modifier in question is so designed that no "leaks" occur and the sound is modulated by a series of shutters, and either a low, high or intermediate tone is secured; in short, the quality of tone that appeals to the ear of the critical and which is most desired to develop the finest musical effects of the record are certain.

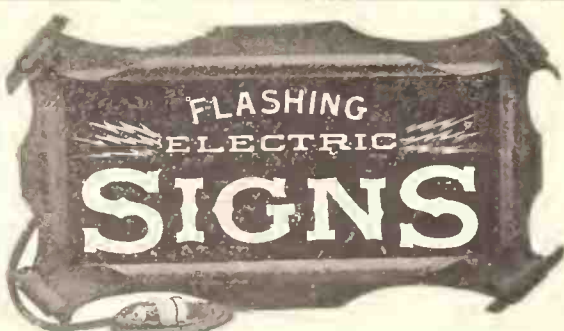

Attract Attention 24 Hours A Day

Artistic-Reliable-Inexpensive

THEY LITERALLY BURN YOUR AD. INTO THE MINDS OF THE PEOPLE

DAY SIGN

This artistic sign is made of Venetian Bent Iron with glass panel. The lettering is outlined with burnished gold and the display line studded with jewels, making a very attractive, high grade

Inside the sign are three electric lights of different colors (red white and green). These are switched on and off, automatically, by our patented thermo-flasher, producing an intermittent iridescent effect which is bound to catch the eye.

A Sure Trade Puller at Night

The glass panel is removable, and one with different lettering may be inserted as often as desired. The cost of running is about one cent an hour.

The Most Inexpensive Automatic Flasher on the Market

The illustration shows a single face inside sign 16x28 inches, outside measurement with six (6) feet of flexible wire cord and attachment plug ready to attach to any incandescent lamp socket, (lettering as ordered). Price complete \$9.75 f. o. b. New Haven. We also make a small double face sign 18x30 inches for outside use, substantially the same as sign described, with square ornamental iron frame, all ready to connect. Price complete, \$15.00. Extra glass panels for either sign (any wording), \$2.00 each. OUR FLASHERS ARE FULLY GUARANTEED AND MAY BE RETURNED IF NOT ENTIRELY SATISFACTORY. We are prepared to furnish designs for all kinds and sizes of electric signs for both inside and outside use, free of charge. Special prices for signs in quantities. Correspondence solicited. Write for our illustrated booklet No. 6, "POWER TO ATTRACT." AGENTS WANTED. Address

THE THERMO-ELECTRIC LIGHTING CO.

Sign Dept. E.

106 PARK STREET, NEW HAVEN, CONN.

LATEST PATENTS RELATING TO TALKING MACHINES AND RECORDS

(Specially prepared for The Talking Machine World.)
Washington, D. C., April 7, 1907.

SOUND-BOX FOR TALKING MACHINES. Edward D. Gleason, Philadelphia, assigner by mesne assignments, to Victor Talking Machine Co., Camden, N. J. Patent No. 846,024.

The object of this invention is to provide the stylus lever of a talking machine sound-box with an elastic connection or mounting whereby a

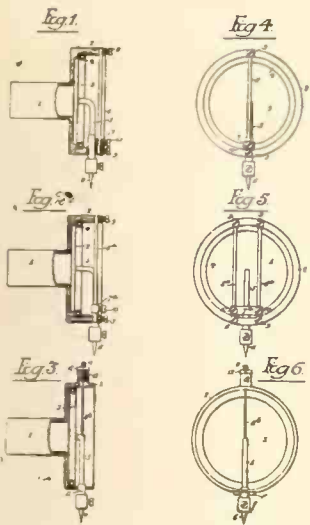

certain amount of tension will always be imparted to the diaphragm and better results in reproduction will be attained than when such elastic connection or mounting is not provided.

In the accompanying drawing, Figure 1 is a sectional view of a talking machine sound-box constructed in accordance with this invention.

Figs. 2 and 3 are similar views illustrating other embodiments of the invention; and Figs. 4, 5 and 6 are front views of the sound-boxes shown in Figs. 1, 2 and 3, respectively.

APPARATUS FOR DUPLICATING PHONOGRAPH RECORDS. Varian M. Harris, Chicago, Ill., assignor of one-fifth to Robert Burns, same place. Patent No. 846,411.

This invention relates to the manufacture of duplicate phonograph records of celluloid or other like material, in which a mold is used having a negative matrix formed in its interior surface or bore, and into which negative matrix surface the duplicate phonograph record in the form of a thin-walled cylinder is pressed to impart to the periphery of such cylinder a positive impression from such negative matrix surface; and the object of the present improvement is to provide a simple and efficient apparatus for use in the described process, and with which the production of the duplicate records can be effected in a rapid, certain and positive manner, all as will hereinafter more fully appear and be more particularly pointed out in the claims.

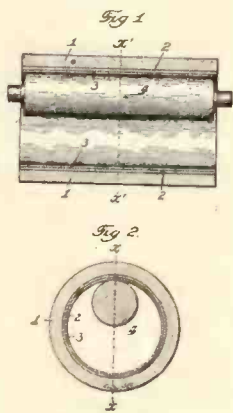

In the accompanying drawings, illustrative of the present invention, Figure 1 is a longitudinal section of a primitive form of apparatus embodying the present invention, the section being taken on line x x, Fig. 2; Fig. 2, a

transverse section of the same at line x' x', Fig. 1.

MECHANISM FOR MAKING SOUND RECORDS. John O. Prescott, Summit, N. J. Patent No. 847,820.

This invention relates to mechanism for making sound records of the disc type for use with talking machines by pressing a plastic composition upon a suitable matrix to form a disc having a spiral sound record groove in one or both of its faces corresponding to the spiral projection on the matrix.

The object of the invention is to effect certain improvements in the construction of the mechanism for performing the pressing operation, by means of which improved apparatus the records may be manufactured more rapidly and at a materially reduced cost.

Sound records of the disc type as now commonly constructed have the record groove formed on one or both faces adjacent the periphery, and the central portion of the disc is of less thickness than the portion having the groove therein. This central portion need not be of

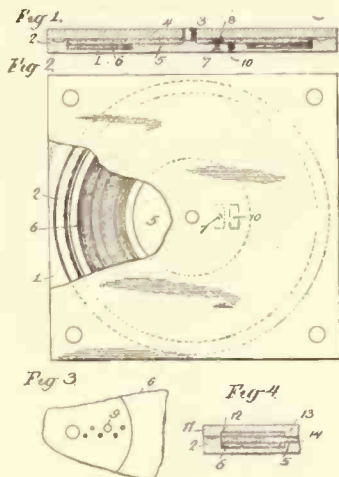

the greater thickness in order to give the requisite strength, and a saving of material is thus effected, and the shallow depression at the center of the disc may receive a label suitably marked with the name of the recorded sound and such other matter as is desired. This improved pressing mechanism is adapted for forming this depression at the center of the disc during the operation of forming the disc with the record groove therein without the provision and manipulation of additional parts, and hence without consuming additional time. To this end a matrix of annular form is employed. Either it is originally made of this form or a circular opening is cut in its center of a diameter but little less than that of the inner convolution of the spiral ridge for forming the record groove. Either one or each of the pressing members is provided with an annular depression in which the annular matrix fits snugly. To form this annular depression, the pressing member is provided with a flange bounding the outer edge of the depression and a central circular raised portion or projection, and this central projection

is made of a height slightly greater than the thickness of the matrix. The matrix thus formed is placed in the annular depression in the pressing member with the projection extending through its central opening and beyond its surface, and the plastic composition is pressed down upon it and the top of the projection and between the outer wall or flange and a central stud. The second pressing member may have a plane surface or both members may be somewhat similarly formed when it is desired to make a disc having a record groove in both faces. A depression is thus formed in one or each of the faces of the record corresponding in size and depth to the portion of the projection extending beyond the surface of the matrix.

It is sometimes desired to provide sound records with an opening in or through the central portion in addition to the central opening to receive a stud on the turn-table of the talking machine. In accordance with this invention means are provided for positioning a stud upon one of the pressing members in any one of a plurality of positions varying in distance from the center. Stud of varying shapes may be employed to give the desired shape of opening in the disc, and the openings for receiving the securing means for the studs may be closed when not in use, so that the material will not enter therein.

An embodiment of the invention is illustrated in the accompanying drawings, in which Fig. 1 is a central section of the pressing mechanism. Fig. 2 is a top view of the same, broken away in part, and Figs 3 and 4 are detail views showing modifications.

APPARATUS FOR MAKING FLAT TALKING MACHINE RECORDS. William Helm Hoyt, Wyoming, N. J. Patent No. 847,338.

This invention relates to the manufacture of flat records or disc records for talking machines, and has for its object to provide means for making a plurality of such records at one operation. Reference is to be had to the accompanying drawings, in which Fig. 1 is a plan view of an

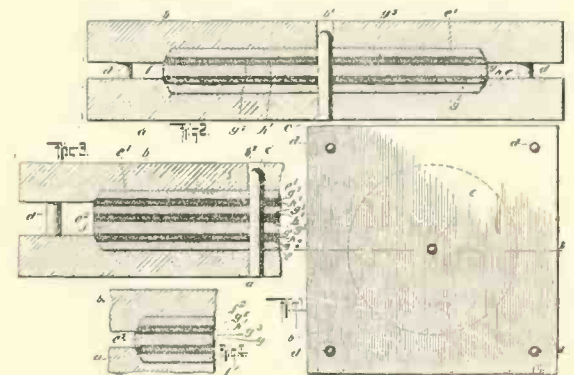

apparatus suitable for the purposes of the invention. Fig. 2 is a sectional elevation thereof on line 2 2 of Fig. 1. Figs. 3 and 4 are partial sectional elevations showing two other ways of carrying out this invention.

PHONIC APPARATUS. Alexander N. Pierman, Newark, N. J., assignor to New Jersey Patent Co., West Orange, N. J. Patent No. 847,687.

This invention relates to phonic apparatus of the type wherein a rotating friction wheel is

We are not Jobbers of "HOT AIR," but

EDISON JOBBERS

Give us the order and you get the goods. No delay if your credit is good.
As to SUPPLIES! Well, give us a trial.

The Edison Co. is still under the management of Mr. A. O. Petit, who has been in the Talking business for 20 years. Satisfaction guaranteed or money refunded.

THE EDISONIA CO., NEWARK, N. J.

used in combination with a friction shoe pressed against the same, power being applied for rotating the friction wheel, and the pressure between the friction shoe and friction wheel be-

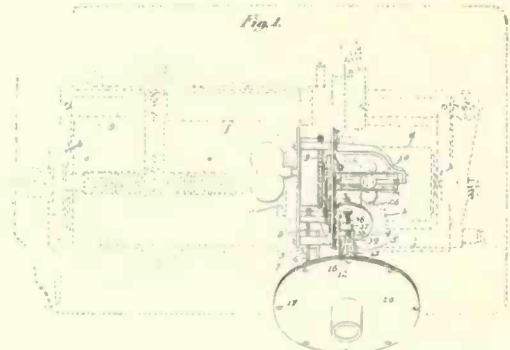

ing varied by suitable means representative of sound vibrations, thus producing variations in the amount of friction, which by suitable mechanical connections may operate a diaphragm or other phonic apparatus.

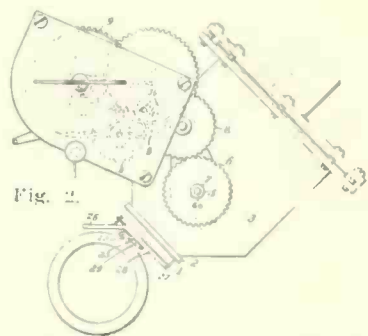

The invention relates more particularly to devices for reproducing sounds through the instrumentality of a phonographic record, the phonographic stylus being connected with said friction shoe and operating to vary the amount of friction.

Heretofore, as far as the inventor is aware, the

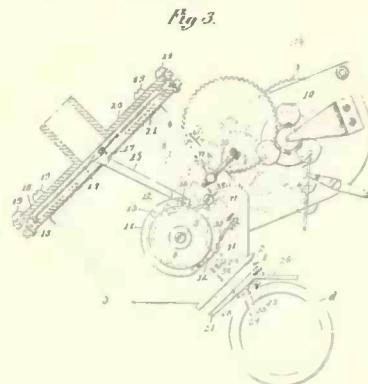

friction wheel has always been driven from a stationary motor, and the said friction wheel has either been mounted so as to have no progressive motion or in case it has been mounted

on a traveling carrier the driving mechanism has been so arranged that the friction wheel may receive its power from the said stationary motor during its movement with the carriage. These devices are objectionable, however, because they are not readily applicable to an ordinary phonograph and require special forms of instruments, which are expensive to construct and which in some cases cannot be used with an ordinary phonographic speaker.

This invention has for its general object the provision of a mechanism of the character referred to and more particularly its application to a phonograph of ordinary construction, so that the mechanism may be interchangeable with an ordinary phonographic reproducer without the addition of any parts whatsoever to the ordinary phonograph. This object has been carried out by the mounting of a complete frictional reproducing apparatus upon a base which is adapted to fit within the ordinary carrier arm of a phonograph or other talking machine, the friction wheel being driven by a motor carried upon a suitable frame secured to or integral with the frame upon which the various operating parts of the reproducing mechanism are carried, whereby the friction wheel may be continuously driven during the progressive movement of the carrier arm without the disadvantages resulting from the use of a stationary motor, and without the necessity of increasing the strength or power of the usual phonograph motor to enable it to drive the friction wheel in addition to the work of driving the mandrel and feed screw.

Reference is hereby made to the accompanying drawing, in which Fig. 1 is a plan showing in dotted lines a phonograph of ordinary construction and in full lines an embodiment of the invention applied thereto. Fig. 2 is a side elevation of the improved reproducer looking from the left of Fig. 1, and Fig. 3 is a similar view, partly in section, looking from the right of Fig. 1.

PHONOGRAPH. Edward L. Aiken, East Orange, N. J., assignor to New Jersey Patent Co., West Orange, N. J. Patent No. 847,631.

This invention relates to phonographs, and more particularly to phonographs of the type shown in United States patent No. 772,485, granted October 18, 1904, to Weber and Hibbard, and has for its object the provision of improved means for raising and lowering the arm which carries the reproducer or recorder and for causing the same to be stepped in a rearward direction whenever desired, said means being adapted to prevent accidental displacement of the recorder or reproducer with respect to the record surface, especially when the instrument is being

used by beginners or those not particularly skillful in its use.

Referring to the accompanying drawings, Fig. 1 is an end view of a phonograph embodying the invention, the recorder or reproducer frame being elevated so that the feed nut is disengaged

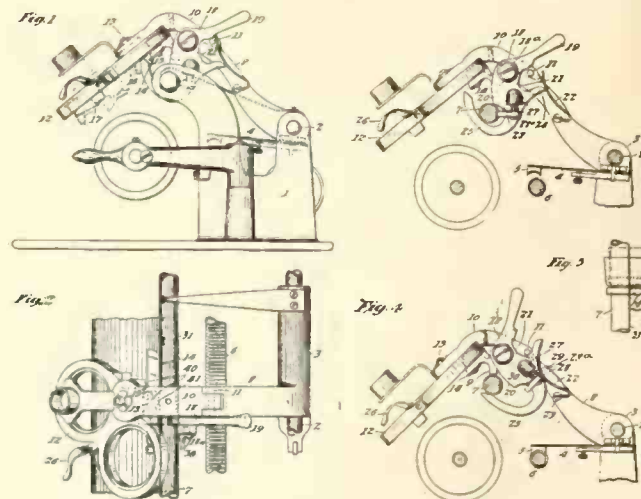

from the feed screw. Fig. 2 is a broken plan view of the same. Fig. 3 is a view similar to Fig. 1, certain of the parts being removed for the sake of simplicity and clearness, and shows the positions assumed by the parts when the recorder or reproducer carrier arm is elevated and is being stepped in a rearward direction. Fig. 4 is a similar view, showing the parts when the recorder or reproducer is in operative position with respect to the rotating record or blank. Fig. 5 is a detail plan view of the mechanism for stepping the carrier arm rearward.

GRAMOPHONE MECHANISM. Eduard Wawrina, Vienna, Austria-Hungary. Patent No. 847,033.

The object of the present invention consists of a receiver mechanism for gramophones in which a displacing mechanism directly operated

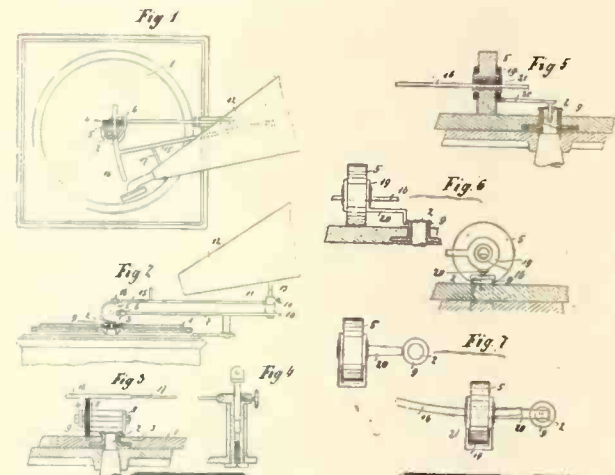

by the motion of the plate and comprising a rotary part engaging the plate causes the receiving trumpet, connected in the usual manner with the reverberator and the stylus, to possess a motion toward the middle of the plate, and thus force the stylus to engrave spiral courses on the plate.

In the drawing the object of the invention is illustrated in three constructional forms by way

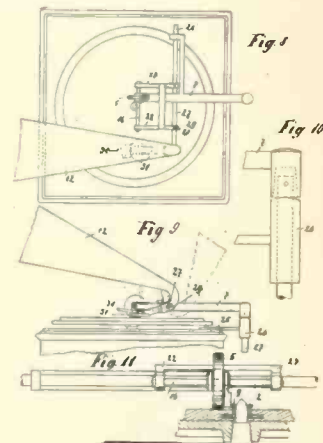

of example. Figs. 1 and 2 illustrate one constructional form in plan view and in side elevation and partial section, whereas Figs. 3 and 4 illustrate details of the apparatus. Figs. 5 to 7 show a second constructional form of the invention in longitudinal section, side elevation and plan, respectively, while Figs. 8 and 9 illustrate the third constructional modification, and Figs. 10 and 11 illustrate further details.

"MIRA" MUSIC BOX
 Best in Construction
 Unequaled for Sweetness, Harmony and Volume of Tone
 Mrs. Mira

The following are some of the dealers handling the "Mira" Music Boxes:—

- LYON & HEALY, Chicago, Ill.
- SHERMAN, CLAY & CO., San Fran., Cal.
- SHERMAN, CLAY & CO., Oakland, Cal.
- SHERMAN, CLAY & CO., Seattle, Wash.
- OLIVER DITSON CO., Boston, Mass.
- J. E. DITSON & CO., Philadelphia, Pa.
- C. H. DITSON & CO., New York.
- JOHN WANAMAKER, New York.
- JOHN WANAMAKER, Philadelphia, Pa.
- MACKIE PIANO & ORGAN CO., Rochester, N. Y.
- DENTON, COTTIER & DANIELS, Buffalo, N. Y.
- S. HAMILTON, Pittsburg, Pa.
- KRELL PIANO CO., Cincinnati, O.
- CARLIN & LENOX, Indianapolis, Ind.
- FINZER & HAMMEL, Louisville, Kentucky.
- O. K. HOUCK PIANO CO., St. Louis, Mo.
- A. HOSPE, Jr., Omaha, Neb.
- S. KANN SONS & CO., Washington, D. C.

Write for Catalogue and Prices

JACOT Music Box Co.
 39 Union Sq., New York

With the Makers and Sellers of Automatic Specialties

THE PROGRESS OF THE TRADE.

Arcade and Nickel Theatres Now in Full Swing
—Importance of Holding Public Support—
Slot-Controlled Devices in Department Stores
—Theatre Managers a Little "Huffy" Over
Progress of the "Small Fellows"—Trade
Stimulators Interest the Public and Talking
Machine Men Find a Profit in Handling
Them—"Parlors" in the South.

The arcade and the 5-cent theatre business is now in full swing. The factories are running full blast, with overtime shifts, yet the incessant call is "rush." A number of new machines, which the arcade men have been anxiously awaiting, have been held up almost indefinitely on account of the congested condition of the metal market. Orders placed six months ago at the foundries still remain unfilled, and manufacturers are kept busy making excuses for delays in shipments. One of the largest manufacturers while discussing trade conditions with *The World*, recently predicted an unprecedentedly brilliant business for 1907. "Never before," said the gentleman, "has this business been on so firm a basis, as at the present day. Of course, there have been a number of failures in the 'arcade' end of it, but in nearly every case these men had given the business little thought, but had opened up their parlors on the impulse of the moment. Their heads got turned at the prospect of making what they called easy money, and they did not stop to consider that it takes years of thought and study to learn just what the public want, and that it is no easy task to catch and hold the fickle public's fancy. The general trend of the demand seems to veer toward higher class productions, which, of course, means more money for all parties concerned."

About a year ago *The World* called the attention of this trade to the possibilities open to agents and representatives of the various manufacturers in placing slot controlled devices in and about the department stores throughout the Union, and quoted the case of the Siegel-Cooper Co., of this city, who, at the time, had just opened an arcade in their building, adjoining the talking machine department. That this scheme was a paying one is evidenced by the number of others who have followed suit since that time. However, there are many such places that have not been approached on the subject. The men who are handling these machines should hurry up and grasp every opportunity in their territory. It is the time for the exploitation of these instruments. It is easy to prove the value of these machines—no proposition could be fairer to any one. You place the machines, the man makes you an initial payment, and agrees to pay you the balance at, say, \$50 a month. Then he doesn't worry. The machine does the rest. The public files in, deposits the coin and furnishes the power. You have the key to the cash depository, and once or twice a month you call and collect the welcome cash, giving him a receipt for it. The purchaser doesn't get a chance to divert the

money coming to you until all bills are settled. The experience of manufacturers, of at least the better class of slot controlled devices, is that the average monthly collections are in the neighborhood of \$50, so it is easy to see about where all parties concerned come out on the deal.

Theater managers along Broadway are getting highly perturbed over the growing popularity of the 5-cent theaters and slot machine arcades. They look down with scorn on what they call these "catch-penny attractions." That is, outwardly they do so, but all the time they are pulling wires at headquarters, in consequence of which the police are continually making themselves obnoxious. One provision of the law which demands only \$25 per annum, the showman's license, from the parlors and moving picture shows, while theater permits cost \$500, especially arouses the ire of our stage friends. Now, the only charge that can be made against the arcade or 5-cent theaters is that some of them put on pieces of the "blood-and-thunder" type, depicting murders, hold-ups, train robberies and other crimes. This charge has led the managers of the new style theaters into hot discussion with the uplifters of the public morals.

"Why should they criticise us," said the manager of one kinetoscope theater, "for putting on an occasional film showing a crime and not attack the regular theaters, who run this class of plays nearly all the time? And then, why should they criticise us when we never put on a piece that is suggestive in the sense that many of the plays and the manner of costuming the chorus are at nearly all the so-called high class theaters?"

While the kinetoscope theater managers do not claim to be trying to elevate the state at 5 cents per elevate, their air of injured innocence seems to be rather becoming.

It has well been said that with the majority of Americans the speculative nature is uppermost. You have only to appeal to it and interest is at once aroused. This is equally true, whether it is on a small or large scale. A good testimonial to the permanency of the speculative nature of man operating on a large scale is Wall street in this city and the various exchanges in the other cities. "Trade Stimulators" appeal to this known spirit of risk or chance so strong in every man. They interest and gratify that element in him at small cost to himself, and they give him a fair show and "a good run for his money" against slight odds. The card or trade machine is simply an innocent form of amusement for a penny with a chance to win merchandise. Talking machine men will find that if they want to add a good side line these slot devices will pay big. They are adapted to cafes, druggists, cigar stores, billiard rooms, etc., and as experience has demonstrated, that they will positively increase trade from 25 to 50 per cent. If a square deal is given, dealers will find no trouble in placing a large number in their territory.

The latest thing in the South in the "penny arcade" line are the "parlors," which have been opened exclusively for the negro population. This enterprise, which was started by Augustus C. Faulkner, a prominent negro of Richmond, Va., has proven a great success. On account of racial conditions the colored man was, of course, ostracized from arcades frequented by the white population, and as in many places below the Mason and Dixon line, the negro is largely in the majority, the loss to the arcade man was apparent, more especially since the "darky" will invariably spend his last cent to hear a new song and have a laugh. However, the movement once started has spread like wildfire throughout the South.

THE PROHIBITIVE TAX

Proposed in a Bill Introduced in the Pennsylvania Legislature and to be Levied on Buildings Used for Talking Machine and Moving Picture Exhibitions.

Proprietors of arcades in Pennsylvania cities and towns have banded together to fight against the bill proposed recently by Representative Moyer, of Lebanon, levying a tax on all buildings used for talking machine and moving picture exhibitions. The rate proposed is \$1,000 in cities of the first class, \$500 in those in the second class, \$200 for those in the third class and \$50 in boroughs and townships.

Proprietors of arcades containing penny-in-the-slot devices say rightly that the tax is prohibitive, and have raised a substantial fund to fight the measure in Harrisburg.

PICTURE SHOWS THREATENED.

Health, Fire and Police Departments Make Objection to Some of Them in New York.

Commissioner Bingham, Dr. Darlington, of the Board of Health, and Deputy Fire Chief Binns held a conference at Police Headquarters two weeks ago, and decided to adopt measures to put out of business many of the moving picture shows in this city. The Police Department, the Board of Health and the Fire Department have been receiving hundreds of complaints about the picture performances. Steps have not yet been taken to revoke the licenses of the nickel vaudeville playhouses.

DEVICE REJECTS SPURIOUS COINS.

(Special to *The Talking Machine World*.)

Chicago, Ill., April 6, 1907.

H. C. Kibbey, the well-known dealer in automatic specialties in this city, has secured patent rights on a new coin box for automatic musical instruments which it is said will reject slugs and spurious coins. This coin box was given a thor-

The American Projectograph

The only machine that will NOT FLICKER
EVEN AFTER YEARS OF USE

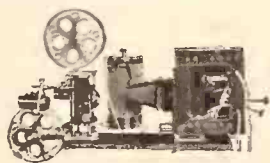

FILMS RENTED AND SOLD

CHAS. E. DRESSLER & CO., 143 E. 23d Street
New York City

The Card Printer

EARNS FROM
\$1,000
TO
\$2,000
PER YEAR

SEND FOR FULL
PARTICULARS

5c. or 1c.
MACHINES
FURNISHED

Orders must be placed
early for spring and
summer delivery.

Manufactured by
**THE CARD
PRINTER CO.**
79 East 130th St.
NEW YORK

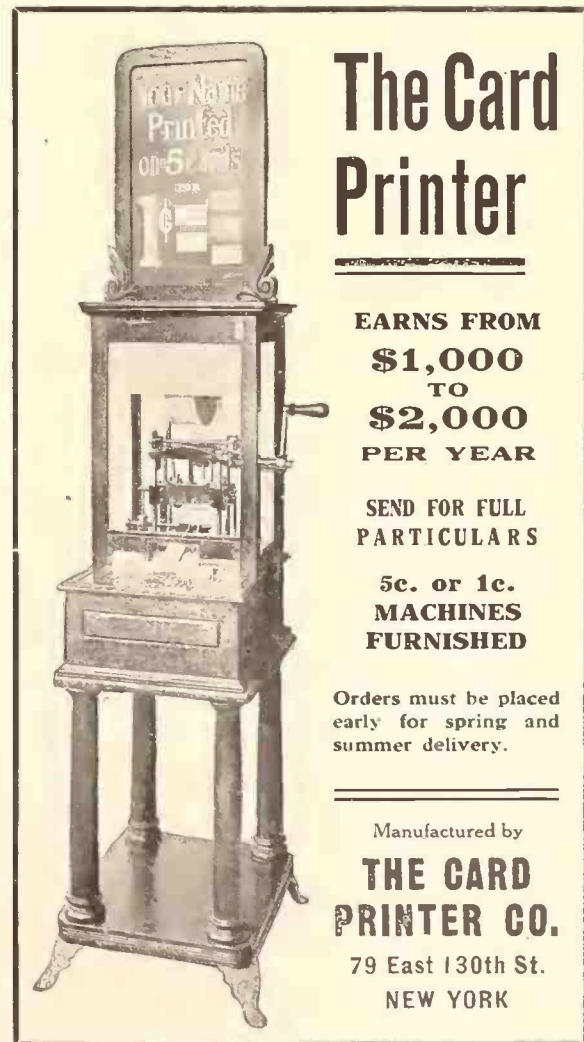

MILLS NOVELTY COMPANY

LARGEST MANUFACTURERS IN THE WORLD
OF ALL KINDS OF

COIN - OPERATED MACHINES

MILLS BUILDING

Jackson Boulevard and Green Street

CHICAGO, U. S. A.

March 27, 1907.

To The Trade:

NOTICE

The attention of amusement parlor owners and other dealers in or users of coin-operated phonograph machines and combined phonograph and picture machines is directed to the fact that the machines manufactured by Mills Novelty Co. are broadly protected by letters patent No. 846439 granted to Herbert S. Mills, March 5, 1907.

The Rosenfield Mfg. Co. has placed upon the market a machine which constitutes a direct infringement of several claims of said patent. We hereby notify all concerned that it is our intention to prosecute infringers of said patent where necessary. The patent secures to us the exclusive right to manufacture, use and sell the patented machine, and friendly notice is hereby given that we shall insist upon a recognition of our patent rights.

Suit upon the above mentioned patent for an injunction and accounting has been brought against Harry Davis, who operates an amusement parlor in Pittsburgh, in which he is making use of coin-operated phonograph machines of the manufacture of the Rosenfield Mfg. Co. Similar action will be brought against other users as the infringement is brought to our notice, unless satisfactory settlement is made.

We are prepared to supply machines of our own manufacture to all users at a reasonable price, so that it is unnecessary for any dealer or user to purchase an infringing machine. We assume that the public will not knowingly infringe patent rights which have been secured to us, but deem it proper to give public notice to all.

Respectfully,

Mills Novelty Co.

ough trial by Mr. Kibbey, who has had a large experience in this line, and according to him, it will save fully \$60 per week to the user. Lyon & Healy, the great music house of this city, have ordered 1,000 of these coin boxes; the Automatic Musical Co., of Binghamton, N. Y., have ordered 3,000; the Regina Co., Rahway, N. J., 1,000; and other concerns are rapidly falling in line. Mr. Kibbey is to be congratulated on his success, for a device of this kind has long been needed. During his recent Eastern trip, Mr. Kibbey closed many big deals for his device.

TRADE NEWS FROM INDIANAPOLIS.

Decision to Run Excursions Sunday Will Help Arcades—Better Class of People Patronize These Resorts—All the Arcades Doing Well—"Peerless" for "The Exhibit"—Sutherland's New Arcade—Terre Haute Now Invaded—Other Items of Interest.

(Special to The Talking Machine World.)
Indianapolis, Ind., April 8, 1907.

Managers of talking machine arcades hailed with delight the decision of passenger officials of the railroads of Indiana handed down last week to the effect that Sunday excursions are not to be abandoned, but that instead they are to be run at lower rates even than those which prevailed last season. Since the last Legislature enacted a two-cent fare law there had been rumors that the Sunday excursion business was to be abandoned. This had caused unrest among arcade managers because Sunday excursions bring large crowds to the city each Sunday, and consequently bring business to the arcades. Passenger officials representing roads of Indiana and Ohio met at the Claypool hotel, and after a long session announced that the rates on Sunday excursions would be lower than ever this year.

One of the noticeable features in the arcades of Indianapolis is the change in the class of trade to which they cater. All of the arcades are introducing pictures and machines now which offer special attractions to women and children.

A few years ago many were patronized liberally by the tougher element of the city. All this has changed.

"Our crowds, even on the biggest days, are always orderly," said F. L. Meier, manager of "the Exhibit" on South Illinois street, owned by R. Wagner. "We have many women and children, and we seldom have need for a policeman."

All of the arcades have had good business within the last month. The Sunday trade has been up to a higher mark than it was at the same time last year. This is due largely to the pleasant weather and the many interurban facilities. The interurban traffic on pleasant Sundays during the summer is something enormous, on some Sundays as many as ten or fifteen thousand coming to the city. The traction companies are all the time improving facilities, and it is believed that the arcade business from this source will be better this season than ever before.

"The Exhibit" on South Illinois street has just installed a new Peerless self-playing piano to attract crowds to its place. The instrument was bought at the Carlin & Lennox store.

The National Amusement Co. will open their new place on Wabash avenue in Terre Haute, April 1, and the amusement will include a 10-cent theater, a 5-cent vaudeville and a moving picture arcade. Sixty Mills machines have been bought, and will be installed in the new amusement place.

Manager Sutherland, who runs the Bijou 5-cent theater on East Washington street, has met with such success that he has started another similar amusement place on West Washington street, in the heart of the business district of the city. He has rented a large building, and it has been remodeled so that it has a most imposing entrance. He uses a Twentieth Century Columbia graphophone to draw trade, and operates a Sterling Columbia graphophone behind the scenes when moving pictures are being displayed. For example, when pictures of a violinist are being shown he turns on a violin record behind the scenes, giving an excellent effect.

THE "VIRTUOSA" IS ALMOST HUMAN.

Something of This Wonderful Master of the Violin Whose Playing Reminds you of the Great Virtuosi—The Invention of H. K. Sandell and Made by the Mills Novelty Co.—Has Astonished Musicians.

(Special to the Talking Machine World.)
Chicago, Ill., April 8, 1907.

Among the latest inventions of automatic musical instruments that of H. K. Sandell, an expert electrical engineer, working for the Mills Novelty Co., of this city, is perhaps the most unusual. This ingenious wonder is an automatically operated violin, called the "Virtuosa," which plays with baffling skill the most delicate and intricate compositions of the world's greatest masters.

The Mills Novelty Co. spent three years and over \$60,000 in perfecting this unique novelty. The Virtuosa is an almost human automaton, ingenious and unusual in construction, and is, so far as skill and ingenuity can make it, mechanically perfect, playing accurately and with the most marvelous execution, solos by such world-renowned artists as Paganini, Wieniawski, Kubelik and other famous musicians. It also renders duets and part compositions with magnificent string-orchestral effects. One of the most ingenious parts of its mechanism is that which causes it to produce the musical impressions peculiar to violin playing. It is hard to believe that by means of mechanically operated bows and fingers such wonderful technique, such beauty of expression, could be produced in this way. It has astonished musicians who have heard it.

George M. Cohan, the playwright said: "The first time I heard it (the Virtuosa) play my song, "The Grand Old Flag," I rushed to make the acquaintance of so fine a soloist, and discovered this marvelous piece of machinery." Prof. Hugo Heermann, one of the greatest living violinists, expressed astonishment that such magnificent music could be produced by purely mechanical means.

To produce music of this character and in this



THE "WURLITZER HARP"

With nickel-in-slot attachment. A wonderful attraction from both a musical and mechanical standpoint. Who has not admired the soft, sweet music of the Italian Harp? Here you have it in automatic form.



THE MANDOLIN QUARTETTE

The most fascinating musical instrument on the market. This is a combination instrument, producing the wonderful music of four mandolins with piano accompaniment.



THE TONOPHONE

THE TONOPHONE King of Electric Pianos

is a full size Automatic Piano Player with Nickel-in-slot attachment operated by electricity.

THE WURLITZER PLAYER PIANO

is the first complete Automatic Player Piano Playing the full keyboard of 83 notes. Operated by Nickel-in-slot attachment or played by hand in the ordinary way.



THE WURLITZER PLAYER PIANO



THE "PIANINO"

The latest addition to our line of Electric Pianos. This is a 44-Note Piano with Nickel-in-slot attachment. A great money-maker.



THE PIANORCHESTRA

Another very popular style and with Nickel-in-slot attachment proves a great money-maker. Nothing could be more desirable for public places where music lovers congregate. We have 10 styles.

DEALERS

will find it profitable to handle this, the greatest line of money makers on Earth for Hotels, Cafes, Drug Stores, Roller Rinks, Amusement Parks, and Resorts of all kinds.

EXCLUSIVE AGENCY IN UNOCCUPIED TERRITORY.

Here is an opportunity for a Lucrative Business with small capital.

WRITE TO-DAY.

The Rudolph Wurlitzer Company, CHICAGO. CINCINNATI.



MONSTER MILITARY BAND ORGAN

THE MONSTER MILITARY BAND ORGAN

Furnishes Music equal to a full Military Band

Especially designed for Amusement Parks, Roller Skating Rinks and other places where a powerful organ is desired. This organ is a perfect representation of a large Military Band.

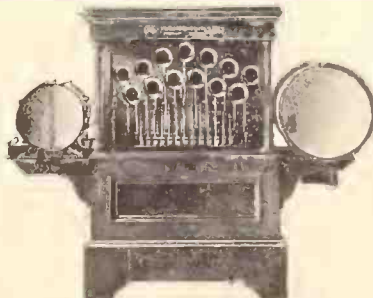

MILITARY BAND ORGAN, Style No. 125

Operated by perforated Paper Rolls. We have 10 styles to select from.

Counting Pennies By Machines

Did you ever realize the amount of Pennies taken in at a *Penny Arcade*? Did you ever know that their number is so great that *spe-*

cial machines have become necessary to save time in counting them?

This being a fact, you will readily understand how such establishments can afford to pay such enormous rents in larger cities.

Their receipts are simply beyond realization, and proprietors of *Arcades* are always ready to pay almost any price for good locations.

Still the *Penny Arcade* business is yet in its infancy, and plenty of opportunities are open *right now* for starting such establishments with every assurance of success.

Large capital is not necessary to start a successful *arcade*, in fact the largest ones are the outcome of an early start with a modest investment.

Properly started, arcades are *always successes* in towns with populations from 5,000 upward.

We are ready to help you to start a Penny Arcade, and will give you the benefit of our 20 years' experience both as manufacturers and operators.

A *postal card* will bring you full details and our Handsome Illustrated Catalog for 1907.

Write us to-day, and don't allow an opportunity for securing a *big income* pass by you and be taken up by others.

Remember that none but Caille Machines possess "Caille Quality."



The Caille Brothers Co.
DETROIT, MICH.

Eastern and Export Office:
32 Union Square, N. Y. City

Western Office:
902 Republic Bldg., Chicago

manner naturally requires a machine of intricate mechanism and many clever devices, although the simplicity with which it can be operated is astonishing. So complete is the invention and its working parts that it doubtless will never have a rival.

The following description will give an idea of how complicated and yet how simple is the operation of the Virtuosa: A coin dropped in the slot turns on an electric current automatically. The motor starts and the power is transmitted by a vertical geared shaft to the violin in the upper section of the cabinet. A contact cylinder, carrying the paper music roll, fed by a secondary cylinder of rubber, revolves, and as the perforations in the paper pass given points contact is

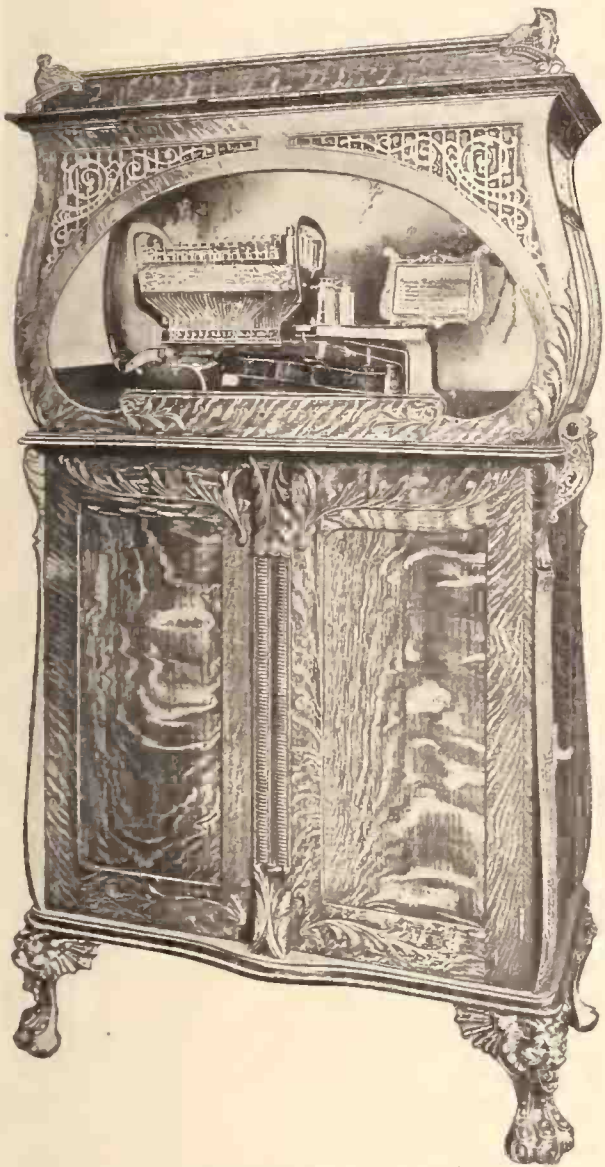

THE MILLS AUTOMATIC VIRTUOSA.

made with one or more phosphor-bronze brushes and an electric current flows to finger magnets resting over the finger board. Each of these magnets attracts an armature connected with a finger operating rod acting upon the violin strings. The bow operating magnets are mounted on an arm which extends over the body of the violin and bridge, at which point four conical celluloid bows revolve, one for each string. The same current which controls the finger operating rods also acts simultaneously upon one or more of these magnets. Another magnet produces the staccato effect, the bow speed variator in the lower section of the cabinet, controlling the speed and pressure of the bows on the strings and the bow action magnet, producing the extraordinary hard actions of the bow, gives the effects of a bow operated by the human hand. The strings are of silvered steel, as the ordinary gut strings do not stand the hard wear nor changes in temperature.

One interesting feature of the Virtuosa is an ingenious device by which it can be tuned by operating a series of buttons. A child can easily be taught to tune the instrument, the work being practically automatic.

A romance could be written about the trials and tribulations incidental to every great invention. The inventor gets to a certain point where it seems that all the labor that he has expended has gone for naught, because of an unsurmountable obstacle which presents itself. Several of these crises occurred when the Virtuosa was being invented. One was at the time when the

question of arranging a bow for the strings was considered. A bow was found impossible for a number of reasons, and to produce a satisfactory substitute was a long and hard problem. Finally the idea occurred to use celluloid discs instead of a bow; in other words, instead of bowing the string to have a separate wheel revolve upon each string. In order to obviate the wear on the string, which would result, the inventor placed a strip of rosin over the celluloid discs, which they constantly played against, the rosin only coming in immediate contact with the string, thus obviating any wear.

Of course, the important feature about the Virtuosa outside of its marvelous musical ability and its ingenious invention is the fact that it will earn a big income for its owner as a coin-operated musical novelty. Yet there is still another fact in regard to the Virtuosa making it unique in the field of automatic instruments, which is, curiously enough, that it increases rather than decreases in value the more it is used. This fact is patent, of course, to any musician who uses a violin, as he knows the more you use a violin the sweeter it grows in tone and the more valuable it becomes.

H. S. Mills, president of the Mills Novelty Co., was particularly interested in securing a high-class violin for the Virtuosa, and he was not satisfied until he had hired the best violin-maker to be had and set him to work in a corner of the big Mills' building. This violin-maker insisted on having the very best materials to work with, which finally resulted in the Mills Novelty Co. sending to Germany for a special kind of wood from twenty-five to thirty years old, which is used there in making rare violins. It is these splendid instruments which when used improve in tone and sweetness, and which are of such an unusual quality of workmanship that they give every composition played on the Virtuosa the character and effect of its being played by a celebrated artist. So rare an achievement in producing a mechanically perfect instrument so nearly human seldom occurs, and the Mills Novelty Co. have good cause to be proud of their new musical wonder.

AN OPTICAL PHONOGRAPH

As Well as Arc Lamp Grand Opera Revealed at the Recent Lecture of Mr. Duddell at the Royal Institution.

(Special to The Talking Machine World.)

London, Eng., April 2, 1907.

Among other wonders that rejoiced the hearts and stirred the imaginations of the audience at the recent lecture of Mr. Duddell at the Royal Institution was an exhibition of what may be called an optical phonograph. Mr. Duddell produced a long gelatine film—the width of that of the smallest pocket kodak—on which was “developed” the electrical record of that entertaining song, “A Little Bit of String.” The record was shown in the form of a continuous series of vertical lines of varying length and interspace, and Mr. Duddell explained what its practical value might be. “We could take the record of a song sung by Patti, say, and regarding that as the pattern of perfection compare it with the optical record of the same song sung by an inferior voice, and see in what way and at what points the inferior voice fell short of the standard set.”

Mr. Duddell showed “the pattern of his voice” on a screen by making weird vocal noises into a transmitter. The pattern appeared in the fluctuations of streaks of light on the screen and illustrated the “distortion and attenuation” of the voice in long-distance telephony, a difficult subject, and one which I do not expect you fully to understand,” said Mr. Duddell; but the juvenile auditory clapped vigorously to affirm its power of comprehension.

Mr. Duddell's lecture embraced practically the whole development of modern telephony from the earliest “fumbings” after electrical transmission of sound down to the most up-to-date switchboard in a modern exchange. His audi-

THE CONCERT-O-PHONE

TWENTIETH CENTURY
COLUMBIA COIN
OPERATED MACHINE

Almost Human in Tone

25 SELECTIONS
AUTOMATICALLY
CHANGED

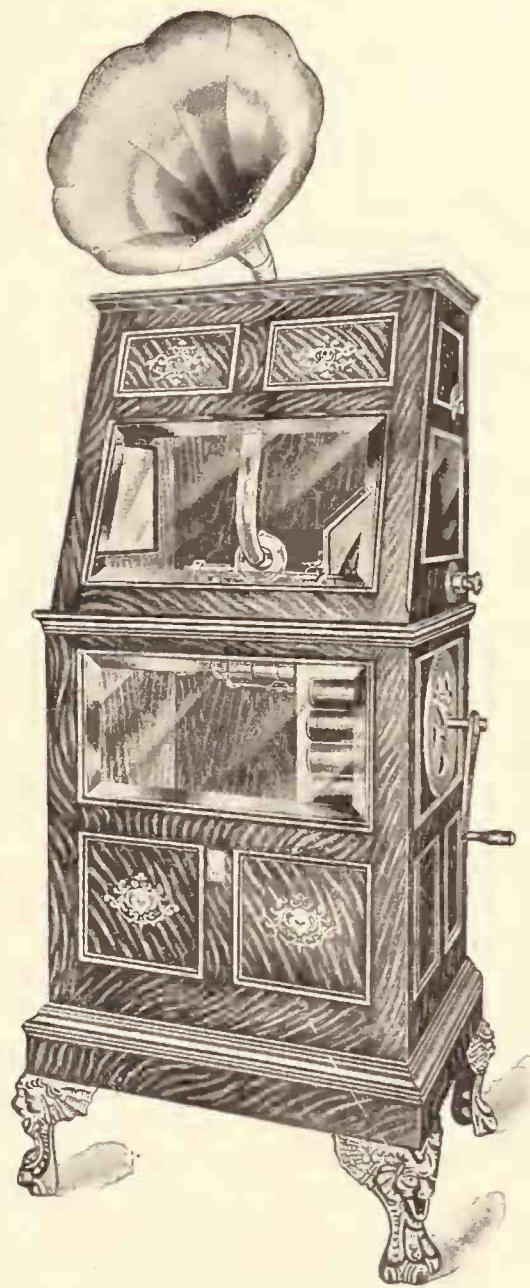

MADE BY

SKELLY MFG. CO.

81 South Jefferson St.

CHICAGO

A. J. POMMER CO., Sacramento, Cal.,

Pacific Coast Sales Agents

HELRIEGEL & CO., Philadelphia,

Sales Agents for Pennsylvania

ence was most impressed by an arc lamp which acted as a telephone. "We have here," said Mr. Duddell, "an arc lamp such as you will see in Oxford street or Piccadilly when you go home from here this evening. That arc lamp can be made to act as a telephone, and I will show you how it is done.

"Mr. Turbini will go into another part of the building and sing, talk or whistle, and you will hear it on the arc lamp." Mr. Turbini left the room, taking with him a microphone—an ordinary transmitter—attached to the arc lamp by an ordinary cord. And very melodiously Mr. Turbini whistled into his microphone—at any

rate, a melodious whistle (a selection from grand opéra was the morceau chosen) emerged from the arc lamp and distributed itself over the theater.

Mr. Duddell then went on to explain that the possibility of telephoning along a beam of light—which he had himself discovered independently, though anticipated by a German scientist—was more than a picturesque experiment; for by the use of silenium, which has the peculiar property that its resistance to electricity varies with the amount of light directed upon it, wireless telephonic messages have actually been sent seven miles.

THE CASE WAS DISMISSED.

Moving-Picture Show Man Wins a Victory in Court.

The graphophone with the big megaphone in front of a moving picture show at No. 243 Washington street, Brooklyn, continues to attract the attention of passersby, and the lawyers for Mrs. Elizabeth B. Estes, occupant of the only mansion left on Washington street, have admitted that they made a false start in their efforts to find power in the law to limit the volume of sound which may be legally spread broadcast in the atmosphere by a talking machine.

William Epspy, proprietor of the moving picture show, had been summoned to the Adams Street Court on complaint of Mrs. Estes, his next door neighbor. Mr. Camp, for the defendants, argued that the instrument was used only within the legal hours, and the case was dismissed.

NEWS FROM ALL POINTS.

The Fort Pitt Film Exchange have taken permanent quarters in the Home Office Building, Pittsburg, Pa.

The Five-cent theater in the McCullough Building, Davenport, Ia., is doing a rushing business.

A new kinetoscope theater will shortly be opened in the Wilkenson Building, Wheeling, W. Va.

The Colonial Moving Picture Theatre, 220 East Houston, San Antonio, Tex., recently gave an entertainment for the benefit of the inmates of the orphan asylums, for which they were lauded by the citizens, and, more to the point, increased their business.

The Orpheum in Utica, N. Y., is making a hit with its new Sunday program.

The Southwest Amusement Co., of Los Angeles, Cal., will open a new motion picture show at the Empire Theater in San Diego.

W. B. Erwin, of Kansas City, will open a 5-cent theater at 236 Pine avenue, Long Beach, Cal.

Geo. Carnes is to open a nickel theater on North Main street, Bowling Green, O.

Chester Whipple will start another in North Baltimore, O.

Brice Bernard will break the ice at Napoleon, O.

Charles D. Silcox, Jr., will open a new theater at 3064 Richmond street, Philadelphia.

A moving picture show will be started on Virginia avenue, near Shelby, in Indianapolis, Ind.

A high-class Nickelodian will shortly be opened at the Union Block, Ottawa, Ill.

S. L. Costley and C. G. Hurnan are putting in two new moving picture shows, one on each side of Congress avenue, Austin, Tex.

Still another is to be added to the already large list in Waukegan, Ill., to be known as the Tichnor Crosby Amusement Co.

George E. McKean will open in Granite City, Mo.

INCORPORATED.

The Garden Amusement Co., New York, capital \$100,000. Incorporators—Sigmund B. Heine, Maurice Reinhardt and Edward E. Benedict.

The Twin City Amusement Co., Menasha, capital stock, \$5,000.

Coin Operated Talking Machines
Coin Operated Illustrated Song Machines
Coin Operated Machines of all other types

THE ROSENFIELD MFG. CO.

591 HUDSON STREET, N. Y. CITY

American Mutoscope & Biograph Co.
11 E. FOURTEENTH ST., NEW YORK

The Mutoscope
Oldest and Best Known
Slot Machine

"The Backbone of the Automatic Parlor Business"
Showing Moving Pictures in their Most Attractive Form

**BIGGEST MONEY SAVER ON THE MARKET
YOU GET**



THIS
← INSTEAD OF →
THIS

SLUG

IF YOU USE

The "GUARDIAN" Coin-Detector

Throws out Slugs (including Brass) — It cannot be choked up!

SAVES 300% OF YOUR MONEY

Nickel-Slot Pianos and all Nickel-Slot machines earn three times as much money when protected with a "Guardian" Coin-Detector. Write now, today, for fullest particulars.

H. C. KIBBEY & CO., Inc. MECHANICAL AMUSEMENT HEADQUARTERS
Coin-Operated Machines of Every Description
209 STATE STREET, CHICAGO, ILLINOIS, U. S. A.



TYPE P

THE MUTOSCOPE

For Summer Parks, Penny Arcades, etc., has proved itself to be the greatest money earner of all coin-operated machines. In fact it has made the "Penny Vaudeville" what it is to-day. The privilege of free exchange of pictures keeping them fresh and up-to-date, make it always attractive. Our New Type E Mutoscope, besides being handsomer in design, possesses many improvements in mechanism over former models.

Write for Particulars

AMERICAN MUTOSCOPE & BIOGRAPH CO., 11 East 14th Street
NEW YORK CITY
PACIFIC COAST BRANCH, 116 North Broadway, LOS ANGELES, CAL.

Do you want more Profit?

Get **THE NICKLIN** The best
Coin Operated Piano
in the World

This is a First-class Upright Piano—Can also be played by hand in the usual way

Manufactured by

Neola Piano & Player Company
General Offices, 201-203 East 49th Street, New York



THE PIANOVA COMPANY,

Manufacturers of

44 AND 65 NOTE ELECTRIC PLAYERS

with or without nickel in the slot attachment

SECURE THE AGENCY NOW.

117-125 Cypress Avenue,

New York.

Talking Machine Dealers!!

IF YOU have not considered selling Coin Operated Pianos heretofore, we venture to suggest your doing so, as many of the largest talking machine dealers in the country have found this one of the most profitable features in their talking machine departments, mainly because the instruments when offered to the buyer have many of the elements of a *something for nothing proposition*. The margin is large, the installments are large and should be large, because the instrument takes in cash and consequently



the buyer does not have to pay out his own cash. The dealer gets his profits quickly. Did you ever stop to consider this?

The largest and most successful dealers in the country handle the PEERLESS COIN-OPERATED PIANO—there's a reason.

Let us show you how it is done. A postal will bring you our handsome brochure entitled "Easy Money."

HIGHEST AWARD—GOLD MEDALS
 Buffalo 1901 St. Louis 1904 Portland 1905

Roth & Engelhardt

(Props. PEERLESS PIANO PLAYER CO.)

Windsor Arcade, Fifth Ave., New York.

Factories: St. Johnsville, N. Y.



DO YOU FOLLOW UP

the leads we make for you in our advertising campaign?

If you don't you are losing many *golden opportunities* for big profits.

We have started the business your way. With but little extra effort on your part, you should reap the benefits in greatly increased sales.

Are you doing it?

COLUMBIA RECORDS

are *household words* throughout America to-day, in consequence of their *universally admitted superior* quality.

Our extensive advertising reaches every nook and corner of the land continually.

It reaches all the people in *your* neighborhood. They have learned, through personal experience, in repeatedly hearing Columbia Records under *test conditions*, to appreciate them at their *true value*.

These people are ready *now* to be turned into *permanent* and *profitable customers*. It's up to *you* to let them know *you* sell Columbia Records.

There are many ways you can do this, we mention two:

You should use your local newspapers to advantage.

You should give frequent concerts, playing all the newest hits, attracting the music-loving people and make them your customers.

If *you* pull with us, *we'll* pull with you, and with a *strong pull all together* you'll pull off the biggest record sales this year since you started in business.

N. B.—You can always count on the recognized superior merits of Columbia Records to *make good every time*.

Pull for the Columbia Record business in your town. It's the pull that pays.

COLUMBIA PHONOGRAPH COMPANY, Gen'l
Tribune Building, New York

GRAND PRIX, PARIS, 1900

DOUBLE GRAND PRIZE, ST. LOUIS, 1904

GRAND PRIZE, MILAN, 1906

STORES IN ALL PRINCIPAL CITIES

DEALERS EVERYWHERE