

# TV TECHNOLOGY™

Vol 10 No 12

December 1992

International Edition

Buyers Guide:  
ENG/EFP Cameras  
See Page 24

## 1992: A Milestone in Digital TV Technology

by Frank Beacham

The theme of a recent conference on high definition television, one of many held in 1992, was "Countdown to Consensus." But, as the year drew to a close, about the only real consensus about television technology in the world is that the future will be digital.

When, how and in what form digital television technology is implemented is the subject of intense debate throughout the world.

This point was driven home earlier this year when the Media Lab at the Massachusetts Institute of Technology, Cambridge, Massachusetts, invited 200 of the world's top television and computer executives to a day-long symposium on the future of television. Though most were financial supporters of the Lab's research, many of the participants were also fierce professional competitors.

### Global disharmony

The Media Lab's original idea was to have these diverse and competing interests hear presentations of what each is doing and try to arrive at some level of industrial cooperation, and even—as the Lab put it—"global harmony."

But harmony was in short supply. "I'm disappointed in the lack of interest in looking at the issues globally," said Nicholas Negroponte, the Lab's director. "But the good news is all agree that the future is digital." That agreement alone from this exclusive group of television industry executives has significant implications for the world's electronic media.

Digital data transmission is the key to bridging conventional home entertainment systems with a new media form that combines improved definition video, digital audio, text and graphics. Its interactive capability will allow on-demand video and audio programming in the home as well as a myriad of new two-way services.

The United States appears to be on the fastest route to implementing a digital advanced television transmission system. Prodded by an aggressive Federal Communications Commission (FCC), the selection process for an American HDTV standard may produce a winner early next year.

Final tests of competing HDTV systems are underway at the Advanced Television Test Center (ATTC), and American TV industry-sponsored laboratory. Results of the tests will be considered by the FCC in

choosing a new HDTV television standard for the United States.

### Digital TV in Europe

The outlook for digital television in Europe is unclear. The European Broadcasting Union (EBU) has advocated an evolutionary approach to advanced television using the analog D2-MAC and HD-MAC systems for satellite and cable, while recommending analog PAL Plus for terrestrial broadcasting.

But a digital system, like HD-Divine, introduced at the 1992 IBC in Amsterdam, may challenge the EBU's analog advocacy. HD-Divine uses advanced data compression techniques to deliver high

(continued on page 6)

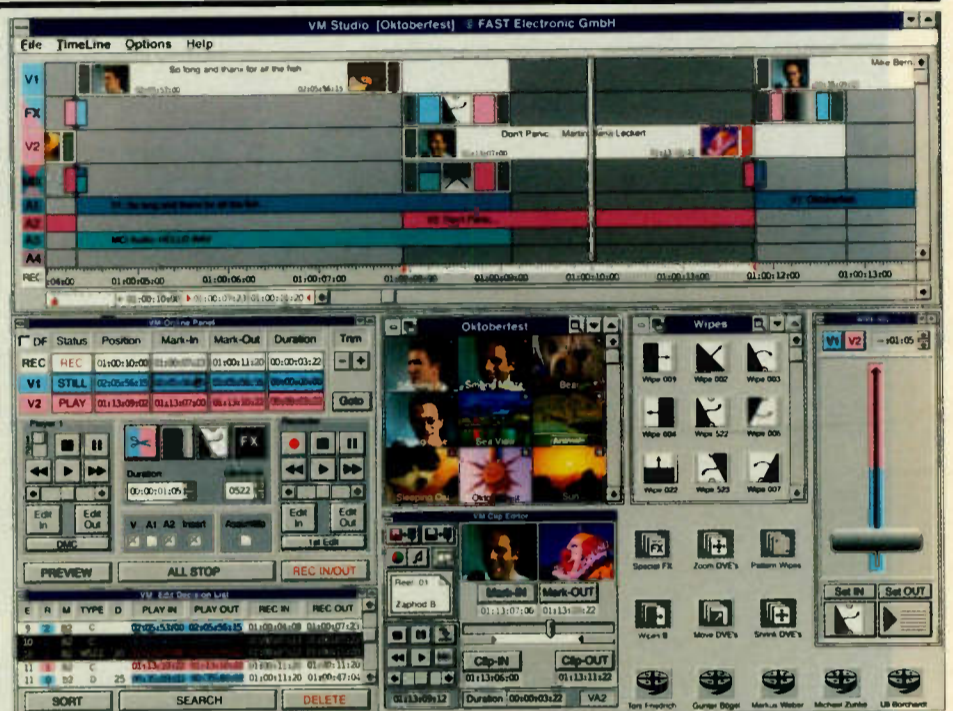

The Video Machine, by FAST Electronic GmbH, lets a computer function as a desktop video studio. Turn to p. 13 for an overview.

## The BBC Puts Thomson to the Test

by Nigel Saunders  
BBC Cameraman

**LONDON** When I first came to the BBC in 1978 and began working on light entertainment programs, CCD cameras

were an unknown commodity.

By 1989, tube-type portable cameras had become more predominant at the BBC, and I had acquired some experience with them. Then came the first CCD models.

I can well remember the novelty of

being able to point the camera at the studio lights without all manner of evil things going on in the picture and in the tubes.

However, after this novelty passed, I realized that these early CCD cameras proved to be temperamental and in need of further development.

### Long-time experience

Over the last four or five years, Thomson Broadcast cameras have been largely chosen by the BBC in London as part of ongoing studio refurbishments. Currently, Thomson cameras are in use in TV Centre and Alstree Studios.

Each large studio generally operates with four Thomson TTV 1652 studio CCD cameras and one TTV 1647 light-weight portable. There is also a pool of seven more 1647s.

When the first 1647s went into the studios, the lightness of the cameras made a noticeable difference, especially for handheld shots.

(continued on page 28)

# Powerful production

**PVS-224**

- Expandable: 1ME/12 inputs to 2 MEs/24 inputs
- Powerful event memory programming
- 6 linear keys, 3 chroma keys
- Quick, efficient touchscreen operation

**UTAH SCIENTIFIC, INC.**

## DYNATECH VIDEO GROUP

Americas - U.S. 608.273.5828  
FAX 608.273.5832

Asia / Pacific - Hong Kong 852.868.1993  
FAX 852.525.8297

Europe / Middle East / Africa - U.K. 44.734.890.111  
FAX 44.734.892.022

# Español

## Vea Las Páginas

### 20, 21 y 25

ALPHA IMAGE ALTA CABLE PRODUCTS CALAWAY COLORGRAPHICS DA VINCI NEWSTAR QUANTA UTAH SCIENTIFIC

# Introducing a value-packed platform for waveform/vector monitoring.



Products shown with optional white phosphor display.

## See it. Believe it.

You can expect more from your next waveform/vector monitor — more performance, more convenience, more value — now that the 1741A, 1751A and 1761 Series from Tektronix have arrived.

An intuitive user interface, streamlined front panel and outstanding display capabilities — all in a half-rack package — make up a new platform for future products to follow. The platform is built on actual input from TV engineers — people whose time is too valuable to be spent learning and re-learning equipment.

Eight video input channels, 12 user presets, waveform and vector cursors, time code display, stereo audio phase monitoring, full field line select and a host of other features are easy to put to work, without slow, hierarchical menus or ambiguous results. You can even view actual pictures at the push of a button.

The 1741A Series offers all this and much more. The 1751A Series adds SCH phase

monitoring, and the 1761 Series provides capability for component TV.

Each series includes PAL, NTSC and dual standard monitors — all with an unsurpassed 3-year warranty.

### Seeing is believing.

Just call your Tek representative to arrange a demonstration — get a closer look at the quality Tek delivers in a new platform for waveform/vector monitoring.



**Tektronix**  
Television Systems

Copyright © 1992, Tektronix, Inc. All rights reserved. TVG-122

Circle 28 On Reader Service Card

# News From JAPAN

Researched and compiled by Masakatsu Ueda

## Matsushita to Market Lightest Three-CCD Camcorder

**TOKYO** It looks like the camcorder is about to get smaller.

Matsushita was expected to market the smallest and lightest S-VHS three-CCD camcorder in the industry, the NV-3CCD1, by press time.

The camcorder weighs 890 grams (31.2 oz.), is sized 140mmWx122mmHx228mmD, and will cost approximately ¥298,000 (roughly U.S.\$2,384). The company expects to begin with a monthly production run of 5,000 units.

The company also planned to introduce two new camcorders with built-in 20X digital zooms and electronic stabilizers—the NV-S99 (¥195,000, U.S.\$1,560) and NV-S77 (¥175,000, U.S.\$1,400)—in September, with monthly production runs of 40,000 units and 10,000 units, respectively.

The cameras are outfitted with three CCDs of 270,000 pixels and a newly-developed "green staggered" three-CCD system, providing a horizontal resolution of 530 lines.

The green staggered system is different from conventional three-CCD systems in that each green signal is slanted by half a pixel from the red and blue signals.

Toshio Tokuda, a general manager in Matsushita's Video Movie Division, said the technology is already being added to business-use three-CCD cameras, but "it is (economically) impossible to adjust and compose three colors with a slant green signal in consumer cameras."

Another breakthrough is that the company has developed technology to fuse the joints of dichroic optical prisms precisely, and to shorten the optical path by a one-time reflection of the blue image. Although this results in reversed pictures, they can easily be converted back to normal through digital processing.

At present, the technology involves reflecting two colors twice, making the optical axis longer and the prism system bigger.

## Manufacturers Improve On Optical Disks

**TOKYO** The drive by Japanese manufacturers to make optical disk technology more efficient continues, as companies here announced new advancements designed to improve the speed at which data is read and written.

Matsushita has developed a new optical disk capable of high-speed rewriting of information. The higher-speed disk was

## CEL and Snell Join Forces

**HAMPSHIRE, U.K.** Two well-known names in standards conversion technology are combining forces. CEL Broadcast, which traditionally concentrated on lower-end conversion products, recently announced that it is joining up with the Snell & Wilcox Group, which specializes in high-end standards conversion products. Negotiations had been taking place between the two companies for nearly a year.

Both companies have recently diversified into other product areas. Snell & Wilcox has introduced a range of products for high definition and encoding/decoding, and incorporated its motion estimation with Ph.C phase correlation into its Alchemist converter and Gazelle Slow Motion system. CEL has developed a number of products for post production, including the Myriad and Meridian digital effects systems.

CEL Broadcast will operate independently within the Snell & Wilcox Group, with its own product range and distribution network. Snell & Wilcox Chairman and CEO David Youlton



**CEL Broadcast President Robin Palmer (left) seals the deal with David Youlton, Chairman/CEO of Snell & Wilcox**

and joint founder Roderick Snell will join the board of CEL Broadcast. CEL Chairman Robin Palmer becomes president and research director of CEL Broadcast; Roderick Snell becomes president and research director of Snell & Wilcox.

## Pioneer Increases CD-ROM Reading Speed

**TOKYO** Pioneer has developed a CD-ROM drive capable of reading data at 600KB per second, which is four times faster than conventional drives.

The higher speed results from digital signal processing equipment, an improved motor and an optical pick-up.

Reportedly, Sun Microsystems, Digital Equipment Corp. and Microsoft have decided to support the drive.

Sony and NEC have already developed CD-ROM drives that are twice as fast as conventional drives.

## IN THIS ISSUE

### News

- 1992: Year of digital TV .....1
- NewsWatch .....3
- HD-DIVINE stirs up Europe .....6
- HDTV Dublin debates future .....7
- Japan's digital Hi-Vision .....8

### Features

- Frank Beacham  
Video Craft .....14
- Warner Johnston  
Signal Technology .....15
- Mario Orazio  
Masked Engineer .....18
- Ron Saxton  
Tech Tip .....19, 21
- Ken Hahn  
Audio para Video .....20
- John Premack  
Focus on Videography .....21
- Doug Lung  
RF Technology .....22

### Computer Video

- Desktop video overview .....10
- Richard Farrell  
Desktop Video .....13

### Equipment

- Marketplace .....26
- Product Showcase .....27
- Equipment Exchange .....29
- Advertiser Index .....30

### Buyers Guide

- ENG/EFP Cameras  
User Reports .....24
- Thomson, Ikegami, Panasonic, Sony,  
Hitachi, Toshiba, JVC, BTS  
Technology Update .....30
- OpTex

developed by adjusting the width of the metal thin-film that reflects the laser beam, and by controlling the temperature increases between crystal and non-crystal (amorphous) parts of the disk.

Meanwhile, Sharp has developed a high-powered semiconductor-laser for use with optical disks that allows the writing speed to be increased sixfold, compared to conventional products.

Sanyo has also come out with an orange semiconductor laser with a wavelength of 615 nm that operates at room temperature.

The new products come on the heels of a development by JVC in which high-density optical disk information is read using a short-

## SHOW LISTING

Upcoming conventions, meetings and exhibitions:

**18-21 January 1993**  
**Middle East Broadcast '93**  
Bahrain. The Middle East Broadcast '93 will be staged at the new Bahrain International Exhibition Center focusing on radio, television and program production. Contact Organizers: Arabian Exhibition, Management WLL, P.O. Box 20200, Manama, Bahrain; telephone: +973-250033; FAX: +973-242381.

**17-20 February 1993**  
**Indonesia 93**  
Jakarta, Indonesia. The 5th International Professional Sound, Film, Video and Lighting Exhibition covering Southeast Asia. Contact worldwide organizers: Overseas Exhibition Services in London at telephone: +44-71-486-1951; or FAX: +44-71-486-8773.

**16-19 March 1993**  
**92nd AES Convention and Exhibition**  
Berlin, Germany. For details on the show, contact Audio Engineering Society in Brussels, Belgium, at telephone: +32-2-345-7971 or FAX:

+32-2-345-3419. [Future show: 28 February-2 March 1994, Amsterdam.]

**19-22 April 1993**  
**IAB '93**  
Las Vegas, Nevada. The 23rd General Assembly of the International Association of Broadcasters will be held in conjunction with the 1993 National Association of Broadcasters Convention. Three days of meetings will be held at the Las Vegas Convention Center.

**19-22 April 1993**  
**NAB 1993**  
Las Vegas, Nevada. The 1993 National Association of Broadcasters Convention, with exhibits and sessions, will be at the Las Vegas Convention Center. For information write NAB at 1771 N. Street, N.W., Washington, D.C. 20036-2891 USA, or contact at telephone: +1-202-429-5409; FAX: +1-202-429-5343. [Future shows: All located in Las Vegas, Nevada 22-25 March 1994].

**13-21 May 1993**  
**SVIAZ '93**  
Moscow, Russia. The 6th biannual Communication, Data Transfer and Processing Equipment Show held in the

EXPOCENTR in Moscow. For information on SVIAZ '93 contact Ms. Susanne Hess, Exposition Manager at TNT Productions Inc. P.O. Box 717, Callao, Virginia, 22435, USA; telephone: +1-804-529-5510; FAX: +1-804-529-5057.

**10-15 June 1993**  
**Montreux '93**  
Montreux, Switzerland. The 18th International Television Symposium and Technical Exhibition. For information contact: +41-21-963-3220; FAX: +41-21-963-8851.

**8-10 July 1993**  
**Broadcast '93**  
Hong Kong. The 2nd Hong Kong International Broadcasting, Sound, Film and Video Exhibition. For exhibiting information contact: Overseas Exhibition Services in London at telephone: +44-71-486-1951; or FAX: +44-71-413-8230.

Send announcements to TV Technology International, P.O. Box 1214, Falls Church, Virginia 22041 USA, or FAX: +1-703-998-2966.

# Frezzi<sup>TM</sup> 90's

## The Frezzi Mini-fill light, a world standard.

This beautifully engineered light head was designed by Frezzolini for the Mount Everest climb. It has since been improved for use at political conventions that require less obtrusive light heads. The Mini fill's reliability, performance and portability have established its international reputation and inspired an entire line of lighting products available today.

Compare the list of features:

- light weight (only 12 oz)
- compact (2"x 4 1/2")
- operates from 12-14.4 or 30v batteries with choice of connectors
- utilizes high efficiency lamps 20-100w
- available with a complete line of light studs and brackets.
- available in a dual light head configuration for maximum light power.
- Flip-up Dichroic Filter available, as shown.
- Professional Mini Fill kit available in crush proof carrying case (shown below)

Shown here with our ML bracket. A complete line of mounting studs available.



**Frezzi... Your total source for Power Products.**



**Pro Kit**

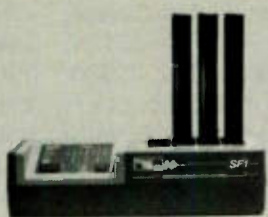

**SF1 charger**



**Micromaster**



**AR30**

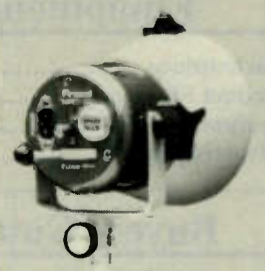

**FL650 light**

**Frezzolini Electronics: 5 Valley st. Hawthorne, NJ 07506  
(201)427-1160 Fax(201) 427-0934 Orders (800)345-1030**

Circle 61 On Reader Service Card

# South America Looks to the PC

by Evelyn Bronson

Throughout South America there is an appetite and appreciation for sophisticated graphics. Although the changing economic climate across the continent has dictated restraint in new purchase decisions, the demand for equipment is still strong.

Nowhere is the challenge fiercer to keep up with new technology within tight budget constraints than in the broadcast markets of South America. That's why equipment price, upgradeability and system integration are key factors in a purchase. Everything from desktop PC hardware and software products to integrated workstations to complex high end systems is evaluated for a wide range of graphics applications.

Grass Valley Group is one of the leading suppliers of graphics effects devices in South America. GVG equipment is found in national and regional networks, small production houses and an emerging corporate video market where managers have recognized the power of graphics to grab and hold a viewer's attention.

## Graphics in Brazil

In Brazil, there are both large national networks and smaller regional facilities. There are over 60 Grass Valley K-Series character generators installed in the country, making them the most popular CG. SBT, Sao Paulo, one of the Brazilian national networks, uses the Grass Valley 20-K character generator heavily in the creation of graphics for news, documentaries and sports. They also have the Grass Valley DPS-I paint system. A graphic can be grabbed from video, painted, modified, or color corrected in the DPS-I and then played back on the air with text effects directly from the 20-K.

The compatibility between the two products allows a high-end graphics look using relatively low-cost systems.

RBS (Rede Brasil Sul) is a regional network in Porto Alegre. They own RBS Video in Sao Paulo, where they have a Quantel Harriet as their main graphics

## GUEST COMMENT

workstation. They have two Grass Valley 5-K character generators and have recently purchased two Presto 100s. Grass Valley's newest, fast, low-cost CG. The Presto offers a 68030 processor for quick keyboard response required in the fast-paced broadcast environment.

### Price plays a part

Today, when purchasing graphics equipment in Brazil, the most important consideration is often price. Targa Systems, Topaz and the NewTek Video Toaster have had considerable success. Grass Valley is entering the low-cost equipment market with a new line of CGs and its new videoDesigner, a PC-based broad-

Brazil," states Frank Schufelt, Grass Valley's representative in Brazil, "there is an emerging market of high-end systems, also. I know of five Silicon Graphics systems with TDI software in Brazil, plus a custom Silicon Graphics system at Globographic in Rio de Janeiro."

These systems are producing work that is being directed toward Brazilian network television and being aired as openings for shows and national advertising. Graphics Factory fits into this market because of its integration of all the graphics chores. It is easy to upgrade with plug-in modules and enhanced software.

The dual user aspects of the system make it extremely productive for tight budgets, also. Because Brazil has been dealing with an economic crisis almost continuously since 1979, Graphics Factory has been an ideal system to grow with as conditions improve.

After-sale support is also a key factor in purchase decisions and affects the type of equipment popular in the market. Import regulations make it difficult to speed replacement parts from the States, so local support has to be available. Tek-

customers are looking for systems that incorporate a character generator, a fast paint system, multilayering capability, a small DVE, a disk recorder for 2-5 minutes, expandable hardware and a feature set and a good price/performance ratio. Grass Valley Group is addressing this market with its present Graphics Factory and its soon-to-be-released digital disk recorder. Presently there are Graphics Factory systems at Televisa, S.A. De C.V., Qualli S.A. De C.V., and Expresiones E Ideas De Toluca.

In Chile, the graphics industry is changing so that "all video systems are integrated with computer devices," says Patricio Del Campo W., business manager for ITV Intervideo in Santiago. More and more editing is done off-line with PCs. PCtranslate, a newly introduced PC software module, allows the transfer of text messages composed from your favorite word processor and spell check system, into your Grass Valley character generator.

Font selection and text positioning is done right on the PC. This allows more efficient use of sophisticated broadcast devices for on-line applications while the PC does the drudgery of data entry.

Channel 13, the Catholic University TV Network, has two Graphics Factory systems networked together to access data from a mass storage device. They also have several K Series character generators and are currently adding another one to serve as a weather display system. Traditional 20-Ks and 30-Ks can be upgraded to WeatherWatch systems to interface to weather computers for gathering and displaying data.

### Dominance in Peru and Argentina

Grass Valley's overall dominance in the major television markets of South America is also seen in Peru, where there is a Graphics Factory at Panamericana De Television that creates and plays back to air all the graphics used by the network, and in Argentina where the K Series and now the Presto are becoming the CGs of choice.

The meeting of the computer age with the broadcast industry is happening now. Corporate and smaller TV markets require sophisticated features previously available only to the big networks and post production houses.

And with the availability of PCs and the deluge of new consumer software programs, the talent to drive these creative devices is also increasing. The manufacturing giants of last year will only be as strong as their flexibility to service, support and provide for a new and exploding computer generation. New emerging graphics facilities will only be as strong as their ability to meet the present creative needs of their clients while still planning for growth to incorporate next year's technology and the latest buzzwords of the computer world.

The market is extremely volatile, which is not a particularly comforting thought in today's economy. But computer graphics is in a growth mode for years to come and that has to be good for everyone.

*Evelyn Bronson is marketing support manager for the Graphics System Division of Grass Valley Group. She may be reached at +1-201-845-8900.*

## *It seems, all in all, change and growth are the bywords for the graphics markets in South America*

cast quality paint system. Long an industry leader in high-end broadcast equipment, Grass Valley now has new products that assure broadcast quality output for emerging video markets and those established broadcast markets no longer buying expensive video gear.

The videoDesigner is two 16-bit ISA boards plus software that runs on any 386 or better PC with at least 4MB RAM. Outputs are NTSC analog or D-2. Software is as extensive as much higher-priced traditional paint systems.

Anti-aliased brushes, stencil cut and paste, image effects, color correction and motion elimination are broadcast features that match more expensive products.

Because of the popularity of PC-based systems, one of the most popular features of the videoDesigner is its file transfer capability.

The videoDesigner imports/exports Targa, TIFF, JIFF, JPEG and Video Toaster files—not to mention its compatibility with GVG graphics product files from the Graphics Factory, K-Series and Presto character generators, and GVG paint systems.

Sistema Clube, in Ribeirao Preto, is a small TV station with its own production house. They recently did an opening for a novella, "Amazonia." Graphic artist Simon Scudder produced 45 seconds of real time animation, a tremendously creative and ambitious project, using the Grass Valley Graphics Factory, an integrated system combining character generator, broadcast paint and 3-D modeling.

### Opting for integration

Unlike SBT, which chose to use compatible standalone graphics products, Sistema Clube selected an integrated system. With Graphics Factory, a single operator performs all the graphics functions at one work site.

"Despite the economic difficulties of

tronix Industria E Comercio, based in Sao Paulo, is one of the largest distributors and service facilities of broadcast equipment including graphics devices.

### PCs in Venezuela

New trends in graphics in Venezuela incorporate both high-end and desktop-type systems. "All major work is still done on the high-end equipment, but every day more and more graphics are created with PC-based systems that are inexpensive and relatively easy to use," reports Alberto Dillon of Omnivideo Del Color in Caracas.

The entire industry has changed dramatically over the past few years. On-air graphics used to be mainly generated from traditional character generators. Now the industry has changed completely. There is a huge potential market for corporate style graphics and presentation, suggests Dillon, as equipment becomes more affordable and easy to use.

Production houses such as Cinemakit have a Quantel Paintbox and a Grass Valley 20-K. Canal Uno Producciones uses a DF/X with Compositum, two Silicon Graphics workstations with Wavefront software, and many have PC-based systems like Targa and Truevista. Networks and TV facilities are heavily into Grass Valley K Series character generators, with HBO Olé using the 30-K and Graphics Factory. Combinations of products and manufacturers are common.

NCTV uses the Grass Valley D1 Turbo Paint and Silicon Graphics with Wavefront, while Venevision uses the Ampex AVA, Grass Valley 20-K, Chyron Scribe and Cubicomp System.

### Trends in Mexico and Chile

The trend toward digital integrated systems as well as PC-based systems is repeated in Mexico. According to Rafael Leyva, of Video Sistemas de MEXICO,

## TV TECHNOLOGY

INTERNATIONAL EDITION

Vol 10, No. 12 DECEMBER 1992

International Editor: Marlene Lane

TV Technology Editor: Richard Farrell

News Editor: Arthur Cole

Technical Consultants:

Jim Cutright, Lew Zager

News Correspondents:

London: Phil Parker; Tokyo: Masakatsu Ueda

New York: Frank Beacham, Mary Gruszka;

Los Angeles: Bruce Goren,

Nancy Jesuale, Kathy Rooks-Denes

Production Director: Kim Lowe

Production: Lisa Lyons

Lisa Mamo, Julianne Stone

Ad Production Coordinator:

Regan Deathrage

Publisher: Stevan B. Dana

Associate Publisher: Carmel King

Marketing Consultant: Albert Leon

Ad Coordinator: Caroline Behan

Circulation Director: Tiana Hickman



TV Technology (ISSN: 0887-1701) is published monthly by Industrial Marketing Advisory Services, Inc., 5827 Columbia Pike, Suite 310, Falls Church VA 22041. Phone: 703-998-7600. FAX: 998-2966. Second-class postage paid at Falls Church

VA 22046 and additional mailing offices.

POSTMASTER: Send 3579 forms and address changes to TV Technology, P.O. Box 1214, Falls Church VA 22041. Copyright 1992 by Industrial Marketing Advisory Services, Inc. All rights reserved. For reprints contact the author and TV Technology.

Free Subscriptions are available to professional broadcasting and audio-visual equipment users. For address changes, send your current and new address to TV Technology a month in advance at the above address. Unsolicited manuscripts are welcomed for review; send to the attention of the appropriate editor.



Member, Business Publications Audit of Circulation

## 1992: The Year Of Digital HD

(continued from page 1)

definition video through an 8 MHz bandwidth channel. It can also accommodate production standards other than Europe's 1250 line system.

An analog ice breaker may also be emerging in Japan. No longer content with its analog MUSE system, Japan will set up a technology council to create an all-digital network that could result in television image quality comparable to 70mm motion picture film, a Japanese executive told the Media Lab symposium.

### UDTV in Japan

A new research and development company, called the Digital Movies Laboratory (DML), is being proposed to the Japanese government to design such an ultra definition (UDTV) system, said Kazuhiko Nishi, president of Tokyo's ASCII Corp.

Japan predicts the digital revolution will spawn a new age of personalized communications, Nishi said. "The consumer wants personalized media. I call it WYWI-WYS...What You Want Is What You See."

Digital personalized audio is a Japanese goal for 1995, while personalized television's arrival is predicted by the year 2001, Nishi said. A system becomes "personalized" when the home viewer can select motion pictures, concerts, museums, libraries or other services on demand. Interactive communication with schools, shopping outlets and medical facilities can also be performed on the same network. Such a digital system should have a life expectancy of 50 years, Nishi said.

### A new way of thinking

Perhaps the most significant milestone in video technology to come in 1992 was a fundamental change of thinking about television. Referring to the significance of recent breakthroughs in digital technology, U.S. FCC chairman Alfred Sikes suggested it is time to bury the "decades old" acronym HDTV.

"We are in fact now dealing with Digital Advanced Television or DATV," Sikes said. "The importance and implications of this transition cannot be overstated. DATV will be higher quality and enable higher capacity while at the same time use the radio spectrum more efficiently. It will be far more flexible than today's analog television and will allow easier and cheaper transcoding between display formats.

"From the consumer perspective, DATV will increase choice," Sikes continued. "It will give consumers greater control over what, when, where and how they use television. Ultimately, we will have customized and personalized television in addition to the mass media television that we know today."

# HD-DIVINE Stirs Up Europe

by Phil Parker

**MONTREUX, Switzerland** The old axiom "Be careful what you wish for, you just might get it" can be applied to the European HDTV situation, with the introduction of what many in the broadcast industry have been clamoring for: a terrestrial digital HDTV transmission system.

The proposal, known as HD-DIVINE (Digital Video Narrow-Band Emission) was announced at this past summer's IBC by a group of Scandinavian firms, including Swedish Television, Teracom and Telia Research.

### Forbidden channels

The system, as proposed, is targeted for use on the "forbidden" 8 MHz UHF channels using a transmission method known as "orthogonal frequency-division multiplex" (OFDM) with

European Community continues to pursue that track, it can only be for political reasons."

George Waters, EBU director of engineering, also touted the significance of HD-DIVINE, saying "many eyes had been opened, perhaps wider than was thought possible. This could well mark the turning point in European thinking concerning HDTV transmission in Europe."

### Formidable resistance

Of course, not everyone greeted the proposal with enthusiasm. On the same platform as McKinney, Peter Groenenboom, senior managing director of Philips Consumer Electronics, said D-2 MAC is available and affordable and HD-MAC is in the final stages of preparation for its market introduction. He also disputed the imminent arrival of digital HDTV, terrestrial or satellite.

*The HD-DIVINE proposal conforms to the European 1250/50 interlaced standard. To have a working model available for the IBC, developers had to compress the 1 Gbps stream to about 25 Mbps.*

16-QAM modulation of the carriers. Its backers contend that an operational public service could be in place before 2000.

The OFDM channel-coding method was originally developed in Europe for digital audio broadcasting. Its major benefit is that it effectively cancels ghosts without automatic channel equalizers. This is done by dividing the signal into a large number of subchannels, each with a symbol length longer than the multipath time-spread.

OFDM is also reported to have excellent co- and adjacent-channel interference rejection.

Supporters of OFDM say the resistance to ghosts make the technology ideal for single-frequency networks (SFNs). These networks utilize low-power cellular transmitters operating on the same frequency to establish reception areas of any size or shape.

The HD-DIVINE proposal conforms to the European 1250/50 interlaced standard. To have a working model available for the IBC, developers had to compress the 1 Gbps stream to about 25 Mbps.

### Into the fray

If the effect the HD-DIVINE proposal had on the IBC conference is any indication of its impact on the overall European HDTV controversy, the proposal is sure to stir things up.

The proposal was given support by James C. McKinney, chairman of the U.S. Advanced Television Systems Committee, who chastised the European Commission for its pursuit of the enhanced television system D-2 MAC as a stepping stone to analog HD-MAC, instead of proceeding directly to digital terrestrial delivery.

"...to withhold HDTV from the public simply to sell them first an enhanced television receiver is a matter of unconscionable greed on the part of the equipment manufacturers," he said. "...if the

"If the consumer wants 16:9, PAL Plus (the PAL-compatible, 625-line widescreen system) was their fastest route," he said. "There will be no connection to digital high definition in terrestrial broadcasting before 2000 and in satellite before 2010."

Dr. A. Ziemer, technical director for the German network ZDF, said PAL Plus was preparing the ground for HDTV, and there would be no opening of the mass 16:9 market without it.

S.O. Eckholm, technical director of Swedish Television, was "very proud that we have proved that terrestrial digital HDTV is possible now."

Eckholm stated that although the system backers are anxious to capitalize on the interest shown by other European countries, they had no wish to go it alone and were "open to any and all kinds of cooperative efforts." They were actively seeking industrial support for continuation of the project at the IBC.

"It was of vital importance...that research concerning new transmission technologies for terrestrial digital TV initiated by the Swedish Government...be instituted at once," he said.

The cost, so far, has been a relatively inexpensive \$3.5 million. However, the immediate objective has been to prove that the system works.

### Outside help

If the HD-DIVINE backers are going to rely on outside funding to further develop the system, they could find the going rough. It is unlikely that the large companies that have invested enormous amounts of time and money into HD-MAC and PAL Plus will abandon these systems for another. The same is true for the EC governments, especially since there are already EC digital terrestrial projects working in the field.

In Europe, there are a number of other research programs besides HD-DIVINE aimed at bringing OFDM into the realm of digital terrestrial television broadcasting.

In the U.K., for example, National Transcommunications Ltd. is developing its Spectre system, which provides digital transmissions in the taboo UHF channels using OFDM. Recent tests involving actual transmitters in multipath-prone hilly country were very successful, resulting in very low error rates and no significant interference with conventional transmissions.

In France, the CCETT has been looking into using OFDM in conjunction with the Eureka VADIS program—Project 625—which seeks to develop an audio visual coding technology to provide digital television with bit rates of up to 10 Mbps.

Neither the Spectre project nor the CCETT is directly concerned with HDTV, just digital terrestrial broadcast. And while the CCETT has also reported positive test results, the consensus is that much still needs to be done before a digital service can be mounted that offers all the advantages of analog, such as reception on portable, battery-driven receivers.

Most researchers are doubtful that such a digital system will be feasible before the end of the decade.

## Union Sound Markets Fairlight

**SYDNEY, Australia** Fairlight ESP Pty. Ltd., manufacturer of the Fairlight MFX2 digital audio workstation, has appointed Union Sound System as a distributor for Korea.

Fairlight Marketing Manager Andrew Bell said that Union Sound is one of Korea's leading pro-audio companies, and sold two MFX2 systems since its recent appointment.

The MFX2 is a 24-track digital editing system using random access disk technology for storage and retrieval. It can be used in place of 24-track tape machines in audio post production for television, film and radio.

The system was recently enhanced by the introduction of EDL Conform, a program for automatic acquisition and conform of source audio. Fairlight

teamed up with another Australian company to add an off-line capability to the MFX2. Shotlister, an edit management system running under Windows, has been serially linked to MFX2 and downloads edits as AutoRecord commands. MFX2 performs the record, acquiring the source audio for the edit, and then moves it to the time code position specified by the EDL (edit decision list).

For more information on the MFX2 in Korea, contact Mr. Hwang Yoo Yun at Union Sound System: telephone +82-2-976-4080, or circle Reader Service 111. For more information on Fairlight in other countries, and on its other products, contact Andrew Bell at +61-2-212-6111, or circle Reader Service 114.

# HDTV Dublin Debates the Future

by Fergal Ringrose

**DUBLIN, Ireland** On the day the U.S. Advanced Television Test Center in Virginia announced availability of its test results for HD system proponent DigiCipher HDTV, Bernard Pauchon of the EBU Technical Committee wondered at the second HDTV Dublin Symposium if the FCC was making a mistake in seeking a digital terrestrial HD transmission system. Pauchon asked, "How stable are digital images?"

By going it alone with digital HD using "untested algorithms in compression," is the FCC in danger of creating "the digital NTSC of the next century?"

The possibility of re-inventing in HD the unwanted characteristics of current television systems is one reason the European Broadcasting Union has advocated an evolutionary, analog approach using D2-MAC and HD-MAC for satellite and cable, with PAL Plus for terrestrial broadcasting.

## European disagreement

But a growing body of Europeans do not buy into that philosophy. At the Symposium, Per Apelqvist of Scandinavian digital terrestrial HDTV consortium HD-Divine, unveiled at IBC Amsterdam, criticized the EBU's "narrow perspective."

Using compression, HD-Divine will squeeze HD pictures into the 8 MHz bandwidth available, and can accommodate production standards other than Europe's 1250 line system. One HD service on HD-Divine is equivalent to four channels of 4:2:2 quality, a facility of particular interest to cable operators. On the reasoning behind HD-Divine, Apelqvist said "to motivate people to change, there must be something in it for everyone."

Joe Flaherty of CBS was unapologetic about the United States' "incompatible, simulcast, full quality terrestrial" digital transmission approach. "There would be no half-way measures in America," he said, in the "technical Olympics to be the best of the best." With the FCC driving the issue, at least U.S. broadcasters know what to expect in the high definition future.

But Jean-Luc Renaud (Advanced Television Markets) thought stations would be more interested in using the FCC's extra channel for several digitally compressed NTSC services, rather than one HD channel. He also wondered if the consumer would see enough difference between everyday programming on NTSC, and fully-fledged HDTV, to want to buy an HD set.

Similarly, if a market does develop for widescreen 625 in Europe, will consumers change to 1250 sets if the difference is marginal? "Paradoxically," he said, "D2-MAC success might weaken the market for HDTV." Following that argument, "isn't 1995 too late for the introduction of PAL Plus, if digital HDTV is just around the corner?"

## Super 16's HD future

As usual with HD debates, this Symposium posed many more questions than answers. Only one issue has been agreed worldwide—the aspect ratio for all widescreen pictures will be 16:9. This explains the dramatic growth in Super 16 film production since the format's introduction. Kodak's Bradley Hunt told the

Dublin audience that in 1990 Super 16 accounted for 20 percent of its European 16mm sales; in 1991 it was 40 percent "and growing."

Swedish Television has decided to shoot only on 16 or 35mm, he said, "because of uncertainty over HDTV production standards." Peter Krieg, a member of the Hi16 Coalition, added that "Super 16 will be the base carrier for HDTV programs."

Whatever the widescreen production formats chosen, the fact remains that for the short- to mid-term future, the majority of viewers will watch 4:3 sets. As European producers discovered during Vision 1250's HD-MAC coverage of the

Olympics in Barcelona, this creates a real dilemma in shot composition.

Thames Television cameraman Len Caynes spoke of the temptation in Barcelona to "stay on the wide angle" with HD, due to its extra screen width and double resolution.

"But if viewers are actually watching on normal domestic sets they won't be able to see the extra detail anyway," said Caynes. The BBC Research Department's Richard Storey observed that for HDTV producers "these two conflicting requirements are very difficult, if not impossible, to resolve."

Overall, the 1250 coverage of the

Games was judged a success by producers and observers, even if there were (understandable) teething problems with focusing, camera locations, camera sensitivity and stability, a lack of big lenses to get in close to the action, and less than ideal editing conditions.

Thames' Chris Dingley, a "4:3 cameraman for 20 years," said Barcelona was "a fascinating experience. We all want to be feature film cameramen!"

But Len Caynes had reservations: "The change to 1250 is nowhere near as dramatic as the change from 405 to 625, or from mono to stereo. HDTV is a definite advancement, but not a revolution."

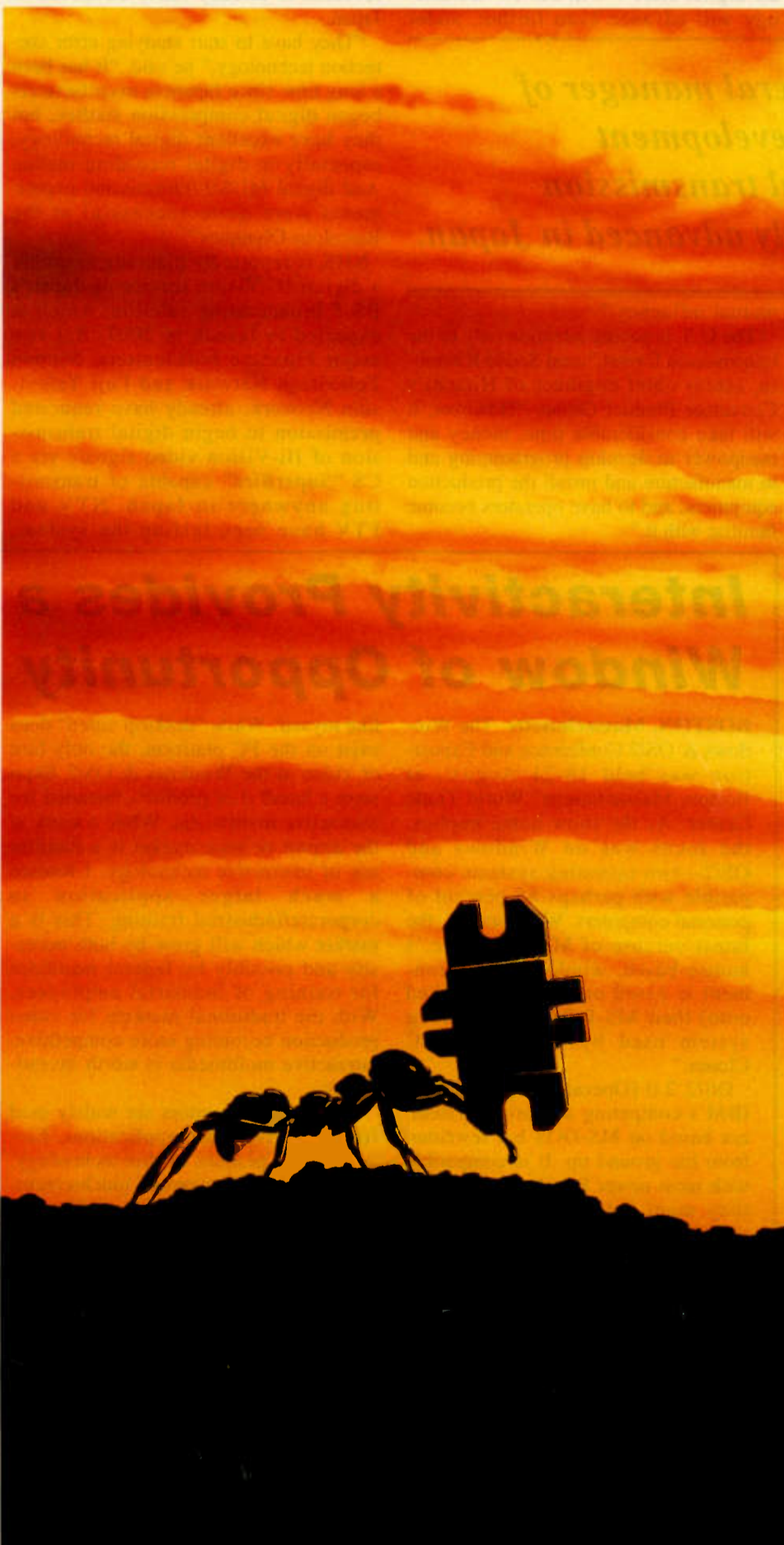

## Cool Operator

GEC-Marconi's Solid State UHF transmitters are somewhat unique.

Launched at IBC 92, the adoption of a liquid cooling system in such equipment is a remarkable innovation. Occupying less than half the floor area of their peers, these transmitters also exhibit a very low acoustic noise level.

However, liquid cooling means much more than this. The superior efficiency of heat removal afforded by a liquid when compared to air means that the transmitter runs cooler by about 10°C. That means a doubling of the output transistor MTF and a dramatic increase in reliability.

But, it is in the earth's hotter places where liquid cooling really scores. Whilst the average air-cooled transmitter struggles to cope with high external ambient temperatures, the GEC-Marconi transmitter remains cool.

Add to this, fully wideband (470 to 860 MHz) modules, no circulators, module changing on power and very gradual failure modes and you have a world beating transmitter - one of the new breed of Solid State transmitters from GEC-Marconi.



THE • NEW • BREED • OF  
**SOLID STATE**  
TRANSMITTERS

**GEC-Marconi**   
Communications

GEC-Marconi Communications Limited, Marconi House, New Street, Chelmsford, CM1 1PL England  
Tel: National 0245 353221 International +44 245 353221 Telex: 99201 MARCON G Facsimile: +44 245 287125

Circle 37 On Reader Service Card

# Japan Muses on Digital Hi-Vision

by Mike Ueda

**TOKYO** Despite recently announced efforts by private industry and the Japanese government to develop digital HDTV transmissions, it appears that the country is committed to the analog, satellite-based MUSE transmission system for its Hi-Vision HDTV format.

However, this does not mean the Japanese video and electronics industries are taking a "wait-and-see" attitude toward digital technology. Although MUSE utilizes analog transmission, all other aspects, including the encoding and decoding, are digital. And Japanese manufacturers are currently in high gear

by the end of 1993.

However, many Japanese manufacturers see the MUSE standard extending into the next decade and doubt whether the United States can meet the FCC's deadline for full digital HDTV service.

"It took 20 years to develop Hi-Vision equipment," said one Mitsubishi official. "It will also take time to develop digital HDTV equipment after the U.S. format is standardized.

"We don't think MUSE will be out of date when all-digital HDTV is implemented in the U.S. MUSE is no more an ultimate HDTV format than all-digital HDTV will be. TV technology will advance even further, under

Even if MUSE is seen as a long-term service in Japan, there is no reason why a digital HDTV service could not co-exist with Hi-Vision.

## Peaceful coexistence

"At least MUSE will continue to be used for BS (broadcast satellite) service," said Toshiba's Makino. "But there is room to consider whether or not MUSE will be used for other new media, such as CS (communication satellite) broadcasting."

Hisafumi Yamada, general manager of Sony's Hi-Vision TV Development Department, said digital transmission research is already fairly advanced in Japan.

"They have to start studying error correction technology," he said. "It has been a long time since Japanese manufacturers began digital compression studies, but they have excellent digital technology, especially in digital recording media. And digital MUSE transmission experiments were quite successful at the Barcelona Olympics."

NHK is reportedly planning to mount a digital Hi-Vision service on Japan's BS 5 broadcasting satellite, which is expected to launch in 2007. But two major Japanese broadcasters, Nippon Television Network and Fuji Television Network, already have requested permission to begin digital transmission of Hi-Vision video signals via a CS "SuperBird" capable of transmitting anywhere in Japan. NTV and FTV have been testing the system,

using mobile EFP stations, since mid-July.

In addition, Mitsubishi recently announced that by May of next year it will have completed development of a digital Hi-Vision transmission system for use on the high-frequency Ka band used by communications satellites.

## Ka band kudos

Unlike the 36 MHz-wide Ku band, the Ka band offers a 100 MHz path able to deliver the 120 MHz Hi-Vision signal with less compression. Moreover, the Ka band is located at 30 GHz for uplink and 20 GHz for downlink, a little-used area of the spectrum with less interference.

Field tests are planned soon, most likely utilizing two Ka transponders on a Super Bird owned by Space Communication Corporation, which is part-owned by Mitsubishi.

Although use of the Ka band has been limited because it is susceptible to interference and rain attenuation, Mitsubishi officials say they hope to overcome these problems using improved error-correction.

But regardless of where or how digital HDTV is established, Japanese manufacturers are sure to take advantage of it.

Matsushita is currently involved in digital R&D in the United States, Japan and Europe. At its Advanced Television Laboratory in New Jersey, the company is working on digital technology to correspond with the forthcoming U.S. standard.

*Hisafumi Yamada, general manager of Sony's Hi-Vision TV Development Department, said digital transmission research is already fairly advanced in Japan.*

designing digital production, post production and reception technology for Hi-Vision.

## The age of digital

"The Hi-Vision era is digital" said Hisao Tajiri, general manager of Toshiba's High Definition Systems Division. Toshiba has developed a prototype digital 8mm HDTV VCR with a 20 Mbps data rate based on the General Instrument DigiCipher format, but which company officials say can be easily reconfigured for other formats.

The Hi-Vision market in Japan is still in its infancy and is undergoing numerous growing pains, including hardware and software development problems. And there is still the question of the enormous cost of Hi-Vision receivers.

Because of the high cost of receivers, few private homes are getting HDTV service. The eight hours per day of programming that is currently available is viewed mostly in public areas.

However, manufacturers expect Hi-Vision to be a full-scale service by 1997, when the next broadcasting satellite, BS 4, is due to launch. Japanese manufacturers are rushing toward this new market, investing huge amounts of money, time and effort, and many industry officials say it would be very difficult, if not impossible, to switch to an all-digital system at this point.

"Both hardware makers and broadcasters will be unhappy if there are changes in the media," said Shinichi Makino, technology executive for Toshiba's High Definition Systems Division. "We want to proceed with Hi-Vision by all means."

## Already a dinosaur?

But with digital technology advancing so rapidly on the production and reception ends, some people are wondering whether an analog transmission format will be outdated before too long, especially considering that the U.S. Federal Communication Commission is due to select a digital, terrestrial HDTV transmission standard

mutual influence."

"The U.S. is paying attention only to the transmission format," said Sadao Kitamura, senior chief engineer of Hitachi's Consumer Product Group. "However, it will take considerable time, money and manpower to develop programming and to manufacture and install the production equipment, and to have operators become familiar with it."

## Interactivity Provides a Window of Opportunity

**BOSTON, Massachusetts** The Windows & OS/2 Conference and Exposition was held 18-21 August, at Boston, Massachusetts' World Trade Center. As the show name implies, the focus was on Windows and OS/2—two operating systems compatible with perhaps 85 percent of personal computers. Windows 3.1, the latest version of Microsoft Inc.'s mouse-based, windowing environment is based on (or rather tacked onto) their MS-DOS, the operating system used by nearly all "PC Clones."

OS/2 2.0 (Operating System 2) is IBM's competing operating system, not based on MS-DOS but rewritten from the ground up. It is compatible with most newer PC clones assuming they meet the computer memory requirements. Besides applications written specifically for OS/2, it is also able to run applications written for MS-DOS and Windows. It is further able to accommodate all three operating system environments at the same time and share information between them.

### Interactive training

The vast majority of the Windows & OS/2 exhibitors focused on business applications. Fortunately there was also a "Multimedia Showcase" to liven the interests of an artist type

like myself. While "desktop video" does exist on the PC platform, the only hint of video at the Windows & OS/2 Expo were a handful of products intended for interactive multimedia. While a kiosk at the airport or supermarket is a familiar use of interactive technology, I foresee a much larger application in corporate/industrial training. This is a market which will grow by both necessity and possibly by federal mandates for training of industrial employees. With the traditional markets for video production becoming more competitive, interactive multimedia is worth investigating.

Touchscreen monitors are widely used for interactive video applications. Elographics, a pioneer in this technology, displayed several types of touchscreens. Touchscreens are an effective human/computer interface, more intuitive than a mouse, a trackball or a keyboard. With a well-defined interface, the user simply points to an icon and the system responds. These icons can be pictures, words or even moving video clips. Elographics's literature reveals many of the current uses of touchscreens which include interactive training, process and machine control in factories; public kiosks for travelers or shoppers; video games such as lotteries; medical monitoring and use by banks for automatic teller machines.

Touchscreens can be purchased as com-

plete monitors or as add-on screens that are designed to fit most existing computer monitors. Elographics includes MonitorMouse software drivers for either Windows 3.1 or OS/2 which allow specific applications to be controlled by touch without any modifications or special programming. The Elographics touchscreen can work independently or in conjunction with a mouse. These software drivers greatly simplify the process of creating interactive applications using existing Windows or OS/2 multimedia software.

### Delivery methods

Another hardware aspect of interactive video is, of course, video delivery. A common method of video delivery is laser disks, which are notoriously difficult and expensive to master. Future methods of video delivery will use various compression schemes to deliver live video from either a CD-ROM or eventually a computer storage device. While these video storage methods are still months or years away, the VGA/video display hardware exists today.

There are several of these TV-in-a-window computer displays on the market. A fairly typical example demonstrated at Windows & OS/2 is Win/TV from Hauppauge Computer Works, Inc. This is a display card that plugs into a 16-bit I/O slot and keys video images onto the VGA screen in a resizable Windows 3.1 window.

Win/TV can access 122-channel television reception with an optional tuner,

(continued on page 13)



# DIGITAL GLUE



When it comes to digital systems, Leitch has the essential glue...digital glue. From DAs to frame synchronisers, Leitch has the widest range: A:Ds, D:As, encoders, serialisers, test generators, routers, AES/EBU audio mux, demux and much more. Over 30 digital products offer you complete choice and a total solution for your digital systems.



**When it comes to digital glue.....call Leitch.**

**LEITCH®**

Leitch Incorporated, 920 Corporate Lane, Chesapeake, VA 23320 - Tel: (804) 548-2300 Fax: (804) 548-4088

Leitch Video International, Inc., 220 Duncan Mill Road, Suite 301, Don Mills, Ontario, Canada M3B 3J5 - Tel: (416) 445-9640 Fax: (416) 445-0595

Leitch Europe Limited, 24 Campbell Court, Bramley, Basingstoke, Hants., U.K. RG26 5EG - Tel: +44 (0) (256) 880088 Fax: +44 (0) (256) 880428

# An Overview of Desktop Video:

## Desktop Video is Here to Stay and, Although Your Facility May Not Want or Need It Now, It Will Probably Play a Part in Your Future

by Rick Lehtinen

Personal computer-based video production systems have garnered a lot of attention in recent years. Do these systems have what it takes to make the cut? The answer is yes—and no. The answer is different for each facility.

This article overviews desktop video (DTV) from an equipment perspective, and explores some of the caveats of DTV technology. Also, it offers hints to help video professionals more successfully integrate DTV into their facilities.

### Face the facts

At the start, let's debunk a myth. Desktop video will not go away. A dozen integrated circuit manufacturers are gearing up their foundries to produce families of chips that are specially tailored to make video on the desktop. Many of these chips were designed to fit into HDTV television receivers. With HDTV development in a stall, chip manufacturers have looked to DTV as a way to soak up some of their emerging devices. Further, there are hundreds of PC manufacturers that are desperate to find a niche in which to set their products apart from the competition. Video is a natural, as are audio, facsimile devices and modems.

The world's 100 million-plus PCs also represent a tremendous

aftermarket opportunity for additional video production cards. This provides further impetus to develop desktop video products.

### Six paths to DTV

Having portrayed the market forces leading to the emergence

The output can be either routed to a switcher, or can key the video directly.

One of the easiest computers to work with in this regard is the Commodore Amiga. Its internal sync rates are adjustable to match NTSC frequencies. For

Figure 1. A PC with genlock can be used for tasks such as character generation.

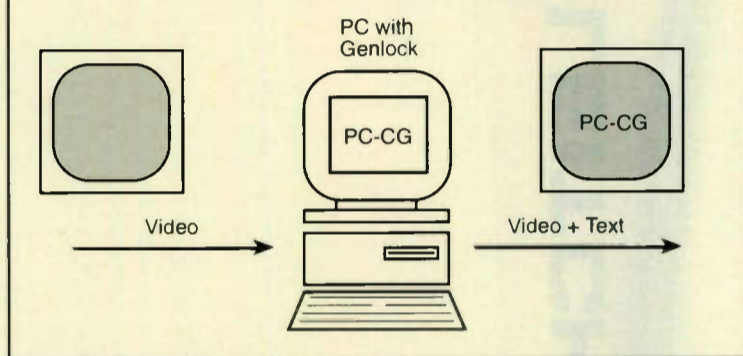

of desktop video, we can now look at what desktop video is. Manufacturers can implement DTV in at least six ways:

#### 1. Using a video overlay card (PC-CG)

Using a genlock device enables the PC to generate characters and graphics. This is the approach taken by several new weather systems. It is also seen in the new Chyron CODI character generator.

This is the simplest kind of desktop video. Genlock cards are available for each platform.

Macs and PCs, the process is more akin to standards conversion. Many VGA cards for PCs now have the capability to output an NTSC signal. The quality of this output varies widely between cards. Check it with a waveform monitor before use. (See Figure 1).

#### 2. PC-based machine control

Figure 2. Using a PC for machine control editing.

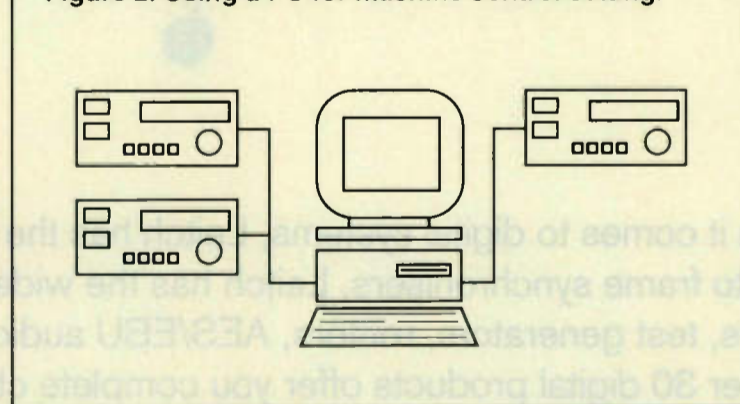

In this scenario, the PC serves as an edit controller. It works by translating edit list commands from the screen into electrical signals that can be understood by serial control tape decks.

Typically, the output of such a system is not video, but rather an Edit Decision List (EDL). This complete EDL and the original footage tapes are then carried to a post house for on-line finishing. (See Figure 2).

#### 3. Recursive compositing

Some systems process video by compositing, that is, adding bits of digital image one to another until the desired effects are achieved. In recursive compositing, the computer ingests a number of frames in a process called image capture or scan-in. It then

stores captured frames to the hard disk.

At process time, the computer calls the images into the frame buffer, where artists' and effects tools modify the image as required. Following modification, the frame is restored to the hard drive. Because the signals are digital, users can repeat the process as often as needed to obtain the desired results. When processing is finished, the system feeds the frames out for conversion into NTSC or other formats.

This is the process used by the GVP ADDI system, and the Xaos enTitle CG and Pandemonium image composition system. It is used as well in certain Video Toaster modes. (See Figure 3).

#### 4. Internal video switching

This method consists of installing a card in the PC which actually has the power to gate two or more input video signals on or off, in real time, as in a switcher. Examples include the NewTek Video Toaster, Matrox Studio, FAST Electronic Video Machine, EchoLab PC-3 and Intelligent Resources Video Explorer. Although these products work as switchers, the actual switching element is likely to be a high-speed keyer.

The user interface for these devices may be a mouse-controlled switcher panel that dis-

If you saw the movie "Terminator 2," you've seen this process. This was the approach taken by the Electric Image system used to create the nuclear explosion dream sequence in the movie. (See Figure 5).

#### 6. Keyframes and a motion interpolator device

One of the newest desktop video techniques involves using a computer to produce strategic keyframes of a video sequence, and then using a sophisticated motion compensation device to generate the in-between frames. One such motion interpolator is the Gazelle, by Snell & Wilcox.

Gazelle is based on the advanced motion interpolation systems used in broadcast standards converters. Gazelles' intended market is remote broadcast vehicles (OB vans), and TV production centers, where it is used as a slow-motion synthesizer (by adding interpolated frames into the signal from a TV camera). Conceivably, however, a desktop video system could record every hundredth frame or so of a video sequence, and let Gazelle create the rest. The Gazelle's real-time output could then be captured by a standard VTR.

Gazelle's current high cost makes this option somewhat pricey. Nevertheless, it may set the scene for some future desktop scenario.

#### Computer overview

Now let's take a look at some popular computers used in desktop video.

#### Commodore Amiga

The Amiga was one of the first DTV platforms because of its flexible, video-friendly scan rates. Amiga's most applicable to desktop video include the 2000HD, 2500, 3000 and the new 4000. Amigas include a DOS option slot so that it may also be used in the IBM PC-compatible environment.

Amigas are intriguing in that they are true multitasking machines. This means that they can support many concurrent programs. While other computers may have a Graphic User Interface (GUI), this usually merely allows a user to have several applications open, or accessible, at once. Generally, the programs do not actually run at the same time.

#### Apple Macintosh

Like the Amiga, the Macintosh uses a graphics user interface (GUI). The Apple is built on the same processor as the Amiga, the 68000 series CPU chip. The Macintosh II series is the basis for many video applications, as is the Quadra.

## The Best Weather

- ✓ **Satellite Pictures...**  
24 hour pictures for anyplace in the world
- ✓ **Custom Weather Maps...**  
for your viewing area
- ✓ **Accurate Weather Forecasts...**  
complete weather news, including audio scripts
- ✓ **Forecast Graphics...**  
for your area or for individual cities
- ✓ **Graphic Equipment...**  
PC, Amiga and Macintosh based systems,  
compatible with other newsroom systems.  
Available in PAL, NTSC and RGB.
- ✓ **Complete, ready-for-air products and services...**  
accurate, informative, visually pleasing total weather presentations done for your audience and schedule!

## Accu-Weather, Inc.

The World's Weather Leader  
619 W. College Avenue, State College, PA 16801

Call (814) 234-9601 x400 for details.

# What It Is, What It Does

Curiously, there are not that many Macs and Amigas out there. Shipments of 68000s for these computers are a fraction of the chips shipped for DOS machines. In the video industry, however, the machines are well represented.

An unusual hybrid desktop video system is composed of a Macintosh driving a Video Toaster. All the user interface takes place on the Mac. The Toaster-equipped Amiga handles the video.

### IBM PC-Compatible

This platform has a huge installed base. It also has a low price, due to cloning. IBM has introduced proprietary bus structures to try and lock in corporate users. The industry typically responds by providing design arounds.

This system is built on the 80X86 series of chips. Most popular are the 80386 and 80486.

*A dozen integrated circuit manufacturers are gearing up their foundries to produce families of chips that are specially tailored to make video on the desktop.*

er's commands into signals compatible with whatever VTR is connected. Video-media (V-LAN), BCD, Diaquest, Lyon Lamb and RGB Technologies are among the manufacturers of such systems.

### Squeeze me

An important focus in desktop video is not to just accommodate, but to overcome, the limitations imposed by the VTR. The most popular method is to try and store video frames on the computer's hard disk.

Unfortunately, video is extremely long-winded when it is converted to data (one picture is worth a thousand words). Video has much spatial redundancy (large parts

of the screen painted the same color) and temporal redundancy (typically less than 25 percent of an image changes from frame to frame). The high data requirement of video hurts two ways: First, it takes a lot of disk space to record a

### NewTek Video Toaster

The Video Toaster is probably the earliest, and easily the most popular, implementation of desktop video. There are between 50,000 and 100,000 Toasters in the field.

Figure 4. Installing a switching engine in a PC, such as in a Video Toaster or Matrox Studio.

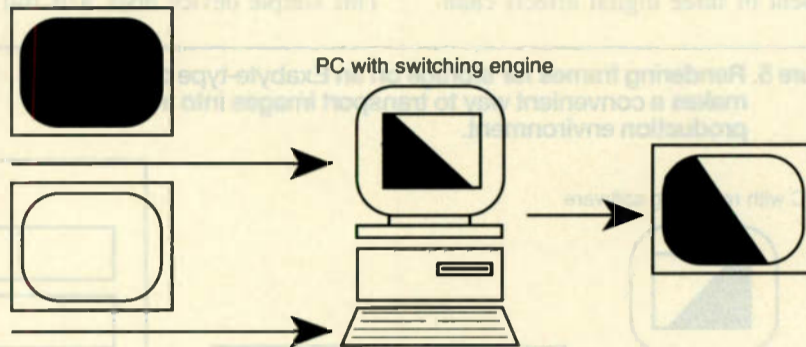

frame. Second, it is hard to move data on and off of the disk fast enough to make video in real time.

The way around the logjam is to use video compression. Compression squeezes out just enough data to shrink the image's file size, but not so much that the image looks degraded when it is reconstructed. Virtually every desktop video system now uses or shortly will use compression.

Compression is also a chip-driven technology. Many manufacturers have products in the offing. Although Discrete Cosine Transform (DCT) systems are in vogue, other methods are also under investigation.

### Meeting the players

There are three major desktop video manufacturers. However, the line is often narrow between a DTV system and a desktop editing system, such as

The Toaster operates on an Amiga 2000 or 2500 computer, or, with a special add-on, the 3000. For proper operation, the computer should have extra chip memory (this is the Amiga lingo for video page memory, not system memory), a speed-up card for the processor and a large hard disk.

Users interface with the Toaster using a mouse-driven on-screen switcher keyboard. As mentioned, Toaster versions also exist which display the Toaster user interface on a Mac, which in turn connects to a Toaster workstation by a SCSI connector. I understand that PC and Indigo versions exist, but are not yet on the market.

As shipped today, the Toaster does only video functions. There is neither audio nor machine control capability. Third party products are available to fill these needs. At this writing, the Toaster is strictly a composite (not Y/C), NTSC (continued on page 12)

Figure 3. Using a PC's hard disk and frame buffer to create images via recursive compositing.

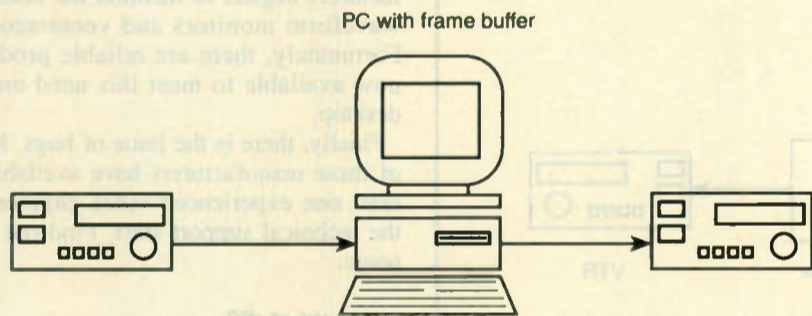

The New Grass Valley paint system (See TV Technology, November 1992, p. 1) is built on this platform.

### Silicon Graphics (SGI) Indigo

This is the scaled down, starter version of the Silicon Graphics IRIS series of workstations (the backbone of many early computer graphics systems). Indigo has several features that make it amenable to desktop production. In the first place, its video output is of excellent quality. The standard video output boards use the Philips chip set.

The Indigo has other production features, such as a full-blown audio synthesizer built-in. Many prominent video equipment manufacturers are said to be conversing with SGI about using Indigo for future applications.

### Machine control

The computer/VTR interface can be so challenging that many manufacturers have ceased trying to cope. Instead, they bundle or recommend one of several machine control systems. These specialty products operate as an interface between the VTR's remote control connector and the computer.

Using a machine control system, the DTV system needs only to issue one set of standardized commands. The machine control system then translates the comput-

# Telemetrics

## NEW TM9250

### Triax/Coax Connected Camera Control Systems

Available only from Telemetrics

### Triax Camera Control Systems for any Betacam™, Hi8™, MII™ or S-VHS™ format camera

Increase programming flexibility and eliminate cumbersome, costly and unreliable multiconductor cable



**Telemetrics Inc.** 7 Valley Street, Hawthorne, NJ 07506 • (201) 423-0347 • Fax (201) 423-5635

Made in U.S.A. Betacam and Hi8 are registered trademarks of Sony. MII is a registered trademark of Panasonic. S-VHS is a registered trademark of JVC.

# Is Desktop Video Right for You?

(continued from page 11)

(not PAL) system. However, third party equipment does exist to make the Toaster Y/C compatible.

The Toaster is currently shipping version 2.0. Expect major changes in 3.0.

## Matrox Studio

Studio is an extremely interesting device. It is unique in that it has the equivalent of three digital effects chan-

elaborate ending keyframe, and then have the computer worry about the middle.

Studio is composite and Y/C compatible, in both PAL and NTSC. Studio also can use several Windows programs to perform effects such as audio processing and image processing.

## FAST Electronic Video Machine

This simple device does A/B roll and

effects. It has the ability to insert graphics and titles. It has fewer input channels than either of the two systems mentioned previously, but it costs less. In addition, it includes audio and machine control.

Users interface with Video Machine using a time line interface. The system comes in both Mac and PC versions.

Video Machine is also composite and Y/C compatible, in both PAL and NTSC. This is a property of the Philips chip set

on which both FAST and Studio are based.

## Caveat Emptor?

There are a few pitfalls the video professional should watch out for when considering desktop video equipment.

First, is everything included in the system? When Video Toaster was first released, NewTek actually got phone calls from people who asked, "Now that I have my Toaster, what is this Amiga thing that I need to go with it?"

Next, find out on which platform a system operates. Are there any extra add-on cards needed, for example, for audio or machine control? What are the hard disk and RAM requirements? Are there any limitations regarding extended vs. expanded memory?

An experienced dealer should be able to answer these questions quickly.

Next, find out if time base correctors (TBCs) are required. For some reason, competing manufacturers and some dealers started a hullabaloo about this so-called "hidden expense" of Toaster ownership. The same question must be asked about any desktop system, and in fact about any switcher, PC-based or otherwise.

The joke may end up being on the naysayers. Some of the new VTRs come with their own TBCs, and both the FAST and Matrox products have TBCs built in.

Don't forget monitoring. To make systems seem inexpensive, most DTV manufacturers neglect to mention the need for waveform monitors and vectorscopes. Fortunately, there are reliable products now available to meet this need on the desktop.

Finally, there is the issue of bugs. Most of these manufacturers have available at least one experienced video engineer in the technical support staff. Find out that name.

## The right stuff?

So, is desktop video something your facility needs? Before you answer, consider first that DTV is coming. A flood of new semiconductor chips assures it. We can embrace it professionally, or wait until our neighbor buys it at the local electronics emporium, but come it shall.

Second, DTV looks good now, and it will look better soon. The first few generations of computer-to-video equipment may have left a lot to be desired, but chip makers and computer people are smart. They will keep after it until they get it perfect. That way they can sell more.

On the other hand, just because a switcher can be shrunk into a PC does not mean it always should be. There are still a lot of positive things to be said for having one-function-per-button user interfaces instead of pushing icons around on a TV screen.

Many conventional video manufacturers have done a good job of increasing efficiency in assembling equipment. If this trend continues, the cost of dedicated traditional equipment may eventually realign to reflect the new competition from the desktop.

*Rick Lehtinen, an experienced broadcast engineer, is a senior analyst with In-Stat, Inc., a semiconductor industry market forecasting firm in Scottsdale, Arizona.*

Figure 5. Rendering frames for storage on an Exabyte-type drive makes a convenient way to transport images into a digital post production environment.

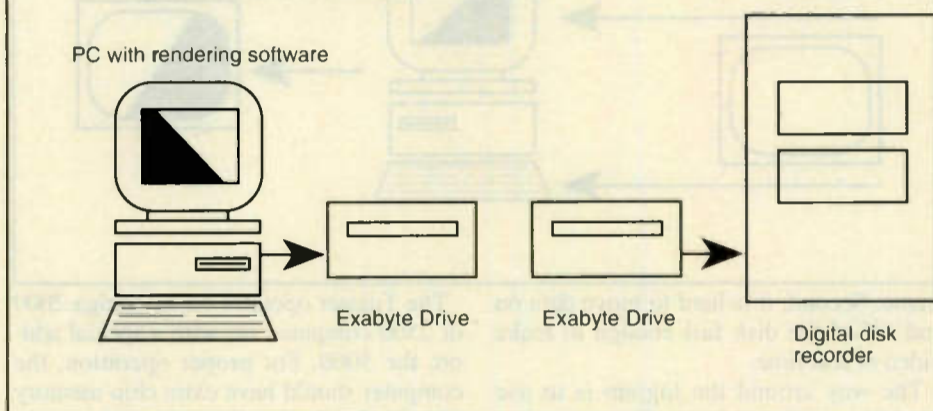

nels built in. Studio also has the ability to insert titles, graphics and backgrounds in real time, and these can be animated through a digital effects channel. This means it is possible to transition three signals at a time. Studio also contains complete audio processing capability and machine control. It is estimated that one Matrox Studio could produce most of the commercials that air on most local TV stations and cable outlets.

Users interface with Studio via a storyboard interface. First, source reels are divided into clips. The user then assembles the clips on the storyboard in the order they are to be displayed. Using a Matrox Studio, it is a simple matter to set up an elaborate starting keyframe, another

*An important focus in desktop video is not to just accommodate, but to overcome, the limitations imposed by the VTR.*

Figure 6. Using a motion interpolator to create intermediate frames.

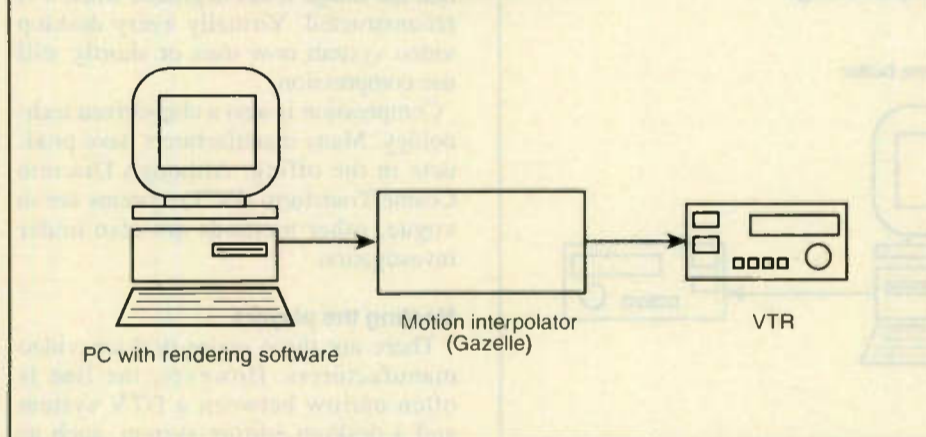

## Don't let their size fool you.

### STEREO HEADPHONE AMPLIFIERS



#### HD-1000 MASTER

- Drives Four Independent Headsets
- High Output for 8 to 600 ohm Headsets
- Stereo Balanced Line Inputs
- Panned Microphone Input for Announcements
- Stereo or Left Only-Mono Output
- Balanced Line Out to HD-100
- Half Rack or Desk Mount

#### HD-100

- Drives Single Headset
- High Output for 8 to 600 ohm Headsets
- Stereo Balanced Line Inputs
- Loop-thru Inputs Feed Multiple Positions
- AC Powered, Compact
- Ideal for Offices and Study Carrels

CALL OR WRITE NOW FOR FREE DETAILED BROCHURE.



AUDIO TECHNOLOGIES INCORPORATED

328 Maple Ave. Horsham, PA 19044, USA

(215) 443-0330 FAX: (215) 443-0394

Circle 81 On Reader Service Card

# FAST Moves on Video Machine

WASHINGTON, D.C. The Video Machine, by FAST Electronic GmbH, of Munich, Germany, was launched last spring. The product is an add-on board and software that lets a computer function as a desktop video studio.

How it works is simple. Video is taken into the computer and digitized via Video Machine's A/D converter. Once the video is input and on the computer screen, the system allows users to cut, mix, and edit two live video sources and to simultaneously include special effects and transitions from the Video Machine library.

A digital encoder chip at the "end of the line" outputs the finished product to a

videotape recorder.

Video Machine can be run from either the IBM or Macintosh platform. For the Mac, system requirements call for a Mac II or Quadra with a NuBus slot, 8MB of memory, a color monitor, and System 7.

#### IBM requirements

From the IBM-PC platform, the Video Machine requires a 386 compatible setup with a 16-bit AT bus slot, 4MB of RAM, a 256 color VGA card with 800 x 600 resolution, and the Windows 3.1 operating system.

Titles, graphics and animations can be imported to Video Machine from any

text processor or paint program, and the product also has an effects library of 100-plus transitions and real-time digital video effects such as dissolves, pans, moves, wipes, tumbles, flips, picture-in-picture, fly-ins and fly-outs, color effects, zoom and shrink, solarization and more.

The system accepts PAL, NTSC and SECAM standards and allows for a mix of PAL and NTSC sources. The Video Machine's output and two input ports

Machine has two keyers (again, one per input channel): a chromakeyer (blue box/color box) and a luminance keyer.

And for frame grabbing and the over-

*Titles, graphics and animations can be imported to Video Machine from any text processor or paint program.*

## Windows Opening on Interactive Training

(continued from page 8)

along with two additional NTSC or PAL video sources. A 91-channel PAL tuner is also available as a separate 8-bit I/O card. Win/TV includes framegrabbing capability and can capture images in various computer graphics formats including TIFF, PCX, Windows BMP, IBM Motion and Targa (TGA). This framegrabbing capability gives Win/TV utility as a graphics production tool.

#### The software

Developing an interactive video training program requires more than hardware. The most difficult task is developing the computer programming to make it work. A newly released program, HCS Interactive from HCS Software, greatly simplifies this process which once required custom programming.

Designed to work with Microsoft Windows and the Windows multimedia extensions, HCS Interactive is described as an integrated multimedia presentation and interactive development software product. This package actually consists of five distinct modules, including: the core authoring module, an animation editor, a painting and image editing utility, a screen capture and image processing module and, most importantly, a run time module that allows application and presentation developers to distribute completed shows or applications license-free. Within these five modules are most of the tools necessary to design and create a stand-alone interactive application.

HCS Interactive is able to utilize and combine common computer graphics and animation formats, as well as audio and video device control offered by the Windows Media Control Interface (MCI) function calls. HCS Interactive directly supports Intel's ActionMedia II video boards, which use DVI compression technology to provide full motion video and audio playback from computer data storage devices such as a hard drive.

The product will also support AVI (Audio Video Interleaved) a synced digital video and audio format to be released by Microsoft. In general terms, AVI will be the Windows equivalent to the Macintosh's QuickTime digital video.

While the specifications of HCS Interac-

tive are impressive, much more important is how it works. Developing interactive multimedia is similar to developing any training program: the first step is creating the lesson plan as a storyboard. With interactive training, the storyboard can become very complex; each response a student makes might flow to a variety of lesson plans.

HCS Interactive takes this storyboard and recreates it on screen as a series of interconnected icons. Each icon represents a system call that might create a user interface screen or run a video clip or computer animation. The computer program is developed by one icon leading to another, much like a storyboard or flow chart on paper.

This storyboard metaphor allows a non-programmer to create complex interactive applications. This approach is not new: it was pioneered years ago with Apple's HyperCard and further refined by programs such as Commodore's AmigaVision. HCS Interactive represents the latest generation of this visual programming technique.

IBM is creating similar tools for the OS/2 operating system. The IBM Multimedia Presentation Manager/2 (MMPM/2) serves as a multimedia extension for OS/2. MMPM/2 supports the playback of digital audio files as well as the recording (sampling) of audio signals by use of the IBM M-Audio Capture and Playback adapter. IBM also has recently announced the availability of Intel's ActionMedia II DVI video boards for use with OS/2.

Elographics, Inc.  
105 Randolph Road  
Oak Ridge, Tennessee 37830  
+1-615-482-4100  
(Or circle Reader Service 4)

Hauppauge Computer Works, Inc.  
91 Cabot Court  
Hauppauge, New York 11788  
+1-516-434-1600; FAX +1-516-434-3198  
(Or circle Reader Service 126)

HCS Software  
1661 Lincoln Blvd. #101  
Santa Monica, California 90404  
+1-310-392-8441  
(Or circle Reader Service 73)

## DESKTOP VIDEO

by Richard Farrell

accommodate composite and S-video signals. Video output can be in PAL or NTSC in composite (VHS, Video8), S-video Y/C (S-VHS, Hi8), and, optionally, YUV (Betacam) and RGB. The system supports all manner of video recorders from the consumer and professional market.

#### TBCs and keying

The Video Machine has two frame synchronizers on board that, after the digitization, synchronize the video channels to the output or an external sync (such as studio sync). Devices can be connected to Video Machine without the need for an additional time base corrector.

As for keying capabilities, Video

lapping of graphics and live video, two 24-bit, true-color RGB frame stores, with alpha channel, can also be found on Video Machine. The Mac version frame store is, of course, QuickTime compatible, and the IBM PC version is compatible with Windows GDI.

Input and output gamma correction are fully programmable. Output is fully genlockable with software-adjustable H-phase and color subcarrier phase.

Video Machine addresses audio by offering support for standard sound cards.

FAST Electronic reports that Video Machine will be available as of press time.

For information on the Video Machine, contact FAST Electronic GmbH at +49-89-50206-0, FAX +49-89-50206-199, or circle Reader Service 52.

## We maintain a Double Standard

Audio Precision offers two different standard-setting product lines.

#### The automated System One — the industry standard for bench and factory.

- Graphic results on PC screen with hard copy to printers
- Automated proof procedures & limits testing
- State-of-the-art performance and speed

#### The self-contained Portable One Plus & Portable One — for service bench and field.

- Compact and affordable stereo test sets for applications not requiring automation
- Both offer comprehensive capability & high performance in a rugged package
- Portable One Plus adds sweeps, graphs and printer port

The System One and Portable One... two families of test sets designed for different jobs, each with the quality and performance that you have come to expect from Audio Precision.



**Audio precision**

P.O. Box 2209, Beaverton, OR 97075  
503/627-0832 1-800/231-7350  
FAX: 503/641-8906, TELEX: 283957 AUDIO UR

# The Art of Crossing the Line

The maxim "every picture tells a story" is usually challenged whenever a videomaker works without understanding the basic language of the moving picture medium. Just as some understanding of grammar is essential to good writing, there are conventions that audiences have come to expect when watching video or film.

Rules, of course, are made to be broken by skilled artists in the medium, but those who ignore the tried-and-true conventions of the moving picture process—without understanding why—are usually doomed to failure.

Every video, whether industrial, education-



by  
Frank  
Beacham

## VideoCraft

al, commercial or dramatic, is designed to tell a story. The way in which the videomaker selects and pieces together the individual images in an edited sequence determines whether the story is effectively told or confuses the audience.

### Maintain direction

A key consideration in creating a sequence of shots is to maintain clear screen direction for the viewer; to keep everything—people and objects—facing the same direction as the camera switches shots. Though this may sound obvious, it is a common problem for the audience to become disoriented when the camera position is changed.

All of us have seen reverse cuts when a person moving one way across the screen

suddenly reverses direction; or when two people, facing each other, are having a conversation and suddenly one appears to be talking from behind the other. In both cases, the camera operator has "crossed the line."

The so-called "line" represents an imaginary linear reference point drawn through a scene over which the camera may not cross without shaking the audience's sense of screen geography. The line can be referenced to movement, eye contact between subjects or any other area of interest in the scene.

As long as the camera stays on one side of the line, it can move freely from shot to shot and maintain screen direction.

Though this sounds like a simple rule to follow in theory, in the real world of production, there are times when crossing the line is necessary.

### Crossing over

There are several ways to cross the line without confusing the audience. These techniques are essential to the videomaker's craft.

One way to cross the line is to let the audience see the subject change direction on screen. For example, a motorcycle which moves toward the right of the screen, then turns and moves toward the viewer and then turns away and moves to the left clearly alerts the audience to the changes in screen direction.

In this case, the camera never moved and the line simply changed with the on-screen action.

Another way to shoot this same scene would be to have the camera move on a track across the line as it follows the movements of the motorcycle. Again, the audience sees the motorcycle reverse direction and keeps its geographic footing on the screen.

A frequently-used method for crossing the line is to place the camera exactly "on the line" for a transition shot. Examples of this can be found in one of the greatest chase scenes ever filmed. The chase in the movie "The French Connection" not only demon-

strates how to cross the line by intercutting an on-the-line transition shot but also shows how the use of artful composition and rapidly sequenced camera angles can build suspense.

### Age-old truths

In constructing the scene, director William Friedkin employed a notion about picture composition that artists have carried for centuries: Objects placed on the right side of a

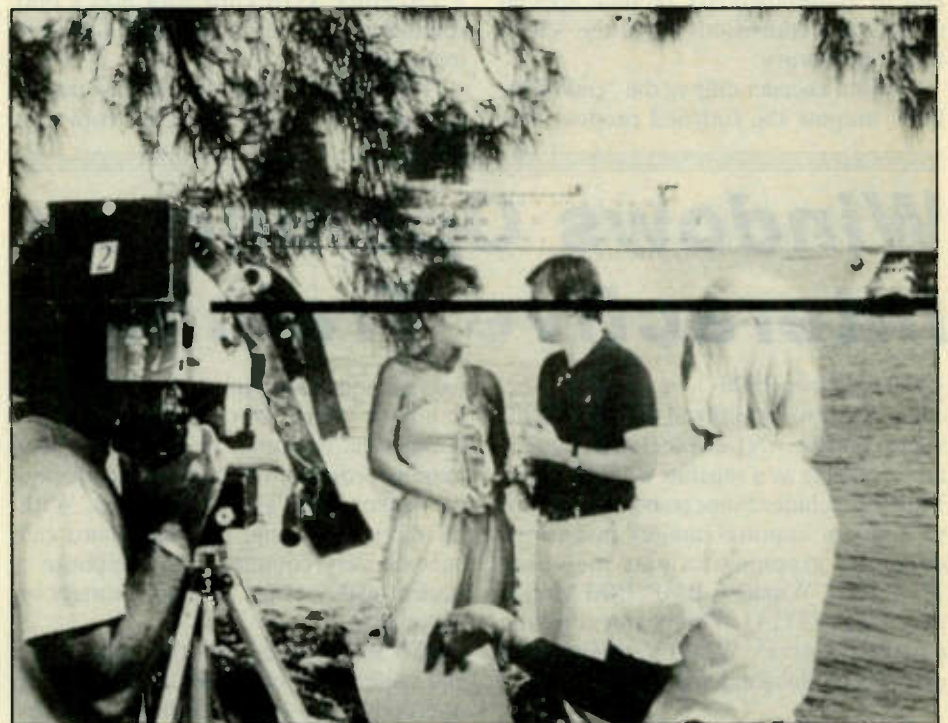

In this case, "the line" is along the eyeline of the subjects. In order to maintain screen direction, the camera stays in front of this line.

rectangle communicate an exaggerated sense of power, while objects placed on the left create tension and uneasiness.

Friedkin also knew that scientists had discovered that when we view a surface—like a television or movie screen—our eyes constantly move in a pattern around the screen. Our brain resolves that movement into a steady image. The director used this natural

line. The human eye and the objects on the screen collide, inducing stress in the viewer.

But as screen direction flip flops back and forth, the audience is never confused or disoriented. The sense of time and place are always secure. The scene is a study in how "crossing the line" can become an art form.

### In the background

Another variation on screen direction rules is often used to benefit videomakers shooting single-camera interviews for news and documentary programming.

Let us assume the best background on a location has been chosen for the interview subject, but the background behind the interviewer is less than desirable. The following rule variation can be used to "create" a new background for the interviewer.

First, tape the interview with the camera on the subject. Then rotate the subject and interviewer until a desirable background is found for the interviewer. In doing this, remember: as long as the camera does not cross the line, it can be placed anywhere. Because the interviewer is still facing the same direction as before, the line has not been crossed and the two shots will cut with the same screen direction.

Interview subjects are often in a hurry and will not sit for "reversals" of the interviewer's questions. So television crews frequently have to record the questions without the interview subject being present. Sometimes, those questions are even recorded at a different time and place from the original interview. As long as screen direction is maintained, the pictures will cut.

Frank Beacham is a New York-based writer, director and producer. Contact him at 163 Amsterdam Ave., #361, New York, New York 10023.



## TV TRANSMITTERS

- BAND I, BAND II, BAND III, BAND IV
- FULLY SYNTHESIZED ACROSS THE BAND
- FULLY METERED WITH LED A & V BAR.
- SWITCHING 100-240 V 50/60 Hz POWER SUPPLY
- DIFFERENTIAL GAIN<4% - DIFFERENTIAL PHASE<2deg.
- LINEARITY PRE-CORRECTION FIELD ADJUSTABLE
- OPTIONAL 22-28 VDC BATTERY POWER
- ADJUSTABLE OUTPUT LEVEL WITH OPTIONAL ALC.
- SCRAMBLING OPTIONS FOR ZENITH AND OTHERS

## WE ARE NOT THE NEW KIDS ON THE BLOCK

We asked over 1,000 broadcasters what they wanted in their ideal exciter. AND HERE IT IS!!! **NOW** BROWNING LABS INC. would like to introduce you to our NEW FCC/DOT Spec. GOLD LINE SERIES of exciters and transmitters. All solid state from 2 watts to 5,000 watts. Our first transmitters were installed in 1980 and still going strong.



**BROWNING LABS INC.**  
8151 N.W. 74th AVE. MIAMI, FL 33166

SE HABLA ESPANOL.

Ph.(305) 885-3356, (305) 885-5032  
Fx.(305) 885-0426, (305) 885-8014

IN CANADA CONTACT: MR. RAY QUESNEL AT AMAR INTERNATIONAL. TEL.(514)333-3393 FAX (514)333-3043

# Dissecting the Microprocessor

The heart of the modern office or laboratory computer is the microprocessor, and the heart of the IBM compatible is the Intel family of microprocessors. This family ranges from the first ever built 4004 to the 80586.

While all chips in this family were originally from Intel, all of those through the 80386 have been second sourced or manufactured by another vendor. Originally, Intel licensed other vendors to manufacture the Intel product under the other vendor name. In some cases, this could actually include a full transfer of the manufacturing documentation. (This is what is commonly meant by the term second source. The second source is building an identical component to the original item manufactured.)

However, in many cases a functionally similar chip is manufactured (with or without the originator's permission), but one that is not identical. In some cases there may be an improvement or a perceived improvement over the original item. In oth-

er cases, there is no functional difference between the items.

The early Intel microprocessors were second sourced, imitated and improved upon by a variety of vendors. However, Intel's later, more complex, chips such as the 80286 and beyond have had few imitators. These chips are not manufactured under license from the original vendor, and though they may be functionally similar, they are

**SIGNAL  
TECHNOLOGY**

by Warner Johnston

not functionally identical.

Even the same chips from the same manufacturer may differ in a functional sense. The operation of the chips will often be no different, but one could find differences in reliability or temperature stability. In other cases, the difference can be much greater.

#### "Hidden" features

Many integrated microprocessors contain what are called undocumented features. The instruction sheets of the chip will describe a particular control code or codes as "reserved" or "reserved for future use." Quite often a programmer, either by experimenting by his or herself, or by hearing from a friend of a friend who knows somebody at the silicon foundry, will discover that this "reserved" feature performs a useful function.

What the experimenter doesn't know is that in all versions of this chip manufactured after August 1989 the mask used to photo-etch this chip was changed and that this control code now causes the microprocessor to reset, but not clear registers. Thus software that worked fine in the lab will not work on the new machine in the boss's office (and he always has the latest machine).

Intel manufactures several families of microprocessor besides those used in IBM PCs and their clones. Often these other families are of great use and interest: the Intel 8048 includes 1K of on-chip EEPROM and some on-chip RAM. It is almost an entire computer on a single chip.

Companies other than Intel also manufacture their own microprocessor families. The Apple computer is based on the Motorola family of 68000 series chips, as are several engineering workstations such as the Hewlett Packard System 9000 Series 300.

As mentioned above, the Intel 4004 was the first single-chip microprocessor. Introduced in 1970, it was developed as a general-purpose CPU for a scientific calculator. The chip had a word width of 4 bits and an instruction word width of 8 bits (which gave a maximum of 64 instructions, 45 implemented). It could address 4K of memory (a mixture of RAM and ROM). The clock speed was 740 kHz and it had an add time of a blinding 10.8 microseconds. It was also expensive enough that my lab could buy only two and only the most senior engineers were allowed to work with them.

The 8008 followed two years later as a true 8-bit chip; three instructions had been added, address space had been increased to 16K (and at eight bits wide, that was 16K) and the clock increased to 800 kHz. This chip still did not have the power to be very

useful as a computer CPU, because the standard mid-1970s minicomputer had an address space of 64K and a 16-bit word (Dec PDP-11).

The 8080 (circa 1974) was a great improvement over the 8008 in that the address space had quadrupled and the add speed dropped to two microseconds. It also included the entire 8008 instruction set as a subset of its own 72 instruction set. The expansion over the nominal maximum of 64 instructions from eight bits had thus been overcome (via various multiplexing techniques), and with the advent of an external stack, the possibility of deeply nested sub-routines became possible.

#### Homeward bound

At this time, the first home computer became available, the Altair. There were no peripherals; data entry and programming were done via toggle switches on the front panel and data readout was via lights or LEDs on the front panel.

Other companies joined the market, still with 8-bit chips, but many of those are long since gone. The price on a machine with 8K of RAM, keyboard/printer and an audio tape interface could approach the down payment for a house.

A major test equipment manufacturer suggested to a young engineer that his idea for a personal computer was excellent, but it did not fit the manufacturer's industrial niche, so why didn't he do it elsewhere? Apple, using the 6502 chip, no longer has the same principal owners but holds a respectable share of the market even now, and is considered in many ways to be the superior system on the personal computer market.

Tandy used Zilog's Z80 chip (a superior variant to the 8080) with its TRS-80.

#### Power increases

Intel continued adding power to its line of processor chips and in 1978 introduced the 8086 as the first microprocessor unit fully 16 bits wide. While its memory still had a maximum segment size of 64K, more than one segment could be dealt with, which increased the memory size available. As usual, the 8086 was downward compatible and could be used as an 8-bit device running code written for the 8080. Investment in software for an 8080 system could thus be moved over to a more powerful unit.

The 8086 had a companion chip that could perform math functions—the 8087, the first such "companion" chip. Now calculations could be done by a chip as opposed to software routines, which could take far longer.

The 8088 appeared in 1979 as an 8-bit version of the 8086. As with the 8086, 16 segments of 64K could be addressed. Data and instruction words of 16 bits had to be loaded a single byte at a time and operated on internally as 16-bit words. The 8088 also could work with the 8087 math co-processor and was the choice of IBM for the CPU of its IBM-PC.

Believe it or not, the dates above are correct—a full 16-bit chip (the 8086) was available before the 8088 was used, and it had the use of the 8087 math co-processor as well. There are good reasons for this seemingly backward step. The CPU is only one small part of the computer—both RAM and the support chips involved make up by far

the greater portion of the cost. At the time of development of the IBM-PC, the cost of manufacturing a 16-bit machine (with no RAM chips) would have been at least twice that of an 8-bit version. Thus the 8088 was used in the IBM-PC because it would take less time to design, and its 16-bit internal architecture could be used as an advertising buzzword.

The machine came with 16K of RAM and provisions for 64K (extra boards could take it to 512K). At the time, this was the size of a good minicomputer.

Send your questions or comments to Warner Johnston c/o TV Technology.

## THE LEADER IS AT IT AGAIN!

State-of-the-art technology  
and JAMPRO continue to  
grow together . . .

We were on the cutting edge  
when we developed the first  
circular polarized television  
antenna . . . and that tradition  
continues today in our Low  
Power series TV systems.

JAMPRO offers the LPTV  
broadcaster a wide variety of  
competitively priced anten-  
nas, all of which contain the  
technology and experience of  
a company that has been the  
leader in the industry for over  
35 years.

**FOR THE MOST  
COMPETITIVELY  
PRICED QUALITY  
LPTV ANTENNAS CALL**

**(916) 383-1177**  
Fax (916) 383-1182

**JAMPRO**  
ANTENNAS, INC.

6340 Sky Creek  
Sacramento, CA 95828

Circle 35 On Reader Service Card

**Core:** Originally from magnetic core. Now a virtually obsolete form of random access computer memory. It is still used to refer to computer memory or the portion of memory in which a program is running, i.e., non-volatile memory.

**CPU:** Central Processing Unit.

**DIP:** Dual In-line Package. An integrated circuit with two rows of pins on 0.1-inch centers. It can have four or more pins.

**Dynamic:** Memory which must have its data read and rewritten or the data is lost. Usually involves storing data on a capacitor, where the charge can leak away.

**ROM:** Read-Only Memory.

**EPROM:** Electrically Programmable ROM. ROM that can be programmed by the user, which implies that it can be erased and reprogrammed with UV light.

**PROM:** Programmable Read-Only Memory. ROM that can be programmed (possibly only once) by the user.

**EEPROM:** PROM that can be electrically altered and erased. See volatile.

**MPU:** Micro Processing Unit.

**RAM:** Random Access Memory. Invariably means Read/Write memory as ROM. It is also often simply called random access.

**Refresh:** The act of reading and rewriting dynamic RAM.

**Static:** Memory that does not have to be refreshed. See dynamic.

**Volatile:** Memory that needs power to maintain data. Almost all RAM is volatile except core. EEPROM is not volatile but is very slow to change.

**WOM:** Write-Only Memory. A Signetics product of the mid-'70s. Normally used for on-board data storage in destructive testing.



**K U D O S**

**...It's something you can get from**





only one company...



## KUDOS

A brand new range of high performance, cost-effective products for broadcast, post production and professional applications by ...

## SNELL & WILCOX



A world leader in digital image processing.

KUDOS by Snell & Wilcox™ incorporates proprietary technology originally developed for high-end post production and broadcast applications.

Whether you're a broadcaster, independent producer, corporate user or facilities house, KUDOS by Snell & Wilcox™ delivers the engineering quality you demand along with one of the best performance-to-price ratios in the industry.

**KUDOS**

by

 **SNELL & WILCOX** 

Snell & Wilcox Inc.,  
2454 Embarcadero Way,  
Palo Alto, CA 94303 USA  
TEL: (415) 856-2930  
FAX: (415) 857-1434

Snell & Wilcox Ltd.,  
Durford Mill, Petersfield,  
Hampshire GU33 5AZ  
United Kingdom  
TEL: +44 (0) 730 821 188  
FAX: +44 (0) 703 821 199

### RANGE INCLUDES

**Standards Converters**

**Test Pattern Generators**

**Decoders**

**Encoders**

**Time Base Correctors**

**Synchronisers**

**Color Correctors**



Circle 41 On Reader Service Card

# Computers and Video Converging

You might not have noticed a few things about computers: They haven't taken over your job yet. They weren't invented yesterday. And they ain't all Macintoshes.

I keep thinking, "No, everyone knows that." Then I start talking to people, and I shock myself every time. I mean, *everybody* knows there are computers other than Macintoshes, right?

Have a look at Table I. Yes, there isn't much new under the sun when it comes to technology.

If you thought Editing Machines Corpo-

ration and Avid Technology are the grand old developers of non-linear editing (1988 and 1989, respectively), guess again. The CMX 600 used computer disk drives and a light pen for instantaneous non-linear editing more than two decades ago. As for computer graphic animations, they were broadcast, in full color, at least as early as 1975.

## That old thing

A really hot computer-video buzzword these days is compression. Well, I have news for you. The interlaced fields of 525-line video system (which followed the British 405-line system, which TV Technology's researchers tell me followed some Chicago, Illinois guy's 1928 45-line interlaced system) compressed bandwidth by a factor of 2:1. Then along came NTSC color, and it squeezed red, green and blue into one signal. Put them

through, and recording a minute in a single chip will be another.

## Getting carried away

At the rate breakthroughs have been taking place in computer technology, it's pretty easy to get carried away and start plotting curves. If prices drop by a factor of ten every five years for awhile, allowing US\$100,000 worth of computing to be purchased for US\$1,000 a decade later, it may seem right to say that in another ten years the same com-

puter will be US\$10, and ten years after that it'll be US\$10¢.

Yeah, right. You can't buy a power supply, a power cord, a fuse and a case for US\$10¢—forget the computer. Other people leave the money out of it but do the same kind of extrapolation with power or memory: if 1kB RAM eventually led to 1MB RAM, they say, then that has to lead to 1GB RAM in the same amount of time, followed by 1TB RAM, and so on. And, I suppose, after we get down to the point where bits are stored on single atoms, we'll just keep right on going through subatomic particles.

## Selections, options and preferences

And what if the computer-based system costs more, not less? You can throw



by Mario Orazio

## Masked Engineer

Table I  
Firsts In Video And Computing

1941 - Commercial TV licenses in U.S.
1946 - Electronic computer - ENIAC
1950 - Computer connected to a picture tube - Whirlwind
1953 - Video compression - NTSC
1962 - Computer drawing system - Sketchpad
1965 - Electronic character generator - Digiset
1971 - Nonlinear, computer-assisted editing - CMX 600
1972 - Computerized video testing - ANSWER
1973 - Digital TBC - CVS 500

together, and you have 6:1 video compression by 1953.

## Advanced degrees

Mind you, I'm not one of those old geezers who is always pooh-poohing the latest developments. I'm a firm believer that questions of degree are really impor-

tant. Sure, the CVS 500 TBC in 1973 used the same basic type of A/D and D/A conversion used in every succeeding digital video device, and, sure, it was followed almost immediately by digital field and frame synchronizers and digital effects, but that doesn't mean today's computer-video environment was inevitable, given the developments of Table I (have you ever noticed that figures and tables are always numbered, even if there is only one?).

Every general knows an unarmed person is no match for a soldier with a gun. Ten thousand unarmed people, on the other hand, can be more than a match. Sure, it's been possible for decades to record video in solid-state memories, but recording a frame in a single chip was a break-

office does. Add a bit of electronic input and output other than keyboards and printers, and you have an editing system, a character generator or a waveform generation and analysis system.

What was Chyron's VP-1, a peripheral

together a VHS-based editing system for a few thousand dollars.

The nonlinear computer system is a lot more expensive, but maybe it dramatically increases your editing speed. Which is better for you? Hey, don't look at me: how should I know? All I can say is that I can easily envision situations where one or the other would be an obvious choice, and I can envision even more where it is not at all obvious.

Then there are situations where there isn't even a choice, like Sonic Solutions' NoNoise software, analyzing an audio waveform, sample by sample, and getting rid of studio radiator banging.

## Electronic fantasies

Oh, yeah, back to that bit about computers replacing you: They won't. Have you looked under the control head of a large production switcher lately? There isn't much there. The major portion of the volume of any control room or edit suite is currently empty space. If shrinking components make the space even emptier, so what?

I know someone who used to fantasize about getting all of the electronics in a large production truck down to a single chip—hey, I don't say it won't ever happen, but I have two major comments: First, the truck is not going to shrink much, since you are still going to need a director (or so they keep telling me), an audio director, a technical director, an audio mixer, a video operator, a recordist and all the other people whose talents make possible our industry. Second, the chip is going to need a gigantic power supply and a gigantic connector.

There is a big difference between computers and all other video innovations, though: old computers rarely become obsolete.

For instance, thanks to some nifty software I picked up, I can read my old Apple II files, and a whole bunch of different PC files I made with different programs, all on my Mac. Translation? Computers don't, in and of themselves, ever become useless. I know a guy who still runs his whole business on an old 8-bit Kaypro.

When it becomes possible to record full-quality, full-length video programs on low-

(continued on next page)

## NovaMate™ For Life

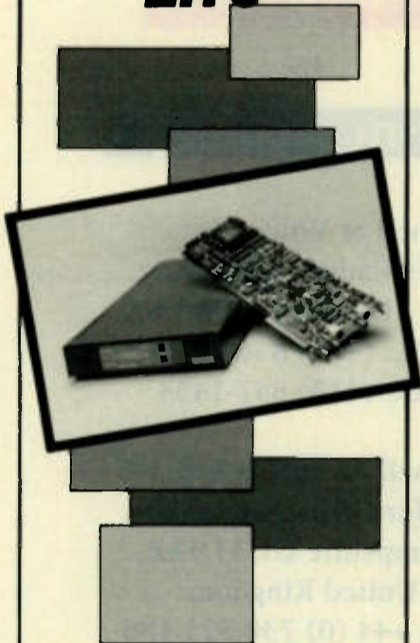

### Marry any VCR to any System

NovaMate™ TBC/Frame Sync:

- Ideal for broadcast and desktop video systems including Video Toaster®
- Plug NovaMate™ directly into a computer (PC® or Amiga®) . . . or choose a single, dual or multi-channel chassis.
- Y/C and Composite Video Inputs and Outputs
- Wide-band adaptive digital comb filter
- Infinite Window Correction
- Full Frame Synchronization
- Freeze Frame/Field with Strobe
- Operate by computer or NovaTrol™ control unit

NovaMate™ . . . The TBC that grows with you.

Call or Fax for your NovaMate™ Information Kit Today.

**NOVA**  
SYSTEMS, INC.

50 Albany Turnpike  
Canton, Connecticut 06019 USA  
tel. 203-693-0238  
fax. 203-693-1497

# Fun Lighting Tips That Can Save You Money

Even though tight economic conditions are hitting most of us, creative thinking can help keep lighting fun.

For example, consider a studio with a large background area, where patterns are needed. The normal solution for projecting the patterns would be to use ellipsoidal spots (Lekos). Instead of buying the stainless steel, commercially-produced patterns, try making your own. Old, scrap printing plates from a local printer or metal roof flashing from a building supply store can be cut with a hammer and cold chisel. (Remember to use proper safety precautions, such as protective goggles.)

The edges may burn open a bit with use, particularly in fixtures with 1K lamps, so

Look for the thinnest. It may be a lot easier to get a little money from the petty cash fund than to convince someone else of the need for a large roll of diffusion or drafting vellum. Hospitals will sometimes give away old sheets, but we found the industrial grade ones were too thick to pass enough light and they also had a color tint. (And, obviously, any sheets should not be placed in contact with a hot light fixture.)

## A wrap

Another helpful item that is inexpensive and perhaps readily available from your shipping area is a roll of brown wrapping paper. If the brown color lends itself to the product and/or program theme, it can be used for seamless paper.

It can also be laid on the floor and painted with a roller. Fast drying, flat latex paint does not soak in completely evenly, so some warping of the paper happens, but it does not show when used for facing on a rise or taped onto a flat to cover a background that may be needed for a future program.

Folding the paper can create three-dimensional backgrounds with shadows for depth, such as clapboard siding. We have wrapped strips of the paper around a back light pole as camouflage, which made it look like the other palm tree trunks in the conservatory surrounding it.

The next time you are confronted with a lighting challenge, take a deep breath and think: can I do that with less money? You will find fun in the technique and process as well as in the images created by the light.

*Ron Saxton is lighting director for WOSU, the Ohio State University, PBS Station 2400 Olentangy River Road, Columbus, Ohio 43210-1027.*

## TECH TIP

by Ron Saxton

do not spend a lot of time trying to make images with minute detail. While they may not last an extended period of time for an ongoing series, they can provide that special image that is unique to your program, one that can be changed at your desire.

## Hanging cookies

As another example, what if you have only a few pattern spots that are not enough to light a large area? Cookies are the common method of creating background patterns. In a single-camera shoot, a cookie hung from a floor stand would probably suffice, but for a larger studio area, shot from multiple camera angles, this approach is not feasible: the cookies will be seen in the camera shots.

In this type situation, we have hung cookies from arms mounted to the top hanger brackets of eight-inch Fresnel fixtures, since we have plenty of them.

The lenses have been removed for more specular light. The arms themselves were old drape track cut to 38-inch (about 96cm) lengths. Paper binder clips with their wire arms bent to grip the aluminum tracks were used to hold the cookies.

Cookies are cut out of inexpensive, 22"x28" (about 56cm by 71cm), or a half sheet, 14-ply black poster board with the top folded over for additional rigidity. If they are being hit with a heavy blow from the studio air conditioning, a few strips of wood or folded paper board can be glued or stapled to add firmness and stop the movement.

## Cheap reflectors

Inexpensive reflectors can be made out of aluminum foil glued to corrugated sheet from scrap boxes. Heavy-gauge aluminum foil can also be wrapped around frames formed of heavy aluminum wire. To broaden the reflected light and eliminate the hot spots, wrinkle the foil surface. Lay the foil flat on a hard floor and with open palms and fingers slide the foil around, creating lots of wrinkles without bunching or folding.

For shooting reflective products, the white tent walls can be made from bed sheets hit with 5K or 2K Fresnels. Thrift stores may be an inexpensive source.

# Computers Meet Video

(continued from previous page)

cost computer storage media (that's when, not if) progress won't suddenly screech to a halt. Newer and different computers and newer and different software will spring up, but the chances are excellent that you'll be able to use old software on your new computer and vice versa.

Yeah, there are around 3.6 zillion different computer video compression and storage schemes out there, all based on different algorithms, and all incompatible, but—hey!—algorithms are just rules, and I already told you computers can remember, organize and calculate. That's any computer (it never ceases to amaze me that people who have no difficulty programming a computer to act like some complex video processing device have a hard time believing they can program a computer to act like another computer).

## We and us

The Society of Motion Picture and Television Engineers (SMPTE) seems ready to enter the computer age; they have people working on generic digital headers and image architectures that can be used in any system. SMPTE's D-2 standard doesn't specify a head drum diameter—that was intentional, so manufacturers could design machines using any techniques that would leave the same tape footprint. I wouldn't be surprised to find a future SMPTE video recording standard omitting a lot more, so that anything from a recordable CD to a DAT streamer could record the image (and maybe in varying amounts of detail and aspect ratios).

We video people have been keeping clear of us computer people for too long. Before SMPTE got moving, we computer video people established our own standards group, VESA (the video

electronic standards association), but I think we're now ready to work with us. Oh, I'm sorry. Are you having a hard time differentiating when I use the personal pronoun to mean video people and when I use it to mean computer people? Good. I accept that confusion as an important step on the road to our understanding each other.

I say "each other" this time, instead of "us," because there are two disciplines involved: computers and video. I have not a scintilla of doubt (that's a fancy word meaning "shred" that my word processor's thesaurus just coughed up—you didn't think I wrote this badly without help, did you?) that computers will spread into more and more aspects of TV technology at a rapid rate (it's only an "alarming" rate if you keep up that silly us-versus-them mentality), just as transistors replaced tubes in most applications.

Ahem. That was "most" applications, not all. Quick, what do you watch TV on? Right, a picture tube. Your camera viewfinder uses a tube, as do your waveform monitors and vectorscopes. If you transmit TV, chances are excellent that you have tubes in the transmitter, terrestrial or satellite. And, even if you don't, the microwave oven in your lounge probably has a . . . Well, if tubes aren't dead yet, non-computer video has a good long life ahead of it, too, and it wouldn't hurt any for us computer folks to learn from us video folks, either.

Anyway, as I've said just about every year I've been in this business, "What a great time to be alive!"

*Mario Orazio is a pseudonym for a well-known television engineer who prefers to remain anonymous. Send your questions or comments to him in care of TV Technology.*

Shure. Transmission - Power Tubes: Amperex, Burle, EIMAC, National and Siemens. Camera Tubes.

Spectrian. Stage/Studio Lamps: General Electric. Microphones:

## Look Around.

A more complete source for broadcast replacement components would be difficult to find.

Richardson Electronics - offering broadcast and studio engineers products to help amplify, transmit, monitor and illuminate.

**NEW**  
for the Studio

Richardson now stocks GE stage and studio lamps and Shure microphones.

**Richardson Electronics, Ltd.**

U S A	(800) 348-5580
Lincoln, England	(0522) 542631
Argenteuil, France	(1) 34.26.4000
Sesto Fiorentino, Italy	1678-62138
Madrid, Spain	(1) 528 37 00
Puchheim, Germany	089/80 02 13-1

CRTs: For Barco, Conrac, Ikegami, Sony and other major manufacturers' monitors. RF Transistors: SGS-Thomson and RF Products. UHF Power Blocks: MMD's

# ¿POR QUÉ 'SUENA RARA' SU MEZCLA?

Después de una lucha ardua ha terminado Ud. su programa. Ahora, únicamente tiene Ud. que mezclar las pistas de audio y entregar la copia maestra ya terminada.

La mezcla del audio debe ser un proceso relativamente simple en el cual es necesario equilibrar el sonido las diferentes pistas y una vez terminado este paso, puede Ud. descansar.

Sin embargo, este proceso, aparentemente tan sencillo, sufre algunas veces accidentes misteriosos.

Puede estar Ud. seguro que lo que pasaremos a describir le ha sucedido a muchos otros profesionales del ramo.

## Ruidos indeseables

El trabajo de mezcla prosigue sin problemas aparentes y produce Ud. la copia final. El problema se descubre al escuchar la mezcla nuevamente; la mezcla suena diferente, hay sonido no escuchados previamente, algunos elementos están más pronunciados o algo hace falta.

Desafortunadamente, en esta situación está Ud. acompañado en su oficina, en un estudio de doblaje, en una instalación en línea o presentándole la mezcla a su cliente.

No hay duda alguna que existe un problema con la mezcla. Si es Ud. afortunado, podrá corregir el problema antes de reproducir la mezcla o de lanzarla al aire. Descubrir la causa del problema no es labor fácil, ya que no todos los que escuchan la pista de sonido están de acuerdo en qué consiste el problema ni en cuál es la razón del mismo.

Lo cierto es que surgirán tantas opiniones como personas presentes y solamente estarán de acuerdo en que "la pista suena rara" y Ud. está seguro que la pista sonaba bien al escucharla en el estudio. Entonces, ¿qué puede haber sucedido?

## No ha habido sabotaje

Podemos asumir que nadie ha causado daño o alteración intencional a la mezcla. Ud. llevó a cabo todos pasos obligatorios al escuchar otros doblajes y al escuchar la cinta en otros sistemas monitores. Finalmente, regresa Ud. al estudio de mezcla para evaluar la situación con la ayuda del ingeniero del ramo.

Ahora es posible que la mezcla suene correctamente al regresar al estudio pero sufre degradación al escucharla fuera de él. ¿Cuál es la causa del misterio y cómo

se puede corregir?

Creo que la causa radica en los altavoces por los cuales está Ud. escuchando, en la sala que se está utilizando, en el volumen a que se está escuchando o por último, en el ingeniero o técnico mezclador.

Para llegar a una mezcla que le satisfaga totalmente, debe usarse equipo monitor



por  
Ken  
Hahn

## AUDIO PARA VIDEO

(altavoces) apropiado. Si no puede Ud. escuchar la mezcla con el equipo apropiado, no se puede llegar a lograr un equilibrio o balance de la pista de audio. La única manera de lograr éxito es instalando altavoces de muy buena calidad en un ambiente apropiado.

Claro está que un altavoz no es el indicado para todo tipo de programas. Los ingenieros de audio y los técnicos mezcladores usan una serie de altavoces para llegar al balance deseado en el audio. Pero, los altavoces no hacen la mezcla; al final de cuentas Ud. es el responsable. Los altavoces ayudan a lograr una mezcla balanceada al dar una representación fiel de lo que existe en la cinta pero es Ud. quien tiene que decidir lo que se va a hacer con la información recibida.

Por ejemplo: yo no sugeriría que se usara un sistema de altavoces biamplificador, de elementos múltiples, de tamaño gigante y de modificaciones especiales para música de fondo en un programa dramático para televisión. La mezcla resultante no tendría el mismo sonido en el estudio y en el aire. Entonces, ¿para qué molestarse usando un sistema tan complicado?

Yo recomiendo que se haga la mezcla en estereofónico y que se escuche en un altavoz pequeño monofónico a volumen moderado o bajo. De esta manera obten-

drá una mezcla equilibrada que se escuchará mucho mejor en el aire. Los altavoces gigantes pueden producir sonidos maravillosos pero no son un medio realista para trabajar. Los altavoces grandes son necesarios y cumplen con su propósito en ciertas situaciones, pero ésta no es una de ellas.

## Escuchemos con atención

Todo el mundo oye y aprecia el audio de manera diferente. El volumen que es excesivo para una persona es perfecto para otra. Una persona prefiere compensar o agregar igualación a las frecuencias altas a una pista de audio mientras que otra cree que este paso causa una aparente falta de frecuencias bajas.

El volumen es un término relativo y el equilibrio de las pistas de audio es un proceso que requiere tomar decisiones subjetivas constantemente. Un sonido considerado muy alto está siendo comparado auditivamente con el sonido o sonidos escuchados previamente, posteriormente o simultáneamente.

Esta comparación tiene lugar constantemente durante la preparación de una mezcla y, por lo tanto, es necesario aplicar un alto grado de concentración para lograr un equilibrio continuo en el audio.

Las frecuencias (altas y bajas) y el nivel (intenso o débil) no pueden ser considerados separadamente como calidades independientes. El oído humano es más sensible a las frecuencias de nivel intermedio y debido a esta sensibilidad, los sonidos en esta región pueden parecer más intensos.

Es entonces evidente que la selección

cas y las conversaciones no relacionadas, con personas que no participan en el proyecto inmediato, son obstáculos para lograr el equilibrio aceptable del audio.

Una sala cómoda y callada es esencial. Es necesario reducir al mínimo el ruido producido por el equipo acondicionador de aire, los abanicos y otro equipo que cause ruidos. Si el nivel de ruido ambiental en el estudio de mezcla es excesivo, no será posible discernir ciertas frecuencias. El tratar de lograr un equilibrio de audio en un ambiente bullicioso se convierte en una labor ardua, ya que es muy difícil lograr la concentración necesaria.

Las decisiones para las mezclas de audio deben estar en manos de aquellas pocas personas con los conocimientos necesarios. Otros pueden dar opiniones y hacer sugerencias pero las decisiones principales deben ser asignadas a un número limitado de personas para lograr continuidad. Demasiadas opiniones son contraproducentes y confundirán a aquellas personas que tratan de atender a todas las sugerencias.

## Confíe en su mezclador

Mi último consejo es que confíe en su mezclador. Si los técnicos que manejan la consola están bien calificados, permítalos que hagan el trabajo para el cual han sido contratados. Su trabajo es mezclar audio. Se ganan la vida haciendo mezclas. Si Ud. ha escogido a la persona indicada, ésta podrá proporcionarle alternativas para satisfacer cualquier circunstancia que surja durante el proceso de mezcla. Su mezclador es un profesional que mezcla audio

## Las llamadas telefónicas y otras distracciones no permiten lograr el equilibrio aceptable del audio.

de un altavoz apropiado es de capital importancia, ya que sin él es imposible tomar las decisiones debidas.

Es preciso reconocer que es la combinación del ambiente y de los altavoces lo que permitirá que Ud. y el mezclador lleguen a una mezcla con sonido óptimo en el ambiente y con los altavoces de su audiencia. Es imperativo que las personas que tomen las decisiones para la mezcla no permitan distracciones. Las llamadas telefóni-

diariamente y que sabe lo que puede sucederle a una pista de audio después de haber terminado él con su trabajo.

Su técnico mezclador anticipará los problemas antes de que ocurran. Ud. decidirá lo que quiere escuchar, pero el mezclador tiene la obligación de producirlo.

Cómo llegar al resultado deseado es parte del arte de mezclar audio. Hay muchos métodos y técnicas que rinden resultados similares. Antes de iniciar la mezcla escoja un mezclador cuya personalidad, hábitos de trabajo y técnicas sean compatibles con los suyos. La selección del mezclador apropiado aumenta dramáticamente las probabilidades de producir una mezcla de calidad.

Para lograr la mezcla recomiendo ciertos puntos fundamentales. Básicamente, debemos simular el ambiente de la audiencia. Se recomienda instalar los altavoces indicados en una sala tranquila y callada y eliminar las distracciones innecesarias. Como punto final recomiendo el uso de un mezclador con experiencia.

Espero que al seguir estas sugerencias logre Ud. mezclas más parejas y con menos sorpresas.

Ken Hahn es cofundador de Sync Sound, en Nueva York y ha recibido muchos galardones por su trabajo. Puede Ud. escribirle a/c de TV Technology.

## FIX YOUR OWN VCR's

Are You Tired of Waiting for EXPENSIVE VCR Repairs;  
Find Problems BEFORE they Cost You \$\$\$\$

More than 85% of VCR problems are due to MECHANICAL misalignment! Most Catastrophic errors including TAPE EATING, EDGE DAMAGE, TAPE INTERCHANGE are due to Mechanical problems. TENTEEL offers powerful, easy to use TEST equipment for U-Matic, Betacam, S-VHS, MII, D2, D3, etc. Over 60,000 users have learned how easy service can be with the right gauges. Universal gauges for tape tension, guide height, torques, video head wear, spindle height, and other critical measurements.

If your service people aren't using TENTEEL test equipment YET, You're in for a pleasant "surprise". Send or FAX TODAY for more information.

IF YOU KNEW HOW GOOD TENTEEL GAUGES ARE, YOU'D ALREADY HAVE THEM!

 TENTEEL® 4475 GOLDEN FOOTHILL PKWY.  
EL DORADO HILLS, CA 95762

Phone: (916) 939-4005

24 hour FAX line: (916) 939-4114



# Steady Shooting On Only Two Legs

There are two contradictory schools of thought about tripods. One says that a camera should not even be turned on until it is securely mounted atop its three-legged base. The other holds that a set of "sticks" is an impediment to visual storytelling, an anachronistic accessory best left behind unless you are doing copy work or an hour-long, sit-down, three-light interview.

One of these extremist views might be the gospel for videographers who never leave the studio, while the other view could be the last word for photojournalists who shoot exclusively for news programs. But reality, for the rest of us, lies somewhere in between.

## FOCUS ON

## VIDEOGRAPHY

by John Premack

### Shoulder the burden

The influence of lightweight cameras and home video, the demands of breaking news and reporters who will not wait, and the growing popularity of the verite shooting style pioneered by "news-feature" shows mean that even studio-based videographers are shooting from the shoulder.

Some photojournalists actually switch between "shoulders" and "sticks" several times while covering a single story. Even a simple news conference will see them using tripods for no-strain steady talking heads and going hand-held for wide shots and cutaways.

But there is more to shooting hand-held than simply

unsapping the camera or leaving the tripod in the car. Capturing unshakable video with a camera perched on your shoulder is not as easy as it looks.

Camera steadiness is influenced by a number of seemingly inconsequential details. While, individually, they are easy to overlook, the videographer who does not monitor his stance, posture, muscle tension, arm positions and breathing will find his hand-held shots no steadier than those featured on home videos.

### Perfect posture

Lacking a third leg, the human "bipod" is inherently less stable than a tripod. The trick is to compensate for this design flaw by becoming a human rock. Stand with your feet shoulder-width apart and pointing in the same direction. Your weight should be distributed equally on both feet. Knees are relaxed—not locked—and hips and pelvis are tucked forward, not jutting rearward. This easy-to-maintain shooting posture will not only prevent you from swaying like a straw in the wind but it also will help maintain a healthy back as well.

Once your stance is set, it is time to concentrate on the camera. Finding a point of balance that allows the camera to remain atop your right shoulder, even when you remove your hands, means you can relax your arm and hand muscles while shooting. Muscles held tense to keep the camera in position atop your shoulder will tire and rebel eventually, and the resulting tremors will be transmitted to the images you want to record.

Of course it is not only fatigued muscles that shake the scenes; intentional movements—even those no greater than a flick of the fingers when operating the zoom

rocker or a stab at the iris switch—can shake the camera noticeably. Your arms, from the camera's perspective, are actually levers, capable of amplifying tiny twitches into screen-shaking earthquakes.

You can maximize steadiness and minimize viewer discomfort by eliminating any arm movement. Tuck both elbows into your chest instead of letting them flutter around in space. Because any movement of your right hand will be transmitted directly to the camera, try not to use it as anything but a motionless camera brace. Relax your finger muscles. Let the bottom of the lens servo housing rest atop your open palm instead of gripping it with your fist. Change focal length by reaching over the top of the lens with your left hand, or use an accessory

(continued on page 22)

## POCO DINERO...NUEVAS IDEAS

Por Ron Saxton

A pesar de las condiciones económicas que nos afectan a todos, si usamos la imaginación podemos divertirnos con la iluminación.

Por ejemplo, considere un estudio con un área de fondo muy amplia y que requiere un diseño en dicho fondo. El método normal para proyectar el diseño sería utilizando las luces (lámparas) elipsoidales de alta intensidad (Lekos). En vez de comprar las láminas de acero inoxidable producidas comercialmente, trate de fabricarlas Ud. mismo, utilizando placas viejas de imprenta o láminas de metal. Estas últimas pueden ser comparadas de un almacén de materiales de construcción y se trabajan con martillo y cortafío. No olvide usar las gafas y otros artículos protectores.

No trate de lograr diseños muy minuciosos, pues los bordes pueden abrirse, especialmente si se usan lámparas de 1K. Es posible que estas láminas no puedan ser usadas durante una serie de larga duración, pero le brindarán la posibilidad de hacer cambios específicos para su programa, siempre que Ud. lo desee.

He aquí otro ejemplo: Si no tiene Ud. suficientes luces de alta intensidad para iluminar un área grande, las láminas colgantes pueden usarse para crear un diseño de fondo. Para una toma de vistas con una sola cámara, una lámina sostenida por un pie probablemente sea suficiente. Si se están usando varias cámaras a diferentes ángulos, este método no dará resultados, ya que la lámina será visible. En este caso colgamos las láminas de brazos montados en los soportes superiores de lámparas de Fresnel.

En el diseño que acompaña a este artículo, los lentes han sido cambiados para proporcionar una luz más especular o directa. Los brazos tienen 38 pulgadas (36 cms.) de largo y se han usado presillas de alambre para sujetar las láminas. Las láminas han sido cortadas de planchas de cartón de yeso (cartón cubierto con yeso) de 22x28 pulgadas (aproximadamente 56 x 71 cms.) o de hojas dobles de cartulina. Si las láminas van a estar al paso de la corriente de aire producida por el aire acondicionado, se les puede pegar tiras o listones de madera para mayor rigidez y eliminar el movimiento.

Un pedazo de cartón corrugado forrado en papel de aluminio puede servir de reflector barato. El papel de aluminio grueso también puede envolverse alrededor de marcos de alambre grueso de aluminio. Para ampliar el área de luz reflejada y para eliminar los puntos de calor excesivo, arrugue la superficie del papel de aluminio. Coloque el papel de aluminio en una superficie plana y dura y con las palmas de la mano deslice el papel de un lado para otro hasta crear arrugas sin dobleces.

Para tomas de productos reflectores de luz, se pueden utilizar sábanas y luces de 2 o 5 Fresnels. Compre las sábanas más baratas del mercado y el costo será insignificante. Es más fácil obtener fondos de la caja pequeña que convencer al departamento de compras para que autorice la compra de un rollo de papel avitelado o apergaminado. Las sábanas gruesas no permiten el paso de suficiente luz y cabe recordar que las sábanas no deben entrar en contacto con ninguna superficie caliente.

El papel de envolver (papel de Manila) es barato y fácil de localizar. Si el color caramelo es aceptable, puede usarse sin cambios. Puede tenderse en el piso y pintarse con un rodillo. La pintura de látex de secamiento rápido no permea el papel de manera pareja, de manera que el papel no permanece totalmente plano. Sin embargo, puede engraparse a una superficie plana y ser utilizado como fondo.

Doblando el papel puede Ud. fondos tridimensionales con sombras. Hemos envuelto postes de luz en papel y este camuflaje los ha disfrazado de troncos de palmas que se confundían con otras palmas a su alrededor.

La próxima vez que se enfrente a un problema de iluminación, piense: ¿cómo puedo lograr los resultados necesarios gastando menos dinero? Use la imaginación y el proceso y las imágenes creadas con la luz le divertirán.

Ron Saxton es Director de Iluminación de la estación WOSU, estación con subsidio oficial de Ohio State University, 2400 Olentangy River Road, Columbus, Ohio 43210-1027.

## More For Less.

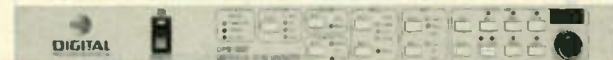

Stay in sync while doing it all with our DPS-365 UNIVERSAL SYNCHRONIZER. This 8-field composite PAL synchronizer has a built-in TBC with automatic mode switching. Direct tape playback from colour under VTR's. Full 6.5 MHz bandwidth for direct colour sources. Digital Adaptive Comb Filter for broadcast quality freeze. Digital Test Generator. Even a VITS inserter. All operated by a Serial Remote Control, to make looking your best all the easier.

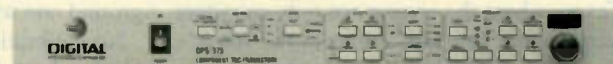

The DPS-375SP TBC/FRASTORE is packed with features to eliminate timebase error and edit your video with ease. Like infinite window correction with four-field memory, selectable frame and field freeze. PAL, Y/C-4.43, Y/C-685, Y/C-924 and Y/R-Y/B-Y (MII® or BETACAM®) inputs and outputs. Variable strobe. Noise reduction. Posterization. Mosaic. Sepia. Even a built-in test signal generator. All this, and a whole lot more. For a whole lot less.

BETACAM® is a registered trademark of Sony Corporation.  
MII® is a registered trademark of Panasonic Broadcast.

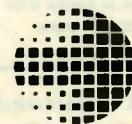

**DIGITAL**  
PROCESSING SYSTEMS INC.

55 Nugget Avenue  
Unit 10 Scarborough  
Ontario, Canada M1S 3L1  
(416) 754-8090  
Telex: 065-25425  
Fax: (416) 754-7046

# Measuring Temperatures Remotely

If temperatures drop outside, do you worry that your heat exchanger or water coolant might freeze? If you have a remote control transmitter in a place where the weather is hot, would you like to know how well the transmitter room cooling is working? If so, there are a couple ways to measure temperatures remotely.

Remote control manufacturers usually offer temperature probes, but at a high price. I have found a direct reading temperature sensor that costs as little as U.S.\$3. works with anywhere from five volts to 30 volts of direct current and reads temperature on a linear scale—no calibration required.

I am referring to the National Semiconductor LM34 (Fahrenheit) and LM35 (Centigrade) precision temperature sensors. These three-pin devices, which look like transistors, have one degree accuracy, with no adjustments. You can obtain them from almost any electronic parts distributor.

Figure 1 shows a circuit for a simple temperature sensor. This circuit only works for

LM35 to work down to -55 degrees C.

Maximum temperatures are +300 degrees F for the LM34 and +150 degrees C for the LM35. Less expensive versions of the sensors have less range—see Figure 1. If an isolated single supply is available, two 1N914 diodes can be used to raise the ground on the sensor above the supply ground to allow negative temperatures to be measured.

Figure 3 shows the circuit without decoupling. Note that the metering must be referenced to the sensor's ground, not



the power supply ground.

One warning when using these ICs. I found that using too much heat while soldering to the IC leads permanently changes the calibration. In my case, the

IC read a couple of degrees high after soldering. Use a heat sink! National Semiconductor advises that lead temperature will directly effect the die temperature and hence the reading.

To improve response time and accuracy, use thermally conductive epoxy to glue the case and leads to a small piece of brass or PC board. National claims the metal case version can be soldered directly to a pipe for fluid temperature measurements.

In any event, do not forget to insulate the leads (in some cases the ground one will not have to be insulated).

No calibration is required or even possible for these sensors. You can check them with an accurate digital multimeter. At 70 degrees F, the output voltage should be 0.70 volts on the LM34. If you use the centigrade sensor, look for an output of 0.20 volts at 20 degrees centigrade. Every ten millivolts equals one degree of temperature, with reference to zero degrees.

One warning about using liquid baths for calibration checks: insulate the leads! Also, if the connections will be exposed to warm, moist air or left outdoors, protect the solder connections with shrink tubing or epoxy. Use thin wire to connect to the LM34/35 to minimize the effect of the wire on the die inside.

If you discover a unique application for these devices at your transmitter site, let me know and I will share it with others here in this column.

## Engineer to engineer

The honors for the first tip contributed to this column go to Bob Getsla, who left me this on CompuServe E-Mail. Through the magic of electronic communication it is easy to let Bob describe it himself:

"I intimidate an RCA TTU-55B one night/week. I had an occasion to test all of the diodes in the rectifier stack. Needless to say, I did not want to spend a lot of time looking at a meter, so I whipped up a 24 volt transformer, a 1 K, 2 watt resistor, and a pair of inverse parallel LEDs, one Red and one Green.

"If only one was lit, the diode(s) being

tested were OK. If both were on, they were shorted, and if neither was on, either I had too many diodes in series, or something was open.

"It worked really well to spot the dead diodes (and lots of shorted ones) so we could get replacement parts for rebuilding the rectifier stacks. This seems like a sim-

Thanks Bob, and good luck with the TTU-55B. Your tip should work well with any transmitter that uses high voltage, high current rectifiers. It is good preventive maintenance to test all the rectifiers every so often. Often, one or two rectifiers can short without any visible effect.

However, the remaining good rectifiers now have more voltage across them and eventually the weakest will fail, until finally the whole string goes.

Figure 4 shows a drawing of Bob Getsla's tester. Oh yes, a reminder: use care when working in the high voltage part of any transmitter! Shut off power at the transmitter and the breaker or disconnect. Make sure interlocks are working and place a shoring stick across the high voltage caps.

Don't forget to send me your news and technical tips at any of the contact points listed below.

Figure 3. Negative Temperatures with a Single Supply

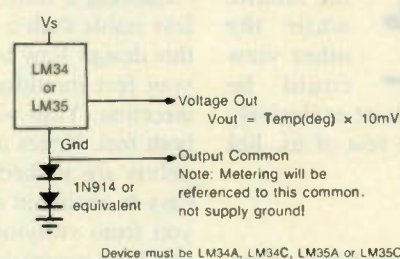

Remote control manufacturers usually offer temperature probes, but at a high price.

Figure 4. Bob Getsla's Rectifier Tester

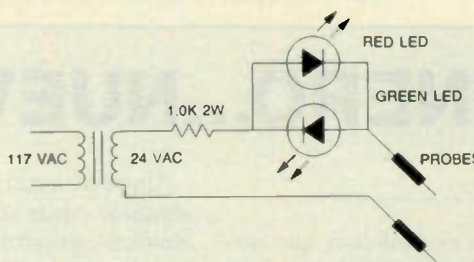

ple device, but when you have hundreds of diodes to test, anything to speed up the job is worth doing.

"I made this up with two probes and put the LEDs next to one of them so they were easy to see while I reached around to make contact with the units I wanted to test."

les, California (+1-818-502-5739) or Miami, Florida (+1-305-884-9664) office. If he is on the road, the Los Angeles number's voice mail gives his current number. Ideas, circuits, tips, hot rumors, hot news, whatever—if it applies to RF, he is interested!

Figure 1. Basic Circuit Temperature Sensor

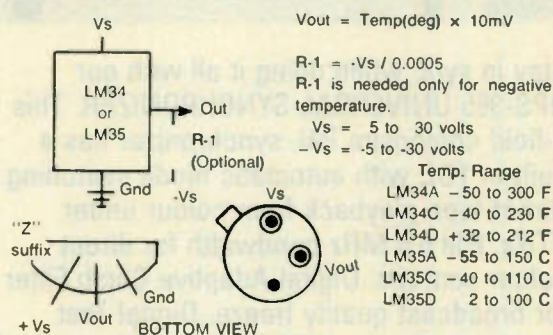

positive temperatures. I have used this circuit with an LM34 at K60EE in Odessa, Texas, where the sensor not only monitors temperature but also controls the room's air conditioner via a remote control unit.

Although I experienced no trouble with

Figure 2. Decoupling Sensor for Driving Capacitive Loads

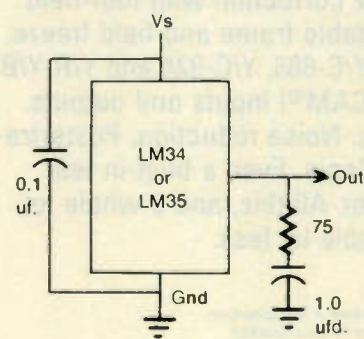

NOTE: This circuit may be used with R-1 as shown in Figure 1 or diodes as shown in Figure 3 for measuring negative temperature values.

this circuit, National Semiconductor advises decoupling the device from capacitive loads such as shielded cable.

Figure 2 shows a circuit with bypassing for RF as well as decoupling.

## Negative temperatures

There are two ways to measure negative temperatures. R1 in Figure 2 is optional. It goes to a negative supply -Vs. Choose R1 so that it equals -Vs divided by 0.00005. This will allow the LM34 to work down to -50 degrees F and the

# Hold the Camera Steady

(continued from page 21)

pistol grip that puts zoom and recorder start functions under your thumb.

To ensure that you and your camera can work together in well-balanced harmony, it is also important to learn how to control your breathing. Take a deep breath when you are ready to roll, exhale slightly, then hold it. When the shot lasts longer than you can hold your breath, breathe gently from the diaphragm. This shallow breathing does not move your ribs, eliminating another major source of unnecessary camera movement.

Steady images also come easier to videographers who are in good physical condition. Nothing is going to keep you steady when you are panting like a St. Bernard on a hot summer's day, out of breath from a short stroll down the street or a dash up a flight of stairs to catch a reluctant subject.

hotel bar can conspire to make you reach for something to steady yourself while looking through the viewfinder.

When that building in the corner of your finder starts bobbing up and down, it is time to either unsheathe your "sticks" or turn your shuddering shoulder into a temporary tripod. Lean against something solid—a door frame, a wall, a telephone pole—or lean forward and rest both elbows on a steady surface such as a table, counter top or car roof.

Sometimes the solution to the shakes is as simple as removing the camera from your shoulder. Hold it across your lap (excellent when shooting aerials from a small helicopter) or place it on the ground. I have had excellent luck grabbing impromptu long-lens shots by kneeling over my camera. A few small stones can be used as wedges to help frame the shot while a little downward pressure keeps things rock-steady.

John Premack has been chief cameraman at Boston, Massachusetts's WCVB-TV for 17 years, covering stories on a daily basis.

# Quality for generations to come.



Ultimate picture quality... advanced image processing... and lasting value. Now video professionals everywhere can own it all, with the new Model 1000 Digital Production Switcher.

Advanced component digital image processing gives you total transparency, generation after generation. A capability that makes the compact Model 1000 a tool of awesome value for post production, graphics, or telecine transfer. And speaking of value, serial digital technology cuts maintenance costs for years to come—who knows, maybe even for generations.

Call your GVG customer representative today for the whole story on the new Model 1000 Digital Production Switcher. Generations from now, you'll be glad you did.

## Grass Valley Group

A TEKTRONIX COMPANY

NORTH AMERICA Grass Valley, CA (916) 478-3000 SOUTH AMERICA Miami, FL (305) 477-5488

EUROPE Basingstoke, UK (0256) 817817 ASIA Hong Kong (852) 5987118 JAPAN Tokyo (03) 5992-0621

© 1992 The Grass Valley Group, Inc.

Circle 122 On Reader Service Card

# BUYERS GUIDE

ENG/EFP Cameras

## Ikegami HL-V55 Helps Cut Weight

by Graham Berry  
Cameraman  
Flying Camera Co.

**LONDON** Two years ago, I was asked to shoot a documentary series on classical music in Venice. The wonderful light blue water and its reflections, as well as the expressions of the locals, hadn't really changed since the artist Canaletto had painted there.

Having such an illustrious history, I wondered if I could do the city justice shooting on video, knowing the medium's limits of contrast ratios, etc.

### Stunning results

Fortunately, Ikegami had just released the new HL-55 camera, and the results were stunning. Ikegami U.K. pulled out all the stops to deliver an HL-55 in time for the start of the shoot.

The HL-55 utilizes Frame Interline Transfer (FIT) CCDs with 400,000 pixels and has an electronic six-speed shutter, giving it a superior dynamic resolution and making it ideal for slow motion

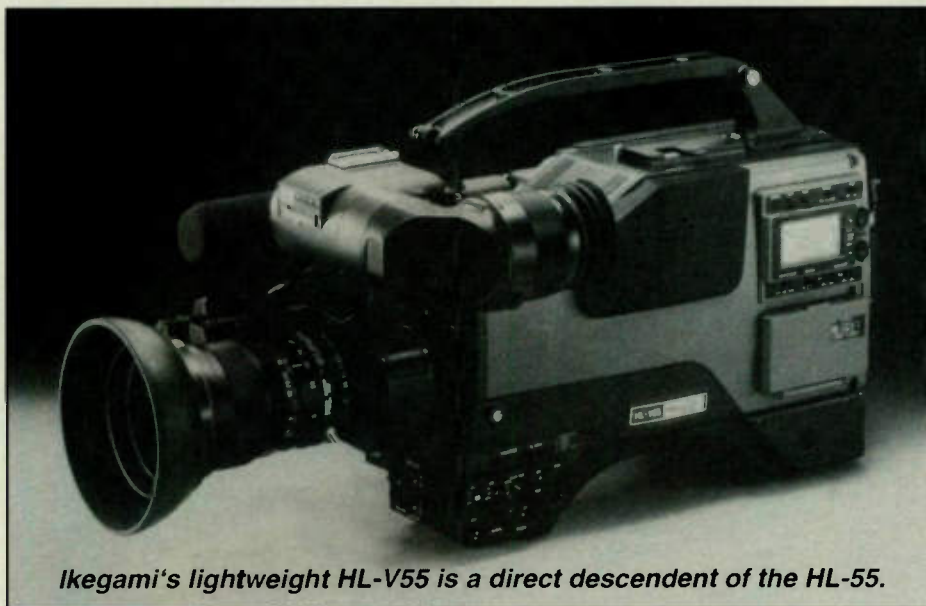

Ikegami's lightweight HL-V55 is a direct descendent of the HL-55.

Betacam SP recorder. It has a horizontal resolution of 700 lines and a light sensitivity of 2K lux at f/6.2. Signal-to-noise

is typically 62 dB.

Being a little nipper, it doesn't drink as much juice as its dad, so I feed it on the

Anton Bauer Compac Magnum 14, saving myself another two pounds.

In addition to its technical advantages, there is another reason to pay attention to this little camera: the people at Ikegami. Throughout our long history with the company, whenever a fault did occur (and that was rarely) the service team put 100 percent into my problem.

If they couldn't fix the problem instantly, they would lend a spare camera and fly in the part or engineer to fix mine.

*Editor's note: Graham Berry is an award-winning cameraman who specializes in high-speed and time lapse filming, aerial and underwater shooting, as well as broadcast and commercial work.*

*The opinions expressed above are the author's alone. For further information on the HL-V55, contact John Turley at Ikegami U.K. (telephone: +44-932-568966; FAX: +44-932-569-637), or circle Reader Service 38.*

## USER REPORT

work. With a horizontal resolution of 700 lines and a signal-to-noise ratio of 62 dB or better, the camera is designed for high sensitivity.

The high S/N ratio allows the gain to be cranked up to +24 dB, if necessary. And a minimum illumination of 10 lux is possible.

During the Venice shoot, I used low key lighting and a lot of candles during interior shots. The FIT chips are wonderful on the HL-55, with no smear or embarrassing lines from candle flame highlights, and the combination of Promists and Sepia filters helped give a very film look to the scenes.

Although the weight of the HL-55 is only 6.8 pounds, I find that as the years roll by, it becomes more and more difficult to do handheld work for long periods at a time.

A few weeks ago, I was out in Greece shooting a "QED" science documentary on ozone depletion and UVB radiation for the BBC. The shoot involved a lot of handheld work on the topless Greek beaches, and by the end of the week the combination of Matte Box, HL-55, Ampex CVR-5 recorder and Anton Bauer Magnum batteries had me visiting my, by now, financially well-off osteopath.

So, trying to be sensible and realizing that field work can be an old man's game with the right kit. The Flying Camera Co. just recently purchased the Son of Ikegami: the much lighter HL-V55 camcorder.

### Chip off the ol' block

The HL-V55 is a 400,000-pixel, 2/3-inch, three-chip FIT CCD model with a

## Broadcaster Chooses The Panasonic AQ-20

by Bill Weber  
Vice President,  
Technology and Engineering Admin.  
WHYY-TV

**PHILADELPHIA, Pennsylvania** When WHYY was looking to replace tube cameras in its Wilmington, Delaware, news operation and first-generation chip cameras in Philadelphia for EFP work, we evaluated a number of different cameras.

We finally selected six 3-CCD AQ-20 digital signal processing cameras from Panasonic Broadcast & Television Systems Co.

The AQ-20s were equal in performance to other top-ranked cameras we tried, and they offered some additional features and an attractive price as well. The station had already converted to M-II for program playback for broadcast, and we were pleased with the format. So we decided to dock the AQ-20s to Panasonic's AU-410 portable M-II videotape recorders.

### Up to the task

I have to admit that going into it, we had some reservations about the camera's ability to hold up in the field where heavy day-in, day-out use means they are subject to a good bit of abuse. Two years after the purchase, however, the AQ-20s have shown that our fears were groundless; the cameras have proved to be exceptionally

durable, with image quality, sharpness and color saturation that is phenomenal.

About half-a-dozen shooters based in Wilmington produce a 30-minute, in-depth "TV 12 News" for Delaware audiences on weekdays. In Philadelphia, five shooters work out of WHYY's Philadelphia broadcast operations, including Lynn Cates, whose camera work has made him a three-time Philadelphia regional Emmy Award winner.

Lynn does a lot of handheld shooting outdoors for programming like our "Spotlight" segments. These clips air

## USER REPORT

throughout the day along with numerous documentaries such as a recent one-hour "States of Mind" program on Philadelphia produced in conjunction with the BBC and offered to Public Broadcasting Service member stations nationwide.

One of the most useful features on the AQ-20 is the built-in black stretch switch, which produces very good pictures in high contrast situations. Without it, the camera operator has to choose between letting the background look blown out in order to get foreground highlights and shadows, or settle for a foreground silhouette to capture background detail. The AQ-20 seems to have a much better range and be much more forgiving in these situations.

The AQ-20 is almost at its best in low-

light situations when the lens is closest to a wide-open iris. In fact, lighting for interviews and room interiors can be kept at a fairly low level while still maintaining a good quality picture. During night shoots when it is not practical to bring in a battery of lights, putting the gain up to +9 dB delivers a picture that is very acceptable for any kind of programming.

### Through the viewfinder

The AQ-20 also has the ability to play video back through a monitor to verify shots and to run video to a number of outputs simultaneously. Furthermore, all the camera parameters can be read through the viewfinder, and time code can be jam-synced to another camera for editing accuracy later on.

The ergonomics of the camera also deserve high praise, and our engineering staff likes the remote control that plugs into the side to allow control of its parameters without opening up the camera. It is a great maintenance feature.

We have had virtually no problems with the AQ-20 in two years of use here, but when we have had to turn to Panasonic service, we have been very pleased with the response. Panasonic's board-swap program enables replacement boards to be shipped overnight, so our cameras can be back in business the next day.

*Editor's note: Bill Weber began his broadcast career at WHYY more than 25 years ago.*

*The opinions expressed above are the author's alone. For further information on the AQ-20, contact your nearest Panasonic representative.*



# AYUDA TÉCNICA DEL CAMCORDER DE SONY

por Roberto Plass  
Director Técnico

Nuestra Corporación de Televisión produce el 50% de la programación que exhibe a través de sus 70 estaciones a lo largo de Chile.

Para realizar esta producción se cuenta con un moderno Centro de Televisión, dotado de 10 estudios en los que se efectúan los distintos programas informativos, educativos y de entretenimiento, algunos de los cuales se exportan a otros países.

## Ayuda a la programación viva

Los tres Noticieros que se transmiten en directo gozan de gran aceptación por parte del público, constituyendo pilares

fundamentales para las 18 horas de programación que emite diariamente el Canal. La implementación técnica con que cuenta el Departamento de Prensa

del tamaño compacto, bajo peso y ausencia de cables de interconexión del BVW-300, hemos podido satisfacer plenamente los requerimientos de la Direc-

recientes Juegos Olímpicos de Barcelona y de la Feria Internacional de Sevilla en España, permitiendo lograr una excelente imagen, gracias a su alta resolución, mejor sensibilidad y buena autonomía.

El medio televisivo chileno vive un período de particular competitividad con la aparición de nuevas estaciones de Televisión, que han enfatizado en su progra-

## USER REPORT

mación la cobertura del noticias. Cabe destacar que nuestro canal mantiene la preferencia del público desde hace muchos años, de acuerdo a las mediciones de audiencia.

En las grabaciones en exteriores para telenovelas, género muy popular en Chile, se utilizan también seis camcorders BVW-300A que ofrecen una buena colorimetría, compatible con el resto del material grabado en nuestros estudios para la misma producción.

Cabe señalar finalmente, que nuestro programa de entretenimiento "Sábado Gigante," producto de exportación a varios países de habla hispana y los Estados Unidos, realiza sus producciones de exte-



Camcorder de Sony modelo BVW-300

comprende cuatro unidades móviles para transmisión en vivo de eventos periodísticos y 20 equipos portátiles de grabación.

Con el fin de lograr óptima calidad que fuera uniforme en todas las grabaciones en terreno, se decidió reemplazar los equipos portátiles de formato U-matic que operábamos (cámara y grabadora separadas), por nuevas unidades en formato Betacam. Para ello se adquirieron un total de 27 camcorders marca Sony, modelo BVW-300, las que se pusieron en servicio este año.

La incorporación del formato Betacam trajo consigo una notable mejoría en la calidad técnica de nuestras producciones en exteriores y añadiendo a ello las venta-

*Los BVW-300 se utilizaron exitosamente en la cobertura noticiosa de los recientes Juegos Olímpicos de Barcelona y de la Feria Internacional de Sevilla en España.*

ción de Prensa, en cuanto al desplazamiento de equipos para llevar a cabo reportajes.

### Destacándose en 1992

Los BVW-300 se utilizaron exitosamente en la cobertura noticiosa de los

teriores con estos mismos equipos de Sony.

*Las opiniones arriba expresadas son las opiniones personales del autor. Para más información referente al Sony BVW-300, póngase en contacto con el representante de Sony más cercano.*

## BUYERS GUIDE CALENDAR

TV TECHNOLOGY INTERNATIONAL

### JANUARY

Mobile, Remote & Satellite

### FEBRUARY

Video Recording

### MARCH

Test Equipment

### APRIL

Switchers & Station Automation

### MAY

Studio Cameras & Teleprompters

### JUNE

TBCs/Frame Syncs

### JULY

Antennas & RF

### AUGUST

Editing Equipment

### SEPTEMBER

Signal Processing

### OCTOBER

ENG/EFP Cameras, Lighting & Support

### NOVEMBER

Audio Equipment

### DECEMBER

Graphics & Animation

## STUDIO FURNITURE & INSTALLATION ACCESSORIES

General System Electronics  
Video Cassette Duplication Systems  
Audio & Video Jackfields  
19" Racking Systems  
Equipment Consoles

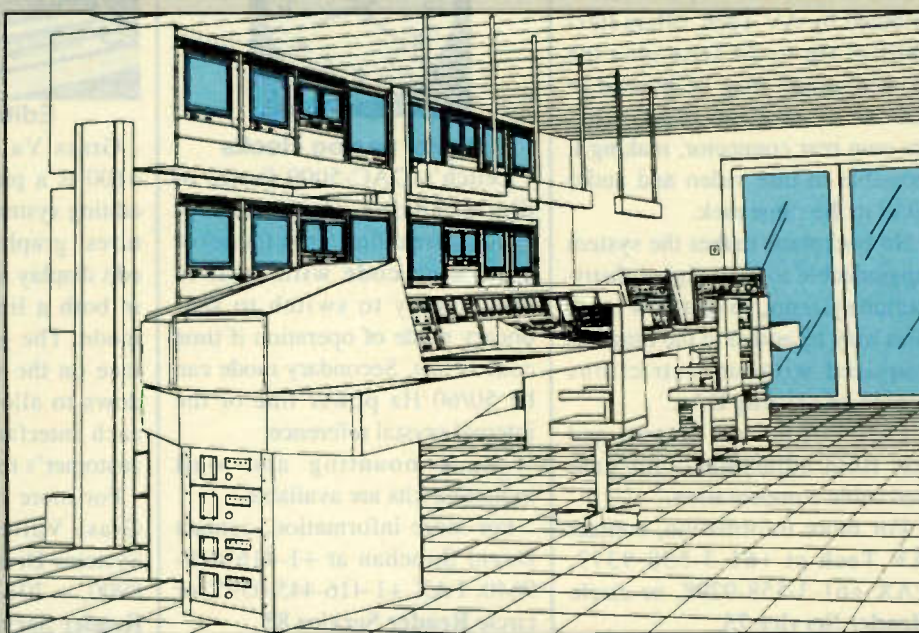

Language Dubbing Systems

Equipment Mounting Kits

AVSYS 3D Planning Software

Monitor Gantry



MW Video Systems Ltd, 64 North Street, Fritwell, Nr Bicester, Oxon OX6 9QR  
Tel: (0869) 345222 or (0869) 345272 Telex: 826715 AERO G Fax: (0869) 346002

Circle 56 On Reader Service Card

... highlighting the latest products available to professionals in the television industry.

# MARKETPLACE

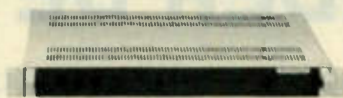

### Framestore synchronizer

Tekniche's TCF-1 is a broadcast quality component framestore and synchronizer with an internal 4:4:4 architecture allowing a full bandwidth GBR picture with the additional option of a key channel.

The device is switchable between 625 and 525 lines, and is contained in a compact one-rack-unit cabinet with a low power requirement.

The TCF-1 has full frame and field freeze capabilities, and both local and remote controls.

For more information, contact Tekniche at +44-81-756-0300, FAX +44-81-813-5162, or circle **Reader Service 54**.

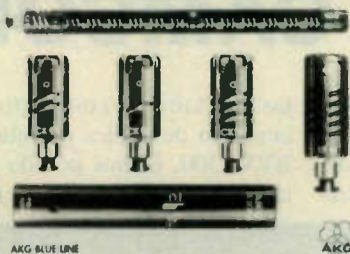

### Modular microphone system

AKG's Blue Line is a modular condenser microphone system that can provide maximum flexibility and ease of use for professional recording.

The system is comprised of one preamplifier, eight different microphone capsules, and a range of dedicated accessories.

For more information, contact AKG at +43-222-95-65-17-241, FAX +43-222-956517-205, or circle **Reader Service 92**.



### Graphics workstation

Spaceward Graphics' Pointstyle is an advanced 24-bit graphic paint system designed for use with a standard desktop personal computer (80286 or 80386-based machines). The Spaceward custom graphics card is at the heart of the processing, with sufficient video memory to store up to four full screen resolution images.

For more information, contact Spaceward Graphics at +44-353-741222, FAX +44-353-741216, or circle **Reader Service 84**.

### Console

Neve's new 55 Series analog broadcast console was designed to meet the needs of the television and radio industry. By drawing on a selection of building blocks, the individual user can personalize the configuration of a 55 Series console.

Frame sizes can be chosen between 24 and 56 inputs, with a selection of mono, stereo line input or stereo mic modules, which can be arranged in any order. Four rack units of space is included as standard, but the user can choose to incorporate additional 19-inch racking sections, and up to 10 group and output modules.

For more information, contact Neve at +44-763-85222, FAX +44-763-853500, or circle **Reader Service 22**.

### YUV digitizer

Amiga Centre Scotland's VLAB offers the Amiga A2000 and A3000 user the capability of capturing high quality images from live video sources such as videotape, video disk, cable TV, broadcast TV and video cameras.

Using its own 768 k buffer, VLAB digitizes a composite input signal in real time. The data in this buffer can then be transferred into the Amiga.

VLAB offers full AREXX support and can be controlled by any third party product which also supports AREXX.

For more information, contact Amiga Centre Scotland at +44-89-687-583, FAX +44-89-687-456, or circle **Reader Service 46**.

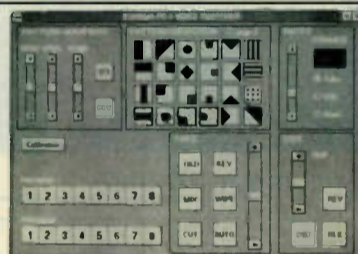

### PC-based switcher

The PC-1 switcher card from ECHOLab plugs into an IBM, is controlled by Windows 3.0, and can be driven by an edit controller.

The traditional switcher's front panel is replaced on the PC-1 by a "soft" front panel on the computer monitor in Windows.

The PC-1 is available in PAL and NTSC.

For more information, contact ECHOLab at +1-617-273-1512, FAX +1-617-273-3275, or circle **Reader Service 96**.

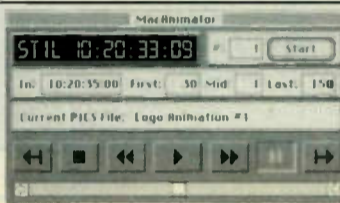

### Animation controller

The MacAnimator, from McQ Productions, is a software-based product for recording PICS animation and PICT file sequences onto videotape.

The device requires a Macintosh computer with 1MB of RAM and System 6.0.5 or later. For output of Mac-generated images, the system requires 5MB RAM, 32-bit QuickDraw, and a secondary video card.

For more information, contact McQ Productions at +1-415-348-1344 or circle **Reader Service 21**.

### Wireless receiver

Telex Communications' new portable wireless microphone receiver, the ENG-1, is designed for use with most video cameras or camcorders. The single channel receiver is available in one of four computer-selected frequencies for minimal interference. It includes both balanced and unbalanced outputs that interface to any audio system, as well as a squelch level control, audio level control, headphone output, headphone level control, line output control, and on/off switch.

For more information, contact Telex at +1-612-884-4051, FAX +1-612-884-0043, or circle **Reader Service 19**.

### Distribution amplifiers

Talia's E310 range of video and audio distribution amplifiers, distributed by AV Tech, offers flexibility. Up to 24 DAs plus the power supply may be housed in the same frame, and each DA has its own rear connector, making it possible to mix video and audio DAs in the same rack.

No backplane makes the system upgradeable to new digital distribution systems, so that new modules may be added to the range as required without restrictions placed on existing DAs.

Each DA has six outputs and has front adjustments for gain and cable compensation.

For more information, contact AV Tech at +61-3-558-9377, FAX +61-3-558-9298, or circle **Reader Service 75**.



### Digital analog clocks

Leitch's DAC-5000 Series of digital/analog clocks accept SMPTE (real time/drop frame) or EBU time code with built-in redundancy to switch to secondary mode of operation if time code is lost. Secondary mode can be 50/60 Hz power line or the internal crystal reference.

Rack-mounting and wall mounting kits are available.

For more information, contact David Strachan at +1-416-445-9640, FAX +1-416-445-0595, or circle **Reader Service 83**.



### Editing system

Grass Valley Group's Sabre 4100 is a picture-based, on-line editing system that combines pictures, graphics and text on the edit display screen. It can operate in both a linear and non-linear mode. The graphical user interface on the screen uses X-Windows to allow customization of each interface according to the customer's requirements.

For more information, contact Grass Valley Group Graphics Systems Division at +1-201-845-8900, +201-845-8063, or circle **Reader Service 58**.

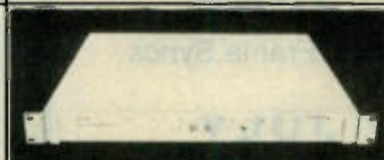

### Master sync pulse generator

Videotron's SPG-100 Master Sync Pulse Generator meets EBU D25 and RS 170A (NTSC) specifications. It is available in PAL B, NTSC, PAL M and PAL N versions. It features auto genlock input loss/presence indication, reliable SC/H phase, black burst output, color frame indication, normalized pulse outputs, normalized SC output, and front panel adjustment of H phase and SC phase.

For more information, contact Videotron at +54-1-298-1839, or circle **Reader Service 88**.

# Hitachi SK-F3 Gets High Ratings

## BBC-trained Production Engineer says Hitachi Camera Delivers Superior Image Quality and Reliability

by Richard Marcus  
Owner  
Marcus Productions Inc.

**NEW YORK** If producing the highest quality video is an objective, then the Hitachi SK-F3 is, in my opinion, the only currently available camera meeting this criterion.

I am a television production engineer, and I received my initial training at the BBC in Britain. I operate my own production and post production facility in New York City, hiring free-lancers when necessary.

### Survival instincts

My business survival rests on being able to offer high quality video, value for the client's money and reliable service. The choice of equipment is a vital concern, and not having the resources to follow all the current fads, I have to follow my own instincts. Therefore, I purchase equipment that will not only provide the highest quality, but will also be reliable and retain its specifications throughout its operating life.

My first experience with Hitachi cameras was in 1978, when I evaluated the SK-80 and was impressed by its ability to produce pleasing skin tones. After renting one for two weeks, I made the decision to buy.

A year later, at NAB, the SK-90 was introduced. This camera was the first to come equipped with the Hitachi-developed chips that fed more beam current during highlights and processed the resulting spikes of video into a soft knee. This camera was the first, to my knowledge, capable of handling specular highlights.

The SK-91 was the next improvement, and these cameras served me well, until I

had the opportunity to evaluate the SK-F3.

The SK-F3 uses three 2/3-inch frame interline imaging CCDs with 700 lines of resolution and 2,000 lux at f/5.6. Micro lens CCDs are available that increase the sensitivity by approximately one f stop. Signal-to-noise ratio is 62 dB and employs I, Q NTSC encoding.

### Skin deep

These specifications indicate that the F3 has the same performance as all the other cameras in its class. "Twere only so," as Shakespeare might have said. If specifications were the only consideration, then price and availability would be the only criterion and the decision would be simple.

Unfortunately there are other unmeasurable performance characteristics that make one camera more desirable than another. These criteria are very subjective and personal and not easily quantified.

*The lighting/camera people I work with are all impressed by the quality of the image and agree that the SK-F3 provides a picture that is the closest to the film look . . .*

The usual choice then depends upon what is in fashion: It used to be the "79," now it's the "400," next week it may be the "400A," perhaps the "F3."

In my opinion the SK-F3 provides the most pleasing picture of any camera I have ever encountered. The Hitachi designers have removed the CCD artifacts with elegant filter networks.

The available soft knee on the peak whites means that highlights are not unreasonably crushed, dare I say it, rather like film. The colorimetry gives a flattering skin tone and the subtle yet effective enhancement circuits provide a visually sharper image without that nasty cartoon effect so beloved by other manufacturers.

My corporate male clients do not like to use makeup, in spite of how much health-

## USER REPORT

ier it makes them look. With the SK-F3, this is not such a serious problem because the skin tone enhancement does not accentuate blemishes.

### Dark stretch

Another useful feature is the switchable contrast, which stretches the scene's dark areas.

Last summer we were taping a black person sitting under a tree with a white

SK-F3 has a number of available features. Among them are a variable masking adjustment that allows the SK-F3 to be color matched to another camera, and a pair of remote CCUs, one for color balance and iris control and a full CCU for a studio setup.

The camera can also have a Betacam or M-II VTR mounted directly on it, with controls on the camera for the VTR. Component R-Y, B-Y and RGB are available.

While these features provide for easier operation, it is the image quality that sets the SK-F3 above the rest. The lighting/camera people I work with are all impressed by the quality of the image and agree that the SK-F3 provides a picture that is the closest to the film look so far.

As well as performing as an engineer I also function as an on-line editor. I therefore have to live with the results of my video long after the shoot is completed.

I now have three SK-F3 cameras and have experienced no down time. The other Hitachi cameras I have owned have been similarly reliable.

If you have a soft spot for the look of an original Technicolor movie and would rather shoot 25 ASA Kodachrome than any other slide film, then you will understand my opinion of the look of this camera.

*Editor's note: Richard Marcus has worked in the video industry for 39 years. He was a video production engineer for the BBC before coming to the U.S. in the mid-1960s. He founded Marcus Productions in 1981.*

*The opinions expressed above are the author's alone. For additional information on the SK-F3, contact Tony Delp at Hitachi (telephone: +1-516-921-7200; FAX: +1-516-496-3718), or circle Reader Service 18.*

## PRODUCTS & SERVICES SHOWCASE

For more information on the products shown below, circle the appropriate Reader Service No.(s) on the enclosed Subscription/Reader Service card or contact the advertiser directly.

### PROFESSIONAL VHF/UHF ENG SYSTEMS



The MARK QDC systems are designed with your high quality, professional ENG needs in mind. The QDC is available in both VHF and UHF frequencies (72 to 470 MHz) to allow you the frequency flexibility you need to have uninterrupted RF transmissions.

**Swintek** 965 Shulman Ave. / Santa Clara, CA 95050  
(408) 727-4889 / FAX (408) 727-3025

READER SERVICE NO. 10

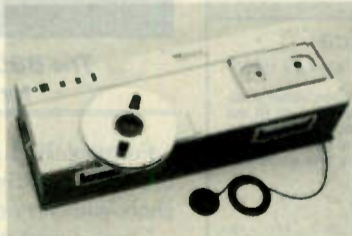

WEIRCLIFFE has over 27 years experience in the design, manufacture and distribution of specialised Magnetic Media Bulk Erasure/Degaussers worldwide.

For an insight into magnetic theory, how to choose the correct Eraser for your application, the company history and details on our complete range, send our complete range, send our "Product Overview Pack".

**Head Quarters/Casa Central:**  
Weircliffe International Ltd  
Exwick  
EXETER EX4 2AG  
UNITED KINGDOM  
Tel: (+44) 392 72132  
Fax: (+44) 392 413511

WEIRCLIFFE tiene 27 años de experiencia en el diseño, fabricación de equipos magnéticos, borradores/desmagnetizadores especiales de ámbito mundial.

Para profundizar en la teoría del magnetismo, cómo elegir el borrador idóneo para la aplicación que Vds. precisen, la historia de la compañía y detalles de toda nuestra gama, solicite pues ahora nuestro "Product Overview Pack".

Weircliffe USA  
2752 Walnut Avenue  
Tustin  
CA 92680, USA  
Tel: (714) 838 8833  
Fax: (714) 838 9619

READER SERVICE NO. 64

### Metal Tape Degausser



ERASES ALL TAPE FORMATS INCLUDING:  
BETA SP - MII - D2 - 1" Reels

OPERATES FROM A STANDARD 115 VOLT OUTLET.

**AUDIOLAB ELECTRONICS, INC.**

5831 Rosebud Lane, Bldg. C  
Sacramento, CA 95841  
Fax 916-348-1512

**916-348-0200**

READER SERVICE NO. 24

# World Bank Counts on Toshiba

by Scott Yann  
 Producer  
 World Bank

WASHINGTON, D.C. I have been in video production at the World Bank's Training Division for about nine years—long enough to have a clear vision of our production needs and to have seen innovations in the technology.

When we first set up our video service in 1983, my basic production objective was to produce role modeling dramatizations for our management trainers. For these productions I was content with having an industrial level base of operation.

### Expanded needs

Since then, however, we have diversified the productions that we offer and the means by which we produce them. For example, I now produce documentaries for our orientation programs and "how-to" videos for our computer trainers. I also offer multiple camera, live switched coverage of forums, interviews and discussions.

Our video productions start with shooting in the field, and this means that our production equipment must be mobile.

Last December we began to buy equipment to replace older systems. I needed to tailor the purchases to our need for producing live switched as well as scripted/edited videos. For this capability I needed both portable and versatile equipment.

I selected two Toshiba TSC-100's.

The Toshiba offered the most in picture quality and durability within an industrial level budget. The picture quality is fan-

cameras when shooting live events, and I benefit enormously from the ease of setting up and operating the TSC-100. For connectivity to the switcher, the TSC-100 offers the genlock capability that I need, providing for synchronization to VBS and BBS signals.



World Bank uses the Toshiba TSC-100 for its training videos.

I cannot light most live events, but the Toshiba's low light capability results in good quality video. I also record back-up video and audio on the TSC-100's Hi8 recording deck during these events.

I do not like anything but XLR audio connectors, and Toshiba has provided these. I also like being able to attach our Sennheiser shotgun microphone to the built-in microphone mount.

One disadvantage of the TSC-100 is the lack of a line level audio input to feed audio from external PA systems on one of the two stereo audio channels.

### Easy integration

The Toshiba camera also fits in well with our existing equipment and has

helped in updating our technology. Since I already have a Sony VO-8800 portable 3/4-inch, I can use the same batteries and charger that I already have.

I am still mastering in 3/4-inch and I prefer shooting 3/4-inch when possible. For this purpose, I would have preferred that the Toshiba have a camera cable connection.

This is not a considerable problem, however. It means I have to power and operate the 3/4-inch deck and the camera separately, which I usually do anyway. I can also record with the on-board Hi8 deck.

The TSC-100 offers more than I thought our budget could provide. I selected this camera because of its picture quality, portability and versatility. It works well where the video always originates in the field and when I must provide a wide range of service.

The Toshiba integrates easily into our present system and provides enhanced features such as the portability of the Hi8 format.

And, by the way, the clients are happy.

*Editor's note: Scott Yann has been working in A/V production for nine years. He has a BA degree from the University of Maryland.*

*For further information on the TSC-100, contact Mark Dziekan at Toshiba: (telephone: +1-708-541-9400; FAX: +1-708-541-1927), or circle Reader Service 63.*

# BBC Puts Thomson Camera to the Test

(continued from page 1)

We shot a children's drama called "Uncle Jack" with a lot of varied location work that really put the cameras to the test. Segments were shot on location and then intercut with studio-based shots, resulting in excellent pictures.

One particular outing was near Loch Lomond in Scotland. At the time, we were not too familiar with the Thomson cameras, and, to make matters worse, it rained throughout the three-day shoot in true Scottish fashion, forcing us to use a camera cover.



The BBC took Thomson 1647s to Scotland for an on-location drama shoot.

Fortunately, I felt at ease with the camera very rapidly and got some beautiful shots with very true-to-life colors.

I have found the contrast handling of the 1647 to be very good. A typical situation is shooting actors against a light sky on location. In earlier days, we had to use a lot of fill light from the front to neutralize, but this always created a false look to the picture.

The 1647s are designed to cope very well with this sort of shot and allow us to use a much lower level of fill, giving a much more natural look.

### Day into night

In another situation, I had to shoot from inside a small structure that we built from woven fencing material. The shot was of a daylit scene outside, but included some of the doorway in the unlit interior. The camera circuitry coped with the extreme

contrast range, and we got the shot we wanted.

Two important areas that camera manufacturers often fail to address properly are the white balance memory and the reliability, accuracy and repeatability of

## USER REPORT

the zebra exposure indication in the viewfinder. On a typical daylight location, one of the remaining problems is providing some way to see the pictures coming out of the camera under ideal viewing conditions.

We don't want to have to bring along a mobile truck just to get a dark area with a decent color monitor to check the exposure and white balance. And we don't have the time or facilities to play back and appraise.

For us, the only way to check the video is to put our trust in the zebra and the white balance, and in this respect, the 1647 has been good to us. Of course, in all zebra patterns, there is a tendency

to obscure major elements of the picture in the viewfinder.

The Thomson 1647 CCD camera is a good, rugged and reliable camera that has allowed us to extend our skills in realistic location recording and to give us handheld shots in the studio that we could not achieve with heavier cameras.

Most importantly, it has let us get on with the business of producing the best-looking picture that we know how.

*Editor's note: Nigel Saunders began as a trainee cameraman at the BBC TV Centre 14 years ago and has worked on a number of the network's most popular shows.*

*The opinions expressed above are the author's alone. For further information on the TTV 1647, contact Mel Noonan at Thomson Broadcast (telephone: +44-753-581122; FAX: +44-753-581196), or circle Reader Service 13.*

## USER REPORT

tastic at 700 lines horizontal resolution and clean at 62 dB signal-to-noise.

Clients often remark on the sharpness of the picture, and the optical clarity of the Canon lens adds to the look.

The hard metal camera body is strong enough to withstand being constantly on the road.

I sometimes bring in extra help to run

USE THIS FORM IF THE SUBSCRIPTION/READER SERVICE CARDS BOUND INTO THIS ISSUE ARE MISSING

## TV TECHNOLOGY

FREE Subscription/International Edition

I would like to receive or continue receiving TV Technology FREE each month.  Yes  No

Signature \_\_\_\_\_ Date \_\_\_\_\_

Please print and include all information:

Name \_\_\_\_\_ Title \_\_\_\_\_

Organization \_\_\_\_\_

Address \_\_\_\_\_

City/Province \_\_\_\_\_

Postal Code \_\_\_\_\_ Country \_\_\_\_\_

Please circle only one entry for each category:

### I. Type of Firm

- A. VHF-TV station
- B. UHF-TV station
- D. Prod/post-prod studio
- E. Cable TV
- G. Network/group owner
- J. Broadcast consultant mfg, dist, or dealer
- L. Corporate TV facility
- M. Medical TV facility
- N. Government TV facility
- P. Educational TV facility
- Q. Recording studio
- K. Other (specify): \_\_\_\_\_

### II. Job Function

- A. Corporate mgt
- B. Engineering/tech mgt
- C. Engineering/tech staff
- F. Other (specify): \_\_\_\_\_
- D. Prod/oper mgt or staff
- E. News mgt or staff
- G. Training

### Reader Service

December 1992 Issue Use until April 1993

Use this card to receive free information about products or services advertised in this issue. First fill out the contact information to the left. Then find the Reader Service number printed at the bottom of each advertisement you are interested in, and circle that same number below.

01	02	03	04	05	06	07	08	09
10	11	12	13	14	15	16	17	18
19	20	21	22	23	24	25	26	27
28	29	30	31	32	33	34	35	36
37	38	39	40	41	42	43	44	45
46	47	48	49	50	51	52	53	54
55	56	57	58	59	60	61	62	63
64	65	66	67	68	69	70	71	72
73	74	75	76	77	78	79	80	81
82	83	84	85	86	87	88	89	90
91	92	93	94	95	96	97	98	99
100	101	102	103	104	105	106	107	108
109	110	111	112	113	114	115	116	117
118	119	120	121	122	123	124	125	126
127	128	129	130	131	132	133	134	135

Telephone \_\_\_\_\_  
 FAX \_\_\_\_\_

Send to: TV Technology, PO Box 1214  
 Falls Church VA, 22041 USA

Copy & Mail

# EQUIPMENT EXCHANGE

TV Technology's Equipment Exchange provides a FREE listing service for all broadcast and pro-video end users. Brokers, dealers, manufacturers and other organizations who are not legitimate end users can participate in the Equipment Exchange on a PAUD basis. Call 1-703-998-7600 for details. Submit your free listings on your letterhead and state the make, model number, a brief description, sale price and complete contact information and mail it to: TV Technology, PO Box 1214, Falls Church VA 2041

## ANTENNAS & TOWERS

### Want to Sell

Rohn 80 400', new w/lighting kit, guy wire & anchors, 40' face, galvanized, solid rod construction, FAA code paint. D Scholten, WXMI, 3117 Plaza Dr NE, Grand Rapids MI 49505. 616-364-8722.

## VIDEO CAMERAS

### Want to Sell

Pana WV-6000 single tube, high res, 12:1 zoom lens, case, charger, batts, cables, low hrs, great shape. Ray, Morning Star, 159 Sawyer Ave, Babylon NY 11702. 516-422-9445.

Sony DXC-M3AK w/15:1 Canon lens, excel cond, \$2500; JVC KY-1900 w/10:1 Tamron lens, very gd cond, \$1500; matching S-VHS & 3/4" port VCRs. F Soo, Quality Video Prod, 18464 Ash Creek Dr, Mt Clemens MI 48044. 313-228-1600.

Sony EDP-10F 2-chips, 550 TV line, CA-10F adap, variable shutter spd, up to 1/2000 sec, Fujinon 1:1 7/10-130 mm lens, VTR cable, low hrs, \$1650. I Shadaram, ComCast Cable, 201 8th St, Seal Beach CA 90740. 310-799-7619.

Ikegami ITC 730 w/Canon J11x10 lens w/zoom & focus rear controls, tripod, O'Connor hd & mtg plate, VTR cable & new tubes in thermo case w/manual, \$1500. D Greenless, 1497 Pine Meadow, Lexington KY 40504. 606-254-5141.

Ikegami HL-792 dockable plumbicon, very gd cond w/Fujinon 14x2 zoom, \$5000. A Panatoni, Total Video, 432 N Canal St #12, San Fran CA 94080. 415-583-8236.

RCA TK-76 w/plumbicons, Schneider 15:1 lens, \$2500, lens only, \$900, excel cond, low hrs. G Fox, 804-868-9351.

JVC and other cameras & accessories new & used, bought, sold & traded. Call John, 212-355-7540

Hitachi FP-21 tube, overhauled w/case, cables, pwr sply, tripod plate & svc manual, lens & tubes exc cond, no scratches/burns, \$950. Chris, WAG Prod, POB 1901, Tucson AZ 85701. 602-620-1934.

Pana WV 555B EFP pckg w/AC adap, batts, mic, tripod plate, cables, orig case, few hrs, excel cond, \$1200. Conrad, 618-457-8271.

Ikegami 730 gd cond, no bum, 16:1 w/Fuji Eagle lens, 1 1/2 viewfinder, 5" B&W mon, control cables, tripod plate, hard case, Anton brckt, manuals. \$1700. M Ferguson, Pumpkin Creek Video, 520 Coffey Ave, N Wilkesboro NC 28659. 919-667-7171.

Hitachi Z31P (4) w/plumbicon tubes, (4) cases, (3) CCU opZ-31, (3) 100' multicore cables, (3) 5" viewfinders, \$16K. R Brown, 713-473-5585.

Sony V101 Hi8 camcorder & underwater housing, new cond, extras, \$1500. S Stames, United Rentals, 4300 Manchaca, Austin TX 78704. 512-444-3287.

Anton Bauer LFC batt chgr, \$450; Life-saver 4-pos quad quick chgr, \$675; Magnum Quad Logic Series, \$950. R Burks, 908-287-3626.

Sony DXC 325 3-chip w/Hi8 EVV 9000 deck w/manual & case, \$4975. L De Salvo, LD Video Prods, 2048 W Jericho Tpke, Huntington Sta NY 11746. 516-385-0128.

Sharp XC-800 clean w/Fujinon lens w/2x. \$1200. G Hultman, Hultman Media Svcs, 300 Limp Creek Rd, Grants Pass OR 97527. 503-474-6466.

Canon VCL-810BX 8-80 servo lens for Sony DXC 325/327 1/2" hot shoe, new, \$500/BO; Sony EVO-9100 hi-8 1-chip indus w/lime code, ssxshoulder brace, 2 new batts, AC adap, chgr, 2 Tiffen filters, \$1300/BO; Sony CA-325 adap for DXC 325/327, very gd cond, \$500/BO. T Bugajski, 719-543-4832.

Sony EDB-10 2-chip w/13x1 Fujinon lens, back, cable, tripod, plate, \$1500; Pana AG7400 port, rec deck, low hrs, \$1100. A Cohen, ACE Video Prods, 509 Ross Pl, Oceanside NY 11572. 516-536-0606.

## Video Head Refurbishing

High Quality  
Compatible Performance

All 1" C-Format  
2" Quad

COST EFFECTIVE

(719) 591-5757

FAX: (719) 591-0027

VIDEOMAGNETICS, INC.

Circle [79] On Reader Service Card



## MOVIE PROD EQUIP

### Want to Sell

Eastman 285 (2) projectors w/options & non-PCB compoents, \$495 ea/\$800 both + s/h. D Shauerberger, KVIQ, 1800 Broadway, Eureka CA 96601. 707-443-3061.

Moviola 4-gang 16mm synch, \$300; Moviscop 16mm viewer, \$225. G Odell, 203-296-2972.

Eiki EX4000P 550 W Zenon 16mm proj, very low hrs w/50/65/75/100 & 75-1.25mm zoom lenses, ATA case, \$1500/BO. Steve, Technicalities, 2340 Chamblee Tucker, Atlanta GA 30341. 404-986-9317.

## SWITCHERS

### Want to Sell

Pana WJ-MX10 exc cond w/manuals, multi-source w/FFF, \$850. R Pahl, Pahl Vid Prod, POB 669, Pt Arena CA 95468. 707-882-3112.

Crosspoint Latch 6119 new, \$2000. S Grushkin, WPS, 101 W Plume St, Norfolk VA 23510. 804-623-9440.

Datatek D2000 25x25, 1 video, 2 audios, master xy controller, 8 buss contr & 2 single buss contrs, exc cond, \$5500/BO. D Nobles, 404-978-1299.

Pana WJ-MX12 3 mos old, excel cond, \$1475/BO. B Knevit, Pro Video Prod, 4725 E Summit, Muskogee MI 49444. 616-788-4942.

Pana WJ-5600 SEG w/8 inputs, 3 busses, AC/DC, var wipes, chroma keyer, DSK, intercom syst, like new, \$3100. J Briggs, Cmd Post, 538 SE Ash, Portland OR 97214. 503-235-0845.

GVG 1400-7 DESK, 21 input, 2 M/E, drop shadow, 6 aux busses, 2 chroma keyers, \$5000/trade small Sony + cash. G Fox, 804-868-9351.

Shintron 370, \$80+s/h. C Burke, Chnl 19 MRHS, Atlantic Ave, Aberdeen NJ 07747. 908-290-2840.

## TRANSMITTERS/EXCITERS

### Want to Sell

**USED TV TRANSMITTERS**  
antennas, STL, cable, rigid line, etc.  
one watt to 120 kW.  
Fair market price paid.  
**BUY-SELL**

**BROADCASTING SYSTEMS**  
602-582-6550  
FAX: 602-582-8229  
Kenneth Casey

Circle [50] On Reader Service Card

## VIDEO PRODUCTION

### Want to Sell

SWony 8800SP very low hrs, mint cond, \$200. Y Zohar, 310-659-2054.

Leitch Proc VPA-331 new, \$3800; Datuum Corp time code readers, rack mount, high spd, red LED display, \$750 ea. G Fox, 804-868-9351.

Chyron IV dual-chnl CG, Sony DXC-M3, head only, TK44 systems/parts, system concepts CG. M Saffell, Trinity Teleprod, 1612 WTVSC, Canon OH 44708. 216-453-0650.

**USED EQUIPMENT:**  
The largest dealer in the USA. We buy, sell, consign, locate & trade used equipment. Pro Video & Film Equipment Group, Dallas. 214-869-0011. FAX: 214-869-0145.

Ampex ADO-100 w/image innovator, 3D, manuals, exc cond, \$20K. R Zeglin, Complex Video, 6444 Ridgeway, Lincolnwood IL 60645. 708-673-5400.

Convergence 195 L/M A/B roll edit controller w/list mgmt chip, time code gener, 3 time code readers, 3 Sony VO-5850/5800 interfazes & set up/svc manual, \$2995. G Strother, Light Images, 490 Ogden Canyon, Ogden UT 84401. 801-621-0084.

Pana AG-7500A. AG-7510, WJMX-12 AV switcher, FOR-A dual TBC, FOR-A VTW22S S-VHS CG, 3 mons, Pana 300 CLE camera w/dockable S-VHS rec, tripod, batt belt, lights, \$20K/BO. J Thome, 816-841-5206.

Sony GCS-50 (2) super Beta edit decks w/GCS-1 contr, low hrs, works great, \$3000. J Briggs, Cmd Post, 538 SE Ash, Portland OR 97214. 503-235-0845.

Sony BVE-500A (2) edit controllers, trade for AV gear. B Barrett, Barrett Prods, 1945 McDonald, Missoula MT 59801. 406-542-2563.

DVE CEL-P-142 frame synch, exc cond w/dig effects & A/B/C switcher, spins, \$2200; Sony batt chgr, 6 pos w/Triconn conn for BP-90 batts/Gel-cells, \$450. R Burks, 908-287-3626.

**RIDICULOUSLY LOW COST TELEPROMPTING** For Your PC!  
COMPLETE SYSTEMS FROM \$950  
ORDER NOW 602-778-6988  
Stewart Instruments, Inc.  
Box 11926; Prescott, AZ 86304

Pana NV-9600 editing syst w/rec, NV-9240 feeder, NV-A960 controller & cables, very gd cond, \$1700/BO. R Jensen, Telecable Prods, 5812 21st St, Racine WI 53406. 414-632-3131.

Laird 3600A char gener, dual 16-pg memory, unld storage via data cass, 2 output chnls, 2 font sizes, full surround edging, drop shadow, Genlock/downstream keying, \$300. G Odell, 203-296-2972.

Sony VO-8800 3/4 SP, 200 hrs, gd cond, Portabrace, 2 batts, \$2400; JVC KM 1200 4-input switcher, \$1200; Pana WV 555 camera, batt, chgr, hard case, cable w/10/14-pin, \$1200; RM 450 edit contr, \$1400. M Ferguson, Pumpkin Creek Video, 520 Coffey Ave, N Wilkesboro NC 28659. 919-667-7171.

## GENLOCK YOUR SYSTEM BLACK-BURST SYNC, AUDIO TONE \$289

Need to genlock your video system? The BSG-50 from HORITA generates black-burst, composite sync, and a 1 kHz audio tone. Provides 6 separate outputs of any mix of up to 4 each of RS-170A black or sync. Also provides subcarrier, blanking, drive. UNCONDITIONAL GUARANTEE. Contact your local video dealer or

HORITA, P.O. Box 3993, Misslon Viejo, CA 92690 (714) 489-0240

Circle [11] On Reader Service Card

## VCRS/VTRS

### Want to Sell

Sony BVW-10/VO-5850 edit package, \$12500. G Allen, Rainbow Video, 4807 Pipestone, St Louis MO 63129. 317-894-5536.

Pana AU65 MII studio edit rec, low hrs, 4-chnl audio, \$9200; AU63 MII studio editing source plyr w/auto tracking, low hrs, 4-chnl audio, \$9200. Greg, AVS, 19 Roots Ln, Oswego NY 13627. 607-687-0545.

Sony VO-5600 U-Matic, new, \$1200; Ampex VPR-2B, 1800 scanner hrs, AST, TBC, sync head, TC gen/reader, dolby, \$9000 ea. G Fox, 804-868-9351.

Pana AG07400 (2) w/cases, excel cond, \$1700 ea; Pana NV-9400 3/4"port VCR

a/AC supply & batt, very gd cond, \$500. F Soo, Quality Video Prod, 18464 Ash Creek Dr, Mt Clemens MI 48044. 313-228-1600.

Sony VO 6800 (2) 3/4" port w/Porta Brace 600D, working, \$975; JVC 4700 3/4" w/Porta Brace, less than 100 hrs, \$775; Pana WJMX 10 AV SEG, like new, less than 50 hrs, \$975; Pana WJ5600 SEG, \$3875; (2) Pana NV8500 1/2" VHS editors w/NV A500 edit contr w/cables & dub conn, \$2500, Ikegami ITC 730A 15x1 Canon lens w/cable for 3/4" & 1/2" VTRs, \$1975.

Sony BVH-1000 1", gd shape w/BVT-1000 TBC, nds audio bias board repair, \$6500. C Tobin, Tobin Cinema Systems, 3227 49th Ave SW, Seattle WA 98116. 206-932-7290.

Sony BVH-1100 w/BVT-2000 TBC, gd cond w/maint records, \$7000. D Holt,

WOFL, 35 Skyline Dr, Lake Mary FL 32746. 407-644-3535.

JVC 8250U, 6650U, 150 hrs, mint, \$3500 both; TEAC V-4200 G/N slo/mo, \$500; (2) Hitachi KS90, nds work, \$600 ea. S Grushkin, WPS, 101 W Plume St, Norfolk VA 23510. 804-623-9440.

Sony BVU-1000 w/TC, \$600. D Risenfeld, 312-733-4715.

Sony BVV-5 Betacam SP, 700 hrs, exc cond; BVP-7s; BVW-50, BVP-5s; BVE-910. R Zeglin, Complex Video, 6444 Ridgeway, Lincolnwood IL 60645. 708-673-5400.

Pana (2) NV-8500 w/control cables; (2) Pana NV-9000 3/4" U-Matic w/control cables; Pana NVA-500 edit contr, \$3500. R Burks, 908-287-3626.

JVC CR 6060-U 3/4 U-Matic R/P, gd cond, \$150+s/h; Sony VP-1200 3/4 U-Matic R/P, \$75+s/h; RCA VDT 102 VHS R/P, \$45+s/h. C Burke, Chnl 19 MRHS, Atlantic Ave, Aberdeen NJ 07747. 908-290-2840.

JVC 4900 3/4" port w/2 batts & chgr, AC adap, \$1350; Sony VO6800 3/4" port, \$1300, both exc cond. Sony VO4800 3/4" port, gd cond, \$450. E Stevens, 215-889-9676.

Sony VP5000, mint, \$1000; VP5020, 7020, mint, \$850; (3) 2860, clean, \$500 ea; (2) RM580 rem w/jogging wheel, \$350 ea; RM330, \$150; VO4800, \$500. S Grushkin, WPS, 1001 W Plume St, Norfolk VA 23510. 804-623-9440.

## services

## BCS World's #1 Dealer Used & New Video Equipment

Buy • Sell • Consign • Service

In stock Pal & NTSC Over 3000 items in inventory. Call for a catalog and save.

London 081-810-9055  
California 818-845-7000  
New York 212-268-8800

**This Space Available**

Call Caroline at +1-703-998-7600

## ACTION-GRAM

### Equipment Listings

Please print and include all information:

Contact Name \_\_\_\_\_  
Title \_\_\_\_\_  
Company/Station \_\_\_\_\_  
Address \_\_\_\_\_  
City \_\_\_\_\_ Postal Code \_\_\_\_\_  
Country \_\_\_\_\_

I would like to receive or continue receiving TV Technology FREE each month.  Yes  No  
Signature \_\_\_\_\_ Date \_\_\_\_\_

Please Circle only one entry for each category:

### I. Type of Firm

- |   |                            |
|---|----------------------------|
| A. VHF-TV station                             | L. Corporate TV facility   |
| B. UHF-TV station                             | M. Medical TV facility     |
| D. Prod/post-prod studio                      | N. Government TV facility  |
| E. CATV company                               | P. Educational TV facility |
| G. Network/group owner                        | Q. Recording studio        |
| J. Broadcast consultant, mfg, dist, or dealer | K. Other (specify): _____  |

### II. Job Function

- |                           |                           |
|---------------------------|---------------------------|
| A. Corporate mgt          | D. Prod/oper mgt or staff |
| B. Engineering/tech mgt   | E. News mgt or staff      |
| C. Engineering/tech staff | G. Training               |
| F. Other (specify): _____ |                           |

Brokers, dealers, manufacturers and other organizations who are not legitimate end users can participate in the TVT Equipment Exchange on a paid basis. Listings are available on a \$1.75/word basis. Call 1-703-998-7600 for details and complete display rates.

WTS:  Category: \_\_\_\_\_  
Make: \_\_\_\_\_ Model: \_\_\_\_\_  
Brief Description: \_\_\_\_\_  
Price: \_\_\_\_\_

TV Technology Equipment Exchange  
PO Box 1214, Falls Church, VA USA 22041  
Phone: +1-703-998-7600 FAX: +1-703-998-2966

# JVC X1 Enhances Small Productions

by Jack Morocco  
Director  
SANNO Institute of Management

**TOKYO** When I first proposed an in-house video department to SANNO management, I was looking for a system that would not be priced too high, but would enable me to produce high quality, impressive teaching videos.

Approximately 20,000 business, industry and public sector organizations take advantage of our vocational and professional training programs.

## Two-man show

What I had in mind was a radically simplified production team, essentially a two-man show with myself as director/editor and a cameraman.

I decided to choose a video camera that was as simple to use as possible, allowing the operator to concentrate on perfecting his creative eye, as well as camera moves and composition.

I selected the JVC X1 (the GY-XITCUL14 in Japan). As I saw it, this was a truly professional video camera with full capabilities, but was also fully programmed and automatic like an amateur camera.

In use, the X1 is just "point and shoot," as my cameraman puts it, meaning camera settings and adjustments are reduced to a minimum.

For example, we have found that the gain can be set at +6 dB and left there. After dialing the filter turret to select the proper filter, either for outdoor use or indoors with fluorescent lights, all that is needed is a quick white balance check before each take.

We have found that indoors, all the offices and schoolrooms in Japan are so evenly lit that additional lighting is

unnecessary with the X1. Freed from having to set up, move and readjust lights, our takes have a feeling of reality.

## Wheelchair effects

This flexibility has allowed us to use a wheelchair for some rather impressive

## USER REPORT

dolly shots, which have enhanced the effect of our small productions and have given them the feel of the big screen.

I edit the Professional S-VHS cassettes on a JVC 22 Series A/B roll edit system

# BTS Performs for SJC

by Tom Johnson  
Co-President  
SJC Video Corp.

**VALENCIA, California** When SJC Video acquired its first BTS LDK-91 cameras in July 1990, it was a natural progression, as we have been using eight LDK-90s since September 1988.

The 91s, as the 90s before them, have been excellent performers. Our primary business is sitcom production for major studios in Hollywood where picture quality is extremely important.

The 91, with the BBC matrix, produces excellent colorimetry and a very sharp picture without an "electronic edge." It has a more film-like look, thanks to great detail circuitry.

Camera matching is a piece of cake, and the cameras are very stable. Our cameras are in a mobile unit that usually spends Monday and Tuesday at one studio and moves to another for Thursday and Friday.

using three BR-S822U video recorders and the RM-G860U editing control unit. Our titles are mostly created using the JVC KM-D600U digital effects generator, together with a JVC camera/copy stand, which, although inexpensive, can create some spectacular title zooms. Our credits are created on a JVC "Isis" character generating computer.

Overall, I feel unencumbered, "point and shoot" camera work leads to results that are very realistic. This, along with careful editing, gives us just the effect we were looking for, which is ideal for the type of videos we create.

*Editor's note: Jack Morocco is originally from Honolulu, Hawaii, where he operated an advertising agency for 16 years.*

*The opinions expressed above are the author's alone. For further information on the X1, contact Gene Ide at JVC (Phone: +3-3246-1139; FAX: +3-3245-1614/1402), or circle Reader Service 12.*

Typically, the video engineer will set the cameras up for the look of the show at the beginning of the season, and the 91s don't require daily tweaks to maintain the look even though they are powered up and down and moved. There are two switch selectable gamma settings, so each show can have its look at the flip of a switch.

## USER REPORT

ENG work often requires shooting in low light, and the same is true in sitcom production, but it is for dramatic effect and there are no compromises. The picture must maintain all of its values and be noise-free. The 91s perform extremely well in these situations.

Another advantage is the ability to use any 4x4 filter that a lighting director may desire.

The camera also has built-in mounting holes for a matte box. We have the cameras mounted on custom plates with LDK-26 studio viewfinders on Vinten pan heads and pedestals.

Because the cameras are ENG units, they can be quickly removed from our mount and go handheld for that special shot. Quite often, we will take one camera totally ENG with a Beta deck and bring back results that perfectly match the studio portion of the show.

We purchased the 90s because we were among the early believers in CCD technology, and in 1988 it was the only CCD camera that performed to our standards. BTS has not disappointed us as time marches on. We have evaluated other CCD cameras and BTS's Frame Transfer (FT) chip is still ahead of the game. Our 91s were among the first to be delivered and BTS has kept them up-to-date.

The LDK-91 is truly a top of the line camera for ENG or studio use.

*Editor's note: Tom Johnson has been operating mobile units for more than 20 years. SJC currently operates four trucks in Valencia, California.*

*The opinions expressed above are the author's alone. For further information on the LDK-91, contact Greg Pine at BTS: Phone: +1-805-584-4700; FAX: +1-805-884-4750 or circle Reader Service 32.*

# OpTex Goes To Olympics

LONDON UK-based broadcast specialists OpTex contracted to RTO '92 to develop a remote camera control system for coverage of the Olympic swimming events in Barcelona. The resulting Pan Bar Input System proved to be a winner, with breathtaking shots achieved particularly in the synchronized swimming events. The system has since been used on several productions, adapting well to complicated crane, jib and tracking shots.

The heart of the Pan Bar Input System is a Sachtler Video 20 MKI-II fluid head, specially developed by OpTex. This is fitted with precision encoders to relay the pan and tilt movements to the remote Radamec 421 head, which instantly and precisely copies them.

Control of the camera and lens functions is by conventionally-mounted pan bar demands for zoom and focus that help to give the operator a feeling of familiarity in the method of control.

The operator works it as if standing behind an ordinary studio camera setup, but with all the control over the shot as if he were right in the heart of the action. Viewing is via a portable tripod-mounted monitor fitted with a Chipbox monitor screen, which can move in a fashion similar to a studio viewfinder or have the tilt fixed for ease of viewing.

All control instructions pass via a single multicore cable from the PBIS head to a head control unit and thence to the remote head and camera, with a total distance between the two heads of up to 75m. Powering is by 220-240V, 110V AC, or by special high-capacity batteries.

The head control unit contains the main processing electronics for zoom and focus interface, drive electronics and servo amplifiers for pan and tilt. Having a separate control unit helps to reduce the size and weight of the remote head, and gives easy access for adjustment. The head itself is capable of supporting up to 10kg, and has a 60 degrees/sec. maximum panning speed.

At the Barcelona Olympics, the OpTex Pan Bar Input System was used mounted on a Panther Dolly, the pedestal of which gave the added benefit of vertical movement. By the ingenious use of a periscope and zoom lens combination and underwater housing, OpTex was able to achieve highly creative and original shots moving from below to above the water surface at will, while the operator was calmly and comfortably in control at a distance that caused no disturbance to competitors.

For more information about the Pan Bar Input System and other remote camera control systems and accessories, contact OpTex at telephone +44-81 441 2199, FAX: +44-81 449 3646, or circle Reader Service 70. Systems are available for sale or rental.

## ADVERTISER INDEX

Page No.	Advertiser	Reader Service No.	Page No.	Advertiser	Reader Service No.
12	ATI	81	15	Jampro Antennas	35
10	Accu-Weather	30	9	Leitch Inc.	2
13	Audio Precision	16	25	M.W. Video Systems Ltd.	56
27	Audiolab Electronics Inc.	24	7	Marconi	37
29	Broadcasting Systems	50	18	Nova Systems	25
14	Browning Labs	112	19	Richardson Electronics	106
31	Circuit Research Labs	6	16,17	Snell & Wilcox	41
21	Digital Processing Systems	109	27	Swintek Enterprises	10
1	Dynatech Video Group	8	2	Tektronix	28
4	Frezzolini	61	11	Telemetry	85
23	Grass Valley Group	122	20	Tentel	121
32	Harris Corp.	15	29	Videomagnetics, Inc.	79
29	Horita	11	27	Weircliffe International	64

While every care is taken to ensure that these listings are accurate and complete, TV Technology does not accept responsibility for omissions or errors.

### Advertising Sales Representatives

<b>East Coast:</b>	Michael S. Dahle 914-762-3572 FAX: 914-762-3107	<b>Japan:</b>	Eiji Yoshikawa 81-3-3350-5666 FAX: 81-3-3356-6200
<b>Midwest:</b>	Gene Kinsella 312-327-3192 FAX: 312-327-3193	<b>Italy:</b>	Dario Calabrese 39-0-2-7530274 FAX: 39-0-2-7532697
<b>West Coast:</b>	Jack Ducart 916-988-4052 FAX: 916-988-4052	<b>Europe (excluding Italy):</b>	Sarah Platts 44-0-71-226-8585 FAX: 44-0-71-226-8586

Classified Advertising: Caroline Behan 703-998-7600 FAX: 703-998-2966

# AUDIO AND TIME CONTROL SOLUTIONS FROM CRL...



## BAP-2000 Mono TV/FM Processing System

- Complete Audio Processing System For TV
- Advanced Two-Band AGC and Limiter
- dynafex® Single Ended Noise Reduction Included

The BAP-2000 is a great tool to use in ENG trucks, translators and on non-stereo ready transmitters. dynafex® noise reduction removes background noise and hiss. Wide range multiband AGC. User selectable functions handle almost any processing job. Excellent for SAP and PRO channel processing.



## IPP-100 Programmable Microphone Processor

- Two-Band Equalizer and Compressor
- Digital Control - 18 Memory Presets
- Key Lock Security - Line or Mic. Level

The IPP-100 is a programmable microphone processor. Great to augment newscasts and production voice work. Pre-sets give talent their own settings. Easy to use and program. Remote control unit is available. Mic. or line level in/out operation. Unit shown with the optional remote control unit; the IPP-100R.

Call us at (800) 535-7648



## TVS-3001 Stereo Tri-band AGC & Loudness Controller

- Linearized Tri-band AGC - 30 dB+ Range
- Improved CBS Loudness Controller
- Stereo Input Phase Reversal Correction

The TVS-3001 is a great processor to use at the studio in front of STL's or as protection for uplinks. Interfaces well with most existing MTS generators and processors. Improved CRL/CBS loudness controller "tames" aggressive commercials. Stereo input phase reversal correction fixes mechanical phase errors quickly. Peak reading Bar Graph LED displays and internal pink noise generator included.



## DX-2 dynafex® Noise Reduction System

- Single Ended Noise Reduction - No Encoding or Decoding
- Up to 30 dB Of Noise Reduction
- Useful On Any Audio Signal

The dynafex® system uses a combination of downward expansion and dynamic filtering to remove noise from audio sources. Great for noisy downlinks and telecine applications. Variable threshold control makes unit easy to use. Stereo/two-channel.



## Real Time Event Sequencer

- Controls Up To 8 Outputs Via Contact Closures
- Can Store Up To 200 Events On A 7 Day Clock
- Backlit LCD Display And Battery Backup

This unique unit is an event timer that can control up to 8 devices, and store up to 200 time events. The microprocessor controlled unit features simple keypad programming and has a battery backup. High accuracy crystal time base.

THE PROFESSIONAL'S CHOICE **CRL SYSTEMS**

Circuit Research Labs, Inc.  
2522 West Geneva Drive  
Tempe, Arizona 85282-3192 U.S.A.  
(800) 535-7648 (602) 438-0888 FAX (602) 438-8227  
Bulletin Board System (602) 438-0459

# SATELLITE SOLUTIONS



## THEY COME IN ALL SHAPES AND SIZES

And who's the creator of all these shapes and sizes for the last 15 years, worldwide? Harris Allied.

From news gathering and network programming to teleconferencing and business, government and emergency communications, we have your solution.

We offer you the high performance of KU or C-Band systems in analog or digital. And we can design this solution in the shape of a simple flyaway uplink to the size of a redundant network quality uplink.

To make a 15 year old story short, just remember Harris Allied... Satellite Solutions.

 **HARRIS  
ALLIED**  
S Y S T E M S

Television and Satellite Systems:  
3200 Wisnann Lane • Quincy, IL 62301 U.S.A.  
Phone: (217) 222-8200 • Fax: (217) 222-7041