

# SPEEDY

## SPEEDX

the dx radio magazine  
for active shortwave listeners



"HOT" logging...

APRIL 1981

VOL XI

NO IV



# KEYNOTES

SEND INFO OF GENERAL INTEREST TO THIS SECTION. HOBBY MEETS, WANT ADS, USEFUL PUBLICATIONS OR DXING AIDES, WHERE TO SEND FOR INFO AND, SHORT ITEMS NOT FITTING THE OTHER SECTIONS OF THE BULLETIN. DEADLINE: 12th.

EDITED BY:

DON JOHNSON, P. O. BOX E, ELSINORE, CA 92330 USA



## 1981← ELECTION NOTICE →1981

**CALL FOR NOMINATIONS** SPEEDX is a democratically operated club with an elected Board of Directors. Elections are held in odd numbered years. In this regard, we are now asking for nominations to fill three(3) positions on the Board. Two present members were elected for four years in 1979 so have two years to serve. Do not nominate SANDY BLAIZE or CHRIS HANSEN.

**DEADLINE** All nominations must be in the hands of the Chairman of the Board by June 10, 1981. Mail your selection(s) directly to: JOHN TRAUTSCHOLD, P. O. BOX 861, MENOMONEE FALLS, WI 53051. Remember, if your nomination is not received by midnight June 10th it will not count.

**ONLY FULL MEMBERS MAY VOTE AND/OR BE NOMINATED** Following this election info is a list of current full members. Only these may nominate or be nominated. You may nominate one, two or three to fill the positions. You may nominate yourself. A post card is preferred as it makes handling easier. Be sure your name and signature appear on your nomination(s).

**OTHER INFORMATION** No member serving as an official staff member of a similar hobby club may serve on the SPEEDX BOD. Such nominations will be rejected.

Updates to the full member list will appear in May & June.

The July issue will contain a list of valid nominees.

July and/or August issues will contain brief statements from the candidates.

September issue will contain an official ballot form (to full members only) listing the candidates. It must be returned by OCTOBER 10, 1981 to be counted.

DON'T FORGET THE DEADLINE TO GET YOUR NOMINATIONS IN! JUNE 10, 1981 TO JOHN TRAUTSCHOLD.



March 1, 1981

### SPEEDX FULL MEMBERS

March 1, 1981

ALEXANDER, Brian	PA	BUTTERFIELD, Bob	MA	DITTRICH, Walter	FL
ALEXANDER, Rodney	IA	BYRON, Leslie	NY	DRAESKE, Gordon L.	CA
AUCOIN, David	LA	CALVER, Steve	ENGLAND	DREW, James	TX
AUDETTE, David	MA	CARANNA, John	VA	EARHART, Ken	PA
AYERS, Wayne	OH	CEREGHIN, John	MD	EDDIE, Rich	MO
BAKER, Donald	DE	CHABAK, Mike	AZ	ERAMO, Mark	MA
BARR, Jose	CA	CHINSKY, Mark	NY	EVANS, James	TN
BEEMAN, William	OH	CLARK, Guy	KS	EWING, David	IL
BERG, Evan 'Jerry'	MA	CLEVELAND, Bill	WA	FACCIOLI, D.M.	URUGUAY
BERKHOLTZ, Nicholas	MN	COHEN, Larry	PA	FALLOWS, John	CANADA
BICKEL, John	CA	COLEMAN, Robert J.	MA	FAMULARO, Ralph	CA
BINAU, Nan	MD	CRABLE, Vera M.	ID	FARMER, R.W.	TN
BLAIZE, E.V. 'Sandy'	LA	CRAWFORD, Duke	CA	FINDLATER, John	CA
BLEDSE, Ricky	MO	CREAMER, John	CO	FISCHER, Mike	KOREA
BLOM, Gordon	NY	CUCURA, Vladimir	PA	FISHER, John	MA
BODELL, Robert	OR	CUNNINGHAM, Ken	CA	FITZGERALD, John	RI
BOEHM, James Jr.	TX	CUNNINGHAM, Larry	OH	FLYNN, Bill	CA
BOWERS, Phillip	KOREA	CUPPY, Brad	IN	FORBES, Lewis	TX
BREWER, Paul	TN	CURNELL, Mark	OR	FORSMAN, Stan	CA
BROOKS, Alan	NH	D'ANGELO, Richard	PA	FOURNIER, Edward	VA
BROOKWELL, Larry	CA	DAVENPORT, William	TN	FRASER, Robert	MA
BROWN, Cliff	IL	DAVIDSON, Ken	SC	FUTCH, John	GA
BROWN, Nathan	NJ	DEKEYSER, Lucien	CA	GAEDE, Allan	CA
BURKE, Lynn	VA	DEMMITT, John	PA	GARMS, James	AZ

GEORGE, Charles	TX	LUCAS, Richard	CA	RICCIUTO, Albert	NY
GETZEL, Arthur	NY	MAISE, Clarence	LA	ROCHA, Craig	CA
GODFREY, Donald	CANADA	MAPPIN, James R.	WA	ROSS, Robert	CANADA
GONZALES, Fernando	NY	MARSHALL, Phillip	GA	SAMS, Mitchell	AR
GREENFIELD, Maxfield	PA	MARSHALL, Ronald	AZ	SANDERSON, John	AZ
GRENIER, Pete	CA	MAXFIELD, David	MI	SAUNDERS, Paul	FL
HALL, Tim	CA	MAYER, Jim	CA	SCHLESINGER, Mark	TX
HANSEN, Chris	NY	MAYO, Paul	FL	SCHROEDER, Arthur	WI
HARDESTER, Mike	CA	MCCURDY, Tim	CA	SCOTT, Thomas	OK
HAUSER, Glenn	TN	McKINNEY, Larry	PA	SEMESKY, Thomas	IN
HESCH, Ruth	NY	MCLEAN, Scott	NY	SERSHON, Edward	MA
HEYMAN, Stephen	NY	McSKIMMING, Hugh	CA	SEYMOUR, Woody	NC
HICKMAN, Mel	OR	MILLER, John	GA	SHEPHERD, Greg	IL
HODSDON, Thomas	MN	MILLER, William	CA	SILVA, Scott	CA
HOFFMAN, Charles	PA	MOMAN, Don	CANADA	SMITH, Thomas	FL
HOLBROOK, Hank	MD	MOSS, Randy	CA	SMITH, Traver	CA
HOLLAND, Darryl	NY	MUNSTER, Ralf	GA	SMITH, Wade	CA
HOOK, Jerry	FL	NEBRON, Larry	CA	SNIDER, Paul	CANADA
HOTALING, Stan	NV	NELSON, Donald	CA	SNYDER, Doug	CA
HOWARD, Ron	CA	NESSLEIN, Kenneth	MO	SOMERS, Jack	CA
HOWARTH, Chester	WA	NEWTON, Andrew	GA	SPARKS, William	CA
HOWELL, Joe	CA	OAKLEY, Marjorie	OR	STECK, Richard	IL
HUDDLESTON, Howard	TX	O'BRIEN, Alex	AUSTRALIA	STEIN, Richard	NJ
HUFFAKER, Carl	MEXICO	OLIVER, Wayne	NH	STONE, Wilfred	CANADA
JARRETT, Dennis	CT	O'RIORDAN, Hugh	ID	TAKAHASHI, N.	JAPAN
JOHNSON, Don	CA	ORTEGA, Dan	CA	TALBOT, Larry	WI
JOHNSON, Fred	IL	OSBORNE, Aaron	MI	THOMPSON, Glenn	NM
JONES, David	VA	OSTERMAN, Frederick	KY	THOMPSON, Peggy	CA
JONES, Jack	MS	PALMER, Robert	WA	THORNE, Dave	CA
KAPINOS, John	MA	PARK, Dale	HI	TOIA, Amelio	ITALY
KENNEDY, Steve	FL	PARKS, William	FL	TRAUTSCHOLD, John	WI
KERN, Steve	CA	PAVELKA, John	NY	VALENTINE, Fred.	CA
KERRIGAN, Patrick	IL	PEARSON, William	PA	VAN BURDEN, Ted	CA
KLASEK, Terry	MO	PETCHESKY, Bruce	NY	VIAU, Robert	CANADA
KOPRIVA, Larry	CA	PETERSON, Adrian	INDIA	VOCKEROTH, John	NJ
KORNEK, Joachim	W.GERM	PETTIT, Lani	IA	VRANES, Alex	PA
KORNEKE, Paul	VA	PICARELLI, Thomas	CA	WALTERS, John	NJ
KOTSAKIS, John	OR	PICKARD, Wilder II	IL	WAMPLER, Michele	VA
KOWALSKI, Paul	WI	PITTS, Stephen	UT	WARRENBURG, Tom	WI
LATTEMANN, Jack	WA	POGUE, James	GUAM	WENTZEL, Robert	MN
LAZARUS, Henry	LA	POKATILOFF, Ronald	IL	WESTBROOK, John	NY
LECUONA, A.R.	ARGENTINA	POVRZENIC, E.	ARGENTINA	WHETZEL, Rex	IN
LEEMAN, Joseph	RI	PROOM, Stephen	ENGLAND	WHITEHEAD, Jim	MA
LENTZ, Hank	PA	RADCLIFF, Ben	IL	WILFINGER, William	OH
LEVIN, J.	NJ	RAY, Richard	PA	WITTE, Marjorie	CA
LINDLEY, Terry	AL	RAYMOND, Bob	MA	WOOD, Dr. Richard	MO
LIPPMANN, Kevin	FL	RAYMOND, Greg	MA	YAJKO, Robert	PA
LOBDELL, Chris	MA	REESE, Orla	KS	ZILMER, Robert	NM

The preceding list is all the FULL MEMBERS on file as of March 1, 1981. If you have any questions about your standing or how many credit points you need to make full member, send a SASE to the Membership Chairman, Vera Crable, 5720 North 17th Street, Coeur d'Alene, Idaho 83814. Do NOT ask HQS about credit points as we do not have that information. Only the membership chairman knows. Don't forget to send her a SASE with inquiry.

Vera also mentions that many members only lack a few points to become a full member. Plenty of time to get those points so you may take part in our election this September.

### CONGRATULATIONS TO TEN NEW FULL MEMBERS

R. W. AYERS EUCLID OH	JOHN DEMMITT BELLEFONTE PA	KENNETH NESSLEIN PERRYVILLE MO	EMELIO POVZENIC ROSARIO ARGENTINA
GREG RAYMOND HAVERHILL MA	JOHN KOTSAKIS PORTLAND OR	WILLIAM WILFINGER MT CARMEL OH	PAUL SNIDER ONTARIO CANADA

LYNN BURKE  
NEWPORT NEWS VA

DONALD NELSON  
SANTA CLARA CA

Each has received our attractive certificate and a copy of our constitution. Well done folks!

## WELCOME TO THE FOLLOWING NEW MEMBERS

RICK SINGEL, Gary IN	ALBERT CHRISTOPHER, Runnemeade NJ (NRD-515)
MIKE REID, Palmdale CA	ROGER PETTENGILL, Mattawamkeag ME (DX-150A)
MARK STUMPF, Pasadena CA	ROBERT REINECKER, Coraopolis PA (FRG-7000)
TOM KNEITEL, Smithtown NY	W C APPEL, Huntington Woods MI (ICF-2001)
LESTER BASKIN, Chicago IL	HONORIO LLAVORE, (RVA) Manile Philippines
ALFRED SCHWANEKE, Rolla MO	ROD DYKE, Bainbridge Island WA (RF-2900)
BEN STRZELEC, New Berlin WI	ADOLPH EKVALL, Green Valley AZ (FR-6600)
KENNETH BRAND, Winchester VA	MICHAEL GEORGETSON, Galeton PA (R7/DR7)
ROBERT ROTELLA, Morristown NJ	SCOTT HARDESTER, Modesto CA (FRG-7000)
WARREN LEMEY, Cherry Valley CA	JAMES DURHAM, Springfield VT (RF-1150)
JOE FLOYD, Florence AL (SPR-4)	BRIAN HELLER, Vancouver WA (FRG-7700)
M A MEGEE, Houston TX (R-1000)	RICHARD BAILEY, Kettering ON (R-1000)
JOSEPH GEAGAN, St Petersburg FL	JAMES HARTUNG, Aberdeen MD (FRG-7700)
BEN GAY, South Bend IN (RF-2900)	PATRICK O'CONNOR, Hinsdale NH (FRG-7)
MICHAEL MAVRIS, Crescent City CA	DAVID HOUDE, Springfield VA (DX-302)
ROGER DE SOTO, Houma LA (DX-100)	SAM ALEXANDER, Asheville NC (DX-302)
JOHN BLACK, Camarillo CA (FRG-7)	MERT FULWILER, Appleton WI (FR-4900)
CARTER CRAIGIE, Devon PA (DX-200)	MARK JOHNSON, Fairfield IA (DX-302)
KARL BITNER, Syosset NY (RF-4900)	GEORGE LOOMIS, Bothell WA (RF-2600)
SCOTT NELSON, Parshall ND (HQ-100)	LOUIS MOE, Hanover Park IL (DX-150)
ALVIN LA ROSE, Houston TX (DX-300)	ALAN WINDSOR, East Point GA (WT-4)
BRUCE SEGLER, Anaheim CA (HQ-129X)	

OK folks, you have joined a club for ACTIVE LISTENERS. How about getting active? HQS and some editors have already heard from several of the new members. How about the rest? Get involved! Support the club you choose to join with loggings, QSL reports and other hobby related items. You're part of the club now so lets all help to make it even better by contributing as often as possible. To make it easier (and less expensive) we have a central location you can send all items for the bulletin. Read on.....

### CENTRAL DISTRIBUTION EDITOR

PEGGY THOMPSON, 2706 ALABAMA STREET, LA CRESCENTA CA 91214 is our CDE. She will forward to the editors, all material received in her hot little hands by the 7th of the month. Please cut loggings into strips and mail early. Coast-to-Coast mail often takes 4-8 days. With the recent increase in the cost of postage, it will probably take longer.

You may also mail items direct to each editor if you wish. Their deadline is the 12th of the month. Again, allow plenty of time for the "Worst" class mail to arrive. Shortwave/Utility/QSL forms are available from club HQS for 6¢ each, min. of 10 forms per order.

### SPEEDX MEMBERSHIP LIST

It's going fast! Better get your copy now. Price is \$1.75 or 6 IRCs (\$1.50 or 5 IRCs to Full Members) in North America. Elsewhere the cost is \$2.25 or 8 IRCs. We might reprint the list with updated info if the demand warrants such. If you previously said to include your QTH in the list or said not to, and have changed your mind, or if you would prefer a home address in place of a temporary one, drop a line to HQS. We will keep the info on hand and use it when/if the list is reprinted this year.

### RESIGNATION FROM THE BOD

Bob Bodell has resigned from the Board of Directors in order to devote more time to the SPEEDXGRAM, which he edits. Both jobs were just too much. If you would like a sample copy of the GRAM, send a SASE to; Bob Bodell, 9118 S.E. Mason Hill Drive, Portland OR 97222. The GRAM is a four page supplement of late and/or hot DX items. Cost is \$4.00 per year in North America.



## OOPS DEPARTMENT LISTEN TO SHORTWAVE...WITHOUT A SHORTWAVE RECEIVER

Several members wrote in suggesting that one not try using a signal generator and a TV to listen to shortwave (see February 1981, page 4) during prime time TV viewing hours or you will have your neighbors threatening to do your person bodily harm! Seems when used as described in the article, part of the antenna becomes a transmitter! It will cause QRM to nearby TV sets. However, this editor, who has no near neighbors, has tried the method and it does indeed work. Of course, my neighbors seldom complain about any of my wierd habits. Maybe my two adult Dobermans need a new deodorant? Hi!

## PUBLICATIONS catalogs....flyers.....books....and what ever

Several folks wrote in saying they liked the info in the March Keynotes column on where to obtain hobby related material so, I will add to the list this month. If you know where to get hobby materials not mentioned of late, drop a line to HQS.

SHORTWAVE HOBBY EQUIPMENT REVIEW 1981 by Larry Brookwell (1826 Cypress St., San Diego, CA 92154) is 170 pages of reviews & users comments of a variety of receivers and accessories. Includes the CRF-1, NRD-515, FRG-7700 and other newer gear. Cost is \$4.95 via bookrate (\$5.25 1st class) in North America. Foreign airmail is \$7.75.

CATALOGS, FLYERS, ETC. MFJ ENTERPRISES, P. O. Box 494, Mississippi State, MS 39762 (601) 323-5869 are getting more and more into SW products. Also utility items. For example, HQS just received a flyer on the MFJ-496 Super Keyboard designed to send CW, Baudot & ASCII w/256 characters. Write to the above address for a catalog.

GROVE ENTERPRISES INC, Brasstown, NC 28902 has a new catalog out containing many interesting items for the hobbyist. They have a toll free number to order by phone. (800) 438-8155. Drop them a line and see what they have to offer.

PALOMAR ENGINEERS, Box 455, Escondido, CA 92025 have items for the SWler, BCber. Send for info.

RADIO WEST, 2015 South Escondido Blvd., Escondido, CA 92025 (714) 741-2891 have an update flyer out. They hope to have their new catalog out soon. Radio West sells a variety of hobby gear as well as making modifications to most receivers. Check out their prices.

QTH AFRICA is published by: Miki Vcelar, P. O. Box 28250, Pretoria, South Africa. Miki has info on the external services from South Africa as well as Cladestine broadcasts from Africa & the Middle East. Drop a line for additional information.

ANARC NEWSLETTER, 1500 Bunbury Drive, Whittier, CA 90601 is available for \$5.00 in North America or \$8.00 airmail elsewhere. A sample is 50¢ or 3 IRCs. Info includes the Marketplace Report, whats happening with the member clubs, HAP news, and more. A list of hobby meets in various areas appears regularly. Send for a sample today. Very interesting.

REVIEW OF INTERNATIONAL BROADCASTING (RIB) is a 40 page monthly bulletin put out by well known Glenn Hauser. Cost is \$15.00 in North America. Write for foreign rates. Sample copy is \$1.25 in North America, \$2.00 elsewhere. This publication covers a lot of material regular shortwave clubs do not have space for or, do not wish to cover. Personal opinions, etc. Send for a sample. Tell Glenn you read about it in SPEEDX.

AMATEUR RADIO, SUPPER HOBBY! (Cologne Press, P. O. Box 682, Cologne, NJ 08213) by Vince Luciani, K2VJ, is a 144 page book you HAMS or "would like to be" HAMS might enjoy reading. 8½" x 11", the book is written in easy to understand terms with info of interest to the curious and the old-pro. Price is \$8.95 plus a buck for shipping and handling. The publication date of this book is March 18, 1981 (today: as I type this) so I doubt if many have this in their library yet. We mention this item on a HAM book, though we do not cover this area, since nearly 20% of our members are also HAMS.

## WHO IS THE ONLY HONORARY MEMBER OF SPEEDX? TOM GAVARAS KNOWS

Per the question asked in the March issue, Tom Gavaras of Plymouth MN was the first one in with the correct answer. CLAYTON HOWARD of HCJB. Tom has been sent a rare SPEEDX pennant. Second in with the answer was Pete Grenier of Azusa CA who received a LISTEN TO THE WORLD ON SHORTWAVE RADIO bumper sticker for the effort.

## ART GETZEL MOVES SOUTH

While less than ten miles, it is a new address for our TIPS & TOPICS editor. Art Getzel, 170 -40 Highland Avenue, Jamaica NY 11432 is the new QTH. Send your articles to Art on any hobby topic. Station write-ups, equipment reviews, personal experiences and any shortwave or utility hobby material.

## ANARC CONVENTION 1981 THUNDER BAY, HERE WE COME

While we have not received any publicity releases from the 1981 ANARC Convention Committee in several months, we thought we should remind you that the 1981 ANARC Convention will be held in Thunder Bay this year. July 17-19 are the dates. ANARC 81, P. O. Box 142, Thunder Bay, Ontario, Canada P7C 4V5 is the address. They request a SASE with return postage for more information. In the USA you may send a SASE to: Jeff White, 409 Laconia Lane Schaumburg, IL 60193. Sorry your friendly HQS person will not be able to make the convention this year but, we will have a SPEEDX rep on hand.

## → TIME CONVERSION WITHIN THE U.S. OF A ←

GMT	PST	MST/PDT	CST/MDT	EST/CDT	EDT	GMT
0000	4:00 PM	5:00 PM	6:00 PM	7:00 PM	8:00 PM	0000
0100	5:00 PM	6:00 PM	7:00 PM	8:00 PM	9:00 PM	0100
0200	6:00 PM	7:00 PM	8:00 PM	9:00 PM	10:00 PM	0200
0300	7:00 PM	8:00 PM	9:00 PM	10:00 PM	11:00 PM	0300
0400	8:00 PM	9:00 PM	10:00 PM	11:00 PM	MIDNIGHT	0400
0500	9:00 PM	10:00 PM	11:00 PM	MIDNIGHT	1:00 AM	0500
0600	10:00 PM	11:00 PM	MIDNIGHT	1:00 AM	2:00 AM	0600
0700	11:00 PM	MIDNIGHT	1:00 AM	2:00 AM	3:00 AM	0700
0800	MIDNIGHT	1:00 AM	2:00 AM	3:00 AM	4:00 AM	0800
0900	1:00 AM	2:00 AM	3:00 AM	4:00 AM	5:00 AM	0900
1000	2:00 AM	3:00 AM	4:00 AM	5:00 AM	6:00 AM	1000
1100	3:00 AM	4:00 AM	5:00 AM	6:00 AM	7:00 AM	1100
1200	4:00 AM	5:00 AM	6:00 AM	7:00 AM	8:00 AM	1200
1300	5:00 AM	6:00 AM	7:00 AM	8:00 AM	9:00 AM	1300
1400	6:00 AM	7:00 AM	8:00 AM	9:00 AM	10:00 AM	1400
1500	7:00 AM	8:00 AM	9:00 AM	10:00 AM	11:00 AM	1500
1600	8:00 AM	9:00 AM	10:00 AM	11:00 AM	NOON	1600
1700	9:00 AM	10:00 AM	11:00 AM	NOON	1:00 PM	1700
1800	10:00 AM	11:00 AM	NOON	1:00 PM	2:00 PM	1800
1900	11:00 AM	NOON	1:00 PM	2:00 PM	3:00 PM	1900
2000	NOON	1:00 PM	2:00 PM	3:00 PM	4:00 PM	2000
2100	1:00 PM	2:00 PM	3:00 PM	4:00 PM	5:00 PM	2100
2200	2:00 PM	3:00 PM	4:00 PM	5:00 PM	6:00 PM	2200
2300	3:00 PM	4:00 PM	5:00 PM	6:00 PM	7:00 PM	2300

## RUMORS FACT & FICTION mostly fiction

If folks out there in readershipland would send more info for Keynotes, I would not have to include a filler like this! Note Keynotes masthead for info wanted. Now.....to insult a few people.....sic. All in fun.....

I hear through the SW grapevine that Stu ManKenzie of ASWLC now has a SW receiver he does not have to pedal to operate! It runs on electricity! .....Larry Talbot's best DX catch is the BBC from the Caribbean....Bob Bodell unpacked his SW set after only a year in his new home....Glenn Hauser actually turned his SW set off once last year.....Vera Crable writes and/or tapes to more club members than we have.....Sandy Blaize buys & sells gear faster than he can turn them on.....

S E L L ↔ S E E K ↔ S W A P NO COLLECT CALLS

FOR SALE: FRG-7. Used little, like new w/manual & carton. \$200.00ppd. George Cady, 1355 N. Dearborn, #502, Chicago IL 60610. (312)337-3975.

FOR SALE: Complete set of SPEEDX. July 1971 to present. \$30.00. Gerry L. Dexter, RR #4, Box 110, Lake Geneva WI 53147.

# PROGRAM

APRIL 1981

WOODY SEYMOUR, JR.  
P. O. BOX 848  
SANFORD, NC 27330

# PANORAMA

AUSTRALIA...More on the Keith Glover/MAILBAG story: SPEEDXer Marge Witte of CA sends a copy of a letter she received from Keith recently. In the letter, he states that "I quite understand the concern expressed by you and other shortwave friends concerning MAILBAG and the general direction of many of our shortwave programs. I can assure you that I'm being kept very busy in the radio world. I do not think of my job as being an executive one because I consider executives to be right up at the top of the tree. But I do have an important supervisory job--I'm in charge of all the announcers in the state of Victoria, which means a control of announcers in Radio Australia, the ABC home service in three different networks and for ABC Television. So I don't have very much time and I try to catch up with mail such as this during my lunch hour and with the help of the (secretaries) when they have time to do some typing for me...You made some comments about the substitute program and I think that some changes may be made in the not-too-distant future(but not of course a complete reversion to the (former) status quo)."

AUSTRIA...Last month we mentioned the times AUSTRIAN SW PANORAMA can be heard. SPEEDXer Ralf Munster of GA would like to see the program scheduled during the transmission to Western North America in the 0430-0500 GMT time slot on 12015 kHz. He sees this as a better slot for the program than the earlier transmission to the East Coast reception-wise(despite some possible problems with USSR interference on channels adjacent to 12015). He urges other SPEEDXers who would like to see this excellent program in the 0430 GMT transmission to write ORF.

BULGARIA...Here's the latest English schedule for Radio Sofia: Mon BULGARIAN ECONOMY, WEEKLY SPORTS ROUND-UP; Tue LIFE IN BULGARIA, CULTURAL OUTLOOK(1st, 3rd weeks), AMONG THE PEOPLE(2nd, 4th weeks); Wed YOUTH CORNER, BULGARIAN PHILATELY(1st, 3rd weeks), THE SOCIALIST WORLD OF TODAY and ACROSS THE MAP OF BULGARIA(both on 2nd, 4th weeks); Thu MOSAIC OF FACTS ABOUT BULGARIA, MIDWEEK MAILBAG; Fri 1st Broadcast-WEEKLY INTERNATIONAL REVIEW, FROM FRIDAY TO FRIDAY(program guide for following week); 2nd Broadcast- DX PROGRAM and SCIENCE NEWS(1st week), DX PROGRAM and NATURE ALMANAC(2nd), DX PROGRAM and HOBBY TIME(3rd), DX PROGRAM and LETTER FROM SOFIA(4th); Sat TOPICAL STUDIO and DISCO CLUB(1st week), SCANNING THE PAGES and THE ART OF THE UNKNOWNNS(2nd), TOPICAL STUDIO and MUSIC IN BULGARIA(3rd), MYTHS AND LEGENDS FROM THE BULGARIAN LANDS AND ROOTS OF A NATION(4th); Sun 1st Broadcast- ANSWERING YOUR LETTERS; 2nd Broadcast- WALKS AND TALKS IN SOFIA(1st week), SPEC-TRUM(2nd), YOUTH MAGAZINE(3rd), CULTURAL LIFE REVIEW(4th). (Edward A. Fournier--VA, Ralf Munster--GA, Direct)(To British Isles 1930-2000 GMT on 9700, 11720; 2130-2200 GMT on 7115, 9665, 11860, 11920; To North America 0000-0100 GMT on 9705, 15330; 0430-0500 GMT on 7115, 11860)

EGYPT(ARAB REP. OF)...Radio Cairo broadcasts in English to North America from 0200-0330 GMT daily on 9475 and 12050 kHz. Daily 0215 GMT NEWS 1, 0315 NEWS 2, 0325 NEXT DAY'S REVIEW, 0330 NATIONAL ANTHEM; also the following feature programs(it appears that the days mentioned are the days in local time despite the fact that the times are in GMT-WS): Sun 0202 ORIENTAL MUSIC 0205 THE WAY WE SAY IT 0225 COMMENTARY 0235 THIS IS ISLAM 0245 LISTENERS MAIL; Mon 0202 ORIENTAL MUSIC 0205 MAIL CALL 0210 EGYPTIAN SONGS 0225 COMMENTARY 0235 BETWEEN CAIRO & WASHINGTON 0250 ISLAM, ITS CULTURE AND CIVILIZATION 0300 EGYPTIAN NIGHTS; Tue 0202 ORIENTAL MUSIC 0205 MAIL CALL 0210 EGYPTIAN SONGS 0225 SPOTLIGHTS ON THE MIDDLE EAST 0235 EGYPTIAN SONG 0240 TALK 0250 HISTORY OF CAIRO STREETS 0300 MUSIC AROUND THE WORLD; Wed 0202 ORIENTAL MUSIC 0205 TOURISM IN EGYPT 0225 COMMENTARY 0235 PIONEERS OF CIVILIZATION 0245 LISTENERS MAIL; Thu 0202 ORIENTAL MUSIC 0205 MAIL CALL 0210 EGYPTIAN SONG 0225 EGYPTIAN ACHIEVEMENTS 0235 GLORY OF EGYPT(Continued)

EGYPT(Con't)...0245 WOMAN'S CORNER 0300 EGYPTIAN FOLKLORE; Fri 0202 HOLY QURAN 0210 EGYPTIAN SONG 0225 U.S. IN THE EGYPTIAN PRESS 0235 SNAPSHOTS 0245 LISTENERS MAIL; Sat 0202 ORIENTAL MUSIC 0205 MAIL CALL 0210 EGYPTIAN SONG 0225 CURRENT EVENTS 0235 EGYPTIAN SONG 0240 READER'S CORNER 0250 ARABIAN MELODIES 0305 STAMP COLLECTORS CLUB. (Ralf Munster)

FRANCE...SPEEDXer Jack Findlater of CA recently wrote to Radio France International to inquire why the station did not have an English transmission directed to North America. He received a courteous personal letter from the station, stating the usual reasons for not broadcasting in English to North America--lack of finances and French government policy. However, the final paragraph is interesting--"Perhaps I can offer a glimmer of hope...In 1984, the four 500 kilowatt transmitters now under construction by RFI in French Guyana will be in operation. It is our hope that by that time it might be made possible for us to broadcast in English to your region of the world."

GREAT BRITAIN...The special series on JOHN LENNON continues this month. Excerpts from a lengthy interview with the late Beatle recorded days before his untimely death are presented each week, along with selections of his music. Tune in Sat 2030, Fri 0030 & 1330 GMT.....DAD'S ARMY is a comedy series set during World War II. Each week you can hear the misadventures of a Home Guard platoon if you tune in Sun 1430, Fri 1030 & 2330 GMT. (London Calling, April 1981)

IRELAND...Radio Dublin can be heard 0200-0700 GMT on 6910 kHz, with a multilingual program in Spanish, French, German and English on weekends, Sun and Mon GMT. Other nights Gerry Marston is the DJ for a Top 40 program in English. They hope to increase power some time in the future, but only time will tell. (Thanks to Ralf Munster)

NEW ZEALAND...NEW ZEALAND CALLING is now scheduled at 0315 GMT(17860 & 75485 kHz) and 1015 GMT(11945 kHz) on the 1st and 3rd Mondays. This schedule is for Mar/Oct(NZ winter); languages Eng./Jap. (Dale Park--HI)

POLAND...Radio Polonia's DX CLUB program can be heard each Sunday evening at 0200 GMT. If you enjoy the program, you can join the club by writing to RP at P.O. Box 46-00950 Warsaw. (John J. Flanagan, Jr.--MA)

USA...The American Forces Radio and Television Service(AFRTS) is set to move from Washington to Los Angeles. It is not known at this time what effect the move will have on the programming of the service. Any information along these lines will be appreciated. We will try to present an update on this story next month. (WS)

USSR...Radio Vilnius has VILNIUS MAILBAG each Saturday at 2315 GMT. Try 7150 kHz for this one...KIEV MAILBAG can be heard Saturdays @ 2015, Sundays @ 0045 & 0315 GMT. (Dale Park--HI)

EQUIPMENT AND SUPPLIES...We occasionally receive letters asking for advice on receivers and other equipment. This editor knows more about what comes out of a set than he does how it comes out. I suggest that you contact Editor Sandy Blaize for technical questions. Sandy can also give you advice on purchasing equipment. Other good sources of equipment and supplies are Gilfer, P.O. Box 239, Park Ridge, NJ 07656, Radio West, 2015 S. Escondido Boulevard, Escondido, CA 92025 and Grove Enterprises, Inc., Brasstown, NC 28902. All of the above have catalogs which they will be happy to send you on request.

WHAT DO YOU THINK IS THE MOST INTERESTING PROGRAM ON SHORTWAVE RADIO? We would like to have answers from as many SPEEDXers as possible. There are hundreds of programs broadcast each week over shortwave, but what is YOUR favorite? Drop a line to Program Panorama and let us know the reason why is 25 words or less. See your name in print! It is important that we receive a large number of contributions. We would particularly like to see some members who have never contributed to Program Panorama to send in a card. So sit down and fill out that card today. We'll be looking forward to hearing from YOU!

Hope to hear from many SPEEDXers. See you in May! Woody 3/18/81





# TECHNICAL TOPICS

Editor

## SANDY BLAIZE

AVC  
AGC  
GAIN  
TUNER  
IMAGE



SSB  
LSB  
FADE  
NOISE  
Smeter

Send Technical Questions  
& Technical Material To: ➡

E. V. "SANDY" BLAIZE  
417 RIDGEWOOD DRIVE  
METAIRIE LA 70001

MISSING MARCH COLUMN!!! - Lost by your friendly Postal Service somewhere between my QTH and Menomonee Falls!! Sorry this happened gents and ladies! Thanks for your kind letters this month, and sorry you were let down.

\*\*\*\*\*  
UNITED PARCEL SERVICE....Has slipped lately...bad! Radio West, Bayoutronics reporting losses/damage by UPS. Worst of all UPS not wanting to honor the insurance. Radio West had to take them to court to recover some of their loss! MORAL?: When shipping by UPS pack carefully! DON'T DEPEND on the original factory packing. Pack in the original box then in another carton allowing at least 2 inches all around to be packed by a "buffer" like expanded polystyrene "peanuts" or foam. If the receiver is heavy (Hammerlunds etc.) be sure to leave 3 inches or more all around first carton. I know this will weigh more, but the insurance is better than the extra you pay for "normal" coverage!! (If you get the drift.) Rumor has it that the Postal service's air parcel post-special handling is getting better and competes with UPS delivery times. What good does 5-7 day delivery time do if the damn radio inside the carton is busted all to hell?!?! Shades of REA Express.

\*\*\*\*\*  
SAN DIEGO DXers CLUB BULLETIN by Larry Brookwell, Issue 32 has receiver "Reviews" for the JVC FR-6600JW and the FRG-7700. For a copy of this issue, write to SDDC, 1826 Cypress St., San Diego, CA 92154. Enclose 75¢ for the issue. Tell Larry that Sandy sent you!

\*\*\*\*\*  
GILFER SHORTWAVE, P.O. Box 239, Park Ridge, NJ, 07656 has published a new catalog (Number 28) New products include the Panasonic RF-085 portable, SONY ICF-6800W, SONY CRF-1, ICF-2001, a new INFO-TECH CW/RTTY converter and the MFJ line of accessories. Drop them a card requesting catalog 28

\*\*\*\*\*  
RADIO WEST has a new address. They have moved from 'out in the woods' into town! New QTH: 2015 S. Escondido Blvd., Escondido, CA., 92025. They are now selling the Japan Radio Co. NRD-515 for \$1350 with optional 24 channel memory unit for \$230. Also new audio filters and a "scanner" line for you VHF/UHF listeners. Write to them for their catalog and supplement.

\*\*\*\*\*  
BAYCUTRONICS, run by yours truly (editor) will soon be handling the MFJ line of converters/filters/preselectors and amateur accessories at competitive prices. Please consider us for MFJ! Some "reviews" of MFJ gear will be forthcoming in this column.

\*\*\*\*\*  
GROVE ENTERPRISES, INC. run by Bob Grove of "Confidential Frequency List" fame, offering various tidbits to the DXer/SWL. Specializing in some of the hard-to-get publications etc. Now has a nice new catalog. Send him your request for it to: Grove Enterprises, Inc., Brasstoen NC., 28902, or request it via his WATS line at 1-800-438-8155.

\*\*\*\*\*  
SPEEDXer Armand DiFilippo says that some FRG-7700 units are "locking" up 1 khz. off frequency when a memory channel is recalled. Yaesu is aware of this and they have corrected it in Technical Bulletin nr. 28. The modification consists of the addition of two diodes and a resistor as well as changes to the printed circuit board. Definitely NOT a "do-it-yourself" modification for anyone not thoroughly familiar with servicing receivers. Contact your YAESU dealer for more information if you have this problem.

\*\*\*\*\*  
MORE COMMENT: This month has been quite a busy one for me, selling off my portables to buy a new 2001, also going on sea-trials in a new ship, as well as tearing apart my radio room/test bench for remodeling! If your mail to me is answered slowly, you will know why. Again I request that writers who desire a personal reply, please send an S.A.S.E. (Overseas readers send stamps of YOUR country for 1 oz. AIRMAIL postage--NO I.R.C.'s please. I'm a stamp collector and the stamps will be much cheaper for you than I.R.C.'s anyway!) Best of DXing until next month!!

*Sandy*

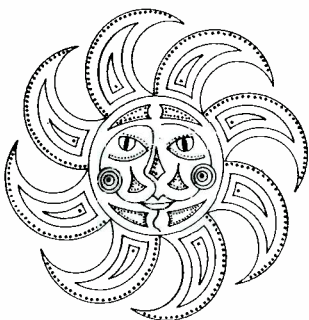

## **SPEEDX** **Western Hemisphere**

**EDITOR: Chris Hansen**  
**2825 Webb Ave. 5F**  
**Bronx, NY 10468**

(212)549-6613 2300-0400 HOME  
(212)975-1608 1330-2200 OFFICE

**Deadline: 12th**

**All times and dates UTC, All freqs in kHz**

ABRIL, 1981

PLEASE REMEMBER TO USE SPEEDX forms, available from HQ for 6¢ each, minimum of 10. Also remember that old loggings should not be submitted -- for the May issue, loggings are eligible dated from March 5 to April whenever. Please print legibly or type.

### BACK-AND-FILL DEPARTMENT

I HAVE BEEN REMISS IN THE LAST FEW MONTHS in not pointing out that the loggings of R. Robore printed in January and March were probably the commonly-heard harmonic of Radio Rebelde from Cuba. I am not a Bolivian expert and in the rush neglected to do my homework on these loggings. Of course, if the reporter has a recording and wishes to send it to me to validate his/her logging, I will be happy to. A DXer wrote and gave me this information, for which I thank him. It has taught me to do more research into rare loggings. I will begin keeping a Bolivian file to keep the errors down.

I WOULD ALSO LIKE TO APOLOGIZE for changing the ID on LV de Mosquitia to LV de Justicia (Honduras) last month. My information was faulty, and so I shall sit here with egg on my face for a while. There are a myriad of reports this month on LV de Mosquitia (which is the name of an area in Honduras).

SPEAKING OF BOLIVIA, ID/AODR for LV OE BOLIVIA (Formerly R. Nacional de Bolivia): ID: "Desde la ciudad de La Paz transmite Radio...La Voz de Bolivia en 1390 kHz onda media, 4945 kHz onda corta, 60 metros, 6025 kHz onda corta 49 metros y proximately en 94 MHz frecuencia modulada." Address: 'La Voz de Bolivia, Casilla 2532, La Paz, BOLIVIA.' Thanks to Lecuona, Argentina (I believe; I have lost the original reference for this) for this address.

I HAVE RECENTLY RECONNECTED MY PANADAPTOR. For those of you who are younger than 30 or so, a panadaptor is an instrument somewhat like an oscilloscope which is connected to the final mixing stage of your receiver. The panadaptor then shows, as peaks on the oscilloscope trace, any signals within a bandwidth you select (15, 50, 200 kHz, for example). This is useful to, for example, monitor a section of band on which you suspect a transmitter will begin transmitting; I believe that the FCC uses them to monitor for illegal transmitters. For DXers, it is useful if you know Radio Station "X," a pirate station, is going to begin transmitting anywhere from 6200-6300 kHz. It also helps a DXer to visually separate two signals close together and tune each one in more accurately. "Peachy keen," you say; "where can I get one?" Well, there's the rub. They aren't available commercially except for very expensive and sophisticated models which are mostly used by FM stations as test equipment; they scan their signal to make sure that the stereo signal is at 19 kHz and the SCA signal is at 67 kHz. Heath once made a kit panadaptor, but have discontinued it lo these many years. Your best bet would be to scan the Ham Trader Yellow Sheets or some such other amateur radio-oriented second-hand equipment listing. Most of these machines were sold to amateur radio operators, and therefore most of the second-hand ones will come from them. If anyone wants information on the panadaptor, you may send me a SASE (18¢, please!!).

AN ITEM FROM "Latin America Weekly Report" comes from Jim Whitehead: "President Rodrigo Carazo (of Costa Rica. ed.) has given instructions to the minister of public security to cancel the frequency allocation of the shortwave radio station, R. Noticias del Continente. The government claims that arms were found when the station was searched last week (the week before 3/2/81. ch). The station has been the object of a number of attacks by right-wing paramilitary groups, and was bombed earlier this year. Last November armed guards repelled an attack by an ex-Nicaraguan National Guard (sic -- probably means 'Nicaraguan ex-National Guardsman.' ch). R. Noticias came onto the air in May 1979."

WELL, REMEMBERING THAT any logging without a language designation was reported as using SS, and that all times and dates are in GMT, I present...

SOUTH AMERICAARGENTINA

- 5985 0940 R. Splendit, OM w/ nx, ID, tlks (222; 3/2. Hotaling, NV)  
 6160 0105 R. Provincia Misiones, OM w/ nx "Panorama Informativo" (422; 2/13. Povrzenic, ARGENTINA)  
 11710 0118 R. Argentina, EE, ID, YL/OM tlk on alcoholism, fqys, sked (322; 2/7. Hodsdon, MN)(0030, 444; 2/12. Grosvenor, CA)

BOLIVIA

- 4699 0230 R. Riberalta, LAm mx, w/ TC/IDs, hrd 3 nights in a row (323; 2/27. Sams, AR)  
 4722 0140 R. Abaroa, Riberalta, OM w/ mx, messages px among the local people (522; 2/14. Povrzenic, ARGENTINA)  
 4739 0020 R. Mamoré, Guayaramerín, OM w/. mx, messages px (522; 2/17. Povrzenic, ARGENTINA)  
 4805 1030 R. Frontera, Yacuiba, ID by OM, slogan: "Una voz en el confin de la patria," & folk mx px called "Mañanitas Yaqueñas," (522; 2/16. Povrzenic, ARGENTINA)  
 4945 0315 LV de Bolivia, Radio-Theater, ID @0335: "Desde la ciudad de La Paz, transmite Radio...La Voz de Bolivia..." (333; 1/20. Lecuona, ARGENTINA)  
 6025 1014 R. Illimani, Lang/SS, tlks, nice Andean flute mx, local folk mx, 1028 ID by YL as "R. Illimani, LV de Bolivia, 1020 kc de onda media, 6025 kc 49 metros, 4945 kc 60 metros de onda corta, y 94 MHz frecuencia modulada en estereo," (322; 2/20. Cunningham, OH)(2340, fr/gd; 2/12. Parks, FL)(\*0028, YL ID as "LV de Bolivia," and OM IDing "R. Illimani," foll. by LAm mx, [232; 2/8. Schlesinger, TX]) (0205, 0240 ID, px: "Biblioradio," [444; 1/21. Lecuona, ARGENTINA])  
 6054 0310 R. Panamericana, Andean mx, OM ID "Panamericana al Mundo," 0315 interview, tlks about drugs (new fqy., not listed in WRTH 80)(444; 1/22. Lecuona, ARGENTINA)  
 6105 1039 R. Panamericana, "Bolivia presente.." mx, alternating between quena/charango & modern instruments, but all Bolivian mx. ID, fqys, good, (453; 3/6. Jones, MS)(1025, OC @1025, \*1030 w/ full ID and going into Bolivian mx. Ancd. the 49-mb channel as 6105. Very good signal; about the strongest I've ever hrd from Bolivia [Berg, MA])

BRAZIL

- 3205 2329 R. Ribeirão Preto, PP, musical saw mx, OM ID @2330, 95% of ID, positive mentions of "Ribeirão, Brazil, ads (222; 2/16. Cereghin, MD) 3/2. Sams, AR)  
 3225 0011 Lins R. Clube, PP, strong, futbol game, ID as "...Lins Radio Clube," (333; 3/6. Jones, MS)  
 3375 0155 R. Nacional de São Gabriel, PP, IDs, YL DJ, PP pops (444; 2/18. Dittrich, FL)(0206, 232; 2/25. Cunningham, OH)  
 4760 0110 R. Educ, Rural, Campo Grande, PP, soccer match, new fqy poss. to avoid QRM from R. Emisoras Bolivia, Oruro on 4755 kHz (422; 2/15. Povrzenic, ARGENTINA)  
 4785 0120 R. Ribamar, PP, string of ads, ID, folk mx (333; 2/25. Alexander, PA)(0820, 333; 2/22. Marshall, GA) 2/28. Nikolich, IL)  
 4835 0943 R. Nacional de Boa Vista, PP, clear w/ ID by OM, into Brazilian pops (343; 3/6. Jones, MS)  
 4885 0735 R. Clube do Pará, PP, same wild live sambas as on 5045, TC for "Amazonia" region, foll by ID @0745, (333; 3/1. Palmer, WA)(0630, 333; 3/1. Alexander, PA)(0327, 0338\* [433; 2/23. Davidson, SC]) (222; 2/10. Marshall, GA)  
 4905 0257 R. Relogio Federal, PP, OM ancr, IDs, YL ancr w/ TC, time pips, 0302\* /  
 4915 0315 R. Anhanguera, PP, OM DJ, into Brazilian mx, then up tempo pop, many IDs (333; 2/18. Nikolich, IL)(0315, 222; 2/15. Alexander, PA)+2  
 4955 0230 R. Cultura, Campos, PP, disco mx px (522; 2/16. Povrzenic, ARGENTINA)  
 4965 0900 R. Soc. Triangulo Mineiro, PP, OM w/ ID giving fqys. One new fqy not in WRTH '81, 99.9 MHz FM. The correct name of this sta is: "R. Sociedade Triangulo Mineiro," (422; 2/9. Povrzenic, ARGENTINA)  
 5025 0219 R. Borborema, PP, nearly non-stop PP pop mx, brief anmts by OM between selections. ID/fqys. @0245. (322; 2/23. Cunningham, OH)  
 5045 0720 R. Cultura do Pará, PP, wild samba mx live from Carnival celebration, fqy. closer to 5045.5 (333; 3/1. Palmer, WA)(0120, 432; 3/1. Davidson, SC)(0220, 433; 2/11. Stone, ON)(\*0702, 242; 2/15. Huddleston, TX) Povrzenic, ARGENTINA)  
 6125 0110 R. Excelsior, Sao Paulo, PP, soccer match w/ team Palmeiras (222; 2/13. /  
 9685 1430 R. Gazeta, PP, OM w/ excited tlk, poss. a soccer match, strange propagation this AM. (322; 2/14. Sams, AR)  
 11780 2113 R. Nacional, PP, IDs & possible ads, OM tlk, very fast as usual (343; 2/21 Calver, UK)(1054, 343; 2/27. McCurdy, CA)  
 11805 0008 R. Globo, PP, tlk by OM w/ interview, ads (333; 2/20. Toia, ITALY)  
 11864.4 0650 R. Clube de Pernambuco, PP, bands, choruses, shouts and whistles, excited cmtry. over mx. Probably carnival. Several IDs (353; 3/4. Pickard, IL)  
 11925 0000 R. Bandeirantes, PP, futbol (333; 2/20. Toia, ITALY)  
 15125 1949 R. Nacional de Brasília, EE, "letters from our listeners," q. on use of alcohol in Brazil (I think they use it for the same purpose we do. ch)(332; 2/16. Olson, CA)(1955, 444; 2/2. Westbrook, FRG)  
 15190 2150 R. Inconfidência, PP, mx @2300, QRM RCI (242; 2/14. Toia, ITALY)

BRAZIL -- (CONTINUED)

- 15290 0230 R. Brás, EE, report on Amazon Highway, native mx (2/10. Langlois, GA)(0230, 454; 2/27. Thompson, NM)(0256, 555; 2/28. Seitner, VA)(0215, 444; 2/18. Vollrath, MO)+2
- 15295 0200 R. Brás, EE, biggest lottery payoff in history (544; 2/6. Valentine, CA)
- 15415 1040 R. Clube Ribeirão Preto, PP, mx px called "Bom Dia, Ribeirão," (422; 2/3. Povrzenic, ARGENTINA)
- 15445 2019 R. Nacional Amazonia, PP, futbol, "Fluminensis - São Paulo" //11780 (544; 2/21. Toia, ITALY)(0210, 444; 2/13. Cereghin, MD)(0205, xmitting soccer game, one team named "Vasco da Gama," [554; 2/12. Grosvenor, CA])+1
- 17830 0247 R. Nacional, EE, greeting listeners by name when checked 3/1 @0247; not sure if this is a regular feature now, //15290 again suffering from jamming. (Hauser, TN)(0250, 322; 2/18. Shepherd, IL)(0217, 454; 2/23. Hesch, NY)+1

CHILE

- 6099.5 0943 R. Calama, hrd s/on on 2/25. No QRM, but pretty muffled at the outset. Picks up a little, but doesn't last long [being hrd regularly per Ralph Perry, comes on before 1000 -- peaks around 1010 during nx. Often plays a few bars of "Johnny One-Note" during nx. Fady at best, and goes out quickly after 1030.] (Berg, MA)(6100, 0930, s/on w/ ID, very bad style by OM that says: "...9700 khz & 6.1 diez Mhz." The correct fqys. of this sta are: 970 MW/6100 SW. [533; 2/13. Povrzenic, ARGENTINA])
- 6135 \*0959 R. Universidad Concepción, SS/EE, slow piano mx ID, then complete IDs w/ fqys and QTH in both SS/EE by OMs, then NA, opening anmts in SS, and into nice Andean flute/guitar folk mx, (232; 2/23. Cunningham, OH)
- 15150 0112 R. Nacional de Chile, breathless play-by-play of a soccer match between N.Y. Cosmos and someone else (533; 2/26. Sanchez, CA)(2330, 454; 2/14. Toia, ITALY)(2251, early US pop/rock, Beatles, etc. @2310, like a "gold weekend" on local AM [433; 2/7. Moman, AB])(2343, 444; 2/26. Windsor, GA)

COLOMBIA

- 4814.7 0212 R. Guatapurí, LAm vocal w/ bongos/accordion, OM, ID: "R. Guatapurí, Emisora HJMS..." (433; 2/24. Davidson, SC)(0130, 344; 2/25. Windsor, GA)+1
- 4855 0405 R. Neiva, Colombian mx, ID after each mx selection (333; 2/15. Alexander, PA)(0311, 333; 2/24. Davidson, SC)(0330, 0403\* [fr; 3/4. Pickard, IL])
- 4865 0324 LV de Cinaruco, ID @0326: "LV de Cinaruco...noche fantastica...LV de Cinaruco...colombiana Caracol, Caracol," fqys, "la primera noticias," (434; 2/24. Davidson, SC)(0220, 0230\* [343; 2/26. Thompson, NM])
- 4875 0330 LV del Norte, OM LAm ballad, marimba-drums-trumpet; OM, slow mx, "Love is Blue," full ID w/fqys @0355, "LV del Norte, Cucuta," (422; 2/24. Davidson, SC)(0145, 333; 2/7. Ray, PA)
- 4945 0711 R. Colosal, IDs, usual hopping-type LAm mx, lots of line noise tonight (533; 2/21. Blaize, LA)(0555, 242; 2/28. Hackney, TN)
- 4965 0550 R. Santa Fé, many IDs, Latin-style mx (242; 2/28. Hackney, TN)(0727, 433; 2/21. Blaize, LA)(0500, 353; 2/21. Fernando, NY)
- 5020 0400\* Ecos del Atrato, very strong at s/off, though slightly overmodulated, clear s/off anmts, NA (544; 2/22. Nikolich, IL)(0330, 333; 2/10. Marshall, GA)
- 5040 1018 R. Cinco, good signal, LAm mx, IDs between songs (343; 2/18. Schlesinger, TX)
- 5075 0846 R. Sutatenza, mx (U.S. standards), non-stop to "oración de la mañana" @0856, long s/on ID @0900, giving 6 MW, 2 TB, and 1 SW call, fqy & location (444; 2/25. Huffaker, MEXICO)(2303, 433; 3/4. Davidson, SC)
- 5095 0005, R. Sutatenza, Bad CW QRM, YL w/ plush orch. mx, 3-tone chimes, OM ID @0028, ID: "Esta es R. Sutatenza de Sistema de Comunicación de Acción Cultural Popular," fqys (523; 3/5. Davidson, SC)(0250, OM/YL w/ German tlk/mx; into SS at 0257 w/ full ID, fqys, etc, [444; 2/15. Sams, AR])(0334, 433; 2/26. Blaize, LA)
- 6045 0554 R. Melodia, rumba mx to xylophone IS and ID @0600, then more mx (423; 2/22. Schlesinger, TX)(0645, 444; 2/17. Hotaling, NV)(0850, 354; 2/1. Fernando, NY)+2
- 6066 0905 R. Super, LAm mx, slightly off-frequency (333; 2/28. Alexander, PA)
- 6115 0800 LV del LLano, LAm mx, ID, TC (444; 2/28. Alexander, PA)
- 6125 0927 R. Super de Calí, enthusiastic IDs "emisora fundamental -- cadena Super..." Super net px // LLano and Super de Bogota (343; 3/7. Jones, MS)
- 6150 0446 LV del Huila, LAm mx, (442; 2/6. Somers, CA)
- 15500 0012 R. dif. Nacional de Colombia, opera mx, SSB w/ a little carrier, //15333 AM (433; 2/16. Davidson, SC)

ECUADOR

- 2340 0340 R. Baha'i, f/in 0340, tlk by YL w/ occasional EZL mx, IDs by YL or OM "transmite R. Baha'i...Otavalo, Ecuador" and gave both SW & MW fqys. 14 or 16 note flute IS, 0400\* (fr; 2/18. Parks, FL)
- 3250 0304 LV del Triunfo, OM w/ class. mx interludes, ads?, ments. of Ecuador (Was there an ID?? ch)(222; 2/20. Cereghin, MD)(0246, 343; 2/18. Thompson, NM)
- 3280 1028 LV del Napo, OM ancr, ID, TC, then YL w/ poss. rel. tlks in lang, LAm mx, did not sound like all talks were in SS (444; 2/22. Marshall, GA)(1007, 343; ctd)



ECUADOR -- (CONTINUED)

- 3280 (LV del Napo, continued) 2/22. Nikolich, IL)(1041, ID as "Radiodifusora LV del Napo, capital Tena, capital de la provincia de Napo." [322; 2/21. Cunningham, OH]) 2/7. Cereghin, MD)
- 3360 0220 R. Federación, plenty of QRN, mellow LAm ballads and instrumentals, (222;/
- 3380 0415 R. Iris, many IDs, a lot of yelling/screaming by OM (343; 2/27. Hackney, TN)(0330, 433; 2/20. Davidson, SC)(3381, 0140, Circuito de Emisoras Iris, ID giving this new name of sta. [522; 2/5. Povrzenic, ARGENTINA])
- 3395 0346 R. Zaracay, Big orch-backed vocals, OM full ID @0400: "R. Zaracay... la República del Ecuador, LV de Santo Domingo de los Colorados," ads (433; 2/20. Davidson, SC) (322; 2/10. Povrzenic, ARGENTINA)
- 3985 0050 Escuelas Radiofónicas Populares, YL/OM w/ educ. px w/ mathematics lessons/
- 4656 0356 CRE, OM tlk to 0400, "March of the Toreadors," ID: "CRE Radiodiffusion del Ecuador transmitiendo de Guayaquil," ads (433; 2/21. Davidson, SC)(0220, 333; 2/6. Cereghin, MD)(0241, 353; 2/23. Brown, NJ) Davidson, SC)
- 4680 0410 R. Nacional Espejo, LAm mx, vocal w/ bongos, echo ID @0413 (433; 2/21./
- 4795 0408 LV de los Caras, LAm mx, vocals, ID @0420, het (433; 3/1. Davidson, SC)
- 4800T 0356 R. Popular Independiente, hrd after R. Lara s/off, low-voiced OM clobbered by Lesotho @0400, poss. ID, flute mx (222; 3/1. Davidson, SC)(0410, OM ID: "En Radio Popular son las 11 de la noche con 10 minutos," tropical mx and ads [444; 1/20. Lecuona, ARGENTINA])(0522, 444; 2/15. Dittrich, FL)
- 4920 0405 R. Quito, LAm vocal w/ guitar, "Wipi" ad (you drink it)[You might -- ch], ID: "Esta es R. Quito, LV de la Capital," (544; 2/24. Davidson, SC)(0515, 333; 2/27. Pickard, IL)
- 4960 0250 R. Federación, class. mx, OM: "con los mejores deseos que nuestros programas culturales hayan sido de su agrado, R. Federación cierra su emisión.." 0300\* (343; 1/20. Lecuona, ARGENTINA)(0200, 522; 2/17. Povrzenic, ARGENTINA)
- 5061 0310 R. Nacional Progreso, OM ancr, LAm mx, long ID as R. Nacional Progreso de Loja, Ecuador, TC (343; 2/15. Marshall, GA)
- 9745 0330 HCJB, EE, música del Ecuador, featured wonderful LAm mx, letter from a gypsy who sent a picture of his caravan (343; 2/27. Demmitt, PA)
- 9760 0610 HCJB, GG, YL inviting mail, tlk about Bible, 0620 DX px by ADDX to 0630, EE ID, into FF //11835 (433 jammed)(544; 2/7. Munster, GA)
- 11900 \*0600 HCJB, GG, requested QRM reports, brief mx, sermon on distortions of Bible. Apparently replaces 11835 (533; 3/4. Munster, GA)
- 15015 0155 HCJB, EE/SS, unusual xmitter mix of 15155 & 15295 EE/SS svce; pxx mixed until 0230\* of 15295 (433; 3/3. Marshall, GA) Coleman, MA)
- 15360 0055 HCJB, EE, Mary Lee Cummings, rel. mx., The Calvary Hour @0100 (444; 3/2./
- 17890 1410 HCJB, EE, SAm/World nx, "Morning in the Mountains," (222; 2/7. Picarelli, CA) + 8 other HCJB reports

FRENCH GUYANA

- 3385 0902 FR3, Cayenne, FF, ID/OM w/ ancmts., light/pop mx, "We Are Family," (353;/ 2/11. Cucura, PA)

GUYANA

- 5950 0833 GBS, EE, OM w/ "Early Morning Show," w/ request mx, ID, nx (353; 2/11. Cucura, PA)(0750, Hindi mx, px about raising cattle, marriage anmts, "The Early Bird Show," [333; 2/12. Alexander, PA])(0910, 453; 2/1. Huddleston, TX)+2
- 5980 A reporter called me this month with a report of R. Demerara. However, the show he reported hearing was the "Early Show"; see the reports above. Since his frequency readout was not exact, I believe he mistook 5950 for 5980. If you do hear R. Demerara, however, please send a tape.

PARAGUAY

- 11915 2107 R. Nacional, Asunción, Guarani, OM w/ cmt. about local events. New fqy. but poor reception because of QRM from R. Gaucha (522; 2/18. Povrzenic, ARGENTINA)(0150, opera, OM, ID @0157, NA, 0159\* [433; 2/22. Davidson, SC])(2300, per GH/RCI item, found new high-power xmitter of RN here, from around 2300, and a gain coming on a little after 1000. Big sig, but a messy fqy -- use of LSB really cuts through it. Many mentions of Stroessner, lots of mx (a little like Chile's). ID: "Transmiten ZPL, ZPAL y ZPBL, RN del Paraguay." [Berg, MA])(2259, varied px 2259-0157\*, long speeches w/ cmt, LAm ballads, many IDs as "R. Nacional de Paraguay al Exterior." From 0130-0154 px called "Música de la Patria" w/ local pop/folk mx. At 0154 closing anmts, IDs/fqys followed by NA sung by OM. 0157\* [422; 2/23. Cunningham, OH])

PERU

- 3386 0223 LV del Valle del Mantaro, OM w/ mx for lovers, w/ px called "El poema central de la noche" at this time (422; 2/9. Povrzenic, ARGENTINA)
- 4790 0512 R. Atlántida, OM DJ, long dedications, IDs, break, into mx, "Colombia y su música," full ID @0605 w/ NA. From IDs, power is 5 KW, beamed N/S, 0400 local time signon. There could be confusion on this one as mx, dedications, and TCs were Colombian and there's a R. Atlántico listed on 4905. Signal here (cont.)

PERU -- (CONTINUED)

- 4790 0512 R. Atlántida, (continued) is exc. and should be good in all the U.S. (444; 2/26. Huffaker, MEXICO)(2336, 222; 2/16. Cereghin, MD)(0329, 322; 2/7. Ray, PA)(0120, 222; 2/24. Alexander, PA) (0345, 332; 2/23. Davidson, SC)(0127, 433; 2/20. Dittrich, FL)(0600, listener called in and talked briefly, then more mx 0630\* [444; 2/15. O'Dell, AR])(0358, 343; 2/17. Pickard, IL)
- 4826 1000 R. Sicuani, SS/Quechua, s/on w/ ID by OM and then beginning folk mx px, "Amanecer Cuzqueño," new fcy, ex. 4835 (322; 2/15. Povrzenic, ARGENTINA)
- 4951 0035 R. Madre de Dios, mx px for lovers (422; 2/15. Povrzenic, ARGENTINA)
- 5040 0640 R. Libertad de Junín, huaynos, anmts, ID (222; 3/1. Alexander, PA)
- 5970 0050 R. El Sol, OM w/ sx, "Perú en Sintonia," (522; 2/13. Povrzenic, ARGENTINA) (\*1017, carrier from 1005, EZL mx 1017, then opening anmts by OM w/ fays, QTH, TC, into Andean mx px [333; 3/1. Cunningham, OH])
- 6115 1057 R. Unión, ID, TC, ads, Peruvian mx. Good (342; 3/6. Jones, MS)
- 6190 \*1103 R. Oriente, Long NA, short theme mx, ID, calls (OAX82 and OAX81), fays, QTH as Yurimaguas, Loreto, Perú. This my Unid. of 3/6. Trx. H. Lazarus for help on this. Hrd. 3/9 very poorly; s/on w/ theme from "The Sting," then NA (332; 3/8. Jones, MS)
- 6195 0920 R. Cuzco, SS/Quechua, ID, Andean mx px, YL/OM w/ birthday greetings to some listeners in Cuzco Department (533; 2/17. Povrzenic, ARGENTINA)
- 9485 1040 R. Tacna, Andean folk mx px called "Buenos Dias, Perú," (533, 2/16. Povrzenic, ARGENTINA)

SURINAM

- 4850 0431 SRS, song "Passion"; record stuck in groove and repeated "New York, Moscow" several times (2/14. Cuppy, IN)(0915, Indonesian, OM ancr, some weird mx, [333; 2/15. Palmer, WA])(0950, mx list of Station IDs, [444; 3/7. McSkimming, CA])+1
- 5006 0515 R. Apintie, interesting Jamaican reggae and dub mx, slow Surinam pop mx w/ OM singing, ID by OM (332; 2/13. Peck, NY)(0340, 333; 2/27. Hackney, TN)(0855, 453; 2/16. Munster, GA)(0620, 353; 2/27. Pickard, IL)(0932, 332; 2/18. Schlesinger, TX)(0605, man said: "Radio Apintie, I love you." then back to Dutch language [444; 2/14. Alexander, PA])

URUGUAY

- 11885 2357 SODRE, EE, ID, YL w/ QTH, sked, LAm mx, (333; 1/24. Hodsdon, MN)(0031, / 322; 2/7. Dittrich, FL)

VENEZUELA

- 3225 0140 R. Occidente, LAm mx, raucous noise due to hets, RTTY, etc. Venezuelan NA @0200, 0203\* (422; 2/17. Davidson, SC)
- 3255 1017 LV de El Tigre, long string of ads w/ TCs and nx between, most ads ended with "en El Tigre." (343; 2/25. Huffaker, MEXICO)(0225, 333; 3/1. Alexander, PA)(0235, 433; 2/17. Davidson, SC)
- 4770 0925 R. Bolívar, non-stop SA. folk mx, ancr @0934, finally an ID, 0944 after a very hyped-up 10-minute long selection of mx (444; 2/15. Palmer, WA)(0230, 444; 2/24. Thompson, NM)
- 4780 0100 LV de Carabobo, LAm mx, ads, OM ID: "En 1981 LV de Carabobo sigue siendo numero uno..."(Lecuona, ARGENTINA)(2334, 333; 2/16. Cereghin, MD])(0225, 444; 3/1. Thompson, NM)(0105, 333; 2/25. Alexander, PA)
- 4800 0333 R. Lara, LAm pop mx, slogan: "La Emisora Musical." Full ID by YL @0358\*. QRM de RTTY/het; (333; 2/18. Pickard, IL)(0347, 433; 3/1. Davidson, SC)(0314, 2/16. Cuppy, IN)(2352, 222; 2/6. Dittrich, FL)
- 4840 0227 R. Valera, continuous ads, singing ID, spoken ID by OM, foll. by anmts and then mx (444; 2/21. O'Dell, AR)(1100, 333; 2/7. Ray, PA)(0315, 222; 3/1. Alexander, PA)(0228, 433; 2/9. Dittrich, FL)
- 4860 0250 R. Maracaibo, IDs, vocals, orch. mx, tlks (444; 2/25. Thompson, NM)
- 4940 0320 R. Yaracuy, LAm instrumentals, OM ID @0324 (555; 2/23. Davidson, SC)
- 4960 1139 R. Sucre, LAm mx, (342; 2/10. Somers, CA)
- 4970 0340 R. Rumbos, OM, punctuated by 3-note chime, OM ID @0344 (433; 3/1. Davidson, SC)(0440, 512; 2/6. Somers, CA)
- 4980 0050 Ecos del Torbes, 0057 march mx, echo ID; full dictation-speed ID, (444; 2/15. Davidson, SC)(1127, 342; 2/10. Somers, CA)(0150, 2/18. Harris, WA)+1
- 4990 2320 R. Barquisimeto, LAm vocal mx, tlk, ID: "R.B. Internacional," (444; 2/22. Davidson, SC)(1124, 442; 2/10. Somers, CA)(0240, 333; 2/22. Stone, ON)
- 5030 0342 R. Continente, YL singing "tango" mx, IDs, foll. by usual LAm mx, (332; 2/26. Blaize, LA)(0330, 433; 3/1. Davidson, SC)
- 6180 1054 R. Turismo, heard w/ EZL LAm mx, which would have been nice to listen to if it hadn't been for VOA @6190. Reception better @0930 (312; 2/17. Schlesinger, TX)(0920, 333; 2/28. Alexander, PA)
- 9660 0959 R. Rumbos, ID by OM @1000 (333; 2/15. Sanchez, CA)(1204, 433; 2/7. Ray, PA)

HAVE SOME ROOM HERE -- WILL START N/C.AM ON NEXT PAGE

NORTH AND CENTRAL AMERICA

ANTIGUA

5975 2300 BBC, EE, nx (433; 2/3. Snider, ON) Johnson, IL)  
 6040 0119 OW, EE, IS, ID as OW Relay Station Caribbean, nx, 0150\* (555; 2/8./  
 11775 1109 BBC, EE, nx, "New Ideas," to Australasia? (444; 2/21. Hesch, NY)+2

BELIZE

3285 0330 R. Belize, EE, using BBC px feed (333; 2/27. Hackney, TN)

CANADA

5960 0100 RCI, EE, DXD hookup w/ Swiss Merry-Go-Round, frequent gaps in xmission  
 from Swiss end (If Swiss cheese has holes... ch)(555; 2/16. Cereghin, MD)+3  
 6031.5 1944 CFVP, Calgary, EE, relay CFCN 1060 MW, distorted today but very loud, usu-  
 ally barely audible, off usual 6030 too (444; 1/29. Moman, AB)(0840, EE, ID as  
 CFCN, local ads, OM/YL tlk about marriage relationships, OC @0845 clobbers sig-  
 nal (332; 2/14. Tacoma, CA)(0830, EE, ID, phone-in tlk show, NHK Japan obliter-  
 ates at 0855 and VOA knocks them both off @0900 (232; 3/5. Findlater, CA)(6030,  
 0230, top 40 mx, "Good Morning, -4 degrees Celsius @ 5:30, I'm Bruce Sills with  
 CFCN nx," clear w/ QSB [232; 3/3. Sams, AR]) (434; 2/28. Davidson, SC)  
 6070 1515 CFRX, Toronto, EE, px on rock gardens, Ad for Liberal Party. SW ID @1521./  
 6080 1702 CKFX, Vancouver, EE, "Inflation #1 Word in Canada," lots of QRN, QRM,  
 splatter, wiped out by USSR @1800 -- Drat! (222; 2/18. Oakley, OR)(2122, 131;  
 2/1. Moman, AB) Dittrich, FL)  
 6130 2311 CHNX, Halifax, EE, pop/rock songs, temp. 7 degrees, ID, ads (322; 2/15./  
 9575 1300 CBCNQSW, The World at 8; Soviet complaint of Western interference in Po-  
 land (555; 2/12. Oemmitt, PA)  
 11720 2345 CBCNQSW, EE, Cross-Country Checkup; topic: NAM cars vs. foreign (333;  
 2/8. Grenier, CA)(1615, "Sixty Mins. With A Bullet," [333; 2/7. Vollrath, MO])  
 11845 0215 RCI, EE, Mailbag (444; 2/23. Grenier, CA)  
 11925 2225 RCI, EE, ID, "The World at Six," (444; 2/11. Wampler, VA)  
 15190 2300 RCI, ID, "Attualidade Canadiense" (544; 2/14. Toia, ITALY)  
 15305 2144 RCI, EE, DXD (444; 2/28. Grenier, CA)  
 15325 2246 RCI, EE, As It Happens, "Sourtoe" drink in the Yukon (You don't want to  
 know about this. I heard the px too. ch)(544; 2/18. Miller, CA)+1  
 17820 0100 RCI now gangbusters on this fqy in EE, the evening bcs are now concentrat-  
 ing on USA rather than Caribbean/SAm...Rare instance of a sta. actually rising  
 to the MUF where theoretically propagation is superior to the lower frequencies  
 (Hauser, TN)  
 17875 2025 RCI, EE, YL/OM, tlk on snow, its depth and effect, mx to 2030\* (444; 2/9.  
 Schroeder, WI)(1900, 444; 2/15. Vollrath, MO)

COSTA RICA

4832 0215 R. Reloj, tlks, mx, ID (444; 2/25. Thompson, NM)(0652, 434; 2/4. Kerrigan, IL)  
 5050 0100 Faro del Caribe, OM, themes from various class. mx pieces, (433; 3/1.  
 Davidson, SC)(0340, 322; 2/26. Blaize, LA) Cereghin, MD)  
 6006 0431 R. Reloj, regular LAM mx, lousy signal as usual in the PM. (222; 2/16./  
 6078 0820 R. Rumbo, LAM mx, ID, anmts (333; 2/28. Alexander, PA)  
 9615 2017 R. Noticias del Continente, ID, foll. by YL anmts, talk, some fading, but  
 overall pretty good signal (433; 2/7. Schlesinger, TX)(1221, Address "Apartado  
 876, Centro Colón, San José." QRM from KGEI, drowned out finally @1238 (222;  
 3/5. McCurdy, CA)  
 9645 1215 Faro del Caribe, SS ID, "TIFC, Faro del Caribe, San José, Costa Rica." Px  
 was gospel talks/songs in SS (343; 2/14. Palmer, WA)(1215, 343; 2/7. Ray, PA)

CUBA

Valentine, CA)

9525 0630 RHC, EE, mx, tlk on Cuban history (544; 2/11. Miller, CA)(0630, 555; 3/1./  
 9600 1008 LV de Cuba, "Música Nuestra" px w/ some fine snappy LAM mx, ID @1026, RMWS  
 in EE @1100 (333; 2/15. Sanchez, CA)  
 9720 1810 RHC, mx, ID (443; 2/9. Toia, ITALY)  
 9770 1550 RHC, bouncy mx, IS, full ID, fqys @1558 (333; 2/21. Davidson, SC)  
 11725 0500 RHC, EE, mailbag px, LAM mx, "Musical QSL" px, px on drinking water (544;  
 2/22. Davidson, SC)(0545, 444; 2/7. Vollrath, MO)  
 11760 0430 RHC, EE, P.O. Box 7026, letter from Texas on Communist Party (555; 2/27.  
 Denmitt, PA)(0355, 454; 2/27. Hackney, TN)(0400, 433; 2/17. Witte, CA)(0100,  
 544; 2/17. Valentine, CA)  
 11930 0154 RHC, EE, propaganda, bad-mouthing the U.S. (555; 2/8. Somers, CA)(0123,  
 "Win a Trip to Cuba!" contest; OM/YL, IS [Insert clever remark here. kdj][No,  
 Kevin, I'd prefer to insert remark after 'contest'. ch][433; 2/22. Davidson, SC])  
 11970 0220 RHC, mx to SAm, YL, OM ID, fqys, sked, IS @0229 (432; 3/5. Davidson, SC)  
 15230 1640 RHC, cheery mx, OM, 1645\* (443; 2/21. Davidson, SC)  
 15340 0035 RHC, OM cmt, RHC IS @0040, ID (555; 2/16. Davidson, SC)

DOMINICAN REPUBLIC

4930 0400 HIBE, R. Mil, OM w/ pop mx, march mx, many mentions of Santo Domingo, IDs, call HIBE (444; 3/4. George, TX)(4929.3, 0433, mellow LAM mx, solo vocals/ choruses [353; 3/4. Pickard, IL])(2325, 344; 2/22. Davidson, SC)

TEL SALVADOR

7032 1251\* R. Venceremos. R. Liberación has not been heard since 2/8 on 8243, but R. Venceremos here seems to have succeeded it; hrd 2/20 1240 talking about El Salvador, some mx to 1253\*, very heavy CW QRM from hams wrapped up in their own little world of dits and dahs; 2/25 @1222 mentioned the Frente Democrático Revolucionario, allied with the FMLN; 2/26 1213 on 7032.5, ID, 1230 ID, calling on foreign stas. to relay them(?) but then went into an off-air relay of their own, making audio quality even worse; ancd. sked as 7-8 AM and 6-7 PM (EST). 1239 ending nx, quoting Washington Post; before 1250 anthem and off, gave ID again, fqy as 40 metros, 7 MHz. (Hauser, TN)(7035, \*1200, also per GH-RCI item, new Salvadorean cland. hrd. Noted at \*1200, also 2300. CW bad at any time, but worse at 2300 vs. 1200. Pretty good strength, but overmod. Usual mx, political tlk format. Drifted down to 7031 for a while; sounds like a very rough operation. "Trasmite R. Venceremos, emisora del Frente Farabundo Martí para la liberación nacional."(Berg, MA) ston, TX)

8243 0115 R. Liberación, YL/OM tlks, multiple ID, patriotic mx (433; 2/5. Huddle-/

GRENADEA

15045 2232 RFG, EE, OM w/ Obits, with schedule for next obit. bc. (Preview of Coming Subtractions?? ch)(433; 2/26. Blaize, LA)(2230, 3/5. Langlois, GA)+4

GUATEMALA

3300 0330 R. Cultural, EE, "Through the Bible," J. Vernon Magee, this station was running about 2-3 mins. behind GMT [How appropriate -- always behind the times. hi! ch](333; 3/5. Brown, NE)(0415, 444; 2/27. Hackney, TN)(0250, 433; 2/22. Stone, ON)(0420, 222; 2/4. Picarelli, CA)(0310, 323; 2/17. Witte, CA)+2

3325 1010 R. Maya de Barillas. "Anchors Aweigh" theme, ID by OM in local language, (433; 2/22. Nikolich, IL)(0220, Indian, tlks, mx, ID [444; 2/19. Thompson, NM])

3360 0215 LV de Nahualá, marimba/sax mx, animal sounds, list of names (422; 2/20. Davidson, SC)

3380 0213 R. Chortis, OM w/ C&SAm. nx, many IDs, LAM mx, 0330\* w/ ID only (333; 2/5. Cucura, PA)(0200, 444; 2/4. Thompson, NM)(0300, 433; 3/4. Davidson, SC)(0302, 343; 2/6. Huddleston, TX)(0320, 332; 2/17. Witte, CA)

HAITI

11835 2325 4VEH, EE, QRM (/9770 322), rel. px (433; 1/31. Blaize, LA)

HONDURAS

3250 0230 R. Luz y Vida, light mx, rel. px @0302, Lone Ranger theme/IDs @0344 (222; 3/1. Alexander, PA)(0125, end of rel. px, many addresses around SAm., foll. by ID w/ calls, fqy. ancd. as 3250 [333; 2/12. Windsor, GA])(0000, HRPC, 0000 f/in w/ ID, choral mx "At Calvary," From letter from Don Moore of the station: "R. Luz y Vida, San Luis, is owned and operated by Faith Missions, Bedford, Indiana. They broadcast daily from 2200-0400 GMT on 1600 & 3250 kHz w/ power of 250 W. Postal address: "Apartado 303, San Pedro Sula, Honduras, C.A." Clobbered by South Africa @0350 (pr/fr; 2/21. Davidson, SC)(3251, 0339, hrd w/ beautiful signal on 2/20 w/ better quality than ever before. Full ID @0339, just a slight het. Ancd 3250 SW + MW. Closing ID 0356, 0359\*, no NA (Berg, MA)

4820 0430 LV Evangelica, EE, rel. px w/ mx/tlk about truth (333; 2/15. Alexander, PA)

4910 LV de Mosquitia, not "Justicia." Mosquitia is the westernmost region of Honduras where Puerto Lempira is located. Hrd on 2/20 w/ fairly good signal to 0257\* without NA. Better on 2/22 w/ Abba songs at 0045, SS anmts, then into EE @0058-0111. Clearly gave call as HRXX, location as P.L. Anchr had a sort of one-way conversation w/ EE-speaking listeners. Asked for reports (no specific addr. given), mentioned WI, MS, FL, KY, apparently places they've hrd from. Said being was new to them, and that listenership was growing. Very interesting little segment. Played some mx, one number in honor of 200th birthday of U.S. Very much a U.S. operation; even the SS ancrs sound as if SS is a second language to them. Back to EE @0111 (Berg, MA)(0300\*, tnx. to tip from Andy Newton, hrd this new station from 2/28 @0030. Noticed immediately that anchr. has heavy U.S. accent when speaking SS, and even more so when speaking EE. Around 0100 he was calling U.S. listeners by name, in EE. Signed off promptly at 0300 this and next two nights, without any NA or to-do. Spends a lot of time reading from Bible, plays some mx. Sounds like a one-man operation -- a missionary sitting in the jungle doing his thing! Newton says it's in Puerto Lempira; usually there's a heavy het and/or other garbage on the low side of fqy, making copy difficult. (Hauser, TN) (0100, EE, into EE @0104 after Miskito lang. px. Missionary station in Gracias a Dios area. Seems to be family operated; folks (continued)



HONDURAS

4910

LV de Mosquitia, either from MS or w/ relative in MS. Said reports received from Pitt McNeil, David Crawford, and others. Sked 1200-1400 and 0000-0300. One or two anmts by young girl. OM ancr said Mary Frances glad to have sister home after visiting in MS & FL. Spelled Lempira phonetically. Thanks to Lazarus for prodding me up on this one! (433; 2/26. Jones, MS)(0105, [I'm sorry I changed your ID last month -- you were right; I was wrong. ch], SS/EE, gave a 15-min. history of sta. in EE; Address: Estacion de Radio HRXK, Puerto Lempira, Honduras. Said had been off the air most of Feb. w/ technical troubles. [fr; 2/20. Parks, FL])(0015, gospel mx w/ ancr in SS to 0100, into EE service and back to SS @0130. Address as HRXK, Puerto Lempira, Honduras [344; 2/28. Windsor, GA])

MEXICO

5985 2326 R. México Internacional, "Mexican Hour" px, interminable credits (333;/ 2/15. Huddleston, TX)  
 6045 1459 R. Univ. de San Luis Potosi, symphonic mx to ID @1459, flute IS (222; 2/11. Schlesinger, TX)  
 6105 1145 Tus Panteras Juveniles, some soft, mushy, mellow Mexican tunes, but a lot of OM tlk, ID @1200 (222; 2/17. Cereghin, MD) 3/1. Hotaling, NV)  
 6115 1600 R. Univ. de Sonora, tlks, IDs, mx (454; 2/27. Thompson, NM)(1545, 322;/ 9515 2010 LV de la América Latina, interview px to 2014, then ads, ID, IS @2022 (332; 2/11. Schlesinger, TX)  
 15430 2307 R. México Internacional, EE, tlk on food production with mx interludes (322; 2/15. Cereghin, MD)(0130, 453; 2/16. Somers, CA)(0020, 433; 2/20. Leeman, RI)(0053, 232; 2/9. Peck, NY)(2340, 534; 2/15. Davidson, SC)(2337, 433; 2/12. Wampler, VA)(0002, SS/EE, "Mexico in 1 Minute" @0002, about town of Champotón in Campeche State, back to SS, ads for the national lottery [333; 2/17. Palmer, WA])(0015, wx for various Mexican cities [433; 2/21. De Koyer, NJ]) +1

NETHERLANDS ANTILLES

9590 0230 RN, EE, nx, DXJB report on RFE/RL bombing, cmt. on RIB, sharply worded remarks about Hauser (454; 2/27. Demmitt, PA)(0305, 444; 2/13. Wampler, VA)  
 9755 0500 TWR has started up a new English bc; I first found out about it from their M81 engineering schedule, but it was already underway in late Feb; skeo gives 0500-0730, but 3/2 @0451 already on and at 0459 said would be on for another hour (only). Is //800, and 9755 now mixes with AFTRS. This presumably would not happen if the US-based TWR were required to coordinate with U.S. stations for its transmissions from elsewhere. At this point, the exact schedule of this transmission, which is for NAM, is not clear to me, and perhaps not even to TWR. (Hauser, TN)(444; 2/23. Palmer, WA)(0400, 444; 2/28. Demmitt, PA)  
 15315 0004 RN, "Espacio Diexista," //6020 (455; 2/7. Toia, ITALY)  
 21685 2030 RN, EE, Happy Station (445; 3/1. Bellard, OH)(2030, 444; 2/4. Rowan, ON) (1727, 434; 2/14. Davidson, SC)(2030, 323; 2/15. Maise, LA)+9 other NAnt. rpts.

NICARAGUA

5950 0340 LV de Nicaragua, IDs/tlk by YL&OM about Venezuela, Guatemala, revolución, Sandino, and Ronnie Reagan (333. 2/19. Leeman/Fisher, MA)(0107, 2/18. Harris, WA)(0110, 423; 2/19. Miller, CA)(0500, 353; 2/15. Fernando, NY)  
 6120 1131 R. Zinica, ranchera mx, vocals, many TCs, "La hora exacta..." TCs right on the nose; very good (444; 3/6. Jones, MS)

UNITED STATES OF AMERICA

6102 1130 R. Clandestine, first time I've run across this one. Hrd. 2/8 @1130 w/ very good sig. and unusually good audio. Playing rock mx and giving very professionally-done phony ads. still there after 1200 (Berg, MA)  
 6185 0555 WYFR, CG, end rel. tlk, into harpsichord mx, ID by OM w/ 0600\* [I don't go hunting for these CG rel. pxx; just keep running into them. hi! tm] (454; 3/12. Munster, GA)  
 6265t 0612 Syncom 48, EE w/ ancr reading letters and giving information on other clandestine stations (Voice of the Pyramids, etc.). Played "Another One Bites the Dust" by Queen. Heavy UTE QRM. Though no ID hrd, I assume this to be Syncom as was previously scheduled to be on this night per tip on DXDigest. Very poor signal. (2/15. Gavaras, MN)+2  
 6280 0745 Syncom 40, EE, better here than 6265, "This is the 1st Anniversary Broadcast from Syncom 40," 0811\* for 8 mins. to see if 6280 was clear. Where is this located? (CT, I believe. ch)(333; 2/14. Sams, AR)  
 6580 \*0423 R. International Music, EE, rock mx, IDs, new name for an old pirate according to 2 station officials undercover at the SCAOS meet. Power was 250 W. (333; 2/16. McCurdy, CA)  
 7074 0337 R. Abdala, pretty sure I had a R. Abdala ID by OM, mostly tlk by OM/YL, 0349\* (222; 1/29. Moman, AB)  
 21525 2200 WYFR, EE, ID, fqys, Unshackled: Mission service converts another sinner in spite of peer pressure (55; 3/1. Demmitt, PA)

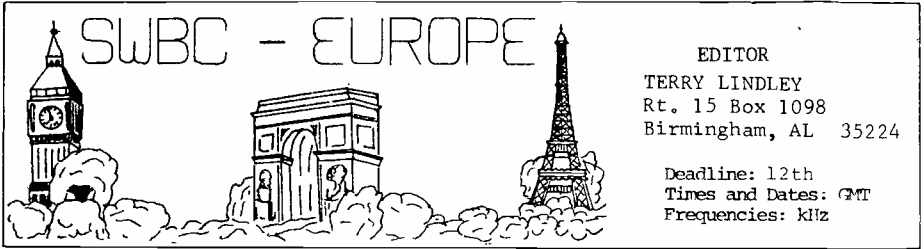

EDITOR

TERRY LINDLEY  
Rt. 15 Box 1098  
Birmingham, AL 35224

Deadline: 12th  
Times and Dates: GMT  
Frequencies: kHz

ALBANIA

5057 0426 R.Gjirokastr: AL-AL folk mx & classical mx, ID.(433 2/16 Cereghin-MD)(Earhart-PA)(Eddie-MO)(Westbrook-FRG)(D'Angelo-PA)(Huddleston-TX)  
6200 0330 R.Tirana: EE-YL w/nx & cmtry.(434 3/4 Lay-VA)  
7065 2214 RT: EE-YL w/ID @ 2215, beamed to Europe.(322 2/4 Hodson-MN)(444 2/1 Blaize-LA)  
7080 0638 RT: Cmtry on American Imperialism.(433 2/8 Grenier-CA)  
7120 0235 RT: EE-YL w/cmtry on women, socialism, & facism.(434 3/5 Nesslein-MO)(434 2/20 Hackney-TN)(333 2/25 Sanderson-AZ)  
7210 0244 RT: EE-Cmtry on "Imperialist" Euro political parties by that same YL who is on night after night.(333 2/19 Cereghin-MD) I feel for you John, cheers...tml  
7265 2222 RT: EE-RT: EE-YL w/mx pgm, sked for N. America.(323 2/8 Miller-MA)  
9375 0705 RT: PO-OM w/nx, beamed to Europe.(222 2/16 Palmer-WA)  
9480 2219 RT: EE-Talk on Albeconomic progress.(555 1/2 Smith-FL)(Cereghin-MD)  
9500 0634 RT: EE-YL w/cmtry on Reagan & U.S. Imperialism.(353 1/10 Earhart-PA)  
9745 0157 RT: EE-YL w/usual propaganda.(333 1/13 Farmer-TN)  
11985 1105 RT: SS-OM & YL w/nx pgm.(555 2/21 Toia-Italy)

ANDORRA

6220 0600 R.Andorra: FF-OM w/IDs & EE pop mx.(323 2/23 Lay-VA)(Eddie-MO)(Newton-GA)+ 1  
15025 0950 RA: EE-OM w/"Voice of Hope" pgm.(353 2/15 Marshall-GA)

AUSTRIA

5945 0130 ORF: EE-"Report From Austria" (433 3/2 Osborne-MI)(Moman-ALB)(Miller-MA)(Toia-Italy)(Forbes-TX)(Hotaling-NV)(Picarelli-CA)(Davidson-SC)(Earhart-PA)  
6155 0830 ORF: EE-OM & YL w/nx & ID.(2/8 Toia-Italy)  
9770 0245 ORF: EE-OM w/cmtry, ID, Austrian mx.(443 2/24 Schrammel-WI)(Demmitt-PA) + 5  
12015 0445 ORF: EE-OM & YL w/"Touring Austria", IDs.(333 2/22 McSkinning-CA)(323 2/25 Vollrath-MO)(Miller-CA)(Earhart-PA)(Shepherd-IL)(Traver-CA)(Forbes-TX) + 3  
15410 0700 ORF: GG-ID & nx, boakwave of 123 degrees to Mid-East.(2/19 343 Munster-GA)  
15560 1830 ORF: EE-Pgms & wld nx.(443 1/16 Snider-ONT)(Miller-CA)  
21655 1230 ORF: EE-Report From Austria, (nx & views).(232 2/25 Zilmer-NM)

BELGIUM

11695 0015 BRT: EE-YL w/nx, mx, cmtry on women in Armed Forces.(554 2/20 Cucura-PA)(Byron-NY)(Pettit-IA)(Maise-LA)(Fernando-NY)(Harris-WA)(Wampler-VA) + 12  
15175 0053 BRT: EE-Mailbag pgm, talk about Brussels./434 2/19 Johnston-IL)(Toia-Italy)  
15210 2059 ORF 2: DD-Classical mx, IS, & national anthem.(444 2/22 Mappin-WA)  
21460 1732 BRT: FF-Pop mx w/some EE songs & classical mx.(433 2/13 Miller-CA)  
21525 1742 BRT: EE-YL w/Mailbag pgm, talk on broadcast services in Belgium.(333 2/19 Audette-MA)(222 2/8 Alexander-PA)(433 2/9 Cucura-PA)  
21810 1655 BRT: DD-Pop mx, ID, freq beams, IS & s/off.(433 2/14 Palmer-WA)(Zilmer-NM)

BULGARIA

7115 0430 R.Sofia: EE-Nx pgm, cmtry on social life in Bulgaria.(544 2/23 Alexander-NC)(Forbes-TX)(Krist-VA)(Smith-FL)(Earhart-PA)  
7667 0425 RS: BG-YL w/folk mx pgm, nx, & ute QRM.(222 1/28 Sams-AR)  
9580 2040 RS: EE-YL w/cmtry on El Salvador Rev, mx pgm & ID.(232 2/21 Audette-MA)  
9665 \*2130 RS: EE-IS, ID, freq -Sked, & wld nx.(444 2/18 Wampler-VA)(Krist-VA)(Nesslein)  
9700 1930 RS: EE-Nx, listeners letters & mx pgm.(333 2/1 Rowan-ONT)(Demmitt-PA)(Smith-FL)  
11830 0000 RS: EE-Barely heard under another station.(Hauser-TN)  
11880 2042 RS; EE-OM w/cmtry & ID, OM & YL w/"Answering Your Letters".(232 3/1 Audette)

CZECHOSLOVAKIA

5930 2220 R.Prague: CZ-OM & YL w/talk, folk mx pgm.(242 2/19 Cereghin-MD)(Earhart-PA)  
6055 0641 RP: EE-YL w/light mx pgm.(333 2/15 Huffaker-MEX)  
7345 0145 RP: EE-Pgm about ham radio & QSL bureaus.(444 2/20 Hackney-TN)(Cereghin-ND)(Coutermarsh-VT)(Picarelli-CA)(Vollrath-MO)(Rowan-ONT)(Eddie-MO)( + 6  
9540 0300 RP: EE-Nx pgm, talk on Reagans foriegn policy.(433 2/18 Demmitt-PA) + 2  
9630 0309 RP: EE-Nat & wld nx bullitens.(323 2/15 Miller-MA)

C Z E C H O S L O V A K I A /

9740 0306 RP: EE-Wld nx, & "Topic of the Day".(433 2/18 Sanchez-CA)(McSkimming-CA) + 4  
 11990 0100 RP: EE-Nx pgm, & "Cmtry of the Week".(534 2/15 Coutermarsh-VT)(Munster-GA) + 3  
 21505 1537 RF: EE-YL w/ID "This Is Radio Prague".(422 2/22 Grenier-CA)  
 21705 0736 RP: EE-Nx pgm, political cmtry & ID.(232 1/29 Moman-ALB)

D E N M A R K /

15165 1800\* R.Denmark: DD-YL w/EE ID.322 2/7 Moman-ALB) Note...Only 1 logging received this month. For those of you who would like to log Denmark you may do so every day at 1700 & 1800. They give an EE ID on the hour but the programming is in Danish. I've never heard any EE from Denmark...tml

F I N L A N D /

9645 0346 R.Finland: EE-Mx pgm, cmtry, hard to hear due to noise.(342 1/12 Earhart-PA)  
 (433 2/5 Nesslein-MO)(222 2/22 McSkimming-CA)(433 2/27 Hotaling-NV)(Miller-CA)  
 11735 0330 RF: EE-Compass North pgm, nx, mx, & ID.(443 2/28 Alexander-NC)(Picarelli-CA)+4  
 11835 2000 RF: ??-IS, ID, & freqs in EE, continuing in unknown lang.(221 1/29 Moman-ALB)  
 11755 0327 RF: EE-Gone back to 11755 @ 0330 in EE to NAM, however Finland is going on DST @ the end of March and is moving all pgming 1 GMT hour earlier.(Hauser-TN)  
 (333 1/24 Eddie-MO)(433 1/18 Audette-MA)  
 15400 1445 RF: EE-OM w/nx, cmtry on USSR disarmament.(444 2/14 Coleman-MA)(G.Raymond-MA)  
 (554 2/18 Forbes-TX)(Picarelli-CA)(Cereghin-MD)(Miller-CA)(Smith-FL)  
 21475 1430 RF: EE-YL & OM w/ID, Nx, & "Northern Report".(333 1/29 Hodson-MN)(333 2/12 Vollrath-MO)(433 2/28 Grenier-CA)

F R A N C E /

6040 2220 RFI: SS-Euro service to Spain, OM talks w/lots of QRM.(232 2/19 Cereghin-MD)  
 7135 0411 RFI: FF-OM w/ff country mx, beamed to Africa.(333 2/21 Cereghin-MD)  
 7280 0750 RFI: FF-OM w/ff pop mx pgm, many IDs.(333 1/24 Audette-MA)  
 9545 0414 RFI: FF-OM w/slow FF pop mx songs.(222 2/20 Cereghin-MD)  
 11730 0420 RFI: FF-OM w/mx pgm, ID.(433 2/22 Davidson-SC)  
 11810 1900 RFI: FF-Pop mx pgm interspersed w/talk.(343 2/14 Findlater-CA)  
 11930 \*1900 RFI: FF-IS, ID, Nx pgm.(454 2/16 Munster-GA)  
 15135 0527 RFI: FF-OM sing a comic song.(322 3/7 Traver-CA)Received these on 13th. ...tml  
 15155 0532 RFI: FF-OM- is it nx? I don't think so.(433 3/7 Traver-CA) I can't help you Traver, if it isn't EE I am out of luck! ...cheers...tml  
 15180 1840 RFI: FF-OM & YL w/nx prm, cmtry on hostages.(343 1/24 Traver-CA)  
 15200 1730 RFI: EE "Paris Calling Africa", OM 2 YL w/ID-sked.(343 2/20 Audette-MA)  
 15360 1710 RFI: EE-OM & YL w/Afro nx, ID.(333 2/20 Audette-MA) MD)  
 15425 1705 RFI: EE-Nx pgm about Africa & France.(222 2/8 Alexander-PA)(222 2/8 Cereghin-MD)  
 15435 2045 RFI: FF-Mx pgm, Giscard annnc his candidacy. This tx is regularly stronger than others from RFI at the same time on 19 mb. Propagation and audio quality suggest possibility of relay from Gabon site.(444 3/2 Pickard-IL)(Sanchez-CA)  
 (Findlater-CA) Not in WRTVH or the sked I received yesterday...tml  
 17720 1705 RFI: EE-"PCA" w/mailbag pgm.(322 2/15 Maise-LA)(333 2/24 Shepherd-IL)  
 17850 1705 RFI: "PCA" special Valentines day pgm.(343 2/14 Palmer-WA)(Snider-ONT)  
 17860 1712 RFI: "PCA"OM w/Afro & wld nx pgm.(333 1/1 Farmer-TN)  
 21515 1713 RFI: "PCA" w/nx & mx pgm.(533 1/8 Snider-ONT)(Audette-MA)(Vollrath-MO)( + 2  
 21620 1705 RFI: "PCA" pgm featuring extract from Sadats press conference.(433 2/20 Thompson-CA) Seems Peggy forgot to include her own loggings in the mailing along with everyone elses. As you can see they got here in time anyway Peggy... (Fair 1/17 Gucinski-WA)(Miller-CA)(Picarelli-CA)(Traver-CA)  
 21645 1545 RFI: FF-OM w/talk & EZL mx.(233 3/1 Sanchez-CA)

G E R M A N D E M O C R A T I C R E P U B L I C /

9730 0253 RBT: EE-RBT DX Club w/talk on active antennas.(222 2/24 Shepherd-IL) + 5  
 11840 2340 RBT: EE-Cmtry & nx, beamed to West coast.(423 2/15 Miller-MA)  
 11890 0408 RBT: EE-Pop mx prm & end of EE pgm, IS 19 times! (333 2/19 McCurdy-CA) + 4  
 11920 0145 RBT: SS-OM w/talk & ID.(433 2/22 Davidson-SC)  
 15240 1455 RBT: EE-IS & ID on RBTs African service.(433 2/16 Sanchez-CA)  
 21500 1800 RBT: EE-Nx & Cmtry in the African service.(323 3/4 Brown-NE)(Wampler-VA)+ 3  
 21540 1438 RBT: EE-Request for listeners to write for souvenir.(1/11 Farmer-TN)

G E R M A N F E D E R A L R E P U B L I C /

3995 0231 Deutsche Welle: GG-Mx pgm, thought I had Switzerland for a moment.(353 Earhart PA)  
 6030 0545 DW: GG-Church mx, singing & ID.(323 2/11 Oakley-OR)  
 6040 0120 DW: EE-Local nx, Press Review, sounds like local AM-FM stations due to such strong signal.(554 2/4 Hesch-NY)  
 6065 0218 DW: EE-Nx pgm & lots of QRM.(222 2/19 Cereghin-MD)  
 6085 0706 Bayerischer Rundfunk: YL w/nx, GG brass band mx.(222 2/7 Huddleston-TX)  
 6145 0040 DW: SS-OM w/pop mx, choral mx, ID.(555 2/6 Davidson-SC)  
 6185 0540 DW: GG-Male chorus, OM w/long talk.(333 3/5 Traver-CA)

YOU CAN STILL BE SOMEONES DREAMBOAT \*\*\* EVSW IF YOUR CARGO HAS SHIFTED

GERMANY

7210 0211 DW: EE-Nx & Cmtry on the Asian service.(333 2/18 Cereghin-MD)(Audette-MA)  
 7265 ???? Sudwestfunk: GG-OM w/nx & ID, mx pgm.(232 2/7 Huddleston-TX)  
 7285 0211 DW: EE-Nx & Cmtry.(333 2/17 Cereghin-MD)  
 9545 0530 DW: EE-Nx pgm.(444 2/21 Vollrath-MO)(Traver-CA)(Earhart-PA)(Miller-MA)  
 9650 \*0530 DW: EE-OM w/nx, cmtry, mx pgm.(533 3/7 Munster-GA)  
 9690 0204 DW: EE-IS, ID, nx & cmtry.(343 2/19 Cereghin-MD)  
 9765 2135 DW: EE-ID & mx pgm to Asia.(444 2/18 Wampler-VA)(Audette-MA)  
 11850 0950 DW: EE-"Music From Germany".(354 2/1 Fernando-NY)  
 15105 0150 DW: EE-Mx & IDs, the Malta relay.(333 2/21 Maise-LA)  
 15150 1940 DW: EE-OM w nx & talk on Reagan.(444 3/6 Audette-MA)  
 21600 1515 DW: FF-IS, ID, rock mx pgm & sked.(433 2/22 Palmer-WA)(Wampler-VA)(Grenier)

GREECE

5955 0510 VOA: EE-OM w/Breakfast Show, talk on Valentines day.(322 2/14 Hotaling-NV)  
 7215 0418 VOG: GG-Greek folk mx, CW QRM.(333 2/21 Cereghin-MD)  
 9515 0130 VOG: EE-YL w/nx pgm & lang.(542 2/12 Miller-CA)(Nesslein-MO)(Miller-MA)  
 9655 2333 VOG: GK-Greek mx & dances.(333 1/31 Blaize-LA)(Fernando-NY)(Audette-MA)  
 9575 0419 VOG: GK-Greek folk mx w/instrumentals.(333 2/20 Cereghin-MD)  
 9655 0130 VOG: EE-NX.(2/12 Huffaker-MEX)(232 2/21 Cereghin-MD)  
 11730 0130 VOG: EE-OM w/wld & Euro nx followed by mx.(343 2/19 Ketzis-KS)(Eddie-MO)(+ 13)  
 11840 0815 VOA: EE-Voa s/off in EE @ 0815.(333 3/3 Sanchez-CA)  
 15160 0548 VOA: EE-OM talks about British House of Lords.(422 3/5 Traver-CA)  
 15260 1544 VOA: EE-Course on "How To Write Love Letters".(533 2/13 Sanchez-CA)

HUNGARY

6110 \*2100 R.Budapest: EE-OM w/ID, Nx & Cmtry.(444 1/29 Audette-MA)(Toia-Italy)  
 9585 0225 RR: EE-Cmtry on Hungary & USSR industry.(333 2/19 Cereghin-MD)  
 9835 0130 RB: HH-Talk of early settlers of Szolnok district.(2/21 Byron-NY)(Osborne-MI)  
 (Sanderson-AZ)(Krist-VA)(Cereghin-MD)(Miller-CA)(Eddie-MO)(Ray-PA)  
 11910 2120 RB: EE-ID & feature on co-op farming.(333 2/18 Wampler-VA)(Davidson-SC)  
 11940 0645 RR: EE-YL w/ID & s/off.(poor 2/3 Gucinski-WA)  
 15220 0310 RB: EE-Talk about Spain & NATO allies.(444 2/20 Hackney-TN)(Miller-MA)  
 17710 0300 RB: EE-OM & YL w/nx, disc about S.Africa.(343 3/2 Tacoma-CA)(Davidson-SC) + 4

ICELAND

12175 1907 ISRS: Icelandic-Talk, mx, ID, s/off.(332 1/18 D'Angelo-PA)(Moman-ALB)

ITALY

6050 \*2135 RAT: CK- YL w/ID, Nx pgm.(323 2/28 Alexander-PA)  
 9575 0105 RAL: EE-YL disc terrorism, wld nx.(322 2/3 Reeman-OH)(Thompson-CA) + 9  
 21555 1830 RAT: II-Nx.(444 3/4 Prown-NE)

LUXEMBOURG

6090 0025 R.Luxembourg: EE-Rock mx pgm w/ads & IDs.(434 2/26 Windsor-GA)(Moman-ALB)  
 (Hesch-NY)(Eddie-MO)(Beeman-OH)  
 15350 2030 RL: FF-Mx pgm, ID, & ads.(433 2/15 Davidson-SC)

MALTA

6025 0400 DW: AA-Arabic chanting, talks, mx.(333 2/26 Hotaling-NV)  
 6100 0018 DW: EE-IS, ID, cmtry on tornados.(555 2/17 Johnson-IL)  
 9510 \*2015 IBRA: IS, ID, "This is IBRA radio broadcasting over R.Mediterran"(333 2/24  
 Wampler-VA)(232 1/27 Moman-ALB)  
 9590 0120 DW: EE-Nx & views to N.Amer.(433 3/2 Zilmer-NM)(Munster-GA)(Thompson-NM)  
 9670 0701 R.Mediterran: EE-IDs, "Malta Calling", Address, nx, mx.(333 2/14 Moss-CA) + 4  
 15105 0145 DW: EE-OM w/pgm about carnivals in W.Germany.(343 3/3 Audette-MA)

MONACO

4595 0740 TWR: EE-"Back to the Bible".(454 2/11 Van Beurden-CA)  
 7100 \*0428 TWR: EE-IS, ID, into religious pgms.(222 1/11 D'Angelo-PA)  
 7200 0830 TWR: ??-IS, OM gives ID in EE.(433 2/22 Davidson-SC)  
 9545 0725 TWR: EE-Rel pgm & mx on Euro ser.(544 2/15 Tate-NV)(Oakley-OR)(Seitner-VA) + 4

NETHERLANDS

5955 0725 R.Nederland: DD-IS, ID, nx pgm, to Euro.(??? ?/?/? Palmer-WA)(Toia-Italy)  
 9590 0210 RN: EE-ID, "Newline", DX Jukebox, "His & Hers" pgm.(434 2/5 Nesslein-MO) + 2  
 15220 2100 RN: EE-Afro scene w/talk on Sierra Leone, skeds.(443 2/16 Olson-CA)(Windsor-GA)  
 17605 2030 RN: EE-YL w/wld nx, OM w/political talk & Cmtry.(434 2/9 Schroeder-WI) + 2  
 21685 2049 RN: EE-Newline w/lengthy wld nx bulliten.(332 2/9 Miller-MA)

Note: For you Pirate buffs I have decided to make a separate heading for pirate stations. I have not quite decided how I stand on the subject. It's true that the freq spectrum & air waves belong to everyone and they should be able to use them. But look what the seemingly unpoliced existence of the U.S. Citizens Band has produced over the years. It has become a radio service that is virtually useless except for short range line of sight transmissions.



NORWAY

6185 0425 RN: NW-OM & YL w/talks , mx.(322 2/26 Hotaling-NV)  
 9590 0826 RN: EE-Pgm of pop mx.(54 2/22 Hesch-NY)  
 11850 0730 RN: EE- s/off w/freq -sked.(354 2/23 Van Beurden-CA)  
 11860 0206 RN: EE-OM & YL reads the mx.(333 1/26 Eddie-MO)(444 1/31 Blaize-LA)  
 11935 \*1800 RN: EE-IS, YL IDs then "News & Views".(232 2/22 Audette-MA)  
 15175 2200 RN: EE-News & Music then ID.(322 2/22 Alexander-NC)(Miller-MA)  
 15345 1217 RN: EE-Told results of recent mx contest.(444 2/22 Westbrook-PRG)  
 21655 1600 RN: EE-OM & YL w/wld mx.(422 2/22 Grenier-CA)(Smith-FL)(Toia-Italy)(Maise-LA)  
 21730 1615 RN: EE-OM & YL w/"Listeners Corner".(333 1/18 Audette-MA)(Zilmer-NM)

PIRATE STATIONS

6250 0920 ??????:Euro Music Radio in EE w/mx pgm.(353 1/18 Proom-United Kingdom)  
 6260 0602 Scotland:Weekend Music Radio in EE w/rock mx, IDs.(Berg-MA)  
 6270 0635 Netherlands:R.Nolan Intl w/pop mx, ID & Address.(222 2/22 Fisher-MA)(Berg-MA)  
 6290 1436 Ireland:R.Dublin w/IDs & ads.(454 2/2 Calver-UK)(Sams-AR)(Lay-VA)(Newton-GA)  
 6294 0445 Netherlands:R.Coral Fisher w/IDs & Address off @ 0602.(Breg-MA)  
 6315 0354 Ireland:R.Dublin w/Mx pgm, IDs, UTE QRM.(422 1/14 Snider-ONT)(Audette-MA)  
 6910 0550 Ireland:R.Dublin w/ID, pop mx, ads.(444 2/22 Marshall-GA)(Fisher-MA)(Munster-GA)(Sams-AR)(Newton-GA)(D'Angelo-PA)

POLAND

6095 0200 R.Polonia: EE-s/on w/nx from Poland.(544 1/21 Eddie-MO)  
 7270 0204 RP: EE-YL telling Russians "we are not being bad, these things just happen.  
 (333 3/4 Lay-VA)(Krist-VA)(Cereghin-MD)(Huddleston-TX)  
 9525 0300 RP: EE-ID, Nx, talk on Polish Unions.(333 2/18 Smith-FL)(Toia-Italy)  
 9675 0630 RP: EE-Nx pgm, cmtry, Euro ser.(444 2/15 Tate-NV)  
 11815 0308 RP: EE-Cmtry on Polish workers party.(332 1/26 Earhart-PA)  
 15120 0300 RP: EE-ID, Nx of Poland.(433 2/24 Schrammel-WI)(Sanderson-AZ)(Miller-MA)

PORTUGAL

6025 2055 R.Portugal: EE-YL & OM w/talks, ID, mx.(232 2/20 Audette-MA)(Hauser-TN)  
 6185 0305 RP: EE-Tour guide thru Lisbon pgm.(333 2/18 Volrath-MO)(Earhart-PA)  
 9575 0520 RP: EE-Mx pgm, ID % s/off.(543 2/7 Picarelli-CA)(Miller-MA)  
 9740 2030 RP: EE-Nx to Euro, freq - sked.(333 2/28 Alexander-PA)(Toia-Italy)  
 11745 1830 R.Renascenca: PP-Time sig, pgm summary, ID.(Hauser-TN)  
 11825 2150 R.Free Euro: EE-ID, cmtry, address.(444 1/16 G.Raymond-MA)  
 11837t 0807 R.Liberty: RR-Non stop nx, report of military action.(322 2/23 McCurdy-CA)  
 11925 0118 R.Idedifusao Portuguesa: EE-YL singer & variety of mx,(533 2/22 Davidson-SC)  
 15125 1515 RDP: PP-Sports, OM w/Music Box.(432 2/22 Davidson-SC)  
 15295 1515 RDP: PP-ID @ 1630, YL w/freq - sked.(433 2/22 Davidson-SC)  
 21530 1620 RP: EE-"Political Nx This Week in Portugal".(222 2/14 Picarelli-CA)  
 21655 1543 RFE: PO-OM w/ID in Polish.(333 2/22 Palmer-WA)  
 21700 1515 RDP: PP-OM w/sports, electronic zipper between items.(333 2/22 Davidson-SC)

ROMANIA

9510 0200 R.Bucharest: EE-Mx, Nx, cmtry on trade unions.(333 3/6 Krist-VA)(Audette-MA)  
 9570 0205 RB: EE-End of nx, cmtry on Socialism.(333 2/16 Tacoma-WA)(Farmer-TN) + 6  
 9670 ??? RP: EE-IS, ID, Wld nx.(243 2/18 Johnson-IL)  
 9690 \*2100 RB: EE-News & Cmtry.(333 2/28 Alexander-PA)  
 9835 0325 RB: EE-Sports-Ice Hockey, Boxing, Tennis.(343 2/3 Smith-FL)  
 14340 0530 RP: EE-IDs, Nx, cmtry & requests for reports.(??? 2/17 Harris-WA)

SPAIN

9630 0251 REE: SS-OM w/nx & cmtry.(444 2/7 Cereghin-MD)(Thompson-ONM)(Hesch-NY) + 16  
 9675 2110 RFE: AA-OM w/SS mx, ID, AA mx.(432 2/8 Davidson-SC)(Alexander-PA)(Miller-MA)+4  
 11880 0115 RFE: EE-YL w/"Spanish Kalideoscope", ID, Mx pgm.(454 2/10 Forbes-TX) +12  
 15190 1637 REE: SS-OM w/talk on U.S. foreign policy.(534 2/13 Sanchez-CA)(no-name)+ 4  
 15395 1300 REE: SS-Resumen de Prensa.(555 2/8 Toia-Italy)  
 17720 2003 REE: SS-ID, Nx, Mx from Spain.(333 1/8 Smith-FL)(333 1/8 Sanchez-CA)  
 17890 1930 REE: AA-OM & YL w/nx, some QRM.(222 2/28 Traver-CA)

SWEDEN

9695 2300 R.Sweden: EE-OM w/nx & IDs.(444 1/16 G.Raymond)(Alexander-VA)(Audette-MA)+ 2  
 11705 2328 RS: EE-Freq & Sked, Rock mx pgm, then IS-ID.(333 1/31 Blaize-LA)(Windsor-GA)+9  
 11725 2326 RS: EE-Newsline, Swedish Press, Panarama.(533 2/19 Miller-MA)  
 11955 2247 RS: SS-"Foletin DX Pgm.(444 2/10 Toia-Italy)  
 15270 2300 RS: EE-Nx pgm, cmtry.(322 3/2 Zilmer-NM)  
 15390 0626 RS: SW-OM sounds like poetry.(333 3/7 Traver-CA)

SWITZERLAND

3985 0700 SRI: EE-Nx & ID.(353 2/3 Huddleston-TX)(232 2/19 Audette-MA)  
 6135 0445 SRI: EE-Tx, ID, nx, talk on Ecuador-Peru border disputes.(444 2/3 Blaize-LA)  
 6165 2201 SRI: EE-Talk on Swiss writers.(333 2/21 Cereghin-MD)

SWITZERLAND

7210 0600 Red Cross Radio: EE-IS, trumpet fanfare, "Red Crossroads".(533 2/23 Pettit-IA)  
 9536 0635 SRI: ??-Swiss folk mx & polkas. To Euro.(433 2/16 Palmer-WA)(Smith-FL) + 2  
 9725 \*0145 SRI: EE-YL w/s-on, OM w/nx "Roundabout Switzerland".(433 2/8 Thompson-CA) + 11  
 11715 0156 SRI: EE-Swiss Shortwave Merry-Go Round.(434 3/1 Grenier-CA)(Hackney-TN) + 10  
 15125 1535 SRI: EE-Rob Zinotti w/Roundabout Switzerland.(333 2/7 Van Beurden-CA)  
 15230 2145 SRI: EE-ID & Nx.(433 2/10 Toia-Italy)  
 17830 1535 SRI: EE-Swiss Shortwave Merry-Go Round.(323 2/28 Grenier-CA)(Toia-Italy)  
 17850 \*1815 SRI: EE-IS, YL w/EE sked to Africa.(322 2/7 Van Beurden-CA)  
 21570 1735 SRI: GG-Swiss Polka mx.(252 2/21 Hackney-TN)(Miller-MA)(Picarelli-CA) + 2

UNITED KINGDOM

3955 0248 BBC: EE-Classical mx, ID, IS, Time.(342 1/28 Earhart-PA)  
 3975 0658 BBC: EE-pgm "Talking About Poetry".(333 2/3 Huddleston-TX)  
 5975 2209 BBC: EE-Nat & wld nx, "Science in London".(423 2/8 Miller-MA)(Earhart)  
 6080 0651 VOA: EE-Talk on how to build beehives out of hollow bamboo.(??? ??/? ?????)  
 6120 2330 BBC: EE-Pgm of pop hits of UK.(454 3/4 Osborne-MI)  
 6175 0530 BBC: EE-Best of "Four Hands in Harmony".(444 2/1 Vollrath-MO)  
 7230 0735 BBC: EE-Pgm on intricacies of writing in EE.(444 2/15 Palmer-WA)  
 7260 0344 RCI Relay: EE-ID, IS, w/heavy QRM.(222 3/1 Seitner-VA)  
 7325 0200 BBC: EE-ID, Wld nx, Orch mx.(444 2/26 Thompson-NM)  
 9410 2300 BBC: EE-Wld nx & cmtry.(433 2/2 Snider-ONT)(Earhart-PA)  
 9580 0205 BBC: EE-Pulliten of wld nx.(522 2/8 Somers-CA)  
 9760 1830 VOA: EE-the "Now Music Program".(555 1/15 G.Raymond-MA)  
 11680 0100 BRC: SS-OM & YL spkg SS to Latin Amer.(343 2/1 Traver-CA)  
 12090 0636 BBC: EE-"Yours For the Asking".(444 2/4 Olson-??) I'll take a NRD-505...chs  
 15070 1620 BBC: EE-Soccer match-Ipswich vs Everton.(Good 1/17 Gucinski-WA)(Traver-CA)  
 15180 1556 BBC: AA-YL w/freq-sked, pop mx, ID.(555 2/13 Sanchez-CA)  
 15260 2315 BBC: EE-Letterbox & Jazz For the Asking.(444 2/28 Demmitt-PA)(Krist-VA)  
 15360 0355 BBC: EE-Englsh best of "Ntework Africa", (444 2/12 Vollrath-MO)  
 15675 2115 BBC: EE-USB tx of "Sandy James Listeners Request Show".(454 2/22 Krist-VA)  
 17790 1245 BBC: EE-ID & "Sports Round-UP".(555 2/21 Toia-Italy)  
 21710 1815 BBC: EE-Nx & Report of entry of Greece to EEC.(242 1/12 Proom-UK) + 3  
 25650 1552 BBC: EE-The pgm "Outlook".(444 2/26 Wimmers-FL)(444 2/25 Blaize-LA)

VATICAN STATE

6015 0220 Vatican R: SS-YL w/rel talk & ID.(544 2/27 Davidson-SC)(322 2/8 Moman-ALB)  
 6210 0650 VR: RO-End of Mass, ID, OM & YL w/cmtry.(232 2/17 Hotaling-NV)(Eddie-MO)  
 9575 0105 VR: EE-A sermon, followed by mx pgm.(444 2/2 Blaize-LA)  
 9645 0750 VR: EE-News in mixed langs, ID.(Good 2/3 Gucinski-WA)(Davidson-SC)  
 11810 1600 VR: EE-Popes speech from Pakistan.(343 2/16 McSkimming-CA)(Westbrook-FRG) + 2  
 11830 0200 VR: SS-Mx pgm & nx w/QRM.(544 2/17 Miller-CA)  
 15110 \*1600 VR: EE-OM w/religious nx to Africa.(444 2/7 Van Beurden-CA)  
 15120 2220 VR: EE-Taped speech by the Pope.(222 2/21 Cereghin-MD)(Sanchez-CA) + 2  
 21505 1120 VR: CC-IS, YL w/ID & Chinese mx.(333 2/11 Faccioli-Uruguay)

YUGOSLAVIA

9620 2159 R.Yugoslavia: SS-IS, talk in Spanish.(343 2/1 Eddie-MO)(Cereghin-MD)  
 (Wampler-VA)(Rlaize-LA)  
 21520 1154 RT: YL-OM w/cmtry, ID by YL.(433 Faccioli-Uruguay)

UNIDENTIFIED

6505 0502 IS, Mx on mx box, YL w/what sounded like ID, Is this Sweden.(222 2/11  
 McSkimming-CA) My guess would be China but can't say for sure...tml...cheers

\*\*\* Europe \*\*\* Europe \*\*\* Europe \*\*\* Europe \*\*\* Europe \*\*\* Europe \*\*\* Europe \*\*\* Europe \*\*\*  
 As you can see I deleted USSR. If you object to this please let me know. This is your club. And when I say yours I mean everyones. So please voice your opinion. I promise you that the majority will rule.

I found this so interesting that I just had to share it with you. On a recent program that I heard about China concerning names, they stated that there was 74 million people in the world with the last name of PING. This is quite a large family to say the least. It just goes to show some of the interesting things that one might hear on shortwave. But then theres always the skeptic. I told my brother this and he said "so what"

Any one who would like to converse on the subject of Pirates please feel free to write to me. As I said I'm not sure how I stand on the subject and your opinions will be welcomed. If you have written to me in the past and I have't answered yet please bear with me. I sometimes find it difficult to get around to answering letters.

One other item and I will close and send the column off to John & Larry. If anyone has any station logos that they would like to see in the column please send them in.

Almost forgot this, we had 82 reporters this month which is very good support. All support is greatly appreciated.

Until next month, 73s & the best of DXing,

AFRICA, which normally follows, does not this month due to ye olde P.O.! Hopefully will be back next month (JRT)

3/17/81

Ferry Lindley

# ASIA-OCEANIA

EDITOR:  
TOM SCOTT  
1200 Cornwell  
Yukon, OK 73099

DEADLINE: 12th of each month  
FREQUENCIES IN KILOHERTZ  
TIMES ARE IN GMT  
\*0000=sign on 0000\*=sign off

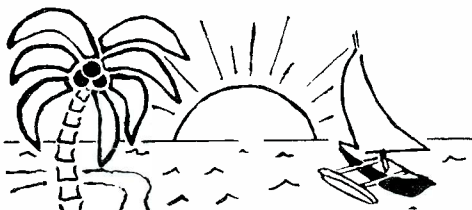

## ASIA

### AFGHANISTAN

4450 0130 R. Afghanistan-Px 1: Dari; Quran chants, OM Tx, Folk Mx //4740  
(141 2/9 Peck-NY)  
15077 1919 RA: EE; ID, Editorial (232 1/29 Moman-ALB-15076.8)

### BANGLADESH

6145t 1242 R. Bangladesh: Bangla; Home Sce, OM Tx, Mx (121 3/6 Newton-GA)  
11765 1818 RB: EE; Nx, ID, Mx (333 2/2 Westbrook-)  
21670 1234 RB: EE; OM Nx, ID, YL Cmty, Mx (222 2/20 Cucura-PA)

### BURMA

4725 1420 Burma Broadcasting Sce: Shan/Burmese; OM/YL, Mx 1445\* (333  
2/18 Hotaling-NV)  
5985 1425 BBS: Burmese/EE; Mx, OM, YL ID, Mx, TC (333 2/19 Hotaling-NV)  
(Van Beurden-CA)

### PEOPLE'S REPUBLIC OF CHINA

3360 1358 Taiwan Sce: CC; Mx, Pips, OM/YL Tx (342 2/14 Lucas-CA)  
3400 1350 Fujian Front Station-2nd Px: CC; YL Mx (343 2/13 Lucas-CA)  
4840 1419 Haerbin Heilangjiang: CC; YL Tx (433 3/1 Sanchez-CA)  
4865 2330 Langzhou Gansu: CC; OM Tx, Mx (354 2/20 Tola-ITALY)  
4915 1425 Nanning Guangxi: CC; Opera (233 3/1 Sanchez-CA)  
4925 1410 Haerbin Heilangjiang: CC; Opera (333 2/15 Hotaling-NV)  
4975 1429 Fuzhou Fujian I: CC; YL/OM Tx (423 3/1 Sanchez-CA) (Hotaling-  
NV) (Nikolich-IL)  
5020 1232 Nanchang Jiangxi: CC; OM Nx, Cmty (333 2/25 Nikolich-IL)  
5240 1310 FFS-1: CC; Opera // 5265 (444 2/14 Palmer-WA)  
5265 1320 FFS-1: CC; Opera // 5240 (333 2/14 Palmer-WA) (Newton-GA) FL)  
5880 1420 Beijing 1: CC; Mx, YL, ID, Opera (323 2/16 Palmer-WA) (Parks-  
5950 1124 Haerbin Heilangjiang: CC; Opera (Poor/Fr 2/22 Gavaras-MN)  
6665 2312 Beijing 1: CC; YL, Nx, OM Tx // 5880 (333 2/15 Marshall-GA)  
6935 2140 R. Peking: SS; OM, Mx, YL, ID, Nx 2155\* (433 2/22 Marshall-GA)  
7025 1120 FFS 2: Mandarin; Mx, YL (323 2/19 Ward-QUE)  
7171 1150 Lhasa Xizang: CC; YL Tx, Mx (232 2/10 Cereghin-MD)  
8345 1410 RP: CC; OM Tx (422 2/23 Sanchez-CA)  
8565 1415 Minority Lang Sce: Kazakh; Mx, YL Tx (322 2/23 Sanchez-CA)  
9064 1350 Beijing 1: CC; OM Tx // 9080, 10245 (444 2/23 Sanchez-CA)  
(Findlater-CA)  
9080 2000 RP: ? Lang; Mx, YL/OM Tx // 9064, 9290 (444 3/5 Findlater-CA)  
(Sanchez-CA)

9170 1254 Taiwan Sce: CC; OM Tx (544 2/23 Sanchez-CA)  
11445 \*2300 RP: SS; IS, ID, YL, Tx (333 2/8 Peck-NY)  
11505t 2315 RP: CC; YL/OM Tx, Mx (343 2/8 Peck-NY)  
11575 1820 RP: CC; Mx, YL, IS (333 2/23 Hotaling-NV)  
11650 1515 RP: EE; OM Cmty, EE/CC Lesson, ID (333 2/22 Hotaling-NV)  
15030 0520 RP: CC; OM, Mx (222 3/7 T.Smith-CA) (McCurdy-CA)  
15099 1727 RP: CC; OM/YL Mx (444 3/1 T.Smith-CA-15099.8) Arabia)  
15165 0140 RP: SS; OM, Opera Mx (444 2/10 Stone-ONT) (Carrier-Saudi  
15260 1240 Beijing: Amoy; CC Mx, ID (343 3/5 McCurdy-CA) (T.Smith-CA)  
15600 0034 RP: PP; Mx, YL Tx (252 2/22 Cereghin-MD)  
15790 1450 Voice of the Malayan Revolution: EE; Cmty Mx // 11830 (242  
2/25 Zilmer-NM)  
17850 2230 RP: CC; ID, IS, Tx SS-2300 (343 3/8 Findlater-CA)  
17855 0055 RP: EE; Mx, Px to N.A. (333 2/25 Vollrath-MO) (Blaize-LA)  
(Coutermarsh-VT) (Cereghin-MD)

### RADIO PEKING

CYPRUS

6155 2210 Cyprus Broadcasting Corp: Greek; IS, OM, ID, Nx, Drana (333 2/22 Curcura-PA)  
 15380 0145 BBC-East Med. relay: World Today (242 3/3 Zilmer-NM)  
 15430 1503 BBC-East Med. relay: EE; Nx, "Focus on Africa" (422 2/13 Sanchez-CA)

INDIA

4860 1305 All India Radio: ? Lang; Mx, YL Tx, Mx (222 3/3 Sams-AR)  
 9912 2103 AIR: EE; ID, OM Nx, Cmty (322 1/24 Hodsdon-MN)  
 10335 1550 AIR: EE; OM Wld Nx, YL, DX hi-lites, Mx (333 2/10 Thompson-CA)  
 15335 \*1330 AIR: EE; Nx, Cmty, Mx // 11810 (333 3/2 Zilmer-NM)

INDONESIA

2475t 1403 R. Angkaran Udara Bersenjata: Indo?; YL DJ, Mx (242 3/8 Lucas-CA)  
 3056 1300 RKPDKT2-Sampang: Indo; Mx, YL ID (222 2/28 Sams-AR)  
 3215 1155 RRI Manado: Indo; ID, Px (333 2/28 Sams-AR)  
 3250 1319 RRI Banjarmasin: Indo; OM Nx (333 2/14 Sams-AR)  
 3325 1252 RRI Palangkaraya: Indo; Tx, Pips, OM/YL Nx, IS (232 2/11 Schlesinger-TX) (Sams-AR)  
 3380v 1307 RRI Malang: Indo, Nat'l Nx (222 2/28 Sams-AR)  
 3385 1314 RRI Kupang: Indo; OM Nx (333 2/14 Sams-AR)  
 3395 1232 RRI Tanjungkarang: Indo; YL Tx, ID (222 2/28 Sams-AR)  
 3427 1312 RRI Manokwari: Indo; Nat'l Px (222 2/14 Sams-AR)  
 3578 1310 RPDT2-Situbondo: Indo; Mx, YL Tx (222 2/14 Sams-AR)  
 3640 1305 RRI Gorontalo: Indo; Nat'l Px (222 2/14 Sams-AR)  
 3960 1300 RRI Palu: Indo; ID, Nx (333 2/14 Sams-AR)  
 3978 1306 RRI Surabaya: Indo; Nat'l Px (222 2/14 Sams-AR)  
 3995 1303 RRI Pontianak: Indo; Nat'l Px (222 2/14 Sams-AR)  
 4000 1258 RRI Kendari: Indo; Mx, ID, Nx (333 2/14 Sams-AR)  
 4698 1327 RKIP Surabaya: Indo; YL Tx, Mx (333 2/14 Sams-AR)  
 4766v 1450 RRI Medan: Bahasa Indo; OM/YL, Mx, ID, Nx (333 2/18 Hotaling-NV) (Sams-AR)  
 4774 1435 RRI Jakarta: Indo; Indo Mx (422 2/15 Hotaling-NV)  
 4789 1329 RRI Pak Pak: Indo; Nat'l Px (222 2/14 Sams-AR) IL)  
 4932 1328 RRI Surakarta: Indo; OM, Tx, ID (333 2/12 Sams-AR) (Nikolich-IL)  
 5046 1338 RRI Yogyakarta: Indo; Mx, ID (333 2/14 Sams-AR)  
 11790 1400 Voice of Indonesia: EE; after 2 months on 11715--a disaster because of VOA--has returned to 11790, EE 1400-1500 (Hauser--TN) (Berg-MA) (Cucura-PA) (D'Angelo-PA)

IRAN

9022 2012 VOIRI: EE; Cmty (454 3/2 Calver-UK) (Moman-ALB) (Lay-VA) (Snider-ONT) (Stone-ONT) (Pettit-IA)  
 15084 0130 VOIRI: Farsi; Tx, Mx (454 2/24 Thompson-NM) (T.Smith-CA)

IRAQ

9745 2215 R. Bagdad: EE; Mx, Nx, YL Tx (323 2/28 Maise-LA) (Wampler-VA) (Moman-ALB) (Blaize-GULF OF MEXICO) (Pettit-IA)

ISRAEL

7465 \*0500 Kol Yisrael-Relay of Home Sce "D", Nx, FF-0515, 0530\* (443 3/6 Munster-GA-7465.1)  
 12025 2230 KY: EE; Nx, Magazine Px (534 2/22 Miller-CA)  
 14728 0027 Galei Zahal-Israel Defence Forces R.: Hebrew; Pop Mx, Nx (2/16 333 Munster-GA) (tip: from Phil Marshall) (Hauser-TN) (Sams-AR) (Marshall-GA) (Newton-GA)  
 15105 \*0500 KY: relay of Home Sce-D, Nx, FF-0515, 0530\* (554 3/5 Munster-GA)  
 15415 0315 KYt: Hebrew, MX (555 3/7 Valentine-CA)  
 15485 \*0500 KY-relay of Home Sce D: EE, Nx, FF-0515, 0530\* (111 3/3 Munster-GA)  
 15582 2225 KY: EE; fq at 2230, 0000, 0100, 0200 ex. 7412.5 (Hauser-TN-15582.6) (Zilmer-NM) (Lucas-CA)  
 17560 1831 KY: Hebrew; Nx (352 3/3 Munster-GA)  
 17630 1300 KY: Hebrew; Mx, YL, ID (333 2/1 Westbrook)  
 17645 2000 KY: EE; OM Cmty, Nx, Mx 2055\* in FF (454 3/3 Findlater-CA) (Carrier-SAUDI ARABIA)  
 17710 \*0500 KY-relay Home Sce D: EE; Nx, FF-0515, 0530\* (443 3/7 Munster-GA)  
 25640 1510 KY: Georgian; YL Tx // 27790 (252 3/3 Zilmer-NM)  
 27790 1510 KY: Georgian; YL Tx 1526\* // 25640 (222 3/3 Zilmer-NM)

JAPAN

3910 1348 Far East Network: EE; Mx, DJ, Ads (533 3/1 Sanchez-CA)  
(Hotaling-NV)  
6055 1345 Nihon Shortwave Broadcasting Co-PX 1: JJ; R. California Px  
(433 3/3 Sanchez-CA) (Lucas-CA)  
7140 1230 R. Japan: RR; IS, ID, Fq, Nx (444 3/5 McCurdy-CA) (CA)  
9505 1450 RJ: EE; ID, OM, Nx (332 2/21 Davidson-SC) (Hodsdon-MN) (Somers-  
9585 \*1300 RJ: EE; Nx, Fq, Cmty (333 2/28 Clark-KS) (Van Beurden-CA)  
11815 1314 RJ: EE/JJ; Cmty, JJ Px (544 2/23 McCurdy-CA) (Van Beurden-CA)  
15270 1900 RJ: EE; OM Nx (544 2/25 Valentine-CA) (Alexander-NC) (Blaise-  
LA) (Olson-CA) (T.Smith-CA)  
15390 2145 RJ: RR; OM Tx (444 3/8 T.Smith-CA) (IL)  
15430 2345 RJ: EE; Nx, NA Px, replaces 15270 (311 3/2 Zilmer-NM) (Pickard-  
17825 0156 RJ: EE; Nx of Pope in Japan (333 2/25 Sanderson-AZ) (Maise-LA)  
(Countermarsh-VT) (Lay-VA) (Van Beurden-CA)

KAMPUCHEA

9695 1210 Voice of the People of Kampuchea: EE; Nx, Mx (211 2/21 Ward-  
QUE)

DEMOCRATIC PEOPLE'S REPUBLIC OF KOREA

2745 1353 Choson Chungan Pangsong--Shinuiju: KK; YL Tx, Mx // 2850  
4270 (242 2/14 Lucas-CA) (Sams-AR)  
3320 1355 R. Pyongyang/Home Sce: KK; YL Tx, Mx (332 2/13 Lucas-CA)  
3560 1300 RP: KK; ID, Tx, Mx (444 2/26 Thompson-NM)  
4273v 1157 Kanggye: KK; Mx, Time Pips, OM/YL Tx (222 2/28 Hotaling-NV)  
(Sams-AR) (SC)  
9420 1225 RP: SS; LA Px, Mx (444 2/14 Palmer-WA) (Fournier-VA) (Davidson  
9570 1024 RP: EE; Cmty, KK Lang. Lesson (333 3/2 Fournier-VA)  
9977 1133 RP: EE; OM Tx, Mx, ID, Cmty (232 2/5 T.Smith-FL) (Fournier-  
VA) (Blaise-GULF OF MEXICO) (Forbes-TX) (Hesch-NY) (Moss-CA)  
(Van Beurden-CA)  
11350 0715 CCP/Pyongyang: KK; Mx, OM/YL Cmty // 9665 (444 2/16 Palmer-WA)  
11905 0935 RP: FF; OM Cmty, ID, Mx Px (322 2/21 McSkimming-CA)

REPUBLIC OF KOREA

7550 1230 R. Korea: EE; IS, ID, Nx (432 2/27 Blaise-GULF OF MEXICO) (Ray  
9570 1050 RK: EE; Nx, Sports Nx, ID, Sked (434 3/2 Clark-KS) (Somers-CA)  
(Picarelli-CA) (TX)  
9720 1605 RK: EE; ID, Nx, Cmty (243 2/17 Wampler-VA) (Palmer-WA) (Forbes  
9870 1028 RK: EE; OM ID, (222 2/17 Sanchez-CA) (Munster-GA) (Thompson-CA)  
11725 1000 RK: EE; OM Nx, ID (233 2/21 McSkimming-CA) (D'Angelo-PA)  
(Van Beurden-CA) (Newton-GA)  
11810 0813 RK: EE; ID, Nx, Cmty (? 2/15 Harris-WA) (Musnter-GA)  
(McCurdy-CA) (Alexander-NC) (Van Beurden-CA) (CA)  
11830 1601 RK: EE; ID, OM Nx, YL ID, Cmty (322 2/17 Hodsdon-MN) (Miller-  
15575 2145 RK: EE; Px, Edit, Mx (252 2/22 Krist-VA) (Munster-GA) (T.  
Smith-FL)  
15775 2205 RK: EE; Edit (343 2/22 T.Smith-FL)

KUWAIT

6055 0050 R. Kuwait: AA; OM Nx (433 2/11 Newton-GA)  
11650 1845 RK: EE; Dramatization History of Oil explor (352 2/23 Munster-  
GA) (Westbrook) (Moman-ALB) (Countermarsh-VT) (Schroeder-WI)  
(Hesch-NY) (Hodsdon-MN) (Newton-GA)  
15345 1808 RK: EE; Mx, Tx, Nx, Wx, ID // 9650 (333 2/7 Tan-W. MALAYSIA)  
21605 1813 RK: AA; OM Tx (433 3/7 T.Smith-CA)

LAOS

6602 2234 National Radio of Laos-Champassak/Pakse: Lao; Tx (251 2/8  
Krist-VA)  
7142 1235 NRL-Vientiane: Camb; YL Tx (233 3/6 Newton-GA)

LEBANON

6215 \*0400 Voice of Hope: EE; Fq, ID, Mx, W.O.R.D. in Lebanon (222 2/17  
Fisher-MA) (Lay-VA) (Marshall-GA) (Newton-GA) (from Jerry  
Berg in MA, Jerry sent report to Holy Land Broadcasting  
Network, High Adventure Ministries, Box 7466, Van Nuys,  
Ca 91409 and received a non-data veri letter, sked 0400-2200,  
stn at Marjayoun--thx Jerry-ed)  
6550 0405 Voice of Lebanon: AA; IS, Mx, ID, Nx, Mx (333 2/19 Leeman/  
Fisher-MA) (Nikolich-IL)





MALAYSIAPeninsula

4845 1455 RTM Kuala Lumpur: Bahasa Malay; Mx, Pips, ID, OM/YL Nx (333 2/15 Hotaling-NV) (Marshall-GA)  
 9750 1348 Suara Malaysia: Indo; OM Nx, Mx (333 2/12 Sams-AR)

Sarawak

4835 1445 RTMS-Kuching-Yellow Net: ? Lang; Mx, YL Tx (433 2/15 Hotaling-NV) (Miller-CA)  
 4895 1247 RTMS-Kuching-Green Net: Iban; OM Cmty // 5005 (232 3/6 Nikolich-IL)  
 5030 1228 RTMS-Kuching-Blue Net: Bidayah; Mx, TP, ID (232 3/6 Newton-GA) (Nikolich-IL)

MONGOLIA

6383 1230 R. Ulan Bator: EE; OM, Nx, Cmty (333 3/2 Van Beurden-CA) (Sams-AR)  
 11825 \*1220 RUB: EE; ID, OM, Fq, Nx // 7230 (232 2/20 Cucura-PA)

NEPAL

9589 1240 R. Nepal: ? Lang; Mx (242 3/6 Nikolich-IL)

OMEN

11890 2014 R. Oman: AA; Mx, ID, Drama, Nx (222 2/11 Cucura-PA) (Cunningham-OH)

PAKISTAN

17660 1920 R. Pakistan: FF; ME Mx, ID, Tx (433 2/22 Davidson-SC)  
 17835 0230 RP: EE; Fq, Nx // 21590 (222 2/24 Zilmer-NM)  
 17910 0350 RP: Farsi; OM Tx, Mx, ID, YL // 17660 (222 2/23 Palmer-WA) (Zilmer-NM) (McSkimming-CA)  
 21485 1545 RP: Urdu; Mx, EE-1600, Nx // 21755 (232 2/12 Alexander-PA) (Facciozi-URUGUAY)  
 21590 0230 RP: EE; ID, Nx (343 2/8 Moman-ALB) (Palmer-WA)  
 21605 1601 RP: EE; Nx at slo-speed // 17650 (222 2/23 Zilmer-NM)  
 21635 2148 RP: Urdu?; OM Mx, YL (444 3/8 T.Smith-CA)  
 21755 0230 RP: EE; Nx // 21590, 17835 (252 3/3 Zilmer-NM)

PHILIPPINES

6110 1325 VOA-relay: EE; Mx, Nx, Cmty (454 2/26 Thompson-NM) (CA)  
 9575 1830 Far East Broadcasting Corp: ? Lang; Mx, Nx (544 2/11 Miller-R. Veritas Asia: KK; Tx, Mx (544 2/24 Miller-CA)  
 11775 0735 VOA-relay: Hindi: s/on, Px (523 3/3 Sanchez-CA)  
 11835 \*1529 VOA-relay: Hindi: s/on, Px (523 3/3 Sanchez-CA)  
 11890 0850 FEBC: EE; OM, ID, Address, Rel. Px (444 2/9 Forbes-TX) (McSkimming-CA)  
 17705 0020 RVA: EE; Address by Pope (222 2/18 Ward-QUE)  
 17770 0000 RVA: EE; Live report of Pope's visit (222 2/21 Picarelli-CA)  
 17810 0030 FEBC: EE; s/off of Voice of Salvation, ID (222 2/21 Picarelli-CA) (DiAngelo-PA)  
 26000 1525 AFRTS-relay, traces detectable (fluttery 1/3 Hauser-TN)

SAUDI ARABIA

11685 0435 BSKSA: AA; OM Lang Lesson?, Mx (433 2/27 Hotaling-NV)  
 11855 1808 BSKSA: EE; YL, Quran, ID, Mx (222 2/17 Wampler-VA)  
 11965 2035 BSKSA: AA; MC Mx, OM/YL Tx // 15060 (434 2/22 Davidson-SC)  
 15060 2140 BSKSA: AA; Mx, Tx, Chants (433 2/23 Schrammel-WI) (Thompson-NM) (Palmer-WA) (Harris-WA) (Davidson-SC) (McSkimming-CA) (T. Smith-CA)  
 15370 0355 BSKSA: Farsi; OM Tx, Mx (232 2/17 Palmer-WA)  
 21705 2045 BSKSA: AA; Chants, ID 2100\* (343 2/22 Davidson-SC)

SINGAPORE

5010 1320 R. Singapore: EE; OM ID, Nx (332 2/11 Schlesinger-TX) (Moman-ALB)  
 5052 1516 R. Singapore: EE; YL Tx, Sked, OM Nx (434 2/19 Miller-CA) (Nikolich-IL)  
 9740 1105 BBC-Far Eastern relay: EE; Wld Nx, Mx (433 3/2 Clark-KS) (Sanchez-CA)  
 11940 1520 R. Singapore: EE; Mx, Pips, ID, Nx, Mx (343 2/24 Thompson-NM) (Sanchez-CA) (Huddleston-TX) (Hotaling-NV) (Miller-CA) (Van Beurden-CA) (McCurdy-CA)

SRI LANKA

15425 0230 Sri Lanka Broadcast Corp: EE; YL, ID, Tx, Disco Mx (443 2/24 Schrammel-WI) (Fisher-MA) (Moman-ALB)

TAIWAN

3230 1313 Central Broadcasting System-DJ31: EE; OM Tx, Mx (343 2/13 Huffaker-MEXICO)  
 5980 1520 Voice of Asia: EE; YL, Mx (343 2/25 Van Beurden-CA)  
 11745 1040 Voice of Free China: Amoy; Mx, OM Tx (323 2/18 Ward-QUE)  
 11825 1103 VOFC: JJ; Nx, OM/YL (333 2/27 McCurdy-CA)  
 15270 \*2040 VOFC: CC; YL Nx (544 2/25 Thompson-CA) (Olson-CA)

THAILAND

9655 1015 R. Thailand: CC; YL Tx, Mx, ID (232 2/17 Schlesinger-TX)

TURKEY

6900 0440 Turkish State Meteorological Sec: TT; ME Mx, YL (222 2/15 Fisher-MA) (Nikolich-IL) (Sams-AR) (Newton-GA) (Marshall-GA)  
 9725 2230 Voice of Turkey: EE; DX Px, OM (222 2/28 Maise-LA) (Calver-UK) (Parks-FL)

UNION OF SOVIET SOCIALIST REPUBLICSArmenian SSR

9795 2130 R. Yerevan: Armenian; IS, ID YL/OM Tx (544 2/16 Peck-NY)

Azerbaijan SSR

4785 2146 R. Baku: Azerbaijani: Chants, Mx, Om, Id 2204\* (242 2/24 Cereghin-MD)

RSFSR (Far East)**MOCKBA**

4485 0820 R. Tikhyy Okean/Petropavlovsk: RR; OM Tx, Mx, YL ID (343 2/3 Huddleston-TX)  
 4610 1025 Khabarovsk: RR; YL Mx //4485 (354 3/3 Van Beurden-CA)  
 5015 1432 Vladivostok: RR; YL Tx (555 3/1 Sanchez-CA) (Ward-QUE) (Nikolich-IL) (Van Beurden-CA)  
 5900 1555 R. Moscow/Petropavlovsk: EE; Jazz Mx, YL, Fq (444 2/15 Palmer<sup>WA</sup>)  
 5940 0855 Magadan: ? Lang; Mx, Chimes, Tx (333 2/28 Alexander-PA) (Van Beurden-CA) (D'Angelo-PA)  
 5960 1050 RM/Vladivostok: JJ/EE; Px (433 2/24 Palmer-WA)  
 7175 0750 RM/Khabarovsk: EE; an interview 0756\* (544 2/17 Palmer-WA)  
 7200 1545 Mayak/Vladivostok: RR; YL, Mx, IS, ID (444 2/14 Palmer-WA)  
 7210 0925 Khabarovsk: RR; Choir singing // 7320, 9810 (443 3/3 Van Beurden-CA)  
 7260 0745 RM/Yuzhno-Sakhausk: EE; Cmty (544 2/17 Palmer-WA)  
 7290 1602 RM/Vladivostok: EE; Nx, YL (444 2/14 Palmer-WA)  
 7320 0810 Magadan: RR; Mx, ID, into R. Tikhyy Okean (333 2/15 Palmer-WA) (Van Beurden-CA)  
 7370 1410 RM/Petropavlovsk: EE; OM, Nx, Px (444 2/21 Palmer-WA)  
 11895t 1230 Khabarovsk: RR; Mx, ID (555 2/23 McCurdy-CA)  
 11990 0600 Mayak/Vladivostok: RR; IS, Pips, Nx, Mx (433 2/16 Palmer-WA)  
 15140 0528 Petropavlovsk: RR; OM/YL Nx (343 3/7 T.Smith-CA)  
 15455 0540 RM/Petropavlsk: EE; Vlad Pozner interview, IS, ID Nx (454 3/3 Munster-GA)

RSFSR (Siberia)

7295 1240 RM/Krasnayarsk: EE; OM, Mx (433 2/14 Palmer-WA)

Uzbek SSR

5945 1440 R. Tashkent: Hindi; OM/YL Cmty, Mx 1500\* (433 2/16 Palmer-WA)

Yakut ASSR Siberia

4940 1220 Yakutsk: RR; Mx, OM Tx (333 3/6 Nikolich-IL)  
 7345 0725 Yakutsk: RR; YL/OM Tx, Mx // 7200 (222 2/15 Palmer-WA)

UNITED ARAB EMIRATES

9505 0330 RCTV-Dubai: EE; Nx (+30 DB 2/18 Flanagan-MA)  
 11755 0330 RCTV-Dubai: EE; World Nx, Mx (544 2/22 Hesch-NY) (Fournier-VA) (Wampler-VA) (Sams-AR) (Countermarsh-VT) (Lay-VA) (Peck-NY) (Marshall-GA) (D'Angelo-PA)  
 21700 0516 RCTV-Dubai: EE; Ragtime non-stop to 0530, Nx, ID, AA 0545 (252 2/19 Munster-GA) (Jones-VA)

VIETNAM

4770t 1320 Son La: ?Viet; Px (222 2/12 Sams-AR)  
 4820 1325 HaTuyen: Viet; Mx, OM Tx (222 2/12 Sams-AR)  
 5140t 1330 Phu Khanh: Viet?: OM, Mx (222 2/14 Sams-AR)  
 9840t 1152 Voice of Vietnam: Camb; Mx, YL Tx 1156\* (343 2/7 Ray-PA)  
 10010 1245 VOV: CC; OM Tx (333 2/23 Sanchez-CA)  
 10040 1535 VOV: EE; OM Nx (343 2/9 Van Beurden-CA)  
 10080 2330 VOV: EE; ID, Px (111 2/22 Shepherd-IL) (Hodsdon-MN)(Tate-WV)



VIETNAM con't

12030 1347 VOV: EE; ID, YL/OM Px, Mx (222 2/19 Hodsdon-MN)  
 15010 2115 VOV: EE; OM ID, OM/YL Tx, Mx (433 2/23 Schrammel-WI) (Hesch-NY)  
 (Ward-QUE) (Hotaling-NV) (Rochow-DC) (McCurdy-CA) (Carrier-  
 Saudi Arabia)  
 15120 1800 VOV: EE; OM Tx (433 2/18 Valentine-CA)

YEMEN ARAB REPUBLIC

9780 0458 R. San'a: AA; OM ID, YL, Mx (322 2/17 Palmer-WA) (Gavaras-MN)  
 (D'Angelo-PA)

**OCEANIA**AUSTRALIA

4920 1243 ABC/Brisbane-VLM 4: EE; OM, Mx (233 2/12 Newton-GA) (Van  
 Beurden-CA)  
 5995 1000 R. Australia/Lyndhurst: EE; Mx, Nx (333 3/2 Fournier-VA)  
 (Alexander-PA) (Hotaling-NV) (Huddleston-TX) (Ray-PA) (Ward-  
 QUE) (Miller-MA) (Newton-GA)  
 6035 2204 RA/Carnavon: EE; Wrld Nx, ID (333 2/5 D'Angelo-PA)  
 6090 0831 ABC/Sydney-VLI-6: EE; OM, Mx, Nx, ID (222 3/2 Hotaling-NV)  
 (Newton-GA) (Schlesinger-TX)  
 6140 1050 ABC/Wanneroo-VLW 6: EE; OM, Mx, Nx, ID (222 3/2 Hotaling-NV)  
 (Newton-GA)  
 7260 0838 RA/Shepparton: EE; OM Nx (333 3/5 Lucas-CA) (Ward-QUE) (from  
 Ralf Munster: GA-according to M-81 sked this freq. 0900-  
 1400 in Indo, a replacement for 7225, this drops Indo on  
 11865 from 0800-1030)  
 9580 \*1058 RA/S: EE; World Nx, Mx // 5995, 9770, 11705, 11820 (444  
 2/27 Clark-KS) (Cucura-PA) (Demmitt-PA)  
 9610 1430 ABC/Wanneroo VLW 9: EE; ID, OM, Mx (333 2/16 Hodsdon-MN)  
 (Alexander-PA) (Davidson-SC) (Fournier-VA) (D'Angelo-PA)  
 9640 1430 RA/C: EE; Nx, ID, Fq, Mx (333 2/12 Alexander-PA) (D'Angelo-PA)  
 9660 0820 ABC/Brisband-VLQ-9 (EE, Nx (444 2/23 Schlesinger-TX) (Calver-  
 UK)  
 9680 0910 ABC/Lyndhurst/VLR-9: EE; Nx, Wx, ID, Mx (343 2/15 Marshall-GA)  
 (Calver-UK)  
 9770 1528 RA/S: EE; ID, OM, Mx, Wx, Sked (322 2/18 Hodsdon-MN) (Snider-  
 ONT) (Sanchez-CA)  
 11705 1118 RA/S: EE; Nx, ID, Mx, Edit (343 2/13 T. Smith-FL) (Newton-GA)  
 11770 2110 RA/S: EE; Tx, Nx (222 2/15 Calver-UK)  
 11820 0830 RA/S: EE; ID, Nx (344 2/23 McCurdy-CA) **RADIO AUSTRALIA**  
 15305 2230 RA/? : EE; Pidgin; ID Mx, Nx (? 2/15 Harris-WA)  
 15320 0435 RA/S: EE; Rock Mx, "Sports Magazine" (444 2/8 Dittrich-FL)  
 (Olson-CA) (T. Smith-CA)  
 17795 1800 RA/S: ? Lang; OM, Nx (555 2/6 Valentine-CA) (Faccioli-  
 URUGUAY) (T. Smith-CA)  
 17870 \*0130 RA/C: EE; IS, ID, Fq, Mx, Nx (222 2/25 Zilmer-NM)  
 21630 1755 RA/S: EE; ID, Sports, Nx (232 2/24 Wampler-VA) (T. Smith-CA)  
 21650 0440 RA/S: EE; Sports, Tx, Mx (544 3/1 Tacoma-CA) (Schroeder-WI)  
 (Wamploer-VA) (Maise-LA) (McSkimming-CA)  
 21660 1534 RA/S: EE; Mx, Wx (233 2/16 Sanchez-CA)  
 21680 0230 RA/S: EE; OM, ID, Mx (232 2/20 Stone-ONT) (Ray-PA)  
 21740 0104 RA/S: EE; Wrld Nx, ID (444 3/5 Johnson-IL) (Snider-ONT)  
 (Vollrath-MO) (Valentine-CA) (Fournier-VA) (Stone-ONT)  
 (Wampler-VA) (Hesch-NY)

COOK ISLAND

5045 0626 R. Cook Island: EE/Maori; Mx, ID, IS, Nx, Rapid DJ Patter  
 (332 2/27 Newkirk-WA)

GUAM

9510 1430 KTWR: EE; IS, ID, Rel Px (433 3/1 Zilmer-NM)  
 11840 0915 KTWR: EE; OM, Rel Px, Sked, ID, Fq, Mx (333 2/9 Forbes-TX)  
 (Ward-QUE) (Van Beurden-CA) (McCurdy-CA)  
 17770 0102 KTWR: EE; OM, DX Px, Rel, Px (232 2/19 Lucas-CA)

NEW CALEDONIA

7170 0910 R. Noumea: FF; OM Tx, Ma (444 2/16 Dittrich-FL) (Palmer-WA)  
 (Lecuona-ARGENTINA) (Van Beurden-CA)  
 11710 0800 RN: FF: Mx, ID (333 3/2 Moss-CA) (D'Angelo-PA) (Van Beurdon-  
 CA)

NEW ZEALAND

11945 1226\* R. New Zealand: RNZ now on this fq instead of 6105 for M81 and with return to st.time,will run 1 hour later, Nx 1200, "NZ Calling" Px 1st, 3rd Mon. 1015-1045 (Houser-TN) (Fournier-VA) (Alexander-NC) (Thompson-CA) (McCurdy-CA)  
 15485 0520 RNZ: EE; 2 OM Tx, Mx, "Reflections" (443 3/3 Munster-GA) (Hotaling-NV) (Vollrath-MO) (Sanchez-CA) (Hodsdon-MN) (McSkimming-CA) (Newton-GA) (Olson-CA)  
 17860 0345 RNZ: EE; Sports, Pips, Mx, Nx 0630\* (555 3/6 Femyer-AZ) (Countermarsh-VT) (Harris-WA) (Hauser-TN) (Miller-GA)

PAPUA-NEW GUINEA

3205 1050 R. West Sepik: Pidgin; Mx, Singing (323 2/15 Oakley-OR)  
 3220 1245 R. Morobe:Pidg: OM, Mx, ID, YL, Pips, 1302\* (333 2/16 Marshall-GA) **PAPUA NEW GUINEA**  
 3245 1225 R. Gulf: Pidg; OM, Mx, ID, Mx (343 2/16 Marshall-GA)  
 3385 1220 R. East New Britain: Pidg; OM, Mx, ID (333 2/23 Windsor-GA) (Lecuona-ARGENTINA) (Schlesinger-TX)  
 3905 1047 R. Manus: Pidg; Mx, Tx (Poor 2/22 Gavaras-MN)  
 4890 1245 NBC/Port Moresby: EE; Mx, Ads (353 2/7 Krist-VA) (Ward-QUE) (Moman-ALB) (Harris-WA) (Forbes-TX) (Alexander-NC)  
 9520 0810 NBC/Port Moresby: EE; Nx, 0827\* abruptly (433 3/1 Pickard-IL)

SOCIETY ISLAND(TAHITI)

11825 0350 R. Tahiti: Tahitian; OM Tx, Mx (322 2/11 Peck-NY) (Somers-CA) ( Mappin-WA)  
 15170 0535 RT: Tahitian: OM Tx (444 3/7 T.Smith-CA) (Mappin-WA)

SOLOMON ISLAND

5020 1125 SIBC/H4B5: EE; OM, ID, Fq 1132\* (343 2/22 Marshall-GA) (Moman-ALB) (D'Angelo-PA) (Lecuona-ARGENTINA) (Thompson-CA) (Cunningham-OH)

VANUATU

3945 0807 R. Vanuatu: Pidg: OM Nx // 7260 (232 1/29 Moman-ALB)  
 7260 1317 RV: EE/FF; Mx, OM DJ, FF ID, Px (343 2/13 Huffaker-MEXICO)

+++++

BBCMS Copyrighted DATELINE BBCMS copyrighted

BURMA: Burma Broadcasting Sce: 4980 has moved to 5060, sked 1030-1330.  
 5040 sked 0930-1600, 4725 sked 1030-1445

CHINA: Nanning Guangxi: 5010 sked 2130-2400, 0250-0610, 0950-1505  
 Wuhan Hubei: 3940 sked 2100-1605  
 Xining Qinghai: 6260, 4940, 3950 sked 2155-0100, 0355-0600. 0925-1520. 9780 sked 0355-0600; 6500 sked 2230-0050, 0350-0545, 1030-1455.

R. Peking: 3390 (1900-2000, 2100-2200), 3500, 4200 (1200-1800) 4130 (1900-2000, 2100-2200); 6995, 8425, 11455, 11720, 17635 (0830-1030); 7480, 9440, 11515 (1930-2130); 7780 (1900-2000, 2100-2200); 8240, 10865, 17680 (0000-0500); 9820 (1200-1300); 9860 (0830-1030, 1400-2000, 2100-2200) 11600 (0830-1400); 11650, 15165 (1400-1800); 15120 (0300-0500, 0830-1030); 15125 (0000-0300); 15280, 17700 (1200-1400); 17855 (0000-0200, 0300-0400) (R.Peking sked is EE Sked)

KAMPUCHEA: Voice of Democratic Kampuchea (all Cambodian) 9470, 11865, 12450 (2330-0030); 11725, 17705 (0400-0500), 11980, 15165 (0900-0500); 5250, 6996, 11685, 11990 (1200-1300)

Voice of the Kampuchean People (Cambodian) 6090, 7008, 7373 (2300-2400, 0400-0500, 1100-1330, add 1 hour to all sce on Sunday) 9695 (0400-0500 1 hour later on Sunday)

TURKEY: Voice of Turkey (EE Sked) 9560 (1200-1300); 15125 (1330-1430); 9725 (2030-2130), 7215, 9725, 11895 (2200-2257)

USSR: R. Baku sked 6110 (0330-0415, 1200-1700); 6135 (1200-1700)  
 Alma Ata sked: 1st Px 4545, 5970, 6180, 9780, 11950 (2358-2000)  
 2nd Px 5035, 5260, 5960, 9505 (0000-1800)  
 Frunze sked: 1st Px 4010 (0000-2000)  
 Duschanbe: 1st Px 4635 (0000-2000)  
 Ashkhabad: 1st Px 4825 (0030-2000); 2nd Px 4895 (1400-1520)

(I had little room again, had to eliminate 1 page of reports--sorry to all reporters--mostly were regular/common reports. Reports for month has been best this year--keep up the good work, Have good Easter, see you in 30, ToH

# WORLD SERVICE STATION SKEDS

## PROGRAMMI

BULLETIN DE PROGRAMMES

ENGLISH SERVICE

PROGRAMME SCHEDULE

Editor:  
CHRIS LOBDELL  
P.O. Box 146  
Stoneham, MA 02180

Deadline: 12th

EMISSIONS

TRASMISSIONI

PROGRAMS

SERVIZIO

COMUNICATI NEL CORSO

Welcome to spring 1981. I hope all of you weathered the winter without too much trouble. Nice to see things beginning to turn green again. We are in the short M81 period which will last until the first Sunday in May. Unless otherwise noted, all schedules are for English language transmissions and all times are in Greenwich Mean Time (GMT). Also, schedules credited to the "BBCMS" are courtesy of the BBC Monitoring Service's World Broadcast Information (WBI) division and are used by permission.

### AUSTRALIA. Here is Radio Australia's AUSTRALIA (CONT):

M81 complete English schedule.

0000-0930	21680	Asia
0100-0300	17795	North America
	21740	"
0130-0330	21740	Pacific
0130-0800	17870	Asia
0130-1000	17725	PNGNWP
0400-0500	15320	Pacific
	17755	Africa
	21525	"
0600-0630	17795	Pacific
	17755	Africa
	21525	"
0600-0700	11825	PNGNWP
0630-1030	15115	Pacific
0700-0900	9570	Pacific/Europe
	11740	"
*0700-0845	5995	Pacific
	9760	PNGNWP
	11820	"
0800-0900	15410	Asia
0800-1100	21570	"
0800-2000	6045	Pacific
1000-1200	11820	PNGNWP
1000-1500	9770	Asia
	11705	"
1000-2000	5995	Pacific
1100-1300	9580	North America
	21660	PNGNWP
1130-1500	17795	"
1230-2030	6080	"
1330-1730	6060	Pacific
1400-1500	9640	Asia
1400-1730	17795	PNGNWP
	21660	"
1500-1730	9770	Asia
1530-1730	6035	"
1800-2000	21630	Europe
1800-2030	9505	Pacific
1800-2130	11725	"
1800-2200	9580	"
1800-0500	17795	"
1900-2200	11790	"
2000-2200	11770	PNGNWP
2100-2230	6035	Asia
2100-2330	11820	"
2100-0530	21650	PNGNWP
2100-0700	15160	Pacific
2100-0730	15240	"

2200-0600	17890	Pacific
2230-0100	15310	Asia
*separate English program for Papua New Guinea		
PNGNWP = Papua New Guinea and the Northwest Pacific.		
(K. Krist, W. Pickard)		

### BULGARIA. Here is Radio Sofia's revised sked which is valid until April 20, 1981.

0000-0100	15330	ECNA
0430-0500	11860	WCNA
1930-2000	9700	Britain
	11720	"
	11880	"
2130-2200	11860	"
	11920	"

(J. Demmitt, M. Eramo, R. Munster)

### CHINA (People's Republic): Radio Peking's current North American Service schedule.

0000-0100	15125,17680,17855	ECNA
0100-0200	" " "	"
0200-0300	15125,15230,17680	"
0300-0400	15120,15230,17680	WCNA
0400-0500	" " "	"
1200-1300	9820	ECNA

(K. Krist)

### CHINA (Taiwan). Here is the current schedule of the Voice Of Asia.

1030-1040	5980	Philippines, Indo.
1100-1200*	5980	"
1500-1530*	5980	Thailand, Singapore

\* = Not Sunday.  
(M. Hardester)

### EGYPT. Radio Cairo's current schedule

For Europe & North America	
0200-0330	9475 North America
	12000 "
2215-2345	9805 Europe

(R. Munster, S. Proom)



FINLAND. Here is Radio Finland's M81 schedule, valid till May 31, 1981

0330-0400 6120 Europe  
\*9645 North America  
11755 "  
0800-0925\*\*15265 Europe  
21465 Far East/Australas.  
0930-1000 6120 North Europe  
11755 Europe/S. America  
15265 "  
21465 Far East/Australas.  
1300-1330 15265 Europe  
15400 North America  
1330-1425\*\*15265 Europe  
15400 North America  
1430-1500 15400 "  
21475 N. America/M. East  
1930-2000 \*11835 Europe/Africa  
15265 Europe  
2130-2200 6120 N. Europe  
11755 S. America, West  
Africa, Europe  
15270 S. America,  
West Africa

\* = Valid until May 3rd  
\*\* = Sunday only  
(W. Pickard, T. Van Beurden,  
Wampler)

FRANCE. Here is Radio France's English "Paris Calling Africa" and the French to America skeds, valid till May 2nd, 1981

PARIS CALLING AFRICA 1600-1700  
11845 North Africa  
15300 North/West Africa  
15315 North Africa  
17720 West Africa  
17850 North/Central/South Africa  
17860 East Africa/Indian Ocean  
21515 West Africa  
21580 Central/South Africa  
21620 East Africa/Indian Ocean  
25820 " "  
FRENCH TO AMERICAS  
1200-1715 17775, 21595, 21645  
(T. Klasek, W. Pickard)

GREECE. Here is the M81 sked to North America from the ERT in Athens.

0000-0150 9515, 9655, 11730  
0200-0350 9515, 9650, 11730  
1200-1250 11730, \*17830, \*21455  
1500-1550 11730, 17830, 21455  
Programming is in Greek & English  
\* = Not on Tuesday.  
(J. Berg, K. Krist, G. Raymond)

GUAM. KTWR, Trans World Radio in Agana sends this M81 tentative frequency schedule.

0000-0140 17770 India  
0745-0930 11840 Japan  
1430-1500 9510 India  
11895\* "

\* = This frequency used for English on Wed./Thurs only.  
(G. Raymond)

HUNGARY. Here is Radio Budapests North American schedule effective from March 28, 1981.

0100-0130\* 6000, 9585, 9835, 11910,  
15220, 17710  
0200-0230 (same as above 0100)  
0400-0415 (same as above)- DX  
program on Wed. & Sat.  
only.

\* = Not on Monday  
(T. McCurdy, T. Smith)

ISRAEL. Kol Israel, M81 English to North America sked.

0000-0030 9815, 11637, 15582  
0100-0125 9815, 11637, 15582  
0200-0225 9815, 11637, 15582  
0500-0515 11637, 15105, 15582, 17710  
1200-1230 11620, 17612, 21675, 25640  
2000-2030 11637, 12025, 15582, 17645  
2230-2300 9815, 11637, 12025, 15582  
HEBREW LANGUAGE "RESMET BET" TO NA  
0400-0610 11655, 17630  
0610-1400 17630, 25605  
1400-1800 17630  
1800-2000 17630, 15615  
2000-2310 11610, 11655, 17630  
(J. Levin, R. Munster)

ITALY. Here is the complete M81 sked from the RAI in Rome.

0100-0120 9575 North America  
11800 "  
0350-0410 15330 South Asia  
17795 "  
21560 "  
0425-0440 7275 Mediterranean Area  
6165 "  
1935-1955 7275 Great Britain  
9710 "  
11800 "  
2025-2045 7235 Near East  
9575 "  
11800 "  
2200-2225 9710 Japan  
11800 "  
15330 "

(C. AuCoin, E. Fournier, K. Krist,  
T. Klasek)

JAPAN. The NHK in Tokyo has this English schedule for the M81 period.

REGIONAL SERVICES  
0130-0230 15235 NALAH  
17725 "  
17825 "  
21640 "  
0800-0830 17870 Europe  
21610 "  
0930-1030 11875 Australia/NZ  
15235 "  
1115-1145 9675 Southeast Asia  
11875 "  
1630-1700 11705 South Asia/Africa  
15235 " "  
1830-1900 11800 Europe  
15425 "  
2015-2045 11780 ME/Africa  
15410 "  
2345-0045 15430 ECNA  
17825 "

NALAH = N. America, Latin America & Hawaii.

JAPAN (CONTINUED):

GENERAL SERVICE (first half in English; second in Japanese)

	ASIA	AMERICAS	EUROPE
0000-0030	15195	17755	11950
0100-0130	17785	"	15310
0200-0230	"	"	"
0300-0330	"	"	"
0400-0430	"	"	"
0500-0530	"	15430	"
0600-0630	"	"	17710
0700-0730	"	"	"
0800-0830	15195	9505	"
0900-0930	"	"	"
1000-1030	"	"	"
1100-1130	"	"	"
1200-1300	11815	"	15310
1300-1330	"	"	"
1400-1430	"	"	"
1500-1530	"	"	"
1600-1630	"	"	"
1700-1730	"	"	"
1800-1830	"	"	"
1900-2000	"	17755	"
2000-2030	"	"	"
2100-2130	"	"	"
2200-2230	15195	"	11950
2300-2400	"	"	"

SINES, PORTUGAL-RELAYS

0700-0730 15170  
 2200-2230 11955  
 (W. Pickard, T. Van Beurden, B. Zilmer)

MOROCCO. The Radio-TV Marocaine has this new Arabic schedule.

1100-2200 21725  
 2200-0100 15155  
 (J. Demmitt)

NEW ZEALAND. Radio New Zealand.

Here is their M81 schedule.

0640-1215 11945 Pacific  
 0830-1215 11945 Australia  
 1800-2105 15485 Pacific  
 1800-2150 11675 "  
 2155-0630 17860 "  
 2115-0815 15485 Australia  
 (M. Femyer, Picarelli)

NIGER. ORTN in Niamey. Sked from QSL recently received.

Monday-Friday 0530-0705; 1130-1500;  
 1700-2200  
 Saturday 0530-0705; 1130-2300  
 Sunday 0530-2200

FREQUENCIES USED

3260 0530-0705  
 5020 1700-2200  
 9705 1130-1500  
 Sked seems incorrect as I've noted them @0530 s/on on 5020, ed.  
 (J. Berg)

NORWAY. Radio Norway (NRK) in Oslo has this M81 sked. English program is on Sunday (GMT) only.

\*0000-0030 9590 North America  
 11870 WCNA, Pacific  
 11895 Far East, Indones.  
 \*0200-0230 9590 North America  
 9685 "  
 11850 West Africa, S. Am.

NORWAY (CONT):

\*0400-0430 6185 North America  
 9685 Pacific  
 11895 WCNA, Pacific  
 \*0600-0630 9645 WCNA, Pacific  
 15175 Europe, Africa, ME  
 21655 " " "  
 0800-0830 9590 Indo, Australia/NZ  
 15135 Pacific  
 25730 Far East, Indones.  
 1200-1230 6015 Europe  
 21730 India, Indo., Austr.  
 25730 Far East, Indo.  
 1400-1430 15175 ECNA, West Indies  
 21730 Europe, ME, Africa  
 25730 Mediterranean, Afr.  
 1600-1630 15175 ECNA, West Indies  
 21730 W. Africa, S. Amer.  
 25730 North America  
 1800-1830 21655 Europe, Africa  
 17840 WCNA, Pacific  
 25730 Europe, ME, Africa  
 2000-2030 11860 North America  
 11895 ME, East Africa  
 25730 Pacific  
 2200-2230 11895 Far East, Indonesia  
 15135 W. Africa, S. Amer.  
 15345 W. Africa, S. Amer.

underlined frequencies 250 kw.

(J. Demmitt, P. Grenier, T. Klasek, R. Munster, W. Pickard, T. Smith)  
 (\* = Monday, GMT)

POLAND. Here is Radio Polonia's current North American sked.

0200-0400 6095, 6135, 7145, 7270,  
 9525, 11815, 15120  
 Programs are in both English and Polish.  
 (S. Proom, T. Smith)

PORTUGAL. Radio Portugal has this M81 schedule to North America.

0300-0330 6025, 11925 ECNA  
 0500-0530 6185, 9575 WCNA  
 (K. Davidson, K. Krist)

SAUDI ARABIA. Here is the M81 sked from the BSKSA in Riyadh.

English service.  
 1000-1100\* 11855  
 1100-1300 "  
 1800-2100 "  
 \* = Thursday & Friday only.  
 (J. Berg)

SWEDEN. Radio Sweden, Stockholm has this schedule to North America valid until May 3rd.

0230-0300 9695, 11705  
 1400-1430 21615  
 2300-2330 11705, 15270  
 (T. McGurdy, W. Pickard)

BAD GUYS MEET IN PLAISTOW

The day was March 1st when the BAD GUYS had their first meeting outside the confines of Massachusetts. About 19 people showed at the home of Wayne Oliver but the biggest attraction of all was the appearance of Alan Brooks our former DX MONTAGE editor. Yes folks, he still exists!

T2  
 Cit

# UTILITY SCENE

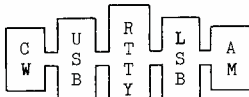

EDITOR:

MIKE CHABAK  
6171 E. Bellevue #19  
Tucson, AZ 85712

DEADLINE: 12th Day of Month

Hello Gang: A big surprise this month. The contributors have been steadily increasing, and the prospects for the column to level off, didn't appear likely. But this month only 48 contributors checked in. Maybe my deodorant failed! Anyhow this means fewer logging cuts, and more informational items....Enough said, now onto the loggings:

\*\*\*\* NORTH AMERICA \*\*\*\*

ALASKA:	5696	USB	1406	NRW2- St. Paul Loran wkg CG 1603 (Chabak-AZ)
	5696	USB	1411	NOJ- CS Kodiak wkg Navy Charlie Tango 285 (Chabak-AZ)
	5696	USB	1359	NMJ2- Attu Loran wkg CG 1603 (Chabak-AZ)
	5696	USB	1427	AKA-Elmendorf AFB! p/p from ROC to CG 1603 (Chabak-AZ)
	(all of the above concerned the fire and abandonment of the So. Korean vessel DAE RIM, off the Aleutians)			
	8628.5	CW	0218	NOJ- CS Kodiak AK CQ Mkr (French-MD)
	8938	A3H	0213	KIS7Ø- Anchorage Aero wkg Spanner 623 (R. Alexander-IA)
	8984	USB	0632	NOJ- CS Kodiak wkg Attu re: DAE RIM (Robertson-WA)
	8984	USB	0437	NOJ- CS Kodiak wkg CG 1348 (Hartung-MD)
	13264	A3H	0200	KIS7Ø- Anchorage Aero wkg Singapore 2 (Hartung-MD)
CANADA:	2598	AM	0111	St. Anthony's CG Radio - WX/ice b/c (Stanbury-ONTARIO)
	6705	USB	0445	VX- CANMIL Edmonton wkg Trenton MIL (Moman-ALBERTA)
	7954	USB	0400	Vancouver R/Telephone - tfc (Moss-CA)
GREENLAND:	6383	CW	0623	OVC- Groennedal Military R. - V Mkr (C. Brown-IL)
	22361	CW	2200	OVC- Groennedal Military R. - V Mkr (G. Thompson-NM)
U.S.A.:	4331	CW	0258	WCC- Chatham R. MA-QRA Mkr into tfc (R. Alexander-IA)
	4413.2	USB	0700	WLO- Mobile R. wkg McDermott Barge 22 (R. Alexander-IA)
	4428.7	USB	0433	NMC- CS San Francisco - NIM b/c (Tate-WV)
	4428.7	USB	0400	NNN- CS Portsmouth VA - NTM b/c (Tate-WV)
	5400	USB	1347	WUD7- USACE Rock Island IL wkg WUD74Ø (Chabak-AZ)
	5653	A3H	0345	WSY7Ø - New York Aero - Volmet b/c (Valentine-CA)
	5696	USB	1430	NMA- CG Miami wkg CG 1350/5785/1339/7240 (Lewallyn-GA)
	5870	CW	0410	NAM- NCS Norfolk VA - multi-Mkr (R. Alexander-IA)
	6235a	SSB	0315	VOA Feeder - Greenville NC (Pettit-IA)
	6506.4	USB	var.	NNN- CS Portsmouth - NTM b/c (Maise-LA)(Lay-VA)
	6540	A3H	0220	KEA5- New York Aero wkg Argentina 317 (Stone-ONTARIO)
	6659	SSB	0244	Lockheed Flight(test center) wkg Ø165 (Stock-CO)
	6785	SSB	1611	WUJ3- USACE Portland OR wkg ABY ?? (Stock-CO)
	7700	USB	1407	KRM264 (DOE) wkg Mobile Ø7 (Chabak-AZ)
	7268.5	LSB	0400	VOA Greenville Feeder (Munster-GA)
	7475	USB	1457	KDM5Ø- FAA Hampton GA wkg KDM95 Gulfport MS(Stock-CO)
	7651	USB	var.	VOA Greenville Feeder (Lay-VA) (Stone-ONTARIO)
	8474.5	CW	0247	WLO- Mobile Radio - QSX Mkr (Emerson-TX)
	8486	CW	0255	WOE- Lantana R. FL - QSX Mkr (Emerson-TX)
	8574	CW	1054	NMC- CS San Francisco CQ/QSX Mkr (R. Alexander-IA)
	8600	CW	0550	WMH- Baltimore Radio - V Mkr (Fernando-NY)
	8630	CW	0259	WCC- Chatham Radio MA - V/QSX Mkr (Emerson-TX)
	8642	CW	0105	KPH- San Francisco Radio - tfc list (Emerson-TX)
	8731.3	SSB	0318	WOM- ATT Ft. Lauderdale- wkg 6VCR & J4BC (Emerson-TX)
	8731.3	USB	1330	WOM- Ft. Lauderdale FL - WX/tfc list (Tate-WV)
	8868	A3H	0315	WSY7Ø- New York Aero - Volmet b/c (Moss-CA)
	8993	USB	0200	AFEB- MacDill AFB FL wkg Albrook AFB (Stone-ONTARIO)
	10235	LSB	0100	VOA Feeder (Wimmers-FL)
	11182	USB	2159	AFG37- Scott AFB IL wkg a/c 621 (Fitzgerald-RI)
	11194	SSB	2145	Lockheed Flight (test center) clg a/c 114 (Stock-CO)
	11239	USB	0303	AFI- McClellan AFB CA wkg Quebec Bravo 88 (Fitzgerald)
	11461	CW	2155	WPK21- New York Radio - QRA Mkr (R. Alexander-IA)
	12022.5	CW	1146	KKN5Ø- State Dept Wash DC- clg KIS45 (Chinsky-NY)
	12970.5	CW	0330	WOE- Lantana Radio FL - V Mkr (Emerson-TX)
	12993	CW	0442	KOK- Los Angeles Radio - CQ/QSX Mkr (Emerson-TX)
	13002	CW	0449	KPH- San Francisco Radio - CQ Mkr (Emerson-TX)
	14466.5	LSB	0133	NNØNIK (MARS) Mayport NAS wkg NNØCTV (Chinsky-NY)
	17359	USB	1810	WLO- Mobile Radio - WX b/c (Valentine-CA)
	18830	ISB	0255	VOA Feeder (Hesch-NY)

\*\*\*\* CENTRAL AMERICA \*\*\*\*

PANAMA: 13950 USB 2040 AHF4- Albrook AFB p/p for AHF1B (Lewallyn-GA)

PANAMA:	13977	LSB	0130	AGA <del>PHO</del> USAF MARS Howard AFB wkg AGA4KE (Chinsky-NY)
				**** CARIBBEAN ****
BARBADOS:	6379.3	CW	0611	8PO- Barbados Radio - Callsign Mkr (C. Brown-IL)
CUBA:	12747.5	CW	1828	CLQ- Havana Radio - CQ Mkr (Hess-OH)
	13970a	CW	0143	CLP1- MINREX/EMBACUBA Havana- clg CLP7 (Chinsky-NY)
MARTINIQUE:	8478.4	CW	0515	FUF- Fr. Naval R. Ft. de France- V Mkr (Stanbury-ONT)
	16961	CW	0108	FUF- Fr. Naval R. Ft. de France- V Mkr (Johnson)
	22390.2	CW	2102	FUF- Fr. Naval R. Ft. de France- V Mkr (Walters-NJ)
				**** SOUTH AMERICA ****
ARGENTINA:	8457	CW	0602	LSA4- Boca Radio - V Mkr (French-MD)
	13159.7	USB	0250	LPL- Gen. Pacheco R.- EE/YL/SS/OM/VM (Maise-LA)
BRAZIL:	4298	CW	0519	PPO- Olinda Radio - QSX Mkr (C. Brown-IL)
	8520	CW	0528	PPO- Olinda Radio - V Mkr (Hess-OH)
	12979.5	CW	var.	PPL- Belem Radio- V Mkr (G.Thompson-NM)(Alexander-IA)
	22352.5	CW	2059	PPR- EMBRATTEL Rio de Janeiro - V Mkr (Walters-NJ)
CHILE:	8626	A3H	0238	Santiago Aero wkg LAN CHILE 150 (French-MD)
COLOMBIA:	8959	A3H	0155	San Andres IS. Aero wkg Panama Aero (French-MD)
ECUADOR:	12711	CW	1436	HCG- Guayaquil wkg HCCT (French-MD)
	13950	LSB	0012	AHF1C- USMILGP Loja wkg AHF4 Albrook (Chinsky-NY)
	13950	LSB	0120	AHF1C- USMILGP Loja-p/p via AHF4 (Chabak-AZ)
	13950	LSB	0030	HCUS1- USMILGP Quito wkg AHF4 Albrook (Chinsky-NY)
PERU:	13950	LSB	2309	OAE21- USMILGP Lima wkg AHF1C Ecuador (Chinsky-NY)
VENEZUELA:	13950	LSB	1332	YWA6- USMILGP - p/p via AHF4 Albrook (Chabak-AZ)
	17141.6	CW	2117	YVG- LaGuaria Radio - V Mkr (Walters-NJ)
				**** EUROPE ****
AZORES:	13328	A3H	var.	CSY- Santa Maria Aero wkg various a/c (Moman-ALBERTA)
BELGIUM:	8652	CW	0200	OST42- Oostende Radio - V Mkr (Coleman-MA)
BULGARIA:	8532	CW	0535	LZW- Varna Radio - DE Mkr (Hess-OH)
DENMARK:	12753.5	CW	0410	OXZ62- Lyngby Radio - CQ Mkr (R. Alexander-IA)
	16897.4	CW	var.	OXZ82- Lyngby R. - CQ Mkr (Hess-OH)(Johnson-ID)
ENGLAND:	4721	USB	0410	MVU- West Drayton - Volmet b/c (Shepherd-IL)
	7973	ISB	0430	BBC Daventry Feeder-LSB/FF-USB/EE (Munster-GA)
	8516	CW	0532	GKC- Portishead Radio - DE Mkr (Hess-OH)
	8557.9	CW	0552	GKB2- Portishead Radio - DE Mkr (Hess-OH)
	10093	A3H	0505	Speedbird Radio (LDOC London)w/Springbok 226 (Hartung)
	11200	USB	0940	MVU- West Drayton- Volmet b/c (George-TX)
	16956	CW	var.	GKC- Portishead R. - DE Mkr (Proom-ENGLAND)(Hess-OH)
FINLAND:	16923	CW	0244	OPJ- Helsinki Radio - QSX Mkr (Johnson-ID)
FRANCE:	8522.5	CW	0527	FPL4- St. Lys Radio - CQ/QSX Mkr (Hess-OH)
	17180	CW	1800	HWN- Fr. Naval R. Paris - V Mkr (G. Thompson-NM)
	18353	USB	1850	FTS Paris- EE/FF/OM- VM (Lay-VA)
GERMANY, EAST:	4233.5	CW	2035	Y5M- Ruegen Radio - V Mkr (Proom-ENGLAND)
	14970a	USB	1154	Berlin PIT - GG/EE/FF - VM (Chinsky-NY)
GERMANY, WEST:	4265	CW	0000	DAM- Norddeich R.- time sig/ V Mkr (C. Thompson-ONT)
	5690	USB	0515	DHM95/VEG- Lehr Military- WX b/c (Shepherd-IL)
	8483.5	CW	0625	DAN- Norddeich R. - CQ Mkr (Hess-OH)
	8512	CW	0530	DAL- Norddeich R. - V Mkr (Hess-OH)
	8638.5	CW	0000	DAM- Norddeich R. - Time sigs (G. Thompson-ONTARIO)
	10065	A3H	0009	Frankfurt Aero wkg Lufthansa 645 (Hartung-MD)
	10065	A3H	0120	Frankfurt Aero wkg a/c Uniform Echo (Moman-ALBERTA)
	13027.5	CW	0450	DAL- Norddeich R. - V Mkr (Fernando-NY)
	14405a	LSB	2243	AEM1AC-MARS Wurzburg wkg AAR3JA (Chinsky-NY)
	14410a	LSB	2037	AGA7BI-MARS Bitburg wkg AIR-Andrews (Chinsky-NY)
	16980.4	CW	2025	DAM- Norddeich R. - V Mkr (Hess-OH)
	17048	CW	2023	DAF- Norddeich R. - V Mkr (Hess-OH)
GREECE:	14407	LSB	1945	AGA7AT- MARS Athens - MARSGRAMS (Russow-W. GERMANY)
	17094.8	CW	2112	SVA- Athens Radio - V Mkr (Walters-NJ)
HOLLAND:	8562	CW	0555	PCH4 <del>ø</del> - Scheveningen R. - CQ Mkr (Hess-OH)
	16900.3	CW	2012	PCH- Scheveningen R.-clg PDRH (Hess-OH)
ICELAND:	13069.5	CW	2143	TPA- Reykjavik Radio - CQ Mkr (Fitzgerald-RI)
IRELAND:	5533	A3H	0244	EIP- Shannon Aero - Volmet b/c (Tate-NY)
	8833	A3H	var.	EIP- Shannon Aero- Volmet b/c(Hesch-NY)(Shepherd-IL)
	13312	A3H	1701	EIP- Shannon Aero - Volmet b/c (Moman-ALBERTA)
ITALY:	8670	CW	0210	IAR- Rome Radio - V Mkr (Coleman-MA)
	8679	CW	0215	IQX- Trieste Radio - V Mkr (Coleman-MA)
	13010	CW	0400	IAR6- Rome Radio - CQ Mkr (Fernando-NY)
NORWAY:	17074.4	CW	2110	LGX- Rogaland Radio - CQ Mkr (Walters-NJ)
POLAND:	8480	CW	0622	SPH- Gdynia Radio - DE Mkr (Hess-OH)
SPAIN:	5917.5	CW	0402	AOK- NCS Rota - multicall Mkr (Alexander-IA)
	7705	CW	2050	AOK- NCS Rota - multicall Mkr (Proom-ENGLAND)
SWEDEN:	8498	CW	var.	SAG- Goteborg R.- V Mkr (R.Alexander-IA)(Hess-OH)

SWITZERLAND: 10089 A3H 0415 Berne Aero wkg Swissair 145 (Hartung-MD)  
 22344.7 CW 2105 HEB- Berne Radio - CQ Mkr (Walters-NJ)  
 U.S.S.R.: 6405 CW 0625 UFH- Petropavlovsk R.-tfc unkn ship (C. Brown-IL)  
 8003 LSB 0356 Radio Moscow Feeder (Hesch-NY)  
 9933a CW 0135 Soviet Military - RR cipher tfc (Chinsky-NY)  
 11048a CW 0120 RIW- Soviet Navy Khiva - RR coded ship tfc (Chinsky-NY)  
 13070 CW var. UDH- Riga Radio- V Mkr (French-MD)(Fitzgerald-RI)  
 13279 USB 0440 Novosibirsk Aero- Volmet EE/YL (Moman-ALBERTA)  
 17059 CW 2230 UKK3- QTH?? - CQ/QSX Mkr (G. Thompson-NM)

\*\*\*\* AFRICA/MIDDLE EAST \*\*\*\*

ALGERIA: 8826 A3H 0319 Algiers Aero wkg Ascot 1105 (Hartung-MD)  
 ANGOLA: 8826 A3H 0146 Luanda Aero wkg unid a/c (Hartung-MD)  
 BAHRAIN: 8448 CW 0250 A9M- C&W Manama - DE Mkr (G. Thompson-NM)  
 CAPE VERDE IS.: 8469 CW 0150 D4A- Sao Vicente R. - V/CQ Mkr (Coleman-MA)  
 CEN. AFRICA: 11022 USB 0523 TLZ2- Bangui - FF/EE/YL/VM (French-MD)  
 CONGO: 6617 A3H 2225 Brazzaville Aero - Volmet b/c FF/OM (Lay-VA)  
 8826 A3H 2214 Brazzaville Aero wkg Romeo Hotel 121 (Fitzgerald-RI)  
 13304 A3H ---- Brazzaville Aero wkg Caledonian 216 (Moman-ALBERTA)  
 EGYPT: 8578 CW 0500 SUH- Alexandria - CQ/tfc list (French-MD)  
 8959 A3H 0508 Cairo Aero wkg Khartoum Aero (Hartung-MD)  
 IRAQ: 20263 USB 0640 OHU36- Finnish Embassy Baghdad wkg CHU (Russow-W. GER)  
 ISRAEL: 12986 CW 0455 4XZ- Haifa Naval R. - V Mkr (R. Alexander-IA)  
 17146.4 CW 2119 4XO- Haifa Naval R. - CQ Mkr (Walters-NJ)  
 IVORY COAST: 13865 LSB 0705 Abidjan PTT - EE/FF/YL/ VM (Pettit-IA)  
 LEBANON: 20942 LSB 0744 ODR88- Red Cross Beirut wkg Geneva (Russow-W. GERMANY)  
 KENYA: 13336 A3H 1734 Nairobi Aero wkg Seychelles Aero (Moman-ALBERTA)  
 MAURITANIA: 7715.5 LSB 0739 OFIPOSTEL Nouakchott - FF/OM VM (Devendorf-CA)  
 NIGER: 8826 A3H 0154 Niamey Aero wkg Uniform Yankee Oscar 73 (Hartung-MD)  
 NIGERIA: 8826 A3H 0148 Kano Aero wkg Quebec Charlie Oscar 21 (Hartung-MD)  
 REUNION IS.: 13215.3 CW 1725 French Naval Radio - V Mkr (Moman-ALBERTA)  
 SAUDI ARABIA: 5526 A3H 0406 Jeddah Aero wkg Saudi 147 (Hartung-MD)  
 SENEGAL: 10049 A3H 0600 Dakar Aero wkg Scandinavia 249 (George-TX)  
 13409 CW var. 6WW- Dakar Naval R.- V Mkr (Moman-ALBERTA)(Pettit-IA)  
 16952 CW var. 6WW- Dakar Naval R.- V Mkr (Walters-NJ)(G. Thompson-NM)  
 SEYCHELLES: 8445 CW 0358 S7Q- Mahe R. - V Mkr/tfc list (French-MD)  
 SOUTH AFRICA: 8514 CW 1330 ZSQ- Port Elizabeth Radio - CQ Mkr (G. Thompson-NM)  
 8566 CW 0558 ZSJ4- Cape Naval R. Silvermine - CQ Mkr (Hess-OH)  
 8605 CW 0606 ZRH4- Cape Naval R. Pisantekraal- tfc (Hess-OH)  
 8688.5 CW 0220 ZSC- Capetown Radio - CQ Mkr (Coleman-MA)  
 14425 USB 1930 ZUD- Olifantsfontein PTT- AF/OM/ VM (Russow-W. GER)  
 SUDAN: 8959 A3H var. Khartoum Aero wkg Tripoli Aero/Saudi 749 (Hartung-MD)  
 TURKEY: 6395 CW 0550 TBA3- Izmir Naval R. - clg T13A (C. Brown-IL)  
 11112 LSB 2342 AJO- Adana AFB - EE/OM/ VM (Russow- W. GERMANY)  
 ZAMBIA: 13336 A3H 1729 Lusaka Aero wkg Dar es Salaam Aero (Moman-ALBERTA)  
 ZAIRE: 8826 A3H 0143 Kinshasa Aero wkg Zimbabwe 1820 (Hartung-MD)

\*\*\*\* ASIA/FAR EAST \*\*\*\*

CHINA, P.R.: 8501 CW 1340 XSG- Shanghai Radio - CQ Mkr (G. Thompson-NM)  
 DIEGO GARCIA: 11176 USB var. NKW- Diego Tower wkg MAC 70401 (Chabak-AZ)(Russow-W.GER)  
 HONG KONG: 13044 CW 0126 VPS61- Cape d'Agullar wkg 3E00 (French-MD)  
 INDIA: 13356 A3H 2310 Bombay Aero wkg unid sta (Moman-ALBERTA)  
 INDONESIA: 8694 CW 1310 PKM- Bitung Radio - CQ Mkr (G. Thompson-NM)  
 JAPAN: 3786.1 USB 1309 NRT- USCG Yokota Monitor wkg Marcus Loran (Chabak-AZ)  
 12788 CW 0823 JFA- Matsudo Radio - CQ (French-MD)  
 13201 USB 2255 AIF- Yokota AFB wkg T.B.913 & Clark AFB (Chinsky-NY)  
 18090a CW 0230 JPA24- INTERPOL Tokyo wkg HSQ Thailand (Pogue-GUAM)  
 KOREA, SOUTH: 8576 CW 1435 HLO- MINCOM Seoul - CQ Mkr (G. Thompson-NM)  
 8635 CW 1320 HLL- MINCOM Seoul - CQ Mkr (G. Thompson-NM)  
 10523.6 USB 1316 Hampyong Loran wkg Yokota Monitor (Chabak-AZ)  
 10523.6 USB 1311 Pohang Loran wkg Yokota Monitor (Chabak-AZ)  
 12916.5 CW 0202 HLF- MINCOM Seoul - CQ Mkr (French-MD)  
 PHILIPPINES: 8586 CW 1325 DZG- Las Pinas Radio - CQ Mkr (G. Thompson-NM)  
 13201 USB 2254 AIC- Clark AFB wkg T.B.913 & Yokota AFB (Chinsky-NY)  
 SINGAPORE: 8707 CW 1305 9VG- Singapore Radio - CQ Mkr (G. Thompson-NM)  
 22427 CW 0155 9VG59- Singapore Radio - CQ Mkr (G. Thompson-NM)  
 VIETNAM: 8590 CW 1430 XSV8- Ho Chi Minh R. - CQ Mkr (G. Thompson-NM)

\*\*\*\* PACIFIC OCEAN \*\*\*\*

AUSTRALIA: 8477 CW 1440 VHP- RAN Canberra - V Mkr (G. Thompson-NM)  
 8706 CW 1300 VIP33 - Perth Radio - CQ Mkr (G. Thompson-NM)  
 13425 USB 2000 AOTC Sydney - OM/EE/VM (Russow- W. GERMANY)  
 COOK IS.: 13304 A3H 1644 Rarotonga Aero wkg a/c ?13 (Moman-ALBERTA)  
 HAWAIIAN IS.: 5000 AM 1250 WVVH- NBS time sta Kauai (Davidson-SC)



HAWAIIAN IS.:	6738	USB	0619	AGA- Hickam AFB wkg World 806 (Tate-WV)
	13113.2	USB	0544	NMO7- Kure Loran clg CS Honolulu (Pogue-GUAM)
	13141.1	USB	2358	KAB- NOAA Honolulu wkg NOAA Miller Freeman (Devendorf)
	13201	USB	0423	AGA- Hickam AFB wkg MAC 59402 (Hartung-MD)
	13336	A3H	0009	Honolulu Aero wkg Braniff 501 (Hartung-MD)
	13555	CW	0135	NMO- CS Honolulu - WX b/c (R. Alexander-IA)
	22475	CW	1745	NMO- CS Honolulu - CQ Mkr (G. Thompson-NM)
MARCUS IS.:	10523.6	USB	1306	NRV6- Marcus Loran wkg Saipan/Yokota Monitor (Chabak)
MARIANA IS.:	7836.6	USB	1407	NRV2- Saipan Monitor wkg Marcus Loran (Chabak-AZ)
	16742	CW	1710	NRV- USCG Guam - CQ Mkr (G. Thompson-NM)
	22527.2	CW	2215	NRV- USCG Guam - CQ Mkr (G. Thompson-NM)
NEW CALEDONIA:	8645	CW	1315	FUJ- Fr. Naval R. Noumea - V Mkr (G. Thompson-NM)
	22460	CW	0205	FUJ- Fr. Naval R. Noumea - V Mkr (G. Thompson-NM)
NEW ZEALAND:	8984	USB	0527	RNZAF Wigram wkg Air Force Auckland (Chabak-AZ)
	12943.5	CW	0425	ZLP5- Irirangi Naval R. - V Mkr (R. Alexander-IA)
	17127	CW	2115	ZLP2- Irirangi Naval R. - V Mkr (Walters-NJ)
	17170.4	CW	2119	ZLB- NZPO Awarua - DE Mkr (Walters-NJ)
OKINAWA:	3786.1	USB	1314	NRT2- Gesashi Loran wkg Yokota Monitor (Chabak-AZ)
VOLCANO IS.:	7836.6	USB	1408	NRT3- Iwo Jima Loran wkg Saipan Monitor (Chabak-AZ)

\*\*\*\* ANTARCTICA \*\*\*\*

9106	SSB	2358	ZHF45 Rothera Base wkg Grytviiken, So. Georgia Is. (French-MD)
13975a	SSB	0440	NNØICE- MARS McMurdo Station- p/p via NNØVOK (Emerson-TX)
11557	USB	2305	ZHF45- Rothera Base wkg Palmer Station (Russow- W. GERMANY)

\*\*\*\* SHIPS \*\*\*\*

5696	USB	1402	NDWA- CGC MORGANTHAU wkg CG 1603 re: DAE RIM fire (Chabak-AZ)
6506.4	USB	0125	WLB291- CGC LAUREL wkg USCG CS Kodiak AK (Maise-LA)
6506.4	USB	1743	NRPN- CGC IRONWOOD wkg USCG CS Honolulu (Pogue-GUAM)
6506.4	USB	0120	NRDB- CGC BIBB wkg USCG CS Portsmouth VA (Maise-LA)
6506.4	USB	0616	WTES- NOAA SURVEYOR wkg USCG CS San Francisco CA (Chabak-AZ)
6506.4	USB	0135	NCRG- CGC COURAGEOUS wkg USCG CS Portsmouth VA (Maise-LA)
8241.5	SSB	0001	PJYG- OLEANDER wkg USCG CS Boston MA (Stanbury-ONTARIO)
8241.5	USB	0138	NZVE- CGC ALERT wkg USCG CS Portsmouth VA (Wimmers-FL)
12428	USB	1910	SEALAND DEVELOPER wkg KHW Oakland Radio (Valentine-CA)
13141.1	USB	2337	WIAL- NOAA DISCOVERER wkg NOAA MILLER FREEMAN (Devendorf-CA)
16460	USB	1935	Tanker SAN DIEGO wkg Port of Long Beach CA (Hess-OH)
22065.2	USB	2010	ELHL- ?? wkg WOM Fort Lauderdale Radio (Bellard-OH)

\*\*\*\* AIRCRAFT \*\*\*\*

4746	USB	0344	AIR FORCE 052 r/c with Lajes AFB Azores (Shepherd-IL)
5696	USB	0522	CG 1476 wkg USCG CS Boston MA (Shepherd-IL)
5696	USB	0515	CG 1452 wkg USCG Long Beach/San Francisco re: Zephyr rescue (Moman)
5696	USB	1352	Navy CHARLIE TANGO 285 wkg CG 1603 re: DAE RIM fire (Chabak-AZ)
8826	A3H	0107	ALITALIA 186 wkg Kano Aero (Fitzgerald-RI)
8826	A3H	0206	SPRINGBOK 232 clg Luanda Aero (Fitzgerald-RI)
8826	A3H	0210	NIGERIA 801 wkg Niamey Aero (Fitzgerald-RI)
8826	A3H	0428	LUFTHANSA ??? wkg Lima Control (aero) (Hartung-MD)
8845	A3H	0400	AVIANCA 11 wkg Santa Maria Aero (Moss-CA)
8847	A3H	0550	CLIPPER 454 wkg Bogota Aero (Hartung-MD)
8855	A3H	1045	PHILIPPINE 106 wkg GUAM Aero (Van Beurden-CA)
8855	A3H	1050	ASIA 206 wkg Tokyo Aero (Van Beurden-CA)
8945	A3H	0222	WEST INDIAN AIRWAYS 900 wkg San Juan/New York Aero (Tate-WV)
8945	A3H	0308	ALITALIA 567 wkg San Juan Aero (Tate-WV)
8959	A3H	0410	SPEEDBIRD 267 wkg New York Aero (Shepherd-IL)
8967	USB	0400	OTIS 20 clg Juliet Quebec 20 (Shepherd-IL)
8987	USB	1309	CG 1342 wkg USCG Radio Miami (Pogue-GUAM)
8989	USB	0308	MAC 40614 wkg McClellan AFB CA (Johnson-ID)
8989	USB	0423	ARMY 66255 wkg McClellan AFB CA (Chabak-AZ)
9001	USB	0149	CUBANA 477 clg Boyeros Dispatcher (Chinsky-NY)
10093	USB	0348	SPEEDBIRD 266 wkg LDOC Speedbird London (Fitzgerald-RI)
11176	USB	1339	ARMY 18118 wkg Albrook AFB Panama (Chabak-AZ)
11182	USB	2332	(RAF) ASCOT 4247 p/p to Scott Dispatch via Scott AFB (Chabak-AZ)
11228	USB	2206	GULL 17 p/p to Gull Ops via MacDill AFB FL (Chabak-AZ)
11246	USB	2234	NOAA 77 wkg MacDill AFB FL (Lewallyn-GA)
11246	USB	1828	(RAF) ASCOT 5476 wkg MacDill AFB FL (Lewallyn-GA)
11249	USB	2147	CANADIAN MILITARY 216 wkg Halifax & Trenton Military (Lewallyn-GA)
13201	USB	1640	MAC 00447 p/p to Silver CP via Loring AFB ME (Fitzgerald-RI)
13244	USB	1810	Navy LIMA QUEBEC 344/ L.U. 34/ L.Q. 345 wkg MacDill AFB (Fitzgerald)
13247	USB	1940	CANADIAN MILITARY 3967 wkg SAM CP via Andrews AFB p/p (Shepherd-IL)
13336	A3H	0401	AEROFLOT 24 SUGAR BAKER wkg Bombay Aero (Hartung-MD)
13950	LSB	0109	AIR FORCE RESCUE 856 wkg HCUS1-USMILGP Ecuador (Chabak-AZ)
15015	USB	2148	MAC 70013 wkg Scott AFB IL (Morgan-NC)
18002	USB	2305	MAC 70020 wkg Hickam AFB HI (Morgan-NC)
18002	USB	2307	AIR EVAC 67944 wkg McClellan AFB CA (Morgan-NC)

\*\*\*\* TACTICAL \*\*\*\*

3135a USB 0150 KILO 7ø wkg 1 OSCAR TANGO (Lewallyn-GA)  
 3190 USB 0245 XRAY 58 MIKE clg XRAY 73 (Stock-GO)  
 4435a USB 0308 YANKEE 5 FOXTROT wkg NOVEMBER 4 WHISKEY (R. Alexander-IA)  
 5700 USB 2110 EDGY 22 (E-3A Sentry AWACS a/c) wkg Scott AFB (Morgan-NC)  
 5751 USB 0141 (DOE) 266 wkg LOBO 431 (Stock-GO)  
 6502a USB 0202 ECHO ROMEO with radio checks (Chinsky-NY)  
 6509a USB 0153 GLADIATOR wkg ø ALFA XRAY/MIKE PAPA SIERRA/MIKE 5 SIERRA (Chinsky-NY)  
 6712 USB 0456 CASTOR wkg STATEMENT (Chabak-AZ)  
 6756 USB 0105 SPAR 57(VIP a/c)wkg Andrews AFB MD (Chinsky-NY)  
 7527 USB 0045 RAMPART wkg SLINGSHOT (US Customs) (Rankin-KS)  
 7527 USB 0000 a/c OMAHA 17 & 45 wkg SLINGSHOT (US Customs) (Rankin-KS)  
 7527 USB 0213 HIGHTIDE wkg a/c-4 ALFA 8ø7 (US Customs) (Rankin-KS)  
 7527 USB 0116 ARAPAHOE wkg HOMEPLATE (US Customs) (Chabak-AZ)  
 7700 USB 0428 (DOE) KRF 364 wkg LOBO 11 (Stock-GO)  
 7706.5 LSB 1738 SWEAT 31 (a/c) wkg ABNORMAL 1ø (Vandenberg AFB- WTR SAMTO) (Chabak-AZ)  
 7827a LSB 1303 SAM 2413ø wkg Andrews AFB with p/p tfc (Chabak-AZ)  
 7847 USB 1354 (US Army) BRAVO 73 wkg BRAVO 73 ALFA (Chabak-AZ)  
 7895 LSB 0717 KILGORE clg TORREADOR (NCS- San Francisco CA) (Devendorf-CA)  
 8973 USB 0348 CHARLIE DELTA wkg HOTEL 7 TANGO (Shepherd-IL)  
 8989 USB 2210 BLACK RAVEN 623 p/p via McClellan AFB CA (Valentine-CA)  
 8989 USB 0148 NAVY FOX 4 wkg MacDill AFB FL (Chinsky-NY)  
 8993 USB 0151 DAVID 33 wkg MacDill AFB FL (Chinsky-NY)  
 8993 USB 0155 BUNK 31 wkg MacDill AFB FL (Chinsky-NY)  
 8993 USB 0152 EXPEL 13 wkg Little Rock CP via MacDill AFB p/p (Chinsky-NY)  
 8993 USB 0153 NAVY FOX 2 wkg MacDill AFB FL (Chinsky-NY)  
 9007 LSB 0243 ERRATA 78 wkg Andrews AFB MD (Chinsky-NY)  
 9014 USB 0230 BRAVO HOTEL r/c with Scott AFB IL (Stone-ONTARIO)  
 9018 USB 1845 SAM 24197 wkg SAM CP via Andrews AFB p/p (Shepherd-IL)  
 9023 USB 1957 DRY RUN wkg AUDIO KIT & ARIZONA PETE re: Red Flag Exercise (Chabak-AZ)  
 9023 USB 2045 DURKEE p/p to REPERTOIRE via CHURCHMAN (Chabak-AZ)  
 9027 SSB 0030 CONCOURSE to Skyking (Pettit-IA)  
 9027 USB 0354 BIMBO with comms test (Shepherd-IL)  
 11076 USB 2317 (DEA) a/c FLINT 355 wkg ATLAS (Rankin-KS)  
 11076 USB 2150 (DEA) a/c SWORDFISH 2 wkg ATLAS with p/p (Rankin-KS)  
 11182 USB 2239 TROUT 98 (VIP a/c) wkg TROUT OPS via Scott AFB p/p (Chinsky-NY)  
 11215 USB 2151 EDGY 25 (E-3A Sentry a/c) wkg RAYMOND 24 (Tinker AFB) (Chabak-AZ)  
 11243 USB ---- BIRDSEYE coded Skyking msg (Stone-ONTARIO)  
 11246 USB 1524 LIMA KILO 03 wkg MacDill AFB FL (Morgan-NC)  
 11267 USB 1508 QUEBEC 1 HOTEL wkg ECHO 8 BRAVO (Morgan-NC)  
 11267 USB 0215 1 XRAY ZULU wkg MIKE 9 FOXTROT/1 FOXTROT VICTOR (George-TX)  
 11555 USB var. (DOE) KRF 263 wkg LOBO 21 & LOBO 331 (Stock-GO)  
 13204 USB 1546 PAGER 3ø wkg BATON COMMAND (Morgan-NC)  
 13218 USB 1741 AGAR 24 wkg ABNORMAL 1ø (Vandenberg -WTR SAMTO) (Chabak-AZ)  
 13241 USB 1807 DRAPE ø7/ROGUE ø6/BUD 1ø3 clg Skybird & BAY RUM (Fitzgerald-RI)  
 13244 USB 1603 PAGER 3ø wkg MacDill AFB FL (Morgan-NC)  
 13244 USB 1559 IBA 42 wkg MacDill AFB FL (Morgan-NC)  
 13244 USB 1733 SAM 1249ø wkg MacDill AFB FL (Shepherd-IL)  
 13756 USB 1748 ACAR 24 p/p to Wright-Patterson AFB via ABNORMAL 1ø (Chabak-AZ)  
 14467 LSB 2215 CANARYSIDE clg MISSIONARY (Russow- W. GERMANY)  
 15015 USB 1921 QUAD 18 p/p via Scott AFB IL (Lewallyn-GA)  
 15031 USB 1948 BARTLEY p/p to WAR 46 (FT. Richie MD) via McClellan (Chabak-AZ)  
 15792 LSB 2116 ABNORMAL 1ø (Vandenberg WTR-SAMTO) clg ABNORMAL 4ø (Stock-GO)  
 17500 SSB 0127 PANAMA r/c with CAMPBELL (Stock-GO)  
 18002 USB 0145 ZIP 43 r/c with Andersen AFB Guam (Morgan-NC)  
 18002 USB 2111 EDGY 22 p/p to RADAR SHOP via Scott AFB IL (Morgan-NC)  
 18666 USB 2215 (DEA) TROPIC AIR wkg ATLAS (Rankin-KS)  
 18666 USB 2245 (DEA) a/c FLINT 356 wkg ATLAS (Rankin-KS)  
 18666 USB var. (DEA) a/c- FLINT 102/458/253/101 wkg ATLAS (Rankin-KS)  
 18666 USB 1529 (DEA) CONDOR 7øø wkg ATLAS (Chabak-AZ)  
 18666 USB 1539 (DEA) a/c - FLINT 101 wkg FLINT 357 (Chabak-AZ)  
 18666 USB 1651 (DEA) a/c - FLINT 102 p/p from TIBURON via ATLAS (Chabak-AZ)  
 18666 USB 1646 (DEA) SUNDANCE 1ø wkg ATLAS (Chabak-AZ)  
 24130 USB 0042 QUEBEC ø DELTA 17 r/c with QUEBEC ø DELTA 18 (Stock-GO)

\*\*\*\* NUMBERS/BEACONS \*\*\*\*

4312 CW 0455 P Beacon (Blaise-LA)  
 5307 CW 0629 O Beacon - 1 sec. cycle rate - stopped at 0630Z (Chabak-AZ)  
 6792 CW 1440 P Beacon - 2 sec. cycle rate (Chabak-AZ)  
 6800 CW 0617 D & C Beacon mixing together - both 1 sec. cycle rates (Chabak-AZ)  
 8656 CW 0605 C, K, & D Beacons all mixing together at different rates (Chabak-AZ)  
 11156 CW 1125 K Beacon - 5 sec. cycle rate (R. Alexander-IA)  
 15654.5 CW 0435 U Beacon (Munster-GA)

3090 CW 0216-0219 AMM ANW, message 18 Feb81 (Munster-GA)  
3445 AM 0303 SS/YL 5dgps 10Feb81 (Huffaker-MEXICO)  
4670 AM 0303 SS/YL - 545 repeat - 23Feb81 (Huffaker-MEXICO).  
4670 AM 0415 SS/YL - 5dgps - 09Feb81 (Huffaker-MEXICO)  
4670 AM 0425 SS/YL - 4dgps - 20Feb81 (Shepherd-IL)  
4730 AM 0507 EE/?? - 3+2 gps - 12Feb 81 (Huffaker-MEXICO)  
4770 AM 0501-0520 GG/YL - 3 x Ø39, 1-Ø count, msg, Ende - 13Feb81 (Munster-GA)  
4873 AM 0603-061 SS/YL - 5dgps "ATT 106-120", Finale - 11Feb81 (Pettit-IA)  
5015 AM 0600-0617 GG/YL - "Papa November"- 5ddblgs - Ende- 16Feb81 (Nida-MN)  
5133 AM 0620 SS/YL - 5dgps 16Feb81 (Nida-MN)  
5420 AM 2105-2112 Music & Bird Calls - Termina x 3 - (Stanbury-ONTARIO)  
5761 AM 0603 SS/YL - 5dgps - 16Feb81 (Nida-MN)  
5813 AM 0205 - SS/YL - 4dgps - 18Feb81 (Stone-ONTARIO)  
5814 AM 0406-0451 SS/YL - 4dgps - "645", 1-Ø count- "Fin"- 17Feb81 //4670 kHz (Nida)  
6508 AM 0500-0538 GG/YL - 5ddblgs preceded by music - 15Feb81 (Nida-MN)  
6572 AM 0903 SS/YL - 5dgps - 14Feb81 (R. Alexander-IA)  
6573 AM 0403-0408 SS/YL - 5dgps - "ATT 649-5Ø"- Final - 07Mar81 (Nida-MN)  
6825 AM 0800 SS/YL - 5dgps - "ATT 592-5Ø" - 07Mar81 (Nida-MN)  
6975 AM 0515 SS/YL - 5dgps - 15Feb81 (Huffaker-MEXICO)  
7404 AM 0600-0618 GG/YL - 5ddblgs - Ende - 19Feb81 (Munster-GA)  
7404 AM 1130-1150 SS/YL - 5dgps "ATT 295-25" - 28Feb81 (Demmitt-PA)  
7404 AM 1201-1206 SS/YL - 5dgps "ATT 947-30" - 28Feb81 (Demmitt-PA)  
7404 AM 0300- GG/YL - 5dgps preceded by CW "N" - 03Mar81 (Demmitt-PA)  
7430 AM 0703 SS/YL - 5dgps - 23Feb81 (Huffaker-MEXICO)  
7515 AM 0422-0428 SS/YL - 5dgps - Final - 09Feb81 (Pettit-IA)  
7527 USB 0610-0620 SS/YL - 5dgps - "ATT 580-75" - Final x 2 - 26Feb81 (Rankin-KS)  
7847 AM 0623-0628 SS/YL - "ATT 178-33" - no gps - 02Feb81 (Pettit-IA)  
8173 USB 0444-0448 GG/YL - 5ddblgs - 22Feb81 (Munster-GA)  
8173 AM 0300-0319 EE/YL - 5ddblgs ' Papa Uniform - End of Info- 17Feb81 (Nida-MN)  
8186 AM 0106-0118 GG/YL - 5ddblgs - 17Feb81 (Nida-MN)  
8418 AM 0100-0137 SS/YL - 4dgps - "335", 1-Ø count, Fin //5814 kHz-04Mar81 (Nida)  
8425 AM 0434-0435 EE/YL - ??? repeated - 06Feb81 (Munster-GA)  
8728.2 USB 0505 SS/YL - 5dgps - 22Feb81 (Munster-GA)  
9049 AM 0210-0217 GG/YL - 5dgps - Ende - 21Feb81 (Stone-ONTARIO)  
9074 AM 0101- SS/YL - 4dgps - "614", 1-Ø count- //11532 kHz - 17Feb81 (Nida-MN)  
9218 AM 0243-0244 SS/YL - 5dgps - Final - 14Feb81 (Pettit-IA)  
9325 AM 0540-0550 GG/YL - 5ddblgs - Ende - 21Feb81 (Munster-GA)  
9435 AM 0344-0349 EE/YL - 4dgps - End - //10613 kHz - 07Mar81 (Nida-MN)  
9435 AM 0305-0322 EE/YL - 4dgps - "102", 1-Ø count- End of Info - 24Feb81 (Nida-MN)  
9450 SSB 0103- GG/YL - 5ddblgs - Whiskey Papa & music - 17Feb81 (Nida-MN)  
9465 AM 0803 SS/YL - 5dgps - 07Mar81 (Nida-MN)  
10020 AM 0910-0914 SS/YL - 5dgps - "ATT-380-20"- Final - 16Feb81 (Van Beurden-CA)  
10452 LSB 1330-1334 CC/YL - ?? (xmsn heard each day) - 06Feb81 (Van Beurden-CA)  
17650 AM 1508-1520 GG/YL - 5dgps - preceded by Achtung - Ende - 09Feb81 (Van Beurden)

\*\*\*\* UNIDENTIFIED \*\*\*\*

3060 CW 0203-0213 Q then --.-.--, msg, AR x3, VA x 3 (Munster-GA)  
7820 LSB 0954 OSCAR clg KILLO (British type accent) ( ??????)  
7908 CW 0700-0706 NU NGU, msg, AR (Munster-GA)  
8692a CW 0850-0900+ PO de OP K - call letters repeated twice (R. Alexander-IA)  
8926a AM 2250-2252 repeats of KILLO PAPA ALPHA 2 ( Fitzgerald-RI)  
11239 USB 2150 EE/OM w/SS accent- TANGO PAPA Ø3 repeated every 30sec. (Lewallyn-GA)  
11496a CW 2200 VVV OMZ OMZ OMZ DE 7L1 7L1 7L1 (Czech Embassy?) (Chinsky-NY)  
12747 AM 2200-0400 10 min. interval repeat -EE/YL-MIKE INDIA DELTA 2 (Nida-MN)  
14390a LSB 2329 WYC wkg WYQ plus others - EE/OM (Chinsky-NY)  
14425a LSB 0045 Sierra Mike wkg WB4LLT/PY4DO & WB4OFL (Chinsky-NY)  
14470a CW 1445 Mkr- ND EAENV6 (Chinsky-NY)  
15849 CW 0725 AØ8K to JHCR (Russow-W. GERMANY)  
18005 SSB 0238 TORONTO wkg COGNIZANCE (Stock-CO)  
19533a RTTY 0005 AAA3V test tape 66/425 (Emerson-TX) probable US MARS  
19885 CW 1728 Y7A79 - V Mkr (Hess-OH)  
21855 CW 0945 7TJD to 7TJN (Russow- W.GERMANY)  
23520 RTTY 1430 3ZB201 to 3ZL301 - 67/??? (Russow- W.GERMANY)

\*\*\*\* RADIOTELETYPE \*\*\*\*

AUSTRALIA: 5100 0859 AXM- Canberra - RY test 66/850 (Devendorf-CA)  
BRAZIL: 5185 0856 PPN9- Brasilia Metro - WX - 66/850 (Devendorf-CA)  
CHINA, P.R.: 7863 1001 BJZ21- Hangzhou Metro - WX - 66/425r (Devendorf-CA)  
CUBA: 11141a 1135 CKN320- Prensa Latina Havana- RY- 66/425r (R. Alexander-IA)  
HAWAIIAN IS.: 4575 1020 NMO- CS Honolulu wkg CGC Sweetbriar- 100/170 (Devendorf-CA)  
8510 0830 NMO- CS Honolulu wkg CGC Glacier - 100/170 (Devendorf-CA)  
HONG KONG: 7542.5 1011 ZEN33- ?? RY test (Devendorf-CA)  
INDONESIA: 19355 0724 PLE6- Bandung wkg Karachi - 66/425r (Russow-W.GERMANY)  
JAPAN: 7327.5 1029 JAE27- Tokyo SS/NX - 66/850 (Devendorf-CA)

NORWAY: 21953 0830 LJA- Foreign Ministry Oslo- 66/425r (Russow-W.GERMANY)  
 SENEGAL: 10492 0857 RFTJF- French Military Dakar- RY- 66/425r (Devendorf-CA)  
 TAIWAN: 7695 0956 3MA26- Taipei- China NX Agency- RY- 66/850 (Devendorf-CA)  
 THAILAND: 21948 1358 HSF212-For.Ministry Bangkok to HSF212 Bonn (Russow-W.GERMANY)  
 SHIP: 8457 0805 NRXD- CGC Evergreen wkg CG Miami- 100/170 (Devendorf-CA)  
 SHIP: 8301a 0344 UGNH- Ribatskaia Slava RY to URB2-66/425 (R.Alexander-IA)

\*\*\*\* VLF//LW//MW \*\*\*\*

CANADA: 212 0414 GX - Gillman, Manatoba (under OGA) (Stock-CO)  
 PUERTO RICO: 467 0250 NMR - USCG San Juan wkg ship in distress (Stock-CO)  
 U.S.A.: 254 1052 SPK - Reno Int'l Airport- Beacon & (AM) WX b/c (Devendorf-CA)  
 263 1041 OGD - Ogden, Utah - Beacon & (AM) WX b/c (Devendorf-CA)  
 326 1045 PQO - Phoenix/Sky Harbor Airport-Beacon/WX (Devendorf-CA)  
 362 1047 FZR - Oakland CA - Beacon & (AM) WX b/c (Devendorf-CA)  
 410 0308 MSB - Iola Kansas (under CZD) (Stock-CO)  
 524 0505 HEH - Newark, Ohio (Stanbury-ONTARIO)  
 530 0655 (AM) travellers info, Gatlinburg TN area (C. Brown-IL)

\*\*\*\* QSLs \*\*\*\*

AUSTRALIA: VNG - Lyndhurst Time Sta - folder card-18d- NO rp - 7500kHz (D. Jones-VA)  
 VID - Darwin Radio - Satellite card- 18d - 1 IRC - 500kHz (Pogue-GUAM)  
 VIO - Broome Radio - f/d ltr - 27d - 1 IRC - 500kHz (Pogue-GUAM)  
 CANADA: VCS - Ketch Harbor CG Radio- card,pics-34d- 1 IRC- 8440kHz (Dupree-MD)  
 CHU - Ottawa Time Sta-Fleming Card- 44d - NO rp - (C. Thompson-ONTARIO)  
 CAROLINE IS:NRV7 - USCG Yap Loran - PFC in 4mo - 10523kHz (Russow-W.GERMANY)  
 HAWAIIAN IS:WVH - NBS Time Sta Kauai- card -26d - NO rp - 15000kHz (D. Jones-VA)  
 HONG KONG: VPS - Cape d'Aguilar R. Ltr- 21d - 1 IRC - 500kHz (Pogue-GUAM)  
 HOLLAND: PCH61 - Scheveningen R. Card- 18d - 1 IRC - 17007.2kHz (Dupree-MD)  
 JAPAN: JOU - Nagasaki Radio- n/d form ltr- 28d- 1 IRC - 12673.5kHz (Dupree-MD)  
 JMX - Kushiro Radio - f/d ltr- 33d - 1 IRC - 500kHz (Pogue-GUAM)  
 KOREA,SOUTH:SAM66- Swedish Delegation Panmunjon- PFC- 30d - 20942kHz (Russow-W.GERMANY)  
 LEBANON: ODR88 - Red Cross Beirut - PFC - 30d - 20942kHz (Russow-W.GERMANY)  
 SENEGAL: WCM - Dakar Aero - PFC - 32d - 2 IRCs - 8882kHz (Maise-LA)  
 TAIWAN: XSX - Keelung Radio - f/d mimeo card- 30d- 1 IRC - 500kHz (Pogue-GUAM)  
 U.S.A.: WQB23 - Akron Ohio - Ltr 37d - 13945kHz (Russow-W.GERMANY)  
 WCM - Pittsburgh Radio - PFC - 6d - MS - 6515.7kHz (Tate-WV)  
 WMH - Baltimore Radio - Card- 17mo! - MS - 8686kHz (Chinsky-NY)  
 WMS5 - Grumman/Bethpage NY- PFC- 18d - MS - 9009kHz (Chinsky-NY)  
 NMG - USCG Belle Chase LA- n/d ltr- 39d - MS - 6506.4kHz (Dupree-MD)  
 NMC11 - USCG Humboldt Bay CA- PFC,ltr- 22d - MS - 2670kHz (Pogue-GUAM)  
 SHIPS: SWSD - AITHINA ZAFIRAKIS (Bulk Carrier) PFC- 45d- 1 IRC - 500kHz (Holbrook-MD)  
 DECF - EPSILON GAS (Liquefied Gas) PFC- 5mo- 1 IRC - 22230kHz (Holbrook-MD)  
 5LWE - ASIA HUNTER (Car/Freight) PFC - 1 IRC - 16720/22240kHz (Holbrook-MD)  
 WZJB - AMERICAN LANGER (Container) PFC- 14mo! - MS - 500kHz (Holbrook-MD)  
 NODL - CGC FIREBUSH - f/d ltr - 23d - MS - 6506.4kHz (Maise-LA)  
 NRUO - CGC POLAR SEA - card - 33d - MS - 6506.4kHz (Dupree-MD)  
 NNUD - USNS SILAS BENT - PFC - 53d - MS - 12550kHz (Pogue-GUAM)  
 WTEP - NOAA OCEANOGRAPHER - PFC,Ltr- 25d - MS - 13113.2kHz (Maise-LA)  
 MNMX - TEXACO WELLINGTON (Tanker) PFC,Ltr- 47d - 22270kHz (Mason-ONTARIO)  
 GTUT - KING CHARLES (Dry Bulk) PFC,ltr - 32d - MS - 16794kHz (Mason-ONTARIO)  
 GZVK - CHARON (Tanker) PFC - 40d - MS - 16713.5kHz (Mason-ONTARIO)  
 GXIA - STRATHEWE (General Cargo) PFC,Ltr- 58d - 16710kHz (Mason-ONTARIO)  
 GYHE - TROUTBANK (General Cargo) PFC - 33d - MS - 16717kHz (Mason-ONTARIO)  
 GQEE - FLEETBANK (General Cargo) PFC,Ltr- 42d - 22255kHz (Mason-ONTARIO)  
 GUYC - LEONIA (Super Tanker) Ltr - 59d - MS - 16715kHz (Mason-ONTARIO)  
 GKMU - CLAN MAGGREGOR (General Cargo) PFC,Ltr-48d - 16717 (Mason-ONTARIO)  
 AIRCRAFT: ZEBCO 37- MO ANG - PFC - 11d - MS - 11182kHz (Chinsky-NY)  
 ALITALIA 567 - Ltr - 10d - MS - 8945kHz (Tate-WV)  
 CG 1452 - PFC, Ltr - 42d - MS - 8984kHz (Curnell-OR)  
 CG 1603 - HC-130H a/c - PFC,Ltr- 9d - MS - 5696kHz (Chabak-AZ)  
 BEACONS: BAHAMAS: ZIN - 376kHz - Inagua - mimeo card - 47d- 1 IRC - (Dupree-MD)  
 CANADA: J - 300kHz - Perroquet Is, Quebec-PFC-75d- (Holbrook-MD)  
 YLD - 335kHz - Chapleau, Ontario-PFC,ltr-38d- 1 IRC (Dupree-MD)  
 YXL - 405kHz - Sioux Lookout, Ontario-PFC-23d (Holbrook-MD)  
 U.S.A.: EQY - 204kHz - Monroe County Airport, NC- PFC-15d - (Dupree-MD)  
 SYS - 209 - Somers Ct Airport, PA-PFC-12d - (Dupree-MD)  
 OQZ - 212 - Everett-Stewart Airport, Union City TN-PFC-50d (Holbrook-MD)  
 BA - 219 - Baltimore-Washington Int'l Airport-PFC-19d (Dupree-MD)  
 MX - 232 - Andrews AFB, Camp Springs MD- PFC-42d (Dupree-MD)  
 HEM - 233 - Sparta-White Cty Airport, TN - PFC- 70d (Holbrook-MD)  
 THV - 242 - York Airport, York PA - PFC- 15d (Dupree-MD)  
 IL - 248 - Greater Wilmington Airport, DE- PFC-22d (Dupree-MD)  
 JAN - 260 - FAA Jackson, MS- Ltr- (Bledsoe-MO)

BEACON QSLs - continued

U.S.A.: HNR - 272kHz - Harlan Muni Airport, IA- PFC- 16d (Holbrook-MD)  
 HG - 278 - Hagerstown Regional Airport, MD- PFC-9d (Dupree-MD)  
 RT - 291 - USCG Rockaway, Ft. Tilden NY- PFC- 25d (Dupree-MD)  
 S - 298 - USCG Charleston Light Sta, SC- PFC- 10d (Dupree-MD)  
 IR - 308 - USCG Indian River/Rehoboth Beach, DE- PFC-14d (Dupree-MD)  
 SP - 310 - USCG St. Inogees, MD - PFC- 18d (Dupree-MD)  
 CP - 314 - USCG Cove Point Light Sta, Lusby, MD-PFC-7d (Dupree-MD)  
 CBE - 317 - Cumberland Muni Airport, MD - PFC- 7d (Dupree-MD)  
 D - 319 - Delaware Light Buoy-via USCG Cape May NJ-PFC 19d (Dupree-MD)  
 GTN - 323 - Washington Nat'l Airport, DC- PFC- 19d (Dupree-MD)  
 BKT - 326 - Blackstone Army Airfield, FT.Pickett, VA- PFC- 13d (Dupree-MD)  
 PWQ - 326 - Grant Cty Airport, Petersburg, WV- PFC- 13d (Dupree-MD)  
 DC - 332 - Washington Nat'l Airport, DC - PFC 19d (Dupree-MD)  
 PWN - 335 - West Plains Muni Airport, MO - PFC 10d (Holbrook-MD)  
 MCZ - 336 - Martin Cty Airport, Williamston, NC- PFC 7d (Dupree-MD)  
 HVS - 341 - Hartsville Muni Airport, SC - PFC 13d (Dupree-MD)  
 UNU - 344 - Marshland Aviation, Juneau, WI - PFC in 8d (Holbrook-MD)  
 DPL - 344.51 - Duplin Cty Airport, Kenansville, NC- PFC- 12d (Dupree-MD)  
 IA - 346 - Dulles Int'l Airport, Wash DC- PFC - 19d (Dupree-MD)  
 TXM - 354 - Transcontinental Gas Pipe Line Corp-off shore-Ltr-25d (Holbrook-MD)  
 MKS - 354 - Moncks Corner Airport, SC- PFC,Ltr 11d (Dupree-MD)  
 FND - 371 - Baltimore-Washington Int'l Airport, MD- PFC 19d (Dupree-MD)  
 PJS - 375 - Newport News Int'l Airport, VA - PFC 15d (Dupree-MD)(Holbrook-MD)  
 ELM - 375 - Chemung Cty Airport, Elmira, NY - PFC 13d (Dupree-MD)  
 BRA - 379 - Asheville Regional Airport, Broadriver,NC- PFC 20d (Dupree-MD)  
 CDX - 388 - Somerset-Pulaski Airport,KY- PFC 50d (Holbrook-MD)  
 NXX - 388 - Willow Grove NAS, PA - PFC 7d (Dupree-MD)  
 XYC - 393.51 - Calla Airport, Irvine, KY PFC 7d (Dupree-MD)  
 NHK - 400 - Patuxent River NAS, MD - PFC 7d (Dupree-MD)  
 JS - 400 - Johnstown-Cambria Cty Airport, PA PFC 15d (Dupree-MD)  
 FGX - 400 - Fleming Mason Airport, Flemingsburg, KY- PFC 25d (Dupree-MD)  
 IVB - 404 - FAA Baltimore, MD PFC 19d (Dupree-MD)  
 CI - 410 - Chippewa Cty Int'l Airport, Sault Ste. Marie, MI- PFC (Dupree-MD)  
 CSS - 414 - Fayette Cty Airport, Washington Court House, OH- PFC 18d (Dupree)  
 AZE - 414 - Hazelhurst Airport, CA PFC 23d (Dupree-MD)  
 FDW - 414.51 - Fairfield Cty Airport, Winnsboro, SC- PFC (Dupree-MD)  
 PKV - 515 - Calhoun Cty Airport, Port Lavaca, TX- PFC 14d (Holbrook-MD)  
 KID774 - 1610kHz - Travelers Info Service, Gettysburg National Military Park, PA  
 Ltr 38d (Holbrook-MD)

\* Mailing Addresses: via Rick Eddie - Commerical Aeronautical Aeradio stations

KSF7Ø Oakland Flight Service Station  
 PO Box 2368 Airport Station  
 Oakland, CA 94614

KIS7Ø Anchorage Flight Service Station/IFSS  
 2016 East 5th Avenue  
 Anchorage, AK 99501

KVM7Ø Honolulu Flight Service Station  
 HIA Building, Room 824  
 Honolulu, HI 96819

WSY7Ø New York Flight Service Station/IFSS  
 5 Airway Road  
 Long Island MacArthur Airport  
 Ronkonkoma, NY 11779

(Sydney)

VLS Supervisor - Flight Service  
 Department of Transport  
 Box 211, P.O. Mascot N.S.W.  
 AUSTRALIA 2020

EIP Shannon Aeradio  
 Ballygirreln  
 Newmarket-on-Fergus  
 County Clare, IRELAND

\* Mailing Addresses: via Mark Chinsky

Marine Radio Station WMH  
 Dundalk Marine Terminal  
 2700 Broening Highway  
 Baltimore, MD 21222

Ops Chief  
 U.S. Naval Communications Station  
 United Kingdom - GXH  
 FPO New York, NY 09516

RF Engineering - WMS5  
 Crumman Aerospace Corporation  
 Bethpage, NY 11714

Officer in Charge  
 Naval Radio Station Grynnedal - OVC  
 Grynnedal 3930, GREENLAND

(Andersen AFB Guam)  
 NCOIC, Aero-SAC SSB Station  
 27th Comm Sq/DONJA  
 APO San Francisco, CA 96334

(Albrook AFB Panama)  
 NCOIC, Aeronautical Station  
 1978 Comm Gp/DONVA  
 APO Miami, FL 34001

\* Additional addresses for Available Ute Publications (on next page)

\* HANDLER ENTERPRISES INC  
 PO Box 48  
 Deerfield, IL 60015

GROVE ENTERPRISES INC  
 Route 1, Box 156U  
 Brasstown, NC 28902

CRB Research  
 PO Box 56  
 Commack, NY 11725



AVAILABLE UTE PUBLICATIONS....

My thanks to those who sent in their comments & opinions. Frankly it was a disappointing showing, for only 10% of the entire ute fraternity bothered to respond. As such, we'll go with what we have..... Many of the below can be purchased from Gilfer Associates. Since prices can change, write them & ask for their latest catalog. Address: GILFER ASSOCIATES INC, PO BOX 239, PARK RIDGE, NJ 07656.

\* CONFIDENTIAL FREQUENCY LIST\* by O.P. Ferrell.... A must item to have! Lists, by freq from 4 to 26 MHz, all stations being heard, operating in the utility bands. Typical line shows: Freq- Xmsn Mode-Call Letters- Sta ID/QTH- Service Type- Output Power & Remarks. Covers all xmsn modes, except for RTTY. NO mailing address data, no numbers, nor specific vessel IDs. The CFL is an excellent basic reference guide, for both the novice ute & the old hand. 6 by 9 inch size - was \$6.95 plus shipping. (order via Gilfer)

\* GUIDE TO RTTY FREQUENCIES\* by O.P. Ferrell... Companion book to the CFL. Same format, but covers ONLY RTTY. Has a good introduction to the basics of RTTY, & a list of commercial/military Z codes. 6 by 9 inch size - was \$8.95 plus shipping. (order via Gilfer)

\* FEDERAL FREQUENCY DIRECTORY\* by R. Grove (Grove Enterprises)... This is ONLY for the avid U.S. Military/Gov't tactical comms buff. A Comprehensive by frequency listing of all NON-classified US government agency stations, worldwide. Lists from 2 to 420 MHz. Approximately one third of the book is devoted to HF, the remainder is VHF/UHF. Typical line shows: Freq- Agency Abbreviation- State/Country- City/Area. If you are a MILTAC buff who knows the ins & outs of these comms, then this book will become a goldmine of info. 8½ by 11 size - was \$15.00 (can be ordered via Gilfer, or from Grove Ent. direct)

\* RADIO COMMUNICATIONS GUIDE\* by S. Handler (Handler Enterprises)... A very good book to have due to its grab bag of data, covering military, governmental (US & foreign), commercial aero/marine, INTERPOL, USCG, etc. Some VHF/UHF material. Frequencies & IDs all grouped in individual sub sections. NO mailing address data. It has a 1979 copyright, & although some of the material is obsolete, it is still a very good buy. 8½ by 11 size - was 6.95 (order via Gilfer or Handler Enterprises)

\* THE BEACON GUIDE\* by Clements & Stryker... Recently published by LWCA (the Long Wave Club of America) This has to be the bible for long wave/medium wave beacon buffs. Lists over 5,500 beacons, by freq, in 2 major sections. North America - 191 to 1744 kHz, & Foreign - 190 to 1921 kHz. Format shows: Freq- Call Letters - WX/Format - State/Country-City/Airport QTH. 3rd section combines both into an alphabetical/numerical format, in a call letter/freq only setup. NO mailing addresses. LWCA will issue updates to the guide. 5½ by 8½ size.. Order from: LONG WAVE CLUB OF AMERICA, Box 33188, GRANADA HILLS, CA 91344.

\* AUSTRALIAN UTILITY RADIO HANDBOOK\* by the Australian Radio DX Club... For the Australian monitor addict! Presented in 3 sections: Aero, Marine & Fixed stations. Very well laid out, and comprehensive in scope. Full of freqs, call letters, QTHs & mailing addresses. Drawbacks: Many stas are low powered, and combined with operational times, makes most impossible to hear in North America. There is NO Aussie military data, and this tends to greatly diminish a well rounded presentation. Fortunatly other listed stations you can hear: aero, coastal, Antarctic, AORTS, etc. The Appendix group lists freqs & call letters, separate from the main sections. ARDX will issue updates, and the rumor is that these may contain some Australian military data.. An excellent book if you're into Australian comms, but not worth it for those only having a casual interest in this part of the world. 5½ by 8½ in size. Was \$11.00 & fortunatly is available via Gilfer Assoc.

\* THE TOP SECRET REGISTRY OF U.S. GOV'T RADIO FREQUENCIES\* by T. Kneitel/CRB Research.... Lists by freq: Freq & Agency. BIG drawback: material starts at 25 MHz (up to 470 MHz) It does have partial listings of some US gov't agency call letters/QTH, and for the QSL buff, many reproductions of old or unique QSL cards.... Since this utility column's coverage stops at 30 MHz, I cannot recommend this for the HF only monitor. But it appears to be ideal for the VHF/UHF scanner crowd... 8½ by 11 size - was 5.95 (Gilfer or CRB)

\* AIR SCAN & ENERGY SCAN\* Also from CRB Research.. ALL VHF/UHF

\* MERCHANT VESSELS OF THE UNITED STATES\* US Gov't Printing Office.. Lists call letters, name & owner of all US registered ships. First write & ask for the free publication, USCG PUBLICATIONS SB-263, Mailing Address: SUPERINTENDENT OF DOCUMENTS, US GOV'T PRINTING OFFICE, WASHINGTON, DC 20402

\* SPEEDX UTILITY GUIDE\* The original SUG is out of print. The revised edition is still in a limbo status. This was the bible for the general utility DX/QSLer. When the revised edition is finally printed, it will undoubtedly retain its top of the heap status. Watch this bulliten for upcoming information on it.

\* ITU PUBLICATIONS\* Very little data came in on these. LIST OF COAST STATIONS IV vol#1 Covers VLF, HF, VHF freqs of all registered maritime coastal stas worldwide. Shows freq-call letters-QTH etc. About \$39.00.... LIST OF CALL SIGNS VIIA - Alphabetical/numerical listing of all vessels with xmtrs registered with the ITU. Contains: call letters vessel name- type. Also a separate list of coast station ID numbers & selective call numbers. About \$20.00.. Available as special publications from Gilfer Assoc.

# QSL REPORTS

This month's editors: John Trautschold  
Larry Talbot

Editor: John Kapinos, 86 S. Quinsigamond Ave., Shrewsbury, MA  
01545

Deadline: 12th of the month.....

Well, howdy QSLers! Welcome to this month's abbreviated edition of the QSL Reports. We mentioned last month that Kap Kapinos was to retire from his position as editor of this column due to other more pressing duties. We are pleased to announce that Kap has cleared up those duties now (involving HAP) and that he has agreed to once again take over as editor of QSL Reports. So, please make sure you send your reports once again next month to Kap, address above, not to publishing HQ's! In any case, your friendly publishers are going to make an attempt at this column this month, I, your former GRAM editor (new IBM typer and all - gee, this thing is fun to type with, maybe I should take over some other column? hi!), and him, your former Station Skeds editor, now ME, Larry Talbot. We normally run this column about 7 pages, however this month it's only 4. I will handle the first half, Larry the other. So, without any further ado, lets get on with.....

## EUROPE

- AUSTRIA: ORF, 6155, f/d QSL card in 45 days air, no rp. Reported in SS and received their "Phantasmagorical Landscape" card! (Toia-ITALY)
- ANDORRA: Adventist World Radio, 6220, f/d letter in 27 days air for EE report. This is the QSL series III w/a close-up photo of snow on Pine Tree w/Bible verse. (Wampler-VA) f/d "Antennas" card in 60 days air, no rp (Dittrich-FL)
- ANDORRA: Radio Andorra, 6220, f/d QSL card in 35 days air for 2 IRC's. It was a "very nice couple in 'native dress' card", hmmm. (I wonder what the natives wear? - jt)(Maise-LA)
- CZECHOSLOVAKIA: R. Prague, 7345, f/d "St. Barbara's Church" card in 80 days air, no rp. Also rcvd sked and invite to join Monitor Club. (Alexander-NC) CA)
- FINLAND: R. Finland, freq(?), no data "Winter in Finland" card in 42 days air. (Van Beurden-  
FRANCE: RFI, 17850, f/d "Centre National d'Art et du Culture" card in 29 days air, also rcvd pennant. (Nelson-CA)
- GERMAN DEMOCRATIC REPUBLIC: RBI, 9730, f/d "Berlin, Capitol of the GDR-Series card #1" in 30 days air, no rp, usual reply in 30 days! (KRIST-??) RBI, 21500, f/d "25th Anniv." card in 34 days, no rp, along with pennant, calendar, and RBI Journal. (Dittrich-FL)
- GERMAN FEDERAL REPUBLIC: Deutsche Welle, 6085, no data QSL card (colorful display of DW in circles) in 40 days air, v/s unrecognizable, also sent book describing DW. (Alexander-NC)
- GREECE: Voice of Greece, 9655, (Athens), f/d "Santorini Island" card in 65 days air, no rp, for SS report. (Fernando-NY) f/d card in 65 days for EE rpt, by air, no rp. (Krist-??) Voice of America, 6015, f/d photo card in 12 days, surface, v/s Wayne Greene. (Wampler-VA) VOA, 15260, f/d card in 12 days surface, v/s Greene. (Nelson-CA)
- HUNGARY: R. Budapest, ???, no data "1980 SW Club card" in 25 days air, no rp, issued to the R. Budapest SW Club members only. (Krist-??)
- HOLLAND: R. Nederland, 11845, f/d "picture of painter Karel Appel" card in 30 days air for SS report. The painting was called "Three Personages". Xmtr site Lopik. (Povzrenic-Arentina)
- IRELAND: R. Dublin, 6315, f/d map card in 60 days air for 3 IRC's, also sent history sheet of station. (Sams-AR) f/d map cd in 36 days for 1 IRC, v/s Angela Meier. (Dittrich-FL)
- LUXEMBOURG: Radio Tele-Luxembourg, 6090, f/d QSL card in 30 days air, 2 IRC's, v/s "CLT". Picture on cd contained 2 SW antennas and lion on blue & white shield w/wings. (Singel-??)
- NORWAY: R. Norway, 21730, f/d "Winter in Norway" cd w/flag on front in 30 days air, no rp. (Dittrich-FL)
- POLAND: R. Polonia, 15120, f/d "Warsaw - Tazienki Park" card in 59 days air. (Nelson-CA)
- PORTUGAL: R. Portugal, 6185, f/d "Aquario Vasco da Gama" cd in 43 days surface, no rp. This is an acknowledgement cd toward membership in the DX Club. (O'Dell-AR) f/d "de Gama" cd in 56 days air. R. Portugal responds that several rpts w/in a 48 hr period are welcomed in a single letter-for freq. chasers! (Nelson-CA) f/d "de Gama" cd and diploma for membership in DX Club in 38 days air, no rp. (Van Beurden-CA) 6185, f/d "zoo" cd in 38 days air (Krist-??) 11925, f/d telephone cd in 88 days air for 1 IRC. Also rcvd sked. (Park-HI) f/d "Bear" cd in 31 days air. (Alexander-NC)
- ROMANIA: R. Bucharest, 9570, f/d "Islamic Moldoua Spa" cd in 20 days air, no rp. (Maise-LA) f/d "Ia Hisa del Euandabosgues" cd in 65 days for SS rpt, no rp. (Fernando-NY) f/d "Spa" cd in 329 days. (Reid-CA) 11940, f/d "Spa" cd in 152 days air, no rp. Also sent a calendar. (Coleman-MA)
- SPAIN: R. Exterior de Espana, 9630, f/d "Bison Wall Painting" cd in 65 days air for 1 IRC, also rcvd pennant. (Van Beurden-CA) f/d "Christ" cd in 65 days air, no rp. (Krist-??) f/d "hart" cd in 65 days air, plus pennant, v/s unreadable. (Nelson-CA) 11880, f/d "Christ" cd in 51 days air, also pennant, v/s unreadable. (Pettit-IA) f/d cd in 83 days air, also sent sked. (Alexander-NC)

Remember: A bad custom is like a good cake, better broken than kept!

SWEDEN: R. Sweden, 9695, f/d card in 32 days air. (Nelson-CA) f/d "Facts" cd in 50 days air, no rp. This is one of those 'listener fill-in' cds ala CBC. (Krist-??)

TURKEY: Voice of Turkey, 9725, f/d "Man in the Moon" cd in 47 days air, also pennant. (Nelson-CA)

USSR: R. Moscow, 9610, f/d "building" cd in 47 days air, no rp. Also rcvd a membership cd for the "Listeners History Club, whatever that is! (Krist-??) 12010, f/d logo/globe cd in 49 days air, no rp, also sked & misc. other junk sent. (Pettit-IA) 12050, (and others), assortment of cds for abt 20 rpts, w/a pennant, pin, & separate 2 books on Lennin & Brezhnev. (Reid-CA) What a haul! jt

VATICAN: Vatican Radio, 6015, f/d card (Antenas) in 30 days air for 1 IRC. (Dittrich-FL) f/d "Technical Center" cd in 31 days air. (Nelson-CA)

### AFRICA

ASCENSION IS: BBC, 11720, no data "Tower Bridge" cd in 65d air, no rp. It was confirmed as Ascension, and it was noted that Lesotho not in use. (Dittrich-FL) BBC, 15105, no data "Bridge" cd in 62d air, no rp. (Toia, ITALY)

CANARY IS: R. Exterior de Espana, f/d "Pantocrator from Barcelona Museum" cd in 60d air, EE/SS rpt form. oops (freq-15365) (Davidson-SC)

GABON: LV de la Renovation, Libreville, 4777, f/d fold-out cd (map of Gabon) in 3 months for EE/FF rpt, 1 IRC, v/s illegible. (O'Riordan-ID) f/d folder card in 104 days air for 2 IRC's. (Schlesinger-TX)

KENYA: Voice of Kenya, 4915, f/d aerogramme verie letter w/pic of bcsting house & tx in 49d air for 2 IRC's. (Huddleston-TX)

LIBYA: SPLAJBC, 17930, f/d "Tripoli in Color" cd in 90d air, no rp, also sked. (Moss-CA)

MALI: RNM, 5995, no data map of Africa cd in 40d air for 2 IRC's. They typed in entire sked on card but didn't fill in verification blanks! (Huddleston-TX)

SOUTH AFRICA: Radio 5, 3250, f/d "collage of S. African scenes" cd in 36d 2nd class mail for 1 IRC, v/s A Van Wyk. (Nelson-CA)

SABC, 4880, f/d "montage" cd in 31d air for 1 IRC, also SABC & R. RSA skeds. (Schlesinger-TX) R. RSA, f/d "Sunset & Silouette" cd in 40d air, FF rpt. (Povrzenic-Mitch Sams - Berryville Arkansas



Elijah being taken up to heaven. A painted ceiling by Winter Carl Hansson, 1777-1805, in an old farmhouse near Rättvik.

Among the strangest blossoms of Swedish popular art are the paintings made a hundred years ago by peasant painters in the province of Dalecarlia, in the heart of Sweden. Their motifs were mostly taken from the Old Testament, whose dramatic tales they pictured as happening in their own everyday surroundings. The naive art of the Dalecarlian painters flourished in a geographical isolation which has long since been broken down. Yet in the midst of the busy present the past lives on in Sweden - the country which sends you this greeting from Scandinavia through **RADIO SWEDEN**.

Thanks to: George Gucinski-WA

August 15, 1980

### VOICE OF REVOLUTIONARY ETHIOPIA



Dear Mr. Sams:  
Your reception report dated: March 9, 1980 has been examined. This QSL card confirms that you were listening to **VOICE OF REVOLUTIONARY ETHIOPIA** on: March 9, 1980

from: 1505-1535 GMT on the frequency of: 9560 KHz.

We thank you for showing an interest in our broadcasts.

AUDIENCE RELATIONS OFFICE

*Lydia Yellotta*  
Asst. A. R. O.

### SOUTHWEST AFRICA/NAMIBIA:

R. South West Africa, 7190, f/d "Mountain Fire" cd in 60d air, 1 IRC, v/s C. Hepp. (Dittrich-FL) 3270, f/d photo of city (Windhoek) at night cd in 48d air for 2 IRC's, v/s J. Hepp. (Sams-AR)

SWAZILAND: TWR, 6070, f/d cd antenna farm (map info on back) in 33d air for 25¢ in mint stamps, plus skeds and booklet on TWR. (Park-HI)

Well QSL gang, that's about it for this half of the QSL Reports column. Remember to send your loggings next month to John Kapinos once again. And now, heerree's Larry.....

"A bad bush is better than the open field...."

## ASIA

- CHINA: Radio Peking, 17680. "Store Grain Everywhere" card plus pocket calendars, maps & pins in 28 & 38 days air for no rp. (Alexander-NC & Krist-VA). Card & letter plus calendars in 35 days for no RP by Kramer-VA) All reports were EE.
- CYPRUS: 9585 Cyprus Broadcasting Corp. f/d statue with Island card in 42 days air for 1 IRC & EE report. (Nelson-CA)
- INDONESIA: VOI, 15200, no data card showing only name & "English", picture of wooden puppet performance, #8000347 for mint stamps & ee rpt. 105 days air, using 175 rupiahs postage. (Park-HI)
- ISRAEL: KOL, 7412, f/d card signed in Hebrew, pictures of Jewish workers in Tel-Aviv, 71d air for EE rpt. Also sent skeds. (Alexander-NC)
- JAPAN: R. Japan (NHK) date & freq cards "Emperor & Empress dolls" and skeds for no rp EE reports on 9505, 15270, 17725. Avg 30d air. (Alexander-NC, Reid-CA, Cuppy-IN). Mt. Fuji cards showing date & freq for no rp EE rpts on 17755 in 57 & 70d air. (Jones-VA, Windsor) Full data card, "noh mask of woman" in 57d air for no rp II rpt on 21610. (Toia-Italy).
- JORDAN: R. Jordan 9560, f/d letters in 28 & 31 days air, one for 2IRCs & one for no rp. (Sorry Clarence, looks like you blew 2 IRCs. hi,lt) Both EE rpts. & both v/s "un-readable" (Schlesinger-TX, Maise-LA)
- PAKISTAN: R. Pakistan, 17910, time & freq card, "A view of Bandshahi Mosque, Lahore)v/s Controller, plans & research. 126d air for no rp EE rpt. (Moss-CA)
- PHILIPPINES: FEBC, 17810, f/d green "sun & hut" card, v/s Jeannette Springer. 32d air for 1 IRC & EE rpt. (Nelson-CA).
- SRI LANKA: SLBC/AWR, 15120. f/d card # 10848 with history of Radio Monitors International DX pgm, v/s Adrian Peterson. 60d air for no rp EE rpt (Povrzenic-Argentina)
- TAIWAN: VOFC, 15270, f/d card "Ming Dynasty vase" v/s Rudy Soone. 103d sfc for 1 IRC EE rpt. Also received newspapers, periodicals & '81 address book. (Tate-WV) f/d "Butterfly" card 30d air for no rp EE rpt Also received newspapers, stamps. (Van Beurden-CA)
- UNITED ARAB EMIRATES: RCTV-Dubai, 17775, f/d map & logo card, 2½ months air EE report, no return postage. (Sams-AR)
- VIETNAM, D.P.R.: VoV, (you forgot the freq Hugh, hi,lt) f/d letter in 6 mo for EE rpt no rp. Also skeds & post cards. (O'Riordan-ID).
- YEMEN: R. San'a, 9780, fd letter 11½ mo air, 2 IRCs. (Jones-VA).

## OCEANIA

- GUAM: KTWR, 11840 & 17770, f/d green & white map cards, v/s G. Lors, 28 & 38 days, both air for EE rpt & ms. (Wampler-VA, Nelson-CA)
- NEW ZEALAND: RNZ, 6105, 15345, 15485, 17860. f/d cards, personal letters, pennants etc from Tony King. Cards are sheep or cows grazing. 21-42 days for ms or IRCs. (Park-HI, Reid-CA, Picarelli-CA)
- PAPUA NEW GUINEA: R. North Solomons, Kieta, 332255 f/d map card & letter in 54d air for 1 IRC & EE rpt. v/s Sam Sawa. (Nelson-CA). R. East New Britain, 3385, Rabaul, f/d usual card signed by Pearson Vetuna, 88d sfc for 1 IRC & ms, EE rpt. sent back his letter. (Moss)

## SOUTH AMERICA

- ARGENTINA: R. Splendid, 5985, f/d logo card, 83days air, for Spanish rpt & mint stamps. Also sent personal letter & microphone pennant. (Dittrich-FL) R. Belgrano, 6090, Buenos Aires, f/d "Plazo de los dos Congresos" card in 45d air for 1 IRC & SS rpt. v/s Felix A. Argota Salinas. (Nelson-CA)
- BRAZIL: Radio Brasil Central, 4985, f/d letter in PP/EE requesting post card from Randy's QTH. 53 days for EE rpt & 1 IRC. (Moss-CA). Radiobras, 17830, f/d xeroxed card in 50 days, air, for EE rpt,

CHILE: La Voz de Chile, 11890, f/d "sunrise scene" card, 435 days (5th try in 3 yrs) for EE rpt & 1 IRC. (peters-KY).

ECUADOR: HGJB, Quito, 6095, 9745, 11915, 15355, 17790. All f/d cards received in 20 to 30 days air, signed by Thomas D. Fulghum, 50th Anniversary cards showing missionaries arriving Ecuador 1930. Also some architecture cards. Some skeds, stickers, pennants etc. (Alexander-NC, Bonilla-IL, Nelson-CA).

VENEZUELA: Ecos del Torbes, 4980, San Cristobal, date & freq letter in 62 days, signed by Gonzalez Lovera. Also a pennant for SS report & 1 IRC. (Nelson-CA).

#### NORTH AMERICA & CARIBBEAN

BELIZE: R. Belize, 3285, no data letter from Ernesto Vasquez in 18 days air for 2 IRCs. Rept was in EE. (Van Beurden)-CA).

CANADA: CFRX, Toronto, 6070, date & freq card "CFRB boat & Toronto skyline" signed by L. Huber/C. Eastwood in 15 days sfc & some bumper stickers for EE report & no rp. (Cuppy-IN)  
CFVP, Calgary, 6030, f/d card & letter in 10 days. "View of Calgary" card signed by Charlene Brisson for EE report. (Nelson-CA).

CUBA: Radió Habana, 11930, an EE report brought a f/d card "Motel Colony, Pinos Island" signed by Maria Montero Triana in 153 days, air. Also enclosed was a humorous revolutionary letter, a Fidel calendar & a sked. (Moss-CA).

GUATEMALA: R. Cultural, TGNA, 3300, date & freq card w/stamps, post card of Miss Guatemala & religious material in 4½ months (Reid-CA)  
Parrot w/microphone card, date & freq only, in 183 days for IRC & EE report. (Nelson-CA)

MEXICO: Radio Universidad, San Luis Potosi, 6045, registered letter in 16 days signed by Francisco Camocho Fernandez plus copy of monthly bulletin for SS report & mint stamps. (Schlasinger-TX)  
Radio Mexico, XERMX, 15430, f/d white card w/sked in 45d, air, for EE report & no rp. (Evans-TN)

NETHERLANDS ANTILLES: Trans World Radio, 9755 & 11815, f/d card "TWR bldg at night" in 30 days air, v/s Mrs. Billie Will, EE reports. Also sent misc info & skeds. (Nelson-CA, Alexander-NC).  
Radio Nederland Bonaire relay, 6165, f/d art card in 67 days, for EE report, no rp. (Dittrich-FL).

U.S.A.: AFRTS, 11790, (Amelio lists Arlington as tx. I know I havn't paid much attn to VOA lately, but this is a new one on me. Does anyone know if there is a xmtr there or is this possibly just where the card was mailed from? lt.) Anyhow, Amelio got a f/d "Department of Defense emblem" card in 70 days air for no rp, EE report. (Toia-Italy).

KGEL, San Francisco, 15280, f/d cards in 41 & 59 days "scenes of san Francisco" also pennants for 15¢ mint stamps & EE reports. (Dittrich-FL, Moss-CA).

WYFR, 5985 & 17845, f/d cards in 23 & 36 days. Both were WYFR/globe cards received surface for EE reports. (Nelson-CA)

No pirate QSLs this month. Guess the FCC has been successful in their crack-down.

Well, thats it for this month. I received a large envelope full of reports from Kap, but it was too late to sort & get in for this month. We will try to get them all in next month.

Remember, a QSL isn't full data unless it contains date, time & frequency. Try to use our standard report forms, & you can cut them for us & it will sure save a lot of time. Thanks to all the reporters. Larry & John. 73s.

*Larry*



**Radio**  
 LA VOZ DE MACUMA  
**HCGM**  
 4.870 MHZ. 60 METROS ONDA CORTA  
**Rio Amazonas**

**QSL  
 SHOWCASE**

*October 4, 1973  
 William S Sparks*

Thanks to: Bill Sparks, John Mosman,  
 Dave Clarke, and Bill  
 Cleveland



**RADIO JAPAN**

JUAN PABLO MORI



TARAPOTO - PERU - 18-06

Sr. DAVE CLARKE- Oshawa, Onta  
 Acuso recibo su Carta del 7-  
 por demorar la respuesta.-  
 Gracias por su buena carta,  
 Radio Tropical de Tarapoto e  
 mes son correctos; Ud. nos si  
 las 11 de la noche, a esa ho  
 Gracias por los Sellos de co  
 como por su mini banderín.-  
 mos algunos sellos Peruanos  
 Emisora esperando sean de su  
 Esperando venga Ud. al Ferú d  
 ravillas que ver, me es muy

*Juan Pablo Mori*

JUAN PABLO MORI  
 GERENTE - PROPIETARIO

TRANSMITIENDO GRATAS NUEVAS ALEGRES  
 Telling the Good News Abroad

From  
 GUATEMALA  
 "Beautiful land  
 of the Quetzal"

Frequencies:  
 730 khz  
 5,955 khz  
 9,505 khz  
 100,8 mhz

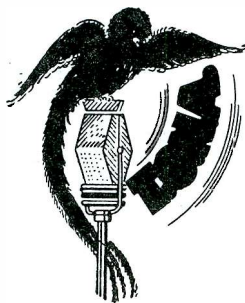

Facts:

The Quetzal is the national emblem of Guatemala. This bird seldom survives in captivity, hence, symbol of liberty.

"If the Son (Christ) therefore shall make you free, ye shall be free indeed".

John 8:36.



Asia

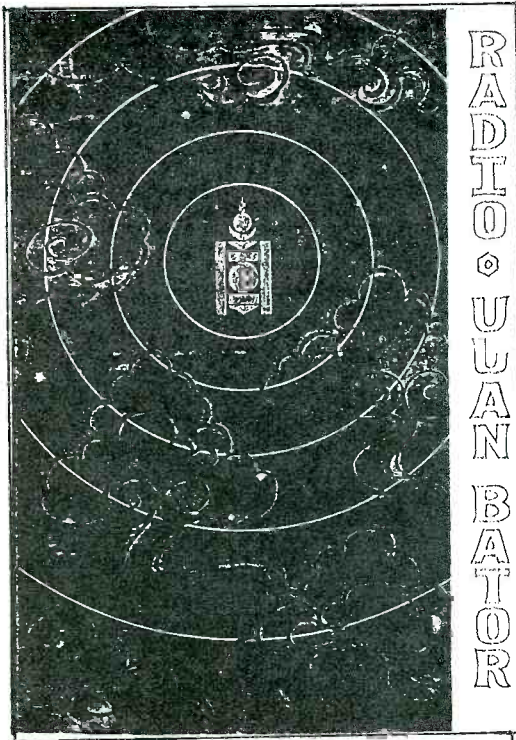

R  
A  
D  
I  
O  
◊  
U  
L  
A  
B  
A  
T  
O  
R



RADIO BANGLADESH

Q S L

This confirms your communication and reception of Radio Bangladesh Short Wave Station listened to on..16.2.77.. from..12.45...hrs. to..12.59...hrs. GMT on frequency..15,270..kHz.

Remarks.....

*M. Rahman*  
 (07) 277  
 Research Engineer,  
 Radio Bangladesh.

# Tips and Topics

The Feature Section of SPEEDX

EDITOR: ARTHUR S. GETZEL - 170-40 Highland Ave., Jamaica, NY 11432

## YAESU FRG-7700 - A USERS REPORT

by Ralph Sanserino

FREQUENCY RANGE: 150 kHz - 29,999 Mhz in 30 bands

MODES: AM, SSB, CW, FM (10 meter Ham band)

SENSITIVITY: OK

SELECTIVITY: Not too good

STABILITY: OK

DIGITAL READOUT: Nice

TIME DISPLAY/TIMER: Useful

AGC fast/SLOW: Works

NOISE BLANKER: Works on pulse type noise

MEMORY UNIT: This is the most useful thing about the FRG-7000. You can program 12 frequencies into the memory unit for instant recall. Very easy to use. Just tune to the frequency you wish to store and push the memory button. Say you store WWV in position #1 and you are tuning around down in LW or MW and you wish to hear the propagation forecast from WWV, just place the switch in position #1 and push the memory recall. There you are, right on WWV.

COMMENTS: Some things that are not too good.

1. The S-meter is very hard to read with the thin white needle and black background. It should be the other way with a white background and a black needle.
2. ATT (RF Gain) has only about 25% adjustment, not enough.
3. ATT switch on back of set should be an antenna switch. This switch serves no useful purpose as you have a gain control on the front panel.
4. This is probably the biggest drawback, selectivity. The wide position is way too wide @12 kHz. There is enough room @12 kHz to listen to stations 10 or 15 kHz away from the tuned frequency. The medium position is also too wide @6 kHz. You can listen to stations 5 or 10 kHz away from the tuned frequency. The narrow position is OK @2.7 kHz, but has a deep skirt selectivity problem @50 db down you still get adjacent frequency interference from strong stations 5 kHz away.

We now come to the SSB and CW modes and a 2.7 kHz bandwidth which is not adequate at all for this type of reception. SSB reception would be better with a bandwidth of 1.9 kHz and a CW @.5 or 1.0 kHz, which would do the job nicely.

I'm trying to figure out why receiver makers spend 100's of hours and 100's of dollars to design and debug a receiver and spend 35 cents for filters, and they don't give you the option to select the filter or filters you want for your application. These same receiver makers build fine Ham transceivers and they should be able to build the same type of communications receiver. They give you the option to buy a \$150 memory unit, why not give the same buyer the option to buy a \$40-50 filter for better selectivity? A receiver not being useful has probably driven as many people from the dials as anything else.

The FRG-7700 will no doubt be modified by Radio West and Gilfer. It's a good thing the receiver maker left you this option.

Maybe I should explain what a useful receiver is. A useful receiver is one that has one or two antenna connections on the back and, after you hookup one antenna you can tune 150 kHz through 30 MHz without changing antennas or antenna connections. You tune in a Ham band and switch to SSB and then tune in a Ham with a minimum of sideband interference. You tune in a SW band and switch to AM broad (6 kHz) and then tune in a SW station. Finding AM broad too wide, you switch to medium (4kHz). Finding this one still a little too wide, you switch to the optional filter you had installed in the sharp position and find the 2.5 kHz bandwidth does the job. A useful receiver has good audio quality with most of the lows cutoff. It also has controls that are easy to operate. An RF gain control that works over most of its range. AGC fast, slow and off switch. Phone jack on front panel. Record jack on back panel.

These next items are optional. A tone control. A noise blanker. A fine tune (only needed if receiver is not stable or main tuning is too fast). A clock/timer (24 hour

format). Memory unit. As we all know, the extras up the price of the receiver. If we can get a receiver that listens well then we can probably do without the extras.

You will have to excuse me for getting side tracked off the FRG-7700 but this information is going to a couple of receiver makers and, I wanted to tell it like it is.

Back to the FRG-7700. After a couple of modifications this can become a very useful receiver. The filters have to be changed if they are to be useful. That's for Radio West and Gilfer. Yaesu has the base here for a very nice receiver.

This review is only one users opinion and some will agree, others may not. Have receivers really progressed that much in the last 25 years? They got rid of the hot tubes, cabinets are smaller, we can tune to a frequency easier, but one of the most important things is that we cannot hear better.

With the 250-500 KW SW stations and the 50 KW AM stations, we need good selectivity more than ever. We know we are not going to get weaker stations.

=====

## NEW EQUIPMENT FOR THE FRG-7700

by Armand Di Filippo

Yaesu Musen Co., Ltd will introduce this month two companion accessories for the FRG-7700 receiver: The FRV-7700 crystal converter series available in four models covering a wide range of bands including marine, land mobile and aircraft; also, the model FF-5 low-pass filter designed to prevent cross modulation and intermodulation caused by strong signals above 500 kHz.

By May 1981 the new FRT-7700 antenna tuner covering a frequency range from 150 kHz to 30 MHz will be available to the world market. Yaesu promises it will greatly improve reception by rejecting unwanted signals and reducing the effects of intermodulation and cross-modulation.

Below you will find a detailed outline of these new products which could be of great interest to those club members who now own the FRG-7700 or who will make a purchase in the future.

FRV-7700 ANTENNA TUNER: The FRT-7700 is an ultra-compact antenna tuner for the FRG-7700 receiver. Designed for operation from 150 kHz to 30 MHz, the FRT-7700 will provide the proper impedance for the receiver, thus rejecting unwanted signals. A built-in attenuator, 60 dB maximum, prevents intermodulation and cross-modulation from occurring when strong signals are being carried to your receiver. Also, a two-section lowpass filter aids in the rejection of interference from strong signals above 2 MHz, when you are listening to bands in the 150 kHz to 500 kHz range.

### INSTALLATION PROCEDURE:

1. Connect the gray coaxial cable coming from the rear apron of the FRT-7700 to the SW/BC terminal on the rear apron of the FRG-7700. Connect the red coaxial cable to the BC terminal. Both outer cables of the coaxial cable should be connected to terminal E.
2. Your antenna should be connected to the ANT B terminal for normal operation. This terminal accepts incoming signals from 150 kHz to 30 MHz. However, the ANT B terminal is best utilized when you are interested in receiving weak signals in the range of 150 kHz to 500 kHz.

The coaxial receptacle (SO-239) is connected parallel to the ANT B terminal in the FRT-7700. If your antenna feeder has a coax jack, it should be connected to the coaxial receptacle.

### OPERATION:

1. Set your FRG-7700 for normal operation on the frequency you desire.
2. Preset the controls and switches as follows:

TUNER	---	OFF
ATT	---	0 (dB)
BAND	---	Desired band
MATCHING	---	3

3. Tune the FRG-7700 to your desired signal.
4. Push the TUNER switch on, and adjust the TUNING control for maximum deflection on the S-meter.
5. Change the position of the MATCHING selector to the point where the S-meter reaches maximum deflection.



6. Repeat the adjustments in Steps 4 and 5 until a maximum S-meter reading is obtained. In some cases, the best sensitivity is obtained at either one coverage above or below the specified coverage of the BAND switch, a trick you might try when you are unable to obtain sufficient sensitivity.
7. When your receiving station receives interference from strong signals, try reducing all incoming signals by adjusting the ATT control, till you find a position where you can receive the signals clearly.
8. When weak signal reception below 2 MHz is desired, push the OUT switch to DXBC, and the weak signals will be clearly received.

#### FF-5 LF FILTER

The FF-5 LF Filter can reject signals above 500 kHz, thus preventing cross-modulation caused by strong broadcasting stations above 500 kHz. The installation of this filter onto your FRG-7700 can be done using the mounting bracket supplied.

#### INSTALLATION PROCEDURE:

When connecting the FF-5 to your FRG-7700, proceed using the following installation procedure.

1. Remove the two feet mounted on the connector side of the FF-5.
2. Referring to Figure 1, fix the supplied mounting angle to the FF-5 with the screw removed in Step 1.

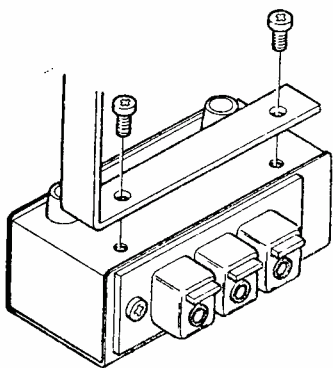

FIG-1

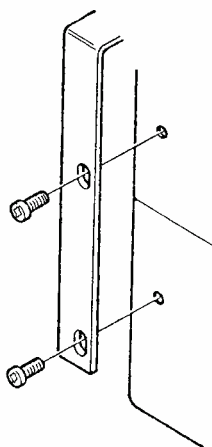

FIG-2

3. Remove the two screws on the left, rear side of the cabinet, and secure the mounting angle of the FF-5 in place, as shown in Figure 2.
4. Connect the gray coaxial cable from the FF-5 to the SW/BC terminal on the rear panel of the FRG-7700.
5. Connect the red coaxial cable to the BC terminal of the rear panel of the FRG-7700.
6. Connect both outer cables of the gray and red coaxial cables to Terminal E of the FRG-7700.

#### CONNECTIONS:

BC Terminal: This terminal can be used to receive weak signals below 2 MHz. However, when receiving local stations, your antenna should be connected to the SW/BC terminal.

SW/BC Terminal: This connector will accept the connection of both antennas to receive above and below 2 MHz. Normally, an antenna is connected to this terminal.

#### OPERATION OF THE SWITCH:

##### SW/BC Position

When you receive signals above 2 MHz, or rather strong signals below 2 MHz, the switch should be placed in this position. While set in this position, your antenna should be connected to the SW/BC terminal.

##### BC Position:

Set the switch to the BC position when receiving weak signals below 2 MHz. If the signal is receiving interference from strong stations in the way of strong unwanted signals, turn the ATT switch on the rear panel of the FRG-7700 to help reduce the interference.

While the switch is in the BC position, your antenna connection should be made to the BC terminal.



## 150 - 500 kHz Position:

When you receive weak signals in the range of 150 - 500 kHz, set the switch to this position and connect your antenna to the BC terminal. Signals which may cause interference in this range will be rejected to a sufficient degree.

## FRV-7700 VHF CONVERTER

The FRV-7700 is designed for use with the FRG-7700 general coverage communications receiver, which is able to convert three 10 MHz coverages on the VHF band to 20 MHz and 30 MHz.

The dynamic range has been improved by a dual-gate MOS FET RF amplifier and mixer. The AGC circuit in the FRV-7700 is controlled by the AGC voltage from the FRG-7700. Also, a manual control attenuator will improve the reception of strong stations.

## AVAILABLE MODELS:

Model A: 118 - 130 MHz, 130 - 140 MHz, 140 - 150 MHz  
Model B: 118 - 140 MHz, 140 - 150 MHz, 50 - 60 MHz  
Model C: 140 - 150 MHz, 150 - 160 MHz, 160 - 170 MHz  
Model D: 118 - 130 MHz, 140 - 150 MHz 70 - 80 MHz

## SPECIFICATIONS:

Sensitivity: AM (H): 2 uV/50 ohms; AM (H): 1.5uV/50 ohms  
SSB/CW: 1.5uV/50 ohms; FM: 0.5uV/50 ohms  
Weight: Approximately 800 g.  
Case size: 35 (H) x 167 (W) x 170 (D) mm.

# TUNING IN MARS

by Ronald A. Weiss

No, I'm not suggesting that DXers tune in on interplanetary transmissions, but rather the Military Affiliated Radio System (MARS). On a daily basis, licensed radio amateurs can be heard volunteering their time and radio equipment to relay messages in CW, RTTY, and SSB to and from military personnel stationed overseas and their families and friends at home.

The system, originally known as the Military Amateur Radio System, was established on November 26, 1948, on the authority of the Secretaries of the Army and Air Force. The primary concept of MARS is to meet the requirements of training for any communication emergency. There are presently three MARS services, Air Force, Army, and Navy. Call signs heard will identify the service being monitored. Typically, Navy stations use the prefix NNNØ, Army uses the prefix AAR, and Air Force, AFA.

Messages fall into one of four categories, Flash (most urgent), Immediate, Priority, and Routing. With Navy MARS, messages originating overseas from such places as Japan, Philippines, Guam, Okinawa, Diego Garcia (Indian Ocean), Antarctica, and Iceland are transmitted to major relay stations such as NAV on the east coast, and NOK on the west coast. From these stations, traffic is passed through District and Area Nets to State traffic nets. Messages are then sent to individual MARS stations within the state closest to the final destination. The receiving station then telephones the message to the recipient. Outbound messages follow the same route but in reverse. Most messages reach their destination within 24 to 48 hours of their time of origin.

Specialty nets can also be heard for such activities as training new MARS members, simulated emergency exercises, handling phone patches from ships at sea, and for service to remote outposts such as Antarctica.

Tune into MARS. Perhaps you can locate a MARS member near you who can help you learn more about the system, and maybe even send a message for you to a friend in the military service. Perhaps you will be fortunate enough to hear NNNØICE, an appropriate call sign for McMurdo Station in Antarctica. Busy frequencies include 4.0 to 4.5 MHz, 7.3 to 7.5 MHz, and 14.35 to 14.5 MHz. Other frequencies further removed from the amateur bands can also be located.

Additional information of the MARS programs can be obtained by writing to Chief, Army MARS; Attn: CP-OPS-OM; Fort Huachuca, AZ 85613; Chief, Air Force MARS; Hq., AFCS/DOYR. Scott Air Force Base, IL 62225; and Chief, Navy-Marine Corps MARS; Building 13, US Naval Communication Unit, Washington DC 20390.

This is your club, so please contribute to all editors. Only you can make it happen!!!!

# DX-302: USERS COMMENTS

by John P.P. Cereghin

I have already written a short article (SPEEDX 2/81) that described the DX-302 in general. Since Christmas, I have been giving my DX-302 from Radio Shack a rugged and merciless try-out. After almost two full months of use, I must say that I'm very satisfied with my new rig.

For all you technical brains out there, here are the specs on the DX-302. Included are the specs for the DX-300, its daddy, for comparison.

	<u>DX-300</u>	<u>DX-302</u>
FREQUENCY COVERAGE	10 kHz - 30 MHz	100 kHz/ 2.5 uV-5 uV
SENSITIVITY (for 10 dB S/N ratio)	All 100 kHz; 20 uV	300 kHz; 2 uV
	300 kHz; 2 uV	900 kHz; 1 uV
	900 kHz; 1 uV	3.1-30 kHz; .5 uV
	3.1-30 MHz; .5 uV	10 kHz-30 MHz
	SSB 100 kHz; 10 uV	50 kHz; 15 uV
	300 kHz 1 uV	300 kHz 1 uV
	900 kHz; .5 uV	900 kHz; .5 uV
	3.1-30 MHz; .3uV	3.1-30 MHz; .3uV
IMAGE RATIO	100-900 kHz/80 dB	100-900 kHz /70 dB
	3.1+ MHz/70 dB	3.1+ MHz/60 dB
SELECTIVITY	plus or minus 3 kHz/ -6 dB	(-6 dB) WIDE 3.5 kHz (-6 dB) NARROW 2.5 kHz
	plus or minus 10 kHz/ -70 dB	(-60 dB) WIDE 6 kHz (-30 dB) NARROW 4 kHz
REQUENCY STABILITY	PLUS OR MINUS 1 kHz/ hour after 60 min.	same
	PLUS OR MINUS 2 kHz/ 10 min. after on	

As you can see, there isn't a whole lot of difference between the two.

For my DXing, I have my radio hooked up to a pair of longwires, 50 and 60 feet long, one running north/south, the other running east/west. Also hooked up to this is my old and trusty DX-160. Ever since I got the DX-302, I've just about ignored my DX-160, but I know better now, because the DX-302 does have a few shortcomings.

I like to snoop around 90 meters a lot, but I have a hard time on the DX-302 because of an image problem. Everyone knows time station CHU on 3330 kHz. Well, I can pick up the strong signals of CHU not only on 3330 kHz, but on 3370, 3350, 3300, 3275 kHz, etc. Radio Canada may show up on 3370 kHz from time to time. These signals can interfere, if not block out stations you want to hear. To use the attenuator, you need a coax cable, if you want to get rid of those signals.

Longwave reception is very disappointing indeed. To DX longwave, I must use my DX-160, which performs well on longwave. On longwave, the DX-302 reaches down to 10 kHz, but you can tune to 0 kHz. However, the radio becomes inoperative then. Besides, what's on below 10 kHz? There is a longwave weather station in Washington DC, about 95 miles away from my northeastern Maryland QTH, which can be heard every now and then on my DX-160, but I have yet to pick it up on my DX-302. On the DX-160, I've logged about 35-40 longwave beacons, and weather stations from as far away as Boston, 600 miles to the northeast. But on the DX-302, I'd be lucky if I could log 4 or 5 beacons in a week! It's that bad. If you need a good longwave radio, forget the DX-302.

Do you want a good MW, shortwave, or utility radio? Then by all means, buy the DX-302! On mediumwave, this set is outstanding. I've been able to add such hard-to-hear countries to my log as Radio Paradise, St. Kitts on 825 kHz, Radio Cayman, Cayman Islands on 1555 kHz, as well as Cuba, Mexico, and Honduras, WWL in New Orleans has been logged here in Charlestown, and even WOAI, San Antonio, Texas, has been heard, but with difficulty. There is a station in Washington that can be heard in broad daylight, with 5 kw. Oh, if I only had a loop antenna. . .

Shortwave performance is pleasing. Except for an occasional image, it's hard to beat, especially with a sensitivity of .5uV. Several African countries (Mali, Chad, Namibia, Gabon's Africa 1) have been logged with average signals. A few 90 meter stations are heard, if you can dodge all those images. DXing on the International bands is easy indeed. The set rarely overloads, and selectivity is good most of the time. However, sometimes, a strong station can splatter 5 or so kilohertz from its frequency. Even when set in the "narrow" slot, it still happens, but it only happens with very strong signals,

and not all that often. Sometimes, I'll be listening to WYFR on 15215 kHz in the afternoon, and bingo! WYFR is all over 19 meters. But anyone will tell you that WYFR is earning a reputation for overloading and over-modulation. For us tropical band DXers, the DX-302 will put a smile on your face. It did mine when I heard my first station from Peru, as well as RSWA in Namibia.

Sideband reception is stable and good. So good, I was able to hear two "Hams" on USB from Scotland on 15 meters one day, as well as a "hiam" in Alaska on USB on 20 meters. For ute DXers, the DX-302 can hold a signal on sideband after the set warms up and settles down.

For any interested, the operator's manual is well written for the greenest DXer, to the oldest pro. It covers subjects like propagation, QSLing, band conditions, and all sorts of operating notes.

So, for \$399.95, the DX-302 is certainly one of the best buys around. While not a WRD-515, or a R-7, it can give any set something to worry about in active competition. I'm very happy with mine, and I'll keep it for a while.

\*\*\*\*\*  
\*\*\*\*SPECIAL DX REPORTS \*\*\*\* A SERIES \*\*\*\* BY THE GREAT ALOTTO CRAPPOLO \*\*\*\* DX \* EDITOR:  
ALOTTO CRAPPOLO \*\*\*\*\* Send all comments, ideas, queries, etc. to me c/o SLIDEX HQS

THE ALL-TIME LARGEST, GREATEST DX-SHORTWAVE LISTENERS CONTEST - FAIR-TO-ALL TOO!!!!!!!

Jak se mach! A little Polish there since Poland is in the news. 'Tis the season for DX Contests. As usual all the contests are rigged to favor the most experienced DXers. Sooooo, I have organized my own contest that is very fair to all participants both novice and semi-pro. Here it is, and let's see a lot of entries!

**WHEN:** From 01 May 1981 thru 02 May 1982. Loggings may only be made between 0500 and 2000 HRS. All monitors use local time if it corresponds with GMT; otherwise you must use UTC!

**WHO:** Entry in this contest is open to all persons who own a radio with SW bands on it. Any one who reads these reports, or who is between the ages of 10 and 99. Also we ask for entries from DXers who have yet to join this club.

**CONTEST FREQUENCIES:** Only loggings made on the following frequencies will be allowed: 525-550 kHz., 1601-1630 kHz., 15600-15900 kHz., 17000-17500 kHz., 9000-9499 kHz., and 6300-6800 kHz. Log only SWBC stations who have external services.

**POINT SYSTEM:** Please use the following scoring system for this contest:

ALL U.S. STATIONS GET ONLY 1 POINT

ALL EUROPEANS GET 10 points if logged between 1700-1830 GMT

ALL ANTARCTIC STATIONS ON 6029 kHz get 3 points if heard at all.

Falkland Islands get only 1 point as it is so easy to hear them now.

ALL SOUTH AMERICANS GET 22.7 points each-except Columbians who get 3.1428 points each.

Remember to be extremely accurate as this should be a very close contest.

**ENTRIES:** All entries MUST be submitted to me - Alotto Crappolo - on my official entry forms. Certified xeroxs or notorized photostats are also acceptable. Official entry forms may be obtained from me for \$75.00 each or 7,000,000,000 SLO-SLOVIAN DENAROS.

All entries on papers other than my official forms will be promptly deposited in the nearest anti-Pollution Office (APO). Yes, stupid, that means trash basket!

**PRIZES:** The overall winner, or winners in case of a tie, will receive a beautiful colour photo of me - ALOTTO CRAPPOLO - in a frame. All you losers will receive the complete works of Antonio Vivaldi recorded on 45 rpm records. These will be sent out at a rate of one per week over a period of 44 years.

\*\*\*\*\*  
**TIDBITS** CHANGE IN GDR ZIP CODE: Rudi Friedel of the North American Department of RDI reports that a recent change has been made in the zip code system for the GDR. All letters and reception reports addressed to Radio Berlin International should use the zip code 1160 instead of the old 116. (John Demmitt)

**VOICE OF HOPE:** The Voice of Hope is audible here, with 0400 s/on in English on 6215 kHz. We've been able to log it on portables as well as our other radios. The format follows the newspaper articles description. It sounds a lot like an American station's morning program. They also use the "call letters" W-O-R-D, and K-I-N-G, announcing their location as Valley of the Springs, Free Lebanon. (Russell Lay)

**MORNING BROADCASTS FOR RADIO BUDAPEST:** Radio Budapest is considering morning broadcasts to North America as well as some program changes. Let your voice be heard by letting Radio Budapest know your opinion. (John Demmitt)

**RADIO AUSTRALIA SCHEDULE:** Radio Australia now sends their program schedules via San Francisco, Calif. Gone are the unique aerogram stamps/flowers of Australia for a cold red meter stamp. (K. Krist)

1981 Arthur J. Hester

CONTRIBUTORS -- APRIL 1981

(compiled by Chris Hansen & the Wang)

Hello again. There were 175 contributors this month. Numbers preceding each name indicate how many columns were reported to. An "\*" signifies credits given for a previous month. Sections other than SWBC/QSL/UTE & SKEDS are credited directly by the Membership Chairman. All columns received this month except Africa; also includes March Africa.

4	ALEXANDER, Brian	PA	R4	6	HESCH, Ruth	NY	R-1000
1	ALEXANDER, R.	IA	?	1	HESS, R.	OH	?
5	ALEXANDER, Sam	NC	?	4	HODSDOON, T.	MN	FRG-7
1	AUCOIN, Claude	LA	?	1	HOLBROOK, H.	MD	?
1	AUDETTE, David	MA	DX-300	4	HOTALING, Stan	NV	RF-2800
4	BEEMAN, William	OH	?	1*	HOWARD, Ron	CA	SB-310
2	BELLARD, W.S.	OH	?	5	HUDDLESTON, Howard	TX	DR-7
5*	BERG, Jerry	MA	HQ-180	4	HUFFAKER, Carl	MEX	HOMEBREW
4	BLAIZE, Sandy	LA	EDDY. 830/7	4*	JOHNSON, Fred	IL	RF-2200
1	BONILLA, Charles	IL	?	1	JOHNSON, M.	ID	?
1*	BROCHU, Maurice	PQ	DX-300	3	JONES, David	VA	5-151-1A
1	BROWN, C	IL	?	1	JONES, Jack	MS	SPR-4
2*	BROWN, Nathan	WA	ICF5900W	1	KERRIGAN, Patrick	IL	?
1*	BROWN, Terry	NE	?	2	KETZIS, Mike	KS	R-1000
1	BUNILLA, Charles	IL	RF-2200	3*	KLASEK, Terry	MO	R-1000
2*	BURKE, Lynn	VA	SPR-4	2	KRAMER, Andrew	VA	RF-2900
2	BYRON, Leslie	NY	?	4	KRIST, Kraig	VA	?
4	CALVER, Steve	UK	R-1000	2	LANGLOIS, Harold H.	GA	NC-98
2	CARRIER, DAN	SAUDI ARABIA	?	4*	LAY, Russ	VA	DX-302
3*	CEREGHIN, John	MD	DX-302	1*	LAZARUS, Henry	LA	SX-190
1	CHABAK, Mike	AZ	?	3	LECUONA, Alberto	ARG	FRG-7000
1*	CHINAKOS, Michael	WA	DX-302	1	LEEMAN, Joe	RI	FRG-7
1	CHINSKY, M.	NY	?	1*	LEITE, Steve	MA	HQ-180A
1	CLARK, Guy	KS	?	1	LEVIN, Jay	NJ	?
1*	COHEN, Larry	PA	FR-4900	1	LEWALLYN, R.	GA	?
5	COLEMAN, Bob	MA	FRG-7	1	LOBDELL, Chris	MA	FRG-7000
2	COUTERMARSH, Jim	VT	?	2*	LUCAS, Richard	CA	R-1000
4	CUCURA, Vladimir	PA	FRG-7000	4	McCURDY, Tim	CA	FRG-7
3	CUNNINGHAM, Larry	OH	?	1*	MCLEAN, Scott	NY	DX-160
2	CUPPY, Brad	IN	RF-2600	6	McSKIMMING, Hugh	CA	FRG-7
1	CURNELL, M	OR	?	5	MAISE, Clarence	LA	FRG-7
8	D'ANGELO, Richard	PA	?	3	MAPPIN, J.R.	WA	?
9*	DAVIDSON, Kevin	SC	DX-300	4*	MARSHALL, Phil	GA	SX-73
1	DE KOYER, Richard	NJ	RF-4900	1	MASON, A.	CAN	?
6	DEMMITT, John	PA	HOMEBREW	8*	MILLER, Bill	CA	DX-300
1	DEVENDORF, C.	CA	?	1	MILLER, John	GA	?
4	DITTRICH, Walter	FL	FRG-7000	5	MONMAN, Don	AB	R-7
1	DUPREE, J.	MD	?	1	MORGAN, T.	NC	?
1*	EDDIE, Rich	MO	FRG-7	4	MOSS, Randy	CA	?
1	EMERSON, D.	TX	?	6*	MUNSTER, Ralf	GA	FRG-7
1	ERAMO, Mark	MA	?	1	NELSON, Donald	CA	FRG-7000
2	EVANS, James	TN	?	1	NESSLEIN, Kenneth	MO	?
4	FACCIOLI, Oan	URUGUAY 2C	?	1	NEWKIRK, David	WA	?
2*	FARMER, Bill	TN	R-1000	5	NEWTON, Andy	GA	?
2	FEMYER, Mike	AZ	?	1	NIDA, J.	MN	?
4*	FINDLATER, John	CA	FRG-7000	2	NIKOLICH, Mike	IL	HQ-180
5	FISHER, John	MA	?	2	O'DELL, David	AR	RF-2600
1	FITZGERALD, J.	RI	?	3	O'RIORDAN, Hugh	ID	SPR-4
3	FLANAGAN, Jack	MA	?	3	OAKLEY, Marjorie	OR	FRG-7
4	FORBES, Lew	TX	FRG-7	3	OLSON, James	CA	R-392
1	FRENCH, R.	MD	?	1	OSBORNE, Aaron	MI	?
2	FOURNIER, Ed	VA	?	4	PALMER, Bob	WA	?
1*	FUTCH, John	GA	DX-300	1	PARK, Dale	HI	?
3	GAVARAS, Tom	MN	?	4	PARKS, William	FL	?
2	GEORGE, Charles	TX	SSR-1	2	PECK, Martin	NY	ICF-6700
4	GONZALES, Fernando	NY	FRG-7	1	PETERS, David, Sr.	KY	?
1*	GREENWOOD, Maxfield	PA	FRG-7000	6	PETTIT, Lani	IA	?
4*	GRENIER, Pete	CA	FRG-7	4	PICKARD, Wilder	IL	R-7
1	GROSVENOR, Norman	CA	FRG-7	6	PICARELLI, Thomas	CA	FRG-7
2	GUCINSKI, G.	NY	RF-2800	1	POGUE, J.	GUAM	?
2	HACKNEY, Richard	TN	DX-302	2	POVRZENIC, Emilio	ARG	DR-28
1	HARDESTER, Mike	CA	?	4	PROOM, Stephen	UK	?
3	HARRIS, Kelly	WA	DX-302	1	RANKIN, R.	KS	?
1	HARTUNG, J.	MD	?	3	RAY, Richard	PA	DX-160
4	HAUSER, Glenn	TN	FRG-7	1*	RAYMOND, Bob	MA	FRG-7

2* RAYMOND, Greg	MA	FRG-7000	4* STONE, Wilfred	ON	FRG-7000
1 REID, Mike	CA	?	3 TACOMA, Scott	CA	?
2 ROBERTSON, Dave	WA	?	1 TAN, Lawrence	MALAYSIA	
1 ROCHOW, Joel	DC	?	5 TATE, Harold	WV	?
3 ROWAN, James	ON	DX-300	1 THOMPSON, C.	CAN	?
1 RUSSOW, H.	FRG	?	5* THOMPSON, Glenn	NM	FRG-7
10* SAMS, Mitch	AR	FRG-7	4 THOMPSON, Peggy	CA	FRG-7
3 SANCHEZ, Sam	CA	?	5 TOIA, Amelio	ITALY	GRUNDIG 2000
4 SANDERSON, John	AZ	R-1000	4 VALENTINE, Fred	CA	RF-4800
4 SCHLESINGER, Mark	TX	FRG-7	6 VAN BEURDEN, Ted	CA	?
2 SCHRAMMEL, George	WI	R-1000	4 VOLLRATH, Ruth	MO	SSR-1
4 SCHROEDER, Art	WI	DX-160	1* VRANES, Alex	PA	FRG-7
3 SEITNER, Allen J.	VA	?	1 WALTERS, J.	NJ	?
1* SEYMOUR, Woody	NC	SPR-4	6 WAMPLER, Michele	VA	?
3 SHEPHERD, Greg	IL	DX-300	1 WARD, Henry	PQ	?
1 SINGEL, Rick	IN	RF-2200	4 WESTBROOK, John	APO NY	?
5* SMITH, Tom	FL	XCR-30	1 WHITEHEAD, Jim	MA	?
3* SMITH, Traver	CA	NRD-505	1* WILFINGER, William	OH	SW-717
4* SNIDER, Paul	ON	DX-160	3 WIMMERS, B.	FL	?
3* SOMERS, Jack	CA	R-1000	5 WINDSOR, Alan	GA	?
1 STANBURY, C.M.	ON	?	1 WITTE, Marjorie	CA	FRG-7
1 STARK, Chris	NB	?	3 ZILMER, Bob	NM	?
1 STOCK, L.	CO	?			

See you next month. I'll be reading the For Sale ads below as avidly as you. 73's Chris

NO COLLECTS! <-> S E L L <-> S E E K <-> S W A P <-> NO COLLECTS!

WANTED: First issue of World Radio TV Handbook (WRTH) 1947. Will accept new, used or photo-copy. Willing to pay for purchase or copying. Adrian Peterson, Radio Monitors International, P. O. Box 15, Poona 411001 India.

WANTED: Scott collector needs a power supply-amplifier for a E.H. Scott Phantom De-Luxe receiver. Uses two 6L6G tubes in the last audio. 1938 receiver. J. R. Mappin, West 2924 Garland, Spokane WA 99205

FOR SALE: Realistic Patrolman-9. \$90.00. Near new, very sensitive. Manual and original carton. Frank Bals, 36041 Hillcrest Drive, Eastlake OH 44094.

WANTED: Nova-Tech Pilot II receiver. Sold in the 60's. It featured a DF loop and covered the LF broadcast & 1600-4000 kHz, plus 108-136 MHz. Paul Zecchino, Maxson Hill Road, Ashaway RI 02804. (401)377-2447.

FOR SALE: Banker & Williamson Model 593 coax antenna switch. 6 months old. Three antennas to one receiver. \$14.00, firm. FOR SALE: Leatherette QSL Album, 14" x 14". Each vinyl page holds 3 or 6 5" x 7" QSLs. 6 months old. \$10.00, firm. J. R. Miller, 206 Ridgewood Road, Baltimore MD 21210.

FOR SALE: Drake SPR-4 with matching MS-4 speaker. Autek QF-1 audio filter, extra crystals. 1975 model in excellent condition. Shipped in original carton. \$450.00. Robert Yajko, 123 Summit Street, #4, Leechburg PA 15656. Phone (412)842-8202 between 2100-0200 GMT.

FOR SALE: Yaesu FRG-7, Gilfer modified. Used 1 1/2 years in excellent condition. \$190.00. McKay Dymek DA-5 BCB ferrite rod antenna. One year old in A-1 shape. Cost \$185.00, sell for \$100.00. WRTH 1978 \$6.00. WRTH 1979 \$7.50. WRTH 1980 \$8.00. Also back issues of various publications. Send a SASE for information. David Morck, 7921 Springer Street, Downey CA 90242.

FOR SALE: Sony ICF-6700W. As new. SW/AM/FM with digital readout on all. \$210.00. Covers AM & FM and SW from 1.6 - 29.5 MHz (excluding 10.0-11.5) with good sensitivity & selectivity. Don Johnson, P.O.Box E, Elsinore CA 92330. No phone calls.

FOR SALE: Mizuho AP-MI Audio Processor. Unused and in mint condition. \$25 postpaid. Ed Pyatt, Morehouse College, Box 116, Atlanta GA 30314.

FOR SALE: Telex HTC-2 Twinset shortwave headphones. \$12.00 (list \$23). Kenwood SP-520 communication speaker. \$14.00. Both in very good condition. Sent postpaid. Tom Adams, P. O. Box 1165, Midland, MI 48640.



THE OFFICIAL DX MAGAZINE PUBLISHED MONTHLY BY SPEEDX

BOARD OF DIRECTORS: JOHN TRAUTSCHOLD-President; SANDY BLAIZE:  
 CHRIS HANSEN: VERA CRABLE  
 PUBLISHER..... JOHN & KATHY TRAUTSCHOLD  
 MANAGING EDITOR..... LARRY TALBOT  
 BUSINESS MANAGER/TREASURER..... DON JOHNSON  
 PROJECTS COORDINATOR..... MEL HICKMAN  
 MEMBERSHIP CHAIRMAN..... VERA CRABLE  
 AWARDS CHAIRMAN..... JACK JONES  
 SPEEDXGRAM EDITOR/PUBLISHER..... BOB BODELL  
 CENTRAL DISTRIBUTION EDITOR..... PEGGY THOMPSON  
 (2706 Alabama St., La Crescenta, CA 91214)

SUBSCRIPTION RATES PER YEAR

FIRST CLASS MAIL TO NORTH AMERICA..... \$16.00  
 SURFACE MAIL TO ALL OTHER COUNTRIES..... \$17.00  
 AO (AIRMAIL) TO CENTRAL AMERICA/CARIBBEAN..... \$24.00  
 AO (AIRMAIL) TO SOUTH AMERICA/EUROPE..... \$28.00  
 AO (AIRMAIL) TO AFRICA/ASIA/OCEANIA/USSR..... \$31.00  
 SAMPLE COPY TO NORTH AMERICA..... \$1.00  
 SAMPLE COPY TO ALL OTHER COUNTRIES..... (8 IRC's) or \$ 2.00  
 (MAKE ALL MONIES PAYABLE TO SPEEDX IN US FUNDS...)

Permission is granted to broadcast, publish, or reproduce any material contained herein (excepting items which state that they appear by permission from other sources) provided credit is given to: SPEEDX, P.O. Box E, ELSINORE, CALIFORNIA 92330 United States of America, and the editor or column.....

INDEX

KEYNOTES.....	DON JOHNSON	2
PROGRAM PANORAMA.....	WOODY SEYMOUR	7
TECHNICAL TOPICS.....	SANDY BLAIZE	9
SWBC WESTERN HEMISPHERE.....	CHRIS HANSEN	10
EUROPE.....	TERRY LINDLEY	18
ASIA / OCEANIA.....	TOM SCOTT	23
STATION SCHEDULES.....	CHRIS LOBDELL	30
UTILITIES.....	MIKE CHABAK	33
QSL REPORTS.....	TRAUTSCHOLD/TALBOT	42
TIPS & TOPICS.....	ART GETZEL	48
CONTRIBUTORS PAGE.....	CHRIS HANSEN	54
COVER DESIGN FOR APRIL..	THOMAS D. HASKETT-IN	

# World of SWL'ing

**SPEEDX**  
 will keep you in touch

**SPEEDX**  
 POST OFFICE BOX E  
 LAKE ELSINORE CALIFORNIA  
 92330 UNITED STATES OF AMERICA



FIRST CLASS MAIL  
 U.S. POSTAGE  
 PAID 35¢  
 Memo, Falls, WI 53051  
 Permit No. 75

**FIRST CLASS**