

# SPEEDY

*the dx radio magazine for active shortwave listeners*



JULY 1976

Vol. VI No. VII

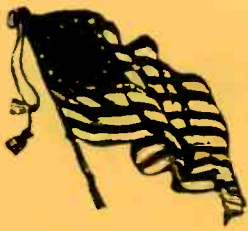

# BOTH OF US

## PRESIDENT'S MESSAGE

by  
DON JOHNSON



July marks the 200th anniversary of the UNITED STATES of AMERICA and the 5th anniversary of our club SPEEDX. The USA & SPEEDX have several parallels in their history.

BOTH OF US had humble beginnings through the efforts of a few dedicated individuals. BOTH OF US have made rapid progress since our beginnings. BOTH OF US have unlimited opportunities to grow and become even better. BOTH OF US are looking towards the future with eager anticipation. BOTH OF US are Young and Proud.

Yes, it's just 5 short years since SPEEDX was founded. We have come a long way since that memorable date. We now have members in 15 countries as well as all but two US states. We have produced such world acclaimed DXing aids as the Utility book, Sunset/Sunrise Booklet, Soviet Guide, BIPs, and more. Recently we have offered members a Foreign Language Report Guide and this month are offering a country list & awards program. Other projects are in the planning stages. You can see that SPEEDX has made great progress in it's short history and with your help, will progress more in the next five years.

The SPEEDX staff thanks each and every member who has helped to make all this possible. We look forward to your continuing support in the years to come. Remember, SPEEDX is a club for hobbyists, by hobbyists. We are all part of the whole!

Good Listening & 73

Don *Don*

-----

### CONGRATULATIONS TO 8 NEW FULL MEMBERS

LARRY ARNESON GRANDVIEW, MD	MALCOIM KAUFMAN JACKSON HTS, NY	THOS. LUNDSTROM TALLAHASSEE, FL	JIM YOUNG WRIGHTWOOD, CA
MARK BAKER DIXON, IL	WM. BREEDEN BILOXI, MS	COLIN PERRY MONTREAL, QUE	JOHN GION WEBSTER, MA

Certificates of Full Membership and a copy of the SPEEDX Constitution are being mailed concurrently herewith to each of the above new members.

-----

### SPEEDX WELCOMES THE FOLLOWING NEW ASSOCIATE MEMBERS

ARTHUR IRVING BEECH GROVE, IN	DONALD ASTON ROCKY RIVER, OH	WILLIAM MANNING EURESS, TX	ALEXANDER KOTOW AUSTRALIA
FRANCIS ROSINSKI PERRYOPOLIS, PA	DAVE TWIGGS BURLINGTON, CT	FLOYD STROHMAIER MINNEAPOLIS, MN	JOHN BALDWIN TOLEDO, OH
GERALD DARTEZ NEDERLAND, TX	EUGENE NYE SEATTLE, WA	GREG WATTS PLAINFIELD, IN	SKIP GROSS NORFOLK, VA
KEVIN QUICK OAK LAWN, IL	OLEN RAIFORD BARTOW, FL	TUULA MAHAFFEY YOUNGSTOWN, OH	GEORGE CLARE SAN MATEO, CA
WILLIAM OLIVER LEVITTOWN, PA	WARREN LEMAY PARAMOUNT, CA	CHARLES YOUNG PALMYRA, NJ	DAVID MARTIN ROCHESTER, MI
SATOSHI WAKISAKA OSAKA, JAPAN	DAVID SAPSFORD ENGLAND	FRANK PAGANO WASHINGTON, DC	DANIEL KOSKO MAPLE HGTS, OH



SPEEDX EDITORIAL CHANGE

A superb job has been done by Bob Butterfield as a SPEEDX staff editor for a period of five years, a tenure surpassed by any SPEEDX staff editor. Bob feels the time has come to turn the Europe Africa column over to a new editor. Beginning immediately all E/A loggings are to be sent to Mark Zimrowski, 20 N Quincy St. Brockton, MA 02402. Welcome aboard Mark. Bob we are looking forward to shortwave articles from you in the near future.

SPECIAL SPEEDX QSL

An attractive QSL card will be offered during the month of July for correct reception reports of our SPEEDX report heard over radio station HCJB's Saturdays DX Party Line. Tune in any Saturday during July and, John Trautschold will give you the details. Reports on the SPEEDX report are to be sent to SPEEDX headquarters in Elsinore, CA only, for the bicentennial card.

SPEEDX COUNTRY LISTS & AWARDS PROGRAM

During July all Full Members will receive a copy of our new country list and awards program. Associate members may obtain a copy of the country list by sending 50¢ to SPEEDX headquarters in Elsinore, CA.

BY-FREQUENCY LIST

A new listing of all frequencies reported to SPEEDX in April, May & June is now available for a number 10 size SASE. This list is a large one and will require 35¢ postage in the U.S. A handy guide for reference to help you ID that mystery station. 6 IRCs for over-sea mailing. Order from Doug Snyder 3130 Woodmont Drive, San Jose, CA 95118. Do NOT order from SPEEDX Hqs.

HEADQUARTERS SUPPLIES

A new supply of our SPEEDX rubber stamps are now available. This is the SPEEDX Emblem (1-1/2 inch) rubber stamp. Really dresses up your hobby mail. Cost is \$5.00, (\$4.50 to Full Members).

Guide to Soviet Broadcasting-40 pages of information on USSR stations. Freq. sites, Soviet map, time chart, report guide and more. Cost is \$1.25, (\$1.00 to Full Members).

Foreign Language Report Guide-16 pages of vocabulary and phrase lists in EE/FF/PP/SS. A handy aid. Cost is 50¢, (25¢ to Full Members).

WORLD RADIO TV HANDBOOK

Jens Frost editor of the WRTH Newsletter is asking for comments and suggestions for improvement from those receiving the Newsletter, see page 88 of WRTH '76 for Newsletter coverage.

MIAMI VALLEY DX CLUB

The 2nd annual Ohio week-end DX Seminar will be held, August 21-22, at the Imperial House Motel, Canton, Ohio. All DXers are invited. Write Bob Beck 1102 Delverne Ave S.W., Canton, Ohio for details.

USIA RE VOA

Dempsey Crews has been informed by Ruth Walter, that VOA no longer identifies transmitter sites, nor do they announce transmitter locations. A QSL for over-seas receptions will state, Washington, DC. This should not affect the Country counter, as the frequency date and time will prove the location.

ANARC CONVENTION 1976

Southern California Area DXers (SCADS), sponsored by all Radio Clubs in Southern California, welcomes the Association of North American Radio Clubs, annual convention to Los Angeles. SPEEDX extends best wishes to all those in attendance for an enjoyable stay.

CONVENTION LOCATION: Holiday Inn, 9901 South La Cienega, Los Angeles, CA.

DATE: Friday July 23 through Sunday July 25.

ROOM RATES: \$18.00 single, \$24.00 double.

REGISTRATION: Convention only \$10.00, Buffet \$6.50, both for \$14.50.

SCHEDULE

FRIDAY : Registration, Get acquainted time, DX gossip.

SATURDAY: 10:00-Call to order.

10:20-Speakers on LW, SW, FM-TV, PS.

12:10-Lunch break.

1:45-Tour of FAA & TRACTON. Approximate time two hours.

2:00-Speakers, (various for those not attending tour)

4:00-Break for dinner.

5:00-Social hour, no host.

6:00-Buffet dinner, followed by guest speaker, James Young.

"Low Frequency Propagation".

8:00-HAP auction. Donate your useable discards. All proceeds go directly to the Handicapped Aid Program.

SUNDAY : 10:00-ANARC business session. Important portion to any convention

12:30-Lunch break.

2:00-Seminars on various subjects.

4:30-Adjurn.

CONVENTION ADDRESS: 1976 ANARC, P.O.BOX E, ELSINORE, CALIFORNIA 92330

All registration and buffet fees must be paid in advance. Mail your check today to 1976 ANARC.



ITEM WANTED

Allied SX-190 receiver for senior citizen. Contact Dennis L. West, 2120 B West Middlefield Road, Mountain View, CA 94043. Please advise price.

ITEMS FOR SALE

Drake SPR-4, 6mos old, all ham and int'l bdest xtals, rack mount, AI4 loop antenna plus brand new Autex audio filter, and Drake dc power cord. \$550.00 plus UPS.

Sony TC 650 reel to reel, echo, sos, tape editing feature, stereo, a pro machine, plus two Sony electret mikes. \$350.00 plus UPS.

Panasonic portable am/fm cassette play/recorder with nice features. \$140.00 These items must be sold by August 1. Contact Richard Orloff, 109 Village Path, Lakewood, NJ 08701. Phone after 6pm..201-363-8061.

Drake SPR-4 with crystal calibrator and tropical bands, mint condition. Best offer takes. Contact Bob Nelson 1919 Iynwood, Pueblo, CO 81005.

Drake R4B, mint condition. \$325.00. Barlow Wadley XCR-30, modified by Grant Manning. \$250.00. Contact Larry Brookwell, 1826 Cypress St, San Diego, CA.

General Electric 6 band "World Monitor" portable w/bandspread. \$35.00. Contact Bob Pierce, 227 St Joseph Ave, Fitchburg, MA 01420.

1890----1976  
AUGUST BALBI-DEAN CF DXERS  
DIED JUNE 17 1976





# DX MONTAGE

RESEARCH/COMPILATION/REDACTION by A. W. BROOKS

74 Massachusetts Road

Oakdale, Connecticut 06370

FIVE YEARS AND COUNTING (or "The Agony And The Ecstasy SPEEDX-style"): In spite of what you may have heard in the popular folklore of the day the phrase "When in the course of human events it becomes necessary..." was not originated on July 4, 1971, by Art Glover, Bill Flynn, and various of their peers. Yet it was at a time approximate to that date that a new and progressive DX club emerged...one that would promote membership participation foremost. In the past five years this club...now an established major DX entity...has contributed a number of significant projects to the SWL fraternity. One of these major accomplishments was changing utility DXing from a "seat-of-the-pants" operation to a more fascinating, less mysterious facet of the activity in which everyone can participate and do so properly....informative columns, instructive pamphlets, and the World Utility DXers Handbook made much of that possible. Of course, another far-reaching project started by SPEEDX was the Handicapped Aid Program. Not only was this much-needed, but it was subsequently embraced by most of the other clubs as well as a number of major shortwave broadcasters. One of the strong points of SPEEDX during its initial years was the care taken not to lose sight of service to the novice as well as the more advanced DXer without catering to very limited special interests or particular experience levels at the expense of other more popular preferences and strata. What does the future hold for SPEEDX? All that is certain may be that there are going to be problems more important than quibbling over what constitutes a new "DX country" or creating still one more new "DX abbreviation"... what is more certain is that the direction we take in the next couple of years depends not on a FEW, but on YOU...



☆☆☆☆☆  
1776

## BICENTENNIAL AMERICA

1976  
☆☆☆☆☆

WORLD DX CLUB YEAR 1976 (or "Fat Yourself On The Bulletin"): The idea of a concerted world-wide effort to gain greater recognition and support for DX clubs and DXing has come to be called World DX Club Year 1976.....Of course, we realize that DX clubs are fundamental to the hobby. We can do little but echo the statement of ANARC Executive Secretary Dave Bromer who reminded everyone that access to well-managed DX clubs is of common interest to shortwave listeners, international broadcasters, and receiver manufacturers...and that the purpose of World DX Club Year is to promote this hobby, to gain new friends for DXing, and to help established DX clubs and individual DXers to join closer together for the benefit of all. The ideals, just as during World DX Friendship Year 1973, must be practiced in order to achieve a desirable effect. The ideals, just as during World DX Friendship Year 1973, will suffer from malpractice on the part of some overzealous members. We worry that such special designation may become the literary crowbar by which an enthusiastic DXer tries to pry that elusive QSL from a station...perhaps getting his desired trophy at the price of goodwill gone aglimmer. For example, we were aghast at the quest for a Lebanese verification proudly delineated in the QSL column of another organization...in which the successful collector traced his multiple harassment of the folks in strife-torn Beirut where it is entirely possible that the person sending the card was more concerned with whether or not he would still be alive on the morrow. After all, a QSL is a courtesy extended to the reporter by the station and DXers should not regard it as a right...

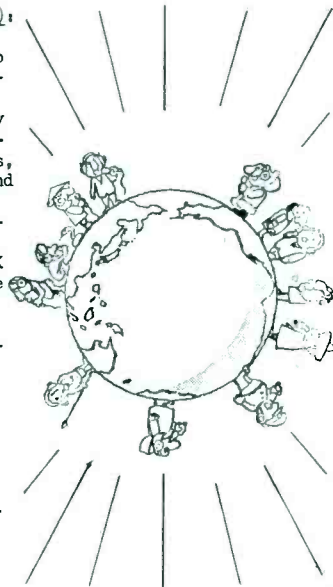

## RESULTS OF THE SPEEDX QUESTIONNAIRE

by Don Johnson

First, SPEEDX says thanks for all who returned the member questionnaire circulated a few months ago. Some 165 members took the time to complete the form and return it. This represents about 25% of our members and is about the same percentage that support the club on a regular basis.

This questionnaire was requested to enable your BOD to better plan the operations of the club over the next couple of years. We needed to know just what you, the membership, wanted to see in your monthly publication. The replies have provided this information.

The first part listing the sections of interest to you by numbering them from 1 through 12 seemed to be the hardest to complete. Many members remarked that they liked all the sections equally, and that each made a part of the whole. Of no surprise, the SWBC columns were far out in front in members interest, closely followed by Skeds, QSL and Tips & Topics. The column members were least interested in was a little surprising though. The HAPPening column was not only the least popular, but the first choice to be reduced and/or eliminated to make room for something else.

The sections SPEEDXers would like to see increased the most are: Technical Topics, Schedules & Tips & Topics.

Number one choice of a new column to add was some sort of a time index.

On the type of material members would like to see more of in the bulletin, technical material & more information for the novice led the list by far.

Several of the suggestions of what to add to SPEEDX to make it even better have already been implemented, or in the works. You asked for a country list and awards program. It's to be issued during July. You asked for more info on Russian sites. You got it. You asked more technical information. With this issue Technical Topics goes to two pages instead of one. You asked for propagation info. You got it. You asked for more utility info. The utility section has been given an additional page. You asked to make SPEEDX bigger. This we have done. How long since you have received a 48 page bulletin? We are running from 52 to 64 pages now.

Almost 90% of the membership feels SPEEDX's present efforts to produce an excellent monthly bulletin is good. At least, 90% of those who replied think so, and we assume this was a good cross section of the total membership. Only 10% rated our efforts as fair and no one thought we were doing poor.

On the question about contests, 50% say they will take part in contests if they are not too tough or too long. Many indicated they would prefer non-QSLing types of contests of short duration.

Yes, your suggestions and comments are being acted upon. After all, SPEEDX is YOUR club. Each and every member is a part of the whole operation. The idea of a club like SPEEDX is to provide a means where people with like interests can exchange information on a regular basis. We are all hobbyists pursuing the elusive and non-elusive radio signals bouncing around the ionosphere.

Remember, your suggestions and comments are welcome the year around, not just every two years or so when we circulate a questionnaire. If you come up with a 'brain-storm' idea, drop a line to any member of the BOD. Your remarks will be given careful thought.

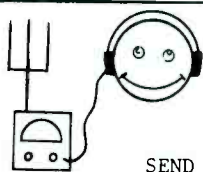

# TECHNICAL TOPICS ???

Editor

RALPH SANSEERINO

TECHNICAL TOPICS  
P. O. BOX E  
ELSINORE, CA 92330

SEND YOUR TECHNICAL QUESTIONS TO: ◇ ◇

First a bunch of attaboys to our friend John Kolb for the fine job he did these past many months. 73 to John, all fellow Speedx members, also to Speedx and the U.S of A on their birthdays, Good Luck to all.

This being my first column a short intro--I am a gray haired young old guy and have been around electronics 25 plus years. I am here to answer your questions and to pass on all interesting and useful technical information I can gather. So if all members would please send in their large, small and in between questions I will do my best to answer them, also send all useful schematics on out-board equipment or receiver modifications, send anything that will improve our chances on the bands.

Technical Topics is also here for the beginning SWL-DXer, I was there myself once and I will be glad to pass on what I have learned. If I cannot answer it I will find someone who can.

This first column will deal with Zero Beat, BFO Tone Control and the Crystal Calibrator.

Zero Beat - A short explanation of zero beat, switch to CW/SSB mode, tune across an incoming signal, the broadcast band is a good band to try this on, as you tune slowly across the incoming signal you will note the tone go from a high pitched tone to no tone and back to a high pitched tone, the no tone position is zero beat. This type of tuning can be used to let the SWL/DXer know that there is a station's carrier on the frequency.

BFO Tone Control - This control must be adjusted when getting ready to use a crystal calibrator or zero beating a station's signal. Switch to band wanted, tune to a strong station or switch on the calibrator to 100 kHz, tune receiver for maximum signal on S-meter, place mode switch in CW/SSB position, a tone should be heard, adjust BFO tone control for zero beat (no tone) as mentioned above, the receiver is now ready to be used with the calibrator in band being tuned. The BFO tone control should be checked or adjusted for each band you wish to tune.

Crystal Calibrator - From the Dictionary of Electronics by Radio Shack we find - Crystal Calibrator - A crystal-controlled oscillator used as a reference to check and set the frequency tuning of a receiver.

★  
  
The day of the IC (integrated circuit) has made the crystal calibrator a much more useful tool in the world of the SWL/DXer. Using a 1000 kHz crystal-controlled oscillator and 2, 3, or 4 IC's you can come up with a calibrator that puts out markers at 1000, 500, 200, 100, 50, 25, 20, 10, 5, 1 kHz, but for all around usefulness on shortwave I found that a calibrator with 1000, 100 and 10 kHz markers will do the job very well on dial cord type receivers like the DX150A, B, 160, HA600 etc. It is preferred that the receiver be equipped with a BFO so it can be used to zero beat the incoming marker. The most useful crystal calibrator will have a trimmer capacitor so it can be checked against a fixed marker like WWV and the trimmer capacitor adjusted for zero beat. Once the calibrator has been set against WWV it will be right on frequency, so now you are ready to tune the 1000, 100 and 10 kHz markers. For example let's use the DX160 and say you wish to tune the frequency of 15190 kHz, switch calibrator to 1000 kHz, switch receiver to CW/SSB mode, tune receiver to 15000 kHz a tone should be heard, switch

calibrator to 100 kHz and slowly tune receiver up the band, the first tone you come to will be 15100 kHz, the next tone will be 15200 kHz zero beat this tone, switch calibrator to 10 kHz, using the bandsread tune down the band, as the bandsread capacitor plates mesh you will hear a tone, this is 15200 kHz, keep tuning and the next tone you hear will be 15190 kHz zero beat and you are right on frequency. The DX150A, B, 160 can be set-up to bandsread the entire 13, 16, 19, 25, 31, 40, 49, 60, 80, 90, and 120 meter bands. The 60 meter band will have to be set-up at 5100 and 4900 kHz for bandsreading, also you will run into some problems in the 25 and 31 meter bands on the DX160 from the receivers image problem when using the 10 kHz marker position. It seems you have the 10 kHz marker and you also have a image marker in between the 10kHz markers, if you bandsread slowly you can do alright. I fed the 10 kHz marker thru a preselector and the image marker was attenuated completely and the band was tuned in a normal manner. I am going to do some more research into this 160 problem.

Again may I ask you for questions, useful schematics on out-board equipment, receiver modifications and receiver reviews.

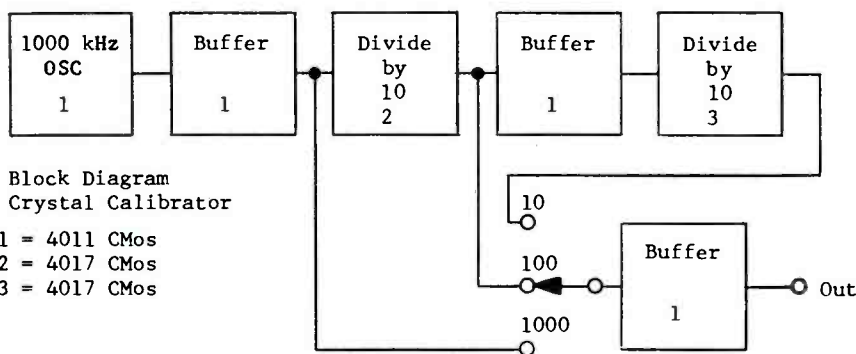

Block Diagram  
Crystal Calibrator

- 1 = 4011 CMOS
- 2 = 4017 CMOS
- 3 = 4017 CMOS

\*\*\*\*\*

Jeff Worman, Milwaukee, WI -- The RD-60/U Code Recorder would more than likely work plugged into the phone jack on your DX160, also you might need some way to monitor the incoming signal if the code recorder is not equipped with a phone jack. Price \$29.95 with shipping weight a very heavy 150 pounds. Order from Fair Radio Sales, 1016 East Eureka Street, Lima, Ohio zip 45802. Send them .25¢ for a catalog.

\*\*\*\*\*

For the beginner and old timer I highly recommend the Radio Shack 1974-75 Dictionary of Electronics by Rudolf Graf. Now selling for \$1.95 on sale. If you cannot obtain one locally, I will send you one postpaid for \$2.50.

\*\*\*\*\*

RECEIVER SPOTLITE: This month the Lafayette HA600A.

Frequency range - 150 kHz to 30 MHz in five bands.

Sensitivity - 1uV at 10dB S+N/N ratio.

Selectivity - 4 kHz at 6dB down; 12 kHz at 60dB down.

Intermediate frequency: 455 kHz.

Controls - noise limiter, CW/SSB, RF gain, antenna trimmer, bandsread, S-meter, 0 - 100 logging scale.

Price - \$169.95, seen on sale for \$129.95 at times.

Summary - Looking at the specifications this receiver looks like a good receiver for the money. FETs in the front end, mechanical filter. A Q-multiplier and crystal calibrator would have been a big plus for this set.

Available from Lafayette Radio Electronics shopping centers nationwide.







# HAP PENINGS

## HANDICAPPED AID PROGRAM

TED POLING -HAP DIRECTOR  
P. O. BOX 163  
MT STERLING, IL 62353

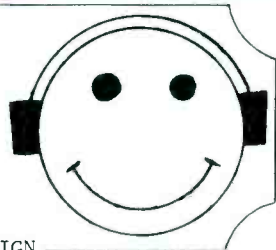

SUPPORT WORLD DX HANDICAPPED AID CAMPAIGN

Happy Birthday to U.S.! We made it, two hundred years of constitutional democracy!

In those two centuries we've seen communications change from the time when that word was synonymous with transportation and that was only the speed of a horse, to the point where one could watch Muhammad Ali knock out Richard Dunn only moments after the event actually took place in Munich.

We just about come full circle at least in terms of the U.S. mail; I can get a letter from Japan in five days, but it often takes longer to get a letter from across the country; Today HAP received among others two pieces of domestic mail, both of which had been back stamped, indicating that they had been misdirected. One of those two pieces had made it's way clear down to Alabama (from the west coast) before arriving here, and that raised it's delivery time to the level of the pony express of more than one hundred years ago.

Those same two hundred years have seen the rise of man's concern for his fellow man, in 1776, it was every man for himself. The handicapped by and large were ignored, and probably didn't survive long at best, in times when the life span of the general population was pretty short and not very pleasant, at least in terms of the way we think of it now.

That increasing life span has meant that there are more of us disabled people trying to find a means of coping, and HAP has tried to fill a need of a segment of that population. We are now growing overseas at a faster rate than in the United States. Holland and Sweden will be the next countries to establish HAP programs. John Rose, chairman of the EDXC Handicapped Aid Committee, has begun to achieve concrete results in Europe, and I want to congratulate him on his success.

The number of applications received from persons in this country has fallen off, leading me to conclude that our publicity is not reaching those we would most like to find: Disabled persons not already in the hobby. We've solicited the places through which we thought we could reach such persons in groups; The VA hospitals and private voluntary health care agencies, but there is still a very large number of people out there, living in geriatric nursing homes, or with parents or relatives.

Surley some of you do volunteer work at nursing homes, or know some one who does; if you could spend a little time finding out about the needs of the disabled in such places, and telling them of HAP's services, you would be doing them, HAP and the hobby a good turn.

The recently completed popularity poll conducted by SPEEDX indicates that this column is ranked twelfth and last in terms of those who take the time to read it. This came a distinctly unpleasant shock to me, and I am at some what of a loss to know how to interpret it.

Does it connote a declining interest in HAP as a viable and worthwhile program, or is it a matter of the form and content of the column? I have already published some guide lines for projects in this column, hoping that the information would result in a widening of our horizons. The one or two suggestions made dealt primarily with money making schemes, and I did not feel that they were quite suitable for us, at the time. Suggestions as to how HAP could reach more prospects would be most welcome, as would suggestions about increasing reader interest in the contents of this column, in whatever form it may appear in the future

We have been grateful for the interest of the staff and members of SPEEDX, We hope that we can work out a way to keep HAP news before fellow club members on a regular basis.

# SWBC DX - Western Hemisphere

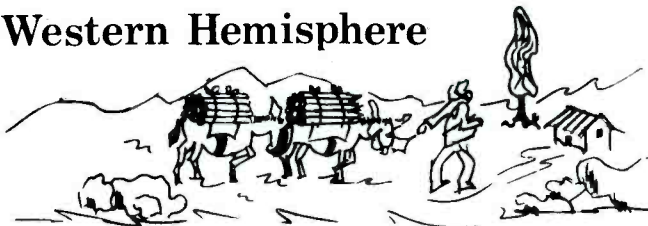

— EDITOR —

E.J. "Jim" Whitehead  
177 Pine Ridge Road  
Reading, Mass. 01867

## LATIN POTPOURRI

This month, as we pause to celebrate the passing of another milestone, let us take a moment to remember those who made it all possible. Like the United States, SPEEDX has succeeded because an awful lot of people have labored long and hard to make it succeed. True, no-one has died defending SPEEDX but many have sacrificed many hours of free time and given generously in their own way. So, as we mark the passing of yet another year let me say to all who have worked so hard a great big THANK YOU!! Thank you for your support, for your comments, and for your criticism. Happy Birthday America!!! Happy Birthday SPEEDX!!

## BRAZIL CREATES NEW BROADCASTING ENTITY

A home service newscast aired by Radio Nacional de Brasilia and monitored by the BBCMS carried the announcement that a Presidential decree signed 24 May had created a new state radio broadcasting enterprise to be called RADIOBRAS. This new company will assume control of all properties, assets and shares now held by Radio Nacional, Rio de Janeiro and the Radio Maua Foundation. Just how this will affect operations of these two stations was not disclosed.

## RADIO YARACUY SPANKED BY GOVERNMENT

Stressing that their action was "punishment, not censorship", the Venezuelan government ordered Radio Yaracuy closed for 48 hours during the first week of June for broadcasting "concepts which threatened public order". Their misdeed, according to the 9 June 1976 issue of Venezuelan Economic Review, was reporting that the Governor General, Pérez Mendez, had prohibited a student demonstration against the high cost of living.

## NEW BRAZILIAN LAW RESTRICTS POLITICAL AIR TIME

A recent decree issued by the Brazilian Ministry of Justice forbids electoral broadcasting over radio and television apart from brief displays of a candidate's name and number. Moreover, only municipalities with their own stations may make these broadcasts and they are clearly in the minority since only 800 of Brazil's 4000 municipalities boast of a broadcasting facility.

According to the informed weekly newsletter, Latin America, this law is clearly intended to intimidate the resurgent opposition party, the MDB, and avoid another embarrassing election defeat such as was suffered by the government backed ARENA party candidates in the last such local elections. The government hope is that by cutting out the MDB's means of communication in the cities the ARENA candidates will have a better chance of winning.

## AND AWAY WE GO

Tis time to get on with the loggings as the mean ole Managing Editor (HI Ollie!!) says I have to stay within my page allocation this month or else. So, its off to the races with the usual reminder that all times are GMT, all dates are given in the month/day format, and that reception conditions noted are reported using the SIO code. Next month's deadline, as always, is the 15th of the month. Please mail early so I can get the column done before I sneak off to the beach for a week late in July. OK?



ARGENTINA

- 6060 1029 LRA31 R. Nacional:w/ SS ID as "LRA, R. Nacional..." (343 6/1 Jones-MS)(343 0842 w/ 2 OM & YL discussion 5/9 Earhart-PA)  
 6120 0700 LRX1 R. El Mundo:w/ SS/EE mx w/ frequent IDs (433 5/11 Lavsevich-WI) You sure this not R. Super de Cali???  
 9690 0304 LRA32 Radiodifusión Argentina al Exterior:w/ EE nxcst by OM & YL ancrs (433 5/20 Worman-WI)(222 0215 w/ tango mx, SS IDs 5/26 Miklejewski-MN)(444 0550 w/ SS nxcst 5/13 Redman-IL)(434 0045 w/ SS anmts, tango mx 5/30 Yajko-PA)(333 0211 w/ SS tlk classical mx (333 5/15 Miller-WA)  
 11710 2325 LRA35 Radiodifusión Argentina al Exterior:w/ mx, ID, EE tlk on "WORLD OF SCIENCE" (433 5/6 Rojewski-WA)(433 2340 w/ SS IDs tango mx 5/23 Redman-IL)(444 2350 5/22 Stephenson-CA)(333 2305 w/ vocals, SS ID 5/16 Naylor-CA)  
 15345 1810 LRA 33 R. Nacional:w/ classical mx, SS anmt by YL but no ID on 5/5 before off @ 1830 abruptly. 5/9 1557 noted LRA33 ID and 5/29 \*1300 w/ TC and wx rpt. Much stronger reception noted in TN than IL (--- 5/5 Hauser-TN)

BOLIVIA

- 4738 \*1100 CP117 R. Riberalta:w/ SS regular pgms noted here from \*1100 (Tony Jones-Bolivia via Numero Uno)  
 4775 \*1000 CP175 Radiodifusora Trópico:w/ strong sigs daily from 1000 s/on (Tony Jones-Bolivia via Numero Uno)  
 4885 \*1100 CP77 R. Saraganda:w/ now back after several wks absence, s/on daily @ 1100 except 1200 on Sunday (Tony Jones-via Numero Uno)  
 5121 0315\* CP90 R. Juan XXIII:w/ daily pgmning to 0315 s/off, location unknown but different from stn on 4970-4980v which operates 1000-1630 and 2230-0130 weekdays and Saturday and 1200-1630 Sundays (Tony Jones-via Numero Uno)  
 6035 1115 CP92 R. Panamericana:w/ SS comls, LA mx (333 but horrible after 1130 6/8 Vokes-TX)(443 1025 w/ ID, Bolivian mx, many ads 6/11 Jones-MS)

BRAZIL

- 2380 0425 ZYE78 R. Educadora de Limeira:w/ PP w/ barley audible tlk, Brazilian mx after 0430. No ID so must remain TENTATIVE (131 5/30 Famularo-NJ)  
 4855 0830 PRC5 R. Clube do Pará:w/ mx, PP tlk (322 5/20 Tannenwald-NY)  
 4985 0141 ZYF208 R. Brasil Central:w/ OM tlk, promos, pop Brazilian mx (334 5/15 Miller-WA)(343 0705 5/16 Redman-IL)(222 0710 6/7 Beal-WA)(332 0900 5/25 Tannenwald-NY)(332 0905 5/19 Jones-MS)  
 5015 0845 ZYX24 R. Cultura de Cuaiba:w/ PP mx (232 5/26 Tannenwald-NY)  
 6000 0145 PRK5 R. Inconfidência:w/ romantic mx, OM slow tlk between discs (433 5/16 Miller-WA)  
 6015 2330 ZYB85 R. Clube de Pernambuco:w/ PP tlk, pop mx w/ some EE songs (433 6/4 Zilmer-WI)(343 0151 5/16 Miller-WA) BEWARE!! Since 6/7 Vatican Radio here 0030 - 0130  
 6035 0930 ZYZ65 R. Globo:w/ PP nxcst, Brazilian mx (343 6/3 Jones-MS)  
 6085 2352 ZYB87 R. Jornal do Comércio:w/ PP soccer match coverage (322 5/29 Yajko-PA)  
 6095 0035 ZYB7 R. Tupi, São Paulo:w/ spts event (132 5/20 Miller-WA)  
 6155 0810 ZYN90 R. Cultura da Bahia:w/ enthusiastic OM, ID as "R. Cultura da Bahia para todos do Brasil" (333 6/2 Miklejewski-MN)(433 2345 6/4 Zilmer-WI)(332 0845 5/25 Tannenwald-NY)(334 0155 5/21 Miller-WA)  
 9595 0030 ZYN29 R. Cultura da Bahia:w/ PP tlk, electronic tones, many IDs (423 6/4 Zilmer-WI)(322 0330 5/31 Lausevich-WI)  
 9675 0829 ZYT29 R. Diário da Manhã:w/Brazilian mx, 0900 ID (333/332 6/1,2 Junqua-JAPAN)  
 9705 1210 ZYZ24 R. Mauá:w/ OM & YL PP tlk, LA mx, 1230 ID (433 5/26 Junqua-JAPAN)(332 0941 6/2 Miklejewski-MN)  
 11780 \*2100 PRL8 R. Nacional de Brasília:w/ EE nxcst, wx rpt (333 6/1 Young- NJ)(333 2131 5/5 Rojewski-WA)(322 2125 5/13 Earhart)  
 11785 0130 ZYU61 R. Guaíba:w/ nice American MOR mx, ID 0200 (343 5/31 Miller-OH)  
 11805 0430 ZYZ65 R. Globo:w/ SS cmntry of boxing match in São Paulo, ID in PP (333 KOed by AFRTS @ 0500 5/28 Brookwell-CA)  
 11885 1036 ZYZ25 R. Mauá:w/ pretty Brazilian mx, OM PP anmts (343 5/22 Miller-OH)  
 11925 0015 ZYR78 R. Bandeirantes:w/ PP spts event coverage, two excited OM ancrs (433 6/7 Redman-IL)(332 1045 6/8 Zilmer-WI)

BRAZIL (cont.)

15145 1300 ZYB87 R. Jornal do Comercio:w/ PP IDs, lively mx, ads (342 6/5  
Estes-MS)(322 2035 5/30 Redman-IL)(433 2325 5/23 Zilmer-WI)

CANADA

5960 2102 CBC Northern Service:w/ special use of freq at early hr of 2100  
Sun 6/6 only, Northern Service and RCI paralleled for  
"Cross Continent Checkup" phone-in pgm, replacing 11720:  
became // to NPR @ 2110; already // 9625, 11855; Daventry  
9620 not audible, and 7215 jammed @ 2259 check at end of pgm.  
15345 poor 9625 had a SAH, 2 Sackville xmtrs on it, but at  
least with same pgm this time. This special pgm replaced  
regular RCI, Armed Forces, and Northern Service pgms 2100-  
2300. A couple of previous versions were carried on NPR (??)  
and CBC but, this first time on short wave (--- 6/6 Hauser-TN)



5990 1108 BBC via Sackville:w/ EE nxcst by YL (554 5/15 Miller-OH)  
6005 2338 CFCX, Montreal:w/ telephone tlk show, ads, ID (333 5/10  
Famularo-NJ)

6070 2230 CFRX, Toronto:w/ "Let's Discuss It" pgm (433 5/23 Redman-IL)  
(423 2210 w/ lt. mx, tire ad, tlk 5/13 Famularo-NJ)

6085 0150 R. Canada Intl.:w/ EE discussion (444 6/11 Karnry-NY)

6140 0620 R. Canada Intl.:w/ EE nxcst, into PF @ 0640 to Europe (544  
5/27 Miller-CA)

6160 0138 CKZU, Vancouver:w/ telephone tlk show (434 5/15 Miller-WA)

9535 0043 R. Canada Intl.:w/ jazz, SS ID @ 0047 (444 5/24 Naylor-CA)

9570 1030 R. Canada Intl.:w/ "World of Science" in "South Pacific Magazine  
to 1059" (444 5/26 Zilmer-WI)

9580 1530 BBC via Sackville:w/ on 1/2 hr early, non-stop mx till 1557 t/out  
(555 5/23 Earnhart-PA)

9625 1042 CBC Northern Service:w/ wx rept in EE (454 6/8 White-FL)(433  
2215 5/23 Rojewski-WA)

9650 0130 R. Canada Intl.:w/ EE magazine pgm (433 5/19 Rojewski-WA)

11720 2107 CBC Northern Service:w/ spts nx, tlk (242 6/5 Miller-WA)(433  
1615 w/ "Dr. Bondola Show", ID 5/8 Rojewski-WA)

11765 0400 R. Canada Intl.:w/ tlk on power crisis, QRM de RHC on 11760  
(433 6/10 McIntosh-PA)

11845 0355 R. Canada Intl.:w/ SS to LA, EE ID (222 5/26 Brookwell-CA)

11940 0112 R. Canada Intl.:w/ EE magazine pgm (434 5/29 Miklejewski-MN)

15365 1719 R. Canada Intl.:w/ "The World Around Us" pgm (222 5/16 Naylor-CA)

CHILE

6135 1059 CE613 R. Universidad de Concepción:w/ IS of string mx, EE ID by  
YL, then semi-classical mx (332 5/31 Jones-MS)

9565 0315 CE956 R. Nacional de Chile:w/ EE version "The Voice of Chile"  
pgm, YL tlks (422 6/4 Redman-IL)(111 0123 5/19 Miller-WA)

9590 0919 CE959 R. Presidente Balmaceda:w/ SS TC/IDs, ads, pop mx pgm  
(443 5/19 Jones-MS)

9650 1230 CE965 R. Tiki (Dimensión 146):w/ John Denver mx, ID, SS tlk  
(222 5/15 Vokes-TX)

9690 1220 CE969 R. Cooperativa Vitalicia:w/ SS chocolate ad, ID, pop mx  
pgm (333 5/15 Vikes-TX)

15150 0217 CE1515 R. Nacional de Chile:w/ ID, address, EE tlk on copper  
(534 5/23 Macris-MO)(353 0212 5/21 Earnhart-PA)(243 0022  
5/30 Breeden-MS)(221 1250 5/30 Miklejewski-MN)(252 0320 6/4  
Estes-MS)(433 0010 5/24 Redman-IL)

CLANDESTINE

13220a 2040 R. Euzkadi:w/ SS political tlks, full ID w/ freqs @ 2100  
followed by chorus and 2301 s/off (333 5/28 Famularo-NJ)

COLOMBIA

2580 0310\* HJ?? UNID: A TODELAR net stn being heard here w/ ads, mention  
of net. Too much T-storm QRM to catch ID. Most likely 2x  
harmonic of 1290. Later noted playing Colombian NA after  
TODELAR plugs (322/221 5/16/5/22 Hauser-TN)

4755 0521 HJKC Emisora Nuevo Mundo:w/ OM tlk, CARACOL net plug, some mx  
(333 5/15 Miller-WA)(433 5/16 0645 Redman-IL)

4865 0900 HJLZ LV del Carrucow:w/ SS mx, ID (332 5/24 Tannenwald-NY)

4885 0420 HJIG Ondas del Meta:w/ tango mx, SS IDs (433 5/19 Redman-IL)  
(353 0936 6/10 Jones-MS)

4915 0358 HJSG R. Guatapurí:w/ OM ID, vocals (222 5/16 Miller-WA)



COLOMBIA

- 4945 0135 HJDH R. Colosal:w/ SS ID, anmts, Colombian pop mx (243 6/5 Breeden-MS)(455 0503 5/5 Miller-WA)(444 0730 5/16 Redman-IL)
- 4965 0509 HJAE R. Santa Fé:w/ Aguila beer ads, local LA mx, TCs (444 5/16 Redman-IL)(444 0509 5/15 Miller-WA)
- 5075 0108 HJGC R. Sutatenza:w/ SS nxcst, ads (433 5/29 Yajko-PA)(433 0045 6/7 Redman-IL)
- 5095 0330 HJGG R. Sutatenza:w/ SS IDs, nxcst, orchestral mx (444 5/29 Thompson-NM)(444 1000 5/30 Redman-IL)(342 0725 5/9 Earhart-PA)
- 5962 0555 HJ?? LV de los Centauros:w/ SS mx, long clear IDs (443 6/6 Berger-TX)(333 0825 6/2 Miklejewski-MN)(343 0830 5/23 Redman-IL)(353 0840 6/9 Zilmer-WI)(343 0809 5/9 Earhart-PA)
- 6000 0907 HJNX R. Super de Medellin:w/ SS TCs, ads, ID, Argentine music (333 6/4 Jones-MS)(422 0540 5/17 Lausevich-WI)(323 0900 6/5 Vokes-TX)
- 6065 0900 HJAX R. Super:w/ LA mx, TC, several IDs (433 5/30 Redman-IL)(343 0740 6/2 Miklejewski-MN)
- 6115 0110 HJIE LV del Llanow:w/ Colombian vocals, TCs, IDs (433 6/7 Redman-IL)(433 1030 5/21 Zilmer-WI)(433 \*0927 6/4 Jones-MS)
- 6121 0720 HJ?? R. Super de Cali:w/ SS mx, w/ frequent IDs (443 5/11 Lausevich-WI)(322 0944 6/10 Jones-MS)(412 0612 6/6 Berger-TX)
- 6150 0730 HJJT LV del Huila:w/ LA mx, TODELAR promos, TCs and "más música" anmts (433 5/23 Redman-IL)
- 6160 0755 HJKJ Emisora Nueva Granada:w/ many RCN plugs, LA mx (233 6/2 Miklejewski-MN)(433 0545 5/21 Redman-IL)(242 1140 6/6 Miller-OH)(333 0900 5/10 Tannenwald-NY)
- 6170 1016 HJBJ LV de la Selva:w/ OM reading President's proclamation on occasion of "Farmer's Day", ranchera mx (222 6/7 Miklejewski-MN)(343 1126 5/31 Breeden-MS)
- 9682v 1200 HJZK R. Nacional:w/ SS IDs, rock mx, classical mx (242 6/3 Vokes-TX)(433 1030 6/3 Zilmer-WI)(242 2234 6/5 Miller-WA)
- 11793 0456 HJZO R. Nacional:w/ sign off anmts giving 5 SW fqys incl 4955, 5985, 6030, 9635, & 15335. None but this unannounced fqy was audible tho! This fqy ex- 11825 which was inexplicably abandoned to move here where HJZO can QRM both 11790 & 11795 and vice versa (???) 5/9 Hauser-TN)

COSTA RICA

- 4832 0701 TIHB Emisoras R. Reloj:w/ ID @ 0701, pop mx (333 6/7 Beal-WA)(444 0920 5/30 Redman-IL)(433 0254 5/26 Famularo-NJ)(344 0413 5/31 Breeden-MS)(323 1037 5/30 Miklejewski-MN)
- 5954 0555 TIQ R. Casino:w/ OM ancr, U.S. pop mx, EE ads, sign-off @ 0602 (322 6/2 Bixby-CA)(333 0525 5/30 Vokes-TX)
- 6006 0825 TIHB Emisoras R. Reloj:w/ many IDs, pop mx (322 5/6 Earhart-PA)(333 0156 5/16 Miller-WA)(221 1105 5/28 Miklejewski-MN)
- 9645 1132 TIFC Faro del Caribe:w/ SS rel. mx, barnyard animal noises, campesinos info pgm, some ranchera mx (221 5/28 Miklejewski-MN)

CUBA

- 6060 0122 R. Habana Cuba:w/ SS nxcst, ID (333 5/30 Yajko-PA)(333 0200 5/26 Miklejewski-MN)(555 0411 5/15 Miller-WA)
- 9525 0730 R. Habana Cuba:w/ EE anmts, tlk, Cuban mx (555 5/22 Miller-CA)(545 0647 5/16 Worman-WI)
- 9550 0330 R. Habana Cuba:w/ LA mx, SS tlk on Angolan involvement of Cuba (444 6/6 McIntosh-PA)
- 11680 0500 R. Habana Cuba:w/ distorted sig, noted on two receivers so not my rig (222 5/21 Brookwell-CA)
- 11760 0345 R. Habana Cuba:w/ EE tlk on various govts and how they are run (333 6/6 McIntosh-PA)(343 2239 6/5 Miller-WA)
- 11930 0200 R. Habana Cuba:w/ EE tlk, Cuban mx (433 5/8 Pollard-RI)(544 0420 5/15 Miller-WA)(553 0218 5/21 Somers-CA)(444 0150 5/7 Rojewski-WA)(444 2250 5/16 Naylor-CA)
- 11970 0555 R. Habana Cuba:w/ SS political tlk (333 5/26 Brookwell-CA)
- 15230 0130 R. Habana Cuba:w/ SS story read by OM, then mx (433 6/12 MacCoy-NJ)(343 0130 6/6 McIntosh-PA)(554 0107 5/16 Macris-MO)
- 15340 0225 R. Habana Cuba:w/ SS ID w/ fqys, into pgm of tlk, mx (242 6/6 McIntosh-PA)(Macris-MO)



DOMINICAN REPUBLIC

- 4882 0055 HIJP R. Comercial:w/ SS anmts, LA mx (333 5/29 Yajko-PA)  
 4930 0315 HIBE R. Mil:w/ SS ID, ads, LA mx pgm (--2 6/9 Cleveland-CA)(444  
 0550 5/16 Redman-IL)(243 0509 6/6 Breeden-MS)  
 11700 1800 HILR R. ClarIn:w/ LA vocals, SS tlks by OM, several IDs (343  
 5/30 Redman-IL)(333/222 0315/1640 5/24/5/20 Brookwell-CA)  
 (444 2314 5/21 Earhart-PA)(--? 1930 w/ engrossing pgm of  
 OM giving 4 & 5 digit numbers in the thousands, invariably  
 followed by another OM yelling "90 pesos". This continued  
 for about 10 minutes. Most likely some kind of market  
 quotations rather than a numbers operation 5/9 Hauser-TN)

EGUADOR

- 3390 1035 HCOT1 R. Zaracay:w/ mixture of rock mx & andean mx, several  
 full IDs (222 6/4 Miklejewski-MN)(433 1030 5/30 Redman-IL)  
 (333 0455 5/18 Miller-WA)  
 4680 0114 HCWE1 R. Nacional Espejow/ SS tlk, Ecuadorian mx (333 5/30  
 Yajko-PA)(--2 0432 5/25 Cleveland-CA)(433 0430 5/19 Redman-  
 IL)(554 0515 5/15 Miller-WA)  
 4820 0935 HCP56 R. Paz y Bien:w/ ID in SS/Indian language, andean mx,  
 may have been sign-on (443 5/27 Jones-MS)  
 4910 1101 HCMJ1 Emisoras Gran Colombia:w/ Anthem, ID, short nx, EE mx  
 (223 w/het 5/31 Breeden-MS)  
 4939 0410 HCX21 R. Nacional:w/ SS ID, short snatches of LA & andean mx  
 (--2 5/25 Cleveland-CA)(332 1122 6/10 Miller-WA)  
 6075 1120 HCJBL LV de los Andes:w/ Delightful guitar mx, into JJ @ 1130  
 (444 5/15 Miller-OH)(433 1202 w/HELLO DXERS 5/30 Zilmer-WI)  
 (333 \*1129 IS, "sakura sakura" ID, "HELLO DXERS" 5/28  
 Makishima-JAPAN)(353 0850 5/9 Earhart-PA)  
 6095 0459 HCJB LV de los Andes:w/ EE fqys, "SONGTIME" (455 5/15 Miller-WA)  
 9560 0040 HCJB LV de los Andes:w/ EE mx, nx, "UNSHACKLED" (454 5/6 Kelly-  
 TN)(444 0033 5/24 Naylor-CA)(444 0230 5/27 Thompson-NM)(554  
 0220 5/22 Miller-CA)(434 0230 6/8 Young-NJ)(444 0240 5/20  
 Worman-WI)(444 0330 6/6 McIntosh-PA)(333 0100 5/20 Pollard-  
 RI)(433 0247 5/9 Smith-FL)(444 0215 5/15 Czaja-WI)  
 9620 0430 HCJB LV de los Andes:w/ Romanian/Russian w/ Romanian rel. pgm  
 to 0430 ID, into Russian (333 6/4 Hardester-CA)  
 9715 \*1129 HCJB LV de los Andes:w/ JJ ID, "ECUADOR ECHO"(333 5/25  
 Makishima-JAPAN)  
 9745 0700 HCJB LV de los Andes:w/ EE ID, rel. pgm in transmission to S.  
 Pacific (454 6/11 Owsley-CA)(222 0925 6/9 McIntosh-PA)  
 9760 0910 HCJB LV de los Andes:w/ EE rel. pgm (343 6/9 McIntosh-PA)  
 11745 1530 HCJB LV de los Andes:w/ "CATHEDRAL OF THE ANDES" // 15115,  
 15160 (444 5/30 Yajko-PA)  
 11885 0215 HCJB LV de los Andes:w/ "WHAT IN THE WORLD" (444 5/16 Miller-WA)  
 (353 0140 ??? Somers-CA)(433 0050 5/30 Yajko-PA)  
 11910 1130 HCJB LV de los Andes:w/ SS ID, TC, tlk, nx (454 5/20 Smith-FL)  
 11915 0230 HCJB LV de los Andes:w/ EE "DX PARTY LINE" (433 5/20 Rojewski-  
 WA)(444 0245 5/30 Woltman-WI)  
 15160 1753 HCJB LV de los Andes:w/ SS ID, Ecuadorian mx (322 6/9 Miller-WA)  
 15300 1910 HCJB LV de los Andes:w/ EE "PASSPORT" pgm (444 6/9 McIntosh-PA)  
 17755 2112 HCJB LV de los Andes:w/ GG tlk, mx (343 5/22 Earhart-PA)  
 17780 1755 HCJB LV de los Andes:w/ EE/Czech w/ YL tlk abt Christ, into  
 Czech @ 1800 after ID (353 5/29 Earhart-PA)

FRENCH GUIANA

- 3385 \*0900 France Region 3, Cayenne:w/ time pips, guitar IS, anthem, FF ID  
 pop mx (342 5/19 Jones-MS)

GRENADA

- 15105 2100 R. Grenada:w/ EE pop mx request pgm (332 5/29 Zilmer-WI)

GUATEMALA

- 3300 0115 TGNC R. Cultural:w/ SS inst. mx pgm, IDs (433 5/20 Redman-IL)  
 3360 0401 TGVN LV de Nahualá:w/ SS anmts, LA pop mx (222 5/29 Beal-WA)  
 (433 0130 5/20 Redman-IL)  
 4825 0040 TGMN R. Mam:w/ Marimba mx, tlks by OM, hvy QRN (322 5/16  
 Redman-IL)

HAITI

- 9770 0008 4VEH R. Station 4VEH:w/ EE rel mx, // 11835 (322 5/19 Bixby-CA)

HAITI (cont.)

- 9770 2345 4VEH R. Station 4VEH:w/ EE ID, rel. pgm (322 5/4 Rojewski-WA)  
(333 2045 5/16 Redman-IL)  
11835 1130 4VEJ R. Station 4VEH:w/ EE ID, wx, nx headlines, "JOY OF LIVING"  
pgm @ 1215 (343 5/29 Miklejewski-MN)(444 1130 5/17 Famularo-  
NJ)(444 0000 5/12 Pollard-RI)(322 0010 5/16 Redman-IL)(332  
2000 5/23 Macris-MO)

HONDURAS

- 4820 0454 HRT2 R. Satélite:w/ cuckoos, TC, audio distortion typical of  
off-tuned FM reception. Noted after HRVC off on same  
carrier due splatter on studio-xmtr link. See last month's  
item (--? 5/9 Hauser-TN)  
4920 0413 HRPL3 R. Progreso:w/ SS tlk, LA mx, het (--1 6/9 Cleveland-CA)  
(433 0145 5/20 Redman-IL)(333 0100 5/13 Famularo-NJ)(344  
0410 5/31 Breeden-MS)(322 1043 5/22 Miklejewski-MN)  
4965 0247 HROX R. Landia:w/ ID, mx, terrific QRM (312 6/8 Jones-MS)  
6125 2355 HRQ R. Suyapa:w/ "MUSICA A LA CARTA", gobs of ads, "La Cariñosa"  
ID (333 5/13 Redman-IL)(322 0009 6/5 Miller-OH)(243 2310  
5/17 Berger-TX)

MEXICO

- 6105 0332 XEQM Su Pantera:w/ SS tlk, U.S. pop mx (322 5/19 Berger-TX)  
6115 0000 XEUDS R. Universidad de Sonora:w/ LA mx, fast tlk (333 5/29  
Berger-TX)  
9515 0528\* XEWV LV de América Latina:w/ SS anmts, ID & sign-off (222 5/28  
Beal-WA)(343 1705 w/ comls, mx, OM anc. 6/10 Estes-MS)  
9705 0225 XERMX R. México:w/ "RADIO CORREO DEL AIRE" pgm, tlk, mx (444  
6/5 Thompson-NM)(433 2045 5/30 Redman-IL)334 0213 5/15  
Miller-WA)(333 0130 5/29 Miklejewski-MN)(322 0100 5/30  
Stephenson-CA)(433 0217 5/11 Macris-MO)(543 0130 6/5 Somers)  
15385 0150 XERMX R. México:w/ "MUSICA Y CANTOS DE CHILE", this is pgm  
reported by BBCMS as scheduled for 0001 but noted here since  
early May. (454 5/12 Estes-MS)(444 2346 5/13 White-FL)(242  
0330 5/26 Miklejewski-MN)(343 0335 6/4 Hardester-CA)(333  
2140 5/2 Stephenson-CA)(444 0030 5/26 Yajko-PA)(444 2355  
5/23 Redman-IL)(--3 1352 5/25 Cleveland-CA)

NETHERLANDS ANTILLES

- 6165 0205 R. Nederland, Bonaire Relay:w/ EE pop mx (444 6/7 Young-NJ)  
(444 0240 6/4 Thompson-NM)(444 0230 5/21 Rojewski-WA)(454  
0500 5/8 Kelly-TN)  
9715 0600 R. Nederland, Bonaire Relay:w/ "HAPPY STATION" pgm (554 5/23  
Miller-CA)(???) 0457 noted running IS as early as 0457 over  
WYFR tho prior to this date had been off courteously keeping  
its IS silent prior to WYFR sign-off @ 0500 Hauser-OK)  
11910 1115 Trans World Radio, Bonaire:w/ EE "FOCUS" (443 5/30 Woltman-WI)  
11925 0119 Trans World Radio, Bonaire:w/ EE rel pgm, severe QRM from RHC  
(323 5/21 Miller-WA)(433 0045 w/"DX SPECIAL" 5/20 Rojewski-WA)  
15190 1642 R. Nederland, Bonaire Relay:w/ EE nx features (444 6/9 Miller-WA)  
15255 1415 Trans World Radio, Bonaire:w/ EE ID, nx, "Thought for the Day"  
(454 5/8 Smith-FL)  
21635 1740 Trans World Radio, Bonaire:w/ various languages rel. tlk, rare  
HF opening (343 6/1 Beal-WA)

PARAGUAY

- 6025 1020 ZPA1 R. Nacional del Paraguay:w/ SS ID, noticias (332 6/3  
Jones-MS)

PERU

- 4790 0949 OAX8F R. Atlantida:w/ SS ID, TC, tlk (343 6/11 Jones-MS)  
4975 0315 OCX4H R. del Pacifico:w/ Peruvian mx, ID @ 0326 (222 5/16  
Beal-WA)  
4995 0437 OAZ4C R. Andina:w/ SS IDs, TCs, Andean mx (221 5/19 Berger-TX)  
6045 1032 OCY4H R. Santa Rosa:w/ SS ID after ad string, into nxcst (342  
6/11 Jones-MS)  
6082 0955 OAX4Z R. Nacional:w/ frequent SS IDs, Andean mx (Peruvian style)  
very bad het. ID was "...desde Lima, transmite R. Nacional."  
(322 6/1 Jones-MS)423 0650 6/5 Beal-WA)  
9505 1155 OAX4V R. América:w/ short historical tlk in SS by OM. Into  
mx pgm (221 5/24 Miklejewski-MN)(343 0335 5/16 Miller-WA)



PERU(cont.)

- 9562 1128 OAX4R R. Nacional:w/ OM tlc, Andean mx in background, ID  
 @1200 (222 6/4 Miklejewski-MN)(232 1128 5/31 Miller-OH)  
 (343 1640 5/14 White-FL)
- 9675 1157 OAZ4L R. del Pacifico:w/ SS cmntry, Peruvian lt. mx, OM/YL  
 ancrs (422 5/31 Lausevich-WI)

UNITED STATES OF AMERICA

- 2190 1107 WTMC, Vanclave KY:w/ local nx summary, no ads,  
 just public service anmts, frequent TCs, ID  
 Is 3x 730 harmonic (344 6/7 Hauser-TN)
- 2600 1030 WSYD, Mt Airy, NC:w/ 2x 1300 harmonic noted with  
 grocery ad in EE, gospel mx (--? 5/16 Hauser-TN)  
 Glenn, you expected some other language??
- 2780 1030 WYKI, Athens, TN:w/ American Entertainment net nx  
 C & W mx. Is 2x 1390 har (--? 5/19 Hauser-TN)
- 5980 1007 KGEI LV de la Amistad:w/ EE nxcst (444 5/15  
 Miller-OH)
- 5985 0400 WYFR Family Radio:w/ SS ID, fqys, tlc (444 6/4 Estes-MS)
- 5995 0300 VOA Greenville:w/ nx analysis pgm (444 6/4 Thompson-NM)
- 6095 0915 VOA Delano:w/ EE "WORLD RELIGIOUS NEWS" pgm (343 5/9 Earhart-PA)
- 9525 \*1130 VOA w/ EE ID, into SS pgm (323 5/21 Famularo-NJ)
- 11740 2345 Voice of the OAS:w/ EE ID, nx, mx (444 5/6 Rojewski-WA)
- 11805 1728 AFRTS:w/ "VOICES IN THE HEADLINES" pgm (343 5/15 Czaja-WI)
- 11805 1728 WYFR:w/ rel pgm (545 5/15 Czaja-WI) Something is wrong here!!
- 15175 2315 KGEI, LV de la Amistad:w/ SS LA nx (344 5/15 Worman-WI)
- 15185 2238 WINB, World Inter-National Broadcasters:w/ "Mailbag Show", ID  
 (343 5/16 Naylor-CA)
- 15440 0050 WYFR, Family Radio:w/ SS rel. pgm (433 5/25 Pollard-RI)
- 17750 1827 VOA: w/ EE "MUSIC USA" pgm (212 5/24 Czaja-WI)
- 21480 1630 VOA: w/ EE African nx, cmntry on Zaire (555 5/2 Smith-FL)

URUGUAY

- 11835 0150 CXA19 R. El Espectador:w/ SS tlc, U.S. pop mx (433 5/29  
 Bixby-CA)
- 15270 2230 CXA14 S.O.D.R.E.:w/ rel. type mx, OM SS tlc, No ID so must  
 remain tentative (211 5/15 Vokes-TX)

VENEZUELA

- 3245 \*0955 YVKT R. Libertador:w/ NA, SS ID, tlc (322 5/19 Jones-MS)
- 3395 0015 YVOJ R. Universidad:w/ SS tlc, mx, ads (333 5/2 Tannenwald-NY)  
 (343 0255 5/16 Earhart-PA)
- 4770 0045 YVNW R. Bolivar:w/ Long ad string, Venezuelan mx (433 6/9  
 Redman-IL)(322 0030 5/15 Tannenwald-NY)(343 0048 5/29 Yajko)
- 4780 1015 YVLA LV de Carabobo:w/ Venezuelan mx, ads (222 6/2 Beal-WA)  
 (343 1001 6/3 Jones-MS)
- 4810 0352 YVMG R. Popular:w/ ID, NA @ sign-off (433 6/6 Berger-TX)(433  
 0245 5/20 Famularo-NJ)(333 0345 5/19 Redman-IL)(443 \*0955  
 6/3 Jones-MS)(333 0052 5/29 Yajko-PA)(243 0201 6/5 Breeden-MS)
- 4820 \*0900 YVWJ R. Tricolor:w/ "AMANECEER CAMPESINO" (332 5/16 Tannenwald-NY)
- 4860 0300 YVQE R. Maracaibo:w/ LA mx, SS tlc (--2 6/9 Cleveland-CA)(322  
 0615 6/8 Beal-WA)(232 0245 5/20 Redman-IL)
- 4880 0152 YVMS R. Universo:w/ SS ID, TC, mx (243 6/5 Breeden-MS)(433 0100  
 5/16 Redman-IL)(332 0100 5/15 Tannenwald-NY)
- 4890 0100 YVKB Radiodifusora Venezolana:w/ SS tlc by YL & OM, pop mx (433  
 6/9 Redman-IL)(--2 0305 6/9 Cleveland-CA)(344 0353 5/31  
 Breeden-MS)(333 0057 5/29 Yajko-PA)
- 4900 0310 YVNK R. Juventud:w/ LA pop mx, ID (333 5/15 Miller-OH)(233 0146  
 6/5 Breeden-MS)(343 \*1000 5/21 Jones-MS)(--3 0310 6/9  
 Cleveland-CA)(433 0105 5/16 Redman-IL)(323 0100 5/29 Yajko-PA)
- 4940 1056 YVPA R. Yaracuy:w/ LA mx, SS ID, ads (243 5/31 Breeden-MS)  
 (343 1020 5/30 Redman-IL)(434 \*0956 6/11 Jones-MS)
- 4970 0406 YVLK R. Rumbos:w/ SS nxcst (--3 0406 5/25 Cleveland-CA)(433 0410  
 5/19 Redman-IL)(433 0101 5/29 Yajko-PA)(344 0129 6/5 Breeden)
- 5040 0900 YVQH R. Maturin:w/ mx, ID, "ADELANTE VENEZUELA" pgm (???) 5/21  
 Tannenwald-NY)
- 9510 1933 YVXJ R. Barquisimeto:w/ OM ancr, ads, LA pops (433 5/22 Bixby-  
 CA)(343 1335 6/9 Breeden-MS)
- 9660 2216 YVLI R. Rumbos:w/ "NOTI RUMBOS INFORMA" (344 6/6 Breeden-MS)  
 (533 0434 6/7 Bixby-CA)(433 0130 5/3 Stephenson-CA)



# SWBC DX

## EUROPE / AFRICA

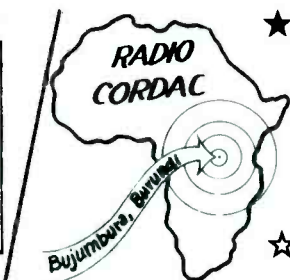

★ NEW EDITOR ★

Mark Zimarowski  
20 North Quincy Street  
Brockton, Massachusetts  
02402 U.S.A.

Deadline: 15th  
Times and Dates: GMT  
Frequencies: kHz

★ OUTGOING EDITOR

Robert Butterfield

-Europe-



### ALBANIA

- 6200 \*0130 R. Tirana: Eng s/on, sked, tlk (344 5/28 Estes-MS); (Worman-WI); (Woltman-WI); (Yajko-PA); (Earhart-PA)
- 7065 0003 R. Tirana: Eng commtry on May Day (343 5/2 Smith-FL); (444 0023 5/19 Yajko-PA)
- 7120 0120 R. Peking via Tirana: Eng world affairs commtry, mx (333 6/4 Kummer-KY); (344 5/18 Yajko-PA)
- 7300 \*0230 R. Tirana: Eng nx, tlk (433 6/2 Butterfield-MA); (Naylor-CA); (Thompson-NM); (Rojewski-WA); (McIntosh-PA); (Hinds-TRINIDAD)
- 9480 1120 R. Tirana: Eng w/ quiz (353 5/3 Dalrymple-AUSTRALIA)
- 9750 0005 R. Tirana: Eng w/ Five year plan commtry (433 5/17 Redman-IL); (454 5/6 Kelly-TN)
- 9780 0131 R. Peking via Tirana: Eng tlk, (444 6/7 Scannell-MA); (433 0315 5/14 Redman-IL)

### AUSTRIA

- 6155 \*0130 Osterreichischer Rundfunk: Eng w/ letters from listeners (333 5/16 Pollard-RI)
- 9770 \*0130 ORF: Eng w/ "Austrian Report" (344 5/25 Young-NJ); (Nebron-CA); (Scannell-MA); (Straumanis-IL); (Sann-NJ); (Redman-IL); (Bixby-CA); (Baker-IL); (Macris-MO); (Earhart-PA)
- 15330 1845 ORF: Eng tlk, ID, s/off (232 5/17 Odhner-PA)

### BELGIUM

- 9725 0015 RTB-BRT 4: Eng w/ ID, mx, "Brussels Calling" (434 6/7 Peters-KY); (Macris-MO); (Zilmer-WI); (Stephenson-CA); (Boyd-NFLD); (Shepard-NY); (Yajko-PA); (Straumanis-IL); (Earhart-PA); (Miller-OH); (Redman-IL); (Miller-WA); (Breedon-MS)
- 9730 2300 RTB-BRT 4: Dutch w/ pgm to 2330 when they switch to 9725 (422 5/17 Zilmer-WI)

### BULGARIA

- 9700 \*0000 R. Sofia: Eng nx, Letterbox (343 6/7 Scannell-MA); (Worman-WI); (Odhner-PA); (Yajko-PA); (Thompson-NM); (Boyd-NFLD); (Young-NJ); (Kelly-TN); (Watts-IN); (Fowler-ONT); (Cohen-NJ)
- 9745 0430 R. Sofia: Sp pgm for IAm, this xmtr also relays R. Moscow's Sp to Cuba/Central Am @ 2330-0430 (444 Legge-VA)
- 9770 1950 R. Sofia: Eng tlks on stamps (343 5/16 Redman-IL); (333 5/16 Pollard-RI)
- 15310 2105 R. Sofia: Eng nx, commtry, mx to Afr, at 2130 in Fr (322 5/15 Zilmer-WI)

### CZECHOSLOVAKIA

- 5930 0145 R. Prague: Eng w/ DX program, mx (433 5/21 Kasday-NJ); (Boyd-NFLD); (Young-NJ); (Scannell-MA); (Kelly-TN); (Pollard-RI)

CZECHOSLOVAKIA (cont)

7345 0140 R. Prague: Eng w/ listener's requests (444 6/6 McIntosh-PA); (Woltman-WI); (Redman-IL); (Famularo-NJ); (Odhner-PA); (Sann-NJ); (Thompson-NM); (433 5/13 Kummer-KY)

9540 0320 R. Prague: Eng w/ tlk on schools (444 6/14 MacCoy-NJ); (Redman-IL); (Worman-WI); (Miller-WA); (Yajko-PA); (S. Shaw-CA)

11990 0310 R. Prague: Eng nx (433 5/27 Jones-MS); (433 0100 5/28 Cohen-NJ); (344 0320 6/5 Breeden-MS); (433 0153 5/26 Yajko-PA); (222 0330 6/1 Brookwell-CA)

15415 0730 R. Prague: Eng w/ nx, comtry (333 5/3 Oriyama-JAPAN)

DENMARK

15165 \*1600 R. Denmark: Danish w/ tlk and mx (333 Young-NJ)

FINLAND

9550 \*0300 R. Finland: Eng w/ s/on after IS, nx, QRM RHC (322 6/19 Butterfield-MA); (Zilmer-WI); (Earhart-PA); (Miller-WA); (Watts-IN); (Baker-IL)

15110 \*1400 R. Finland: Eng w/ nx, HCJB QRM from 15115 (332 6/4 Cohen-NJ); (Earhart-PA); (Kasday-NJ); (Rogers-ONT); (Miller-WA); (Baker-IL); (Fowler-ONT)

FRANCE

11845 1605 R. France International: Eng w/ "Paris Calling Africa" (322 5/10 Stephenson-CA)

15200 1647 RFI: Eng mailbag (353 5/2 Fowler-ONT)

15210 1605 RFI: Eng nx, "PCA" (433 6/1 Woltman-WI)

15300 1602 RFI: Eng s/on. mx "PCA" // 15200 15210 15310 (433 5/30 Yajko-PA)

17720 1610 RFI: Eng w/ mx, mx "PCA" (343 5/30 Shepard-NY); (433 5/15 Bixby-CA); (434 5/30 Yajko-PA) // 17850 17860

17855 1620 RFI: Eng intvws (433 5/29 Odhner-PA)

GERMAN DEMOCRATIC REPUBLIC

9730 0120 R. Berlin International: Eng w/ features to NAM (534 6/1 Watts-IN); (Baker-IL); (Scannell-MA); (Cohen-NJ); (Earhart-PA); (Fowler-ONT);

11840nf 0345 RFI: Eng w/ report on a report // 11895 (343 5/18 Beal-WA); (334 0335 5/18 Miller-WA); (323 0415\* 5/14 Baker-IL); (343 0400 5/19 Nebron-CA); (444 0400 5/26 Brookwell-CA)

11895v 0355 RFI: Eng w/ nx, spts, mx (333 5/17 West-CA); (322 0345 6/5 nf Breeden-MS)

GERMANY, FEDERAL REPUBLIC OF

3960 1225 R. Free Europe, Biblis: Russ w/ mx pgm to 1230, into tlk (322 5/16 Beal-WA)

6040 0132 Deutsche Welle: Eng nx // 6075 6100 (433 5/26 Yajko-PA); (444 5/27 Thomson-NM)

6075 0130 Deutsche Welle: Eng nx (444 5/20 Boyd-NFLD); (343 0149 Young-NJ); (444 5/28 Thompson-NM)

9545 0550\* Deutsche Welle: Eng w/ s/off to NAM (422 6/10 West-CA); (433 5/22 Rojewski-WA); (444 5/13 Redman-IL)

9605 0145 Deutsche Welle: Eng tlk (444 6/5 Estes-MS); (433 0130 5/23 Redman-IL)

9765 2152 Deutsche Welle: Eng nx, comtry (Dalrymple-AUSTRALIA); (233 5/15 Miller-WA); (433 5/16 Yajko-PA); (Beal-WA)

11905 1935 Deutsche Welle: Eng w/ Afr Svc (333 5/8 Fowler-ONT); (534 6/6 Watts-IN)

15135 1743\* Deutsche Welle: Eng nx, tlk, s/off (333 5/10 Odhner-PA); (422 5/10 Beal-WA)

17880 1220 Deutsche Welle: Eng tlk, ID (454 5/31 Macris-MO)

GREAT BRITAIN

5975 0045 BBC: Eng drama (444 5/16 Redman-IL); (444 6/4 Estes-MS)

6055 0250 BBC: Eng play, ID, nx (342 6/5 Hardester-CA)

7325 2315 BBC: Eng World Radio Club (444 5/12 Fowler-ONT); (444 6/6 McIntosh-PA); (222 6/1 S Shaw-CA); (444 5/15 Redman-IL)

9410 0255 BBC: Eng drama, nx (444 6/14 MacCoy-NJ); (333 6/2 S Shaw-CA); (444 5/22 Thompson-NM)

9510 0230 BBC: Eng w/ Men from the Ministry" pgm (434 6/12 Kannry-NY); (444 6/8 Estes-MS) This fgy via Sackville 2300-0030, from Great Britain 0030-0330 to NAM. Note also that 9580 from 1500-1715 (listed 1600-1715) is via Sackville, we goofed last month. rfb.

GREAT BRITAIN (cont)

9915 2340 BBC: Eng w/ ballet mx pgm (444 5/16 Redman-IL)  
 11750 0400 BBC: Eng e/ nx (232 6/10 McIntosh-PA);(433 6/7 Redman-IL);  
 (223 5/17 Naylor-CA)  
 11955 0545 BBC: Eng nx to Australia (222 5/26 Brookwell-CA);(454 4/25  
 Dalrymple-AUSTRALIA)  
 12095 1512 BBC: Eng w nx (444 5/30 Miller-CA)  
 15070 2015 BBC: Eng w/ letterbox (433 5/23 Redman-IL);(434 5/26  
 Yajko-PA)  
 15180 \*1900 BBC: Russ w/ English by Radio (354 5/31 Watts-IN)

GREECE

9760 0019 Voice of Greece (EIP): Eng w/ nx, 0015-0030 (232 5/25  
 Boyd-NFLD);(Pollard-RI);(Macris-MO);(Breedon-MS);(Miller-  
 OH);(Redman-IL);(Famularo-NJ);(McIntosh-PA);(Scannell-MA)  
 (Yajko-PA);(Brooker-MI) also at 0215-0230  
 15345 \*1215 Voice of Greece (EIP):,Eng nx, comtry, hrd daily (332 5/16  
 Zilmer-WI)

HOLLAND

11730 2206 R. Nederland: Eng "European Scene" (333 5/7 Czaja-WI);  
 (242 6/8 Nebron-CA);(555 4/25 Dalrymple-AUSTRALIA);(Mill  
 443 5/29 Miller-OH);(444 5/27 Straumanis-IL) Again a  
 reminder that the 0200 xmsn in Eng on 6165 is from Bonaire,  
 as is the 0800-0920 xmsn on 9715. We will no longer "bend"  
 the rules and include such "misplaced" xmsns. rfb.

HUNGARY

6000 0400 R. Budapest: Eng DX pgm (333 5/22 Odhner-PA);(Young-NJ)  
 7215 \*0300 R. Budapest: Eng w/ mx, tlk, DX pgm (433 5/16 Kasday-NJ);  
 (232 6/1 Hardester-CA);(444 0200 6/6 McIntosh-PA);(443 0325  
 5/18 Naylor-CA);(444 0205 5/23 Redman-IL)  
 9585 0205 R. Budapest: Eng tlk, ID (444 6/2 Miller-OH);(333 5/18  
 Yajko-PA);(434 0213 6/8 Estes-MS)  
 9833 0319 R. Budapest: Eng w/ mx requests, clear (344 5/18 Miller-WA);  
 (454 5/18 Boyd-NFLD);(343 6/2 0300 Thompson-NM)  
 15220 2300 R. Budapest: Sp to LAM (242 5/18 Legge-VA)  
 15415 2130 R. Budapest: Eng for Eur // 9655 (242 5/18 Legge-VA);(333  
 2150 5/23 Cohen-NJ)

ITALY

9575 \*0100 Radiotelevisione Italiana: Eng w/ nx, mx to NAM (433 5/30  
 Cohen-NJ);(Kasday-NJ);(Miller-WA);(Boyd-NFLD);(Beal-WA);  
 (Stephenson-CA);(Straumanis-IL);(Yajko-PA)  
 11810 \*0100 RAI: Eng nx (343 5/31 Bethge-MO);(Pollard-RI);(Brookwell-CA);  
 (Yajko-PA);(Boyd-NFLD);(Redman-IL);(Jones-MS);(Rogers-ONT)

LUXEMBOURG

6090 0118 R. Luxembourg: Eng w/ rock mx, QRM RCI 6085 (322 6/7  
 Scannell-MA);(454 5/16 2327 White-FL);(433 0057 5/18  
 Yajko-PA);(343 0000 5/23 Redman-IL);(222 6/1 0030 Straumanis-  
 IL)

MALTA

6035 2030 IBRA R.: Eng rel tlk, address POB 396, Stockholm, Sweden  
 (242 5/16 Beaudoin-CT)  
 6100 0145 Deutsche Welle, Cyclops: Eng w/ mx, 0150\* (444 6/6  
 McIntosh-PA);(333 0155 in Ger 5/28 Thompson-NM)

NORWAY

9550 \*0300 R. Norway: Eng w/ ID, s/on, into Norw pgm (222 5/22 Pierce-  
 MA)  
 9645 0200 R. Norway: Eng "Norway This Week" (433 6/7 Zilmer-WI);(343  
 5/16 Pollard-RI);(433 5/24 Cohen-NJ);(343 5/24 Earhart-PA)  
 11870 0253 R. Norway: Norw pgm, Eng IDs (434 5/27 Mercado-CA);(433  
 5/16 Stephenson-CA);(533 5/22 Bixby-CA)  
 15175 1200 R. Norway: Eng "Norway This Week", ID (444 5/16 Ishizahi-  
 JAPAN);(433 1229 5/28 Numata-JAPAN);(433 1735 in Norw 5/26  
 Beal-WA);(444 1812 in Eng 5/22 Odhner-PA);(222 0130 in Norw  
 6/14 MacCoy-NJ)



POLAND

6135 2230 Polish R.: Eng nx, ID (333 5/15 Beaudoin-CT) to Eur  
 7270 0207 Polish R.: Eng nx to Nam (322 5/19 Zilmer-WI);(322 5/15 White-FL)  
 9540 1834 Polish R.: Eng nx, commtry (322 6/1 Zimarowski-MA)  
 9675 0300 Polish R.: Eng w/ fays, times, Eng and Polish, mx to 0307, nx (322 5/19 Zilmer-WI);(322 5/18 Yajko-PA)  
 11815 0220 Polish R.: Eng w/ pop mx, ancmts (232 5/9 Mitchell-CA); (Zilmer-WI);(Beal-WA);(Rojewski-WA);(Brookwell-CA);(Jones-MS);(Miller-WA)  
 11840 0234 Polish R.: Eng/Polish w/ mx (422 5/18 Brooker-MI);(433 5/19 Zilmer-WI)  
 15120 0230 Polish R.: Eng pgm into Polish at 0230 (334 6/8 Baker-IL); (143 5/29 Breeden-MS);(242 5/19 Zilmer-WI)

PORTUGAL

6025 0230 R. Portugal (ENR): Eng nx, mx (333 6/8 Bernstein-GA);(Beal-WA);(Odhner-PA);(Miller-WA);(Redman-IL);(Somers-CA)  
 7190 0502 R. Free Europe, Lisbon: Polish nx, ID, commtry (433 5/18 Zimarowski-MA)  
 7285 0413 Deutsche Welle, Sines: Bulgarian w/ IS, ID, tlk (333 5/28 Thompson-NM)  
 9505 \*0358 R. Free Europe, Lisbon: Czech/Slovak w/ tuning signal, IS, s/on (545 6/2 Watts-IN)  
 9670 2100\* IBRA R.: Eng w/ closing ancmts, address (343 6/8 Bodell-OR)  
 9755nf 2220 R. Portugal (ENR): Eng w/ tlk, mx, 2230\* (343 5/19 Earhart-PA)  
 11885 0520 R. Free Europe, Lisbon: Czech w/ tlk (333 5/23 Brookwell-CA)  
 11935 0250 R. Portugal (ENR): Eng tlk on holidays (443 5/24 Rogers-ONT);(444 6/2 Redman-IL);(433 0250 5/27 Jones-MS)  
 21495 1605 R. Portugal (ENR): Eng nx, mx (222 5/29 Odhner-PA)  
 21720 1622 R. Free Europe, Lisbon: Polish tlks (222 5/29 Famularo-NJ)

ROMANIA

9570 0415 R. Bucharest: Eng tlk on scientific developments (434 5/19 Worman-WI);(Boyd-NFLD);(Hardester-CA);(Watts-IN);(Rojewski-WA);(Kummer-KY);(Zilmer-WI);(Yajko-PA);(Earhart-PA);(miller-OH);(Fowler-ONT);(232 5/19 Miller-WA)  
 11940 0200 R. Bucharest: Eng nx (322 6/3 McIntosh-PA);(333 5/18 Yajko-PA)  
 15250 0642 R. Bucharest: Eng?, IS, open, ID, f/out (141 5/31 Makishima-JAPAN);(343 5/9 Rogers-ONT)

SPAIN

6065 0330 R. Nacional de Espana: Eng tlk (222 5/4 Stephenson-CA); (433 5/18 Yajko-PA);(333 6/8 Bernstein-GA)  
 11880 0105 RNE: Eng commtrys on the King, Woman, folksongs (434 5/19 Kummer-KY);(443 5/25 Woltman-WI);(344 6/5 Estes-MS);(444 0233 5/26 Famularo-NJ);(444 5/27 Jones-MS); (434 5/26 Yajko-PA);(322 5/19 West-CA);(454 5/22 Boyd-NFLD);(433 0215 5/20 Rojewski-WA);(323 5/16 Miller-WA);(444 5/24 Rogers-ONT);(545 5/7 Czaja-WI)

SWEDEN

6120 2300 R. Sweden: Eng nx, SCDXers (443 6/8 Estes-MS);(444 5/20 Boyd-NFLD);(433 5/23 Redman-IL)  
 9695 0245 R. Sweden: Eng mailbag (554 6/6 Somers-CA);(S Shaw-CA); (Watts-IN);(Miller-OH);(Redman-IL);(Macris-MO);(Czaja-WI); (Brooker-MI);(Yajko-PA);(Nebron-CA);(Straumanis-IL); (Estes-MS);(Sann-NJ)  
 11705 0230 R. Sweden: Eng w/ folk mx (433 5/17 West-CA);(Straumanis-IL); (Jones-MS);(Earhart-PA);(Boyd-NFLD);(Zilmer-WI);(Fowler-ONT); (Thompson-NM);(Bethge-MO)  
 11955 0030 R. Sweden: Eng w/ IS, ID, "Sunday Echos", mailbag (333 5/24 Rojewski-WA);(Beal-WA);(Odhner-PA);(Zilmer-WI);(Boyd-NFLD); (Yajko-PA);(Earhart-PA)  
 15120 1230 R. Sweden: Eng w/ ID, ID, nx (333 6/3 Ishizaki-JAPAN)  
 15275nf 1230 R. Sweden: Eng nx (353 5/5 Dalrymple-AUSTRALIA)  
 15305 1400 R. Sweden: Eng nx (444 5/28 Rogers-ONT);(443 5/16 Naylor-CA);(323 5/15 Beaudoin-CT)

SWITZERLAND

6135 0210 SBC: Eng "Dateline" (444 5/28 Redman-IL);(433 5/15 Odhner-PA);(444 6/2 Thompson-NM)



SWITZERLAND (cont)

9725 0430 SBC: Eng "Dateline" to WCNA // 11715 (433 5/31 Bixby-CA);  
(West-CA);(Yajko-PA);(Redman-IL);(Beal-WA)  
11715 0430 SBC: Eng tlk (444 5/26 Beal-WA);(Smith-FL);(Miller-WA);  
(Rojewski-WA);(Odhner-PA);(Nebron-CA);(Cohen-NJ);(Brookwell-  
CA);(Powler-ONT);(Hardester-CA)  
15140 1320 SBC: Eng w/ nx (343 5/29 Earhart-PA);(444 5/24 Boyd-NFLD);  
(444 5/28 Rogers-ONT);(333 5/22 Odhner-PA)  
15305 \*0655 SBC: Eng w/ IS, ID, nx (444 5/17 Makishima-JAPAN)

UNION OF SOVIET SOCIALIST REPUBLICSUkrainian SSR:

9500 0235 R. Moscow, Simferopol': Eng tlk (333 6/1 S. Shaw-CA);(433  
5/8 Smith-FL)  
15445 1340 Radiostantsiya Atlantika, Simferopol': Russ w/ relay of  
program, mx // 15150 12020 (353 5/29 Earhart-PA)  
17885 1330 R. Moscow, Vinnitsa: Eng to Afr, also Eng at 1500 and 1630  
(243 5/25 Legge-VA)

RSFSR European:

5960 1052 R. Moscow: Jap w/ science rpt, 1100\* (444 5/28 Makishima-  
JAPAN)  
7390 2006 R. Moscow: Eng w/ Ham DX pgm, to Britain and Ireland (242  
5/16 Beaudoin-CT);(454 2140 Watts-IN)  
9500 1643 Third Program: RR opera excerpts (444 5/31 S Shaw-CA)  
First "A" Program: RR cl mx (444 5/31 S Shaw-CA)  
Second Program Mayak: RR pop mx (444 5/31 S Shaw-CA)  
9575 1440 Third Program HS: RR cl mx (333 5/30 S Shaw-CA)  
9600 1921 Second Program Mayak: RR tlk (333 5/31 S Shaw-CA)  
9710 1711 Second Program Mayak: RR pop mx // 9600 at this time also  
(444 5/31 S Shaw-CA)  
1926 Third Program: RR cl mx concert (444 5/31 S Shaw-CA)  
9720 0040 R. Vilnius: Eng tlk (433 5/17 Redman-IL);(545 2145 5/29  
Watts-IN);(343 0035 5/17 Boyd-NFLD)  
9745 2230 R. Vilnius: Eng w/ week in review, nx, mx (433 5/16  
Shepard-NY)  
11690 0400 R. Moscow: Eng tlk, ID (243 6/5 Hardester-  
CA)  
11700 0017 R. Moscow: Eng nx // 11720 11735 11750 11770  
11850 11870 (333 5/19 Yajko-PA)  
11735 \*0030 R. Kiev: Eng to Nam (545 6/4 Watts-IN);(454  
5/18 Yajko-PA)  
11790 2330 R. Moscow, Ryazan: Sp to Cuba 2330-0200,  
Central Am 0200-0300 // 9470 9610 9745 9760  
11805 (333 6/10 Legge-VA)  
11860 \*2200 R. Moscow, Gor'kiy: Port to Brazil // 9775  
9810 12020 (333 6/10 Legge-VA)  
11900 2230 R. Vilnius: Eng w/ nx, comtry // 9720 @ 0030 (322 5/16  
Pierce-MA)  
2330 R. Moscow: Sp to LAm w/ new IS (333 5/13 Brookwell-CA)  
12000 2030 R. Moscow, Tula: Eng to Afr, also at 2130, 2230 // 12040  
12070 (232 6/10 Legge-VA);(444 0530 Brookwell-CA);(333 0635  
5/10 Odhner-PA)  
12010 0100 R. Moscow: Sp "Escucha Chile" (545 6/4 Watts-IN);(Legge-VA)  
15200 1600 R. Moscow, Kalach: Eng to S/SEA, QRM RFI, also 1100-1600  
S Asian languages (222 5/26 Legge-VA)  
15295 1100 R. Moscow, Voronezh: Eng to S/SEA, also R. Peace and Progress  
@ 1230 (232 5/18 Legge-VA)  
15385 1600 R. Moscow, Gor'kiy: Eng to S/SEA (232 5/25 Legge-VA)  
17795 1615 R. Moscow, Serpukhov: Eng to Afr, 1630\* (333 5/13 Beaudoin-  
CT)

VATICAN STATE

5995 0100 R. Vaticana: Eng rel nx // 6105 9605 (443 5/19 Zilmer-WI);  
(444 5/12 Pollard-RI);(433 6/5 Odhner-PA);(433 6/4 McIntosh-  
PA);(444 5/9 Earhart-PA)  
6105 0100 R. Vaticana: Eng nx (433 6/7 Redman-IL)  
9560 0311 R. Vaticana: Eng pgm (333 5/20 Worman-WI)  
9645 2032 R. Vaticana: Eng rel nx (433 5/28 Famularo-NJ)

YUGOSLAVIA

- 9620 \*2200 R. Belgrade: Eng w/ nx, 2215\* (444 5/15 Beaudoin-CT);(433 5/16 Redman-IL);(322 5/9 Fowler-ONT);(433 5/18 Yajko-PA); (343 5/13 Earnhart-PA);(333 5/17 Famularo-NJ)
- 15240 1538 R. Belgrade: Eng w/ end of nx, mx, ID, 1555\* (323 5/29 Famularo-NJ)

-Africa-

ALGERIA

- 9720 2055 Radiodiffusion Television Algérienne: Ar mx (242 6/8 Bodell-OR)
- 11810 1835 RTVA: Ar mx pgm (223 5/24 Beal-WA)
- 17790 1725 RTVA: Ar w/ yl singing (343 6/2 Bodell-OR)

ANGOLA

- 9535 0545 R. Nacional de Angola: Vern w/ choral mx (333 6/10 Bodell-OR)

ASCENSION ISLAND

- 7270 0505 BBC, Atlantic Relay: Eng nx (444 5/19 Redman-IL)
- 17840 1558 BBC, Atlantic Relay: Eng mx, ID, nx (443 5/16 Naylor-CA)

BENIN, PEOPLE'S REPUBLIC OF

- 4870 0547 La Voix de la Revolution du Beninoise: Fr/vern w/ tlk, pol chants, afro mx (333 5/24 Zimarowski-MA);(333 6/4 0530 Hardester-CA);(433 5/16 0600 Redman-IL);(333 5/4 Tannenwald-NY);(443 5/23 Shepard-NY);(554 0540 6/2 Watts-IN and // TI 90 312 0655 6/6 Watts-IN)

BURUNDI

- 4900 0443 R. Cordac: Vern w/ afro mx, tlk (212 5/30 Watts-IN)

CAMEROON

- 5010\* 0435 R. Garoua: U/lang w/ chants, not sked on til 0500 (232 5/15 Bixby-CA)

CANARY ISLANDS

- 15365n1\*2045 R. Nacional de Espana, Tenerife: Sp w/ locally ancd mx to 2145, then relay of Madrid to Americas 2145-0200 (343 6/10 Legge-VA)

CENTRAL AFRICAN REPUBLIC

- 5038 2230 Radiodiffusion Nationale Centrafricaine: Fr w/ American, afro, and French pop mx, nx, anthem @ 2305\* (433 5/15 Shepard-NY);(222 5/20 2251 Miller-OH);(111 Dalrymple-AUSTR)

CHAD

- 4904.5 2130 Radiodiffusion Nationale Tchadienne: Fr w/ mx, tlk with background mx, nx, anthem @ 2300 (222 5/23 Shepard-NY);(Tannenwald-NY); (Dalrymple-AUSTRALIA)

CONGO, PEOPLE'S REPUBLIC OF THE

- 15190 1255 Radiodiffusion Television Congolaise/La Voix de la Revolution: Fr w/ tlk, mx, IDs (434 5/28 Yajko-PA);(333 1500 5/29 S Shaw-CA);(444 2107 5/18 Scannell-MA)
- 1732 Voice of Namibia (RTVC): Eng ID, tlk (242 6/9 Estes-MS)

EGYPT, ARAB REPUBLIC OF

- 7050 0430 R. Cairo (HS): Ar "Voice of the Arabs", tlk, mx (332 5/15 Earnhart-PA)
- 9475 0320 R. Cairo: Eng w/ ME mx (444 6/10 Jones-MS);(Bethge-MO); (MacCoy-NJ);(Miller-OH);(Estes-MS);(Straumanis-IL);(Hinds-TRINIDAD);(S Shaw-CA);(Thompson-NM);(Redman-IL);(Earnhart-PA); (Woltsman-WI);(Stephenson-CA)
- 9805 2230 R. Cairo: Eng "Spirit of Islam" pgm (444 6/9 McIntosh-PA); (444 5/13 Redman-IL)
- 11630 2059 R. Cairo (HS): Ar chants, ancmts // 12005 (443 5/18 Scannell-MA)

EGYPT, ARAB REPUBLIC OF (cont)

- 15475 1930 R. Cairo (HS): Ar mx, chants (343 5/28 Yajko PA)  
 17725 1640 R. Cairo (HS): Ar vocal mx (444 5/15 Bixby-CA);(322 5/26 Beal-WA)  
 17920 1315 R. Cairo: Eng ID, quiz, mx, Arabic by Radio (444 5/12 Ishizaki-JAPAN);(333 5/11 1930\* Odhner-PA)

ETHIOPIA

- 11910 \*1945 ETLF: Eng s/on w/ IS, nx (322 5/17 Zimarowski-MA)  
 15190 1600 ETLF: U/lang w/ singing, Eng ID at 1608, 1610\* (343 6/10 Klontz-CA);(433 6/3 1610 Makishima-JAPAN)

GABON

- 4777 2305 Radiodiffusion Television Gabonaise: Fr w/ nx, speech, mx, many IDs (443 5/30 Shepard-NY)

GHANA

- 4915 0600 Ghana Broadcasting Corporation 1, Accra: Eng nx, s/on 0530 (554 5/30 Watts-IN);(444 5/27 Brookwell-CA)  
 4980 0543 GBC 2, Ejura: Eng request pgm (322 5/24 Zimarowski-MA);(534 \*0530 Vern/Eng nx 0600 5/30 watts-IN)

IVORY COAST

- 4940 0600 Radiodiffusion Television Ivoirienne: Fr pgm (553 5/30 Watts-IN);(Tannenwald-NY)  
 7215 0630 RTVI: Fr w/ mx, tlk (222 6/6 Berger-TX);(432 5/19 0620 Bixby-CA)  
 11920 0000\* RTVI: Fr w/ band mx, s/off, too strong to be true (333 6/6 Brookwell-CA)

LIBERIA

- 4770 0700 ELWA: Eng w/ BBC nx (333 5/16 Redman-IL)  
 11860 1620 VOA, Monrovia: Eng tlk, intvw, 1630 ID, QTH ASWLC (333 5/16 Naylor-CA)  
 21660 1612 VOA, Monrovia: Eng tlk, mx (242 5/29 Famularo-NJ)

MALAGASY REPUBLIC

- 11730 2028 R. Nederland, Talata: Eng "Netherland Top 40" (545 5/15 Smith-FL)  
 11740 \*1356 R. Nederland, Talata: Eng IS, "Happy Station" (433 5/30 Makishima-JAPAN)

MALAWI

- 3380 0320 Malawi Broadcasting Corpoation: Chichewa tlk, afro mx (242 6/7 Shepard-NY)

MALI

- 4783 0600 Radiodiffusion National du Mali: Fr nx, mx (532 5/31 Watts-IN)  
 11960 1740 R. Mali: Vern w/ afro mx, tlk, many mentions of Mali (333 5/15 Bixby-CA)

MAURITANIA

- 4845 2330 Radiodiffusion Nationale de Mauritanie: Ar chants, 0003\* (443 5/19 Shepard-NY)

MOROCCO

- 6100 2330 Radiodiffusion Television Marocaine: Ar chants, story by yl with sexy voice (222 5/13 Estes-MS)  
 7170 0107 VOA, Tangier: Eng nx (332 6/1 Smith-FL)  
 9615 1943 RTVM: Ar w/ chants, nx @ 1957, ID. 1t mx, speech 2007 (433 5/13 Famularo-NJ);(222 5/9 Beal-WA)  
 11735 1612 RTVM: Ar tlk, exotic local mx (433 5/21 Bixby-CA)  
 15360 1652 RTVM: Ar singing (333 5/17 Bodell-OR)

MOZAMBIQUE

- 4855 1647 R. Mocambique: Port w/ tlk, 1700 nx (232 6/2 Junqua-JAPAN)  
 4865t 0455 R. Mocambique: Port? w/ instr mx, tlk @ 0500 (131 5/11 Zimarowski-MA)

NIGERIA  
7275 0600

Voice of Nigeria (NBC): Eng nx (434 6/7 Owsley-CA);(333 5/16 Worman-WI);(433 5/21 Redman-IL);(433 6/6 Berger-TX); (343 5/22 McIntosh-PA)

15120 1830

VON (NBC): Eng nx (333 6/2 Shepard-NY)

RHODESIA  
3396 0400

Rhodesia Broadcasting Corporation: Eng w/ nx, mx, ads (322 5/21 Shepard-NY)

RWANDA  
7225 \*Q430  
11795 0035  
15410 2245

Deutsche Welle, Kigali: Eng to Afr (545 5/30 Watts-IN)  
Deutsche Welle, Kigali: Ger tlk (322 5/14 Beal-WA);(Miller-OH)  
Deutsche Welle, Kigali: Ger w/ marching type mx (353 5/22 Earhart-PA)

SEYCHELLES  
11810 1800

Far East Broadcasting Association: Ar pgm, Eng ID € 1800 (222 5/14 Beaudoin-CT)

SIERRA LEONE  
3316 2235

Sierra Leone Broadcasting Service: Eng w/ cl and instr mx, ID @ 2300 (242 5/16 Beaudoin-CT)

SOMALIA  
9585 1945

R. Mogadishu (SBS): Somali w/ vocal mx, nx, IDs (433 5/25 Zimarowski-MA);(333 1950 5/20 Pierce-MA);(332 1743 5/23 Bixby-CA);(444 1745 5/17 Sheppard-NY); (444 1938 5/15 Beaudoin-CT)

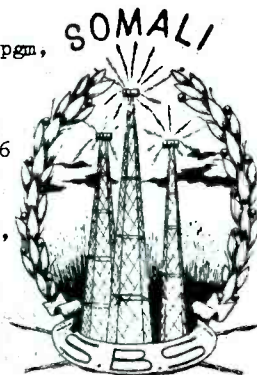

BROADCASTING SERVICE

SOUTH AFRICA  
3250 0130

SABC, Springbok: Eng w/ old pops (333 6/5 Shepard-NY)

3980 0405

SABC, Springbok: Eng/Afrikaans tlk, mx, ads (423 5/17 Beal-WA)

9585 2301

R. RSA: Eng w/ DX Corner, 2320\* (444 6/5 Straumanis-IL); (Woltman-WI);(Miller-WA);(Miller-CA);(Redman-IL);(YaJko-PA); (Thompson-NM);(EstesOMS);(Earhart-PA);(Jones-MS)

11900 0614

R. RSA: Eng nx (544 5/30 Watts-IN);(322 5/23 West-CA);(343 5/9 Odhner-PA)

15220 1411

R. RSA: Eng drums, ID, intvw, nx (333 6/4 Ishizaki-JAPAN); (243 5/22 0640 Mercado-CA);(353 5/26 1100 Kelly-TN);(344 1435 5/8 Rogers-ONT)

21535 \*1559

R. RSA: Eng ID, TC, nx (352 5/29 Famularo-NJ)

SWAZILAND  
4980 0459

Swazi Commercial Radio: Eng "popcora." IS, brief tlk, mx (242 6/4 Berger-TX)

TANZANIA  
5050.5m 1703

R. Tanzania: Swahili w/ nx (232 5/13 Junqua-JAPAN)

TOGO  
5046.5m 0600

Radiodiffusion du Togo: Fr w/ weird mx (323 5/27 Brookwell-CA);(343 5/8 2228 Earhart-PA);(453 \*0530 6/2 Watts-IN)

TUNISIA  
15225 1903

Radiodiffusion Television Tunisienne: Ar nx (222 5/24 Zimarowski-MA);(343 2100 5/31 Watts-IN);(222 1850 5/24 Beal-WA);(333 5/17 1631 Bodell-OR)

UGANDA  
6030 1430

Uganda Broadcasting Corporation: Eng w/ song by "Abba", afro mx (332 5/2 Dalrymple-AUSTRALIA)

9730 2031

UBC: Eng nx (322 6/2 White-FL)

15325 2020

UBC: Fr tlk (433 5/26 Beal-WA)

ZAIRE  
4839m 1656

R. Bukavu:(TENT) U/lang w/ afro mx, no ID hrd, only afro along with SABC 4835 in Eng listed near this fqy (322 6/2 Junqua-JAPAN)

15245 1738

La Voix du Zaire: Vern tlk (544 5/30 Watts-IN)

15350 1800

La Voix du Zaire: Fr tlk (244 5/30 watts-IN)



ZAMBIA

3346 0400

R. Zambia: Eng nx, speech calling for the liberation of Zimbabwe, afro mx (312 6/4 Shepard-NY) General Service.

-Clandestine-

CLANDESTINE

10108 2200

R. Espana Independiente (Bucharest): Sp tlk, mx // 12140 (332 6/4 Zilmer-WI)

12140 2134

R. Espana Independiente (Bucharest): Sp w/ pol tlks, mx, ID, jammed (422 5/11 Famularo-NJ)

-Unidentified-

UNIDENTIFIED

11970 2130

"GR": w/ CW variable tone jamming station on 11970 which is unidentified (333 5/30 Hardester-CA)



## Europe / Africa Roundup:

Ciao! As usual my thanks go to first time reporters: Tom Czaja, M. Dalrymple, Randolph Macris, Richard Mitchell, J. Hugh Odhner, Mitutosi Oriyama, Gregg Watts, and Dennis West. A record number of European loggings which helped to make the longest Europe/Africa column to date, ten pages! And if you don't think that was work ...

This month marks the 5th Anniversary of SPEEDX, as well as the 200th of the United States. I'm happy to say that for those past five years I've been doing a monthly column for SPEEDX, two as Station Skeds editor and the last three as Europe/Africa editor. And as the saying goes, "I think its time for a change". After five years I think I'm due for a rest and so I've decided to step down as the editor for this column and let Mark Zimarowski take the challenge. I must say that it was a very rewarding experience which perhaps I might someday return to in the future. The life of an editor is not always easy, publishers know the feeling too I think (hi!), but the "good" far outweighs whatever there is to be considered "bad".



Since I'm one of those who hate "short" good-byes, I'd like to thank some people publically who've really made it easy. Thanks to Dave Thorne, SPEEDX's founding Secretary/Treasurer. If you must blame someone, blame Dave, he's the one that got me started. Thanks to Bill Flynn, former Managing Editor of SPEEDX who made things easy. Thanks to Art Glover, founding President of SPEEDX whose help was always where and when I needed it. Thanks to Oliver Ellsworth who whethered the problems column editors such as myself have ... and give, and my thanks to Don Johnson who knows what the word "problem" means and who I tried, not always successfully, from giving additional "meanings" to the word. Then too, it wouldn't be fair if I didn't mention the names of other helpful individuals such as Steve d'Adolf, Jim Whitehead, Alan Brooks, Wendell Benedetti, Doug Snyder, all the Boston Area Daers, and to Bob Zilmer, who if he ever missed reporting to a Europe/Africa column certainly hid the fact well, plus other faithful reporters Robert Yajko, Mark Bixby, Glenn Thompson, Ralph Famularo, Al Miller, and Tom Smith. I will continue writing special articles and the like and hope that'll you'll keep in touch. My address will remain the same: P.O. Box 398, Belmont, Massachusetts, 02178, U.S.A.



Now on to some news, BBC items appear with permission



Radio Norway - Norway: Radio Norway is requesting reports for its new 250 kw transmitter now in operation at Fredrikstad. Special interest for reports on the 1300 GMT beam to North and Central America on 15175, the 1900 GMT beam to Africa on 15175, and the 2100 beam to West Africa and South America on 17795. The new transmitter is supposed to be in use on all overseas transmissions.

(Mel Hickman)

Portugal - Radio Portugal/Radio Liberdade: During the period 2030-2100 transmissions from Radio Portugal (ENR) in Portuguese to Africa and Brazil on 9645 clash with transmissions from Radio Liberdade (from the Portuguese Ministry of Social Communications) from Sines on the same frequency.

(BBC MS)

Mozambique - Radio Mocambique: The Beira station of Radio Mocambique has been observed broadcasting a 15 minute bulletin off domestic and world news in a vernacular (believed to be Chinhunge) at 1400 on 4815 kHz. The station later identified itself in Portuguese as the "B" Programme of the Beira studios of Radio Mocambique.

It has also been observed that the frequency of the Maputo station of Radio Mocambique has been moved from 7240 kHz to 7249 kHz.

(BBC MS)

Zaire - La Voix du Zaire: The "Voice of Zaire", Kinshasa, has announced the introduction of a new program schedule/format (effective 19th May) to enable the radio to act as an instrument of education and "Mass mobilization". A large part of the broadcasting time will be devoted to listeners participation.

The "First Service" will operate from 0400-1000; the "Second Service" from 1000-1600; the "Third Service" from 1600-2300 and the "Fourth Service" from 2300-0400.

A programme schedule summary follows:



0400-0430	News in Swahili and Tsiliba
0500-0530	Magazine programme
0600-0630	News in Lingala and Kikongo
	Economic chronicle in Swahili (Mon),
	Tsil ba (Tue), Lingala (Wed), Kikongo (Thu),
	French (Fri?)
0700	Press review (presumably in French)
1000-1030	News in Swahili and Tsiliba
1100-1130	News in Lingala and Kikongo
1200-1300	"Zaire Actualities Magazine" in French
1600-1630	News in Swahili and Tsiliba
1800-1830	"Zaire Soir" in French (replaces former 1830 bulletin)
1900-1930	News in Lingala and Kikongo
2100-2115	News in French (replaces former 2030 bulletin)
2300-2330	"Zaire Mondial" in French
0001	"Radio Tribune" in French - roundtable debate

(BBC MS)

Help wanted: The writers of the Guide to Soviet Broadcasting are looking for someone with musical knowlege to transcribe Interval Signals from tape to paper. A tape recorder (cassette or reel to reel) is needed. Also wanted are monitors with a tape recorder to monitor Interval Signals. Contact Bob Butterfield, P.O. Box 398, Belmont, Massachusetts 02178, U.S.A.

Arrivederci! Bob



# ASIA-OCEANIA

BOB BODELL - EDITOR  
5230 S.E. 48th AVE  
PORTLAND, OR 97206

DEADLINE: 15<sup>th</sup> of the month



Frequencies in KiloHertz                      Time in GMT                      month/day format  
a=approximate    l=listed    m=measured    t=tentative    \*0000=S/on    0000\*=S/off

FREQ	TIME	SIO	LOCATION	ASIA
<b>BRUNEI</b>				
4865	1044	333	JPN	R. Talivishen Brunei: Bahasa Malaysia tlk, IDs, mx, chants (Junqua 6/7).(Cleveland 5/17).....
7215	1427	433	CA	RTB: EE tlk, classical mx (Bixby 5/30)(Cleveland)
<b>BURMA</b>				
4725	1145	242	JPN	BBS: mx, tlk in Pwo Karen (Wakisaka 6/2)
<b>CHINA</b>				
2340	1145	333	WA	Fuzhou 1: CC tlk by OM, mx (Miller 6/10)
2493a	1152	121	WA	Unid Chinese w/ YL tlk (Miller 6/10)
3200	1205	232	WA	PLA 2: Amoy tlk by YL, Chinese mx (Miller 6/10)
3450	1217	242	WA	Beijing 1: CC tlk by OM, YL singing (Miller 6/10)
4045	1359	--3	CA	FLA 1: CC mx, OM tlk, // 3535 (Cleveland 5/19)
4840	1320	222	WA	PLA 2: Amoy w/ tlk, weak, QRM (Miller 6/11)
4925	1258	332	WA	Ha'erbin: CC w/ play? (Miller 6/11)
5950	1025	342	MS	Unid Chinese, YL annx, CC mx (Jones 5/19) Ha'erbin?
6290	1346	--2	CA	R. Peking: EE tlk by YL, // 6590 (Cleveland 6/2)
6540	1045	342	WI	RP: U/lang tlk, 1059 IS (Zilmer 5/23)
6955	1047	555	JPN	RP: JJ w/ nx, etc. (Makishima 5/28)
7315	1359	333	CA	RP: EE ID, IS (Mercado 5/11)
7335	1354	433	CA	RP: CC tlk, mx (Mercado 5/11) Viet listed, reb.
8240	0333	333	FL	RP: EE cmtry mx, ID, 1356* (Smith 5/16)
9940	0100	333	RI	RP: EE nx, mx (Pollard 5/14)
10262t	1320	232	CA	Beijing 2: CC tlk, "Internationale", jammed (Naylor)
11375	1138	233	MN	RP: Italian w/ tlk, ID, CC mx (Miklejewski 5/26)
11505	0515	222	CA	Beijing 2: CC tlk, 6 pips (Brookwell)(Miklejewski)
11600	0400	211	CA	RP: RR soap opera, under Nikolayevsk (Brookwell 5/20)
11650	1515	353	CA	RP: EE nx, cmtry to SEA (Miller 5/21)(Miller WA)
11660	1630	222	CA	RP: CC tlk by YL, IS (Brookwell 5/20)
15060	0109	242	MA	RP: EE nx, cmtry (Scannell 6/7)(Thompson NM)(Yajko)
15080	0202	343	PA	RP SS tlk (Yajko 5/26)
15360	0303	221	NJ	RP SS? tlk, "East is Red" (Famularo 5/26)
<b>CYPRUS</b>				
11925	2000	???	PA	BBC-Limassol: EE World Svce to E. Africa (Yajko ???)
<b>INDIA</b>				
3268	1530	232	JPN	AIR-Kohima: cmtry, TPs, ID (EE nx (Wakisaka 5/8)
3315	1535	222	JPN	AIR-Bhopal: EE nx (Wakisaka daily)
4820	*1230	222	JPN	AIR-Calcutta: IS, ID, tlk by OM (Wakisaka 6/2)
9705	1130	332	WI	AIR-Alligarh: EE/U/lang local nx, 1140* (Zilmer 5/15)
9912	2324	221	NJ	AIR-Delhi: Hindi chants (Famularo)(2050 EE, Yajko PA)
11620	2046	333	PA	AIR-Delhi: EE nx of India (Yajko 5/29)
11740	2200	322	WI	AIR-Delhi: EE nx, // 9525, 9912 (Zilmer 5/16)
15080	1720	353	WI	AIR-Bombay: Indian mx (Worman 5/25)(Bodell OR)
<b>Kashmir</b>				
3277t	1530	322	JPN	R. Kashmir: OM cmtry, EE nx, AIR ID (Wakisaka 5/9)



INDONESIA

3205	1400	332	JPN	RRI Bandung: Indo tlk, ID (Wakisaka 5/31)(Miller WA)
3223	1258	222	WA	RRI Mataram: Indo tlk, fading (Miller 6/12)
3232	1305	211	WA	RRI Bukittinggi: Indo tlk by OM (Miller 6/12)
3276*	1210	232	OR	RRI Jakarta: OM w/ Jakarta nx (Bodell 6/15)
3295	1415	332	JPN	RRI Samarinda: Indo tlk, songs (Wakisaka 5/31)
3325	1157	333	OR	RRI Jayapura: Indo annx by OM (Bodell 6/15)
3935	1226	333	OR	RRI Semarang: Indo tlk by OM (Bodell 6/15)
3960	1225	222	WA	RRI Padang: Indo? tlk, ID (Beal 5/16)
3974	1145	322	TX	RRI Surabaya: Indo mx, "Love Ambon", ID (Vokes 6/4)
3985	1231	333	OR	RRI Biak: Indo tlk by OM, mx (Bodell 6/15)
4000t	1055	222	WA	RRI Kendari: island mx (Beal 5/14)(Cleveland CA)
4719	1335	322	WA	RRI Ujung Pandang: Indo pop mx (Beal)(Miller WA)
4764	1350	--2	CA	RRI Medan: Indo w/ mx (Cleveland 5/18)
4775	1145	222	WA	RRI Jakarta: Indo w/ EE pop mx (Beal ???)
4805	1318	222	WA	RRI Jakarta: Indo w/ speech by OM (Miller 6/12)
4830	1200	423	WA	RRI Madiun: Indo ID, nx, pop mx (Beal 6/4)
4845	1335	343	WA	RRI Ambon: EE songs, annx, "LA", songs, 1402* (Miller)
4855	1215	322	WA	RRI Palembang: Indo tlk (Beal 6/4)
4870	1226	242	WA	RRI Sorong: Indo speech relay from Jakarta (Miller)
5987	1334	--3	CA	RRI Menado: Indo OM w/ local mx (Cleveland 5/18)
7110	1340	433	CA	RRI Yogyakarta: Indo w/ ads, tlk (Bixby 5/18)
9615nf	0850	433	JPN	RRI Jayapura: Indo tlk, IDs, KGEI QRM (Junqua 6/3)
11789	1100	& ---	NA	V. of Indonesia: EE tlk, cmtry, mx (Baker IL)(Mitchell CA)(Vokes TX)(Crable ID)(Rojewski WA)(Pimblett ALB)(Miklejewski MN)(Stephenson CA)(1600* in AA Hardester)
	1400			

IRAN

15084	0200	433	NJ	VOI: Farsi tlk, Persian mx (MacCoy 6/14)(Miller OH)
15135	0440	222	CA	VOI: Farsi ID, nx, // 15084 (Hardester 6/9)

I.R.A.

11785	1647	323	OR	R. Baghdad: AA tlk, mx, severe het (Bodell 6/14)
12060	1906	222	NJ	RB: 2 x 6030? w/ chants, AA tlk, mx (Famularo 5/11)

ISRAEL

9009	2000	343	NJ	IBA: EE nx, features, // 9815, 11645 (Cohen 5/23)
9435	2250	444	PA	IBA: EE w/ pop mx, 9815 (Yajko 5/18)
9815	*2000	333	NJ	IBA: EE nx (Young 6/7)(McIntosh PA)(Kasday NJ)(Bixby)
9820	2245	444	WA	IBA: EE ID, "Israel Hit Parade" (Rojewski 5/18)
11602	2305*	544	NJ	IBA: Heb tlk, ads, mx (Famularo 5/13)(Zilmer WI)
11625	*2230	434	NJ	IBA: EE nx, DX Corner (Kasday 5/23)(Beal WA)
11645	2053	444	MA	IBA: FF pgrm after 2000-30 EE (Scannell)(Earhart PA)
11690	2235	434	PA	IBA: EE w/ world nx (Yajko 5/18)
12045	2253	433	WI	IBA: EE w/ "Dx Corner", nx 2301* (Zilmer 5/16)(Yajko)
12077	2200	433	WI	IBA: Hebrew tlk, pop mx, ads (Zilmer 5/15)
15100	*2000	342	MS	IBA: IS, ID, EE nx (Jones 5/30)(Smith FL)(Yajko PA)
15460	*1200	343	FL	IBA: EE nx, 1230*, // 15100 (Smith 5/28)
15485	1220	243	PA	IBA: EE nx, wx, mx (Earhart 5/28) / (Baker IL)
15512*	1423	444	FL	IBA: Hebrew tlk, ads, ID (Smith 5/25)(Famularo NJ)
15540nf	*2200	434	PA	IBA: FF pgrm, 2230 EE (Yajko 5/16)(Zilmer WI)
17865	1206	353	FL	IBA: EE nx, cmtry, wx, ads, 1230 FF (Smith 5/10)

NIPPON HOSO KYOKAI

3377	1218	322	OR	NHK 2, Osaka: JJ tlk by OM (Bodell 6/15)
3925	1220	423	WA	NSB: JJ tlk, PNG QRM (Miller 6/11)(Cleveland CA)
3910	1112	343	TX	FEN: EE nx, wx, mx (Vokes 5/31)(Miller WA) out of order
5990	1000	444	TN	R. Japan: EE nx, cmtry (Kelly 5/15)(Miller CA)
6055	1400	--2	CA	NSB: EE w/ JJ lessons (Cleveland 5/20)
6130	1248	232	OR	NHK Kumamoto: OM/YL tlk in JJ (Snyder/Bodell 6/21)
6155	1004	333	MS	FEN: EE nx, wx, lite mx (Jones 5/17)(Cleveland CA)
7285	1100	343	TX	NHK Yamata: JJ rock mx, OM tlk (Vokes 6/8) CA)
9505	1700	323	MN	RJ: EE nx (Wallman 6/6)(Kelly TN)(Miller WA)(Miller)
9530	1053	443	MN	RJ: PP tlk, ID, 1100 into SS, // 11705 (Miklejewski)
9585	1029	333	MS	RJ: EE in GOS (Jones 5/17)(Earhart PA)(Miller CA)
9595	1158	232	OH	NSB: JJ/EE mx, ads (Miller 5/30)(Stephenson CA)
9670	0940	354	FL	RJ: EE nx, cmtry (White 5/18)(Miklejewski 6/5)
9750	0900	222	WA	RJ: EE w/ nx (Beal 6/4) unlisted, reb
11705	1630	433	WA	RJ: EE nx, ID, "DX News" (Rojewski 5/23)(Brookwell)
11815	1425	333	CA	RJ: EE nx of Japan (Shaw 6/5)
11870	1043	343	MN	RJ: IS, JJ/EE annx, Indo pgrm (Miklejewski 6/2)



JAPAN (continued)

15105	0406	252	MO	RJ: EE nx, economic tlk (Bethge 5/23)(Smith FL)
15195	0351	333	WI	RJ: Japanese mx (Czaja 5/26)(Kelly TN)
15270	*2345	333	MA	RJ: EE to NA, // 15300 (Scannell 5/17)(Yajko PA)
15310	0700	343	CA	RJ: EE nx by OM (Mercado 5/22)
15325	0800	323	IL	RJ: EE nx, cmtry, // 15430 (Baker 5/18)
15530	*0300	343	HI	RJ: EE/JJ annx, anthem, suddenly off, //s (Trubee 5/21)
17880	*0700	444	CA	RJ: EE S/on in GOS, nx (Harding 6/7)

D. P. R. KOREA

2300	1110	242	JPN	Hyesan w/ Korean tlk by OM (Wakishima 5/25)
6770	1500	343	CA	R. P'Yongyang: FF tlk, ID, mx (Naylor 5/23)
7580	1530	--2	CA	RP: EE w/ S/off annx (Cleveland 5/21)
9420	2030	322	WA	RP: EE mx, cmtry, ID (Rojewski 5/21)(Miller WA)
9510	1345	433	CA	RP: EE tlk, ID, anthem (Birby 5/18)(Zilmer WI)(Beal WA)
9977	1705	343	CA	RP: AA tlk, mx (Naylor 5/31)
11535	1005	322	MN	RP: EE nx, tlk by YL, // 9420 (Miklejewski 6/2)
15650nf	2200	353	WI	RP: KK tlk, mx, // 11535, 2200-2248 (Zilmer 5/25)

REPUBLIC OF KOREA

3140	1336	433	JPN	HLDA-Cheju-do: 2 x 1570, CC w/ lite mx, ID (Junqua)
6348	1030	342	WI	V. of Echo of Hope: KK? tlk, mx (Zilmer 5/23)
9635nf	1225	444	JPN	RK: KK pgrm, 1230 AA, 0900 CC, 1130 EE, // 7150, 11860 (Junqua 6/2)...ex-9640? reb.....
9640	1535	454	TN	RK: EE pgrm (Kelly 5/11)(Rojewski WA)(Miller WA & CA)
11860	1814	333	KS	RK: EE nx, IDs (Boyer 6/1)(Baker IL)(Kelly TN), and in SS @ 1030 (Miklejewski MN)(Beal WA).....



KUWAIT

1184nf	*1700	222	OH	RK: EE w/ pop mx, 2000*, ex-11940 (Miller 6/6)(Legge)
15345	*0500	222	CA	RK: flute IS, ID, pop mx, Soviet QRM (Mitchell 6/3)

RADIO KUWAIT

MALAYSIA

4985	1341	--2	CA	RM-Penang: EE nx, mx, CW QRM (Cleveland 6/7)
6195	1300	343	NM	BBC-Tebrau: EE w/ TPs, world nx, cmrty (Thompson 6/5)
9665	1530	322	CA	RM-KL: EE nx, wx, Malay mx (Stephenson)(Rojewski)
9740	1246	443	JPN	BBC-Tebrau: EE tlk, mx (Makishima 5/30)
11750	1550	333	ALB	BBC-Tebrau: EE w/ cricket (yawn!) results (Pimblett)
11955	*1100	222	JPN	BBC-Tebrau: IS, nx in JJ (Makishima 5/28)
17880	0001	142	FL	BBC-Tebrau: world nx (White 5/16)

PAKISTAN

5060nf	1441	433	JPN	RP: Urdu w/ subcont mx, tlk, ID, ex 5065? (Junqua)
9780	2100	222	MA	RP: EE w/ nx, tlk, pop mx (Pierce 5/19)
11670	2033	353	FL	RP-Karachi: EE, 2100 FF (White 5/18)(Cohen NJ)(Beal WA)(Miklejewski MN)(Zilmer WI).....
15325	0200	232	IL	RP: U/lang tlk, EE ID, to Indo (Baker 5/18)(Zilmer WI)
15521*	*0500	242	OR	RP-Islamabad: Qur'an, Urdu nx, // 17830 (Snyder/Bodell)
17665	1503	233	MI	RP-Islama: ID, Urdu? nx, mx (Brooker 5/16)(Bodell OR)
17750	0640	333	HI	RP-Karachi: Urdu ID, nx by OM (Trubee 5/29)

PHILIPPINES

3345	1400	332	JPN	FEBC: EE w/ relig pgrm (Wakisaka 5/21)(Bodell OR)
6030	1245	222	WA	FEBC: mx pgrm, EE ID @ 1300 (Beal 5/10)
7225	1115	333	TX	FEBC: EE relig pgrm, 1130 into JJ (Vokes 6/9)(Naylor)
9545	2200	333	NM	VOA-Poro: EE nx, TCs, orch, mx (Thompson 6/5)
9580	0700+	322	CA	VOP: EE nx, mailbag, etc. (Stephenson)(Rojewski WA)(Miller WA)(Jones MS)(Miklejewski MN)(Cleveland CA)
9615	0859	322	JPN	PBS: EE ID, nx, // 6170 (Junqua 6/2)
11725	1342	333	CA	R. Veritas: EE tlk, freqs, IS, mx (Cleveland 5/14)
11890	1129	322	OH	FEBC: EE ID, fres, U/lang tlk (Miller 5/13)(Beal WA)
11920	1035	433	JPN	FEBC: JJ tlk, // 11890 (Makishima 5/28)
15280	0100	333	JPN	R. Veritas: EE to SEA, IS, ID, tlk (Ishizaki 6/6)
15290	*2200	232	CA	VOA-Tinang: EE w/ nx in Special EE (Harding)(Miller OH)
17810	0028	242	FL	FEBC: EE relig hymns, ID, 0030 nx (White 5/20)

RYUKYU ISLANDS

7165	1230	343	NM	VOA-Okinawa: EE w/ "VOA Jazz Hour", nx (Thompson 5/28)
------	------	-----	----	--

SABAH

4970	1346	--2	CA	R. Malaysia Sabah: BM w/ Islamic chants (Cleveland)
------	------	-----	----	---

SARAWAK

4835	1155	322	WA	RMS-Kuching: BM nx, ID (Beal 6/11)(Beal WA)
4950	1349	--2	CA	RMS-Kuching: CC tlc by OM (Cleveland 5/30)(Miller WA)
5030	1450	343	WA	RMS-Kuching: Bidayah: annx, mx (Miller 5/30)
6060	1245	433	JPN	RMS-Miri: Kenyah w/ ID, tlc, // 3385, 6 pips @ 1300 then into relay of Kuching, // 3385 (Junqua 5/26)...
7270	1305	222	WA	RMS-Kuching: Kayan? tlc, mx (Beal 5/22) // 3385, 6060?

Radio Malaysia SarawakSAUDI ARABIA

11780	1730	222	MA	BSKSA: AA mx, tlc (Pierce 5/17)
11795	0513	433	CA	BSKSA: AA w/ local vocals, 0515 ID (Birby 5/22)
15245	*1700	444	OR	BSKSA: almost cont. Qur'an, 1700-2000 (Bodell daily)

SINGAPORE

5010	1344	--2	CA	R. Singapore: EE nx by YL (Cleveland 6/4)
5052	1344	333	CA	RS: EE w/ pop oldies (Cleveland 5/17)
11940	1630*	433	CA	RS: EE w/ pop mx (Stephenson)(Miller WA)(Rojewski WA)

SRI LANKA

9720	1630	333	WA	SLBC: EE w/ "Revival Time", ID, mx (Rojewski ???)
11800	1435	322	CA	SLBC: Hindi mx, tlc (Mitchell 5/31)(Beal WA)(Birby)
15185	0256	353	FL	VOA-Colombo: lite mx, U/lang tlc, ID, mx (White 6/10)
15425	0130	323	IL	SLBC: EE w/ ID, "Back to the Bible" (Baker)(White FL)

SYRIA

9541	2035	222	FL	R. Damascus: EE nx, prgm to Europe, QRM (White 5/15)
------	------	-----	----	--

TAIWAN

11825	1402	433	JPN	VOFC: JJ nx, ID (Makishima 5/28), 1325 in CC (Beal WA)(Miklejewski MN).....
17890	0211	242	FL	VOFC: EE tlc on Taipei (White 5/20) Broadcasting Corporation

TURKEY

9515 &	2200-	---	NA	VOT: EE w/ nx, pop & Turkish mx, DX prgm (Bonds NY) of China
11880	0115			(Young NJ)(Famularo NJ)(Czaja WI)(Shaw CA)(Cohen NJ) (Miklejewski MN), 2135 FF (Sarnhart), 0435 TT (Birby)

**T R T**UNION OF SOVIET SOCIALIST REPUBLICS

3492	1108	322	JPN	R. Moscow (site?): cont. lite mx Mayak IS (Junqua 5/16)
3960	0838	333	JPN	RM (site?): RR tlc, 0859 "Govorit Baku", 0930 "Govorit Moskva", 1000 "Govorit Nikol'yevsk" (Junqua 5/14)
4040	1345	--2	CA	RM via Vladivostok: RR w/ classical mx (Cleveland)
4485	1120	423	WA	RM via Petro Kam: RR mx (Beal 6/4)(Miller WA)
4610	1345	--3	CA	RM via Vladivostok: RR w/ opera mx (Cleveland 6/9)
4825	1330	333	JPN	RM via Vladivostok: KK w/ IS, ID, nx (Wakisaka 5/19)
5015	0830	444	CA	RM via Vlad: RR tlc, mx (Harding 6/6)(Miller WA)
6020	1100	222	TX	RM via Petro Kam: IS, RR mx (Vokes 5/25)
6190	1238	444	CA	RM via Khabarovsk: RR play, 5 time pips (Naylor 5/14)
7150	*0030	333	PA	R. Kiev: EE ID, freqs (McIntosh 4/30) Euro site?
9500	0400	222	CA	RM via Magadan: RR tlc, lite mx, ID (Harding 6/7)
9675	0140	433	KS	RM (site?): EE w/ letters, mx (Boyer 6/4)
9760	1733	242	CA	RM (site?): RR tlc, Mayak 2 ID @ 1800 (Naylor 5/31)
11600	0240+	222	CA	Nikolayevsk USB feeder, various prgms (Brookwell)
11790	0302	333	WA	R. Kiev (site?): EE w/ nx, cmtry, DX prgm (Miller)
11830	0515+	222	CA	RM (site?): CC tlc, RM, P & P ISes (Brookwell 5/19)
15100	0201	353	MS	RM via Vlad: EE nx (Jones 6/5)(Mercado CA)(Harding)
15110	0233	353	WA	RM (site?): EE nx, cmtry, mx (Miller 6/8)
15130	0744	444	JPN	Radiostantsiya Tikhyy Okean: RR ID, tlc (Junqua 6/6)
	0800	353	CA	RM via Petro Kam: EE to ANZ, // 15260 (Harding 6/5)
15505	0131	343	FL	RM (site?): EE nx (White 5/16)
17745	0730	232	CA	R. Station Pacific Ocean: RR ID, //s (Harding 6/4)
17825	*0700	252	CA	RSPO: RR ID, mx, // 11745, 17810, 17720 (Harding 6/4)

Azerbaijan SSR

9840	0406	232	OR	R. Baku: weak w/ RR instrumentals (Bodell 6/5)
------	------	-----	----	--

Georgian SSR

9760	2330	222	VA	RM via Tbilisi: SS to Cuba, // 9745 (Legge 6/10)
11710	0100	242	VA	RM via Tbilisi: SS to Chile, // 11830, etc. (Legge)
11805	2100	232	VA	RM via Tbilisi: EE to UK, // 7390, 9610, 9720 (Legge)

U. S. S. R. (continued)

<u>Kirghiz SSR</u>					
9710	0000	222	VA	RM via Frunze: PP to Brasil, 2230-0330 (Legge 5/10)	
<u>Tadzhik SSR</u>					
7300t	2130	343	FL	RM via Dushanbe: ½ pgrm in U/lang (not EE) (White 5/17)	
<u>Turkmen SSR</u>					
15185	1000	232	FL	RM via Ashkhabad: EE to SEA, // 15295 (White)(Legge VA)	
<u>Uzbek SSR</u>					
15115	1200	242	VA	R. Tashkent: EE pgrm, ex-6025? (Legge 5/27)	

VIETNAM

6905	1357	443	JPN	R. Viet Bac (per Ugusa): Viet w/ mx, tlk (Junqua 5/31)
7373	1045	222	WI	Hanoi 1: VV tlk, IS, // 10060 (Zilmer 5/17)
7470	1050	222	WI	Hanoi 2: VV tlk, // 7417, 10226 (Zilmer 5/23)
7512	1100	222	WI	V. of Vietnam: Cambodian (1) tlk (Zilmer 5/17)
10040	*1000	342	WI	VOV: VV tlk, 1100 into U/lang (Zilmer 5/17)
10060	1045	232	WI	Hanoi 1: VV tlk, mx, // 7373 (Zilmer 5/17)
10226	1100	222	WI	Hanoi 2: VV tlk, // 7417, 7470 (Zilmer 5/17)
15010	1840	322	WA	VOV: EE cmtry, ID, mx (Rojewski 5/23)(Beal WA)(Zilmer)

YEMEN ARAB REPUBLIC

9780	2145	322	MA	R. Sana': AA nx, Qur'an, ID anthem, 2158* (Pierce 5/19) (White FL)
------	------	-----	----	---

PEOPLE'S DEMOCRATIC REPUBLIC OF YEMEN

11770	1435	322	WA	DYBS: AA tlk by OM, ID (Beal 5/10)
-------	------	-----	----	------------------------------------

**OCEANIA**



AUSTRALIA

					C=Canarvon	L=Lynnhurst	S=Shepparton
4920	1114	242	OH	ABC-Brisbane: EE nx, mx (Miller 6/6)(Miller WA)			
5995	0945	333	PA	RA (L): EE w/ nx, mx, interviews (McIntosh 6/9)(Miller WA)(Stephenson CA)(Earhart PA)(Miller CA).....			
6005	1300	333	NM	RA (L): EE nx, "Focus on Australia" (Thompson 5/24)			
6090	1131	242	OH	ABC-Sydney: EE w/ pop mx, cmtry (Miller 6/6)			
6140	1348	--2	CA	ABC-Perth: EE w/ horse race (Cleveland 5/21) WA)			
6150	1042	322	MN	ABC-Melbourne: EE w/ nx, mx (Miklejewski 6/7)(Miller WA)			
7235	0950	343	PA	RA (S): Indo, then 1000 EE (Earhart 5/9)(Smith FL)			
7290	1009	343	PA	RA (S): EE w/ "Popular Songs" (Earhart 5/9)			
9515	1149	344	WI	RA (S): EE mx, nx (Woltman 5/28)(Miklejewski 6/2)			
9530	0750	333	HI	RA (S): EE w/ "Listeners' Club" (Trubee 5/9)			
9540	1805	333	MN	RA (S): EE nx, pgrm annx, mx (Miklejewski 5/22)			
9560	1040	343	PA	RA (C): Mandarin w/ mx, tlk (Earhart 5/9) CA)			
9570	0900	444	PA	RA (S): EE nx, // 9530, 9515 (McIntosh)(Zilmer)(Miller WA)			
9580	1100	444	NJ	RA (S): EE nx, mx (Young 5/24)(Worman MN)(Baker IL)			
9610	1600*	444	ALB	(Estes MS)(Kasday NJ)(Kelly TN)(Miller CA)..... ABC-Perth: EE nx, nx (Pimblett 6/4)(Smith FL)(Bixby CA)(Famularo NJ)(Miller WA)(Cleveland CA)(Yajko PA)...			
9680	1040	343	MN	ABC-Melbourne: "Sunday-Nite R-2", play, nx (Miklejewski)			
9760	*0959	444	JPN	RA (S): IS, "Waltzing Matilda", JJ pgrm (Makishima)			
9770	1445	343	WA	RA (S): EE w/ "DXers Calling" (Miller)(Miller CA)(Smith)			
11780	0300	343	MO	RA (S): EE world nx, "Editorial Opinion", 0330 Aust nx (Bethge)(Pimblett ALB)(Earhart PA)(Shaw CA)(Thompson)			
11810	*0959	433	JPN	RA (S): IS, ID, etc, JJ pgrm (Makishima 5/24)			
11845	0500	333	CA	RA (S): EE nx, on former NZBC freq (Brookwell 5/23)			
11880	2210	222	HI	ABC-Melbourne: piano mx, 2215 ID (Trubee 5/25)			
11965	1600	433	WA	RA (S): EE ID, pop mx (Rojewski 5/23)(Pimblett ALB)			
15140	0415	343	WI	RA (S): EE w/ cooking pgrm (Czaja 5/26)			
15160	0330	443	WI	RA (L): EE nx, mx (Worman 5/20)(Mercado CA)(Estes MS) (Jones MS)(Earhart PA)(Zilmer WI)(Hickman OR).....			
15190	0430	433	CA	RA (S): EE Aust nx (Harding 6/4)(Miller CA & WA)			
15230	0325	333	CA	ABC-Melbourne: EE w/ stock market rpt (Shaw 5/28)			
15240	0229	353	FL	RA (L): EE w/ IS, ID, freqs, nx, mx (Smith)(Shaw CA)			
15290	0405	444	WI	RA (S): EE nx, mx, pgrm skeds (Woltman 6/2)(Shaw CA)			
15320	0145	322	NJ	RA (S): EE w/ "Mailbag", nx (MacCoy 6/13)(McIntosh PA) (Somers CA)(Estes MS)(Earhart PA)(Smith FL)(Thompson)			
15355	0240	322	CA	RA (S): "DXers Calling" (Somers 6/5) GMT Sundays, reb			

AUSTRALIA (continued)

15415 0620 343 HI  
17795 0125 232 NY  
117870 0730\* 353 CA

RA (C): EE w/ 0629 ID (Trubee 5/28)(Zilmer WI)  
RA (S): EE to NA (Kannry 6/12)(Scannell MA)(Pollard RI)(Smith FL)(Stephenson CA)(Yajko PA).....  
RA (S): EE pop mx (Harding 6/6)(Jones MS)(Miller CA)

NEW CALEDONIA

3355 1055 232 JPN  
7170 0945 343 PA

R. Noumea: FF w/ tlk, mx (Wakisaka 5/25)(Snyder/Bodell)  
RN: FF w/ possible play (Earhart 5/9)

NEW HEBRIDES

3945 0713 232 OR

NHBS: pop & lite mx (Snyder/Bodell 6/21)

\*\*\*NEW ZEALAND\*\*\*

6105 0845 342 MS

RNZ: EE nx, wx, radio play, now relaying National Pgrm

9585 0547 343 OR

(Jones 6/10)(Miller WA)(Hickman OR)(Bodell OR).....  
RNZ: mx, EE annx, nx in Maori (Bodell 6/14)

11705nr 0433\* 444 OR

RNZ: National Pgrm w/ NZ-Ireland rugby (Bodell 6/5)  
(Sparks 6/5)(Hardester 6/5).... "Auckland being heard on shortwave, this is the National Program ." (Sparks)  
RNZ: mx, TCs on Nat. Pgrm (Hardester 6/7) Z 6/9)

15380 0152\* 353 CA

PAPUA NEW GUINEA

2428 1155 131 OR

R. New Ireland: weak w/ lite mx (Snyder/Bodell 6/21)

2468 1200\* 333 OR

R. No. District: mx, Pidgin annx, Anth (Snyder/Bodell)

3220 1200\* 333 WA

R. Morobe: Pidgin annx, ID by YL, anthem (Miller 6/6)

3245 1132 232 OR

R. Gulf District: Pidgin annx, mx (Snyder/Bodell 6/21)

3260 1145 444 WA

R. Madang: EE/Pid. annx, freqs, 1200\* (Miller 6/11)

3275 1200\* 232 OR

R. So. Highlands: anthem, S/off (Bodell 6/15)

3305 1136 232 OR

R. West. District: c & w mx (Snyder/Bodell 6/21)

3322 1157 333 OR

R. Bougainville: Pidgin w/ island mx, 1200\* (Bodell)

3360 1145 333 OR

R. Milne Bay: Pidgin annx, c & w mx (Snyder/Bodell)

3385 1130 322 TX

R. E. New Britain: Pidgin w/ mx, 1200\* (Vokes 5/31)

3925 1230 333 WA

NBC-Port Moresby: EE nx, sprts, under NSB (Miller 6/11)

4890 0935 141 PA

NBC: EE nx, tlk (McIntosh 6/6)(Miller OH)(Miller WA)

9520 0655 433 CA

NBC: EE/Pid. w/ requests (Stephenson 5/31)(Miller CA)

SOLOMON ISLANDS

5020 0946 433 WA

SIIBS: EE w/ local nx, mx (Miller 6/12)

TAHITI

6135 0434 333 ALB

RT: Tahitian tlk by OM, island mx (Pimblett 5/22)

11825 & 1600- --- NA

RT: FF/TT tlk, requests, island mx, 1900 EE nx

15170 0730

(MacCoy NJ)(Harding CA)(Worman WI)(Somers CA)(Shaw CA)  
(Earhart PA)(Stephenson CA)(Naylor CA)(Famularo NJ)etc.

CLANDESTINE

3549\* 1220 333 OR

R. Dili: OM tlk in U/lang, pop mx (Bodell 6/15)

3850 1125 232 OR

E. Timor Provisional Gov Sta: Indo mx (Snyder/Bodell)

4557 1350 --4 CA

VRPR: KK tlk, not // 4115 (Cleveland 6/9) Z 6/21

7080 1203 222 OR

V. of People of Malaya: YL tlk in SEA lang (Bodell)

11830 1446 333 CA

V. of Malayan Rev: EE w/ martial mx, ID (Mitchell 5/31)

UNIDENTIFIED STATIONS

4115 1355 --2 CA

YL tlk in RR? dialect, ID? (Cleveland 6/9) not VRPR?

11790 1600\* 211 CA

Unid w/ So. Sea mx (Brookwell 6/4) is V. of Indo.

21715 0940 343 HI

sub cont mx, American show tunes, 1032\*, no annx,  
also 0645-0700\*, no annx (Trubee 5/25+) Algeria listed

----- D A T E L I N E -----

AFGHANISTAN - despite earlier reports that RA has dropped 4775 it is still being heard in EE from 1400 to 1430.....SCDX # 1383, 6/23

AUSTRALIA - feeder transmitters have been recently observed on 9450 and 9210 in EE (1430-1730 and 1800-2250), believed to be feed programmes to the Canarvon transmitters.....BBCMS, copyright items

BANGLADESH - the External Service of Radio Bangladesh in English (1230-1300), is currently heard on 15268 (ex-15160).....BBCMS



CLANDESTINES - Voice of the Malayan Revolution now broadcasts in Mandarin on 11830 and 15790 (0515-45, 1115-45, 1330-1400); and on 7305 and 15790 (2245-2315). Voice of the People of Malaya is a new clandestine station on 7084v, broadcasting twice daily in Malay, Chinese, and ??? (2130-2315 and 1200-1345), with combat reports in its programming.....BBCMS

INDIA - AIR announced it will begin broadcasting slow speed news in Hindi as well as in English in its domestic service. English is 0850-0915, Hindi 0915-0940; news broadcasts at 0930 in Hindi and English are discontinued....BBCMS

IRAN - R. Tehran announced that its German Service (1900-1930) would be shifted to 11770 from 9022 on June 20.....SCDX # 1383

IRAQ - R. Baghdad's External Service, back on 9745 from 9758 has "Voice of the Masses" in Arabic, 1500-1930 (ex-1630-1930)....Baghdad's Russian prgm (1900-2000), and at other times in Arabic, now alternates between 7180 and 7196 / BBCMS

NEW ZEALAND - Partly due to the flood of protests from short wave listeners around the world, Radio New Zealand resumed SW broadcasting on 6/5 with a relay of the NZ/Ireland rugby match (the National Programme). In a press release the Minister of Broadcasting, Mr. Templeton, outlined other reasons for the return to SW, including the fact that a SW relay of the National Programme would cost less than the Telex and tapes services to the Pacific Islands, etc., which were envisaged as a replacement for the SW services. Mr. Templeton also pointed out that the National service includes programmes of interest of the Pacific Islands including news in Samoan and Cook Islands/Maori...via Snyder

PHILIPPINES - the latest announced sked for R. Veritas in English to So./So. East Asia is as follows: on 11725 and 15280 (0100-0200); and on 9550 and 11725 (1400-1500).....via Yasuo Ishizaki, Japan

QATAR - QBS may supplement its facilities with a new station to improve reception to all parts of the world, operational in 20 months'.....BBCMS

SAUDIA ARABIA - the External Service for BSKSA, Jiddah, has this current sked: (0500-0700) in FF on 11855; (1100-1250 from 1000 Th/Fr) in EE on 11855; (1300-1355) in Indo on 15115; (1400-55) in Urdu on 17740; (1500-55) in Persian on 11825; (1600-1700) in Arabic, "Call of Islam" on 9670; (1600-55) in Swahili on 21520; (1700-1900) in FF, (1900-2200) in EE, both on 11855.....the "Holy Qur'an" Station now has this sked; (0300-0500) -announced-; (0630-1030 Fri only) on 9730, 17755; (1400-1700) on 21525; (1700-2000) on 15425...BBCMS

SINGAPORE - According to the WRTH Newsletter the BBC relay will be moving from its site in Johore, Malaysia, to the island of Singapore within the next three years, following termination of BBC's lease at Tebrau. The new facilities are expected to include eight high powered transmitters which will be transferred in stages from the Tebrau site.....via Barry Harding

E. TIMOR - reports from Darwin of resumed broadcasts from the station operated by the pro-independence FRETILIN forces, heard 1030-1200 Wed, Fri, Sun. no frequency was given.....David Foster via Bob Yeo via NU

E. TIMOR - Jakarta Radio announced that the Provisional Government of East Timor plans to set up parliament and establish 13 district popular assemblies within the month, and that President Suharto would officially announce the integration of East Timor with Indonesia on 8/15, the day before National Day.....R. Australia News 5/26

I'm really running late this month, having spent the last few days visiting with our good friend from San Jose, DXoug Snyder....We all know that July is America's 200th birthday, and it is also SPEEDX's birthday too. We hope that over the past few years SPEEDX has helped contribute to greater world friendship and better understanding....Before I close I want to thank the 63 reporters who supported A/O this month, and welcome the following new contributors: Eugene Bonds, Tom Czaja, Barry Harding, Rich Mitchell, Satoshi Wakisaka, Dennis West, Charles Young; and from last month: Eunice Pollard, Jim Wallman, Jeff Worman.....73, .....6/23/76

# WORLD SERVICE STATION SKEDS

EMISSIONS

## PROGRAMMI

Editor:

TRASMISSIONI

BULLETIN DE PROGRAMMES

LARRY TALBOT

PROGRAMS

ENGLISH SERVICE

N84 W15119 Knoll Terrace  
Menomonee Falls, WI 53051

SERVIZIO

PROGRAMME SCHEDULE

Deadline: 15th

COMUNICATI NEL CORSO

### CURRENT ENGLISH SCHEDULES TO NORTH AMERICA

COUNTRY	STATION	TIMES (GMT)	FREQUENCIES	REPORTERS
Albania	R. Tirana	0000-0030 0130-0200 0230-0300 0330-0400 0430-0500 1100-1130 1100-1300	7065, 9750 6200, 7300 6200, 7300 6200, 7300 7300 9500, 11895 9580	Watts      Thompson
Australia	RA	0100-0300	15320, 17795	
Austria	ORF	2300-0400 0400-0600	6155, 9770, (ECNA) 6015 (WCNA)	Direct
Belgium	ORU	0015-0045	9725	Harding
Bulgaria	R. Sofia	0200-0230 0400-0430	9700 9700	Watts
Canada	RCI	0100-0157 0400-0600 1115-1215 2157-2400	6085, 9650 9655, 11765 5970-9655 6040	Bernstein Benjamin Rogers Lunstrum
China, P.R.	BBC relay R. Peking	1600-1730 0000-0100 0100-0200	9580 (1745 Sun) ECNA 11675, 11945, 15060 7120, 9780, 9940, 11945, 12055	Wood  Famularo
The United States of America		0200-0300 0300-0400 1200-1300 0300-0500	9940, 12010, 12055 7120, 9780 11685 WCNA 9460, 11650, 12055, 15060	Crews Bernstein Thompson, Harding
Cuba	RHC	2050-2150 0100-0450 0100-0600 0330-0600 0630-0800	11865, 17750 11725, 11930 11725 11760 9525	Benjamin Famularo BBCMS
Czechoslovakia	R. Prague	0100-0157 } 0300-0357 }	{ 5930, 7345, 9540 9630, 9740, 11990	Radtke BBCMS
Ecuador	HCJB	1215-1230 1230-1630 0040-0300 0300-0500 0500-0700	11745 11745, 15115 9560, 11915 6095, 9560, 11915 6095, 9560	Smith Harding
England	BBC	1500-1615 2115-2330 2115-0330 2300-0330 2300-0430 1100-1330	17840 11780 9580 9510* 7325 (*9510 is VOA ) 6175, 5975 (Greenville xmtr) 5990 (from 0030-0330)	Direct Earhart
Finland	R. Finland	1400-1430 2300-2330	15185, 15110 15185, 15110	Harding Wilson Yajko, Kasday
Greece	EPT (Avlis)	0015-0030 0215-0230 1215-1230 1515-1530	9760 9760 9520 9520	Cleveland
Germany, F.R.	DW	0130-0150	6040, 6075, 6100, 9565 9605, 11865 6100 (Malta) 6185, 9545	Watts Earhart
Germany, G.D.R.	RBI	0530-0550 0100-0145 0230-0315 0330-0415	9730 (ECNA) 9730 (ECNA) 11840, 11890, 11970 (WCNA)	Straumanis Harding



Ghana	GBC	2000-2100	11850	Perry
Holland	RN (ECNA)	2130-2250	9715 11730	Young, Yajko
Hungary	R. Budapest	0200-0230	6000, 7215, 9585, 9833	
		0300-0330	11910, 15220, 17710	Tu-Su.
		0400-0415	same freq, daily	Bernstein
			same freq, W&S	Radtke
Israel	IBA	0500-0515	7413, 9435, 9815	Harding
		1200-1230	11655, 15100, 15485, 17685	Earhart
		2000-2030	9435, 9815, 11645	Smith
		2230-2300	9435, 9815, 11625, 12045	
			Bernstein, Thompson,	
Japan	R. Japan	2345-0045	15270, 15300	Boyd, Wilson
		0130-0230	15195, 15420	Yajko
			17725, 17825	Thompson
Netherlands Ant.	RN	0200-0320	6165	★ Talbot
		0500-0620	6165, 9715	
Norway	R. Norway	1400-1430	15175 (Sun)	Yajko
		1600-1630	15175, 17800 (Sun)	
		1800-1830	15175 (Sun)	
		2200-2230	15175 (Sun)	
		0000-0030	9645, 11860, 15175 (Mon)	
		0200-0230	9645, 11860 (Mon)	
		0400-0430	9645, 11860, 11870 (Mon)	
		0600-0630	11870 (Mon)	
Philippines	FEBC	1100-1130	7225	Benjamin
		0800-1000	11920	
		1100-1130	11920	
		2300-0000	15440	
		2300-0100	17810	
Poland	Polskie R.	0200-0400	5995, 6095, 6135	Bixby
			6155, 7125, 7145	Smith
			7220, 7285, 9525	Radtke
			9540, 9675, 11800	
			11815, 11840, 11955, 15120	
Romania	R. Bucharest	0130-0230	5990, 6155, 6190	Watts
		0400-0500	9570, 9690, 11775, 11940	
S. Africa	RSA	2226-2320	4875, 9585, 11900	Owsley
	Harding, Gebhardt, Yajko, Bernstein, Thompson, Kannry			
Spain	RNE	0100-0400	6065, 11800	Bodell
	Thompson, Rojewski, Famularo, Harding			
Sweden	RS	0030-0100	11955	Watts
		0230-0300	9695, 11705	
		1230-1300	15305	
		1400-1430	15305	★
		2300-2330	6120, 9695, 11705	
Switzerland	SBC	0145-0215	5965, 6135, 9725, 11715	Harding
		0430, 0500	9725, 11715	Bernstein
		1315-1345	15140	
Taiwan	VOFC	0200-0350	11825, 15345, 17890	
		1830-1930	9510, 11860, 15370	Rojewski
		2000-2100	17720	Straumanis
Turkey	VOT	2200-0030	9515	Watts
USSR	R. Kiev	0030-0100	6020, 7180, 7205, 9600	
			9635, 9665, 11690, 11735	
			11850, 12040, 12050, 15100	
			15210, 15245, 17720	
		0300-0330	6020, 7150, 7205, 7390	
			9610, 9635, 11790, 11960	BBCMS
			12040, 12050, 12070, 15210	Lunstrum
			15245, 15505	Radtke
(Sa-Su)	R. Vilnius	2230-2300	9655, 9720, 11900	BBCMS
(Su-M)		0030-0100	7150 7380 9655 9720 11900	
	R. Yerevan	0325-0330	11690 11870 12000 15100	
		(Su-W-Th-Sa)		BBCMS Mullen
Vatican	Vatican R.	0100-0115	5995, 6105, 9605	Wood
		6165 & 11845	discon. Bernstein, Lunstrum, Harding	



Thanks for the tremendous response for my first effort. Only have room for EE to NA this month. I also have R. Moscow current sched but it takes too much space. If anyone wants a copy just drop me a card. Please be sure all skeds are dated or indicate date recd or heard. Want info on new freqs? Subscribe to SPEEDXGRAM. See you next mo. 73 Larry Talbot

# UTILITY REPORT

Deadline: 15th of the month



EDITOR:  
KEN COMPTON  
7 MOUNT VERNON STREET  
BRIGHTON, MA 02135

200th Anniversary  
UNITED STATES OF AMERICA  
1776-1976



5th Anniversary  
SPEEDX  
1971-1976



John Walters-NJ very kindly sent the following latest list of transmitter locations for the NBT/GXH/AOK/NRK/NGR/NAM/NSS/NAR markers:

- NST - Londonderry, No. Ireland: 7504.5 and 12691 kilohertz
- GXH - Thurso, Scotland: 3724 khz
- AOK - Rota, Spain: 5917.5 and 7705 khz
- NRK - Keflavik, Iceland: 5167 and 8518 khz
- NGR - Nea Makri, Greece: 4623 and 13372.5 khz
- NAM - Norfolk, Virginia, U.S.A.: 16180 and 20225 khz
- NSS - Annapolis, Maryland, U.S.A.: 8090 and 12135 khz
- NAR - Key West, Florida, U.S.A.: 5870 and 25590 khz

Long wave enthusiasts will be interested to know that SPEEDXer Bill Trubee, frequent contributor to this column, has recently become president of the Long Wave Club of America. The price of membership in this club could hardly be lower: 12 business size SASEs mailed to the publisher John Clements 11425 Albers St. #5 North Hollywood, CA 91601. Don't send the envelopes to Bill, although he'd be happy to answer your questions about the club (but please enclose an SASE).

All times GMT		LOGGINGS		All freqs in khz	
		North America			
ALASKA:	4577.5	0837	NRW Cape Sarichef Loran wkg NRW USB (Chabak-CO)		
		0907	NRW2 USCG Loran St Paul Is. AK wkg NRW1 & NRW3 USB (Chabak-CO)		
		0910	NM22 Attu Loran wkg NRW2 USB (Chabak-CO)		
	5317	0717	NRW2 St. Paul Loran wkg NRW USB (Chabak-CO)		
	5589	0828	Anchorage Aeradio YL EE tfc USB (Chabak-CO)		
	6521.8	0904	NOJ USCGAS Kodiak marine info bcst USB (Chabak-CO)		
	6738	0917	AKA Elmendorf AFB Skyking bcst USB (Chabak-CO)		
	6935	0851	NRW1 USCG Loran Sitkinak Is. wkg NRW USB (Chabak)		
	7442.5	0539	NRW USCG Cape Sarichef Loran wkg NRW1 USB (Chabak)/		
CANADA:	6431	1915	CFH Navy Ellershouse NS wx bcst CW (Cook-MN)		
	8675	0145	VAI DOT Vancouver FF wx CW (Cook-MN)		
	8709	0128	VGS DOT Halifax V mkr CW (Somers-CA)		
	8722	1550	VAI DOT Vancouver BC CQ mkr CW (Somers-CA) 1551 (Thompson-NM)		
	12876	2325	VAI DOT Vancouver V mkr CW (Trubee-HI)		
	12921	2333	CKN Vancouver Military V mkr CW (Trubee-HI)		
	12990	0115	CFH Navy Ellershouse NS wx CW (Cook-MN)		
	13272	2224	Gander VOLMET OM EE wx AM (Cook-MN)		
U.S.A.:	2182	0623	NMQ USCG Long Beach OM EE tfc w/"Monte Carlo" SSB (Owsley-CA)		
	2670	0351	NMA USCG Miami FL OM Notice to Mariners SSB (French-MD)		
	4332	0325	WCC RCA Chatham MA Press bcst CW (Cook-MN)		
	4428.6	0145	WOM ATT Ft Lauderdale FL wkg "Bolero" USB (Cook-MN)		
	4467.5	0121	RED CHIP CAP TN wkg Blue Chip, KI4448 USB (Cook-MN)		
	5320	2325	NIK USN Cape Cod MA V mkr CW (Olsson-CT)		
	6210	1214	KMB Houston TX wkg WY6630 "Mr. Jim" SSB (Jones-MS)		





6210a	1227	WRI Magnolia Marine Transport Jackson MS wkg WZD9783 SSB (Jones-MS)
6455	1705	WFM Ancom Inc. Jeffersonville IN tfc USB (Cook-MN)
6924.5	2237	KKN50 State Dept Wash DC QRA mkr CW (Compton-MA)
7920	0323	Blackbird MO G&P mobile tfc SSB (Owsley-CA)
8090	0212	NSS USF Annapolis MD multi-call V mkr CW (Compton)
8465	2150	NMN USCG Portsmouth VA CQ mkr CW (Thompson-NM)
8467	0215	NOM USCG Tng Ctr Alameda CA CQ mkr CW (Cook-MN)
8502a	2350	NIK USN Cape Cod MA V mkr CW (MacLennan-ONT)
8514	0102	WSL ITT Amagansett NY wkg "Florentia" CW (Cook-MN)
8575	0055	NMC USCG San Bruno CQ tfc CW (Cook-MN)
8610	0101	WSC RCA Tuckerton NJ V mkr CW (Somers-CA)
8993	2327	AFES MacDill AFB FL a/c tfc USB (Cook-MN)
8658	0106	WSL ITT Amagansett NY CQ mkr CW (Somers-CA)
8742	2350	KPH RCA Bolinas CA V mkr CW (Trubee-HI)
8754.4	1430	WOO Oceangate R. NJ wkg "Leonardo Davinci" USB (Cook-MN)
8792.8	2350	WOM ATT Ft Lauderdale FL wkg "Teledyne 16" (Cook-MN)
8790	2341	WWD BUCOM Fisheries CA tfc USB (Cook-MN)
8807	2334	WLO Mobile Marine R. AL tfc USB (Cook-MN)
8984	0137	USCG St Fran CA wkg CGAS Astoria OR SSB (French-MD)
9023	0257	AFG37 Scott AFB Belleville IL wkg Raymond 28 USB (Cook-MN)
9029	1420	Cape R. FL ORION CONTROL Wkg Aygon 20 & 28, Cape Tom, & Silver 19 OM EE SSB (Compton-MA)
10017	0110	KIL8 Aeradio Miami FL wkg Lufthansa 495 (French-MD)
10637	2230	KKN50 State Dept Wash DC QRA mkr CW (Cook-MN)
11246	2011	AFES MacDill AFB FL OM EE tfc SSB (French-MD)
12422	2343	WFE Houston TX clg "Kirsten Bravo" SSB (French-MD)
12022.5	1545	KKN50 State Dept Wash DC QRA mkr CW (Cook-MN)
12135	1848	NSS Annapolis MD multi-call V mkr CW (Compton-MA)
13033.5	2135	WCC RCA Chatham MA wkg 5LLW CW (Cook-MN)
13172	1438	WOO Ocean Gate R. NJ wkg Queen Elizabeth II USB (Cook-MN)
12993	0255	KOK ITT Cerritos CA tfc list CW (Cook-MN)
13051.5	1602	WPD Marine R. Tampa FL CQ mkr CW (Thompson-NM)
13244	1722	AFES Macdill AFB FL wkg Swing 89 USB (Cook-MN)
13272	0142	WSY70 NY VolMet OM EE wx AM (Cook-MN)
13344	0140	Oakland VOLMET OM EE wx AM (Cook-MN)
13038	0200	KLC ITT Arcadia TX marine tfc CW (Cook-MN)
13201	0002	AFI McClellan AFB CA Skybird tfc USB (Cook-MN)
14830a	0620	KMI ATT Dixon CA OM EE vm LSB (Owsley-CA)
5540	0040	KKN50 State Dept Washington DC QRA mkr CW (Hardester-CA)
17016.5	2253	KPH RCA Bolinas CA V mkr CW (Trubee-HI)
17184.8	2215	KPS ITT Palo Alto CA CQ mkr CW (Cook-MN) 2315 OM EE wx to ELKP CW (Cook-MN)



-----

CARIBBEAN

BARBADOS:	8718	2358	SPO C&W St Philip ID mkr CW (Cook-MN)
BERMUDA:	6487.5	0113	VRT C&W tfc CW (Cook-MN)
SO. CAICOS:	4048.5	0758	NMA5 USCG Loran wkg NMR14 USB (Chabak-CO)
GUANTANAMO:	13755a	1200	AAC&R OM EE vm USB (Trochimczyk-DC)
CUBA:	8515	1550	CIS La Fé R. ID mkr CW (Thompson-NM)
	8573	1536	CLA21 EMRAIN Havana CQ mkr CW (Thompson-NM)
	8702	0145	CLA22 EMRAIN Havana CQ mkr CW (Somers-CA)
JAMAICA:	6470.5	0229	6YI C&W Kingston CQ mkr CW (Thompson-NM)
MARTINIQUE:	6389	0110	PUF Fr. Navy Fort-de-France V mkr CW (Thompson-NM)
	6792a	0924	FTS Fort-de-France YL EE/FF vm USB (Chabak-CO)
	8675.2	0315	FFP3 PTT Fort-de-France CQ mkr CW (Thompson-NM)
NETH. ANTILLES:	8694	0001	PJC PTT Willemstad Curacao CQ mkr CW (Thompson-NM)
PUERTO RICO:	5610	0701	WNA3 San Juan Aeradio OM EE wkg Iberia 493 USB (Chabak-CO)
TRINIDAD:	8710	0103	9YL North Post R. CQ mkr CW (Thompson-NM)

-----

CENTRAL AMERICA

COSTA RICA:	8478	0240	TIM CORAIN Limon V mkr CW (Thompson-NM)
MEXICO:	4250	0235	XFU Veracruz de Veracruz R. CQ mkr CW (Thompson-NM)
	8658.5	1543	XFM Manzanillo R. CQ mkr CW (Thompson-NM)
	12772.5	0102	XFL Mazatlan de Sinaloa R. CQ mkr CW (Trochim DC) 1545 (Thompson-NM)

-----

ARGENTINA:8646	0131	LPD86 Gen. Pacheco R. V mkr CW (Somers-CA)
8726	0047	LSA4 Boca R. V mkr CW (Thompson-NM)
12488.5	2340	LPD88 Gen Pacheco R. V mkr CW (Trubee-HI)
12998.5	2140	LPD88 Gen Pacheco R. V mkr CW (Thompson-NM)
BRAZIL:	0327	PPO Olinda Pernambuco R. V mkr CW (Trochimczyk-DC)
12979.5	0059	PPL PTT Salinopolis V mkr CW (Thompson-NM)
14605	2200	EMBRATEL Rio YL FF/EE OM PP vm SSB (Trochimczyk)
CHILE:	0047	CBV Valparaiso Playa Ancha R. CQ mkr CW (Trochimczyk-DC)
12725		
COLOMBIA: 6386.5	0727	HKC2 Emnatel Buenaventura CQ mkr CW (Trubee-HI)
6463	0220	HKB Emnatel Barranquilla CQ mkr CW (Thompson-NM)
6418a	0301	HCG Guayaquil R. CQ mkr CW (Thompson-NM)
GUYANA:	0125	SRB C&W Georgetown CQ mkr CW (Cook-MN)
8719	1615	SRB78 C&W Georgetown CQ mkr CW (French-MD)
16454	0008	PZN LTT Paramaribo CQ mkr CW (Thompson-NM)
SURINAM: 8662.5	2137	CWA Cerrito R. CQ mkr CW (Thompson-NM)
URUGUAY: 12750	0260	YVTO Obs. Cagigal times sigs (Estes-MS)
VENEZUELA:6100		

-----  
EUROPE

AZORES:	6750	0726	CUW Lajes AFB wkg MAC60202 USB (Chabak-CO)
	7348	0010	CTD41 Portuguese Navy Horta V mkr CW (Olsson-CT)
	8967	0646	CUW Lajes AFB tfc USB (Chabak-CO)
BELGIUM:	6496.5	0251	OST3 Oostende R. V mkr CW (Thompson-NM)
DENMARK:	6446.5	0305	OXZ3 PTT Lyngby CQ mkr CW (Thompson-NM)
	10240	1402	OKR20 Skamlebaek YL EE/Dan vm SSB (French-MD) 2255 (Olsson-CT)
ENGLAND:	5793	0000	GFT26 Bracknell tfc w/ocean stas C7C, C7L, & C7M CW (Olsson-CT)
	6510.5	0247	GKK BPO Portishead ID mkr CW (Thompson-NM)
	8501.5	2243	GLO20 Ongar R. V mkr CW (Thompson-NM)
	8591.5	0218	GKG BPO Portishead ID mkr CW (Thompson-NM)
	13006.5	2041	GKK BPO Portishead ID mkr CW (Thompson-NM)
	13020	2036	GKC BPO Portishead ID mkr CW (Thompson-NM)
FRANCE:	6802	0210	FTS Paris OM FF vm SSB (French-MD)
	8522.5	0225	FFL4 Ste. Lys R. CQ mkr CW (Thompson-NM)
	10195	2250	FPK9 FTS Paris OM EE/FF vm USB (Olsson-CT)
	13161.5	1235	FFL35 Ste. Lys R. YL EE/FF/mx vm AM (Olsson-SWEDEN)
	19110a	1200	Internatl Network Paris YL EE/FF vm SSB (Kiyomiya)
HOLLAND:	10502	2305	R. Nederland Kootwijk SS feeder USB (Olsson-CT)
GERMANY, E.:13100	0045	DHS PTT Ruegen V mkr CW (Thompson-NM)	
GERMANY, W.:8512	0231	DAL Norddeich R. V mkr CW (Thompson-NM)	
	17177.6	0650	DAL Norddeich R. V mkr CW (Kiyomiya-JAPAN)
GIBRALTAR:4348a	0242	GYU BRN ID mkr CW (Trochimczyk-DC)	
GREECE:	6479	0223	SVA3 OTE Athens V mkr CW (Thompson-NM)
HOLLAND:	6404	0317	PCH96 PTT Scheveningen CQ mkr CW (Thompson-NM)
	10735	0530	PTT RN feeder OM EE nx AM (Wirrell-MA)
	13550	1514	PCK43 PTT Amsterdam OM EE vm SSB (Kiyomiya-JAPAN)
ICELAND:	13069.5	2030	TFA13 PTT Reykjavik CQ mkr CW (Thompson-NM)
ITALY:	8469.5	0215	ICB PTT Genova CQ mkr CW (Thompson-NM)
	13015.5	1740	IAR3 PTT Rome V mkr CW (Thompson-NM) 2137 OM EE/It vm AM (Olsson-SWEDEN)
	19910a	1210	ITALCABLE Rome YL EE/FF/SS/It vm SSB (Kiyomiya-J)
NORWAY:	12727.5	1410	LGJ Rogaland R. V mkr CW (French-MD)
	13980	1158	LCO Jeløy R. Moss Bergersborg V mkr CW (Kiyomiya)
POLAND:	8482	0258	SPH Gdynia R. V mkr CW (Thompson-NM)
PORTUGAL:	4235	0226	CTV4 Navy Monsanto V mkr CW (French-MD)
	8490	0017	CUL7 CPRM Lisbon CQ mkr CW (Thompson-NM)
	8528a	0130	CTU4 Navy Monsanto V mkr CW (Thompson-NM)
SPAIN:	8682	0053	EAD3 EMNATEL Aranjuez CQ mkr CW (Thompson-NM)
SWEDEN:	8694	0115	SAG2 Göteborg R. CQ mkr CW (Thompson-NM)
SWITZERLAND:13023.8	1735	HEB Berne R. CQ mkr CW (Thompson-NM)	
U.S.S.R.:10000	1940	RWM Moscow time sigs CW (French-MD)	
	10120	2245	RG124 Tass Moscow SS press CW (Olsson-CT)
	10992a	1739	Moscow R/T YL EE vm AM (Wirrell-MA)
	16960a	1635	UMV Murmansk R. V-CQ mkr CW (French-MD)
	1713a	0200	MKL RAF Pitreavie wkg a/c CW (French-MD)

-----  
AFRICA

a	0312	FUV Fr. Navy V mkr CW (Trochimczyk-DC)
	1515	TFJ73 INTELCAM Douala YL FF/EE vm SSB (Kiyomiya-J)
	1135	CQR55 CTT V mkr CW (Kiyomiya-JAPAN)

37

IVORY COAST:5775	0025	TUP57 INTELCl Abidjan YL EE/OM FF vm LSB (Olsson)
KENYA: 7462.5	2255	EAE TC Nairobi OM EE vm LSB (Olsson-GT)
SENEGAL: 4294a	0453	6WW Fr. Navy Dakar V FAAN mkr CW (Trochimczyk-DC)
	0245	6WW Fr. Navy Dakar-Hann V mkr CW (Trochimczyk-DC)
SO. AFRICA:6386.5	0120	ZSJ Capetown R. CQ mkr CW (Thompson-NM)
	0253	ZRQ Cape Naval R. Simonstown V mkr CW (Thompson-NM)
TOGO: 10800	0400	5VH308 PCR Lomé YL FF/EE mkr SSB (French-MD)

-----  
ASIA

CHINA:	8514	1650	XSQ4 CGRA Canton CQ mkr CW (Thompson-NM)
	8720a	1550	XSQ4/7 Shanghai R. CQ mkr CW (Thompson-NM)
	12969	1608	XSV CGRA Tientsin CQ mkr CW (Thompson-NM)
INDIA:	19490a	1206	OTS Poona OM EE/Hindi vm SSB (Kiyomiya-JAPAN)
JAPAN:	5505	1110	Tokyo Aeradio OM EE wkg Northwest 3 USB (Chabak)
	6491.5	0712	JOS KDD Nagasaki CQ mkr CW (Trubee-HI)
	6738	0941	AIF80 USAF Yokota Airways wkg GD688 YL EE USB (Chabak-CO)
	8479	1708	JCU KDD Choshi City CQ mkr CW (Thompson-NM)
	8547.5	1544	JFA KDD Matsudo CQ mkr CW (Thompson-NM)
	8653.5	1618	JCS KDD Choshi City CQ mkr CW (Thompson-NM)
	8706	1527	JOS KDD Nagasaki V mkr CW (Thompson-NM)
	8967	0723	AIF80 USAF Yokota Skyking bcst USB (Chabak-CO)
	11247	0735	AIF80 USAF Yokota OM EE clg AIE USB (Chabak-CO)
	12878	2329	JCU KDD Choshi City CQ mkr CW (Trubee-HI)
KOREA:	8636a	1605	HLM MinCom Mogpo V mkr CW (Thompson-NM) // 12711a
	12720	0015	HLC MinCom Inchon ID mkr CW (Cook-MN)
	17079	2300	HLP MinCom Pusan V mkr CW (Trubee-HI)
OKINAWA:	5505	0953	Naha Aeradio OM EE wkg MAC57655 USB (Chabak-CO)
	6369.5	0730	NCN USN Futema call repeated CW (Trubee-HI)
PHILIPPINES:6715	1025	1102	AIC Clark AFB YL EE clg AIE USB (Chabak-CO)
	6738	1102	AIC Clark AFB Luzon Foxtrot bcst USB (Chabak-CO)
	8646	1720	DZG Globe Mackay Las Pinas CQ mkr CW (Thompson-NM)
	8993	1025	AIC Clark Airways OM EE phone patch for Swan 76 USB (Chabak-CO)
SAUDI ARABIA:11417	1518	HZQ141 PTT Jeddah OM EE/Ar vm SSB (Kiyomiya-JAPAN)	
SINGAPORE:8480	1620	9VG54 CQ mkr CW (Thompson-NM)	
	8688	1557	9VG33 DITEL CQ mkr CW (Thompson-NM)
TAIWAN:	8714	1516	XSX Keelung R. CQ mkr CW (Thompson-NM)
U.S.S.R.:	8680	1602	UQB Khmsk R. V-CQ mkr CW (Thompson-NM)
	12628	2145	UEK Feodosia R. V mkr CW (Thompson-NM)
	12792a	0330	UXN Archangel R. V-CQ mkr CW (Trochimczyk-DC)

-----  
OCEANIA

AUSTRALIA:4136.3	0758	VIT OTC Townsville OM EE wkg "Pacific Trader" USB (Trubee-HI)	
	4500	1145	VNG APO Lyndhurst time sigs AM (Miklejewski-MN)
	5688	0859	RAAF Darwin OM EE wkg RAAF Sydney USB (Chabak-CO)
		0901	RAAF Sydney wkg RAAF Pearce USB (Chabak-CO)
		0904	RAAF Pearce OM EE wkg ALJ & XDM USB (Chabak-CO)
	6429	0700	VHP RAN Canberra V mkr CW (Trubee-HI)
	6721.5	0921	NWC BASTILLE USN Exmouth tfc OM EE USB (Chabak-CO)
	7500	1215	VNG APO Lyndhurst time sigs AM (Miklejewski-MN)
	8490	0748	VIS6 OTC Sydney CQ mkr CW (Trubee-HI)
	12709a	0335	VHP RAN Belconnen V mkr CW (Trochimczyk-DC)
CAROLINE IS.:7581.5	0749	NRV4 USCG Loran Angaur, Palau tfc USB (Chabak-CO)	
	0844	NRV7 USCG Loran Yap OM EE wkg NRV USB (Chabak-CO)	
HAWAII:	2980	0750	KVM70 Honolulu VOLMET OM EE wx AM (Owsley-CA)
	4050	0803	NRO4 USCG Tern Is. wkg NRO USB (Chabak-CO)
		0907	NRO Johnston Loran wkg NRO4 & Kauai O2 USB (Chabak)
	5519	1250	KVM70 Honolulu VOLMET OM EE wx AM (Thompson-NM)
	6697	0635	NPM USN Lualualei OM EE test USB (Chabak-CO)
	13029	1730	KHK RCA Honolulu V mkr CW (Thompson-NM)
	13655	2030	NMO USCG Honolulu NERK & NUKO tfc CW (Cook-MN)
MARIANAS:	6521.8	0913	NRV USCG Guam OM EE test USB (Chabak-CO)
	7581.5	0751	NRV1 USCG Loran Orote Pt OM ee wkg NRV2 (Chabak-CO)
		0921	NRV USCG Guam OM EE vm USB (Chabak-CO)
		0659	NRV2 USCG Loran Saipan wkg NRV USB (Chabak-CO)
NEW ZEALAND:5638	0936	Auckland Aeradio OM EE wkg a/c#575 AM (Chabak-CO)	
	6518a	0946	NZPO Foxton OM EE vm USB (Chabak-CO)
	8504	1600	ZLB2/4 NZPO Awarua CQ mkr CW (Thompson-NM)
	8598	1535	ZLO RNZN Iirirangi ID mkr CW (Thompson-NM)
NEW CALEDONIA:8646	1623	FUJ Fr. Navy Noumea V mkr CW (Thompson-NM)	



	8678	1432	ZLP2/4 RNZN Irirangi V mkr CW (Thompson-NM)
	8770.4	1510	ZLW NZPO Wellington OM EE vm SSB (Kiyomiya-JAPAN)
	12715	0108	ZLO RNZN Himatangi ID mkr CW (Trochimczyk-DG)
	17171	0300	ZLB4 NZPO Awarua ID mkr CW (Cook-MN)
TAHITI:	9053	0611	FZ090 PTT Papeete <u>new?</u> YL FF/EE vm USB (Chabak-CO)
WESTERN			
SAMOA:	11620	0522	5WB? Apia OM EE tfc & ID USB (Hardester-CA)

UNIDENTIFIED

Please help with the IDs of these if you can:

5055a	1210	6F4Y	"V APC2 DE 6F4Y" CW (Kiyomiya-JAPAN)
5793.5	2345	KNY37	QRA mkr & wkg DBW2 - E. German Embassy? CW (Olsson-GT)
6478a	1345	9MB2	Malaysia - Penang R.? - V mkr CW (Thompson-NM)
6518	0445	YL EE	"KMK clg WV9166" repeated several times USB (Hardester)
6977	0115	DBU36	QRA mkr CW (Cook-MN) Embassy?
8197	1155	GOJ1	"V MWD DE GOJ AT 66 OOT 06 800 KHZ CFG" CW (Kiyomiya-J)
8830	0437	HA26:	OM EE calling SSB (Crews-FL)
9000a	2325	PEORIA	OM EE s/off w/VERBO(?) 15, then "PEORIA TEST 123321 PEORIA" SSB (Compton-MA)
9155a	0720	FET8	ID mkr CW (Kiyomiya-JAPAN)
10639.7	2353	KAY37	(Washington Embassy?) QRA mkr CW (Davis-CA)
19940	0910	"VVV QRA DE U"	CW (Kiyomiya-JAPAN)
15960a	0020	Music,	then: "This is a test for government equipment to be used overseas." by OM. AM (Owsley-CA)

ALL AT SEA

2182	0109	"Kaptai"	clg Toronto R. SSB (French-MD)
	0159	CGC "Ingram"	MRDK clg IKZI OM EE re med advice SSB (French)
4136.5	0758	"Double Star"	EE wkg "Triple Star" USB (Trubee-HI)
6521.8	0627	NRFX	CGC "Buttonwood" wkg NMO USB (Chabak-CO)
	0707	NGDF	CGC "Munro" OM EE wkg CGC "Sedge" USB (Chabak-CO)
	0745	NODU	CGC "Sedge" wkg NOJ USB (Chabak-CO)
	0833	NETM	CGC "Polar Star" wkg NMC USB (Chabak-CO)
	0938	NODO	CGC "Mallow" OM EE clg NMO USB (Chabak-CO)
	0952	NRPY	CGC "Plantree" clg NOJ USB (Chabak-CO)
8239.5	0615	LADE	"Royal Viking Sky" wkg VIS USB (Trubee-HI)
16470	0627	"warship Dutchess"	calling Sydney USB (Trubee-HI)
4435	0125	USCGC "Cape Fox"	wkg NMA USB (Cook-MN)
12540a	0000	"Anna Oulnanova"	UJUF clg WNU CW (French-MD)
12542a	1630	OYHI	"Jutlandia" clg OXZ62 CW (French-MD)
12537a	1438	GYGD	"Welsh Minstrel" clg GKC CW (French-MD)
	0016	JPHV	"Fushu Maru" clg NMC CW (French-MD)
12539a	1438	WTKA	"San Francisco" clg NMF CW (French-MD)
12542a	1629	5MZR	"Conqueror" clg NMN CW (French-MD)
12545a	1441	JXPR	"Eldrid" clg LFI CW (French-MD)
22031.5	0637	SVSO	"Petra" OM G4 clg Athinal R. USB (Trubee-HI)

AIRCRAFT

67	<del>0157</del>	Aeroflot 333	RPGWV clg RFNW & COL CW (French-MD)
13244	2336	Bataan 09	wkg MacDill AFB FL USB (Cook-MN)
13247	2341	RP31	wkg Andrews AFB MD USB (Cook-MN)

TACTICAL

4412a	0959	XOT	OM EE R. cks w/E3H, C2E, & E8H USB (Chabak-CO)
5445a	0605	SEAGRADE	OM EE wkg BLACKBUD USB (Chabak-CO)
6015a	1058	W3Q	clg J9N OM EE SSB (Jones-MS)
6721.5	0827	NDT	BACKLASH USN Yokosuka Japan wkg KILO PAPA USB (Chabak)
	0919	ORANGE JUICE	NPN USN Guam OM EE r/c w/TANGO 2 USB (Chabak)
	0931	WHITE TREE	NPO USN San Miguel Philippines R. ck w/WHISKY PAPA USB (Chabak-CO)
	1006	OOC	OM EE clg V4X USB (Chabak-CO)
	1030	DUNKIRK	USN NPM Honolulu HI wkg A5K USB (Chabak-CO)
6723	0908	BIDDY KADENA	USNAS Okinawa OM EE wkg SCHOOLBOY USB (Chabak)
	0925	BIDDY ATSUGI	NJA1 USNAS Japan OM EE tfc USB (Chabak-CO)
6761	0850	WORLD TRAVELER	OM EE short count test xmsn USB (Chabak-CO)
8972	2254	PHENOMENON	OM EE wkg GOLDENHAWK Brunswick ME NAS (Cook-MN)
9027	0915	OVERMASTER	OM EE Skyking best USB (Chabak-CO)
	0916	DOORBELL	OM EE Foxtrot type best USB (Chabak-CO)
11267	0638	BLUE GRANITE	OM EE R. ck w/HAMPSHIRE USB (Chabak-CO)
13241	0031	NEW DEAL	SAC U.S.A. YL EE tfc USB (Cook-MN)
15055	0426	TOREADOR	NPG USN Dixon CA YL EE freq ck USB (Hardester-CA)



"SPY" NUMBERS STATIONS

5810 0128 YL SS 4-digit groups AM (Cook-MN) 6/1/76  
 8420 0125 YL SS 4-digit groups AM (Cook-MN) 5/25/76  
 9075 1401 "330 171" YL SS 4-digit 171 gr mag. Mag rptd @ 1426 AM  
 (Compton-MA) 6/11/75  
 2338 YL SS 4-digit, off @ 2354 AM (Compton-MA) 6/7/76  
 11545.5 0040 YL GG 5-digit 0042\* USB (Brooker-MI) 6/2/76  
 13452 1445 YL SS 4-digit USB (Cook-MN)

Attention all "Spy" Numbers Station fans! I am compiling lists of all numbers stations heard during 1975 and to the latest date possible in 1976 for inclusion in the new SPEEDX Utility Guide. Please send me any "Spy" Numbers Stations loggings you may have that have not been published in SPEEDX during those periods, for inclusion. In addition, I am particularly interested in YL EE nbrs xmsns that include the word "disinformation" in the xmsn. If you have loggings of any date of such xmsns I would be most interested in hearing about them. Thanks, # sta fans!

RADIOTELETYPE

\*ANTARCTICA: 7921 1335 VNJ Casey Sta EE wx & tfc to Australia. Some tfc from Mawson also 66 wpm/425 hz shift (Green)  
 BRAZIL: 10245 0210 PPN9 City unkl EE wx 66/425 (Green-UT)  
 CHINA: 17400 0000 BBE52 Shanghai EE/SS tfc 66/425 (Green-UT)  
 CUBA: 17453 0100 CLN565 Havana EE/SS to BBE52 66/425 (Green-UT)  
 ENGLAND: 14515 1615 GPN34 Reuters Grigglon FF nx 66/425 (Green-UT)  
 GERMANY, E.: 9966.5 0555 DMV9 ADM Koenigswueterhausen RY test 66/425 (Green-UT)  
 GERMANY, W.: 11216.5 1700 DFL26 DPA Bonames RY test/nx 66/425 (Green-UT)  
 GILBERT & ELLICE ISLANDS: 16080m 0550 VSZ11 Tarawa RY test 66/425 (Green-UT)  
 HONGKONG: 8046 1415 ZEN35? EE tfc to Pyongyang 66/425 (Green-UT)  
 JAPAN: 10313.5 1540 JAF30 Osaka EE tfc to Rangoon 66/425 (Green-UT)  
 NEW CALEDONIA: 18785 0210 Noumea RY test FF nx 66/425 (Green-UT)  
 20078 0315 Noumea FF nx 66/425 (Green-UT)  
 SHIP: 12491 0310 KFPCP SS "Mariposa" EE tfc w/KPH 66/170 (Green)  
 TAHITI: 10992 0320 FXP58? Papeete wx & tfc 66/850 (Green-UT)  
 17655 0610 FUM Fr. Navy Papeete FF wx 100/850 (Green-UT)  
 TAIWAN: 10960 0550 C.N.A. Taipei RY test 66/850 (Green-UT) 3MA28  
 UNKNOWN: 7616 0540 "C9E3" RY test 66/850 (Green-UT)  
 10461 0455 4UZ UN sta RY test & EE et al tfc to & from everywhere, most originated with UNESCO Paris 100/425 (Green-UT)  
 10718 1510 INFORMEX SS press 60/170 (Brooker-MI)  
 14907 1725 FKØH EE test 100/c.60 (Green-UT)  
 11405 0500 RKUG (Russian ship?) RY test-clg RGG2 RR 66/425 (Green-UT)  
 U.S.S.R.: 14425 0550 Tass Moscow EE nx 66/425 (Green-UT)  
 WALLIS & FUTUNA IS.: 15976 0505 FF test 66/c.60 (Green-UT)  
 YUGOSLAVIA: 12408 1645 YZG TANJUG Belgrade EE nx 66/850 (Green-UT)

LONGWAVE

UNIDENTIFIED: 340 0650 "AHN" beacon CW (Trubee-HI)  
 FR.POLYNESIA: 367 0656 "HA" fol by 15 sec dash Hao Atoll CW (Trubee-HI)

QSLs

ALASKA: NUD T-BONE USN Adak ???? PFC 17d air for MS. 10kw. (Chabak-CO)  
 NRW USCG Lorsta Unimak Is. 4575. PFC 18d air for MS. 1kw. (Chabak-CO)  
 ARGENTINA: LOL Buenos Aires 15000. F/d folder cd 24d air for no RP (Estes-MS) Same in 6m registered surface for no RP (Wirrell-MA)  
 BARBADOS: 8PX74 C&W Bridgetown 15930. Map cd f/d 12d air for ms (Walters)  
 CYPRUS: 5BA Telecom Auth 8738.4. F/d ltr 82d air for 2 IRCs (Gion-MA)  
 SENEGAL: 6WW Fr. Navy Dakar 4575. PFC 15d air for 2 IRCs (Hardester-CA)  
 GREENLAND: OXI68 QTO Godthaab 14900. F/d folder cd 45d air, 2 IRCs (Gion-MA)  
 GUADELOUPE: FTS Point-à-Pitre 10160. Ltr for EE rpt & IRC (Denissen-HOL)  
 JAPAN: NDT BACKLASH USN Yokosuka 6721.5 PFC 12d for MS (Chabak-CO)  
 USNAS BIDDY Atsugi 6723 PFC 19d air for ms; 5kw. (Chabak-CO)  
 KENYA: 5YF55 EAETC Nairobi 12282.5 f/d PFC 35d air for ms. (Walters-NJ)  
 MAURITANIA: PTT Nouakchott 5735 PFC & f/d ltr & 8 different Mauritania mint stamps for ms. Call letters not given. 60d air. (Walters-NJ) Same in 18 months for FF rpt & ms. VS: Director G. A. Dialel. (Chabak-CO)  
 OKINAWA: MARS Sta Camp Foster Okinawa 7380 PFC 12d air for ms (Chabak-CO)  
 PORTUGAL: CTV4 Navy Monsanto 4235 white f/d cd 19d air for ms (Walters-NJ)

**TOGO:** 5VH308 FCR Lome 10801. PFC f/d in 33d surface for ms&FF rpt(Walters)  
**U.S.A.:** BUTTERFIELD NPM USN San Diego 15050 f/d ltr 3d air (Hardester-CA)  
**NIK** USCG Marshfield MA 5320 f/d PFC 35d surface for ms (Walters-NJ)  
**SHIPS:** WTEG USC&GS "Mount Mitchell" MSS-22 5696. PFC in 67d surface for  
 ms. QTH: SE of St. Thomas, Virgin Is. 250w. (Chabak-CO)  
**ADDRESS:** NOAA Ship, "Mount Mitchell"  
 439 West York Street  
 Norfolk, VA 23510  
 CGC "Mallow" NODO 6521.8 PFC in 15d for ms-QTH: Laysan Island. 500w.  
 (Chabak-CO)  
 NRQW CGC "Sweetgum" buoy tender 4380.6 PFC 9d for ms. 180w. (Chabak-CO)  
 -NBTM CGC "Polar Star" Icebreaker 6521.8 PFC 9d for ms. 1kw. (Chabak-CO)  
 NRYZ CGC "Walnut" buoy tender 2694 khz PFC 23d for ms. (Chabak-CO)  
 NLBI CGC "Point Swift" PFC IN 24d for ms. 80w. (Chabak-CO)

Another reminder to send any material you may have for the new SPEEDX  
 Utility Guide: Addresses, freqs, QSL policies, networks, USCG info, long-  
 wave info, network info, feature articles, how-to tips, etc., to:  
 SPEEDX P.O. Box E Elsinore, CA 92330 U. S. A.

GOVERNMENT OF



MAURITIUS

DEPARTMENT OF TELECOMMUNICATIONS

My Reference: 238

Telecommunications Headquarters.

Edith Cavell Street.

Port Louis.

MAURITIUS.

Your Reference:

4th February 1976

DR JUERGEN TROCHIMCZYK,  
 Carnegie Institution of Washington,  
 Geophysical Laboratory,  
 2801 Upton St., N.W.,  
 Washington, C.D. 20008,  
U.S.A.

Dear Sir,

Thank you for your letter of the 3rd January 1976  
 in which you submitted a reception report of the station  
 3BM/3/5.

The fact is that the department started scheduled  
 transmissions on

3BM3 - 6351.5 KHZ output 4KW

3BM5 - 12988.5 KHZ output 4KW

3BM6 - 16978.4 KHZ output 8KW

Frequencies which were allocated to the H.M.S.  
 Mauritius Naval Station - GZC - but taken over by Mauritius  
 Radio/3BA for weather broadcasts to ships since the 1st  
 December 1975, date at which HMS Mauritius stopped all W/T  
 operations in the country.

Yours faithfully,

for Director of Telecommunications

/RI



**U.S. DEPARTMENT OF COMMERCE**  
**National Oceanic and Atmospheric Administration**  
 NATIONAL WEATHER SERVICE

April 5, 1976

Mr Bill Coleman Jr  
 SML WDX4DNO  
 114 Circle Drive  
 Rocky Mount, N.C. 27801

Dear Sir:

This is to confirm your SML report of the reception of our VHF Broadcast. The following information applies: -

Date	-	March 30, 1976	Time	-	0040 EST
Frequency	-	162.55 Mhz	Call Sign	-	K1G 77.

We are using a transmitter with a noutput power of 330 Watts. Including the gain of the 8 bay antenna (approx 8DB), we have an Effective Radiated Power of near 2375 Watts. The equipment is located near the Coast Guard Station approximately 1 1/2 miles WSW of the Cape Hatteras Lighthouse near Buxton, N.C. The Antenna is mounted up on a 410 ft tower..

The service has 24 hours per day, 7 days per week continuous broadcasts excluding an occasional maintenance period. Special bulletins are issued with a preceeding warning tone for special storm warnings - such as typrades, hurrinames, etc.. And at the present time this station does not feed any other stations.

We are enclosing two maps that will be of further benefit to you showing locations of other NOAA Weather Service broadcast stations within this area, as well as some around the Washington, D.C. area..

Thank you for your interest.

*Leray La Baume*

Mr Leray La Baume - Electronic Technician  
 WSO, Cape Hatteras, N.C.

US COAST GUARD LORAN A-C STATION

**KC6CG**

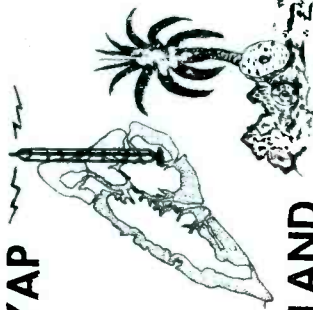

**YAP**

**ISLAND**

The island of Yap is located at 9.32N 138.06E and is rich in history being occupied at times by the Spanish, Germans, Japanese and at present is a trusteeship of the United Nations being administered by the United States. Yap is perhaps best known for its unique monetary system based on "Raap", which are large wheel like-stones.

U.S. Coast Guard Loran Station  
 Yap, Western Caroline Islands  
 Trust Territory, Pacific Island 96943

Radio ~~is~~ Confirming

1 way:  isb  cw  am  
 QSO 26.074Mhz 1976  
 at 0954 GMT

Ur.....MHz. sigs RST.....  
 Swan 500CX Mostley Beam

PSE OSL TNX

*Mike*  
*There are also*  
*stations on Yap*  
*Island. For more*  
*info suggest a letter*  
*or call WPTC*  
*at 2230763407 or*  
*142255. We'll provide*  
*13 copy*

MIKE CHAGAK

# QSL REPORTS



Editor: Bill Cleveland  
2441 Fairview Drive  
Visalia, Calif. 93277



Verified Countries - 152

Deadline: 15th of month



Another year gone by; it's the 5th birthday of SPEEDX and the 200th of the USA. Just think--in another 195 years SPEEDX too will be able to celebrate a bicentennial! So keep those cards and letters coming, folks.

Now "why didn't I think of that" department: Re the EPT/ERT controversy, Bob French and Chris Hansen submit essentially the same argument, i.e., EPT (in Greek) is Epsilon Rho Tau; ERT is the English equivalent. Sounds good, fellows. I'll buy that argument until someone comes up with a better one. On with the show.

## Europe

ALBANIA: R. Peking Relay, 7120, date/fqy cd "Timber forests of the Changpai Mountains" + stn pin and form ltr in 16d air (ROBINSON AL)

AUSTRIA: ORF, 6155, "Schloss Esterhazy" cd in 50d air, 1 IRC (SMITH MD); 9770, f/d cd of Vorarlberg in 53d air, no rp (FOWLER ONT), f/d "mountain" picture cd, no time, 1 IRC (LAUSEVICH WI); 15225, f/d "Sunny South of Austria" cd in 49d air, 1 IRC (MILLER WA); 17765, f/d cd "Harmony of landscape and culture" in 36d air, no rp (MAKISHIMA JAPAN)

CZECHOSLOVAKIA: R. Prague, 5930, f/d cd, b/w photo of Chodské Kroje (national costumes) in 40d, no rp (BOWEN NS); "Zizka Square" cd in 42d, no rp (MILLER WA); 7245, f/d "St. Nicholas Cathedral and Prague Castle" cd in 37d, no rp (MILLER WA), f/d cd "Ruins of the Trosky Castle" in 42d air, no rp (PETERS KY), f/d cd "Spinderuv Mlyn" in 38d, no rp (SMITH FL), f/d cd "Javorova Valley" in 43d, no rp (SMITH FL); 9540, "High Tatra Mountains" cd in 60d, no rp (RADTKE CA)

DENMARK: R. Denmark, 15165, usual f/d antenna cd in 34d, 1 IRC (VOKES TX), same in 19d for 2 IRCs (SOMERS CA)

FINLAND: R. Finland, 15185, f/d "Summer in Finland" cd + pennant, no time (VOCKEROTH PA)

FRANCE: R. France International, 15300, aerial view cd of "Arch de Triumph" in 57d air for 1 IRC (DAVIDONIS MA), same in 60d, no rp (RADTKE CA). Both rcvd pennants.

GERMANY (Federal Republic): Deutsche Welle, 9545, logo cd + pennant in 35d air for 2 IRC (TOMORI HI)

GREECE: V. of Greece, 9760, f/d white cd in 16d (FAMULARO NJ), in 17d (MEEHAN CT), in 17d for 2 IRCs (OLIVER NH), 23d for 2 IRCs (YOUNG CA), 30d for no rp (VOKES TX), 30d for 1 IRC (BUTTERFIELD MA), 39d for 2 IRCs (BAUMGARTNER ONT)

Thanks

to

Bill

Miller

## IN MEMORIAM

**Edward Startz**

20 February 1899 - 18 March 1976 †

Edward (Eddie) Startz, the world's pioneer shortwave broadcaster and for more than 40 years compere of the world's most popular shortwave programme - the Happy Station - has gone from us.

Before Startz, BC-DX was unknown. It started with him. On the occasion of the 40-th anniversary of the Happy Station in 1968, the Swedish Federation DX-Alliansen awarded him its Gold Plaque in recognition of his service to the DX hobby. But his services to shortwave broadcasting in general were equally important, for his vast audience was made up of every SWL category. Among the stars on the shortwave firmament, he was the greatest.

RADIO NEDERLAND

Q

S

L





HOLLAND: R. Nederland, 11730, f/d "Eddie Startz Memorial" cd in 28d for 1 IRC (THOMPSON), same in 40d, no rp (SMITH FL)

HUNGARY: R. Budapest, 6000, f/d "Parliament" cd in 35d air, 1 IRC (MACRIS MO), f/d globe cd in 60d, no rp (RADTKE CA)

ITALY: RAI, 2725, f/d cd "Il Settecento Italiano 'Amore e Psiche'" in 183d sfc, no rp (SMITH FL); 2575, f/d "Il Settecento" cd in 154d air for 3 IRCs (ROJEWSKI WA)

MALTA: Deutsche Welle Relay, 6100/9745/11865, no data logo cd w/"confirmed as reported" statement, 33d for no rp (TRAUTSCHOLD WI)

NORWAY: R. Norway, 11895, f/d cd "The Karl Johan Street", 19d air, no rp (TOMORI HI)

POLAND: Polskie R., 9540, DX-Club cd in 35d, no rp (LEGGÉ VA)

PORTUGAL: Adventist World R., 9670, studio picture cd in 3 wks air for 1 IRC (OLIVER NH), f/d "Loma Linda Univ. Medical Center" cd in 30d air, no rp (FAMULARO NJ)

IBRA R., 9670, f/d red cd w/DXer w pennant, no time (VOCKEROTH PA)

R. Portugal, 6025, f/d "St. George's Castle" cd in 14d, no rp (RADTKE CA), same in 22d for 1 IRC, "Aquaduct" cd in 16d for 1 IRC (MACRIS MO), "Lisbon--The Old City" cd in 17d for no rp (BERNSTEIN GA), pennant and club membership certificates for 5 rpts, no rp (HARDESTER CA)

ROMANIA: R. Bucharest, 5990, f/d logo/map cd in 34d for 1 IRC (FOWLER ONT)

SPAIN: RNE, 6065, f/d cd of xmtr site, 63d air, no rp (SMITH FL), same in 71d air, no rp (FOWLER ONT); no fgy, same cd in 62d sfc for 1 IRC, SS rpt (SMITH MD). No comment, Eunice! bc

SWITZERLAND: SBC, 5965, f/d cd w/pix of city, 11 wks air, no rp (WICKETT MD), f/d cd of Swiss Nat'l Tourist Office, 47d air, no rp (YOUNG NJ); 6045, f/d cd "Arcades in the Old Town of Berne", 44d sfc, no rp (MILLER WA); 6135, "Carnival of Basle" cd in 40d, no rp (FLEMING NY); 9590, f/d cd "Basle's Griffin" in 50d (FLEMING NY); no fgy, f/d cd w/photo graph of Bern, 25d sfc, no rp (SHAW CA)

ICRC, 7210, date/fgy note of thanks for rpt, v/s Michèle Mercier, in 46d air, no rp (MEEHAN CT)

USSR:

Lithuanian SSR: R. Vilnius, 7255, f/d stylized flower cd + pennant in 54d air (MEEHAN)

ESFSR (European): R. Moscow, 5905 (Starobelsk), 5960, 7350, 7360 (Moscow), 9530 (Moscow), 9720 (Ryazan), 9795 (Serpukhov), 15140 (Ryazan), 15360 (Moscow); f/d cds in 29-30d.

"Kalinin Prospekt" (ROUTENBURG ONT)(FAMULARO NJ), "Moscow State University" (REDMAN IL), "Buildings" cd (VOCKEROTH PA), no desc. (LEGGÉ VA)(SMITH TN)

R. Peace and Progress, 11870, cd w/ drawing of Red Square, 23d air (BAUMGARTNER ONT), no fgy, same cd in 85d air (SMITH FL)

Ukrainian SSR: R. Kiev, 7205, 7400, 11960, 12000, 15140, 15180; f/d cds in 30-75d air, no rp. "Boy and girl in native dress" (BUTTERFIELD MA)(MEEHAN CT)(MAKISHIMA JAPAN) (MERCADO CA)(THOMPSON NM)(SMITH MD)(MACRIS MO), "Man and woman in folk costumes" (BOWEN NS), "Abstract circles cd" (MEEHAN CT), "triangle/circles" cd (TOMORI HI), "Map of USSR" (MEEHAN CT), yellow/gold/red/blue "map" cd (MILLER WA), red/blue horizontal "stripes" cd (MEEHAN CT)

R. Moscow, 7115 (Ivano-Frankovsk), 7210 (Lvov), "CMEA" bldg cd (LEGGÉ VA), "Moskva River" cd (VOCKEROTH PA)

VATICAN CITY STATE: R. Vaticana, 5995, f/d cd of xmtr towers, in 15d air for no rp (ROUTENBURG ONT), same in 19d air for 1 IRC (SMITH MD)

#### Africa

ASCENSION ISLAND: BBC Relay, 7105, no data Parliament bldg cd in 29d air, no rp (QSL came from London the rpt sent to Ascension Island site) (TRAUTSCHOLD WI)

CONGO (People's Republic): V. de la Revolution Congolaise, 15190, f/d form ltr in FF in 19d air for MS and FF rpt (WHITE FL), same in 22d air for 2 IRCs, EE rpt (GELFAND NY)

EGYPT: R. Cairo, 9475, f/d "Ramses II" cd in 1 yr air, no rp (REDMAN IL), "Aswan--a part of Abu Simbel Temple" in 370d air, no rp (MITCHELL CA); 9805, f/d cd of Egyptian street scene in 53d air for 1 IRC (THOMPSON NM). v/s for this cd, Mrs N. Waked

GABON: Rdif. TV Gabonaise, 4777, map cd + date only verie ltr in 61d air for 2 IRCs, FF rpt (ROUTENBURG ONT) See next page. bc

GAMBIA: R. Gambia, 4820, date only form ltr in 236d for MS, v/s G. Jannah (WHITE FL), no data form ltr w/verie statement in 43d for 2 IRCs (BAUMGARTNER ONT)

GHANA: R. Ghana, 4915, f/d cd w/Ghana crest, 93d air for 2 IRCs (PERRY QUE)

GUINEA-BISSAU: R. Nacional, 5041, date/fgy cd w/verie statement in PP, FF, EE, in 75d air for MS and PP rpt (LEAMY OH)

LIBERIA: ELWA, 11950, f/d native drummer cd in 422d sfc for 2 IRCs (BAUMGARTNER ONT)

MALAGASY (Republic): 11730, f/d EDXC cd in 45d, no rp (FLEMING NY)

MAURITANIA: Rdif. Nationale, 4850, f/d map cd in FF, 115d air for tape, MS and EE rpt (HARDESTER CA), same in 3½ mo for 1 IRC (LEGGÉ VA)

MOROCCO: VOA Tangier, 9760, date only Kennedy Center cd in 18d sfc (BOWEN NS)

NIGERIA: V. of Nigeria, 7275, f/d cd w/green/white crest, 46d, no rp (WORMAN WI), f/d flag cd (same cd??? bc) in 67d for 1 IRC (BUTTERFIELD MA)

RHODESIA: RBC, 3396, f/d antelope cd in 93d air for 2 IRCs (BAUMGARTNER ONT), same in 15d air for 2 IRCs (MITCHELL CA)



# RADIODIFFUSION TÉLÉVISION GABONAISE

LIBREVILLE

LA VOIX DE LA  
RENOVATION



Thanks  
to  
Paul  
Routenburg

- RWANDA:** Deutsche Welle Relay, 7225, f/d map cd in 28d air for 1 IRC (THOMPSON NM); 15410, same cd in 45d air, no rp (BOWEN NS)
- SEYCHELLES:** FEBA, 11810, f/d orange/blue map cd in 16d for 3 IRCs (ROJEWSKI WA), same in 17d for 2 IRCs (MITCHELL CA)
- SOMALIA:** R. Mogadishu, 9585, f/d mimeo ltr in 110d for 2 IRCs (FLEMING NY)
- SOUTH AFRICA:** RSA, 9585, f/d "Springbok" cd in 18d air, no rp (MILLER CA), same in 26d for 2 IRCs (ROJEWSKI WA), "animal" picture cd in 29d air, no rp (YOUNG NJ), SADXC cd in 43d for 2 IRCs (ROJEWSKI WA); no fqy, SADXC cd in 20d (FLEMING NY)
- SABC,** 4810, f/d "industries" cd in 15d sfc(??) for no rp (LAUSEVICH WI), same in 15d, no rp (SHAW CA)
- TOGO:** R. Togo, 5047, f/d green/white map cd in 3 wks air for 2 IRCs (OLIVER NH), same in 24d air for 2 IRCs, FF rpt (BOWEN NS)
- TUNISIA:** Rdif. TV Tunisienne, 11970, "Tunise de Toujours" cd in 6 wks air for 2 IRCs, EE rpt (OLIVER NH); 15225, f/d cd "A visit to the pottery" in 251d (67d after f/up) (WHITE FL)
- ZAMBIA:** R. Zambia, 9580, f/d plain black/white cd in 33d air, no rp, v/s Peter Masuba (ROUTENBURG ONT)

## Asia

- CHINA (People's Republic):** R. Peking, 6955, fqy only cd of agricultural technician, 61d air, no rp, JJ rpt (ISHIZAKI JAPAN); no fqy, "Great Wall" and "Young girl at a picnic site" cds in 6d (you sure you didn't lose another figure here, Bill? bc) (MILLER CA). See next page for a unique R. Peking HS QSL.
- CYPRUS:** BBC Relay, 15400, usual no data Thames cd in 19d air, no rp (SMITH FL)
- INDIA:** AIR, 6085, f/d ltr in 34d air for 1 IRC, sent to and rcvd from Madras, direct, v/s D.P. Ramachandra (MAYER IL); 9525, f/d cd "Tiger in Kanha Park", 110d air for 3 IRC (ROJEWSKI WA)
- INDONESIA:** RRI Tanjungkarang, 3995, vague time only Indo ltr of confirmation w/wrong fqy; expresses surprise and pleasure at reception and extends an invitation to visit the station. In 33d air for MS (used), Indo rpt and cassette of xmsn; 2.5 kw, v/s R. Abusholeh Syukur BA (CLEVELAND CA)
- RRI Ambon,** 4845, f/d Indo ltr w/stn data, 40d air for 2 IRCs and Indo rpt, v/s A.W. Rakimin (CLEVELAND CA)
- IRAN:** V. of Iran, 2022, f/d "Zahedan Television" cd in 26d air for 1 IRC (BUTTERFIELD MA) f/d "Shiraz Television" cd in 35d air, no rp, + pennant (MAKISHIMA JAPAN); 15084, f/d cd "Abadan Television" + pennant in 25d for stamps (VOKES TX)
- ISRAEL:** IBA, 5900, f/d cd w/view toward the Shrine of the Book and Knesseth Building, in 81d air, no rp (BETHGE MO); 7412, date/fqy "Jerusalem, the Western Wall" cd in 47d air, no rp (WORMAN WI), "Shrine of the Book and Knesseth Bldg" cd, f/d in 47d air (SMITH FL); 2815, "Western Wall" cd in 79d, no rp (ROUTENBURG ONT), same in 56d, 1 IRC (SMITH MD), same in 19d, no rp (TRAUTSCHOLD WI), "Knesseth Bldg" cd in 47d, no rp (SMITH FL), same in 58d, no rp (THOMPSON NM); 11645, "Western Wall" cd, 46d, no rp (MILLER WA); 17685, same cd in 61d, no rp (SMITH FL)

To err is human. But to really mess things up you need automation.

閣下:

你一月廿九日之信已收到，內容關於南越我們電台

之收播情況很好，無逾此可說，若無任何信件

其他雜誌以及其定刊刊物在下封信申寄給你，我

真想與你在收音機中交談，謝你

鄭志生 啟

11月12日

北京人民广播电台

中國北京人民广播电台

The above letter was received by Lance Barber in reply to a two page Mandarin Chinese letter, hand painted with brush and paint, and reporting on a R. Peking Home Service bcst on 5163 kHz. Roughly, the reply states: "Yes, you did hear our Home Service on 5163 kHz, at the time and day stated, but R. Peking does not send QSL's to it's Home Service listeners." It also states that some literature is on it's way by separate post. Obviously, the reply was a favor on the part of the writer, since a reply is against station policy. Note also that certain phrases have been stroked out and replaced with others. A most unique "QSL".

- JAPAN: R. Japan, 5990, date/fqy cd "Japanese Bamboo grove" in 18d air, no rp (MILLER CA); 9505, same in 13d, no rp (CLEVELAND CA); 11815, same in 17d, 1 IRC (MACRIS MO); 15105, same in 11d (TOMORI HI), same in 11d (HARDING CA), same in 14d (THOMPSON NM); 15270, same in 14d (FLEMING NY), same in 27d (BOYD NFD), "Hakata Dolls" cd in 12d (MILLER WA); 15300, "Kamakura" cd in 14d (VOCKEROTH PA); 17880, "Bamboo Grove" cd in 9d (TOMORI HI)
- KOREA (Democratic People's Republic): R. Pyongyang, 9510, f/d cd w/pix of "People studying a shrub outdoors", 65d air, no rp (SNYDER CA) (Doug sent his report registered mail; the QSL contained 3 IRCs originating in Japan--reimbursement for registering the rpt? bc) 9820, f/d cd w/photo of chorus on stage, 58d air for JJ rpt (ISHIZAKI JAPAN)
- KOREA (Republic): R. Korea, 9640, f/d "Buddha" cd, 291d air, no rp + pennant (MAYER IL), f/d "Farmer's Band" cd, 265d air for 2 IRCs (MILLER CA)
- KUWAIT: R. Kuwait, 11940, usual (?) cd in 37d for no rp (VOKES TX)
- MALAYSIA: BBC Relay, 17880, Parliament cd in 29d air, 3 IRCs (TOMORI HI) V. of Malaysia, 15290, f/d folder cd in 60d air, no rp (ROUTENBURG ONT)
- MONGOLIA: Ulan Bator R., 5053, f/d gold/white/blue emblem cd in 4½ mo air, no rp, v/s Tuvdennyam (ROUTENBURG ONT)

OMAN (Sultanate): OBS, 11890, f/d "picture" pc, data on reverse, 30d air for 3 IRCs (YOUNG CA)

PHILIPPINES: FEBC, 7225, time/fqy FEBC staff cd in 57d sfc, no rp (MILLER CA)

R. Veritas, 9570, f/d yellow/green map cd in 10½ mo (17d after f/up), no rp (MAYER IL)

V. of Philippines, 9580, date/fqy regular white QSL in 130d air, no rp (MAKISHIMA JAPAN),

same, xcpt a pink cd in 194d air, no rp (MAKISHIMA JAPAN)

RHODES: VOA Relay, 7105, f/d Capitol cd in 7d (VOCKEROTH PA)

SAUDI ARABIA: BSKSA, 6130, f/d white cd, friendly verie ltr in 115d air, no rp, v/s A.M.

Babtam (FAMULARO NJ)

SINGAPORE: R. Singapore, 5010/5052, fqy only red/blue/green "SRT" cd in 20d air for 2 IRC (MILLER WA)

SRI LANKA: VOA Relay, f/d Capitol cd in 8d (ROJEWSKI WA)

TURKEY: V. of Turkey, 9515, f/d "Bosphorus Bridge" cd in 32d air, 2 IRCs (FOWLER ONT),

same in 40d, no rp (ROUTENBURG ONT), f/d "Nasreddin Hodja" cd in 23d air, no rp (BAUM-

GARTNER ONT), same + pennant in 40d (FLEMING NY), same in 27d (SMITH FL); 11880, f/d

"Bosphorus Bridge" cd, no time or postage (VOCKEROTH PA); no fqy, same cd in 10d, no rp (SHAW CA)

USSR:

RSFSR (Asiatic): R. Moscow, 5960, 7105 (Khabarovsk), 7150 (Khabarovsk), 9540, 15100

(Khabarovsk); f/d cds in 18-30d for EE rpt, 65d for JJ rpt. "Kalinin Prospekt"

(BUTTERFIELD MA) (RADTKE CA), "CMEA" bldg (BUTTERFIELD MA) (TOMORI HI), "Moscow Bldgs"

(ISHIZAKI JAPAN)

Uzbek SSR: R. Tashkent, 11925, red/white/blue f/d cd in 6 wks. Cd says 10 rpts necessary for pennant (VOCKEROTH PA)

### Oceania

AUSTRALIA: ABC Melbourne, 6150, f/d cd in 45d air, no rp (ROUTENBURG ONT)

R. Australia, 5995, 9570, 9580, 9770, 15160, 15190, 15320, 17795, 17860; f/d cds, v/s

Peter Homfray or P.S. Noch, in 46-320d sfc for no rp, 23d air for 1 IRC, 13-37d air

for 2 IRCs, 24d air for 3 IRCs. "Grevillea flower" (HARDING CA) (MILLER CA), "Blue Wren"

(YAJKO PA) (HARDING CA), "Scarlet-crested parakeet" (PIMBLETT ALB) (HARDING CA), "Net-bush"

(FLEMING NY) (MILLER CA) (THOMPSON NM), "Kookaburra bird" (HARDING CA) (MILLER CA) (SANN NJ)

"Stanley Chasm" (OWSLEY CA) (TOMORI HI), "Kangaroo" (MILLER CA), "San Michele Sheep

Station" (MILLER CA), "Wrest Point Hotel Casino" (THOMPSON NM), "Marina" (YOUNG NJ)

VNG (standard fqy stn), 7500, f/d veri ltr in 30d air, no rp, v/s P. Schleager (ROUTEN-

BURG ONT), same in 4 wks (VOCKEROTH PA), same in 37d for 1 IRC (BOWEN NS)

NEW CALEDONIA: R. Noumea, 7170, date/time orange/blue/black map cd in 42d air for 2 IRCs,

EE/FF rpt (PIMBLETT ALB)

PAPUA NEW GUINEA: R. East Sepik, 3335, EE verie ltr w/stn info in 38d air for 2 IRCs,

v/s Paul Kafafi (ROUTENBURG ONT), same in 37d for stamps (VOKES TX)

NBC, Port Moresby, 4890, f/d verie ltr in 140d sfc for 3 IRCs, v/s C. Ketsimur

(BAUMGARTNER ONT), same in 24d air for 2 IRCs (MILLER WA)

TAHITI: R. Tahiti, 11825, f/d "Tahitian island-girl" cd, in ??d for 1 IRC, EE rpt (VOCKEROTH PA)

### South America

ARGENTINA: R. El Mundo, 6120, date/fqy white/red/black cd w/SS and EE verie statements

on back, 64d sfc for 2 IRCs (MILLER WA); 11755, black/white microphone/map cd in 44d

air for 1 IRC, SS rpt (MAYER IL) Both rcvd stn sticker.

RAE, 11710, blue/white modern design cd w/wrong fqy, 60d air for no rp (REDMAN IL)

BRAZIL: R. Nacional de Brasilia, 11780, f/d map cd in 21d air, no rp, SPEEDX rpt form

(SANN NJ), time/fqy map cd in 15d air, no rp, EE rpt (YOUNG NJ), f/d map cd in 30d for

1 IRC, EE rpt (VOCKEROTH PA)

R. Maua, 11885, ltr (on R. Nacional letter head) + pc verie in 14d, no rp, v/s Dr. Luiz

Cesar Oliveira, Supervisor Tecnico (LEGGE VA)

COLOMBIA: R. Meridiano 70, 4925, no fqy ltr & pennant (fqy on pennant), 30d, no rp, v/s

Ingeniero Sergio Perez, Gerente (LEGGE VA)

R. Sutatena, 5075, date/fqy folder cd w/photo of xmtr studio, 96d air for 2 IRCs and

SS rpt on Gilfer form (BAUMGARTNER ONT)

La Voz del Llano, 6115, no fqy ltr on Villavicencio photo folder in 45d, no rp, v/s

Jairo E. Cifuentes, Director Proprietario (LEGGE VA)

Emisora Nueva Granada, 6160, friendly no data ltr of confirmation in 163d sfc for 2 IRCs

EE rpt, v/s Francisco Restrepo Arroyave (MILLER WA)

"Bogotá", 9635, (is this R. Nacional, 9630, Stan?? bc), date/fqy cd w/photo of "Basílica

del Señor de los ???, Buga, Colombia", in 85d sfc, no rp, SS rpt (SHAW CA)

ECUADOR: R. Zaracay, 3386, fqy only ltr in 35d + pennant, no rp, SS rpt, v/s Elsy Cun C,

Secretaria (LAUSEVICH WI)

R. Quito, 4920, no data blue/white folder cd w/multilingual "thanks for ltr", 27d air

for 1 IRC, v/s Fernando Fegen, Gerente (MILLER WA), cd in 60d, no rp (LEGGE VA)

(One spells it "Fegen"; the other "Fegan"--take your choice. bc)

For everyone looking forward to taking a vacation, there is someone looking forward to

taking a vacationer...



ECUADOR (continued): HCJB, 6095, 9560, 9715, 9745, 11745, 11915, 15160, 15300, 17755, f/d cds, v/s Sam Rowley or Herbert P. Jacobson, in 21d to 6 1/2 mo (for JJ rpt) for no rp, 30d for 1 IRC, 28-37d for 2 IRCs. "Bread dough owl" (NUMATA JAPAN)(MILLER WA), #2 in bread doll series (Andean Indian couple in festive dress) (YAJKO PA)(FOWLER ONT)(TOMORI HI)(SMITH FL)(FLEMING NY)(THOMPSON NM)(MILLER CA)(REDMAN IL), #4 "Woodcarving in Ecuador" (MAKISHIMA JAPAN), "Ecuadorian Echoes, Series 'B'" (SMITH FL), 1968 "Project Outreach" reissue, phase 3, 50 kw xmtr (SMITH FL), 1968 "Project Outreach" reissue, phase 4, enlarged xmtr bldg (SMITH FL), 1968 "Project Outreach" reissue, phase 5, arrival of xmtrs (SMITH FL)(MILLER CA), 1968 "Project Outreach" reissue, phase 6, RCA 10 kw xmtr (MILLER) 15th anniversary of DX Party Line (FLEMING NY)

GUYANA (French): FR3, 3385, no data black/white/blue cd in 27d air for MS and FF rpt (ROUTENBURG ONT)

PERU: R. Atlantida, 4790, no fqy ltr in 30d, no rp, v/s Susy Diaz Lanatta (LEGGE VA)

VENEZUELA: R. Trujillo, 3295, EE ltr in 35d, no rp, v/s Pedro J. Torres, Dir. (LEGGE VA)

R. Lara, 4800, cd in 2 mo, no rp (LEGGE VA)

R. Táchira, 4830, f/d ltr in 6 wks, no rp, v/s Juan Agustín Chacón, Dir. (LEGGE VA)

R. Universo, 4880, date/fqy network cd in 35d air for 2 IRCs, SS rpt (TRAUTSCHOLD WE)

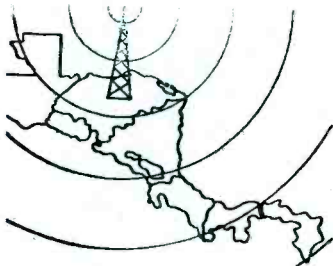

**RADIO "LUX" S. DE R. L.**

H. R. V. L. Su Estación en la Zona Norte de la República de Honduras 4.880 Kcs. 80 Metros

OLANCHITO, YORO, HONDURAS, C. A.

Mayo 12 de 1976

Sr. Jack R. Jones  
Jackson Mississippi

Estimado amigo:

Con sumo agrado damos contestación a su reporte del 23 de Marzo de 1976.

Le agradecemos sinceramente su reporte desde U.S.A. comparandolo con la programación del día en que nos escucho estamos dando el visto bueno a su reporte internacional de sintonía para esta radio emisora a través de esta carta de confirmación, pues es nuestro sistema de contestación; ya que no contamos con tarjetas Q.S.L.

Su reporte verdaderamente corresponde a esta emisora "Radio Lux", que tiene una potencia de irradiación de 1000 Watt en la Onda Corta.

Esperando nos vuelva a escribir, cuente usted con nuestra amistad.

De usted Atentamente.



VENEZUELA (continued): R. Dif. Venezuela, 4890, date only SS personal ltr, 50d sfc for 2 IRCs and EE rpt, v/s Antonia Cajade F. (MILLER WA)  
R. Rumbos, 4970, f/d cd "La Casa Fuerte" ruins, 148d air, 2 IRCs, SS rpt (THOMPSON NM), f/d cd "Iglesia Santa Teresa" in 249d air for 2 IRCs, EE rpt (MILLER CA)

### North America

CANADA: BBC Relay, 6175, usual cd w/site in 63d, no rp (BUTTERFIELD MA)  
CBC Northern Svc, 5960, f/d "Polar Bear" cd in 25d sfc, no rp (SHAW CA); 9625, same in 40d (MILLER WA), same in 68d (FOWLER ONT)  
CFRX Toronto, 6070, date/fqy "Carnival" cd in 47d air for 1 IRC (MILLER WA), same in 23d air for 10¢ (Canadian?? bc) (PIMBLETT ALB)  
CHU (time/fqy stn), 3330, fqy only cd w/pix of Sir Sanford Fleming, 8d (PIMBLETT ALB)  
CKZV Vancouver, 6160, date/fqy CBC Radio cd in 28d sfc, 2 IRCs (MILLER WA)  
RCI, 6085, f/d "do it yourself" XXI Olympiad cd in 17d sfc (THOMPSON NM); 9655, same in 16d (HARDESTER CA) and in 20d (CLEVELAND CA); no fqy, same in 7d (MILLER CA)

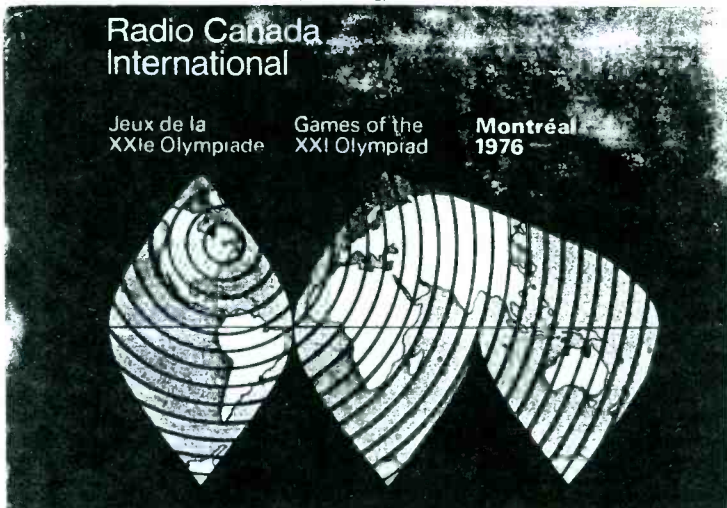

Thanks to all  
who sent in  
copies

CUBA: R. Havana, 11760, f/d yellow "circles" cd in 43d air for 2 IRCs (MACRIS MO); 11815, same in 82d air, no rp (MILLER WA)  
DOMINICAN REPUBLIC: La Voz de las Fuerzas Armadas, 4825, cd, ltr, and large pennant in 60d, no rp, v/s Coronel Fidel T. Baez Berg, Director General (LEGGE VA)  
GRENADA: R. Grenada, 9550, f/d cd in 4 mo (LEGGE VA); 15105, f/d plain pale brown cd in 64d air for 2 IRCs (BAUMGARTNER ONT)  
GUATEMALA: R. Mam, 4825, f/d ltr in SS, in 46d for 1 IRC and SS rpt, v/s Gladys Maria Landa (TRAUTSCHOLD WI)  
HAITI: R. 4VEH, 11835, f/d stn cd in 30d air for MS (WALLMAN MN), same in 62d for 1 IRC (SMITH MD)  
HONDURAS: LV Evangelica, 4820, date only blue/red/white map cd, 28d, 2 IRCs (BOYD NFLD)  
R. Lux, 4890, date only SS ltr in 57d air for 1 IRC, SS rpt (JONES MS) (Previous page)  
NETHERLANDS ANTILLES: R. Nederland, 6165, "Tom Meyer" photo cd in 14d air (MILLER CA), Eddie Startz Memorial cd in 34d (MILLER CA), black/white optical illusion cd in 19d air for 1 IRC (MACRIS MO); 17775, Eddie Startz Memorial cd in 39d, 1 IRC (HARDING CA)  
UNITED STATES: AFRTS, 11840, f/d insignia cd in 11d sfc, no rp (CZAJA WI)  
VOA, 17750, Kennedy Center cd in 4d (CZAJA WI)  
WINB, 15185, f/d cd in 37d for MS (THOMPSON NM); 17720, same in 2 wks, no rp (VOCKEROTH)  
WWV (time/fqy), 2500, f/d "Arapahoe Chief" cd in 27d (PIMBLETT ALB)  
WYFR, 11780, f/d microphone cd in 28d for MS (THOMPSON NM); 11805, same in 9d (CZAJA WI)



Well, we made it again (I think). Last month's sign thanks to Miss Nadica Djordjevich, was Serbo-Croatian and said "Closed Sundays and Holidays". Sheldon Dunham read it perfectly and his HAP patch should have arrived by now. Now take a good long look at this one. It was written by, and in the native language of, an individual known to DXers throughout the world--and if that isn't a clue as to who wrote it and what the language is, I never saw one (clue, that is). But translating it may

ਬਿਨਾਂ ਬੰਦੇ ਤੁਹਾਨੂੰ

be a bit more difficult. (Yes, it is printed right side up). And so to bed (to coin a phrase).

73's, Bill

6/16/76

# SPEEDX QSLs -- 1975

E = ECNA; W = WCNA; F = Foreign; X = several reports from a wide area. ECNA is US & Can. East of the Rockies; WCNA is West of same

	J	F	M	A	M	J	J	A	S	O	N	D		J	F	M	A	M	J	J	A	S	O	N	D
<u>EUROPE</u>													<u>SWEDEN</u>												
<u>ALBANIA</u> (People's Rep. of)													R. Sweden												
R. Tirana													SWITZERLAND												
R. Peking Relay													SBC												
<u>AUSTRIA</u>													Red Cross												
<u>ORF</u>													USSR												
<u>AZORES</u>													Byelorussian SSR												
Em. Reg. dos Acores													R. Minsk												
<u>BELGIUM</u>													R. Moscow												
RTB													Estonian SSR												
<u>BULGARIA</u>													R. Tallinn												
R. Sofia													Latvian SSR												
<u>CZECHOSLOVAKIA</u>													R. Moscow												
R. Prague													Lithuanian SSR												
<u>DENMARK</u>													R. Vilnius												
R. Denmark													R. Moscow												
<u>FINLAND</u>													RSPSR (European)												
R. Finland													R. Moscow												
<u>FRANCE</u>													R. Peace and Progress												
RFI													Radiostantsiya Rodina												
<u>GERMANY</u> (Democratic Rep.)													<u>VATICAN CITY STATE</u>												
RBI													Vatican R.												
<u>GERMANY</u> (Federal Rep.)													<u>YUGOSLAVIA</u>												
Deutsche Welle													R. Belgrade												
Bayerischer Rundfunk													<u>AFRICA</u>												
Rias-Berlin													<u>AFARS &amp; ISSAS</u>												
Sudwestfunk													ORTF												
R. Free Europe													<u>ALGERIA</u> (Dem. People's R.)												
VOA													Rdif. TV Algerienne												
<u>GREAT BRITAIN</u>													<u>ANGOLA</u>												
BBC													R. Cl. do Huambo												
VOA													R. Commercial de Angola												
<u>GREECE</u>													R. Cl. do Moxico												
EIRT													V. do Zaire												
VOA (Kavala)													<u>ASCENSION ISLAND</u>												
<u>HOLLAND</u>													BBC												
R. Nederland													VOA												
<u>HUNGARY</u>													<u>BOTSWANA</u>												
R. Budapest													R. Botswana												
<u>ICELAND</u>													<u>BURUNDI</u>												
ISES													R. Cordac												
<u>ITALY</u>													<u>CAMEROON</u> (Fed. Republic)												
RAI													R. Buea												
<u>LUXEMBOURG</u>													R. Caroua												
R. Luxembourg													R. Yaounde												
<u>MALTA</u>													<u>CANARY ISLANDS</u>												
Adventist World R.													RNE												
Deutsche Welle													<u>CENTRAL AFRICAN REP.</u>												
IBRA													Rdif. Nationale												
R. Canada International													<u>CHAD</u> (Republic)												
Xandir Malta													Rdif. Nationale												
<u>MONACO</u>													<u>COMORO ISLANDS</u>												
TWR													ORTF												
<u>NORWAY</u>													<u>DAHOMY</u> (Republic)												
R. Norway													LV de la Revolution												
<u>POLAND</u>													<u>EGYPT</u> (Arab Republic)												
Polish R.													R. Cairo												
<u>PORTUGAL</u>													<u>ETHIOPIA</u>												
R. Portugal													R. Ethiopia												
Adventist World R.													ETIF												
IBRA													<u>GABON</u> (Republic)												
R. Free Europe													Rdif. TV Gabonaise												
<u>ROMANIA</u>													<u>GAMBIA</u>												
R. Bucharest													R. Gambia												
<u>SPAIN</u>													<u>GHANA</u>												
RNE													GBC												







3.

SPEEDX QSL SUMMARY -- 1975

E = ECNA; W = WCNA; F = Foreign; X = several reports from a wide area. ECNA is US &amp; Can. East of the Rockies; WCNA is West of same

	J	F	M	A	M	J	J	A	S	O	N	D		J	F	M	A	M	J	J	A	S	O	N	D
<u>PHILIPPINES (Republic)</u>														<u>PAPUA NEW GUINEA (cont.)</u>											
FBCB	W	W	W	E		X	W		W		E		R. Milne Bay	E											
PBS							W						R. Morobe	E	E	E									
VOP				W	X	X	W		W	E	E		R. New Ireland			W			E	W			E		
VOA				E	X		X	X	W				R. Rabaul	W	E	E	E								
<u>QATAR</u>													R. Southern Highlands			E							E		
QBS												E	<u>SOLOMON ISLANDS</u>												
<u>SABAH (Fed. of Malaysia)</u>													SIRS			W				E	E	X	W		
RM Kota Kinabalu Sabah	W												<u>TAHITI</u>												
<u>SARAWAK</u>													R. Tahiti	E	W	X	X		W	X	X	X			
R. Malaysia Sarawak		W	E			W	W		W				<u>SOUTH AMERICA</u>												
<u>SAUDI ARABIA</u>													<u>ARGENTINA</u>												
BSKSA			E	E	E					E			RAE	X	E	E	X		E	E					
<u>SINGAPORE</u>													<u>BOLIVIA</u>												
R. Singapore	E	W	W		X	W	E	E	W	X			R. La Cruz del Sur	E	W						W	E	E		
<u>SRI LANKA</u>													R. Altiplano		W										
VOA			E	F									R. Panamericana									E	E		
<u>SYRIAN ARAB REPUBLIC</u>													<u>BRAZIL</u>												
R. Damascus		E		W									R. Bandeirantes							E		W			
<u>THAILAND</u>													R. Brasil Central											E	
R. Thailand										F			R. Cl. de Pernambuco							E			E		
<u>TURKEY</u>													R. Cl. do Para							E					
V. of Turkey	X	X	X	X	X	E	X	X	X				R. Educadora de Bragança										E		
<u>UNITED ARAB EMIRATES</u>													R. Gaúcha										E		
R. Dubai						E							R. Inconfidência									E			
<u>VIETNAM (Dem. Republic)</u>													R. Nacional, Brasília	X	E	X	E		X	X	X	X	X	E	
V. of Vietnam	X	E	E		W				W	W			R. Nacional, Rio							E					
<u>VIETNAM (Republic)</u>													R. Rio Mar		E										
VTVN	X												R. Tabajara							E					
<u>YEMEN ARAB REPUBLIC</u>													<u>CHILE</u>												
R. Sanaa						E			E				R. Nacional de Chile	E	E	X					E	E	E		
<u>USSR</u>													R. Pres. Balmaceda									W			
<u>Armenian SSR</u>													R. Univ. de Concepción											E	
R. Yerevan	W	W			W	W		W					<u>COLOMBIA</u>												
<u>Azerbaijan SSR</u>													Em. Nuevo Mundo								E			E	
R. Baku						E							LV del Huila							E			E		
<u>Georgian SSR</u>													LV del Llano	W					E		W			E	
R. Moscow						F							R. Continental							E					
<u>Kazakh SSR</u>													R. Mira							E					
R. Moscow						F							R. Nacional	W	E	E			W	W			X	E	
<u>Kirghiz SSR</u>													R. Neiva												
R. Moscow							X	X		X			R. Super, Bogotá						X	W	X				
<u>Tadzhik SSR</u>													R. Super de Medellín								W				
R. Moscow						F							R. Surcolombiana								E				
<u>Uzbek SSR</u>													R. Sutatenza			E	E	E	W				W	E	
R. Moscow									E				<u>ECUADOR</u>												
R. Tashkent			E	X	E	W		E					Em. Gran Colombia			X									
<u>RSFSR (Asiatic)</u>													Esc. Radiofónicas										W		
R. Moscow	W	X	X	X	X	X	X	X	X	X			LV de Galápagos											E	
<u>OCEANIA</u>													LV del Napo								E		W		
<u>AUSTRALIA</u>													Ondas Quevedeñas												
R. Australia	X	X	X	X	X	X	X	X	X	X			R. Casa de la Cultura								E				
ABC Brisbane	W		E	E					W				R. Cenit							E					
ABC Melbourne						E	E	W		W			R. El Mundo										E		
ABC Perth			E	X	E		X	E	X	X	W	E	R. Federación							X					
ABC Sydney	W	E						E	E	E			R. Paz y Bien							E					
<u>NEW CALEDONIA</u>													R. Quito												
R. Noumea	X	E			E	W	E		X	X			<u>GUYANA (Republic)</u>												
<u>NEW HEBRIDES</u>													GBS	W	W	E				E	E	E			
R. Vila										W			<u>PARAGUAY</u>												
<u>NEW ZEALAND</u>													R. Nacional										E	E	
R. New Zealand	X	E	X	X	X	X	X	X	X	X			<u>PERU</u>												
<u>PAPUA NEW GUINEA</u>													LV de la Selva										W		
NBC Port Moresby		E	W		W	X	X	X	X	X			R. América										E		
R. Bougainville	X		E	E		E							R. Atlántida									E	E	E	
R. Gulf District													R. Quillabamba												
R. Madang							E						R. Unión	E											



# Tips and Topics

The Feature Section of SPEEDX

EDITOR: ARTHUR S. GETZEL - 70-29 KISSENA BLVD - FLUSHING - NY 11367

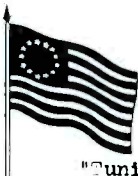

INTERNATIONAL BROADCASTING IN EUROPE AND AMERICA  
1930 - 1945

by Arthur S. Getzel



"Tuning across the shortwave dial any summer evening - especially on the major shortwave broadcasting bands can sometimes be a very boring experience for a DXer looking for that elusive low powered African or Asian station. Instead of hearing exotic music in a strange unknown language, the DXer will hear such fanfare as 'Hier ist die Deutsche Welle' broadcasting 500 kilowatts worth of news and music already known to him or her. With a station, such as Deutsche Welle, that 5 kw African does not stand a chance."

To many DXers, the paragraph above is the basic grievance against the international broadcaster. However, I hardly ever hear a DXer ask the basic question: Why is there international broadcasting if it is suppose to be such a terrible thing? To find the answer to this question, it is necessary to understand the historical development of international broadcasting. Now I am sure you are thinking that we shall go on a nostalgia trip to the "good old days" when the bands were uncluttered by such stations as the VOA, BBC, and Deutsche Welle. If you are planning to hear such a story - do not read further. You will find that such a DXing fantasy world really never existed.

If you do not believe me, I will do my best to prove this fact to you. Lets go back a half a century to 1926 and listen to the 31 meter band on our new crystal set. The DXers among us will be happy to notice there is not one international broadcaster on the air. Therefore, the channel is clear to hear that elusive low powered African station located deep in the heart of the dark continent. However, that African station is still very difficult to hear. Why? Oh one reason. That African station does not exist either!

Shortwave broadcasting activity did not really start until about 1930 in Europe and somewhat later in the Americas. Europe by 1930 had a grand total of three shortwave transmitters and 3 kilowatts were considered to be of enormous power. However, before we discuss the development of international broadcasting in Europe, it is worthwhile to talk about the basic structure of radio in Europe and America at that time.

Today it is common knowledge that in Europe and America most international shortwave broadcasting stations are under government control or supervision in one way or another. In the 1930's a slightly different situation existed. In the United States all shortwave stations were under private control. It can be said that this was the direct result of American political culture. After all, in our country, previous to the invention of radio, the information medium was and has always been in private hands. Why should radio - medium as well as shortwave - be any different.

In Europe on the other hand there were three different means of ownership during the 1930's. First there was private ownership as in the US. This system was most popular in the northern and western European democracies. Then there was the public corporation. The BBC is the best example of this type of system. The BBC is a non-profit public body chartered by the Crown and operated for national benefit. However, Parliament never interfered with the type of programs broadcast unless such programs violated public morality. In other words, the BBC never expressed the political views of the Parliamentary majority in power for the moment. We all know that private stations are financed mainly by commercials. However, stations like the BBC are financed by a license fee or tax upon the radio owner.



This is comparable to the way cable TV is financed today in the US. And the third method of ownership is, of course, direct government control and operation. In some European countries two or sometimes all three types of ownership existed concurrently.

The question now to be asked is why did international broadcasting start in the first place? There is no one answer to this perplexing problem. To find the answer, I believe it is best to look at the development of international broadcasting in each European country and the US separately.

Who was the first international broadcaster? Technically it is the Soviet Union. However, it may come as a surprise that the USSR became an international broadcaster by necessity. We are all aware that the Soviet Union is approximately three times the size of the United States. Thus, it would be difficult for a medium-wave transmitter located in Moscow to reach an Asiatic province in the Soviet Union. Therefore, Moscow had to resort to shortwave transmissions broadcasting in the many different languages spoken within her orbit. Then I am sure some Commissar must have thought, "If you can reach Turkestan, you can reach Europe too by shortwave." By 1939, the USSR had four big 100 kw shortwave transmitters broadcasting on about 24 frequencies. Most famous was the Moscow station HW96 with a 100 kw transmitter aimed toward Europe or should we say Germany.

World War II saw the rapid expansion of shortwave broadcasting in the Soviet Union. Not that she built many new transmitters; when she annexed Finland, Poland, and the Baltic states, their various shortwave stations were included in the package.

We all know that shortwave in the USSR has always been a government affair. Thus, programing has always expressed the political views of the Communist Party of the Soviet Union. Hence, Radio Moscow has the honor of being the first shortwave station to use radio for political ends. Political propaganda and programing has always been one in the USSR. However, during the 1930's propaganda was mainly for domestic consumption. Their broadcasts to Europe heralding the end of capitalism and the coming of a world proletarian revolution was something to do on the side. Their first duty was the "enlighten" through radio the citizenry within the USSR. The art of political propaganda was to be perfected by another country - Germany.

The first intentional international broadcaster was Great Britain. It is not difficult to guess the reason. Unlike today, in the 1930's, the sun never set on the British Empire. Therefore, in 1932, the BBC Empire Service was inaugurated. She had 6 shortwave transmitters at Daventry from 10 to 50 kilowatts broadcasting "only" in English to Africa, the Falkland Islands, and Newfoundland. There was no political purpose to this service. Its purpose was to broadcast news and information concerning Britain to British colonials and the native populations within her colonies.

The third major international broadcaster was Germany. Before the Nazis came to power German broadcasting was made up of 15 private and regional societies, affiliated with the democratic Weimar government through the "ReichsRundfunk - Gesellschaft" (RRG). Through this organization, the Weimar government along with the federated German states controlled and influenced programs and delegated commissioners and counsellors to the Board of Directors and advisory committees of each station. The roots of government control already existed under the democratic Weimar Republic.

Thus, when the Nazis came to power in 1933, it was not too difficult for them to nationalize German radio. The Nazis abolished the radio societies and incorporated them into the RRG. The RRG became an official government institution and all stations were put under the direct control of the state or more specifically the Nazi party. Radio would only serve a political function. Even cultural, musical, and entertainment programs had a political purpose.

The head of German Radio was the "Reichspropagandaminister" who just happened to be the "Reichspropagandaleiter" of the Nazi Party. Thus, as we said, radio became a party organ. However, the Nazis said that the RRG was a joint stock company. A non-profit government chartered corporation serving the public interest of the Reich. Nevertheless, the Nazis always neglected to mention that the government, meaning their party, owned all the stock.



The center of German shortwave broadcasting was located in Zeesen. This station came into its own during the 1936 Olympic Games held in Berlin. The Nazis set up for this event 8 powerful shortwave transmitters of 12, 20 and 50 kilowatts. By 1938, the RRG became the most potent international broadcaster in the world.

Unlike Britain, Germany did not have any real colonies to broadcast their programs to. But according to the Nazis, they did have "colonies" of Germans all over the world to broadcast Nazi propaganda and German nationalism. And like any other broadcaster, they did claim to promote "good will" with other countries. RRG wanted to convince the world of German greatness and the justice of German aspirations.

The Nazis knew how to use international broadcasting well; they knew that in order to make their presence felt, they had to be heard by everyone. In order to do this, the Nazis had to broadcast in many different languages. By 1938, Germany was broadcasting in about 6 languages: English, German, French, Afrikaans, Spanish, and Portuguese to the United States, South Africa, South America, France and her colonies, and Great Britain and her colonies. A major target of the RRG was the former German colony of Tasmania. At this time a British mandate under the League of Nations. Their broadcasts started friendly enough. "Hello, Tasmania, beautiful Apple Isle." However, the remainder of the program was full of pro-German and anti-British propaganda.

Following in Germany's goosesteps was Italy. By 1938, Italy had two 100 kw, three 50 kw, and four 35 kw shortwave transmitters located in Rome at Prato Smeraldo. Furthermore, she had an ultra-shortwave transmitter at Monte Mario. The question that the world asked itself at the time was why did little Italy need such powerful transmitters? The answer came everyday at the start of each of her broadcasts. "This is the Italian Empire Station. . ." This was quite interesting when you consider the fact that Italy had no empire.

Her propaganda was in the form of history lessons, news programs, and information about the march of Italian civilization in Africa. Like Germany, Italy broadcast in many different languages. By early 1937, she was broadcasting in Italian, English, Spanish, Portuguese, German, Arabic, Chinese, Japanese, and Hindustan. Later on she expanded her Arabic programs - especially to British mandated Palestine in order to spur insurrection against British colonials. Furthermore, she added news in Serbian, Greek, Turkish, Rumanian, and Albanian just before the start of hostilities.

England saw this great expansion of international broadcasting by the dictatorial powers of Europe. She decided to act and a shortwave power war soon started. A war that some say continues to this very day in a different form. Britain became a full fledged international broadcaster very late - 1938. She felt menaced in the Mediteranean, in India, and in the Near and Far East by Italy's and Germany's propaganda broadcasts to her colonies. Thus, she started to broadcast in Arabic, Spanish, Portuguese, German, Indian, and French. This was a rather modest beginning to what would become one of the largest international broadcasters in the world.

Leaving the shortwave superpowers of the 1930's for now, we must now embark upon an exploration of shortwave in the rest of Europe and, of course, in the US. Like Britain, other European countries started to broadcast on shortwave because they had colonies in other parts of the world. France, Belgium, Holland, and Portugal used shortwave to provide their colonials and the native populations of each colony with news and entertainment. Leaving aside nationalistic boosterism, there was very little propaganda on these stations beyond a legitimate scope.

Just before the start of the war, Holland had two 60 kw shortwave transmitters owned by the Philips Company broadcasting from Huizen programs to the Dutch East Indies. Belgium had one small shortwave transmitter aimed toward the Belgium Congo under the management of the "Institut National Belge de Radiodiffusion." And Portugal broadcast to Angola, Mozambique, and Macao through five 10 kw transmitters in Lisbon and several colonial transmitters.

The first non-colonial international broadcaster was Czechoslovakia. Czechoslovakia inaugurated in the mid-1930's an overseas service for Czechs and Slovaks abroad. By 1938, Czechoslovakia had a powerful 35 kw transmitter at Podibrad with thirty studios broadcasting in Czech, Slovak, and English to the United States.

Shortwave broadcasting grew rather slowly in the Balkans. Yugoslavia had one shortwave transmitter at Belgrade owned by a private company. Greece had one 1 kw shortwave transmitter while both Rumania and Bulgaria had none. Only Turkey who nationalized her radio in 1936 had any worthwhile international service. She had two 20 kw transmitters broadcasting in English, French, the Balkan languages, and Arabic to the Near East. The Second largest international broadcaster was Hungary with one 5 kw shortwave transmitter controlled by the state.

Spain is an interesting case because she was destined to become the training ground for the first "war of the waves." Before the Spanish Civil War, there were 66 private medium-wave stations. Once the war started, these stations joined either the Nationalist or the Republican side of the conflict. Each side took control of several stations and used them for propaganda against each other. Then each side introduced for the first time "jamming" to block out each others political propaganda. In other words - a radio war foreshadowing future events to come. When the Nationalists won the war, they placed many stations under state control and established a state service. Thus, 22 standard broadcasting stations and 2 shortwave stations were now operated by the Radio Nacional de España. 50 or 60 private stations were allowed to exist with the government service. However, they had to broadcast programs by the national service besides their own commercial fare.

All Portuguese stations were consolidated in the late 1930's under the Emissora Nacional de Radiodifusora. This was a government sponsored organization controlled by the Secretariat of National Propaganda. We already discussed Portugal's shortwave service; however, there was near Portugal in the tiny Republic of Andorra a 60 kw private shortwave station broadcasting in the evening a commercial program of an entertainment nature. But to avoid all political friction with her more powerful neighbors, Radio Andorra refrained from all transmissions of information and news.

There was some shortwave activity in Scandinavia before the war. The privately owned Swedish broadcasting company "Aktiebolaget Radiotjänst" was the most innovative. This station had complete government autonomy and many small radio clubs in Sweden worked very closely with this station. It had a 12 kw transmitter broadcasting to three million Swedes residing in the United States. Finland had a few small private shortwave stations just before the war broadcasting overseas. And Iceland had one 7 kw shortwave station in Reykjavik which was a non-profit government corporation similar to the British system.

The last European country we shall talk about is Switzerland. In 1931, seven regional societies grouped together to form the "Société Suisse de Radiodiffusion" (SSR) or "Schweizerische Rundspruch - Gesellschaft" (SRG). In 1938 SSR started to broadcast on shortwave. SSR had one 25 kw shortwave station in Schwarzenburg to ensure liaison with Swiss living abroad and offered programs in the three national languages - German, French, and Italian. Also located in Switzerland at Prangins was Radio Nations owned and operated by the League of Nations. This station formed in 1932, had two 20 kw shortwave transmitters broadcasting weekly news bulletins in English, French, and Spanish. It also broadcast special meetings of the Assembly as well as speeches by eminent personalities of the time. When the war started, Radio Suisse took over the transmitters at Prangins and started to use the station for commercial communications and transmissions of programs for Swiss living abroad as well as for relays of some American broadcasting company programs.

Now we come to the country we have all been waiting for - the United States. When we think today of international broadcasting in the US, the VOA pops into our head as the dominant station. VOA is criticized today on all sides. Some want it to decrease in size. Some want it to increase in size. Some want it to be controlled by the government. And some want it to be independent. However, in the early 1930's, the question was should the US even venture into the international broadcasting scene?

International broadcasting in the US started very slowly and hesitantly; and unlike Europe, all shortwave stations were owned by private companies. By 1935, only NBC had a shortwave transmitter, inaugurated in 1932 at Boundbrook, New Jersey broadcasting in English to South America. Why were we so slow? The answer lies in the fact that we were in a period of

isolationism. We saw no need for an international service. What was going on in Europe was no concern of ours. So we thought.

With tensions on the rise in Europe, FDR set up a committee to study international broadcasting in the US. The committee said that unless the private broadcasting companies started to improve international broadcasting, the government would be forced to operate its own international broadcasting station. Then the private companies woke up. By 1938, CBS started an international service transmitting from Brentwood, Long Island and NBC was broadcasting 16 hours a day in 6 languages. These two stations were not enough. Therefore, the FCC in 1939, in order to stimulate international broadcasting passed a resolution saying that all shortwave stations must have at least 50 kilowatts and equipped with a directional antenna giving it a ten fold increase in power. Furthermore, a special license was now needed by the FCC in order to become an international broadcaster and the station had to promise it would be on the air at all times.

At first shortwave broadcasts were aimed at two areas. South America in order to improve Pan-American relations and to Europe in order to counteract Axis propaganda. Later, when war started with Japan, many broadcasts were aimed toward the Far East. By 1939, NBC, CBS, General Electric, Westinghouse, the Crosley Corporation, and the World Wide Broadcasting Foundation were broadcasting on 13 transmitters with a combined total of 700 kilowatts over 37 frequencies.

"Nations shall speak peace unto nations," so read the BBC Coats-of-Arms during the 1930's. Soon after Hitler blitzkrieged his way into Poland on September 1, 1939, this insignia was removed. The international broadcasters were at war. It can be said that modern international broadcasting, shortwave as we know it today, came into existence during World War II. All over Europe private broadcasting organizations were dissolved and numerous services were oppressed or taken over by the government. Even in the US, international broadcasting became more centralized as a result of the war.

It is a myth to believe shortwave ceased to exist in occupied countries. It continued. Germany, when she took over a country, incorporated the station into the RRG. Incorporated was Czechoslovakia's 35 kw transmitter at Podbrad; Holland's two 20 kw shortwave transmitters at Huizen; shortwave transmitters in Belgium and Luxembourg; and a new 100 kw transmitter in France.

In the 1930's, France had both private stations grouped under the "Fédération Française de Radiodiffusion" and a government service called the "Radiodiffusion Nationale Française." The foreign service of the government station was controlled by the Colonial Ministry and broadcast in German, French, Italian, and Portuguese. The programs were only broadcast in these four languages because these were the only languages spoken in French territory. (We all know the French ego.) Nevertheless, many private French stations did broadcast shortwave programs in English. The fact of the matter was that many of these small private stations were more international in their scope than the government station. In 1940, just when France completed a new 100 kw shortwave transmitter called "Paris Mondial," the Germans marched in and put an end to the independence of French radio.

In eastern Europe 12 Baltic, Polish, and Russian transmitters were incorporated into the "Sendergruppe Ostland" and 3 Soviet transmitters were grouped into the "Sendergruppe Ukraine" headed by a station in Kiev. By 1941, Germany had a total of 32 shortwave transmitters broadcasting in 27 languages.

Listening to shortwave in Europe during the war was as dangerous as it was interesting. Can you believe that in Germany as well as in the occupied territories, it was a "Rundfunk Verbrecken" (radio crime) to listen to foreign broadcasts. If you were caught listening to Moscow or the BBC, you were jailed for a minimum of six years or put to death. The Germans tried to stop this international shortwave listening by only producing low powered "peoples radios" so the listener could only hear "Deutsche Europasender" (German European Transmitters) broadcasts. However, by connecting these radios to bedsprings, the listener secretly listened to the powerful transmitters of the BBC, VOA, or Radio Moscow.



The BBC quickly re-organized and expanded. She organized her broadcasts into three services: The Home Service; the Armed Forces Service; and the Empire Service quickly became the BBC Overseas Service broadcasting to the Empire, Europe, North America, and South America. The BBC now had over a dozen transmitters, some as high as 100 kilowatts, broadcasting around the clock in about 39 languages on about 40 frequencies.

The radio war was on. Jamming and propaganda was the daily fanfare. Oh what propaganda! Germany had to be the king at this time. In English there was Lord Haw-Haw with his Oxford accent. The Nazis always ended their broadcasts with the statement: "Germany fights for the removal of an injustice, the others for its continuation." The theme of each broadcast was "am deutschen Wesen wird und die Welt genesen." (The spirit of Germany will conquer the world.) Germany's broadcasts contained about 4 to 6 hours of war reports; three hours of propaganda announcements; and at least 4 to 6 hours of out-and-out propaganda against everyone. Then a beautiful German Waltz would come on the air only to be interrupted in the middle by a propaganda announcement. Who said Germans do not have a sense of humor. Would you believe the Nazis invented comic propaganda! An English comedian named "Charlie" was on the air every Wednesday and an American comic Fred Kaltenbach was on each Monday denouncing us all.

The British learned a great deal from Nazi propaganda. The idea of comments from the world press was invented by the Nazis not the BBC. Of course, in its Nazi form, it was best called denouncements from the world press. Nevertheless, the BBC took it up and turned the tables. This time the world press denounced the Nazis. However, British propaganda was "relatively" more truthful than the Nazis.

Jamming was really extreme during the war. It can be said everyone was jamming everyone else. However, for the most part, the jammers were usually Germany and Italy while the jammees were all allied powers. Little tricks were invented to avoid jamming. The BBC would change frequency in the middle of a broadcast without warning. News from the BBC was broadcast by Morse Code to occupied territories on many frequencies. However, Germany had the most trouble with clandestine stations, such as the Free French and Gustav Siegfried Eins. These stations would go from frequency to frequency many times a day. The jammer could really never keep up.

During World War II, the United States became a full fledged international broadcaster. Just before we entered the war, we had less than a score of shortwave transmitters. By 1944, we had 34 high powered shortwave transmitters broadcasting all over the world in dozens of languages on hundreds of frequencies.

During the years between 1939-1945, the government slowly started to take more and more control of international broadcasting. At first, the private companies broadcast only commercial programs on shortwave, such as Jack Benny, Amos and Andy, and the usual soap operas. Then in July 1941, FDR gave Colonel William Joseph the job of Coordinator of Information. His job was to coordinate the broadcasting activities of the privately owned international broadcasting stations in case of national emergency. Also, at this time, the control rooms of various stations were guarded by Pinkerton detectives alluding to the growing importance of international broadcasting during times of crisis. In November 1942, the Coordinator of Inter-American Affairs and the Office of War Information (OWI) leased all private shortwave transmitters in order to have a free hand in broadcasting "Voice of America" programs without commercial interruption. Transmitters in the East broadcast to Europe and in the West to the Far East. It was possible to broadcast to Latin America by transmitters located anywhere in the US. The main programs for Europe originated in the studios of NBC and CBS in New York. The OWI passed a resolution saying that there must be at least 6 hours of news and propaganda in each language for Europe and 8 hours for Latin America. The Army Special Services had charge of rebroadcasting domestic entertainment for military personnel also without commercial interruption.

Five weeks before D-Day, the American Broadcasting Station in Europe (ABSIE) made its debut with the opening bars of Yankee Doodle. Operated by the OWI, it broadcast on 2 medium-wave and 5 shortwave BBC frequencies. It broadcast, like the BBC, news, propaganda, talks, music, and instructions



to the underground. The news was broadcast 8 times a day in 7 languages at dictation speed for the underground press. A third of its programs were beamed to Germany. The Germans, so I was told, especially liked an ABSIE program called "Music for the Wehrmacht." Nazis tried in vain to jam the programs but at its height of operation, 80% of occupied Europe tuned in. Early in July 1945, America's first but not last relay station left the air.

By the end of the war, the OWI operated 36 transmitters broadcasting 280 hours worth of programs on hundreds of frequencies to Europe, Latin America, and the Far East. In the hands of the US government was the core of what was to become the Voice of America. Of course the private companies thought that after the war the US government would return their transmitters and that they would use shortwave for commercial purposes. We all know this did not happen. International broadcasting became permanently a function of our national government and taken almost completely out of the hands of private industry.

By the time the war ended, modern international broadcasting existed in full potency. There were 100 kw transmitters broadcasting scores of languages on hundreds of frequencies. It can be said that the tensions of the 1930's and World War II was the catalyst for the creation of our shortwave world. We may criticize our international broadcasters today but we cannot deny that stations like the BBC and the VOA performed an important function during the last world crisis. They helped the underground and informed millions who were enslaved by the Axis powers. If we learned anything from this history, we learned that our shortwave world of super-power transmitters, relay stations, directional antennas, propaganda, and jamming came about by world events beyond the control of any individual shortwave listener or DXer.

For the moment, in 1945, there were very few international broadcasters left on the shortwave radio spectrum. Germany's shortwave transmitters laid in a heap of rubble along with many transmitters of the occupied nations. The only superpowers to be heard were the BBC, VOA, and Radio Moscow. It was thought that finally "nations (would) speak peace unto nations." But world events soon interfered and a new international broadcasting power race soon began. However, that is another story. . .

#### APPENDIX

#### Shortwave Stations in 1942

<u>Power in KW</u>	<u>Station</u>	<u>Country</u>
100	Paris-Mondial (Allouis)	France
100	Daventry (Overseas Transmitters)	Great Britain
100	Prato Smeraldo (Rome)	Italy
100	Moscow RW96	USSR
100	Boundbrook WRCA (Also 50 kw)	USA
100	Schenectady WGE0	USA
100	San Francisco KWID	USA
100	Scitvale MA WRUS	USA
80	Kootwijk PCV	Nederland
75	Mason, Ohio WLWO	USA
60	Huizen PCJ	Nederland
50	Zeesen (Deutscher Kurzwellensender)	Germany
50	Daventry (Overseas Transmitters)	Great Britain
50	Prato Smeraldo (Rome)	Italy
50	Lisbon	Portugal
50	Moscow	USSR
50	Belmont, CA KGGT	USA
50	Boundbrook WNBC	USA
50	Brentwood WCRC	USA
50	Brentwood WCBX	USA
50	Hall MA WBOS	USA
50	Schenectady WGEA	USA
50	Scitvale MA WRUW and WRUL	USA
25	Paris Mondial (Les Essarts le Roi)	France
25	Prato Smeraldo (Rome)	Italy
25	Schwarzenburg	Switzerland
25	Vaticana	Vatican City



BIBIOGRAPHY

- "Clandestine Stations." Science Digest. July, 1944, pp. 83-4.
- "Enemy Voices." Time. July 24, 1944, p. 51.
- "The Future of Shortwave." Business Week. February, 8, 1947, p. 110.
- "For German Ears." Time. January 30, 1939, p. 22.
- "Germany's Final Sign-off." Time. May 14, 1945.
- Hugh, Arno. Radio Today: History of Broadcasting till 1942. New York: Arno Press and the New York Times, 1971.
- "Jamming." Time. November 2, 1942, p. 91.
- Kranz, H.B. "War on the Shortwave." Nation. February 3, 1940, pp. 123-7.
- Makin, W.J. "Shortwave Warfare." Readers Digest. May 1938, p.42.
- Saerchinger, Cesar. "Radio as a Political Instrument." Foreign Affairs. January, 1938, pp. 244-59.
- "Shortwave." Business Week. July 15, 1944, pp. 106-7.
- "Shortwave in the US." Time. November 3, 1941, pp. 54-6.
- "US International Broadcasting." Harper. April, 1941, pp. 301-12.
- "Voice of America." Inter-American Affairs. October 1945, pp. 26-8.
- Whitten, J.B. "Radio After the War." Foreign Affairs. January, 1944, pp. 309-17.

\*\*\*\*\*



ANNIVERSARIES

Arthur S. Getzel



The above article is my birthday present to SPEEDX. Five years ago, July 1971, SPEEDX was found in my mailbox. At first, I did not know what this little offset bulletin was doing at my address. But in a little while I knew that I had to become a member. Looking back to that July day, I never would have dreamed that I would for way over two years devote so much time and energy to this club as an editor. Friends, I must admit that I have enjoyed my tenure as editor. This column has made it possible for me to meet many new people and learn a great deal more about our hobby through your articles. Congratulations SPEEDX on a job well done and may your success be increased ten fold (according to FCC regulations) over the next half a decade.

This month is another anniversary. You guessed it! The United States is 200 years old. Five years is a short time compared to two centuries and this greater anniversary should and must take precedence over our own. Lets all wish our country a happy birthday and may her Stars and Strips fly proudly over this great continent for another two hundred years.

\*\*\*\*\*

Odds and Ends: In looking through my files, I have come to the conclusion that I am slightly short on manuscripts. I know it is summer and that the mind often wanders to more worldly things. However, it would be nice if you would take a few hours and write me an article for "your" column. This column is only as good as you make it. Send all manuscripts of any length to the above address. All manuscripts should be typed on 8 1/2" x 11" typing paper and should be double spaced and indented.

Summer is upon us and good DX is now at a very low point. Thus, I would recommend that now is the time to have your rig overhauled and all wiring checked. Don't get caught with a broken rig in the middle of December. I remain, Best Wishes & 73's, *Arthur*

JULY CONTRIBUTORS LIST

1 ARNESON, JARRY	MD....NC-57	1 MAYER, ALAN	IL....SPR-4
3 BAKER, MARK	IL...HA-129X	2 MC INTOSH, RANDALL	PA....SPR-4
1 BARBER, LANCE	MAN....SX-190	1 MEEHAN, JIM	CT....SX-190
1 BARON, BRUCE	PA.....R4C	3 MERCADO, MARJO	CA.....R4
2 BAUMGARTNER, BRIAN	ONT...DX-160	3 MIKIEJEWSKI, STANLEY	MN...D-7000Y
3 BEAL, BART	WA....SB-313	3 MILLER, AL	OH...HRO-500
2 BEAUDOIN, ROBERT	CT....R-388	4 MILLER, BILL	CA...YORK-21
1 BENJAMIN, IORENZO	CA...SX-190	4 MILLER, CARLETON	WA.....ROSS
2 BERGER, JEFF	TX...DX-160	*3 MITCHELL, RICH	CA....SSR-1
3 BERNSTEIN, ROGER	GA...DX-160	3 NAYLOR, SPENCE	CA...HQ-180
3 BETHGE, JANE	MO....SW-717	2 NEBRON, LARRY	CA...SX-190
4 BIXBY, MARK	CA...HA-225	2 NUMATA, NORIYUKI	JAPAN....SSR-1
2 BODELI, BOB	OR....SPR-4	*1 ODHNER, JUI IAN	PA....SX-71
*1 BONDS, EUGENE	NY.....???	2 OLIVER, WAYNE	NH....SX-190
1 BO'EN, PETER	N.S...EDY-750	1 OISSON, ERIC	CT....SPR-4
3 BOYD, RODNEY	NFID....S-38E	*1 OISSON, GUNNAR	SWEDEN...SPR-4
*1 BOYER, DONNA	KS....SW4A	5 O'SSLEY, BENTON	CA...HQ-145
2 BREEDEN, BILL	MS.....R4B	2 PERRY, COLIN	QUE.GRU-2000
3 BROOKER, JIM	MI....SPR-4	2 PETERS, DAVID	KY....SPR-4
1 BROOKS, ALAN	GT...DX-150A	2 PIERCE, BOB	MA...SAT-210
3 BROOKWELL, LARRY	GA...XCR-30	2 PIMBLETT, NIGEL	ALB...DX-150A
2 BUTTERFIELD, BOB	MA...HQ-100	3 POILARD, EUNICE	RI...HITACHI
2 CHABAK, MIKE	CO...DX-150B	2 RADTKE, CARL	CA....SPR-4
1 COOK, MELVIN	MN....SPR-4	3 REDMAN, RON	IL....SSR-1
4 CLEVELAND, BILL	CA....SPR-4	1 REBINSON, NANCY	AL....SPR-4
3 COHEN, JON	NJ...SW-717	2 ROGERS, WESLEY	ONT...SX-190
1 COLEMAN, BILL	NC...DX-150A	5 ROJEWSKI, DON	WA...DX-160
1 CREWS, DEMPSEY	FL....SPR-4	1 ROUTENBURG, PAUL	ONT...R-2311
*3 CZAJA, TOM	WI....GR-78	2 SANN, RON	NJ...DX-160
*1 DAIRYMPLE, M.	AUST....R-390	2 SCANNELL, MARK	MA...SB-313
2 DAVIDONIS, LEONARD	MA...HA-600A	3 SHAW, STAN	CA....SPR-4
*1 DUNHAM, SHELDON	VA.....???	*1 SHEPARD, DANNY	NY...HA-700
4 EARHART, KEN	PA....SX-190	1 SMITH, EUNICE	MD...DX-160
4 ESTES, SNAPPER	MS...SX-190	5 SMITH, TOM	FL...HA-600A
5 FAMULARO, RALPH	NJ...XCR-30	1 SMITH, WOODY	TN...TRANS-0
1 FLEMING, KEVIN	NY...DX-150A	3 SNYDER, DOUG	CA....SPR-4
2 FOWLER, GARY	ONT...D-7000	5 SOMERS, JACK	CA....SPR-4
2 FRENCH, BOB	MD....S-108	1 SPARKS, BILL	CA.....R4B
1 GEBHARDT, JIM	IA...DX-160	3 STEPHENSON, NORMAN	CA....SPR-4
1 GELFAND, STEVE	NY...NC-183D	2 STRAUMANIS, ANDRIS	IL...SW-717
1 GION, JOHN	MA...DX-150A	2 TANNENWALD, LEON	NY.NORMEADE
1 GREEN, DALE	UT....R-392	5 THOMPSON, GLENN	NM...HQ-145A
1 HANSEN, CHRIS	NY...HQ-200	1 TOMORI, ROBIN	HI...RF-1260
7 HARDESTER, MIKE	CA....SPR-4	1 TRAUTSCHOLD, JOHN	VI...SB-310
3 HARDING, BARRY	CA...DX-150A	2 TROCHIMCZYK, J.	DC...XCR-30
1 HAUSER, GIENN	IL...HQ-160	2 TRUBEE, BILL	HI....SPR-4
1 HICKMAN, MEL	OR...A-2515	1 VOCKEROTH, JOHN	PA....SX-190
1 HINDS, RON	W. INDIOS.ICF-8000	2 VOKES, BOB	TX...XCR-30
3 ISHIZAKI, YASUO	JAPAN.IGH-5900	*1 WAKISAKA, SATOSHI	JAPAN...9R-590
5 JONES, JACK	MS...DX-150A	2 WAIMANN, JIM	MN...DX-160
3 JUNQUA, "GIB"	JAPAN....R4C	2 WALTERS, JOHN	NJ...R-1530
4 KANNRY, JOE	NY...XCR-30	*2 WATTS, GREG	IN...DX-150B
3 KASDAY, MORTON	NJ.....R4C	*2 WEST, DENNIS	CA....SPR-4
3 KELLY, BOB & RITA	TN...CRF-230	4 WHITE, JOHN	FL....SPR-4
1 KIONTZ, WINSTON	CA....SPR-4	1 WICKETT, BOB	MD....S-120
1 KUMMER, MARVIN	KY...D-7000Y	1 WILSON, BOB	IL...XCR-30
1 KURTZ, JOE	MN...DX-160	2 WIRRELI, BOB	MA...SX-110
*2 LAUSEVICH, ARNOLD	WI...HQ-180C	3 WOLTMAN, FRANK	WI...DX-160
1 LEAMY, ROBB	OH...HQ-180	1 WOOD, RICHARD	NY...R-390A
3 LEGGE, ROGER	VA....51-J	4 WORMAN, JEFF	VI...DX-160
1 LUNSTRUM, TOM	FL...DX-160	5 YAJKO, BOB	PA....SPR-4
2 MAC COY, DON	NJ....R-392	*5 YOUNG, CHARLES	NJ...DX-160
*3 MACRIS, RANDOLPH	MO....DX-160	2 YOUNG, JIM	CA...HQ-180A
4 MAKISHIMA, JAMES	JAPAN....FRG-7	3 ZILMER, BOB	VI...SPR-4
		1 ZIMAROWSKI, MARK	MA...SX-190



\* First time reporters, A 21 gun salute to 15 first timers. SPEEDX says thanks to 129 reporters.

HAPPY BIRTHDAY TO U.S.A. AND TO SPEEDX

THE OFFICIAL DX MAGAZINE PUBLISHED MONTHLY BY SPEEDX

BOARD OF DIRECTORS

- PRESIDENT.....DON JOHNSON  
 VICE PRESIDENT.....JOHN TRAUTSCHOLD  
 MEMBERS.....JIM WHITEHEAD, DOUG SNYDER, ALAN BROOKS
- MANAGING EDITOR.....OLIVER ELLSWORTH  
 BUSINESS MANAGER/PUBLISHER/TREASURER.....DON JOHNSON  
 PROJECTS COORDINATOR.....DOUG SNYDER  
 MEMBERSHIP CHAIRMAN.....ART GLOVER  
 SPEEDXGRAM EDITOR/PUBLISHER.....JOHN TRAUTSCHOLD

SUBSCRIPTION RATES PER YEAR

- FIRST CLASS TO USA/CANADA/MEXICO.....\$12.00  
 AD (AIRMAIL) TO SOUTH AMERICA/EUROPE.....20.50  
 AD (AIRMAIL) TO ASIA/AFRICA/OCEANIA.....23.00  
 FIRST CLASS WORLDWIDE (OUTSIDE USA/CANADA/MEXICO).....14.00  
 SAMPLE COPY WORLDWIDE.....6 IRC's or 1.00  
 (MAKE ALL MONIES PAYABLE TO SPEEDX IN US FUNDS)

Permission is granted to broadcast, publish, or reproduce any material contained herein (excepting items which state that they appear by permission from other sources) providing credit is given to: SPEEDX, P. O. BOX "E", ELSTONRE, CALIFORNIA USA and to the author or contributor when stated.

INDEX

- KEYNOTES.....OLIVER ELLSWORTH 2  
 DX MONTAGE.....ALAN BROOKS 5  
 TECHNICAL TOPICS.....RALPH SANSEERINO 7  
 HAPPENINGS.....TED POLING 9  
 SWBC WESTERN HEMISPHERE.....JIM WHITEHEAD 10  
 EUROPE AFRICA.....BOB BUTTERFIELD 17  
 ASIA OCEANIA.....BOB BODELL 27  
 STATION SCHEDULES.....LARRY TALBOT 34  
 UTILITY SECTION.....KEN COMPTON 36  
 QSL SECTION.....BILL CLEVELAND 44  
 \*\*SPECIAL QSL SUMMARY FOR 1975\*\* BILL CLEVELAND 51  
 TIPS & TOPICS.....ART GETZEL 55  
 CONTRIBUTORS PAGE.....OLIVER ELLSWORTH 63

**S P E E D X**  
 P O BOX E  
 ELSTONRE CALIFORNIA  
 U S A  
 9 2 3 3 0



U.S. POSTAGE PAID  
 FIRST CLASS MAIL  
 PERMIT NUMBER 36  
 ELSTONRE CA 92330

WILLIAM FARMERIE 0377  
 15165 rue ST HYACINTHE  
 STE. GENEVIEVE, QUEBEC  
 H9H 1E7  
CANADA



FIRST CLASS MAIL