

SPEEDX

the dx radio magazine for active shortwave listeners

Keynotes	<i>staff</i>	2
DX Montage	<i>brooks</i>	3
Ghana	<i>neumann</i>	5
Speedxtras	<i>white</i>	7
SWBC DX		
Western Hemisphere	<i>whitehead</i>	9
Europe-Africa	<i>butterfield</i>	17
Asia-Oceania	<i>johnson</i>	24
Station Skeds	<i>koukol</i>	30
Utility Chaser's Corner	<i>mayo</i>	32
Utility QSL Report	<i>handler</i>	34
QSL Section	<i>snyder</i>	37
Features	<i>staff</i>	45
Speedx Contributors	<i>ellsworth</i>	47

1973

world dx-friendship year

Oct. 1973



Vol. III — No. X



KEYNOTES



CONGRATULATIONS TO 4 NEW FULL MEMBERS

ROSEMERY A. TRZASKUS
CHICAGO, ILL.

JOSEPH SMITH JR.
JOHNSON CITY, NY.

DAVID P. SIMON
ROCHESTER, NY.

TOM CAVARAS
WAYZATA, MN.

Certificates of Full Membership and a copy of the SPEEDX Constitution were mailed to each of the above in September.

ANNOUNCEMENT

A copy of the latest NASWA reprint, RECOGNITION OF LANGUAGES, by professor Richard E. Wood, is available to any DXer. This article explains techniques DXers can use in identifying the language of a program they are hearing.

To obtain a copy, just send a self addressed stamped, legal size envelope to.

NORTH AMERICAN SHORTWAVE ASSOCIATION
P.O. BOX 8452
SOUTH CHARLESTON, WEST VIRGINIA 25303

DXers outside the United States can obtain a copy for one (1) IRC. The article will be sent via AIRMAIL if two (2) IRC's are included.

HAP has done so much for the handicapped, and there is much more to be done. Lets all support HAP by donating \$1.00, \$2.00 or more to the CHRISTMAS TREE fund c/o SPEEDX, P.O. Box 321, Santa Ana, Calif. 92702. See HAP-penings in the September issue of SPEEDX for particulars.

A MESSAGE OF THANKS

Members of our hobby, in and out of SPEEDX are to be complimented for the interest they show in others.

Recently members of SPEEDX, FRENDX, SWAPS NEWS LETTER and other SWL publications heard of a SPEEDX member being in the hospital. The cards and messages they sent him, and delivered to his room by the "Candy Strippers" (volunteers) was over-whelming. There was no room to display the cards, so about one third of them were hung on the venetian blinds of the windows. All the nurses on the 5th floor West, at one time or other, visited the room to see the beautiful display.

The thoughts and prayers contained in those messages will never be forgotten by this SPEEDXer, they meant so much to him. The thoughtful messages, renewed his faith in humanity, and proved to him the best are members of our hobby.

It is mighty nice to be back home after my 54 day stay at the Hollywood Presbyterian Hospital. Thanks again for your messages and prayers.

Over Reserved



DX MONTAGE

RESEARCH/COMPIATION/REDUCTION by A. W. BRUCKS

74 Massachusetts Road

Oakdale, Connecticut 06370

THE BUNDY-d'ADOLF SYNDROME REVISITED (or "Hafa Adai To Tropical Isle DX"):

There I was...an east coast SWL suddenly placed on a 32-mile long island in the tropics half-way around the world. Difficult as it may be to think of 1100-1400 GMT as "prime time"...it is still more difficult to attempt to make some sense from an overabundance of Indonesian regionalism when the sum total of your experience with that exotic land has been to leg Voice of Indonesia English transmissions four years previous. Undaunted...armed with a Teshiba portable purchased that afternoon and a few free hours before departure...I settled down near the shores of Agana Bay for a quick course in Asian DX. Visions of Maldives danced in my head...so what to my wondering ears should appear...but Nihon at 1045 with Japanese lessons...the same legging so oft present on the old DX-150A at the family homestead 9,000 miles to the East! So, of course, I gave up and went looking for uninformed Japanese soldiers in the hillside caves!



SNYDER'S LOG: For those DXers whose logs or log-keeping aren't what they'd like them to be, Doug Snyder may have found the answer. It's an accountant's book called "DAY BOOK"...sturdy...at 8x12 large, but still convenient and has many columns of various sizes for numbers or words...can handle up to 37 entries per page and should be available in most stationary stores...

GEE...M.T.! For those among us still having trouble converting Greenwich Mean Time, prepare for the arrival of "Moon Time". Scientists devised a system of time registration for the moon calculated in lunar stellar days. The 50th Anniversary SPEE DX Edition will inaugurate a column utilizing this method for coverage of interplanetary DX...



YOU'RE NOT LIKELY TO HEAR IT ON RADIO PRAGUE, BUT... a July TV Guide article sites Czechoslovakia's first color telecasts as a useful object lesson in free vs. government controlled communications. The Czechs had to choose between a West German or a French color system...which, it seems, are incompatible...i.e., the German set cannot receive the French colorcasts and vice versa. Enter the Soviets, under yet another of the ubiquitous secret pacts, as user and manufacturer of equipment for the French system to sell the hardware to the Czechs and also to assist with the development of the new Czech system. One "advantage" in their eyes is that such a system would render it impossible for border-dwelling Czechs to receive color programs from West Germany and Austria. It is obvious that government control of communications is not always as crude as the old jamming technique. Oddly enough, the black-and-white broadcasts in Europe are not plagued by incompatibility. The Czechs who cling to their old sets will continue to receive a free flow of news and entertainment from beyond the Iron Curtain...Czech-Mate!



ANONYMOUS CONTRIBUTION: "This is the Israel Broadcasting Authority on 9,625 kilohertz... but for you...only 9,624..."



ACORNS FROM OAKDALE:

A Candidate is a man who makes an issue of himself...

NORTHEAST REGION SOCIAL CALENDAR: The Greater Philly group gathering reported upon in two other columns last month is living proof that the hobby spans all ages...Bill Shaw is 78, host Harlan Bye 50-plus, John Vackeroth 26, and youngster John Fischer but 19! However, in response to a challenge by one of these reporting columnists...and rejecting as too obvious the immediate impulse to dub them the "PENN-MEN"...I tentatively label this imposing body the "SUPRE - MEN", an acronym derived, of course, from SUBurban Philadelphia Radio Enthusiasts. Mr. Bye provided the surprise of the September 9th B.A.D. Guys gathering at the Whitehead estate by dropping by to say hello to all the Boston Area DX followers...and though he didn't stay long enough to partake of the usual fine Italian cuisine, another Philadelphia DXer, John Fischer, and Metropolitan DXer Phil Schnabel did. Which reminds us that the Metropolitan Area DXers...who, at the risk of offending activists in Maryland or Manitoba, have been called "THE M.A.D.-MEN"...are planning a Greater New York meeting on the afternoon of November 11th in Bronxville. For further details...and so that he might warn his parents...contact Philip Schnabel, 163 White Plains Road, Bronxville, NY, 10708...or if classical Greek or Latin is your bag chisel out an inquiry and send it along to Chris Hansen, 927 Farnald Hall, Columbia University, New York, NY, 10027...See you there?

SUBURBAN PHILADELPHIA



RADIO ENTHUSIASTS

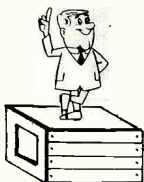

The SOAP BOX

A DIVISION OF "DX MONTAGE"

Moderator: *Glan W. Brooks*

This month THE SOAP BOX features a rebuttal from the Grand Order of Oregon DXers, commonly known throughout the DX World as "The G.O.O.D. Guys", to the SPEEDX Exposé which had been published in the April Edition of the club bulletin...

"Certainly some comment seems indicated on behalf of 'The G.O.O.D. Guys', depicted as cherubs, indeed!...

GRAND ORDER



"Following April's 'DX MONTAGE', an informal poll was taken from the ranks in an effort to formulate an official response from the group. After an exhaustive tour of the taverns and other watering holes known to be frequented by the membership, we can now officially state that 'The G.O.O.D. Guys' are the most representative collection of SWIs anywhere... we can't agree on anything...except the inadequacy of the SWling monarchy...

"Most noteworthy of our indecisions is the propensity for not scheduling regular meetings...we do, however, manage to break with this time-honored tradition about once each year and descend upon whoever might be coerced into saying:

...'we ought to get together sometime'... the record for hosting 'The G.O.O.D. Guys' presently stands at one....a distinction shared by several...and, unless some new blood is soon infused, this may stand for all posterity...

"Actually, if it were not for our deep sense of responsibility toward the order we would not consider disrupting our personal affairs for any such gathering... but, since the ANARC group sees fit to establish its annual convention at a distance beyond our modest means of horse and buggy transport...as well as to totally ignore our recommendations...after concerted solicitation of same...we do extract a modicum of pleasure by harmoniously joining in a rather raucous 'Bronx Cheer' as a salute to that august body..."

"THE G.O.O.D. GUYS"

Four months ago our mailbox was graced by a most eloquent letter addressed to SPEEDX club members from fledgling DXer Arjon D'Angelo...who calls Sherman Oaks, California, her home...and we'd like to share it with you now:

DISTAFF DX

"...First of all, I am a woman...which seems to be rare in this particular hobby...besides being a housewife and mother. I am twenty-five and started listening last December. My husband purchased a Lloyd's Pathfinder 10-band portable for me during Christmas...and away I went. Nobody I talked to knew a thing about shortwave listening, so I went about the task of finding...or should I say digging up...books concerning the hobby. Finally, after reading several paperback books on it, I began to understand all the history and details of it.

"...Next step was to put on the roof a cheap long wire, which helped my receiver a great deal. I read about clubs and joined one, which helped me discover how bad my receiver was for DXing. After huddling about with my portable I decided I enjoyed the hobby enough to go on to better things and, therefore, purchased an Allied SX-190. My husband constructed a multi-band antenna and my reception seems to be 100% better...

"...I still have many problems, however, because of my limited abilities on being 'stupid' when it comes to mechanics, on being a woman listening to shortwave; for instance, people say, 'YOU listen to shortwave radio', or 'That's odd for a WOMAN to do, etc...I also have a hard time picking up Europe and I get discouraged thinking I just don't have what it takes to really be a good DXer..."

"...Anyway, I enjoy my new hobby and am able to 'travel' while sitting at home. I recently joined your club and was truly amazed at the way it was run and organized. I hope to participate in it and also hope being a woman will not have its drawbacks!!!!...

"...I have found that Radio Nederland has been a big help and also the kindest of all the stations in generating enthusiasm for the hobby..."

"...I hope that I'll meet other members in the future and that I'll get a little better at DXing harder to find stations in the months ahead. I know your bulletin will help and I am glad that I am with your organization..."

GHANA BROADCASTING CORPORATION OFFERS YOU

THE FASTEST, MOST DIRECT WAY TO THE GHANAIAN MARKET



- * There are more than 600,000 radio sets in Ghana
- * There are more than 100,000 TV viewers
- * 'Ad' spots are inexpensive and effective

For Rate Cards and full details write to:

GHANA BROADCASTING CORPORATION

Broadcasting House, P.O. Box 1633, Accra, Ghana.

Sole Overseas Sales Representatives:

RMA LIMITED 28 Margaret Street, London W.1., England.

GHANA BROADCASTING CORPORATION

(Written exclusively for SPEEDX by PAUL K. KUSSE, Senior Technical Assistant, RADIO GHANA, and edited by Serge C. P. Neumann).

THE GHANA BROADCASTING CORPORATION began operations July 31st, 1935, as a wired relay station in the Gold Coast, now Ghana. The station, then a wing of the information services, was known as Station ZOY, and operated from a small bungalow in Accra, the capital of Ghana. Initially, the station relayed BBC programs to about 300 listeners in Accra only.

In 1936, the service began to expand. A radiodiffusion center was opened in Cape Coast (a regional center), and a year later, broadcasting stations opened at Sekondi, Kumasi and Koforidua.

In 1939, the Colonial government provided the funds for the construction of a new broadcasting house in Accra, and the purchasing of a 1.3 kilowatt transmitter—the first transmitter to carry programs from Ghana to its neighbors.

On recommendation of a Commission appointed in 1952, the government established the Gold Coast Broadcasting System in 1954. The first Director of Broadcasting was Mr. J. B. Miller, who came to that post from the BBC. He was the Chairman of the Commission which brought reforms to the Service after 19 years of operation.

The first Ghanaian to be appointed to the post of Director of Broadcasting was Mr. W. F. Coloman. He held the post from 1960-1968, when he was appointed Director-General. He held that position until 1970.

The Ghana Broadcasting Corporation (GBC) was formally incorporated on March 1st, 1968 under a decree that (now) consists of nine main areas; Sound (programmes), Television programs; Engineering, News and Current Affairs; Common Services; Administration; Accounting; Music; and Commercials (advertising).

The objectives of the GBC are, among others, to undertake sound, commercial and television broadcasts; to prepare in the field of culture, education and information-entertainment, programs reflecting national progress and aspirations; to carry on an external service of sound broadcasting; and (in its) public service broadcasting—including the airing of government announcements; political party speeches; and the expression of differing viewpoints on matters of public controversy.

The GBC operates with funds derived from its commercial broadcasting (both radio and television), wired broadcast service, television license fees, and thorough financial support of the Ghana Government.

The Corporation employs more than 3,400 men and women, including engineers, lawyers, administrators, accountants, producers, technicians, announcers, designers, carpenters, monitors, artists and workers.

The GBC operates three radio networks in its National Service. It also operates the External Service and the Television Service. The three National Services are NBL-1, GBC-2 and NBL-3.

(continued)

GHANA BROADCASTING- continued.

The GBC-1: Broadcasts in the major Ghana languages, Akan, Ga, Ewe, Hausa, Dagbani and Nzema. But there are a few programs in English broadcast on this network, such as news, commentaries, Ghana Newsreel and various school or educational broadcasts. Most of the transmission time is devoted to programs on culture, plays, features, health talks, and so on. This service operates on 3350 kHz, 4915 kHz, and on 5990 kHz, respectively.

The GBC-2: This service which is our commercial service, is heard on radios only, and covers 13½ hours per day on weekends and on holidays. Inaugurated five years ago, GBC-2 carries mainly popular music programs and English programs, with "News on the Hour". Advertisements and social and public announcements are also part of the program fare. Frequencies are 4980 kHz and 3366 kHz.

GBC-3: This is the third network of the Corporation, and it carries only English-language programs. The programs have been designed to fulfill functions of cultural leadership, and patronage in the fields of Music, Drama, the Arts, Literature, and the Sciences. It operates from 1655 (GMT) until 2300 (GMT) daily, Sunday through Saturdays, on 3295 kHz and on 3326 kHz.

The External Service: This Service was inaugurated on June 1, 1961, and broadcasts in English, French, Swahili, Arabic, Portuguese and Hausa on four 100 kilowatt transmitters situated at Tema. Two high power transmitters of 250 kilowatts each at Ejura in the Ashanti Region augment the service. Service areas include North America, the Caribbean, Europe and the Middle East.

GBC-TV: The 30th anniversary of sound broadcasting in Ghana also marked the birth of the Television Service on July 31, 1965. It consists of studios at Accra, with four transmitters of about 20 kilowatt E.R.P. (effective radiated power) and linked by microwave to the studio center at Accra. GBC-TV is on the air for two-and-a-half hours in the morning when schools and colleges are in session. It goes back on the air from 1755 GMT on weekdays, and at 1600 GMT on Sundays, with entertainment programs.

* * *

(Editor's note: Our sincere thanks to Mr. Kusse for providing our readers with an insight into the Ghana Broadcasting Corporation. It can be said without qualification, that the GBC has been a consistently good verifier, now as in former days. This, in combination with their very interesting programs, makes it no wonder that the GBC must be considered as one of the broadcast leaders in Africa. Their programs and attitude clearly reflect the new and progressive Ghana. We hope you'll give it a listen, often).

From antenna expert and HAP Vice-Chairman, Bill Paschke, comes word of a new antenna tuner, known as the "TG RANDOM WIRE ANTENNA TUNER". It is billed as "especially helpful if you are limited to an inadequate, short indoor antenna. Yet equally beneficial with a too-long Inverted-L". "...Simple to operate and install".

Bill tells us that he has tested out the first one manufactured and found it to be "a FB producer... a good and economical antenna tuner unit". Further, "I can highly recommend this antenna tuner and, I am a hard one on either testing or recommending a product unless it is a producer".

Should you care to investigate this one, you may write for detailed information directly to Todd Graves, SWL GUIDE, 414 Newcastle Road, Syracuse, NY 13219. The advertised price is \$ 17.95 postpaid.

* * *

We pass along this request that we invite SPEEDXers to contribute to a DX Poll being conducted by the Crestwood DX Club (CDX), in Maryland. Between the dates, 15 September to 15 December, you are invited to submit your list of what you deem to be "The ten best SW stations". Mail your list to CDX, c/o Joe Geckle, 421 Sudbury Road, Linthicum, MD 21090.

Joe says, "The winning station will receive a copy of our CDX Bulletin and five beautiful picture post cards".

* * *

SPEEDXTRAS

THE PROJECTS DIVISION of SPEEDX

Projects Coordinator — Jack White • 780 NW Wallula Ave • Gresham Oregon • 97030

SPEEDX SELECT AWARD

● L A R G E S T 1972 Q S L ————— 1049.64 Sq Cm

Verification/Program Schedule folder from Radio Bougainville/VL9BA for a 17 August 1972 logging at 1103 GMT on 3322.5 kHz.

Winner: Mike Hardester, 401 Birchwood Ct, Modesto CA 95350

● L A R G E S T 1972 Q S L C A R D ————— 301.32 Sq Cm

Verification Card from Ma Bell's Overseas Telephone Service station WOO in Manahawkin NJ for an 8 April 1972 logging.

Winner: Andris Straumanis, RFD#1, Box 213, Murphysboro IL 62966

● S M A L L E S T 1972 Q S L ————— 107.00 Sq Cm

Spanish language QSL card from Difusoras del Uruguay/CXA19 for a logging on 11935 kHz at 2302 GMT 27 March 1972.

Winner: Ron Lanoue, 69 Blackinton St, North Adams MA

Congratulations to Messrs Hardester, Straumanis, and Lanoue!! They have been mailed their SPEEDX Select Award certificates in recognition of their achievements.

A portion of an actual Select Award certificate has been used to highlight the QSL size winners, but the editor isn't at all sure just how well it will come through the photoreduction process. In the event it happens to turn out badly, we'll state that they are 5½ x 9 inches, brown and gold in color, and have a fancy engraved border and background (just like money....almost).

It will be noted that the winning entries are shown in terms of square centimeters (Sq Cm). This was done since the metric system provides units that more readily lend themselves to resolving a really close situation....and such a situation did arise!!

We received two entries for "Smallest QSL" using a veri from Radio Yerevan which being of slightly different proportions, appeared to be at least as small as the one from Uruguay. Putting an accurate engineer's scale to work, it was determined that R Yerevan officially came in at 108,00 square centimeters...or only one Sq Cm more than CXA19!! (In case you're wondering how big a Sq Cm is, just divide a standard sized US postage stamp into fourths, and you'll come pretty close). Also not too far off the pace was Radio Peace and Progress' verification which came up 112.45 Sq Cm.

The degree of interest generated in this slightly off-beat award offering insures its continuation and certainly sometime next year SPEEDXers may expect the "Second Annual QSL Size" competition for 1973 verifications....So keep a ruler handy to the mailbox in the meantime.

Somewhat the opposite seems to be the case for the "Most Non QSLs" award announced last month. Even though no less than four SPEEDXers suggested the idea, we have not as yet received a single entry!! As of this writing there are still a few days left until the deadline, but it appears as though "Most Non QSLs-1972" will be vacated by reason of default. (This editor received at least four turn-downs last year that would qualify...and would slip in the back door...but alas, he is inellegible). Needless to say, any consideration of continuing this particular award on an annual basis is presently in limbo.

SOME SIMPLE ARITHMETIC:

6 Christmas Cards @ 0.10	\$0.60
6 US postage Stamps @ 0.08	0.48
TOTAL	\$1.08

If you normally send these half-dozen Xmas cards to fellow SWLs, why not donate the buck to CHRISTMAS TREE instead, and still have your holiday greetings passed along to everybody rather than just six??? Gene Moser can get more worthwhile miles-per-dollar than either the Post Office or card manufacturer....See HAPPENINGS for details.

HAPpenings

NEWS ABOUT THE SPEEDX HANDICAPPED AID PROGRAM

HAP Chairman — Gene Moser • 6805 Woodland Ct • Coloma MI 49038

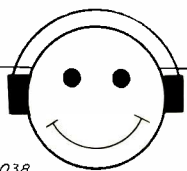

SOLD OUT: The SPEEDX emblem stamp is gone. We sold 50 stamps in one year, and because of the slow sales, a new supply will not be ordered until the first of the year, if then. Our club emblem will be available, but how soon will depend upon you. Because HAP can't tie its money up in products that don't move, we cannot order this stamp until 25 stamps are ordered by the membership. For a new price and ordering instructions, see the January 1974 "Happenings" column.

SCADS Meeting in Tustin: I hope all the CA SPEEDXers have signed up to attend this ASWLC/SPEEDX get-together. Latest report indicates a packed house, and I urge you to contact **Don Johnson** pronto!!

William Shaw, good friend and HAP supporter, sends news that Philadelphia DXers are holding DX meetings, and that they would like more SWLs to attend. If you live near Philly, write **Bill** at 7-5 Wilde Ave, Drexel Hill PA 19026. Get in on the real action!!

Evelyn Dolyak, HAP-5, has been named HAP Hospitality Hostess. She is a charming "old gal" (I mean that in the fondest interpretation) and will send birthday, get-well, or sympathy cards to any SWL brought to her attention. You can send a card on its way to someone "special" by sending a note to Evelyn "Dolly" at Box A, Griswold Iowa 51535.

Frank Testa, HAP-19, is the new Welcome Wagon Chairman. This is our official greeting committee for new HAPees.

Willard "Whitey" Herman, HAP-9, has recently undergone serious surgery on both eyes when both retinas became detached. Whitey is a gentle man who we enrolled this year. Your cards and letters would be appreciated greatly. Send them to Central YMCA, Reed and Washington Streets, Reading PA 19601.

No. 5 ————— In the SPOTLIGHT ————— No. 5

Well, it's my turn this month, and I hope you can resist the temptation to yawn. I'm 32, born 5 June 1941. I was born with muscular dystrophy, and luckily it is of the slowly progressing variety. In 1962 I graduated from Benton Harbor High with all "A's". After high school I went into a negative retouching business which lasted ten years. I live with my mother, father, and brother (who has MD also, is 29, and a good part-time artist) who was my partner in the retouching business. Asas 1968 began my "armchair travelling" when I was given a 5 band portable. The 4.5-13.0 MHz SW band was something new and exciting and led me to a Lafayette Mark VI, then to my present DX150A. I'm a member of NNRC, Lunar (AM-SSB) Club in addition to SPEEDX. I served 3 years on the NNRC CPC, and in 1972 started HAP at the request of the guy on the page before this. He placed a lot of faith in a "SW nobody", and with his help, and that of my staff, HAP is now a multi-committee-club-international-program.

NOTICE IMPORTANT !! HAP needs your help! There is this month, November, and until 15 December for you to send your donation to HAP. Please, send \$1.00-\$2.00 to: CHRISTMAS TREE, % SPEEDX, PO Box 321, Santa Ana CA 92702. Checks payable to SPEEDX, cash accepted. Your donation will place your name on a special Christmas page in December. We can't do it without Y O U !!!

SAVE THOSE STAMPS! Wes Ogden, Lunar Club President, has begun a used US stamp drive. All stamps will be sold to a stamp dealer and the proceeds go to HAP. We need thousands of US Stamps. Please leave stamps on the paper and send them to Wes at PO Box 283, Bell CA 90201.

Since June HAP has been mentioned on the following SW broadcasts: Radio Nederland's DX Juke Box, Radio Canada SW Club, BBC World Radio Club, Sweden Calling DXers, Radio Bucharest, Radio Australia, and HCJB's DX Party Line. Thank you for the loan of your international voices!!! Through your generosity we have made contacts with the handicapped worldwide.

On 13 September Serge Neumann reported Harry Van Gelder had spent some time in the hospital. However, Harry is now back home and on the air. Welcome back dear friend!!

SPEEDX joins the ranks of NNRC this month in sending out our bulletin on cassette to our blind HAPies. NNRC began sending their excellent bulletin out around May. If you know a blind person who would enjoy this hobby more through a taped bulletin, contact me for SPEEDX. Robert H Ladd, 178 Vreeland Ave, Rutherford NJ 07070 for NNRC on cassette. Rates and further details sent on request.

That about does it for this month...except for one plea: Please don't play trick-or-treat on HAP. If you all give \$1.00, it will add nearly \$400.00 to our treasury and make HAP totally self-supporting....for the first time. Just think of the help we could provide then!!! **HAPPY Halloween!!**

SWBC DX - Western Hemisphere

- EDITOR -

E.J. "Jim" Whitehead
177 Pine Ridge Road
Reading, Mass. 01867

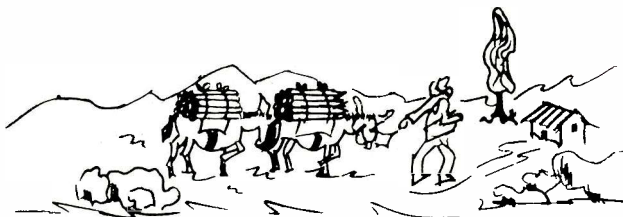

- REFRAN -

"Quien no se atreve no pasa el mar"

YOU CAN'T TELL YOUR PLAYERS WITHOUT A SCORECARD

For some time DXers have noted Radio Tupi programming on channels allocated to Radiodifusora de São Paulo and recently Radio Panamericana has appeared on frecuencies allocated to Radio Record. In addition, there are recorded instances of frequency switches by Radio National and Radio Excelsior and by Radio América and Radio Novo de Julho. Although this all seems a general state of confusion, one look at the ownership of these flip flopping pairs reveals that they are all linked together in some way. Either the stations are both owned by the same owner or organization or they are so closely related that, for all intents and purposes, they may be considered a single entity.

Radio Tupi and Radiodifusora de São Paulo are both owned by the same company. Both operate medium wave outlets in their respective cities but, when it comes to shortwave, on Radio Tupi broadcasts are relayed. From time to time the license holder's name might be aired but, for the most part, only Radio Tupi programming is heard.

A slightly different situation is true for Radio Panamericana and Radio Record. Although they are separate organizations, the Board of Directors is so closely interlocked that it is no wonder that Panamerica would turn to Radio Record to "rent" transmitter time. I suspect, however, that the rent is more a bookkeeping transaction than a sale of spare transmitter time.

The National-Excelsior and Novo de Julho-América switches are also the result of common ownership, a fact which should come as no surprise to most old timers. This won't tell you who is on first, but at least you'll know why he is there.

A MONTH OF SURPRISES

Several DXers checked in this month with the news that Radio Colosal, 4945 khz, has been noted with English language announcements in the time slot of 0500 - 0630 GMT. These announcements thank those who have written to the station and promise an answer and a souvenir to those who write in to the station. Do you suppose this means they will at last answer one of my reports????

Was not a clue to the impending coup in Chile noted while tuning to Radio Corporación the night before it all happened. Not a sign of that pro-government station now at this QTH nor of Radio Portales either. I suspect we might not hear from those two for some time. Look for Radio Presidente Balmaceda to be back soon, however, as the Christian Democrats, who own the station, have endorsed the junta in power.

Got to get on to the reports as the biggest and most pleasant surprise of all this month was the pile of reports sent in by 51 great guys. Keep these cards and letters coming in boys, I love it. And, so to the loggings.

ARGENTINA

- 5985 1005 LRS2 R. Splendid:Sp.w/talks,anmts (444,8/28;Simon-NY)
 6120 0420 LRX1 R. El Mundo:Sp.w/anmts,dedications by OM, ads, mx
 suffers from VOA same channel (322,8/23;Flynn-CA)
 9690 0647 LRA32 Radif. Argentina al Exterior:Eng.w/ID as "Argentine
 National Radio", mx, commentary (554,8/27;De Angelis-CA)
 (??? ,0523,8/30;Handler-IL)(--3,0005,9/2;Calkin-SPAIN)(443,
 0420,8/24;Cleveland-CA)(444,0610,8/30;Stephenson-CA)(--4,
 0600,8/13;Warren-CA)(444,0120,8/28;Bye-PA)(444,0430,8/24;
 Fischer-PA)(333,0603,8/29;Snyder-CA)(544,0623,8/23;Gede-CA)
 11710 2300 LRA35 Radif. Argentina al Exterior:Eng.w/news, press review
 (433,9/5;Zilmer-WI)
 15345 1420 LRA33 Radio Nacional:Sp.w/concert "sinfónica", ID as "LRA,
 R. Nacional" (233,8/25;Flynn-CA)

BOLIVIA

- 4689 0016 CP114 R. San Miguel:Sp.w/ads, anmts by
 OM (--1,9/2;Henderson-MD)
 4875 2302 CP75 Emisora La Cruz del Sur:Sp.w/ID,
 orchestral mx pgm called "Desde
 Europa con Alegria",TC "Exactamente
 siete de la noche treinta
 y cuatro minutos en Emisora la
 Cruz del Sur" (333,9/16;Whitehead-
 MA)(333,0257,8/18;Lazear-OH)
 (454,0242,8/24;Simon-NY)

**RADIO****" SAN MIGUEL "****C. P. 14****BRAZIL**

- 3385 0253 ZYG22 R. Clube de Teresina:Port.
 w/nx,ads,s/off at 0302 (252,
 8/19;Lazear-OH)
 4806 0350 ZYS8 R. Dif. do Amazonas:Port.w/tlk,little mx,ID s/off @ 0400
 (332,9/2;Cleveland-CA) Serge, I believe this is your UNID
 station this channel not ZYV71. ejw
 4865 2150 PRC5 R. Clube do Para:Port.w/tlk,possibly soccer match (222,
 8/20;Neumann-NETHERLANDS)
 4905 0445 ZYZ20 R. Relógio:Port.w/ID by OM (332,8/27;Atchisson-MO)
 4915 0920 ZYE2 Radif. de Macapá:Port.e/mx pgm, OM ID,tlk (222,8/3;
 Eichenhorn-MI)(422,0210,9/11;Whitehead-MA)
 4995 0895 ZYX2 R. Brasil Central:Port.w/LA mx,ID (--3,8/26;Dawson-CA)
 (323,0230,8/20;Shaw-PA)(--4,2315,most days;Brooks-CT)
 6000 2310 PRK5 R. Inconfidencia:Port.w/vocals,tlk on Brazil (322,8/28;
 Fischer-PA)
 6035 2330 ZYZ26 R. Globo:Port.w/tlk, hrd under RSA (322,9/4;Zilmer-WI)
 6095 0900 ZYB7 R. Tupi, São Paulo:Port.w/talk,mx (433,8/25;Zimorowski-MA)
 6175 0720 ZYV74 R. Guarani:Port.w/OM ID, mx,TC,comls (433,8/21;
 Eichenhorn-MI)
 9620t 0815 ZYR97 R. Novo de Julho:Japanese w/romantic songs by YL,YL ancr.
 no ID (142,9/2;Flynn-CA)
 9665 0800 PRL- Rádio Nacional de Brasília:Port.w/mx pgm (232,8/11;
 Snyder-CA)
 11785 0015 ZYU61 R. Guaíba:Port.w/American pop mx,time pips every 15 min.
 (232,8/29;Bye-PA)
 11805 2300 ZYZ36 R. Globo:Port.w/talks,nx (432,8/28;Fischer-PA)(343,1058,
 8/13;Fay-MA)
 11865 0310 ZYB85 R. Clube de Pernambuco:Port.w/coml, ID, ballads (354,9/3;
 Lanoue-MA)(333,2145,8/25;Fischer-PA)(332,2159,8/13;Fay-MA)
 11925 2216 ZYR78 R. Bandeirantes:Port.w/talk by YL under R. Nederland
 (222,8/13;Fay-MA)
 11935 0000 ZYS35 R. Clube Paranaense:Port.w/ID w/frequency, music
 (322,8/19;Trauttschold-WI)
 11950 2212 PRL3 R. Ministério da Educação:Port.w/talks by OM, het noted
 (343,8/13;Fay-MA)
 15135 2345 PRB23 R. Panamericana:Port.w/mx,tlk, ID, jingles // 6055
 (434,8/31;Zilmer-WI)(434,0143,8/11;Eichenhorn-MI)
 15155 2115 ZYB9 R. Tupi, São Paulo:Port.w/mx, ID into nx @ 2130 (232,
 8/21;Cleveland-CA)(333,2058,8/3;Eichenhorn-MI)
 15445v 2245 ZYN32 R. Nacional de Brasília:Eng.w/"Our Land, Our People" pgm,
 economic nx,pop mx (212,7/24;Gelfand-WY)(343,2350,9/4;
 Zilmer-WI)(322,2334,9/11;Porth-IL)(343,0034,8/19;
 Trauttschold-WI)(--4,2337,9/7;Miller-OH)(444,0015,8/29;
 Shaw-PA)(423,2300,8/25;Fischer-PA)
 17815 2250 ZYR58 R. Cultura:Port.w/tlk until VOA @ 2300 (343,9/4;Zilmer-WI)

BRITISH HONDURAS

3300 0450 Radio Belize:Eng.w/Lng. language discs,Eng./Sp. IDs (323 8/26;Shaw-PA)

CANADA

5960 2016 CBC Northern Svc.:Eskimo w/nx (444,9/11;Rose-MANITOBA)(434, 0530,8/30;Britton-FL)(443,0350,9/9;Cleveland-CA)(--4,0600, 8/3;Warren-CA)

5970 1315 Radio Canada Intl.:Enr.w/"Latitude","Cross Canada Hx" (--5, 9/3;Geckle-MD)

6005 1730 CFCX, Montreal:Eng.w/ID,nx,TCs,"7-UP" ads (333,9/3;Shaw-PA)(222, 1330,8/14;Vockeroth-PA)(333,1500,8/18;J. Smith Jr.-NY)

6010 1240 CJCK, Sydney:Eng.w/nx,shaving cream ad (--4,9/5;Geckle-MD)

6030 0530 CFVP, Calgary:Eng.w/OM DJ,mx (323,8/19;Getzel-NY)

6070 1930 CFRX, Toronto:Eng.w/YL and OM tlk (353,8/25;Wickett-MD) (433,0555,8/17;Redman-IL)(433,1715,9/3;Shaw-PA)

6085 0430 Deutsche Welle, Sackville Relay:Eng.w/nx,"Germany Today" (444,9/5;Nebron-CA)(444,0435,8/25;Fischer-PA)

6130 0525 CHHX, Halifax:Eng.w/music pgn (434,8/19;Kamber-SC)(333,1230, 8/17;Vockeroth-PA)(--3,1204,8/26;Miller-OH)

6150 2018 Radio Canada Intl.:Eng.w/"Inside Out" pgn (445,9/11;Rose-MAN) This frequency not listed in their sked,a new freq. ???

6160 0150 CAZU, Vancouver:Eng.w/mx,nx (353,9/5;Nebron-CA)

9605 0430 Deutsche Welle, Sackville Relay:Eng.w/mx,nx (433,9/4;Nebron-CA)

9625 0330 CBC Northern Svc.:Eng.w/mx (434,9/2;Kelley-FL)(544,0825,8/19; Trzaskus-IL)(544,1100,8/30;Buehler-MO)(534,2300,9/3; Zimarski-MA)(555,1510,8/18;J.Smith Jr.-NY)(--4,1200,8/14; Dolyak-IA)

9635 0112 Radio Canada Intl.:Eng.w/nx,spts (433,8/10;Oliver-NH)(544,0058, 8/16;Trzaskus-IL)(--4,0130,9/6;Geckle-MD)

11720 0415 Cbc Northern Svc.:Eng./Lang. w/ID into tlk (434,9/8;Britton-FL)

11835 2320 Radio Canada Intl.:Eng.w/"Shortwave Club"(544,8/18;Kamber-SC)

11860 0100 Radio Canada Intl.:Eng.w/nx,"Focus" (--3,8/25;Dolyak-IA)

11945 0150 Radio Canada Intl.:Eng.w/features,spts (544,8/26;Buehler-MO) (323,0134,8/21;Wickett-MD)(--4,2420,8/1;Dolyak-IA)

17820 1420 Radio Canada Intl.:Lang. w/tlk by YL & OM (534,8/19;Trzaskus- IL)(443,1830,8/19;Buehler-MO)

CHILE

6150 0405 CE615 R. Corporación:Sp.w/sign off w/"Pomp & Circumstance" chimes (131,9/1;Flynn-CA)

9571 0140 CE957 R. Portales:Sp.w/ID,pop stds.(343,8/27;Cleveland-CA)(422, 1100,9/5;Zilmer-WI)(--4,0225,8/26;Miller-OH)(--3,1200, 8/27;Dolyak-IA)

9590 0015 CE959 Radio Presidente Balmaceda:Sp.w/tlk,QR: from R. Nederland 0020 on (422,8/23;Zilmer-WI)

9750 1110 CE975 Radio Min-ría:Sp.w/talk,mx (433,9/10;Zilmer-WI)

15150 0000 CE1515 R. Corporación:Sp.w/ads,TC, ID,talk (354,8/30;Simon-NY) (333,2300,8/25;Snyder-CA)(433,1150,8/31;Zilmer-WI)(243,1500 8/25;Flynn-CA)

COLOMBIA

4755 0505 HJJC Emisora Nuevo Mundo:Sp.w/ID,LA mx (333,8/26;Shaw-PA)(333, 0350,8/25;Cleveland-CA)(222,0515,8/26;Trubee-NI)(454,0615, 8/28;Forth-IL)

4885 0500 HJIG Ondas del Meta:Sp.w/LA mx,IDs,s/off @ 0505 (343,8/30; Collier-NY)(434,0410,9/4;Shaw-PA)(344,0500,8/17;Lanoue-MA) (454,8/23,0445;Simon-NY)

4905v 0713 HJAG Emisora Atlántico:Sp.w/up tempo vocals,ID w/freqs (445, 8/19;Sheedy-CA)(343,0630,8/25;Flynn-CA)(333,0600,8/26; Shaw-PA)(--2,0515,9/8;Miller-OH)(422,1000,9/9;Snyder-CA) (343,0410,8/25;Sparks-CA)(333,0555,8/26;Fischer-PA)(332, 0314,8/16;Lazear-OH)(444,0743,8/19;Kamber-SC)

4915 0430 HJSG R. Guatapuri:Sp.w/IDs,slow LA mx (433,8/29;Forth-IL)

4945 0712 HJDI R. Colosal:Sp./Eng. w/Sp. tlk,mx,Eng. ID,request for reports (--3,9/8;Warren-CA)(544,0535,9/7;Kamber-SC)(444, 0500,8/17;Shaw-PA)(444,0516,8/27;Collier-NY)(343,0530, 8/25;Forth-IL)(352,0422,8/28;Cleveland-CA)(334,0600,8/28; Fischer-PA)(322,0745,9/2;Redman-IL)(444,0425,8/27; Atchisson-MO)

4955 0315 HJCO R. Nacional:Sp.w/ID,classical mx (444,8/20;Shaw-PA)(444, 0145,8/25;Redman-IL)(242,0500,8/15;Snyder-CA)(545,0420,8/27; Atchisson-MO)

COLOMBIA (cont.)

- 4965 0415 HJAF R. Santa Fe:Sp.w/ID,mx pgm (545,8/27;Atchisson-MO)(455,0541,8/25;Forth-IL)(434,0445,8/17;Shaw-PA)(342,0400,8/23;Cleveland-CA)(434,0620,8/26;Fischer-PA)(252,0735,8/20;Whitehead-HI)(333,0525,8/17;Redman-IL)(454,0308,8/29;Simon-NY)
- 5035 0350 HJIC LV de Caquetá:Sp.w/pop mx, ID (343,8/25;Sparks-CA)(444,1003,8/24;Simon-NY)
- 5075 0320 HJGC R. Sutatenza:Sp.w/nx,pop mx (444,9/4;Shaw-PA)(555,0355,9/4;Sheedy-CA)(444,0330,8/21;Atchisson-MO)
- 5095 0900 HJGG R. Sutatenza:Sp.w/inspirational talk and wake-up mx (444,8/20;Sheedy-CA)
- 6030 0256 HJZJ R. Nacional:Sp.w/nx after ID (444,8/23;D'Angelo-NY)
- 6065 0600 HJAX R. Super:Sp.w/ID, LA music (444,8/25;Forth-IL)(343,0415,9/3;Cleveland-CA)(434,0610,8/26;Fischer-PA)(555,0700,9/5;Redman-IL)(354,0725,9/4;Lanoue-MA)(222,0630,8/4;Trubee-HI)(534,0842,8/25;Zimarowski-MA)(443,1046,8/26;Atchisson-MO)
- 6075 0535 HJID R. Sutatenza:Sp.w/mx (333,8/1;Trubee-HI)
- 6095 1050 HJIW LV del Centro:Sp.w/tlk,VOA QRM after 1100 (342,8/23;Zilmer-WI)
- 6105 1159 HJNV R. Visión:Sp.w/OM & YL tlk, ID (222,8/3;Eichenhorn-MI)
- 6115 1055 HJIE LV del Llano:Sp.w/local mx (433,8/23;Zilmer-WI)
- 6125 0630 HJKE R. Continental:Sp.w/"servicio nacional", operates 24 h/24 (342,8/20;Flynn-CA)(544,1100,9/10;Zilmer-WI)(131,0700,8/4;Trubee-HI)
- 6141 0755 HJNE R. El Sol:Sp.w/Col mx,TC, ID (353,8/20;Whitehead-HI)
- 6160 0540 HJKJ Emisora Nueva Granada:Sp.w/Col. mx,amnts of "La noche Colombiana" (433,8/20;Redman-IL)(343,0605,8/26;Fischer-PA)
- 6183 0800 HJOO R. Nacional:Sp.w/LA mx (--2,8/22;Dolyak-IA) I doubt if this R. Nacional which usually signs off @ 0500 except for very unusual events. Did you hear an ID? Tentative maybe?
- 9635 1130 HJZM R. Nacional:Sp.w/sign on, chimes,sked,address, music,nx (454,9/4;Lanoue-MA)
- 15335 2000 HJZP R. Nacional:Sp.w/pop mx (--4,8/18;Dolyak-IA)

COSTA RICA

- 4832 0505 TIHB R. Capital:Sp.w/ID,mx pgm (444,8/27;Atchisson-MO)(343,0433,8/28;Cleveland-CA)(444,0540,8/17;Redman-IL)(555,0515,8/28;Forth-IL)(333,0415,8/20;Shaw-PA)(444,0559,8/28;Fischer-PA)(323,0500,8/25;Trubee-HI)(555,0500,9/4;Sheedy-CA)
- 5954 0535 TIQ R. Casino:Eng.w/LA mx,amnts (322,8/25;Britton-FL)
- 6006 0509 TIHB R. Reloi:Sp.w/LA mx,IDs (333,9/2;Cleveland-CA)(444,0800,8/28;Fischer-PA)(--4,1115,8/20;Dolyak-IA)
- 6037 0900 TIFC Faro del Caribe:Sp.w/LA mx,nx (--4/8/14;Dolyak-IA)
- 6150 1045 TIRS R. Atenea:Sp.w/Local mx (443,8/23;Zilmer-WI)(534,0945,8/25;Zimarowski-MA)
- 9645 0308 TIFC Faro del Caribe:Eng.w/ID, "Glad Tidings" pgm, off @ 0430 (343,8/24,w/VOA blackout 0345-0400;Fischer-PA)

CUBA

- 9550 0345 R. Habana Cuba:Sp.w/mx, ID @ 0356 (343,7/14;Trubee-HI)
- 11760 0130 R. Habana Cuba:Sp.w/"Cuba Responde" pgm (555,8/14;Redman-IL)(343,0505,8/25;Britton-FL)(333,0520,9/7;Kamber-SC)
- 11830 0130 R. Habana Cuba:Sp.w/mx (--4,9/1;Dolyak-IA)
- 11910 0330 R. Habana Cuba:Eng.w/nx (333,8/17;Vockerorth-PA)(444,0355,8/30;Shaw-PA)(544,0202,8/27;Buechler-MO)
- 11930 0110 R. Habana Cuba:Eng.w/nx(444,9/9;Brown-CA)(544,0225,8/19;Kamber-SC)(555,0123,8/17;Trautscheld-WI)(453,0245,8/10;Oliver-NH)(545,0245,9/6;Kelley-FL)
- 15130 0150 R. Habana Cuba:Sp.w/Cuban mx (544,8/18;Redman-IL)
- 15140 2045 R. Habana Cuba:Eng.w/V of V,nx (454,8/21;Cleveland-CA)
- 15425 0036 R. Habana Cuba:Sp.w/talks on Cuba (444,8/18;Trautscheld-WI)(444,0030,8/29;Shaw-PA)
- 17715 1415 R. Habana Cuba:Sp.w/rumba mx (--4,9/1;Dolyak-IA)
- 17885 2115 R. Habana Cuba:Sp.w/nx,nx, tlks (--4,8/26;Dolyak-IA)



APARTADO DE CORREOS 70-26
LA HABANA, CUBA

DOMINICAN REPUBLIC

- 3365 0445 HIRL R. Éxitos:Sp.w/LA mx,reactivated but irregular (233,8/29;Flynn-CA)(433,0325,8/19;Lanoue-MA)(--3,0411,9/8;Miller-OH)

DOMINICAN REPUBLIC

- 4775 0625 HIAS Onda Musical:Sp.w/pgm of music (433,9/10;Redman-IL)(343,0410,8/25;Cleveland-CA)(333,0430,8/28;Atchisson-MO)
 4911 0550 HIN R. HIN:Sp.w/US pops,LA ritmos (243,8/11;Flynn-CA)
 4930 0345 HIBE R. Mil:Sp.w/ID,ads,US and LA mx (333,8/20;Shaw-PA)(423,0455,8/21;Kamber-SC)(453,0310,8/26;Lanoue-MA)(212,0300,8/3;Gelfand-NY)
 5010 0315 HIMI R. Cristal:Sp.w/ID,mx (322,8/28;Atchisson-MO)
 95050 0130 HISD R. TV Dominican:Sp. w/clear ID,music (--3,8/11;Calkin-SPAIN)(433,0115,8/21;Bye-PA)(422,0220,8/14;Kamber-SC)

ECUADOR

- 3325 0530 HCHA2 Ondas Quevedañas:Sp.w/Ecuadorian mx, ID & off @ 0550 (354,8/28;Sparks-CA)(242,0450,9/2;Flynn-CA) RADIOdifusora
"LA VOZ DEL RIO CARRIZAL"
H C O S 4 - 3630 KLC
BANDA INTERN. DE LOS 82 METROS
DESDE CALCETA EN MANABI - ECUADOR
 3380 0440 HCDY4 R. Iris:Sp.w/comls,ballads,off @ 0456 w/ID,anthem (344,8/18;Lanoue-MA)
 3390 0445 HCOT1 R. Zaracay:Sp.w/andean tunes,LA vocals (232,9/2;Flynn-CA)(433,0930,9/9;Collier-NY)(332,0413,8/27;Cleveland-CA)(354,0500,8/27;Sparks-CA)(555,0530,9/4;Sheedy-CA)
 4679 0340 HCWE1 R. Nacional Espejo:Sp.w/spts event, IDs (343,8/25;Cleveland-CA)(344,0545,8/28;Fischer-PA)(434,0355,9/4;Sheedy-CA)(444,0620,9/5;Redman-IL)(--3,0500,9/8;Miller-OH)(434,0430,9/4;Shaw-PA)(454,0600,8/28;Forth-IL)(433,0505,8/28;Atchisson-MO)
 4765 0355 HCAJ2 C.R.E.:Sp.w/lt. mx,ID,comls (433,8/17;Lanoue-MA)
 4780 0500 HCEH3 R. El Progreso:Sp.w/Ecuadorian style vocals,OM anmts (242,8/13;Flynn-CA)
 4790 0333 HCVP2 Sistema de Emisora Atalaya:Sp.w/inst. mx,TCs,IDs (443,8/18;Lazear-OH)
 4820 0949 HCRT6 R. Paz y Bien:Sp.w/mx,IDs, anmts (333,8/15;Collier-NY)
 4923 0358 HCRQ1 R. Quito:Sp.w/anmts,ID,ads,TC (444,8/17;Simon-NY)
 4939 0415 HXCZ1 R. Nacional:Sp.w/soft vocals (343,8/14;Collier-NY)
 5990 0737 HCBJ LV de los Andes:Eng.w/"Back to God Hour" (444,8/19;Trzaskus-IL)
 6050 0245 HCBJ LV de los Andes:Sp.w/tlk, ID (433,8/18;Trzaskus-IL)
 9560 0300 HCBJ LV de los Andes:Eng.w/"DX Party Line" (--4,8/13;Warren-CA)(534,0309,8/30;Buechler-MO)
 9745 1130 HCBJ LV de los Andes:Sp.w/rel. mx (534,8/24;Zimorowski-MA)
 11740 0230 HCBJ LV de los Andes:Eng.w/"DX Party Line" (444,9/2;Yaney-IN)(--5,0300,9/4;Geckle-MD)(444,0150,9/6;Kelley-FL)(--4,1515,9/8;Miller-OH)
 11745 0100 HCBJ LV de los Andes:Eng.w/ID,nx (555,8/10;Oliver-NH)(545,C230,9/9;Brown-CA)(--5,0000,8/13;Dolyak-IA)(454,0310,8/21;Wickett-MD)(444,0015,8/20;Buechler-MO)
 15115 0130 HCBJ LV de los Andes:Eng.w/"New Song" (454,8/21;Wickett-MD)
 15300 1915 HCBJ LV de los Andes:Eng.w/"DX Party Line" (--2,9/6;Geckle-MD)(333,2045,8/14;Vockerath-PA)
 15315 1930 HCBJ LV de los Andes:Eng.w/"DX Party Line" QRM from Canada (422,9/3;Zilmer-WI)(444,1910,9/3;Kelley-FL)
 15375 0040 HCBJ LV de los Andes:Ger.w/mx,tlk (555,8/19;Trauttschold-WI)(433,2241,8/19,w/Russian;Trzaskus-IL)
 17885 2210 HCBJ LV de los Andes:Japanese w/talk (353,8/1;Trubee-HI)
 21820 2115 HCBJ LV de los Andes:Sp.w/Religious pgm (333,8/28;Shaw-PA)

FRENCH GUIANA

- 3385 0248 O.R.T.F. Cayenne:Fr.w/OM w/tlk,pop mx,s/off @ 0252 (332,8/19;Lazear-OH)

GALÁPAGOS ISLANDS

- 3520 0340 HCVG8 LV de Galápagos:Sp.w/classical,operatic mx, OM anmts (141,9/2;Flynn-CA)

EL SALVADOR

- 5980 0011 YSS R. Nacional de El Salvador:Sp.w/tlk (--3,8/26;Handler-IL)(--3,1229,8/26;Miller-OH)(322,0245,8/26;Fischer-PA)(343,0309,8/24;Cleveland-CA)

GUATEMALA

- 3300 0350 TGNA R. Cultural:Eng.w/rel,tlk,mx (--2,9/8;Miller-OH)(212,8/20 0155,8/20;Britton-FL)(343,0430,8/25;Sparks-CA)

GUATEMALA (cont.)

- 3325 1140 TGEA R. Maya:Lang. w/OM talk (354,9/1;Sparks-CA)(232,0300
9/2;Flynn-CA)
- 3360 0430 TGVN LV de Nahuala:Sp.w/marimba mx,ID (343,9/1;Sparks-CA)
- 5995 0330 TGNA R. Cultural:Eng.w/religious tlk,hymns (433,8/28;Snyder-
CA)(--2,0340,8/13;Warren-CA)(343,0340,8/24;Nebron-CA)
(342,0132,9/3;Cleveland-CA)

GUYANA

- 3290 0146 GBS. Action Radio:Eng.w/news (--2,8/27;Miller-OH)(323,0820,
8/23;Lanoue-MA)(221,0802,8/21;Eichenhorn-MI)(322,0215,
8/20;Britton-FL)

HAITI

- 9770 1200 4VEH Radio 4VEH:Eng.w/IDs,world nx,wx (444,8/12;Shaw-PA)
(434,1105,8/30;Fischer-PA)
- 11835 1200 4VEH Radio 4VEH:Eng.w/nx,wx,mx (443,heavy fading,9/4;Kelley-
FL)(222,1400,8/22;Kamber-SC)(343,1250,8/16;Gelfand-NY)
(344,1115,8/30;Fischer-PA)(433,1145,9/9;Snyder-CA)
(352,1320,8/25;D'Angelo-NY)
- 15280 0140 4VVI Radio 4VEH:Sp.w/religious pgm (555,8/20;Britton-FL)

HONDURAS

- 4820 0425 HRVC LV Evangelica:Eng.w/"Night Watch" pgm (535,9/4;Sheedy-CA)
(323,0400,8/27;Brown-CA)(433,0350,9/10;Redman-IL)(--3,0414,
8/26;Miller-OH)(333,0315,9/8;Kamber-SC)(222,0415,8/28;
Atchisson-MO)
- 4920 0410 HRFL3 R. Progreso:Sp.w/spots,LA mx (455,8/29;Forth-IL)(333,
0400,8/20;Shaw-PA)(333,0458,8/21;Kamber-SC)(343,0425,8/25;
Cleveland-CA)(444,0255,8/18;Redman-IL)343,0318,8/26;
Lanoue-MA)(444,0430,8/27;Atchisson-MO)
- 5875 0300 HRN LV de Honduras:Sp.w/ID into nx (343,8/25;Cleveland-CA)

MARTINIQUE

- 3316 0045 O.R.T.F. Fort de France:Fr.w/US mx,
OM & YL tlk (--2,9/8;Miller-OH)



MARTINIQUE-INTER
FORT-DE-FRANCE
Martinique
B.P. 662 F.W.I.

MEXICO

- 6115 1930 XEUDS R. Univ. de Sonora:Sp.w/cl.mx
(343,8/20;Cleveland-CA)(444,0125,8/9;Stephenson-CA)
(442,1930,8/19;Hardester-CA)
- 6165 0500 XEWW LV de America Latina:Sp.w/mx,anmts (111,8/9;Trubee-HI)
- 9600 1252 XEYU R. Univ. Nac. de Mexico:Sp.w/organ mx,ID, into BBC's
"English by Radio" @ 1300 (353,8/18;Brooks-CT)(--3,1302,
9/1;Miller-OH)(--4,1130,8/26;Dolyak-IA)
- 9705 2255 XERMX R. Mexico:Sp.w/LA mx,ID,TC (433,8/27;Cleveland-CA)(--4,
0030,8/21;Dolyak-IA)
- 11770 0245 XERMX R. Mexico:Sp.w/mx pgm,YL ancr (333,8/28;Bye-PA)(444,1600,
8/26;Atchisson-MO)(545,1300,9/4;Forth-IL)(544,0100,8/14;
Redman-IL)(323,0030,8/31;Shaw-PA)
- 15125 0005 XERMX R. Mexico:Sp.w/mx,tlk (544,9/9;Brown-CA)(434,0230,8/25;
Kelley-FL)(444,1520,8/21;Cleveland-CA)(333,0240,8/26;
Fischer-PA)(--3,1400,8/23;Dolyak-IA)
- 15160 1450 XEWW LV de America Latina:Sp.w/"XEWW presenta Comentario
Hollandesa" (233,8/25;Flynn-CA)

NETHERLANDS ANTILLES

- 9570 0245 Trans World Radio:Sp.w/tlk,mx (423,9/2;Bye-PA)
- 9715 0800 Radio Nederland,Bonaire Relay:Eng.w/"Happy Station" to South
Pacific (544,8/19;Trzaskus-IL)
- 15350 0045 Trans World Radio:German w/mx,tlk,ID(555,8/19;Trautschold-WI)

PARAGUAY

- 6025 2326 ZPA1 R. Nacional:Sp.w/ID,nx,until 2354 when Portugal cranked
up and killed it (--2,9/4;Miller-OH)

PERU

- 3390 0727 OCX4R R. Industrial:Sp.w/LA mx (--2,8/12;Dawson-CA) You sure
this not HCOT1 usually dominant here? ejw
- 4785 0400 OAX8F R. Atlántida:Sp.w/andean mx,ID (344,8/17;Lanoue-MA)
- 4995 0705 OAZ4C R. Andina:Sp.w/andean mx,ded's by OM (243,8/25;Flynn-CA)

PERU (cont.)

- 5010 0418 OAX8V R. Eco:Sp.w/vocals, IDs (444,8/18; Collier-NY)
 5025 0257 OAX7Q R. Quillabamba:Sp.w/mx, ID, anthem (222,9/2; Collier-NY)
 5970 1045 OBX4Q R. El Sol:Sp.w/andean mx (443,9/5; Zilmer-WI)(333,0520, 9/5; Cleveland-CA)
 6020 1055 OAX4Q R. Victoria:Sp.w/march mx (443,9/6; Zilmer-WI)
 6045 0330 OCY4H R. Santa Rosa:Sp.w/andean style mx (422,9/8; Zilmer-WI)
 6115 0430 OBZ4O R. Unión:Sp.w/romantic mx (333,8/23; Flynn-CA)(454,0510, 9/9; Cleveland-CA)
 9520 0100 OAX4J R. La Crónica:Sp.w/LA mx, pips, ID (332,8/26; Collier-NY) (343,0000,8/21; Zilmer-WI)
 9675 1100 OAZ4L R. del Pacífico:Sp.w/religious mx, tlk (443,9/10; Zilmer-WI)

URUGUAY

- 11835 0000 CXA19 R. El Espectador:Sp.w/commentary, TC, ID (--3,9/2; Calkin-SPAIN)(323,0130,8/29; Forth-IL)(433,0225,8/14; Eichenhorn-MI)

VENEZUELA

- 3245 0251 YVKB R. Libertador:Sp.w/anmts, mx, het (342,8/22; D'Angelo-NY)
 4770 0100 YVNW R. Bolívar:Sp.w/LA mx, IDs (354,8/29; Forth-IL)(332,0320,9/7; Cleveland-CA)(344,0930,9/6; Lanoue-MA)(434,0940,8/3; Eichenhorn-MI)
 4800 0233 YVMO R. Lara:Sp.w/tlk, ID, TC, mx (444,8/28; Simon-NY)(444,0240,9/2; Lanoue-MA)
 4830 0335 YVOA R. Táchira:Sp.w/TCs, interesting ad for "Ferrocarril Nacional"(233,9/6; Flynn-CA)
 4840 0500 YVOI R. Valera:Sp.w/mx pgm (354,9/2; Sparks-CA)
 4860 0930 YVQE R. Maracaibo:Sp.w/mx (544,8/18; Kamber-SC)
 4870 0130 YVKP R. Tropical:Sp.w/vocals, ID (342,8/29; Forth-IL)
 4880 0310 YVMS R. Universo:Sp.w/LA mx, TCs, signal off @ 0323 (333,8/27; Fischer-PA)
 4890 0208 YVKB Rdif. Venezuela:Sp.w/NA pop mx, "Estación de Alegría" ID (454,8/20; Hardester-CA)(444,0330,9/1; Lanoue-MA)(343,0300,8/21; Cleveland-CA)(343,8/29,0000; Forth-IL)(321,1015,9/8; Snyder-CA)(554,0240,8/18; Redman-IL)
 4940 0330 YVPA R. Yaracuy:Sp.w/IDs, LA mx (333,8/20; Shaw-PA)(333,0330,9/3; Cleveland-CA)
 4960 0106 YVAO R. Sucre:Sp.w/IDs, LA mx, pop mx, TCs (353,8/20; Simon-NY)
 4970 0300 YVLR R. Rumbos:Sp.w/music (343,9/5; Nebron-CA)(333,0345,9/10; Redman-IL)(545,0500,8/28; Forth-IL)(434,0430,8/17; Shaw-PA)
 4980 0340 YVOC Ecos del Torbes:Sp.w/Eng. ID, mx, Sp. tlk (--4,9/13; Henderson-MD)(333,0300,9/2; Nebron-CA)(444,0300,8/20; Shaw-PA)(544,0215,8/18; Redman-IL)(434,0310,8/30; Fischer-PA)(333,0225,8/3; Gelfand-NY)(332,0344,8/28; Atchisson-MO)
 4990 0230 YVMQ R. Barquisimeto:Sp.w/talk, music (333,9/5; Nebron-CA)(343,0322,9/3; Cleveland-CA)(333,0315,8/28; Atchisson-IO)
 5030 0400 YVMK R. Reloj Contiente:Sp.w/ads, LA mx (434,8/17; Shaw-PA)(342,0250,8/24; Cleveland-CA)(433,0320,9/1; Lanoue-MA)(544,0900,8/20; Sheedy-CA)(--4,0447,9/8; Miller-OH)(433,0300,8/28; Atchisson-MO)
 5050 0915 YVKD R. Mundial:Sp.w/slogan IDs, loud mx (444,8/20; Sheedy-CA)(333,0215,8/20; Shaw-PA)(455,0855,8/27; Forth-IL)
 6070 1100 YVSR R. San Sebastián:Sp.w/tlk, mx, JRM from Canada (422,9/5; Zilmer-WI)
 9510 1125 YVXI R. Barquisimeto:Sp.w/nx by 2 OM, ID (354,9/4; Lanoue-MA)(433,1145,9/1; Zilmer-WI)(343,1120,8/30; Fischer-PA)
 9660 0330 YVLM R. Rumbos:Sp.w/mx, nx (333,7/29; Trubee-HI)(433,0450,8/24; Fischer-PA)(343,0430,8/24; Cleveland-CA)(322,9/3; Kelley-FL)



WINDWARD ISLANDS

- 3300 0035 Radio Grenada:Eng.w/political talk (--2,9/8; Miller-OH)(323,0155,8/27; Fischer-PA)
 15105 2100 Radio Grenada:Eng.w/spts evnt between Antigua and Grenada (--3,8/20; Calkin-SPAIN)

LATE FLASH!!!

- 9590 0000 CE959 Radio Presidente Balmaceda:Sp.w/communique relayed from armed forces station, slogan "Año de la Renovación", mx, TCs IDs for CE 959. (343,9/21; Whitehead-MA) No sign of Portales or Corporación formerly leftist stations. Bye Amigos!!!!

Jaimé Cabzablonce
xc

RADIO FREE AMERICA

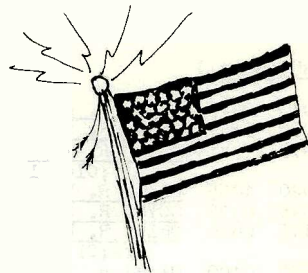

CONDENSED FROM ARTICLES WHICH APPEARED IN THE
N.Y. TIMES 20 AND 21 SEPTEMBER 1973

By E. J. "JIM" WHITEHEAD

America's first "pirate" broadcaster took to the air at 12:23 P.M. on 19 September from a location some 12 miles off Cape May, New Jersey. With the words "This is Radio Free America, the silence of the sea is broken at 1160 on the AM dial", Dr. Carl McIntire fulfilled his pledge to continue broadcasting after the F.C.C. shut down his station in Media, PA WKUR. The broadcasts lasted only a day, however, as technical difficulties developed and the transmitter was shut down until some minor adjustments could be made.

Radio Free America was born after the F.C.C. shut down WKUR last July for allegedly misrepresenting programming plans and favoring conservative over liberal speakers, a violation of the F.C.C. "fairness doctrine". Charging the F.C.C. violated his right of "free speech", McIntire choose the "pirate" broadcasting route to escape F.C.C. jurisdiction.

Delayed for a time by money and legal problems, McIntire finally arranged for the use of a former minesweeper, the S.S. Oceanic, and outfitted it with a 10kw transmitter. The 138 ft. wood hulled vessel put to sea on 30 August but first the loss of a sea anchor and later transmitter troubles delayed the commencement of broadcasting. Finally, however, the difficulties were overcome and, on 19 September, broadcasting was begun only to be discontinued a day later.

The termination of broadcasting on 20 September was the decision of Dr. McIntire after he received a complaint from station WHLW in Lakewood, New Jersey that Radio Free America was interfering with its signal on 1170 khz. Dr. McIntire is quoted as saying "There is no dearth of wavelengths and we do not want to interfere with other stations." Present plans call for Radio Free America to try to eliminate the problem of interference through the use of a directional antenna but, if that fails, a move to 1613 khz is contemplated.

The shutdown also stalled for the the moment the confrontation that was brewing with the F.C.C.. Initially the F.C.C. simply trailed the ship as it cruised along making no attempt to interfere. However, the F.C.C. plans to seek a restraining order in Federal Court should broadcasting resume. The order will be sought on the grounds that the converted minesweeper, which is of U.S. registry, must have a license under the terms of the Communications Act of 1934 which states "No person shall use or operate any apparatus for the transmission of energy or communications or signals by radio upon any vessel or aircraft of the United States without a license."

By the time this reaches you, Radio Free America may be on the air once again as the required adjustments are expected to take about a week to complete. You had best keep a close watch, however, as there is no assurance that Radio Free America will be around for long. Larry Magne reports in "FRIENDX" that reports to Radio Free America, Cape May, N.J. Attn: John Jones, Engineer will be answered so, if you hear it, report it. Good luck!!!!

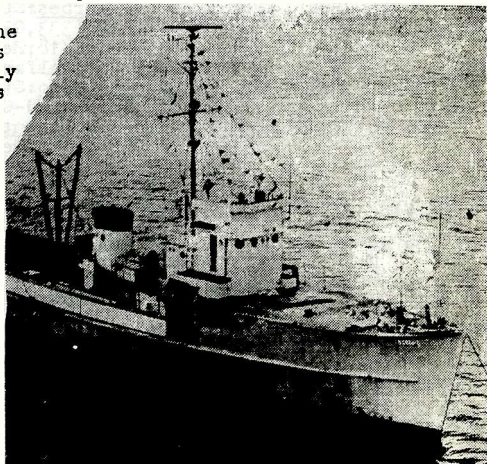

Associated Press

Radio Free America off Cape May, NJ

SWBC DX - EUROPE/AFRICA

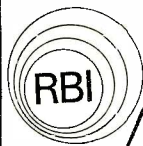

Deadline: 15th
Times & Dates: GMT
Frequencies: kHz

Robert Butterfield
38 Highland Road
Belmont, Massachusetts

NEW ADDRESS

ON THE MOVE

Your editor is on the move to a few towns over. However, the shortage of post offices boxes has led me to keep one near my "home away from home". Having a post office box makes it all the more important for you to get your reports in on time, the earlier the better. Here's the address:

Robert Butterfield
P.O. Box 398
Belmont, Massachusetts
02178

-EUROPE-

ALBANIA

- 6200 0130 R. Tirana: Eng nx & mx (434 8/27 Shaw-PA);(333 0146 8/27 Wickett-MD);(232 0230 8/28 Buehler-MO);(333 0245 8/17 Vockeroth-PA);(good 9/11 Hyndman-IL)
- 7065 0000 R. Tirana: Eng nx (555 8/31 Oliver-NH);(433 8/22 Wickett-MD)
- 7120 0115 R. Peking via Tirana: Eng w/ country (333 8/27 Britton-FL)
- 7300 0140 R. Tirana: Eng nx (544 8/31 Britton-FL);(exc 0145 8/26 Getzel-NY);(good 8/21 Dawson-CA);(343 8/14 Mappin-WA);(342 0350 8/23 Cleveland-CA);(323 0330 9/7 Hebron-CA)
- 9780 0105 R. Peking via Tirana: Eng w/ nx // 7120 (533 8/21 DiPrete-RI);(good 0310 8/31 Geckle-MD)

AUSTRIA

- 6155 0235 Osterreichischer Rundfunk: Ger w/ mx (332 9/7 Cleveland-CA);(422 0328 in Eng 9/3 Lanoue-MA);(333 0330 8/10 Vockeroth-PA);(222 0355 8/17 Smith-NY)
- 7250 0500 ORF: Ger w/ IS, ID, nx (fair 8/19 Getzel-NY)
- 9770 0128 ORF: Eng w/ ID, fays, nx (544 8/17 Trautschold-IL);(333 0340 9/3 Snyder-CA)

BELGIUM

- 11920 2255 Radiodiffusion-Television Belge: Eng w/ "Belgium Speaking" to RA 2255-2315 & 0040-0100 on new freq replacing 15235 (QR covers completely, not heard 9/2 Zilmer-IL)

BULGARIA

- 9700 2130 R. Sofia: Eng nx (fair 8/21 Blake-IL);(444 0400 8/18 Gaede-CA);(333 0003 9/3 Kelly-FL);(544 0404 8/18 Przaszkus-IL);(333 0410 8/13 Warren-CA);(332 0415 9/3 Snyder-CA);(444 1950 8/23 Britton-FL)
- 11765 2100 R. Sofia: Eng nx, mx // 15310 (422 8/20 Zilmer-IL)
- 17825 1905 R. Sofia: Eng nx (242 8/17 Kamber-SC)

CYPRUS

- 11955 0150 BBC, East Meditteranean Relay: Eng nx 0200 // 6195, Cyprus is indicated, not ID'ed as such (232 8/10 Eye-PA)

CZECHOSLOVAKIA

- 5930 0300 R. Prague: Eng w/ nx (good 9/5 Hyndmann-IL);(342 0335 0/2 Cleveland-CA)
- 7345 0300 R. Prague: Eng nx talk (333 8/13 Mappin-WA);(good 0300 8/22 Dawson-CA);(good 0321 9/7 Dennis-IL);(fair 2305 8/2 Rose-LANITON-CA)
- 9540 0100 R. Prague: Eng w/ s/on (221 8/21 Snyder-CA);(333 0105 8/23 Buehler-CA);(444 0120 8/31 Britton-FL)
- 9740 0130 R. Prague: Eng w/ sports (433 8/10 Oliver-IL);(333 145 8/2 Trautschold-IL);(444 0345 8/9 Stephenson-CA)
- 11990 0300 R. Prague: Eng nx (444 8/15 Zelasko-IL);(333 8/21 Shaw-PA)

PLEASE! GET YOUR REPORTS TO THE EDITOR, P.O. BOX 398, BELMONT, MASS.

DENMARK

15165 1359 R. Denmark: Danish, IS, s/on (222 8/20 Kamber-SC);(232 w/
Eng ID 1830 8/15 Snyder-CA);(232 1958 9/3 Kelly-FL)

FINLAND

9585 0428 R. Finland: Eng s/off (533 9/2 De Angelis-CA)
15185 1400 R. Finland: Eng w/ s/on (poor 9/1 Geckle-ID);(454 8/30 Smith-
TN);(good 1430 Dolyak-IA).(444 1430 8/14 Oliver-NH);(333 1800
8/21 Cleveland-CA);(454 1815 8/21 Wickett-MD);(311 2300 8/19
Snyder-CA);(444 2310 8/18 D'Angelo-NY)

FRANCE

9680 0520 Office de Radiodiffusion Television Française: Eng w/
"Spotlight on Africa", "Paris Calling", "Box 9516, Paris - new
QTH?" (243 ??? Flynn-CA)
15120 1800 ORTF: Fr w/ pop mx & ID (444 9/4 Forth-IL);(444 2315 Stephenson-
CA);(333 2325 8/17 Trzaskus-IL)
15295 1045 ORTF: Eng w/ "Paris International" // 15155 (252 9/3 Zilmer-
WI)
15315 1800 ORTF: Fr w/ mx, talk, nx 1815 (good 8/12 Miller-CA)
17720 1500 ORTF: Eng & Fr nx to Africa (434 8/24 Stephenson-CA);(242
1720 in French 8/21 Snyder-CA)
17765 1920 ORTF: Fr w/ nx, comtry (322 9/7 Britton-FL)
21580 1930 ORTF: Fr w/ mx (334 9/2 Bye-PA)
21675 1940 ORTF: Fr w/ pop mx // 21620 (444 9/2 Bye-PA);(333 2045 8/28
Shaw-PA)

GERMANY, EAST

6080 2329 Radio Berlin International: Eng s/off into Fr progr (433 8/30
Oliver-NH)
7260 2304 RBI: Eng w/ talk (333 8/15 Eichenhorn-WI);(333 2325 8/14
Smith-NY)
9650 0340 RBI: Eng w/ nx (444 9/2 Kelly-FL)
9725 0330 RBI: Eng w/ nx & mx (v good 9/1 Blake-ID)
9730 0125 RBI: Eng progr (444 8/10 Oliver-NH);(333 0135 9/2 Trautschold-
WI);(322 0145 8/15 Snyder-CA)
11890 0100 RBI: Eng, IS, s/on (433 8/21 Wickett-LD);(poor 8/14 Miller-
CA);(444 0200 in Ger 8/14 Stephenson-CA);(523 0235 9/3
Britton-FL)

GERMANY, WEST

6040 0157 Deutsche Welle: Eng progr (443 8/27 Wickett-MD);(444 0225 8/16
Zelasko-IN)
6075 0130 DW: Eng s/on w/ nx // 6040 6010 9545 9690 (423 9/5 Buehler-
MO) That's they to write in details Lou! rfb. (444 0155
8/27 Wickett-MD)
6145 0140 DW: Ger progr (422 8/9 Stephenson-CA)
9545 0245 Dw: Eng w/ s/off at 0250 (545 9/2 Kelly-FL);(433 0545 8/19
Snyder-CA)
17845 0931 DW: Eng w/ "Panorama" (333 8/28 DuRant-THAILAND)
21540 0920 DW: Eng w/ ID, nx // 21560 Kigali (444 8/27 Durant-THAILAND)

GREAT BRITAIN

9600 0745 BBC: Eng w/ talk on Uganda unrest (444 9/1 Vockeroth-PA)
9750 1804 BBC: Turkish progr at 1815 (222 8/19 Trzaskus-IL)

GREECE

6015 2359 VOA, Rhodes: Eng w/ "Jazz Hour", local relay ID, s/off (good
8/24 Calkin-SPAIN)
9760 2120 VOA, Kavala: Eng w/ nx at 2200 (333 8/27 D'Angelo-NY)

HOLLAND

11730 2115 R. Nederland: Eng w/ "DX Jukebox" (343 8/23 Britton-FL);
(433 2125 9/4 Nebron-CA);(good 2130 8/16 Miller-CA);(poor
2130 8/14 Warren-CA);(good 2230 8/22 Blake-ID);(good 0200
8/14 Dolyak-IA);(444 0315 ??? Zelasko-IN) wheecwww!

HUNGARY

9833 0100 R. Budapest: Eng nx (good 8/31 Geckle-MD);(433 0300 8/31
Cleveland-CA)
11910 0245 R. Budapest: Eng w/ DX progr (333 8/15 Zelasko-IN);(poor 0425
8/12 Getzel-NY)

INTERNATIONAL WATERS

6205v 0120 Radio Nordsee International: Eng w/ pop mx and annmts (444
9/7 Butterfield-MA);(323 9/2 Smith-TN);(333 0003 8/19 Shaw-
PA)

ITALY

6060 2300 Radiotelevisione Italiana: Eng nx (333 8/10 Oliver-NH)
7275 0415 RAI: Italian w/ IS, ID, talk (332 8/15 Eichenhorn-WI);(533
0425 8/20 Dirrete-RI)
9510 2230 RAI: Italian w/ talk & good ID at 2230 (good 9/4 Wyndman-ID,

ITALY (cont.)

- 9575 0100 RAI: Eng s/on w/ fqys, nx, Ital nx, s/off @ 0120 (454 9/2 Trautschold-WI);(444 0110 8/27 Shaw-PA);(good 0120 9/6 Geckle-MD)
- 11810 2230 RAI: Ital w/ s/on 2230 (332 8/19 Snyder-CA);(424 0100 8/19 Bye-PA);(434 0100 in Eng // 9575 9/5 Buehler-MO);(323 0100 8/27 Britton-FL);(433 0100 8/20 Stephenson-CA)

LUXEMBOURG

- 6090 0000 R. Luxembourg: Eng s/on w/ pop mx, nx, headlines (322 8/17 Trautschold-WI);(322 8/21 Wickett-MD);(444 0003 8/31 Shaw-PA);(333 0200 8/17 Vockeroth-PA)
- 15350 1940 R. Luxembourg: Fr w/ pop mx (555 9/7 Britton-FL);(fair 2045 9/5 Dennis-IN)

MONACO

- 7100 0709 Trans World Radio: Eng w/ rel talk, "Gospie Call" (fair/poor 9/8 Dennis-IN)
- 11700 1815 TWR: Eng ID into u/lang prgr (poor/fair 9/3 Miller-OH)

NORWAY

- 6185 0205 R. Norway: Eng prgr (332 9/3 Flynn-CA)
- 9645 0400 R. Norway: Eng nx (333 9/3 Smith-TN)
- 11860 0400 R. Norway: Norwegian w/ Eng ID (322 8/10 Stephenson-CA);(243 0623 9/3 in Eng Flynn-CA);(poor/fair 1615 8/26 Miller-OH);(555 1420 8/19 Britton-FL)

POLAND

- 11815 0200 Polish R.: Eng w/ talk, folk mx (fair 8/13 Dolyak-IA);(v poor 0300 8/22 Blake-IN);(fair 0350 8/12 Getzel-NY)

PORTUGAL

- 6025 0200 R. Portugal: Eng prgr (433 8/20 Wickett-MD);(443 0225 8/26 Buehler-MD);(poor 0404 9/6 Dennis-IL)
- 9670 2105 Adventist World Radio: Fr w/ rel talk, hymn, s/off w/ address, asked, request for rpts, "LV de L'Espérance" (333 8/17 Lanoue-MA)
- 9670 2200 Secretaria de Estado da Informação e Turismo (S.E.I.T.): w/ tourism prgr to Nordic countries over Sines (as above station. rfb.). QSL's from Apt. 2495, Lisboa 2 (exc 8/26 Calkin-SPAIN)
- 11840 0215 R. Portugal: Fr w/ s/on to Canada (332 8/26 Snyder-CA);(333 0300 in Eng 8/23 Blake-IN)
- 11895 0130 R. Free Europe: Site? Eng & Ger w/ ID's, s/off 0200 (222 8/19 Trautschold-WI) Your prgr details were a bit confusing John, hope these are correct. rfb.
- 11935 0215 R. Portugal: Eng talk (444 8/23 Buehler-MO);(344 0215 9/4 Bye-PA);(444 0415 8/10 Stephenson-CA);(544 0217 8/19 Kamber-SC)
- 15215 2315 n. Free Europe: Slavic? w/ speech, on top of WNYW, very strong (523 8/19 Flynn-CA)
- 21495 1915 R. Portugal: Eng w/ commtry (444 9/2 Shaw-PA);(232 1345 8/29 DuRant-THAILAND)

ROMANIA

- 9570 0130 R. Bucharest: Eng nx (423 9/3 Zilmer-WI);(232 0430 9/4 Flynn-CA)
- 11775 1940 R. Bucharest: Eng nx & mx (433 8/31 Britton-FL);(433 1950 8/27 Cleveland-CA)
- 11940 0445 R. Bucharest: Eng w/ talk on village life (232 8/18 Snyder-CA)

RSFSR, EUROPEAN

- 11735 2230 R. Vilnius, Vinnista: (WRTH) Eng w/ s/on prgr on Lithuanian life, s/off 2300 (232 8/18 Snyder-CA)

SPAIN

- 6065 0115 Radio Nacional de Espana: Eng w/ "nice" mx & talk (333 8/31 Shaw-PA);(454 0135 8/11 Oliver-MH);(222 0320 8/17 Vockeroth-PA)
- 9630 0045 RNE: Sp w/ mx (unlisted fqy),(444 8/28 Bye-PA);(343 2355 8/19 Buehler-MO)
- 11770 0440 R. Liberty, Playa de Flais: (TENT) U/lang w/ talk, very hvy jam (322 8/21 Flynn-CA)
- 17805 1300 RNE: Sp w/ IS, s/on (455 8/19 Britton-FL);(433 1307 8/22 Wickett-MD)

S.WEDEN

- 6045 0330 R. Sweden: Eng w/ Sat show to WCNA, replaces 11705 (422 9/2 Zilmer-WI);(333 9/2 Nehren-CA);(433 0343 9/2 Cleveland-CA)
- 15420 1800 R. Sweden: Fr w/ IS & s/on (454 9/4 Forth-IL)
- 17815 1420 R. Sweden: Eng mx & talk (444 8/11 Britton-FL)

GET YOUR ABBREVIATIONS LIST FROM SPE3DA HQ.

SWITZERLAND

9535 0145 SBC: Eng w/ "Swiss Scene" (good 8/20 Yaney-IL);(444 0145 8/19 Trzaskus-IL);(322 0145 8/19 Snyder-CA);(433 0200 8/23 Buehler-MO);(444 0206 8/14 Zelasko-IL)
 9750 0425 SBC: Eng nx (443 8/19 Nebron-CA);(333 0215 8/21 Wickett-MD)
 11870 2100 SBC: Eng w/ nx, comtry, features (433 8/24 Fisher-PA)
 15420 1100 SBC: Eng w/ "dateline" to Africa // 15305 (342 8/22 Zilmer-WI)
 17830 1317 SBC: Eng w/ nx (323 8/18 DuRant-THAILAND)
 21520 1320 SBC: Eng w/ nx (252 8/30 DuRant-THAILAND)

USSR, EUROPEAN

9665 2255 R. Vilnius: Eng w/ fqys, s/off 2300, then R. moscow s/on in Eng (433 9/1 Zilmer-WI)
 9750 0100 R. Vilnius: Eng w/ ID, fqys, s/off (poor 9/2 Geckle-MD)
 11900 2350 R. Kiev: Eng w/ comtry (544 8/18 Kamber-SC);(343 8/19 Flynn-CA);(343 8/12 Snyder-CA)
 12000 0030 R. Kiev: Eng nx (333 8/10 Vockeroth-PA)
 15280 1255 Radiostantsiya Rodina: Russian w/ IS, ID, talk (243 9/4 Lanoue-MA)

VATICAN STATE

5995 0100 R. Vaticana: Eng w/ s/on (555 8/19 Trautschold-WI);(434 0105 8/20 Britton-FL);(good 0115 9/3 Geckle-MD) // 9605 11845
 9605 0100 R. Vaticana: Eng w/ s/on (332 8/13 Snyder-CA);(233 0045 in Sp 8/28 Bye-PA);(333 0130 in Fr 9/2 Trautschold-WI)
 11725 0000 R. Vaticana: Sp w/ s/on (433 9/5 Buehler-MO);(433 0100 8/21 Wickett-MD)
 11845 0057 R. Vaticana: Eng w/ talk on rel vocations (544 8/20 Buehler-MO)

YUGOSLAVIA

15240 1530 R. Belgrade: Eng w/ comtry (222 8/18 Bye-PA)

-AFRICA-

ALGERIA

17825 2145 Radiodiffusion-Télévision Algérienne: Eng lang speech w/ u/lang interperatation (433 9/5 Zilmer-WI)

ANGOLA

5060 0500 R. Clube de Huambo: Port w/ bird IS, anthem, & s/on (333 8/24 Greenall-ONTARIO)
 9660 1447 A Voz de Angola: Port w/ mx, ID @ 1500, nx, more mx 1505 (443 8/27 Cleveland-CA)

ARAB REPUBLIC OF EGYPT

9475 0200 R. Cairo: Eng, ID, sked, nx (422 8/13 Stephenson-CA);(332 0200 9/5 Buehler-MO);(433 0251 8/18 Trzaskus-IL);(443 0308 0309 Cleveland-CA);(v poor 0240 9/4 Warren-CA)
 15195 2005 R. Cairo: Eng nx (good 9/5 Dennis-IN)

ASCENSION ISLAND

7105 0500 BBC, Atlantic Relay: Eng prgr to Africa (454 8/20 Mapoin-WA)
 15105 1645 BBC: Eng s/on (433 8/16 Snyder-CA)

BOTSWANA

4845 0439 R. Botswana: Eng nx & ID (243 8/24 Greenall-ONTARIO);(252 0459 8/24 Gavaras-ILN)

CAMEROUN

5010 2100 R. Garoua: Vern w/ mx, clear ID on the hour, talk (good 8/27 Calkin-SPAIN)

CANARY ISLANDS

11800 0030 Radio Nacional de Espana, Tenerife: Sp mx & talk (343 8/30 Bye-PA);(444 0200 8/31 Cleveland-CA);(353 0330 8/19 Hardester-CA);(232 0415 8/29 Snyder-CA)
 15365 0230 RNE: Sp w/ opera mx (333 9/3 Kelly-FL)

CONGO, PEOPLE'S REPUBLIC OF THE

4765 0330 Radiodiffusion Television Congolaise: Fr w/ afro drum mx, talk (333 8/17 Shaw-PA);(555! 0445 9/4 Sheedy-CA)
 4863 0505 RTVC, Pointe Noire: Vern prgr, seemed // 4765 transmitting in vern @ 0500 (TEINT) (222 9/4 Sheedy-CA) lists as 4843 in WRTH. rfb.
 9715 1930 RTVC: Fr w/ talk & mx (poor/fair 9/3 Miller-CA)
 15190 1913 RTVC: Fr w/ ID & afro mx (444 8/25 Greenall-ONTARIO);(333 1930 8/20 Shaw-PA);(343 1930 8/23 Cleveland-CA);(433 2035 8/23 Fisher-PA)

DAHOMAY

4870 0512 Radiodiffusion du Dahomey: Fr w/ drum ID, nat anthem, then full ID, "best this station ever heard" (544 8/24 Greenall-ONTARIO)

ETHIOPIA

7185 0410 ETLF: Eng prgr (v noon 8/10 Hyndman-IL)
 11850 0330 ETLF: Fr prgr (444 8/16 Gaede-CA)
 15250 0530 ETLF: Ar w/ rel mx, talk, Eng ID (322 8/6 Snyder-CA) too old!

EGYPTIAN GUINEA

4926 0535 R. Bata: (TEMT) U/lang w/ mx (242 8/21 Flynn-CA)
 6250 0545 R. Santa Isabel: (TEMT) U/lang w/ vocal & instrumental mx (221 8/21 Flynn-CA)

GABON

4777 0430 Radiodiffusion Television Gabonaise: Fr w/ comtry & native mx, drums (333 9/4 Sheedy-JA)

GAMBIA

4820 0630 R. Gambia: Eng anents followed by chanting (243 8/28 Forth-IL); (242 0658 w/ BBC nx 0700 Snyder-CA); (333 9/3 0700 Greenall-ONTARIO); (333 0702 9/6 Sheedy-CA); (333 0711 9/1 Hambright-NJ); (fair 2000 8/31 Calkin-SPAIN) Gregg notes that the new name of the Gambian capital is Banjul. rfb.

GHANA

4915 0535 Ghana Broadcasting Corporation: U/lang w/ Eng ID (544 8/24 Atchisson-MO); (fair 0605 in Eng 8/25 Getzel-NY); (433 0610 8/24 Fisher-PA); (443 2230 8/18 Lanoue-MA)
 4980 0615 GBC: Eng nx, mx (333 8/24 Fisher-PA)
 9545 2200 GBC: Eng local nx & mx (fair 8/29 Hyndman-IL)
 11850 2005 GBC: Eng w/ afro mx, talk (444 8/28 & others, Fisher-PA); (454 2010 8/31 Britton-FL); (354 2015 8/12 Oliver-NH); (333 2030 8/28 Vockeroth-PA); (343 2040 8/23 Cleveland-CA)

GUINEA, REPUBLIC

9650 0255 Radiodiffusion Nationale: Fr prgr (242 8/26 Snyder-CA); (454 0400 8/27 Gianni-IL); (fair 2338 8/25 Miller-OH)

IVORY COAST

4940 0610 Radiodiffusion Television Ivoirienne: Fr w/ native mx, talk (333 9/4 Sheedy-CA)
 11920 0750 RTVI: Fr w/ talk & mx (8/6 Stephenson-CA); (423 1905 9/7 Britton-FL); (323 1928 8/14 Eichenhorn-MI); (444 2200 8/25 Fisher-PA); (444 2215 8/30 Bye-PA); (343 2350 9/9 Snyder-CA)

KENYA

4915 0359 Voice of Kenya: Swahili w/ time pips, ID, into prgr (354 8/24 Gavaras-MN); (333 0615 8/26 Shaw-PA); (fair 2015 8/21 Calkin-SPAIN)

LIBERIA

4770 0645 ELWA: Eng prgr "dull" (333 9/4 Sheedy-CA)
 6045 2340 VOA, Monrovia: Eng w/ jazz hour (434 8/30 Oliver-NH)
 7195 0410 VOA: Eng w/ "Breakfast Show" (ggod 9/1 Geckle-ID); (333 0520 8/12 Nebron-CA); (fair 2343 9/5 Dennis-IN)
 17800 2230 VOA: 433 Fr prgr // 1777; s/off 2230 (433 9/2 Snyder-CA)
 17875 1845 VOA: Eng w/ "Now Sound" (443 8/27 Cleveland-CA)

MALAGASY REPUBLIC

7205 0025 R. Nederland, Talata: Eng ID 0630, nx // 9605 (423 8/25 Zilmer-WI)
 11740 1400 R. Nederland: Eng s/on (222 8/22 Kamber-SC); (444 1400 8/30 DuRant-THAILAND)
 15195 1230 R. Nederland: Indonesian prgr, IS, ID w/ specific QTH, nx (344 9/2 Lanoue-MA)
 15320 1218 R. Nederland: Eng w/ nx headlines (333 8/31 Zilmer-WI)

MALAWI

3380 0344 Malawi Broadcasting Corporation: Eng prgr (fair 8/26 Miller-OH)

MALI

4780 0601 Radio Mali: Fr w/ chanting, ID (253 8/25 Gavaras-MN)

MAURITANIA

4850 0655 Radiodiffusion Nationale Mauritanie: Fr w/ IS, ID, s/on into Arabic chanting (444 9/6 Sheedy-CA)

MOROCCO

7270 0530 VOA, Tangier: Eng w/ "Breakfast Show" (333 8/12 Nebron-CA)
 11735 0258 Radiodiffusion Television Marocaine: Arabic chanting, ID (344 8/11 Gavaras-N)
 15195 1630 VOA: Eng s/off, then into Turkish, different xmtr? (433 9/9 Forth-IL)
 15360 1325 RTVM: Arabic chanting (332 8/26 Eichenhorn-MI)

MOCAMBIQUE

4855 0430 Radio Clube de Mocambique: Port w/ ID & pop mx (544 8/24 Greenall-ONTARIO)
 4923m 0510 RCM: (TEMT) Eng/Afrikaans w/ U.S. rock mx, muddy audio, no positive ID (333 9/9 Sheedy-CA)

MOZAMBIQUE (cont.)

4925 0430 RCM: Eng w/ pop mx, ads (332 8/25 Cleveland-CA)
 11782m 0535 RCM: Eng w/ DJ show (444 9/8 Britton-FL)

NIGER

5020 0540 Office de Radiodiffusion-Television du Niger: Fr w/ chanting
 (111 8/25 Gavaras-MN)

NIGERIA

6025 2300 Nigerian Broadcasting Corporation, Enugu: (TENT) Eng nx, s/off
 @ 2305 (poor/fair 9/6 Miller-OH)
 7235 0500 NBC, Enugu: Eng w/ drum Is, s/on w/ ID & local TC (333 8/25
 Greenall-ONTARIO);(222 0545 8/24 Fisher-PA)
 7275 0630 Voice of Nigeria: Eng w/ nx (good 9/2 Getzel-NY);(323 0545
 8/24 Fisher-PA)

RHODESIA

3396 0500 Rhodesian Broadcasting Corporation: Eng w/ nx, editorial,
 afro mx, TC's (322 8/24 Fisher-PA)

RWANDA

11965 2210 Deutsche Welle, Kigali: Ger w/ ID, IS (343 8/25 Snyder-CA)
 15380 2025 DW: Ger w/ s/on (353 8/27 D'Angelo-NY)
 17765 1237 DW: Eng progr (good 8/28 Smith-IN)
 21560 0950 DW: Eng w/ "Panorama" (454 8/28 DuRant-THAILAND)

SENEGAL

7210 0630 Radiodiffusion du Senegal: Fr w/ mx progr, ID @ 0700, nx 'til
 0715, more mx, progr "La Voix du Esperance" (444 8/24 Fisher-
 PA);(good 0705 8/13 Dawson-CA)

SEYCHELLES

11955 1748 Far East Broadcasting Association: Eng w/ mailbag progr, ID
 @ 1800 w/ end of Eng progr (fair 9/8 Miller-OH)

SOUTH AFRICA

3250 0240 SABC: Eng/Afrikaans w/ mx (333 8/22 D'Angelo-NY);(343 9/5
 Nebron-CA);(555 0400 9/6 Sheedy-CA);(343 0435 8/24 Cleveland-
 CA)
 3285 0358 SABC: Eng w/ ID into Afrikaans progr 0400 (434 9/6 Sheedy-CA);
 (343 0435 in Eng 8/25 Cleveland-CA)
 3320 0410 SABC: Afrikaans progr (444 9/6 Sheedy-CA);(333 0428 8/18
 Lanoue-MA)
 3997 0015 SABC: Afrikaans ID & cl mx (544 8/25 Greenall-ONTARIO);(443
 0056 in Eng/Afrikaans 8/21 D'Angelo-NY);(good 0131 8/27
 Miller-OH);(333 0200 8/20 Britton-FL);(poor 9/6 Dennis-IN);
 (322 0400 8/26 Lanoue-MA)
 6035 0130 RSA: Eng progr to N.A. // 9695 9585 6000 (433 9/2 Zilmer-WI);
 332 0130 8/28 Fisher-PA)
 7270 0415 RSA: Swahili w/ ID in Eng @ 0428 (544 8/20 DiPrete-RI)
 11900 1330 RSA: Eng w/ Rugby game (333 9/3 Vockeroth-PA);(443 2215 9/10
 Zilmer-WI)
 11970 2215 RSA: Eng s/on (422 9/2 Zilmer-WI)
 15155 1605 RSA: Eng w/ nx, ID @ 1610, more nx (343 8/17 Smith-NY)
 17780 1730 RSA: U/lang w/ talk (344 9/2 Bye-PA)
 21535 1020 RSA: Eng w/ s/on (433 8/29 DuRant-THAILAND)

SUDAN

5039 0315 R. Omdurman: Arabic mx & talk (good 8/15 Calkin-SPAIN)

TANZANIA

15435 1800 R. Tanzania: Eng nx, piano mx, U/lang talk, afro mx (433 9/8
 Zilmer-WI)

TOGO

5047 0605 Radiodiffusion du Togo: Fr w/ nx, vocals, ID (444 9/4 Sheedy-
 CA);(433 0620 8/24 Fisher-PA);(333 0630 8/26 Shaw-PA);(545
 2200 8/25 Greenall-ONTARIO)

UPPER VOLTA

4815 0601 Radiodiffusion-Television Voltaique: Fr w/ IS, ancmts, mx incl
 some old U.S. pops. (242 8/18 Flynn-CA);(fair 2300 8/24
 Calkin-SPAIN)

ZAIRE

15245 2025 Radiodiffusion Television Nationale du Zaire: Fr w/ afro &
 pop mx progr, ID @ 2030 (332 8/23 Fisher-PA);(312 2330 8/26
 Snyder-CA)

-CLANDISTINE-

CLANDISTINE

6230 1009 R. Gemini: ??? pop mx, 3rd fqy noted in recent weeks after
 6220 & 6235 (fair 8/26 Calkin-SPAIN)
 12170a 2310 R. Espana Independiente: Sp w/ political talk, full ID & s/off
 w/ fqys & folk song 2314 (343 8/18 Lanoue-MA)

Europe/Africa Roundup

Ciao! First off, thanks go to new reporters Dave Atchisson, Arch Dawson, Kevin De Angelis, Karl Forth, Joe Geckle, Eugene Kelly, Gus Miller, Dan Sheedy, and a special welcome to Henry Durant who sends his reports in all the way from Thailand. Also, a welcome back to Lynn Hyndman. A total of 51 reporters. In fact, we would have had more 'cept for the fact that these guys were late: Bob Beck, Scott Brown, Mike Collier, Steve Handler, Ian Henderson, Serse Neumann, and Andris Straumanis. Remember, late reports cannot be used nor credited. (Especially now that I can't s-t-r-e-t-c-h the rules a little).

Cape Verde Islands: We have a correction to report. Phil Schnabel in response to my query at the recent BAD guys meeting—his report on R. Barlavento in the September SPEEDX should be 3930 kHz.

Greece - Radiofonikos Stathmos Macedonias: Gregg Calkin writes us in response to my query in the August SPEEDX on this Greek station: "The station is a new one in recent months it seems. It seems to operate regularly, best here (Spain) around 1300 GMT on 9710 kHz; it is located in Thessaloniki and QSL's (LIR card) are sent from Veniselou 4, Thessaloniki." Thanks Gregg.

Reporting forms available: Don't forget that SPEEDX reception report forms are available from SPEEDXPARAS. These are tri-lingual forms (English, French, & Spanish) for use in reporting to individual stations. These forms are available free to active SPEEDX'ers only ... three (!) forms are available for each magazine credit point received (up to a maximum of 18 forms per month) with only return postage.

Soviets cease radio jamming: Perhaps the article put here for your edification (coming from the Boston Globe recently) may not do too much for your love of Radio Moscow, but is of some interest.

LONDON — The Soviet government has stopped jamming official and semi-official Western broadcasts to the Soviet people, the British Broadcasting Corp. reported today.

A spokesman said interference with the reception of the BBC Russian Service and the Russian-language services of the Voice of America and West Germany's Deutsche Welle stopped on Monday.

"But the jamming of Radio Liberty, the American station based in the Federal German Republic, and Israel's transmission to the Soviet Union in Russia, is reported to be continuing," the spokesman added.

The Voice of America is an official division of the US government; Radio Liberty and Radio Free Europe are financed by Congress but do not have official status.

It is interesting to note, however, that it will be no easier to decipher what is behind all that noise over R. Free Europe and R. Liberty. The tides of change do come in, but not all that fast.

(direct)

B.A.D. Guys do it again! Not being exactly sure what we did 'cept for the fact we did meet at Jim Whitehead's lovely residence in suburban Reading. In attendance besides yours truly and the host and hostess were John Fisher, Harlan Eye, Phil Schnabel, Chris Hansen, Jon Fay, Frank Testa, Ken Compton, Mike Macken, and the ever-present Alan Brooks. As usual we all had a grand time being served the famous traditional meatballs and lasagne (or should I say infamous). Much of the rest of the time was spent exchanging the latest D.'ing info and in the case of Phil Schnabel and myself, watching Jon Fay trying to hang himself in the Whitehead's backyard trying to put up a temporary antenna.

Then, what may become an annual event—the first BAD Guys Grand Prix came as all were about to leave. Alan Brooks and his navigator, daughter Belinda, along with excess "baggage" Phil Schnabel and Chris Hansen headed out in the Brooks' Volkswagon Camper, ahead of the second entry, piloted by your Europe/Africa editor along with co-pilot and sometimes ASLAC Americas editor and ASLAD'er John Fisher. There must have been a mix-up at the starting gate. It was to our surprise to then see the hasty Alan coming up behind us. After we had made our entrance on to the highway, he must have taken a further up entrance ramp (hoh!). From then on it was practically no-contest with John and I easily setting the pace. As we went off our exit ramp we saw Alan and his companions streaking off down the road coming in a close second.

Hey Alan, what does that blue flashing light mean? 73's Bob

ASIA-OCEANIA

editor
Don Johnson
P. O. Box E
Elsinore CA
92330 USA

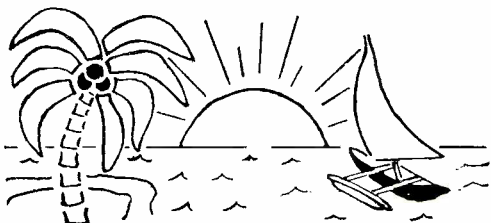

Frequencies in khz Deadline: Here by 15th Times in GMT

Many interesting loggings this month. Note the many Indo stations reported. SIBS & TIMOR are still being logged. KHMER is heard on 60 meters. And MORE! What you may NOT find this month are the high frequency loggings from the well heard stations such as; Australia, Japan, China, ect. This is necessary due to the fact that A/O has over 50 reporters this month, which is twice as many as in June with the same number of pages. I'd rather print the lower freq. loggings, since this is where the DX is at. As the Asian DX season is starting now, try working into the lower bands a bit earlier. You'll be surprized at what you may hear. TRISTAN da CUNHA.....HERE I COME.

Thanks are in order to SPEEDX editors Jim Whitehead & Alan Brooks for sending in loggings from their recent trips to the Asian area. And you fellows get PAID for this? I'll go for free.

A S I A

AFGHANISTAN

15265 *1800 Radio Afghanistan:Eng nx, mx, & cmtry to 1830* (--4 9/1 Miller OH)(333 9/1 Fay MA)(433 9/4 Forth IL)(221 8/5 Eichenhorn MI)

BANGLADESH

11650 1700 R Bangladesh:Hindi w/Eng ID(333 8/18 Zilmer WI)(--2 Warren CA)
15455 *1230 RB:Eng nx, tks, mx to 1300* (233 9/2 Lanoue MA)(343 9/2 Zilmer WI)//17690 222 (232 on 17690 (//15457 444) 9/2 Fay MA)

BRUNEI

4865 1412 R Brunei:Malay pgm to 1430* w/GSTQ (343 8/30 Cleveland CA)
7215 1314 RB:Eng TC, ID, nx. ARO QRM. (323 8/15 Nebron CA>Welcome aboard Larry....dj..(332 1400 9/6 Cleveland CA)(Chi 1020 242 Fay MA) (Eng 1427, QRM AFTN: 334 8/24 Brooks Guam)..Who/where????????

BURMA

BBS = Burma Broadcasting Service Rangoon.
4725 1230 BBS:lang pgm of native mx & tks(333 9/5 Sheedy CA)(1350 343 8/30 Cleveland CA)(353 8/24 Brooks GUAM)No, not//5040 normally...dj
5040 1430 BBS:Eng mx & nx. Weak. (232 8/18 Nebron CA)(1435 pop mx, no Eng heard 242 9/2 Flynn CA)Bill, usually 10 minutes of native or Eng mx at 1430 w/Eng nx at 1440. Very much accented.....dj (1445 332 8/23 "much better in lang at 1330" Cleveland CA)

CHINA PEP REP

4913 1320 Radio Peking, Harbin:Chi speeches, 6 pips on the hour (454 9/2 Sheedy CA) last reported on 4917½.....dj
5075 1345 RP:Chi tks (434 9/2 Sheedy CA) this is HS2.....dj
6290 1355 RP:Eng tks on Chi waterways (444 Stephenson CA)
6938 1400 RP,Kumming:Chi w/music(--4 8/20 Dawson CA)...Welcome Arch.....dj
6955 1456 RP:Chi singing & mx (--3 8/21 Dawson CA)
6974 1442 RP,Huhohot, Inner Mongolia: Chi music pgm(--3 8/21 Dawson CA)
7620 1315 RP: Chinese w/YL talks (343 8/13 Mappin WA)
9860 1435 RP:Eng 'thoughts of chairman Mao'(333 9/4 Cleveland CA)Oh boy...
17673 0015 RP:Eng tk on Chi 9th Congress(444 8/31 Shaw PA)

CYPRUS

11955 0340 BBC Limassol:Eng w/"Pop Tracks" (222 8/21 Brown CA)I wonder why WRTH calls this Europe???? Its south of Turkey ain't it?...dj

INDIA

9705 1132 AIR:Eng w/nx & wx (home service)//11850(433 9/9 Zilmer WI)
 11810 *1330 AIR:Eng nx in GOS(241 8/27 Fay MA)(322 8/24 Stephenson CA)
 11850 *1225 AIR:Eng pgm notes & nx.//9535(322)(443 9/3 Zilmer WI)
 11945 1845 AIR:Eng tks & Indian music (--2 8/14 Warren CA)

INDONESIA

RRI = Radio Republik Indonesia.

3204t 1402 RRI Bandung:Indo nx? & tks. QRN. (343 8/25 Cleveland CA)(on 3205 at 1355 w/jazz mx, nx. 242 9/2 Flynn CA)
 3250 1345 RRI Baandjarmasin:Indo opera mx.IS "Love Ambon"(332 Cleveland CA)
 3294 1340 RRI Samarinda:Indo waltzes, ID 1400,nx(342 9/4 Cleveland CA)
 4715t 1346 RRI Makassar:Indo mx & anmts. No clear ID due to "my limited exposure to Indo lang" (343 8/24 Brooks GUAM) Gee Alan, I thought thats what you wrote your column in.....Anonymous.....
 4719 1235 RRI Ujung Padang:Indo w/OM talks(434 9/5 Sheedy CA)??ID???.dj
 4765 1330 RRI Medan:Indo variety of MX, ID's QRM 4770(343 8/24 Brooks GUAM) (1340 w/1347 ID, 1358 IS 333 8/24 Cleveland CA)(243 Flynn CA)
 4805 1244 RRI Jarkarta:Indo mx, interview,clear ID(444 8/24 Brooks GUAM)
 4839t 1348 RRI Ambon:Indo w/mx incl "La Paloma", "Romona"(332 Cleveland CA)
 4855 1245 RRI Palembang:Indo w/YL tks, US mx, 1300 ID(333 9/8 Johnson CA) (1415 pops, ID, world nx 333 8/23 Cleveland CA)
 4871 1215 RRI Sarong:Indo mx & tks "who knows what subject?"QRM (332 8/24 Brooks GUAM)(1350 YL & pops, 1356 ID 333 8/22 Cleveland CA)(1300 w/ chimes IS into Indo music 333 9/5 Sheedy CA) ✓ GUAM
 4900t 1141 RRI Gorontalo:Indo hard to read via RP QRM splash(332 Brooks ✓
 4927 1340 RRI Jambi:Indo mx, "Love Ambon", ID (342 9/7 Cleveland CA)
 4932 1310 RRI Surakarta:Indo w/beautiful native mx & YL tks(444 9/2 Sheedy CA)(1415 C&W mx, ID, Indo tks 333 8/27 Cleveland CA)
 5047 1200 RRI Jogjakarta:Indo w/OM tks on world affairs(333 9/4 Flynn CA) (1340 mx & tk, 1400 ID 333 8/23 Cleveland CA)(444 Sheedy CA)
 5054 1215 RRI Ujung Padang:Indo in//Jogjakarta w/net feed(233 9/4 Flynn CA)(1402 443 8/21 Cleveland CA)(1303 534 9/2 Sheedy CA)
 5987 1010 RRI Menado:Indo mx & anmts(232 9/1 Fay MA)(1050 442 9/7 Zilmer WI)(1417 mx w/some Eng lyrics, ID 343 8/21 Cleveland CA)
 6045 1020 RRI Jakarta:Indo w/mx "Love is Blue"(is it?), anmts. //7269 (333 8/22 et all Fay MA)(1500 to 1552 f/out 443 Cleveland CA)
 6070 0810 RRI Jayapura:Indo w/Eng lessons //7165 (343 8/21 Trubee HI)
 11713 1100 RRI Jakarta:Eng nx, ID's QRM via RA 1115(343 9/3 Fay MA)(1230 to 1300* in lang w/tks & mx 443 9/8 Zilmer WI)(2325 s/on w/IS in Eng to Asia 533 9/5 Sheedy CA)Huh? Is this time right?...dj

IRAN

9022 2000 R Tehran:Eng cmtry on oil scarcity (343 8/31 Oliver NH)(1855 in lang w/native music & tks 353 8/23 Britton FL)
 15084 1300 R Tehran:in lang to past 1900. Well heard from coast to coast.

IRAQ

6155 0225 R Baghdad:Ar w/bird IS into tks (332 8/18 Flynn CA)
 9745 1945 R Baghdad:Eng news, ID, mx.(343 8/14 Smith NY)
 11782v 1700 R Baghdad:Ar nx, gong on the hour(443 8/25 Giannini IL)(1641 w/chanting endless songs --3 8/26 Miller OH)

ISRAEL

9009 *0500 IBA:Eng ID into news. QSB.--3 8/12 Getzel NY)(1905 in Hebrew w/talks and music 231 8/23 Britton FL)
 11700 2010 IBA:Eng nx. New freq? (444 9/7 Britton FL)
 15105 2000 IBA:Eng news(232 9/2 Zilmer WI)
 15160 *2000 IBA:Eng w/new freq. Ex 15165 (433 9/2 Zilmer WI)
 15315 *2000 IBA:Eng nx. QRM de HCJB & RCI. Useless(411 9/2 Zilmer WI)

JAPAN

NIPPON HOSO KYOKAI

- 3910 1300 FEN:Eng w/nx via AFRTS, into local DJ pgm (243 8/26 Whitehead TAIWAN)(1300 333 9/2 Sheedy CA)(0945 in Jap w/tks & Asian mx 232 9/9 Fay MA)?? FEN in Japanese? Positive ID Jon?.....dj
- 3925 1300 NSB:Jap pgm like 830 (BCB) & others (333 9/2 Sheedy CA)
- 6010 1530 VOA Okinawa:Eng nx & mx to 1600* (232 8/24 Nebron CA)//7165...d
- 6030 *1130 NHK:Kor pgm, Eng ID.//6080/7140 (443 9/3 Zilmer WI)
- 6055 1045 NSB:Eng/Jap "Lets Learn Japanese"(OK, lets)444 8/24 Brooks GUAM, (1440 same details 443 8/21 Cleveland CA)
- 6155 1400 FEN:Eng nx, wx, ID, mx.(333 8/20 Cleveland CA)(353 Nebron CA)
- 6190 0745 NHK?:Japanese baseball game(252 8/20 Trubee HI)
- 9505 0800 NHK:Jap/Eng to past 1500 well heard by 15 reporters.....dj
- 9555 1630 NHK:Eng w/Jap lang lesson, nx (--4 8/12 Dolyak IA)
- 9560 1205 NHK:Eng news (323 9/4 Buehler MO)
- 9655 0635 NHK HS:Japanese program(232 8/14 Trubee HI)
- 9675 1045 NHK:Eng nx to SEA.//11875 (343 8/22 Zilmer WI)
- 11705 *1230 NHK:Eng s/on with GOS (444 8/12 Britton FL)
- 11725 *2345 NHK:Eng to NA //15455. Replaces 17825. Ancd, not heard. Zilmer V
- 11815 *1300 NHK:Eng IS, ID, news (--2 9/3 Miller OH)
- 11875 *1045 NHK:Eng to SEA. ID, nx, tks, mx. (454 8/28 DuRant THAILAND)

STICK TO IT

JORDAN

- 7155 0510 R Amman:Arabic w/chanting, OM tk. ARO QRM (--2 8/19 Getzel NY)

KHMER

RNK = Radiodiffusion Nationale Khmer.

- 4907 1050 RNK:lang tks by YL/OM. Freq measured at 4907.5(221 9/3 Fay MA) (1348 in lang(Cambodian, WRTH)Asiatic mx, 1400 ID into nx?, 1406 march mx followed by speech.1427 jammed. 344 8/29 Cleveland CA)
- 6090t 1402 RNK:Fr w/commentary mixed w/fanfares(342 8/24 Brooks GUAM)

KOREA NORTH

KCBS = Korean Central Broadcasting Station.

- 3015 1245 KCBS Pyongyang:Jap w/OM polical tk (333 9/5 Sheedy CA)
- 3320 1238 KCBS:Korean w/YL commentary (333 9/5 Sheedy CA)
- 4560t 1412 KCBS:nx in lang, maybe Eng. "Korea will never.....", 1414 maybe NA followed by more talks. VOA QRM de 4553(332 8/31 Cleveland CA)
- 4770t 1353 KCBS:lang w/mx, little tk. (332 9/11 Cleveland CA) could be.....d
- 6540 0915 KCBS:Japanese news program (433 8/24 Trubee HI)
- 7580 1320 KCBS:Eng w/YL newscast (454 8/13 Mappin WA)
- 9455 *1000 KCBS:Eng nx to the Americas to 1050. Russian 1100-1150, Eng 1200-1250. (242 9/3 Dobosenski MI)Tks Michael & welcome.....dj (1003 Eng nx --5 9/3 Castello CA)(1040 Eng cmtry 222 8/17 Vockeroth PA)(0900 in Sp to LA w/IS, ID, nx --4 8/26 Castello CA)
- 9515 0810 KCBS:Eng w/anti USA talks (222 8/17 Trubee HI)
- 9820 0640 KCBS:Eng cmtry on conditions in N Korea (222 8/18 Trubee HI)
- 11535 2130 KCBS:Eng w/YL cmtry on S Korea policy (333 8/25 Snyder CA)(2150* in Eng --4 8/14 Calkin SPAIN)(1130 lang 342 8/18 Zilmer WI)
- 12074 *1800 KCBS:Eng IS ID & nx, cmtry & mx (343 9/6 Johnson CA)
- 15630 2316 KCBS:Eng tks by YL/OM, many ID's (--4 8/19 Dawson CA)

KOREA SOUTH



RADIO KOREA

- 9640 1007 R Korea:Eng nx pgm(454 8/19 Hardester CA)(1100 444 Shinn CA)
- 15280 0905 RK:Eng nx. New frequency. (131 8/27 Trubee HI)
- 15335 *0300 RK:Eng nx & mx(252 9/2 Smith TN)(132 9/9 w/QRM AFRTS Brown CA)

LEBANON

- 9545 *0230 R Beriut:Eng nx. Reactivated freq. (333 9/5 Johnson CA)
- 11790 *0230 RB:Eng nx, mx(343 Britton FL)(544 Kamber SC)(443 Cleveland CA) (444 Shaw PA)(131 Buehler MO)(242 Trubee HI)

MALAYSIA

- 4845 1225 R Malaysia:Hindi w/sub cont mx. Indian Service(333 9/5 Sheedy CA)
- 6195 1045 BBC:Eng mx pgm(433 9/8 Snyder CA)(454 8/31 Cleveland CA)



MALAYSIA (cont)

SUARA MALAYSIA

7110	1428	RM:Chi(WRTH)w/mx, Malay ID,(433 Cleveland CA)	P.O. Box 1074
7295	1110	RM:Eng w/Asian mx, nx,US mx (232 9/9 Snyder CA)	Kuala Lumpur
11750	1630	BBC:English programing (544 8/21 Brown CA)	MALAYSIA.
15310	1600	BBC:Eng nx(--3 9/3 Miller OH)(1515 drama 444 8/21 Cleveland CA)	

PAKISTAN

11672	1300	R Pakistan:Eng nx,cmtry (433 9/8 Zilmer WI)(2045 in lang nx w/Eng ID 2100 434 8/19 Shaw PA)
17915	*1530	RP:Eng w/slow speed nx to 1545* (343 9/2 Zilmer WI)
17935	*0200	RP:lang tks & mx. Eng ID. To 0245* (252 9/9 Zilmer WI)

PHILIPPINES

3345	*2000	FEBC:Eng/Vern. ½ hr ahead of sced s/on (253 8/22 Whitehead TOKYO)I doubt if I can hear this one Jim, its high noon local...
6030	1235	FEBC:Eng ID "You are tuned to the sound of inspiration, DZAS 680 Radio",followed by rel pgm (544 8/23 Whitehead TOKYO)
6170	1010	PBS:Eng nx, US pops. "A real surprize" (333 8/21+ Fay MA)
9555	1300	VOA:Chi pgm w/Eng lesson(--3 9/8 Miller OH)(1130 333 Snyder CA)
9580	1510	VOP:Eng nx,views,mx to past 1800(444 Stephenson CA)(--4 Warren CA)(454 Giannini IL)(454 Nebron CA)(433 Whitehead HI)
9630	1515	VOA:Indo(WRTH)pgm, Eng ID & site 1530*(443 8/27 Cleveland CA)
11920	*2150	FEBC:Indo w/mx. Heard over RTVI (322 8/25 Snyder CA)
15300	0845	FEBC:Eng religious program (333 8/27 Trubee HI)
15440	2330	FEBC:Eng nx & cmtry. NHK QRM 2345 s/on (--2 8/13 Warren CA)

SABAH

4970	1340	R Malaysia Sabah:Eng tks (332 8/22 Cleveland CA)(1350 Eng lesson (notice my improved diction?)333 9/2 Sheedy CA)(1118 in Eng w/ Vern anmts, Eng pop mx 343 8/24 Brooks GUAM)
------	------	--

SAUDI ARABIA

11855	1820	BC Svs of the Kingdom of Saudi Arabia:Eng w/mx pgm (--2 8/22 Calkin SPAIN)
11950	2120	BSKSA:Ar tks & mx(343 8/25 Giannini IL)(0355 232 8/7 Trubee HI)

SINGAPORE

5010	1215	R Singapore:Chi tks(333 9/5 Sheedy CA)
5052	1335	RS:Eng nx,TC,ID,mx(443 8/20 Cleveland CA)(1330 333 9/2 Sheedy CA)(1500 Soccer game with Burma 222 9/6 Nebron CA)
		NOTE: R Singapore does indeed issue a full data QSL now. I found this out when the Leistner's came to my Qth and shoved one in my face (full data & all). However, they refused to trade for my 22 QSL's from R Kiev. Spoil sports!.....dj

SRI LANKA

5020	1401	R Ceylon:Eng nx headlines, music (332 8/23 Cleveland CA)
11725	1515	RC:Eng w/ pop music (343 8/25 Flynn CA)(1600 BBC nx,Rel pgm 332 8/25 Snyder CA)(1700 Rel pgm 122 9/10 Brown CA)(1700 with canned Rel pgm to 1730* --4 8/18 Warren CA)
11800	1600	RC:Hindi program of Hindi music (555 8/25 Giannini IL)
11825	1110	RC:Eng pgm to SEA. ID,nx,feature on Dylan Thomas(444 8/27 DuRant THAILAND)
15120	*1025	RC:Eng to SEA(322 8/27 DuRant THAILAND)(0230 Eng 332 9/2 Zilmer WI)(1600 322 Fay MA)(0809 lang 343 8/27 Trubee HI)

THAILAND

7108t	1420	Thai TV Co:Thai w/US pop standards(422 8/28 Cleveland CA)
-------	------	---

TIMOR

3668	1325	Dili:Port pops & tks(232 8/23 Flynn CA)Ditto here....
------	------	---

UZBEK SSR

11730	1207	R Tashkenk:Eng nx(--3 9/8 Miller OH)(343 8/31 Smith TN)
-------	------	---



VIETNAM NORTH VOV = Voice of Vietnam.

15012 *1800 VOV:Eng nx,mx to 1830 Fr pgm(343 Zilmer WI)(352 Oliver NH)

VIETNAM SOUTH

4877 1220 VTVN:lang tks. Maybe //7175. QRN(444 9/5 Sheedy CA)(1343 Viet n
& tk. 1359 IS ID & nx? by YL/OM 443 8/27 Cleveland CA)
6165 1130 VTVN:Viet w/pop Viet music (352 8/24 Giannini IL)
9620 1028 VTVN:Viet tks(Is Trucial still here?)(343 Fay MA)..A good quest
10010 1110 Lib Radio:English news and ID (232 8/24 Trubee HI)

O C E A N I A

AUSTRALIA

RADIO AUSTRALIA

4920 0800 ABC Brisbane:Eng nx(141 8/27 Forth IL)(1205 mx 333 8/27 Zelasko
IN)(1402* GSTQ 443 8/22 Cleveland CA)
6090 1358 ABC Sydney:Eng to 1402*(then Khmer?)(332 8/24 Brooks GUAM)maybe
6150 1055 ABC Melbourne:Eng 5 min news, music (333 8/14 Shaw PA)
6160 1500 RA:Eng news(333 9/7 Nebron CA)(1520 433 8/28 Cleveland CA)
9570 1115 RA:Eng pop mx(444 8/12 Shaw PA)(1155 mx,1200 nx, 423 8/24
Zimarowski MA)(1230 to SEA, Het. 422 8/18 DuRant THAILAND)
9580 1115 RA:Eng past 1205,well heard by all(Trzaskus IL)(Zimarowski MA)
(Britton FL)(Gelfand NY)(Shaw PA)(Dolyak IA)(Shinn CA)(Vockerot
9610 1100 VLW9 Perth:Eng past 1500 fr-gd(Smith TN)(Cleveland CA)(Shinn CA
(Buehler MO)(Shaw PA)(Trzaskus IL)(Zimarowski MA)(Mappin WA)
(Forth IL) No Rosemary, its not had living in a P O Box.....
unless you have a whole lot of guests..... ..dj
9680 1305 VLH9:English w/ ABC news (555(wow) 8/13 Mappin WA)
11790 1350 RA:Eng mx pgm,1400 nx (333 9/4 Kelley FL)(433 DuRant THAILAND)
15160 0230 RA:Eng past 0530 noted by Woody Smith TN, and 20+ other DXers..
15320 0140 RA:Eng pgm of nx & mx heard by Joseph Smith NY, and 15+ more...
15355 0330 RA:Eng music & nx logged by Ron DiPrete RI,& many other SWL's..

NOTE: 12000 & 7500 are the Australian time station. Utility like WWV.dj

NEW CALEDONIA

3335 1035 R Noumea:Fr mx pgm w/anmts (232 8/18 Fay MA)
7170 0700 RN:Fr nx. QRM & QRN.(-2 8/13 Dawson CA)(0730* 444 Trubee HI)

NEW ZEALAND

9520 1000 RNZ:Eng past 1040(444 Shaw PA)(545 Leistners CA) CA)
9540 *0555 RNZ:Eng past 0715(545 Brown CA)(332 Snyder CA)(434 Stephenson
11705 0910 RNZ:English program of music (212 8/7 Trubee HI)
15110 2200 RNZ:Eng pgm of mx & features past 0545 in//17770 heard by DXers
Eugene Kelley FL &(Shaw PA)(Oliver NH)(Trautschold WI)(Bye PA)
(Britton FL)(Smith IN)(Cleveland CA)(Giannini IL)...& me.....

PAPUA/NEW GUINEA

3322½ 1015 R Bougainville:Pidgin tks & mx(232 9/11 Fay MA)(232 Snyder CA)
3245t 1145 R Kerema:lang w/local mx(222 8/22 Flynn CA)Ditto here.....dj
3360 1030 R Milne Bay:Pidgin tks & jazz mx, native mx(242 9/11 Fay MA)
3385 1030 R Rabual:Pidgin w/island mx & tks(344 9/6 Fay MA)(1338 C&W mx
343 8/21 Cleveland CA)(1246 YL DJ, nx. 333 'bleah' 9/5 Sheedy
CA)Dan, was that 'bleah' for the YL DJ, the reception quality,
or me? A 'bleah' is always poor to bad in quality. If you didn't
like the program you should turn down to 3290 kHz and listen to
TRISTAN DA CUNHA. Much better programming... ..Hi... ..dj
4890 0830 ABC Pt Moresby:Eng pgms past 1345 heard by Leo Zelasko Indiana &
(Forth IL)(Brooks GUAM)(Cleveland CA)(Dawson CA)(Lanoue MA)
(Leistners CA)(Buehler MO)(Nebron CA)(Eichenhorn MI)(Snyder CA)
(Fay MA) most report fair to good reception.....
9520 0645 ABC Port Moresby:English w/sports news(221 8/11 Eichenhorn MI)

SOLOMON ISLANDS

3995 1010 SIBS:Eng to 1115*(333 Fay MA)(332(tent)Brooks GUAM)





TAHITI

- 11825 0323 R Tahiti:Fr/Tahitian w/mx pgn(444 Smith TN) (0305 323 (//15170 exc) Hardester CA
- 15170 0230 RT:Fr/Tah to past 0520 w/good music heard by Ron DiPrete RI & (Mappin WA)(Leistners CA) (Kelley FL)(Smith NY)(Stephenson CA)(Shaw PA) (Cleveland CA)and in English at 1745 w/news (Snyder,Nebron,Brown CA)(Giannini IL) & ME...

A large THANKS to 53 reporters this month. Late loggings rec'd from Steven Handler, Dan Henderson & Allan Gaede. Best mail a day or so earlier next time fellows. The US Post Office is not always prompt. Mail arrives here in two days from Australia but takes up to 6 days from ECNA. Here are a few of the more interesting loggings that arrived to late to go in regular section.

- 4635 *0000 R Dushambe, Tadjik SSR(DH)
- 4656 0014 R Baku, Azerbaidjan SSR(DH)
- 9610 1030 ABC Perth, Eng SIO 555 (AG)
- 11620 2156 ATR India, Eng (SH)
- 11672 1952 R Pakistan, Eng (SH)
- 11740 2345 VOA Sri Lanka (AG)

DX TIP Bill Klett suggests the use of the NBS booklet on services of WWV/WWVH. Available from: Supt. of Documents, US Gov Printing Office, Washington DC 20402. Ask for Spec. Pub. 236, 1973 edition. Cost ¢45.

A / O N E W S C A N

HELP STAMP OUT RUMORS

Mike Hardester took the time to clear up a point raised by a ?DXer? in another club bulletin in regards to the VOA site in Honolulu. From a letter of 29 August 1973 from George Jacobs of the VOA: "In regards to the question concerning the former VOA Honolulu Relay Station, you are informed that VOA has completely dismantled the station, has no plans to reactivate it, and has disposed of the site." Thanks for the info Mike.....dj

PAKISTAN

Radio Pakistan has added a new slow-speed newscast in English, beamed to Western Europe. 1100-1115 @ 17915 & 15305. (BBC-MS)

INDONESIA

Having trouble writing reception reports in Indonesian? You might try English reports to these studios; Jakarta, Jayapura, Ambon, & Yoyakarta. They have recently verified English reports. Send return postage.....dj

A/O DX NEWS

My thanks to the interested DXers who took the time to remark on my 'opinions wanted' (cf Sept. issue). The comment from Woody Smith, Knoxville Tennessee is typical of replies rec'd. "I like A/O NEWSCAN and think that you should keep it. Your readers may not be supporting your feature because they don't have any news. A/O DX news doesn't grow on trees! That is one other reason why you should keep it. Readers who can't always listen to DX shows can look in A/O NEWSCAN." Thanks Woody. True, DX news doesn't grow on trees, but surely more than one SWler a month has news of interest. Remember, if you chance across an item of general interest, send it in. 'til next month....73 Don

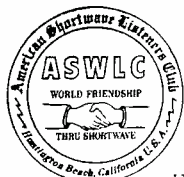

S C A D S



Last chance to register for the upcoming meeting of the SOUTHERN CALIFORNIA AREA DXERS to be held in Tustin, California the week-end of October 20 & 21. This meet is co-hosted by ASWLC & SPEEDX in the spirit of DX FRIENDSHIP, and all DX'ers are welcome, club member or not, novice or expert. If you have not contacted me yet, and would like to attend, drop a note to address below for full details, maps, ect. Don Johnson, P. O. Box E, Elsinore, CA 92330.

STATION SKEDS



Trans World Radio

EDITOR: Mark Koukol
1232 N. Eagle St.
Naperville, IL 60540

Times: G.M.T. Frequencies: kHz.

Deadline: 15th

Algeria: RTA Algiers noted on four frequencies simultaneously at 0000 s/off- 11715, 11965, 17790, 17825. S/on at 0600 noted on 9510, 11715, 11965. All in Arabic.(Richard Wood)

Austria: ORF has this English to N. A. sked:

0200-0400 6155
2300-0000 6155
2300-0400 9770 (Scott Brown)

Belgium: CRU has this Autumn sked of N.A. broadcasts:

French
2235-2255(daily) 9655
0020-0040(daily) 9655
2330-0000(Fri-Sat) 9655

Dutch
2215-2235 9655
0000-0020 9655

English
2255-2315 9655
0040-0100 9655

Portuguese
2330-2345 11920

Spanish
2345-0000 9655 (Arthur Getzel)

Ecuador: HCJB Quit0 in English to N.A. has moved from 11745 to 11740 in use 0000-0700, //15115 at 0000-0230 and 9560 0100-0700.(Richard Wood) HCJB'S DX Party Line has the following sked Mon-Thurs-Sat:

To North America
0230-0300(Mon 0300-0330) 11740,
9560

To South Pacific
0930-1000 11915, 9745, 6130

To Europe
1930-2000 17755, 15300
(Denise Yaney)

Ethiopia: ETLF sends this English sked valid to November 3:

To East Africa
0400-0425 7165
1755-1810 9705

To West Africa
0530-0610 11890
1930-2015 11810

To Sri Lanka
1255-1325 15320

To N. India
1330-1345 11945

To S. India
1330-1400 15400

To Ethiopia
1655-1710 60650

To S. Africa
1830-1910 7255 (Louis Buehler)

Dominican Rep.: Radio-TV Dominicana has returned from drifts to nominal 5970, noted 0100.(R. Wood)

Finland: Radio Finland has this Eng-

lish sked to N.A. until Nov. 4:

1400-1430 15185
2300-2330 15185

0300-0330 9585 (Scott Brown)
France: ORTF skeds English to Africa at 0515-0545 on 17730, 17720, 15290, 15150, 11730, 9710, 9680, 7130, and 6030. Also 1030-1115 on 21580, 17720, 17730, 15290, and 15150.(Ronald Warren)

Gabon: The sked of these French xmtrs comes from a recent QSL-

Lioreville
0430-0630 4777
0630-1630 7270
1630-2300 4777

Franceville
0530-0800 4830
1130-1500 6030
1800-2300 4830 (James Maher)

Germany,D.R.: English N.A. service of RBI effective Sept. 2-

To East Coast
0100-0145 9730, 11890

To West Coast
0330-0415 6080, 9650, 9725

To East Coast(sorry)
0230-0315 9730, 11890 (R. Wood)

Germany, F.R.: Deutsche Welle has this N.A. English sked from Sept.2-

To East Coast
0130-0250 6010, 6040, 6075, 9545,
9690

To West Coast
0435-0555 6010, 6085, 6145, 9545,
9605, 9765(Henry DuRant)

Great Britain: In a surprise move BBC has reversed its two 49-mtr xmtrs beamed to Americas. 6110, for-

merly English to N.A., is now Spanish to L.A. 0015-0415. English is

now on 5975 2115-0415. 11780 now s/off at 0030.(Richard Wood)

Guinea: Conakry 15310 listed in WRTH as s/off 1600 is noted in French at 1730. Some programming also noted on 9650 at 0500.(Richard Wood)

Hungary: Radio Budapest's DX program is aired to:

North America
0245-0300 15155, 11910, 9825,
7220, 6165

Israel: IBA has replaced 12045 in all of its xmns(except Russian at 0345-0412) with 9625.(direct) IBA

English at 2000 on 15165 has not been heard recently; instead, Denmark noted at 2000 s/on in Danish.

(Bill Klett)

Japan: Radio Japan broadcasts to N.A. in English at 2345-0045 on 15445, 11725. And in Japanese, English, &

Spanish at 0100-0300 on 15235, 17725, 17825, 17745. (H. DuRant)
Malagasy: Radio Madagasikara has this sked Mon-Fri:
 Malagasy
 0230-0500 3232, 4985, 6134, 7155
 0505-1100 4985, 6134, 7155, 9690
 1435-1930 4985, 6134, 3232, 7155
 French
 0300-0500 3288, 7105, 6170
 0900-1100 6170, 7105, 9515
 1600-1900 3288, 6170, 7105
 English-French
 1500-1600 3288, 6170, 7105, 17730 (1/840)

Sundays there are 3 xmsns:
 Malagasy
 0300-0500 3232, 4985, 6134, 7155
 0530-1430 4985, 6134, 7155, 9690
 French
 0500-1430 6170, 7105, 9515

(James Maher)
Mexico: XEWW Mexico City 19 mtr xmtr is regularly active during day only. Noted on both 15160 (apparently weekdays) and 15176 (weekends?) around 1500-1800. 9515 also noted 1400. (Richard Wood)

Morocco: RTM Rabat was noted in Arabic on 15360 at 1730; s/on 0500 on 6190 noted daily. (Richard Wood)
Neth. Antilles: TWR has this English sked:
 To Far East (heard in N.A.)
 0030-0130 11815
 1105-1245 11815- To N. A. (Scott Brown)

Nigeria: NBC English External Service has made several freq. changes for its 0530-0730 time-slot. Now on 7275, 11925, 15120, and 15185. (HCJB)

Portugal: EN Lisbon on 15340, not scheduled to xmt 1330-1715, is noted throughout this segment. Also, Spanish to L.A. 0100-0145 is now on 11840, 15295, 15315, and 15340. (Richard Wood)

South Africa: Radio RSA has this English sked to N.A. effective thru October:
 2215-2315 11970, 9695
 2326-0242 11970,, 9695,, 9585, 6035 (Henry DuRant)

R. RSA will have this English sked in effect Nov.'73-Feb'74:
 To Africa & Middle East
 0515-0613 15220, 11970
 1056-1200 25790, 21535, 15220, 11900
 1300-1550 as above
 1556-1650 17780, 11900
 1856-1950 11970, 15153
 To Europe
 1756-1850 17885, 15155
 To North America
 2230-0242 11970, 11900, 9695, 9585
 To New Zealand
 0756-0850 15220, 21545, 17805

To Australia
 0856-0950 15220, 21545, 17805 (Louis Buehler)
Sweden: Radio Sweden has this English sked for Sept 2-Nov. 4:

To Europe
 1100-1130 9630
 1230-1300 9630
 1600-1630 6065
 2045-2115 6065
 To Africa
 1100-1130 21690
 1830-1900 15240
 To Far East
 1230-1300 15105
 2045-2115 9715

To East North America
 1400-1430 17815
 0030-0100 9665
 0200-0230 9665

To South Asia
 1400-1430 17770
 0515-0545 17840
 To Middle East
 1600-1630 11930
 1830-1900 11705
 West North America
 0330-0400 6045

To Australia, New Zealand
 0515-0545 11840 (direct)

Swaziland: Frans World Radio relay here will be installing a 35 kW SW xmtr soon. (HCJB)
Togo: Radio Togo is building 3 SW xmtrs to serve Northern Togo. They will operate on 3222 (Morn & Eve, 50 kW), 6155 (all day, 10 kW), and 11960 (afternoon, 50 kW). Test xmsns are expected to start this November. (HCJB)

U.S.A.: Organization of American states announces regular xmsns in French, Spanish, Portuguese, and English daily 2345-0000 on 11740 and 15160. (Richard Wood)

A special thanks to new reporters William Klett, Ronald Warren, and Evelyn Dolyak. Please keep your reports coming.

Note: Please remember to put your name and state on every item you send in, so they can be more easily credited.

At present I am residing at Northern Illinois University in De Kalb. My SX-130 is a bit sluggish on a 20 foot longwire bent at 90 degree angles, but they don't make worms very big. My mail is forwarded from Naperville so don't worry about an address change for your reports.

73s in 1973, Mark Kukul

Utility Chaser's Corner

	ITALCABLE ROMA BELL SYSTEM USA STRATCOM	PAUL MAYO 41 GLEELAND STREET DEER PARK, NEW YORK 11729 DEADLINE: 15TH OF THE MONTH
ISRAEL NAVAL STATION 4XZ KDD		

NOTE: The change in our address and in the deadline date. I anticipate another move around the 1st of the year and will keep you informed of any changes

North & Central America

<u>BAHAMAS:</u>	396	ZBB, Bimini beacon w/mkr @ 0228-A2	(Burton)
<u>BARBADOS:</u>	12709.5	8PO, Bridgetown Rad w/mkr @ 0157-CW	(Burton)
<u>BERMUDA:</u>	9907.5	ZFD44, C&W, St Georges w/Eng-YL/Vm @ 0650-SSB @ 0145-RCSSB (Smith)	(Handler)
	10385	ZFD48, C&W, St Georges w/Eng-YL/Vm @ 0119-SSB	(Handler)
	14360	ZFD68, C&W, St Georges w/Eng-YL/Vm @ 2247-SSB	(Greenall)
	17695	ZFD82, C&W, St Georges w/Eng-YL/Vm @ 1553-SSB	(Simon)
<u>CANADA:</u>	2182	VBB, Sault St Marie w/ld & no tfc @ 0130-AM	(Greenall)
	7335	CHU, Ont w/time in Fr & Eng @ 1923-AM	(Dolyak)
	8708.6	VCS, Halifax Rad w/V mkr @ 0130-CW	(Hardester)
	8722	VAL, Vancouver w/V mkr @ 0150-CW	(Hardester)
	9375a	COTC, Drummondville w/Eng-OM/Vm @ 2053-SSB	(Handler)
	10580	COTC, Drummondville w/Eng-OM/Vm @ 1615-SSB	(Handler)
	11209	CHR, Trenton Mil (CAF) w/VXA @ 0848-A2	(Burton)
<u>CANAL ZONE:</u>	10515	NBA, Balboa clg LOL @ 2219-CW	(Burton)
<u>COSTA RICA:</u>	17620	TI, RCGR, San Jose w/RT tfc @ 0507-LSB	(Dawson)
<u>CUBA:</u>	14770	CML56, IRTS, Bauta w/Eng/Sp-YL/Vm @ 1520-SSB	(Testa)
	16010a	IRTS, Habana w/Eng/Sp-YL/Vm @ 1330-SSB	(Handler)
<u>GREENLAND:</u>	8967	Thule AFB w/Foxrot bc @ 0409-USB	(Greenall)
<u>GUATEMALA:</u>	1613	RAB, Rabinal w/weak id mkr @ 0445-A2	(Greenall)
<u>HONDURAS BR:</u>	10700	ZIK48, C&W, Belize w/Eng-OM/Vm @ 1319-SSB	(Handler)
<u>JAMAICA:</u>	9396	6YR42, JIT, Kingston w/Eng/Vm @ 0515-SSB	(Kamber)
<u>MEXICO:</u>	20150	XDD276, PTT, Mexico City w/Eng/Sp-YL/Vm @ 1704-SSB	(Greenall)
<u>PANAMA:</u>	17682.5	HOD72, TRT, Panama City w/tfc @ 0146-SSB	(Dawson)
<u>PUERTO RICO:</u>	5692	USCG AS, San Juan w/1491 @ 2346-USB gd	(Simon)
<u>UNITED STATES:</u>	212	"MPZ", Mt Pleasant, IOWA beacon @ 1054-A2	(Holbrook)
	232	"MX", Andrews AFB, Md beacon @ 1134-A2	(Holbrook)
	251	"NRB", Mayport FLA Naval beacon @ 1015-A2	(Holbrook)
	299	"HKA", Blytheville, ARK beacon @ 0346-A2	(Holbrook)
	325a	"RUV", Bellfontaine, OH beacon @ 0230-A2	(Burton)
	341	"CCJ", Clark County ? beacon @ 0236-A2	(Burton)
	344	"CLE", Cleveland, OH beacon @ 0235-A2	(Burton)
	360	"RW", Andrews AFB beacon @ 1131-A2	(Holbrook)
	410	"MPJ", Morrilton, ARK air beacon @ 0948-A2	(Holbrook)
	385	"GAI", Gaithersburg, MD beacon @ 1252-A2	(Holbrook)
	415a	CS, QTH? beacon @ 0227-A2	(Burton)
	2506	KFH, S, Francisco Rad w/tfc @ 0332-AM	(Dawson)
	2566	KOU, San Pedro w/tfc @ 0340-AM	(Dawson)
	2980	Oakland Rad w/wx @ 0706-AM	(Dawson)
	5692	USCG AS, Detroit, MI w/CG45 @ 0012-USB	(Greenall)
	5692	USCG AS, New Orleans, LA w/1477 @ 2329-USB gd	(Simon)
	5692	USCG AS, Savannah, GA w/1464 @ 2355-USB vry gd	(Simon)
	5696	NO, USCG AS, Cape Cod, MA w/1438 @ 0128-USB	(Greenall)
	5696	NOZ, USCG AS, Elizabeth, NJ w/1347 @ 0100-USB	(Greenall)
	5696	NOT, USCG AS, Traverse City, MI w/1366 @ 0129-USB	(Greenall)
	5696	USCG AS, Houston, TX w/1397 @ 0538-USB fair	(Simon)
	5696	NOM, USCG AS, Miami, FLA w/N, Orleans AS @ 0532-USB	(Simon)
	5696	USCG AS, S, Francisco, CA w/7213 @ 0329-USB gd	(Simon)
	6920	WIA36, ATT, Ft Lauderdale, FL w/Eng-OM/Vm @ 0122-SSB	(Greenall)
	7555	WEA67, ATT, NY w/Eng-OM/Vm @ 0355-LSB @ 0335-LSB (Warren)	(Dawson)
	8590	KOK, Los Angeles, CA w/ld mkr @ 0030-CW	(Hardester)
	8755	WOO, New York w/Eng tfc @ 0530-SSB	(Warren)
	13200a	USCG San Francisco w/wx @ 1610-SSB	(Handler)
	13915	WES43, RCA, Rocky Pt NY w/Eng-OM/Vm @ 2350-AM then into feed of Yankee Tigers game at 0000	(Greenall)

South America

BRAZIL: 13440 PPX, EMBRATEL, Rio w/Eng/Pt-YL/Vm @ 0411-SSB (Testa)
CHILE: 4250a CCM, Punta Arenas w/V mkr @ 1025-CW fair (Greenall)
COLOMBIA: 1690 MDE, Medellin w/id mkr @ 0440-A2 fair (Greenall)
GUYANA: 10528 8RB47, C&W, Georgetown w/Eng-OM/Vm @ 0342-SSB (Testa)
 @ 0515-SSB (Warren) @ 0650-SSB (Gavaras)
 15645.2m C&W Ltd, Georgetown w/Eng-OM/Vm @ 2220-USB (Hardester)
PARAGUAY: 18512 ANTELCO, Asuncion w/Sp-YL/Vm @ 1400-SSB (ZP26) (Greenall)
URUGUAY: 10770 CXL24, PTT, Montevideo w/Sp-YL time/Vm @ 0539-SSB (Handler)

Europe

BULGARIA: 8563 LZL4, Burgas w/id mkr @ 2135-CW good (Greenall)
GERMANY, FR: 8670.5 DFS, Bonames w/V mkr @ 0820-CW (Hardester)
 8650a DHJ59, Wilhelmshaven Harbor w/V mkr @ 2240-CW weak
 (Greenall)
 11039 DDJ9, Bonames w/V mkr @ 1818-CW fair (Greenall)
ICELAND: 12175 TFJ, Reykjavik Rad w/Eng-OM/Vm @ 1505-AM (Handler)
IRELAND: 13112 EIP, Shannon Aer w/wx @ 2115-AM (Greenall)
NETHERLANDS: 10735 PCL50, PTT, Kootwijk w/Eng-OM/Vm @ 0645-SSB (Dawson)
PORTUGAL: 5015 CTV25, Monsanto Rad clg CTAB @ 2204-CW gd (Greenall)
RSPSR EUR: 10670 HZA26, PTT, Moscow w/Eng-YL/Vm @ 0430-USB (Simon)
 @ 0454-SSB (Gavaras)
SPAIN: 14985 CTNE, Pozuelo del Rey, w/MM @ 2355-AM (Handler)

Africa

ANGOLA: 11000 CQX36, CPRM, Luanda w/Pt-OM/Vm @ 0045-SSB pr (Greenall)
ASCENSION I: 9885 ZBI43, C&W w/Eng-OM/Vm @ 2110-LSB good (Simon)
CAMEROON: 12015 TJF20, ITC, Douala w/Fr tfc @ 0745-LSB (Dawson)
CONGO: 15745 TNH58, Office of Telecom, Brazzaville w/Eng/Fr-OM/Vm
 @ 2105-SSB good (Greenall)
 6617 Brazzaville Volmet w/Fr wx @ 0522-AM (Handler)
ETHIOPIA: 11945 NKA, Asmara (USN) w/Eng-OM/Vm @ 2230-SSB (Greenall)
LIBERIA: 20112 KKN44, Monrovia w/QRA mkr @ 2140-CW (Greenall)
MADEIRA: 8460a CUB, Funchal w/Cw mkr @ 2155-CW (Greenall)
UPPER VOLTA: 5813 XTA58, FCR, Ouagadougou w/Eng/Fr-YL/Vm @ 0300-RCSSB (Greenall)
 14921 XTA49, FCR same @ 2239-RCSSB good (Greenall)
 18090 XTA80, FCR same @ 1742-RCSSB fair (Greenall)

Asia

CHINA PR: 7564a Shanghai RT, Techs estb circuits @ 1358-SSB (Dawson)
IRAQ: 18900 YIG87, PTT, Baghdad w/Eng/Arab-YL/Vm @ 1403-SSB (Greenall)
LEBANON: 19920 ODR92, PTT, Beirut w/Fr-OM/Vm @ 1425-SSB (Greenall)
MALAYSIA: 5087(5095L)MTA, Kuala Lumpur w/Eng-OM/Vm @ 1330-LSB (Sheedy)
PAKISTAN: 8480a AQP1/2/3/4, (QTH?) w/V mkr @ 2145-CW pr (Greenall)
SAUDI ARABIA: 8480 HZY, Tannurah w/C: mkr @ 0048-CW weak (Greenall)
SRI LANKA: 10485 4Q047, OTS, Colombo w/Eng-OM/Vm @ 0110-USB (Simon)
TIMOR: 6893 XXI30, Baucau w/V mkr @ 2255-CW weak (Greenall)

Oceania

AUSTRALIA: 7500 VNG, Lyndhurst w/time pips @ 0745-AM (Handler)
 10017 Sydney Volmet w/wx @ 0502-AM (Dawson)
MARCUS IS: 11606 NRW6, USCG LORSTA w/Saipan Loran @ 1418-USB (Simon)
NEW CALEDONIA: 9290 FUJ, Noumea (Fr Navy) w/V mkr @ 1005-CW fair (Greenall)
NEW ZEALAND: 7820 ZLZ5, NZPO, Himatangi w/Eng-OM/Vm @ MM @ 0628-SSB (Warren)
 8770.4 ZLW, Wellington Rad w/Eng-OM/Vm @ MM @ 1115-USB (Hardester)
 11000 ZLX20, NZPO, Himatangi w/Eng-OM/Vm @ MM @ 0541-SSB (Handler)
TAHITI: 11665 FZP6, FTS, Papeete w/Fr-YL/Vm @ 0523-SSB (Handler)
 @ 0435-USB (Warren) w/tfc @ 0630-SSB (Dawson)
 19305 FZP93, FTS, Papeete w/Eng-YL/Vm @ 1841-SSB (Greenall)

 Thanks to this months 16 contributors. Welcome first-timers Arch Dawson,
 Dan Sheedy and Woody Smith!

By the time you read this, the World Utility DX Handbook should have been
 published. Steve and myself would appreciate your comments and corrections/
 additions.

til next month

73s

Paul
 Paul

UTILITY QSL REPORT

Deadline: 13th of the month

Steven J. Handler
1270 Carol Lane
Deerfield, IL. 60015

BELGIUM: OSU OOSTENDE RADIO 13189.5 kc/s sent B&w card full data for EE rpt & IRC's. (Koret)

BRAZIL: EMBRATEL Rio de Janeiro 13440 kc/s sent PFC w/all data in 6 weeks for an EE rpt and IRCs. (Koret) 11670 using their own card in 4 weeks for an EE rpt and 3 IRC's. Card has a photo of the Tangua Earth Station. VS: Edison Soffiatti. (Warren)

CANADA: COTC CGBZ 10520 Drummondville sent full data personal letter in 10 days for EE rpt and ms. (Straumanis) COTC CGBZ 10520 Drummondville sent letter in 1 1/2 weeks for ms. power 30kw, vs: R.B.Millar. (Forth) VCS-HALIFAX sent full data PFC for rpt of 2182. 22 days for EE rpt and IRC (Koret)

FRANCE: St. Lys Radio 12912 returned french PFC w/full data for FF rpt and ms. Rply Air in 12 days. (Straumanis)

FRENCH GUIANA: FKL35 6816 kc/s French Telecommunications Service Cayenne sent a form letter with no definite verification statement. 14 days air for FF rpt and 1 IRC. (Straumanis)

MOROCCO: RADIO ELECTRICAL CENTRE (PTT) Rabat CNR28 13965 20 kw FF letter w/freq. only in 27 days for 3 IRC's and EE rpt. VS:Mouhcine (Simon)

POLAND: Gdynia Radio 13141.9 PFC from PTT in Warsaw. Full QSL in 35 days for EE rpt and IRCs. (Koret)

SENEGAL: TELESENEGAL 6VK217 17610 French letter w/incorrect frequency as 20327.5 khz. (7VK221) 20 kw also no time or date. I guess they don't check their logs that well, in 26 days for French rpt and 2 IRC's. (Simon) I know what you mean about not checking reports. However in your case it could be they sent you someone elses QSL? That happened to me with the PTT in Liberia. The sent me some guy in West Germany's QSL. I sent it on to him. About a week later I received my QSL from a guy in California who had gotten it by mistake. If you ever do get a QSL that is not yours, please be good enough to forward it on to the owner. Many times after addressing the envelopes, stations line them up to put in the letters. More often than not, this involves several people having their QSLs put into the wrong envelope.

SPAIN: I sent a rept to CTNE in Madrid for one of the FTP stations on 14.9 MHz.

In 3 weeks I got a QSL for their Coastal Station on 13,17, and 22 MHz. This may be an indication that they do not read their mail to well, or that my Spanish is pretty bad. In any case, if this type of thing happens to you, all you can do is send a follow up.

TAHITI: FTS-Papeete FZ099 9928 French no data ltr from Paris but rpted to Tahiti. 25 days for 3 returned IRC's and a FF rpt.

WEST GERMANY: Lahr Military 5690 reject ltr from Lt. Col. Belliveau saying that

"It is not the Canadian Forces policy to either acknowledge or deny xmsns made on military nets. Therefore we are unable to comply with your request of 13 July 1973." Is this a New Policy?(Koret) Lahr Military Canadian Forces Europe sent a personal letter saying they can't veri due to regulations. PFC and SASE sent and returned. VS: R.A.Sieffert. How did you get it verified(Simon). I guess I got lucky? My QSL letter is dated April 26, 1973. It say's- "Your letter of March 16 is acknowledged. The Lahr station on the Canadian Military Aeronautical Communications Service provides communications for Canadian Forces aircraft to or from Europe. Being a military unit we are unable to impart any classified information, however, our international Call Sign is DHM 95 and our voice call sign is Lahr Military/ We broadcast weather information on a schedule on the hour plus 16 minutes, for Lahr, Soellingen, Dusseldorf and Stuttgart, followed by terminal forecasts for these locations. We confirm that we commenced our broadcast at 0616 on March 16th on 5690 upper side band. Thank you for your evaluation of our signals. Your reply coupon was not required, and is returned, Signed-T.R.Barber, Captain, for the commander Canadian Forces, Europe." Since I sent them a report for their 0616 wx forecast, the Captain QSLed it as it could hardly be called a classified broadcast. However even my QSL is not as "Tightly worded", as I would like. I wrote to them using a West German address-Lahr Military, Canadian Forces Station, Commanding Officer, Canadian Forces Europe, Lahr, West Germany. However they QSLed via CFPO 5000 via Belleville, Ontario, Canada. If you tried the CFPO try direct or visa versa. Also try addressing it directly to Captain T.R. Barber.

As long as I am answering questions, I get about 10 requests a month for addresses of stations. I don't mind answer them, however, you may have to wait a week or so for my answer. However, I would suggest that you purchase the new **WORLD UTILITY DXER'S HANDBOOK**. It is available from Jack White, 780 NW Wallula, Gresham, OR. 97030. The price for Speedx full members is only \$6.95 (\$7.95 for others). The Handbook is over 200 pages and contains over 100 pages of individual station data, listing alphabetically by country, the addresses, QSL policy, operating frequency and other information on literally thousands of utility stations throughout the world. Also, remember the advise of the Sage of Utility DXing, when you don't have an address of a station and are in doubt, make one up., something is better than nothing.

Back to Utility QSLs. Once again the US loggings dar outnumber the others so I have changed the US logging format- all QSLs listed below are USA.

WWV-National Bureau of Standards 10000kc/s 13 days for no rp. (Straumanis)
NOS-USCG Air Stn Cape Cod 5696 SSB 100 watts PFC 9 days for SASE (Simon)
NOI-USCG Air Stn Detroit 5692 400 watts PFC 15 days for SASE. (Simon)
NMF14-USCG Radio Station-Sturgeon Bay, WI 2670 25 watts PFC 6 days (Straumanis)
NMB-USCG Air Stn-Savannah 5692 150 watts PFC 11 days for SASE (Simon)
NOT-USCG Air Stn-Traverse City, MI 5696 125 watts PFC in 7 days for SASE (Simon)
NOP-USCG Air Stn-Brooklyn 5692 100 watts PFC 7 days for SASE (Simon)
NOZ-USCG Air Stn-Elizabeth City 5696 400 watts PFC in 13 days for SASE (Simon)
NOH-USCG Air Stn-Chicago 5692 100 watts PFC 11 days for SASE (Simon)
NOY-USCG Radio Stn-Galveston 2670 PFC & personal ltr 32 days (Straumanis)
NMK-USCG Air Stn Cape May, NJ 5692 30 watts full data PFC 5 days for SASE (Simon)
NMF21-CG Castle Hill, RI 2694 PFC full data 10 days (Koret)
NMX-USCG Port Safety (Baltimore) 2670 PFC full data 12 days (Koret)
NMH-Washington CG AIR 5697.5 kc/s PFC w/full data 10 days for ms (Koret)
NOT-USCG Air Stn Traverse City, MI 5696 PFC full data 11 days for ms (Koret)
MAE-Norfolk Marine Operator 2538 PFC w/full data 30 days for ms (Koret)
NMD2-CG Rochester 2670 PFC w/full data 6 days for ms (Koret)
NMK-CG Air Stn Cape May 5692 PFC full data for ms in 8 days (Koret)
KOK-ITT Coastal Radio Stn-Los Angeles 17064.8 PFC in 17 days (Straumanis)
NOB-USCG Air Stn-San Francisco 5696 SSB 1kw full data PDC 15 days after followup total days 56. (Griffith)
NOP-CGAS Brooklyn 5692 SSB 100 watts full data PFC in 6 days for ms (Griffith)
NMF17-St Ignace CG 5696 PFC w/full data 11 days for ms (Koret)
NOM-Miami Air Stn CG 5696 PFC w/full data in 14 days for ms (Koret)
NOQ-Mobile Air Stn CG 5696 PFC with full data and personal ltr in 10 days for ms (Koret)
NOZ-Elizabeth City Air Stn CG 5696 PFC w/full data 10 days for SASE (Koret)
NOP-Brooklyn CG Air Stn 5692 PFC w/full data 10 days for ms (Koret)
RCA Global Communications long card full data varie 16015 in 17 days for ms (Koret)
NMY-Moriches CG 2182 PFC w/full data in 12 days for ms (Koret)
NOH-Chicago CG Air Stn 5692 PFC with full data in 15 days for ms (Koret)
NMN11-Stillpond, MD CG 2670 w/full data PFC less freq and power for ms (Koret)
WAX-Tropical Radio Telegraph Co., Ojus, FL. 8526 with blue TRT card with date & freq. - only and no definite veri stnt. VS: Robert L. Klein. 6 days for ms (Straumanis)
KLB-ITT Marysville, WA 6411 returned PFC in 12 days for 1 IRC (Unknown)
WCC-RCA N. Catham, Mass. 8630 letter w/full data in 17 days for a dime (Unknown)
WWD-Bureau of Fisheries, La Jolla, CA 17408.6 kc/s sent PFC in 20 days for SASE (Unknown)
KLB-ITT Marysville, WA 17007.2 sent PFC in 7 days (Straumanis)
BRA-Broad River, NC Beacon 379 PFC full data 6 days (Peters)
PSK-Ft. Scott, KS Beacon 379 PFC full data 6 days (Peters)
SD-Standiford Field, Louisville, KY Beacon 359 full data 8 days (Peters)
TY-Pounds Field, Tyler, TX Beacon 320 PFC full data 8 days (Peters)
PETERSON RADIO-USAF Colorado Spgs, CO. 13247 PFC full data 3 weeks (Peters)
CH-Charleston AFB/Municipal Apt, Charleston, SC 329 Beacon PFC 8 days. (Peters)
KMI-ATT Oakland 1732k.5 kc/s standard ATT card in 1½ weeks for ms (Forth)
NRW1-Sitkinak Loran USCG 6945 SSB 750 watts PFC full data 14 days after followup total 60 days. (Griffith)
DFI-Defiance Ohio Beacon 246 PFC full data 4 days (Peters)
NSS-US Naval Communications Station, Washington 5870 full data blue/gold card 8 days for ms (Fisher)
LORING AERADIO-USAF 8989 kc/s SSB 4kw full data PFC 81 days for ms (Griffith)
NAH-US Navy, Norfolk, VA 12135 sent PFC & mimeo ltr with no data in 32 days for no rp. (Witkins)

WPA- 6455 personal letter w/date and trans. info in 2 weeks for ms and address label which was used. (d'Adolf)
KOK- 17064.8 sent personal ltr with full data on IIT stationary for ms and address label from T.W. Hennessy in 1 month air. (d'Adolf)
WNH- 8686 personal letter not mentioning reported data but giving station details in 7 days for ms (d'Adolf)
WCE- 17160.8 personal ltr with full facts and data 2Kw for ms (d'Adolf)
WOB-Lantana Radio, Florida 12970.5 full data personal ltr 10 days via surface for ms (Straumanis)
WCC-Catham Radio 6376 sent personal ltr with date only in 6 days for ms (Straumanis)
WCC-Catham Radio 8586 sent personal ltr with full data in 7 days for ms (Fisher)
NCS-CGAS Cape Cod 5696 SSB 100 watts full data PFC 7 days for ms (Griffith)
NOI-CGAS Detroit 11201 SSB 100 watts full data PFC 42 days (Griffith)
NMC-USCG San Francisco 5696 SSB 3kw full data PFC in 17 days for ms (Griffith)
NMF-USCG Boston 8984 SSB 10kw full data PFC in 21 days for ms returned (Griffith)
NMG-USCG New Orleans 8984 SSB 8kw full data PFC in 10 days for ms (Griffith)
NMA-Miami Radio CG 5696 SSB 1kw sent typed post card full data less time for ms and followup. 49 days (Griffith)
NMN12-USCG Cape Lookout 2670 16 days for PFC & SASE (Koret)
NMN75-USCG Taylors Island, MD 2702 17 days for PFC & SASE (Koret)
NMY51-USCG Rockaway 2670 14 days for PFC & SASE (Koret)
NMD15-USCG Marblehead, OH 2670 9 days for PFC & SASE (Koret)
ELM-Chemung County Airport-Elmira, NY 375 beacon PFC 9 days (Peters)
OM-Epply Airfield, Omaha, NB 320 beacon PFC 12 days (Peters)
OK-Will Rogers Field, Oklahoma City, OK 406 beacon PFC 4 weeks (Peters)
AI-Niagra Falls Int'l Airport, NY 329 beacon PFC full data 7 days (Peters)
LI-Adams Field-Little Rock, Ark. beacon 353 PFC full data 9 days (Peters)
AAF-APA Lachicola, FL beacon 410 sent PFC full data 12 days (Peters)
NMF-Boston 8728 sent PFC and booklet of the International Ice Patrol in 14 days for no rp. (Witkins)
NWH-Washington Radio 11201 SSB 100 watts full data PFC in 8 days for ms (Griffith)
NMY53-USCG Shark River 2670 12 days for PFC and SASE (Koret)
NMY33-USCG Annapolis 2670 8 days for PFC and SASE (Koret)
NMQ27-CGAS Los Angeles 5692 SSB 400 watts full data PFC in 9 days for ms (Griffith)

At last I am caught up, all reports to date have been used. I even have some room left for a few brief addresses-

Telesenegal
 B.P. 69
 Dakar, Senegal

Commanding Officer
 US Coast Guard Air Station
 Selfridge Ang, MI 48045

US Coast Guard
 Air Station Savannah
 Hunter AFB
 Savannah, GA

US Coast Guard
 Air Station Cape May
 Cape May, NJ 08212

Sydney Volmet
 Commonwealth of Australia
 Dept. of Civil Aviation
 Box 211
 Mascott, NSW 2020, Australia

Empresa Nacional de Telecom.
 Casilla 4450
 La Paz, Bolivia

Directorate General
 of Posts & Tele-
 communications
 37 Kebon Sirih St.
 Djakarta, Rep. of
 Indonesia

Once again QSL will be using ALL reports each month. Keep them coming. Also any news about the stations can and will be used, so if you have any new info, send it on in. The winter DX season will be here soon, so good luck, and

SECTION

L



DOUG SNYDER
3130 WOODMONT DRIVE
SAN JOSE, CALIF.
95118

DEADLINE: OCTOBER 15th

NEWS

A rather long news section this month, but well worth it ... I have received a copy of Chris's Sept. column and herewith include some of his closing remarks; With this edition of the SPEEDX QSL Section, I round out my career as a column editor, at least for the time being that is. I would like to thank all those who helped get me on my way and encouraged me when things looked gloomy. Special thanks should go to people like Art Glover, the late Don Billingsley, Mike Macken, Steve d'Adolf, Jim Whitehead, and Frank Testa (and his meatballs, hi!) not to mention many other people. For those who want to keep in touch, my new school address is: Box 1614C, 700 Commonwealth Ave., Boston, Mass. 02215. The telephone no. is (617)353-8689."

In adding my remarks, I would like to thank Chris for a job well done and I know that everybody in SPEEDX wishes you all the best and thanks you for your dedicated contribution to SPEEDX and to the hobby.

I only hope I can carry on the column as well as Chris, so I am asking for support from all you super SPEEDX'ers, and the best support you can give is to send those QSL reports in. But please don't hold back in writing to me with your comments, suggestions, criticisms, or nifty little pieces of information that you come across concerning QSL's. All will be welcome! And I sure appreciate the use of those QSL report forms that are available from headquarters for just a SASE.

Enough chitchat. Not being as adept as Chris in picking out rare or unusual QSL's, I'll make a stab at it as well as include some from his Sep. list. Starting in Europe, there is Mike Wiseberg's reply from Radiostantsia Rodina, and Al Sizer's great catches from Radio Baku in the Azerbaidjan SSR and Radio Riga in Latvia. On the African scene, Alan Mayer received his reply from the ORF-St. Denis station at Reunion and Ron Lanoue received his card from Radiodiffusion Television Tunisienne. In Asia, several of the regional stations in Indonesia have started replying and in Central America, Radio Lux, Honduras, replied to Gregg Calkin.

EUROPE

ALBANIA: Radio Tirana, 6200, full data folding card w/picture of building on the front, sea mail in 100 days for 2 IRC's and report in EE. (Kamber)

AUSTRIA: ORF, Aldrans, 6000, full data color card of the Tirol; 2 months airmail for 2 IRC's; also received packet of info on ORF. (Calkin)

ORF, 9770, full data, full color "Haydn's Home" card by air in 47 days for 3 IRC's. (Bye)

Azerbaidjan SSR: Radio Baku, 9840, responded direct w/all data; Farsi form in 4 months by registered mail. Used Radio Moscow format and QSL'ed pgm's beamed to Iran and Arabic countries. No RP. (Sizer)

BELGIUM: Radio-TV Belge (ORU), 9655, Map card and schedule, 55 days for 3 IRC's (Trzaskus); Map card and script, 27 days using RTB rpt. form, No RP. (Straumanis) Full data Map card, 1 month air, no RP (Eichenhorn) Map card and returned report, 25 days by air, English rpt, no RP (Flynn) RTB, 15235, same map card, no time or signature, 24 days air, 3 IRC's (Bye)

BULGARIA: Radio Sofia, 9700, Climent of Ohrid University card (first in series of six), 145 days by sea for 3 IRC's and EE report (Cleveland)

CZECHOSLOVAKIA: Radio Prague, 7345, Blue buildings card in 25 days for English report and no RP. (Vockeroth) Radio Prague, 11990, 50 years of broadcasting in Czech. card and gold medal w/blue writing and white.

(Vockeroth) real gold? I'll send for one too! -ds-

FINLAND: Radio Finland, 15185, Summer In Finland card, plus letter and antenna folder in 2 months by air for English rpt and no RP. (Miller) Full data Summer In Finland card along w/sked and sheet on Pori Xntr, plus SW receiving techniques in 15 days air for no RP. (Straumanis) Summer In Finland card plus schedule and pennant in 18 days air for 1 IRC. (Brown)

FRANCE: ORTF, Paris, 9680, ORTF Building card in 35 days airmail for EE report and 1 IRC. (Kelley)

ORTF, Paris, 15120, orange card showing various ORTF photos and Fr. schedule in 41 days for French report and 3 IRC's. (Trzaskus)

ORTF, Paris, 15135, ORTF Building card in 77 days sea for English

report and 2 IRC's. (Kamber)

GERMANY (Dem Rep): Radio Berlin International, 7260, full data photo card of Rostock, 66 days seamaill, no RP, rpt'd in German (Schwartz)

RBI, 9730, photo card of Rostock, 75 days surface for EE rpt and no RP. (Buehler) Goethe picture card, #3 of DDR Series, 3 months by air for EE rpt and no RP. (Eichenhorn)

RBI, 11840, #6 of DDR series, Humboldt University; in 76 days by air for EE rpt and 2 IRC's (Cleveland)

RBI, 11890, World Festival card, 63 days, no RP. (Yaney) Full data card #1 in DDR series in 10 days by air for EE rpt and no RP. (Eichenhorn) World Festival card; full data, 10 days for EE rpt and no RP. (Eichenhorn) Full data Rostock card, 75 days by air for 2 IRC's and EE rpt. Also sent RBI Journal (Geckle)

GERMANY (Fed Rep): Deutsche Welle, Koln, 6040, multi-colored circle card in 146 days, no RP. (Yaney) Same card, 6145, 6 months, EE rpt, no RP (CLEVELAND) Same card, 9765, 4 months for 2 IRC's and Ger/Eng rpt (Trzaskus)

VOA, Munich, 6150, full data Anniversary card, 10 days (Wickett) Bayerischer Rundfunk, Munich, 6085, optical illusion card w/ freq, date and thank you note, plus tech. data; 3wks, 2 IRC's (Calkin)

GREAT BRITAIN: BBC, 9580, usual no data Thames card in 18 days air; also sent sked; no RP. (Straumanis)

VOA, Wooferton, 11710, Antenna card w/no time or date, 15 days surface, no RP. /s/ Monica Vall (Kelley) VOA, Wooferton, 17855, 30 year Anniversary card w/site and freq., 6 days, no RP (Smith)

GREECE: VOA Rhodes, 7110, Antenna card in 10 days, No RP. (Gavaras)

VOA Kavala, 7240, Antenna card in 7 days, no RP. (Gavaras)

VOA Kavala, 11960, full data, 10 days, no RP; (Wickett)

HUNGARY: Radio Budapest, 11910, green card in 2 months by surface for no RP and EE report. Also sent red, white & green pennant. (Castello)

ITALY: RAI, Rome, 9575, #1 in new series of paintings reproductions, 70 days by air, rpt in Eng/It., no RP. (Brooks) Same card, full data, 19 days, Eng. rpt, no RP (Smith)

RAI, Rome, 11810, map/antenna card w/full data, 105 days for Eng. rpt; pgm schedule arrived earlier; (Sullivan)

LATVIA: Radio Riga, 5935, full data card and letter for report on a Swedish language pgm, 3 months, no RP; /s/ L. Brjantseva (Sizer)

HOLLAND: (sorry about that!) R. Nederland, 11730, 73 DX card in 10 days for 2 IRC's and Eng. rpt. (Geckle)

R. Nederland, 11730, 11740, 73 DX card marked via Lopic, Bonaire and Madagascar plus a pennant in 2 wks for 1 IRC. (Brown)

LUXEMBOURG: Radio Luxembourg, 6090, card with full data in 2 months from Villa Louvigny for report with mint stamps sent to London. Apparently they have stopped earlier procedure of also replying from London as in mid-60s. (Calkin)

MONACO: TransWorld Radio, 6165, full data PC of Monaco scene and personal letter (not too personal, I hope! -ds-), 6 days for EE rpt and 2 IRC's; test transmission; sent tape. (Johnson)

NORWAY: Radio Norway, 9610, sent a card, sked, and small cloth Nor. flag in 2 wks for 2 IRC's (Wickett)

R. Norway, 11850, full data, full color card of "The University" in 23 days with 2 IRC's (Gaede)

R. Norway, 17825, "In The Mountains" card, full data, by air in 25 days for 3 IRC's (Bye)

POLAND: Polish Radio, Warsaw, 9675, first map card, 35 days by air for Eng. rpt and 2 IRC's; also sent 3 postcards, schedule, personal letter and noted that RP is not necessary. (Kamber)

Polish Radio, 11815, "Warsaw Mermaid", full data, 105 days by air w/no RP; also sent #3 in pennant series and personal letter (Johnson)

PORTUGAL: R. Portugal, 11935, World Map card, 18 days, 1 IRC (Beck) Radio Renascenca, Lisboa, 6155, full data Eng/Port. card in 50 days after copy of original report presented in person at their studios during visit to Lisbon. (Calkin)



Contributed by Ken Hamilton

PORTUGAL: Radio Trans-Europa, Sines, 9670, full data card in 4 wks airmail w/note that program sked not available; Address: Casier Postal 235, 1211 Geneva 11, Switzerland. (Calkin)

RSFSR, EUROPEAN: Radio Moscow, 9610, full data with site as Tula from N.A. Service, 33 days by air for English report (Maher) RM, Tula, full data gray/white/blue card and personal letter in 24 days air for their report form and no RP. (Straumanis) RM, 9685, full data red card w/shields and Moscow as site; used RM report form, no RP; 68 days by air (Mayer) Radio Moscow, 15240, card w/site as Moscow, 44 days air, no RP; also rec'd Russ. alphabet and translation (The Testa's) RM, Voronezh, 15295, red/white and blue card w/all data including site; 5 months by air after followup; no RP (Griffith)

Radiostantsiya Rodina, 11690, full data white card in 110 days by air for no RP; also sent a program sked. (Wiseberg)

SPAIN: RNE, Madrid, 6065, Sp. letter w/date, time and freq. in 59 days, Eng. rpt and no RP (The Testa's) (and their world renown meatballs! -ds-)

SWEDEN: Radio Sweden, 9715, 25th Anniversary card and sked, 4 wks by air for 2 IRC's and Eng. rpt (Miller) 17815, same card, 10 days, 2 IRC's (Geckle)

SWITZERLAND: Red Cross Broadcasting Service, Geneva, 7210, bright card in 4 wks for 2 IRC's; also friendly letter from Alain Modoux, Head of Information and Press Division, plus sked & rpt forms. (Calkin) SBC, Berne, 11715, full data skiing slope card, 30 days by air for Eng. rpt /s/ J.A. Chisholm (Sullivan) Full data, "The Clock Tower" card, 23dys (Gaede)

UKRAINIAN SSR: Radio Moscow, Kiev, 9710, Full data card from European services in 28 days by air for English rpt and no RP. (Maher)

RM, Vinnitsa, 11735, full data red and blue card w/site in 1 month for no RP; also sent a report form and thankyou note (Wiseberg) Radio Moscow, Kiev, 11770, red card w/shield, full data in 68 days by air for no RP; (Mayer)

Radio Kiev, 11900, Boy and Girl card, 26 days by air for 2 IRCs and English report; also sent schedule and report cards (Kamber)

Radio Moscow, 15175, Lvov; red, white and blue card w/all data including site in 5 months by air for no RP after followup (Griffith)

VATICAN STATE: Vatican Radio, 6190, full data photo card of Pope Paul in 78 days by surface mail; English report and 1 IRC (Kelley)

Vatican Radio, 11845, full data card and schedule in 2 months for English report and 1 IRC (Brown)

Vatican Radio, 11045, photo card of building in 45 days, surface; English report and 2 IRC's (Kamber)

AFRICA

ASCENSION ISLANDS: BBC, 15260, usual Thames card w/no data other than A.R.S. typed at top of card; surface mail, no RP. (Trubee) Card, 34 days w/ "BBC Atlantic Relay" typed in; no RP. (Wickett) Freq. please -ds-

BOTSWANA: Radio Botswana, Gaborone, 4845, Amarylilis Lillies card w/ freq. only in 101 days by surface for 2 IRCs and English rpt (Greenall) Giraffe card, freq. only in 6 months by surface for 1 IRC and Eng rpt (Mayer) Same card, same data, same time, but for 2 IRCs (sorry about that, Don Johnson)

CAMEROON: Radio Garoua, Garoua, 5010, green/yellow map card, same as Radio Yaounde; all data but freq.; 7 months surface; rpt in Fr., mint stamps and sent registered; PC & Canadian stamps included (Marshall) determination pays!

CANARY ISLANDS: RNE, Tenerife, Antenna PC w/med. wave list of stations in Spanish; 26 days, surface for 1 IRC and Eng. rpt. (Trubee)

CONGO: RTC, Brazzaville, 15190, full data form letter, schedule in 66 days for 2 IRCs (Schwartz) Same, in 71 days air, 1 IRC & Eng. rpt. (Gavaras)

EGYPTIAN ARAB REP: Radio Cairo, 9475, full data color PC of Abu Simbel Temple & sked in 42 days air for Eng. rpt & 1 IRC. (Straumanis)

ETHIOPIA: Radio Ethiopia, Addis Ababa, 6185, Camel Driver PC w/sked on back, w/statement "your QSL confirmed"; in 14 days air for Eng, 1 IRC (Mayer) ETLF, Addis Ababa, 15190; blue card, white lettering, w/full data in 15 days air for Eng. rpt. and no RP. (Eichenhorn) ETLF, 15250, letter and card w/full data, 55 days, 2 IRCs. (Schwartz)

GABON: Radiodif. TV Gabonaise, Libreville, 4777, PC of Africa w/words "La Voix De La Renovation"; 22 days air for Fr. rpt & 2 IRCs (Maher)

GHANA: GBC, Accra, 4915, full data green, yellow, red and white card in 3 months by air for 2 IRCs. (Wiseberg) GBC, Tema, 9545, same card in 80 days by air, 2 IRCs; both included sked. (Wiseberg) R. Ghana (GBC), 9545, same card in 51 days by air for 3 IRCs; no penpal request! (Bye) same in 40 days, 2 IRCs (Straumanis) same info for (Kamber) and (Wickett)

IVORY COAST: Radiodif. TV Ivoireenne, Abidjan, card by surface in 22 days for Fr. rpt and 2 IRCs (Handler) Steve, please list freq., -ds-

KENYA: Voice of Kenya-Nairobi, 4950, personal letter confirming reception in 7 months; Eng. rpt & mint stamps/s/ J. Musella (Collier) Nice Catch, Mike-crl-

LIBERIA: ELWA, 11940, card & sked in 5 months for 2 IRCs (Forth)

VOA, Monrovia, 11925, 9740, 15250, usual card in 4, 10, 10 days (resptvly); last two full data, no RP (Wickett)

MALAGASY REPUBLIC: Radio Madagascar, Tananarive, 3288, PC of station w/no data in 40 days by air for Eng. rpt and mint stamps; (Maher) R. Nederland, 11740, full data card in 40 minutes; that's how long it took me to carry it to work, hi! (Neumann-Holland) R. Nederland, 11740, 73 DX card in 17 days by air for no RP. Also sent pennant (DuRant)

MOZAMBIQUE: R. Clube de Mocambique, 3210 w/card in 29 days; Port. rpt and 2 IRCs; /s/ H Sigueva; card had photo of building. (Neumann) R. Clube, 4855 same card w/full data in 7 wks by surface for Eng. rpt, 1 IRC (Greenall)

NIGERIA: NBC, Calabar, 6144; full data aerogramme in 1 month by air for 2 IRCs; /s/ E.B. Ntekim for Engineer in Charge (Wiseberg) Voice of Nigeria, Ikovodu, 7255, full data flag card and sked, 16 days air for Eng. rpt; returned IRC. (Straumanis)

REUNION ISLAND: ORTF, St. Denis, 2446, full data form letter by air in 96 days; used Gilfer form w/note in Fr. and 2 IRCs /s/; R. Carrie (Mayer)

RHODESIA: RBC, Salisbury, 3396; Antelope card, full data in 19 days by air for Eng. rpt and 1 IRC; /s/ E. McKenzie. (Greenall)

SENEGAL: R. Senegal, Dakar, 4890; PC of stringed instrument w/full data in 31 days by air for Eng. rpt and 1 IRC. (Maher) R. Senegal, 7210, same card, 25 days by air for no RP and Eng. rpt (Atchisson) Same, w/date and time only for Fr. rpt & 1 IRC (Straumanis) Same card, 15 days for Fr. rpt. and 2 IRCs (Handler) R. Senegal, 11895, same card, 1 month, Eng. rpt & 1 IRC; full data except day (Goldenberg)

SOUTH AFRICA: SABC, Verwoerd, 7185; Industries & Nat. Resources card w/ full data in 23 days surface for Eng. rpt and 1 IRC (Trubee) Radio RSA, Johannesburg, 9695, PC of Lilac Breasted Roller (a bird) in 11 days by air for no RP and Eng. rpt; also sent RSA Calling mag. (Buehler) Same card, but included pennant, 1 IRC and Eng. rpt. (Mayer) RSA, 15175, same card, 19 days by air, no RP (Miller) RSA, Verwoerd, 15220, same card, full data, 1 month by air, Eng. rpt. and no RP. (Eichenhorn)

TANZANIA: Radio Tanzania, Dar Es Salaam, 15435; yellow, brown card w/full data except time in 3 wks by air for Eng. rpt. and no RP. (Greenall)

TUNISIA: Radiodif. TV Tunisienne, Tunis, 6125, color PC w/view of coast, has full data on back of card in English; 19 days by air for 2 IRCs and Eng. rpt; also sent cancelled stamps and PC. (Lanoue)

ASIA

AZAD KASHMIR: Radio Srinagar, 3277, full data a/crogram letter in 6 months from /s/: J.C. Bhanjwa. Rpt'd in Eng. w/3IRCs. Very prized. (Varderson)

CHINA (P.R.): Radio Peking, Peking; card w/Painting Yangshu Landscape, full data except time, in 4 months surface, no RP and Eng. rpt. (Eichenhorn)

INDONESIA: RRI, Ujung Pandang, 5054, blue/white card of studio w/ date and freq (claim 5055), personal letter in Eng.; 24 days by air for 3 IRCs, Eng. rpt. using SPEEDX form, plus local postcard cancelled U.S. stamps. /s/: Slamet Poedjono (Cleveland) VOI, Dja'arta, 11715, reg. full data card in 68 days by air for mint stamp and Eng. rpt. /s/: Mrs. Lies (Mayer)

ISRAEL: IBA, Jerusalem, 11960, card w/view of Jerusalem, full data in 1 mo. by air; no RP and Eng. rpt. (Smith-Tenn) IBA, 15165, Menorah photo card w/ full data in 45 days by air for Eng. rpt. and no RP. (Eichenhorn)

IBA, 17370, PC of Jerusalem in 1 mo. by air; no RP. (Zelasko)

JAPAN: VOA Okinawa, 7165, Antenna card in 7 days for Eng. rpt (Gavaras) Radio Japan (NHK), Tokyo, 9505, Koyomon Gate card w/full data and new type pennant, in 12 days by air for no RP and Eng. rpt (Paschke) 9505, picture of Japanese playing cards (or Japanese playing cards? -ds-) in 10 days by air for no RP, Eng. rpt; also sent sked, 3 PC's (Buehler) 9505, "Noh" music text card w/date & freq. only. Also sent First Day Cover, sked; in 14 days for their rpt. form and no RP (Straumanis)

NSB, 9595, card in 14 days by air for Eng. rpt. and no RP. (Castello)

R. Japan, 11875, "Traditional Living Room" card, pennant, 4 R. Japan cards and R. Japan News, in 21 days by air, for Eng. rpt. and no RP. (DuRant)

R. Japan, 15105, "Japanese House" card and map of Japan in 2 wks for blue monitor sheet; no RP. (Brown) R. Japan, 15235, Koyomon Gate card (Zelasko)

R. Japan, 17825, "playing cards" card, 19 days, no RP (Gelfand)

KUWAIT: Radio Kuwait, 15415, 3 page folder card w/building in 36 days by air for 2 IRCs and Eng. rpt; sked came too. (Kamber)

PHILIPPINES: FEBC, Manila, 11890, native hut card w/full data in 50 days for 2 IRCs. /s/ Joan Ross, QSL Secretary (Gaede) Full data brown map card in 80 days by air for 2 IRCs. Sked, religious info. and questionnaire came also (same station -ds-) (Wiseberg) FEBC, 15430, card in 10 weeks by air for 1 IRC. Stated 15430 a test freq. (Trubee)

SOUTH KOREA: Radio Korea, 15335, SOKKURAM Buddha card w/full data in 30 days by air for no RP and Eng. rpt. Sent pgm. brochure (Korea, not Bill) (Flynn)

R. Korea, 15335, full data "Gold Ear-Rings" card in 3 wks by air; also received personal letter; Eng. rpt and no RP (Johnson)

(BREAK TIME)

SRI LANKA: VOA, Colombo, 11740, Anniversary card w/full data in 11 days for 2 IRCs /s/ R.C. Smith (Gaede)

TURKEY: Voice of Meteorogy, Ankara, 6900, replied by friendly letter and sked from Prof. Dr. Uman E. Colosan, Director General; 25 days for 2 IRCs. (Calkin) Same, in 10 days. (Neumann)

Voice of Turkey, 11880, "Topkapi" card and sked in 5 wks for 1 IRC (Brown)

Same, in 70 days (Gelfand)

USSR (ASIATIC): Radio Moscow, Nikolayevsk-on-Amur, 15240, maroon card and map of what appears to be 15 autonomous Regions; in 3 wks by air for no RP and Eng. rpt. Full data, w/site (Eichenhorn) RM, 15240, same as above except Green circle with "Kockba" card (Eichenhorn)

RM, Krasnoyarsk, 17340, card w/full data, 21 days by air (Maher)

RM, Komsomolsk-on-Amur, 17865, full data brown card w/site in 45 days for no RP. (Wiseberg)

OCEANIA

AUSTRALIA: R. Australia, Shepparton, 9570, "Sun Orchid" card, full data in 136 days by surface for no RP and Eng. rpt (DuRant) RA, 9570, Wildflower/Green Kangaroo Paw card in 3 mo. w/full data; no RP (Eichenhorn)

RA, 9560, Radio Telescope card in 4 mo. surface, no RP (Beck)

RA, 11765, Parliament House card w/full data in 75 days, 2IRCs (Gaede)

RA, 11790, Parliament House card w/full data in 136 days (DuRant)

RA, 17795, Same as above in 4 mo, no RP (Trubee)

RA, 17795, Opera House card in 3 mo. /s/: William Pierce (Nebron)

RA, 21740, Parliament House card in 3 mo. for no RP (Buehler)

RA, 21740, Parliament House and Opera House cards in 12 days for 2 IRCs (Wickett)

VHG, Lyndurst, 12000, folder card in 67 days for 1 IRC (Gavaras)

NEW ZEALAND: Radio New Zealand, Wellington, 11780, usual globe card in 3 months by surface for Eng. rpt and no RP (Miller)

R. New Zealand, 11780, the good old globe card in 4 months by surface for no RP (Castello)

PAPUA/NEW GUINEA: Radio Rabaul, Rabaul, 3385, full data folder w/nams and sked in 22 days for 3 IRCs and Eng. rpt./s/:B.W. Potter (Cleveland)
 ABC, Port Moresby, 4890, regular blue and yellow full data map card in 29 days by air for Eng. rpt and 2 IRCs (Luberski)
 ABC, Port Moresby, 4890, same as above plus bird of paradise card in 32 days and 2 IRCs;note says 3 IRCs needed for future airmail QSLs(Strau-manis)ABC, Port Moresby, 9520, same card in 40 days air, 3IRC's(Hamilton)

NORTH & CENTRAL AMERICA

CANADA: CFRX, Toronto, 6070, Toronto skyline card in 13 days by surface for 2 IRCs (Buehler)

Radio Canada International, 6085; green/blue map card in 2 months by surface for 1 IRC (which was returned) (Geckle)
 CHNX, Halifax, 6130, plain white card w/no time in 21 days by surface for 2 IRCs on second try; /s/: J.M. Connors (Kamber) Same, w/confirmation statement and freq. only in 7 months after followup.Mint Stamps (Calkin) Same, black/white card, letter, full data, 60 days, no RP (The Testas)
 CBC Northern Service, 9625, card in 2 wks, no RP (Nebron)
 Same, Map and Eskimo; sculpture card in 4 wks surface (Zelasko)
 Radio Canada Int., 9635, gold on white w/wheat card in 19 days by air; /s/: Brian Lowmley (Luberski)
 RCI, 11835, wheat card in 2 weeks by air, also sent wrestling mag., for no RP and Eng. rpt. (Miller)

RCI, 11945, map card in 11 days using RCI rpt form (Zelasko)
 RCI, 11945, wheat card in 11 days by surface for no RP (Atchisson)
 RCI, 17820, wheat card in 18 days by surface, no RP (Trzaskus)

COSTA RICA: Faro del Caribe, San Jose, 9645, red and white card, full data w/ Eng. and Sp. statement, also sent sked and personal letter; in 19 days for 1 IRC and Spanish report, by air. (Smith Tenn)

CUBA: Radio Havana, 11930, concentric circles card and FDC's for philatelic answer; in 4 months surface (Zelasko) RH, 11930, red,white and blue card plus flag, sked and pennant; in 4 months by surface for no RP (Miller)
 Radio Havana, 17885, blue and white card plus letter and program in 5 months (Dolyak)

DOMINICAN REPUBLIC: Radiotelevision Dominicana, Santo Domingo, 9505; usual vague acknowledgement in Spanish, but a pennant included; in 14 months by air for Sp. rpt. and mint stamps./s/: R.A. Font Bernard;(Lovell) R. TV Dominicana, 9505, letter w/ thanks for report and pennant; letter gave frequency only (Wickett) Same info, 16 months, Sp.rpt. (Lanoue)

GUATEMALA: Radio Maya de Barillas, 3325, white card w/background of warrior & pyramid; full data in 7 1/2 months by air for mint stamps and English rpt /s/: Loran Veith, mgr (Marshall) R. Maya de Barillas, 3325, full data card in 10 months by air for 3 IRCs and Eng. rpt (Johnson)

Radio Cultural, Guatemala City, 9505, TGNA quetzal card w/date&freq. and form letter w/verie statement;6 1/2 mo. for Eng. rpt (Sullivan)

HONDURAS: Radio Lux, Olanchito, 4890; friendly Sp. letter in 3 months, 4 months after f/up w/mint stamps; very prized. (Calkin)

Radio Progreso, 4920; printed form letter and Angel decal in 10 days by air for 2 IRCs and SP. rpt./s/: Jerry Tolle (Kamber)

MARTINIQUE: ORTF, Fort de France, 4895; card w/ beach scene and some dead fish, hi; in 30 days by air for 1 IRC and Eng. rpt./s/:L. Larrieu(Gavaras)

MEXICO: R. Universidad de Sonora, 6115, card w/no data except freq. in 15 days for 1 IRC (Nebron)

NETHERLAND ANTILLES: Radio Nederland, Bonaire, 9715, full data "73" card in 11 days by air for Eng. rpt. and no RP (Straumanis)

R. Nederland, 11730; "Save the Amsterdam" card w/ full data in 12 days by air for 1 IRC; sked, pennant came also (Kelley)

R. Nederland, 11730; 2 "73" cards in 10 and 11 days by air for 2 IRCs and Eng. rpt (The Testas)

Trans World Radio, Bonaire, 11815, full data card showing buildings and antennas; in 18 days by air for Eng. rpt and IRC. also received sked. and religious material. /s/: Julius F. Schipper (Straumanis)

TWR, Bonaire, 11815, 2 cards plus pennants in 16 weeks by surface and 2 weeks by air, for 1 IRC each (Brown)

TWR, Bonaire, 15320, card of studio at night w/full data, plus sked and religious information, for 1 IRC and English rpt. (Mayer)

NICARAGUA: Radio MAR, Puerto Cabezas, 9594, friendly letter w/ details of Puerto Cabezas economy, all data except freq; they request more reports; also received pennant; reported in Spanish and sent 1 IRC, which they returned. /s/ Ricardo Perez Ulloa (Flynn)

UNITED STATES: AFRTS, Delano, 6110; standard blue on white card w/full data in 10 days by air for no RP; also received sked. (Du Rant)
 VOA, Dixon, 6185, 30th Anniversary card, all data but time, in 73 days by surface for no RP. (Mayer)
 VOA, Greenville, 6190; standard anniversary card in 2 days by surface for Eng. rpt. (Beck)
 U.H. Radio, 9520, blue and white card, w/five languages of the UN and UN symbol. In 7 days. (Gaede)
 VOA, Bethany, 9525, standard card, no RP, Sp. report (Vockeroth)
 VOA, Dixon, 9730, same good old card, 80 days, Eng. rpt. (Vockeroth)
 AFRTS, Delano, 9755, full data usual card in 10 days by air for a mint U.S. stamp. Also received sked and ngr. guide. (Wiseberg)
 WWV, Fort Collins, 10000, Indian folder card in 3 weeks by surface for mint stamps and Eng. rpt. /s/: John L. Stanley (Geckle)
 Organization of American States, Greenville, 11740; letter gives freq., date, thanks & sked of xmsns. In 24 days, no RP. (Flynn)
 VOA, Bethany, 11830, and guess what - same old VOA card (Gaede)
 WIKB, Red Lion, 15185, plain B/W card in 44 days for 8¢ stamp (Gelfand) same, 23 days for 8¢ stamp; /s/: John Morris (Kamber)
 same, 12 days for 11¢ stamp, full data card (Trubee)
 VOA, Greenville, 15410, standard card in 73 days, no RP. (Mayer)
 VOA Dixon, 17730, card in 3 days (Wickett)
 WNYW, New York, 17755, plain card in 10 days, for mint st. (Buehler)

WINDWARD ISLANDS: Radio Grenada, 5015, second letter from N.P. DaBreo, Manager, in 6 months for same report. (Calkin)
 Radio Grenada, St. Georges, 11930; form letter w/date and freq, and travel brochure in 2 months by air for 3 IRCs; /s/ Allan Palmer (Greenall)

SOUTH AMERICA

ARGENTINA: R.A.E., Buenos Aires, 9690; globe card, 66 days, No RP (Yaney)
 R.A.E., 11710; green globe card, full data, 2 1/2 mo., no RP (Nebron)
 Same, globe card, full data, air, 49 days, 3 IRCs (Bye)
 Same, globe card, 4 months, no RP, Eng. rpt. (Zelasko)
 R.A.E., 15345, globe card, 48 days, 3 IRCs, Sp. rpt. (Cleveland)

BRAZIL: R. Jornal do Commercio, Recife, 6085; B/W card w/data except time in 22 days air for 2 IRCs and Eng. rpt. (Greenall)
 R. Bandeirantes, 11925; form letter, freq. only in 4mo. surface for 2 IRCs and Port. rpt.; also sent pennant and postcard (Wiseberg)

CHILE: Radio Portales, Santiago, 9572; Sp. letter on 5th try; 16 days air for S.A.S.E (not used) and Sp. rpt.; their envelope had 2700¢ worth of postage on it! /s/: Arturo Tarud Siwady (Flynn)

COLOMBIA: R. Nacional, Bogota, 6180; scenic card for Eng. rpt. (Trubee)

ECUADOR: Emisora Luz y Vida, 4825; letter & pennant w/full data; in 5mo. total, 2mo. after f/up; desire mint stamps, not IRCs (Calkin)

HCJB, 9560, oil pipeline, 21 days air for 2 IRCs & Eng. rpt. (Buehler)
 Same, 29 days (The Testas) Same, 21 days (Straumanis)

VENEZUELA: Ecos del Torbes, San Cristobal, 4930, no data letter and pennant in 5wks air for a. stamps and Sp. rpt. (Laroue) Same info, (Wiseberg)
 Same, 17 days for 1 IRC and Sp. rpt. All /s/: E. Gonzalez De Chacon (Luberski)
 R. Barquisimeto, 4990, green/white card, 18 days, 1 IRC, Sp. rpt. (Luberski)

In closing my first column, I want to thank all contributors and I promise to do better next month, hi!. During the last few days, several items have come up. First off, please obtain all QSL report forms from headquarters in Santa Ana; please list frequencies heard and be sure to put your name with every item. Also, I have a few questions for all SPEEDKer's - would you like to continue the policy of placing the name of the state after the contributors name? I know its necessary for the other columns, but I'm not sure about this particular column. Be sure to let me know. I will put the state in certain cases, like for Smith, which we all know there are several that belong to SPEEDX, and for certain other cases. Also, please send suggestions for a new name for the column, something catchy and distinctive for SPEEDK. It must refer to QSL's or verifications and not be too long. The winner will receive a neat little surprise from me, and the judges decision is final!

Next month, there will be more reports and less chatter from me, you can be sure! But in the meantime, let me thank Chris Lobbell, Art Glover, Oliver Ellsworth, Don Johnson and Bill Flynn for getting me started this month and a bunch of contributors for keeping me going.

New deadline is 15th of every month.

Radiodifusora "Cenit" de Portoviejo - Ecuador S.A.

Le Augura

*Felices Pascuas de Navidad y
Un Venturoso Año Nuevo*

GRACIAS POR SU AMABLE SINTONIA

Diciembre 25/71.-

Dr.
RICHARD E. WOOD
Dept. of Foreign Languages
Louisiana State University
Baton Rouge, La. 70803, U.S.A.
Distinguido oyente:

Reposa en nuestro ARCHIVO DE HONOR su gentil reportaje.— Todo cuanto indica coincide con lo programado en la fecha a que Ud. hace mención

Gracias por tan valioso envío, y permítanos contarle entre nuestros amigos de siempre. Si algún día visita Ecuador, le invitamos para que llegue a nuestra ciudad donde será muy placentero atenderlo. La presente misiva le servirá como la mejor tarjeta de presentación.

Reciba el cordial saludo de los que hacen Radiodifusora CENIT de Portoviejo - Manabí - Ecuador S.A.)

Wilfrido Macías Parrales
GERENTE

Nuestra Emisora transmite en dos frecuencias: 1.155 y 4.770 Kcs.
Programaciones artísticas - culturales - deportivas - comerciales, etc. Esta Emisora pertenece a la Empresa Radial CENIT del Ecuador, con Emisoras en Portoviejo, Manta - Bahía y Guayaquil.

From the collection of Dr. Richard E. Wood.



RADIO SUTATENZA

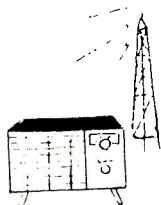

ESCUELA RADIOFONICA

by E. J. WHITEHEAD

For 24 years, Radio Sutatenza has been a pioneer in the use of radio for educational purposes--especially in the education of the rural adult, the "campesino". From modest beginnings Radio Sutatenza has grown into a major force in the battle against illiteracy in Colombia. Its multi-media approach has been so successful, in fact, that it is now being widely copied by other developing nations in Asia, Africa, and Latin America.

Radio Sutatenza is an arm of Accion Cultural Popular, an organization of educational media dedicated to providing the 8 million rural adults of Colombia with the wherewithal to assume the responsibility for their own development. Radio Sutatenza functions as the primary means of reaching these people with a program of instruction based upon the five basic notions of Health, Alphabet, Numbers, Economy and Work, and Spirituality. These programs in hygiene and basic health care, reading and writing, simple arithmetic, increasing productivity, and the recognition of personal dignity are supported and reinforced with a newspaper "El Campesino", rural libraries, personal correspondence, extension schools, and institutes for farmers.

Accion Cultural Popular was founded in 1948 by Monsignor Jose Joaquin Salcedo, the pastor of Sutatenza, a small village in the Andes. An amateur radio operator, Msgr. Salcedo realized radio was the most effective way to bring educational instruction to the far flung rural adults of Colombia. His dream was realized in 1949 when Radio Sutatenza began educational broadcasts using a 100 watt transmitter. At first there were but a few battery operated receivers to receive the broadcasts but the audience quickly grew. So too did Radio Sutatenza which then moved to Bogota and added more powerful transmitters. Later, to meet regional needs, Radio Sutatenza added transmitters in other major cities.

Radio Sutatenza operates two different programming formats simultaneously. The "A" program is a general purpose format mixing entertainment and sports coverage with educational instruction while the "B" program concentrates on instruction with frequent repeat broadcasts of lessons for the convenience of the students. The "A" program serves as the attention getter drawing the attention of the people to the instruction which is then reinforced with repeat broadcasts by the "B" program. Among the many features broadcast by Radio Sutatenza is one of special interest to the SWL. Called "Frecuencia Internacional", this program designed for foreign listeners is aired daily Monday through Friday at 1400 GMT.

The studios of Radio Sutatenza are located in Bogota, Cali, Barranquilla, Magangue, and Medellin. The station in Bogota is the largest with a 300 kw medium wave transmitter operating on 810 khz and three shortwave transmitters, a 50 kw RCA unit operating on 5095 khz, a 25 kw water cooled GE unit operating on 5075 khz, and a 10 kw Gates unit operating on 6075 khz. The Cali station operates on medium wave only. The transmitter there is 120 kw and operates on 700 khz. The same is true of the stations at Barranquilla, Magangue and Medellin which operate 120 kw on 960 khz, 120 kw on 590 khz, and 100 kw on 1810 khz respectively. This totals over 600 kw making Radio Sutatenza the most powerful educational radio in the world.

R-390A/URR

The R-390A/URR is a 26 tube superhetrodyne receiver for reception of cw, am, ssb, and RTTY signals. This receiver covers 500 Khz to 32 Mhz in 30 1 Mhz wide bands and one 500 Khz wide band. From 500 Khz to 8 Mhz the R390A/URR is a triple conversion receiver, and from 8 Mhz to 32 Mhz, it operates as a double conversion receiver. The first IF stage is variable from 17.5 to 25 Mhz and is used on the eight lowest bands. The second IF stage is also a variable type with a range of 3 to 2 Mhz. The third IF stage operates at 455 Khz. There is one stage of tuned RF amplification prior to the first mixer. The oscillators feeding the first two mixers are crystal controlled. There is provided a set of heaters for these crystals, but they are not needed if the receiver is to be used indoors. Also, there is a built in crystal calibrator. The readout is by means of a digital counter type of arrangement, and there is a mark every 10 Hz. The readout is accurate to 300 Hz. The linear tuning is accomplished by means of the insertion of powdered iron cores into the RF and IF coils at a rate controlled by a complex arrangement of gears, shafts and cams. The IF selectivity is 100 Hz to 16 Khz in six steps. There are inputs for both a balanced antenna and an unbalanced antenna. An output from the 455 Khz final IF is also provided. There also is an 800 Hz audio filter for use with cw reception. The carrier strength meter is marked 0 - 100 and there is a graph in the technical manual for converting this reading into microvolts. There is audio outputs for a 600 ohm unbalanced line, a 600 ohm set of headphones, and a 600 ohm balanced audio line. The balanced audio output is fully metered in volume units (VU Meter). The R390A/URR operates from 115/230 volts ac and consumes 140 watts of power with the crystal ovens off. The receiver comes in a standard 19 inch rack mount and weighs 75 pounds. Also, there is a noise limiter, the clipping action of which is manually controlled. The R390A/URR is now available from surplus dealers for about \$750.

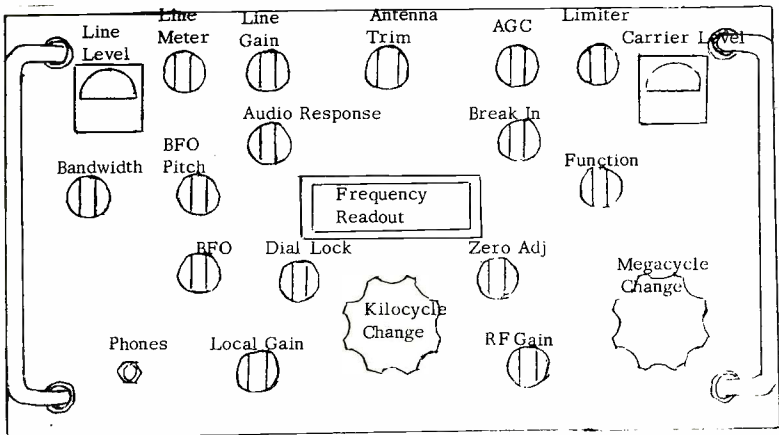

*****CONTRIBUTORS TO OCTOBER SPEEDX*****

Numbers indicate how many credits each contributor has earned this month. One credit per column reported to. List is complete this month except for Station Sceduals, which is missing again this month. Note that September QSL reporters will be given credit as loggings are used.

3	ATCHISSON, DAVID	MD	..SX-190	1	MAHER, JAMES	NY	...DX-150A
1	BECK, ROBERT	OH???	2	MAPPIN, RUSS	WASPR-4
3	BRITTON, BILL	FL	..R-390	1	MARSHALL, CEDRIC	ONT	...SX-130
3	BROOKS, ALAN	CT	..DX150A	1	MAYER, ALAN	ILSB-310
3	BROWN, SCOTT	CA???	3	MILLER, AL	OH	...HRO-500
4	BUEHLER, LOUIS	MO	..SX-190	2	MILLER, GUS	CA	..DX-150A
1	BURTON, ROBERT	OH	..R-391	4	NEBRON, LARRY	CA	...SX-190
1	BUTTERFIELD, BOB	MA	..HQ-100	1	NEUMANN, SERGE	HOLANDSPR-4
4	BYE, HARLAN	PA	...SPR-4	3	OLIVER, WAYNE	NH	..DX-150A
4	CALKIN, GREGG	SPAIN	...SW4A	1	PASCHE, BILL	WI	...SX-190
1	CASTELLO, GEORGE	CA	..TRI-818	1	PETERS, FRANK	IL51-S1
4	CLEVELAND, BILL	CA	...SPR-4	1	PISTEK, RICHARD	ILHQ-180
1	COLLIER, MIKE	NY	..HQ-129X	1	REDMAN, RON	IL	..PRLS-1660
1	D'ADOLF, STEVE	ND	..R-530	2	ROSE, ROBERT	MAN	...SX-190
2	D'ANGELO, RICHARD	NY???	1	SCHWARTZ, RICHARD	DE???
4	DAWSON, ARCH	CA	...SPR-4	3	SHAW, BILL	PASPR-4
2	DEANGELIS, KEVIN	CA	..DX150B	4	SHEEDY, DAN	CASPR-4
2	DENNIS, AMEL	IN	..SX-190	1	SHINN, VERLIN	CAR-530
2	DIPRETE, RON	RI	..ASTRO-8	3	SIMON, DAVID	NY	...SX-190
1	DOBOSENSKI, MICHAEL	MI	..SX-190	3	SMITH, JOSEPH	NY	...SX-190
5	DOLYAK, EVELYN	IA	..HA-700	4	SMITH, WOODY	TNTRANS
3	DURANT, HENRY	THAILAND	..R-7000	4	SNYDER, DOUG	CASPR-4
4	EICHENHORN, SANDY	MI	...SPR-4	1	SPARKS, BILL	CAR4B
2	FAY, JON	MA	..SB-310	3	STEPHENSON, NORMAN	CASPR-4
3	FISCHER, JOHN	PA	..SX-190	2	STRAUMANIS, ANDRIS	ILSW-717
4	FLYNN, BILL	CA	..HQ-180	1	SULLIVAN, DAVID	OK???
5	FORTH, KARL	IL	..HQ-160	3	TESTA, FRANK	MADX-150
4	GAEDE, ALLAN	CA	..HQ-180	3	TRAUTSCHOLD, JOHN	WISB-310
3	CAVARAS, TOM	MN	..HQ-180	3	TRUBEE, BILL	HISW4A
3	GECKLE, JOE	MD	..DX150B	4	TRZASKUS, ROSEMARY	ILS-125
4	GELFAND, STEVE	NY	..NC183D	4	VOCKEROTH, JOHN	PA	...S-200
3	GETZEL, ART	NY	..HA-600A	5	WARREN, RONALD	CAR4B
2	GIANNINI, ROGER	IL???	1	WHITEHEAD, JIM	MA	...SX-190
1	GOLDENBERG, JOE	MO	TFM-1600	4	WICKETT, ROBERT	MDS-120
4	GREENALL, DAN	ONT	..DX-150B	1	WISEBERG, MICHAEL	ONT???
2	GRIFFITH, DON	COR4B	1	WITKINS, DAVID	ILR-530
2	HAMBRIGHT, JEFF	NJ	...SPR-4	3	YANEY, DENISE	IN	...AIR-17
1	HAMILTON, KEN	CA???	3	ZELASKO, LEO	INSPR-4
5	HANDLER, STEVE	IL	..SX-190	3	ZILMER, BOB	WISPR-4
4	HARDESTER, MIKE	CA	..XCR-30	2	ZIMAROWSKI, MARK	MADX-150
1	HENDERSON, DAN	MD	..HQ-180				
1	HOLBROOK, HANK	MD???				
1	HYNDMAN, LYNN	IN???				
2	JOHNSON, DON	CA	...SPR-4				
5	KAMBER, EARL	SC	..DX-150B				
4	KELLY, EUGENE	FL	..SX-190				
1	KLETT, BILL	FL???				
1	KOLB, JOHN	CA	...SPR-4				
1	KORET, RICHARD	NY	..SX-122A				
1	LANES, BRAD	NJ	..SX-190				
4	LANOUE, RON	MA	SEARS-20				
1	LAZEAR, KEN	OH	..SX-130				
1	LEISTNER, L & E	CA	...SPR-4				
1	LOVELL, JIM	KY	..SX-100				
1	LUBERSKI, THOMAS	MI	..HRO-501				

95 reporters turned out this month, including these 12 'First Timers': Arch Dawson, Kevin DeAngelis, Michael Dobosenski, Joe Geckle, Lynn Hyndman, Eugene Kelley, Bill Klett, Gus Miller, Richard Schwartz, Dan Sheedy, David Sullivan, and Michael Wiseberg. TNKS

REPORT OFTEN! SUPPORT YOUR CLUB!

(compiled this month by Don Johnson)

Order the WORLD UTILITY DX HANDBOOK from SPEEDXTRAS. \$6.95 to full members, \$7.95 to all others. ORDER NOW!

The Official DX Magazine published monthly by:

"The Society to Preserve the Engrossing Enjoyment of DXing"

BOARD OF DIRECTORS - ART CLOVER - GARY ANGELES, WA - DISTRICT MANAGER

DAVE THORNE - SANTA ANA, CA - BUSINESS MANAGER

PAUL MAYO - BROOKLYN, NY - UTILITY CHASER'S CORNER

CHRIS LOBBELL - READING, MA - WIDE-RESIDENT

BILL FLYNN - MOUNTAIN VIEW, CA - DISTRICT MANAGER

DON JOHNSON - ELIZABETH, NJ - SWRC DX, ASIA/OCEANIA

JIM WHITEHEAD - READING, MA - SWRC DX, W. HEMISPHERE

BOB BUTTERFIELD - BELMONT, MA - SWRC DX, EUR/AFRICA

JACK WHITE, GRESHAM, OR - SPEEDXTRAS, & PROPAGATION

MARK KOUKOL, NAPERVILLE, IL - SWRC DX, STATION SKEDS

PAUL MAYO - BROOKLYN, NY - UTILITY CHASER'S CORNER

STEVE HANDLER - DEERFIELD, IL - UTILITY DXS

ALAN BROOKS - OAKDALE, CT - DX MONTAGE

WENDELL BENEDETTI - LOS ANGELES, CA -

OLIVER ELLSWORTH - LOS ANGELES, CA -

HANDICAPPED AID PROGRAM (HAP) - GENE MOSER - CALIFORNIA, MI -

SUBSCRIPTION RATES (PER YEAR):

Via First Class Mail to United States.....\$ 10.00 (U.S.)

FOREIGN: Please write for rates. Available via Air or Seemall.

SAMPLE COPY: Postpaid worldwide.....\$ 1.00 (U.S.)

BACK ISSUES: Available as supply lasts - ppd. \$ 1.00 (U.S.)

INTERNET HOME ADDRESS: SPEEDX, PO BOX 321, SANTA ANA, CALIFORNIA 92702 USA.

(Make all checks, money orders, & bank drafts payable to SPEEDX.)

Permission is granted to broadcast, publish, or reproduce, any of the material contained herein (excepting those items which acknowledge that they appear by permission from other sources), provided, credit is given to SPEEDX, PO Box 321, Santa Ana, CA, 92702 USA, and to the author or contributor, when stated.

The accuracy of station listings and loggings in SPEEDX cannot be guaranteed due to the frequently changing schedules of many stations.

PRINTING BY - KWIK PRINT, Santa Ana, CA 92701 USA.

P.O. Box 321

Santa Ana, Calif. 92702

U.S.A.

(Address Correction Requested)

JOHN E DAY
19134 CHERRY CREEK RD
AUBURN CA 95603



OCT 4
PM



FIRST CLASS