

RADIO & TELEVISION

FORMERLY

SHORT WAVE & TELEVISION



RADIO GUIDES CLIPPERS

SEE PAGE 327



NEW TELEVISION AERIAL

In This Issue —

2-Inch Tube, Low-Cost Television Receiver

The Navy Amateur Net — John L. Reinartz

International Radio Review

Switch-type, All-band, Ham Transmitter

QSL Card Contest

2-Tube Portable Receiver; 110 Vt. A.C.-D.C.

Facsimile Recorder Assembled in 4 Hours

Accurate S-W Station List



**THE GIRL
RADIO "HAM"**

**HUGO
GERNSBACK**
EDITOR

**RADIO EXPERIMENTING
AMATEUR RADIO**

25¢
IN U.S. AND
CANADA

**OCT.
1939**

THE NEW MODEL 1250 MULTITESTER



Sloping panel for precise rapid servicing.

Specially designed electronic rectifier enables linear A.C. scale, high stability and little or no temperature drift.

Here is an opportunity to acquire a Multi-Service, Precision Engineered Instrument, for less than you would have to pay for an ordinary Volt-Ohm Milliammeter. Besides making the usual volt, resistance and current measurements (both A.C. and D.C.) this unit accurately measures the CAPACITIES of mica, paper and electrolytic condensers, INDUCTANCE of coils, chokes, and transformers, DECIBEL gain or loss, of power amplifiers and public address systems, WATTS output of amplifiers, receivers, etc.

SPECIFICATIONS

Complete A.C. and D.C. Voltage and Current Ranges.

D.C. Voltage: 0-15, 0-150, 0-750 Volts.

A.C. Voltage: 0-15, 0-150, 0-750 Volts.

D.C. Current: 0-1, 0-15, 0-150, 0-750 ma.

A.C. Current: 0-15, 0-150, 0-750 ma.

2 Resistance Ranges: 0-500 ohms, 500-5 megohms.

High and Low Capacity Scales: .0005 to 1 mfd. and .05 to 50 mfd.

3 Decibel Ranges.

-10 to +19, -10 to +38, -10 to +53.

Inductance: 1 to 700 Henries.

Watts: Based on 6 MW. at 0 D.B. in 500 ohms .000000 to 600 watts.

Model 1250 works on 90 to 120 Volts 60 cycles A.C. Complete with test leads, tabular charts and instructions. Shipping weight 9 pounds. Size 9 1/2" x 11" x 6 1/2". Our Net Price

Portable Cover \$1.00 Additional

\$11⁸⁵

THE NEW MODEL 1240 TUBE TESTER



Instantaneous snap switches reduce actual testing time to absolute minimum.

Tests all tubes 1.4 to 117 volts.

Sockets for all tubes — no adapters.

Superior is proud to offer the newest and most practical tube tester ever designed. Unbelievably low in price—unbelievably high in performance.

- * Tests all tubes, 1.4 to 117 volts, including 4, 5, 6, 7, 7L, octals, octals, 6X4, 6X5, 6X6, 6X7, 6X8, 6X9, 6X10, 6X11, 6X12, 6X13, 6X14, 6X15, 6X16, 6X17, 6X18, 6X19, 6X20, 6X21, 6X22, 6X23, 6X24, 6X25, 6X26, 6X27, 6X28, 6X29, 6X30, 6X31, 6X32, 6X33, 6X34, 6X35, 6X36, 6X37, 6X38, 6X39, 6X40, 6X41, 6X42, 6X43, 6X44, 6X45, 6X46, 6X47, 6X48, 6X49, 6X50, 6X51, 6X52, 6X53, 6X54, 6X55, 6X56, 6X57, 6X58, 6X59, 6X60, 6X61, 6X62, 6X63, 6X64, 6X65, 6X66, 6X67, 6X68, 6X69, 6X70, 6X71, 6X72, 6X73, 6X74, 6X75, 6X76, 6X77, 6X78, 6X79, 6X80, 6X81, 6X82, 6X83, 6X84, 6X85, 6X86, 6X87, 6X88, 6X89, 6X90, 6X91, 6X92, 6X93, 6X94, 6X95, 6X96, 6X97, 6X98, 6X99, 6X100, 6X101, 6X102, 6X103, 6X104, 6X105, 6X106, 6X107, 6X108, 6X109, 6X110, 6X111, 6X112, 6X113, 6X114, 6X115, 6X116, 6X117.
- * Tests leakages and shorts in all elements AGAINST all elements in all tubes.
- * Tests BOTH plates in rectifiers.
- * Tests individual sections such as diodes, triodes, pentodes, etc. in multi-purpose tubes.
- * Latest type voltage regulator.
- * Features an attractive etched aluminum panel.
- * Works on 90 to 125 volts 60 cycles A.C.

INSTANTANEOUS SNAP SWITCHES REDUCE ACTUAL TESTING TIME TO ABSOLUTE MINIMUM.

Model 1240 comes complete with instructions and tabular data for every known type of receiving tube. Shipping weight 12 pounds. Size 6" x 7 1/2" x 10 3/4". Our Net Price

Portable Cover \$1.00 Additional

\$11⁸⁵

THE X-RAYOMETER FEATURES A NEW

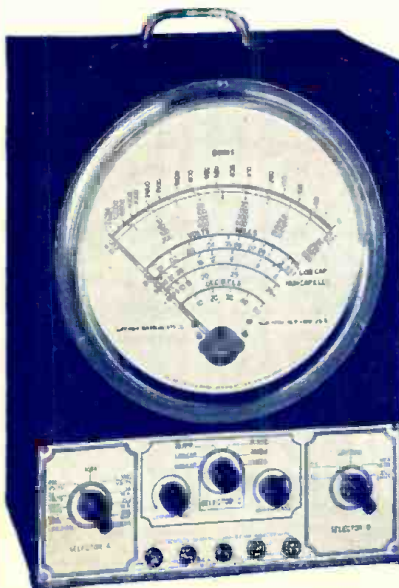

GIANT 9 INCH METER—AND A BUILT-IN POWER SUPPLY ENABLES RESISTANCE MEASUREMENTS UP TO 30 MEGOHMS

SPECIFICATIONS

RESISTANCE MEASUREMENTS IN 3 RANGES: 0-1000 Ohms, 0-100,000 Ohms, 0-30 Megohms.

D.C. VOLTAGE MEASUREMENTS IN 5 RANGES: 0-50, 0-250, 0-500, 0-1000, 0-2500 Volts. Television and other high voltage power supply circuits easily measured.

A.C. VOLTAGE MEASUREMENTS IN 4 RANGES: 0-50, 0-250, 0-500, 0-1000 Volts.

D.C. CURRENT MEASUREMENTS IN 6 RANGES: 0-1 Ma., 0-50 Ma., 0-250 Ma., 0-1 Ampere, 0-10 Amperes, 0-25 Amperes. High current ranges suitable for automotive and industrial work.

CAPACITY DIRECTLY READ ON METER SCALE IN 2 RANGES: .005-1 Mfd., 2 Mfd.-50 Mfd.

PERCENTAGE OF LEAKAGE of electrolytes read DIRECTLY on meter scale. Actual condition of condenser, quickly determined.

INSULATION, INTER-ELEMENT and A.C. LEAKAGES directly read on meter scale up to 30 Megohms.

OUTPUT MEASUREMENTS IN 4 RANGES: 0-50, 0-250, 0-500, 0-1000 Volts. Built-in blocking condensers enable rapid alignment of radio equipment.

INDUCTANCE MEASUREMENTS IN 2 RANGES: 0-7 Henries, 7-703 Henries.

DECIBEL MEASUREMENTS IN 3 RANGES: D.B. based on 6 MW. at 500 Ohms. -10 to +29, -10 to +43, -10 to +49. Audio frequency measurements in both radio and P.A. amplifiers.

X-RAYOMETER comes housed in a new army gray crystalline, heavy gauge cabinet. Complete with test leads, instructions and tabular data. Shipping weight 20 pounds. **\$17⁹⁵**

ONLY

THE NEW MODEL 1130-S SIGNAL GENERATOR WITH AUDIO FREQUENCIES



1. Combination R.F. and Audio Signal Generator. R.F. 100 kc. to 100 megacycles A.F.—100-7500 cycles. All direct readings, all by front panel switching.
2. R.F. and A.F. output independently obtainable alone or with A.F. (any frequency) Modulating R.F.
3. Accuracy is within 1% on I.F. and Broadcast bands; 2% on higher frequencies.
4. Audio frequencies in 5 bands: 100, 400, 1000, 4000, and 7500 cycles.
5. Giant airplane full vision, direct-reading dial.
6. Condenser and other leakages tested to 100 megohms.
7. All services on 90-130 volts A.C. or D.C. (any frequency).

Model 1130-S comes complete with tubes, test leads, **\$11⁸⁵** carrying handle and instructions. Shipping weight 16 lbs. Our net price.

SUPERIOR INSTRUMENTS CO. 136 LIBERTY STREET, RT-10
NEW YORK, N. Y.



J. E. SMITH, President
NATIONAL RADIO INSTITUTE
 Established 25 years

He has directed the training of more men for the Radio Industry than anyone else.

I will send you a Lesson Free to show how I train you at home in spare time for Good Jobs in Radio



Broadcasting Stations employ operators, installation, maintenance men and Radio Technicians in other capacities and pay well.



Set Servicing pays many Radio Technicians \$30, \$40, \$50 a week. Others hold their regular jobs and make \$5 to \$10 extra a week in spare time.

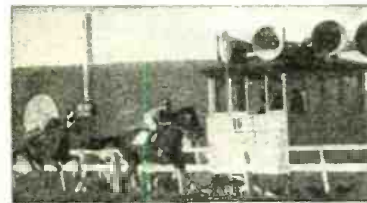

Loud Speaker System building, installing, servicing and operating is another growing field for well trained Radio Technicians.

Clip the coupon and mail it. I'm so certain I can train you at home in your spare time to be a Radio Technician that I will send you my first lesson free. Examine it, read it, see how clear and easy it is to understand. See how my course is planned to help you get a good job in Radio, a young, growing field with a future. You don't need to give up your present job, or spend a lot of money to become a Radio Technician. I train you at home in your spare time.

Jobs Like These Go to Men Who Know Radio

Radio broadcasting stations employ engineers, operators, station managers and pay well for trained men. Radio manufacturers employ testers, inspectors, foremen, servicemen in good-pay jobs with opportunities for advancement. Radio jobbers and dealers employ installation and servicemen. Many Radio Technicians open their own Radio sales and repair businesses and make \$30, \$40, \$50 a week. Others hold their regular jobs and make \$5 to \$10 a week fixing Radios in spare time. Automobile, police, aviation, commercial Radio; loudspeaker systems, electronic devices, are newer fields offering good opportunities to qualified men. And my Course includes Television which promises to open many good jobs soon.

Why Many Radio Technicians Make \$30, \$40, \$50 a Week

Radio is already one of the country's large industries even though it is still young and growing. The arrival of Television, the use of Radio principles in industry, are but a few of many recent Radio developments. More than 28,000,000 homes have one or more Radios. There are more Radios than telephones. Every year millions of Radios get out of date and are replaced. Millions more need new tubes, repairs, etc. Over 5,000,000 auto Radios are in use and thousands more are being sold every day. In every branch Radio is offering more opportunities—opportunities for which I give you the required knowledge of Radio at home in your spare time. Yes, the few hundred \$30, \$40, \$50 a week jobs of 20 years ago have grown to thousands.

Many Make \$5 to \$10 a Week Extra in Spare Time While Learning

The day you enroll, in addition to my regular Course, I start sending you Extra Money Job Sheets which

start showing you how to do actual Radio repair jobs. Throughout your training I send plans and directions which have helped many make \$200 to \$700 a year in spare time while learning. I send special Radio equipment; show you how to conduct experiments, build circuits. This 50-50 training method makes learning at home interesting, fascinating, practical.

I Also Give You This Professional Servicing Instrument

Here is the type of Instrument Radio Technicians use—an All-Wave Set Servicing Instrument. It contains everything necessary to measure A.C. and D.C. voltages and current; to check resistances; adjust and align any set, old or new. It satisfies your needs for professional servicing after you graduate—can help you make extra money fixing sets while training.



You Are Trained For Television Also

With N.R.I. you take up Television principles right along with Radio principles—the correct method—since Television receivers combine both sight and sound. You also get more than ten text books devoted entirely to Television.

Sample Lesson and 64-page Book Free

Act today. Mail coupon now for sample Lesson and 64-page Book. They're FREE. They point out Radio's spare time and full time opportunities and those coming in Television; tell about my course in Radio and Television; show many letters from men I trained, telling what they are doing and earning. Read my money back agreement. Find out what Radio offers you. Mail coupon in envelope or paste on penny postpaid—NOW.

J. E. SMITH, President
 Dept. 9KB3,
 National Radio Institute
 Washington, D. C.



Sample Lesson Free

I want to prove my Training gives practical, money-making information, that it is easy to understand—what you need to master Radio. My sample lesson text, "Radio Receiver Troubles—Their Cause and Remedy," covers a long list of Radio receiver troubles in A.C., D.C., battery, universal, auto, T.R.F., superheterodyne, all-wave, and other types of sets. And a cross reference system gives you the probable cause and a quick way to locate and remedy these set troubles. A special section is devoted to receiver check-up, alignment, balancing, neutralizing, testing. You can get this lesson Free by mailing the coupon.

I TRAINED THESE MEN

Owns Shop, Makes \$3,000 a Year



"During the last year I have made about \$3,000 in Radio. I now own my own shop." KARL KELLY, 306 W. Calhoun St., Magnolia, Ark.

\$10 to \$20 Week in Spare Time



"I repaired many Radio sets when I was on my tenth lesson. I have made an average of \$10 to \$20 a week—just spare time." JOHN JERRY, 1529 Arapahoe St., Denver, Colo.

Good for Both 64 PAGE BOOK Free

J. E. SMITH, President, National Radio Institute
 Dept. 9KB3, Washington, D. C.

Without obligating me, send your Sample Lesson and 64-page Book FREE. I am particularly interested in the branch of Radio checked below.

- | | |
|---|---|
| <input type="checkbox"/> Radio Service Business of My Own | <input type="checkbox"/> Loud Speaker Systems, Installation and Service |
| <input type="checkbox"/> Spare Time Radio Repair Work | <input type="checkbox"/> Auto Radio Installation and Service |
| <input type="checkbox"/> Service Technician for Retail Stores | <input type="checkbox"/> Television Station Operator |
| <input type="checkbox"/> Broadcasting Station Operator | <input type="checkbox"/> Commercial Radio Station Operator |
| <input type="checkbox"/> Aviation Radio Technician | <input type="checkbox"/> All-around Servicing Technician |

(If you have not decided which branch you prefer—mail coupon now, for information to help you decide.)

Name Age

Address 14N1

RADIO & TELEVISION

The Popular Radio Magazine

October — 1939
Vol. X No. 6

HUGO GERNSBACK, Editor
H. WINFIELD SECOR, Manag. Editor
ROBERT EICHBERG, Assoc. Editor

New!
Radio
Listener's Contest

See Page 356

In This Issue

GENERAL FEATURES

The Naval Communication Reserve—John L. Reinartz..	325
Television's Super-Shows	326
Featured on the Cover	327
World-Wide Radio Digest	328
New Plaque Award for Best "Ham" Station Photo	330
International Radio Review	332
Practical Radio Ideas	336

CONDENSED FEATURES

Pretty Girl Radio Ham	327
New Dipole Television Aerial	327
Radio Guides Clippers	327
2-Way Television	328
The Musa Steerable Antenna	328
Theatre Television	329
British Television Vans	329
Cold Cathode Tube	332
Steering by Television	332
Short-Wave Autodyne Converter	332
Optical Microphone	333
Phase Inversion Methods	333

INSTRUCTION

Getting Started in Amateur Radio —C. W. Palmer, E.E., Ex-W2BV	334
Radio Test-Quiz—Robert Eichberg	349
The Radio Beginner— Martin Clifford, W2CDV	352
Question Box	358

TELEVISION

Television's Super-Shows	326
New Dipole Television Antenna ..	327

CONSTRUCTION

Facsimile Recorder Assembled in 4 Hours— Robert Eichberg	331
How to Obtain Bigger Television Images	335
Practical Radio Ideas	336
The Twinplex Again—But Modernized—Allan Stuart ..	336
The "Half-Pint" Portable Receiver—2 Tubes Equal 4— H. G. Cisin, M.E.	339
Building a Low-Cost Television Receiver—Peter Scozzari	340
The ECO Switch-Band Transmitter— Herman Yellin, W2AJL	350
Volt-Ohmmeter—John T. Wilcox, W2CLS	374

First Two-Way Television	328
Theatre Television Projector	329
British Television Vans	329
Peaking Image and Sound Stages in Television Receivers	335
Ten-Inch Images from a Five-Inch Tube	335
Building a 2-Inch C-R Television Receiver	340

MISCELLANEOUS

Newest Radio Apparatus	323
Radio Construction "Shorts"	338
World Short Wave Stations	342
Let's Listen In with Joe Miller ..	343
S-W League—"DX" on the HAM Bands—Elmer R. Fuller	345
What Do YOU Think?	347
Radio Diagram Quiz	349
Radio Kinks	354
QSL Contest and Radioddities ..	356
Question Box	358
I Cover the Pacific Coast!—Lyle M. Nelson	370
Why Be A Lid?—John G. Hart ..	376
Book Reviews	377

In the November Issue

For the Beginner—The Electrified Twinplex—Allan Stuart.

More Construction Data on Home Television Receivers, including how to operate 3" C-R Tube on the 2" Receiver, described by Peter Scozzari.

Details of New *Free* TELEVISION COURSE Contest

How to *Record* Radio Programs

"Power-Pack" for the Switch-band Transmitter—Herman Yellin, W2AJL

Certified Circuits



When you see this seal on a set it is a guarantee that it has been tested and certified in our laboratories, as well as privately in different parts of the country. Only construction—experimental sets are certified.

You need not hesitate to spend money on parts because the set and circuit are bona fide.

This is the only magazine that renders such a service.

Cover composition by H. Gernsback and Thos. D. Pentz. Photos courtesy of NBC, RCA and Pan American Airways. See description on page 327.

RADIO & TELEVISION—Published monthly on the tenth of the month. Entered as second-class matter Feb. 15, 1938, at the post office at Springfield, Mass., under the act of March 3, 1879. Trademarks and copyrights by permission of H. Gernsback. Text and illustrations are copyright and may not be reproduced without permission. Subscription price \$2.00 a year in the United States and possessions and Canada, \$2.50 in foreign countries. Make all subscription checks payable to Popular Book Corporation.

Published by Popular Book Corporation, Publication Office—99 Worthington St., Springfield, Mass. Editorial and Executive Offices—89 Hudson St., New York, N.Y. HUGO GERNSBACK, President; H. W. SECOR, Vice-President; EMIL GROSSMAN, Director of Advertising. European Agents: Atlas Publishing and Distributing Co., Ltd., 18 Bride Lane, Fleet St., London, England; Brantano's—London and Paris. Australian Agents: McGill's Agency, 179 Elizabeth St., Melbourne.

Copyright 1939 by H. Gernsback

Newest Radio Apparatus

Two-in-One Ham Amplifier

● A "PROFESSIONAL" type Public-Address amplifier which is equally well suited to the requirements of the ham as a speech amplifier and driver, or as a complete modulator, is announced by Radio Wire Television, Inc. (formerly Wholesale Radio Service Co., Inc.), in their Model 440T. For either P.A. or ham work, it provides 25 watts of high quality output (35 watts on peaks) from a pair of 6L6G's in a reverse feed-back circuit. Four input channels, three of which may be operated simultaneously, provide for microphone, radio and phono inputs. Gain is 118 db. in the two low-level channels, and 84 db. in the other two.

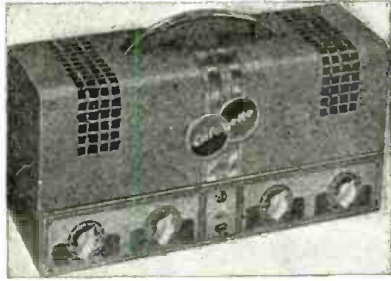

The built-in output transformer provides correct matching for speaker loads of 2, 4, 8, 16, 250 and 500 ohms. In addition, the amplifier as supplied for hams has the output plate leads brought out through feed-through insulators to provide for universal application (with shunt feed) as either a driver or modulator for transmitters.

Other features of the 440T include frequency range of 50 to 10,000 cycles, variable tone control, provision for remote volume control of two channels, field supply for two 2500-ohm speaker units, 3-channel mixing. Tubes used are two 12SJ7's, two 6SC7's, two 6L6G's and one 5X4G.

New Miniature Sets

● TEN graceful Little Nipper radios which incorporate smart "cabinet character" in addition to performance qualities have been announced by RCA Victor.

Two of the receivers have a Magic Voice tone chamber; all have the new magic loop antenna, are self-contained, needing only to be plugged into an electric outlet, and have carrying handles. They all utilize the same 5-tube superheterodyne chassis, and have provision for Television or Victrola plug-in.

The magic voice is accomplished by a basic scientific improvement in the cabinet design, utilizing the principle of the Helmholtz resonator to build up the needed low frequencies and filter out the objectionable ones, thus providing a balanced over-all tone. This development is incorporated in two models.

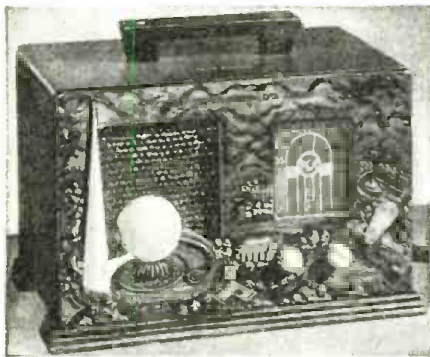

Radio Soldering Iron

● A NEW light-weight soldering iron, specially designed for radio and similar fine work, has been produced by the Drake Electric Works, Inc. The new iron, illustrated herewith, is known as their No. 400. It measures only 8" overall, weighs



but 8 oz. and is rated at 60 watts. The iron is fitted with a 1/4" tip and is particularly adapted for very light soldering. Radio experimenters and set builders will welcome it, for it is small enough to get into the tightest corners.

(Continued on page 360)

BOOST YOUR INCOME!



These 3 Big Electrical Guides
can help you
EARN MORE MONEY

EXAMINE 10 DAYS FREE

● No argument about it — the **BIG-MONEY JOBS** go to those who **KNOW HOW!** Nowadays you can't expect to hold a good job — you can't expect to get ahead — unless you **KNOW YOUR STUFF!** But for the fellow who's **PREPARED**, good jobs, good pay, steady advancement are ahead as always! Why not prepare **YOURSELF** for the boundless opportunities in **ELECTRICITY?** These big **ELECTRICAL REFERENCE AND INSTRUCTION BOOKS** will help you. Equip yourself now for success in this big, modern, fascinating field.

What You Want to Know — Told So You GET It

● These remarkable books lay before you — in compact, convenient, ready-reference form — the very **essence** of the world-renowned instruction in **ELECTRICITY** given at famous Coyne Electrical School. Coyne, you know, is one of the world's leading electrical schools where men are trained in electricity by **actual shop work**. These valuable Guides are built around this practical "Learn by Doing" course of training and are a thoroughly practical reference set for the most experienced electrical man — yet written so clearly and completely, they're an easy-to-follow course for the beginner! They'll aid you **right on the job** — or they'll help you prepare for a **better job and bigger pay**.

1,100 big pages, size 8 1/2 by 11 inches, 2,000 subject listings in the handy index. Over 2,000 carefully-selected illustrations and diagrams so you can **SEE HOW IT'S DONE** while you **READ HOW TO DO IT!** Quick-Reference Celluloid Tab Index enables you to turn in a jiffy to any section.

FREE WITH GUIDES

One Year of Personal Advice by Mail

Right now, with each set of Guides, I'm offering a service that may in itself pay for the Guides many times over! I'm offering one year's free advice by mail on any electrical problems. Yes, I mean that. The Coyne staff of experts will give you consultation service for one whole year! And this personal service won't cost you a single additional penny.

SEND NO MONEY

Just mail the coupon — that's all. No risk — no obligation. When books arrive, just pay few cents delivery charge. Keep the books 10 days. You'll be **THRILLED**, I promise, by this 10-day examination! After 10 days, if you decide to keep the books, send \$2 and then \$2 a month until advertised price of \$12 is paid. If you don't want them, return them at my expense within 10 days. Mail the coupon **NOW** while you can take advantage of this 10-Day Examination Offer!

H. C. LEWIS, President
COYNE ELECTRICAL SCHOOL
500 S. PAULINA ST. Dept. 79-REF CHICAGO, ILL.



H. C. Lewis

Some of the Subjects Covered in These Guides

Electricity, Magnetism
Signal Systems
Signal, Plan and Installation
Telephones
House Wiring, Code, Conductors
Power Wiring, Fuses, Switches
Illumination
Armature, and Stator Winding
Motor Repairs
D. C. Generators, Operation and Care
D. C. Switchboards and Meters
D. C. Motors and Controllers
A. C. Circuits and Calculations
A. C. Instruments, Power Factor Tests
A. C. Generators and Switchboards
A. C. Transformers
A. C. Motors and Maintenance
A. C. Rectifiers and Converters
A. C. Central Stations
A. C. Substations
Photo Cell Controls
Automotive Electricity
Electric Storage Batteries
Diesel Engine
Operation and Care
Refrigeration Servicing
Air Conditioning
Radio Servicing, Public Address
Television

Mail This Coupon Now

H. C. LEWIS, President
COYNE ELECTRICAL SCHOOL,
500 So. Paulina St., Dept. 79-REF Chicago, Ill.
Send me the 3 Big Coyne Electrical Reference and Instruction Guides. I will pay the few cents delivery charges. Within 10 days after receiving the books, I'll either return them or send you \$2 and then \$2 a month until advertised price of \$12 is paid.

NAME.....
ADDRESS.....
CITY..... STATE.....

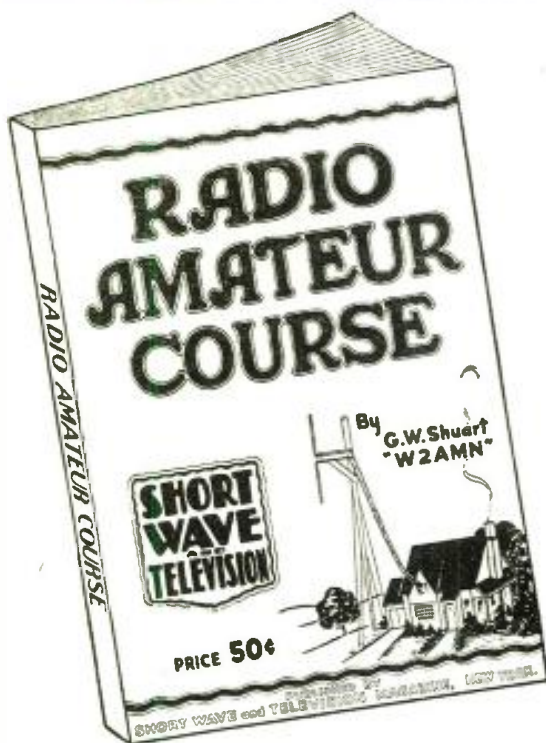

Your Money Back—

IF THE **RADIO AMATEUR COURSE** DOES NOT REPRESENT THE GREATEST BOOK VALUE EVER OFFERED TO THE RADIO "FANS" FOR **50c**

TO convince you that there isn't a better book buy today, the publishers of the **RADIO AMATEUR COURSE** make the sensational offer of a money-back guarantee on such a low-priced book. Stop in at any of the many dealers listed at the right and examine this volume. See for yourself if the **RADIO AMATEUR COURSE** isn't just the book you've always wanted.

Printed on the finest coated paper—well illustrated attractive 4-color cover—complete with radio information you must have. It contains a step-by-step program for obtaining a short-wave radio education.

Written by **George W. Shuart, W2AMN,**
foremost short-wave authority

148 PAGES

6¼ x 9½ INCHES

OVER 150 RADIO DIAGRAMS
and **TECHNICAL PHOTOGRAPHS**

RADIO AND TELEVISION
99 Hudson Street, New York, N. Y.

1939 Edition Just Off the Press!

All Prominent **RADIO DEALERS**
Ready to Show You This Big Book!

- ARIZONA**
Sam's Cigar Store,
127 N. First Ave., Phoenix.
- CALIFORNIA**
Scott Wholesale Radio Co.,
344 E. Fourth Street, Long Beach.
Offenbach Electric Co., Ltd.,
1452 Market Street, San Francisco.
Zack Radio Supply Co.,
1428 Market Street, San Francisco.
- COLORADO**
Auto Equipment Co.,
14th at Lawrence, Denver.
- CONNECTICUT**
Radio Inspection Service Co.,
227 Asylum Street, Hartford.
Stern Wholesale Parts, Inc.,
210 Chapel St., Hartford.
- GEORGIA**
Radio Wire Television, Inc.,
265 Peachtree St., N. W., Atlanta.
- ILLINOIS**
Allied Radio Corporation,
633 West Jackson Blvd., Chicago.
News & Electric Company,
228 W. Madison Street, Chicago.
Radio Wire Television, Inc.,
901 W. Jackson Blvd., Chicago.
- INDIANA**
Van Sickle Radio, Inc.,
34 West Ohio Street, Indianapolis.
- MASSACHUSETTS**
Greater Boston Distributors,
40 Waltham St., Boston.
E. Jappe Co., 46 Cornhill, Boston.
Radio Wire Television, Inc.,
110 Federal Street, Boston.
Springfield Radio Co.,
387 Dwight Street, Springfield.
H. Jappe Co.,
57 Mechanic Street, Worcester.
- MICHIGAN**
Rissi Brothers, Inc.,
5027 Hamilton Ave., Detroit.
Rissi Brothers, Inc.,
443 S. Division St., Detroit.
- MISSOURI**
Modern Radio Company,
409 No. Third Street, Hannibal.
Burstin-Applebee Co.,
1012-14 McGee Street, Kansas City.
Van Sickle Radio Co.,
1113 Pine Street, St. Louis.
- NEBRASKA**
Radio Accessories Company,
2366 Farnam Street, Omaha.
- NEW JERSEY**
Arco Radio Co.,
227 Central Avenue, Newark.
Radio Wire Television, Inc.,
24 Central Avenue, Newark.
- NEW YORK**
Radio Wire Television, Inc.,
542 E. Fordham Rd., Bronx.
Radio Wire Television, Inc.,
90-08 186th Street, Jamaica. L. I.
Ilan, The Radio Man, Inc.,
64 Dey Street, New York City.
Eagle Radio Co.,
84 Cortlandt Street, New York City.
Federated Purchaser, Inc.,
25 Park Place, New York City.
Harrison Radio Co.,
12 West Broadway, New York City.
Sun Radio Co.,
212 Fulton Street, New York City.
Terminal Radio Corp.,
80 Cortlandt Street, New York City.
Thor Radio Corp.,
60 Dey St., New York City.
Try-Mo Radio Co., Inc.,
85 Cortlandt Street, New York City.
Radio Wire Television, Inc.,
100 Sixth Avenue, New York City.
Radio Parts & Equipment Co.,
244 Clinton Avenue No., Rochester.
- M. Schwartz & Son,
710-712 Broadway, Schenectady.
- NEW HAMPSHIRE**
Radio Service Laboratory,
1187 Elm Street, Manchester.
- OHIO**
News Exchange,
51 So. Main Street, Akron.
Canton Radio & Supply Co.,
1140 Tuscarawas Street, W. Canton.
United Radio, Inc.,
1103 Vine Street, Cincinnati.
The Hughes-Peters Electric Corp.,
178-180 N. Third Street, Columbus.
Standard Radio Parts Co.,
135 East Second Street, Dayton.
- OREGON**
Portland Radio Supply Co.,
1300 W. Burnside Street, Portland.
- PENNSYLVANIA**
Radio Distributing Co.,
1124-26 Market Street, Harrisburg.
M. & H. Sporting Goods Co.,
512 Market Street, Philadelphia.
Cameradio Co.,
963 Liberty Ave., Pittsburgh.
- RHODE ISLAND**
W. H. Edwards Co.,
32 Broadway, Providence, R. I.
- TEXAS**
Amarillo Electric Co.,
111 East 8th Avenue, Amarillo.
- UTAH**
O'Loughlin's Wholesale Radio Supply,
315 South Main Street, Salt Lake City.
Radio Supply, Inc.,
46 Exchange Place, Salt Lake City.
- WASHINGTON**
Spokane Radio Co., Inc.,
611 First Avenue, Spokane.
- WISCONSIN**
Radio Parts Co., Inc.,
536-538 W. State Street, Milwaukee.
- AUSTRALIA**
McGill's Agency,
183-184 Elizabeth Street, Melbourne.
- CANADA**
The T. Eaton Co., Ltd.,
Winnipeg, Manitoba.
Canadian Electrical Supply Co., Limited,
285 Craig Street W., Montreal, Que.
Metropolitan News Agency,
1248 Peel Street, Montreal, Que.
- CUBA**
The Diamond News Co.,
Palacio Asturiano, Por San Jose.
Habana.
- ENGLAND**
Gorrinse's American News Agency,
9a, Green Street, Leicester Square,
London, W.C.2.
- HOLLAND**
Radio Peeters, Van Vorstraat, Amsterdam, Z.
- INDIA**
Empire Book Mart,
Box 631, Bombay.
- MEXICO**
American Book Store, S. A.,
Avenida Madero 25, Mexico City.
Central De Publicaciones,
Avenida Juarez, 4, Apartado 2430,
Mexico, D. F.
- NEW ZEALAND**
Te Aro Book Depot, Ltd.,
64 Courtenay Place, Wellington.
- SOUTH AFRICA**
South African Radio Publications,
40 Trust Bldgs., Cor. Fox and Loveday Sts.,
Johannesburg.
Technical Book Co.,
5, Strand Street, Cape Town.

If this book is not at your dealer's, send your order directly to us. We will credit your dealer with the sale of this book. To order your copy of **RADIO AMATEUR COURSE**, fill in coupon below and mail.

RADIO AND TELEVISION, 99 Hudson St., New York, N. Y.
Gentlemen: I enclose herewith my remittance of Fifty Cents (50c) for which please send me **POSTPAID**, my copy of the **RADIO AMATEUR COURSE**. (Remit by check or money order; register letter if you send cash or unused U. S. Postage Stamps.)

Name

Address

CityState..... R&T-10-39

The Naval Communication Reserve

John L. Reinartz,

Lieut. U. S. Naval Reserve

One of the best known experts in the realm of short waves, and radio in general, is John L. Reinartz. He originated receiving circuits which have been used by thousands of amateurs. Recently he has been identified as an engineer with various branches of the radio industry.



• IT could only have been done in the United States. Only here is there enough love of Country for its accomplishment. This army of 6000 radio operators who are pledged to serve their Country in time of need, be it during peace time when there is danger because of flood and storm, or during war time when the need for them is even greater. The remarkable part is, that these radio operators have, at no expense to the Government worth mentioning, trained themselves, and have allowed themselves to be trained into an efficient "Naval Communication Reserve," quite worthy of the name. Composed of officers and men from every conceivable activity in and out of the radio industry, educational institutions and radio amateurs, there are represented among this group, the country's foremost radio communication engineers.

Administered in the several Naval Districts by the Commandant, the District Communication Officer and the Naval Communication Reserve Commander, the organization then splits up into Sections. Officers commanding sections are charged with the responsibility of properly interpreting the Naval Communication Reserve policies as forwarded to them by the Naval Communication Reserve Commander, and inculcating the Unit Commanders with them, to the end that a smooth-running organization will result. Section Commanders then, must be men trained in the handling of other men in such a manner that it is never apparent that orders have been given. The reason for this will be clear when I tell you that the entire Naval Communication Reserve functions on a voluntary basis without pay.

Specifically, officers in command of sections are charged with the duty of procurement, training and continued interest of men qualified for communication duties. They are forever on the lookout for new men and closely keep track of radio amateurs since from among that fraternity the greater number are procured. Training proceeds under a well designed plan and instruction is given in the manner in which naval messages must be sent, when and how to transmit and in general inculcate the required discipline to insure that the transmission of messages take place only when required and not indiscriminately.

To reduce the administrative burden of the Section Commander, he is provided with a staff of officers and men who interpret his wishes and pass them on to the Unit Commanders. Directly responsible to the Section Commander is the Executive Officer of the Section. This officer takes the burden of the administrative duties to the extent that his civilian duties allow. In all matters of administration the executive officer represents the section commander and tries to act as he knows the section commander would

act under like conditions and when carrying out orders is executing such orders as of the commanding officer as the authority and not of his own authority. This delegated authority to the executive officer is real and carries the authority of the commanding officer which must be obeyed by all other officers in the section.

Another aid to the section commander is the Operations Officer who is charged with the duty of keeping the instruction of the section on such a plane that it retains interest and prevents the stagnation that follows routine. This officer also follows up errors made in communication and sees to their correction to prevent repetition. Since it is unlikely that a section will exist without error, it can be seen that the operations officer has as much to do as his time will allow outside of his active civilian life.

Then we have the Personnel Officer who watches the rolls of the section to see that men who are nearing their time limit of enlistment are advised and again join the organization for another four years. As new amateurs appear on the amateur radio horizon, this officer arranges to contact them for possible recruiting into the section; if their age is less than 21 years he follows them up at a later date. As men come up for promotion, the personnel officer looks up their record and advises the executive officer of the necessary facts, so that proper recommendation may be made for advancement.

Not only can we not get along without a Medical Officer, but this same medical officer has the last word when it comes to allowing a man to be sworn in. Many fine radio amateurs cannot belong to the NCR because of some physical defect. If the defect is such that it does not interfere with the duties of radioman in the Naval Communication Reserve, it is sometimes possible to obtain a waiver for the defect and induct the man into the organization. However, it is the medical officer who decides the fitness of the men as laid down by the rules of the Navy Department, and which may not be abridged.

(Continued on page 357)

Thirty-second of a series of "Guest" Editorials

Television's Super-Shows



As these pictures taken in the National Broadcasting Company's television studios show, recent programs are elaborate and entertaining.

SPORTS seem to be one of the most consistently entertaining phases of television programs. In this one Lou Nova is seen sparring with Patsy Pernoni before the camera and microphone. The program which presented the Baer-Nova fight has received wide acclaim.

BEAUTY at the N. Y. World's Fair was televised in a contest, the judges of which were leading artists and columnists. The charming young lady shown before the camera was adjudged the winner. The judging was done at television receivers in order to estimate the contestants' "telegenic" qualities.

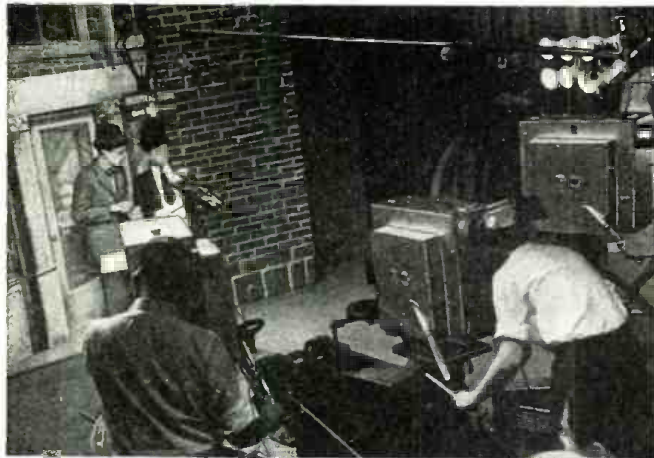
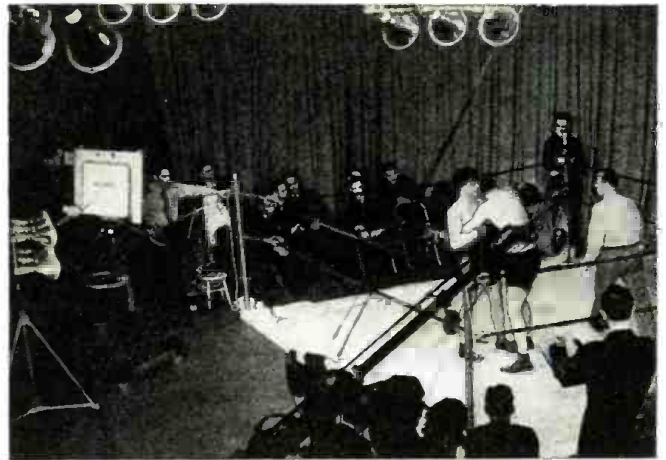

DRAMA of the most thrilling kind was presented in *Missouri Legend* which utilized almost the complete original Broadway cast. The scene reproduced herewith shows two of the Jesse James gang fighting over their allegiance to their vicious leader. The boy at the left was the gang's musical member.

COMEDY at its best came to television when Tom Howard and Roy Shelton, witty wizards of stage, screen and radio, put on a side-splitting act before the eye of the "iike". The dry humor of the two comics registered as one of the funniest spots that television has yet presented to "lookers-in".



MUSICAL shows have great attraction for television set owners. One of the earliest and best was the *Magnolia Floating Theatre* which told the story of a "Tom Show" on a show-boat. Simon Legree was the kindly friend of Little Eva and Uncle Tom, and the henpecked husband of Eliza, in backstage sequences.

Cover Features . . .

Pretty Girl Radio Ham

● MISS LENORE KINGSTON is here shown in her amateur transmitting station W9CHD. Miss Kingston is an enthusiastic radio amateur and recently received her "ticket" from Uncle Sam. Bob Jensen, one of the engineers at the NBC Chicago studios, snapped the accompanying picture of Miss Kingston "in action."

W9CHD will undoubtedly receive plenty of calls over the "ham" waves. Miss Kingston is heard regularly over the NBC-Blue network as Jane Daly in the "Affairs of Anthony." She recently graduated from the RCA Institutes, Inc., Chicago, and became a "YL" because she was so thrilled when a "ham" invited her to his station to let her talk to her folks in California.

Miss Kingston has had experience in vaudeville and pictures.



W9CHD is the radio amateur station call assigned to Miss Lenore Kingston. Well, here she is, "hams"! Heard from her yet? Well, have you called her yet? Hmmm!!

New Double Dipole Television Aerial

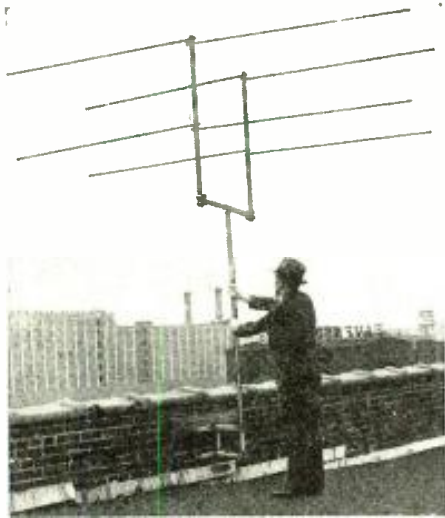

The new Double Di-pole television receiving antenna with reflector, designed for use by amateurs, experimenters, and "lookers-in."

● PERHAPS the major determinants of a television receiver's efficiency are the antenna to which it is connected and the transmission line running from the antenna to the receiver. In locations which are reasonably close to the transmitter and which are not surrounded by reflecting surfaces, a simple dipole should be satisfactory. However, where the antenna must be erected between the transmitting antenna and high buildings or mountains (which might cause reflections) a reflector to cut off the re-

Radio Guides Clippers

● THE photo at the right shows a radio operator making a check on a land radio station for the purpose of determining the location of a clipper plane while flying across the Atlantic. In some radio systems which have been used for checking planes in flight, the plane's transmitter sends out periodically a certain signal, and two or more receiving stations on land take bearings of the plane. When their observations are cross-checked by means of two or more lines (strings) on a map, the exact location of the plane is determined and this information transmitted by radio to the plane's operator.

In the new system in use by the trans-Atlantic clippers, the plane's radio operator takes bearings on two or more land stations, and he may also take radio bearings on ships at sea. Every half hour the operator on the plane transmits a position report to the land control station, located in the vicinity of New York. The clipper planes rely on four methods for spotting their location: 1—celestial navigation; 2—radio bearings; 3—dead reckoning; and 4—a check of radio bearings and celestial sights.

Atlantic Clipper planes spot their location by taking bearings on land radio stations.



flected waves is virtually a necessity. Such a reflector is also needed when the antenna is erected at considerable distance from the transmitter, for this increases signal strength very appreciably.

A double doublet with reflectors, as shown in the illustration herewith, is superior to the single doublet from the point of view of signal strength. With it, the user is able to secure plenty of power from the transmitted wave and to cut down unwanted reflections. With an antenna of this sort, installed by Tel-Tech for RADIO & TELEVISION, a set now undergoing tests is enabled not only to pick up good television images free from interference, but good European broadcast stations regularly on its associated all-wave receiver, an RCA Model TRK-12.



WORLD WIDE



REDUCED HEAT under brilliant television studio lighting is made possible by the new *water-cooled* quartz mercury arc lamps devised by General Electric engineers. At the extreme top is shown a close-up of the lamp with an engineer making adjustments on it. The lower picture shows these lamps in use in the G-E television station at Schenectady, N. Y.

BEATING THE RACES by radio was the achievement of a family in St. Louis, Mo., according to *United Press*. The woman, whose name is Mrs. *Cheatham*, is said to have done much what the name implies. She had a miniature receiver concealed in her hat (no mean task, considering the size of most women's hats today)!

Two bookies complained against Mrs. Cheatham, claiming that her husband in a car outside the betting office transmitted race results to her in sufficient time for her to get her money down before the bookies knew the race was over. The story says that the Cheatham family made between \$5000 and \$6000 in two months of operation.

FACSIMILE is being sent over W5XD, 1000 watt, 25.25 mc. station operated by WFAA at Dallas, Texas. *Morning News*. The equipment being used is RCA.

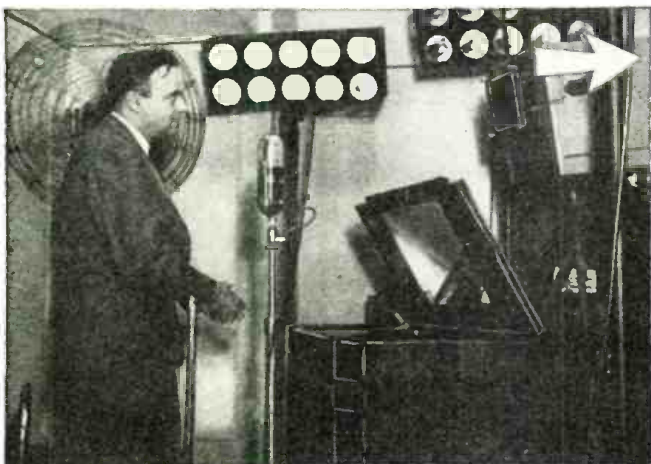

MULTIPLE UNIT steerable antenna, more familiarly known as *Musa*, is being used by the new radio telephone receiving station at Manahawkin, N. J. As the upper figure shows, short wave transmissions usually involve one or more deflections between the surface of the roof and the Kennelly-Heaviside layer or ionosphere. *Musa* provides a means of separately receiving such signals coming at various angles even though the angle shifts due to the rise and fall of the ionosphere. At Manahawkin, sixteen rhombic units are used, although only two are shown in the lower figure below. By inserting phase shifting networks in each transmission path between the antenna and the receiver, a small group of waves striking the various antennas reinforce each other. *Musa* increases input about 200 times according to A. T. & T.

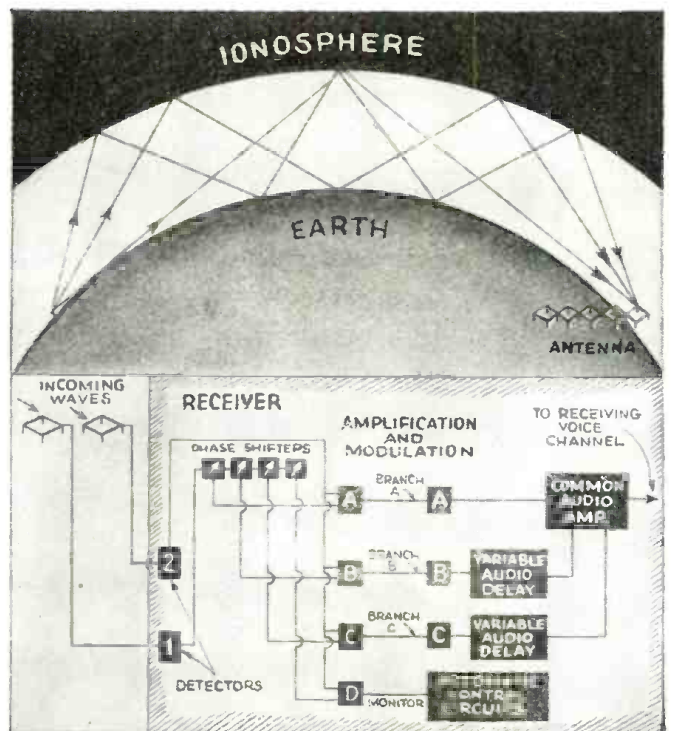

» » First Two-Way

ELMER F. ANDREWS (left), Federal Wage and Hour Administrator, and Dr. John W. Studebaker (right), U. S. Commissioner of Education, are pictured here as they took part in the first successful two-way demonstration of high definition television, which was recently conducted by the RCA Manufacturing Company at the annual meeting of the National Association of Broadcasters in Atlantic City.

Standing before television cameras located in separate studios, Mr. Andrews and Dr. Studebaker were able to see each other simultaneously as they conversed during the two-way demonstration. Dr. Studebaker, who said the future possibilities of television in education seem limitless, was so amazed when he stepped before the television receiver and saw Mr. Andrews' image, that he exclaimed with startled surprise, "Well, I declare!

RADIO DIGEST

TELEVISION THEATRES are now operating in London with two major companies making installations. The large screen television projector, as installed by Scophony for the Odeon Theatre in London, is shown herewith. As was explained in

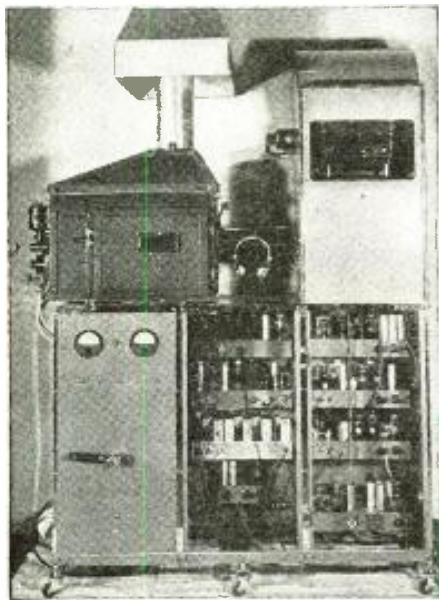

the February issue of RADIO & TELEVISION, the Scophony system makes use of mechanical scanning and a light storage modulator cell. The image detail used in England is 405 lines, as compared with the 441 lines used by American systems. The size of the image obtainable with this Scophony apparatus approximates regular standard theatre motion picture screen size. Back - of - screen projection is generally employed, a portable screen being mounted on the front of the

stage when no translucent screen is already in the theatre.

EUROPE'S TALLEST radio mast is said to be at Herzberg, Saxony. It is 1,111 feet high and is used by the new 150 kw. station, the power of which is soon to be increased to 200 kw.

APPROXIMATELY 75% of man-made static can be eliminated, according to the *RCA Family Circle*. The article states that 25% of all neon signs cause static because dirt is allowed to collect on the tubes. Other offenders are thermostats in tropical fish tanks and heating pads, electric razors, oil burners, ignition systems and horns of automobiles. However, the prime cause is the diathermy machines in use by doctors.

Television Talk « « ←

Hello, Andrews." (Fortunately his exclamation is printable!) The demonstration was conducted by RCA engineers with duplicate sets of equipment like that now on display in the RCA Exhibits at the New York and San Francisco World's Fairs. Each participant stood before a television receiver under a battery of lights. Behind the receiver, and facing him, was a television pickup and a microphone. Thus there was complete sight-sound reception and transmission in both studios. In a viewing room adjacent to one of the temporary studios, television receivers placed side by side showed both images and made both voices audible.

Following the demonstration, Mr. Andrews said, "If television takes the strides which have characterized the radio industry, it should go a long way toward solving the unemployment problem."



BRITISH TELEVISION trucks are used much like those in America to pick up special events for the benefit of televiewers. Above is seen the scanning truck outside the stage entrance of the Phoenix Theatre from which *Twelfth Night* was telecast. At left are the television transmitting station at Woldford Junction and, left to right, the aerial truck, the power truck, and the scanning and transmitter truck.



ALTHOUGH Dr. W. R. G. Baker, head of G-E's radio and television division, believes that *frequency modulated* transmissions will "be filling the air in the major markets in this country within the next year," he does not think that our present radios will be obsoleted in the near future. While some authorities do not agree with the first part of Dr. Baker's prediction, all agree with the latter portion.

PEAK LIMITING amplifiers now allow W2XAD and W2XAF to transmit their programs at a higher power level. This has the effect of doubling the carrier power of these two G-E stations.

THE DEAF will find television a new means of entertainment, according to Mrs. Evelyn Sass, 1930's national lip-reading champion. Viewing a G-E exhibit at the New York World's Fair, Mrs. Sass was able to understand many of the words said over the television system by watching the lips of the announcer.

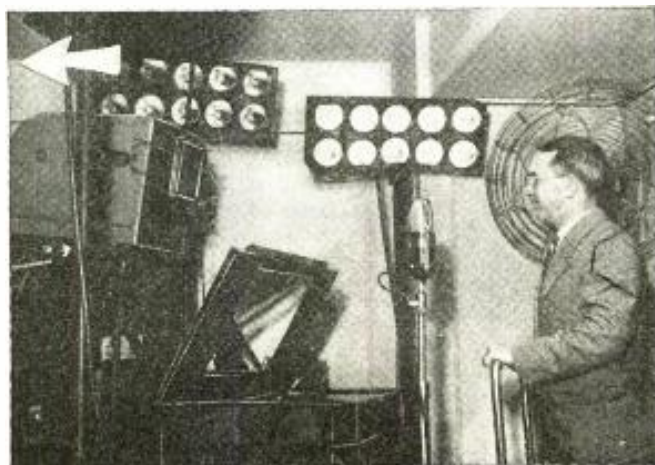

Here is Handsome
New PLAQUE
"Award of Honor"

Given Monthly
 for the Best

Amateur Station
PHOTO

●
 First **PLAQUE** Awarded
 to

Freeman F. Gosden, W6QUT
 ("Amos" of "Amos 'n' Andy")

Palm Springs, Calif.

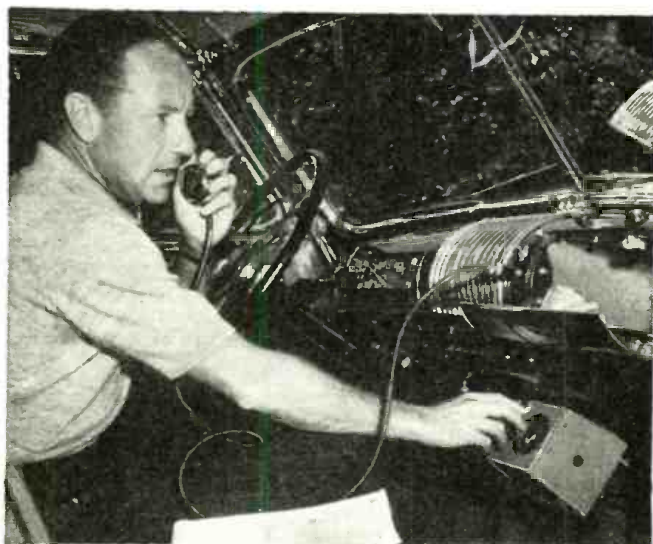

"Amos" (Freeman F. Gosden), of the famous team of "Amos 'n' Andy," has become a Ham, and the portable set installed in his car is shown above.

● "AMOS" (Freeman F. Gosden), of the famous "Amos 'n' Andy" team, is the winner this month of the new **RADIO & TELEVISION Honor Award Plaque**, shown on this page.

Mr. Gosden has become an enthusiastic "ham," as the accompanying pictures show, and he has two sets—one at home and one in his automobile. The home station, W6QUT, is housed in a specially built radio shack at Palm Springs, Calif. Mr. Gosden uses a Collins type 30J transmitter, with a capacity of 250 watts

RADIO & TELEVISION

THIS
Award of Honor
 Presented to

Freeman F. Gosden

by

RADIO & TELEVISION
MAGAZINE
 for the
 Best
PHOTOGRAPH
 of an
AMATEUR RADIO STATION
 Submitted in the monthly
 Amateur Station Photo Contest

H. Gennsback, Editor

Here is the new "Award of Honor" Plaque which measures 5" x 7" in size. It is handsomely executed in colors on metal, and can be framed and hung on the wall. The letters appear in black against a beautiful red background, and we are sure that our amateur friends who are awarded one of these new "badges of merit" will be more than pleased with it. The name of the winner will be suitably inscribed.

output. The receiving equipment includes an RME-69 and a DB-20 pre-selector.

On the portable automobile transmitting and receiving station, Mr. Gosden uses a telescopic antenna fastened on the rear bumper. The microphone is kept in a small storage compartment in the dash panel, and when in use, it is plugged into a jack located near the speedometer. The converter apparatus is installed in the space under the auto-instruments. A 15-watt input transmitter and battery charger are kept under the roadster's turtle deck.

(Continued on page 371)

Here is Freeman F. Gosden—"Amos" to you—at his home transmitter, W6QUT.



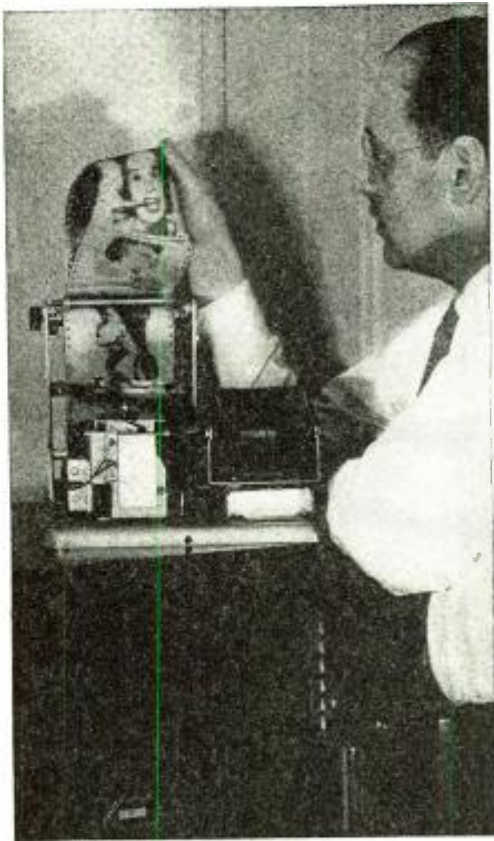

Some of the particularly fine facsimile pictures received by the author on the home assembled Crosley kit using the Finch system are here reproduced.

The Crosley facsimile "kit" receiver set up in the author's home—the pictures were picked up on the WOR broadcast wave (710 kc.)

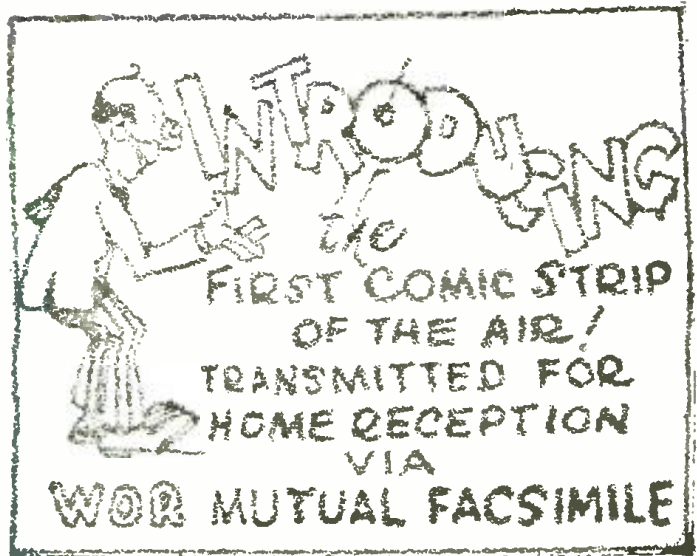

Facsimile Recorder

Assembled in 4 Hours

Robert Eichberg

● **PERHAPS** the cleverest bit of packing that the writer has ever seen is that used in the Crosley "Reado" Kit. Inside the shipping carton are a set of instruction sheets and four corrugated cardboard boxes lettered A B C and base plate. If the constructor follows the instructions, he cannot go wrong, for they tell him just what parts to unpack for each stage of assembly.

For example, the first of the inner boxes (A) contains the framework for the paper rack and several small envelopes, AB, AC, etc. One envelope contains the parts necessary for assembling the lower paper roller; another contains the upper paper roller and shaft, another the drive gears, etc. The assembly is absolutely fool-proof except for the lower paper roller, for on this must be mounted two toothed wheels which must fit into the holes on the sensitized paper. The easiest way to space these wheels correctly is to tear a length off the roll supplied with the kit and use this as a guide for proper spacing. It is also suggested that the assembler have a few standard screws

and washers available. The only tools needed in the assembling are a pair of pliers, a medium-sized screwdriver and a soldering iron.

Facsimile pictures are being transmitted on ultra short waves as well as on certain broadcast waves from stations in all parts of the country. The present article describes how one experimenter put together a facsimile receiving kit, and some of the pictures he received are reproduced on this page.

Although the instructions tell how to assemble the stylus and scanning arm, the constructor gets a real "break" from the manufacturer, for this unit comes com-

pletely assembled. Even if it did not, the assembly is simple and would not take long to do. Another advantage which the constructor gets is that although explicit instructions are furnished for wiring up the electrical circuits in the sub-chassis using the OZ-4 tube, this, too, comes completely wired.

It required exactly 3 hours and 50 minutes to assemble the kit from start to finish.

The Reado unit was then connected to the output of an RAE-84 (RCA Victor) 12-tube broadcast receiver. This set has a rated output of 20 watts. Connections were made in a variety of ways to see which would afford best results. The most successful connection was directly from the plates of the power tubes to the outer terminals of the transformer in the Reado unit, through two .25 mf., 600 volt fixed condensers. No changes were made in the broadcast receiver, the connections being made directly to the plate prongs of the two power tubes.

(Continued on page 371)

Below: A sample of pictorial material as received through the air. Text and halftone (photographs) are also reproduced very well.



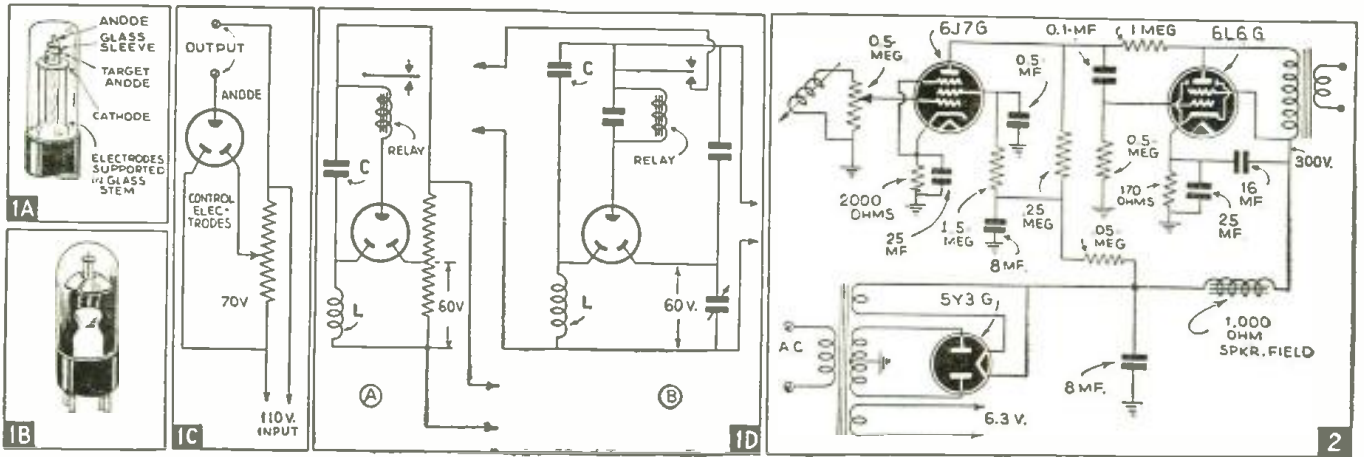

Cold Cathode Tube

1 SOME new cold cathode tubes were recently described in a French publication, *La Nature*. In these new tubes, shown at Figs. 1A and 1B, electronic emission is produced by the well-known Villard effect. The tubes are filled with some such rare gas as argon, neon or helium at low pressure. Either two or three electrodes are employed and these are of different forms. For example, in Fig. 1A, the anode is a metal rod while the cathode is a disc. Similar to certain American tubes is the second model, shown at Fig. 1B. This has two half discs as the control electrodes and a nickel wire anode. A hook-up for utilizing a tube of this sort in a radio circuit is shown at Fig. 1C, while Fig. 1D shows various ways of using such tubes to operate relays.

An Economy Amplifier

2 A LOW-COST amplifier for use in such applications as public address, phonograph pick-up, or even to hook on after the detector stage of the set, is shown in Fig. 2, taken from *The Australasian Radio World*. The set uses inverse feedback.

The tubes used in the receiver described are readily obtainable in the United States, and a complete list of parts for the 7-watt, high-fidelity low-cost amplifier follows:

1 power transformer, 385 v., C.T., 385 v., 6.3 v., 80 ma.; 3 octal sockets; 1 4-pin wafer socket; 1 small knob; 1 500,000-ohm potentiometer. Fixed resistors: one each .05 meg., 1-watt carbon; .5 meg.; 1-watt carbon; .25 meg., 1-watt carbon; 1 meg., 1-watt carbon; 1.5 meg., 1-watt carbon; 2,000 ohm wire-wound; 170 ohm wire-wound. Fixed condensers: one .1 mf. tubular; one .5 mf. tubular; two 25 mf. electrolytic. Tubes: one 6J7G, one 6L6G, one 5Y3G. One 12-inch speaker to match single output pentode, 1,000 ohm field.

Steering by Television

3 A SIMPLE means of navigating by television is described in *The Wireless World* of Britain. The arrangement shown in Fig. 3A illustrates how a beam is radiated from a loop aerial, L, rotated at a constant speed by a motor, and mounted on a compass scale, S. Suspended just below S is an indicator, I, which carries identification letters of the station but does not rotate. A beam of light, focused on I and S, is reflected, and these rays are passed through a scanning disc, K, to a photoelectric cell, P, which feeds television signals through an amplifier, A, and modulator, M. The latter is also supplied with a carrier wave from an oscillator, O, and the modulated output is fed back to the loop

aerial. Thus the loop radiates an image showing the identification indicator, I, together with the particular point of the compass through which the beam is passing at any given moment. Fig. 3B shows another means of transmitting direction, in which a non-directional aerial is used with two or three scanning lines omitted.

Fig. 3C shows two known beacon stations at A and B, so that a receiver at O can determine its position, by means of an automatic make-and-break system that produces a fluorescent image indicating position.

Short-Wave Autodyne Converter

4 A SIMPLE short-wave converter for autodyne reception was recently described in *Radio Technica* of Buenos Aires. As shown in Fig. 4, the circuit is very simple, using standard parts throughout. The tubes are a dual diode-triode and a dual diode. The value of the resistances in the filament circuit will depend upon the filament voltage required for the tubes selected by the experimenter. The only parts which are not standard are the coils L1, L2 and L3, which are wound on 1 1/2" plug-in forms. Specifications for three bands:

Band	L1	L2	L3
20 to 40 m.	3 turns	7 turns	3 turns
40 to 80 m.	5 turns	10 turns	5 turns
80 to 200 m.	8 turns	27 turns	8 turns

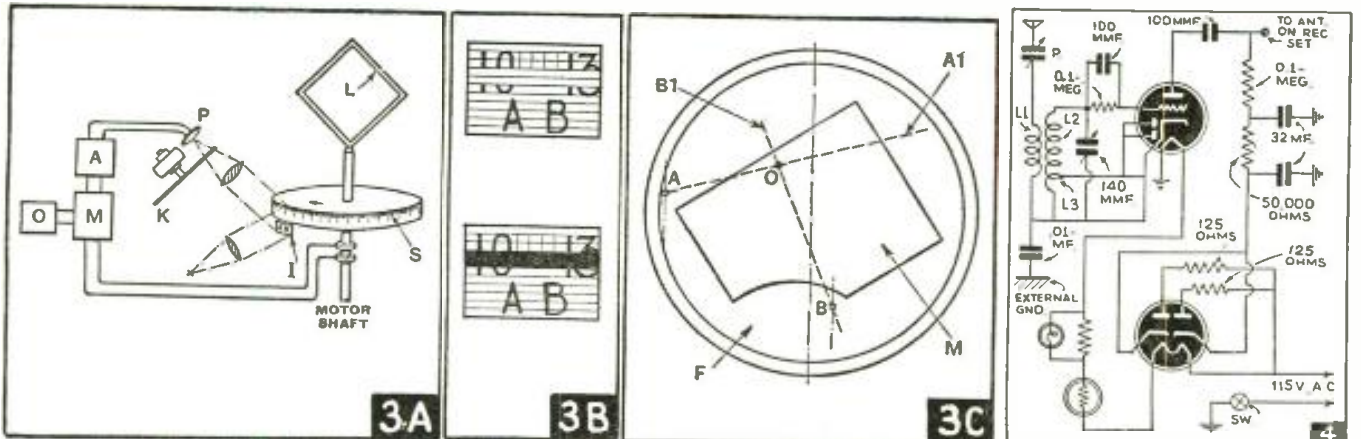

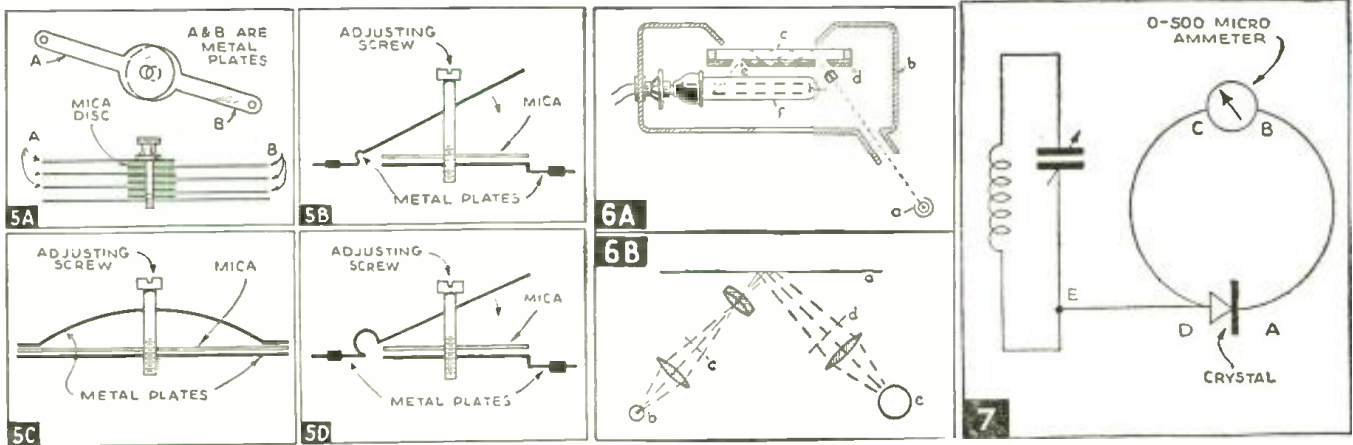

Experimentation in spacing windings may be necessary for best results. The wire to use is No. 24 s.c.c.

Adjustable Condensers

5 AN interesting article on various forms of trimmers appears in *La T.S.F. Pour Tous* of France. Fig. 5A illustrates a rather primitive form which makes use of alternate discs of mica and metal, the latter being provided with connecting tabs. More or fewer of these metal discs may be connected in the circuit, as desired. Fig. 5B shows a more familiar type which makes use of one fixed plate and one flexible plate controlled by a screw. Fig. 5D is similar, but an additional bend has been put into the movable plate in order to increase the flexibility. Fig. 5C shows a still simpler method in which the movable plate is bowed.

Optical Microphone

6 IN a new patent recently granted to Marconi's Wireless Telegraph Co., Ltd., and G. B. Banks, a light beam is used in a high fidelity microphone. In Fig. 6A, light from a source, A, is passed through an aperture in the microphone casing, B, and falls obliquely on the reflecting surface of a thin ribbon, C. The ribbon, C, is supported at the ends parallel to a second rigid mirror, D. The light is reflected back

and forth from this mirror, and so on, until (after a predetermined number of reflections) it is brought to a focus on one edge of a slit aperture, E, near the other end of the rigid reflector. Some light (about 50 per cent in the static condition) is passed through this aperture onto a photo-electric cathode of a normal electron multiplier, F. Acoustic vibration of the ribbon reflector will vary the amount of light reaching the photo-electric cathode, and the microphone output is taken from the output electrode of the electron multiplier.

In a modification of this system, as shown in Fig. 6B, A is the ribbon-like deflecting diaphragm, B the light source, and C and D two optical gratings composed of alternate equal opaque and transparent strips. In the absence of incident sound, the image of the first grating is displaced by one half strip with respect to the second grating, so that 50% of the light passes through. On displacement of A by incident sound, the image of C moves over D, so that the amount of light reaching the photo cell or electron multiplier E is varied.

U. H. F. Wave Meter

7 FIG. 7, taken from an article by H. R. Heap (G5HF) writing in *The T. & R. Bulletin* of England, shows a sensitive and selective U.H.F. wave meter. In this

circuit, the distances A-B and C-D should be about four inches for use on 56 megacycles or thereabouts. The wire E-D is to be kept as short as possible—the shorter it is, the more sensitive the meter. With this meter, accurate readings were possible three feet away from a wire carrying 100 ma. of R.F. at 58 mc. Selectivity was so good that a vernier dial had to be fitted to the apparatus. Tuning had to be conducted with an insulated extension handle. A fixed crystal detector should be employed. The values of the coil and condenser will depend upon the frequencies to be measured.

Phase Inversion Methods

8 GOOD push-pull transformers are costly, but by the use of phase inversion, resistors can be used in a push-pull system. An article appearing in *Radio Trade-Builder* shows several such circuits.

Fig. 8A gives one method in which 180 degree phase shift may be had. The second tube in this diagram, it must be remembered, does not provide any gain whatsoever.

In Fig. 8B, the phase inverter tube may be considered as an alternator, generating audio frequency voltages. Thus the plate is positive when the cathode is negative, etc., as far as A.F. voltages are concerned.

(Continued on page 371)

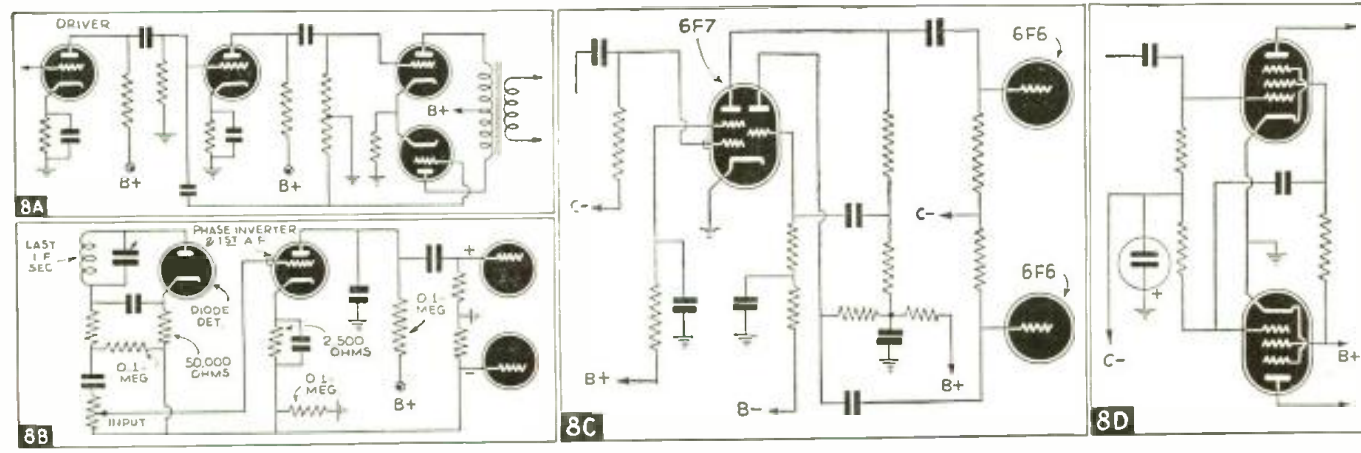

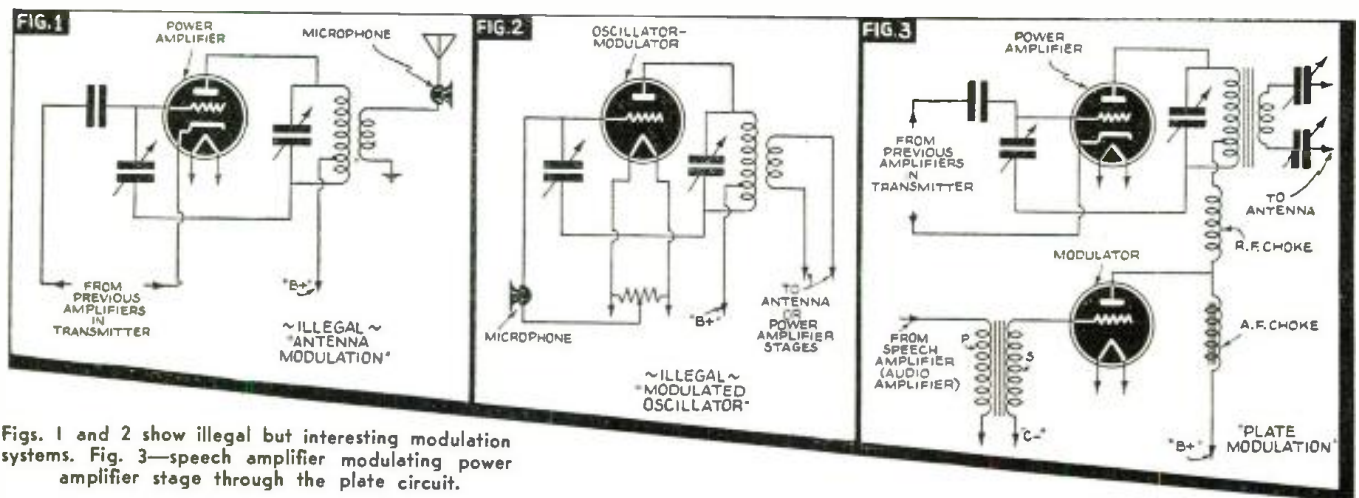

Figs. 1 and 2 show illegal but interesting modulation systems. Fig. 3—speech amplifier modulating power amplifier stage through the plate circuit.

Getting Started in Amateur Radio

C. W. Palmer, E.E.
Ex-W2BV

6th Lesson—
MODULATION

● IN THE design of *phone* transmitters, consideration must be given to the method of varying the output by means of the human voice, music or other characteristic sounds. The ham transmitter that we have made so far in this series has consisted of an oscillator to generate radio-frequency signals, an amplifier to make the signals stronger and to increase the frequency when desired, and a power supply unit to supply the tubes of the transmitter with plate voltage and filament current.

This transmitter must be equipped with some means of *modulation* to be used as a phone transmitter.

There are several types of modulators and a brief description of the types will be given.

Simplest Modulators

The simplest modulator would be a microphone connected between the transmitter and the aerial, as shown in Fig. 1. However, such a microphone would have to carry the full current supplied by the transmitter and unless the latter was very tiny,

the microphone would undoubtedly burn up in a short time. There are other disadvantages, too. Such a modulator would *cause the frequency of the transmitter to vary* and with strict government supervision, this is not allowed. (Modern frequency modulation is something else again!)

Next, comes the combined oscillator-modulator which uses the same tubes for generating and amplifying as for modulating. This, too, is impractical because of *instability* and variation of the oscillator frequency. Fig. 2 shows the general idea of this system in block form.

There are several other simple ways of modulating a transmitter for voice and music, but each has its disadvantages and so we will omit them.

The first practical modulator—and perhaps the one used most commonly in amateur systems—is the “plate modulation” method (Fig. 3). In this system, the microphone is connected through a series of amplifiers to the plate circuit of the last amplifying tube in the transmitter.

It will be seen that this is a variation of the first method (Fig. 1) but the amplifiers are added to increase the strength of the voice variations and to separate the microphone from the heavy currents of the power amplifier. The amplifier in the modulator unit is very similar to the audio amplifiers used in radio receivers and public-address systems, but instead of being connected to a loudspeaker, it is connected to the output of the radio transmitter. Modulator amplifiers may be either Class A, Class A prime, or Class B, just like audio amplifiers and in modern ham transmitters (for economy reasons) Class B is used most frequently.

The second type of modulator is known as the “grid-bias modulation” method (Fig. 4). Instead of feeding the modulation signals into the plate circuit of the power amplifier of the transmitter, they are fed into the control-grid circuit of this amplifier tube. The advantage of this circuit is that a smaller amplifier can be used in the modulator than with the plate

(Continued on page 363)

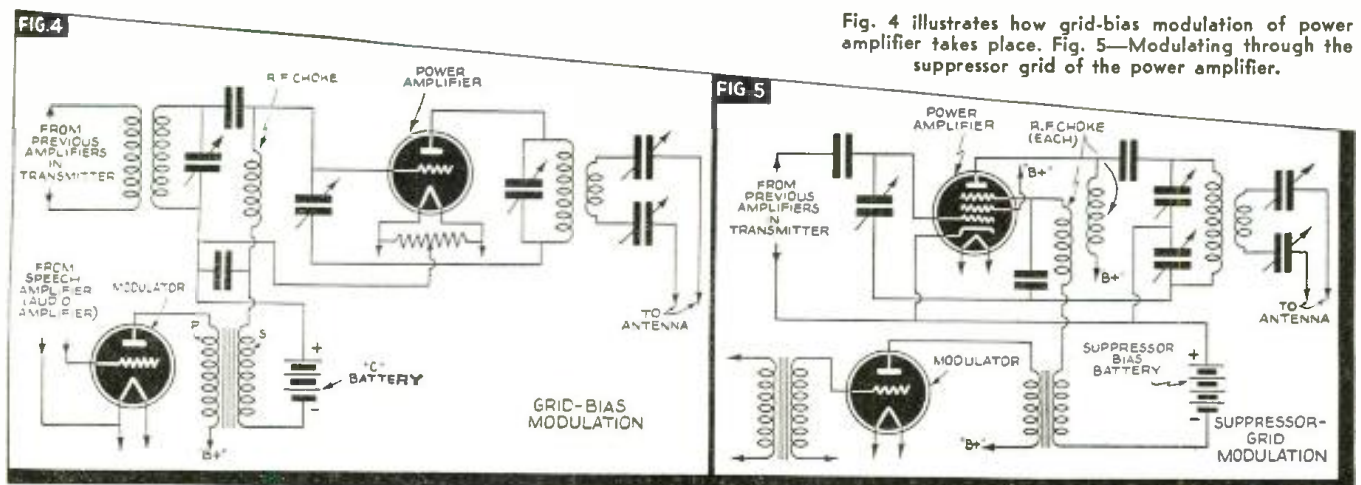

Fig. 4 illustrates how grid-bias modulation of power amplifier takes place. Fig. 5—Modulating through the suppressor grid of the power amplifier.

Peaking Image and Sound Stages In Television Receivers

How to Adjust the Sound I.F.; "Sound-Trap"
Trimmers and the R.F. Alignment

Harold J. Heindel

Chief Engineer, Andrea Radio Corp.

● SURPRISING as it may seem, the adjustment and alignment of a television receiver is less complicated than similar operations on an all-wave sound receiver. The prevailing idea that complicated and mysterious rites must be performed on a sight-and-sound set is due to lack of familiarity with new circuits.

While it is necessary to impress upon the uninitiated set owner the importance of leaving the trimmers and R.F. condensers strictly alone, servicemen and set builders should have the experience of making these adjustments on a complete television receiver, so that they will be able to tackle any type of television receiver with complete confidence based on knowledge.

Accordingly, the steps for setting the sound I.F. and sound trap trimmers used in most television receivers, and the R.F. condensers are given here. You will see that only standard instruments are required, and that the adjustments can be carried out in complete safety. While these instructions are designed for Andrea televisions, they also apply to other makes.

ADJUSTING SOUND I.F. TRIMMERS: Following are the steps in which the sound I.F. trimmers should be adjusted:

1. Remove the 879 or 2Y2 high-voltage rectifier tube as a measure of safety.
2. Connect a signal generator to pin 4 of the 1852 modulator tube. Set the generator accurately at 8.25 mc.
3. Put a rectifier-type meter across the voice coil of the loud-speaker. It is preferable to use a meter having 2000 ohms per volt.
4. Adjust audio I.F. and A.V.C. trimmers, B, C and D for

maximum output, as indicated by the meter. After the initial adjustments, go over them carefully a second time.
(Continued on page 369)

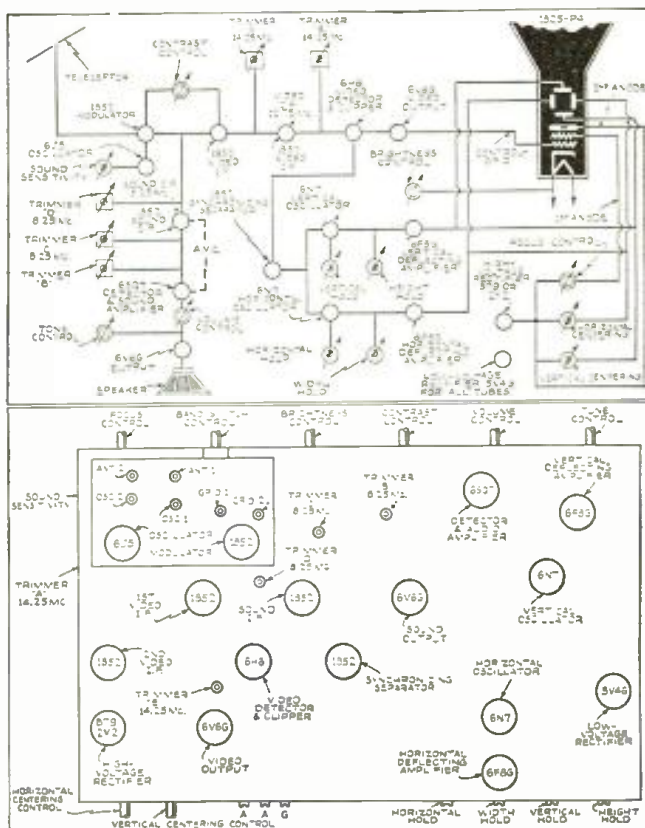

These two diagrams, with the aid of the accompanying explanation, will help the experimenter "hunt bugs" in television receivers.

10-inch Images on 5-inch Television Set

● IF you are like the majority of radio experimenters (and, incidentally, like the writer), you never, never throw anything away. While this may be distressing to your family, it can stand you in good stead. For example, one of the components of an old Jenkins television receiver—vintage of about 1927—made it possible to secure pictures much like those obtainable from a 12-inch cathode-ray tube, although the set in use employed only a 5-inch tube.

This lens assembly consists of two plano-convex lenses arranged in a shadow-box mount. The smaller lens is approximately 6" in diameter; the larger about 11". The lenses are so positioned and are of the correct curvature so that when an object is placed one or two inches behind the smaller lens, which it fills, it is made to fill the larger lens with very little optical distortion. Therefore the writer mounted the assembly with the smaller lens about 1 1/2" in front of the screen of the National Union cathode-ray tube employed in his Andrea KTE-5 television receiver.

The images appearing on the 5" tube
(Continued on page 362)

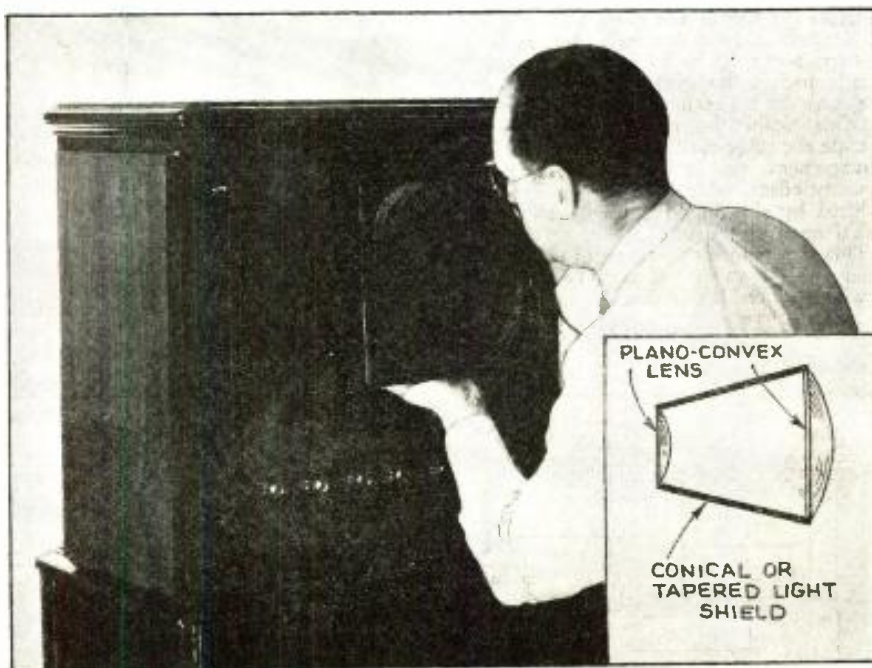

Variable Voltage Transformer

● MANY times the experimenter wishes to obtain a reduced A.C. voltage for operating or testing various apparatus. There is on the market at the present time a series of variable voltage transformers which will supply a higher or lower voltage than that supplied by the line. The secondary winding is usually made of bare wire and a switch plate attached to a rotary knob can be moved over the turns of this

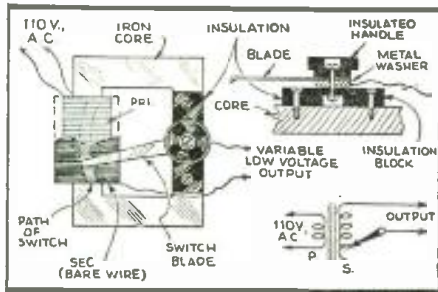

How to make a variable voltage transformer.

bare winding, so as to provide any desired voltage within the range of the transformer. If the secondary is made with the same number of turns and size of wire as the primary coil, then voltages lower than the line potential may be obtained by moving the switch across the various turns of bare wire in the secondary. If the secondary has more turns than the primary, then a higher voltage than that applied to the primary may be obtained whenever the switch is moved so as to include more turns than those of the primary. If the primary has 100 turns, for example, and the secondary 120 turns, then with 100 volts applied to the primary, as high as 120 volts can be obtained from the secondary, and lower voltages in proportion, depending upon the position of the secondary switch.

Simple Photo-Electric Cell

● A TYPE '45 tube may be used as a photo-electric cell when connected as shown in the accompanying drawing. A '45 tube, which has no mica support at the top of the elements should be used, since—apparently—the grid is the active element in the photo-electric emission which occurs. The light is made to illuminate the grid through the top of the glass bulb and the filament should be operated at a reduced voltage, about 1.5 to 1.7 volts. No connection is made to the grid, and the plate voltage may be between 15 and 25 volts, depending upon the current necessary to operate the relay used with the circuit. This arrangement will show a slight body-capacity effect, which can be eliminated or reduced by shielding the tube, leaving the shield open at the top.

This is a unique experimental circuit and other tubes than the '45 may be tried and possibly much better results obtained.—
J. A. SCHINDLER.

Diagram of hookup using photo-electric cell.

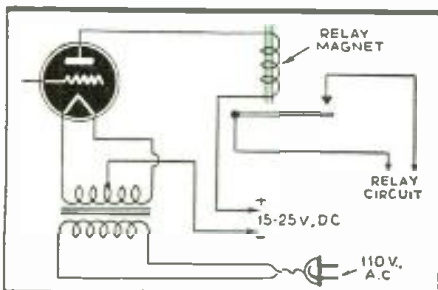

This is YOUR department and you can help to make it a very "live" one by sending your favorite radio "idea" to the editors. Photos are welcome, but pencil or pen and ink sketches will do—our draftsmen will remake all drawings. Just write a simple but accurate description of the idea and keep it within 500 words.

Practical

The Twinplex

Allan

2 Tubes Work as 4

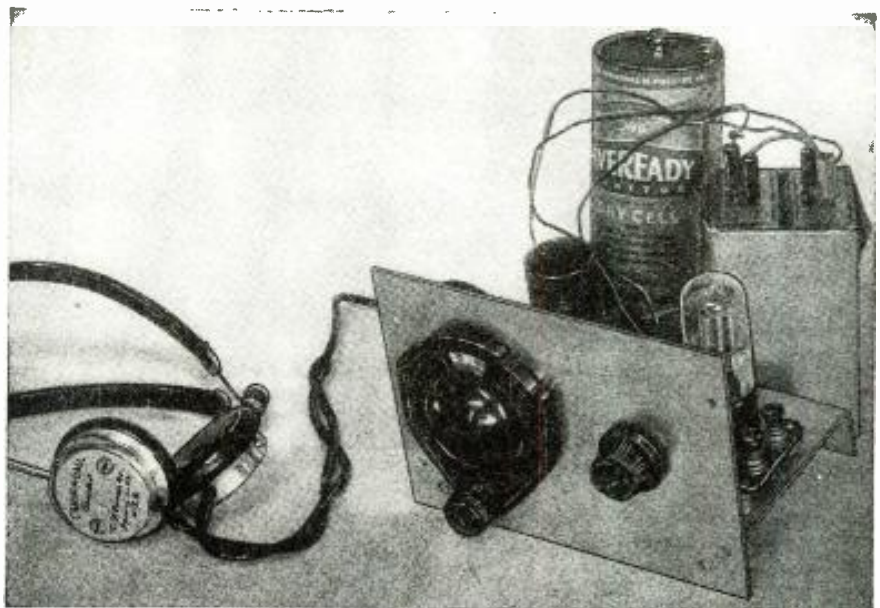

In the modernized Twinplex receiver here shown, one tube does the work of two. Plug-in coils permit all-wave coverage.

● BOY, how it rolls 'em in! Space is no limit! This new Twinplex certainly lives up to the enviable reputation of its two predecessors. Remember the first Twinplex? —the one using a type 53 tube, way back in the October 1933 issue of *Radio and Television* (then called *Short-Wave Craft*). What a hum-dinger that was and what a furore it created among short-wave fans! It was hardly out in print when manufacturers and mail-order houses started selling kits of it—by the hundreds. The type 53

tube made such a set possible. This tube was among the first duplex types put on the market, a tube containing two sets of elements (triodes) in one glass envelope.

Then came the "19 Twinplex." And now we have the "1G6G Twinplex"—the modern counterpart of the "19" set. The "1G6G" tube, basically, is a twin-triode class "B" amplifier, but may be used as a class "A" amplifier with good results—which is exactly what we do in the output section of our circuit. (See Fig. 1.) The

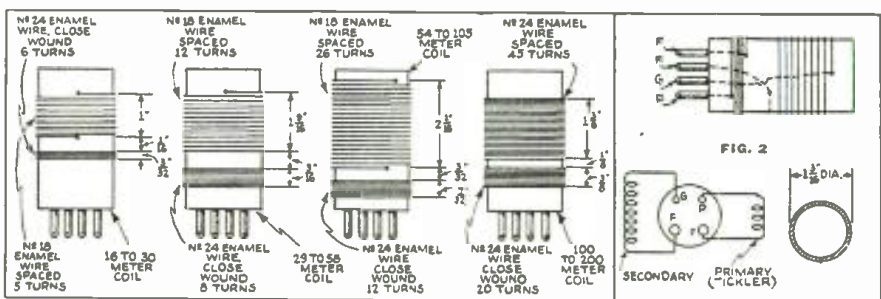

Radio Ideas

All articles accepted by this department will be paid for at regular space rates. Each month the editors will select the best article and it will receive a special price—double the usual space rates.

Address all articles, photos and diagrams to the Editor, Practical Radio Ideas, c/o RADIO & TELEVISION, 99 Hudson Street, New York, N. Y.

Again — But Modernized

Stuart

This Month's Feature

other section of the tube is used here as a gridleak-type detector. The high amplification factor (30) of this tube gives plenty of "umph" to the set.

As with the preceding "Twinplex," this receiver uses resistance-capacity coupling between the detector and amplifier sections of the circuit. Regeneration, however, is controlled by means of a 140 mmf. variable condenser instead of a potentiometer in the plate circuit of the detector. The output section of the tube receives its grid bias via the voltage drop across the 400-ohm resistor

between B- and chassis. Regarding the coils, these are home-made, wound on good grade bakelite forms and designed to cover the range of 16 to 200 meters without jumps. Complete specifications for winding these coils are given in Fig. 2.

The chassis is made of 1/16-in. aluminum, the front panel measuring 7 x 5 ins. and the sub-chassis 7 x 4 ins., with 1 1/4 ins. front and rear skirts.

Mount the 2 variable condensers on the front panel as shown in the illustrations. (Continued on page 366)

Fig. 1. Wiring diagrams for the Twinplex, both schematic and pictorial, are given below.

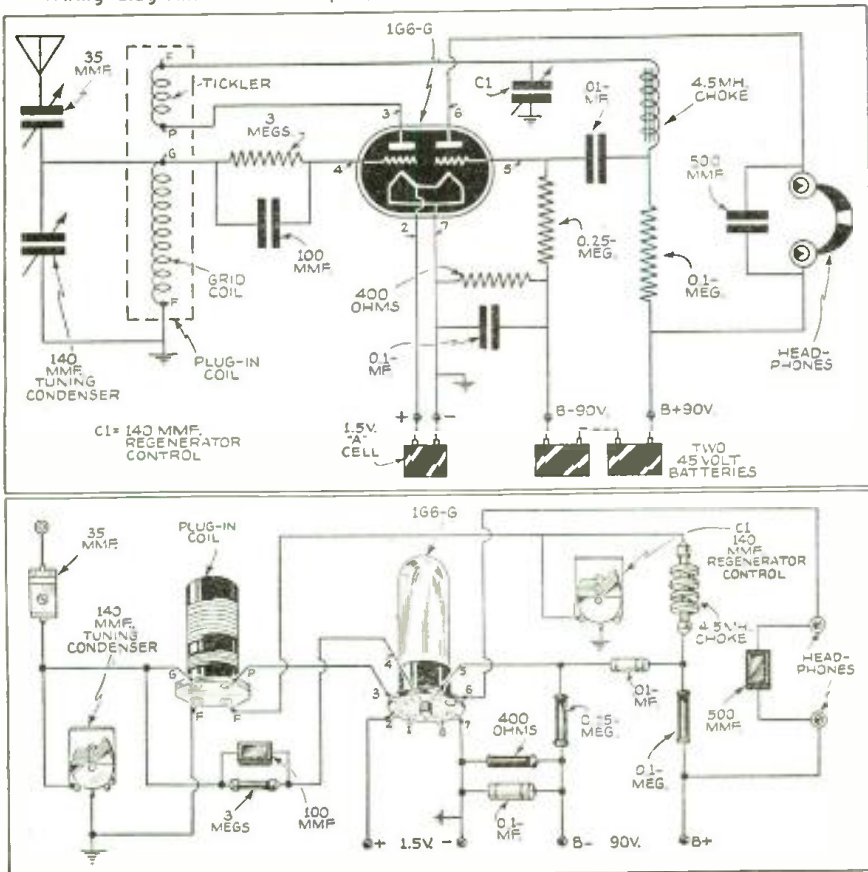

A Simple Monitor for the Ham

THE diagram herewith shows my favorite monitor which is completely self-contained and was built from an old transformer case measuring 4" x 4 3/4" x 5 3/4". This monitor is built entirely of odd parts found about the average Ham shack, and even the tubes were found on a local serviceman's scrap heap! This monitor, nevertheless, produces a pure D.C. signal and

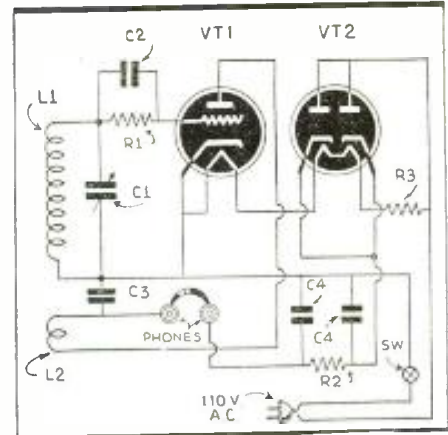

Midget monitor, made from spare parts, checks signals of ham "rig" in phones.

shows immediately any trace of modulation on my c.w. carrier. The list of parts for building the monitor are as follows: C1, 100 mmf.; C2, 250 mmf.; C3, .01 mf.; C4, dual 4 mf., 150 v.; R1, 100,000 ohm; R2, 5,000 ohm (10 watt); R3, 30 watt bulb; L1, 35 turns No. 24 d.c.c., 1 1/4" dia.; L2, six turns No. 24 d.c.c., 1 1/4" dia.; VT1, 76; VT2, 25Z5.—H. E. Eddy, W8MTZ.

An Edge-Glow Sign

THIS edge-glow electric sign will appeal to radio experimenters in general and to the Ham in particular. The sign is made from a piece of 1 1/4" plate glass, measuring about 3" x 7", with the Ham call letters or personal initials sand-blasted (or etched) on the surface of the glass. The piece of glass is mounted on a wooden base measuring about 1" x 2 3/4" x 8 1/2". By using 6-volt pilot lights concealed in the base, so that the light shines edgewise up through the glass, a very weird and beautiful effect is obtained. You have probably seen similar signs used for advertising perfumes, etc., in drug store windows, but here is how to make one of your own. This sign is particularly useful for illuminating house numbers and, of course, is ideal for the Ham's station call.—WILLIAM A. J. DEAN.

Easily-made electric sign adds distinction to Ham shack or SWL listening post.

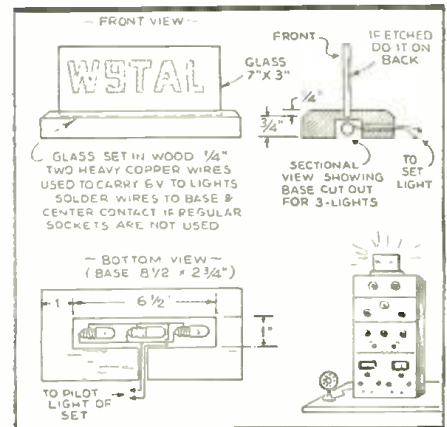

More Experimental Ideas

A.C.-D.C. Photo Cell Hookup

● THE radio experimenter often desires a simple hook-up for a photo cell, such as the 868 tube, with a suitable amplifier. The diagram herewith shows how to use an O1A tube as an amplifier for such a photo cell, together with a relay for opening or closing lamp or motor circuits, etc. The parts required for the photo cell circuit are simple and of low cost, the parts being available in most radio stores. The coupling between the photo cell and the amplifier tube is adjusted by the 400 ohm potentiometer, and the circuit shown will operate on 110 volts A.C. or D.C. The list of parts for building up this circuit is here given: One 868 tube; one O1A tube; two 4-prong sockets; one resistor, adjusted to 350 ohms; one 4,000 ohm resistor; one 6,000 ohm resistor; one 100 ohm resistor; one 5 meg. ohm resistor; one 2 mf. condenser; one 400 ohm potentiometer; one relay, 100 watt non-inductive load; one switch; one line cord.—*Courtesy Radio Wire Television, Inc.*

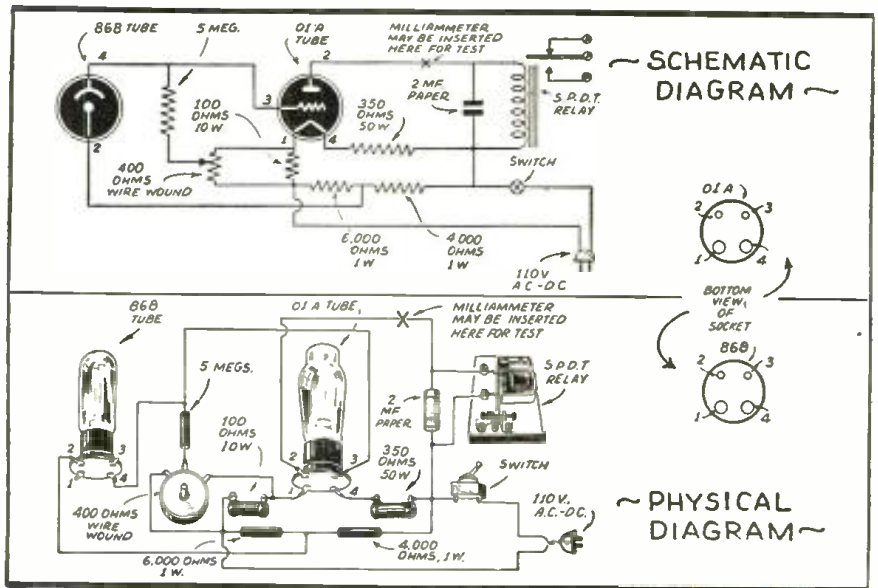

Above: Schematic and picture diagrams, showing how to build the A.C.-D.C. photo cell circuit.

Uses for Old Fuses

● IN the accompanying picture we see some ingenious uses for old plug fuses. They may be used as an insulating support for R.F. chokes, or they may serve as a soldering iron holder, as a base for antenna rods, insulating feet for platforms, stand-off insulators and what-not. The porcelain part of the fuse has a fairly high insulating value, and for many radio purposes the metal parts should be ripped off of the porcelain base with a pair of diagonal cutting pliers.—*LOUIS PASCAL, W2LTQ.*

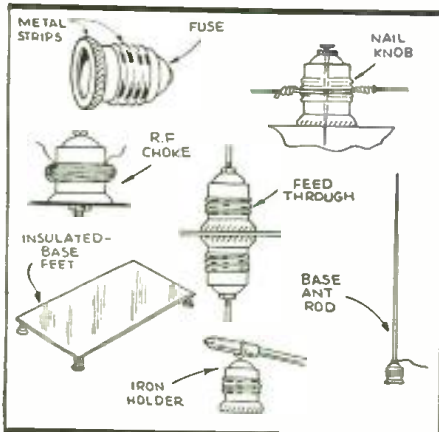

Save your old fuses! You can use them in one of the many ways shown above.

Larger Television Images

● THE television experimenter is usually handicapped by the use of a small cathode-ray tube and he is always trying some method whereby to enlarge the small image. The accompanying sketch shows how a "close-up" photo can be obtained. By simply adjusting the sweep controls on the television receiver, the picture is enlarged so that the head of a person, for instance, appears from one and one-half times to twice the size that it ordinarily would. The picture will over-run the round screen on the end of the tube but, all-in-all, several viewers inform us, people enjoy the re-

production much better because the faces, for example, are much larger. It is best to view the images a little farther away when the images are enlarged in this manner.

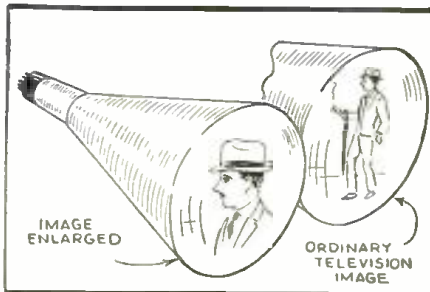

A little fiddling with the size controls of a C-R tube makes every image a close-up.

Voltmeter-Ohmmeter

● THE circuit diagram illustrates a very useful instrument for the radio man—a combination voltmeter, ohmmeter and milliammeter measuring circuit. This instrument will measure resistances up to 100,000 ohms, voltages up to 1,000, and currents up to 100 ma. The parts required for building this simple yet effective measuring instrument are: One Beede 0-1 m.a. meter; one scale (special); one 4,000 ohm, 1 watt resistor; one 10,000 ohm resistor; one 100,000 ohm resistor; one 500,000 ohm resistor; one 1,000,000 ohm resistor; one fuse and fuse-holder; eight binding posts; two switches; one 0-1,000 ohm control (variable resistor); one push button; one 7" x 10" panel; one 100 m.a. shunt; one 4½ v. battery; one wire and hardware assortment.—*Courtesy Radio Wire Television, Inc.*

Below: Schematic and picture wiring diagrams of an easily made all-purpose Volt-ohmmeter.

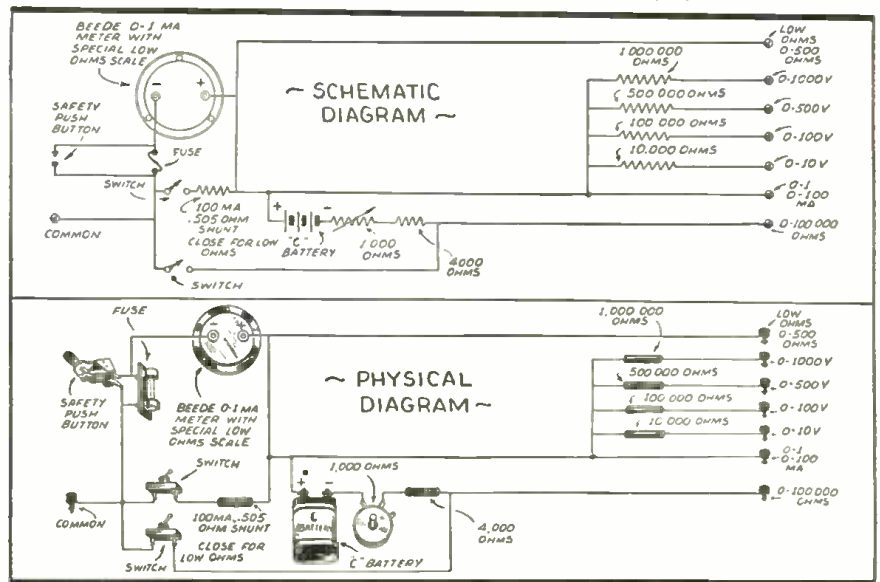

"Half-Pint" Portable

H. G. Cisin, M. E.

2 Tubes do work of 4 in this Receiver. Range 10 to 560 Meters. Uses 110 Volts A. C. or D. C.

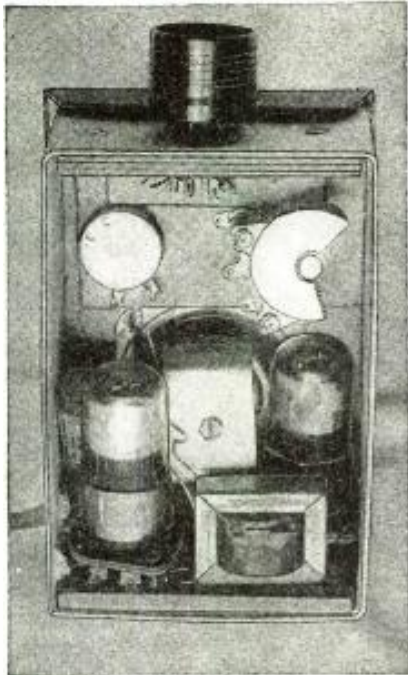

Rear view of the "half-pint" receiver. The 2 dual-element tubes give 4-tube results.

midget, dual-purpose tubes so that 4-tube operation is actually obtained. It also uses a new development in loud speakers, a 2" P.M. dynamic speaker, claimed to be the smallest loud speaker in the world. The performance of the set is really amazing, since it operates like a standard four-tube receiver with plenty of volume and with other features generally found only in full size sets.

One of the tubes employed is a 12B8GT which consists of a pentode section and a triode section. The other tube is a 32L7GT, consisting of a beam power output pentode section and a diode section. The pentode portion of the 12B8GT is used as a regenerative detector, while the triode section serves as a first audio stage, feeding into the pentode portion of the 32L7GT. The output of this last pentode operates the P.M. dynamic speaker. The diode section serves as a *rectifier*.

Resistance coupling is used between each of the audio stages. Filtering is accomplished by means of a resistor between the cathode of the rectifier and the high voltage points of the set, such as the plates and screen grids, the resistor, being by-passed at its input and output by means of etched foil, midget type electrolytic condensers.

Plug-in coils are used to cover the *short-wave* bands. The tuning is accomplished by means of a midget size .00014 mf. variable condenser. The control for this variable condenser can be seen at the left of the receiver. The other control is the combined "on-off" switch and regeneration control potentiometer. The power supply is of the standard A.C.-D.C. variety, the ballast resistor being included in the line cord.

The two tube sockets are mounted on a small wooden base which fits into the lower end of the carrying case. The output transformer is also mounted on this base. A similar base is made for the other end of the case, but this is

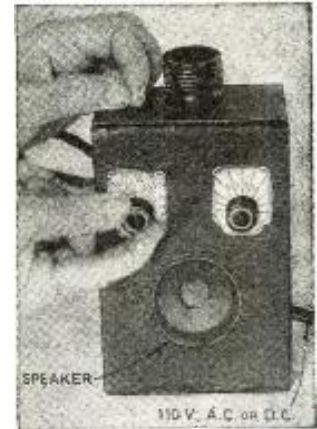

The complete receiver is illustrated above.

(Continued on page 365)

Simple diagram for portable receiver construction is presented below.

● THIS year we are experiencing a phenomenal demand for portable radios. To meet this demand the manufacturers have been turning out a great variety of broadcast receivers ranging in size from sets which can almost be carried in the pocket to outfits resembling small suitcases. Practically all of these sets are equipped with batteries, while some of them have the additional feature that they may be plugged into a house lighting circuit when a 110-volt source of current is available. The chief disadvantage of this type of portable is the weight of the batteries, which cannot be reduced below a fixed minimum amount. From the standpoint of the short wave "fan" these portables also have the disadvantage that the reception is chiefly on the *broadcast* (200 to 550 meters) band.

The "Half-Pint" Portable is the only one as far as the writer knows, which has been designed primarily for the needs of the *short wave* enthusiasts. This set is of the pocket variety, designed for operation wherever a source of house lighting current is available. It is made to cover not only the broadcast band, but also the complete short wave band, ranging uninterruptedly from 10 meters to 560 meters.

The set is extremely compact and light, being built into a sturdy cardboard carrying case, size 4 1/4" x 6 5/8" x 2 3/4". Or a cigar box could be used. The complete receiver weighs only 1 1/2 pounds.

2 Tubes Act as 4

This set employs two of the latest type,

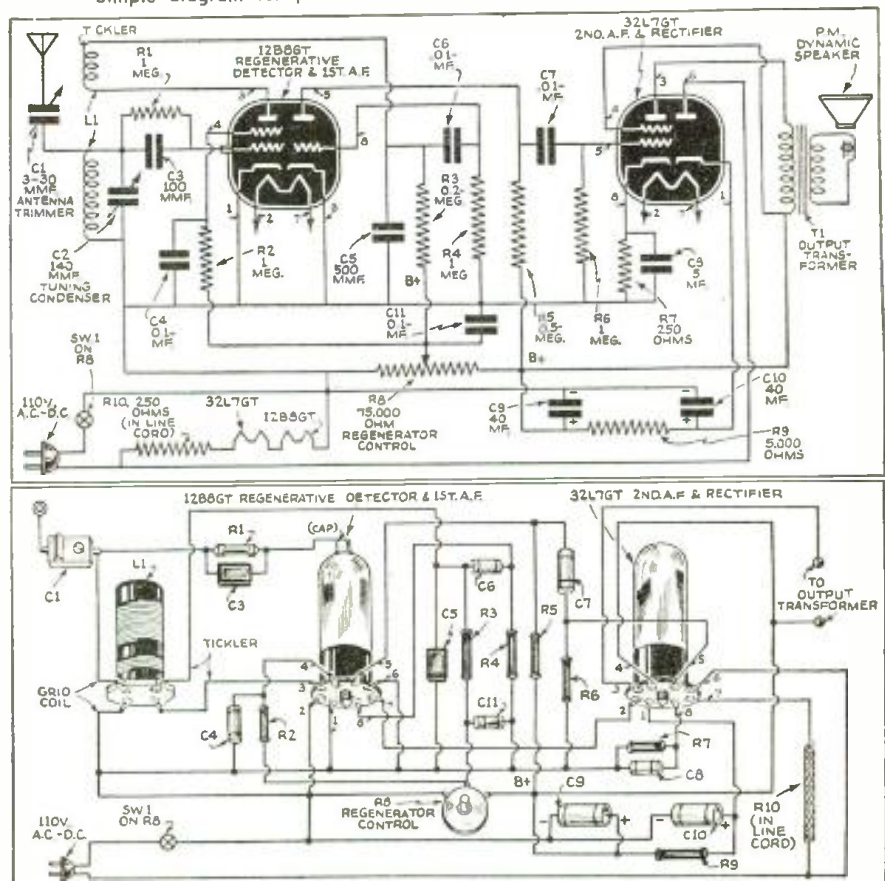

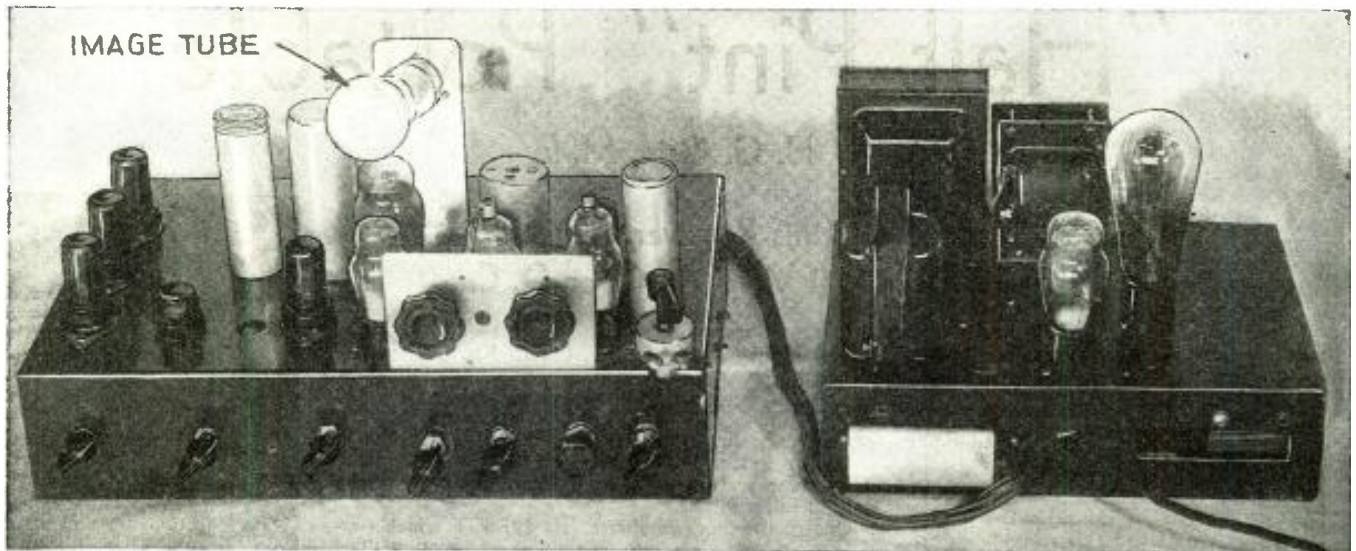

Above—The complete television image receiver using 14 tubes. The image appears on a 2-inch standard cathode-ray tube.

Building a Low-Cost

● THE art of television has made such rapid progress in the past few months that experimenters should take a serious interest in gaining all the knowledge they can in this most fascinating of all radio sciences.

Insofar as the practical side of it is concerned, there is no better way of learning the functions of television than by building a set. However, the cost of the necessary parts, particularly a large cathode-ray tube, is usually rather high for the beginner.

The set about to be described is within the means of the average experimenter, and the voltages involved are not much higher than those encountered in ordinary radio receivers. A 2-inch Type 902 cathode-ray tube is used, and the quality and brilliance of the picture are very satisfactory. The design is such that at a later date, as the experimenter progresses, the set can be arranged to accommodate a 5-inch tube with the necessary changes in the power supply, etc.

The set is built in two units, the power supply and the chassis containing the tuner, video amplifier, sweep circuit oscillators and associated circuits. The tubes are arranged in the proper sequence to permit the most efficient layout and the shortest leads.

A peek at the bottom of Mr. Scozzari's television receiver.

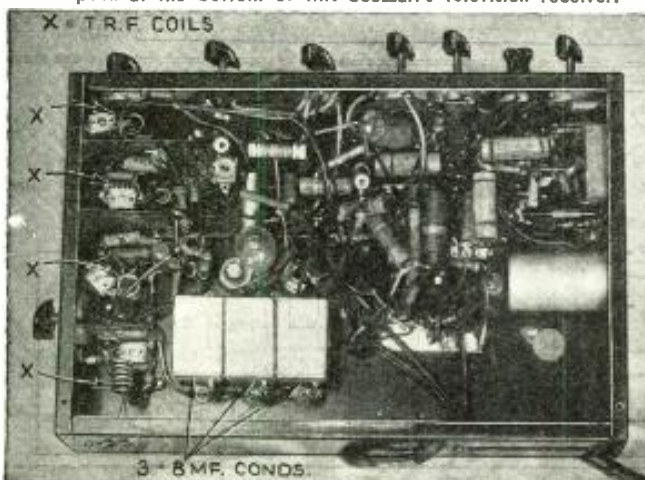

The power-pack is interconnected by a cable and plug arrangement, thus effectively segregating it from the main chassis.

MAIN CHASSIS

The main chassis is 11" x 16½" containing the following components.

T.R.F. System Used

A 3-stage T.R.F. (tuned radio frequency) unit using the special high gain 1852 single-ended television amplifying tubes is followed by a 6H6 diode detector. Another 1852 is used as a first video stage, followed by a 6F6 second video stage.

A 6H6 is used as a synchronizing separator which feeds the synchronizing pulses to a 6F7 frequency separator which uses a selective circuit to feed the vertical and horizontal pulses. Two 6N7 tubes are used as sweep circuit generators, connecting as blocking type oscillators. A single 6F8G is used as the horizontal and vertical amplifier which feeds the deflecting plates of the cathode-ray tube.

The set should be regarded as a combination of units and each wired up in a progressive manner and tested before proceeding to the next unit. In that manner the experimenter can better understand the principles and less trouble will be experienced.

The sockets should be mounted on the chassis and so placed that the wiring will be as short as possible. A heavy bus wire is next soldered to the chassis alongside of the sockets; *all ground return leads should be soldered to this wire.* The potentiometers are mounted and all filaments wired up. A center-tapped resistor is soldered across the detector tube heaters and grounded to the bus.

An 8-wire cable should be connected to a terminal strip in the main chassis so that it can be connected to the power supply unit. Potentiometers R59, R58, R65 and R63, which are the horizontal centering, vertical centering, intensity and focusing controls, should be wired next. The cathode-ray socket is also wired up. At this point the power supply unit should be constructed so that the first tests can be made.

Power Supply Details

The chassis for the power supply is 9" x 12" and is of ample size for the required units. Two separate power transformers and filter systems are used. The *high voltage* is supplied by a single 81 half-wave rectifier, providing the various voltages for the cathode-ray tube. Inasmuch as the current drawn from this circuit

is very low the filter requirements are very simple, so that a high value resistor can be used without any appreciable voltage drop, which also permits the use of smaller filter condensers. The other power transformer is of the conventional type, supplying voltage to an 80 type rectifier and a 6.3 V. potential for the heaters. As can be seen in the wiring diagram the *positive* terminal of the high voltage supply is grounded and the *negative* of the 80 rectifier is also grounded; thus the voltages in the high ends of the rectifiers are additive. *These leads should be handled with care and must be well insulated.* When this unit is completely wired up, the cable from the main chassis should be plugged into it, and a *continuity test* of the cathode-ray voltage supply circuits should be made.

Oscillators

The two 6N7 blocking oscillators are wired up next, together with the 6F8G amplifier and the 6F7 frequency separator.

After this has been carefully done and tested for continuity, the power should be turned on. As soon as the tubes heat up, an oblong of light should appear on the screen of the cathode-ray tube, the size of which can be controlled by the horizontal and vertical size controls, R49 and R46.

If this pattern does not appear, the centering controls R58 and R59 should be manipulated. If only a vertical line appears, check for an error in the wiring or other defect in the horizontal

Mr. Scozzari demonstrated his low-cost television receiver in the editorial offices of this magazine and very good images were observed on the 2-inch cathode-ray tube. This makes a dandy television image receiver for the beginner, or for those wishing to make a start in television at reasonable cost. A total of 14 tubes is used.

circuit. The converse is true if only a horizontal line appears.

After this part of the circuit has been tested successfully, the most difficult part of the set has been built.

The next step is to wire up the R.F. tuning unit. R.F. coils L2-3-4-5 comprise 6 turns No. 12 copper wire wound on a half inch diameter form and removed. The antenna coil, L1, is 4 turns No. 18 wire wound on a quarter inch diameter form and is inserted, properly spaced, into L2.

The circuit does not differ very much from the conventional.

(Continued on page 364)

Television Receiver



Peter Scozzari

Wiring diagram of the television image receiver.

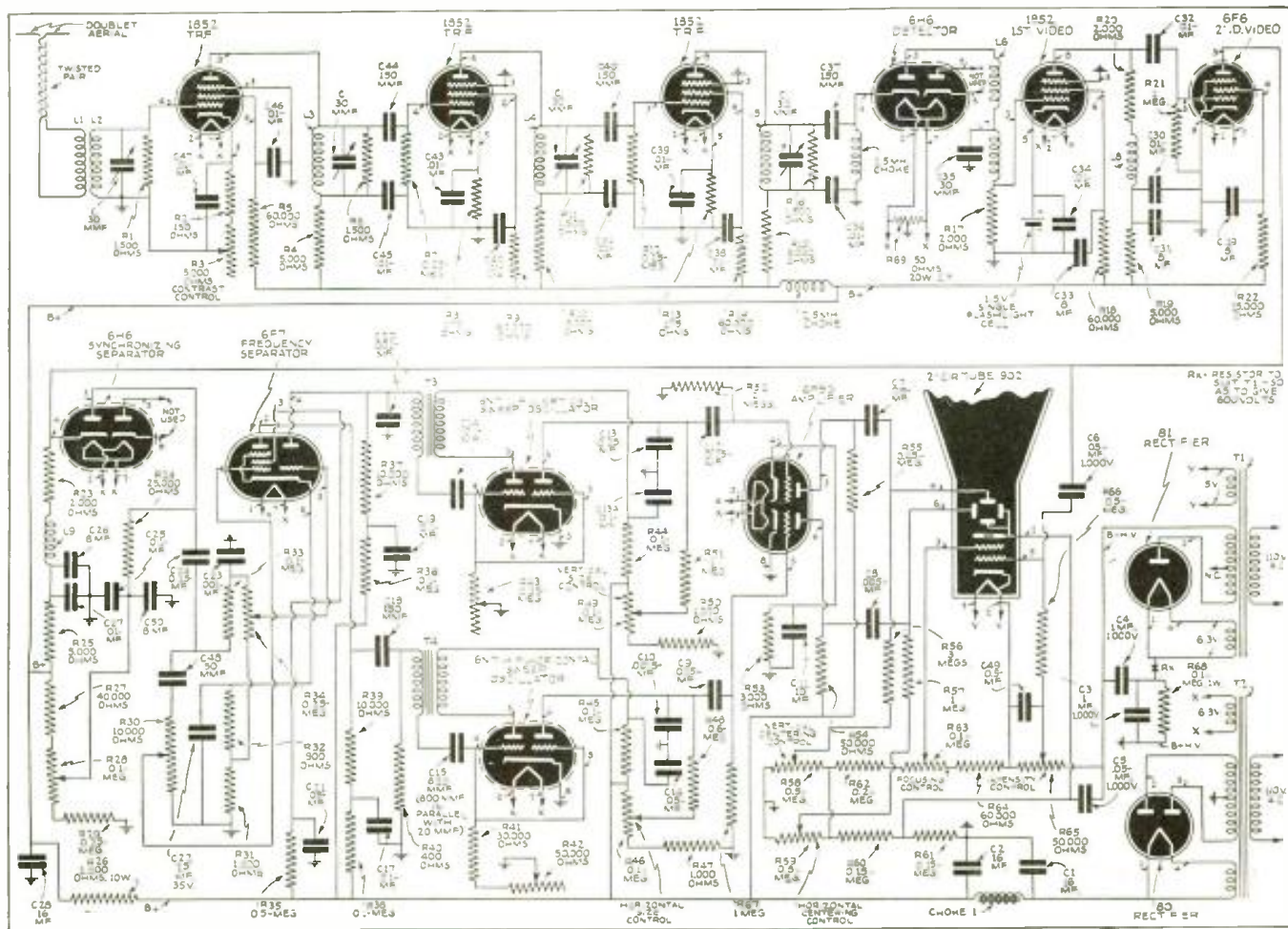

World Short Wave Stations

Revised Monthly

Complete List of SW
Broadcast Stations

Reports on station changes are appreciated.

Mc.	Call		Mc.	Call		Mc.	Call	
31.600	WIXKA	BOSTON, MASS., 9.494 m., Addr. Westinghouse Co. Daily 6 am.-1 am., Sun. 8 am.-1 am. Relays WBZ.	21.550	GST	DAVENTRY, ENG., 13.92 m., Addr. (B.8.C., London) Irregular at present.	17.310	W2XGB	HICKSVILLE, L. I., N. Y., 17.33 m., Addr. Press Wireless, Box 296. Tests 9.30-11.30 am. except Sat. and Sun.
31.600	WIXKB	SPRINGFIELD, MASS., 9.494 m., Addr. Westinghouse Co. Daily 6 am.-1 am., Sun. 8 am.-1 am. Relays WBZ.	21.540	WPIT	PITTSBURGH, PA., 13.93 m., Addr. Grant Bldg. Relays KDKA 5:30-8 am.	17.280	FZE8	DJIBOUTI, FRENCH SOMALILAND, 17.36 m. Test XMSN 1st Thurs. each month 8-8.30 am. Next B.C.S. Oct. 5 & Nov. 2.
31.600	W3XEY	BALTIMORE, MD., 9.494 m., Relays WFBR 4 pm-12 m.	21.530	GSJ	DAVENTRY, ENG., 13.93 m., Addr. (See 21.550 mc.) 5.45-10.30 am.	15.550	CO9XX	TUINICU, ORIENTE, CUBA, 19.29 m., Addr. Frank Jones, Central Tuinicu, Tuinicu, Santa Clara. Broadcasts irregularly evenings.
31.600	W2XDV	NEW YORK CITY, 9.494 m., Addr. Col. Broad. System, 485 Madison Ave. Daily 6-11 pm.; Sat. and Sun. 1.30-6, 7-10 pm.	21.520	WCAI	PHILA., PA., 13.94 m., Addr. Col. Broad. Syst., 485 Madison Ave., N. Y. C. Irregular.	15.510	XOZ	CHENG TU, CHINA, 19.34 m. Daily 9.45-10.30 am.
31.600	W9XHW	MINNEAPOLIS, MINN., 9.494 m. Relays WCCO 9 am.-12.30 am.	21.510	2RO16	ROME, ITALY, 13.94 m. Tests 10-11 am.	15.370	HAS3	BUDAPEST, HUNGARY, 19.52 m., Addr. Radiolabor, Gyali Ut 22. Sun. 9-10 am. Daily 8-9 pm.
31.600	W3XKA	PHILADELPHIA, PA., 9.494 m., Addr. NBC. Relays KYW 9 am.-10 pm.	21.500	WGEA	SCHENECTADY, N. Y., 13.95 m., General Electric Co., 7-10 am.	15.360	DZG	ZEESEN, GERMANY, 19.53 m., Addr. Reichspostzentramt. Tests irregularly.
31.600	W5XAU	OKLAHOMA CITY, 9.494 m. Sun. 12 n-1 pm., 6-7 pm. Irregular other times.	21.480	PHI3	HUIZEN, HOLLAND, 13.96 m. Addr. N. V. Philips, Hilversum. Irregular, 6.10-9.35 am.	15.360	—	BERNE, SWITZERLAND, 19.53 m. Irreg. 6.45-7.45 pm.
31.600	W9XUY	OMAHA, NEBR., 9.494 m. No sched. known.	21.470	GSH	DAVENTRY, ENG., 13.97 m. (See 21.550 mc.), 5.45 am.-12 noon. To Africa.			
31.600	W4XCA	MEMPHIS, TENN., 9.494 m. Addr. Memphis Commercial Appeal. Relays WMC. 10 am.-6 pm.	21.460	WSLA	BOSTON, MASS., 13.98 m. Addr. University Club. Sun. 9-11.30 am., Tues. 10-11 am.			
31.600	W8XAI	ROCHESTER, N. Y., 9.494 m., Addr. Stromberg Carlson Co. Relays WHAM 7.30-12.05 am.	21.450	DJS	BERLIN, GERMANY, 13.99 m., Addr. Broadcasting House. 6.05-7.50 am.			
31.600	W8XWJ	DETROIT, MICH., 9.494 m., Addr. Evering News Ass'n. Relays WWJ 5 am.-11.30 pm. Sun. 7 am.-11 pm.	19.020	HS6PJ	BANGKOK, SIAM, 15.77 m. Mondays 8-10 am. See 15.23 mc.			
31.600	W9XPD	ST. LOUIS, MO., 9.494 m., Addr. Pulitzer Pub. Co. Relays KSD.	18.480	HBH	GENEVA, SWITZERLAND, 16.23 m., Addr. Radio Nations. Sun., 10.45-11.30 am.			
31.600	W5XD	DALLAS, TEXAS, 9.494 m., 11.30 am.-1.30 pm. Ex. Sat.-Sun.						
26.500	W9XTA	HARRISBURG, ILL., 11.32 m., 1-4 pm.						
26.450	W9XA	KANSAS CITY, MO., 11.33 m., Addr. Commercial Radio Eopt. Co. 10 am.-1 pm., 3-7 pm.						
26.400	W9XAZ	MILWAUKEE, WIS., 11.36 m., Addr. The Journal Co. Relays WTMJ from 1 pm. to midnight.						
26.150	W9XUP	ST. PAUL, MINN., 11.47 m. Rel. KSTP 8 am.-1 am.						
26.100	W9XJL	SUPERIOR, WIS., 11.49 m. Relays WEBC daily. 10 am.-8 pm.						
26.050	W9XTC	MINNEAPOLIS, MINN., 11.51 m. Relays WCTN 10 am.-9 pm.						
26.050	W9XH	SOUTH BEND, IND., 11.51 m. Addr. South Bend Tribune. Relays WSBT-WFAM 2.30-6.30 pm., exc. Sat. and Sun.						
25.950	W6XKG	LOS ANGELES, CAL., 11.56 m., Addr. B. S. McGlashan, Wash. Blvd. at Oak St. Relays KGFJ 24 hours daily. DX tips Mon., Wed. and Fri. 2:15 pm.						
25.950	W8XNU	CINCINNATI, OHIO, 11.56 m., 7 am.-1 am. Sun. 8 am.-1 am.						
25.500	W2XQO	NEW YORK CITY, N. Y., 11.76 m. Noon-9 pm.						
25.300	W2XJI	NEW YORK, N. Y., 11.86 m., Addr. Bamberger Broad. Service, 1440 Broadway. Relays WOR 12 n-6 pm.						
21.640	GRZ	DAVENTRY, ENG., 13.86 m. Addr. B.8.C., London. Unused at present.						
21.630	WRCA	BOUND BROOK, N. J., 13.8 m. Addr. N.8.C. N. Y. C. 8 am.-4 pm.						
21.570	W2XE	NEW YORK CITY, 13.91 m. Addr. CBS, 485 Madison Ave. Irregular.						
21.565	DJJ	BERLIN, GERMANY, 13.92 m., Addr. Broadcasting House. Irreg.						

16 Met. Broadcast Band

19 Met. Broadcast Band

17.850	TP83	PARIS, FRANCE, 16.8 m. Addr. (See 15.245 mc.) 5:30-10 am.	15.340	DJR	BERLIN, GERMANY, 19.56 m., Addr. B'dcast'g House, 4.50-10.50 pm. to C.A.
17.845	DJH	BERLIN, GERMANY, 16.81 m., 12.05-7.50, 8-9, 9:15-11 am.	15.330	WGEA	SCHENECTADY, N. Y., 19.56 m., Addr. General Electric Co. Relays WGY, 10.15 am.-5 pm.
17.840	HVJ	VATICAN CITY, 16.82 m. Heard 12 n. on Wednesday.	15.330	KGEI	SAN FRANCISCO, CALIF., 19.56 m. Addr. General Electric Co., 6.30-11.15 pm. to So. America.
17.840	—	MOYDRUM, ATHLONE, EIRE, 16.82 m. Addr. Radio Eireann. 8.30-10 am. 12.30-4.30 pm. irreg.	15.320	OZH	SKAMLEBAK, DENMARK, 19.58 m., Sun. 8 am.-1:30 pm.
17.830	W2XE	NEW YORK CITY, 16.83 m. Addr. CBS, 485 Madison Ave., N. Y. C. Daily 8.15-10 am., 1-6 pm. Sat., 8.15 am.-12 n., 12.30-6 pm. Sun. 8 am.-12 n., 12.30-6 pm.	15.310	GSP	DAVENTRY, ENG., 19.6 m., Addr. (See 17.79 mc.) 12.25-4, 4.20-6 pm.
17.820	2RO8	ROME, ITALY, 16.84 m., Addr. (See 2RO, 11.81 mc.) 5-8.45 am.	15.300	YDB	SOERABAJA, JAVA, N. E. I. 19.61 m. Addr. NIROM. 10.30 pm.-2 am., Sat. 7.30 pm.-2 am.
17.810	GSV	DAVENTRY, ENGLAND, 16.84 m., 5.45-8.50 am. to Far East.	15.300	XEBM	MAZATLAN, SIN, MEX., 19.61 m., Addr. Box 78, "El Pregonero del Pacifico." Irregularly 9-10 am., 1-2, 8-10 pm.
17.800	OIH	LAHTI, FINLAND, 16.85 meters, 4-9 am.	15.300	2RO6	ROME, ITALY, 19.61 m., Addr. (See 2RO, 11.81 mc.) 4.15-4.55, 10 am.-12.04 pm. 3-5.30, 6-9 pm.
17.800	XGOX	CHUNGKING CHINA, 16.85 m., 9-10.30 pm. Mar. 21-Sept. 21 to No. America.	15.290	VUD3	DELHI, INDIA, 19.62 m. Addr. All India Radio, 9.30-11.30 pm., 1.30-3.30 am., 7.30 am.-12.30 pm.
17.790	GS6	DAVENTRY, ENG., 16.86 m., Addr. B.8.C., London. 5.45 am.-12 n., 12.25-4 pm.	15.290	LRU	BUENOS AIRES, ARG., 19.62 m., Addr. El Mundo. Relays LRI, 7-9 am.
17.785	JZL	TOKYO, JAPAN, 16.86 m., 4.30-5.30 pm. to S.A., 8-9 pm. to Eastern U. S.	15.280	DJQ	BERLIN, GERMANY, 19.63 m., Addr. Broadcasting House. 12.05-11 am., 4.50-10.50 pm.
17.780	WNBI	BOUND BROOK, N. J., 16.87 m., Addr. Natl. Broad. Co., 9 am.-5 pm. to Europe, 5-10 pm. to So. Amer.	15.270	H13X	CIUDAD TRUJILLO, D. R., 19.65 m. Relays HIX Sun. 7.40-9.40 am. Tues. and Fri. 8.10-10.10 pm.
17.770	PHI2	HUIZEN, HOLLAND, 16.88 m., Addr. (See PHI, 11.730 mc.) Daily 7.10-8.15 am. Mor. & Thurs. 7.10-8.30 am. Sun. 6.10-9.35 am.	15.270	WCAI	PHILA., PA., 19.65 m. (Addr. See 21.52 mc.) Dly. 10.45-11.45 am. 12.30-5.15 pm. Sat. Noon-5.15 pm. Sun. Noon-5 pm.
17.760	DJE	BERLIN, GERMANY, 16.89 m., Addr. Broadcasting House. 12.05-11 am., 4.50-9 pm. Also Sun. 11.10 am.-12.25 pm.	15.270	W2XE	NEW YORK CITY, 19.65 m., Addr. (See 21.57 mc.) 6.30-8.30 pm.
17.755	Z8W5	HONGKONG, CHINA, 16.9 m., Addr. P.O. Box 200. Dly. 11.30 pm.-1.15 am., 5-10 am., Sat. 9 pm.-1.30 am., Sun. 5-9.30 am. Operates irreg.	15.260	GS1	DAVENTRY, ENG., 19.66 m., Addr. (See 17.79 mc.) Mid. to 2.15 am. to Oceania. 12.25-4 pm.
			15.250	WSLA	BOSTON, MASS., 19.67 m., Addr. University Club. 2-3:30, or 4 am., ex. Sat. and Sun.
			15.245	TPA2	PARIS, FRANCE, 19.68 m., Addr. 98 Bis. Blvd. Haussmann. "Paris Mondial" 5-10 am. to Asia.
			15.240	2RO	ROME, ITALY, 19.68 m. Irregular 3-9 pm.
			15.240	CR7BD	LOURENCO MARQUES, MOZAMBIQUE, 19.68 m. Testing 1-4 pm. Irreg.

End of Broadcast Band

(Continued on page 344)

All Schedules Eastern Standard Time

Let's Listen In

with

Joe Miller
"DX" Editor

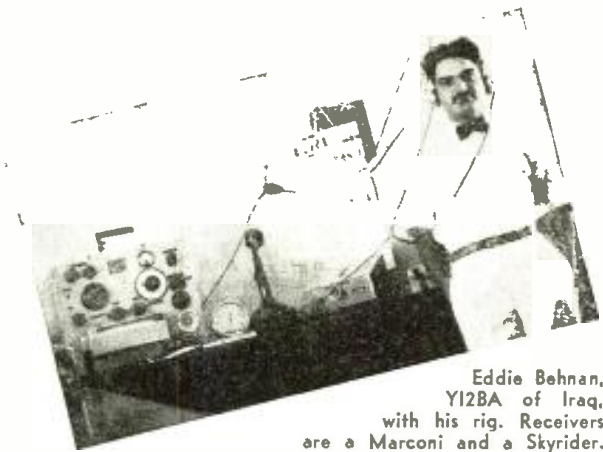

Eddie Behnan, YI2BA of Iraq, with his rig. Receivers are a Marconi and a Skydrer. Watch for Eddie's special transmissions soon.

● DOING our monthly chore here, in late summer, we are eagerly awaiting the resurgence of the ol' DX enthusiasm, markedly absent during the outdoor summer season now waning. We have missed some good DX, but as we now enter the fall, a season which really presents a bonanza of fine DX conditions and reception, watch our smoke, hi!

If you want a crack at some real FB DX, watch this page. Eddie Behnan (YI2BA) is planning several special broadcasts to the U.S., and has requested us to publish the dates. Sure we will—as soon as the information reaches us from Eddie. This will be a fine opportunity to add a rare DX country to your phone list, so WATCH FOR DETAILS!

9.695 mc., both at Tyureki, are on daily from 9:05-10:20 a.m. BCing to China and the South Seas. JIE is often on as early as 8 a.m.

CHINA

XGOK, 11.81 mc., Canton, operated by Japanese, is a new Chinese station to be heard, from 5:30-8:40 a.m. daily, with an English program after 8 a.m. (I. D. A.) XGAP, 9.56 mc., Peking, also operated by Japanese, heard at 9:45 a.m. regularly by Gus Gallagher.

XGOV and XGOX, Chungking, have been conducting test Xmsns to the eastern and western coasts of the U. S. These tests concluded on Sept. 8. All four frequencies were used, each one for a different week. Xmsns timed for East Coast from 1:30-2:40 p.m., and for West excluding the 9.50 mc. freq., from 2:55-3:30 a.m., all times E. S. T. (Gus Gallagher).

DX country to their verified fone list, as all Javanese phones QSL promptly.

Jack Buitekant tried for a few of the PLs listed last month, and came through with PLL, 13.60 mc., at 6:45 a.m., PLJ, 14.630 mc., at 7:25 a.m., and PMA, 19.345 mc., at 8:34 a.m., all good sigs. Remember, these usually are heard in inverted speech, but look for the wavering Asiatic carrier, characteristic of all Javanese stations, which help identify these strong signals from Asia. PLE, 18.83 mc., Bandoeng, the station which contacts Holland, with its 80 kw, was heard at 7 p.m. and 2 a.m. by Gus Gallagher, W6.

MANCHUKUO

NTCY, 6.125 mc., Hsingking, is now Xming daily from (approx.) 7-9 a.m., often beginning Xmsns from as early as midnite. Also heard on 15.20 and 13.53 mc., this station may be heard irreg. relaying programs for rebroadcast in other parts of Asia. However, QSL cards are not as yet ready, so listeners may either receive a letter veri, or have their reports held till cards are ready. JDY, 9.92 mc. at Dairen, is sending out an attractive new card. (Sked in station list.) A last minute addition by OM Gus Gallagher, W6, shows NTCY on a regular daily Xmsn from 1:30-2:15 a.m. using 11.775 mc., another frequency. NTCY, 15.20 mc., was logged by Jack Buitekant, W2, while on one of their specials, at 3:35 a.m., a FB DX catch.

JAPAN

JFHA, city unknown, is a new station operating on 3 frequencies, 7.30, 9.61, and 9.71 mc., heard between 9:30 and 10:15 a.m. by Gus Gallagher. JVA, 18.91 mc., Nazaki, also heard by Gus at 7 and 8 p.m., and at 1 a.m. In Taiwan, formerly called Formosa, two new Xmters using 10 kw, are being well heard. JIE, 7.295 mc., and JIE2,

What Do YOU Hear?

Get credit for your DX catches! Tell Joe Miller about the distant stations you hear, and see your name published in this department. Address DX Editor, RADIO & TELEVISION, 99 Hudson Street, New York, N. Y.

Mr. Ying Ong, 1001 E. Roosevelt St., Phoenix, Arizona, requests listeners to send him reports of their reception of the Chungking stations, as he wishes to send comprehensive data from all over the U. S. to Chungking to aid the station engineers to better reach the U. S.

JAVA

YBF, 9.93 mc., Sumatra, heard several times between 5:30-6:30 a.m. with the strong signal. YBF alternates with YBG, 10.425 mc., also in Sumatra, in contacting Bandoeng, Java's capital, always heard during above times. Both are easy to log (YBG usually on more often), and afford all DXers a fine opportunity to add this romantic

ASIATIC REVIEW

SIAM—HS8PJ, 9.51 mc., at Bangkok, is now on daily except Mons. 8-10 a.m. HS4PJ, 6.13 mc., same sked as HS8PJ. HS6PJ, 19.02 mc., still on Mon., 8-10 a.m. due to operate daily soon. (I. D. A.) HSP, 17.74 mc., Bangkok phone, heard at 7 p.m. by Gus Gallagher, W6. HS8PJ, reported by Jack Buitekant, W2.

PHILIPPINES—KZRH, 6.10 mc., Manila, is a new Xmtr operating irreg. from 5-8 a.m., and requesting reports. KZHS, 9.685 mc., daily from 6 a.m. on, is also a new station requesting reports to be sent to P. O. Box 119, Manila (I. D. A.) KBD, 17.95 mc., Manila, heard phoning at 7 p.m. by Gus Gallagher.

AMATEUR REVIEW

A brief résumé of some fine fone DX submitted by a number of Ham DXers follows:

ASIA

J5CW, 14065, Japan, reported with fine sigs at the unusually late hour of 8:45 a.m., a nice catch by Ralph Gozen, W2. Also reported by Murray Buitekant.

XU1B, 14600, at 6:30 a.m. by Ralph Gozen. Also by Ralph, XU8MC, 14280, 6:30 a.m.

ZB2B, 14135, Gibraltar, reported by Eddie Strowbridge, BSWL, 1144, England. ZB2B QSL'd Ralph Gozen, giving QRA as Box 201.

FN1C, 14070, French Indo-China, R6 at 7 a.m. by OM Ralph and BSWL, 1144.

VS7RA, 14260, Ceylon, reported by Eddie. Murray Buitekant reports 7RA's QSL, FB for a W2.

VS2AL, 14080, Federated Malay States, reported by Ralph Gozen, nice going!

VQ2CM, 14030, Northern Rhodesia, putting a good signal into East Coast in afternoons. Reported by Jack Buitekant and Eddie Strowbridge.

VU2FA and VU2CQ, India, well heard by Eddie.

PK2LZ, 14060, at 6 a.m. by Ralph. PK2AY, 14020; PK3WI, 14045, and PK1OG, PK1RI, PK4JD, all these in D. E. Indies, reported by Eddie, FB! Also PK3WF, 14035, by Ralph.

K6OCL, 14160, Guam, at 6 a.m. a nice one for Ralph, as was KF6QKH, 14200, at 7 a.m. from Baker Island, mid-Pacific.

KA1BB, 14255; KA1JP, 14130; KA1JM, 14260; KA1LB, 14130; KA1FH, 14130 and 14270; KA1AP, 14130; KA1CS, 14140; KA1ME, 14145, and KA7EF, 14250, all Philippine fone-lately logged by Ralph Gozen, very FB! Also KA2OV, 14250, and KA3KK, 14370, by Eddie Strowbridge, England.

Best o' luck to you fellow DX hounds.

R. S. G. B. FONE 73 DE. CEYLON. R. C. C. and S. I.

TO RADIO J. Miller EAR (BEPT RCVD) ON My Fone No. 101 G.M.T. on 18th March 1938

RST. QRN QRM QSB WX MC

TRANSMITTER TRI-TET-CO Ac/P-Ac/HL-MOD RK 20 PA AERIAL 4 WAVE ZEPP

V57RA

1. SG-V-PEN
2. HFP-2LF-PEN
3. 10 V-SUPERHET AERIAL 66' WINDOM

QRA - R. P. WALKER - ALEXANDER, HYNDFORD - NAWALAPITIYA.

Tks a lot O.M fer ur rpt CEYLON. (on my fone which was Q S A2/3/ R2/3 on 18 March 1938 FONE AND C.W.)

TNX } QSL
PSE } QSL

28/3/38

A bright red outline and green call letters make this card from R. Alexandre, Ceylon, an extremely handsome catch.

Mc.	Call		Mc.	Call		Mc.	Call	
15.230	HS6PJ	BANGKOK, SIAM, 19.7 m. Irregularly Mon. 8-10 am.	14.420	HCIJB	QUITO, ECUADOR, 20.80 m. 7-8.15, 11.30 am.-2.30, 4.45 pm.-10.15 pm. Exc. Mon.	11.830	W2XE	NEW YORK CITY, 25.36 m., Addr. Col. Broad. System, 485 Madison Av., N.Y.C. 9-11.30 pm.
15.230	OLR5A	PRAGUE, BOHEMIA, 19.7 m. Addr. (See OLR4A, 11.84) Daily 4.55-8.15 am., 6.55-10.20 pm.	14.166	PIIJ	DORDRECHT, HOLLAND, 21.15 m., Addr. (See 7.088 mc.) Sat. 12 n.-12.30 pm.	11.826	XEBR	HERMOSILLA, SON., MEX., 25.37 m., Addr. Box 68. Relays XEBH. 9.30-11 am., 1-4 pm., 9 pm.-12 m.
15.220	PCJ2	HUIZEN, HOLLAND, 19.71 m., Addr. N. V. Philips' Radio Hilversum, Wed. 9.30-11.30 am. Sun. 6.10-9.35 am. Daily 7.10-8.15 am. Mon., Thurs. 7.10-8.30 am. Tues. 1-2 am. to Australia.	13.997	EA9AH	TETUAN, SPANISH MOROCCO, 21.43 m. Apartado 124. 5.15-6.15 pm., 6.30-7.30 pm., 9-10 pm. Relays Salamanca from 5.40 pm.	11.810	2RO4	ROME, ITALY, 25.4 m., Addr. E.I.A.R., Via Montello 5. Daily 4.30-8.45 am., 10 am.-2.30 pm., 6-9 pm.
15.210	WPIT	PITTSBURGH, PA., 19.72 m., Addr. (See 21.540 mc.) 8 am.-1 pm.	13.635	SPW	WARSAW, POLAND, 22 m. Daily 6-8 pm. Sat. & Sun. 6-9 pm.	11.805	OZG	SKAMLEBAK, DENMARK, 25.41 m. Addr. Statsradiofonien. Irreg.
15.200	DJB	BERLIN, GERMANY, 19.74 m., Addr. (See 15.280 mc.) 12.05-11 am., 4.50-10.50 pm. Also Sun. 11.10 am.-12.25 pm.	12.862	W9XDH	ELGIN, ILL., 23.32 m. Press Wireless, Tests 2-5 pm.	11.801	DJZ	BERLIN, GERMANY, 25.42 m. Addr. See 15.280 mc. Irreg.
15.195	TAQ	ANKARA, TURKEY, 19.74 m., 5.30-7 am.	12.486	HIIN	TRUJILLO CITY, DOM. REP., 24.03 m. 6.40-10.40 am., 5.10-10.10 pm.	11.800	COGF	MATANZAS, CUBA, 25.42 m., Addr. Gen. Betancourt 51. Relays CMGF. 2-3, 4-5, 6 pm.-Mid.
15.190	OIE	LAHTI, FINLAND, 19.75 m. Addr. (See OFD, 9.5 mc.) 1.05-4 am, 9 am.-5 pm.	12.460	HC2JB	QUITO, ECUADOR, 24.08 m. Daily exc. Mon. 7-8.15, 11.30 am.-2.30, 4.45-10.15 pm.	11.800	JZJ	TOKYO, JAPAN, 25.42 m., Addr. Broadcasting Co. of Japan, Overseas Division 7-7.30, 8-9.30 am. Irreg.
15.190	ZBW4	HONGKONG, CHINA, 19.75 m., Addr. P. O. Box 200. Irregular. 11.30 pm. to 1.15 am., 3-10 am.	12.235	TFJ	REYKJAVIK, ICELAND, 24.52 m. Works Europe mornings. Broadcasts Sun. 1.40-2.30 pm.	11.795	DJO	BERLIN, GERMANY, 25.42 m. Addr. (See 15.280 mc.) Irreg.
15.180	GSO	DAVENTRY, ENG., 19.76 m., Addr. (See 17.79 mc.) 9.10-11 am., 4.20-6, 6.25-9.20 pm.	12.230	COCE	HAVANA, CUBA, 24.53 m.-8 am.-11.30 pm. Sun. noon-11.30 pm.	11.790	WSLA	BOSTON, MASS., 25.45 m., Addr. (See 15.250 mc.) 2.30-5.30 pm. Sat., 2-6.30 pm.
15.180	RV96	MOSCOW, U.S.S.R., 19.76 m., Daily 1-2, 3-4 am. Mon., Wed., Thurs. 7-9.15 pm.	12.200	—	TRUJILLO, PERU, 24.59 m., "Rancho Grande," Address Hacienda Chinlin. Irregular.	11.780	HP5G	PANAMA CITY, PAN., 25.47 m., Addr. Box 1121. Noon-1 pm., 6-10 pm.
15.170	TGWA	GUATEMALA CITY, GUAT., 19.77 m., Addr. Ministre de Fomento. Daily 12.45-1.45 pm.; Sun. 12.45-5.15 pm.	12.000	RNE	MOSCOW, U.S.S.R., 25 m. 6-6.30, 10-10.30 am., 1-1.30, 3-5.30, 8.30-10 pm., Sun. 6-10 am., 1-6, 9-10 pm.	11.780	OFE	LAHTI, FINLAND, 25.47 m. Addr. (See OFD, 9.5 mc.) 1.05-3 am., 5-6.20 am., 10 am.-12.30 pm.
15.166	LKV	OSLO, NORWAY, 19.78 m. 6.40-10 am.	11.970	CB1180	SANTIAGO, CHILE, 25.06 m. 7-11 pm.	11.775	MTCY	HSINGKING, MANCHUKUO, 25.48 m. Addr. Central Broadcasting Station. 1.30-2.15 am.
15.160	JZK	TOKYO, JAPAN, 19.79 m. 12 m.-1.30 am. to Canada & Hawaii, and Pacific U.S. 8-9 pm. to Eastern U.S. 7-9.30 am. to China and 2-4 pm. to Europe.	11.970	H12X	CIUDAD TRUJILLO, D. R., 25.07 m., Addr. La Voz de Hispaniola. Relays HIX Tue. and Fri. 8.10-10.10 pm. Sun. 7.40-9.40 am.	11.770	DJD	BERLIN, GERMANY, 25.49 m., Addr. (See 15.280 mc.) 11.30 am.-4.25 pm., 4.50-10.50 pm.
15.160	XEWW	MEXICO CITY, MEXICO, 19.79 m., 12 n.-12 m., irregular.	25 Met. Broadcast Band			11.760	TGWA	GUATEMALA CITY, GUAT., 25.51 m. (See 17.8 mc.) Irregular 10-11.30 pm. Sun. 6-11.30 pm., irregular.
15.155	SBT	MOTALA, SWEDEN, 19.80 m. 1-4.15 pm. Wed., Sats. 8-9 pm.	11.940	T12XD	SAN JOSE, COSTA RICA, 25.13 m. La Voz del Pilot. Apartado 1729. 7.30 am.-noon, 4-10 pm.	11.760	XETA	MONTEREY, MEX. 25.51 m., Addr. Box 203. Relays XET, n.-3.30 pm. and evenings.
15.150	YDC	BANDONG, JAVA, 19.8 m., Addr. N. I. R. O. M. 6-7.30 pm., 10.30 pm.-2 am., Sat. 7.30 pm.-2 am., daily 4.30-10.30 am.	11.940	XMHA	SHANGHAI, CHINA, 25.13 m. 5-11 am.	11.760	OLR4B	PRAGUE, BOHEMIA, 25.51 m. Addr. (See 11.840 mc.) Daily exc. Sun. 8.25-10.05 am.
15.140	Gsf	DAVENTRY, ENG., 19.82 m., Addr. (See 17.79 mc.) 5.45 am.-12 n.	11.910	CD1190	VALDIVIA, CHILE, 25.19 m., P. O. Box 642. Relays CB69 10 am.-1 pm., 3-6, 7-10 pm.	11.750	GSD	DAVENTRY, ENG., 25.53 m., Addr. B.B.C., London. 12-2.15 am., 12.25-4, 4.20-6, 6.20-9.15, 9.40-11.30 pm.
15.135	JLU3	TOKYO, JAPAN, 19.82 m., 8-9.30 am. to China.	11.910	—	HANOI, FRENCH INDO-CHINA, 25.19 m., "Radio Hanoi", Addr. Radio Club de l'Indochine. 3.45-4.15 am., 7-9.30 am., 150 watts.	11.740	SP25	WARSAW, POLAND, 25.55 m., 6-9 pm.
15.130	TPB6	PARIS, FRANCE, 19.83 m., Addr. "Paris Mondial," 98 Bis Blvd. Hausmann, 1-4 am.	11.900	XEWI	MEXICO CITY, MEXICO, 25.21 m., Addr. P. O. Box 2874. Mon., Wed., Fri. 3-4 pm., 9 pm.-12 m. Tues. and Thur. 7.30 pm.-12 m., Sat. 9 pm.-12 m., Sun. 12.30-2 pm.	11.740	HVJ	VATICAN CITY, 25.55 m. Tues. 8.30-9 am.
15.130	WSLR	BOSTON, MASS., 19.83 m., Addr. World-Wide B'cast'g Foundation. University Club. 2.30-5.30, 9-10 pm. ex. Wed., Sat., Sun. 2.30-3 pm.	11.900	XGOY	CHUNGKING, CHINA, 25.21 m., 5.30-7.10 am. to North Asia, 7.15-7.55 am. to Japan, 8-10.30 am. to South Asia. 11-11.45 am. to U.S.S.R. 4-6.30 pm. to Europe. Mar. 21-Sept. 21—35 kw.	11.740	CR6RC	LOANDA, ANGOLA, 25.55 m., Tues., Thurs., Sat. 2-3.30 pm.
15.120	SP19	WARSAW, POLAND, 19.84 m., 6-9 pm.	11.895	2RO13	ROME, ITALY, 25.23 m. Irregular 6-9 pm.	11.735	COCX	HAVANA, CUBA, 25.57 m. P. O. Box 32. Daily 8 am.-1 am. Sun. 8 am.-1 am. Relays CMX.
15.120	HVJ	VATICAN CITY, 19.84 m., 10.30-10.45 am., Tues., Sun. 1-1.30 pm.	11.885	TPB11	PARIS, FRANCE, 25.24 m., 8.30-11 pm. beamed to U.S.	11.735	LKQ	OSLO, NORWAY, 25.57 m. 2-6.40, 10 am.-3 pm.
15.120	CSW4	LISBON, PORTUGAL, 19.84 m., 6-8 am., irreg.	11.885	TPB12	PARIS, FRANCE, 25.24 m. (See 15.245 mc.) 6-8.15 pm. Beamed to S. A.	11.730	PHI	HUIZEN, HOLLAND, 25.57 m., Addr. N. V. Philips' Radio.
15.110	DJL	BERLIN, GERMANY, 19.85 m., Addr. (See 15.280 mc.) 12.10-2, 8-9 am., 10.40 am.-4.25 pm.	11.870	WPIT	PITTSBURGH, PA., 25.26 m., Addr. (See 21.540 mc.) 1-10 pm.	11.730	WSLR	BOSTON, MASS., 25.58 m., Addr. World-Wide B'cast'g Foundation, University Club. Daily 7 or 7.30-9, 9.15-11 pm. Sat.-Sun. 2.30-5 pm.
15.100	CB1510	VALPARAISO, CHILE, 19.87 m. Testing near 7.30 am.	11.870	VUM2	MADRAS, INDIA, 25.26 m. M.W.F. 3.30-4 am. Irregular.	11.725	JVW3	TOKYO, JAPAN, 25.57 m. Now on regular schedule from 1.15 am. daily on, and irregular from 4-7.30 am.
15.100	2RO12	ROME, ITALY, 19.87 m. Testing irreg.	11.865	—	BERNE, SWITZERLAND, 25.28 m. Irreg. 8-9 pm. to No. Amer.	11.720	CJRX	WINNIPEG, CANADA, 25.6 m., Addr. James Richardson & Sons, Ltd. Daily 6 pm.-12 m., Sat. 6 pm.-Sun. 4 am.
15.080	RKI	MOSCOW, U.S.S.R., 19.95 m. Works Tashkent near 7 am. Broadcasts Sun. 12.15-2.30 pm. Daily 7-9.15 pm.	11.860	GSE	DAVENTRY, ENG., 25.30 m., Addr. (See 11.75 mc.) 9.45 am.	11.720	ZP14	VILLARICA, PARAGUAY, 25.60 m. 5.30-7.55 pm. irreg.
End of Broadcast Band			11.855	DJP	BERLIN, GERMANY, 25.31 m., Addr. (See 15.280 mc.) Irregular.	11.718	CR7BH	LAURENÇO MARQUES, PORTUGUESE E. AFRICA, 25.6 m. Daily 12.05-1, 4.30-6.30, 9.30-11 am., 12.05-4 pm., Sun. 5-7 am., 10 am.-2 pm.
14.960	RZZ	MOSCOW, U.S.S.R., 20.05 m., Thurs. 6 pm. Dutch program.	11.850	CB1185	SANTIAGO, CHILE, 25.32 m. Sat. 6-11 pm. and irreg.	11.715	TPA4	PARIS, FRANCE, 25.61 m., (See 15.245 mc.) 6-8.15, 8.30-11 pm. to No. America.
14.930	PSE	RIO DE JANEIRO, BRAZIL, 20.09 m. Broadcasts 6-7 pm., Wed. 4-4.10 pm., Thurs. 3-3.30 pm.	11.850	OAX2A	TRUJILLO, PERU, 25.32 m. Testing on this freq. (See 12.200).	11.710	YSM	SAN SALVADOR, EL SALVADOR, 25.62 m., Addr. (See 7.894 mc.) 1-2.30 pm.
14.920	KQH	KAHUKU, HAWAII, 20.11 m. Sats. 1-1.30 am., 11-11.30 pm. Fri. 9-10 pm.	11.840	KZRM	MANILA, P. I., 25.35 m. Addr. Erlanger & Gallinger, Box 283. 9 pm.-10 am. Irregular.	11.710	—	SAIGON, FRENCH INDO-CHINA, 25.62 m., Addr. Boy-Landry, 17 Place A Foray. 7.30-9.15 am.
14.795	IQA	ROME, ITALY, 20.28 m. 4.30-5 am. In Arabic.	11.840	CSW	LISBON, PORT., 25.35 m. Nat'l Broad. Station. 11.30 am.-1.30 pm., Irregular.	11.705	SBP	MOTALA, SWEDEN, 25.63 m., 1-4.15 pm. Sun. 3 am.-4.15 pm. Wed and Sat. 8-9 pm.
14.600	JVH	NAZAKI, JAPAN, 20.55 m. Works Europe 4-8 am. Rel. JOAK Irr. after midnight.	11.840	OLR4A	PRAGUE, BOHEMIA, 25.35 m., Addr. Czech Shortwave Sta., Praha XII, Fochova 16. Daily 6.45-9 pm.	11.700	HP5A	PANAMA CITY, PAN., 25.64 m. Addr. Radio Teatro, Apartado 954. 10 am.-1 pm., 5-10 pm. Sun. 6-10 pm. 7-8.30 am.
14.535	HBJ	GENEVA, SWITZERLAND, 20.64 m. Addr. Radio Nations. Broadcasts Sun. 10.45-11.30 am., Mon. 4-4.15 am., 6.45-8.15 pm.	11.830	WCBI	CHICAGO, ILL., 25.36 m., Addr. Chicago Federation of Labor. Irregular 7 am.-6 pm.	(Continued on page 346)		
14.440	—	RADIO MALAGA, SPAIN, 20.78 m. Relays Salamanca 5.45-7.30 pm. Sometimes 2-4 pm.						

All Schedules Eastern Standard Time

The Short Wave League

DX on the Ham Bands



HONORARY MEMBERS

Dr. Lee de Forest Manfred von Ardenne
 D. E. Replogle E. T. Somerset
 John L. Reirantz Hollis Baird
 Hugo Gornshack Executive Secretary

(with the "Listening Post" Observers)

Edited by Elmer R. Fuller

TEN BEST DX'ERS LAST MONTH

Name	Call	Freq.	R	S	Distance
Fleming	PK1X M	14.09	4	7	11,700 miles
V. Slaughter	PK3W I	14.05	5	7	11,500 miles
Hogler	PK1V M	14.09	5	6	11,000 miles
Spencer	PK6X N	14.04	3	5	10,900 miles
W. Halliday	PK3W I	14.04	4	6	10,900 miles
Henderson	VU2C O O	14.01	4	7	10,700 miles
	K6B N R	14.14	5	7	10,600 miles
	K4I M E	14.15	5	8	10,600 miles
	VK2M H	14.12	5	8	10,300 miles
	K4I F H	14.275	5	7	10,200 miles

● WELL, here is another month, and the DX certainly fell off during the past summer! Conditions during the month of July were about the worst we have seen for several months. Very few periods were found when one could really sit down and pull in some good DX. Nearly everything heard in this country was the W's and the VE's.

Another mystery station has been reported and this time it is SX4C, which was, when last heard of, in the southern part of the Atlantic, somewhere off Brazil. Where it is going, and what it is doing is unknown to us. If anyone has information in regard to this station, it will be greatly appreciated.

This month we have just one report on the five meter band, and this is from Todd Storz of Omaha, Nebraska. He reports hearing the following stations:—

Nebraska Noyes, Storz
 New York Fuller
 South Carolina Halliday
 Texas Slaughter
 Quebec Clarke
 England Spencer
 South Africa Westman
 Australia Jones

The Asiatics are very few in number this month, only three being reported.

Call	Freq.	R	S	Where Heard
V8TRA	14.16	4	7	England
VU2C O	14.01	4	7	Florida
VU2C O O	14.01	4	7	Florida

AFRICA

CN8B B	14.1	5	8	Kansas
CT2B P	14.125	5	8	Kansas, Quebec
EK1A F	14.145	5	7	N. Y.
ZF1J A	14.05	5	6	England
ZS2A Z	14.1	5	6	Texas
ZS3Q	14.1	5	7	Iowa
ZS3T	14.07	5	8	Florida
ZS6B Y	14.1	5	7	Texas
ZS6E V	14.1	5	6	Texas
ZS6A J	14.05	4	6-7	Kansas

NORTH AMERICA

Call	Freq.	R	S	Where Heard
TG5J G	14.1	4	5	Australia
VE5U S	14.12	5	8	England
VE4A P	14.1	5	7	Australia
VE5A O	14.1	5	8	Australia
W4M Z	14.1	5	8	Australia
W5DE K	14.1	5	7	South Africa
W5B K S	14.1	5	7	Australia
W5M L T	14.1	5	7	Australia
W6A L F	14.1	5	8	Australia
W6P D B	14.1	5	8	Australia
W6N T S	14.1	5	7	Australia
W6M P S	14.1	5	7	Australia
W6I P L	14.1	4	6	Australia
W6A L B	14.1	5	9	Australia
W6A F O	14.1	5	7	Australia
W6C Y L	14.1	5	7	Australia
W6H C E	14.1	5	7	Australia
W6B E K	14.1	8	8	Australia
W6L Y M	14.1	5	9	Australia
W6G S A	14.1	5	6	Australia
W6G V M	14.15	5	8-9	England
W6M V X	14.1	5	8	England
W6S Z	14.1	5	9	England
W6C O S	14.18	5	7	England
W7D C W	14.1	5	8	Australia
W8O M I	14.1	5	8	Australia
W8I N V	14.1	5	8	South Africa
W9I H Y	14.1	5	8	Australia
W9I M C	14.1	5	8	Australia
W9I F I	14.1	5	7	Australia
W9A Z I	14.1	5	9	Australia
W9B E V	14.1	5	7	Australia
W9V E A	14.1	5	8	Australia
W9J M K	14.1	5	8	South Africa
XE1L L	14.025	5	9	Connecticut

SOUTH AMERICA

CE3C G	14.05	4	6	Connecticut
CE3C K	14.005	4	5	Quebec
CE3D W	14.035	5	9	England
CE3C O	14.1	5	7	Iowa
CX2C O	14.05	5	6	Arkansas
HK4D F	14.04	5	8	Arkansas
LU7A P	14.108	4	5	Connecticut
OA4C	14.27	5	7	Quebec
OA4A I	14.1	5	7	Australia
PY2G C	14.12	5	6	Iowa
PY4C T	14.2	5	7	Florida
YV1A B	14.047	5	7	New York
YV1A Q	14.047	5	7	New York

RADIO & TELEVISION

OFFICIAL LISTENING POST

This is to certify that
William D. Noyes
 has been appointed an Official Listening Post
 Observer by the DX Department of
RADIO & TELEVISION

Hugo Gornshack
Editor in Chief

Elmer R. Fuller
Listening Post Editor

The handsome RADIO & TELEVISION official "listening post" certificate is reproduced above. The original certificate measures 7 1/4 by 9 1/2 inches and is attractively printed in two colors, red and blue.

EUROPE

Call	Freq.	R	S	Where Heard
E4V B A	14.02	5	8-9	Kansas
F8N T	14.07	4	7	Florida
F8N X	14.01	4	7	Quebec
G2P U	11.035	5	8	New York
G2B B	14.18	5	6	New York
G2M K	14.12	5	9	Connecticut
G2X V	14.02	3	6	Iowa
G3K B	14.115	5	9	Connecticut
G5L U	14.125	5	9	New York, Conn.
G5M L	14.125	5	9	New York
G6V X	14.08	4	7	New York
G6L R	14.3	4	7	New York
G6B Y	14.3	4	7	Florida
G6P G	14.12	4	7	Florida
G5I L	14.12	4	7	Connecticut
G7C P	14.107	5	6	Connecticut
G7I L	14.08	5	7-9	Kansas, Quebec
GM8M X	11.05	5	6-7	Kansas
G7I L	14.04	5	6	Florida
GW5K I	14.1	5	6	Quebec
GW5P I	11.015	5	6	Quebec
HP9C T	11.005	5	6	Quebec
11S M	11.0	5	7	Alabama
11P B	12.05	7	7	Alabama
OX1O F	14.01	4	4	Quebec
OZ7K G	14.21	5	7	Florida
PA0D H	14.1	5	6	Connecticut
PA0U N	14.04	4	4	Connecticut
PA0M Z	14.06	4	4	Quebec
ZB2B	14.135	5	5	Quebec

OCEANIA

K6B N R	14.14	5	7-9	England, Australia
K6B S W	14.1	5	8	Australia
K6M Y B	14.1	5	8	Australia
K6K G A	14.1	5	8	Australia
K6A O S	14.1	5	9	Australia
K6O T H	14.1	5	8	Australia
K6D O S	14.1	5	7	Australia
K6B E M	14.1	5	8	Australia
K6P C F	14.1	5	6	Iowa
K4I A P	14.11	5	6-8	Alabama, Texas
K4I B H	14.27	5	6	Alabama
K4I H P	14.42	4	5	Alabama
K4I L B	14.13	5	7	Alabama, Colorado
K4I M E	14.15	5	8	Ala., Tex., Colo.
K4I F H	14.143	5	7-9	Nebraska, Arkansas
K4I C S	14.155	5	8	Colorado
KA7E F	14.12	5	6-7	Ala., Kans., Iowa
PK1V M	14.0	5	6	Tex., Mo.
PK3W I	14.05	4-5	6-7	Alabama, Kansas
PK6X N	14.04	3-5	5-8	Ala., Kans., Colo., Conn., S. C., Mo.

VK's were too numerous for all to be listed, but they were heard by observers in Nebraska, South Carolina, Missouri, Texas, Iowa, Arkansas, Colorado, and England.

ZL2B E	28.4	5	9	Arkansas
ZL2B M	28.375	5	7	Arkansas
ZL3I N	28.4	5	6	Arkansas

The number of reports has fallen off, and it is thought that many are not sending in their reports because of the poor DX that is coming in. Do not let this keep you from sending in what little you do receive. This month, one observer had just two stations instead of ten, but still his name appears in the box at the top of this page.

Reports this month were received from the following places:—

Alabama	Well
Arkansas	Henderson
Colorado	Watten
Connecticut	Kemp
Florida	Leite
Iowa	Mombheimer
Kansas	Heller
Missouri	Fleming

R. W. Reid, newly appointed observer for Scotland.



Mc.	Call	
11.700	CB1170	SANTIAGO, CHILE, 25.65 m. Addr. P.O. Box 706, Relays CB89 10 am.-2 pm., 3.30-11 pm.
End of Broadcast Band		
11.676	IQY	ROME, ITALY, 25.7 m. 5.20-5.40 am. ex. Sun., Daily 12.07-12.56, 1.50-2.30 pm.
11.535	SPD	WARSAW, POLAND, 26.01 m. Addr. 5 Mazowiecka St. 6-9 pm.
11.402	HBO	GENEVA, SWITZERLAND, 26.31 m., Addr. Radio Nations. Sun. 7-7.45, 8-8.45 pm. 1.45-2.30 pm. Mon. 6.45-8.15 pm.
11.040	CSW5	LISBON, PORTUGAL, 27.17 m., Addr. Nat. Broad Sta. 11 am.-4.30 pm. Sun. 10 am.-4.30 pm.
11.000	PLP	BANDOENG, JAVA, 27.27 m. Relays YDB, 6-7.30 pm., 10.30 pm.-2 am., 4.30-10.30 or 11 am. Sat. until 11.30 am.
10.950	—	TANANARIVE, MADAGASCAR, 27.40 m., Addr. (See 9.38 mc.) 12.30-45, 10-11 am., 2.30-4 am.,
10.670	CEC	SANTIAGO, CHILE, 28.12 m. Irregular.
10.660	JVN	NAZAKI, JAPAN, 28.14 m. Broadcasts daily 1.50-7.40 am. Works Europe irregularly at other times.
10.535	JIB	TAIHOKU, TAIWAN, 28.48 m. Works Japan around 6.25 am. Broadcasts, relaying JFAK 9-9.55 am., 1-2.30 am. Sun. to 10.15 am.
10.400	YSP	SAN SALVADOR, EL SALVADOR, 28.85 m., 1-3, 6.30-11 pm.
10.360	EAJ43	TENERIFE, CANARY ISL., 28.96 m., 3-4.30, 5-7, 7.45-8.45, 9-10 pm.
10.350	LSX	BUENOS AIRES, ARG., 28.98 m., Addr. Transradio Internacional. Tests irregularly.
10.330	ORK	RUYSSELEDE, BELGIUM, 29.04 m. Broadcasts 12.30-2 pm. Works OPM 1-3 am., 3-5 pm.
10.260	PMN	BANDOENG, JAVA, 29.24 m. Relays YDB 6-7.30 pm., 10.30 pm.-2 am., 4.30-10.30 or 11 am., Sat. to 11.30 am.
10.220	PSH	RIO DE JANEIRO, BRAZIL, 29.35 m., Addr. Box 709. Broadcasts 6-7 pm., Mon. 8-8.30 pm., Fri. 7-7.30 pm.
10.100	—	DEUTSCHE FREIHEITS SENDER, 29.70 m., loc. in Germany, under-cover. 4-5 pm.
10.050	TIEMT	SAN JOSE, COSTA RICA, 29.85 m., 4.30-8 pm.
10.050	DZC	ZEESEN, GERMANY, 29.16 m., Addr. (See 15.360 mc.) Irregular.
10.042	DZB	ZEESEN, GERMANY, 29.87 m., Addr. Reichspostzentralemt. Irregular.
9.995	COBC	HAYANA, CUBA, 30.02 m., Addr. P. O. Box 132. Relays CMBC 6.55 am.-1 am.
9.920	JDY	DAIREN, MANCHUKUO, 30.24 m. Relays JOAK daily 7-8 am. Works Tokyo occasionally in early am.
9.892	CPI	SUCRE, BOLIVIA, 30.33 m., 11 am.-n., 7-9 pm.
9.855	EAQ	MADRID, SPAIN, 30.45 m., Addr. P. O. Box 951. 7.30-8, 8.40-9 pm., 3.45-4.05, 4.45-5.05 am., also.
9.830	IRF	ROME, ITALY, 30.52 m. Works Egypt afternoons. Relays ZRO 12-12.25 pm. Thurs. Daily 12.40-1, 1.37-3.35, 6-9 pm.
9.815	COCM	HAYANA, CUBA, 30.57 m. Addr. Transradio Columbia, P. O. Box 33. 8-1 am. Relays CMCM.
9.785	HH3W	PORT-AU-PRINCE, HAITI, 30.66 m. Addr. P. O. Box A117. 1-2, 7-9.15 pm.
9.753	ZRO	DURBAN, SOUTH AFRICA, 30.75 m. Addr. S. A. Broadcasting Corp., P. O. Box 4559, Johannesburg. Daily exc. Sat. 11.45 pm.-12.50 am. Daily exc. Sun. 3.30-7.30, 9 am.-12.30 pm., Sun. 5.30-7, 9 am.-12.30 pm., also 4-5 am. on 3rd Sun. of month.
9.735	CSW7	LISBON, PORTUGAL, 30.82 m. Addr. Nat. Broad. Sta. n.-2 pm., 6-9 pm. for No. Amer.
9.730	CB970	VALPARAISO, CHILE, 30.83 m., 6.30-11.30 pm., or mid.
9.708	COCQ	HAYANA, CUBA, 30.90 m. Addr. 25 No. 445, Vedado, Havana, 7-1 am. Sun. 6.55 am.-1 am.

31 Met. Broadcast Band

Mc.	Call	
9.705	—	FORT DE FRANCE, MARTINIQUE, 30.92 m., Addr. P. O. Box 136. 6-8.10 pm. Irr. to 9.30 pm.
9.700	—	SAIGON, INDO-CHINA, 30.93 m., Addr. 17, Place A. Foray, "Radio Boy-Landry." 7.30-9.45 am. Irreg.
9.695	JIE2	TYUREKI, TAIWAN, 30.95 m. 9.05-10.20 am.
9.690	T14NRH	HEREDIA, COSTA RICA, 30.96 m., Addr. Amando C. Marin, Apartado 40. Sun. 7-8 am., Tues., Thurs., Sat. 9-10 pm.
9.690	LRAI	BUENOS AIRES, ARG., 30.96 m., 6-9 pm. Mon-Thur., 4-9 pm. Fri., 7-9 pm. Sat.
9.690	—	TANANARIVE, MADAGASCAR, 30.96 m., 12.30-12.45, 3.30-4.30, 10-11 am., Sun. 2.30-4 am.
9.690	ZHP	SINGAPORE, MALAYA, 30.96 m. Sun. 5.40-9.40 am., Wed. 12.40-1.40 am., Mon.-Fri. 4.40-9.40 am., Sat. 12.25-1.40 am., 4.40-9.40 am., 10.40 pm.-1.10 am. (Sun.)
9.690	GRX	DAVENTRY, ENGLAND, 30.96 m., Addr. See GSC, 9.58 mc., 10 am.-6 pm.
9.685	TGWA	GUATEMALA CITY, GUAT., 30.96 m. Daily 10-11.30 pm.; Sun. 7-10.45 pm.
9.683	HNF	BAGHDAD, IRAQ, 30.98 m. 6 am.-3 pm.
9.680	JFO	TAIHOKU, TAIWAN, 30.99 m. Relays JFAK irreg. 4-10.30 am.
9.675	DJX	BERLIN, GERMANY, 31.01 m., Addr. (D.J.D. 11.77 mc.) 11.30 am.-4.25 pm. To Africa.
9.670	WRCA	BOUND BROOK, N. J., 31.03 m. Addr. NBC, N. Y. C. 6 pm.-1 am.
9.665	ZRO9	ROME, ITALY, 31.04 m. 12.40-1, 1.37-5.30 pm., 6-6.30 pm.
9.660	LRX	BUENOS AIRES, ARG., 31.06 m., Addr. El Mundo. Relays LRI, 6-6.45 am.-9.15 am.-10 pm.
9.660	HVJ	VATICAN CITY, 31.06 m. Sun. 5-5.30 am.
9.650	W2XE	NEW YORK CITY, 31.09 m. (See 21.570 mc. for addr.) Irregular.
9.650	CS2WA	LISBON, PORTUGAL, 31.09 m., Addr. Radio Colonial. Tues., Thurs. and Sat. 4-7 pm.
9.650	IABA	ADDIS ABABA, ETHIOPIA, 31.09 m., 3.55-4.05, 4.15-4.45, 11 am.-noon, 1-3 pm. Sun. 3.30-3.55 am.
9.645	JLT2	TOKYO, JAPAN, 31.10 m., 2.30-4 pm. to Europe.
9.640	CXA8	COLONIA, URUGUAY, 31.12 m., Addr. Belgrano 1841, Buenos Aires, Argentina. Relays LR3. Buenos Aires 5 am.-10.45 pm. Sat. to 1 am.
9.635	ZRO3	ROME, ITALY, 31.13 m., Addr. (See 11.810 mc.) 12.07-3 pm., 5.30-9 pm., also Mon. 3.50-4.05 pm., Fri. and Sat. 4-4.20 pm.
9.620	CXA6	MONTEVIDEO, URUGUAY, 31.19 m., Rel. CX 6 to 9 pm.
9.610	LLG	OSLO, NORWAY, 31.22 m., 3-6, 8-9, 11 pm.-mid.
9.606	ZRL	KLIPHEUVAL, SOUTH AFRICA, 31.23 m., Addr. P. O. Box 4559 Johannesburg. Daily, exc. Sat. 11.45 pm.-12.50 am. Daily exc. Sun. 3.20-7.20, 9-11.45 am., Sun. 3.30-4.30 or 4-5, 5.30-7, 9-11.45 am.
9.600	RAN	MOSCOW, U.S.S.R., 31.25 m. Daily exc. Sun. 6-10 pm. Sun. 6-7, 9.15-10 pm.
9.600	CB960	SANTIAGO, CHILE, 31.25 m., 8-11.30 pm.
9.600	GRY	DAVENTRY, ENG., 31.25 m., Addr. See GSC, 9.58 mc., Irreg. 12.25-6 pm.
9.595	—	MOYDRUM, ATHLONE, EIRE, 31.27 m., Radio Eireann, 12.30-4.30 pm. Irreg.
9.595	HBL	GENEVA, SWITZERLAND, 31.27 m., Addr. Radio Nations. Irregular.
9.590	HP5J	PANAMA CITY, PANAMA, 31.28 m. Addr. Apartado 867. 12 n. to 1.30 pm., 6-10.30 pm.
9.590	VUD2	DELHI, INDIA, 31.28 m. Addr. All India Radio, 1.30-3.30 am., 7.30 am.-12.30 pm., 8.30-10.30 pm.
9.590	PCJ	HUIZEN, HOLLAND, 31.28 m., Addr. (See 15.220 mc.) Sun. 2-3, 7.15-9.25 pm. Tues. 1.45-3.30, 7-8.30, 8.45-10.15 pm., Wed. 7.15-8.40 pm., Fri. 8-9 pm.

Mc.	Call	
9.590	VK6ME	PERTH, W. AUSTRALIA, 31.28 m., Addr. Amalgamated Wireless of Australasia, Ltd. 6-8 am. exc. Sun.
9.590	VK2ME	SYDNEY, AUSTRALIA, 31.28 m., Addr. Amalgamated Wireless of Australasia, Ltd., 47 York St., Sun. 1-3 am.; 5-9, 10.30 am.-12.30 pm.
9.590	WCAI	PHILADELPHIA, PA., 31.28 m. (Addr. See 21.52 mc.) Mon. & Thurs. 5.30-6.15, 6.30-10.30 pm., 11 pm.-Mid. Sat. 5.30-6, 6.30-10.30 am.
9.580	GSC	DAVENTRY, ENGLAND, 31.32 m., Addr. B. B. C., Portland Pl., London, W. 1., 12.25-4, 4.20-6, 6.25-9.20, 9.40-11.30 pm.
9.580	VLR	MELBOURNE, AUSTRALIA, 31.32 m. Addr. 303 1686, G. P. O. Daily exc. Sat. 3.30-7.15 pm., Sat. 5-10.30 pm. Daily exc. Fri., Sat. 9 pm.-8.30 am., Fri. 9 pm.-9 am. (Sat.), Sat. 12 m.-7.30 am. (Sun.).
9.570	KZRM	MANILA, P. I., 31.35 m., Addr. Erlanger & Galinger, Box 283. Wkdays. 4.30-6 pm. m. tof. 5-9 am., Sat. 5-10 am., Sun. 4-10 am.
9.570	WBOS	BOSTON, MASS., 31.35 m., Addr. Westinghouse Electric & Mfg. Co. 7 am., Sun. 8 am.-1 am.
9.566	OAX4T	LIMA, PERU, 31.37 m., 7-8, 11.30 am.-1.30 pm.
9.560	XGAP	PEKING, CHINA, 31.38 m. Addr. S. Yoshimura, Dir. Peking Central Sta., Hsi-chan-an-chieh, Peking. 4-9 am.
9.560	DJA	BERLIN, GERMANY, 31.38 m., Addr. Broadcasting House. 6.30-10.50 pm.
9.550	HVJ	VATICAN CITY, 31.41 m., Sun. 5-5.30 am., Wed. 2.30-3 pm.
9.550	TPBII	PARIS, FRANCE, 31.41 m. Addr. (See 15.245 mc.) 11.15 am.-7 pm., 9.30 pm.-mid. Irreg.
9.550	WGEA	SCHENECTADY, N. Y., 31.41 m., General Electric Co., 6.15-9.15 pm. to So. Amer.
9.550	OLR3A	PRAGUE, BOHEMIA, 31.41 m. (See 11.840 mc.) Irreg. 4.40-5.10 pm.
9.550	XEFT	VERA CRUZ, MEX., 31.41 m. 10.30 am.-4.30 pm., 10.30 pm.-12.30 am.
9.550	YDB	SOERABAJA, JAVA, 31.41 m., Addr. N.I.R.O.M. Daily exc. Sat. 6-7.30 pm., 10.30 pm.-2 am.-4.30-10.30 am. Sat. 7 pm.-2 am.
9.550	VUB2	BOMBAY, INDIA, 31.41 m., Addr. All India Radio. 9.30-10.30 pm., 1-3.30 am. 5-6 am. also.
9.540	DJN	BERLIN, GERMANY, 31.45 m., Addr. (See 9.560 mc.) 12.05-2.30, 9.30-11 am., 4.50-10.50 pm. to So. Amer.
9.538	VPD2	SUYA, FIJI ISLANDS, 31.46 m., Addr. Amalgamated Wireless of Australasia, Ltd. 5.30-7 am., exc. Sun.
9.535	SBU	MOTALA, SWEDEN, 31.46 m. 4.15-5.05 pm.
9.535	—	SCHWARZENBURG, SWITZERLAND, 31.46 m., 1-2 pm. 6.45-7.45, 8-9 pm.
9.530	KGEI	SAN FRANCISCO, CAL., 31.48 m., Addr. Gen. Elec. Co., 12 m.-3 am., 7 am.-12 n. to Asia.
9.530	WGEO	SCHENECTADY, N. Y., 31.48 m., Addr. General Electric Co. 4 pm.-12 m.
9.530	VUC2	CALCUTTA, INDIA, 31.48 m. Addr. All India Radio. 2.06-4.06 am. 10 pm.-2 am.
9.526	XEDQ	GUADALAJARA, GAL., MEXICO, 31.49 m., N.-4.30 pm., 7 pm.-midnight.
9.526	ZBWB3	HONGKONG, CHINA, 31.49 m., Addr. P. O. Box 200. 5-10 am., 11.30 pm.-1.15 am. Sun. 5-9.30 am.
9.525	LKC	JELOY, NORWAY, 31.49 m., 4.30-10.30 am., Sun. 2.30-10.30 am.
9.523	ZRG	ROBERTS HEIGHTS, S. AFRICA, 31.5 m., Addr. (See ZRK, 9.606 mc.) Daily exc. Sun. 5-7.30 am.; Sun. 5.30-7 am.
9.520	OZF	SKAMLEBOAOK, DENMARK, 31.51 m., Addr. Statsradiofonien, Hejlsbergsgade 7, Copenhagen, 8-9.30, 6-9.05 am. and 8.30 pm.-2.40 am.

(Continued on page 348)

All Schedules Eastern Standard Time

George Mathews "Solves" the QSL Problem

Editor:

Well, here I am back again with more of my gab to fill up your page, but as you know, it always feels better to get it off your chest. So here goes—

My last article didn't have much effect, it seems, because some Hams still do not QSL, so I've hit upon an idea and I've tried it out. It works swell. Here's the idea:

I naturally keep a log of all Ham stations heard, so every week or so I check over my log, and if I find a Ham to whom I sent a card over 2½ months ago, I send him another card (a regular Government post-card) and write as follows:

"On (date) I heard you calling—

on—k.c.—P. M. I send you my SWL card but have received no news from you. It has now been 2½ months.

"The object of my card is to find out what you expect us to send you to receive your veri. All dope sent out to me will be passed on to my fellow SWL's through R. & T. (I hope). This will benefit you and save us a lot of expense. Be a good sport and send all dope; after all, you were once an SWL yourself. Thank you and 73."

Well, the part about them being published in R. & T. is doubtful, but if you, Mr. Editor, will use your influence to get us a little space in your magazine, we will appreciate it.

Now listen fellows, if we do get space in the magazine, here's what you do: Try my system, send all information to me and I will send it to R. & T.

Well, that's my solution for straightening out this QSL card business.

I also thank all you fellows who sent cards or letters on your praise and your swell ideas, and I also thank the editor for publishing my last letter.

So, I'll sign off and say 73 to you guys and gals and wish you lots of DX (I don't need it—much).

GEORGE MATHEWS,
854 Wrightwood Ave.,
Chicago, Ill.

What Do YOU Think?

We're Tops! He Says

Editor:

After comparing RADIO & TELEVISION with several other popular radio magazines, I have come to the conclusion that it is the best magazine for first-hand information covering the great variety of radio and television subjects. It has articles of interest and value for everyone—the Radio Beginner, the Experimenter, the Serviceman, and the advanced Radio Man.

Your television articles are exceptionally instructional and sections such as "Radio Kinks" and "Question Box" contain the answers to many puzzling problems.

DONALD MAURICE SCHMECHEL,
Doyon, N. Dak.

No Exaggeration

Editor:

Three months ago, while in the agency handling your magazine, I picked up a back number to find out what this amateur short wave radio was all about. Result—the "bug" got me because the issue contained *A Beginner's 1-Tube Receiver* using the then new tube, 6L8G. On inquiry I was disappointed to hear that the tube was not available in Australia, but placed an order and bought the first tube available last December. It was well worth waiting for. I thought the "world on headphones" was an exaggerated statement but No, Sir! In two hours listening on one night of the recent CQ contest, I heard every district in the States except W6 on just that 1 Tube!! The following is a list of Ws heard on that night only, on 20 meters. Boy! What a night—the 26th of March. W1ADM, W21KV, W4DRZ, W4BMR, W5VU (?), W5ACY, W7AGB (?), W8DST, W8KML, W9BCV (Portable), W9ARA, W9CVN, W9MDF, W9RUK, W9MCD, W8AAJ, W3DRG. I have in a "log" the check numbers given by the above Hams to their respective contacts. Also heard were VE4SS and VE4ZK. Since putting the job together a few months ago, I have heard VK's 1-7, incl. 9 PK's, KA's, 1-2K4, ZL's, VV's, VE's, W's, VS6, XS2, J's, also FNIC and XU8ET and many broadcast stations (in which I am rather uninterested as I have not the patience to wait for identity).

The little job seems capable of getting anything going, provided conditions are favorable, and some pals of mine are now building the receiver. Melbourne has sold out the April number and so my copy is now well worn.

Overseas broadcasts come in at considerable volume here, more especially, of course, London and Berlin. W6XBE at Treasure Island has given me interesting listening in the past two weeks, although tonight the band is absolutely dead.

The antenna I use here is a doublet (20' sections with a 10' stub and transposed 25' feeders). I added a condenser for finer tuning across the band.

I am now considering building the "5 for 4" also, using the 6L8G as described by the same author in the May number. As I am now a regular reader of your fine magazine, I will watch for any new circuit you give me through your *Question Box* or direct.

I must express my appreciation for your articles which make radio and set building easy for the novice. And also wish your journal continued success.

C. G. WARREN,
153 Sycamore St.,
Caulfield, S.E. 8,
Victoria, Australia.

P.S. I am expecting quite a bunch of QSL's, as so far have received back all that could have reached me. Probably the Hams QSL more readily on the reports from this midget, as same may give better idea of how they get out than one received from listener using Super job. Let us hope so.

80 Countries on R. & T. Sets

Editor:

I have been a reader of *Short Wave & Television* (now RADIO & TELEVISION) since 1936 and think your magazine is the best on the market for the SWL and the Amateur. I enjoy Joe Miller's DX tips. (Keep up the good work, Joe.) I think Louis C. Bremer, W3LE, is a regular fellow and I agree with him on the subject of SWL-QSLing. I sent him a QSL and got his back within a week. If all the Hams were like him, everything would be FB in this SW DXing game. Some of the SW broadcast stations are as bad as some of the Hams.

I think that all SWL's should always try to give as correct a report as possible. I always use an "R" meter when logging a station. I put the "R" meter on my receiver myself and any SWL who has a superhet can put one on his receiver at slight expense.

My receiver is a Browning 35 (with an "R" meter) and I use a 58 pre-selector which I got from your FB *Question Box* page. I use two different antennas; one half-

wave doublet 66 feet long and 50 feet high running NW-SE and a half-wave doublet 33 feet long and 30 feet high running E-W.

I have built many receivers from your FB magazine and all have worked fine. I have heard 80 countries and received verifications from 40 of them. I have heard 45 states on the 20 meter phone band and received QSL's from 29 of them.

I would like to exchange QSL's with other SWL's all over the world. Very best 73 and DX; very best wishes for your FB magazine.

Member, Short Wave League
U.S.N.C.R.

I.B.C. of London, England.

CUSTER C. EDWARDS,
Radio Signal Survey League
Monitoring Station W3F6O
18 Wellman St., Beverly, Mass.

Plea to Latin America

Editor:

I like your magazine in general as it does not give radio in only one or two phases of its field, but in the fullest detail from the simplest oscillator to unique transmitters and receivers. And now with Television coming into full sway, your items in this field are of exceptional interest. Being just a short-wave listener at the present time, I take great pleasure in telling you that you have gone far to make the "Listener's Department" a great success, and I'm sure it is winning you many friends not only in the States but in the world at large.

There is one article I would like to see appear in your magazine, and that is an article to urge the stations, principally those of Central and South America, please to honor correct listeners' reports, provided there is enough postage sent to cover cost of mailing a QSL card. Many listeners send report after report to stations in Central and South America, but never receive any response. This is not being fair to the listeners; in reality it is not even being honest. I don't say all the stations in Central and South America are like this, as there are many stations there that answer very promptly and are very glad to hear from their listener friends. But, in speaking on behalf of myself and the many other listeners, we ask for your guidance and helping hand.

GEORGE S. STARRY,
210 N. Ligonier St.,
Latrobe, Penna.

Mc.	Call		Mc.	Call		Mc.	Call	
9.520	YSH	SAN SALVADOR, EL SALVADOR, 31.51 m., Addr. (See 7.894 mc.) Irregular 6-10 am.	8.841	HCJB	QUITO, ECUADOR, 33.5 m., 7-8.30 am., 11.45 am.-2.30 pm., 5-10 pm., except Mon. Sun. 12 n.-1.30 pm., 5.30-10 pm.	6.790	PZH	PARAMARIBO, SURINAM, S.A. 44.16 m., Addr. P. O. Box 18. Sun. 8.40-10.40 am. Tues. & Fri. 5.40-8.40 pm. 1st & 3rd Thurs. monthly 6.40-8.40 pm.
9.520	RV96	MOSCOW, U.S.S.R. 31.51 m., 1-3, 4-7 pm. and irr.	8.830	COCQ	HAVANA, CUBA, 33.98 m., 6.55 am-1 am.	6.775	HIH	SAN PEDRO DE MACORIS, DOM. REP., 44.26 m., 7-9.40 pm. Sun. 5.20-6.40 pm.
9.510	GSB	DAVENTRY, ENGLAND, 31.55 m., Addr. (See 9.580 mc.)—GSC 12 m.-2.15 am., 6.20-9.15, 9.40-11.30 pm.	8.700	HKV	BOGOTA, COLOMBIA, 34.46 m. Tues. and Fri. 7-7.20 pm.	6.730	HI3C	LA ROMANA, DOM. REP., 44.58 m., Addr. "La Voz de la Feria." 12.30-2 pm., 5-6 pm.
9.510	—	TANANARIVE, MADAGASCAR, 31.55 m., Addr. Le Directeur des PTT, Radio Tananarive, Administration PTT. 12.30-12.45, 10-11 am., 2.30-4 am.	8.665	COJK	CAMAGUEY, CUBA, 34.64 m., Addr. Finlay No. 3 Altos. 11.30 am.-12.30 pm., 3.30-6, 8-9 pm.	6.720	PMH	BANDOENG, JAVA, 44.64 m. Relays N.I.R.O.M. programs. 4.30-11 or 11.30 am. Also Sat. 9.30 pm.-1.30 am.
9.510	HS8PJ	BANGKOK, SIAM, 31.55 m. Daily Ex. Mon. 8-10 am.	8.665	W2XGB	HICKSVILLE, N. Y., 34.64 m., Addr. Press Wireless, Mon. to Fri. News at 9 am. and 5 pm.	6.690	TIEP	SAN JOSE, COSTA RICA, 44.82 m., Addr. Apartado 257, La Voz del Tropico. Daily 7-11 pm.
9.510	—	HANOI, FRENCH INDO-CHINA. 31.55 m. "Radio Hanoi", Addr. Radio Club de L'Indochine. 12 m.-2 am., 6-10 am. 15 watts.	8.580	YNPR	MANAGUA, NICARAGUA, 34.92 m. Radiodifusora Pilot. 12.45-2.15, 6.45-10.15 pm.	6.675	H8Q	GENEVA, SWITZERLAND, 44.94 m. Addr. Radio-Nations. Sun. 1.45-2.45 pm.
9.503	XEWW	MEXICO CITY, MEX., 31.57 m. Addr. Apart. 2516. Relays XEW. 7:45 am.-12.30 am.	8.572	—	BUCHAREST, ROUMANIA, 35.02 m., 8.15-10.30 am., 4-7 pm.	6.660	HI5G	TRUJILLO CITY, D. R., 45.05 m., to 8.40 pm.
9.501	PRF5	RIO DE JANEIRO, BRAZIL, 31.58 m., 4.45-5.55 pm. Ex. Suns.	7.894	YSD	SAN SALVADOR, EL SALVADOR, 37.99 m., Addr. Dir. Genl. Tel. & Tel. 7-10.30 pm.	6.635	HC2RL	GUAYAQUIL, ECUADOR, 45.18 m., Addr. P. O. Box 759. Sun. 5.45-7.45 pm., Tues. 9.15-11.15 pm.
9.500	VK3ME	MELBOURNE, AUSTRALIA, 31.58 m., Addr. Amalgamated Wireless of Australasia, 167 Queen St. Daily except Sun. 4-7 am.	7.870	HCIRB	QUITO, ECUADOR, 38.1 m. La Voz de Quito. 8.30-11.30 pm.	6.630	HI1T	CIUDAD TRUJILLO, D. R., 45.25 m., Addr. "La Voz de la RCA Victor," Apartado 1105. Daily exc. Sun. 12.10-1.40 pm., 5.40-8.40 pm.; also Sat. 10.40 pm.-12.40 am.
9.500	OFD	LAHTI, FINLAND, 31.58 m., Addr. Finnish Brct. Co., Helsinki. 12.15-5 am.	7.854	HC2J5B	GUAYAQUIL, ECUADOR, 38.2 m. 11 am.-2, 4-11 pm.	6.625	PRADO	RIOBAMBA, ECUADOR, 45.28 m. Thurs. 9-11.45 pm.
9.497	KZIB	MANILA PHIL. ISL., 31.59 m., 6-9.05 am. and 8.30 pm.-2.40 am. Irreg.	7.797	HBP	GENEVA, SWITZERLAND, 38.48 m., Addr. Radio-Nations.	6.610	YNLG	MANAGUA, NICARAGUA, 45.39 m. Emisora Ruben Dario. 1.30-2.30, 6-10.15 pm.
9.488	EAR	MADRID, SPAIN, 31.6 m., Addr. (See 9.860 mc.) Irreg.	7.614	CR6AA	LOBITO, ANGOLA, 39.39 m., Mon., Wed., Sats. 2.30-4.30 pm. Also 7.177 mc.	6.600	HI6H	TRUJILLO CITY, D. R., 45.45 m., 7.40-8.40 pm.
End of Broadcast Band			7.520	KKH	KAHUKU, HAWAII, 39.89 m., Fri. 9-10 pm., Sat. 1-1.30 am., 9.30-10 pm.	6.565	HI5P	PUERTO PLATA, D. R., 45.70 m., 5.40-7.40, 9.40-11.40 pm.
9.465	TAP	ANKARA, TURKEY, 31.70 m., 11.30 am.-5 pm.	7.490	EAJ43	TENERIFE, CANARY ISL., 40.05 m., 8-9.30 pm. and Irreg.	6.558	HI4D	CIUDAD TRUJILLO, D. R., 45.74 m., Addr. Apartado 623. 12.30-2, 6-8 or 9 pm. Except Suns.
9.445	HCODA	GUAYAQUIL, ECUADOR, 31.77 m., 8.15-10.15 pm., exc. Sun.	7.450	TI2RS	SAN JOSE, COSTA RICA, 40.27 m. "Radioemisora Athene". 7-11 pm.	6.550	XBC	VERA CRUZ, MEX., 45.8 m. 8.15-9 am.
9.437	COCH	HAVANA, CUBA, 31.8 m., Addr. 2 B St., Vedado. B am.-11 pm. Sun. 8 am.-10 pm.	7.440	FG8AH	POINT-A-PITRE GUADELOUPE, F.W.I., 40.32 m., 6-7.10 pm., also 9-10.30 pm. Irreg. P. O. Box 125.	6.540	YNIGG	MANAGUA, NICARAGUA, 45.87 m., Addr. "La Voz de las Lagos." 1-2.30, 8-10 pm. Except Sundays.
9.390	OAX5C	ICA, PERU, 31.95 m., Radio Universal, 7-11.30 pm.	7.410	HCJ84	QUITO, ECUADOR, 40.46 m., 7-9.30 pm. irregularly.	6.490	TGWB	GUATEMALA CITY, GUAT., 46.2 m. La Voz de Guatemala. Daily 7.45-9 am. 12.45-3.45 pm., 7.30 pm.-12.15 am. Sun. 10.30 am.-5.15 pm., 7 pm.-12 m.
9.370	XOY	CHENG TU, CHINA, 32.02 m., 9.45-10.30 am.	7.380	XECR	MEXICO CITY, MEX., 40.65 m., Addr. Foreign Office. Sun. 6-7 pm.	6.480	HIIL	SANTIAGO DE LOS CABALLEROS, D. R., 46.28 m., Addr. Box 356. 9.40-11.40 am., 7.40-9.40 pm.
9.355	HC1ETC	QUITO, ECUADOR, 32.05 m., Addr. Teatro Bolivar, Thurs. until 9.30 pm. 8-11 pm. Sats.	7.310	VIG	PORT MORESBY, PAPUA, 41.01 m., 2nd & 4th Sats. each month. 3-5 am.	6.470	YNLAT	GRANADA, NICARAGUA, 46.36 m., Addr. Leonidas Tenorio, "La Voz del Mombacho." Irregular.
9.350	COCD	HAVANA, CUBA, 32.08 m., Addr. Box 2294, Relays CMCD 10 a.m.-11.30 pm. Sun. 10 am.-9 pm.	7.295	JIE	TYUREI, TAIWAN, 41.13 m. 9.05-10.20 am.	6.455	HI4V	SAN FRANCISCO DE MACORIS, D. R., 46.44 m., 11.40 am.-1.40 pm., 5.10-9.40 pm.
9.345	HBL	GENEVA, SWITZERLAND, 32.11 m., Addr. Radio Nations. Sun. 7-7.45, 8-8.45 pm. Mon. 6.50-8.15 pm.	7.280	TPB12	PARIS, FRANCE, 41.21 m., 10.15 am.-5.15 pm., 8.30-11 pm.	6.420	HIIS	SANTIAGO, D. R., 46.73 m., 5.40-7.35 pm. Ex. Suns.
9.340	OAX4J	LIMA, PERU, 32.12 m., Addr. Box 1166, "Radio Universal." 12 n.-3 pm., 5 pm.-indefinite.	7.260	CSW8	LISBON, PORTUGAL, 41.32 m., addr. Emisora Nacional de Radiodifusao, rua do Quelhas. Tue., Thur., Sat. 4.05-5 pm.	6.400	TGQA	QUEZALTENANGO, GUATEMALA, 46.88 m., Mon.-Fri. 9-11 pm. Sat. 10 pm.-1 am. Sun. 1-3 pm.
9.295	HI2G	CIUDAD TRUJILLO, D. R., 32.28 m., 6.40-8.40 am., 11.40 am.-2.10 pm., 3.40-4.40 pm.	7.250	YDA	TANDJONGPRIOK, JAVA, 41.37 m., Addr. N.I.R.O.M., Batavia, 10.30 pm.-2 am.; Sat. 7.30 pm.-2 am.	6.388	HI9B	SANTIAGO, D. R., 46.95 m., Mon. 6-6.45, 8-8.45 pm.
9.280	LYR	KAUNAS, LITHUANIA, 32.33 m., 11 am.-1.25 pm. and Irreg.	7.220	YDX	MEDAN, SUMATRA, N. E. I., 41.55 m. Daily exc. Sat., 10.30 pm.-2 am. Sat. 7.30 pm.-1.30 am. Irreg. to 9 am.	6.384	ZIZ	BASSETERRE, ST. KITTS, W. IN. DIES, 46.99 m., 4-4.45 pm., Wed. 7-7.30 pm.
9.200	ZMEF	SUNDAY ISLAND, 32.61 m., Conts. ZIL5, N.Z. 1.45-2.15 am. Irreg.	7.200	Y15KG	BAGHDAD, IRAQ, 41.67 m., 7.30 am.-4 pm.	6.357	HRPI	SAN PEDRO SULA, HONDURAS, 47.20 m., 6-7.30 am., 2-4 pm. & Irreg. to 10 pm.
9.200	COBX	HAVANA, CUBA, 32.61 m., Addr. San Miguel 194, Altos. Relays CMBX 8 am.-11.30 pm.	7.200	YNAM	MANAGUA, NICARAGUA, 41.67 m. Irregular at 9 pm.	6.340	HIIX	CIUDAD TRUJILLO, D. R., 47.32 m. Sun. 7.40-10.40 am., daily 12.10-1.10 pm., Tues. and Fri. 8.10-10.10 pm.
9.188	HC2AB	ECUADOR, 32.65 m., nightly to 10 pm.	7.177	CR6AA	LOBITA, ANGOLA, PORT. WEST AFRICA. 41.75 m., Mon., Wed., and Sats. 2.45-4.30 pm. Also see 7.614 mc.	6.335	OAXIA	ICA, PERU, 47.33 m., Addr. La Voz de Chiclayo, Casilla No. 9. 8-11 pm.
9.170	HC1GQ	QUITO, ECUADOR, 32.72 m., Mon. Wed., Sat. 9-9.55 pm.	7.128	YN3DG	LEON, NICARAGUA, 42.09 m., 2-2.30, 8.30-9.30 pm. ex. Suns.	6.324	COCW	HAVANA, CUBA, 47.4 m., Addr. La Voz del Radio Philco, P. O. Box 130. 6.55 am.-12 m. Sun. 9.55 am.-10 pm.
9.125	HAT4	BUDAPEST, HUNGARY, 32.88 m., Addr. "Radiolabor," Gyali-ut, 22. Daily 7-8 pm., Sat., 6-7 pm.	7.100	FO8AA	PAPEETE, TAHITI, 42.25 m., Addr. Radio Club Oceanien. Tues. and Fri. 11 pm.-12.30 am.	6.310	HIZ	CIUDAD TRUJILLO, D. R., 47.52 m. Daily except Sat. and Sun. 11.10 am.-2.25 pm., 5.10-8.40 pm. Sat. 5.10-11.10 pm. Sun. 11.40 am.-1.40 pm.
9.124	HC2CW	GUAYAQUIL, ECUADOR, 32.88 m., 11 am.-1, 7-11 pm.	7.088	PII1J	DORDRECHT, HOLLAND, 42.3 m., Addr. Dr. M. Hellingman, Technical College. Sat. 11.10-11.50 am.			
9.100	COCA	HAVANA, CUBA, 32.61 m. Addr. Galiano No. 102. Relays CMCA Noon-1.15 am. Irreg. to 3 am.	6.990	XEME	MERIDA, YUCATAN, 42.89 m. Addr. Calle 59, No. 517, "La Voz de Yucatan desde Merida." Irregular.			
9.091	PJCI	CURACAO, D. W. INDIES, 33 m., 6.36-8.36 pm., Sun. 10.36 am.-12.36 pm.	6.977	XBA	TACUBAYA, D. F., MEX., 43 m. 9.30 am.-1 pm., 7-8.30 pm.			
9.030	COBZ	HAVANA, CUBA, 33.32 m., Radio Sales Addr. P. O. Box 866, 7.45 am.-1.15 am. Sun. 7.45 am.-12 m. Relays CMBZ.	6.970	XPSA	KWEIYANG, CHINA, 43.05 m., 5.30, or 6-11 am.			
8.965	COKG	SANTIAGO, CUBA, 33.44 m. Addr. Box 137. 9-10 am., 11.30 am.-1.30 pm., 3-4.30, 5-6, 10-11 pm., 12 m.-2 am.	6.960	ZZ8	WELLINGTON, N. Z., 43.10 m., Mid.-7 am.			
8.960	TPZZ	ALGIERS, ALGERIA. 33.48 m. Tues. 12.30-1.30 pm.	6.880	XOJD	HANKOW, CHINA, 43.60 m., 6-8.30 am.			
			6.805	HI7P	CIUDAD TRUJILLO, DOM. REP., 44.06 m., Addr. Emisora Diaria de Comercio. Daily exc. Sat and Sun. 12.40-1.40, 6.40-8.40 pm. Sat. 12.40-1.40 pm. Sun. 10.40 am.-11.40 am.			

(Continued on page 382)

All Schedules Eastern Standard Time

Radio Test-Quiz

Edited by Robert Eichberg

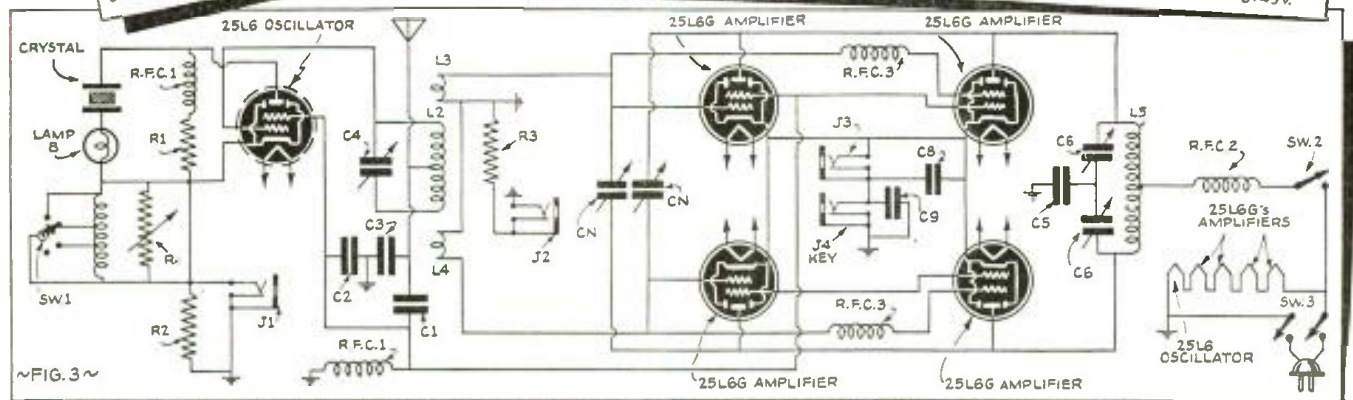
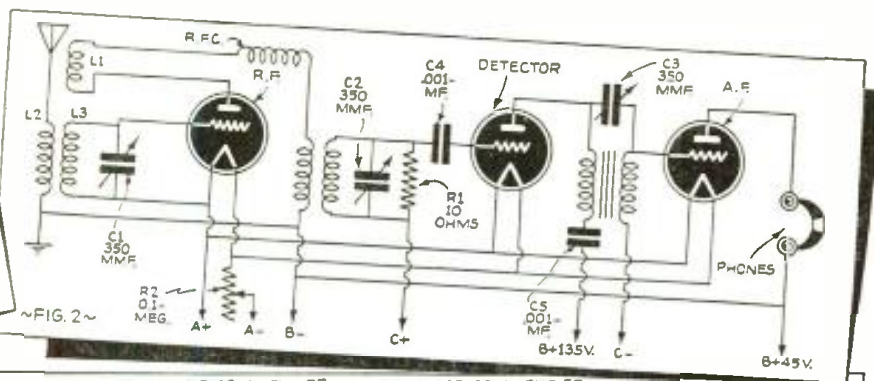
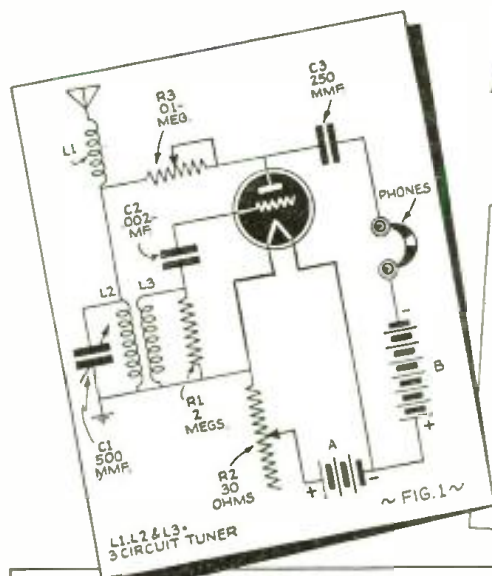

Do not try to build these sets.—Fig. 1 shows how "Nat the Novice" went wrong when he tried to build a 3-circuit regenerative receiver. Can you correct his diagram?

Fig. 2 is a heart-breaking idea of what "Terry the Tyro" achieved when he attempted to build a 3-circuit regenerative receiver with one stage of R.F. and one stage of A.F. amplification. Can you find mistakes?

Fig. 3 illustrates the woes of "Bert the Beginner" in attempting to build a D.C. powered transmitter. Can you put "Bert" on the right track to success?

Again let us repeat: Do not try to build these sets. The diagrams are purposely incorrect and no receiver built according to them could possibly work if built as shown above.

● THIS month we are offering readers of RADIO & TELEVISION a little novelty in their "Radio Test-Quiz." While the usual Test-Quiz reveals the reader's general knowledge, this month's quiz will put him through his paces as a "bug hunter."

Printed on this page are three diagrams. Do not try to build sets according to them, for each contains many serious errors which would not only make the apparatus inoperative but would probably also damage any apparatus used. Here, however, is your first problem.

1 Your friend, Nat the Novice, has built what he fondly believes to be a simple one-tube regenerative set from parts found in his junk box. The set refuses to work so he calls you in to lend your expert advice. Tracing out the wiring of the set, you get something that looks like Fig. 1 in which L1 is the tickler coil, L2 the primary, and L3 the secondary of a standard 3-circuit tuner. C1 is a .0005 mf. condenser. C2 a .002 mf., and C3 a .00025 mf. R1 is a 2 meg. fixed resistor. R2 a 30 ohm resistor, and R3 a 100,000 ohm potentiometer. Inspecting the diagram in Fig. 1, can you tell where Nat went wrong or can you draw a correct diagram using some or all of the parts which Nat employed?

2 Your next problem is the result of a visit to Terry, the Tyro. Terry, a little more ambitious than your other friend, has attempted to build a 3-tube set with one stage of tuned radio frequency amplification, a regenerative detector and a stage of audio frequency amplification. He likewise employed a 3-circuit tuner, L1, L2 and L3; three .00035 mf. variable condensers, C1, C2 and C3; two .001 mf. fixed condensers, C4 and C5; one 10 ohm rheostat, R1; and one 100,000 ohm fixed resistor, R2. He was also employing a "C" battery—and as you can guess by looking at the circuit which he drew up for himself (shown in Fig. 2), it is the first time he ever saw a battery of this sort. See if you can correct Terry's diagram so that, by following it, he will be able to build the set for which his heart pines.

3 While Bert the Beginner believes himself far advanced beyond the novice stage and can construct receivers that will pull in Afghanistan at any hour of the day or night, he is totally at sea when it comes to building a simple Transmitter. Fig. 3 shows Bert's idea for a nice transmitter to work directly from the D.C. lines. When Bert hooked up this transmitter, he was

a very sad young man, for it did none of the things that it should have done and all of the things it shouldn't. You, being an old-time ham (or at least a steadfast reader of RADIO & TELEVISION), were his first thought when he needed help. He called you in and showed you the diagram of his set, Fig. 3. He asked what you would do to make the apparatus function as a real rig should. You sat down and found 12 mistakes in it—*or did you?*

Answers to all three problems appear on page 362.

This month's quiz will test your practical knowledge as opposed to your theoretical knowledge. If you can solve the first problem, credit yourself with 15 points. If you can solve the second problem, give yourself 25 points additional, and if you can solve the final problem, give yourself another 60 points. The first two problems must be solved completely in order to attain any credit as they are relatively simple. However, in the final problem, give yourself 5 points for each error you find. If you can get 100 points on this quiz without having to refer to diagrams in other publications—boy, you know your stuff!!

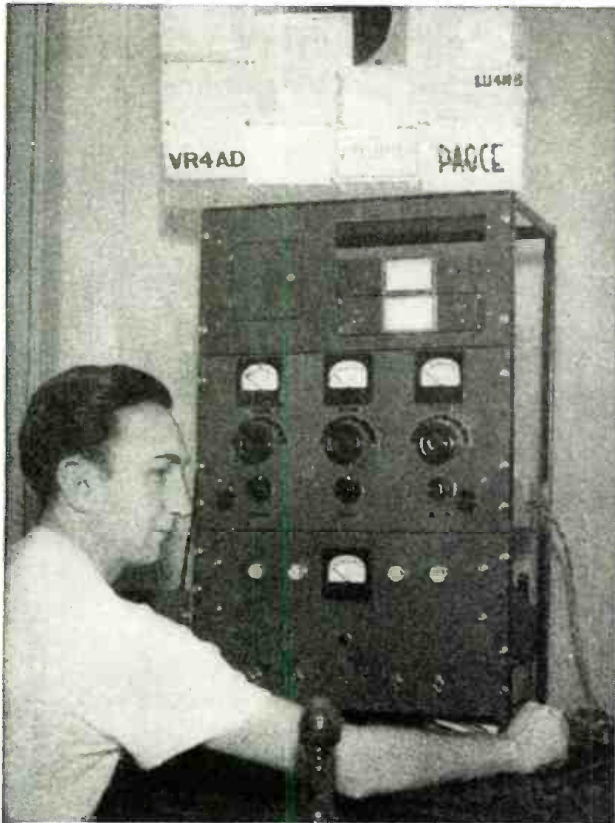

The ECO Switch-Band Transmitter

Rapid change of frequency is a big feature of this ECO transmitter, which covers the 1.75, 3.5, 7, 14 and 28 mc. bands. Coil data is given. Oscillator is an 89, buffer an 807, and the final is an HK54.

This transmitter has an HK54 final amplifier. The oscillator grid-tuning assembly is available in kit form.

● **FLEXIBILITY** in a transmitter is probably even a greater desideratum than high power. Flexibility can be judged by the ease and rapidity of both inter-band and intra-band frequency changes. Not only in contest work, but in every-day operation, the ability to change frequency rapidly adds greatly to the convenience of "hamming".

Where it is desirable to operate on any and all parts of the amateur bands, the use of an electron-coupled oscillator is a virtual necessity. In contest work the ECO has proven its worth often; however, for net operation, such as traffic nets and Army-Navy nets, where all stations in the net operate on the same frequency, it is desirable to have a crystal oscillator. In order to afford the greatest possible use of

the crystals, the oscillator should provide output not only on the crystal's fundamental frequency, but on its second harmonic as well. The use of the tri-tet crystal oscillator would therefore seem to be indicated.

807 Supplies Ample Excitation

In the writer's transmitter, being described, an 89 type tube was used as the oscillator, with a switching arrangement

Diagram of the very flexible ECO transmitter. Ground suppressor grid No. 4 of 89 oscillator.

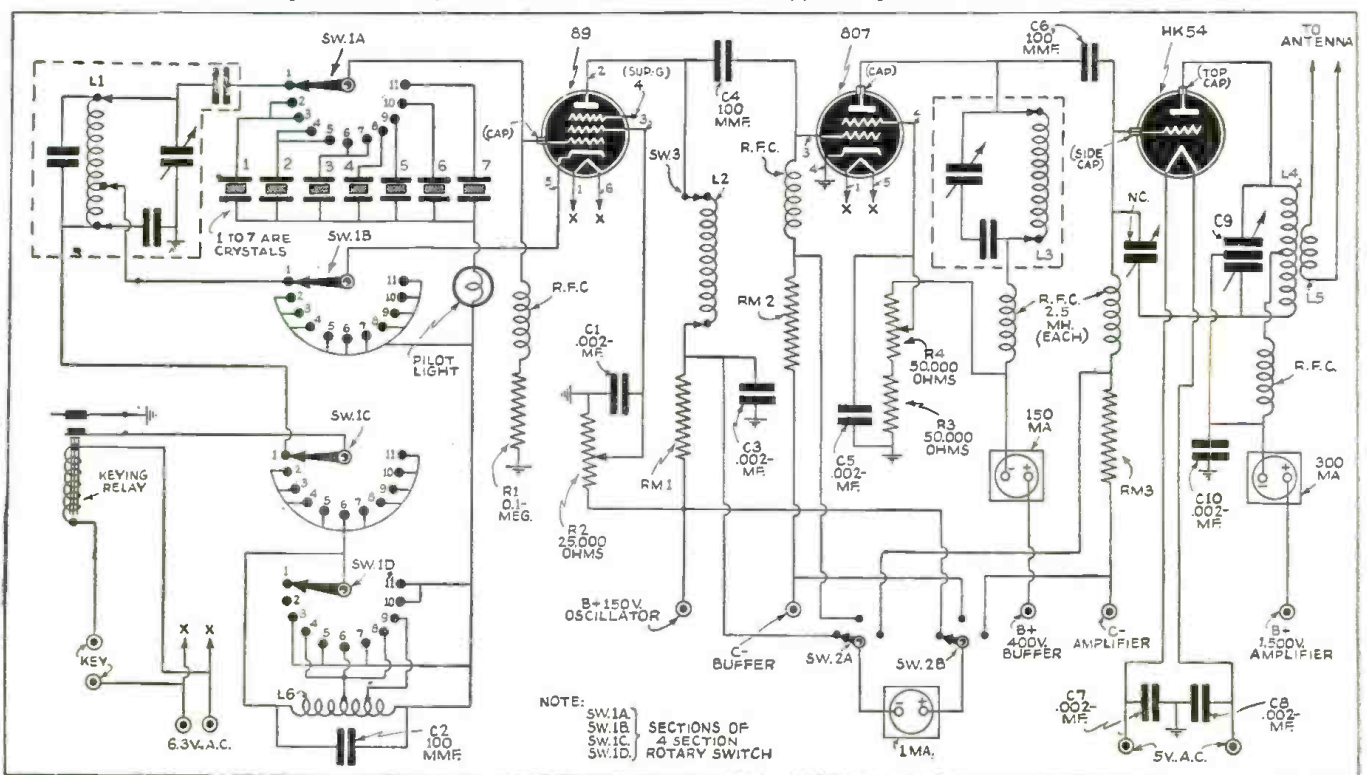

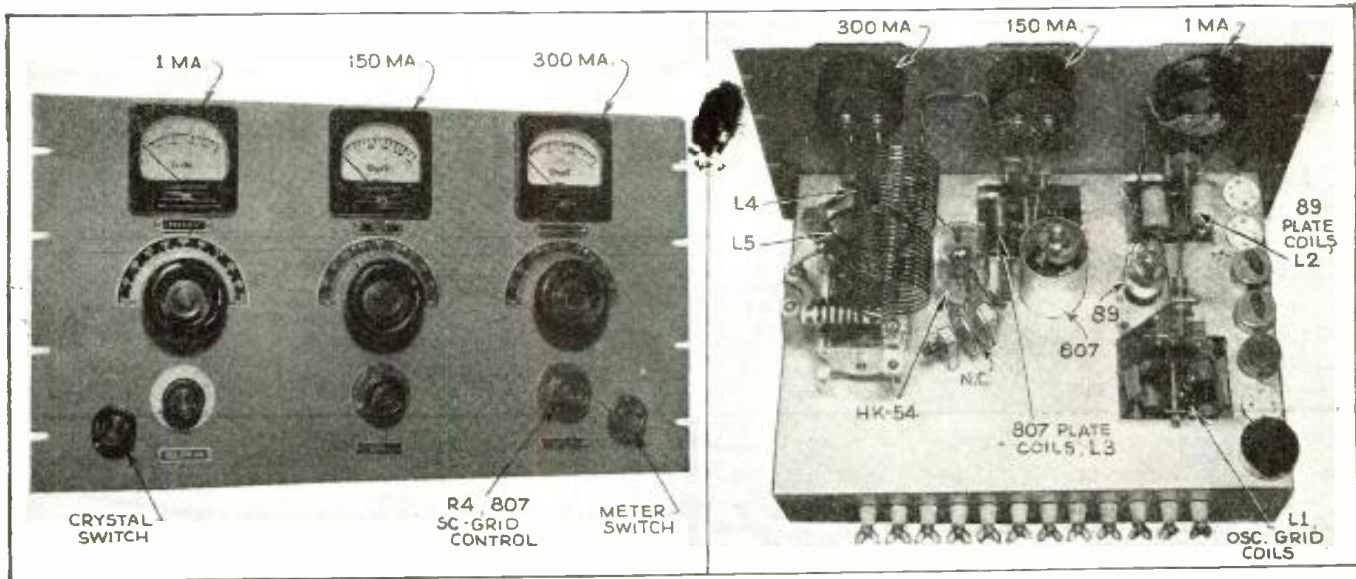

Above—Front and rear views of transmitter. Below—Bottom view.

Herman Yellin, W2AJL

allowing the tube to be used either as an *electron-coupled* oscillator (ECO), a pentode crystal oscillator, or as a *tri-tet* crystal oscillator. This was followed by an 807 buffer stage which, in turn, fed into the HK54 final amplifier. The comparatively low power output from the oscillator was sufficient to fully excite the 807, a beam power tube. In tests, 200 watts input to the HK54 were applied with the 807 being able to supply more than sufficient excitation. In fact, a control in the 807 screen grid had to be installed to cut down on the amount of R.F. excitation supplied to the HK54.

Band-Switchings

Band-switching was used in all circuits except the final amplifier plate coils (L4) where greater efficiency and a lack of space dictated the use of plug-in coils.

A chassis 17" x 12" x 3" permitted all the components to be mounted without undue crowding. A 10½" x 19" grey aluminum rack panel bolted to the chassis supports the tuning condensers and meters, while serving as a decorative front for the completed unit. Large cut-outs in the chassis allow the band-switching coil units, mounted underneath the chassis, to protrude somewhat above deck.

Returning to the oscillator circuit, with its several switches and its complicated appearance, it should be mentioned that this is not as fearsome as it might appear at first glance.

The oscillator grid tuning assembly is the Browning 5G tuner which comes completely assembled with five coils already mounted and wired on a band-switch. Fixed silver mica condensers across each coil contribute to a high CL ratio, so necessary for stable ECO operation. A 100 mmf. tuning condenser is also wired up to the assembly and comes mounted, together with the coil-switch, on a metal bracket, thus greatly

facilitating mounting the unit on the chassis. This condenser is connected to a panel-mounted vernier planetary drive by a length of flexible shafting. The pointer is removed from the wheel knob and soldered to the part of the planetary drive which rotates at the same speed as the condenser, while the knob mounts on the vernier shaft.

Arrangement of ECO Tuning Unit

This ECO tuning unit is mounted behind the plate coil assembly and somewhat out of line, the two being coupled by a short length of flexible shafting such as is used in auto radios. One slight change must be made in the 5G tuning unit. As supplied by the manufacturer, the 100,000 ohm grid-leak is shunted across the grid condenser. Remove the grid resistor and use it in series with the R.F. choke in the 89 grid circuit. The oscillator plate circuit is somewhat unique in that it is *untuned*. These plate coils are wound so that they have sufficient inductance in conjunction with their distributed capacity to tune to the center of the ham band. Naturally, with such a low capacity or high LC ratio, tuning is extremely broad so that the same output is available over the whole band. Some trimming of the coils may be necessary to hit the center of the band, especially with the 20 and 10 meter coils. Tuning from one end of the band to the other should result in little, if any, variation in grid current to the 807.

It will be noticed that the parts list specifies two 3-section rotary switches. These

must be rebuilt for our use since we need a two-section switch with wide spacing between sections and a four-section switch with close spacing between sections. The two switches are disassembled and one reassembled so that it has two sections separated about 1½ inches. This is used for the oscillator plate coils. The other switch is reassembled together with the unused section from the first switch to provide a four-section switch with sections spaced about ½ inch.

Type of Oscillator Is Switch-Selected

This four-section switch is really the heart of the oscillator unit, since with it the oscillator can be changed from EC to crystal control; any one of 7 crystals can be selected and also the choice of a pentode or tri-tet oscillator circuit. Let us analyze this switch, section by section: The deck nearest the front panel, SW-1A in the diagram, when on the first contact, causes the oscillator to operate as an *electron-coupled* oscillator. From contact 2 to contact 11 inclusive, it selects any one of 7 crystals, there being 7 special crystal-holder receptacles mounted along the left-hand edge of the chassis. It will be noticed that some

(Continued on page 368)

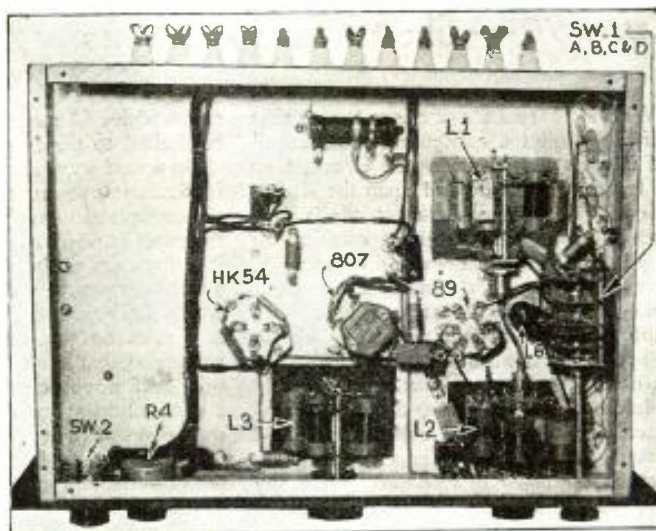

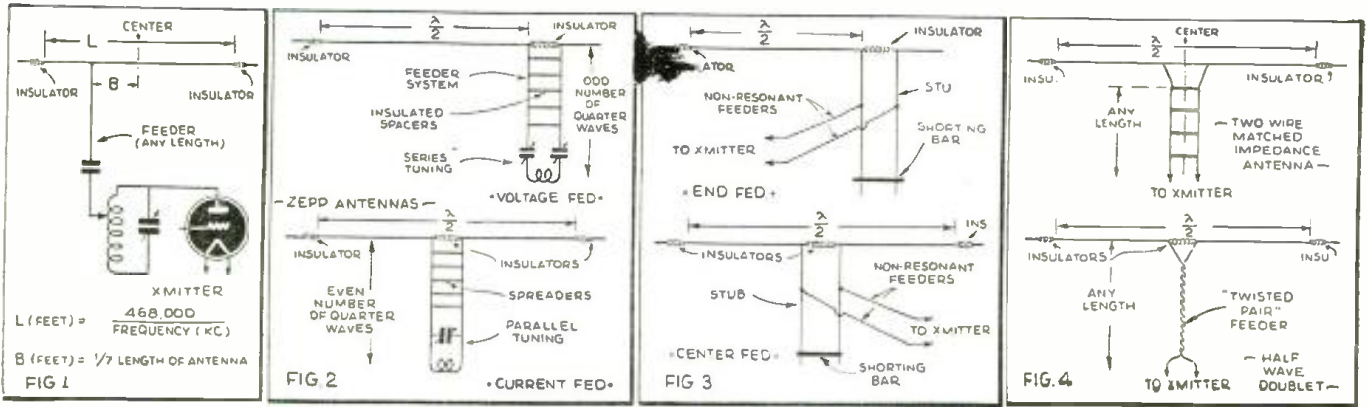

Above—Single-wire fed antenna; Zepp antennas, and use of a "matching stub."

The Radio Beginner

Lesson 10 — Short Wave Antennas

Martin Clifford, W2CDV

● WE recall from our previous lessons that if we connect a condenser across a coil and impress a charge on this circuit, then the frequency will depend upon the size of the coil and condenser. An antenna is very much like the coil-condenser combination since it also has inductance and capacitance, but where the coil and condenser have their radio frequency field confined to a very small space, the antenna is strung out in the open. The transmitted radio waves consist of a *ground component* which rapidly diminishes in strength away from the transmitter, and a sky wave which is radiated upward toward the Kennelly-Heaviside layer. If the *angle of radiation* of the sky wave is small, a greater distance is traveled by the wave than if the angle of radiation is larger, the traversed area—known as *skip distance*—decreasing with the increase in the angle of radiation. Angle of radiation is thus an important factor in determining antenna design.

All antennas can be grouped under two general headings: The *Hertz* and the *Marconi*. Numerous varieties of antennas come under these classifications, the Hertz type having *half waves*, or its multiples, and the Marconi type having *quarter waves* or odd multiples of a quarter wave. Since Marconi antennas find their greatest appli-

cation above 80 meters, this discussion will be limited to the types of Hertz antennas.

On a half wave antenna, operating on its fundamental, the current is a maximum at the center and the voltage is a maximum at the ends. The *impedance* of such an antenna is a minimum at the center and increases to a maximum at the ends. It is the impedance which determines the amount of current at any point on the wire for the particular voltage at that same point. The impedance of a half wave antenna varies from about seventy ohms at the center to several thousand ohms at the ends. Maximum efficiency can be obtained if the impedance of the feeder system matches the impedance of the antenna. For example, the amplifier output of a transmitter can excite an antenna through the use of a single line feeder, provided that the feeder is connected to the proper point on the antenna to give a good impedance match. In Fig. 1 we see such a system. Since the average impedance of a single wire feeder is about 600 ohms, it merely becomes necessary to connect the feeder to a point on the antenna where the impedance is also 600 ohms. This point will be a little off center of the antenna. Such an antenna is termed a *Single Wire Fed Antenna*.

One of the most popular antennas among

hams has been the *Zepp*. The antenna itself is a half wave long and is connected to the transmitter by two parallel wires spaced about six inches apart. As shown in the diagram, the Zepp may be fed at either end, or in the middle, whichever arrangement is more advantageous for connection to the transmitter. In such a system, the standing waves upon the feeder will tend to neutralize each other, thus preventing radiation from the feeders. The end fed Zepp is alternately called *Voltage Fed*, since the feeders are connected to points of high voltage. In similar fashion, the center fed Zepp is termed *Current Fed* because the center is the point of maximum current. The Zepp is widely used because it functions very readily with a minimum of fuss. The Zepp also lends itself very readily to operation on a number of bands. Because of feeder radiation losses, however, the Zepp usually doesn't work at very high efficiency. These radiation losses can be avoided through the use of a *non-resonant* feeder system. Such a feeder system can be obtained through the use of an *impedance matching stub*, as shown in Fig. 3. The stub consists of a pair of feeders which may be either *shorted* at one end or left open. The impedance at the shorted end of the stub is only a few

(Continued on page 367)

Below—Illustrating use of reflector; flat-top beam antenna, concentric feeder and ultra-high frequency aerials.

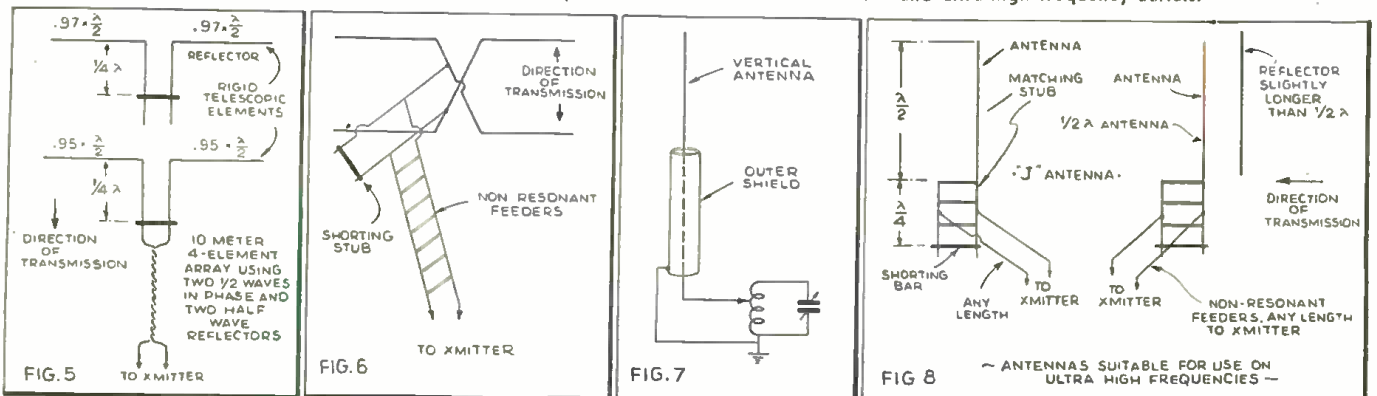



WE HAVE GROSSED THE THRESHOLD OF TOMORROW

For twenty years we here at Wholesale Radio Service Company have blazed new trails in Public Service. Scarcely a phase of the communications field has been left untouched during the years of our growth. Today thousands of discriminating buyers in every land are listed among our satisfied customers. For into every shipment we have always put more than just top-flight merchandise.

It has been this spirit of extra service that has enabled us to grow from a modest shop into a worldwide organization. We operate seven retail branches

today, with three giant central distributing points from which flow thousands of shipments daily.

As we have grown however, so too have grown the demands of the people we serve. Industry, for new and better materials; individuals, for finer instruments and forms of reception. We have lived to see many new developments replace the old, many of our former services, once essential, no longer required.

In fact, our very name for so many years perfectly adapted to our business now belongs to yesterday. It does not fit with our plans for tomorrow.

Naturally, we were attached to our old name, but sentiment has no place in progress. And so from now on we shall be known as

Radio Wire Television Inc.

A name selected because it accurately pictures the very business we are engaged in.

What do we mean? Let's look at that name more closely.

RADIO : Up through the years we have grown and expanded with Radio—very backbone of our business. Yet even in the face of today's magic, life-like reception, much remains to be done. So naturally Radio Broadcasting will continue to engage our interest.

WIRE : A new service gaining momentum with each day is WIRE BROADCASTING. Already many of today's entertainment forms are available by means of wire with great fidelity, reliability, and economy. We believe that soon the art of broadcasting by wire will encompass the transmission of both sight and sound. Every current technological development points to this end.

TELEVISION : Third and newest term in our name. Breath-taking is television's power to reproduce for man's entertainment and knowledge, the life and happenings of storied lands afar, the news events that will make tomorrow's headlines. With television a vast new field of human relationship is magically thrown open. Whichever way you choose to receive your television programs, by wire or radio, we will offer the finest services available anywhere.

The new name, thus embodies all of those features which from now on are to comprise the principal part of our business. Radio Wire Television Inc., proposes to extend its activities into every phase of the electronic art. Several associate enterprises which control important patents relating to the entire communications field have already been merged with our com-

pany. With these patents, we hope to throw open a vast number of new services to the general public. Of special interest are plans to expand the number of retail outlets for Radio Wire Television Inc. in order that local branches may be placed at the disposal of all who are interested in finer entertainment services, better products and lower costs.

Radio Wire Television Inc., is licensed by arrangement with Electrical Research Products Inc. under patents of Western Electric Company, Bell Telephone Laboratories, Inc., and American Telephone & Telegraph Company.

Radio Wire Television Inc.

formerly **WHOLESALE RADIO SERVICE CO., Inc.**

NEW YORK • CHICAGO • ATLANTA • BOSTON • NEWARK • BRONX, N. Y. • JAMAICA, L. I.

FIRST PRIZE WINNER

Radio in Every Room

If you have a radio set installed in one room of your home and have a spare loud speaker, it is very easy to wire the house so that the speaker may be installed in any room where radio reception is desired for the moment. No switches or moving parts are needed. All you require is some standard electric outlets—one for each room which is to be so equipped

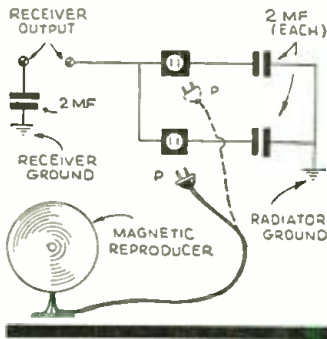

—and one 2 mf. fixed condenser for each installation, plus an additional 2 mf. condenser at the receiver.

The diagram herewith shows how the high voltage end of the receiver output is connected by means of a single wire, with as many branches as desired, to the standard outlet switches which are installed in conjunction with it. The other side of each outlet connects to one terminal of an individual 2 mf. fixed condenser which had best be rated at 400 volts D.C. for safety. The remaining terminal of each 2 mf. condenser is grounded. The other output terminal of the receiver is also connected to ground through a 2 mf. fixed condenser, similarly rated as to voltage.

The loud speaker cord has its terminals brought to a standard line cord plug for insertion into the outlets installed in the receiver's output. Thus, when the loud speaker is plugged in, it is in the output circuit of the receiver, and when the plug is removed, the circuit is automatically opened.—*Sam Glass.*

Electronic Music

Any old electric pick-up can be employed to make a microphone for use with a stringed instrument, as shown herewith. Remember one thing, however—the music you get from this arrangement cannot be better than the pick-up used. The support may be made of any easily bent metal, such as strip brass, and the vacuum cups can be had at any 10c store. The two leads from the pick-up are connected to any amplifier, as in a radio

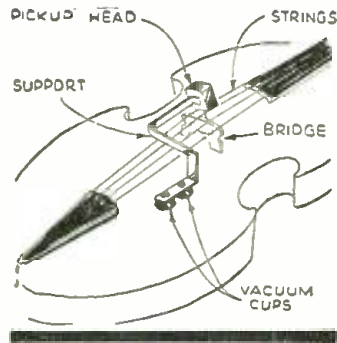

set or phonograph. The illustration shows how an ordinary violin, for example, may be made to play through a loud speaker. The same system can be used with any other stringed instruments.—*Jack Bittner.*

Instrument Stand

When using portable test instruments, it is much more convenient if they are tilted at an angle to make their scales more readily visible. A single piece of heavy wire (the length of which depends on the size of the instrument) can easily be bent to form a stand that will hold the meter at the desired angle, as the illustration shows.—*Stanley Garner.*

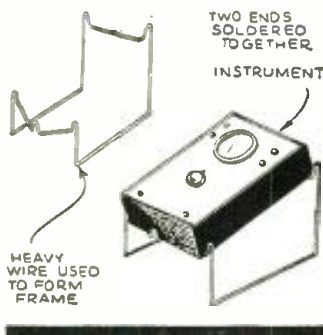

Improved Cord Tips

The tips on phone cords have a habit of coming off and becoming lost. When no replacement tips are available, others can be improvised from the small prongs from the bases of old or damaged vacuum tubes. The tips of the tinsel phone cord are scraped bright, wound with very fine copper wire, inserted into the old tube prongs and soldered neatly around.—*F. Sterk.*

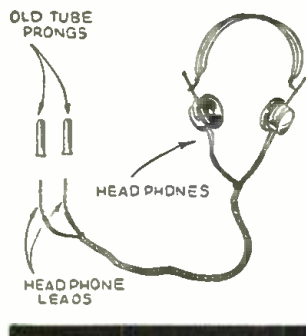

Radio Kinks

Each month the Editor will award a 2 years' subscription for the best kink submitted. All other kinks published will be awarded eight months' subscriptions to RADIO & TELEVISION. Read these kinks; they will be of real use to you, besides indicating what is wanted. Send a typewritten or ink description with sketch of your favorite to the Kink Editor

Plug-In Coil Handle

Plug-in coils, especially those wound on tube sockets, are often damaged while being inserted in and removed from their sockets unless they are provided with

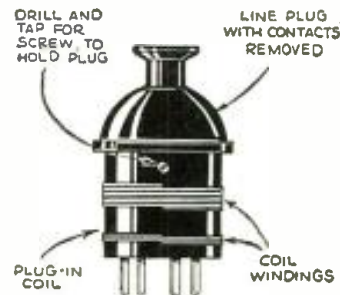

handles. Grasping the coil by the body tends to loosen or at least displace the windings. Therefore, I have hit upon the idea of taking old line cord plugs, removing the contacts, and fastening these plugs to the tops of the coils. If the plug makes a tight fit in the coil, cement may hold it; otherwise it is better to drill both the coil form and the plug and fix them together with either pins or small screws.—*James Gruhuskas.*

Emergency Power Pack

While this power pack will not operate a multi-tube set, it is perfectly satisfactory for one- or

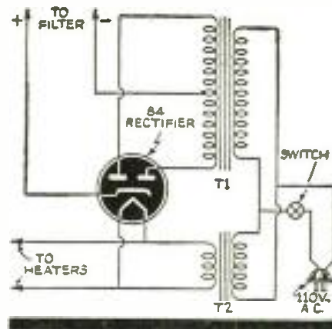

two-tube receivers using 6.3 volt tubes. In the diagram, T1 is a push-pull input interstage audio transformer, with a ratio anywhere from 3:1 to 6:1; T2 is a bell-ringing transformer, with a secondary of 6 to 8 volts. This will be sufficient to light two .3 ampere tubes besides the 84 rectifier. This "junk box" apparatus makes a complete power supply for the set.—*James Paquin.*

Pillow Speaker

If you wish to listen to your radio late at night without disturbing your whole family, a speaker which is audible only a foot or two away, yet which is clearly heard when your ear is pressed against it, can be improvised—if you have a cheap electric razor. You merely connect the razor (which must be of the vibrator type) in place of the output transformer to the loud speaker. While it does not give real high fidelity reproduction, it does give surprisingly good results on both voice and music. The diagram herewith shows how such a razor is connected.—*E. M. Thompson.*

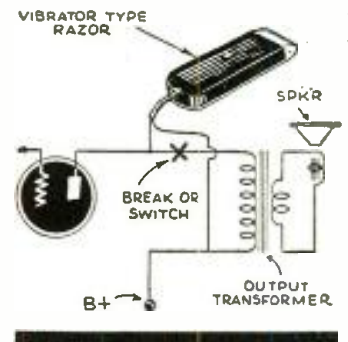

A Low-Ohmage Resistor

A piece of lead, such as is used in a mechanical pencil, is the heart of a low resistance variable resistor, as the sketch shows. A few turns of No. 29 tinned wire, or other wire about that size, is wound around each end of the lead, after which a drop of solder is sweated on to tighten the contact. The resistance can be varied to suit your needs by sliding one or both of the contacts. This gadget, of course, is useful only where little resistance is needed.—*Sam Wolfe.*

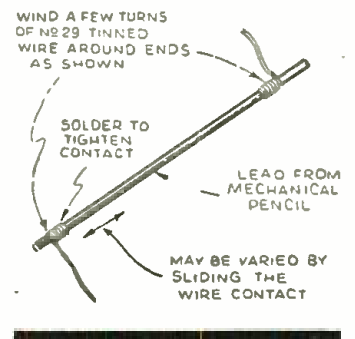



DEALERS!



SERVICE MEN!



AMATEURS!



P.A. SPECIALISTS!



BUILDERS!

Get Radio's Biggest Catalog!



ALLIED'S *New* 1940 CATALOG BRINGS YOU EVERYTHING IN RADIO AT LOWEST PRICES

Never before a book like ALLIED's 1940 catalog! 204 pages, exclusively radio—5 big complete sections, for Dealers, Servicemen, Amateurs, Sound Specialists and Builders. Whatever your interest in radio, here's everything in radio at your finger-tips, for instant reference, at lowest prices! Packed with the latest equipment from cover to cover—more than 15,000 items—newest Sets, Kits, P.A., Recording Equipment, Ham Gear, Test Equipment, parts, books, tools, etc., all organized for quick and easy reference. This new 1940 catalog from ALLIED's "Radio Headquarters" saves you time and saves you money, and assures you of the highest quality merchandise at amazingly low prices. Send coupon today for ALLIED's 1940 catalog—it's Free.

<p>60 NEW SETS</p>  <p>Greatest set values in ALLIED's history! 60 new Knight models, 4 to 12 tubes, featuring built-in Air-Magnet Aerials and new Push-Button Tuning. New lower-priced portables—1 1/2-volt models, AC-Battery, strap-type, etc.—new plastic cabinets, etc.—sets for every purpose—and phonographs (11-tube electric, etc.)—11 phono-radios (5, 7, 11 tube)—new recorder-phono-radio combination cabinets, complete phono accessories. They're all in ALLIED's new catalog at lowest prices. Send coupon today.</p>	<p>P. A. 3 NEW LINES</p>  <p>Now, "Economy," "Standard" and "De Luxe" lines—14 new systems, portable, mobile, permanent.—6-65 watts. New beauty utility. New system for 110-115 volts AC-DC, battery, 32 volts, etc.—20-watt with built-in phono, new Power Stages, etc. Also new Knight "inkles," complete and cording equipment and P.A. accessories, new low-priced discs, etc.—Hearing Aid, and other specialties.</p> <p>New Time Payment Plan Lowest carrying-charge, easiest terms. See ALLIED's 1940 Catalog.</p>	<p>HAM GEAR! ALL LEADING LINES</p>  <p>The largest Ham Section ever published!—every receiver, transmitter, transceiver from every leading line, spread before your eyes at lowest prices! All newest receivers; Sky-rider "Defiant"; Television equipment, Rotary Beam equipment, etc. 20,000 Amateurs buy from ALLIED, because ALLIED knows Ham problems, needs, desires. Get this big new Catalog today!</p> <p>New Time Payment Plan Lowest carrying-charge, easiest terms. See ALLIED's 1940 Catalog.</p>	<p>TESTERS! ALL NEWEST ITEMS</p>  <p>ALLIED's biggest Service Section, with everything in Test Equipment from every leading manufacturer. New television equipment, latest Analyzers, Oscilloscopes, Set-Testers, Meters, etc. 110-volt tube testers, Rider Volt-Ohmyst, etc. And all the parts you need under one roof, for instant shipping. Thousands of service men know it pays to order from ALLIED—saves time, means satisfaction always. Write for Catalog today. Time Payment Plan.</p>	<p>ALL THE NEWEST KITS</p>  <p>In ALLIED'S 1940 Catalog, dozens of new kits. Beginners 1, 2, and 3-tubers to the most advanced—New Television Kit, Wireless Phono and 1 1/2 volt, etc. and diagrams and projects for building 100 different circuits. ALLIED is Builders' Headquarters, answers hundreds of letters daily on building problems, fills hundreds of orders daily for builders all over the world. See what's new in ALLIED'S 1940 Catalog.</p> <p>FREE PARTS LISTS We supply matched kits for any circuit described in any magazine.</p>	<p>PARTS! BIG NEW SECTION</p>  <p>See latest new type tubes—110, 117-volt, etc.—thousands of exact duplicate and replacement parts for every need—new tool section, complete listery replacement listery accessories—television aerials, new loop-aerial attachment, new Book "Everything in Radio" in one book, at lowest prices! Send for a Free Catalog today—a Free Catalog today—make ALLIED your headquarters for radio supplies, as thousands do, and save time and trouble on every order.</p>
---	--	---	--	--	--



And a Big New Bargain Section Where Prices meet their Waterloo!

Specials, every one!—the country's biggest radio bargains, in the special "color" section. Don't miss these values!

ALLIED RADIO CORPORATION

ALLIED Radio Corporation
833 W. Jackson Blvd.,
Chicago, Ill. Dept. 3-K-O

FREE SEND COUPON

Send your Free 204-page Radio Catalog.

Name

Address

City State

QSL CONTEST!

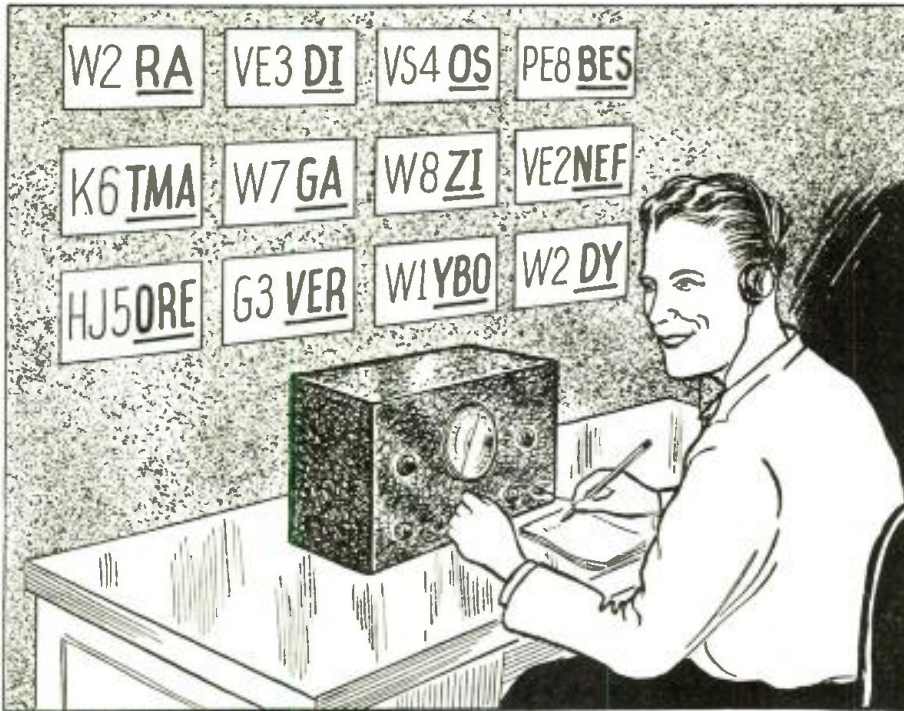

Win with Your QSL Cards

● LOOK over your collection of QSL cards. Pick out those from which you think you can spell out messages in a way similar to that illustrated at the left.

A prize of one year's subscription to RADIO & TELEVISION will be given to each of the TEN contestants submitting the best messages.

The simple rules that you must follow appear below:

Rules

1—You must actually have QSL cards for all the call letters you use in making up your message. You may be called upon to submit these cards for proof, if your entry is considered for one of the prizes.

2—All messages must include the words "RADIO AND TELEVISION" or "R AND T."

3—The editors of RADIO & TELEVISION will be the judges, and their decision is final.

4—Neatness will not be counted in judging this contest. Prizes will be awarded to (Continued on page 371)

Drop the district letters on the imaginary QSL cards in the illustration above, using the rest of the letters (i.e., those at the right of the numbers) and you will see that from left to right these remaining letters spell out a simple message—"RADIO'S BEST MAGAZINE FOR EVERYBODY." In this contest you can win by making your own QSL cards spell out messages in a similar manner. Read the simple rules herewith.



Believe it or not (and we don't!), Stanley Learning of Mass., sitting in his car, heard a telephone conversation coming in on his radio. Just for the heck of it, Mr. Learning chimed in on the conversation, and according to his story, the woman who was talking on the telephone replied! Not only did Mr. Learning hear what was going on through his radio, but it also acted as a transmitter, so that the people whom he happened to hear, happened to hear him!

This story is reported by David Delano Clark of Austin, Tex., who has a newspaper clipping to prove it is true—if you believe everything you read in the newspapers. Anyway, it won him FIRST PRIZE.

⚠ Danger! Warning! Beware! Be careful. Don't try this radioddity yourself unless you have an asbestos face!

Michael Krewal tells of a little cigarette lighter used by a local Ham and his guests at Racine, Wis. When the boys want to smoke and no matches are on hand, they just walk over and light their cigarettes on the "final" of the 140 watt transmitter arc. Mr. Krewal says it is very "amusing"—but don't try it unless your insurance is paid up!



RADIODDITIES



When Philip Broecker sent his radio out to be repaired, he was not left without programs of speech and music. For no good reason, his hot air furnace picked up the broadcasts of WBEN, which is only a few hundred feet from his house. Thus, Mr. Broecker had programs "piped" throughout his house, according to Donal G. Buck of N. Tonawanda, N. Y.

Concluding the Radioddities Contest, R & T awards 1-year's subscriptions to Messrs. Krewal, Buck and Rocas.

Ignatz Rocas of Great Neck, L. I., has returned from a trip to the tropics with the report that static there is frequently so strong that it is possible to draw sparks from the antenna, even on a clear day. Sparks can be seen to jump across the gap of a lightning arrester, or if there is a lightning switch, across a small gap between the blade and the jaw. It makes listening on 600 meters practically impossible, according to our reporter.



The Naval Communication Reserve

(Continued from page 325)

We have then, the staff of the Section Commander, so that the commander's duties may be lightened as much as possible and so that the organization will proceed to function in case of illness or other incapacitation. The arrangement of the staff also allows training for the officers so they may be capable of duty in any of the positions on the staff and are regularly shifted around, except the medical officer who necessarily follows his profession only.

Officers are allowed active duty on shore or aboard ships of the navy each summer when such active duty is available. At such times officers obtain pay for their tour of duty which usually is for two weeks. Also they may request active duty without pay for a period as long as six months whenever the Navy Department feels that it is to mutual advantage to allow this. All tours of duty count for the officers, and their proficiency as shown during their active duty period determines to a great extent if or not an officer will be promoted or dropped from the rolls.

Now that we have an idea what the Section Commander and his Staff are doing as a matter of routine, suppose we take a look at the organization on an active drill night, and see what they really have to do. Let us take a typical drill night. On this drill night, it has been decided by the Section Commander to inspect a Unit. The Section Executive Officer and the Section Personnel Officer will make the inspection with the commander so they may know what the condition of the unit is. When we enter the Quarters, all the men snap to attention and remain so until the word is given to "carry on." The time indicates that the drill is already in progress and the supervisor in charge of the transmitter advises that the Master Control Station located at the District Headquarters is transmitting. Two Radio men are on duty at the transmitting and receiving location with wire connections between the receiving location and the radio practice table, so that those radio men who are qualified may also copy the transmissions from the Control Station as well as the transmissions from the transmitter of the unit. Six men are at the practice table and with the three at the transmitter location account for nine men.

Off to one side, is a group of men being instructed in the manner in which messages must be made up before they are transmitted. A blackboard is used to show how these messages are made up and the students take turns at putting the problems on the board. When mistakes are made they are at once corrected and before the drill is over, another group of radiomen will have made progress in the requirements of naval communication.

At a smaller table in the room we see four recruits taking code lessons. The radioman in charge tells the men what the code character means and then transmits it slowly so that the men will learn to identify the characters that go to make up the alphabet and from which letters, words and messages are made up. While amateur radio operators are desired as recruits for the Naval Communication Reserve, any interested man who is willing to learn the code and obtain a federal license for himself is eligible as a recruit, and it is a noteworthy fact that this unit has a waiting list of men who want to belong and who are taking code lessons in the meantime. The men are allowed to attend the unit drills as prospective members

(Continued on page 359)

LEARN RADIO

at HOME in SPARE TIME

The Complete Ghirardi Course
in ONE Handy Volume
TRAINS YOU QUICKLY
for a good-paying job in
Radio or Television

THOUSANDS HAVE STARTED
SUCCESSFUL RADIO CAREERS
FROM THIS ONE BIG BOOK

Your Big Chance—
Take It!

NOW—at last—you can get your start in radio, you can prepare for a good-paying radio job, without expensive schooling or lengthy study. Here in one inexpensive volume is a complete radio education for you, —everything is illustrated and explained clearly—right from basic electrical theory up through television—36 different Chapter-Sections in all—36 separate self-instruction courses condensed into one easy-reading home-training book.

AS EASY AS ABC

Use Ghirardi's Short-Cut Methods

It's absolutely amazing the way Ghirardi makes every phase of radio clear and simple to understand. No previous training is necessary—no "math." Yet when you finish the book you may have a better grasp of the subject than many so-called "experts." Even if you can devote only a few minutes a day to your training, you will be surprised and delighted at the rapid progress you make if you use this great book.

**ALL YOU NEED TO KNOW
about Radio is Between these 2
covers—Basic Fundamentals
—Practical Applications**

Never before has it been possible to master the fundamentals of the whole science of Radio so easily, so quickly, so economically. Just imagine a book that really gives you a thorough grounding in every phase of this fascinating field! Take Electricity alone, for example—no textbook ever written will give you a clearer picture of electrical theory and principles. Ghirardi brings out his simple explanations with such vivid clarity you'll never be in doubt again the rest of your life. Radio broadcasting and receiving are explained to you in full detail, but without one wasted word. Over one hundred diagrams, drawings and photos illustrate the graphic descriptions he gives you. This great book will give you the basic knowledge that is essential for landing any kind of a radio job—in a broadcasting studio, in a radio service organization, in a plant manufacturing radio equipment, etc., etc.

Learn Television Too!

Yes, this course gives you a solid background in television fundamentals, SOUND, too, with all its different branches—Microphones, Public Address Systems, Sound Films, etc. You'll master the intricacies of Cathode-Ray Tubes and Photoelectric Cells as easily as if it were child's-play. And though all this knowledge is at your command, it is but a fraction of the book's contents! There's Testing and Servicing; Automobile, Aircraft and Ship Radio; Short-Wave Reception; and still that isn't all! Just to visualize the scope of this gigantic home-study course, you'll really have to get the book and thumb through the pages at your leisure.

Get It All for Only \$4 Complete!

Believe it or not, this inexhaustible storehouse of radio knowledge is yours to own and use for the price of an ordinary hat! You would have to pay many times this price to cover the same ground in any other course—and even so you could never duplicate Ghirardi's "Radio Physics Course." Because this book is used by more radio schools and students than any other radio textbook in the world. Think of it—only \$4 you can get your practical radio training at home, the very same way thousands of others have, who are today earning good money in a consistent ever-broadening career. Follow their example and seize this opportunity to get started with Ghirardi. Send for your copy without delay!

Use It 5 Days—OUR RISK!

You can't possibly lose—our Money-Back Guarantee protects you 100%. Read the book as much as you want for 5 days. Examine it critically—see just what you're getting. Then if you feel you'd rather not keep it, just send it back undamaged. Your money will be immediately refunded—no fuss, no trouble. We gladly take this risk. So why not take us up on this offer? You owe that much to yourself. You have all the ability you need. Now get the training, and show the world what you can do!

Take the first step right now—fill out and mail this coupon . . . AT ONCE!

Get Started - RUSH COUPON NOW!

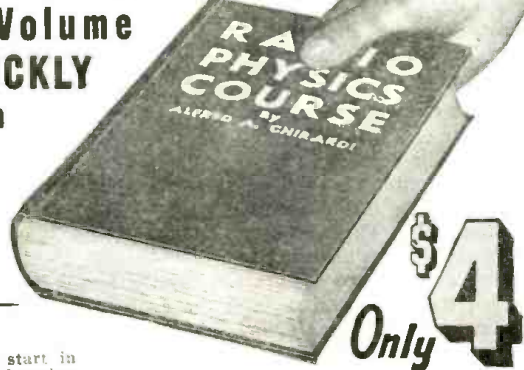

RADIO, TELEVISION
ELECTRICITY, SOUND
CATHODE-RAY TUBES, etc.

36 Volumes in 1

RADIO, ELECTRICITY and SOUND Complete Plus Many Other Valuable Special Features are Covered in These 36 Big Chapter-Sections. 972 Pages. 508 Schematic Diagrams, Charts and Photos. 856 Review Questions.

1. Radio Broadcasting System.
2. Sound, Speech and Music as Related to Broadcasting.
3. Electron Theory, Electric Current.
4. Electrical Units, Ohm's Law, Resistance.
5. Electrical Circuits, Batteries.
6. Magnetism.
7. Electromagnetism.
8. Electromagnetic Induction.
9. Inductance and Inductors.
10. Capacitance and Condensers.
11. Alternating Current Circuits.
12. Electric Filters.
13. Electrical Measuring Instruments.
14. Electromagnetic Radiations.
15. Radio Transmission, the Broadcasting System.
16. The Receiving Station, Detection with Crystal.
17. Elementary Study of the Vacuum Tube.
18. Vacuum Tube Characteristics.
19. Construction Features of Vacuum Tubes.
20. Vacuum Tube Detector and Amplifier Action.
21. Radio Frequency Amplification.
22. Superheterodyne Receivers.
23. Design of R.F. Amplifiers and Tuning Coils.
24. Audio Amplification.
25. Loud Speakers.
26. The Battery Operated Receiver.
27. The Power Supply Unit.
28. Electric Receivers.
29. Automobile and Aircraft Receivers.
30. Phonograph Pickups and Sound Amplifier Systems.
31. Short Wave Reception.
32. Vacuum Tube Applications and Photoelectric Cells.
33. Television.
34. The Antenna and Ground.
35. Testing and Servicing.
36. Sound Motion Pictures, Appendices.

972 Pages

Wouldn't Trade for a \$100 Course,
Says California Radio Man!

"I sure am enjoying the 'Radio Physics Course.' It's just the book that I've been wanting for a long time. It can't be beat—so simple and educational from the start. I don't think there's another book on the market like it. It sure teaches! I wouldn't give it up for a Hundred Dollar Radio Course!"
—E. C. Garcia, Paso Robles, California.

MAIL COUPON TODAY

RADIO & TECHNICAL PUBL. CO., Books Shipped
45 Astor Place, New York, N. Y. Postpaid
Dept. R&T-109. Anywhere!

Enclosed find \$4 (\$4.50 foreign) for my copy of Ghirardi's "RADIO PHYSICS COURSE," with your 5-day Money-Back Guarantee.

NAME

ADDRESS

CITY STATE

Please send me free descriptive literature about "RADIO PHYSICS COURSE."

Question Box

Capacity Relay Circuit

? If possible could you publish a circuit of a capacity relay circuit, one that when the body is brought up near a metallic body a circuit can be made to operate through a capacity-controlled relay?—L. H. J., Brooklyn, N. Y.

A. Here is a circuit, one that makes use of a grid glow tube and metallic coated glass sphere. The circuit is extremely sensitive to body capacity near the sphere. The hand near the sphere changes the capacity between the grid anode elements, as the anode is capacitatively coupled to the ground through the capacity of the transformer windings of which one side of the primary is grounded. Novel connections can be made by using the auxiliary terminal. By making connection to a large surface with precautions to prevent excessive leakage from the grid by the wiring, etc., and with proper condenser adjustment, the presence of a body within 2 or 3 feet from the surface is detectable.

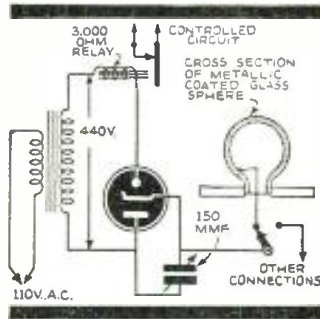

Capacity Relay Circuit for burglar alarms and similar uses. No. 1195.

Trouble with Receiver

? I have one of the GE receivers which has a color-light tuning system. Occasionally one set of lights burns out after a short period of time and in some instances the lights fail to work at all. What is the best remedy to correct this trouble so that the lights do not fail?—K. L. Moler, Kansas City, Mo.

A. In areas where the signal strength is very high usually this trouble will occur. However, the best remedy is to remove the short brown wire on the terminal strip above the lights. This wire runs from the third lug on the right to the end lug and should be replaced by a 35 ohm, 10 watt resistor. This will protect both sets of lights from high voltage but will not interfere with their operation.

Trouble with Car Radio

? I have an RCA model 104 receiver in my automobile and of late am being troubled with motor interference and vibrator hash. Can you suggest a remedy?—Harold Johnson, Racine, Wis.

A. The trouble you are experiencing is caused by the breaking of the shielded antenna lead directly at the set. To remedy it slip a short piece of shielding over the lead directly to the clip provided on the set.

Pair of 55's in Final

? I intend to build a transmitter and in the final stages plan to make use of a pair of 55's. Would like a circuit that features perfect symmetry both electrically and mechanically. Can you

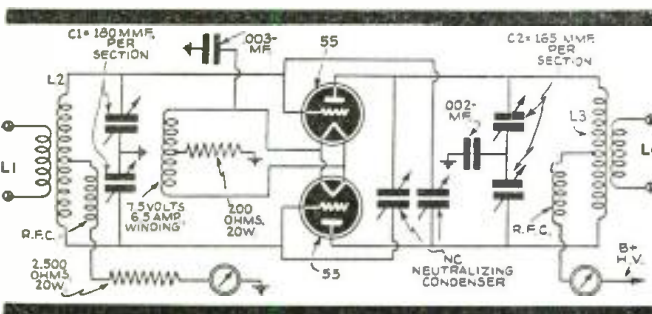

Transmitter using 55's in final. All values are shown. No. 1196.

furnish a sketch showing the parts and size of coils and condensers needed for bands from 10 meters to 160 meters?—Bud Oplin, Hopewell, N. J.

A. The circuit diagram shown herewith is that of one using a pair of 55's in a push-pull final stage. The arrangement features perfect symmetry both electrically and mechanically. In addition, all leads which are important should be extremely short. The neutralizing condensers should be ganged for easy operation.

Coil Chart

Band	L2	L3
160	68 t. No. 20 1 3/4" dia. close wound	46 t. No. 12 3" dia. 4" long
80	36 t. No. 14 1 3/4" dia. close wound	26 t. No. 10 2 1/2" dia. 4" long
40	20 t. No. 14 1 3/4" dia. close wound	20 t. No. 10 2 1/2" dia. 4" long
20	14 t. No. 10 1 3/4" dia. 2" long	12 t. No. 10 2 1/2" dia. 4" long
10	8 t. No. 10 1 3/4" dia. 2" long	6 t. No. 10 2 1/2" dia. 4" long

L1—One or two turns at center of coil to be determined experimentally.
L4—One or more turns at center of coil depending upon impedance of antenna system.

Untuned R.F. Stage

? Please publish a diagram of an untuned R.F. stage that can be added to an A.C.-D.C. receiver, one which makes use of a 6D6 in the R.F. stage.—Paul Winkler, Germantown, Pa.

A. Here is the circuit that you requested employing a 6D6 tube. The heater of this tube should be connected in series with the 6.3 volt heaters of the tubes in your present receiver and B minus grounded to the common terminal of the receiver. The B plus connection should go to the screen grid terminal of your receiver. For best results the line cord resistor should be replaced by one having 20 ohms less than that now in the set.

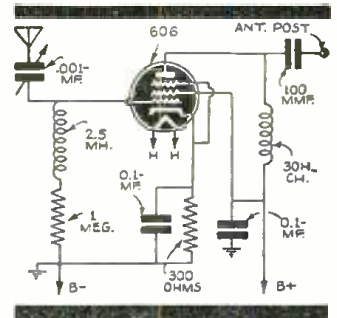

Untuned R-F preamplifier. No. 1197.

Kilocycles, Megacycles and Meters

? Please give a clear explanation of the relation between kilocycles, megacycles and meters, and how they differ, with a formula to translate the frequency in mc. to the equivalent wavelength in meters, etc.—Robert E. Flanagan, Altoona, Penna.

A. The frequency in kilocycles is found by dividing 300,000 (the velocity of ether waves in kilometers per second) by the wavelength expressed in meters. To find the frequency in cycles when the wavelength in meters is known, we divide 300,000,000 by the wave length in meters. To find the wave length in meters when the frequency in kilocycles is known, we divide 300,000 by the frequency expressed in kilocycles. If the frequency is expressed in kilocycles, this value may be expressed in mc. (megacycles) by simply dropping the three figures at the right of the term. 60,000 kc., for example, is equivalent to 60 mc. To find the result in kilocycles when a station frequency is given in megacycles, we add three ciphers to the right of the term; thus 15 mc. becomes 15,000 kc. (kilocycles), or by adding six ciphers to the right of the frequency expressed in mc., we find the frequency in cycles per second; thus 15 mc. is the same as 15,000,000 cycles.

The accompanying table will help to clarify all these relations in your mind.

Meters Wave Length	M.C. (Megacycles)	K.C. (Kilocycles)	Cycles per Second
1	300	300,000	300,000,000
5	60	60,000	60,000,000
10	30	30,000	30,000,000
20	15	15,000	15,000,000
40	7.5	7,500	7,500,000
80	3.75	3,750	3,750,000
160	1.875	1,875	1,875,000
200	1.5	1,500	1,500,000
550	0.54	545	545,000
600	0.5	500	500,000

The Naval Communication Reserve

(Continued from page 357)

for a period of two months, then they are given a test to see if progress has been satisfactory and if a vacancy exists they are sworn in, having first been examined by the Unit Medical Officer to make sure that they qualify as to the required physical fitness.

The yeoman of the unit advises that he has three men who are ready to be sworn in. Those men are looked over by the Section Commander and told what they are about to do. Since they do not want to change their minds about being sworn in for service with the Naval Communication Reserve for a period of four years, they are duly sworn in, sign the shipping articles and receive the congratulations of the members of the unit. These men will now be measured for their uniforms which are furnished by the Navy and then proceed to take their places among the members of the unit, and in the departments of the various radiomen in charge.

After all the various activities have been inspected with notes made for further discussion with the Unit Commander, the men are told to assemble on the drill floor. When the men have been assembled there, the officers enter to make an inspection of the unit, and to see if the uniforms are clean, worn properly and complete in detail. Any necessary suggestions are made and the yeoman makes a note of them for further reference. The men are then told to fall out, and assemble in the quarters for such remarks as are deemed necessary by the Section Commander. Because it is felt that more and more military discipline must be in evidence, military discipline, its need and usefulness, is the topic. The men are then told to carry on and continue on into the various activities they were engaged in.

The Unit Commander and his Staff together with the Section Commander and his Staff now have a conference and discuss the progress of the unit. As questions of policy are brought up, they are given consideration, and every effort is made to lighten the burden of the unit commander. Shortcomings of some of the men are noted, as well as the fact that some of them are making satisfactory progress toward advancement.

The time now indicates that the drill is concluded and the different watches clean up their activities and stow away the materials that were in use. The deck is cleared, and the coffee pot is brought out. From some hideaway appears the necessary wherewithal for making coffee, a can of milk is opened, sugar is located, spoons from as many different homes as there are men in the unit appear with cups of all makes, paper napkins are laid out on the practice table and everyone is cautioned not to set a cup down on the table direct. The unit is very jealous of the cleanliness and appearance of its quarters.

Thus we complete the picture of the activities of a Unit of a Naval Communication Reserve Section in a Naval District. This picture is repeated every week on one night, first at one unit, then at another. You see, then, that we are doing our bit to keep in readiness to serve our country and communities in case of flood, storm or national emergency.

* * *

The opinions or assertions contained herein are the private ones of the writer, and are not to be construed as official or reflecting the views of the Navy Department, or the Naval Service at large.

IT'S FREE!

LAFAYETTE'S
Brand New 1940
RADIO CATALOG

LIKE THE WORLD OF TOMORROW . . .

This new **FREE** Lafayette catalog for 1940 is different from anything you have ever seen before. The size is bigger, the selection is bigger, the savings are bigger! Send for a copy at once.

EVERY MAN INTERESTED . . .

In radio and sound—the ham, serviceman, experimenter and dealer will want this great new book for what it can do for him. Has everything in radio—receivers, parts, tubes, equipment, new Build-It-Yourself Kits—all arranged for split-second reference. Makes ordering by mail easy, quick, sure. Here's a book that saves you time!

PRICES ROCK-BOTTOM . . .

On all latest type nationally advertised merchandise. Literally thousands of items listed, and every one a smashing value. Here's a book that saves you money on everything you buy! Make it your easy-chair shopper.

SEND AT ONCE . . .

For big **FREE** copy. Know what it is to have a book like this at your elbow—complete, up-to-the-minute, money-saving! Tear out this coupon and mail.

LOOK WHAT IT COVERS!

**1940 RADIOS • PARTS • TUBES
PUBLIC ADDRESS EQUIPMENT
ELECTRICAL APPLIANCES
HAM APPARATUS**

Radio Wire Television Inc. formerly **WHOLESALE RADIO SERVICE CO., INC.**

LAFAYETTE RADIO

NEW YORK • CHICAGO • ATLANTA
100 SIXTH AVE. • 501 W. JACKSON BLVD. • 265 PEACHTREE ST.
BOSTON • JAMAICA • BRONX • NEWARK

**TEAR OUT
AND MAIL
COUPON
Today!**

Radio Wire Television Inc.
Dept. 4K9—100 Sixth Ave., New York, N. Y.
Rush **FREE** 1940 Radio Catalog No. 78

Name.....

Address.....

State.....

City.....

RADIO COIL WINDING MACHINES

FOR EVERY PURPOSE

The largest selection in America!

Items 1 to 4

Automatic paper layer power transformer coil winding machine. Will wind power transformer coils of every description. Cork friction clutch, belt drive. Weight

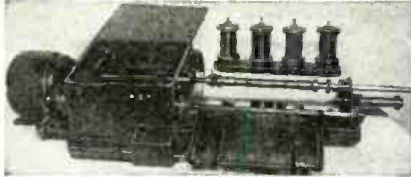

30, 60 and 110 lbs. Four sizes \$20.00 \$35.00
\$60.00 \$75.00

Item 8

Field coil winding machines, with tension device & spool holder complete. Tight & loose pulley belt drive.

Price \$16.00

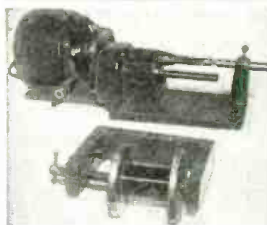
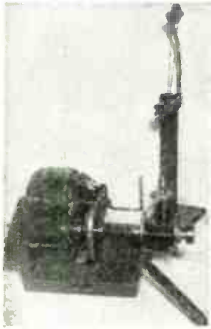

Item 9
Resistor coil winding machines. 30 machines. 15" long x 5" wide x 5" high, with tension device & spool holder. Price each \$15.00
15 Machines 18" long x 6" wide x 5" high. Price each \$10.50

Item 6
I.F. & R.F. Coil Winding machines. Arranged for straight layer winding with dial turn counter, automatic stop equipped with lead screw and wire feed, cork friction clutch, belt drive with tension device & spool holder. Price each \$25.00

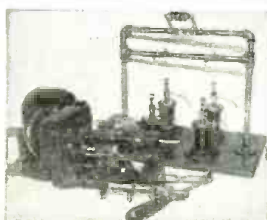
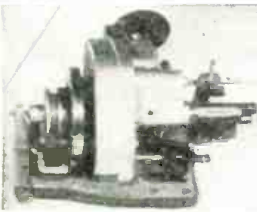

Item 12
I.F. & R.F. coil winding machines. Arranged for honeycomb winding. Equipped with dial turn counter, automatic stop, hand knock out for removing coils from arbors. Will wind 4 1/2" coils at one time. Complete with 4 spool holders and tension device. Price each \$95.00

Belt drive, cork friction clutch. Price each \$95.00

Item 7
Filament coil winding machines. Cork friction clutch, belt drive. Price each \$10.50

Item 10
Hand operated coil winding machines, geared Price each \$9.00

All prices are NET (no motors included) F.O.B. New York City

All of the above equipment has been purchased by us from the Atwater Kent Manufacturing Company, Phila., Pa.

Machines are fully reconditioned and tested before making shipment.

Terms 1/3 cash with order, balance S.D.B.L.

Write for our four page catalog No. 639.

M. M. LEVINE COMPANY

84 Warren Street, New York, N. Y.
Telephones Worth 2-3716-3717

Newest Radio Apparatus

(Continued from page 323)

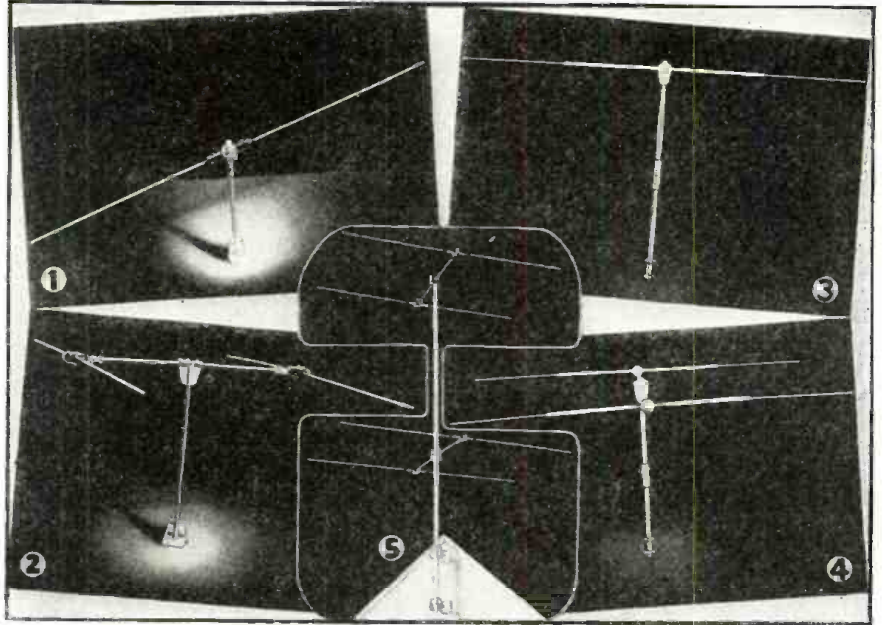

Pictured above are the new General-Electric Television antennas. 1—Single dipole. 2—Same, with reflector. 3—De luxe dipole. 4—Same, with reflector. 5—Four dipole (double dipole with reflectors) array.

Vibrator Inverter Gives A.C. from D.C.

• A DEVICE which eliminates the need for motor-generator sets for television receivers operated in districts served with direct current power, is being made by the General Electric Company.

This is a new type of vibrator inverter for changing direct into alternating current. Television sets cannot be operated on direct current, and somewhat costly motor-generator sets have been necessary to provide alternating current in districts where it is not commercially available.

Previous type of inverters have not been capable of supplying sufficient power for television set operation in making the change in current.

set builders may find the router shoe extremely useful in building radio cabinets, routing out channels for concealing wires, etc. More than 20 types of molding cuts can be made with this router shoe. The set makes it possible for the novice to cross-hatch, carve, drill, engrave, cut and grind on glass, metal, bakelite and other materials with accuracy and precision. The set includes a curved carving index, straight edge ruler, compass depth gauge, router shoe, holder and protective sleeve and two special steel cutters.

New Midwest Receivers

• THE Midwest Radio Corporation of Cincinnati, Ohio, has just announced its new 1940 "Twentieth Anniversary" line of radios. The line consists of 17-, 14-, 12-, 9- and 6-tube radios.

A good portion of the line is built around the giant, new 17-tube, 5-band chassis, which is characterized by such features as "Organ-Fonic" Tone Filter, Organ Key Tone Control and the Antenna-Scope.

The Organ-Fonic Tone Filter incorporates organ resonating pipes arranged in graduated sizes, that are said to more than triple the baffle effect.

The Organ Key Tone Control makes it possible to choose fourteen distinct vibrations of tone.



Useful Hand Tool

• A NEW set of attachments for the Handee grinder, particularly suited for radio work, has just made its appearance on the market. Presumably everybody knows these little high-speed grinding tools with their myriad accessories to adapt them to various types of jobs. Now the combination carver and depth gauge set has been introduced and should be of particular interest to radio experimenters and constructors. The manufacturer claims that, without sacrificing any of the flexibility of the light 12 oz. De Luxe model, these fixtures give it the same accuracy and precision in performing its various functions as would draftsmen's instruments in making a drawing. Radio

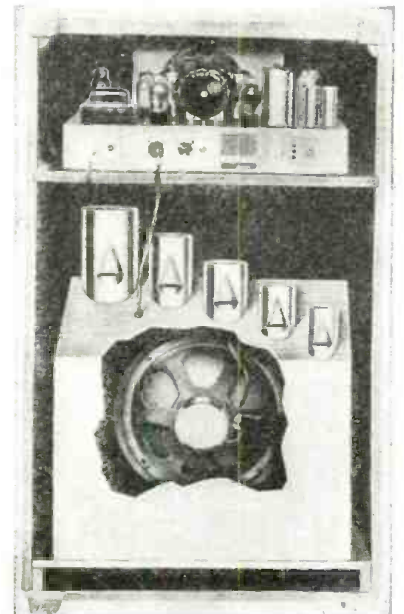
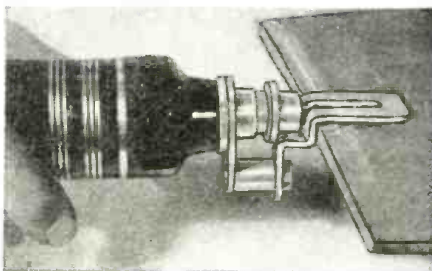

New Coil Turrets for Low-Power Band Switching

● **FOUR** new Baby Coil Turrets are efficient 5-band switching units for use in low-power transmitters and exciter stages. Each turret utilizes five of the familiar Baby Coils, covering the amateur bands from 10 to 160 meters and may be tuned with any of the midget condensers having an effective capacity of 100 mmf.

Switches employed in the Baby Coil Turrets have ceramic sections for the coil ends where high voltage is encountered. The link terminals and center tap sections are switched by bakelite sections. The coils are mounted as an integral part of the switch by means of a stamped metal spider which maintains permanent coil alignment and a maximum of rigidity in the assembly. All leads from the coil to the switch are extremely short.

Baby Coil Turrets are rated at 35 watts and are available in four distinct types. Type BTM is a straight untapped coil unit for single-ended unneutralized stages. Type BTCT consists of center-tapped coils for balanced output with either single tube or push-pull. Type BTEL is an end-linked unit, each coil having a low impedance link as an integral part, and is designed for single-ended stages, unneutralized. Type BTCL is a center-linked unit for low impedance coupling in balanced output stages, either single-ended or push-pull. These Turrets are made by Barker & Williamson.

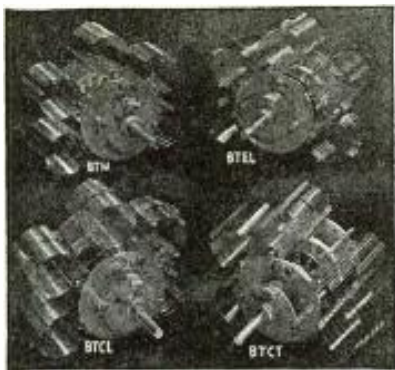

The New Tubes

● **SEVERAL** new tubes have just been issued by Radio Corporation of America. One of these is the 5AP4/1805-P4, a high-vacuum cathode-ray tube designed for black-and-white reproduction of television images. This tube, of the electrostatic deflection type, measures only approximately 13" in length and is thus particularly suitable to horizontal mounting. Other specifications of the tube are: heater voltage 6.3; heater current .6 amp.; high-voltage electrode (Anode No. 2) max. 2000 volts; focusing electrode (Anode No. 1) max. 1200 volts; peak voltage between anode No. 2 and deflecting plates max. 500.

Also new in the RCA line is the 924 Gas Phototube, with caesium-surfaced cathode, of compact design, with circular cathode facing the end of the bulb to facilitate its use in end-on applications.

The 925 Vacuum Phototube, with caesium-surfaced cathode, is only about 2½" long and is suited to applications where the use of a high resistance load is desirable to give maximum circuit sensitivity with stability. The large spectral response of this tube in the red region makes it particularly useful where tungsten-filament light sources are used.

The 926 Vacuum Phototube is of the cartridge type, with rubidium-surfaced cathode. It has short double-ended construction which eliminates the conventional base and provides a long insulating path between electrodes. Its spectral sensitivity characteristic closely approximates that of the human eye and, as a result, this tube is especially useful in colorimetry.

The 927 Gas Phototube, with caesium-surfaced cathode, is only 11/16" in diameter and 2¾" long. It is intended primarily for sound reproduction in connection with 16-mm sound equipment.

● **HYTRONIC LABORATORIES** are also out with several new tubes. The latest development is a 1.4 volt ultra-high frequency Triode. This tube is known as the HY114. Its filament current is .12 amp.; its amplification factor 20; mutual conductance 1000 micromhos; plate resistance 20,000 ohms. Inter-electrode capacitance of this tube is Cgp 1.7 mmf., Cgf 1.2 mmf., Cpf .6 mmf. Plate and grid leads are brought out to caps at the top of the tube which may be used as R.F. amplifier, detector and oscillator.

Also in the Hytron series are the ceramic-base "Bantams" which have similar characteristics to the standard "Bantams," save that they are specially selected, subjected to rigid tests and have improved dynamic characteristics, particularly at the high frequencies.

The Hytron line also includes most of the usual standard tubes.

(Continued on page 380)



Model 460—The ONLY Radio with Built-in FREQUENCY MONITOR!

Model 460 is the most outstanding 10 tube communication receiver of the year! **Built-in Frequency Monitor and Noise Limiter**—features unequaled by any other amateur receiver. **Pre-set to any frequency.** You hear the frequency monitor on the channel you want. **You can check any incoming amateur signal and report back the exact frequency. Check your own transmitter frequency.**

Model 460 has two **BFO** systems; conventional i.f. BFO with adjustable pitch and intensity and frequency monitor BFO which checks the frequency of the incoming CW signal as it is being received! **Extended Electrical Band Spread** which can be calibrated against the Monitor!

Crystal Filter Circuits built-into Models 460, 450A, and 438. Complete receivers are quoted with crystal, tubes and speaker. **Model 460 complete, \$89.95 or \$79.95 less crystal.** Long-wave models and models for special voltages and/or frequencies! Export prices higher.

Displayed by leading distributors.

HOWARD RADIO CO.

1735 Belmont Ave. • Chicago, Ill.

Cable Address: HOWARDCO, U. S. A.



Model 430, 4 band. Complete\$29.95



Model 438, 4 band. Complete\$59.95

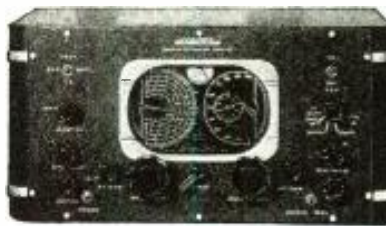

Model 450A, 6 band. Complete\$105.45

THE COIL YOU WANT!

whether it's an Iron Core High Gain IF Regenerative Iron Core IF or any other coil used in communications or broadcast receivers or in UHF transmitters. —you will find it in the latest catalog of DX precision made coils. DX Coils are used by well known receiver manufacturers, engineers, service men, set builders, etc. Teachers of radio and students praise DX color coded circuits as easy to understand.

Leading radio jobbers have DX Coils or can get them for you at attractive prices. Send 15c today with your jobber's name and receive DX Deluxe catalog illustrating DX coils in full size photos.

DX RADIO PRODUCTS CO.,
1575-B Milwaukee Ave., Chicago, Ill.
Also manufacturers spiderweb loop antennas used on latest model receivers.



PRECISION CRYSTAL CONTROL FOR ALL AMATEUR BANDS
BLILEY CRYSTALS Now \$3.35 UP
BLILEY ELECTRIC CO., ERIE, PA.

"TINY MITES"



A series of versatile condensers especially suited to tune Ultra-High Frequency circuits. While compact in size, they incorporate every worthwhile feature known to small condenser design. SEE them at your BUD jobber's and USE them in your next layout.

For complete catalogue RT-109, write

BUD RADIO, INC.

5205 Cedar Ave. Cleveland, Ohio

It Will Pay You!

When you need amateur equipment it will pay you to write me. I make it my business to be able to supply all amateur receivers, transmitters, kits, antennas, and parts at the lowest net prices in any catalog or advertisement. I try to be the first to supply the newest equipment. I will help you get the best equipment for your use. All equipment is available on 6% terms financed by myself so you can buy with less cost and more convenience.

You get personal attention you can't get elsewhere; fair trade-in value for your receiver and equipment; ten day trial of all receivers; and my cooperation in every way to see that you are 100% satisfied. No wonder W9ARA's customers are boosters. You will be too.

Your inquiries and orders invited. You can reach me by letter, telegram, phone, or visit nearly 24 hours a day, 365 days a year. Foreign orders solicited too. Write for full information.

Bob Henry
W9ARA

Henry Radio Shop
Butler - - - Missouri

Headset Headquarters



Scientifically Built Heavy bar magnets greatly increase their efficiency.

GUARANTEE CANNON-BALL

Phones to give absolute satisfaction. Unusually sensitive. Noted for fidelity and clarity of tone. Folder T-10 illustrates complete Cannon-Ball line. Write

C. F. CANNON COMPANY
SPRINGWATER, N. Y.



FREE!

SIGMON'S NEW FALL AND WINTER 1939-40 CATALOG

Here is the greatest guide to radio buying ever published, over 200 pages of bargains for the Ham, the Serviceman or the Radio Experimenter. All of the new receivers, transmitters and parts. Send for your Free Copy Today!

We design and build amateur equipment to meet the most exacting specifications. Write for our low prices.

SIGMON RADIO SUPPLY COMPANY
"Custom-Built Radio Headquarters"
104 Washington St., East, Charleston, W. Va.

DESIGNED BY A. C. MARNEY

DIRECT COUPLED AMPLIFIERS

Sensational value in this new line

10, 20, 30 Watt Models ALL-PUSH-PULL THROUGHOUT. Ideal for all high-fidelity amplification.

10 WATT BASIC KIT \$9.68. 20-WATT BASIC KIT \$14.52

Top-notch performance guaranteed.

WRITE FOR NEW BULLETIN

AMPLIFIER CO. of AMERICA
17-23 WEST 20th STREET NEW YORK, N. Y.

FROM 96¢ NEW

Answers to QUIZ on page 349

• WERE you able to help Nat the Novice correct the mistakes he made in his 3-circuit regenerative receiver shown at Fig. 1 on Page 349? If not, see Fig. 1A herewith. You will notice that R3 (which Nat had installed for no good reason) is not used in the correct diagram. Also notice that the grid of the tube is no longer floating, that the polarity of the "B" battery has been corrected, that it is now possible for plate current to flow through the phones, that the various windings of the 3-circuit tuner have been connected in their proper places, and that the secondary rather than the primary of this tuner is tuned by means of the variable condenser.

Fig. 2A shows the correct diagram for a 3-tube set with one stage of R.F. amplification, regenerative detector and one stage of A.F. In comparing this with the original problem given on Page 349, you will notice that the values of two components, C4 and R2, have been changed to correct specifications. Parts C3, C3 and R1, shown in the problem, are omitted in the correct diagram given herewith.

Fig. 3A shows the correct way in which Bert the Beginner should have wired up his 110-volt direct current transmitter. You did not have to be an experienced hand to catch these errors, you merely had to be a faithful reader of RADIO & TELEVISION. An article on the construction of this transmitter, written by Herman Yellin, W2AJL, appeared on Page 420 of our November, 1938, issue. In the problem, purposely drawn incorrectly, "jumps" were drawn as connections, connections were drawn as "jumps," condensers were used to isolate units which required current, short circuits to ground were inserted, power leads were omitted, the antenna was incorrectly installed and various leads to tube elements were transposed.

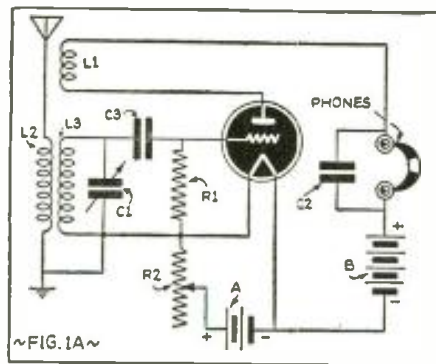

Fig. 1A, above, shows correct wiring of 1-tube set using 3-circuit tuner.

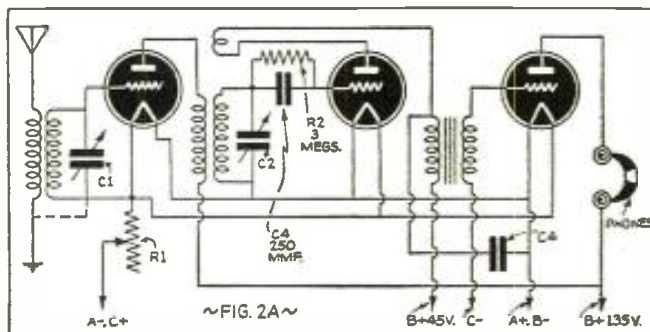

Fig. 2A, above, gives correct circuit for receiver using stage of R.F., regenerative detector, and stage of A.F. amplification.

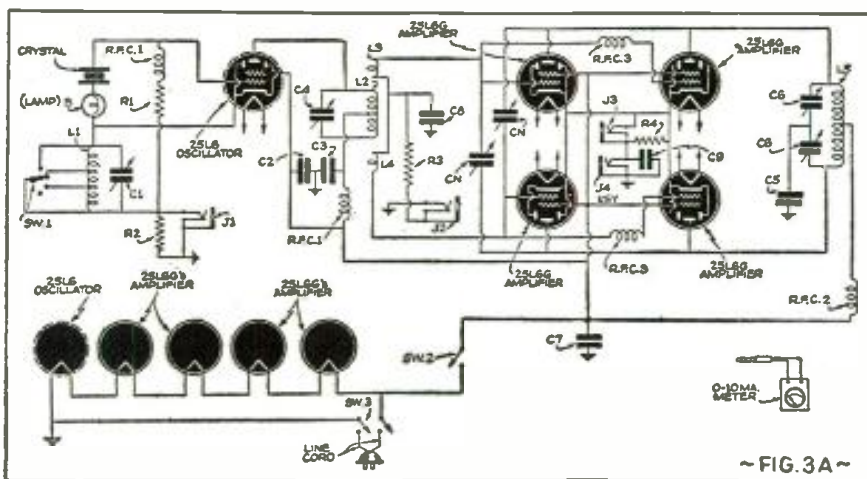

Fig. 3A, above, gives correct diagram of D.C. powered amateur radio transmitter.

10-Inch Images on 5-Inch Television Set

(Continued from page 335)

then filled the 11" lens, giving pictures approximately 7" x 9".

There was no noticeable diminution of brilliance and very little distortion was introduced. The only objection was that the viewing angle is considerably cut down.

When the image was viewed directly on the end of the C-R tube, the viewing angle was at least 120 degrees. However, with the lens in place, the angle was kept to approximately 20 degrees. This means that if you want big images on a moderate size cathode-

ray tube and use a lens system of this sort to provide them, you and your guests will have to sit rather directly in front of the television receiver.

However, when the family group is small, and if guests are infrequent, the magnified image is thoroughly practical. Observers who have seen this system in operation state that the larger picture is far more enjoyable than the smaller one, and that, while the former is adequate, the latter is highly preferable.

Getting Started In Amateur Radio

(Continued from page 334)

modulation method. This is not a serious consideration though, except in *high-power* transmitters where expensive tubes are used and the current requirements are high.

Suppressor-Grid Modulation

The third method used in modern ham transmitters is known as the "suppressor-grid modulation" method. In this case, the power amplifier (last stage) of the transmitter must use a pentode type tube. The modulator is fed into the suppressor grid of this pentode tube instead of into the control grid, as mentioned in method No. 2.

Systems of Modulation

The foregoing description will give the student a general idea of the systems generally used in *amateur phone stations*. There are several other specialized circuits used, but they are rarely employed in ham rigs, so no detailed descriptions will be given. For example, there is the screen-grid method, where the modulator terminates in the screen-grid of the output amplifier tube, but this is only capable of partial modulation (usually expressed in percentage as *60% modulation*).

Practically all phone stations, including broadcast stations, commercial communication stations, ham stations, aircraft transmitters, etc., use what is known as *amplitude modulation*. In other words the strength of the signal from the transmitter is varied to transmit the words, music, etc. There are two other systems of modulation known to the radio art, though they are seldom used. The first of these has been given quite a boost in popularity in the last few years by the experiments of Professor Edwin Armstrong, and there are several transmitters using this system experimentally at the present time. It is called *frequency modulation* and, as the name implies, the frequency to which the transmitter is tuned is varied by the voice or musical sounds. This has the disadvantage of requiring a wide frequency range—that is to say, only a few transmitters can be used in a given band of wavelengths where many could be used with amplitude modulation. The use of *frequency modulation* is therefore limited to the very high frequencies (ultra-high frequencies) where there is room for such wide-band transmission as television and frequency modulation.

Phase Modulation: The other system of modulation is known only as a scientific fact and is not used in practical transmission. This system is called *phase modulation* and depends on changing the "phase" or wave-shape of the alternating currents sent out by the transmitter. Phase modulation occurs to some extent in both amplitude and frequency modulation.

As mentioned before, the only system used in amateur stations is the *amplitude* system and several of the commonly used circuits for obtaining this modulation have been shown. In the next issue we will construct a modulator for our transmitter. This will be an amplitude modulator feeding into the plate circuit of the power amplifier tube. It will use a carbon microphone so that the number of tubes in the modulator can be kept at a minimum. If other types of microphones were to be used, such as the dynamic mike, ribbon or velocity mike, or the condenser mike, additional amplifiers would be needed. The advantage of the latter types lies in the finer quality of transmission, but where only voice transmissions are to be used, a well made carbon microphone is adequate.

THE NEW CHANNEL-ANALYZER

Follows Signal from Antenna to Speaker

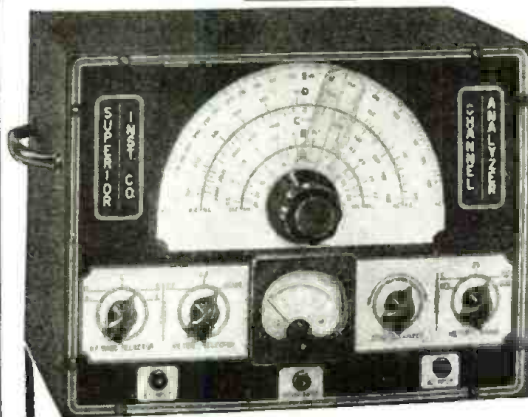

Fundamentally, what the Superior Channel Analyzer does is to permit the serviceman to follow the **SIGNAL** from antenna to speaker through each and every stage of any set ever made, and inferentially, of any set that ever will be made, using the **SIGNAL** as the basis of measurements. Thus if there is trouble in one particular channel or stage of a receiver, the serviceman can isolate the faulty stage and then proceed to ascertain the very part or component that causes the trouble. Many of the troubles in modern receivers are due to the Automatic-Volume-Control and Automatic-Frequency-Control circuits and ordinary instruments do not permit measurements directly upon these circuits, so the Superior Channel Analyzer includes a direct-current Vacuum-Tube Voltmeter that DOES make these measurements directly and with a negligible loading of the measured circuits. Other problems cease to be problems too, when the quick-solution method of the Channel Analyzer is applied. For instance, suppose a local oscillator in a superheterodyne

The Superior Channel Analyzer comes housed in shielded cabinet and features an attractive etched aluminum panel. Supplied complete with tubes, three specially engineered shielded input cables, each identified as to its purpose. Also full operating instructions. Size 13"x10"x6". Shipping weight 19 pounds. Only

THE CHANNEL-ANALYZER WILL —

1. Follow signal from antenna to speaker through all stages of any receiver ever made.
2. Instantly track down exact cause of intermittent operation.
3. Measure both Automatic-Volume-Control and Automatic-Frequency-Control, voltages and circuits without appreciably loading the circuit, using built-in highly sensitive Vacuum-Tube Voltmeter.
4. Check exact gain of every individual stage in receiver.
5. Track down and locate cause of distortion in R.F., I.F., and A.F. amplifier.
6. Check exact operating voltage of each tube.
7. Locate leaky condensers and all high-resistance shorts, also show opens.
8. Measure exact frequencies, amount of drift and comparative output of oscillators and superhets.
9. Track down exact cause of noise.

operated. The Channel Analyzer has a switch operated, tuned input circuit with amplifier, whereby not only the presence of drift may be discovered, but also the amount and direction of drift.

Distortion is another difficulty that often nettles a serviceman. The Channel Analyzer has a jack for the insertion of earphones so that you can listen to the signal directly from any stage and, therefore, discover the stage in which the distortion takes place. Next, the VTVM is used to discover the very component in that circuit that is causing the trouble. D.C. Voltages have important bearings on receiver performance. All these voltages can be measured on the Channel Analyzer with the receiver in reproducing operation. In fact, that one important consideration, **MEASUREMENTS WITHOUT MOLESTATION OF THE RECEIVER**, gets rid of the drawback of most conventional equipment which greatly reduces the very voltage it attempts to measure, or kills the signal completely.

\$1975

SUPERIOR INSTRUMENTS COMPANY
136 LIBERTY ST., DEPT. RT-10 NEW YORK, N. Y.

COMPLETE RADIO COURSE \$195

Regular RADIO TECHNICAL INSTITUTE Training



A SPECIAL OFFER

A limited quantity of R.T.I. \$39.00 radio courses have been reprinted and are offered to you at only \$1.95. These are the latest courses, complete in every detail, and exactly the same as the originals.

Radio is the present-day opportunity field. Hundreds of men with no special talents have studied Radio Servicing for a short time and are now making twice and three times as much money. R.T.I. unique radio training brings rich rewards; you can get ready quickly, inexpensively, easily, and in your spare time for a good job in radio.

ACCEPTED BY INDUSTRY

Forty large radio manufacturers have helped to prepare the R.T.I. course. Just think what this backing by the radio industry means to you. R.T.I. practical training will give you facts and real data you will need on the job. Hundreds of diagrams and illustrations will help you. You will pass quickly from lesson to lesson and in a surprisingly short time will be ready to do real radio servicing.

COMPLETE IN ALL DETAILS

No special previous education or experience is needed. R.T.I. course will give you all the training you need. The lessons are clear, interesting, easy to master and use. Fellows who knew nothing about radio before taking a radio course are now the leading servicemen in their communities. This is your chance to obtain R.T.I. excellent course for only \$1.95.

From the very start you are introduced to practical servicing equipment and practices. You are told how to open your own shop or radio store. Lesson 15, "The Radio Servicing Business," will give you many practical ideas and hints. The course is so planned that you will be able to earn spare-time money before you have reached your tenth lesson. The special \$1.95 price of the complete course can be earned in a single hour's work of radio servicing.

YOUR GUARANTEE

You are completely protected. We guarantee these courses to be exactly as the original \$39.00 Radio Technical Institute courses. Money back guaranteed. References: Liberty National Bank, Chicago, Dun & Bradstreet, or any magazine publisher.

3 COURSES IN 1

R.T.I. course is really three complete essential courses combined. You get training in (1) Practical and Applied Radio; (2) Fundamentals of Radio Principles; and (3) Advanced Specialized Training. This is the training that will place you above the average radio servicemen—and you get this training for only \$1.95.

There are over 37,000,000 radio sets in use. The R.T.I. easy practical course will pave the way to your success in Radio work.

TELLS HOW TO USE INSTRUMENTS

The training is complete. Everything from simple facts to complex alignment problems. Many servicemen have found that R.T.I. training is excellent for brush up and study of modern servicing methods. This is the best buy in a radio education. Take advantage of the bargain price today.

LATEST DATA

Yes, in the R.T.I. course you will find a complete explanation of A.V.C., how to use an oscilloscope, sound feed-back, resonance phenomenon . . . every possible fact you must know to be the best serviceman. You get a real radio training. One of the BEST radio courses is yours for only \$1.95.

LIMITED QUANTITY

Hurry your order to us today. There is but a small quantity of the courses left at the special price. You are completely protected with our guarantee. Postal money orders, checks, currency, unused stamps accepted. Answer today.

SUPREME PUBLICATIONS,
3727 W. 13th St., Room 106,
Chicago, Illinois

Please send the complete R.T.I. radio course at the special \$1.95 price. I am to be protected with your money back guarantee.

- I am enclosing \$1.95, send prepaid.
 Send C.O.D. I will pay mailman \$1.95, plus a few cents postage.

NAME

ADDRESS

SWISS MODEL "PLAN" COMPASS



Floating Day and Night Dial on Jeweled Pivot Army marching compasses used for map reading; setting and keeping a course.

SPECIFICATIONS—Heavy metal case with automatic stop; sighting window with a reflecting mirror enables the user to locate his position and maintain his bearings. Jeweled floating dial, radium marked, 0 to 360 degrees. $\frac{1}{2}$ inverted markings, radium arrow on lens. Complete with instructions for use.

Regular Value \$6.00. Our Special Price. **\$4.50**
P.P. Prepaid in U.S. and Canada.....

GOLD SHIELD PRODUCTS

Dept. RT-10 350 Greenwich St. New York

THE NEW RIDER

CHANALYST • VOLTOHMYST

Are modern service instruments and every Service Engineer should use them for speedy present-day radio servicing

NOW IN STOCK FOR IMMEDIATE SHIPMENT

CAMERADIO

963 LIBERTY AVE. 30 TWELFTH ST.
PITTSBURGH, PA. WHEELING, W. VA.

Established 1919



**A WHOLE TOOL SHOP
IN YOUR HAND**

Smooth, steady power at your finger tips. Uses 300 accessories to grind, drill, polish, rout, cut, carve, sand, saw, sharpen, engrave, etc. Plugs in any AC or DC socket. 18,000 r.p.m. 16 oz.

Get A Demonstration at Hardware, Tool or Dept. Stores, or order on 10-Days Money-Back Trial. \$10.75 postpaid with 3 Accessories... De Luxe Model, 25,000 r.p.m. 12 oz. \$18.50 with 6 Accessories.

Chicago Wheel & Mfg. Co., 1101 W. Monroe St., Dept. RT, Chicago, Ill.



FREE 64-PAGE CATALOG

Complete information on Handee Products and their wide application in crafts work and industry all over the world.



CODE MADE EASY

Plug in key, connect to A.C. or D.C. and every dot-dash reproduced through built-in speaker. Learn with Keystoner and master hardest part of becoming amateur. KIT list \$11.50, net \$8.90. Wired, less tube list, \$16.50, net \$9.90. Order from Jobber or direct.

EDWIN I. GUTHMAN & CO., INC.
400 SO. PEORIA ST., CHICAGO

Building a Low-Cost Television Receiver

(Continued from page 341)

Broad R.F. Band

In order to meet the requirements for sufficient picture detail, a very broad frequency band (2.5 megacycles or better) must be passed. To achieve this result, some compromise must be made in the gain. For that reason each tuned circuit is shunted with a resistor to broaden the response. Furthermore, a tuned circuit of this type peaks very sharply when resonated. It is therefore best when aligning this circuit to slightly detune each stage so that the peaks will be grouped closely together and afford a better band-pass characteristic. In wiring this unit, careful attention should be given to every detail, or instability will result. Copper shielding, as shown in the illustration, should be provided, and all wiring kept as short as possible, with the by-pass condensers connected directly to the point specified.

Detector Circuit

The detector circuit is the conventional diode, except that different circuit constants are used in order to pass the higher video frequencies. This brings us to the video amplifier which is somewhat the counterpart of an audio system, except that much higher frequencies are handled.

Each plate circuit is shunt compensated, utilizing a choke and a very low resistance plate load in order to maintain the high frequency response. In wiring this circuit, all grid and plate wiring must be kept at least one-half inch away from the chassis in order to avoid capacity losses.

To appreciate the need for such a high frequency response it must be realized that in the infinitely short space of time between synchronizing pulse pedestals, namely 13,230 cycles per second, the video modulation occurs, and it is at this point that the horizontal line is traced out with its many shadings, which make up the picture detail.

Following the second video stage is the 6H6 synchronizing separator which functions to separate the synchronizing pulses from the video signal.

Potentiometer R28 so biases the 6H6 that only the synchronizing pulses are passed. This signal constitutes two frequencies: the horizontal line frequency which is 13,230 cycles and the vertical (or frame) frequency which is 60 cycles, interlaced to produce 30 complete pictures per second.

Frequency Separator

The 6F7 frequency separator serves to separate the 13,230 cycle from the 60 cycle line and frame components.

The circuit works in the following manner. The input of the pentode section is fed through a 50 muf. condenser which offers a high reactance to the low frequency component; the high frequencies are passed very easily.

The same function in a reverse manner occurs in the triode section, in which the output is shunted with a .25 mf. condenser which effectively eliminates the high frequencies.

These components are then fed to their respective horizontal and vertical sweep oscillators where they serve to trip the grids of the oscillators at the precise moment necessary to maintain proper synchronization.

When the set is completed, it should be connected to a suitable dipole antenna which must be carefully constructed. For the 44-50 megacycle band, each rod should be 63 inches in length in order to resonate properly.

At the time this set was designed only one television transmitter was in operation in the metropolitan (N. Y. City) area. Therefore, no provision was made for switching to other channels. However, the set can be easily accommodated to receive other stations by incorporating a suitable switching arrangement that will interpose another pre-aligned set of trimmer condensers across each coil for each additional channel desired.

The R.F. unit should be carefully aligned by using a pair of phones in series with a .01 mf. condenser across the plate of the 6F6—2nd video stage and ground. The video signal will be easily recognized by a 60 cycle buzzing note, after which the image tube itself can be used for better alignment.

After the signal is tuned in, the intensity control, R65, should be turned until a pattern appears on the screen; then the horizontal control, R42, is rotated until the picture locks in horizontally. Next the vertical control, R43, is rotated until the picture is locked in vertically. Then the centering controls should be adjusted to properly center the picture. The contrast control, R3, which is really the R.F. gain control, should be turned just far enough to give the proper degree of contrast. Finally focus the picture by means of R63 for best detail.

In operating the set, care should be taken to keep the intensity control, R65, in the off position while the set is warming up or a stationary spot will appear on the screen which may damage the cathode-ray tube. It was also found advisable to use a 5 volt potential on the C.R. Heater in order to permit the sweep circuit to warm up sooner, thus preventing a stationary spot.

The pictures obtainable with this set, considering the small size of the tube, are very entertaining and together with the experience gained by the experimenter should prove a very worthwhile accomplishment.

(The accompanying sound can be picked up on a S-W converter connected to your regular broadcast or all-wave receiver, or possibly your present sound receiver tunes down to 6 meters and below, so that the television sound channel can be tuned in. NBC image is transmitted on 45.25 mc.; sound on 49.75 mc.)

PARTS LIST

RCA (Tubes)

- 4—185Z
- 2—6H6
- 1—6F7
- 1—6F8G
- 1—6F6
- 2—6X7
- 1—80
- 1—81
- 1—902 C-R

(Transformers)

- 1—Horizontal oscillation transformer No. 32899 (T4)
- 1—Vertical oscillation transformer No. 32898 (T3)

THORDARSON

- 1—(T-1) T13R11-650 V.C.T. (C.T.—not used)
- 1—(T-2) T13R15: 0.3 V, 5A.; 5 V, 4 A. 750 V.C.T.
- 1—(CH1) T75C49, 28 henries

IRC (Potentiometers)

- 3—100,000 ohm
- 1—10,000 ohm
- 2—50,000 ohm
- 2—150,000 ohm
- 2—.25 megohm
- 2—.5 megohm

(Resistors)

- 3—1,500 ohm
- 1—150 ohm
- 5—5,000 ohm
- 5—60,000 ohm

Please say you saw it in RADIO & TELEVISION

RADIO & TELEVISION

- 5—250,000 ohm
 - 2—175 ohm
 - 1—1,500 ohm
 - 2—2,000 ohm
 - 4—1 megohm
 - 1—40,000 ohm
 - 2—5 megohm
 - 1—3 megohm
 - 1—2 megohm
 - 1—5,000 ohm
 - 1—3,000 ohm
 - 2—1,000 ohm
 - 6—100,000 ohm
 - 1—30,000 ohm
 - 1—400 ohm
 - 2—10,000 ohm—10 watt, wire wound
 - 1—900 ohm
 - 1—600,000 ohm
 - 1—2,000 ohm—1 watt
 - 1—50 ohm center tap 20 watt
 - 1—100,000 ohm 1 watt
- (All ½ watt, except those specified otherwise)

CORNELL-DUBILIER (Condensers)

- 3—16 mf. 450 v.—JR-516
- 5—8 mf. 450 v.—JR-508
- 2—1 mf. 1,000 v.—R10100
- 2—.05 mf. 1,000 v.—DT-10S5
- 3—.05 mf. 400 v.—DT-4S5
- 2—.005 mf. 600 v.—DT-6D5
- 1—.0015 mf. mica—1W-5D15
- 12—.01 mf. 400 v.—DT-4S1
- 3—.25 mf. 400 v.—DT-4P25
- 5—.1 mf. 400 v.—DT-4P1
- 2—.5 mf. 400 v.—DT-4P5
- 1—.25 mf. 25 v.—BR-252
- 1—.10 mf. 25 v.—BR-102
- 4—.150 mmf. mica—3L-5T15
- 1—.820 mmf. mica—1W-5T8*
- 1—.50 mmf. mica—5W-5O5
- 2—.001 mf. mica—1W-5D1

*An 800 mmf. cond. connected in parallel with a 20 mmf. cond.

MISCELLANEOUS

- L-1—4 turns No. 18, ½" length.
- L-2—6 turns No. 12, turns spaced thickness of wire
- L-3—6 turns No. 12
- L-4—6 turns No. 12
- L-5—6 turns No. 12
- L-6—175 turns No. 34 enameled
- L-7—175 turns ½" form
- L-8—85 turns No. 34 enameled
- L-9—85 turns No. 34 enameled
- 2—2.5 M. H. chokes

"Half-Pint" Portable

(Continued from page 339)

constructed with a small wood front panel, on which is mounted the variable condenser and the combined regeneration control and "ON-OFF" switch. The coil socket is mounted on the inside of this latter base or chassis, so that the coil may be inserted through holes punched or drilled in the top of the carrying case. The wood used for this base and the panel should be three-ply wood of about 3/16" or ¼" thickness. A 1¾" hole is cut into the front of the case at the center as shown in the illustration, and the speaker is mounted directly on the inside of the case.

The constructional directions given here are purposely made rather general as they are meant to serve as suggestions, leaving the specific design to the ingenuity of the constructor. In other words, this receiver as shown has been made as compact as possible with the components employed, but if the constructor wishes to vary the specifications by using slightly larger parts at various points, he may then re-design the carrying case to meet his particular needs.

"Half-Pint" Portable—List of Parts

HAMMARLUND (Condenser)

- 1—Antenna trimmer, 3 to 30 mmf., type MEK-30 (C-1)
- 1—140 mmf. variable tuning condenser midget, type MC-140S (C-2)

CORNELL-DUBILIER (Condensers)

- 1—Mica condenser, .0001 mf., type SW5T1 (C-3)
- 1—Mica condenser, .0005 mf., type SW5T5 (C-5)
- 2—Tubular condensers, .01 mf., type DT-4S1 (C-6, C-7)
- 2—Tubular condensers, 0.1 mf., type DT-4P1 (C-4, C-11)
- 1—Dry electrolytic condenser, 5 mf., 50 volts, type EDJ-3050 (C-8)
- 2—Dry electrolytic condensers, 40 mf., 150 volts, type BR-4015

for October, 1939

MARINE and COMMERCIAL-TYPE RECEIVERS

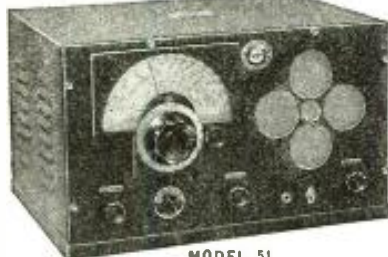

MODEL 51

- 13 Tube Performance (10 used)
- Isolantite insulation
- Iron Core I.F.
- Band Spread
- C.W. Pitch Control
- R.F. and Det. Panel Trimmers
- Push-Pull Audio
- A.C.-D.C. Circuit
- Full Wave A.C. Rectification
- High voltage, oiled paper filter condensers—no electrolytics
- Both power lines filtered
- Shielded, moisture-proof bypasses

An AC-DC, communication-type superhet. built to highest standards. Continuous tuning range 9.7 to 3.750 meters in Model 51-MK covers time signals, weather and airplane beacons, 800 meters, broadcast, police, yacht phone, amateurs and short wave broadcast. Dial fully calibrated with all amateur, broadcast and time bands marked. Regenerative input gives almost complete image rejection, brings up weak signals that are unreadable without it.

A rugged, dependable communication receiver afloat or ashore. A go-getter for DX. ALWAYS IN ALIGNMENT. No need to depend upon line-up adjustments made in a factory thousands of miles away. R.F. and detector trimmers, on the panel, allow the operator to align the receiver perfectly for any frequency. Built of the best materials. No electrolytics or deteriorating parts except the tubes.

MODEL 51 NET PRICES

- Model 51-AK, 9.7-550 meters, 110 volts AC-DC net \$157.00
 - Model 51-MK, 9.7-3,750 meters, 110 volts AC-DC net \$175.00
- Battery model also available.

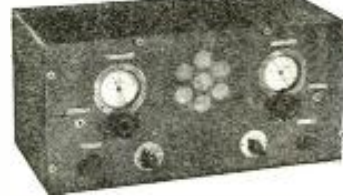

MODEL 11 9.5 TO 20,000 METERS—

Continuous tuning from the ultra highs to the audio frequencies—the greatest tuning range of any advertised receiver. An exceptional CW receiver but good also for phone and broadcast. Designed for the operator whose interests are not confined to any one set of frequency bands. Flexible, quiet, easy to operate, ultra-sensitive. Employs tuned R.F. and regenerative detector circuit—believed by many to be most sensitive C.W. receiving circuit ever developed. Selectivity compares favorably with larger multi-tube sets.

Features: Model 11 has coil switching, band spread, calibrated dial, break-in switch, phone jack, built-in speaker and power supply. Ideal for the commercial operator's personal receiver. Available in any voltage and for A.C., D.C. or battery, in 3 tuning ranges. An accepted standard in this field since 1936.

MODEL 11 NET PRICES

- Net Prices—A.C. Models
 - Model 11-AA, 9.5-550 meters.....\$52.00
 - Model 11-MA, 9.5-3750 meters.....\$57.00
 - Model 11-UA, 9.5-20,000 meters.....\$77.00
- Immediate Delivery. Prices include power supply, speaker and RCA tubes.

E. M. SARGENT CO.

212 9th St. Oakland, Calif.

RECEIVER CABINETS



Combines

Beauty—Economy—Utility

For complete Catalogue RT-109, write

BUD RADIO, INC.

5205 Cedar Ave. Cleveland, Ohio

I.R.C. (Resistors)

- 4—Fixed resistors, 1 meg., ½ watt (R1, R2, R4, R6)
- 1—Fixed resistor, 200,000 ohms, ¼ watt (R3)
- 1—Fixed resistor, 500,000 ohms, ¼ watt (R5)
- 1—Fixed resistor, 250 ohms, ½ watt (R7)
- 1—75,000 ohm potentiometer, with switch (R8) (SW1)
- 1—Fixed resistor, 5,000 ohms, 1 watt (R9)
- 1—Resistor in line cord, 250 ohms, 50 watts (R10)

ARCTURUS (Tubes)

- 1—12B8GT dual purpose tube
- 1—32L7GT dual purpose tube

MISCELLANEOUS

- 1—Universal type output transformer (T1)
- 1—2-inch P.M. dynamic speaker
- 1—Cigar box or similar carrying case
- 1—Set of 6 Find-All plug-in coils, 10 to 560 meters (L1)

COIL DATA FOR 1½" DIAMETER COILS

Range Meters	Grid Turns	Tickler Spacing*
200-500	126T. No. 28	28T. No. 34
135-270	82T. No. 28	16T. No. 30 1¾"
66-150	38T. No. 26	11T. No. 30 1½"
33-75	18T. No. 24	6T. No. 30 1¼"
17-41	9T. No. 16	5T. No. 30 1¼"
9-20	3½T. No. 14	3T. No. 30 1"

*Spacing is length of winding. All coils wound on 1½" diameter ribbed forms. Space between grid coil and tickler ¼". All ticklers wound with No. 30 D.S.C. wire (except 200-500 meter coil).

PERSONAL SERVICE

By *Bill Harrison*

HAMS! SWL's!

It will pay you to visit or write to me whenever you want to buy anything in Radio or Photography. I am authorized factory distributor of all Amateur Receivers, Transmitters, Kits, Parts, etc.

I guarantee to give you a fair and square deal with most liberal trade-in allowance and, above all, complete satisfaction!

Since 1925, more and more men in all parts of the world are being satisfied with my prompt Personal Service, and my low prices. You will be, too!

73, Bill Harrison, W2AVA

EASY TIME PAYMENTS ON EVERYTHING!

HARRISON RADIO CO.

12 WEST BROADWAY - NEW YORK CITY



FREE!

HAMMARLUND NEW "39" RADIO CATALOG

The latest Hammarlund catalog with complete data, illustrations, drawings and curves on the entire Hammarlund line. Address Department RT-10-39 for your free copy.

HAMMARLUND MFG. CO., INC.

424-438 West 33rd Street, New York City



UNIVERSAL

Grasp-to-talk in single and double button, crystal and Dynamic models. Streamlined, rugged, compact. Lightweight. Hand grasp closes circuit. For police cars, fairs, window demonstrations, p. a., amateurs, call systems, sports event, etc. Incl. 6 ft. cord.

Universal Microphone Co., Ltd. 424 Warren Lane, Inglewood, Calif., U.S.A.

Please say you saw it in RADIO & TELEVISION

FACTORY GUARANTEED

NEW REMINGTON NOISELESS
PORTABLE AS LITTLE AS



**10¢
A DAY**

**MONEY BACK GUARANTEE.
10-DAY FREE TRIAL OFFER**

AT LAST! The famous Remington Noiseless Portable that speaks in a whisper is available for as little as 10¢ a day. Here is your opportunity to get a real Remington Noiseless Portable factory guaranteed. Equipped with all attachments that make for complete writing equipment. Standard keyboard. Automatic ribbon reverse. Variable line spacer and all the conveniences of the finest portable ever built. **PLUS** the **NOISELESS** feature. Act now while this special opportunity holds good. Send coupon **TODAY** for details.

YOU DON'T RISK A PENNY

We send the Remington Noiseless Portable direct to you with 10 days' **FREE** trial. If you are not satisfied, send it back. **WE PAY ALL SHIPPING CHARGES.**

GREATEST TYPEWRITER BARGAIN IN 10 YEARS

Imagine a machine that speaks in a whisper... Equipped with all attachments that make that can hardly be heard ten feet away. For complete writing equipment, the Remington Noiseless Portable produces manifolding and stencil cutting of exceptional character. Disturbing others. And finished in black with shining chromium at superb performance. Find out literally makes the words seem to flow without obligation from the machine. Mail coupon today!

FREE - Touch Method Instruction Book

With your New Remington Noiseless Portable we will send you—absolutely **FREE**—a 24-page typing instruction book featuring the Touch System, used by all expert typists. It is simply written and completely illustrated. Instructions are as simple as A B C. Follow these instructions during the 10-Day Trial Period we give you with your typewriter and you will wonder why you ever took the trouble to write letters by hand. You will be surprised how easy it is to learn to type on the fast Remington Noiseless Portable.

SPECIAL-CARRYING CASE

Also under this new Purchase Plan we will send you along with your Remington Noiseless Portable a special carrying case sturdily built of 3-ply wood. This handsome case is covered with heavy Du Pont fabric. The top is removed by one motion, leaving the machine firmly attached to the base. This makes it easy to use your Remington anywhere—on knees, in chairs, on trains. Don't delay...send in the coupon for complete details!

SEND COUPON WHILE LOW PRICES HOLD

Remington Rand Inc. Dept. 300-10
465 Washington St., Buffalo, N. Y.

Tell me, without obligation, how to get a Free Trial of a new Remington Noiseless Portable, including Carrying Case and Free Typing Booklet for as little as 10¢ a day. Send Catalogue.

Name.....
Address.....
City.....State.....

The Twinplex Again—But Modernized

(Continued from page 337)

and the other components on the sub-chassis. The tuning condenser and coil socket are on the left side and the regeneration-control condenser and tube socket, on the right. The coil socket must be raised on 1/2-in. bushings to keep the magnetic field of the plug-in coils away from the metal chassis—for R.F. loss minimization. The antenna post is on a stand-off insulator which also supports the 35-mmf. antenna compensating condenser. In wiring the variable condensers do not rely upon the mounting of these units to the metal chassis as positive connections. Run wires from the rotor soldering lugs to ground.

The batteries required are two 45 V. "Bs" and one No. 6 drycell. Since the "A" current is only 100 milliamperes, the No. 6 will last for several months and the "B" much longer.

Incidentally, it is quite an easy and inexpensive matter to electrify receivers using the 1.4-V. tubes. A single rectifier, working from the 115-V. light lines plus 1 or 2 resistors and condensers are all that are necessary. Next month the author will describe the electrification of the "1G6G Twinplex."

In operation, the set is exactly the same as the conventional 1 2-tube regenerative receiver and consequently it will not be necessary to go into detail regarding same. The receiver is an excellent go-getter for both phone and C.W. stations on all bands between 15 and 175 meters.

List of Parts

HAMMARLUND

Two variable condensers, type HF-140, 140 mmf.
One antenna compensating condenser, 35 mmf.
One octal Isolantite socket
One 4-prong Isolantite socket

I.R.C. (Resistors)

One grid-leak resistor, 3 meg.
One resistor, 400 ohms, 1/2-W.
One resistor, 0.1-meg., 1/2-W.
One resistor, 0.25-meg., 1/2-W.

Fixed Condensers

One condenser, 0.01-mf., 200 V.
One condenser, 0.1-mf.
One condenser, 100 mmf.

C. F. CANNON CO.

One pr. 2000 ohm headphones

NATIONAL UNION RADIO CORP.

One 1G6-G tube

NATIONAL CARBON CO. (Eveready)

One No. 6, 1.5 volt drycell (A battery)
Two small size 45 B batteries

Miscellaneous

One antenna stand-off insulator
One R.F. choke, 4.5 mh.
One ground binding post
One twin headphone binding post
One K.K. 3-in. tuning dial
One tuning knob
Chassis, miscellaneous hardware, etc.

More Television

Hints and
Latest News in
Next Issue

Please say you saw it in RADIO & TELEVISION

OUR STOCK OF U.S. ARMY SIGNAL CORPS LAMPS IS RAPIDLY DEPLETING. EVEN AT \$3.95, COMPLETE WITH FITTINGS AND PACKED IN A WOODEN CARRYING CASE, THE SAVING IS NEARLY 90% FROM THE GOVERNMENT COST.



**U. S.
ARMY
SIGNAL
CORPS
LAMPS**

The lamp of 100 uses

Scout Signalling
Night Bowling Alleys
Trailer Lamp
Night Motor Boat Races
Auto, Truck and Trailer Camps
Tractor Light
Camp Light
Barnyard Lighting
Night Fishing
Radio Shacks
Bungalows
Picnics, etc.



Scouts Signalling

Large size—12 1/4" wide, 5 1/4" deep, 15" high including socket, fitted with 10" silver plated reflector (no glass, nothing to break). Packed in portable wooden carrying case, with hinged cover, haap and handles. Every case contains weatherproof extension cord and plus 2 extra bulbs, telegraph signalling key and 16 page U.S. Army Instruction Manual. Shipping weight 15 lbs. Price **\$2.50** SPECIAL FOR 30 DAYS ONLY F.O.B. N. Y.

Same size lamp without wooden case or extra fittings \$2.00
Small lamp, 6" \$1.00
Send for catalog containing full descriptions of this and many other interesting items.

GOLD SHIELD PRODUCTS

Dept. RT-10-9 350 Greenwich St. New York

Radio Men Find This Book Handy

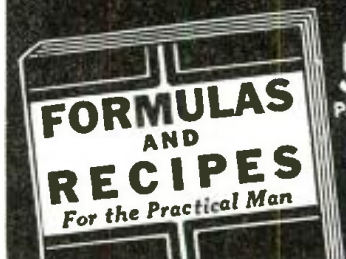

**50¢
POSTPAID**

Here Is the Contents of the Book

1. Adhesives: Glues, Cements, Gums, Mucilages, Lubricants 2. Cleansing: Stain Removers, Paint Removers, Bleaches, Cleaning Fluids, 3. Metal Craft: Coloring, Oxidizing, Plating, Repairing, Welding, Polishes, Alloys, Solders, Amalgams, 4. Paints: Colors, Stains, Varnishes, Enamels Luminous Paint, Washable Paint, Paint Removing, Waterproofing, Fireproofing, 5. Glass Working: Cutting, Drilling, Boring, Bending, Blowing, Etching, Engraving, Frosting, Silvering, etc. 6. Wood-craft: Fillers, Fireproofing, Acid-proofing, Waterproofing, Furniture Polishes Finishes, etc. 7. Ink Recipes, Eradicators, Ink Stain Removers, Special Inks, Colored, Inks, Quills, Sympathetic, Invisible, Hectograph, 8. Photography: Developers, Emulsions, Fixers, Sensitizing, Toning, Printing, Photographic Paper, Blueprint Paper, 9. Antidotes for Poisons, Remedies for Burns and Scalds, Disinfectants, First-Aid in Accidents, Emergency Remedies, Home Remedies, 10. Preparation, Manipulation, Handling, Mixing, Measuring, Weighing, Filtering, Straining Solutions; List of Technical Substances; Emulsifying; Use of Hydrometer, Use of Thermometer; Tables of Weights and Measures, Decimal Systems, Useful Tables.

TECHNIFAX, Division RT-1039
1915 So. State Street, Chicago, Illinois

TECHNIFAX, Division RT-1039
1915 So. State Street, Chicago, Illinois

Gentlemen: Enclosed please find 50¢ (check, money order, coin or unused U.S. stamps accepted) for which send me **POSTAGE PREPAID**, One Copy of **FORMULAS AND RECIPES For the Practical Man**.

Name.....
Address.....
City.....State.....

The Radio Beginner

(Continued from page 352)

ohms, but increases as we go toward the antenna proper. Since the stub must be in resonance with the antenna, the shorting bar can be moved up or down until this condition is obtained. The feeders are attached to the stub at such a point that there are no standing waves on the line.

A *Two Wire Matched Impedance Antenna* is more efficient than the Single Wire Fed, but is also more difficult to construct. The feeders are connected to the antenna at that point where the antenna impedance matches the impedance of the feeders. In this case it is necessary to connect the feeder line off center of the antenna to obtain the correct impedance match. An antenna that is quite similar but much easier to construct is the *Twisted Feeder Antenna* or *Half Wave Doublet*, Fig. 4. It will be recalled that the center of a half wave antenna is a point of low impedance. A twisted pair of conductors also have a very low impedance, the exact impedance depending on the size of the wire and the proximity of the wires to each other. A more accurate impedance match can be secured by fanning out the twisted feeders where they connect to the antenna. The writer has used lamp cord as a feeder on such an antenna for both transmitting and receiving. However the losses in such a feeder make it advisable to use a twisted pair of No. 18 rubber covered wire.

Directive Antennas. All the antennas that we have described thus far are *half wave* antennas, and as such have maximum radiation at right angles to the wire itself. If we were to concentrate as much of the radiation as we could in *one* direction it would be equivalent to increasing the power of our transmitter as far as that particular direction would be concerned. By concentrating antenna radiation in one direction a transmitted radio beam is obtained that is the equivalent of a substantial increase in power. The idea behind a *directive antenna* is very much like placing a highly polished reflector behind the bulb in an auto headlight in order to concentrate all the light in a forward direction. Radio waves can similarly be reflected. In Fig. 5 we see how this condition is obtained. This very simple directive antenna consists of a *reflector* placed $\frac{1}{4}$ wavelength (or multiple) away from the antenna. Such a reflector, known as a *parasitic reflector*, is made slightly larger than the antenna itself. It is not connected to the antenna or transmitter in any way. The field that is radiated away from the antenna is *re-radiated* by the reflector, so that the radiation back to the antenna is reinforced. In actual practice a number of such reflectors are used in order to secure a greater concentration of the beam in one direction. The radio beam can be further concentrated in one direction through the use of *directors*. Referring to our analogy of the auto headlight, if the reflector is comparable to the mirrored surface behind the bulb, then the director is similar to the lens placed in front of the bulb. If the director wire is placed in front of the antenna, it will aid the radiation in a forward direction. Directors are frequently used in combination with reflectors. One such antenna, known as the *Yagi* antenna, uses a large number of directors and reflectors to produce a narrow beam. Directors are made shorter than reflectors, and when not connected to the transmitter or antenna, are known as *parasitic directors*.

The methods of feeding antennas already described in this article are equally ap-

plicable to directional antennas. Zepp feeders may be used, or a non-resonant two-wire feeder employing a matching stub. In order to secure radiation in all directions, some provision should be made for *rotating* the directive antenna. Where the directive antenna or *array* is used on ultra short waves, it is feasible to rotate the antenna manually, but a motor is essential when the weight of the array makes hand operation impractical. A consideration that should be kept in mind when erecting a directive antenna is that radiation currents are large and detuning will occur with small variations in the spacing between the elements of the antenna. For this reason particular attention should be paid to construction to obtain maximum rigidity of the radiator and its associated reflectors and directors.

A *Flat-Top Beam* antenna is shown in Fig. 6. The flat-top may be fed at the end, in which case it is termed an end-fed flat-top, or in the center—when it is called a center-fed flat-top. If the Zepp resonant feeder system described is used, then the antenna lengths are not critical, since compensation can be made through the use of series or parallel tuning in the feeder line. A non-resonant feeder system employing a matching stub can be used as shown in the diagram. Such an antenna has a beam in two equally opposite directions. Compare this with the antenna shown in the preceding diagram in which the radiation is unidirectional.

Directive antennas, where the frequency is sufficiently high to permit small antenna elements, may be erected vertically. Half wave directive antennas, whether vertical or horizontal, are sometimes termed *dipoles*, a number of dipoles using reflectors finding wide application in the reception of television programs.

On wavelengths below ten meters the physical dimensions of the antenna are sufficiently small to permit portable use. Antennas operating on the ultra short wavelengths make use of the ground wave as opposed to the sky wave that is used for lower frequency operation. Since the visual range appears to be the limiting factor in ultra high frequency work, it is advisable to mount the antenna as high above the ground and intervening obstructions as possible. It is not practical to use Zepp feeders, since the antenna may be as much as several wavelengths away from the transmitter and too much power may be lost in feeder line resonance waste. The antenna could be fed by two wire non-resonant line and matching stub, a two wire matched impedance system, or by the use of a *concentric feeder*. See Fig. 7. Because of the small antenna dimensions on the ultra high frequencies, the use of directive elements, reflectors and directors, is highly advisable to secure an increase in the transmitted power. The concentric line represents one of the best feeder methods for carrying radio frequency power to the antenna. The feeder proper is protected from the weather; the outer shield may be grounded at any point and is thus at zero potential; no radiation can occur from the feeder line and losses from the transmitter to the antenna are kept at a minimum. The inner conductor should be accurately spaced from the outer shield, and carefully insulated from it. This is frequently done through the use of beads which act as small insulators and at the same time keep the necessary spacing between feeder and shield. Concentric lines can be made to give a very good impedance match.

POCKET SIZE A.C.-D.C.

Volt-Ohm-Milliammeter

TRIPLET

Model 666-M



NET PRICE
\$14.50

5000 VOLTS SELF-CONTAINED

● WITH RED ● DOT Lifetime Guaranteed Measuring Instrument. Range: A.C. Voltage up to 1000 ohms per volt; 0-10-50-250-1000-5000; D.C. Milli-amperes 0-10-100-500; Resistance 0-300 shunt type 10 ohm reading at center scale; 0-250,000 series type, 3700 ohms at center scale. Complete in Bakelite case, with Exclusive Triplet Low Loss Selector Switch. Handiest and most compact tester built expressly for the Amateur trade. Indispensable for setting up a new circuit or peaking up the old one. Also the "best friend" when something goes wrong. **\$14.50 Net Price**

Model 666—same case as above—reads to 1000 volts A.C. and D.C. **\$14.00 Net Price**

See Your Jobber—Write for Catalog
Section 2810, Harmon Ave.

TRIPLET ELECTRICAL INSTRUMENT CO.
Bluffton, Ohio

Just Published . . . a NEW RADIO AND ELECTRONIC DICTIONARY Containing 3,800 Definitions

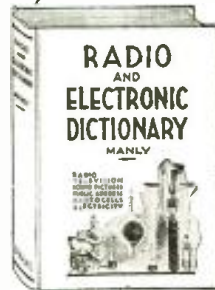

THIS RADIO AND ELECTRONIC DICTIONARY, written by Harold P. Manly, explains the meaning of 3,800 words used in radio, electronics and other closely allied fields. It includes new terms used in radio transmission, sound pictures, television, public address, aviation radio, navigation and industrial control, photo-electricity, photocell application, telephony, etc. This dictionary permits learning every new expression whether you hear it or read it. Alphabetically arranged for quick reference, 550 illustrations augment definitions in the text.

The book is recommended for students, engineers, electricians, experimenters, salesmen and everyone in any way associated with radio. ONLY BOOK OF ITS KIND—HANDY—EASY TO USE—AND TIMELY. The RADIO AND ELECTRONIC DICTIONARY is new, authentic and printed in a single volume of 300 pages, size 6 x 9 inches. The book weighs only 1 1/2 lbs. and is bound in durable cloth. SHIPPED ANYWHERE **\$2.50** IN U. S. A. POSTPAID Price

Mail remittance by check or money order to
RADIO PUBLICATIONS
99 HUDSON STREET NEW YORK, N. Y.

RADIOS.. SAVE UP TO 50%

DEAL DIRECT — FACTORY PRICES—Many models to choose from at wholesale prices. A.C. DC. midgets \$4.98. Portable sets, battery sets \$8.98 up. Car sets \$11.75 up. Also consoles, all-wave, etc. Samples at 50% off. Send for FREE 1940 bargain catalog giving details of 10 day FREE trial and agent's proposition and discounts. No obligation. write today.

GOLDENTONE RADIO CO. DEPT. RT. Dearborn, Mich.

Free Catalog

EVERYTHING IN RADIO!

A COMPLETE SOURCE FOR YOUR RADIO NEEDS

Our immense stock of radio sets, parts and supplies enables you to purchase your entire needs on one order. You will find all your Nationally Known Favorites in this big book which is FREE for the asking. Practically every order is shipped the same day it is received.

WRITE FOR BIG NEW CATALOG

BURSTEIN-APPLEBEE CO.
1012-14 McGee St. • Kansas City, Mo.

RADIO INSTRUCTION

FASTEST WAY TO LEARN CODE

Easy, Fascinating, LEARN by EAR
To Be a GOOD OP.

The New All Electric Master Teleplex Code Teaching Machine is exactly what thousands are looking for. No experience needed. Ideal for beginners—steps up WPM for ALL Ops. There is no guess work with Master Teleplex, because it records your sending in visible dots and dashes. You SEE and HEAR exactly how you are making your signals. You learn code the way you'll be using it—by SOUND. That's why practically every school teaching code uses TELEPLEX. Complete course included at no extra charge. Used by many schools for teaching code. Low cost; easy terms. MONEY BACK GUARANTEE. Send now for booklet \$10, no obligation. Postcard will do.



TELEPLEX CO., 67-69 Park Place, New York
In Canada write:
CANADIAN ELECTRONIC INST., TORONTO, ONT.

IF You are an experienced radioman;
You are ambitious to get ahead rapidly in radio;
You realize the necessity of a directed training in the engineering principles of radio but are unable to take advantage of college training,—

Then -- Send for our new illustrated book "A Tested Plan." It will give you complete details of an advanced home study course in Practical Radio and Television Engineering written for the experienced radioman.

CAPITOL RADIO ENGINEERING INSTITUTE
3224-16th St. N. W., Dept. ST-10, Wash., D.C.

RADIO plus TELEVISION

mastered by pre-tested Training

No matter where you are or what you do, National has a complete training plan for you—to fit your circumstances. National's plan is for those seeking immediate shop-training as well as for those who cannot give up present employment and income. Mail coupon below.

NATIONAL SCHOOLS

NATIONAL SCHOOLS, Dept. 10-RT
6000 So. Figueroa St., Los Angeles, Calif.

Please send free literature and full details.

NAME _____ AGE _____

ADDRESS _____

CITY _____ STATE _____

RADIO ENGINEERING

RCA Institutes offer an intensive course of high standard embracing all phases of Radio and Television. Practical training with modern equipment at New York and Chicago schools. Also specialized courses and Home Study Courses under "No obligation" plan. Catalog Dept. RT-39.

RCA INSTITUTES, INC.
A Radio Corporation of America Service
75 Varick St., New York. 1154 Merchandise Mart, Chicago

LEARN RADIO TELEVISION

500 LICENSED graduates placed in past 7 years in shipping, broadcasting, aviation, police, etc.; we also teach radio servicing and repairing; new beginners' class now forming; 60-page catalog free; oldest, largest and best equipped.

MASS. RADIO SCHOOL
18 BOYLSTON ST., BOSTON Est. 1899

RADIO ENGINEERING

broadcasting, aviation and police radio, servicing, marine radio telegraphy and telephony, Morse telegraphy and railway accounting taught thoroughly. 48 weeks' Engineering course equivalent to 3 years of college radio work. All expenses low. Catalog free. School established 1874.
Dodge's Institute, Turner St., Valparaiso, Ind.
368

ECO Switch-Band Transmitter

(Continued from page 351)

of the crystal holder receptacles are wired to two switch contacts. This is done so that the crystal can be operated either in a pentode or tri-tet oscillator.

Section SW-1B has its rotor in the cathode of the 89 and operates so that the cathode is connected to the grid coil when the oscillator is operated as an ECO, and to the crystals and cathode coil when used as a crystal oscillator.

SW-1C switches the key from the ECO grid coil to the cathode return of the crystal oscillator.

How Cathode Coil Is Switched

SW-1D is used to short out sections of the cathode coil L-6. When operating as a tri-tet oscillator, L6-C2 must be tuned to a frequency approximately 1 1/2 times the crystal frequency. When operating as a pentode oscillator, this coil is shorted out. For 160 meter crystals, the entire coil is employed, while with 80 and 40 meter crystals, part of the coil is shorted out so that the remaining turns in the coil will resonate with the 100 mmf. condenser to 1 1/2 times either the 3500 or the 7000 kc. band. Incidentally, both SW-1A and SW-1B are wired up to suit the individual constructor's needs as dictated by his assortment of crystals (if any).

The diagram shows one arrangement which uses three eighty meter crystals, two of which would be operated either in pentode or tri-tet fashion, with the third in pentode only; a 160 meter crystal in both methods; a 40 meter crystal in tri-tet and the last two receptacles can be used in pentode connection only.

In designing a different arrangement, it should be remembered that where it is desired to operate the 89 as a pentode oscillator, SW-1D must be connected so as to short the cathode coil (L6).

A small miniature base socket is wired in series with the crystal receptacles and a 60 milliamper pilot light is used as a fuse to protect the crystals against excessive current.

The 807 buffer stage is capacitively coupled to the oscillator and contains a Browning 5L tuning unit in the plate circuit. This consists of a double-section

RADIO INSTRUCTION

EASY TO LEARN CODE

It is easy and pleasant work to learn the modern way—with an INSTRUCTOGRAPH CODE TEACHER. Ideal for the beginner or advanced student. Many tapes available ranging from alphabet for beginners to typical messages on all subjects. Speed range 5 to 40 WPM. Always ready, no QRM, beats having someone send to you.



FOR SALE OR RENT
STANDARD with 10 tapes and book of instructions \$20.25
JUNIOR with 5 tapes and book of instructions (not rented) \$12.00
RENTAL Standard with 10 tapes and book of instructions \$3.00 (first month, \$2.25 each additional month). All rental payments may be applied on the purchase price should you decide to buy the equipment.

Write for details today
INSTRUCTOGRAPH COMPANY
Dept. 5W, 912 Lakeside Place, Chicago, Ill.
Representatives for Canada:
Radio College of Canada, 663 Bay St., Toronto

RADIO COURSES

New Fall Classes Now Starting
RADIO OPERATING—BROADCASTING

- RADIO SERVICING — a practical course
- RADIO AMATEUR CODE ● TELEVISION
- ELECTRONICS—1 yr. day course 2 yrs. eve.

Day and Evening Classes. Booklet Upon Request.
New York Y.M.C.A. Schools
6 W. 64th Street New York City

BE A RADIO SERVICE EXPERT

Modern receivers require men with modern training for service work
LEARN AT HOME
Our home instruction method and service equipment offer starts you earning money almost at once. Up to \$3 an hour easy in a short time. Write for free book.
Radio Training Ass'n of America
Dept. RT-109
4525 Ravenswood Ave., Chicago

AMATEUR RADIO LICENSES

Day and evening classes in code and theory
Home Study Courses
Hundreds of students now on the air. Results guaranteed. Reasonable, efficient and thorough.
AMERICAN RADIO INSTITUTE
1123 BROADWAY NEW YORK, N. Y.

switch with 5 coils mounted and wired thereon and a 50 mmf. tuning condenser already connected. Both this switch and the switch used in the oscillator grid circuit are of the type which short out the unused
(Continued on page 372)

		COIL DATA			
		L-1 (Browning 5G)		Tap from	Fixed Shunt
Freq.	Turns	Wire	Length	Ground	Capacity
875-1000 kc.	104	No. 33 enam.	close wound	20	225 mmf.
1.75 mc.	53	No. 28 enam.	7/8"	10	225 mmf.
3.5 mc.	27	No. 24 enam.	7/8"	6	200 mmf.
7 mc.	14	No. 22 tinned	7/8"	2 1/2	200 mmf.
14 mc.	6	No. 16 tinned	3/4"	1 1/2	200 mmf.
		L-2 (Oscillator Plate)			
Freq.	Turns	Wire	Length	scramble wound	
1.75 mc.	117	No. 28 d.c.c.		close wound	3/4" diameter
3.5 mc.	69	No. 28 d.c.c.		close wound	
7 mc.	33	No. 28 d.c.c.		close wound	
14 mc.	14	No. 24 enam.		close wound	
28 mc.	7	No. 18 enam.		close wound	
		L-3 (Browning 5P) (Buffer Plate)			
Freq.	Turns	Wire	Length	Diameter	
1.75 mc.	108	No. 31 enam.	close wound	3/4"	
3.5 mc.	53	No. 26 enam.	close wound	3/4"	
7 mc.	31	No. 24 enam.	15/16"	3/8"	
14 mc.	14	No. 18 tinned	7/8"	3/8"	
28 mc.	7	No. 18 tinned	7/8"	3/8"	
		L-4			
Freq.	Turns	Wire	Length		
1.75 mc.	56	No. 18 enam.	4"	All coils 2 1/2" diameter and have 3/8" space at center of coil for hinged link coil.	
3.5 mc.	40	No. 16 enam.	4 1/4"		
7 mc.	22	No. 12 enam.	4 1/4"		
14 mc.	12	No. 12 enam.	4"		
28 mc.	6	3/8" diameter copper tubing	5"	All coils "air-wound."	
		L-5			
		3 turns No. 18 enam., 2 1/2" diameter, hinged, to permit swinging into center of L-4.			
		L-6			
		46 turns No. 24 enam., close wound, 3/4" diameter. Tapped 6 turns from end (40 meters). Tapped 14 turns from end (80 meters).			

Peaking Image and Sound Stages in Television Receivers

(Continued from page 335)

ADJUSTING THE ADJACENT SOUND-TRAP TRIMMERS: The adjacent sound-trap trimmers are provided to keep the audio signals out of the video circuits. These trimmers should be adjusted as follows:

1. Remove the socket from the base of the picture tube. Connect a rectifier type meter from Pin 10 on the picture tube socket to the ground, through a .5 mfd., 600 V. paper condenser.
2. Connect a 400 cycle modulated signal generator to Pin 4 of the 1852 modulator tube. Set the generator accurately at 14.25 mc.
3. Adjust the signal generator for maximum deflection on the meter.
4. Adjust video I.F. trimmers A and E for *minimum* deflection of the output meter.

NOTE: The signal generator frequency must be accurate. Otherwise, this adjustment may be carried out on a frequency within the pass-band of the video I.F. system resulting in loss of picture detail and synchronization.

ADJUSTING SOUND SENSITIVITY: The normal position for the sound sensitivity condenser is when the variable plate is half-way interleaved with the fixed plates. To adjust this condenser, turn the shaft very slowly until the maximum audio signals are obtained. If the adjustment of this condenser affects the picture, set the condenser for best picture details. Then readjust sound I.F. trimmers B and C, and finally readjust the sound sensitivity condenser.

ADJUSTING R.F. ALIGNMENT: Since the R.F. units of all television receiver and KT-E-5 kit are aligned with great precision at the factory, and because the designs of such parts have been found exceedingly stable under all operating conditions, it is most unlikely that realignment will be necessary. However, in case the adjustments are changed for any reason, realignment should be carried out in the following manner:

NOTE: These instructions apply to Andrea 5" sets and kits having only television channels 1 and 2. If your set is equipped for receiving other channels, follow the special data supplied by the maker's factory. Keep the bottom plate on the chassis during the R.F. alignment.

1. Because of the design of the R.F. unit, Band 2 must be aligned first, and Band 1 afterward. Incorrect settings will be obtained if Band 1 is aligned first.
2. Make sure that the sound I.F. trimmers have been adjusted to 8.25 mc. Otherwise, the R.F. alignment will not be accurate.
3. Connect a signal generator to the antenna terminals A,A of the receiver. Set the generator accurately at 55.75 mc. (55,750 kc.).
4. Put the band switch on channel 2.
5. Connect a rectifier type meter across the voice coil of the loudspeaker.
6. Loosen the locknut on Oscillator Condenser 2, so that the plunger moves freely. It is a great help to have a tool with a side pin to hook into the hole in the plunger.

7. Adjust the plunger for maximum output. Tighten the locknut part way.
8. When the locknut is nearly tight, re-adjust the plunger for maximum output. Then tighten the locknut firmly.
9. Connect the rectifier type meter from 10 on the picture tube socket to the ground, through a .5 mfd. 600 V. paper condenser.
10. Adjust the signal generator to 52.5 mc. (52,500 kc.).
11. Turn the chassis on its side, and slip a Spintite wrench through the hole in the bottom of the chassis, and put it over the tubular bottom end of Grid Condenser 2. This just adds capacity to detune it slightly.
12. Loosen the locknut on Antenna Condenser 2, and adjust the plunger for maximum picture output, as indicated by the meter. Then tighten the locknut part way, readjust the plunger, and tighten the locknut firmly.
13. Remove the Spintite from Grid Condenser 2, and put it on Antenna Condenser 2.
14. Loosen the locknut on Grid Condenser 2, and adjust the plunger for maximum picture output, as indicated by the meter. Then tighten the locknut part way, readjust the plunger and tighten the locknut firmly.
15. To align Band 1, carry out the preceding steps to 14 using 49.75 mc. for the signal generator (step 3), put the band switch on channel 1 (step 4), and adjust Oscillator Condenser 1 (step 6).
16. Use 46.5 mc. for the signal generator (step 10) and use Grid Condenser 1 and Antenna Condenser 1 in the subsequent steps.

This completes the R.F. and Oscillator realignment of Bands 1 and 2.

The 12.75 mc. video I.F. system is self tuned and no adjustments are necessary.

PERMANENCE OF ADJUSTMENTS: Once these settings have been made, they will hold their adjustment for an indefinite period. The reason lies largely in the high quality of the parts used for television receivers. You see, no compromise in performance is permissible because the functioning of the circuits is made visible in the picture tube.

Because successive models of sound receivers have been produced at cheaper and cheaper prices, many people expect that television sets, too, will soon cost much less than current types. What is not generally recognized is that reductions in the cost of sound sets have been achieved largely by lowering the standards of audio quality.

The average present-day varieties of cheap sound receivers may be acceptable to non-critical ears. In fact, the ear is a most inaccurate organ, and any tendency to tone-deafness favors the loudspeaker.

On the other hand, the eye recognizes and rejects distortion and lack of sharpness in video reproduction. Furthermore, defective vision calls for still more perfect sight reception! From this it is clear that video quality must be the primary consideration of future development, with lower prices a definitely secondary issue.

RADIO INSTRUCTION

CODE SPEED RECORDS SMASHED!

By Candler Students

At the Asheville Code Tournament July 2, McElroy copied 75.1 W.P.M., retaining the championship. His nearest competitor, McDonald, W8CW, also Candler trained, copied 75 W.P.M., and Jean Hudson, W3BAK, age 14, Candler trained, won in Class B. Jean won Class E championship at age of 9 at Chicago in 1933.

Whether learning code or increasing your speed, you can have the training these champions had.

FREE New BOOK OF FACTS. — In it the champions tell how they learned code and acquired speed. They give you many tips that will help you. A postal will do. No obligation.

CANDLER SYSTEM CO.

Dept. S-10, Asheville, N.C., U.S.A.



See Pages 370 and 374 for Special Subscription Offers!

YOU CAN BECOME A MONEY-MAKING RADIO EXPERT

WITH THE **NEW SPRAYBERRY** Personalized HOME TRAINING in RADIO and TELEVISION

You Learn Easily in Your Spare Hours By Doing Many Experiments with Up-To-Date Equipment

Here's a really fine, up-to-the-minute Radio and Television Training that's specially designed to give you quick results.

TRAINING PREPARES YOU FOR GOOD RADIO JOBS . . . AT EXCELLENT PAY. My training starts right at the beginning of Radio . . . unfolds each subject in a simplified, logical, understandable style. You easily learn Television, Electronics, Facsimile Radio, Radio Set Repair and Installation Work, etc.

NO PREVIOUS EXPERIENCE NEEDED It makes no difference what your education has been. I can fit you for a good-paying Radio job. Your success is my full responsibility.

YOU GET PROFESSIONAL TEST EQUIPMENT PLUS EXPERIMENTAL OUTFITS

Includes 136 Radio Parts (to build complete Receiver), Tools, All-Wave, All-Purpose Analyzer, and Experimental Outfits for conducting actual experiments with your own hands.

I Supply

EARN WHILE YOU LEARN My BUSINESS BUILDERS show you how to put your Equipment to practical use in handling actual money-making Radio Service Jobs shortly after you begin training.

SERVICEMEN

I offer Advanced Training for those already in Radio. Get complete details in my FREE 52-page Book. **The Sprayberry Course is Sold Under a Money-back Agreement**

HUSH COUPON FOR BIG FREE BOOK

SPRAYBERRY ACADEMY OF RADIO
F. L. Sprayberry, Pres.
245-K University Place, N.W.
Washington, D. C.

Please send me FREE copy of "HOW TO MAKE MONEY IN RADIO."

Name Age

Address

City State

Tear off this coupon, mail in envelope or paste on penny postcard.

Servicemen—Check here



NEW!

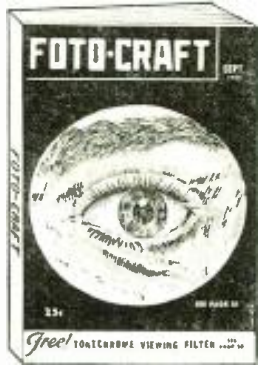

A NEW GERNSBACK PUBLICATION

The Constructive Photo Magazine

ON ALL NEWSSTANDS

FOR serious-minded amateur photographers, here's a photo magazine, FOTO-CRAFT, vastly different from any you've read. It tells you how and why to do things—it's a constructive publication which shows what can be done with the equipment you have, and how to make handy, photographic accessories. FOTO-CRAFT, with its broad editorial features, covers such important branches of photography as—New Scientific Researches; Developing; Printing; Enlarging; Dodging; Cropping; Photo-micrography; Color Photography; Amateur Movies; How to Make It Items.

A Few of the Articles in the Current Issue
 What Makes a Good Photograph—Making Photos without a Camera—One-Eye Stereoscope—A Color Transparencio-Scoper—Pistol or Gun Grip for Your Camera—Edge and Border Designs—Making a Scene Selector—Permanent Retouching Desk—Building a Focus Magnifier—Motor Driven Film Tank—Stamp Photos—Color in Photography—Film and Print Dryer—Ventilated, Dustless Garage Dark-room—Making a Dial-Type Film Tank Thermometer—Combination Spot and Floodlight—Home-Made Pan and Tilt Tripod Head—Home-Made Emergency Changing Bag—Creator of Missions—Photo Quiz—Use Your Enlarger for Copying—Most Bizarre Photo Contest—Hints and Kinks—Questions and Answers—What's New.

Fotocraft—Two magazines in one—Now Combined with Photo Review.

And another Free Gift—Tonochrome Viewing Filter.

BIG OPPORTUNITY! Get a FOTO-CRAFT Press Card today—with it you can get permission to take photos which might be difficult to obtain. PRESS CARDS are sent FREE to subscribers of FOTO-CRAFT. Enter your subscription for Seven Months for \$1.00—and get your PRESS CARD immediately.

FOTO-CRAFT

99-T HUDSON STREET NEW YORK, N. Y.

PYRO PANTAGRAPH



Size of Box: 12 1/2 x 8 1/2 inches

\$2.75

VOGUE Shipping weight, 3 lbs.

THIS electrical outfit is especially designed for burning designs permanently on materials such as Leather, Wood, Cork, Bakelite, etc. Plug the Pyro-electric pencil in any 110 volt AC or DC outlet and it is ready to be used. Plug and cord furnished.

By the use of the Pantagraph included in the outfit, any design may be reproduced either in original, reduced or enlarged form.

Outfit consists of: one Pyro-electric Pencil; one Pantagraph; three hardwood plaques; one bottle of Varnish; one Brush; one tracing tip and four-page instruction sheet.

Size of box: 12 1/2 x 8 1/2 inches.

Outfit will be forwarded by Express Collect if not sufficient postage included with your order.

WELLWORTH TRADING CO.

1915 S. State St., Dept. RT-1039 Chicago, Ill.

I Cover the Pacific Coast!

Lyle M. Nelson

(All time is P.S.T.)

● WITH the approach of winter, daytime reception of European and Asiatic stations will gradually begin to fade out and will be replaced by afternoon and evening reception from South and Central America. During the fall months reception is also best from the "Down and Under" stations.

A new Manila station has been reported by several listeners. This station is broadcasting on 9.58 mc. daily from 4 to 7 a.m. According to announcement, the call letters are KZHS, although C. F. Burns of Vancouver, Washington, reports hearing the call KZAS. The address is given as: P.O. Box 119, Manila.

Early rises are again reporting excellent reception from VPD (9.54 mc.) in Suva, Fiji Islands. This station was missing from the airplanes for a short time but is again broadcasting from 2:30 to 4 a.m. Reports of reception are requested.

Recent word from Chinese authorities received by Kendall Walker, of Yamhill, Oregon, brings the information that NGOY is now operating on 11.90 mc. from 2:30 to 8 a.m., from 8:10 to 8:30 a.m. and from 1:30 to 3:20 p.m. Station NCOX on 17.8 mc. is broadcasting a special program for North America from 6 to 7:30 p.m. but is not regularly received here at that hour. Best reception on the Pacific coast is from NCOY from 5 to 7 a.m.

Mr. Walker also reports a new station on 11.74 mc., announcing as "Radio Hucke." The station can be heard until as late as 8:30 p.m., when they sign off with an English announcement. The location is given as Santiago, Chile. Occasionally interference from London's GSD, on the air on 11.75 mc. at the same time, blots out reception.

Another Asiatic station to be reported with good strength the last month has been "Radio Saigon" of Saigon, Indo-China. This station now operates on 11.78 megs. from 5:30 to 6:45 a.m. and from 9:15 to 9:45 p.m. A new station on 9.49 mc. is heard broadcasting simultaneously with the 11.78 megacycle station. John Cavanaugh of Oregon City reports this station on the air as early as 5 a.m., with an English program.

All Colombian stations have changed call letters by dropping the number and next to last letter. The only Colombian station heard here at present is HJLABP, now HJAP, on 9.61 mc. Recent schedules from Colombia list this station on 4.93, but Mr. Cavanaugh and Mr. Walker both report the station on 9.61 mc.

JZK (15.16 mc.) in addition to the regular broadcast for the Pacific Coast from 9 to 10:30 p.m. daily, is now carrying a program for China from 5 to 6:30 a.m. The station is well received here at that time. Several listeners also report JZK from 4 to 4:30 p.m. with a program for the East Coast.

Tahiti's popular FO8AA continues to be heard here with good volume every Tuesday and Friday night from 8 to 9:30 p.m. The station broadcasts on a frequency of 7.10 mc. and interference from nearby code stations sometimes ruins reception.

Jack McCliment of Portland reports hearing a new Motala (Sweden) station announcing as SBT on 15.01 mc. The station is on the air near 10 a.m. according to Mr. McCliment. Has anyone else heard this station?

Recent word says that powerful new "Radio Schwarzenburg" was destroyed by fire in July, which accounts for its absence from the airplanes. We are sorry to hear of this misfortune to "Radio Schwarzenburg" and wish them the best of luck in the construction of a new transmitter to replace the burned one.

After a short absence from the airplanes, HS8PJ of Bangkok, Siam, is back on 9.51 mc. broadcasting daily except Monday from 5 to 7 a.m. Reception is excellent. A new station on 6.11 mc. is occasionally heard broadcasting simultaneously with HS8PJ.

ROUND 'N' ABOUT—From listener's reports.

New station announcing as 2RO16 of Rome is heard on 21.51 mc. daily from 6 to 6:35 a.m. . . . VUD3, 5.14 mc., of Delhi is occasionally heard here from 4:30 to 7 a.m. . . . Code interference blots out Saturday North American program from Sweden over SRP on 11.73 mc. . . . The Chinese government station XMHA is excellent from 4 to 8 a.m. on 11.78 mc. Also heard from 8 to 11 p.m. . . . New 100 kw. transmitters under construction in France will soon be on the air. . . . Finland also plans 100 kw. station to broadcast Olympic games . . . Station KQH (14.92 mc.) Honolulu, heard with excellent volume on Sunday nights from 6 to 6:30 p.m. . . . New powerful station CB946 under construction in Santiago, Chile. Will operate with 5000 watts power on 9.46 mc. . . . Special English broadcast from HCJB on 12.46 mc. heard here on Tuesdays at 8 p.m. . . . HCZET of Quayaquil, Ecuador, now on 9.19 mc. from 6 to 8 p.m. . . . PIA (9.42) heard phoning San Francisco near 6:45 a.m. daily . . . World Peace Foundation of Oakland, Calif., has applied to the FCC for permission to operate a 5,000 watt short wave station . . . W2NAF now has new 100 kw. transmitters on the air testing in the evenings . . . New station reported on 12.20 mc. near 6 p.m. announcing call as "Rancho Grande" of Trujillo, Peru . . . Address of MTCY is Hsingking, Manchukuo.

FREE- REAL ELECTROPLATING OUTFIT



Now
You Can ELECTROPLATE
Easily with a BRUSH!

SOMETHING new for amateurs, fans, set builders—something which gives you the opportunity with which to experiment. Here's an ELECTROPLATING KIT amazingly simple to operate—you just Electroplate with a Brush! Requires only one single dry cell.

NOT A TOY

You can electroplate for profit, hundreds of things in the household—ashtrays, fixtures, water faucets, worn brackets, door knobs, musical instruments, jewelry and silverware and other articles. It's an indispensable piece of equipment to you for plating articles in hotels, apartments, office buildings, medical and dental offices, factories, schools, laboratories, etc. Exactly the same outfit (but larger) is used professionally by electricians, radio service men, automobile repair shops, etc. And for radio work, you can electroplate tarnished receiver parts, chassis, contacts, worn radio parts and accessories.

Put this REAL ELECTROPLATING KIT to use immediately—make it the most useful article in your lab or work bench. And, you can get it absolutely FREE (except for slight mailing cost).

Send your subscription today to RADIO AND TELEVISION for One Year (12 issues) and receive absolutely FREE one of these REAL ELECTROPLATING KITS—New subscribers are accepted or you may extend your present subscription another twelve months under this offer. Mail your remittance of \$2.50 (Plus 10c for shipping charges on kit) to the publishers of RADIO AND TELEVISION, (Canada and foreign \$2.85.) You will promptly receive your FREE REAL ELECTROPLATING OUTFIT by return mail. Use the coupon below to order your subscription.

RADIO AND TELEVISION

99 Hudson Street New York, N. Y.

RADIO AND TELEVISION

99 HUDSON STREET, NEW YORK, N. Y.

Gentlemen: Enclosed you will find my remittance of \$2.50 for which enter my subscription to RADIO AND TELEVISION for One Year (12 Issues). Send me promptly my FREE REAL ELECTROPLATING OUTFIT. (Canada and foreign \$2.85.) In U.S. add 10c additional to cover shipping charges on kit.

() NEW SUBSCRIBER

() EXTEND PRESENT SUBSCRIPTION

Name

Address

City State

(Send remittance by check, money order or unused U. S. Postage stamps. Register letter if you send cash or stamps.)

RT-10-39

QSL Contest

(Continued from page 356)

the messages which the judges consider cleverest.

5—In case of ties, duplicate prizes will be awarded.

6—All entries submitted become the property of RADIO & TELEVISION.

7—Your entry in this contest is evidence of your willingness to abide by all rules.

8—It is not necessary that you be a subscriber to or a purchaser of RADIO & TELEVISION. This contest is open to everybody.

9—This contest closes October 10, 1939, at which time all entries must be in the editor's hands. Winners will be announced in the December issue.

10—Address all entries to QSL Contest, RADIO & TELEVISION, 99 Hudson Street, New York, N. Y.

October, 1939

RADIO-CRAFT

How to Design a Flexible All-Push-Pull Direct-Coupled 30-Watt Amplifier

A. C. Shaney

New Circuits in Modern Radio Receivers—No. 25

F. L. Sprayberry

Service Data on Pilot Lights

Video Amplifier Design Behind the Scenes of a Trans-Atlantic Radio Hookup

Eugene Goddess

A.C.-D.C. Power Supply for Battery Portables

N. H. Lessem

8 New Tubes

R. D. Washburne

Home-Made Frequency Modulator

George F. Baptiste

Emergency Servicing Without Test Meters

Charles R. Leutz

Facsimile Recorder Assembled in 4 Hours

(Continued from page 331)

The WOR signal was tuned in at 2 A.M. and the rather sleepy constructor adjusted the electro-magnetic clutch system—an arm which catches a point on a friction clutch—until it released perfectly with the synchronizing pulse which was transmitted over the air. This required but about five minutes. Then, to his great delight, pictures and type material began to take form on the sheet which was being fed through the Reado facsimile recorder. A copy of some of the matter transmitted is reprinted with this article.

There are various time switches on the market which enable a radio receiver to be turned on and off at pre-determined hours. Some of these are quite old in design and can be had for a dollar or so at various bargain radio houses. If a ten-cent store 3-way outlet is plugged into the controlled circuit of the time switch, the radio receiver and the facsimile recorder which it operates may be controlled by a single time switch.

The writer's home installation includes a time switch clock which the writer rebuilt from an old bakelite-encased model. The clock is set to turn the Reado on at 2 A.M. and off at 4 A.M. Thus when the writer arises in the morning, he finds a completely printed miniature paper awaiting him with his breakfast of crumpets and marmalade.

Television Has Its Own Slang

● TELEVISION'S own glossary of slang designates a blonde as a "blizzard head," a brunette as a "dark angel" and a red-haired actress as a "problem child."

When all three are booked on the same program it means a lot of headaches for the studio lighting crew, according to Thomas S. Lee, president of the Mutual Don Lee Broadcasting System and owner of W6XAO, only television station in the West.

Lee pointed out that a brunette's hair absorbs light whereas a blonde head reflects light. Because auburn hair is in-between, tests must be made to determine the degree of lighting required. Hence the owner of red tresses is called a "problem child."

Other terms:

FLOOD THAT SPOT . . . is an order to adjust a spotlight unit to give a larger and therefore a less intense spot.

WASHED OUT . . . is a term applied to a person's face when too much light causes the features to become indistinct. (Too much light overloads the camera tube, shows clothing and hair floating about by themselves because wearer's face and hands are WASHED OUT.)

HARD LIGHT . . . refers to strong beamed illumination from reflector and lens lighting units.

SOFT LIGHT . . . is any light which has been diffused or dispersed by cloth net screens or filters.

BROAD . . . a large studio light used in illuminating a television set.

GOBO . . . is a fin used to deflect light in the studio and also to shield the iconoscope lens from glare.

PAN . . . to swing television camera horizontally across scene.

New Plaque Award

(Continued from page 330)

Note These Important Rules

The photos must be sharp and clear and preferably not less than 5" x 7".

The pictures will be judged for the general layout of the station, the quality of workmanship exhibited, and the appearance of the photograph itself. The judges will also consider neatness as an important point.

When you submit the photograph of your Ham station, send along a brief description not longer than 300 words, describing the general line-up of the apparatus employed, the size, type and number of tubes, the type of circuit used, name of commercial transmitter—if not home-made, watts rating of the station, whether for c.w. or phone or both, etc., also name of receiver.

State briefly the number of continents worked, the total number of stations logged or contacted, and any other features regarding the station which you think will be of general interest to the reader. Mention the type of aerial system used, especially any unique or new features about it, and which type of aerial you use for transmitting and receiving; also what type of break-in relay system, if any, is used.

Important—Don't forget to send along a good photograph of yourself, if your likeness does not already appear in the picture!

Note that you do not have to be a reader of RADIO & TELEVISION in order to enter the contest. Pack all photographs carefully and the description had best be mailed in the same package with the photos. The Editors will not be responsible for photos lost in transit.

Do not send small, foggy-looking photos because they cannot be reproduced properly in the magazine. If the picture you have or may take of your station is not thoroughly sharp and clear and at least 5" x 7", it would be best to have a commercial photographer take a picture of your station. If you cannot do this, you most probably have a friend who owns a good camera and who can arrange to take the photograph. You are not limited to one picture, but may submit as many different views as you like.

Address all photos and station descriptions to Editor, Ham Station Photo Contest, c/o RADIO & TELEVISION, 99 Hudson Street, New York, N. Y.

International Radio Review

(Continued from page 333)

Fig. 8C shows another type of inversion, in which the 6F7 tube serves both as driver and phase inverter, the triode section performing the latter function.

One of the push-pull tubes acts as its own phase inverter in Fig. 8D, where a signal is secured from the screen circuit of one of the push-pull tubes and is transferred to the grid of the other tube.

SPRAGUE ATOMS

"Mightiest Midgets of All"

YOU SAVE 2 WAYS!

Sprague ATOMS (Midget Etched Foil Dry Electrolytic Condensers), save you a whale of a lot of money—and they save space, too! You'll find them far better than most of the big old-style electrolytics for which they are used as universal replacements. Not a "blow-out" in a carload. Unquestionably the highest quality midgets,—the smallest midgets—and the only midgets made in a full line of dual capacity combinations with common negative leads. Write for catalog. See your jobber today!

HOW'S THIS FOR VALUE?

This dual 8-8 mfd. 450 V. ATOM is only 1" x 2 1/2" and lists at only \$1.00. A single 8 mfd. ATOM lists at 60c.



SPRAGUE
450 VOLTS

SPRAGUE
PRODUCTS CO.
North Adams, Mass.

High Value! Low Prices!

ALL GUARANTEED

FOR SIX MONTHS
SEALED CARTONS

1H5GT	.. \$.50	42 \$.30
1A7GT	.. .50	5520
1Q5GT	.. .50	6A8GT	.. .35
1N5GT	.. .50	6Q7GT	.. .35
95035	6K7GT	.. .35
3035	25Z6GT35
4130	3240
		25L6G	.. \$.45

We have a complete line of Tubes.
Write for Prices.

NEW YORK
RADIO SUPPLY CO.
152 W. 42 ST., Dept. RT, N. Y. C.



"JIFFY" Magazine Binders

Sturdily built and covered with black fabric. Has two stamped metal ends with 12 spring wire separators. Magazines can be inserted and removed in a jiffy. No fuss—no lost time—no labor.

No. 1, 12 1/2" x 9 1/2", with 2-inch back for R. & T. Radio-Craft, Radio News, etc.	— \$1.00
No. 2, 10 1/2" x 7 1/2", with 3-inch back for QST, Radio, Popular Mechanics, etc.	— \$1.00
No. 3, 8 1/2" x 6 1/2", with 3-inch back for Reader's Digest, etc.	— \$1.00

P.P. Prepaid in U.S. and Canada. Send for catalog containing full descriptions of many other interesting items.

GOLD SHIELD PRODUCTS
Dept. RT-10-9 350 Greenwich St. New York

THOUGHTS HAVE WINGS

YOU CAN influence others with your thinking! Learn to impress others favorably—get across your ideas. Let the Rosicrucians show you how to use the power of mind. For free book write Scribe X.Z.O. The ROSICRUCIANS (AMORC) San Jose, California



2 NEW 10c BOOKS

Now Added to Gernsback Series!

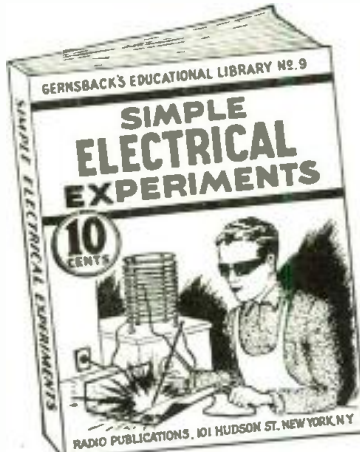

NO. 9—SIMPLE ELECTRICAL EXPERIMENTS

Over 100 interesting and practical electrical experiments are described in this book, covering every branch of electricity—from simple experiments with magnets to high frequency "stunts". Among the experiments, all of which are clearly illustrated with special drawings, we find: Experiments with Magnets, Static Electricity, Transformers, Induction, Motors, High Frequency Machines, Switches and Lamps, Polarity Experiments, Dimmers, etc. All of the experiments described can be carried out with simple apparatus, most of which can be found about the home. Further, anyone can make them and thus this book becomes not only instructive but highly entertaining as well!

RADIO FANS EVERYWHERE
—these fine ten cent text books give you an excellent foundation for the study of radio. They are clearly written, profusely illustrated and contain over 15,000 words in each book. You'll be amazed at the wealth of information these books have. Handy for review or reference. Your money back if you are not pleased!

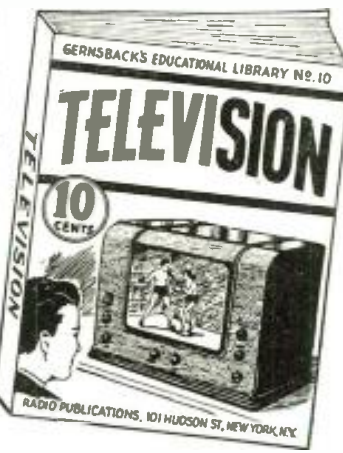

NO. 10—TELEVISION

Every one is asking the question—How does television work? This book explains all of the different systems of television from the simplest to the most complex. It describes in A-B-C style just how the image is scanned, how the scene is picked up by the television camera and broadcast to your home. Various types of television receiving systems are described in easily understood language, and the book is very completely illustrated with dozens of special drawings. The book tells how the accompanying sound for television images is picked up and transmitted and answers hundreds of other questions which the student and layman ask daily.

AND HERE ARE 8 MORE 10c BOOKS

NO. 1—HOW TO MAKE FOUR DOERLE SHORT WAVE SETS

Literally thousands of radio fans have built the famous DOERLE Short Wave Radio Receivers. So insistent has been the demand for these receivers, as well as construction details, that this book has been specially published. Thousands of copies of this book have been bought by short-wave enthusiasts. Contains EVERYTHING that has ever been printed on these famous receivers. These are the famous sets that appeared in the following issues of SHORT WAVE CRAFT: "A 2-Tube Receiver that Reaches the 12,500 Mile Mark," by Walter C. Doerle, "A 3-Tube Signal Gripper," by Walter C. Doerle, "Doerle 2-Tube Adapted to A.C. Operation," "The Doerle 3-Tube 'Signal-Gripper' Electrified," and "The Doerle Goes 'Band-Spread'".

NO. 2—HOW TO MAKE THE MOST POPULAR ALL-WAVE 1- and 2-TUBE RECEIVERS

This book contains a number of excellent sets, some of which have appeared in past issues of RADIO-CRAFT. These sets have been carefully engineered. They are not experiments. To mention only a few of the sets the following will give you an idea. "The Alexandrine 1-Tube Pentode Loudspeaker Set," by Hugo Gernsback, a "Electric Set," by J. T. Bernsley, and "How to Make a 1-Tube Loud-Speaker Set," by W. F. Chesney, a "How To Make a Simple 1-Tube All-Wave Electric Set," by F. W. Harris, a "How To Build a Four-in-Two All-Wave Electric Set," by J. T. Bernsley, and others. Not only are all of these sets described in this book, but it contains all of the illustrations, hookups, etc.—each book is up-to-date.

NO. 3—ALTERNATING CURRENT FOR BEGINNERS

This book gives the beginner a foothold in electricity and Radio. Electric circuits are explained. Ohm's Law, one of the fundamental laws of radio, is explained; the generation of alternating current; sine waves; the units—volts, amperes, and watts are explained. Condensers, transformers, A.C. instruments, motors and generators. Here are some practical experiments to perform at home. Simple tests for differentiating between alternating and direct current; how to light a lamp by induction; making a simple electric horn; demagnetizing a watch; testing motor armatures; charging storage batteries from A.C. outlet; testing condenser with A.C.; making A.C. electro magnets; frying eggs on a cake of ice; making simple A.C. motors; many others.

NO. 4—ALL ABOUT AERIALS

This book explains the theory underlying the various types of aerials: the inverted "L," the Doublet, the Double Doublet, etc. It explains noise-free reception, how low-impedance transmission lines work, why transposed lead-ins are used. It gives in detail the construction of aerials suitable for long-wave broadcast receivers, for short-wave receivers and for all wave receivers. Various types of aerials for the amateur transmitting station are explained. It eliminates, once and for all, confusion about the type of aerial to choose for best broadcast and short-wave reception. For the thousands of radio fans who wish to know just what type of antenna they should use and why, this book has been published. Experts in radio have furnished valuable information in this book.

NO. 5—BEGINNERS' RADIO DICTIONARY

Are you puzzled by radio language? Can you define Frequency? Kilocycle? "Tetrode"? Screen grid? Baffle? Anode? Triode? Pole? Ionization? Joule's Law? Harmonic? Gravity Cell? If you cannot define these very common radio words and dozens of other, more technical, terms used in all radio magazines and instruction books, you need this book in your library. It's as modern as tomorrow—right up to the minute. It tells you in simple language just what the words that puzzle you really mean. You cannot fully understand the articles you read unless you know what radio terms mean. This is the book that explains the meanings to you. Can you afford to be without it, even one day longer?

NO. 6—HOW TO HAVE FUN WITH RADIO

Stunts for parties, practical jokes, scientific experiments and other amusements which can be done with your radio set are explained in this fascinating volume. It tells how to make a newspaper talk—how to produce silent music for dances—how to make visible music—how to make a "silent radio" unit, usable by the deafened, to make toys which dance to radio music—sixteen clever and amusing stunts in all. Any of these can be done by the novice, and most of them require no more equipment than can be found in the average home. Endless hours of added entertainment will be yours if you follow the instructions given in this lavishly illustrated book. Get a copy today by using the coupon below—mail it today.

NO. 7—HOW TO READ RADIO DIAGRAMS

All of the symbols commonly used in radio diagrams are presented in this book, together with pictures of the apparatus they represent and explanations giving an easy method to memorize them. This book, by Robert Eichberg, the well-known radio writer and member of the editorial staff of RADIO-CRAFT magazine, also contains two dozen picture wiring diagrams of simple radio sets that you can build. Every diagram is completely explained in language which is easily understood by the radio beginner. More advanced radio men will be interested in learning the derivation of diagrams, and the many other interesting facts which this book contains. It is also helpful in solving many of the problems of servicemen.

NO. 8—RADIO FOR BEGINNERS

Hugo Gernsback, the internationally famous radio pioneer, author and editor, whose famous magazines, RADIO AND TELEVISION and RADIO-CRAFT are read by millions, scores another triumph with this new book. Any beginner who reads it will get a thorough and clear understanding of the many radio theories clearly explained in simple language, and through the use of many illustrations. Analogies are used to make the mysteries of radio as clear as "2-2 is 4." It also contains diagrams and instructions for building simple radio sets, suitable for the novice. If you want to know how transmitters and receivers work, how radio waves traverse space, and other interesting facts about this modern means of communication, this is the book for you!

BOOKS ARE ALL UNIFORM

Every book in the GERNSBACK EDUCATIONAL LIBRARY has 32 pages—with illustrations varying from 30 to 66 in number. Each title volume contains over 15,000 words. Positively radio's greatest book buys! If you do not think these books worth the price asked, return them in 24 hours and your money will be instantly refunded.

RADIO PUBLICATIONS • 101 HUDSON STREET • NEW YORK, N. Y.

RADIO PUBLICATIONS Dept. RT-1039
101 HUDSON STREET, NEW YORK, N. Y.
Gentlemen: Please send immediately, POSTPAID, the book numbers circled below, I am enclosing cents—each book being 10c.

1 2 3 4 5 6 7 8 9 10
NEW NEW

Send FREE listing of 48 new 10c publications.

Name Address

City State

Remit by check or money order—register letter if you send cash or unused U. S. postage stamps.

MAIL COUPON TODAY!

ECO Switch-Band Transmitter

(Continued from page 368)

coils, thereby eliminating any absorption effects by the unused coils. A 50,000 ohm potentiometer allows the screen voltage to be varied within quite wide limits, thus giving effective control over the output of this stage, and therefore the excitation to the final stage. Shielding the 807 with a short tube shield will eliminate any necessity for neutralizing this stage. About 50 volts of negative bias should be applied to the grid with about 400 to 500 volts on the plate.

A power-supply and further details of this set will be described next month.

Parts List—All-Band Switching Transmitter BROWNING LABORATORIES (Tuner)

- 1—BL-5G oscillator tuner
- 1—BL-5P plate tuner

BUD RADIO

- 12—No. 435 Cone-type, feed-through insulators

GUARDIAN ELECTRIC CO. (Relay)

- 1—K-100 keying relay

HAMMARLUND MFG. CO. (Condensers and Chokes)

- 1—100-100 mmf. transmitting condenser, type MTC-D-100-B (C9)
- 1—10 mmf. neutralizing condenser, type N 10 (NC)
- 1—Special 807 tube shield, type PTS
- 1—2.5 mh., 500 ma. R.F. choke, type CH-500 (RFC-1)
- 4—2.5 mh., 125 ma. R.F. chokes, type CH-X (RFC)
- 1—Each of 4-prong, 5-prong and 6-prong isolantite sockets, type S-4, S-5, S-6
- 7—Crystal holder mountings, type XS-2

RCA RADIOTRON (Tubes)

- 1—89 tube
- 1—807 tube

TRIPLETT ELECTRICAL INSTRUMENT CO. (Meters)

- 1—0-1 ma., 3-inch meter, type 327-A
- 1—0-150 ma., 3-inch meter, type 327-A
- 1—0-300 ma., 3-inch meter, type 327-A
- 1—Each, 10 ma. and 50 ma. ring shunts for use with 1 ma. meter (RM-2, RM-1, RM-3)

CORNELL-DUBILIER (Condensers)

- 2—.0001 mf. mica receiving condenser No. 3LL-5T1 (C-4, C-2)
- 4—.002 mf. mica receiving condenser No. 3LL-5D2 (C-1, C-3, C-7, C-8)
- 1—.002 mf. mica transmitting condenser 1200 W.V. No. 4L-12D2 (C-5)
- 1—.0001 mf. mica transmitting condenser 1200 W.V. No. 4L-12T1 (C-6)
- 1—.002 mf. mica transmitting condenser 2500 volts No. 9L-25D2 (C-10)

BARKER & WILLIAMSON (Coils)

- 1—Type "TV" Jack Base
- 1—Each 160 TVL, 80 TVL, 40 TVL, 20 TVL, 10 TVL tuning coils (L4, L5)

BIRNBACH RADIO CO. (Wire)

- No. 18 solid Radex pushback wire; red, green, black and brown

HEINTZ & KAUFMAN (Tube)

- 1—HK54 Gamma-ray tube

P. R. MALLORY & CO.

- 2—3-section, 11-point shorting-type switches, type 1231-L
- 1—2-circuit, 3-point non-shorting switch, type 3223-J (SW-2)
- 1—50,000 ohm wire-wound potentiometer, type M-50-MP (R-4)
- 1—50,000 ohm, 10 watt fixed resistor, type 1-HJ-50,000 (R-3)
- 1—25,000 ohm, 25 watt varichm resistor, type 2-AV-25,000 (R-2)

PAR-METAL PRODUCTS (Chassis and Panel)

- 1—12" x 17" x 3" cadmium-plated chassis, type C4517
- 1—10½" x 19" gray aluminum relay rack panel

GORDON SPECIALTIES (Dial fittings)

- 3—2½" hand wheels and scales, type No. 301
- 5—1½" hand wheels with pointers, No. 314
- 1—Planetary drive, No. 599 (for oscillator tuning)
- 1—Each following name plates: OSCILLATOR, BUFFER, POWER AMP. PLATE, OSCILLATOR TANK, 1ST BUFFER PLATE, EXCITATION

NEW CATALOGS

New I.R.C. Catalog

● A NEW, easy-reference type of catalog just issued by the International Resistance Company lists the complete line of their products available through the jobbing trade and includes a number of important new items and developments in standard units.



Among the new items are low range L-Pad and T-Pad attenuators from 50 ohms to 500 ohms; a new 30-step, type B-31 attenuator utilizing a bridged "T" circuit; a new 50 watt, Type PR-50, all-metal rheostat on which tests at full load indicate a temperature rise of only 138 degrees C.; and several new Type BT insulated resistor kits.

Catalogued for the first time is the complete line of I.R.C. volume controls including the "Special Standard" Type CS controls with plug-in shafts; dual controls; Type D midge controls with plug-in shafts; midge auto radio controls with friction clutch and Type W wire-wound controls. A new construction feature recently added to all of these controls is a steel coil spring used as a thrust washer on the shaft instead of the usual "C" washer. Included in the catalog is a complete resistor color-code chart and other helpful information on resistance.

Catalog

● CREI, published by Capitol Radio Engineering Institute, Washington, D. C. Contains 48 pages, size 7 3/8" x 10".

The book, which begins with a foreword by E. H. Rietzke, president of the Institute, is divided into three major sections. The first gives general information about the Institute including its history and background, its faculty, its facilities, the opportunities for trained men, a list of organizations employing Institute graduates, etc.

The second section deals with the residence courses, including a one-year day course, a two-year evening course, a Summer television course, inspection trips, dormitories, living accommodations, tuition expenses, text books and equipment.

The third section covers the home study courses and describes the introductory and advanced courses, special courses in audio and acoustical engineering, broadcast transmission engineering, advanced mathematics, aircraft and navigational radio, television engineering, and various other features.

The book is profusely illustrated with photographs.

Lafayette 1940 Master Catalog

● THE new 188-page "Master" Catalog for 1940, published by Radio Wire Television, Inc. (formerly Wholesale Radio Service Co., Inc.), is now ready for distribution. It includes 40 pages of home, portable and auto radios and accessories; 35 pages of public address equipment; 50 pages of equipment, parts and tools for the serviceman; and 30-odd pages for the "Ham" and television experimenter, as some of its major sections.

(Continued on page 381)



So Small but...

● These dual-section units, added to the already extensive DANDEE line of midge metal-can electrolytics, provide the widest choice of capacities and voltages for cramped assemblies.

● Single-section units in 25, 50, 150, 250, 350 and 450 v., D.C.W., from 4 to as high as 100 mfd. ● Dual-section units in 8-8, 8-16, 450 v.; 8-8, 8-16, 16-16, 200 v.; 8-8, 8-16, 20-20, 150 v.; 16-10, 50 v.; and 10-10, 25 v.

New CATALOG...

Latest issue, just off press, includes these dual Dandees and many other new types of condensers for your up-to-the-minute needs. Ask your local jobber for copy—or write direct.



Westinghouse Power Generator

Manufactured for U. S. Signal Corps
200 Watt. 110 V. AC



A. C. ELECTRICAL POWER

from a Windmill, from available Waterpower, from your Automobile, from your Motorcycle, from your Bicycle. Foot-pedals or Handcrank (for transportable Radio Transmitters, Strong Floodlights, Advertising Signs); do you want to operate AC Radio sets from 32 V. DC farm light systems; operate two generators in series to get 200 V. AC; obtain two phase and three phase AC, etc., etc.

There Are Over 25 Applications
Some of which are:

A.C. Dynamo lighting from eight to ten 20 Watt 110 Volt lamps. Short Wave Transmitter supplying 110 Volts AC for operating "Ham" transmitter. Operating 110 V. AC 60 Cycle Radio Receiver in DC districts. Motor Generator. Public Address Systems. Electric Sirens on motor boats, yachts, etc. Camp lighting. Short Wave artificial "fever" apparatus. Television. Pelton Waterwheel for lighting or other purposes. Airplane: for lighting strong searchlights or electric signs. Laboratory work, etc., etc. 1/2 to 1/2 H.P. needed to run generator.

BLUE-PRINT 22 x 28 in. and Four-Page
8 1/2 x 12 in. INSTRUCTION SHEETS
FREE with Generator.

Generator, as described, including Blue-print and instructions **\$7.90**
Send \$2.00 deposit, balance C.O.D.
Shipping weight 18 lbs.

MONEY-BACK GUARANTEE

WELLWORTH TRADING COMPANY

1915 S. State Street, Dept. RT-1039, Chicago, Ill.

Get Your VAC Certificate?

Rules for VAC Certificates

● RADIO & TELEVISION Magazine has prepared a hand-some VAC (Verified All Continents) certificate which will be issued to all short-wave listeners submitting adequate proof of verification from all continents. To secure a VAC certificate the listener must send in a verification card from each of the continents. The VAC certificate will only be issued for verifications of radio-telephone stations, not C.W. stations. The certificates will be signed by the DX Editor, and Hugo Gernsback, Editor-in-Chief of RADIO & TELEVISION.

It is advisable that the cards be sent in a neat

package and insured for safe delivery. All cards submitted will be returned. The listener should enclose return postage.

A nominal charge of twenty-five cents (25c) will be made for the certificate to cover the cost of handling and printing.

The DX Editor will be the judge as to whether the verifications submitted are bona fide.

A special notation will be made on the certificate in the event that a listener has more than one complete set of verifications from all continents.

All entries should be made to the VAC Editor, RADIO & TELEVISION, 99 Hudson Street, New York, N. Y.

VAC
VERIFIED ALL CONTINENTS
RADIO & TELEVISION
MAGAZINE
This is to certify that
Frank Bordon
is admitted to Membership in the VAC CLUB
having submitted adequate proof of his reception
of Radio Phone Signals from each of the six Continents.
Hugo Gernsback
Joe Miller

Volt-Ohmmeter Economical to Build

John T. Wilcox, W2CLS

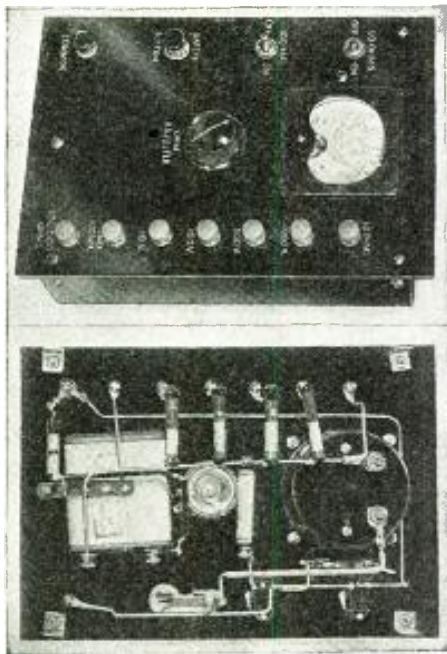

Above, front and back views of the volt-ohmmeter. Column at extreme right shows, in Figs. 1-6, the circuits utilized.

IF there is any one piece of equipment that is most generally useful to the radio experimenter it is a combination meter which provides voltage, current and resistance measurements in wide variety. Such an instrument, which combines accuracy with wide utility and low cost is described in this article for the benefit of the home constructor who wants to take advantage of the saving that can be obtained by assembling his own equipment from standard parts.

In deciding on the features to be incorporated in such a meter it is usually necessary to balance the desired features against cost. Some features, such as the measurement of alternating current voltages, for instance, are nice to have but when the extra cost of a rectifier type meter and the other complications involved in an A.C. instrument are balanced against the relatively few times that A.C. measurements are really necessary, such a refinement falls pretty definitely in the "luxury" class.

In designing the instrument described here, the effort has been to include provision for the most generally used measurement scales with maximum operating convenience and speed, the fewest possible complications in construction and use, and to avoid refinements which would disproportionately increase the cost.

The result is a meter unit which, at a moderate cost, provides D.C. voltage ranges (1000 ohms per volt) of 0-10, 0-100, 0-500

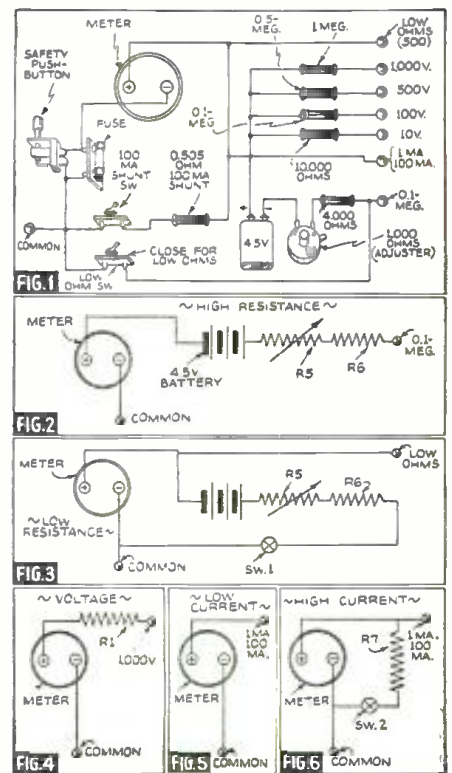

TELEVISION'S Stride Today Makes It Essential for You to Read—"ABC of TELEVISION"—

WITH important progress being made in Television every day—and with developments satisfactory to Television engineers that consistent programs will be broadcast shortly, it is important that principles be understood quite thoroughly.

The publishers of RADIO AND TELEVISION give you the opportunity to add "ABC of TELEVISION" or two other books to your technical library. They make the offer even more attractive by giving these books to you absolutely FREE. A subscription to RADIO AND TELEVISION for seven months at the cost of One Dollar gives you a choice of either of the three books shown in this advertisement. For Two Dollars you receive RADIO AND TELEVISION for fourteen months and you receive any two books of your choice absolutely FREE. To get all three books FREE, enter your subscription for twenty-one months for only Three Dollars. ANOTHER SAVING FOR YOU—THE PUBLISHERS PAY POSTAGE ON THE BOOK OR BOOKS YOU CHOOSE.

Partial Contents of ABC of Television

CHAPTER 1—The simplest television receiver; how the eye sees; its likeness to television equipment.
 CHAPTER 2—Theory of scanning; the Nipkow disc and its relation to television; the photo-electric cell; neon lamps; brief description of several modern mechanical systems.
 CHAPTER 3—Need for a large number of picture elements; need for broad channel width in transmission of high-fidelity television signals.
 CHAPTER 4—The use of the cathode ray tube in television receivers; necessary associated equipment used in cathode-ray systems.
 CHAPTER 5—How a television station looks and how the various parts are operated.

CHAPTER 6—The Iconoscope as used for television transmission in the RCA system.
 CHAPTER 7—The Farnsworth system of television transmission.
 CHAPTER 8—The future of television; probable cost of receivers; some expressions of opinion by prominent men; list of present television transmitters.

64 PAGES—100 ILLUSTRATIONS
 Stiff, Flexible Covers, 5½x8¾ INCHES

Get One or All of These Books

FREE!!

RADIO AND TELEVISION, 99 Hudson Street, New York, N. Y. R&T-10-39
 Gentlemen: Enclosed you will find my remittance of \$..... for which enter my subscription to RADIO AND TELEVISION as checked below; also send me, postpaid, the book or books which I have marked below

- ABC of TELEVISION
 S.W. RADIO QUIZ BOOK AND KINKS
 SHORT WAVE GUIDE
- 7 months—\$1.00—choice of any one of three (3) books. (Canadian and foreign—\$1.30)
 14 months—\$2.00—choice of any two (2) of the three (3) books. (Canadian and foreign—\$2.60)
 21 months—\$3.00—all three books. (Canadian and foreign—\$3.90)
 If you are a subscriber now, we will extend your present subscription.
 Now subscriber Old subscriber

Name..... Address.....
 City..... State.....

Send your remittance by check or money order. If you send cash or unused U.S. postage stamps, please be sure to register your letter for your own protection.



SHORT WAVE GUIDE
 Covers hundreds of short-wave questions and answers; illustrates popular short-wave kinks; gives explicit instructions for building simple short-wave receivers; instruction on the best type of antenna installation; diagram and construction details for building transmitters.

S. W. RADIO QUIZ BOOK

This book covers questions and answers on transmitters, short-wave receivers, ultra short-wave receivers; practical diagrams and coil winding data; novel hook-ups for experimenters; how to "hook-up" converters, noise silencers, power supplies, modulators, beat oscillators, antennas, pre-selectors and 5-meter receivers.



and 0-1000; current ranges of 0-1 and 0-100 milliamperes; and resistance ranges of 0-500 and 0-100,000 ohms. The meter scale is direct reading for five of these ranges, and for the others it is only necessary to multiply or divide the lowest scale range by 10.

The desired range is selected by connecting the positive test lead to the appropriate binding post along the right-hand edge of the panel, the other test lead (negative) being permanently connected to the "common" binding post at the lower left for all measurements. The only variation from this is found in making current measurements, for which purpose one binding post serves for both ranges and the selection is made by the "100 MA." toggle switch. With this switch in the "OFF" position the 0-1 ma. range is available. For higher current measurements, the switch is thrown to the "ON" position and this puts the 0-100 ma. range in service.

In the case of resistance measurements there are separate terminals which provide the test lead connections for the two ranges. In addition to this, however, it is also necessary to provide the toggle switch shown in the upper left-hand corner of the panel. The reason for this is that different circuits are employed for these two measurement ranges. These can be traced in the complete diagram of Fig. 1 but for simplicity are shown in Figs. 2 and 3, stripped of all but the essentials of these particular circuits. It will be noted in Fig. 2 that a high resistance under measurement is in effect connected in series with the meter, battery and limiting resistors R5 and R6. In use, the test leads are first temporarily shorted and R5 varied until the meter reads full scale. Then, when the unknown resistor is connected to the proper terminals, its value may be read directly from the high-resistance scale on the meter.

In Fig. 3, the previous series circuit is closed by setting the "LO OHMS" switch in the "ON" position, allowing current to flow through the meter, R5 and R6. R5 is then adjusted to again show full-scale reading on the meter. When the low resistance to be measured is connected to the terminals it acts as a direct meter shunt. If it happens to be a 50-ohm resistor, the original full-scale current of 1 ma. will divide equally between the meter (which has a resistance of 50 ohms) and the resistor under measurement, with the result that the meter reading will be reduced to exactly half scale. Other low resistance values (up to 500 ohms) will vary the meter reading proportionately and their values are read directly on the low-resistance scale on the meter face.

The actual portions of the circuit utilized for voltage and current measurements are shown in Figs. 4, 5 and 6. These are self-explanatory, except that it might be pointed out that in Fig. 6 the value of R7 is 1/99th part of the resistance value of the meter itself. Any current applied for measurement will there divide, with only 1/100th of it flowing through the meter and 99/100ths through the shunt. Thus the normal meter current range is, in effect, multiplied by 100.

The meter fuse is an important safety factor to safeguard the meter should excessive current or voltage be applied. The meter will momentarily withstand currents up to 30 times its full-scale rating, and will withstand 1000 per cent overload (10 ma. in this instance) for a longer period. The fuse selected is therefore one rated at 1/100th ampere, and will pop instantly if 10 ma. or more is applied to the circuit. Thus a fuse of this value provides adequate protection for the meter.

A push-button switch is shunted across

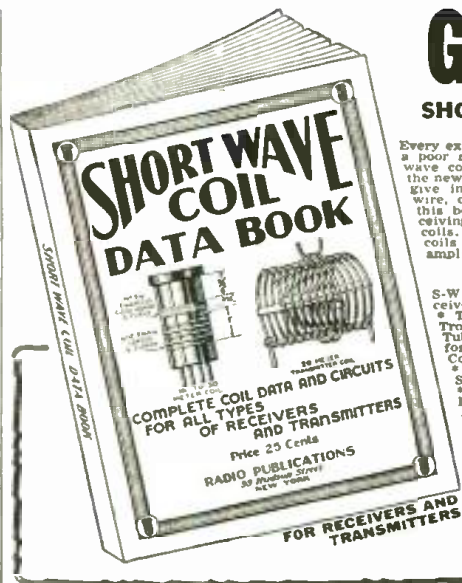

GET THIS!

SHORT WAVE COIL DATA BOOK

Every experimenter knows that the difference between a good and a poor radio set is usually found in the construction of short-wave coils. Coil winding information is vitally important and in the new coil book all "dope" appears. There're illustrations which give instructions on how to wind coils, dimensions, sizes of wire, curves and how to plot them. Every experimenter needs this book—it also contains complete data on all types of receiving coils, together with many suitable circuits using these coils. Also complete data on various types of transmitting coils with many transmitting circuits such as exciters and amplifiers using the various coils described.

Contents Briefly Outlined

S-W Tuning Inductance Charts • Coil Data for T. R. F. Receivers • One Tube Oscillodyne • Two Tube Bandspreader • The Mono-Coil • 2-Tube Old Reliable • 2-Tube Globe Trotter • 2 Winding Coils—10-500 Meters • Doerle 3-Tube "Signal Gripper" • Electrified • 3-Tube Bandspreader for the Ham • General Coverage Coils on Ribbed Forms • Coil Data for Superhet or S-W Converter • Ultra S-W Coils • Switch Coils for S-W Superhets • Experimental Coils • S-W Antenna Tuner • Most Popular S-W Tuning Coils • Self-Supporting Transmitting Circuits Employing Coils Described • All Band Antenna Tuner for Transmitting • Plug-in Coils for Exciters • Frequency-Wavelength Conversion Chart.

PRICE 25c PREPAID

For a copy of this handy book, send 25c in U.S. Coin or stamps to

RADIO PUBLICATIONS

97 HUDSON STREET NEW YORK, N. Y.

the fuse because the fuse has an appreciable amount of resistance and would therefore introduce errors in making low resistance and high current measurements. By pushing this button the fuse is shorted out, allowing accurate measurements. At all other times, however, it is in the circuit, doing its job of protecting the meter.

Checked against standard precision meters at several points in each range, the accuracy of the model proved to be excellent. The greatest deviation encountered at any point in any range was 5% of full scale. Averaging the maximum errors for all ranges the result was 2.3%.

All parts are assembled on a 7" x 10" bakelite panel and their placement will be made clear by examination of the photos. No. 12 tinned bus wire is used for all wiring and the shunt and multiplier resistors are suspended directly on this wiring. All joints must be securely soldered to avoid undesirable resistance. This is particularly true of all wiring that appears in Figs. 3 and 6, where an added resistance of a fraction of an ohm will result in serious meter errors.

The multiplier resistors, R1 to R4 inclusive, are of the semi-precision type. High precision resistors would still further improve the overall accuracy of the instrument, but likewise would cost from five to ten times as much. The shunt resistor, R7, is of the precision type and accurate to within 1% of its rated value. R5 and R6 are ordinary resistors, as their values are not critical.

The parts are available as a kit, known as the "Lafayette Volt-Ohmmeter Kit," which consists of the following:

- 1—Lafayette meter, Type K10696, 0-1 milliamperes
- 1 4000 ohm, 1 watt resistor
- 1—10,000 ohm, semi-precision resistor
- 1 .1 megohm semi-precision resistor
- 1—5 megohm semi-precision resistor
- 1 1 megohm semi-precision resistor
- 1 100 ma. precision shunt (.505 ohm)
- 1—1000 ohm variable resistance with knob
- 2—Toggle switches, S.P.S.T.
- 1—1/100th ampere instrument fuse and mounting
- 8 Binding posts, insulated tops
- 1—Push-button switch, circuit closing type
- 1—7" x 10" bakelite panel, undrilled
- 1—4 1/2 volt battery
- 1—Wire and hardware assortment
- 1—7" x 9" dust cover (optional)
- 1—Set instruction sheets

**500,000
Volts
THRU
the
BODY!
You Can
Do It
Too!**

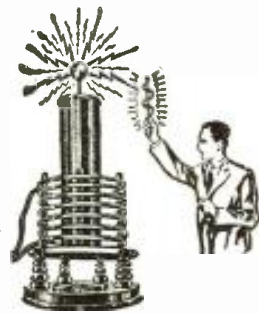

DATAPRINTS

SHOW YOU HOW!

20c Each in Order for 10
\$3.50 buys set all prints in list
TESLA-ODDIN HI-FREQ. COILS

(Data and Drawings only)

- 30" Sp'k Tesla-Oudin Coil.....40c
 - (1 K.W. Exc. Trf. Data, incl. FREE!)
 - 8" Sp'k Tesla-Oudin Coil.....40c
 - (1/4 K.W. Exc. Trf. Data included FREE!)
 - 3" Sp'k Oudin; 110 Vt. "Klick Coil" type.....40c
 - 3" Sp'k Tesla Works on Ford Sp'k Coil.....40c
 - 1" Sp'k Violetta Hi-Freq. Coil.....40c
- FREE with order for \$1.00 or more—20 Tricks with Hi-Freq. Coils" (40c separate)

Television Hook-ups "Sight & Sound" . . .40c

20 ELECTRIC PARTY AND LODGE TRICKS!
Loads of Fun!



How to Shock 'em!.....40c
Order with other prints; see special price below and save.

Solenoid & Magnet Data—Get Our List!

20 Telephone Hook-ups—Build Your Own . . .40c



GET OUR LIST OF MODEL SHIP PRINTS

S-W DIATHERMY
(Artificial Fever)

Dataprint giving Constructional data for Small, Medium and Large size App. (All 3)...40c



20 ELECTRIC PARTY AND LODGETRICKS!
How to Shock 'em! Loads of Fun!.....40c
RADIO CONTROL FOR MODEL BOATS, PLANES, Etc.

(Circuit data 40c. Get our List of Model Ship prints.

You NEED these DATAPRINTS !!
40c Each.

- 20 A.C. Problems and 20 Simple Bell Circuits, their Solutions.
- 1/2 Meter Transm. & Rec. Welding Trans. 2 K.W.
- 20 Telephone Hook-ups. Rewinding Armatures.
- 5 Meter Superhet. Einthoven String Galv.
- 100 Mechanical Movements. Wheatstone Bridge.
- 20 Motor Hook-ups. Model Ships—get list.

Special Prices: 4 prints \$1.00; 10 for \$2.00; 40c each, single orders. Get New List 100A.

The **DATAPRINT Co.**

Lock Box 322A

RAMSEY, N. J.

RADIO'S MOST COMPLETE LOW-PRICED TECHNICAL LIBRARY

EACH VOLUME ONLY 50c



THE RADIO-CRAFT LIBRARY SERIES (each volume fifty cents)—a most complete and authentic set of Volumes—treats individually, important divisions of radio, refrigeration and air conditioning. Each book has been designed to give you the opportunity to learn one or more branches of the fields mentioned. The authors of the books are well-known to everyone. Each is an expert—an authority on the subject—each is thoroughly familiar with the field which he represents.

ALL BOOKS ARE UNIFORM—The volumes in the RADIO-CRAFT LIBRARY SERIES measure 6 x 9 inches. Each book contains on an average of 50 to 120 illustrations. The books are printed on an excellent grade of paper which makes the type easy reading.

Here Are the Titles - - -

- | | | |
|--|--------------------------------------|--|
| No. 2. MODERN VACUUM TUBES | No. 13. ABC OF AIR CONDITIONING | No. 18. POINT-TO-POINT RESISTANCE ANALYSIS |
| No. 3. THE SUPER-HETERODYNE BOOK | No. 14. POCKET RADIO GUIDE | No. 20. THE CATHODE-RAY OSCILLOSCOPE |
| No. 6. BRINGING ELECTRIC SETS UP-TO-DATE | No. 15. ABC OF REFRIGERATION | No. 21. BREAKING INTO RADIO SERVICING |
| No. 9. AUTOMOBILE RADIO AND SERVICING | No. 16. PRACTICAL RADIO CIRCUITS | NEW |
| No. 10. HOME RECORDING AND ALL ABOUT IT | No. 17. SERVICING WITH SET ANALYZERS | No. 23. PRACTICAL PUBLIC ADDRESS |

RADIO PUBLICATIONS • R&T 10-39 • 99T Hudson Street, • New York, N. Y.

I have circled below the numbers of books in the RADIO-CRAFT LIBRARY SERIES which you are to send me. I have included my remittance in full, at the price of 50c each. (Stamps, checks or money orders accepted).

2 3 6 9 10 13 11 15 16 17 18 20 21 23

Name Address

City State

All books are sent Postage prepaid



HEY FELLOWS! 6 BACK NUMBERS OF RADIO AND TELEVISION SENT ANYWHERE IN U.S. FOR 70¢

For a limited time only, and as long as they last, we will send you six back numbers of RADIO & TELEVISION assorted, your choice, for 70 cents.

The usual price for six copies would be \$1.50, and most publishers charge a higher price for back numbers over one year old.

We can supply only the following back numbers: Dec., 1930; Feb., April, June, Sept., Oct., 1931; July, Oct., 1932; Jan., April, Oct., Nov., 1933; Jan., Feb., Mar., May, June, July, Aug., Sept., 1934; 1935—all issues, except January, February and March; 1936, 1937, 1938—all issues; 1939—all issues to date.

If you do not specify copies, we will send assorted numbers to fill your order. Note, we cannot exchange the copies for ones that have been sent to you.

Every copy of RADIO & TELEVISION contains information which you should have. Here is a chance to get those copies.

As only a small supply of back numbers on hand, this offer will be withdrawn as soon as they have been sold.

We accept U. S. stamps, U. S. coin, or money order. Rush your order today.

RADIO & TELEVISION 10-39
99-101 Hudson Street, New York, N. Y.

Gentlemen: I enclose herewith 70c, for which you are to send me six back number copies of RADIO & TELEVISION as follows:

Name

Address

City State

Our Great, New 68-Page Book

"CASH IN"

SHOWS 300 WAYS TO MAKE MONEY IN SPARE TIME!

Costs only 10c per copy

Book has 40,000 words in text SOLD ON A MONEY-BACK GUARANTEE! In "CASH IN" you get ALL the real money-makers—dozens of profitable tested mail-order plans, confidential business secrets, many practical tested formulas, successful tested schemes, tested money-makers, actual experiences of men who have started on a shoestring—with less than \$10 capital.

CASH FOR YOUR SPARE TIME!

BUYERS OF THIS BOOK TELL US

"Biggest value I've yet to see. Book is worth at least \$1.00."

S. SUDA, Brooklyn, N. Y.

"Your book is as good, if not better, than others selling at \$1.00."

GEORGE BRUNET, Montreal, Can.

"CASH IN is the best value I have yet to see in the mail order field."

LAWRENCE FOX, Brooklyn, N. Y.

"CASH IN" contains only tested ideas covering every type of full- or part-time enterprise—IT'S A MASTER-GUIDE FOR SMALL BUSINESS VENTURES.

10c per copy. Sent POSTPAID everywhere upon receipt of 70 cents in U.S. stamps or coin.

NATIONAL PLANS INSTITUTE
246-T FIFTH AVENUE, NEW YORK, N. Y.

Greatest Slide Rule VALUES ever offered!

8 inch slide rule in case 25c

Eight inch, white wood, accurate slide rule with A, B, C, D, CI and K Scales, a 20-page Book of Instructions, How to Use a Slide Rule, a 36-page Book of 300 Examples and Answers, a two-toned "Facsimile of the Declaration of Independence," suitable for framing, and an 8-page catalog illustrating and describing indoor games and many unusual items, all five prepaid anywhere in the United States and Canada for **50c**

10 inch enameled slide rule, only 35c

10 inch enameled slide rule, made of kiln dried genuine mahogany wood, has auxiliary removable magnifier with pins to fit (cursor) runner. This rule has inch, millimeter, sine, log and tangent scales, packed in individual carrying case. This rule is equal in performance to a \$10.00 rule.

Our special price, P.P. prepaid anywhere **\$1.00**

GOLD SHIELD PRODUCTS
Dept. RT-109 350 Greenwich St. New York

Why Be a Lid?

By JOHN G. HART

● EVERY now and then another article on how to send code, improve your fist or how to avoid a "glass arm" pops out. Having taught, copied and transmitted code for over twenty years, I must admit that most of these articles have left me somewhat bewildered. A great many worthwhile hints have been given, but the main points never seem to be brought up. And the major item of all of them is not mentioned, i.e., rhythm. And listening in over the air the only conclusion one can draw is that the majority of amateurs are sadly deficient in this.

In the directions on code transmission in any good radio handbook, the proper rhythm is explained. To repeat it here, the proper procedure is one count for a dot, three counts for a dash, one count interval between the components of a character, three counts between characters and five counts between words. And the only way to acquire rhythm when transmitting code is to COUNT.

The tragic part of it all is that, whereas code reception practice by one's self is a slow, awkward and difficult process, anyone who can count up to five may, with a little patience, acquire a fist that is a pleasure to copy and which makes the man at the other end say, "Boy, that fist is a honey!"—not to speak of the direct benefit of obtaining many more successful QSO's than the man with the poor fist. Any individual who is willing to count for twenty minutes each day will, in a very few months develop into a first class operator. But 99% of the would-be Hams are too much in a hurry to acquire the coveted speed of at least 15 wpm to bother about the rudiments of proper keying. Practically every other candidate for a Ham ticket who comes to my desk admits that he is very deficient in copying code but that he can transmit "oh, about 20 wpm." Given the key, he proceeds to spell out some undecipherable hash after which he sits back with a "well, what do you think of that?" smile.

When he is gently broken to the idea that he has to start all over again if he wants to acquire the proper rhythm, a look of wounded vanity appears; this often changes to one of incredulity. But let it be said to the credit of the majority of them that, once they can hear the difference between proper and improper keying, they are amenable enough.

Let it be said at this stage that counting is all right for beginners but that the rhythm is lost anyway when the speed is stepped up, let me assure you that it is possible to count at the proper tempo at the rate of thirteen words per minute. If you keep it up for a long time you may get slightly breathless but that is about all the damage that will be done. And a rhythm acquired at thirteen per, will stay with you no matter how fast you eventually may be able to send.

The best way to start practising is to take a few easy words like:

THIS IS THE MAST

and, while pressing the key down, start counting one-two-three for the T, then release the key and count in the same rhythm one-two-three for the space between the T and H, then for the H, alternately press down and release the key while counting ONE each time. At the fourth up-stroke (releasing the key) instead of ONE you count THREE for the space between the H and I, then count ONE down for the first dot of the I, release the key, count ONE, press down the key again while counting ONE, then release the key and count THREE for the space between the I and S. The S is spelled the same way, with the difference that after the three ONES have been counted for the three dots, the count on the third release of the key is FIVE for the spacing between the word THIS and IS. The same procedure is followed all the way through.

Now reading this as it is written down here, it sounds terribly complicated and probably the first time you try it will result in failure. But if you draw a diagram like this:

T	H	I	S	T	H	E	M	A	S	T										
3	1	1	3	1	1	5	3	1	1	3	5	1	1	3	1	1	3	1	1	3
1	1	1	1	1	1	1	1	1	1	1	1	1	1	1	1	1	1	1	1	1
3	1	1	1	1	1	1	1	1	1	1	1	1	1	1	1	1	1	1	1	1

and keep your eyes on this while pressing down and releasing the key, counting at the same time, you will at the fifth try begin to keep it straight. At the tenth try you begin to get the "rhythm" and at the twentieth it becomes automatic. Once you begin to feel the rhythm you can say uh, uh, uh, instead of counting one-two-three etc., and then, when you really begin to get sure, count mentally.

Stick to the easy letters and words for a while, lengthening the sentence as you add words, always maintaining the same rhythm. Do not try to hurry the process, rhythm and a perfect fist are dead sure to follow if you stick to it and give your fist and subconscious mind a chance to absorb what you are trying to stuff into it. This subconscious mind stuff has a lot to it. We have often proved that, by trying out a man's left fist after he had acquired a perfect right one for sending code, and

usually after a few tries he could send almost as well with his left as with his right fist. As you all know, it takes a little time for the subconscious mind to absorb things, but once it is there and you use it for a while, you'll never lose it! Proof of this is that some individuals forego radio work for years and, when re-starting, after an hour's practice are right back where they left off.

Don't worry too much about how to hold the key. The orthodox way is to hold it with the index and middle finger. Hold it lightly, or rather make the motion as if you want to pull the key towards you, without actually doing so. But there is no hard and fast rule how to hold a key. Perfect sending may be done with the fingers resting right on top of the knob. The only thing that is required is to flex the wrist. If your fist becomes easily tired, try exercising the wrist. Just hold the arm out stiff and bend the hand back and forth a number of times. This will cause the wrist to become very flexible and facilitate effortless transmitting. I personally have punched a large tape at the rate of 28 wpm on a straight key for a solid hour and a quarter, turned the tape around and gone at it again for another hour and a quarter, without feeling the slightest fatigue in either wrist or hand. Therefore it must be possible to keep going for hours at a time without tiring.

And don't worry about *glass arms*. No one who follows the method outlined above and who flexes his wrist once in a while has to my knowledge ever had such a thing as a glass arm. This is mostly an excuse for poor operators to excuse their unintelligible sending.—*Courtesy American Radio Institute.*

BOOK REVIEW

● **PRACTICAL RADIO MATHEMATICS** by M. N. Beitman, published by Supreme Publications, Chicago, Ill. Contains 24 pages, size 8½" x 11".

This book, which is designed for home study use, is divided into numerous chapters for rapid reference. The first deals with numbers, fractions, decimals and simple formulas, as used in radio servicing. Chapter 2 discusses how units are sub-divided, color code, meter scales and accuracy. In Chapter 3, Ohm's Law is discussed, various radio examples are given, graphs are explained, and an introduction is made to A.C. and the Ohmmeter. Chapter 4 deals with wattage ratings, and series and parallel connections. Chapter 5 takes up condensers. Chapters 6 and 7 deal with inductances and transformers, giving useful mathematical formulae for reactance, impedance and combined circuits.

Tubes, voltage and power amplification and output coupling are included in Chapter 8, while Chapter 9 gives a resumé of point-to-point testing and the volt-ohm-milliammeter method. Chapter 10, which concludes the book, is a discussion of decibel ratings.

THEORY AND APPLICATIONS OF ELECTRON TUBES, 670 pages, illustrated, size 6" x 9", published by McGraw-Hill Book Co., Inc., of New York and London.

The author, Herbert J. Reich, Ph.D., Associate Professor of Electrical Engineering at the University of Illinois, has done a fine piece of work in preparing his exhaustive treatise on electron tubes and their applications, and the theories applicable to them.

Perhaps the best idea of this book can be had through a brief examination of its chapter headings which are as follows: Physical Concepts; Thermionic Emission—the High-Vacuum Thermionic Diode; Grid-Controlled High-Vacuum Tubes; Methods of Analysis of Vacuum Tubes and Vacuum-Tube Circuits; Modulation and Detection; Amplifier Definitions, Classifications, and Circuits; Analysis and Design of Voltage and Current Amplifiers; Class A and Class AB₁ Power Amplifiers; Class B, Class AB₂, and Class C Amplifiers; Vacuum-Tube Oscillators; Electrical Conduction in Gases; Glow- and Arc-Discharge Tubes and Circuits; Light-Sensitive Tubes and Cells; Power Supplies and Electron-Tube Instruments and Measurements.

The book also has an excellent appendix containing charts for the determination of reactance and decibel gain, operation characteristics of rectifiers, operating data for amplifiers, conversion-factor chart for power tubes, etc., and is lavishly illustrated with diagrams and graphs. At the back of the book are three indexes arranged as to subjects, authors and symbols.

This is a book which will be highly valuable to any one interested in modern radio practice.

RADIO OPERATORS' MANUAL. Stiff paper covers, size 5¼" x 7¾", 182 pages, illustrated with diagrams. Published by the General Electric Co. Radio Dept., Schenectady, N. Y.

This radio operators' manual should find a place on every radio student's book-shelf as it contains many valuable diagrams and explanations which will help to complete his radio education. The Radio Operators' Manual is a completely revised

(Continued on page 379)

STOP—LOOK and BUY

Rockbottom Prices on All Our Merchandise

When prices are low we buy! They're low now—**LOWER THAN THEY EVER WILL BE—** hence this sale, 100% satisfaction on each transaction or your money refunded. **ORDER FROM THIS PAGE.** Use the convenient coupon below. Be sure to include sufficient extra remittance for parcel post charges, else the order will be shipped express, charges collect. Any excess will be refunded. C.O.D. shipments require a 20% deposit. If full remittance accompanies order deduct 2% discount. Send money order—certified check—new U. S. stamps. No C.O.D. to foreign countries.

ORDER TODAY QUANTITIES LIMITED QUICK SHIPMENTS ASSURED

VARIABLE SPEED UNIVERSAL MOTOR

FOR 110 VOLTS. A.C. OR D.C.

Made for Dictaphone machines by American Gramophone Co. Used, but in excellent condition. Special lever control permits variable speeds up to 3000 r.p.m. ¼" shaft extends from both sides of motor. Measures 7½" x 3¼" diam. overall. Shp. Wt. 6½ lbs.



ITEM NO. 11
Your Price \$2.55

WELDING! BRAZING! SOLDERING!

3-IN-1 PORTABLE ELECTRIC TORCH

WORKS FROM 110 VOLTS A.C. OR D.C. LINE

This electric torch is not a gadget or a toy but a sturdy built outfit using the finest materials. With it you are able to do professional type of welding, brazing and soldering work, regardless of whether or not you've had previous experience. It will do a thousand and one jobs: fender welding, auto body repairs, bumpers, cylinders, tanks and industrial repairs—ideal for steel fitters, plumbers, sheet metal jobs, engineers, maintenance men, radio and bicycle repair men, etc. Works on aluminum, brass, copper, iron, steel and other metals.

The 3-in-1 electric torch is so simply constructed that even a boy can operate it after reading the simple and concise instructions furnished with the unit. Not necessary to know how to strike an arc! All you do is plug the torch into the light socket, adjust the controls per instructions, and presto!—you have an intense, blazing flame, ready for work. The outfit comes complete with power unit, electric cord, electrode holder, carbons, welding rods, brazing rods, solder flux, goggles, and instructions.

Save money! Do your own repairing. Earn money by doing repairing for others. Simple, practical, durable and safe to handle—that's why the price is amazingly low. Don't delay—order one today. Shp. Wt. 8 lbs.

ITEM NO. 50
Your Price \$6.95

POWER JIG SAW

A trouble-proof powerful tool with self-contained power unit. Cuts 7200 strokes per minute, leaving smooth edges. An ideal machine for wood-crafters, model makers, handymen, etc. Has 10" square table and gray iron frame mounted on rubber to absorb vibration. Arm blade depth 13½". Designed for 110-120 V. A.C. use. Measures 9¼" x 19¼". Adjustable guide and stroke. Sold complete with 8 ft. approved cord and plug, ready to use. Shp. Wt. 12 lbs.



ITEM NO. 45
Your Price \$9.96

COMPLETE ELECTRIC SPRAYER OUTFIT



ITEM NO. 46
Kit less motor, but with gun
Your Price \$6.36

ITEM NO. 47
The complete kit including ¼ HP motor
Your Price \$14.53

Consists of a sturdy compressor 110 V. ¼ HP, 1750 R.P.M. motor, 10 ft. hose, efficient spraying gun and all necessary mounting accessories. Costs only 2 cents per hour to operate. Delivers considerable air pressure. Positively will not pump oil. Few working parts to wear. Sprays practically anything. Shp. Wt. 40 lbs.



NEW FUEL PUMPS

Brown & Sharpe pumps. Brand new, never been used. Can be used for gasoline, oil, kerosene, and other fuels. Not good for water. Takes standard thread ¼" input and output pipes. Has ¼" drive shaft. Measurements 4 x 3¼ x 3¼" diam.

overall. Shp. Wt. 8½ lbs.
ITEM NO. 24 Your Price \$4.45

SPERRY GYROSCOPE LIQUID COMPASS

Made for U.S. Signal Corps; sensitive and accurate. Quick readings easily made from top; accurate readings of graduations through focusing magnifying lens on side of instrument. Complete with level sight and rubber carrying case. Excellent for boats, boy scouts, campers, hikers, etc. A few turns of wire around its case makes it usable as a galvanometer. Shp. Wt. 3 lbs.



ITEM NO. 12
Your Price \$1.85



1/75 HP AC MOTOR

Develops 1/75 HP at 3000 R.P.M. The entire motor is only 3¼ inches in diameter. 7/32" shaft. Inductor type motor with shaded pole for self starting. Speed can be varied with suitable rheostat. Complete with cord, plug and base, but less pulley. For use on 110 V. 60 cycle AC line. Shp. Wt. 8 lbs.

ITEM NO. 44
Your Price \$1.75

20,000 RPM HAND GRINDER

Save 50% on a tough little hand grinder that is extremely useful to radio servicemen, experimenters, jewelers, dental mechanics, etc. Develops 20,000 R.P.M. Fits solidly in the palm of the hand. Operates on 110 V. A.C.



or DC, 25 or 60 cycles. Its features are: high torque, oilless bearings, sturdy thrust, cool running, handy switch, collet chuck, for ¼" and 3/32" wheels, finger support for precision work. Shp. Wt. 6 lbs.

ITEM NO. 48
Your Price \$7.62

VENTILATION FAN

Handy for eliminating kitchen odors. Installs on either window or flue on chimney. Can also be used as radiator fan for room circulation, induction motor. Operates on 110 volts, 60 cycles A.C. only.



ITEM NO. 49
Your Price \$4.50

WE HAVE NO CATALOG. ORDER DIRECT FROM THIS PAGE.

HUDSON SPECIALTIES - 40-T West B'way - N.Y.C.

IT'S EASY TO ORDER—CLIP COUPON—MAIL NOW

HUDSON SPECIALTIES CO., 40-T West Broadway, New York, N. Y. RT-1039

I have circled below the numbers of the items I'm ordering. My full remittance of \$..... (include shipping charges) is enclosed.

OR my deposit of \$..... is enclosed (20% required), ship order C.O.D. for balance. (New U.S. stamps, check or money order accepted.)

Circle Item No. wanted: 11 12 24 44 45 46 47 48 49 50

Name Address

City State

Send remittance by check, stamps or money order; register letter if you send cash or stamps.

... THESE OUTSTANDING SHORT WAVE BOOKS ARE *Now Available* AT YOUR DEALER!

YOU buy parts, tubes, kits, accessories from your local radio dealer—that's what countless thousands of short-wave fans do. Now through a nation-wide distribution service our numerous books are available at your favorite radio dealer—right where you buy other radio equipment. It's more convenient, saves time and you can inspect the books before you buy. Ask your dealer to show you all the books advertised on this page—they're always in stock.

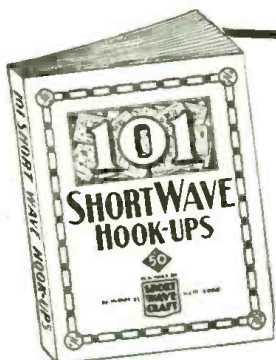

101 SHORT WAVE HOOK-UPS

Compiled by the Editors of RADIO & TELEVISION

Here is a worthwhile book that every short wave listener, every short wave fan, and every short wave amateur has wanted for a long time. It gives you the 101 best short wave hook-ups which have appeared heretofore.

100 Illustrations 50c
72 Pages

HOW TO BUILD AND OPERATE SHORT WAVE RECEIVERS

This is the best and most up-to-date book on the subject. It is edited and prepared by the editors of RADIO & TELEVISION and contains a wealth of material on the building and operation, not only of typical short wave receivers, but short wave converters as well.

150 Illustrations 50c
72 Pages



TEN MOST POPULAR SHORT WAVE RECEIVERS

HOW TO MAKE AND WORK THEM

The editors of RADIO & TELEVISION have selected ten outstanding short wave receivers and these are described in the new volume. Each receiver is fully illustrated with a complete layout, pictorial representation, photographs of the set complete, hook-up and all worthwhile specifications.

75 Illustrations 25c
40 Pages

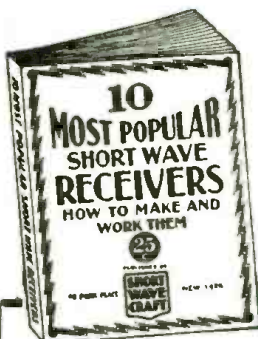

HOW TO GET BEST SHORT WAVE RECEPTION

M. HARVEY GERNSBACK tells you everything you have ever wanted to know about short wave reception. The author, a professional radio listener and radio fan for many years, gives you his long experience in radio reception and all that goes with it.

40 Illustrations 50c
72 Pages

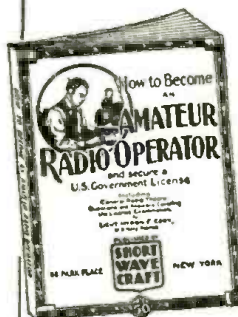

HOW TO BECOME AN AMATEUR RADIO OPERATOR

By Lieut. Myron F. Eddy, whose experience in the amateur field has made him pre-eminent in this line.

If you intend to become a licensed code operator, if you wish to take up Phone work eventually—this is the book you must get.

150 Illustrations 50c
72 Pages

THE SHORT WAVE BEGINNER'S BOOK

Here is a book that solves your short wave problems—leading you in easy stages from the simplest fundamentals to the present state of the art as it is known today. It is the only low-priced reference book on short waves for the beginner.

75 Illustrations 25c
40 Pages

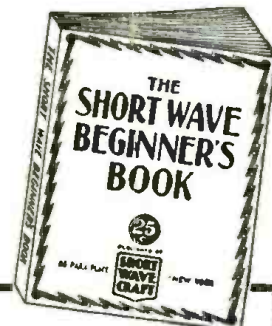

LOOK FOR YOUR NEAREST DEALER

For convenience the publishers list below dealers in all parts of the world where our books are available. On your next shopping trip be certain to examine these volumes. You're sure to want them for your technical library.

- ALABAMA**
Walther Bros., Montgomery
- ARIZONA**
Sam's Clear Store, Phoenix
- CALIFORNIA**
Electric Supply Co., Oakland
Radio Supply Company, Los Angeles
Radio Television Supply Co., Los Angeles
Pacific Radio Exchange, Inc., Los Angeles
Western Auto Supply, Los Angeles
Zack Radio Supply Co., Los Angeles
Vroman's Book Store, Pasadena
Western Radio & Elec. Co., San Diego
Offenbach Electric Co., San Francisco
Technical Book Co., San Francisco
Zack Radio Supply Co., San Francisco
Radio Specialties Co., San Jose
- COLORADO**
Auto Equipment Co., Denver
Interstate Radio Supply, Denver
- CONNECTICUT**
The Edward P. Judd Co., New Haven
- DELAWARE**
Wilmington Elec. Spec. Co., Inc., Wilmington
- FLORIDA**
Radio Accessories Co., Orlando
- GEORGIA**
Radio Wire Television, Inc., Atlanta
- ILLINOIS**
Allied Radio Corporation, Chicago
Walker C. Braun, Inc., Chicago
Chicago Radio Apparatus Co., Chicago
A. C. McClurg & Co., Chicago
Midwest Radio Mart, Chicago
Newark Electric Co., Chicago
Sears, Roebuck & Co., Chicago
Max Stein & Co., Chicago
Montgomery Ward & Co., Chicago
Radio Wire Television, Inc., Chicago

- INDIANA**
Van Sickle Radio, Indianapolis
- MASSACHUSETTS**
DeWolfe & Fluke Co., Boston
The Personal Book Shop, Boston
Radio Wire Television, Inc., Boston
Library Book House, Springfield
Tremont Elec. Supply Co., Boston
- MICHIGAN**
Rissi Brothers, Detroit
- MINNESOTA**
St. Paul Book & Stat. Co., St. Paul
- MISSOURI**
Burststein-Applebee Co., Kansas City
Radio Labs., Kansas City
Walter Ashe Radio Co., St. Louis
Van Sickle Radio Co., St. Louis
- NEW JERSEY**
Radio Apparatus Co., Newark
United Radio Co., Newark
Radio Wire Television, Inc., Newark
- NEW YORK**
Fort Orange Radio Dist. Co., Albany
Radio Wire Television, Inc., Newark
Radio Wire Television, Inc., Jamaica, L. I.
Harrison Radio Co., New York City
American News Cos., New York City
Baker & Taylor Co., New York City
Blum, the Radio Man, New York City
David Bogen & Co., New York City
Federated Purchaser, Inc., New York City
Radio Circular Co., New York City
G. E. Stechert & Co., New York City
The Steiger Co., New York City
Sun Radio Co., New York City
Thor Radio Corp., New York City
Try-Mo Radio Co., New York City
Van Bienenstyk Book Stores, New York City
Radio Wire Television, Inc., New York City
H. W. Wilson Co., New York City
Radio Parts & Equipment Co., Rochester
M. Schwartz & Son, Schenectady
- OHIO**
College Book Exchange, Toledo

- OREGON**
J. K. Gill Co., Portland
- PENNSYLVANIA**
Radio Electric Service Co., Philadelphia
Cameradio Co., Pittsburgh
- WASHINGTON**
Seattle Radio Supply Co., Seattle
Wedel Co., Inc., Seattle
Spokane Radio Co., Spokane
- WISCONSIN**
Radio Paris Co., Milwaukee
- ARGENTINA**
Radio Revista, Buenos Aires
- AUSTRALIA**
McGill's Authorized Agency, Melbourne
- BELGIUM**
Emil Arens, Brussels
- CANADA**
T. Eaton & Co., Winnipeg, Man.
Electrical Supplies, Ltd., Winnipeg, Man.
Wholesale Radio Supply, Winnipeg, Man.
Canadian Electrical Supply Co., Ltd., Toronto, Ont.
Radio Trade Supply Co., Ltd., Toronto, Ont.
Canadian Electrical Supply Co., Ltd., Montreal, P. Q.
- BRAZIL**
Agencia Soave, Sao Paulo
- CHINA**
China News Co., Shanghai
International Booksellers, Ltd., Shanghai
- CUBA**
Diamond News Co., Havana
- ENGLAND**
Gorrings's Amer. News Agency, London
- FRANCE**
Toute La Radio, Paris
- GERMANY**
Rehr G.M.B.H. SW13, Berlin NW No. 7

- HOLLAND**
Radio Peeters, Amsterdam, Z.
- INDIA**
Empire Book Mart, Bombay
- MEXICO**
American Book Store, Mexico, D. F.
Central De Publicaciones, S. A., Mexico, D. F.
Jaques Salvo, Mexico, D. F.
- NEW ZEALAND**
Johns. Ltd., Auckland
James Johnston, Ltd., Dunedin
Te Aro Book Depot, Ltd., Wellington
- SOUTH AFRICA**
Technical Book Co., Cape Town
Central News Agency, Johannesburg
International House, Johannesburg
South African Radio Publications, Johannesburg

IF YOUR DEALER DOES NOT CARRY THESE BOOKS, ORDER DIRECT FROM US. FILL OUT COUPON BELOW. SHIPMENT WILL BE MADE IMMEDIATELY.

POPULAR BOOK CORP. R&T-10-39
99 Hudson Street, New York City.

Gentlemen: I enclose herewith my remittance for _____ for which please send me the following books:

.....

Name

Address

City State

(Send remittance in form of check or money order. If letter contains cash or unused U. S. postage stamps, register it.)

POPULAR BOOK CORPORATION • Publishers • 99 HUDSON STREET • NEW YORK, N. Y.

Book Review

(Continued from page 377)

edition of the previous Police Radio Operators' Manual.

The scope of this manual has been expanded to include not only broadcast transmitters and police radiotelephone and radiotelegraph systems, but also radio systems for land and marine fire departments, transit and electric power companies and conservation departments.

Its publication has a triple purpose: to assist those who wish to qualify for commercial radio-telephone and radiotelegraph operator licenses; to assist prospective station licensees in obtaining Federal authorizations; and to present general information on radio systems in various fields of application.

The book describes radio systems in use; outlines the organization and function of the Federal Communications Commission; lists numerous questions and answers relevant to Federal examinations; and includes sections on maintenance, definitions, study references, radio-telegraph code, and "Q" abbreviations.

MENLO PARK REMINISCENCES, Volume One, Francis Jehl, size 7 $\frac{1}{4}$ " x 4 $\frac{1}{4}$ ", 430 pages plus index, illustrated. Published by Edison Institute, Dearborn, Mich.

Mr. Jehl was formerly a laboratory assistant to Thomas Alva Edison. In chatty, intimate style, Mr. Jehl discloses the inside story of the wizard of Menlo Park. Mr. Jehl tells of the birth of such devices as the mimeograph, the electric light, the carbon telephone, the phonograph, the dynamo, etc. Particularly intimate sidelights are found in such chapters as: Mrs. Jordan's Boarding House; A Bear Story; and New Year's Eve. It would be interesting to give a complete list of the chapters but, inasmuch as there are 53 in the volume, space does not permit. The book is fascinating to all and has run through three editions. This first volume deals with the years prior to 1879 and covers fully the earlier inventions of Thomas Alva Edison.

LA TELEVISION, Marc Chauviere; stiff paper covers, size 5 $\frac{1}{2}$ " x 8 $\frac{1}{4}$ ", 208 pages, illustrated. Published by Dunod, 92 Rue Bonaparte (VI^e) Paris, France. (Printed in French.)

The television student who is attempting to branch out and broaden his reading on the subject and who can read French, will find this volume very interesting and instructive. The first part of the book deals with the general physics of television and the geometrical analysis of the formation of the television image. Mathematical formulas are given when necessary and unlike many of the popular treatises on the subject, the author goes into the physics of the various optical effects taking place, wherever he finds it necessary. The photo-electric cell is discussed, with curves, showing how the resistance and activity of the cell varies with the amount of light falling on it, and such other interesting tubes as the neon crater tube are discussed.

Also, we find the Kerr cell covered, and then the subject of scanning is taken up, starting with the scanning disc. Mirror scanning systems are then analyzed, and directly we come to the subject of the cathode ray tube for television. The physics of this tube and what takes place inside it is quite completely covered and will be found very valuable to the student of the subject. Different methods of causing the cathode beam to sweep across the screen are explained. Various types of sweep circuits are described, as well as the method of amplifying the oscillations broadcast by relaxation oscillators. The thyratron type of oscillator is covered also.

Closing chapters of the book deal with the iconoscope, the use of film in transmitting, the transmission and reception of television images and modern systems of television, etc.

THE RADIO ANTENNA HANDBOOK, edited by W. W. Smith, 112 pages, paper covers, illustrated, size 6" x 9". Published by Radio, Ltd., Los Angeles, Calif.

This volume affords complete coverage of the antenna problem, particularly as applied to transmitters. Not only are there diagrams of various antennas, but there are a number of highly usable charts for calculations which most experimenters have to make from time to time. These charts greatly simplify the mathematical end of antenna installation. The various chapters deal with: Fundamentals; Feed Systems; Transmission Lines; Harmonic Operation; Directive Properties; Ultra-High Frequency Work; Supports; etc. This reviewer is particularly pleased with one paragraph which says in effect that a first rate antenna connected to a second rate set will provide better results than the best receiver connected to an inferior antenna. If more people recognized this fact, there would be fewer headaches in the radio business.

**Free Television Course
Contest Details in Next
Issue!**

FREE CATALOGS and INFORMATION

By carefully reading the advertising columns, you will find many offers to furnish literature containing valuable technical information that will help you in your work. Use this list freely.

Firm	Business	Offer	No.	Cost	Ado. Page
Aerovox Corporation	Parts Mfr.	New Catalog		Free	373
Allied Radio Corp.	Mail Order	1940 204-page Catalog		Free	355
American Radio Institute	Radio School	Booklet		Free	368
Amplifier Co. of America	P.A. Equipment	New Bulletin		Free	362
Bliley Electric Co.	Parts Mfr.	Engineering Bulletin	E-6	10c	361
		Circular	A-6	Free	
		Bulletin	E-7	Free	
Bud Radio, Inc.	Parts Mfr.	Catalog	RT-109	Free	361,365
Burstein-Applebee Co.	Mail Order	Catalog		Free	367
Cameradio Co.	Mail Order	1939 Catalog		Free	364
Candler System Co.	Code Course	Book of Facts		Free	369
Cannon, C. F., Co.	Parts Mfr.	Folder	T-10	Free	362
Capitol Radio Engineering Institute	Radio School	Book		Free	368
Chicago Wheel & Mfg. Co.	Manufacturer	64-page Catalog		Free	364
Cornell-Dubilier Elec. Corp.	Parts Mfr.	Catalog	165A	Free	B.C.
		Catalog	166A	Free	
		Catalog	167A	Free	
Coyne Electrical School	Trade School	Electrical Catalog		Free	323
		Radio Catalog		Free	
Dodge's Institute	Radio School	Catalog		Free	368
DX Radio Products Co.	Parts Mfr.	DeLuxe Catalog		15c	361
Goldentone Radio Corp.	Set Mfr.	1940 Bargain Catalog		Free	367
Gold Shield Products	Mail Order	Catalog		Free	364,366,371,376
Guthman, Edwin I., & Co.	Set & Parts Mfr.	Catalog		Free	364
Hammarlund Mfg. Co.	Set & Parts Mfr.	1939 Catalog		Free	365
Harrison Radio Co.	Mail Order	Information		Free	365
Henry Radio Shop	Mail Order	Information		Free	362
Howard Radio Co.	Set Mfr.	Technical Information		Free	361
Instructograph Company	Code Machine	Information		Free	368
International Correspondence Schools	Corres. School	Booklet		Free	384
Levine, M. M., Company	Coil Winding Machines	4-page Catalog	639	Free	360
Mass. Radio School	Radio School	60-page Catalog		Free	368
National Company, Inc.	Set & Parts Mfr.	Catalog	300	Free	I.B.C.
National Radio Institute	Radio School	64-page Book		Free	321
National Schools	Radio School	Literature		Free	368
New York Radio Supply Co.	Dealer	Information		Free	371
New York Y.M.C.A. Schools	Trade School	Booklet		Free	368
Radio & Technical Publ. Co.	Radio Textbooks	Circulars on each Book		Free	357
Radio Train. Assn. of Amer.	Radio School	Book		Free	368
Radio Wire Television Inc.	Mail Order	1940 Radio Catalog	78	Free	353,359
Radolek Co., The	Mail Order	1940 Radio Profit Guide		Free	383
RCA Institutes, Inc.	Radio School	Catalog		Free	368
Remington Rand, Inc.	Typewriter Mfr.	Catalog		Free	366
Rosierucians, The	Fraternal Society	Book		Free	371
Sargent, E. M., Co.	Set Mfr.	Information		Free	365
Sigmon Radio Supply	Set Mfr., Dealer	1939-1940 Catalog		Free	362
Solar Mfg. Corp.	Parts Mfr.	General Parts Catalog	9S	Free	384
		Transmitting Catalog	2X	Free	
		Condenser Testers Cat.	CBCC-1	Free	
Sprague Products Co.	Parts Mfr.	Catalog		Free	371
Sprayberry Acad. of Radio	Radio School	52-page Book		Free	369
Superior Instruments Co.	Test Equipment	Catalog		Free	I.F.C., 363
Supreme Publications	Publisher	Information		Free	363
Teleplex Co.	Code Machine	Booklet	S-10	Free	368
Triplett Electrical Inst.Co.	Parts Mfr.	Catalog		Free	367
Universal Microphone Co., Ltd.	Parts Mfr.	Information		Free	365

COMMERCIAL NOTICES 10¢ A WORD

Under this heading only advertisements of a commercial nature are accepted. Remittance of 10¢ per word should accompany all orders. Copy should reach us not later than the 10th of the month for the second following month's issue.

AGENTS WANTED
300% PROFIT SELLING GOLD Leaf Letters for Store Windows; Free Samples. Metallic Co., 446 North Clark Chicago.

CORRESPONDENCE COURSES
CORRESPONDENCE COURSES in educational books, slightly used. Sold, Rented, Exchanged. All subjects. Satisfaction guaranteed. Cash paid for used courses. Complete details and bargain catalog free. Send name Nelson Company, R-210 Manhattan Building, Chicago.

INSTRUCTION
ALGEBRA PROBLEMS SIMPLIFIED \$1.30; Low Voltage Transformer Construction \$0.60; Data on 350 to 20,000

Volt Step-up Transformer Construction \$1.35 (Prepaid). H. Arkerson Box 322-D, Ramsey, N. J.

PATENT ATTORNEYS
INVENTORS — PROF. CT. Y. F. rights before disclosing your invention to anyone. Form "Evidence of Conception"; Schedule of Government Attorneys' Fees; and instructions sent free. Lancaster, Allwine & Rommel, 436 Bowen Building, Washington D. C.

QSL-CARDS-SWL
100 NEAT SWL CARDS PRINTED with your name and address sent postpaid for \$1. Bunch of supplies and RST Chart for five cents in stamps. WHEE, 78 Warrenton St., Springfield, Mass.

SWL'S QSL'S, 150 FOR 7¢ OR \$1.00. Any 2 colors, free samples. WDEE, Mantle Shade, N. J.

RAD'O DIAGRAMS
ANY RADIO DIAGRAMS 25¢. SPECIALLY MANUFACTURED, model, Radio magazine free. "Television Cyclopedic" 25¢. Supreme Publications, 3227 West 13th, Chicago.

ULTRA HIGH FREQUENCY
3 TUBE 24 METER TRANSCEIVER kit \$7.60. We construct ultra high frequency equipment to your order. U.I.F. Service, 64 Zeilner Street, Haverbury, Mass.

FOR SALE (NON COMMERCIAL) 3¢ A WORD

Under this heading we accept advertisements only when goods are offered for sale without profit. Remittance of 3¢ per word should accompany all orders. Copy should reach us not later than the 10th of the month for the second following month's issue.

SELLING OUT: 70 WATT 40 METER c.w. rig with smooth power and bias supplies. Best grade of parts used. Good dx worked. Complete with tubes, xtals, key, antenna tuning, etc. Sky Challenger receiver with tones. Price Call for \$97. Nothing else to buy. W. Zalner, 8 Judson Ave., Binghamton, N. Y.

FOR SALE: MILLION TUBE VOLT- meter \$15; Weston 772 \$35; Brush mike \$10; Audio osc \$17.50; Jackson volt-ohmmeter tube tester \$20; Triumph 120 Nig. Generator \$17.50; Volume 4 Riders \$5.00; Sun Lamp \$20. N. L. Hardinger, Tinley Park, Illinois.

PORTABLE TELEVISION DEMON- strator, 5" CRT, 4000 volt power supply, 350 volt power supply 2203 NT Monitor, four stage video amplifier. Perfect working condition. \$150. Cash. Richard Botney, Box 196, Schererville, Indiana.

HAVE SET OF LIONEL STANDARD gauge trains valued at approximately \$40.00. Would like to get \$20.00 or \$25.00. All letters answered. Ernest Hall, 3941-59th Street, Woodside, N. Y.

SWJS \$4.00. SKY BUDDIES \$15.00. Sky Clampons \$79.00. Super-Skriders \$8-11 \$40.00. NC100s \$19.00. NC100Ns \$79.00. RME-60's \$99.00. Practically all other models at 50% v. luss. Terms. List free. W9ARA, Butler Mo.

HAMMARLAND STANDARD PRO \$19. 5 ft Bud relay rack \$10. 35 watt CW xmit \$15. Paris bargains. Stamp 1st. W9VGS, Hutchinson, Kansas.

SEVERAL WRESTINGHOUSE WATT- hour meters (electric light meters), \$3 each, postpaid. Hart Radio, New Smyrna, Fla.

BARTER AND EXCHANGE - FREE!

NO ADVERTISEMENT TO EXCEED 35 WORDS, INCLUDING NAME AND ADDRESS

Space in this department is not sold, it is intended solely for the benefit of our readers, who wish to buy or sell. We do not accept responsibility for any statements made by the readers. Use these columns freely. Only one advertisement can be accepted from any reader in any one issue. All dealings must be above board. Remember you are using the U. S. mail in all these transactions and therefore you are bound by the U. S. Postal Laws. Describe anything you offer accurately and without exaggeration. Treat your fellow men the way you wish to be treated. We welcome suggestions that will help to make this department interesting and helpful to our readers.

TRADE AMPLIFIER, MIKE, SPEAK- er, radio, camera, projector, field glasses, radiotele, electric shaver, etc. Send your list for mine. M. Epstein, 2953 Rueckle St., Indianapolis, Ind.

WANTED: BILLEY 3615-8KC, 7000+, 7200- crystals. City tube or 80 meter xtals for each. Have new radio bug, tubes, parts. Want World's Fair mint stamps. Have mint Bolivia triangle set. W7GPP, The Dalles, Oregon.

WILL SWAP A 9-INCH A.C. DY- namo speaker that will handle 15 watts undistorted power for a 9-200 ma. meter, jewelled 3-inch type. All letters answered. W9MIO, 919 W. 4th St., Mt. Carmel, Ill.

SWAP COMPLETE \$150 1939 RADIO course for radio parts, printing press, or what have you. All inquiries will be acknowledged. M. W. Zmoud, 3 Monardnock Bldg., Winnipeg, Man., Canada.

SWAP: 25 WATT 45-46-48, 75 WATT 59-46-100 250 watt transmitters, 1500 V. power supply bridge, Neel 1500 V. 5 power transformer and 81A RCA. What have you? C. Kowalski, W9KHC, 1239 Kinsmoor Ave., Fort Wayne, Ind.

WANTED: HALLICRAFTER SKY Buddy. Will swap such Thomas, quarter hour, four chime, eight air named and other types of receiving and xmitting tubes. Want velocity or crystal mike, bug or 36" rack. John Zubas, Irvington, N. Y.

LAFAYETTE RECEIVER USING 30, 33 tubes double spaced 50 mmf. isolantite condensers, 801, 211E, and other types of receiving and xmitting tubes. Want velocity or crystal mike, bug or 36" rack. John Zubas, Irvington, N. Y.

HAVE LINO CARVING TOOLS, anti-capacity and dial switches, mikes, Weston photo cell, relay, Laboratory glassware, books, masks, and black leather toilette case. Want receiver, parts, multi-tester or meter outfit. George Fried, 1764 Weeks Ave., Bronx, N. Y.

HAVE COMPLETE LABORATORY equipment, also transmitter, mikes, meters, etc. An interested in phone xmitter complete. Pauline White, Pitts-ville, Maryland.

HAVE COMPLETE N.R.I. RADIO and television course, new 1939 Sky Buddy, Want 16 mm Keystone camera and projector in A1 condition. Exchange SWL cards. 1 QSL 100%. John Basta, 31 Luke Street, Brooklyn, N. Y.

OFFER 1-BAT. OPERATED FRE- quency monitor, 1 20 W. phone c.w. transmitter, 1 615 oscilloscope complete, 1 6 V. (Little Joe) light plant. Want 110 V. A.C. plant, Dan. Heckart, W9EYB, Mission, So. Dak.

WANTED: BOOKS (USED) ARRL Handbook, license manual, 101 S.W. Hook-ups, radio dictionary, R.C.A. Tube Manual, and will swap diagrams of space-charge S-W. receivers. Prices must be reasonable. Marvin Blancett, Halleyville, Oklahoma.

EXCHANGE PARTS, TUBES 2 1/2 and 5 meter set, unvalued, 2 button mike. Wanted, 6K7, preselector, 10 meter set, A.C. S.W. set such as Doerle or Ellen Francis Baker, Pack anack Lake, New Jersey.

SWAP: NEW '39 CROSLEY 5 A.C. D.C. inlet, radio books, parts, test equipment, s.w. magazines, study courses, Scott album, stamps. Want Halleraster's late model Sky Buddy John J. Vilkas, 1515 South 49th Court, Cleora, Ill.

TRADE HAYNES A.C. 5 CLIPPER Columbia portable radio-phonograph, A.C. 120-220 transformer, mike, power supply, office model typewriter, all working order, all for good communications receiver. Details first letter. Exchange SWL's. Horer, Jamul, Calif.

WANT CAPEHART RECOR- ding, Browning "Sweet Sixteen" or Ilanca 16 Dump shotgun, 38/40 or 44/40 Remington rifle, Smith Kit-gun wrist watch with full sweep second hand. A Welker, 406 N. Harrey, Oak Park, Ill.

SWAP: LASALLE EXTENSION University Business Administration, Principles and Practice for good receiver. Prefer Sky Buddy or Sky rider or other with ten meter band. Ned Dunn, Hurley, New Mexico.

I HAVE VIROFLEX BUC D.B. MIKE, 211 tube with socket, single slot 22, speakers, Want s.w. recr. or Dave Jones, Box 214, Route 3, Sprta, Wis.

AIR KING PORTABLE BATTERY superheterodyne receiver for trade. Brand new batteries. Broadcast, police bands. Self enclosed antenna. Extremely sensitive, featuring AVC. Want test equipment, transmitting parts. Irving Goldstone, 332 Alabama Avenue, Brooklyn, N. Y.

SWAP NATIONAL A.C. S.W. 3, four sets of coils, 12 to 50 meters and 115 to 200 meters. Want Argus camera model A, 2F, or what in cameras, James A. Dalton, Sr., 441 S. Lincoln Avenue, Glenside, Pa.

INTERESTED IN 16 OR 8 MM camera, projector, screen; hi-power binoculars; 2 1/2 to 10 meter receiver or transmitter. PA equipment, all types; Austin or Bantam auto. State price. Elwood Brooks, 1636 East 36th St., Cleveland, O.

CARTER GENEOMETER 110 TO 500 VOLTS D.C. 200 MA new. Cost \$40. Also Billey crystals B5, 7127 KC and LD2 3650 KC unused. What trade offers? C. Laing, St. Paul, Island, General Delivery, North Sydney, N. S.

HAVE STHD-100, 50 MMFD Meissner 3-band coil, 2.5 V. filament transformer, two 56's, 7 1/2 (dynamic metal cabinet). Want Stoppal compass, SB transf., A.C. D.C. S.W. receiver or? George Province, 3427 Olive, Kansas City, Mo.

80 METER XTAL KEY, 0-7 WES- ton voltmeter, isolantite sockets and other parts, also 5 tube midget to trade for 35 mm enlarger. Write description. I will send list. J. Hartos, 61 Columbia St., Hempstead, N. Y.

HAVE DOUBLE DISC CONSTANT type record player, power amplifier, Ansley portable radio-phonograph, radio books, Want 8 mm movie equipment. N. J. Winkler, 62 Bergen Ave., Clifton, N. J.

HAVE DUAL BAND CROSLEY, M- otorola auto radio, Sprague interference analyzer; typewriter, S.B. carbon mike and 6 volt power supply. Melvin Herdler, North English, Iowa.

WANTED—MAGAZINE OR BOOK dated around 1924 or between 1923-1927 with a complete listing of broadcast band stations of that time. Will pay cash. Nicholas Woytan, 309 South Wilbur Avenue, Syracuse, N. Y.

Newest Radio Apparatus

(Continued from page 361)

All-Purpose Antenna

THE new Verti-Flex antenna is designed to give optimum results for broadcast and short-wave reception, and for Ham transmission. It is of the vertical type now used by most of the larger broadcasting stations for transmission work, and is said to have greater energy pick-up than the ordinary horizontal type of receiving antenna when used for reception.

It mounts in a vertical position with a heavy rugged bracket and giant ceramic insulator, and as it requires no guy wires, it avoids reflections and the occasional "dead spots" which careless guying may cause. Made of an aluminum alloy, it is light in weight and fairly rigid, but sufficiently flexible to withstand all ordinary wind pressure.

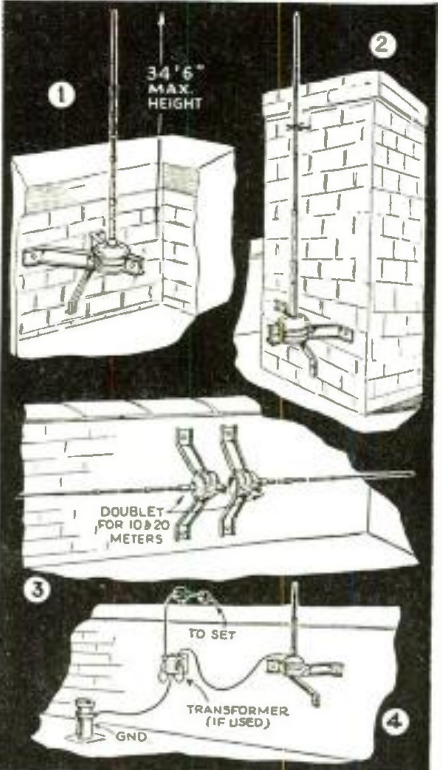

When short transmission lines can be used, the ordinary Zepp feeder can be employed, but when long transmission lines are needed, a matched impedance line should be used. If a directive antenna is desired, two 17-foot sections may be mounted horizontally and coupled into a 72-ohm line. Where it is desired to use the antenna for broadcast reception or as a noise reduction installation, as many as 12 sets can be operated from the same antenna. This requires the use of transformers, which the manufacturer is prepared to furnish. The upper transformer has a built-in lightning arrester and couples into the feeder lines. The set transformers are matched to the line and one is required for each set to be fed from the system. The antenna has an attractive appearance and does not detract from the looks of the home upon which it is installed. It is made by Illinois Seating Corp.

Condensers for High Gain Amplifiers

Life tests for 1,000 hours on the new round Type PC Sprague inverted screw-cap condensers show no failures, according to the manufacturer. Recently introduced, these units have been especially designed for high gain amplifiers such as are employed in television, etc., as well as for transmitters and exacting P.A. applications.

Like all Sprague high voltage condensers, the new units are both oil impregnated and oil filled. Type PC condensers are available in four ranges: 2 mf., 600 d.c. working voltage; 4 mf., 600 d.c. working voltage; 1 mf., 1,000 d.c. volts, and 2 mf., 1,000 d.c. volts. They are made by the Sprague Products Co.



Gas-Filled Condensers



● A LINE of gas-filled condensers has just been announced by the Lapp Insulator Company. Advantages claimed for this type of condenser are: minimum loss, because there is no large volume of dielectric in which loss can occur; minimum space requirements; zero change in capacitance with temperature; and for certain applications, the possibility of varying the capacitance while the condenser is in service. The main problem is to prevent leakage but to make the units sufficiently rugged to withstand normal usage. The problem was solved in these condensers by the use of gaskets automatically tightened by the gas pressure. All movable parts are mounted on ball bearings and all metal parts are of aluminum or bronze. The condensers are available in variable, adjustable and fixed types. They are intended for broadcast service.

New Rectifier Tube



● UNITED Electronics type 967 Grid Controlled Rectifier. This tube is a triode using a 2 1/2-volt, 5-amp. oxide coated filament. It is a half-wave tube with a maximum peak inverse voltage of 2500, a maximum peak forward voltage of 2500, and a maximum instantaneous anode current of 2 amps. The average anode current is 1/2 amp. and the maximum surge for not longer than one second is 20 amps. Used in a full-wave circuit employing two tubes, the maximum peak inverse voltage per tube is 7500, and the maximum peak forward voltage per tube is 2500. The maximum anode current is the same as for a single tube except that the average per tube is 1/4 amp.

New Catalogs

(Continued from page 373)

New Solar Catalog

● CATALOG No. 10 has just been issued by the Solar Manufacturing Corporation, makers of radio and television capacitors. This 32-page book describes the complete line, with special pages devoted to Solar's testing instruments. Also included are various new capacitors especially designed for television use.

Miller's Latest Catalog

● CATALOG No. 40, Miller Quality Radio Products; contains 32 pages, size 8 1/2" x 11"; published by J. W. Miller Co., Los Angeles, Calif. This new catalog is designed to meet the needs of engineers in the field or laboratory, technical students, experimenters, professional or amateur radio operators, and industrial engineers who need ready reference to coils for various radio and electric needs.

The catalog includes various types of iron core chokes, T.R.F. and superheterodyne coils, loop antennas, honeycomb and oscillator coils, coil kits which contain complete apparatus for making broadcast, all-wave, aircraft and other receivers, beat frequency oscillators, a complete new television foundation kit, variable condensers, multi-band switches, numerous types of dials, electric exposure meters for photography, push-button tuning assemblies, chassis, and too many other parts to list. There is also a supplementary sheet describing a band-pass T.R.F. coil kit for true fidelity receivers.

Bud Catalog No. 140

● THIS new 36-page Bud catalog has even more units in the manufacturer's well-known line of components than has heretofore appeared in preceding catalogs. For example, at least 25 different types of knobs are illustrated, and many of these come in several sizes and finishes. The catalog is conveniently laid out and well indexed. In addition, it includes highly useful tables, such as R.M.A. color code for resistors and fixed condensers; a drill chart; Ohm's Law; etc.

BARTER and EXCHANGE FREE ADS (continued)

I HAVE AMERICAN BOSCH RADIO 7-tube model 660, also a 640; these are all-wave receivers in the best working order. Would like to exchange for tubes. Robert C. Dole, 10 Clinton Ave., Rutland, Vt.

EXCHANGE—MEISSNER MIDGET, 3 tubes, 4 coils, also 40 s.w. parts. (List). Want 4-5 tube receiver. 100% QSL. All countries, QRA: C. Ducey, 514 N. 7th St., Phila., Pa., U.S.A.

WANTED—TO EXCHANGE INFORMATION and diagrams on treasure locators. Need 0-1 M.A. D.C. meter. Answer all, Shotguns and miscellaneous to trade for what have you. G. M. Bettis, Smeethwater, Texas.

WANTED—AUTO RADIO. PUBLIC address system, phonograph records, offers. Have: Printing, poultry fountains, water cooler, family record books, photographer's supplies, postmarks, antique organ, magazines, several cheap radios, etc. Jonah Dunn, Dellsview, W. Va.

300 x 20 TIRES. WILL SWAP FOR tube testers or other radio test equipment or Riders Manuals 1 to 9. S. J. Battery, 35 Potter Place, No. Adams, Mass.

CASH FOR A NATIONAL PRECISION dial and worm drive, with or without condenser, or will trade a complete paint spraying outfit. All all replies. Carl G. Gaer, Martins, Ill.

POWER SUPPLY, 400 VOLTS D.C. at 75 ma. and 2 1/2 volts A.C. center, tapped at 3 amperes for filaments. Requires 110 volts, 60 cycles. Want 8mm film or M. Rosen, 496 Stone Ave., Brooklyn, N. Y.

HAVE ONE-TUBE RADIO. Complete course in collecting roots and herbs for profit. Want anything useful. John Haynes, Doe Run, Missouri.

HAVE CHEMISTRY APPARATUS, value \$7 or more, will swap for a two- or three-tube all-wave battery receiver in working condition. Elmer Woods, Box 220, Mina, Nevada.

HAVE SKY BUDDY RECEIVER, rotary stencil duplicator, Schick shaver, U. S. stamps, 150 National Geographic, 100 Popular Mechanics, one minute camera, Want 16 mm projector films, screen, art books, or 7 Trakus, 349 Fifth St., Maline, Ill.

HAVE NEW EMERSON PORTABLE radio, value \$19.95; Argus candid camera, typewriter, 2 chromium desk lamps, stapling machine, Detroit radio, vibrating machine, also cash. Want social security stamping machine, or Hartman, 728 E. 9th St., N. Y. C.

WANTED—ORIGINAL COILS FOR Pilot A.C. Super Wave, all 160 meter coils. Will trade transmitting parts. Clarence Zachow, WTDQ, 5928 So. Eye St., Tacoma, Wash.

WILL TRADE—5 METER SUPER-regen. using 30 and 33 tubes, voltmeter, using 3" Triplet 0-1 M.A. meter for what have you? Jack Klein, 1983 Bryant Ave., Bronx, N. Y.

HAVE LOTS OF FICTION AND hunting and fishing magazines to trade for radio parts, science-fiction. F. H. Hood, 37 Club Drive, Greenville, S. C.

TRADE: MEISSNER IRON-CORE I.F. Weston 0-1/2-0 ma. meter, 4" Marco dial, 6-tube power transformer, 2 Hammarlund Star variables. Want xtal holders or other parts. WOULD, 3848 N. Rideaway Ave., Chicago, Ill.

HAVE RADIO PARTS, TUBES, etc., photographic equipment, 8 and 16 movie equipment and films, writer's books, plot aids, etc. Send your list for mine. L. B. McCullough, Mansfield, Ohio.

TRADE 1 GROSS CW25 TRANSMITTER 3 band with xtal minus tubes and 1 Sky Rider TRF5, 1934 receiver for typewriter, service equipment books or ham equipment, S. L. Chmielewski, 332 Johnson St., Jackson, Mich.

HAVE INSTRUMENTOGRAPH TAPES 7, 8, 12 and 13, also High Speed Candler Course, all in first class condition. Will swap for transmitting and power supply equipment. Write George, 438 Coalinga, Rochester, Pa.

TRADE 6L6—T50—337, ALSO other parts. Need high voltage transformers, parts. H. G. Gwinn, 935 W. 21, Anderson, Ind.

HAVE COLLECTION FIRST DAY covers worth over \$25. 8 Erector, Moviematic camera, Want testing equipment, radios, tubes, parts, manuals, magazines, books, etc. Howard Benson, 737 Regester Avenue, Govans, Baltimore, Md.

HAVE NATIONAL S.W.5—45's IN final stage, 7 sets of coils from 9 meters to 200, 40 and 80 band spread coils. Want tenkey code machine. J. J. Warner, 1547 E. 71 St., Cleveland, O.

HAVE SET OF HAWKINS ELECTRICAL Guide books. There are ten books in practically new condition, soft leather bound. Swap for S.W. receiver in good condition, either portable or otherwise. Don Stoner, 1134 Hickory, Fremont, Ohio.

SWAP 160 METER PHONE—CW transmitter, battery operated, and 6 volt music receiver for good A.C. broadcast super. Dorothy M. Smith, Lakeview, S. Dak.

WANT METERS, VIOLET RAY and electrodes, high-frequency parts. My swap list for yours. F. Copeman, 207 East 39th St., New York City.

WANTED—1939 RADIO AMATEUR Call Book. Will trade Popular Science and Popular Mechanics, Harry Serhey, 850 West 171 Street, New York, N. Y.

HAVE JOHN F. RIDER'S SERVICING Receivers by Means of Resistance Measurement, also Servicing Superheterodynes. These are in A-1 condition and are just new and the late editions. Want new tubes. Edwin Davenport, Pittsford, Vt.

WANTED—USED 2, 3 OR 4 TUBE long wave recr. 800—4000, 600—20,000 meter or what have you? I have plenty of parts. Nate Copeland, 48 Emerson St., Portland, Me.

HAVE PARKARD ELECTRIC RAZOR, F35 camera and accessories, S.W. transmitting tubes and parts. Want 16 mm projector and camera, 1/4 h.p. motor or what have you. L. Willner, 2731 N. 47th St., Phila., Pa.

HAVE CODE COURSE WITH MACHINE and tapes, also N.R.I. course. Want good S.W. receiver, Michael Tretnik, 2 Monroe Ave., Uniontown, Pa.

HAVE TRIPLEX TRI-SIGNAL CODE set. Would like an S.W. set, parts, or what have you. All mails answered. F. Richards, 327 Putman Street, W. Hazleton, Pa.

HAVE 12-INCH R.C.A. DYNAMIC speaker and an amplifier power supply. Want a short wave receiver, must have more than 3 tubes. All letters answered. H. L. Hale, Jr., 1758 Wallen Avenue, Chicago, Ill.

HAVE ATWATER KENT DYNAMIC speaker, Thordarson 500 V. transformer, 500 mfd. xmitting cond., 20, 40 meter coils for self-excited rig, tubes, resistors, dials. Want 2 1/2 meter transceiver, swap or buy. W3ENX, 1714 1/2 N. Front St., Philadelphia, Pa.

WILL TRADE 3,000 MIXED, 1600 diff. stamps from 130 countries with album, etc., for best offer. S.W. receiver. Prefer 10 meter Sky Buddy or better. Jay Seyler, 6407 Oaklea Ave., Superior, Wis.

HAVE L. C. SMITH STANDARD typewriter, some test equipment, meters, 2 genemotors, 5 meter transceiver. All perfect. Want Sky Champ, Challenger, Euy, S.W. Need receiver. Swap lists. Al Burnard, 11216 Buckeye Road, Cleveland, Ohio.

SCIENTIFIC CANDLE R JUNIOR wanted CW course. Desire to swap for 2 volt postcard projector, Electric Razor, collection of 500 stamps, R.C.A. earphone adapter (with instructions), SWL's 1 QSL 100%, Arthur Radcliff, 29 Day St., Fall River, Mass.

HAVE A NATIONAL RADIO INSTITUTE course. Desire to swap for 2 volt broadcast superheterodyne. G. E. Ward, Jr., Willis Wharf, Va.

NEW 53 TUBE AND CERAMITE socket, five-tube, five-meter receiver (new parts), 16mm Keystone projector, new. Late model .22 cal. target pistol, 6" barrel. Want Sky Buddy, QSL's answered. W. J. Weightman, Midland, Ind.

HAVE P. E. CELL, POP SCIENCES and Mechanic, movie projector, small radio, American Boy, BB gun, radio parts, induction coil, B. H. power supply (less tubes), 1500 volt trans. Douglas Phelps, Sidney, N. Y.

HAVE EILEN HF35 THREE-TUBE transmitter kit and HV475 power supply. Also Doerle BSSW receiver. Want late model tube tester or what do you offer? M. Konutnik, 297 DeKalb Ave., Brooklyn, N. Y.

SWAP NEW 3 POWER BINOCULARS, with built-in compass. New electric pants-presser. Value \$1.00, 6 new fixed condenser, new watch—needs cleaning. Want anything in radio. Donald Nelson, 138 Johnson Ave., Dumont, N. J.

HAVE STAMP COLLECTION: OVER 2,000 diff.; over 6,000 mixed; plenty high value S. Americans. One modern album; two blank albums. Catalogue hinges. Want Sky Buddy, Howard 430 good condition. Robert Grzeskowiak, 302 Adams St., Alpena, Mich.

WANTED UNIVERSAL CLIPPER OR similar set. Factory built. No earlier than 1937. Must be in excellent condition. Will pay about \$10.00. Best offer taken. Write details, Harry Monk, 90 Main St., Bridgton, Maine.

WANTED GASOLINE ENGINE 1/4 Horse Power. Exchange for carphones. 2 motors, model Battery Boat motor, stamps, 5" Magnet speaker, and radio tubes, and alcohol blow torch. Arthur Bently, 645 New Park Ave., Elmwood, Conn.

WILL GIVE LARGE STAMP COLLECTION for radio equipment. Almost every stamp issuing country in the world is represented. Contains many U. S. and British Colonials. J. Weiss, 547 E. 103 St., Cleveland, Ohio.

COMPLETE 40 WATT PHONE & C. W. transmitter. Trade for motor or what have you? Jimmy Gwinn, 935 W. 21, Anderson, Ind.

WOULD LIKE TO BUY A USED Radio Amateur Call book. Will exchange post card views. Mrs. Lucy E. Jennings, RFD 1, Box 68, Gladys, Va.

SEND UP TO 5 PICTURE POST-cards with return postage and receive same number in exchange. I also have a 4 tube electric radio to swap. What have you? M. Deskin, Windhorst, Texas.

HAVE EILEN HF 25 CHASSIS and cabinet for transmitter. Also HF 35 chassis and cabinet. Am interested in teleplex or test equipment. Isidore Samkofsky, 213 S. 3rd, St., Bklyn., N. Y.

HAVE RADIO PARTS TO EXCHANGE. What am I offered? Would like to get receiver or preselector. Exchange QSL cards with everyone. Bill Basins, 6811 S. Rockwell St., Chicago, Ill.

ONE PHILCO CAR RADIO IN EXCHANGE for saxophone. Also a large number of match covers to exchange. All replies answered. Robert J. Donaldson, Eighty-Four, Pa.

HAVE REMINGTON PORTABLE with case, Compressor and 1/2 motor. Gross 3 tube Short Wave battery receiver, 4 coils 3 Volt tubes. Want Hallfrater's Sky Rider SX 17, Jensen, 211 East 200 St., Bronx, N. Y.

TRADE GE 24/1500 VOLT DYNAMOTOR; Mimeo-graph 110 volt DC to AC converter; 8 HP Outboard motor; 35 mm. projector; Ranker signal oscillator. Wanted—Radio test equipment and manuals; 16 mm and 85 mm sound or silent projector, RCA 16mm sound camera, Wm. Hansen, Niles, Mich.

WANT RIDERS MANUALS, SIGNAL generator, tube tester, service equipment and parts, heavy PM speakers, gasoline engine, mike stand, typewriter. Have coon, opossum, skunk, and rabbit hounds, science-fiction, amplifier, crystal microphone, Hadley Hopper, Herrick, Ill.

WANTED: A SKY BUDDY RECEIVER, not more than two years old in exchange for Million tube tester, brand new, or RCA all-wave receiver, model 679, 1937. Richard Walker, 2351 D'Amplain St., N. W., Washington, D. C.

WANTED—33 OR 30 TUBE SCOTT Receiver, State Price, condition. Have DeForest Radio Course, oil filter condensers, RCA phonograph Oscillator, Auto Radio, Triplet tube tester, meters, tubes, Hallfraters, O. F. Klein, 2335 N. 39th St., Milwaukee, Wis.

HAVE 2 TUBE SW. HEARD 24 countries. Also have N.R.I. course, 1 tube portable, 3 power packs, 1 tube Philco. Want Sky Buddy or V. O. M. Robert Perlich, 3635 S. Wood St., Chicago, Ill.

WANTED—A PRE-SELECTOR IN first-class condition. Will trade merchandise and cash. Give full particulars. Herman Flecher, 626 Carlton Ave., Brooklyn, N. Y.

HAVE CANDLER COURSE. WOULD like to swap for good ham receiver. Course is in good condition. Harry Dent, 112 Beaver St., New Britain, Conn.

WILL TRADE: 616G OSCILLATOR, two crystal sockets with switch. No power supply. Meter included. Crystal not included. Antenna tuner included. Next job. What have you? W3SNA, 305 Grant, Greensburg, Pa.

TRADE ADVANCED CANDLER course for a DB 20 Pre-selector. C. D. Larimore W9HR8, 408 East 11th St., North Platte, Nebr.

WILL SWAP X-RAY MACHINE complete except tube for test equipment or what have you? William Dale, 1123 Marion St., Winona, Minn.

WANTED: GHIRARDI'S MODERN Radio Servicing and test equipment. Have 1928 Chev. car parts in very good condition. Also many receiver parts. F. Ryder, 764 Monroe St., Brooklyn, N. Y.

WILL SWAP TRANS-ATLANTIC first day covers, stamp collections and 350 shot air rifle for telegraph key, transmitter parts or good dry cells. Rubin Shore, 32 Davenport St., Pittsburgh, Pa.

WANT SERVICE MANUALS, TEST instruments and radio parts. Have for trade phonograph records, radios and various radio parts or cash. Send list or price. Eugene Patterson, 743 South West St., Winchester, Ind.

HAVE NOV. '38 TO JULY '39 Popular Science, Civil War rifle, electric train. '38 ARRL handbook, 250v. power supply, 7 1/2 erector, size 17 complete scout uniform. Want good pair of carphones such as Bruco or Western Electric or will trade for what have you. H. Patchen, Sidney, N. Y.

SWAP NEW D-104 ASTATIC CRYSTAL mike and 337 tube, photograph, etc. equipment. Harry Evans, W3TIB, 296 New Lots Ave., Brooklyn, N. Y.

(Continued on following page)

BARTER and EXCHANGE FREE ADS (continued)

World S-W Stations

(Continued from page 348)

I HAVE 150 WATT TRANSMITTER Trade Rack, and Panel. Six onagers on rollers. 6L69 to T20, to T53 Pone or C. W. T220's modulator. Will include maps, call book, handbooks, extra 866's etc. What have you? Leonard Wright, Creighton St., N. Cambridge, Mass.

WANTED: DELCO COMBINATION starter-generator as was used on Lincoln, Cadillac, and Buick; must have 2 commutators. Also 12 volt Dodge generator. State prices. Gerald E. Splitstoser, Stacy, Minn.

WANTED A GOOD 5 TO 10 ME- tor converter. Have back issues Popular Mechanics. Short Wave and Radio Craft mags. Lifetime lonely heart club membership. C. Holstein, 246 E. 148 St., Bronx, N. Y.

HAVE 2 1/2 x 4 PRINTING PRESS with type, 35 good boy's books, pair Northland akla. Want 6.3-600 volt power supply rated at about 150 ma. Also want n. meter crystal. Or? Ovide Lee, 220 Adams, Albena, Mich.

HAVE CAPACITY METER, MILLI-ammeters, voltmeters, power transformers, radio parts. Want 16 mm. movie camera or what have you? John D. Williams, 1033 Stuyvesant Ave., Irvington, N. J.

HAVE SMALL AC MOTOR. 710 Headrite Analyzer, College Chemistry Kit, and 1000 stamps. Want late edition Ghirardi Physics and Serriving books and/or 0-1 Mil D'arsonval meter. Harry Singer, 328 Neptune Ave., Brooklyn, N. Y.

HAVE C MELODY SAXOPHONE with case, archery set, guitar, early edition American Cyclopaedia (16 vol.) assorted National Geographic, Philco speaker model 70. Want 35mm. candid camera. Walter Clemmens, 44 North Front Street, Reading, Pa.

SWAP QST'S FOR PHOTOGRAPHIC equipment or what have you? May, June, Aug. 1925; Feb.-Dec. '26; Feb. '27; Jan. '29; June '29; Aug.-Nov. '29; Jan. '30; April '31; Nov. Dec. '31; Jan. Oct. '32. Herman Yellin, W42J1, 351 New Lots Ave., Brooklyn, N. Y.

WILL SWAP A S.W. RECEIVER, S.W. Converter, radio parts, radio mags., radio tubes and small photo enlarger for a good code machine or good S.W. Receiver. Anthony Conlin, 83 Westfield, Rock Hill, Mass.

HAVE 1936 ZENITH RADIO. LESS tubes speaks, one set of headphones, 1/2 h.p. motor, transformers, speakers, condensers, other items. Want tube tester, or tester of any kind, and meters. Ward Smith, 7428 Idlewild Street, Pittsburgh, Pa.

WANT 1200 VOLT, 200 MIL. TRANS- former, 40 m. extal and communications receiver. I have cash. G. A. Harry Greenberg, 701-86 St., Brook- lyn, N. Y.

TRADE—MIMOGRAPH, 8MM CAMERA and 8mm and 35 mm projectors. 10 battery size projector. Want—Motion picture or still photos of foreign lands. Prefer oddities, strange sights or unusual customs. Wm. Hansen, Niles, Mich.

TRADE: 100 PHOTOS MOVIE actresses, 8 x 10" for camera or small electric radio. Also have S.W.T.'s, Radio News, QST's, stamp book by Kimble, E. V. Marquez, 515 Norumbeka, Montclair, Calif.

SWAP LIONEL TRAIN SET (LIKE new, cost fifteen dollars) 3,500 stamps, radio parts for Sky Buddy, SW3's any good short wave receiver. Swap QSL's or SWL's. E. Kulze, 137-19 Carson St., Springfield, L. I., N. Y.

SWAP FOR LOW POWERED C.W. or phone xmitr. Denny Shute model golf clubs, one year old. Cost \$40.00. All steel shafts. Complete set of iron, driver and brassie. Some balls, tees. Elmer Ertman, 1213 Williamson, Saginaw, Mich.

WANT RIDER AND GHIRARDI manuals, small plate camera, adj. developing tank, tube tester, 8 mm camera, projector, supplies. Have receiver, auto radio, 1/2 H.P. motor. Stevens, 222 colns. cash. W. J. Clason, 295 8th Street, Troy, N. Y.

WANTED: ALL KINDS OF INDIAN relics, such as arrowheads, spear points, etc. Have radio parts to trade but prefer to buy, so what say? Swap picture postcard. Mike Hovchuk, 5547 Saxon Drive, Garfield Hts., Ohio.

WANT "GHIRARDI'S RADIO PHYSICS Course." Handbook of Chemistry and Physics, and other radio books (theoretical or service). Have radio metal tubes, etc. H. G. Dinacrus, 800 6th St., Reading, Pa.

I HAVE NEW SHURE ZEPHYR crystal pickup, latest model. Excellent for high fidelity equipment. Heavy duty motor, self-starting, 10" turntable. Want a microphones, Astatic 104, Irving Goldstone, 323 Alabama Avenue, Brooklyn, N. Y.

HAVE CHEMICAL EQUIPMENT, value \$25.00. Want rifle, camera, shotgun, fishing rod, sporting equip- ment, radio parts, magazines or code instructor. I QSL 100%. W. R. Graham, 38 Wardman Road, Kenmore, N. Y.

HAVE 200 WATT PIONEER GASO- line Motor Generator, Philco 11-tube super radio parts, all types tubes. I use for experimenting. Send for my list and what have you. H. Silber, Lake Ronkonkoma, N. Y.

WANTED: TRANSMITTER OR COM- munications receiver. Will exchange Curtiss Robin Kax model and Brown, etc. Model B motor for one Eugene Morgan, Roebuck Springs, Box 350, Route 5, Birmingham, Ala.

HAVE 2 STANCOR POWER PACKS delivering 6 volts A.C.-D.C., at 8 amps. each. Used to test auto receiver or as light welder. What have you to offer? Irving Hudeac, 323 Alabama Avenue, Brooklyn, N. Y.

WILL SWAP MOTION PICTURE projector, film, one-tube radio and parts for good telescope or what have you. Gerald Engleka, Box 262, Grant Town, W. Va.

WANTED—SENIOR INSTRUCTO- graph, complete outfit, key tapes, etc. Write for trade particulars. Henry F. Heckert, 910 Coolbaugh Street, Bed Oak, Iowa.

I HAVE TWO BATTERY CHARGERS, a hand-driven 16mm. projector, No. 3 1/2 Chemcraft set, radiotopian and a 6-volt generator, to trade for meters, late magazines, callbook, tubes, SW receiver, etc. WDMR, Mandysville, Mo.

TRADE PICKWICK CANDID TYPE camera, takes 16 instantaneous and time exposures on Kodak V127 roll- film, with case, cost \$1.75. Want box camera, pair of headphones or what have you? Alexander Podstepny, 217 Pine St., Phila., Penna.

SWAP WESTON TUBE TESTER, counter type model 674. For Supreme "585" Weston or Supreme oscillator 110 volt operation A.C. "60 Cycle" etc. Transformers for 20 W. amp. for tube condenser tester. David Dehston, 69 W. 23 St., Chattanooga, Tenn.

SUPREME 89-D: RIDER MANUAL V: 96 lesson guitar course; violin, and limited amount of cash. Want amateur equipment. James C. Smith, 71 Reynolds St., Rock Hill, S. C.

WILL TRADE 1180-S SUPERIOR tube tester and super allmeter and unused Cine Kodak Model B movie camera for communication receiver such as Howard 438, NC44, or Hallcrafters. Write Merlin Upshaw, Hominy, Okla.

WANTED—CORRESPONDENCE ALL over the world with fellows interested in radio. Will trade stamps, maga- zines, radio parts. We QSL 100%. Huber Krist, 2505 West 69th Street, Chicago, Ill.

HAVE METERS, ALL TYPES, radio parts, time relays. Will accept all classes of goods, your list for mine. Lupo, 1408 E. 63rd St., Chicago.

WANT 3- OR 4-TUBE S-W RADIO or radio parts. Have new Alex Taylor tennis racket, stamps and Univex camera, also world's smallest camera. All replies answered. Harold Tucker, West Point, N. Y.

HAVE 260-LB. ADJUSTABLE MILO bar bell; 3 dumbbells, 2 kettlebell handles; 12 lock collars (2 "wrench- less"), wrench; "York," "Milo" Bar- bell Course. Trade for Sky Buddy or similar make set. George Murakami, Welmar Sanatorium, Welmar, Calif.

WANT A.C. SHORT WAVE RE- ceiver. Have Spartan 6-tube receiver, Robt. Barber, 57 Beech St., Belle- ville, N. J.

HAVE PAIR NEW 852 AND 303 xmtr/lt tubes, 20 watt xmtr/lt with key, power supply and tubes. Tunker battery charger and all radio parts. Need a good quality. Harry Parker, Sibley, N. J.

WANTED A.C. TYPE COILS FOR Nat. SW3, using 58's, 160 and 20 meter bands. Will pay cash. QTH Bob Bennett, 618 Herkley Ave., Elmhurst, Ill.

WOULD LIKE TO EXCHANGE postcards, SWL cards and stamps. All letters answered. Have Jan., Feb., March issues of Radio-Craft to swap for other mags. Walter Monk, 51 Vineyard St., Providence, R. I.

WANT A.C. SHORT WAVE RE- ceiver such as Sky Buddy. Have RCA R.C. 9 tube superhet. Western Electric hand set, Radiola balanced amplifier. Rudolph Zirm, 79 Beech St., Belle- ville, N. J.

WANT 2- OR 3-TUBE S.W. RECVR. Have tubes, power transformers, audio trans., speakers and other parts. Dick Conrad, Saco, Mont.

WANT TO BUY OR TRADE FOR automobile vibrator tester. Solar con- denser tester, oscillator or most any- thing in test equipment or a short wave receiver of the larger type. Sudar Pro. etc. P. Villeplazie, Chanute, Kans.

HAVE WESTON 301, 50 AND 500 ma. Want Photographic supplies, trays, magazines, printers, lenses, etc. or what have you? Joe Novak, 2535 So. Highland Ave., Berwyn, Ill.

WANTED—MARCH, 1932 ISSUE OF Popular Mechanics for cash, recent radio mags., parts, etc. Clarence Karz- mark, Casselton, N. D.

WILL TRADE NEW PORT. UNDER- wood 135ewriter, Ralston record tele- graph course, Neon sign trans. (7500 volts), radio parts, telephone and test equipment for an oscillator, radio course, phono motor and pickup mike or? Len Farler, Silva, N. C.

WANT GHIRARDI'S RADIO PHYS- ics. Have stamps, also some radio parts. State your wants for this book. SWL's exchanged, foreign. I also want phono Pick-up, Daniel Platak, 225 Division Ave., Brooklyn, N. Y.

HAVE NEW ELECTRO- VOICE model V-3 mike (list \$50.00); Hickok model 49X volt-ohm meter; 18-foot "Old Town" canoe; RCA 804. Want 16 gauge shotgun; record player; 807; meters, test copper, 17 South 17th, Fort Dodge, Iowa.

HAVE REMINGTON IMPROVED model 6 22 rifle in good condition, stamps, candid camera, lenses for 100X telescope. Want short wave receiver, 9 to 560 meters A.C. M. Cohen, 6139 Locust Street, Phila., Penna.

WANTED—OLD TRANSMITTING tubes, burned out or obsolete, and old license plates from anywhere. Have postcards, postmarks, match covers, etc., radio parts. Carl Roman, 354 Dakota Street, Paterson, N. J.

WILL TRADE CANDLER CODE Course, 5-tube T.R.F. Bradley radio- stats and others for small ham superhet or testing equipment, W9IMJ, 618 N. Central Ave., Chicago.

INTERESTED IN BUYING ANY Ham equipment, including meters at the right price. Send your offer. Peter Bennett, 628 Means Ave., Belle- vue, Pa.

WANTED—SKY BUDDY, HOWARD or any other factory made communica- tions receiver. Must be in good con- dition. Pay cash and radio parts. QRA: Earl Youngquist, 1121 12 St., Lorain, Ohio.

SWAP 8" RCA SPEAKER TUBES, size 13 Scout uniform, microscope, motor, stamps, Arbans cornet course, old pop. music and books for what have you? I QSL 100%. John Ed Wilson, Millington, Tenn.

WANTED—6 VOLT GASOLINE driven battery charger, will pay cash or swap. Have Radio Physics Course, tubes, books, etc. State lowest cash price, condition of the unit. W9CDK, James N. Glass, R.R.1, Box 17, Eddyville, Ky.

SWL EXCHANGE

UNITED STATES

J. I. VAUGHT, P.O. Box 1424, New Orleans, La.

PHILIP BRADY, Box 67, McComb, Miss.

ERIC BUTCHER, Cokerille, Wyo.

JACK WELSH, Kingston, Illinois.

FRANKLIN O. PEASE, 3160 Dodge, No. 9, Omaha, Nebr.

BILL WILLIAMS, 1254 E. 100 St., Cleveland, O.

ELDRED AUBREY, 10 Calverley St., Houghton, Mich.

ODDGER BARNESON, 3060 Ros- well St., Los Angeles, Calif.

EARLE S. MILLER, P.O. Box 663B, East Worcester, N. Y.

BOB LARSON, 618 N. June St., Hollywood, Calif.

JOHN L. BALLIN, W40H58, 40 East 66 St., New York, N. Y.

CONRAD ALBERT, 49 Chadel St., Shirley, Mass.

BOB PACKSCHER, 268 E. 237 Street, Bronx, Woodlawn, N. Y.

BOB GREENOUGH, 46 Chapel Street, Shirley, Mass.

WALTER McMAHAN, 320 Hunstock Ave., San Antonio, Texas.

ALLEN J. SCHWARTZ, P.O. Box 695, Albany, N. Y.

BOB JOHNSON, Box 146, Logan, W. Va.

ENGLAND

RAY SMALL, 21 The Paddocks, Wem- bley Parks, Midds.

CLIFTON C. RICHARDS, 21 Clar- ence St., Penzance, Cornwall.

HARRY RICE, 129 Austin Street, Kings Lynn, Norfolk.

MAURICE COUTU, 51 Wingfield Street, Portsmouth.

INDIA

DARA, % N. Mehta, Esqr., Kirpam St., Surat.

PORTUGAL

ANTONIO DO VALLA DOMINGUES, Av. Ivens 72, Cruz Quebrada, Lisboa.

SCOTLAND

COLIN SMITH, 49 Eastbank, Forfar, Angus.

SOUTH AFRICA

EDWARD TANNER, "St. Cair," Holdens Rd., Plumstead, C. P.

Mc.	Call		
6.276	OAX46	LIMA, PERU, 47.63 m., Addr. Apartado 1242. Daily 7-10.30 pm.	
6.280	HIIG	TRUJILLO CITY, D. R., 47.77 m., 7.10-9.40 am., 11.40 am.-2.10 pm., 3.40-9.40 pm.	
6.243	HIIN	CIUDAD TRUJILLO, D. R., 48 m., Addr. "La Voz del Partido Dominicano." 12 n.-2 pm., 6-10 pm.	
6.236	HRD	LA CEIBA, HONDURAS, 48.12 m., Addr. "La Voz de Atlantida." 8-11 pm.; Sat. 8 pm.-1 am.; Sun. 4-6 pm.	
6.210	—	SAIGON, INDO-CHINA, 48.28 m., Addr. Radio Boy-Landry, 17 Place A. Foray. 4.30 to 5.30-9.15 am. 11.45 pm.-1 am.	
6.200	HI8Q	CIUDAD TRUJILLO, D. R., 48.36 m. Irregular.	
6.190	JLK	TOKYO, JAPAN, 48.47 m. 8-9.30 am.	
6.190	HVJ	VATICAN CITY, 48.47 m., Mon., Wed., Thur., Sat. 2-3.30 pm., Tues., Fri. 2-3 pm. Thur. also 3-3.30 pm.	
6.190	T02	GUATEMALA CITY, GUAT., 48.47 m., Addr. Dir. Genl. of Electr. Commun. Relays TGI Mon.-Fri. 6-11 pm., Sat. 6 pm.-3 am. Suns. 7-11 am., 3-8 pm.	
6.186	HIIA	SANTIAGO, D. R., 48.5 m., Addr. P. O. Box 423. 7 am.-5 pm.	

49 Met. Broadcast Band

6.170	WZXE	NEW YORK CITY, 48.62 m., Addr. Col. B'cast System, 485 Madison Ave., 12 m.-1 am. in November.
6.153	HIBN	MOCA CITY, D. R., 48.75 m. 6.40-9.10 pm.
6.150	HJDE	MEDELLIN, COLOMBIA, 48.78 m., 9.30 am.-1 pm., 5-11.30 pm.
6.150	CJRO	WINNIPEG, MAN., CANADA, 48.78 m., Addr. (See 11.720 mc.) Daily 6 pm.-12 m., Sun. 5-10 pm.
6.150	ZPI4	VILLARRICA, PARAGUAY, 48.78 m. 4-6 pm.
6.148	ZTD	DURBAN, SOUTH AFRICA, 48.8 m., Addr. (See ZRO, 9.753 mc.) Daily 12.40-3.45 pm., Sat. till 4 pm., Sun. till 3.20 pm.
6.147	ZE8	BULAWAYO, RHODESIA, S. AFRICA, 48.8 m., Daily 12.05-1, 4.30-6.30, 9.30-11 am., 12.05-4 pm., Sun. 5-7 am., 10 am.-2 pm.
6.140	WPIT	PITTSBURGH, PA., 48.83 m., Addr. Westinghouse Electric & Mfg. Co. Relays KOKA 10 pm.-12 m.
6.140	LEOPOLVILLE, BELGIAN CONGO,	48.83 m. Suns. 5.35-7 am.
6.140	SP48	WARSAW, POLAND, 48.83 m., 3-5.30 pm.
6.137	CR7AA	LAURENCO MARQUES, PORT. E. AFRICA, 48.87 m., Daily 12.05-1, 4.30-6.30, 9.30-11 am., 12.05-4 pm., Sun. 5-7 am., 10 am.-2 pm.
6.133	XEXA	MEXICO CITY, MEX., 48.93 m., Addr. Dept. of Education. Daily 8-11 am., 2.30-4 pm., 7.30 pm.-12.45 am. Sun. 1.30 pm.-12.45 am.
6.130	VP38C	GEORGETOWN, BRIT. GUIANA, 48.94 m. 9-10 am., 2.15-6.30 pm., Sun. 5.30-11.30 am., 3-5 pm.
6.130	TIEM	SAN JOSE, COSTA RICA, 48.94 m., "El Mundo" Apartado 1049. 11 am.-11 pm., Sun. 10 am.-6 pm.
6.130	CHNX	HALIFAX, N. S., CAN., 48.94 m., Addr. P. O. Box 998. 7 am.-11.15 pm. Sat. 8 am.-11.30 pm. Sun., Noon-11.15 pm. Relays CHNS.
6.130	HS4PJ	BANGKOK, SIAM, 48.94 m. Daily Ex. Mon. 8-10 am.
6.130	LKJ2	JELOY, NORWAY, 48.94 m. Noon-6 pm.
6.125	CXA4	MONTEVIDEO, URUGUAY, 48.98 m., Addr. Radio Electrico de Montevideo, Mercedes 823. 8 am.-Noon. 2-10 pm.
6.122	HP8M	PANAMA CITY, PAN., 49 m., Addr. Box 1045. 10 am.-1 pm., 5-11 pm.
6.122	FK8AA	NOUMEA, NEW CALEDONIA, 49.00 m., Radio Noumea, Addr. Charles Gaveau, 44 Rue de l'Al- ma., Wed. & Sets. 2.30-3.30 am.
6.120	W2XE	NEW YORK CITY, 49.01 m., Addr. See 6.170 mc., 12 m.-1 am. in October.
6.117	XBUZ	MEXICO CITY, MEX., 49.03 m., Addr. 5 de Mayo 21. Relays XEFO 9 am.-1 pm., 7 pm.-2 am.

Mc. Call		Mc. Call	
6.116 —	SAIGON, FR. INDO-CHINA, 49.05 m., 6 or 7 to 9.30 am., 11-11.30 pm.	6.040 WSLA	BOSTON, MASS., 49.65 m., Addr. University Club, 7-9 pm. exc. Sat. & Sun. Sun. 2.30-6 pm.
6.115 OLR2C	PRAGUE, BOHEMIA, 49.05 m. (See 11.40 mc.)	6.033 HP5B	PANAMA CITY, PAN., 49.75 m., Addr. P. O. Box 910, 10.30 am.-2, 6-10 pm.
6.110 XEGW	MEXICO CITY, MEX., 49.1 m., Addr. La Voz de Aguila Azteca desde Mex., Apartado 8403. Relays XEJW 11 pm.-1 am.	6.030 CFVP	CALGARY, ALTA, CAN., 49.75 m. Thur. 9 am.-1 am.; Sun. 12 n.-12 m.
6.105 HJAB	MANIZALES, COL., 49.14 m., Addr. P. O. Box 175, Dly. 5.30-10 pm. Sat. to 11 pm. Sun. 2.30-5 pm.	6.030 RW96	MOSCOW, U.S.S.R., 49.75 m. 1-3, 4-7 pm.
6.100 YUA	BELGRADE, JUGOSLAVIA, 49.18 m. 1-3, 6.30-8.30 am., Noon-6.30 pm.	6.030 OLR2B	PRAGUE, BOHEMIA, 49.75 m. (See 11.875 mc.) Off the air at present.
6.100 W9XF	CHICAGO, ILL., 49.18 m., 4-6.50 pm. (Sat. to 5.30 pm.) 1-2 am.	6.023 XEUW	VERA CRUZ, MEX., 49.82 m., Addr. Av., Independencia 98, 10 pm.-1 am.
6.100 WNBI	BOUND BROOK, N. J., 49.18 m., Addr. Natl. Broad. Co. 9 pm.-12 m.	6.020 DJC	BERLIN, GERMANY, 49.83 m., Addr. (See 6.079 mc.) 11.30 am.-4.30 pm.
6.097 ZRK	KLIPHEUVEL, S. AFRICA, 49.2 m., Addr. S. African Broad. Co., Johannesburg. Daily 12 n.-4 pm., Sun. 12 n.-3.20 pm.	6.017 HI3U	SANTIAGO DE LOS CABALLEROS D. R., 49.84 m. 7.30-9 am., 12 n.-2 pm., 5-7 pm., 8-9.30 pm.; Sun. 12.30-2, 5-6 pm.
6.097 ZRJ	JOHANNESBURG, S. AFRICA, 49.2 m., Addr. S. African Broad. Co. Daily exc. Sat. 11.45 pm.-12.50 am.; Daily exc. Sun. 3.15-7.30, 9-11.30 am. (Sat. 8.30-11.30 am.) Sun. 3.30-4.30 or 4-5 am., 5.30-7, 9-11.30 am.	6.015 PRAB	PERNAMBUCO, BRAZIL, 49.85 m., Radio Club of Pernambuco, 4-9 pm.
6.095 JZH	TOKYO, JAPAN, 49.22 m., Addr. (See 11.800 mc., JZJ.) Irregular.	6.010 OLR2A	PRAGUE, BOHEMIA, 49.92 m. Addr. (See OLR, 11.84 mc.) Irreg.
6.090 ZNS	NASSAU, BAHAMAS, 49.26 m., Addr. Dir. of Tel. East St., Nassau. 1.30-2, 8-9 pm.	6.010 COCO	HAVANA, CUBA, 49.92 m., Addr. P. O. Box 98, Daily 7.55 am.-12 m., Sun. until 11 pm.
6.090 CRCX	TORONTO, CAN., 49.26 m., Addr. Can. Broadcasting Corp. Daily 6.45 am.-4 pm., Sun. 9.30 am.-11 pm.	6.010 VK9MI	S. S. KANIMBLA, 49.92 m. (Travels between Australia and New Zealand). Sun., Wed., Thurs. 6.30-7.30 am.
6.090 ZBW2	HONGKONG, CHINA, 49.26 m., Addr. P. O. Box 200, Irregular.	6.010 CJCX	SYDNEY, NO'VA SCOTIA, 49.92 m. Relays CJC8 7 am.-12.30 pm.
6.090 ZHJ	PENANG, FED. MALAY STATES, 49.26 m., 6.40-8.40 am., except Sun., also Sat. 11 pm.-1 am.	6.007 XYZ	RANGOON, BURMA, 49.94 m., 6.30-10 am., 9-11 pm., Sat. 9.30-11 pm.
6.083 VQ7LO	NAIROBI, KENYA, AFRICA, 49.31 m., Addr. Cable and Wireless, Ltd. Mon., Fri. 5.30-6 am., 11.15 am.-2.15 pm., also Tues. and Thurs. 8.15-9.15 am.; Sat. 11.15 am.-3.15 pm.; Sun. 10.45 am.-1.45 pm.	6.007 ZRH	ROBERTS HEIGHTS, S. AFRICA, 49.94 m., Addr. (See ZRK, 9.606 mc.) Daily exc. Sun. 9.30 am.-3.30 pm.; Sun. 9 am.-12 n., 12.15-3.15 pm. Daily exc. Sat. 11.45 pm.-12.50 am.
6.080 WCB1	CHICAGO, ILL., 49.34 m., Addr. Chicago Fed. of Labor, Relays WCFL irregular.	6.005 HPBK	COLON, PAN., 49.96 m., Addr. Box 33, La Voz de la Victor. 7-9 am., 10.30 am.-1 pm., 5-11 pm.
6.080 CRY9	MACAO, MACAO, 49.34 m., Tues. 8.30-10 am.	6.005 CFCX	MONTREAL, CAN., 49.96 m., Can. Marconi Co. Relays CFCF 6.45 am.-12 m.; Sun. 8 am.-10.15 pm.
6.080 HP5F	COLON, PAN., 49.34 m., Addr. Carlton Hotel. 7-9 pm.	6.005 VE9DN	DRUMMONDVILLE, QUE., CAN., 49.96 m., Addr. Canadian Marconi Co.
6.079 DJM	BERLIN, GERMANY, 49.34 m., Addr. Broadcasting House. Irregular.	6.002 CXA2	MONTEVIDEO, URUGUAY, 49.98 m. Addr. Rio Negro 1631. Relays LS2, Radio Prieto, Buenos Aires 5.30-10.30 pm.
6.077 OAX4Z	LIMA, PERU, 49.35 m. Radio National 7 pm.-1.30 am. Except Sun.	6.000 XEBT	MEXICO CITY, MEX., 50 m., Addr. P. O. Box 79.44, 10 am.-1.45 am.
6.075 VP3MR	GEORGETOWN, BRI. GUIANA, 49.35 m. Sun. 7.45-10.15 am.; Daily 4.45-8.45 pm.	5.990 ZEA	SALISBURY, RHODESIA, S. AFRICA, 50.08 m. (See 6.147 mc., ZEB.) Also Sun. 3.30-5 am.
6.070 CFRX	TORONTO, CAN., 49.42 m. Relays CFRB 6.30 am.-11 pm., Sun. 9 am.-11 pm.	End of Broadcast Band	
6.070 VE9CS	VANCOUVER, B. C., CAN., 49.42 m. Sun. 1.45-9 pm., 10.30 pm.-1 am.; Tues. 6-7.30 pm., 11.30 pm.-1.30 am. Daily 6-7.30 pm.	5.977 CS2WD	LISBON, PORTUGAL, 50.15 m., Addr. Rua Capelo 5, 3.30-6 pm.
6.069 —	TANANARIVE, MADAGASCAR, 49.42 m., Addr. (See 9.51 mc.) 12.30-12.45, 3.30-4.30, 10-11 am., Sun. 2.30-4.30 am.	5.975 OAX4P	HUANACAYO, PERU, 50.16 m. La Voz del Centro del Peru. 9-11 pm.
6.065 SBO	MOTALA, SWEDEN, 49.46 m. Relays Stockholm 4.15-5 pm.	5.968 HVJ	VATICAN CITY, 50.27 m. Off the air at present.
6.060 —	TANANARIVE, MADAGASCAR, 49.5 m., 12.30-12.45, 3.30-4.30, 10-11 am.	5.950 HH25	PORT-AU-PRINCE, HAITI, 50.37 m., Addr. P. O. Box A103, 7-9.45 pm.
6.060 YDD	BANDONG, JAVA, 49.5 m., 5.30 am. on.	5.940 OAX2A	TRUJILLO, PERU, 50.51 m., Tue., Thu., Sat., Sun. 7-10 pm.
6.060 WLWO	CINCINNATI, OHIO, 49.5 m., Addr. Crosley Radio Corp. Relays WLW Sun. 7 am.-6.30 pm., Mon., Tues., Thur. 5.45-11 pm., Sat. to 10 pm. Other days to 10.30 pm.	5.900 ZNB	MAFEKING, BRI. BECHUANALAND S. AFRICA, 50.84 m. Addr. The Govt. Engineer, P. O. Box 106, 6-7 am. 1-2.30 pm. Ex. Suns.
6.060 WCAI	PHILADELPHIA, PA., 49.5 m., Tues., Wed., Fri. 5.30-6.15, 6.30-11 pm. Sat. 11 pm.-1 am. Sun. 6.30-11 pm.	5.900 TILS	SAN JOSE, COSTA RICA, 50.85 m. 6-10 pm.
6.054 HJAA	PEREIRA, COLOMBIA, 9 am.-Noon, 6.30-10 pm.	5.885 HI9B	SANTIAGO, D. R., 50.95 m. Irregular 6-11 pm.
6.050 GSA	DAVENTRY, ENGLAND, 49.59 m., 6 am.-6 pm.	5.875 HRN	TEGUCIGALPA, HONDURAS, 51.06 m. 1.15-2.16, 8.30-10 pm.; Sun. 3.30-5.30, 8.30-9.30 pm.
6.045 XETW	TAMPICO, MEXICO, 49.6 m. Irregular 7-11 pm.	5.855 HI1J	SAN PEDRO DE MACORIS, D. R., 51.25 m., Addr. Box 204, 11:40 am.-1.40 pm., 6.10-8.40 pm.
6.040 WDJM	MIAMI BEACH, FLA., 49.65 m. 1-3 pm., 9 pm.-2 am., Sun. 4-6 pm. Relays WIOD.	5.825 TIGPH	SAN JOSE, COSTA RICA, 51.5 m., Addr. Alma Tica, Apartado 800, 11 am.-1 pm., 6-10 pm. Relays TIX 9-10 pm.
		5.813 TIGPH2	SAN JOSE, COSTA RICA, 51.59 m., Addr. Senor Gonzalo Pinto, H.
		5.810 VONG	ST. JOHNS, NEWFOUNDLAND, 51.6 m., Add. Broad. Corp. of Newfoundland.

(Continued on following page)

Save Money!

With the

RADOLEK RADIO PROFIT GUIDE!

164 PAGES

EVERYTHING IN RADIO AT LOWEST PRICES!



Radolek offers you the MOST for your money! Lowest Prices! Best Quality! Biggest Values! Most Complete Stock! Fastest Service! Send for your FREE copy NOW!

OVER 15,000 REPAIR PARTS

The world's most complete stock of radio repair parts and exact duplicate replacements. All leading brands. All guaranteed. Lowest Prices!

COMPLETE TUBE SELECTION

All types RCA, Sylvania, Raytheon, Philco, etc. Includes Kellogg, special Majestic types and transmitting tubes. Complete selection.

NEWEST TEST INSTRUMENTS

The most complete line ever displayed in any catalog. All leading makes. Latest improved models at lowest prices.

GREATEST RADIO VALUES

A huge selection of money-saving set bargains! New 14-tube radio combinations. Automatic tuning sets. Beautiful cabinets. New "Ham" receivers and equipment.

EVERYTHING FOR AUTO RADIO

Complete auto radio section. Includes vibrator replacement guide, new auto aerials, custom panel control plates for all autos, newest Auto Sets.

COMPLETE P. A. SELECTION

New 1940 public address amplifiers from 4 to 100 watts. Complete P. A. Systems for permanent, mobile and portable installations. Best values!

NEW ELECTRICAL APPLIANCES

Extra profits for you! Standard Brand Electric Irons, Stoves, Heaters, Percolators, Waffle Irons, Vacuum Cleaners, Trains, Clocks, Mixers, etc., at lowest prices!

FREE!

Mail Coupon Catalog!

The RADOLEK Co.
 601 W. Randolph, Chicago,
 Dept. T-34

Send the 1940 Radolek Radio Profit Guide FREE.

Name

Address

Service man? Dealer? Experimenter?



RADIO— MANY OPPORTUNITIES STILL AHEAD

• The radio industry has hit its full stride! The future, with Television, presents great opportunities—for the trained man! The I. C. S. Radio Course, prepared by experts in practice as well as theory, is constantly revised to meet new developments. This Course can make you a trained man—prepare you for promotion and a trained man's salary! Send for free booklet.

INTERNATIONAL CORRESPONDENCE SCHOOLS

Box 2880-F, Scranton, Penna.

Send me—free—information on subject checked:

- Radio Radio Service Man
 Radio Operator Electrical Engineer

Name.....

Address.....

Short-Wave fans need this WORLD-TIME CLOCK

The Only Clock for Universal Use
Throughout the Entire World!

- A REGULAR CLOCK**
with A.M. and P.M. divided dial
- A WORLD-TIME CLOCK**
Instantly Indicating time in all 24 zones
- INTERNATIONAL CLOCK**
with A.M. and P.M. 24 hour dial



Here is really the first new clock advanced in 200 years—three clocks in one, a world-time clock. It is revolutionary! It is years ahead! The Sky Pilot WORLD-TIME CLOCK is the only clock designed for use anywhere in the world. For short-wave fans this clock offers great convenience—it is educational and at the same time indicates world time differences. In a few seconds you can determine the correct time in London, Moscow, Hawaii, Tokyo, Buenos Aires, Halifax—anywhere. American made—it is exceptionally easy to operate. It carries a guarantee of ninety days against defects in material or workmanship. In modernistic design, it is made of brushed brass—measures 5 1/2" high by 4 3/4" wide—and has convex crystal. Spring driven model

\$4.95
Electric driven (for A. C. 110-120 volts, 60 cycles) **\$5.95**
Remit by check or money order; register letter if you send cash or unused U.S. postage stamps. Add 25c to cover postage and insurance in U.S.A. Canadian and foreign add 35c.

RADIO AND TELEVISION Magazine
99-T HUDSON STREET NEW YORK, N. Y.

SOLAR
quality above all

ALL TYPES OF
FIXED CAPACITORS
FOR RADIO AND
TELEVISION . . .

Catalog on Request

SOLAR MFG. CORP. Bayonne, N. J.

Mc. Call	5.790 TGS	GUATEMALA CITY, GUAT., 51.75 m. Casa Presidencial, Senor J. M. Caballeroz. Irregular.
5.735 HCIPM	QUITO, ECUADOR, 52.28 m. Irregular 10 pm.-12 m.	
5.460 YNOP	MANAGUA, NICARAGUA, 52.40 m., 8.30-9.30 pm. Sun. 2-3 pm.	
5.300 ZIK3	BELIZE, BRIT. HONDURAS, 56.6 m., Tue., Thurs., Sat. 1.30-2, 8.30-9 pm.	
5.145 OKIMPT	PRAGUE, BOHEMIA, 58.31 m., Addr. (See OLR, 11.84 mc.) Irregular.	
5.145 PMY	BANDOENG, JAVA, 58.31 m. 5.30-11 am.	
5.040 YVSRN	CARACAS, VENEZUELA, 59.52 m., 4-11.30 pm., Sun. 8.30-11.30 am., 3.30-10 pm.	
5.020 YV4RQ	PUERTO CABELLO, VENEZ., 59.76 m., testing nightly. Off 9.20 pm.	
5.010 YV5RM	CARACAS, VENEZ., 59.88 m., 3.30-10 pm., Sun. 8 am.-10.30 pm.	
4.990 YV3RX	BARQUISIMETO, VENEZ., 60.12 m., 10 am.-11 pm.	
4.970 YV1RJ	CORO, VENEZ., 60.36 m., Irreg.	
4.960 VUD2	DELHI, INDIA, 60.48 m., Addr. All India Radio. 7.30 am.-12.35 pm.	
4.960 YV5R5	CARACAS, VENEZ., 60.48 m., Irreg.	
4.950 YV4R0	VALENCIA, VENEZ., 60.61 m., Noon-1, 6-10 pm.	
4.940 YV5R0	CARACAS, VENEZ., 60.73 m.	
4.930 YV4RP	VALENCIA, VENEZ., 60.85 m. Irreg.	
4.920 YV5RU	CARACAS, VENEZ., 60.98 m., 6.30-7.30, 10.30 am.-1, 3.30-10 pm.	
4.920 VUM2	MADRAS, INDIA, 60.98 m. Addr. All India Radio, 6.30 am.-12.10 pm.	
4.910 YV1RY	CORO, VENEZ., 61.10 m., 6.30-9.30 pm., ex. Sundays.	
4.905 HJAG	BARRANQUILLA, COLOM., 61.16 m., 11 am.-11 pm., Sun. 11 am.-8 pm.	
4.900 YV6RT	BOLIVAR, VEN., 61.22 m. Signs off at 9.30 pm.	
4.900 HJCH	BOLIVAR, VENEZ., 61.22 m., Signs off at 9.30 pm.	
4.900 HJCH	BOGOTA, COLOM., 61.22 m., 11.30 am.-2, 6-11 pm.	
4.890 YV1RX	MARACAIBO, VENEZ., 61.35 m., 10.30 am.-1.30, 4.30-10.30 pm.	
4.890 HJGD	BUARAMANGA, COL., 61.35 m., 5.45-6.30, 11.30 am.-1 pm., 6-11 pm.	
4.885 HJDU	MEDELLIN, COLOM., 61.42 m., 8 am.-2, 6-11 pm.	
4.880 VUB2	BOMBAY, INDIA, 61.48 m. Addr. All India Radio, 7.30 am.-12.30 pm.	
4.880 YV6RU	BOLIVAR, VENEZ., 61.48 m., 6.30-9.30 pm. except Sundays.	
4.875 HJFH	ARMENIA, COLOM., 61.54 m., 8-11 am., 6-10 pm.	
4.865 HJBJ	SANTA MARTA, COLOM., 61.67 m., 5.30-10.30 pm.	
4.860 YV1RL	MARACAIBO, VENEZ., 61.73 m., 11 am.-1 pm., 4.30-10.30 pm.	
4.855 HJCF	BOGOTA, COLOM., 61.80 m., 7 pm.-mid. ex. Sundays.	
4.850 YV1RZ	VALERA, VENEZ., 61.88 m., 11.30 am.-1, 5.45-8.45 pm.	
4.845 HJCD	BOGOTA, COLOM., 61.92 m., 6-11.30 pm.	
4.840 VUC2	CALCUTTA, INDIA, 61.98 m. Addr. All India Radio. 6.30 am.-12 n.	
4.840 YV4RX	MARACAY, VENEZ., 61.98 m., 6-11 pm. ex. Sundays.	
4.835 HJAE	CARTAGENA, COLOM., 62.05 m., 7 am.-6, 7-11 pm.	
4.830 YV5RH	CARACAS, VENEZ., 62.11 m., 5-9.30 pm. (Sun. to 10.30 pm.)	
4.825 HJED	CALI, COLOM., 62.17 m., 7-11 pm. ex. Sundays.	
4.820 YV3RN	BARQUISIMETO, VENEZ., 62.24 m., 11.30 am.-1.30, 5.30-9.30 pm.	
4.815 HJBB	CUCUTA, COLOMBIA, 62.31 m.	
4.810 YV1RU	MARACAIBO, VENEZ., 62.38 m., 10.45 am.-12.45 pm., 4.30-10.30 pm.	
4.800 YV1RV	MARACAIBO, VENEZ., 62.50 m., 10.45 am.-12.45 pm., 4.30-10.30 pm.	
4.795 HJDX	MEDELLIN, COLOMBIA, 62.57 m., 9.30-10.30 pm.	
4.795 HJFC	PEREIRA, COLOM., 62.57 m., 9 am.-noon, 6.30-10.30 pm. ex. Sun.	
4.790 YV5RY	CARACAS, VENEZUELA, 62.63 m., 5.30-8 pm.	
4.785 HJAB	BARRANQUILLA, COLOM., 62.69 m., 4.30-10.30 pm. ex. Sundays.	
4.772 HJGB	BUARAMANGA, COLOM., 62.87 m., Nightly to 10.45 or 11 pm.	
4.745 HJCX	BOGOTA, COL., 63.23 m., Addr. Apartado 26-65, 12 n-2 pm., 5.30-11 pm., Sun. 6-11 pm.	
4.560 HC2ET	GUAYAQUIL, ECUADOR, 65.79 m., Wed. & Sat. 8-10 pm.	

Index to Advertisers

A	
Aerovox Corporation	373
Allied Radio Corporation	355
American Radio Institute	368
Amplifier Co. of America	362
B	
Barter & Exchange Free Ads.	380, 381, 382
Bliley Electric Co.	361
Bud Radio, Inc.	361, 365
Burstein-Applebee Co.	367
C	
Cameradio Co.	364
Candler System Co.	369
Cannon, C. F., Co.	362
Capitol Radio Engineering Institute	368
Chicago Wheel & Mfg. Co.	364
Commercial Notices	380
Cornell-Dubilier Electric Corp.	Back Cover
Coyne Electrical School	323
D	
Dataprint Company	375
Dodge's Institute	368
DX Radio Products Co.	361
F	
For Sale Ads.	380
Foto-Craft	370
G	
Goldentone Radio Corp.	367
Gold Shield Products	364, 366, 371, 376
Guthman, Edwin I., & Co., Inc.	364
H	
Hammarlund Manufacturing Co., Inc.	365
Harrison Radio Co.	365
Henry Radio Shop	362
Howard Radio Co.	361
Hudson Specialties Company	377
I	
Instructograph Company	368
International Correspondence Schools	384
L	
Levine, M. M., Company	360
M	
Mass. Radio School	368
N	
National Company, Inc.	Inside Back Cover
National Plans Institute	376
National Radio Institute	321
National Schools	368
New York Radio Supply Co.	371
New York Y.M.C.A. Schools	368
R	
Radio Amateur Course	324
Radio & Technical Publ. Co.	357
Radio Publications	367, 372, 375, 376
Radio Training Assn. of America	368
Radio Wire Television, Inc.	353, 359
Radolek Co., The	383
RCA Institutes, Inc.	368
Remington Rand, Inc.	366
Rosierucians, The	371
S	
Sargent, F. M., Co.	365
Sigmon Radio Supply	362
Solar Mfg. Corp.	384
Sprague Products Co.	371
Sprayberry Academy of Radio	369
Superior Instruments Company	Inside Front Cover, 363
Supreme Publications	363
T	
Technifax	366
Telex Co.	368
Triplett Electrical Instrument Co.	367
U	
Universal Microphone Co., Ltd.	365
W	
Wellworth Trading Company	370, 373

(While every precaution is taken to insure accuracy, we cannot guarantee against the possibility of an occasional charge or omission in the preparation of this index.)

NATIONAL RADIO PRODUCTS



THE NEW NATIONAL CATALOGUE

TWENTY-FIFTH ANNIVERSARY!

National Company was founded twenty-five years ago this month. For most of this time it has devoted itself to the building of fine radio equipment. You will see these years of experience reflected in the outstanding quality of the parts shown in the big new National Catalogue. A copy is yours for the asking. The coupon will bring it.

NATIONAL COMPANY, INC., MALDEN, MASS., U.S.A.

IS READY!

NATIONAL COMPANY, INC., MALDEN, MASS., U. S. A.
Gentlemen: Please send me a copy of the big new National Catalogue No. 390 by return mail

Name _____
Address _____



Facts Show It— Servicemen Know It!

**C-D
GIVES YOU
MOST FOR
YOUR MONEY**

**LOOK AT THESE
CORNELL-DUBILIER
MONEY MAKERS!**

- ☛ **COMPLETE CAPACITOR LINE**—The only line with a capacitor for every radio, electrical and industrial application.
- ☛ **CAPACITOR TEST EQUIPMENT LINE**—Capacitor Analyzer, Bridge and Decades—accurately built—laboratory tested—time savers and money makers.
- ☛ **COMPLETE LINE OF QUIETONE INTERFERENCE FILTERS**—There's a C-D Quietone Interference Filter for every application. Every set owner a prospect. No lost sales with C-D's extensive line.



**NOW! SAVE "SERVICING" TIME
AND INCREASE YOUR PROFITS!**

C-D CAPACITOR TEST EQUIPMENT SHOWS YOU HOW!

Speed-up service work—remove the "guess" work. Make more money with C-D's new line of Capacitor Test Equipment. Economically priced—guaranteed.

CAPACITOR ANALYZER Accurately measures capacity of all types of capacitors from .00001 to 240 mfd. Measures P.F. from 0 to 50% on all electrolytics, including motor starting types. Indicates insulation resistance of paper and mica capacitors. Also many types of insulation. Indicates leakage of electrolytics by means of built-in power supply. Direct reading linear scale calibration. Push-button switching. Six color coded scales. Self-contained—portable. Model BF 50 dealer net, less tubes..... **\$24.90**

CAPACITOR BRIDGE Accurately measures capacity of all types of capacitors from .00001 to 50 mfd. Indicates P.F. of electrolytics. Checks for opens, shorts, high and low capacity. Can be used as continuity meter. Employs Wien Bridge circuit for accuracy. Dual type visual bridge balance facilitates quick tests on service jobs. Direct reading scale with all markings in microfarads. Self-contained—extremely compact. Model BN dealer net, less tubes..... **\$9.90**

CAPACITOR DECADES Ideally suited for experimental circuits, filter design, bridge measurements and a variety of other applications. Capacity range between .0001 and 11.1 mfd. is available in three decade units. Can be used individually or group combination. Decades can also be used continuously on 220 volts A.C. or 600 V.D.C. circuits. Model CDA-5 .011 mfd. in .0001 steps, dealer net **\$5.40**
Model CDB-5 1.1 mfd. in .01 steps dealer net..... **5.40**
Model CDC-5 10, mfd. in 1, mfd. steps, dealer net **9.60**

CAPACITORS FOR EVERY RADIO AND ELECTRICAL REQUIREMENT



Type BR

Type TLA

Type DT

Type I-W

For twenty-nine years, Cornell-Dubilier has specialized in the manufacture of capacitors... exclusively. The result of that specialization has been the development of the world's finest and most complete line of capacitors for every radio, electronic and electrical requirement. That is why servicemen insist on C-D's. They're the country's biggest value in **QUALITY CAPACITORS**... and that is why there are more Cornell-Dubilier capacitors in use today than any other make.

DRY ELECTROLYTICS

Outstanding in C-D's complete line of dry electrolytic capacitors are the new improved type BR "Blue Beavers". Compact, scientifically vented, with self-supporting leads, the type BR is the serviceman's choice for an all around utility capacitor. Completely eliminates exact duplicate replacements. Available in single and dual capacities in 25, 150, 250, 350 and 450 volt. D.C. ratings.

WET ELECTROLYTICS

C-D "Hi-Mike" wet electrolytics with high scintillation point, are mechanically and electrically perfected units. Vented to allow generated gas to escape harmlessly, these self-healing units have remarkably long life and fine filtering efficiency. Available with palmnuts or mounting rings in a complete capacity range at 200, 300, 475 and 500 and 600 volts peak.

DYKANOL FILTER CAPACITORS

Solving, at once, the need for a compact high voltage filter capacitor to use with high fidelity public address amplifiers, power supplies for short-wave portable transmitters and transceivers, Type TLA, Dykanol Filter Units in cylindrical aluminum containers are ideal in every respect. One terminal is well insulated, the other being the metal can itself. Substantially made. Will withstand transient voltages as well as high peak voltage surges. Designed to operate for continuous full load duty.

PAPER TUBULAR CAPACITORS

C-D's famous "Dwarf-Tiger" Paper tubulars are non-inductively wound and specially impregnated and sealed. A specially treated cardboard tube and high melting point wax ends keeps moisture out and adds strength and extra protection to the capacitor section. Supplied with rigidly anchored wire leads in a complete capacity range at 400, 600 and 1000 V.D.C.

MICA RECEIVING CAPACITORS

Tested at 1000 volts D.C. (on capacities up to .003 mfd.: 600 V test on higher capacities), checked for accuracy of capacity by an electrical testing and sorting machine, these tiny units are characteristic of the quality which C-D builds into its every product regardless of size or price. The efficiency of these capacitors is better than 99.94%!

Send for Cat. No. 165 A describing the complete C-D line of capacitors, Cat. No. 166 A on Interference Filters and Cat. No. 167 A on Capacitor Test Instruments.

QUIETONE RADIO INTERFERENCE FILTERS



Every set owner is a prospect. Talk "Quietones" when making service calls and increase your profits. Remember there's a C-D Quietone Radio Interference Filter for every application. Facts show it—you can increase your business and make it more profitable by standardizing on the complete C-D line of capacitors, Quietone Interference filters and capacitor test instruments.



**CORNELL-
DUBILIER**

ELECTRIC CORPORATION

1027 HAMILTON BOULEVARD
SOUTH PLAINFIELD, NEW JERSEY