

# RADIO & TELEVISION

FORMERLY  
**S** SHORT WAVE & TELEVISION



TELEVISION  
and  
Ultra Short Wave  
Antennas  
SEE PAGE 8

## *In This Issue —*

- O. B. Hanson discusses  
Television Aerials
- A New Tube for Television
- DeLuxe Beam Transmitter
- Building Remote Control for  
Radio Receivers
- 2½, 5 & 10 Meter Converter
- International Radio Review
- Best S-W Station List

**25¢**  
IN U.S. AND  
CANADA

**HUGO  
GERNSBACK**  
EDITOR

**RADIO EXPERIMENTING  
AMATEUR RADIO**

**MAY  
1939**



# SUPERIOR PRESENTS 5 INSTRUMENTS

from its NEW 1100 series!!!! Never before has Superior offered so much for so little! Always the Best Buy in the Instrument Field, Superior in this new 1100 series gives you even more value! We have incorporated many refinements, many new features . . . all proven to be sound and practical. We urge you to read the descriptions below carefully; see how these instruments fit your needs. Buy direct from manufacturer and save 50%.

ments, many new features . . . all proven to be sound and practical. We urge you to read the descriptions below carefully; see how these instruments fit your needs. Buy direct from manufacturer and save 50%.

Superior Instruments are Guaranteed for One Year

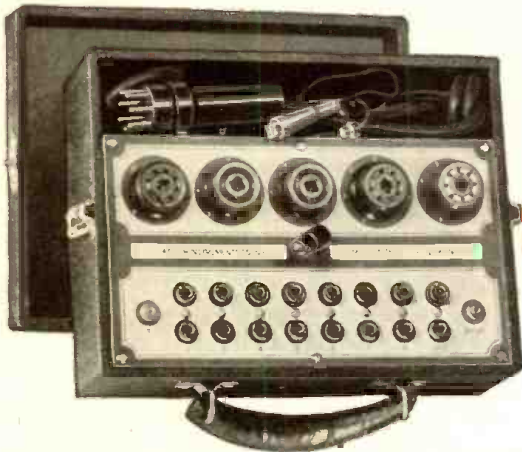

**THE NEW MODEL 1175-S**

**FREE POINT ANALYZER UNIT**

Complete with portable carrying case and cover

May be used with any multimeter or set tester for testing by the point-to-point method of isolating and locating trouble.

**SPECIFICATIONS:**

1. Enables you to test tubes by the plate current method when used in conjunction with any multimeter. 2. Rapid current measurements under actual operating conditions without opening circuit for meter insertion. 3. Enables you to locate defects in any particular stage without removing chassis from cabinet. 4. Permits rapid and precise voltage and resistance measurements between any two points in a radio receiver, terminating at a tube socket. 5. Standard R.M.S. numbered tube chart for quick identification of tube elements. 6. Sockets are all R.M.S. coded. Complete with six slip-proof adapters. Slip-proof type analyzer plug, dual insulated Grid cap. 7. Etched aluminum panel, housed in leatherette covered portable type cabinet, cover included.

Model 1175-S complete in carrying case and cover, with all accessories included, all necessary adapters, plug, R.M.S. coded tube base chart and instructions. Shipping weight 7 pounds. Our net price . . . . .

**\$8<sup>85</sup>**

**THE NEW MODEL 1130-S**

**Signal Generator with Audio Frequencies**



**SPECIFICATIONS:**

1. Combination R.F. and Audio Signal Generator. R.F. 100 kc. to 100 Mc., A.F.—100-7,500 cycles. All Direct reading, all by front panel switching. 2. R.F. and A.F. output independently obtainable alone or with A.F. (any frequency) modulating R.F. 3. Accuracy is within 1% on I.F. and Broadcast bands; 2% on higher frequencies. 4. Audio frequencies in 3 bands; 100, 400, 1000, 5000, and 7500 cycles. 5. Giant airplane full vision, direct-reading dial. 6. Condenser and other leakages tested to 100 megohms. 7. All services on 90-130 volts A.C. or D.C. (any frequency).

Model 1130-S comes complete with tubes, test leads, carrying handle, instructions. Size 12" x 9" x 6½". Shipping weight 15 pounds. Our net price . . . . .

**\$11<sup>85</sup>**

**THE NEW MODEL 1150-S SUPER-ALLMETER**

Featuring the New Sloping Panel



A genuine achievement! For accurate and rapid measurements. Note the following features: A.C. and D.C. Volts, A.C. and D.C. currents, Resistance, Capacity, Inductance, Decibels, Watts.

**SPECIFICATIONS:**

D.C. Voltage: 0-15, 0-150, 0-750 volts D.C.  
A.C. Voltage: 0-15, 0-150, 0-750 volts A.C.  
D.C. Current: 0-1, 0-15, 0-150, 0-750 ma. D.C.  
A.C. Current: 0-15, 0-150, 0-750 ma. A.C.  
2 Resistance Ranges: 0-500 ohms  
500-5 megohms  
High and Low Capacity Scales: .0005 to 1 mfd. and .05 to 200 mfd.  
3 Decibel Ranges: -10 to +19, -10 to +38, -10 to +53.  
Inductance: 1 to 700 Henries  
Watts

Based on 6 mw. at 0 D.B. in 500 ohms. .006000 to 600 Utilizes new 4½" square 0-1 d'Arsonval type meter with precision resistors housed in our newly devised sloping case for rapid and accurate servicing.

Model 1150-S supplied complete with test leads, tabular charts and instructions. Size 10" x 7¼" x 4¼". Shipping weight 9 pounds. Our net price . . . . .  
Model 1150-A Portable carrying cover 75c additional.

**\$11<sup>85</sup>**

**THE NEW MODEL 1180-S SET TESTER**

A Complete Laboratory All in One Unit!

Featuring Our New Type Sloping Panel for Precise and Rapid Servicing



A complete testing laboratory all in one unit! Combines Superior models 1140-S and 1150-S. For specifications read the description of both these models herewith. Comes housed in sturdy, black case with sloping panel for rapid and simple measurements. Complete with test leads, tabular charts, instructions and tabular data for every known receiving type tube, including many transmitting types. Size 11¼" x 9¼" x 5". Shipping weight 18 pounds . . . . . Our net price . . . . .

**\$17<sup>85</sup>**

Model 1180-A for Portable Cover, add 95c.

**THE NEW MODEL 1140-S TUBE TESTER**



A really modern tube tester conforming to all standards of good engineering practice. Utilizes a 3" d'Arsonval type meter with calibrated scale. Furnished in a sturdy black case with sloping panel for easy operation. Removable cover and carrying handle for either portable or counter use.

**SPECIFICATIONS:**

1. Tests all 4, 5, 6, 7, 7L and octal base tubes, including diodes.  
2. Tests by the well-established emission method for tube quality, directly read on the GOOD? BAD scale of the meter.  
3. Affords separate neon test for leakage and shorts between elements.  
4. All services performed by the use of only five controls at maximum, and many tests do not require working all the controls.  
5. Supplied with instructions and reference table so that the filament voltage and emission measuring controls may be properly set for the enumerated long list of tubes, which includes all tubes commonly encountered in servicing.  
6. Works on 90-120 volts A.C. 60 cycle.

Model 1140-S comes complete with instructions and tabular data for every known receiving type of tube as well as many transmitting types. Shipping weight 10 pounds, size 10" x 7¼" x 4¼". Our net price . . . . .  
Model 1140-A with Portable Cover . . . . . 75c additional

**\$10<sup>85</sup>**

## SUPERIOR INSTRUMENTS CO.

136 Liberty St., RT-5  
NEW YORK, N. Y.



# Read what happened



**YES!**

I'll take your training. That's what S. J. Ebert said. He is making good money and has found success in Radio.

to these  
two men  
when I said:



**NO!**

I'm not interested. That's what this fellow said. Today he would be ashamed if I gave you his real name and salary.

## I will Train You at Home in Spare Time for a GOOD JOB IN RADIO

These two fellows had the same chance. Each sent me a coupon, like the one in this ad. They got my book on Radio's opportunities. S. J. Ebert, 104-B Quadrangle, University of Iowa, Iowa City, Iowa, saw Radio offered him a real chance. He enrolled. The other fellow, whom we will call John Doe, wrote he wasn't interested. He was just one of those fellows who wants a better job, better pay, but never does anything about it. But read what S. J. Ebert wrote me: "Upon graduation I accepted a job fixing Radio sets. Within three weeks I was made Service Manager. This job paid me \$40 to \$50 a week compared with \$18 I earned in a shoe factory before. Eight months later I went with station KWCR as operator. From there I went to KTNT. Now I am Radio Engineer with WSUI. I certainly recommend the N. R. I. to all interested in the greatest field of all, Radio."

### Many Radio Experts Make \$30, \$50, \$75 a Week

Radio broadcasting stations employ engineers, operators, station managers and pay well for trained men. Fixing Radio sets in spare time pays many \$200 to \$500 a year—full time jobs with Radio jobbers, manufacturers and dealers as much as \$30, \$50, \$75 a week. Many Radio Experts open full or part time Radio sales and repair businesses. Radio manufacturers and jobbers employ—testers, inspectors, foremen, engineers, servicemen, in good-pay jobs with opportunities for advancement. Automobile, police, aviation, commercial Radio, loud speaker systems are newer fields offering good opportunities now and for the future. Television promises to open many good jobs soon. Men

### Get My Lesson on Radio Servicing TIPS FREE

I'll prove my Training gives practical, money-making information: is easy to understand—is just what you need to master Radio. My sample lesson text "Radio Receiver Troubles—Their Cause and Remedy" covers a long list of Radio receiver troubles: to A.C., D.C., battery, universal, auto, T.H.P., super-heterodyne, all-wave, and other types of sets and a cross reference system gives you the probable cause and a quick way to locate and remedy these set troubles. A special section is devoted to receiver check-up alignment, balancing, neutralizing and testing. Get this lesson Free. No obligation. Just mail coupon.

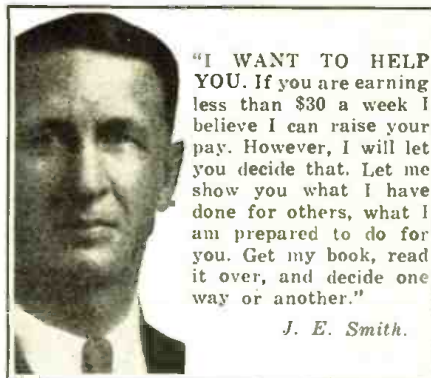

"I WANT TO HELP YOU. If you are earning less than \$30 a week I believe I can raise your pay. However, I will let you decide that. Let me show you what I have done for others, what I am prepared to do for you. Get my book, read it over, and decide one way or another."

J. E. Smith.

I trained have good jobs in these branches of Radio. Read how they got their jobs. Mail coupon.

### Many Make \$5, \$10, \$15 a Week Extra in Spare Time While Learning

The day you enroll I start sending Extra Money Job Sheets: show you how to do Radio repair jobs. Throughout your training I send plans and directions that made good spare time money—\$200 to \$500—for hundreds, while learning. I send you special Radio equipment to conduct experiments and build circuits. This 50-60 method of training makes learning at home interesting, fascinating, practical. I ALSO GIVE YOU A MODERN, PROFESSIONAL ALL-WAVE, ALL-PURPOSE RADIO SET SERVICING INSTRUMENT to help you make good money fixing Radios while learning and equip you for full time jobs after graduation.

### I Also Give You This Professional Servicing Instrument

Here is the instrument every Radio expert needs and wants—an All-Wave, All-Purpose, Set Servicing Instrument. It contains everything necessary to measure A.C. and D.C. voltages and current; to test tubes, resistance; adjust and align any set, old or new. It satisfies your needs for professional servicing after you graduate—can help you make extra money fixing sets while training.



### You Are Trained for Television Also

With N.R.I. you take up Television principles right along with Radio principles—the correct method—since Television receivers combine both sight and sound. You also get more than ten text books devoted entirely to Television.

### Find Out What Radio Offers You

Act Today. Mail the coupon now for "Rich Rewards in Radio." It's free to any fellow over 16 years old. It points out Radio's spare time and full time opportunities and those coming in Television; tells about my training in Radio and Television; shows you letters from men I trained, telling what they are doing and earning. Find out what Radio offers YOU! MAIL COUPON in an envelope, or paste on a postcard—NOW!

J. E. SMITH, President  
Dept. 9EB3, National Radio Institute  
Washington, D. C.



## FOR FREE BOOK OF FACTS ABOUT RADIO

J. E. SMITH, President, National Radio Institute  
Dept. 9EB3, Washington, D. C.

Without obligating me, send your service manual "Radio Receiver Troubles—Their Cause and Remedy" and free book about spare time and full time Radio opportunities and how I can train for them at home in my spare time and about the N.R.I. Set Servicing Instrument you give me.

I am particularly interested in the branch of Radio checked.

- |   |   |
|---|---|
| <input type="checkbox"/> Radio Service Business of My Own         | <input type="checkbox"/> All-around Servicing Expert                    |
| <input type="checkbox"/> Spare Time Radio Service Work            | <input type="checkbox"/> Loud Speaker Systems, Installation and Service |
| <input type="checkbox"/> Retail Sales of Radio Sets and Equipment | <input type="checkbox"/> Television Station Operator                    |
| <input type="checkbox"/> Broadcasting Station Operator            | <input type="checkbox"/> Service Expert with Radio Factory              |
| <input type="checkbox"/> Aviation Radio Operator                  | <input type="checkbox"/> Commercial Radio Station Operator              |
| <input type="checkbox"/> Auto Radio Installation and Service      |   |

(If you have not decided which branch you prefer—mail coupon now, for information to help you decide.)

NAME ..... AGE .....

ADDRESS ..... 14X-1

Please say you saw it in RADIO & TELEVISION

# RADIO & TELEVISION

*The Popular Radio Magazine*

MAY — 1939  
Vol. X No. 1

HUGO GERNSBACK, Editor  
H. WINFIELD SECOR, Manag. Editor  
ROBERT EICHBERG, Assoc. Editor

## TELEVISION SPECIAL!

June Number Tells ALL about this New Art

### In This Issue

#### GENERAL FEATURES

Transoceanic Radio Telephony on Short Waves—Dr. Frank B. Jewett, President, Bell Telephone Laboratories	5
Television Holds the Spotlight	6
Television and Ultra Short Wave Antennas	8
New Cathode-Ray Tube Gives Brilliant Images	9
World-Wide Radio Digest	10
International Radio Review	12
Robert Eichberg's Test-Quiz	16
O. B. Hanson of NBC Discusses Television Antennas	17

#### CONDENSED FEATURES

How a Television Receiver Is Born	7
Most Powerful Television Transmitter	7
Why NOT "Commercial" Television Licenses?	8
First Facsimile Network	10
Televise Operating Room	10
New Tubes for Air Safety	11
New Magnetic Pick-up	12
Cathode Ray Microscope	12
Connecting Extra Loud Speakers	13
New Marconi Aerials	13
2-Tube 3-Meter Adapter	14
Home Recording Hints	14
New Television Tube	14
Interference in Television	15

#### INSTRUCTION

Radio Test-Quiz	16
Getting Started in Amateur Radio	
C. W. Palmer, E.E., Ex-W2BV	19
Television Course—Henry Townsend	21
Question Box	36

#### TELEVISION

Television Holds the Spotlight	6
How a Television Receiver Is Born	7

Cover composition by H. Gernsback and Thomas D. Pentz.  
Television and Ultra Short Wave Antennas—See page 8.

**RADIO & TELEVISION**—Published monthly on the tenth of the month. Entered as second-class matter Feb. 15, 1938, at the post office at Springfield, Mass., under the act of March 3, 1879. Trademarks and copyrights by permission of H. Gernsback. Text and illustrations are copyright and may not be reproduced without permission. Subscription price \$2.50 a year in the United States and possessions and Canada, \$3.00 in foreign countries. Make all subscription checks payable to Popular Book Corporation.

Published by Popular Book Corporation, Publication Office—29 Worthington St., Springfield, Mass. Editorial and Executive Offices—89 Hudson St., New York, N.Y. HUGO GERNSBACK, President; H. W. SECOR, Vice-President; EMIL GROSSMAN, Director of Advertising. European Agents: Atlas Publishing and Distributing Co., Ltd., 18 Bride Lane, Fleet St., London, England; Brentano's—London and Paris. Australian Agents: McGill's Agency, 179 Elizabeth St., Melbourne.

Copyright 1939 by H. Gernsback

#### CONSTRUCTION

The "Bauer" T-R-F Four—Francis J. Bauer, Jr., W6FPO	29
De Luxe "Beam Power 3"—Howard G. McEntee, W2FHP	30
Remote Control Box Selects Stations from Any Spot—C. W. Palmer, E.E.	32
Television Sound Converter—2½, 5 and 10 Meters—Herman Yellin, W2AJL	34
"Wireless" Oscillator for Phono and Mike	48

Most Powerful Television Transmitter	7
Television and Ultra Short Wave Antennas	8
Brilliant Image Cathode-Ray Tube	9
A Television Network?	10
Hospital Operating Room Televised	10
Television Torpedo Aerial	12
New Television Tube	14
Interference in Television	15
O. B. Hanson of NBC Discusses Television Antennas	17
Television Course	21
Television "Sound" Converter—Herman Yellin, W2AJL	34

#### MISCELLANEOUS

Radio Kinks	18
"Ham" Radio Course	19
What Do YOU Think?	20
World Short Wave Stations "Directory"	22
Let's Listen In with Joe Miller	23
Silver Trophy Award for Best "Ham" Station Photo	25
"On the HAM Bands"—Elmer R. Fuller	27
Question Box	36
I Cover the Pacific Coast!	42
Newest Radio Apparatus	39

"FIPS" Isolated  
by *Interstellar Electric Storms—no Transmission from Mars to Earth this month!*

### June "TELEVISION" Issue

Opportunities in Television—Dr. Alfred N. Goldsmith
How to Build a Television Receiver
Solving Problems in CBS Television—Dr. Peter C. Goldmark
De Luxe "Beam Power 3"—Part 2—Howard G. McEntee, W2FHP
Ultra Short Wave Receiver—Herman Yellin, W2AJL

#### Certified Circuits



When you see this seal on a set it is a guarantee that it has been tested and certified in our laboratories, as well as privately in different parts of the country. Only constructional—experimental sets are certified.

You need not hesitate to spend money on parts because the set and circuit are bona fide.

This is the only magazine that renders such a service.



# An Interview with F.C.C.'s Chief—Frank R. McNinch

Robert Eichberg

WHEN Federal Communications Commission Chairman Frank R. McNinch came to New York to address some fifteen representatives of leading women's clubs, he granted the press an interview.

Mr. McNinch made it clear that he favors the Wheeler Bill and, indeed, had something to do with its framing. The bill, among other provisions, calls for a Federal Communications Commission with but three commissioners. The work of the Commission will be divided into three branches—common carriers (telephone and telegraph), broadcasting, and international affairs. Under the new bill, the Commission will vote on all necessary matters. There is also provision for the creation of a Bureau of Research and Information to keep the Commission abreast of developments.

In broadcasting (which includes television, amateur, and experimental work, etc.), this added department would not only keep the Commission informed as to engineering developments, but would gather data on public likes. The Commission now receives considerable mail describing what the public dislikes but listeners do not habitually send fan mail to the Commission. The Bureau will also take advantage of surveys now made by Crossley and similar services.

The Commission may soon be issuing licenses for extended periods—possibly up to three years, when the Havana treaty is ratified by Mexico. As ratification is not possible before next September, the Commission may even take action to issue longer licenses in advance of this date, if the Mexican Government puts the treaty into effect at an earlier time, as is expected.

Commissioner McNinch explained that there will be frequency reallocations (though on a small scale) when the treaty goes through. For this reason, it would have been unwise to issue licenses for longer than a six months' period prior to such necessary changes. After the changes, longer licenses will be possible and will probably be preferable from the stations' viewpoint, saving executives much work in preparing applications for renewal licenses. Station owners also believe that it will help them to obtain more adequate financing.

**Television:** As to television, Commissioner McNinch stated that it is doubtful whether commercial licenses would soon be granted to television and facsimile broadcasting stations. The reason for this is that, in the opinion of the Commission, television is "still in the experimental stage" and not enough receivers have been distributed, although great progress has been made technically in the art.

No police applications for television stations have been received as yet. Facsimile is, of course, being used by the press of the nation, and it is said that one police station is in operation—at least experimentally.

The problem of censorship was next raised at the discussion, with Father Coughlin as the "jumping off" point. Commissioner McNinch said that some 4,000 cards and letters giving the pro and con of the controversy had been received relative to Father Coughlin. They were about evenly divided as to whether or not Father Coughlin should be forbidden the air and whether the stations which refused to broadcast his talks should have their licenses revoked. As far as the Commission is concerned, however, whether a station decides to put on any individual or not is the station's own concern, and as long as both sides of a controversy are fairly presented, the Commission is satisfied.

(Continued on page 47)



H. C. Lewis

# QUICK, EASIER WAY TO TRAIN FOR ELECTRICITY

TO TRAIN FOR

12 Weeks Practical WORK IN MY CHICAGO SHOPS

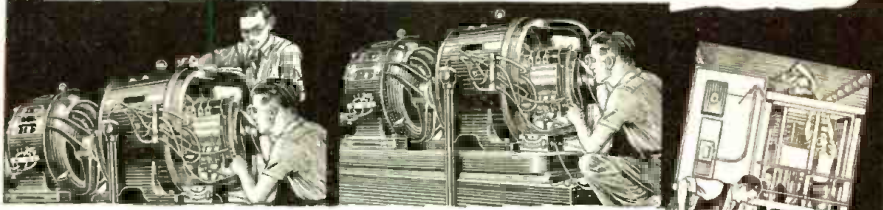

FIRST—You are told and shown how to do it. THEN—You do the job yourself.

## WANT TO EARN MORE MONEY?

Have you ever dreamed of holding down a steady, good pay job? Have you ever dreamed of doing the work you really like in a job that holds promise of a real future in the years ahead?

Well, we all know that you can't get the good things in life by just dreaming about them. Hundreds of fellows are today holding down mighty fine jobs with prospects of a bright future. They are filling these jobs because they had the foresight to equip themselves with the right kind of training. Most of these men were only average fellows a short time ago, but the proper training helped to lift them out of the low pay ranks of unskilled workers. The same opportunity is now offered to you. The \$5,000 and \$10,000 a year men of the future will be those who are preparing and planning now. The great fascinating fields of **ELECTRICITY** and **RADIO** offer a real future to many men and young men who are willing to prepare for a place in this giant industry.

AN EXTRA 4 WEEKS COURSE IN RADIO INCLUDED

Here at my school in Chicago the world's Electrical Center, you can get 12 weeks' Shop Training in Electricity and an Extra 4 weeks course in Radio at No Extra Tuition Cost, that can help give you your start towards a better job.

You will be trained on actual equipment and machinery and because of our method of training, you don't need previous experience or a lot of education. Many of my successful graduates never even completed Grammar School.

Here in my school you work on generators, motors, dynamos, you do house wiring, wind armatures and do actual work in many other branches of electricity and right now I'm including valuable instruction in **Diesel, Electric Refrigeration and Air Conditioning** at no extra cost. Our practical shop methods make it easier to learn—First the instructors tell you how a thing should be done—then they show you how it should be done—then you do the actual work yourself.



HOUSE WIRING One of the many branches you "Learn By Doing."



"... Everything was just as stated in literature. And by Coyne's method plenty of instructors to take care of everything, easy to learn. I really was satisfied with Coyne training." — J. Halyk, Canada

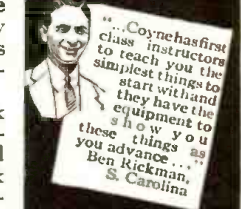

"... Coyne has first class instructors to teach you the simplest things to start with and they have the equipment to show you these things as you advance." — Ben Rickman, S. Carolina



## I'LL FINANCE YOUR TRAINING

You can get this training first—then pay for it later in easy monthly payments, starting 60 days after your 12 weeks' training period is over—then you have 12 months to complete your payments.

If you need part time work to help out with expenses while training in my shops, my employment department will help you get it. Then after graduation this department will give you valuable lifetime employment service.

Send the coupon today for all details. When I get it I'll send you my big free book containing dozens

of pictures of students at work in my shops. I'll also tell you about my "Pay After Graduation" plan, how many earn while learning and how we help our students after graduation. Fill in, clip coupon, mail today for your start toward a brighter future.



H. C. LEWIS, President  
**COYNE**  
ELECTRICAL SCHOOL  
500 S. Paulina St., Dept. 59-81, Chicago

H. C. LEWIS, President, COYNE ELECTRICAL SCHOOL, 500 S. Paulina Street, Dept. 59-81, Chicago, Ill.

Dear Sir: Please send me free your big catalog and full particulars of your present offer, also your "Pay-Tuition-After-Graduation" Plan and your Extra 4 weeks Radio Course.

NAME .....

ADDRESS .....

CITY ..... STATE .....

Please say you saw it in RADIO & TELEVISION



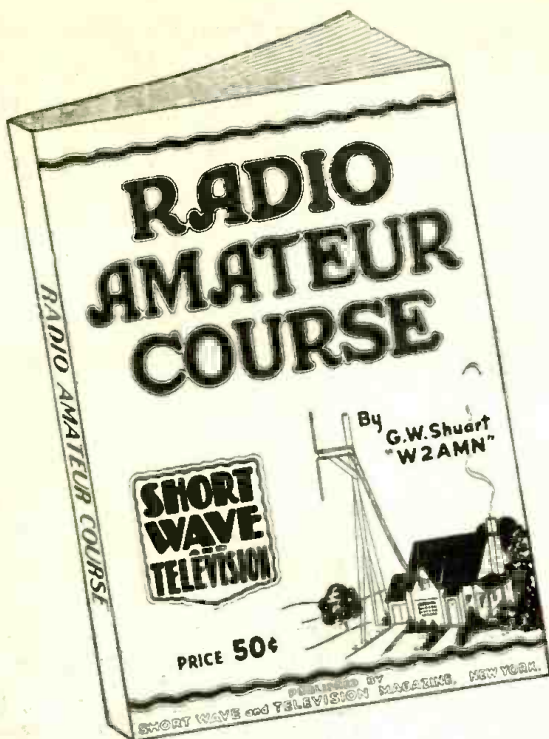

*Your Money Back—*

IF THE **RADIO AMATEUR COURSE** DOES NOT REPRESENT THE GREATEST BOOK VALUE EVER OFFERED TO THE RADIO "FANS" FOR 50¢

To convince you that there isn't a better book buy today, the publishers of the **RADIO AMATEUR COURSE** make the sensational offer of a money-back guarantee on such a low-priced book. Stop in at any of the many dealers listed at the right and examine this volume. See for yourself if the **RADIO AMATEUR COURSE** isn't just the book you've always wanted.

Printed on the finest quality paper—well illustrated attractive 4-color cover—complete with radio information you must have. It contains a step-by-step program for obtaining a short-wave radio education.

Written by George W. Shuart, W2AMN,  
foremost short-wave authority

**148 PAGES**

6¼ x 9½ INCHES

**OVER 150 RADIO DIAGRAMS**  
and **TECHNICAL PHOTOGRAPHS**

**RADIO AND TELEVISION**

99 Hudson Street, New York, N. Y.

## All Prominent **RADIO DEALERS** Ready to Show You This Big Book!

- ARIZONA**  
Sun's Clear Store, Phoenix.  
127 N. First Ave., Phoenix.
- CALIFORNIA**  
Scott Wholesale Radio Co.,  
344 E. Fourth Street, Long Beach.  
Offenbach Electric Co., Ltd.,  
1452 Market Street, San Francisco.  
Zack Radio Supply Co.,  
1426 Market Street, San Francisco.
- COLORADO**  
Auto Equipment Co.,  
14th at Lawrence, Denver.
- CONNECTICUT**  
Radio Inspection Service Co.,  
277 Asylum Street, Hartford.  
Stern Wholesale Parts, Inc.,  
210 Chapel St., Hartford.
- GEORGIA**  
Wholesale Radio Service Co., Inc.,  
130 W. Peachtree St., N. W., Atlanta.
- ILLINOIS**  
Allied Radio Corporation,  
433 West Jackson Blvd., Chicago.  
Newark Electric Company,  
226 W. Madison Street, Chicago.  
Wholesale Radio Service Co., Inc.,  
901 W. Jackson Blvd., Chicago.
- INDIANA**  
Van Slekke Radio, Inc.,  
34 West Ohio Street, Indianapolis.
- MASSACHUSETTS**  
Greater Boston Distributors,  
40 Waltham St., Boston.  
H. Jappe Co., 46 Cornhill, Boston.  
Wholesale Radio Service Co., Inc.,  
110 Federal Street, Boston.  
Springfield Radio Co.,  
397 Dwight Street, Springfield.  
H. Jappe Co.,  
37 Mechanic Street, Worcester.
- MICHIGAN**  
Rissl Brothers, Inc.,  
5027 Hamilton Ave., Detroit.
- MISSOURI**  
Modern Radio Company,  
409 No. Third Street, Hannibal.  
Burstein-Applebee Co.,  
1012-14 McGee Street, Kansas City.  
Van Slekke Radio, St. Louis,  
1113 Pine Street, St. Louis.
- NEBRASKA**  
Radio Accessories Company,  
2566 Farnam Street, Omaha.
- NEW JERSEY**  
Arco Radio Co.,  
227 Central Avenue, Newark.  
Wholesale Radio Service Co., Inc.,  
219 Central Avenue, Newark.
- NEW YORK**  
Wholesale Radio Service Co., Inc.,  
542 E. Fordham Rd., Bronx.  
Wholesale Radio Service Co., Inc.,  
90-08 166th Street, Jamaica, L. I.  
Llan, The Radio Man, Inc.,  
64 Dey Street, New York City.  
Eagle Radio Co.,  
84 Cortlandt Street, New York City.  
Federated Purchaser, Inc.,  
25 Park Place, New York City.  
Larrison Radio Co.,  
12 West Broadway, New York City.  
Sun Radio Co.,  
212 Fulton Street, New York City.  
Terminal Radio Corp.,  
80 Cortlandt Street, New York City.  
Thor Radio Corp.,  
60 Dey St., New York City.  
Try-Ao Radio Co., Inc.,  
85 Cortlandt Street, New York City.  
Wholesale Radio Service Co., Inc.,  
100 Sixth Avenue, New York City.  
Radio Parts & Equipment Co.,  
243 Clinton Avenue No., Rochester.  
M. Schwartz & Son,  
710-712 Broadway, Schenectady.
- NEW HAMPSHIRE**  
Radio Service Laboratory,  
1187 Elm Street, Manchester.
- OHIO**  
News Exchange,  
51 So. Main Street, Akron.  
Canton Radio & Supply Co.,  
1140 Tuscarawas Street, W., Canton.  
United Radio, Inc.,  
1103 Vine Street, Cincinnati.  
The Hughes-Peters Electric Corp.,  
178-180 N. Third Street, Columbus.  
Standard Radio Parts Co.,  
135 East Second Street, Dayton.
- OREGON**  
Portland Radio Supply Co.,  
1300 W. Burnside Street, Portland.
- PENNSYLVANIA**  
Radio Distributing Co.,  
1124-26 Market Street, Harrisburg.  
M. & H. Sporting Goods Co.,  
512 Market Street, Philadelphia.  
Cameradio Co.,  
963 Liberty Ave., Pittsburg.
- RHODE ISLAND**  
W. H. Edwards Co.,  
32 Broadway, Providence, R. I.
- TEXAS**  
Amarillo Electric Co.,  
111 East 8th Avenue, Amarillo.
- UTAH**  
O'Loughlin's Wholesale Radio Supply,  
315 South Main Street, Salt Lake City.  
Radio Supply, Inc.,  
46 Exchange Place, Salt Lake City.
- WASHINGTON**  
Spokane Radio Co., Inc.,  
611 First Avenue, Spokane.
- WISCONSIN**  
Radio Parts Co., Inc.,  
536-538 W. State Street, Milwaukee.
- AUSTRALIA**  
McGill's Agency,  
183-184 Elizabeth Street, Melbourne.
- CANADA**  
The T. Eaton Co., Ltd.,  
Winnipeg, Manitoba.  
Canadian Electrical Supply Co., Limited,  
285 Craig Street W., Montreal, Que.  
Metropolitan News Agency,  
1248 Peel Street, Montreal, Que.
- CUBA**  
The Diamond News Co., Inc.,  
Palacio Asturiano, Por San Jose,  
Habana.
- ENGLAND**  
Gorringe's American News Agency,  
9a, Green Street, Leicester Square,  
London, W.C.2.
- HOLLAND**  
Radio Peeters, Van Vorstraat, Amster-  
dam, Z.
- INDIA**  
Empire Book Mart,  
Box 631, Bombay.
- MEXICO**  
American Book Store, S. A.,  
Avenida Madero 25, Mexico City.  
Central De Publicaciones,  
Avenida Juarez, 4, Apartado 2430,  
Mexico, D. F.
- NEW ZEALAND**  
Te Aro Book Depot, Ltd.,  
64 Courteray Place, Wellington.
- SOUTH AFRICA**  
Technical Book Co.,  
5, Strand Street, Cape Town.

If this book is not at your dealer's, send your order directly to us. We will credit your dealer with the sale of this book. To order your copy of **RADIO AMATEUR COURSE**, fill in coupon below and mail.

**RADIO AND TELEVISION, 99 Hudson St., New York, N. Y.**  
Gentlemen: I enclose herewith my remittance of Fifty Cents (50¢) for which please send me **POSTPAID**, my copy of the **RADIO AMATEUR COURSE**. (Remit by check or money order; register letter if you send cash or unused U. S. Postage Stamps.)

Name .....

Address .....

City ..... State ..... R&T-539



HUGO GERNSBACK, EDITOR

H. WINFIELD SECOR, MANAGING EDITOR

# Transoceanic

## Radio Telephony on Short Waves

Frank B. Jewett,

President, Bell Telephone Laboratories



Dr. F. B. Jewett, President of the Bell Telephone Laboratories, New York. Transatlantic radio telephony, as it is known today, has been made possible largely through the vast researches carried out by the laboratories which he directs.

● IT is twelve years since the opening to public use on January 7, 1927 of the first long distance *radio telephone* circuit. This point-to-point channel across the Atlantic Ocean initially joined New York and London, but almost from the outset (and of course this was the intention) became a *trunk line* whereby any telephone in the United States and any telephone in the western part of Europe could be used for intercommunication.

Quickly following the inauguration of overseas telephony, a network of radio circuits has sprung into existence whereby nearly all the wire telephone systems of the world can be interconnected. This network is at once invisible and very substantial. A graphic view of the present-day status of overseas telephone facilities is given in the accompanying map. While a table listing all of the channels which the map portrays would far exceed the space allowed me, it is interesting to know that the total mileage of all of these channels adds up to nearly 125,000 miles. The circuits shown permit intercommunication of

about 93 percent of the world's telephones and enable the United States telephone subscriber to reach seventy-three other countries.

The technical achievements underlying this widespread commercial use fall roughly into three categories. The first covers those factors which made possible the beginning of commercial radio telephony. In the second are the things without which its rapid growth and wide expansion could not have occurred. In the third are several interesting and valuable technical features which are not readily classifiable, but without which the success we know today could not have been achieved.

At the outset radio telephony presented difficulties in addition to those existing in radio telegraphy. First and foremost, telephone communication has to be two-way,—and of course the system must be linked in with the wire telephone systems so as to be available to any instrument. Second,

until the connection is actually established, the subscriber cannot deliver his message, so that delay due to unfavorable transmission conditions is less to be tolerated. Finally, the grade of transmission required to satisfy the average telephone user is higher than that permissible in telegraph reception by an experienced operator.

The realization that a relatively high degree of reliability was essential to success discouraged any attempt at commercial service until high power transmission on a practical basis was assured. For this reason the starting point of successful long distance radio telephony was the water-cooled

(Continued on page 37)

Twenty-seventh of a series of "Guest" Editorials

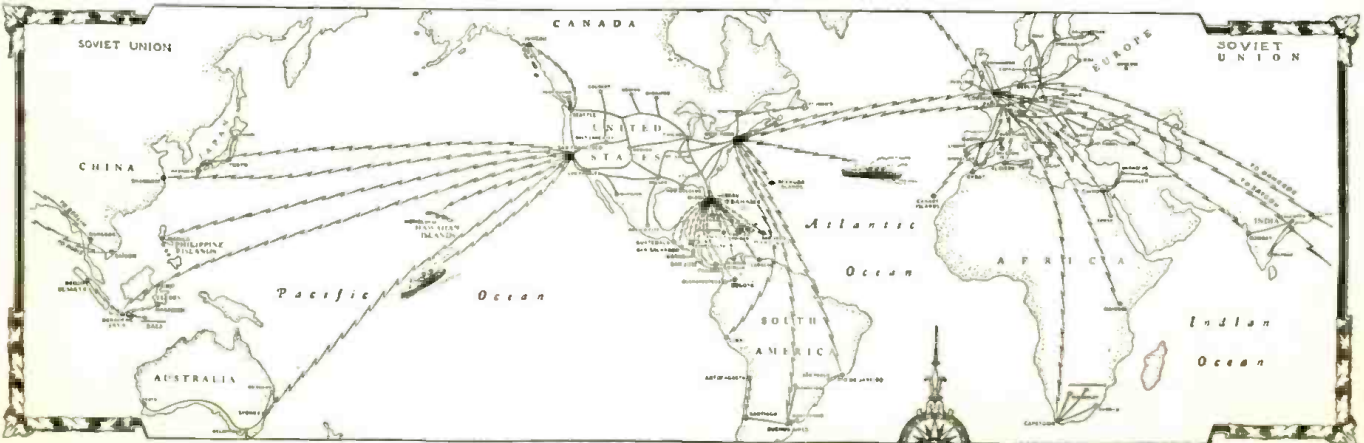

Map of the world showing the more important radio telephone channels.



# TELEVISION HOLDS THE SPOTLIGHT

Television is scheduled to make its bow to the American public this spring. Programs are promised in the following areas: New York, Schenectady, Philadelphia, Los Angeles, Milwaukee, Chicago and Kansas City.



Miss Thelma A. Prescott, television's first woman program director, who is now a member on the staff of the National Broadcasting Company. Miss Prescott will produce television fashion shows and other programs which appeal to women. Miss Prescott lived ten years in Paris.

The television image shown at the right is not a very clear one but it hopped 3400 miles from London, England to Riverhead, L. I.



Above—This television image, although not very clear, is truly remarkable in that it represents the first image transmitted between England and America. The BBC television station has an average range of 50 to 100 miles, but this image broke all the rules of ultra short waves and hopped clear across the Atlantic, where it was picked up by the apparatus shown at the left. The British image was picked up on a rhombic antenna 800 feet long and 150 feet wide.

Right—Dewitt R. Goddard, a member of the RCAC engineering staff, is shown here using a motion picture camera to photograph television images broadcast from London, England, at RCAC's Riverhead, Long Island, N. Y., receiving station.



Above—Television in the rain—note the powerful new type spotlights which resemble cathode-ray tubes—this picture was taken in Washington, D. C., during a recent N.B.C. demonstration, when people from all walks of life, from scientists to school girls, were asked to step in front of the camera and say a few words. Even the chairman of the F.C.C., Frank R. McNinch, appeared before the television camera.



Above and left—The new Philco television apparatus. The 83 tube portable transmitter is shown at the left, and it was recently successfully demonstrated at Palm Beach, Fla., and also in New York. One of the new Philco receivers uses 22 tubes: it is shown above with dipole aerial. Albert F. Murray, Philco's chief television engineer, faces the reader in the photo above.



Who are these men on the television screen? Why, it's Amos 'n' Andy, who recently visited the New York World's Fair and gave a special television broadcast for the benefit of those in the New York area who possessed television receivers. Photo courtesy N.B.C.

Right—Gov. Herbert H. Lehman of New York was recently televised over the N.B.C. system, and the photo at the right gives some idea as to the excellent image observed on one of the receivers. Actually, the images are much clearer than they appear in these photos, as the images are moving and therefore difficult to photograph.





# How a Television Receiver Is Born



1 Trimming the chemical screen deposited on the inside of glass blank for cathode-ray tube.

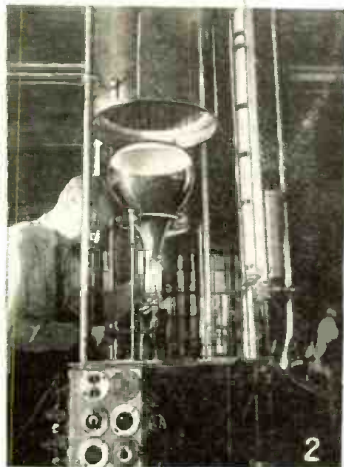

2 Sealing off a television cathode-ray tube, following pumping and bombardment operations in the exhaust position.

TO meet the immediate demand for television receivers in areas being served by experimental transmitters, and in anticipation of the greatly increased demand which will follow regular television programs this spring, the Allen B. Du Mont Labs., Inc., of Passaic, N. J., have gone into regular production on the 14-inch *teletron* or cathode-ray television tube.



5 Assembling a television receiver which will afford 8 x 10 inch screen images, with synchronized sound.



4 A few Du Mont sets about half completed, on the assembly line.

3 Chassis of the 21-tube television and sound receiver.



Originally made in the laboratory by skilled mechanics and glassblowers, and exhausted in crude pumping positions, resulting in very high cost, the present 14-inch tubes are now fabricated by highly trained factory workers and exhausted in a battery of specially-built exhaust positions capable of hand-

*(Continued on page 64)*

# Most Powerful Transmitter for New Television Station



Top—G-E television camera. Small pilot lights glow when in use.



Middle—Front of television camera with cover removed. Focusing is done with knob at lower left.



Bottom—This tube, mounted in television pick-up, performs the same function as the film in an ordinary camera, but at the rate of 30 a minute.

The new 10 kw. G-E television transmitter station. The left tower will support the receiving antenna, picking up studio signals from Schenectady; the next will broadcast the televised pictures; the one at right will broadcast the sound. Small pole at right is part of the power line.

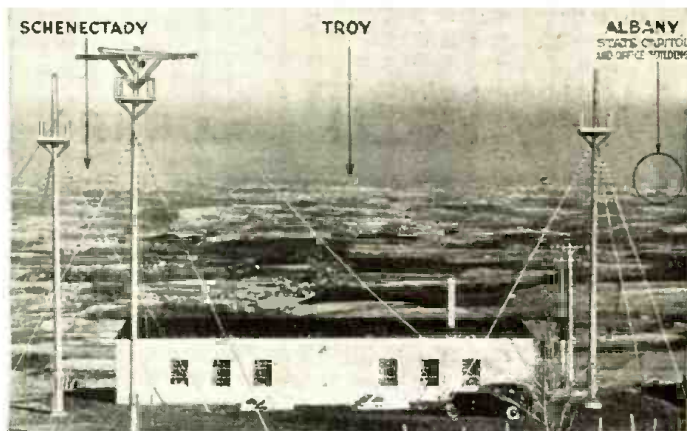

A 10 KW. television transmitter, more powerful than any now in use in this country and designed to broadcast pictures with much improved picture definition, will be put into operation before the end of April by General Electric at Indian Ladder in the Helderberg Hills, 12 miles from Schenectady, N. Y., according to Chester H. Lang, the company's manager of broadcasting.

ing the picture will also be broadcast on the same band, on a frequency immediately adjoining the picture.

The television studio will be located in Schenectady, in quarters formerly occupied by WGY. At such times as studio programs are not available, motion picture film will be used much the same as electrical transcriptions now fill-in on broadcast programs.

More than 250 vacuum tubes, many of

*(Continued on page 64)*

From an ultra short-wave transmitter on top of the studio building, the images will be relayed over the 12-mile gap on a 1.4 meter band to the \$155,000 main transmitter in the Helderbergs, where they will be broadcast for public reception on a wavelength in the 66-72 megacycle band or on about 4½ meters. The voice accompany-

Table model G-E television receiver.





# Television and Ultra Short Wave Antennas

(Front Cover Feature)

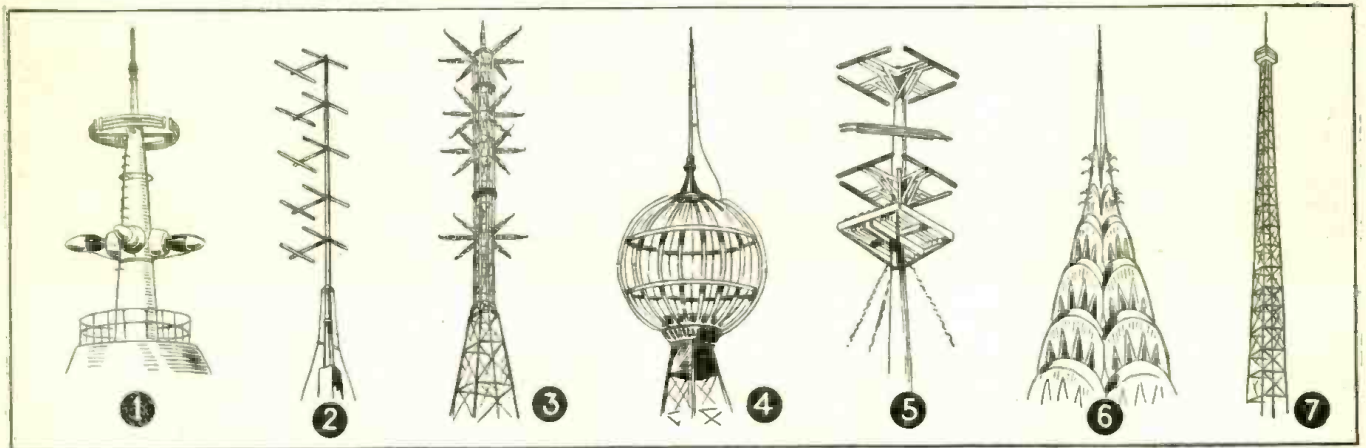

1—New NBC television aerial on the Empire State Building, New York City. 2—Aerial used on NBC mobile television truck. 3—Image and sound aeriels used by BBC television station (London). 4—Ultra short wave antenna of station W8XWJ in Detroit. 5—New GE television antenna. 6—CBS television aeriels atop the Chrysler Tower, New York City. 7—Ultra short wave aerial erected by station W9XUP.

● OUR front cover and the accompanying illustration show various types of television and ultra short wave antennas.

Fig. 1 shows the new NBC television image and sound transmitting antenna atop the 1300 foot Empire State Building in New York City. This antenna is especially designed and will operate on frequencies as high as thirty million cycles per second without peaking.

Fig. 2 shows the novel type of U.S.W. antenna devised by NBC experts for use with their mobile television transmitting truck. This antenna is demountable and it

serves to relay television images picked up by the truck's camera to the nearest NBC receiving station.

Fig. 3 shows the image and sound aeriels used at the BBC transmitting station in London. The dipoles are mounted vertically, as vertically polarized waves are employed there instead of the horizontally polarized waves used in this country.

Fig. 4 shows the ultra short wave (7.3 meter) antenna used at station W8XWJ (Detroit *News*), Detroit. It is employed for phone.

Fig. 5 illustrates the new G.E. 10 kw.

television antenna to be used at the company's new television transmitting station at Indian Ladder, twelve miles from Schenectady. This antenna comprises eight hollow copper bars, each 4 inches in diameter and 7 feet long, or equivalent to one-half wave length. Powerful horizontally polarized waves will be radiated from the antenna, with both image and voice components, on a wave length of  $4\frac{1}{2}$  meters. It is located atop a 1500 foot hill and should therefore give a good account of itself.

Fig. 6 shows the new Columbia Broad-  
(Continued on page 55)

## Why NOT "Commercial" Television Licenses?

● A vast new industry will give employment to thousands, and spread millions of dollars around the United States, when television becomes commercial. Knowing this to be true, RADIO & TELEVISION magazine has made a move to clarify the television situation. On this page there appears copy of a letter which was sent to Frank R. McNinch, Chairman of the Federal Communications Commission.

In order to attract sponsors so that they will put on high quality programs, RADIO & TELEVISION believes that it will be necessary to permit such sponsors to advertise their products via television. It is to the end that this may be made possible that the letter printed on this page was sent. The reply from Commissioner McNinch appears on page 57 of this issue.

March 4th, 1939

Mr. Frank R. McNinch, Chairman  
Federal Communication Commission  
Washington, D. C.

My dear Mr. McNinch:

We are sending, under separate cover, two copies of the February issue in which your guest editorial (*Emergency Uses of Radio*) appears.

There is a very important problem occupying the minds of magazine writers as well as radio manufacturers today, on which we would greatly appreciate an opinion from you.

1—How soon do you think commercial licenses may be issued to radio facsimile stations?

2—What, in your opinion and that of

your Commission, is the present status of television?

It seems to us that if in the near future commercial television broadcasting licenses were granted, this would certainly help to start the television business rolling along and help, to a tremendous degree, to put the country's business back on its feet.

We have interviewed a number of people in the radio industry and those who are thinking of taking a venture in television, and they all sing the same tune—they are waiting for the F.C.C. to say the word so far as "commercial" licenses are concerned, so that they can proceed to solicit sponsored television programs.

The writer has seen the present television images, as reproduced by several of the leading systems, and they are certainly very excellent.

The writer would certainly appreciate learning, even though your opinion

is to be a personal and strictly private one, why it is that the F.C.C. keeps deferring the issue of commercial television broadcast licenses. It would seem to the writer, judging by past experience in the radio broad-  
(Continued on page 57)

### Congressman Approves

Congress of the United States

House of Representatives

Washington, D. C. March 9, 1939

A. PARKELL THOMAS  
700 BROADWAY, N. Y.

COMMUNICATIONS  
DIVISION  
U. S. DEPARTMENT OF  
COMMERCE

Mr. R. W. Secor,  
Radio Television,  
99 Hudson Street,  
New York City.

My dear Mr. Secor:

Thank you for sending me a copy of your letter of March 6th, addressed to the Chairman of the Federal Communications Commission.

I agree with your statement that if in the near future commercial broadcasting licenses were granted, this would certainly help to start the television business rolling along and help, to a tremendous degree, to put the country's business back on its feet.

Thanking you again for bringing this to my attention and assuring you of my desire to be of any possible assistance, I am

Sincerely,



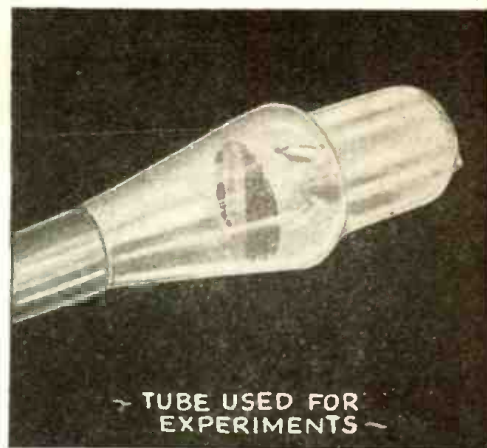
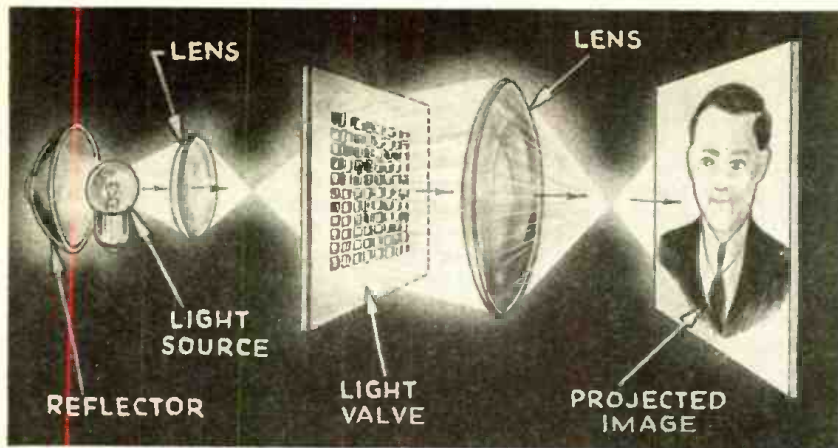

# New Cathode-Ray Tube Modulates Light Beam For Brilliant Images

German Engineer replaces fluorescent screen with midget Kerr cell crystals, producing brilliant images capable of projection to large size on wall.

● ONE of the most intricate problems of television design pertains to the low intensity of illumination obtainable with cathode-ray tube screens. Practically all image reproducers of present design suffer from this defect.

The illumination of these image reproducers is so low that a terrific strain on the eye results after one or two hours of observation. The low-powered television screen as now used seems to be the finest device on the market to create permanent trouble in the family. This sounds strange, but let us remember that most of the present television receivers (those in the stage of development as well as those already on the market) must be operated in a more or less darkened room. The illumination in the room will be "less" rather than "more," and will make it impossible for some of the people in the room to read while others watch the program. In short, if television is to become the popular means of home entertainment we all dream about, engineers will have to increase the illumination of the television screen, and at the same time, lower cathode-ray tube prices.

### von Ardenne Has New Invention

A young European scientist, Manfred von Ardenne, well-known for a great number of important discoveries in the field of electronics, has found an interesting method

which bids fair to eradicate a considerable number of inherited faults of present television systems.

We all have read that present cathode-ray tube receivers operate on a principle whereby a cathode-ray beam is shot toward a chemically treated screen. The impact of the cathode-ray beam produces a peculiar effect on the screen which is known as *fluorescent light*.

If we consider that a cathode-ray beam has practically no weight, we will understand that a very minute amount of light can be obtained by this method. There are, however, means known to increase the power of impact, and thus to increase the intensity of illumination. (The large screen television receiver of the projection type is a typical example.) But this type of receiver is very expensive.

Since the present system of image reproduction by means of fluorescent screens has its physical limitations in regard to the power of illumination obtainable, other means will have to be employed. Such a means has now been proposed by von Ardenne.

### Screen Acts as Light Valve

He recommends a screen similar in shape and size to that used in present cathode-ray tubes. But, and this is of great importance, the impact of the cathode-ray

beam does not produce any fluorescent light on the screen. In fact, the new screen does not produce any light whatsoever. But it does something else, and this is *absolutely new* (as far as the author could ascertain). It seems that the new principle may be of great importance in the future development of television, for the new screen changes its *translucency* under the impact of the cathode-ray beam.

In order to bring the principle of *varying translucency* home, let us use an analogy. Assume that instead of a television screen we have a large wall, and that there are many tiny doors installed in this wall. Further, assume that these are opened or closed by a cathode-ray beam, as shown at the top of this page.

When a strong source of light is arranged behind the wall, a beam of light will pass through the doors which are open. By varying the width of the door openings, a light pattern of specific shape and with varying degrees of illumination is produced.

In short, if we substitute the customary picture elements of television reception for the doors in this example, we have a television screen which is able to reproduce roughly sketched images. By increasing the number of doors, making each of them smaller, images of greater detail may be obtained.

### Cathode Ray Serves as Relay

So far, we have only described the idea behind the proposed system of television image presentation, but have not emphasized its most important feature—the fact that the cathode-ray beam is *not* used to produce the light by its impact on the screen, but rather as a means to *control* the amount of light to be projected as the many picture points which constitute a television image.

That it is possible to obtain powerful illumination by this method is easy to grasp, since all that is required is a powerful electric bulb behind the screen.

(Continued on page 43)

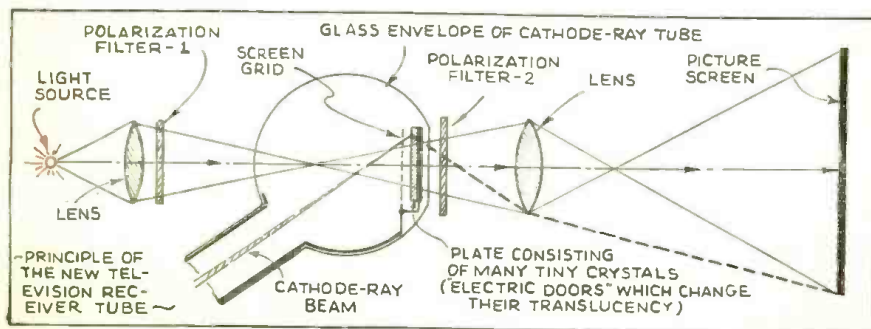



### Radiobeacon in Buoy

George Eaton, Superintendent of Lighthouses at Chelsea, Mass., has told the inside story of the radiobeacon buoy which is now in the North Channel of Boston Harbor. According to Superintendent Eaton, the buoy uses a low power battery-operated radio-beacon transmitter, in duplicate. This is located in one of the tank pockets which normally would contain the gas cylinders for operating a lighted



buoy. The other tank pocket contains a set of low-discharge type storage batteries mounted in a steel rack.

The photograph herewith shows the batteries being lowered into a tank pocket. The batteries furnish power for the transmitter which continually emits a characteristic signal of 5 dashes every 15 seconds on a frequency of 310 kilocycles.

"The antenna system," says Supt. Eaton, "consists of a fifteen-foot vertical radiator mounted on a ceramic insulator above the superstructure of the buoy. The radio frequency current is fed to the antenna by means of a co-axial cable which runs from the transmitter to a terminating unit at the base of the antenna."

While little is known of its actual range, it is expected that radio bearings will be obtained at a radius of about four miles.

### First Facsimile Network

A preliminary experiment with the first facsimile network was made in mid-March when stations WGN in Chicago, WOR in Newark and WLW in Cincinnati went on the air. It is expected to extend the network if the tests prove successful.

### Televising Operating Room

For many weeks there had been a lot of discussion about plans to televise a surgical operation in a Brooklyn, New York, hospital. The purpose of the experiment was to see whether or not television could be used as a means of giving medical students and internes a closer view of operating technique.

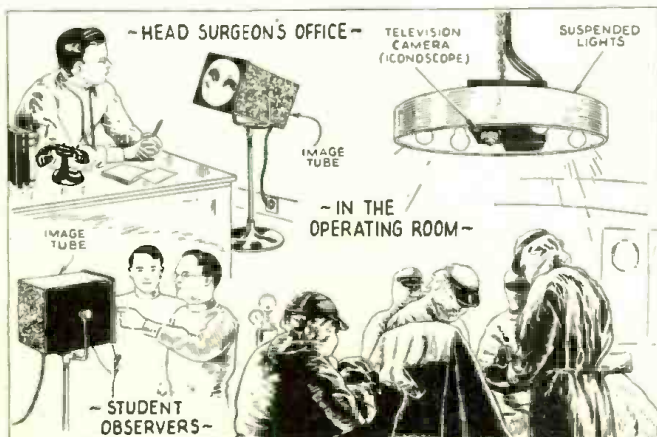

A local television company provided the equipment which the hospital used. Hospital authorities were enthusiastic as to the future applications of television in this field.

The problem of providing adequate illumination for television pick-up was solved by using filters to cut off the heat (infra-red) rays.

### A Television Network?

In a recent talk before the New York Advertising Club, John Black of the J. M. Mathes Advertising Agency stated that if television transmitters were installed in America's 96 largest population centers, 45% of the nation's population could be serviced with television programs even though the range of each station was no more than 50 miles.

That the country is well on its way to a good start in such service is indicated by a statement from the Philco Radio & Television Corporation. This company not only plans to produce a limited number of television receivers for the public, but may operate stations in New York, Philadelphia, Schenectady, Milwaukee and Los Angeles.

### Mules and Radio



According to the Chapel Hill, N. C., *Weekly*, J. M. Yarborough, a Jonesboro farmer, has equipped his plow with a portable radio. As he follows his mules up and down the furrows, he listens to music, news broadcasts, plays, lectures and advertisements from all over the world. (The mules' reaction can only be guessed.)

# WORLD WIDE

### Airplane Static Suppressor

A static suppressor to insure normal reception of both directive beam and voice radio signals, irrespective of static conditions, has been developed by the Bendix Radio Corporation and United Air Lines. The device has been installed in the tails of United's entire fleet.



Now, when a pilot encounters static, he pressed a button which electrically releases a wire in the slip-stream. This wire extends to its full length behind the plane, permitting static, which formerly leaked off the plane, to discharge harmlessly.

### Crowds Are Televised

More than 12,000 people visited the R.C.A. exhibit at the Frisco Fair on opening date. During the first two days more than 10,000 were televised—this being at the rate of 15 persons per minute for twelve hours.

### Ears of the Army

Radio has been used for some time to keep the various ground units of an army in communication with one another. For almost as long, airplane radio has been used. Now the United States Army has adopted portable pack transmitter and receiver equipment to enable men on the ground to maintain communications with planes in the air.

As the accompanying picture shows, the equipment is no more than can be carried by a single man in a small back pack. The antenna, as shown, extends vertically above it.

In this particular set-up, two men are operating the equipment—the one who carries the pack and antenna, as an observer, while his companion can devote his full attention to operating the radio equipment.





## Pants For "DX"



Short Wave Magazine, the British publication, reports that one SWL tried practically every means of getting rid of the effects of *body capacity*. As a final despairing gesture, he set up a chair, put a grounded metal plate on it, took off his pants, sat down and started tuning. Hand capacity was then considerably worse.

## F.C.C. Releases Figures

According to a report from the Federal Communications Commission, there are now more than 51,000 licensed amateur radio operators in the United States. There are even more licensed amateur stations than there are operators, as several Hams own at least two stations—some, for example, have stations in their town and country homes, and not a few have portable rigs. Of these Hams, more than 1000 are *shut-ins*, whose chief contacts with the world are through radio. These include the blind, the crippled and the bed-ridden. Blind operators, estimated at more than 100, frequently take their license exams in Braille. Many of these Hams are affiliated with the Naval and Army Reserve Systems.

## Instrument of Many Uses

A new type of highly sensitive seismograph has been designed by H. A. Chinn and V. N. James, CBS engineers. While the primary purpose is to show irregularities of current traveling through the network, it is so sensitive that it can pick up vibrations resulting from the movement of subway trains underneath the Chrysler Tower near the top of which it is located. It can even record the steps of a bur-



# RADIO DIGEST

## Medal Awarded David Sarnoff

AT the annual dinner of the Veteran Wireless Operators Association in New York, President William J. McGonigle announced that a new award had been inaugurated. Mr. Sarnoff, a former wireless operator, was then presented the Marconi Memorial Medal for Achievement, as the outstanding radio executive of today who was formerly a wireless operator. The award and its acceptance were made over long distance telephone wires to Palm Beach, Fla., where Mr. Sarnoff was recovering from an illness.

## Meet Sifalala

Mr. Carlo Spatari, Director of the Spatari language foundation, has allotted to the Short Wave League the word "SIFALALA." This, in the Spatari language, means not only the name of the League, but also its address, by street, city, state and nation. The language, the syllables of which are based on the musical scale, was devised to facilitate international radio communications. One of the synthetic words may mean a complete message. For example, "LASIFARE" is a complete greeting, in *thirty-five words!*

glar entering a bank-vault!

Designed for testing radio lines, sound stages, etc., it permits engineers to perform in a single hour, work which previously took several weeks. Another of its many uses is to make tests for sound-proofing buildings. If the sound takes one-tenth of a second or more to fade out, the instrument will record it. Also, by means of its recordings in the study of acoustics, engineers can tell whether a studio is "live" or "dead."

Picture above shows James at the controls; Chinn's photo is inserted.



## Britain Calls All Radio Men to Register for Emergency

Although experts say that the tension in Europe has decreased, an indication that the war clouds are still lowering is seen in a recent issue of *Wireless World* which devotes two pages to the registration of all radio enthusiasts who might be of use to the Government in the event of a national emergency.

Reproduced at the right is one of the pages of the questionnaire inquiring as to the capabilities of the respondent. The reverse of this questionnaire carries a printed envelope addressed to the Navy.

## New Tubes For Air Safety

A new type of radio tube developed by General Electric generates a radio wave which is even shorter than the tube itself. As seen in the illustration below, the tube measures 8 inches overall, but the wave it generates is only about 5½ inches (14 cm.) long. Radio beams of this length are highly directional and may be aimed like a searchlight, making it possible to measure distances by reflection.

Directed at the ground or any other obstacle from an airplane, the beam is reflected so that an altimeter can immediately record and translate the time required for the beam's reflection. With the equipment positioned beneath the plane, an indication of altitude can be had. With the instrument installed in the nose of the plane, it will signal approach to mountains, high buildings or other dangerous obstacles.

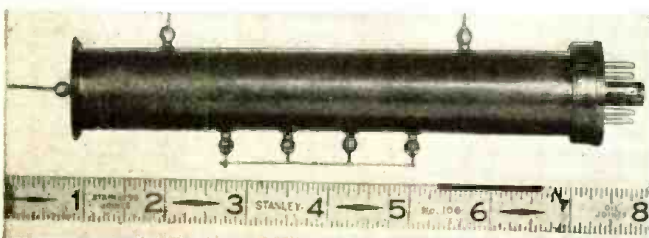

## NATIONAL WIRELESS REGISTER

THE MINISTRY OF LABOUR is issuing a booklet giving the details of various services which are essential for the defence of our country, and is asking members of the public to volunteer their services so that the whole efforts of the country may be rightly directed. Every individual can then be put to that task for which he is most fitted by previous training. A large percentage of readers of "THE WIRELESS WORLD" possess technical qualifications which in many cases have been acquired from years of training and practical experience. In the event of a state of emergency arising, the defence services of the country will have a great need of wireless operators, teleprinter operators, and technical personnel capable of caring for and repairing wireless and light electrical apparatus. During the Great War the needs of the Services for operators were largely met, especially during the early stages by the voluntary enlistment of trained Post Office operators, but as Morse is no longer used in the Post Office, this possible source of supply is rapidly dwindling. It is therefore imperative that all our readers who have at least a good working knowledge of Morse or have other qualifications such as ability to service and repair wireless and electrical apparatus, should apply to help fill the vacancies which now exist in the R.N.V.(W./R), the Royal Corps of Signals, T.A., and the R.A.F.C.W.R.

Such applications will enable much valuable time to be saved and will facilitate volunteers being in their right position at the right moment if the necessity arises.

Readers who are not at present in a position to volunteer in the above-mentioned Services are asked to complete the Questionnaire which is reproduced below, and post it without delay. From the answers to this Questionnaire a register of wireless experts who are willing to serve their country should an emergency arise will be compiled in conjunction with the Wireless Telegraphy Board. This Register will be regarded as confidential and the information contained therein will only be made available to the Defence Services.

1. Name in full (in capitals) .....
2. Permanent address .....
3. Age .....
4. State whether British by
  - (1) Birth .....
  - (2) Naturalised .....
  - (If naturalised, state former nationality and date of naturalisation)
5. Give particulars of any technical degrees or other recognised qualifications .....
6. In which of the following categories would you place your qualifications —
  - (1) Research and design of wireless apparatus .....
  - (2) Servicing and tracing faults .....
  - (3) Construction of apparatus from blueprints and designs .....
  - (4) Wireless operating. State number of words per minute .....
  - (5) Teleprinter operation .....
7. Have you a sound knowledge of wireless theory and the ability to read circuit diagrams? .....
8. Have you had war experience, if so, give brief details .....
9. Are you already liable for service with any Force or Organisation? (If so, state particulars) .....
10. Have you any preference for service in either the Navy, Army or Air Force? .....
11. Are you physically fit? .....
12. Present occupation .....



## Home-Made Deaf Aid

1 AN aid for the hard of hearing may be assembled out of three tubes, a microphone, a headphone and a few parts from the junk box, according to *Radio Revista* of the Argentine. A schematic diagram showing all values of components is given in Fig. 1. The iron core choke is any 30 h. filter choke. The microphone may be connected across the points marked "MIC" and the author recommends that a midget mike be used. This may be either crystal, dynamic or velocity and it is suggested that a crystal headphone be used as the mike. The diagram shows magnetic headphones

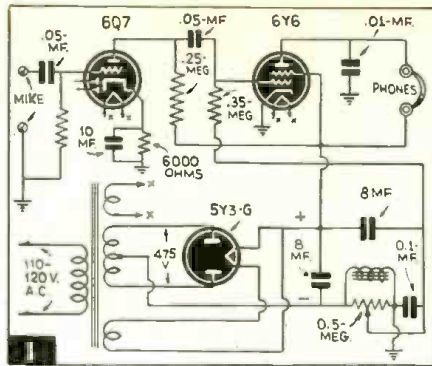

The accompanying sound program is radiated from the antenna, positioned directly above the "torpedoes."

Co-axial cable is used for feeding all of these units. It is particularly interesting to notice that the point to which the video feed line is attached is so positioned that a quarter wave length "U" is formed, as shown on the diagram.

## Dual Twin-Triode Transmitter

4 TWO twin triodes, such as the 6A6, form the basis of an ingenious exciter which was designed by Austin Forsyth, G6FO, editor of *The Short-Wave Magazine*, a British publication.



being used for the output. If it is desired to replace these with crystal phones, a filter network must be employed to permit the B voltage to get to the plate without passing through the phones, which would be damaged.

## New Magnetic Pick-Up

2 AN improved magnetic pick-up which uses four poles has been developed in

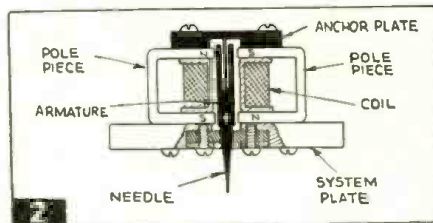

Keying can be handled in any of the jacks shown, but J3 is recommended. The 6A6's, according to the author, work very well up to 14 megacycles. The components specified are the same as in author's single tube transmitter, a description of which follows.

One point to remember is that the four R.F. chokes must be dissimilar in order to avoid self-oscillations. Use chokes of different make or of slightly different values.



Germany. This pick-up, which is described in *Bastelbriefe*, is shown schematically in Fig. 2. An ingenious means of cutting out material from the armature permits it to be pivoted at the exact center and provides adequate rigidity, as it actually forms an integral spring. The armature is also very easy to center, as the anchor plate forms the base of the entire system.

## How the Television Torpedo Aerial Works

3 THE phantom drawing in Fig. 3 shows the connections which are utilized in the television sight and sound antenna which has been installed by the National Broadcasting Company atop the Empire State Building, New York City. Assigning arbitrary directions for the sake of clarity, you will notice that the North and West torpedoes are connected to one phase of the push-pull output of a video transmitter, while the East and South torpedoes are connected to the other phase of the video output.

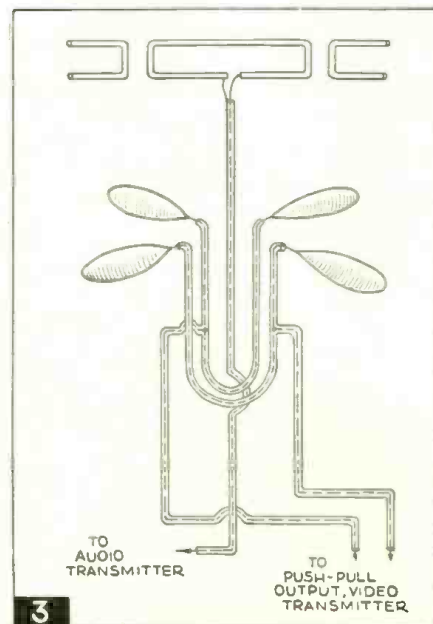

## Single Twin-Triode Transmitter

5 VALUES used in the one-tube CO-PA unit are as follows: R2—10,000 ohm, 3 watt resistor; RFC—standard transmitting R.F. choke; C3—.0001 mf. for all bands between 3.5 and 14 mc.; C3—.0003 mf. for 1.7 mc.; C1 and C4—.0001 mf. for higher frequency bands or .00016 for 1.7 mc.; C2, C6 and C7—.005 mf.; R1—25,000 ohms. Coils L1 and L2 should be electrically well separated and are standard coils for the frequencies to be employed. C5 is a neutralizing condenser; C4—.0001 mf. double-spaced condenser. Tank coil L2 is a standard 10 watt in mount and must be center-tapped. Plate voltages are 400 maximum with a 6A6 or 250 if a 6E6 is used.

## Cathode-Ray Microscope

6 AN excellent explanation of a cathode-ray microscope, as shown in Fig. 6, appears in *Wireless World*, of Britain. The diagram is virtually self-explanatory, as the optical analogy at the right explains



the cathode-ray system shown at the left. It is found that magnification up to 100,000 diameters is obtainable with this apparatus. The electron beam is produced by a cold cathode in a low vacuum tube at the top.

The object to be inspected is placed on a revolving plate and examined with the optical microscope at the right and then rotated into the electron beam. Its image is produced at moderate magnification on the upper screen so that it may be focused. This screen is then raised and the projection coil below it gives greatly increased enlargement on the final screen at the bottom of the microscope.

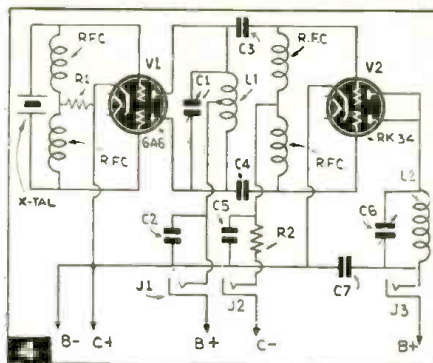

speakers in parallel to this transformer.

Fig. 7J indicates the connection of eight speakers in series-parallel.

The impedances of the speaker voice coils are: Fig. F—8 ohms; Fig. G—8 ohms; Fig. H—12 ohms; Fig. I—32 ohms; and Fig. J—25 ohms.

### New Marconi Aerials

8 FIG. 8A illustrates a tapered artificial line to match impedance and to secure maximum energy transfer and optimum tuning when a receiver is connected to a remote aerial. The line consists of a series of progressively changing units of inductance-capacity.

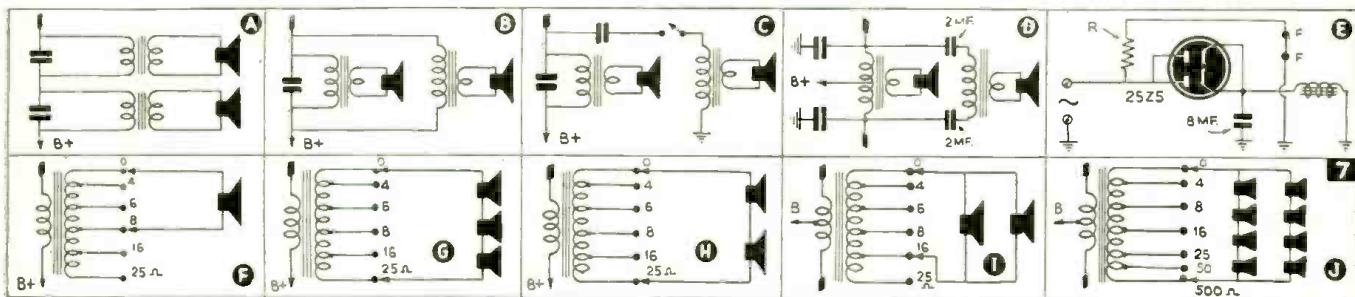

### Connecting Additional Speakers

7 FIG. 7A shows a method by which a supplementary loudspeaker is used in conjunction with the loudspeaker of a set. This series connection affords a plate impedance which is the sum of the primary impedance of both speaker transformers.

Fig. 7B shows parallel connection of the speakers in which the impedance is decreased, the formula being the usual one

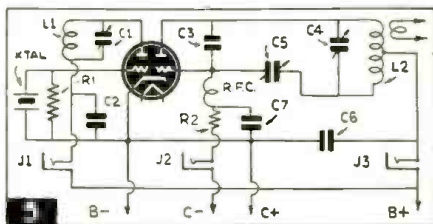

ance-capacity. The figure shows two aerials of different characteristics connected to the same cable.

The line going to the long and medium wave aerial has an impedance of about 3000 ohms at the aerial, decreasing to 100 ohms at the cable. The short wave antenna's line has an impedance of from 400 ohms at the aerial, decreasing to 100 ohms at the cable. Each line offers high impedance to

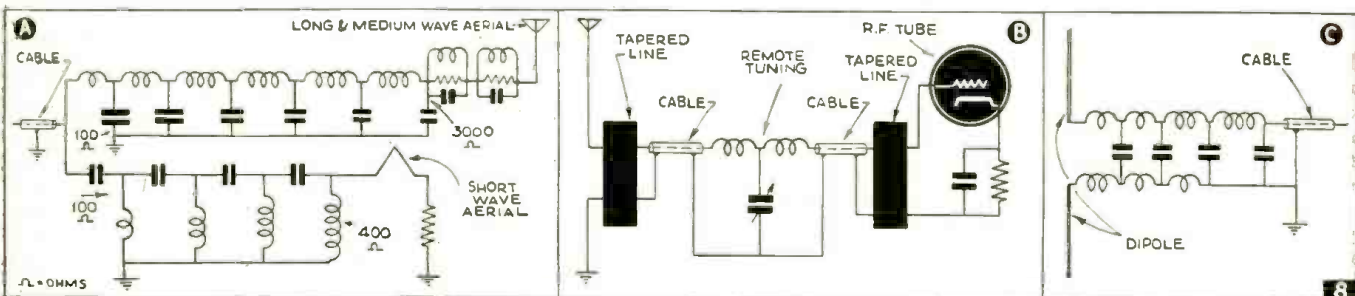

for impedances in parallel.

Fig. 7C shows connections for one speaker connected directly in the plate circuit, to reproduce the bass end of the spectrum, while the second speaker, connected through a condenser, will reproduce high frequencies.

Fig. 7D shows connection of an additional loudspeaker which does not have a center-tapped primary to a push-pull output stage.

Fig. 7E shows a method of affording excitation for a speaker field. The tube is a 25Z5. The resistance is 300 ohms at 300 ma., for 115 volt a.c., the condenser is 8 mf., and the speaker field may vary between 1500 and 4000 ohms.

Fig. 7E simply shows a means of using a variable impedance secondary transformer to match a speaker to an output stage.

Fig. 7G shows how three speakers in series would be connected to such a transformer, and Fig. 7H shows how two speakers in series would be so connected, while Fig. 7I indicates the connection of two

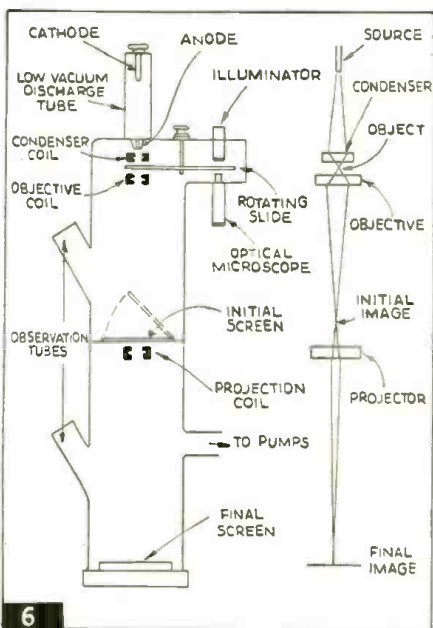

the frequencies on the other aerial.

A remote control unit may be previously calibrated and inserted in the cable at any point, as shown in Fig. 8B.

Fig. 8C shows the adaptation of the circuit to a dipole antenna.

### Curing Key Clicks

9 A KEY may be inserted in the screen-grid lead of an oscillator, in the high voltage lead, or in the high voltage plate lead of the power amplifier. Even if the key is inserted in the first mentioned place, which is the best, sparking is apt to result at the key's contact. This causes interference.

The simplest filter to eliminate this trouble is seen in Fig. 9A, where a 2 mf. condenser and a 1000 ohm resistor are in series across the key. If the current in the key's circuit exceeds 10 ma., additional components are necessary. This is the circuit, as shown in Fig. 9B, where a high inductance choke in parallel with a 100,000 ohm variable resistor is connected in series (Continued on next page)



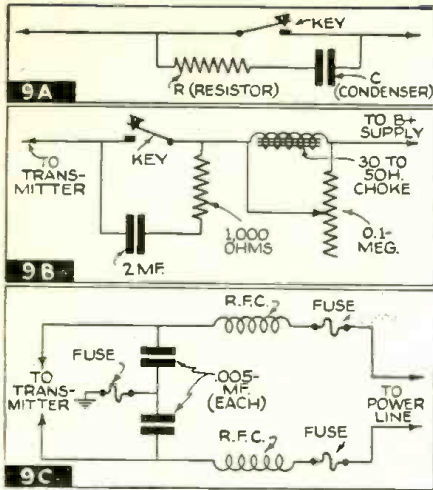

(Continued from preceding page)

with the key. If interference from keying still feeds into the line, an r.f. filter may be inserted in the A.C. power leads, as shown in Fig. 9C. This will prevent interference with broadcast reception.

### 2-Tube 3-Meter Adapter

**10** AN extremely simple converter can be made at a maximum cost of about \$7.50, as described in *Short Wave Magazine* of England. All the coils are wound on one-inch corks and are permanently mounted on their associated condensers. The radio receiver, with which this converter is used, is tuned to approximately 1500 kc., the coil L4 consisting of 150 turns. Both tubes must be shielded as are the three tuned circuits.

To operate, tune the oscillator until a hissing sound is heard, then tune for a signal with the antenna connected to the cathode tap of the detector stage. When a signal is tuned in in this way, shift the antenna to its correct position and balance the r.f. stage.

Specifications for the coils and other components are: R.F. stage, L1, 6 turns spaced to cover 1-in. Cathode tap  $\frac{3}{4}$ -turn from ground end; 1st det., L2, ditto, with 3-turn coupling coil close to ground end; osc. coils, L3, 5 turns each, wound continuously to cover 2 ins. With both coils wound in the same direction, the connections, starting from either end, should be: 1 plate, 2 B, 3 grid condenser, 4 ground.

List of parts and values: C1, C, C4, C5—.01 mf.; C3—.001 mf.; C6—.0002 mf.; C7, C8, C9—15 mmf.; C10—.0001 mf.; R1—500 ohms, 1 watt; R2—1500 ohms, 1 watt; R3—100,000 ohms, 1 watt; R4—30,000

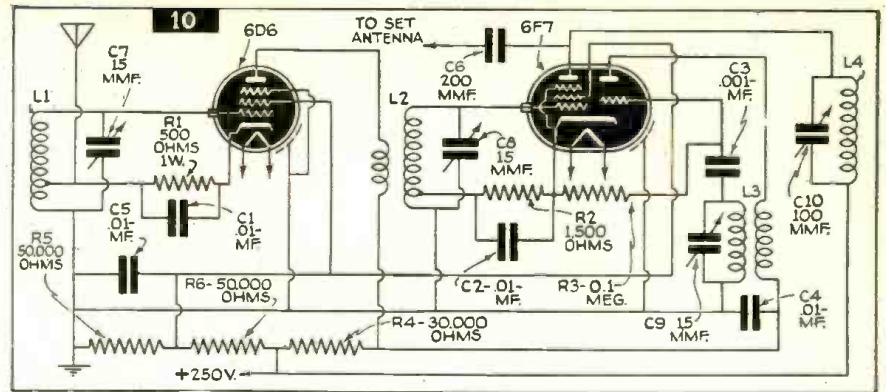

# INTERNATIONAL

ohms, 1 watt; R5, R6—50,000 ohms, 1 watt; filament transformer, 6.3 v., 1 amp.; 6D6 and 6F7 tubes.

### Home Recording Hints

**11** A SIMPLE circuit for home recording is given in Fig. 11A, from *Practical and Amateur Wireless* of England. Two double-pole, double-throw switches are used to permit either the microphone or pick-up to be connected to the input of an amplifier which, incidentally, may be the audio channel of a radio receiver. Either the microphone or a pick-up may be connected to the input, permitting play-back through the loud speaker or recording on the cutting-head connected with the output.

If the radio frequency and detector stages of a receiver are connected to the input, broadcast programs may either be played through the speaker or recorded by the cutting head.

Fig. 11B shows a simple mixer for recording from a microphone and pick-up, permitting any degree of fading of either unit.

Fig. 11C shows a constant impedance volume control for the input circuit. In this way, the input may be regulated without getting the circuit out of balance and thereby destroying its frequency characteristics.

When playing back, surface noise (particularly manifest in home recording) may be eliminated by means of a simple scratch filter, as shown in Fig. 11D. This consists of a fixed condenser and a variable resistor in series. Many circuits use a fixed resistor, which is cheaper, but the variable resistor is preferable as it permits the passage of a maximum range of highs while allowing the scratch to be taken out.

### Making an "S" Meter

**12** AN "S" meter to measure signal strength may be used to replace the magic eye often incorporated in communications receivers. The advantage is that an "S" meter gives a definite reading, while the magic eye merely indicates an approximate signal strength.

The basic principle of the "S" meter, as described by J. F. S. Carpenter, G8JQ, in *The T. & R. Bulletin* of Great Britain, is merely a Wheatstone Bridge as shown in Fig. 12A. The ratio of the resistances, when no current flows, is expressed by the ratio  $R4/R1 = R2/R3$ .

Fig. 12B shows how a tube is substituted for R4. Its internal resistance must remain constant so that no current flows through the meter when the bridge is balanced. This balance is achieved by installing a variable resistance of the correct value in series with the tube.

Practical application of this circuit is shown in Fig. 12C. In this figure, resistances 1, 2 and 3 correspond to those similarly numbered in 12D. In the writer's case, R1 was 2000 ohms; R2, 100,000 ohms; R3, 24,000 ohms. A 0-1 ma. meter was employed.

If, in actual use, the meter tends to go off scale, a shunt can be used to increase its range.

### New Television Tube

**13** T. C. BUTTALL and Baird Television, Ltd., have applied for a patent on a new type of television tube, which has been described in *Wireless World*, a British publication.

In this system, the picture signals developed in an electron camera are passed directly from the scanning aperture in the

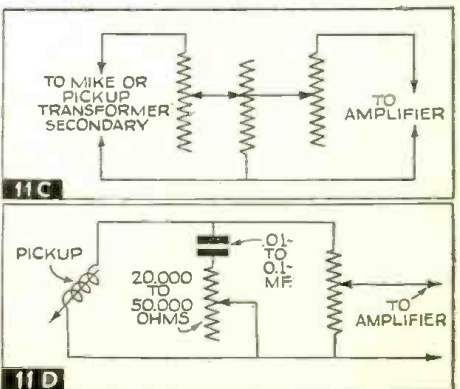
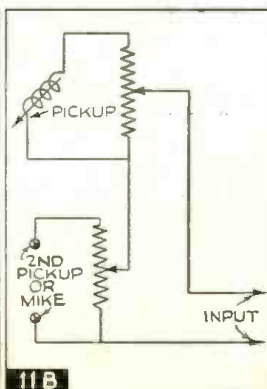
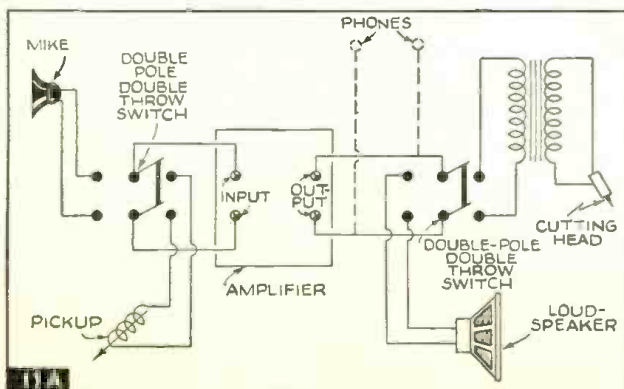



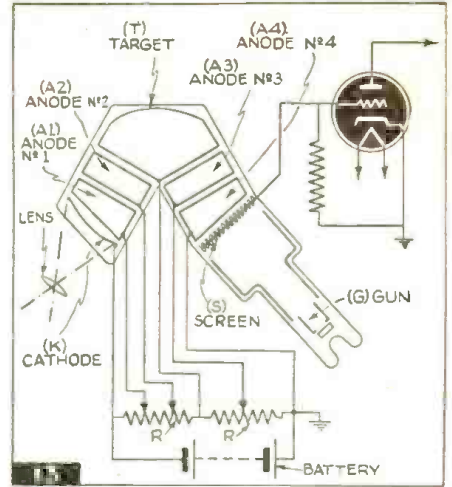
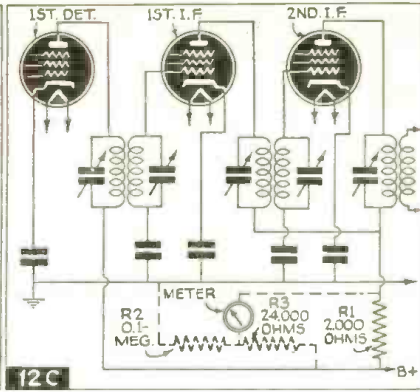
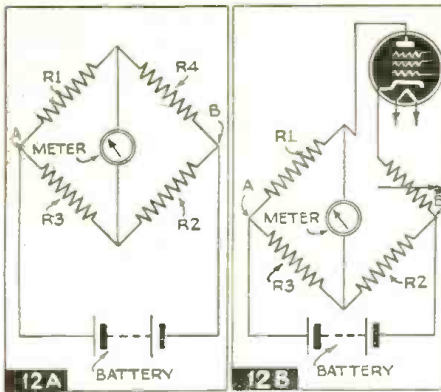

# RADIO REVIEW

anode on to the first of a series of target electrodes arranged in a projecting part of the same tube, where they are subjected to intensive amplification by secondary emission.

According to the invention, the signals are modulated, as they pass through the tube, by applying a carrier-wave frequency directly to one or more of the target electrodes in the electron multiplier. Preferably a periodic blocking potential is also applied to the electron multiplier, in order to cut off the output during the flyback period.

## Simplified Variable Selectivity

**14** HIGH selectivity is an advantage in a radio receiver when one wishes to separate the signals of stations on adjacent bands, but a lesser degree of selectivity is preferable in order to get high fidelity reproduction when extra sharp tuning is not needed.

A method suggested by a British writer, R. E. Spencer, in *Wireless World*, is shown in Fig. 14. This consists of adding two windings to a coupling transformer and having a single-pole, double-throw switch with an "OFF" position connected to them. The insert in Fig. 14 shows how these coils are added, while the schematic shows their place in the circuit. When the switch is in the middle position, with neither coil "shorted," medium selectivity is obtained. This selectivity may be increased by placing the switch in one position, and the tuning broadened by placing it in the other position.

## Interference in Television

**15** ONE trouble that British television viewers are experiencing, according to

*Wireless World*, is due to interference from the heterodynes of various stations which impinge on the video band. The use of a reflector can do much to overcome this difficulty.

In normal use the reflector is positioned directly in back of the receiving antenna in a straight line with the video transmitter to be received. If the interfering station is located as shown in Fig. 15A, its signals will reach the antenna and cause distortion of the image. Fig. 15B shows how a simple change in the position of the reflector will block the wave from the interfering station. In this case, however, there will be some decrease in the strength of the signal received from the vision transmitter. Therefore, the editors of *RADIO & TELEVISION* suggest that instead of changing the position of the reflector, an additional reflector be installed so that two are in use—one as shown in Fig. 15A and the other as shown in Fig. 15B.

## Operation of Automatic Bias

**16** THE basic circuit in which cathode bias is used is shown in Fig. 16A. The direction of the plate current which flows from the cathode to the plate inside the tube is shown by the arrows. Flowing through resistor R3, it creates a voltage drop which is equal to  $IR_3$ , I being the current in amps., and R3 the resistance in ohms, thus making the cathode positive with respect to the negative B lead, to which the grid is returned through R1. In normal operation, no grid current flows, so that the grid is at the same potential as negative B, making the cathode positive with respect to the

grid. When a signal is applied across R1, the grid becomes alternately positive and negative, with respect to negative B.

When the grid swings positive, the grid potential is less negative than before with respect to the cathode, so that the plate current increases. The voltage drops across R2 and R3, therefore, increase as well. With respect to negative B, the plate is less positive than formerly, and the cathode is more positive.

When the grid swings negatively, exactly the reverse happens, the plate current falls and the voltage drops across R2 and R3 are decreased. Consequently, the plate becomes more positive, and the cathode less positive relative to negative B.

It is therefore clear that when a signal is applied, both plate and cathode potentials fluctuate, and that the change of plate potential is in the opposite direction, and the change of cathode potential is in the same direction as the grid voltage change. All potentials are reckoned with respect to negative B. The output voltage at the cathode is thus in the same phase as the input, and the output voltage at the plate is in the opposite phase.

One difficulty sometimes experienced with automatic bias is the possibility of feedback. This, however, can be suppressed by using a large capacity by-pass condenser C, as shown in Fig. 16B. In this way, although the plate current fluctuates and follows a change of grid voltage, the current through R3 does not change, for the condenser absorbs the difference.

The values of C are: 25 to 50 mf. in A.F. amplifiers; .1 mf. in broadcast I.F. and R.F. amplifiers; or .1 mf. or smaller for short wave work.

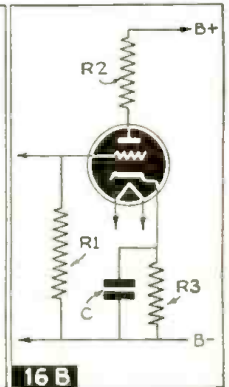
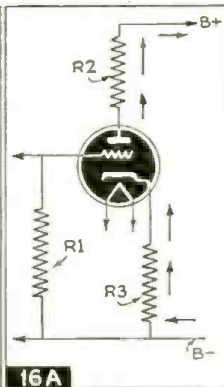
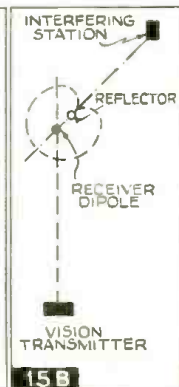
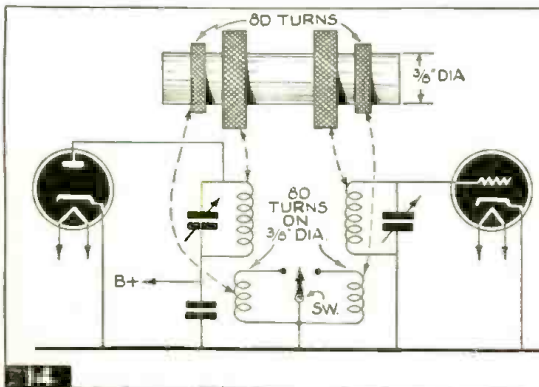



Robert  
Eichberg's

# Radio Test-Quiz

For each question answered fully, count 10 points; half right, 5 points; etc. A perfect score is 170, a good score is 110; below 60 is poor.



**WHICH IS NEAREST AND FARTHEST--?**

Hugo Gernsback, Editor of "R & T," scored 130 points in 19½ minutes. What is your score?

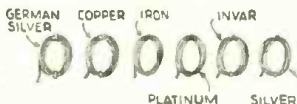

**FOR MINIMUM RESISTANCE WHICH WIRE TO USE?**

1. When you want to wire up a circuit with the least possible D.C. resistance, which of the following would you use to keep resistance at a minimum?

- a. Copper wire
- b. Silver wire
- c. Platinum wire
- d. Iron wire
- e. German silver wire
- f. Invar wire

2. Manfred von Ardenne, noted German physicist, has recently received much publicity for his work on

- a. a new type of submarine detector.
- b. a new type of "death ray".
- c. a new type of cathode ray tube.
- d. a means for creating interference with enemy broadcasts.

3. Here are the names of three noted radio engineers and three well-known companies. Can you tell which engineer is with which company?

- a. Ed Cohan
- b. Charlig Horn
- c. Jack Poppele
- A. NBC
- B. MBS
- C. CBS

4. No matter what your opinion of them may be, the most popular programs in the rural districts are

- a. Lum & Abner
- b. Major Bowes
- c. Kate Smith
- d. Charlie McCarthy
- e. Information Please
- f. Benny Goodman

5. When Guglielmo Marconi, Italian inventor, died, his yacht, the *Elettra*, was

- a. seized by Mussolini for his personal use.
- b. sunk with the body of its owner aboard.
- c. turned into a floating radio museum.
- d. put into the Italian National Museum of Science.

6. A radio listener in Denver tunes in a number of s-w broadcasts. Of the following cities where these broadcasts might have originated, which is farthest from, and which nearest to, the listener?

- a. Tokyo
- b. Caracas
- c. Paris
- d. Moscow
- e. Berlin
- f. Rome

7. Certain motion picture executives have decided that their stars should cease broadcasting because

- a. the programs were so bad they hurt the stars' prestige.
- b. the programs were so good that people stayed home to listen to them instead of going to the movies.
- c. the public got so much free entertainment from the stars that they were unwilling to pay to see their pictures.
- d. the stars got swelled heads and wanted more money.

8. Instructions for mounting certain radio parts call for the use of 6/32 screws, which means that

- a. one should use six screws of the No. 32 size.
- b. the screws are size No. 6 in diameter and have 32 threads to the inch.
- c. the screws are 6/32" in diameter.
- d. the ratio of the diameter to the length of the screw is 6:32.

9. When Sunday sermon broadcasts were commenced nearly 20 years ago, a number of ministers condemned them as

- a. attempts to win converts from one religion to another.
- b. giving a false impression of a church service.
- c. another reason for the public to stay away from church.
- d. too strong a drive for new church members, and therefore undignified.

10. At the end of February, 1939, the number of licensed amateurs (Hams) in the United States was

- a. less than 25,000
- b. between 25,000 and 35,000
- c. between 35,000 and 45,000
- d. between 45,000 and 55,000
- e. more than 55,000



**ACHIEVED AT WHICH DATE--?**

11. (A) Thomas Edison discovered that a heated filament emits electrons. (B) J. A. Fleming discovered that a positive plate would attract these electrons, and (C) Lec de Forest controlled the flow by means of an interposed grid. From the following table, choose the date of each man's achievement.

- a. 1869
- b. 1876
- c. 1883
- d. 1888
- e. 1896
- f. 1899
- g. 1905
- h. 1907
- i. 1909

12. In scanning an image, the cathode ray in a kinescope must swing back to the beginning of each line. The relation between the time it takes for the back-swing and the time taken for the image swing may be expressed by the ratio

- a. 10:1
- b. 5:1
- c. 1:1
- d. 1:5
- e. 1:10
- f. 1:11½

13. A famous broadcaster was recently granted a Ham license. The "air name" of this person is

- a. Gracie Allen
- b. Amos, of Amos 'n' Andy
- c. Andy, of Amos 'n' Andy
- d. Lum, of Lum & Abner
- e. Abner, of Lum & Abner
- f. Fibber McGee

14. The screens of some cathode ray tubes show a green image, while others show a white image, the difference being caused by

- a. the electron emitting material on the cathode.
- b. the fluorescent material on the screen.
- c. the voltage applied to the tube.
- d. the war in China.

15. In New York City, the title of the man in charge of the police department radio system is

- a. Radio Supervisor
- b. Chief of Communications
- c. Director of Broadcast Division
- d. Superintendent of Telegraph Bureau

16. A "hard" tube, as used in radio, is

- a. any metal tube.
- b. a highly evacuated tube.
- c. a tube containing a large percentage of gas.
- d. any tube suitable for use in high frequency work.

17. In the following list, can you pick out one artist who has never sung over the air?

- a. Lily Pons
- b. Lawrence Tibbett
- c. Paul Chabas
- d. Enrico Caruso

(Answers appear on page 64)



# What About THAT Television Antenna?

An interview with O. B. Hanson, chief engineer of N.B.C., discloses many interesting things we did not know before concerning receiving aerials for television.

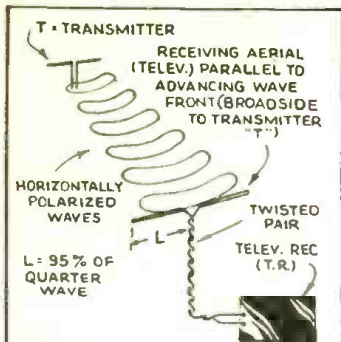

FIG. 1-A

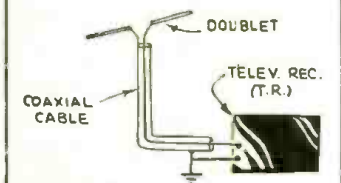

FIG. 1-B

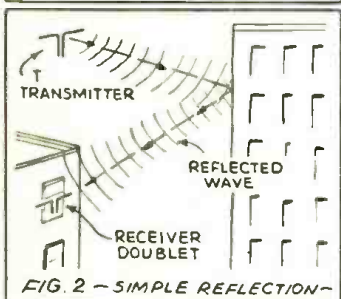

FIG. 2 - SIMPLE REFLECTION -

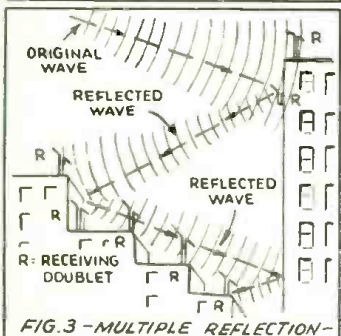

FIG. 3 - MULTIPLE REFLECTION -

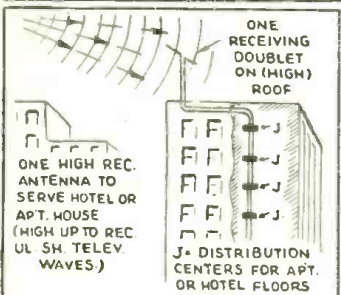

FIG. 4

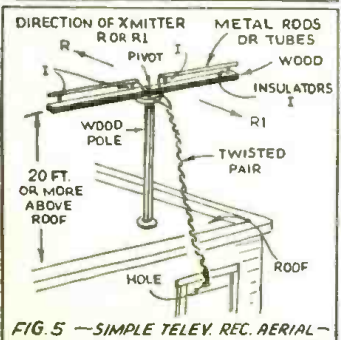

FIG. 5 - SIMPLE TELE. REC. AERIAL -

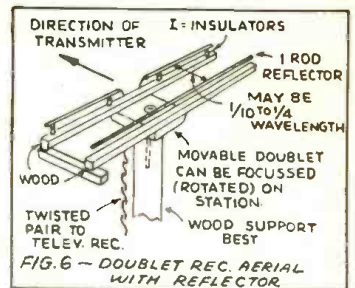

FIG. 6 - DOUBLET REC. AERIAL WITH REFLECTOR

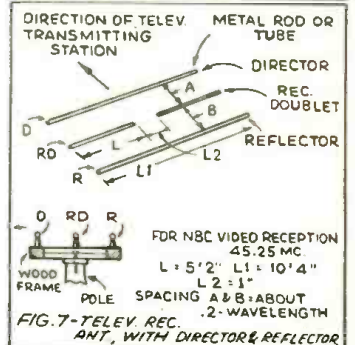

FIG. 7 - TELE. REC. ANT. WITH DIRECTOR & REFLECTOR

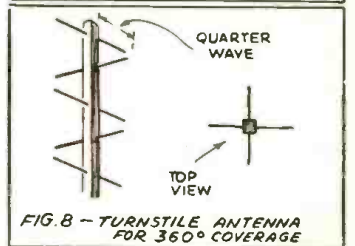

FIG. 8 - TURNSTILE ANTENNA FOR 360° COVERAGE

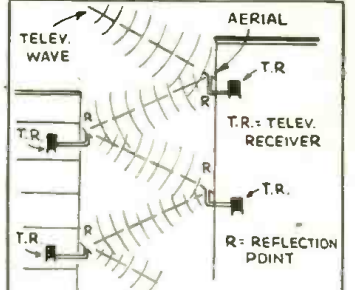

FIG. 9 - HOW REFLECTED WAVE MAY BRING TELE. TO CITY "CANYONS"

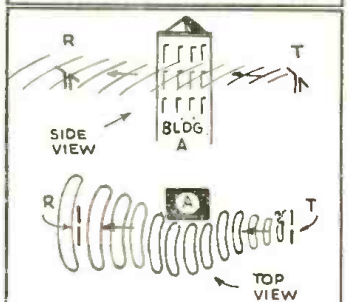

FIG. 10 - HOW WAVES MAY BEND AROUND OBSTRUCTION "A"

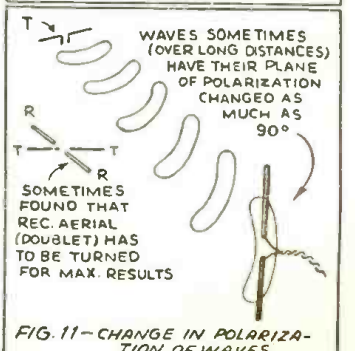

FIG. 11 - CHANGE IN POLARIZATION OF WAVES

● FOR receiving television images transmitted on waves in the 6-meter region, a horizontal doublet is generally advocated. The accompanying pictures show various locations in which the doublet may be placed. It is interesting to note for those who read the English television articles, that their doublets are shown in a vertical position, the waves being vertically polarized over there. In this country, horizontally polarized waves are used for television, and the doublet should be placed horizontally also, as shown in the accompanying sketches.

Fig. 1 shows how the doublet, each leg of which measures one-quarter wave length, may be connected to the television receiver by means of a twisted pair. The twisted pair comprises two rubber covered wires which are twisted together, similar to lamp cord; the better the insulation, the more reliable the reception, especially in wet weather when leakage may occur, if the wires are poorly insulated.

Fig. 1B shows the use of co-axial cable between the antenna and the television receiver itself. The principal thing to remember in connection with a television aerial or doublet is that it should be elevated to the highest position possible, at least twenty to thirty feet above the roof, so as to be free from interfering electric light or telephone circuits, and capacity or inductive effects from any nearby metal or other masses.

In a recent article in the *New York Sun*, Mr. O. B. Hanson, vice-president and chief engineer of N.B.C., revealed some interesting conditions that will undoubtedly occur in television reception in large cities. With buildings of various heights, all sorts of wave reflections are bound to occur and our television experimenters will often find conditions similar to those illustrated in Figs. 2, 3, etc.

As Mr. Hanson pointed out (see Fig. 2), the receiver doublet or aerial may pick up a very good signal on a wave reflected from the wall of a building.

Fig. 3 shows a doublet and even a triple reflected wave, and many of our television experimenters in the near future may find that by moving the doublet up or down, a point of maximum signal with minimum multiple path reception will be found for their particular location. Of course, the waves will spread out a great deal more than is apparent from the simple diagrams here shown, and in each case the point where the maximum strength of signal (especially on a reflected wave) is to be found, will have to be determined by experiment (rotation of the antenna while viewing received image). Sometimes much better reception will be found by moving a doublet closer to or farther from the wall of the building. Even moving the doublet a few feet may spell the difference between success and failure.

Mr. Hanson brought out the fact that while absorption of energy from the television wave, due to metal structures in close proximity to the receiving aerial, is to be considered, National Broadcasting Company engineers have found this

(Continued on page 44)



## First Prize Winner

### Regeneration Indicator

One of the "magic eye" or electron ray tubes, such as the 6G5, 2E5, etc., can be used to indicate when a set is regenerating or when it has "popped out".

The circuit shown may be used on broadcast T.R.F. as well as on regenerative sets. Points to remember are that the filament of the magic eye need not be grounded if the filament supply in the power pack is. Also that it may be necessary to experiment with values of C1 and R1 to get the best results. —Michael Schmitt.

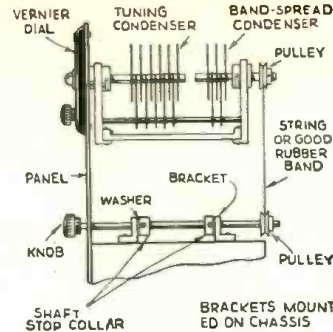
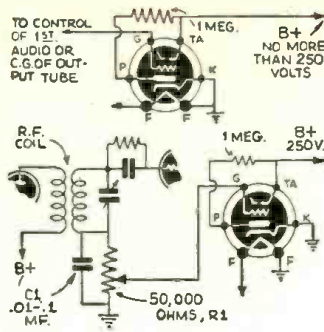

### Band-Spread Tuning

Many condensers which are equipped with band-spread sections have no means of tuning the band-spread from the front of the panel. In order to obtain such control, I am using the system illustrated herewith. The sizes of the pulleys will determine the ratio of vernier control for the bandspread. The drive may be a piece of strong string or fish line, or even a strong rubber band. It saves a great deal of trouble as one does not have to reach behind the panel to tune the band-spread condenser.—Richard J. Blackburn.

### Heavy Duty Phone Cord

As my phones are used a great deal and subject to hard use, I found that standard phone cords did not last very well. In order to make a heavy duty cord that would stand almost unlimited abuse, I used the system shown herewith. The cord is ordinary electric light wire; the plug is a standard electric light plug; and the jack is a standard electric outlet.—Andres Enongelis

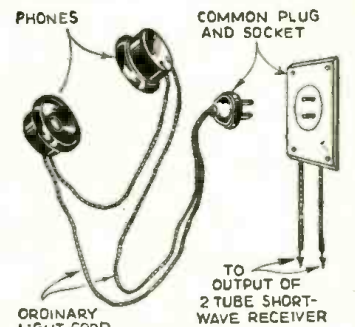

# Radio Kinks

### Locating Distortion

A quick way to locate distortion or dead stages in a radio is to connect a fixed crystal detector in series with a pair of phones and, with the set tuned to a strong broadcasting station or coupled to a modulated signal generator, connect the phones across the secondaries of the R.F. and I.F. transformers, starting with the R.F. and going toward the output. When you reach the audio stages, substitute a .1 mf. 600

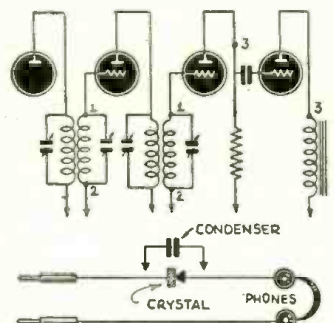

volt condenser for the crystal and connect directly from plate to chassis. Sometimes this will locate a faulty stage when nothing else will. Use crystal when testing between points 1 and 2, and condenser between 3 and 4. —William H. Perkins.

### Making Variable Condenser

A midget variable condenser can be made from an old burned out volume control and a little sheet brass. First the volume control components, such as the resistance, contact, etc., must be taken out. The plates are then cut to size and shape from the sheet brass; the rotor is fastened to the shaft either by tapping the shaft and securing the plate with a screw, or by soldering, or swaging. The stator plate or plates can be secured either by bolting or by affixing with a household cement. A two or three plate condenser

Each month the Editor will award a 2 years' subscription for the best kink submitted. All other kinks published will be awarded eight months' subscriptions to RADIO & TELEVISION. Read these kinks; they will be of real use to you, besides indicating what is wanted. Send a typewritten or ink description with sketch of your favorite to the Kink Editor.

is most easily made, but with a little practice, multi-plate condensers can be made in this way. —Tony R. Smolar.

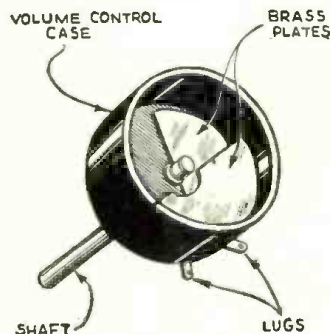

### Code Practice Oscillator

The cheapest efficient code-practice oscillator can be made out of an old bell-ringing transformer, a key and a headset. The primary of the bell-ringing transformer is connected across

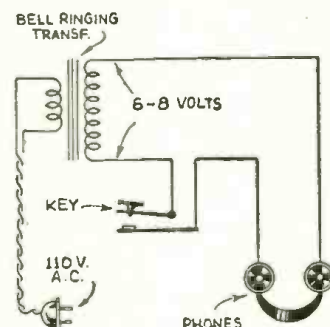

the 110 volt line, while the secondary is connected in series with the key and phones, as shown. This, of course, can be used only on A.C.

Some experimenters prefer using a glass of water with a pair of leads submerged in it as a resistance, instead of a trans-

former. Although this is considerably cheaper, it is quite dangerous should the user be wearing a pair of grounded phones and accidentally come across a ground or touch a metal part of the key.—Jerome Mulberg.

### Plug-In Condensers from Old Auto Fuses

I have found that burnt-out fuses of the small auto and radio type make fine antenna trimmer condensers. The idea is simply this—a small hole is drilled in one of the end caps, just large enough to admit the thread of a machine screw, which forms one plate of the condenser. (Better, the hole in the cap may be threaded for the

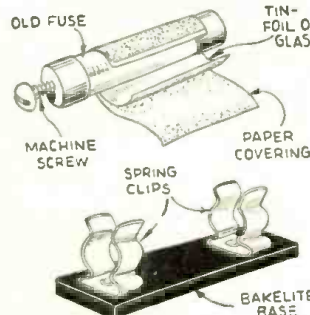

screw, or a nut soldered to it, if no tap is at hand. A lock nut may also be provided.) The other plate is formed of tinfoil glued on the outside of the glass tube and underneath the other end cap. Ordinary paper is then glued over the fragile foil to protect it. I use standard fuse clips for mounting. Being simple and cheap to construct, I find it best to have one for every coil and just clip them in, instead of adjusting every time I change coils.—Ivan Walker.

### Bending Jig

With this easily built jig, sheet metal for radio cabinets or chassis may be quickly and evenly bent to any desired angle up to 90 degrees. Two boards are hinged together, with a wooden clamp to hold the metal in position while one of the hinged portions is being raised. Use hard-

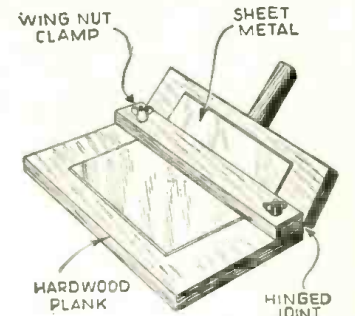

wood throughout, especially if you plan to bend sheet steel. The large board is secured to the top of the bench, while the smaller board, which is hinged to it, is provided with a long hardwood or iron pipe handle. —Bill Smith.

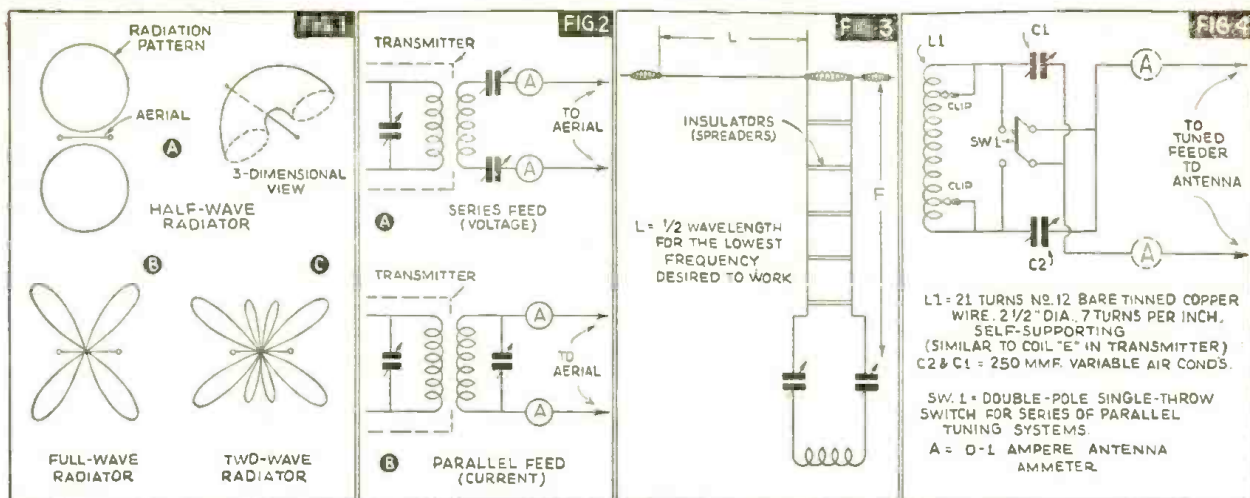

Various connections for the amateur transmitting antenna and feeder system are here shown, with special regard to the transmitter described in the March number.

# Getting Started in Amateur Radio

C. W. Palmer, E.E., Ex.-W2BV

Third of a New Series

● PERHAPS no part of amateur radio has changed more rapidly in the past few years as much as the *aerial* or antenna. Especially in ultra-high frequency transmissions, the changes have come so rapidly that the ham who always wants to try the "latest" has difficulty in keeping up with developments.

On the lower frequencies used for amateur communication, the changes have been somewhat slower and set rules can be given for the design and construction of dependable radiating aerials.

First, there are two general types—the "Marconi" and the "Hertz"—named for the men who first applied them to radio transmission. The Marconi type which may consist of a single wire either vertical or horizontal or a combination of both, is connected to "ground" through a coupling and tuning arrangement. The Hertz antenna is a single wire suspended above the earth and the "ground" plays no direct part in the means of radiation, though it does of course have a very important effect on its performance.

Since the Hertz antenna is used almost exclusively in amateur transmission, the description which follows will apply directly to this type. The natural wavelength to which a Hertz antenna resonates is approximately twice the length of the wire, and is affected to some extent by the proximity of surrounding objects which tend to raise the natural wavelength. A rule of the thumb for figuring antenna length is to multiply the desired wavelength in meters by 1.56 and the result is the *length in feet* required.

This length is for a *half-wave* radiator and it must be understood that an antenna

can be any multiple of half-wavelengths and still operate efficiently as a transmitting radiator. Thus an aerial twice the length figured above will have two half waves on it. This fact makes it possible to use the same antenna for several "ham" bands since a full-wave (2 half-wave lengths) antenna for one band will be a half-wave antenna on another band. It will be remembered that the ham bands are approximately in harmonic relation—that is, one band is twice the frequency of the next lower in frequency. Conversely the full-wave antenna will be two wavelengths long for the next higher frequency band, etc.

The direction or directions in which a Hertz antenna will radiate when not obstructed by surrounding objects is shown graphically in Fig. 1. This illustration does not show the true shape, as, for example, the half-wave antenna pattern is in reality in the shape of half of a cruller, set upright on the surface of the earth—that of the full-wave aerial is in the form of two half-cones set in similar fashion, etc.

An important characteristic of a transmitting aerial is its *radiation resistance*. This varies with the length of the wire and is greater for longer wires than for short ones. However, there is another factor which must be considered which offsets this to some extent. The radiation resistance of a half-wave radiator is about 70 ohms. That of a four-wave radiator is considerably higher and even though the power in the major lobe of the four-wave antenna is about twice that in the major lobe of the half-wave radiator, the antenna current fed from the transmitter to the radiator will be reduced by an increase in radiation resist-

ance. Thus, though the efficiency of the four-wave antenna is greater, the advantage is offset by the smaller amount of power supplied by the transmitter. In actual practice, the longer aerial shows some gain over smaller aerials.

## Feeding Current to the Aerial

In Part 2 (see March issue) we constructed a c.w. transmitter to the point of coupling it to the aerial. We can now complete the X-mitter by actually putting up an aerial and coupling the unit to it.

There are two methods of feeding the aerial: *current* and *voltage* feed. This simply means that the current from the transmitter is introduced into the antenna at either a point at which current is maximum or a point at which voltage is at its peak.

Figure 2 shows the difference between *voltage* and *current* feeds. For voltage feed a coil and condenser or two condensers are connected in series with the antenna. When coupling by the voltage feed method it is necessary to feed the power to the antenna at a high R.F. voltage (and corresponding low current) and for this purpose the coil and condenser are connected as shown in Fig. 2A. A balanced antenna is shown, in the latter case, but if desired, one of the half-wave radiators could be omitted.

Transmission lines feeding an antenna from a transmitter may be either tuned or untuned. The untuned type must be matched very carefully in impedance with the impedance of the aerial and are usually limited to transmission on one frequency. The tuned type on the other hand is readily

(Continued on page 56)



# Another "SWL Punk" Speaks Up!

Editor,

I just finished reading Austin Wardman's letter on "SWL punks" in the January issue of *RADIO & TELEVISION*. Well, Austin, OB, you were pretty good, but not good enough, so I'm going to throw my 2 cents' worth in.

First of all, I'll say a few words about QSL cards. Some of these amateurs will send you their cards as soon as they receive yours, but others won't send you one for love or money and these amateurs ought to get out of the game.

In the past six months I've logged 135 amateur stations and I've sent them all my

SWL card; and how many of these guys answered? Only 40! Pretty good out of 135. Some of these I sent International Reply Coupons and they didn't even reply!

So far, there have been only two amateurs that I think are worth their weight in gold. Of course there are many more but these two head the list. One is HH2B, Eric Bleo in Haiti—he's really one swell guy! He answers all SWL's right away—he doesn't wait a month or two! The other is W3LE. Judging from his letter in "R.&T." for October, he's really a swell guy and I would sure like to know him. These two hams are "hams what am!"

This business of putting R9 reports on cards is a lot of hooey! I never give an R9 report unless they deserve it.

My suggestion to amateurs who are too cheap to QSL is:—at the end of every contact say, "I don't QSL to SWL's" or "I don't QSL to SWL's unless they send a 2c or 3c stamp."

Well, that's all boys, but I'll be back with more; in the meantime I'm open for all criticisms—or praise!

GEORGE MATHEWS,  
854 Wrightwood Ave.,  
Chicago, Ill.

Member Short Wave League.

# What Do YOU Think?



This photo shows the business-like short-wave "listening shack" maintained by Capt. Paul B. Silver and his son at Woodbridge, N. J. One of the principal receivers used in this post is the Mallicrafter, shown in the photo. Captain Silver has hundreds of veri cards, a special veri letter and photos of the crew of the *China Clipper*, visible in the frame at the left of the photo.

## Found Our Circuits OK!

Editor,

Have read *RADIO & TELEVISION* for a long time and can say "it is the berries" for any one interested in radio and television receiver construction. I have built and tested many of the circuits shown in your magazine and have sure had lots of luck with them.

WALTER BURDINE,  
Waynesville, Ohio.

## U.H.F. Listening Neglected? Aussie Hears Calif.!

Editor,

A phase of S.W. listening which I feel is greatly neglected is the Ultra-High Frequency stations on 11, 9 and 7 meters.

Although these U.H.F. stations are primarily intended for "local" reception, you may be interested to know I have already received verifications from 14 of them and have reports away to 6 others. Included in my veris are four from Californian Police radios on 30.1 mc. Most of these veris

were for the first reports received from Australia.

In my general short-wave listening, I have received verifications from stations in 104 different countries.

R. SIMPSON,  
80 Wilga Street,  
Concord West, N.S.W.,  
Australia.

## An English S-W Listener

Editor,

I have been reading *RADIO & TELEVISION* for about ten months and thought it a very F.B. magazine, but lately it has changed—I think it is better!

If the shack photos you publish are an example of the majority of American SWL's, you guys certainly "go places!" I have been S-W listening for about 18 months; I started on a 1-tube adapter; now I have a 5-tube all-wave set. In a month or so, I am going to buy an American S-W receiver and have some SWL cards printed. I have very little time for listening, but I have managed to hear all continents and 37 countries, also 23 states of the U. S. Compared with some of your SWL's—this is "chickenfeed." I would like a correspondent in the U. S. who is interested in S-W listening. I will answer all letters and will send an English television catalog to all who write. (Please note these are limited.)

Well, I will say 73s to you, and wish the magazine long life.

S. BURRAGE,  
25 Grosvenor Road,  
Forest Gate,  
London, E.7, England.

## Here's an "Aussie Contact," Fellows!

Editor,

I am a constant reader of *RADIO & TELEVISION* and thoroughly satisfied with my 25 cents worth, and how!

I think Joe Miller's (Let's Listen In) corner to be the best reading, and tips on the DX and QSL cards, etc. This corner apparently is a popular page for many other readers, judging by the correspondence you receive.

I am using a 5-tube superhet. dual-wave commercial receiver and a 38-ft. single-wire center-fed aerial, running N-S, and this seems to be the one most satisfactory and up-to-date. I suffer terribly from auto-

mobile QRM which makes SWL impossible at times, and I quite agree with Franklin Jarvis' letter in the September, 1938, issue. When the car is being registered, the police should make the owner install an ignition suppressor of some kind!

I have 30 countries in my "log," including s.w. Commercials and Amateurs, but lately have been only listening on 14 mc. as I find the Amateurs far more interesting to listen to and to "log."

SWL cards out here are very expensive to have printed—about 200 cost \$4.00—that is for one color only. Wow!

I would like very much to hear from any of you chappies in the States or any other part of the world and will reply to all letters, also if any would like a call-book of the VK's and ZL's, I will gladly exchange or send one along. I would like some U.S.A. stamps from any correspondent (1c) and I will forward some "Aussie" stamps in return.

IAN B. PORTER,  
201 Tooronga Road,  
East Hawthorn E3,  
Melbourne, Victoria, Australia.

## Voice from Honolulu

Photo below shows the short-wave listening post of Ricardo Murakami, 1014 Gulick Ave., Honolulu, Hawaii. He uses several receivers covering all of the important short-wave bands, and is a member of the *Short Wave League*, certificate of which is seen on the wall.

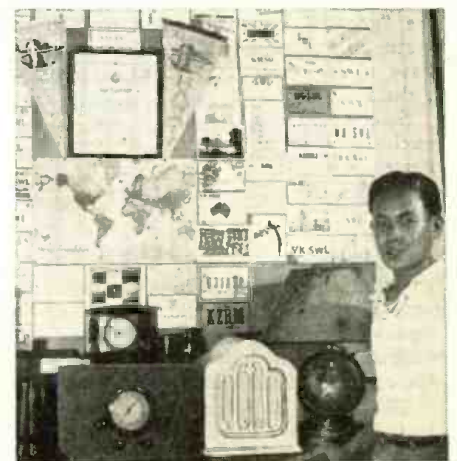

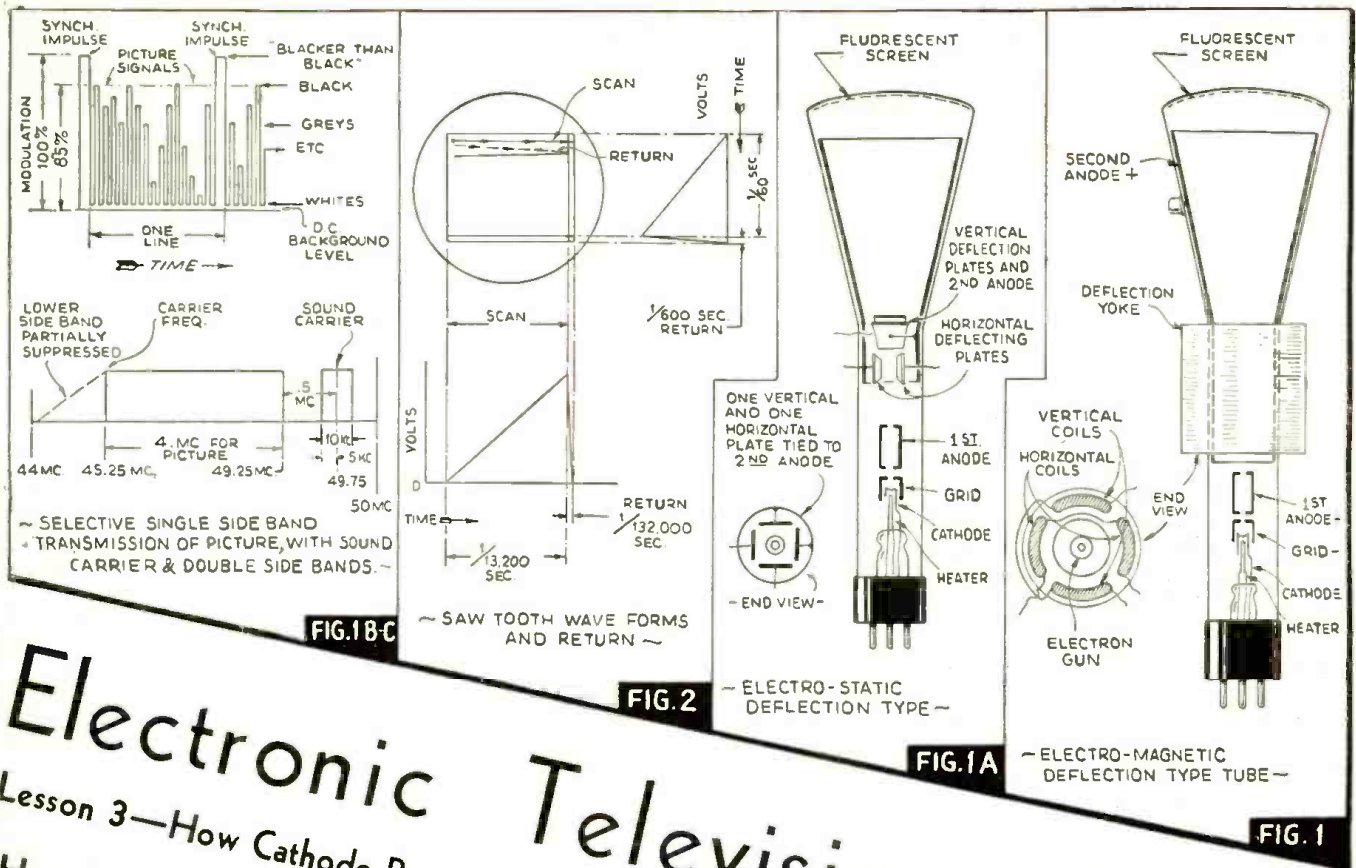

# Electronic Television Course

## Lesson 3—How Cathode Ray Tube Works

Henry Townsend

● AT the present time, the Federal Communications Commission has allotted three channels to the transmission of television pictures and the accompanying sound. The channels are: 44-50 mc., 50-56 mc., 66-72 mc. If double-side band transmission is used, the carrier would be modulated 2.5 mc. on each side (in the 44-50 mc. channel). The carrier would be 46.5 mc., with the upper side band extending to 49 mc. and the lower side band to 44 mc. The sound accompanying the picture is spaced 3.25 mc. from the picture carrier and this separation remains the same for all channels.

Recently the Radio Manufacturer's Association has recommended that selective single side bands transmission should be adopted. The following recommendations were tentatively adopted as a standard. The audio carrier remains at 49.75 mc. (in the 44-50 mc. channel). The video carrier is 4.5 mc. lower in frequency, at 45.25 mc., and only the upper side band is transmitted totally, giving a video side band channel of 4 mc. (See Fig. 1-B.) This extremely wide band of frequencies must be preserved in both transmission and reception of the television signal in order to convey to the eye the maximum detail available on 441 lines, 30 picture per second with an aspect ratio of 3-4.

When we consider the extremely high carrier frequencies and the tremendously wide side bands employed in the transmission and reception of television images, we can realize some of the engineering difficulties that had to be overcome before

television arrived at its present state of perfection. But they have been solved!

### Beam of Electrons "Paints" Image

In the reception of electronic television images, the transducer is a cathode ray tube. This tube is similar in construction to the picture tubes already described in previous chapters on this course. The cathode beam of electrons originating in an electron gun is passed through a series of negatively and positively charged electrodes and caused to impinge upon a fluorescent screen where it is transformed into visible light. In the *electro-statically* deflected tubes, this beam is caused to pass between two vertical and two horizontal plates or electrodes which deflect it across the fluorescent screen when voltage is applied to the set plates. In the *electro-magnetic* deflection types of cathode ray tubes, the beam of electrons is caused to pass through a vertical and horizontal magnetic field generated by two electro-magnetic coils surrounding the neck of the cathode ray tube. In Fig. 1, the negatively charged cylinder surrounding the electron gun is usually termed "the grid" and this electrode or grid acts in an identical manner to the grid of a common 3 or 4 element radio tube with which we are familiar. This element, in present day tubes, is usually biased at minus 50 volts. This bias exerts a sufficient repelling force on the electron beam that no electrons reach the fluorescent screen and consequently the screen is dark.

This effect is called the *current cut-off*.

When the signal from the television receiver partially or completely overcomes this bias, more and more electrons reach the fluorescent screen making it fluoresce to a greater or lesser degree, representing the *whites* and *greys* of the picture. A grid signal-swing voltage of approximately 25 volts modulates this cathode beam completely for optimum contrast in present type tubes.

### How Beam "Scans" Screen

Since a picture is scanned from left to right and top to bottom, as previously explained, the cathode beam at the receiver must begin at the upper left hand corner, move across the screen in synchronism with the transmitter, return in one-tenth of the time to a point representing the third line and repeat this cycle 220½ times, at which time the beam must return again to a point between the first and third lines and scan the even lines (namely 2, 4, 6, 8, etc.) to complete one frame of the picture. In order to do this (in the electro-static deflection type tubes) the *voltage* applied to the deflection plates must rise gradually and fall sharply, as shown in Figure 2. This wave shape assumes the form of a saw-tooth and consequently is termed a "saw-tooth". In the electro-magnetic de-

(Continued on page 40)



# World Short Wave Stations

## Revised Monthly

Complete List of SW  
Broadcast Stations

Reports on station changes are appreciated.

Mc.	Call	Me.	Call		
31.600	W1XKA	BOSTON, MASS., 9.494 m., Addr. Westinghouse Co. Daily 6 am.-1 am., Sun. 8 am.-1 am. Relays WBZ.	21.500	W2XAD	SCHENECTADY, N. Y., 13.95 m., General Electric Co., 8-10.15 am.
31.600	W1XKB	SPRINGFIELD, MASS., 9.494 m., Addr. Westinghouse Co. Daily 6 am.-1 am., Sun. 8 am.-1 am. Relays WBZ.	21.480	PCJ	HUIZEN, HOLLAND, 13.96 m., Addr. N. V. Philips, Hilversum. Irregular.
31.600	W3KEY	BALTIMORE, MD., 9.494 m., Relays WFBR 4 pm.-12 m.	21.470	G3H	DAVENTRY, ENG., 13.97 m. (See 21.550 mc.), 5:45-8:50, 9 am.-noon.
31.600	W2XDY	NEW YORK CITY, 9.494 m., Addr. Col. Broad. System, 485 Madison Ave. Daily 6-11 pm.; Sat. and Sun. 1:30-6, 7-10 pm.	21.460	W1XAL	BOSTON, MASS., 13.98 m. Addr. University Club. Tues., Thurs., Sat., 11 am.-12 n.
31.600	W9XHW	MINNEAPOLIS, MINN., 9.494 m., Relays WCCO 9 am.-12 m.	21.450	DJ5	BERLIN, GERMANY, 13.99 m., Addr. Broadcasting House. 12:05-7:50 am.
31.600	W3XKA	PHILADELPHIA, PA., 9.494 m., Addr. NBC. Relays KYW 9 am.-10 pm.	19.020	HS6PJ	BANGKOK, SIAM, 15.77 m. Mondays 8-10 am. See 15.23 mc.
31.600	W5XAU	OKLAHOMA CITY, 9.494 m., Sun. 12 n.-1 pm., 6-7 pm. Irregular other times.	18.480	HBH	GENEVA, SWITZERLAND, 16.23 m., Addr. Radio Nations. Sun., 10:45-11:30 am.
31.600	W4XCA	MEMPHIS, TENN., 9.494 m. Addr. Memphis Commercial Appeal. Relays WMC.	<b>16 Met. Broadcast Band</b>		
31.600	W8XAI	ROCHESTER, N. Y., 9.494 m., Addr. Stromberg Carlson Co. Relays WHAM 7:30-12:05 am.	17.850	TPB3	PARIS, FRANCE, 16.8 m. Addr. (See 15.245 mc.) 5:30-10 am.
31.600	W8XWJ	DETROIT, MICH., 9.494 m., Addr. Evening News Ass'n. Relays WTVJ 6-12:30 am., Sun. 8 am.-12 m.	17.850	HVJ	VATICAN CITY, 16.8 m. Heard 12 n. on Wednesday.
31.600	W9XPD	ST. LOUIS, MO., 9.494 m., Addr. Pulitzer Pub. Co. Relays KSD.	17.845	DJG	BERLIN, GERMANY, 16.81 m., 12:05-11 am.
26.550	W2XGU	NEW YORK CITY, 11.3 m. Relays WMCA.	17.840	—	MOYDRUM, ATHLONE, EIRE, 16.82 m. Addr. Radio Eireann. Daily 10 am.-5:30 pm.
26.450	W9XA	KANSAS CITY, MO., 11.33 m., Addr. Commercial Radio Eqpt. Co. Testing	17.820	2RO8	ROME, ITALY, 16.84 m., Addr. (See 2RO, 11.81 mc.) 4:30-8:45 am.
26.400	W9XAZ	MILWAUKEE, WIS., 11.36 m., Addr. The Journal Co. Relays WTMJ from 1 pm.	17.810	GSV	DAVENTRY, ENGLAND, 16.84 m., 5:45-8:50 am.
26.300	W2XJL	NEW YORK, N. Y., 11.4 m., Addr. Bamberger Broad. Service, 1440 Broadway. Relays WOR 12 n.-6 pm.	17.800	OIH	LAHTI, FINLAND, 16.85 meters, 4.9 am.
26.100	W9XJL	SUPERIOR, WIS., 11.49 m. Relays WEBC daily.	17.790	6SG	DAVENTRY, ENG., 16.86 m., Addr. B.B.C., London. 5:45-8:50, 9 am.-12 n., 12:20-4 pm.
26.050	W9XTC	MINNEAPOLIS, MINN., 11.51 m. Relays WCTN 9 am.-1 pm., 7 pm.-12 m.	17.780	W3XL	BOUND BROOK, N. J., 16.87 m., Addr. Natl. Broad. Co., 9 am.-5 pm. to Europe, 5-11 pm. to So. Amer.
26.050	W9XH	SOUTH BEND, IND., 11.51 m., Addr. South Bend Tribune. Relays WSBT-WFAM 2:30-6:30 pm., exc. Sat. and Sun.	17.770	PHI2	HUIZEN, HOLLAND, 16.88 m., Addr. (See PHI, 11.730 mc.) Daily 7:40-9:10 am. Mon & Thurs. 7:40-9 am. Sun. 6:25-9:45 am.
25.950	W6XKG	LOS ANGELES, CAL., 11.56 m., Addr. B. S. McGlashan, Wash. Blvd. at Oak St. Relays KGfJ 24 hours daily. DX tips Mon., Wed. and Fri. 2:15 pm.	17.760	DJE	BERLIN, GERMANY, 16.89 m., Addr. Broadcasting House. 12:05-11 am., 4:50-9 pm. Also Sun. 11:10 am.-12:25 pm.
25.950	W9XUP	ST. PAUL, MINNESOTA, 11.56 m. Relays KSTP evenings.	17.755	ZBW5	HONGKONG, CHINA, 16.9 m., Addr. P.O. Box 200, Dly. 11:30 pm.-1:15 am., 5-10 am., Sun. 9 pm. (Sat.)-1:30 am., 5-9:30 am. Operates irreg.
21.640	GRZ	DAVENTRY, ENG., 13.86 m. Addr. B.B.C., London. Unused at present.	<b>End of Broadcast Band</b>		
21.630	W3XAL	BOUND BROOK, N. J., 13.8 m. Addr. N.B.C., N. Y. C. 9 am.-4 pm.	17.310	W2XGB	HICKSVILLE, L. I., N. Y., 17.33 m., Addr. Press Wireless, Box 296. Tests 9:30-11:30 am. except Sat. and Sun.
21.570	W2XE	NEW YORK CITY, 13.91 m. (Addr. CBS, 485 Madison Ave., N. Y. C. Daily 7:30-10 am. Sat. 8 am.-12 n. Sun. 8-11:30 am.)	17.280	FZEB	DJIBOUTI, FRENCH SOMALILAND, 17.36 m. Test XMSN 1st Thurs. each month 8-8:30 am. Next B.C. April 6.
21.565	DJJ	BERLIN, GERMANY, 13.92 m., Addr. Broadcasting House. Irreg.	15.550	CO9XX	TUINICU, ORIENTE, CUBA, 19.29 m., Addr. Frank Jones, Central Tuinicu, Tuinicu, Santa Clara. Broadcasts irregularly evenings.
21.550	GST	DAVENTRY, ENG., 13.92 m., Addr. (B.B.C., London) Irregular at present.	15.510	XOZ	CHENG TU, CHINA, 19.34 m. Daily 9:45-10:30 am.
21.540	W8XK	PITTSBURGH, PA., 13.93 m., Addr. Grant Bldg. Relays KDKA 6:45-9 am. Also Sunday, 6 pm.	15.370	HAS3	BUDAPEST, HUNGARY, 19.52 m., Addr. Radiolabor, Gyali Ut 22. Sun. 9-10 am.
21.530	GSJ	DAVENTRY, ENG., 13.93 m., Addr. (See 21.550 mc.) 5:45-10:30 am.	15.360	DZ6	ZEESEN, GERMANY, 19.53 m., Addr. Reichspostzentralamt. Tests irregularly.
21.520	W3XAU	PHILA., PA., 13.94 m., Addr. Col. Broad. Syst., 485 Madison Ave., N. Y. C. Daily 1:30-2:30 pm., Sat. & Sun. 1-2:30 pm.	15.360	—	BERNE, SWITZERLAND, 19.53 m. Irreg. 6:45-7:45 pm.

Mc.	Call	Mc.	Call		
15.340	DJR	BERLIN, GERMANY, 19.56 m., Addr. Broadcast'g House, 4:50-10:50 pm.	<b>19 Met. Broadcast Band</b>		
15.330	W2XAD	SCHENECTADY, N. Y., 19.56 m., Addr. General Electric Co. Relays WGY, 10:30 am.-6 pm.	15.340	DJR	BERLIN, GERMANY, 19.56 m., Addr. Broadcast'g House, 4:50-10:50 pm.
15.330	W6XBE	SAN FRANCISCO, CALIF., 19.56 m., Addr. General Electric Co., 7-10 am., 6:30-10 pm.	15.320	OLR5B	PRAGUE, BOHEMIA, 19.58 m. Addr. (See 11.840 mc.) Irreg.
15.320	OZL5B	PRAGUE, BOHEMIA, 19.58 m. Addr. (See 11.840 mc.) Irreg.	15.320	OZH	SKAMLEBAK, DENMARK, 19.58 m., Sun. 8 am.-1:30 pm.
15.310	GSP	DAVENTRY, ENG., 19.6 m., Addr. (See 17.79 mc.) 4:20-6 pm., 12:20-1:15 pm.	15.310	GSP	DAVENTRY, ENG., 19.6 m., Addr. (See 17.79 mc.) 4:20-6 pm., 12:20-1:15 pm.
15.300	YDB	SOERABAJA, JAVA, N. E. I. 19.61 m. Addr. NIROM, 10 pm.-2 am.	15.300	XEBM	MAZATLAN, SIN., MEX., 19.61 m., Addr. Box 78, "El Pregonero del Pacifico." Irregularly 9-10 am., 1-2, 8-10 pm.
15.300	2RO6	ROME, ITALY, 19.61 m., Addr. (See 2RO, 11.81 mc.) 10 am.-12:04 pm., 3-5:30, 6-9 pm.	15.290	VUD3	DELHI, INDIA, 19.62 m. Addr. All India Radio. 9:30-11:30 pm., 1:30-3:15 am.
15.290	DJQ	BERLIN, GERMANY, 19.63 m., Addr. Broadcasting House. 12:05-11 am., 4:50-10:50 pm.	15.290	LRU	BUENOS AIRES, ARG., 19.62 m., Addr. El Mundo. Relays LRI, 8-10 am.
15.270	H13X	CIUDAD TRUJILLO, D. R., 19.65 m. Relays HIX Sun. 7:40-10:40 am. Tues. and Fri. 8:10-10:10 pm.	15.280	DJQ	BERLIN, GERMANY, 19.63 m., Addr. Broadcasting House. 12:05-11 am., 4:50-10:50 pm.
15.270	W3XAU	PHILA., PA., 19.65 m. (Addr. See 21.52 mc.) 3-7 pm.	15.270	H13X	CIUDAD TRUJILLO, D. R., 19.65 m. Relays HIX Sun. 7:40-10:40 am. Tues. and Fri. 8:10-10:10 pm.
15.270	W2XE	NEW YORK CITY, 19.65 m., Addr. (See 21.570 mc.) 1-3 pm., Sat. 12:30-2:30 pm., Sun. 12 n.-2:30 pm.	15.260	GS1	DAVENTRY, ENG., 19.66 m., Addr. (See 17.79 mc.) 1:30-3:50 am.
15.260	GS1	DAVENTRY, ENG., 19.66 m., Addr. (See 17.79 mc.) 1:30-3:50 am.	15.250	W1XAL	BOSTON, MASS., 19.67 m., Addr. University Club. 2:30-3:00, or 4 pm., ex. Sat. and Sun.
15.245	TPA2	PARIS, FRANCE, 19.68 m., Addr. 98 Bis. Blvd. Haussmann. "Paris Mondial" 5-10 am.	15.245	TPA2	PARIS, FRANCE, 19.68 m., Addr. 98 Bis. Blvd. Haussmann. "Paris Mondial" 5-10 am.
15.230	HS6PJ	BANGKOK, SIAM, 19.7 m. Irregularly Mon. 8-10 am.	15.230	OLR9A	PRAGUE, BOHEMIA, 19.7 m. Addr. (See OLR4A, 11.84) Daily 4:55-8:15 am.
15.230	OLR9A	PRAGUE, BOHEMIA, 19.7 m. Addr. (See OLR4A, 11.84) Daily 4:55-8:15 am.	15.220	PCJ2	HUIZEN, HOLLAND, 19.71 m., Addr. N. V. Philips' Radio Hilversum. 3:40-3:50 am. Tues., 9:30-11:30 am. Weds. Daily 7:25-8:25 am.
15.210	W8XK	PITTSBURGH, PA., 19.72 m., Addr. (See 21.540 mc.) 9 am.-1 pm.	15.210	W8XK	PITTSBURGH, PA., 19.72 m., Addr. (See 21.540 mc.) 9 am.-1 pm.
15.200	DJB	BERLIN, GERMANY, 19.74 m., Addr. (See 15.280 mc.) 12:05-11 am., 4:50-10:50 pm. Also Sun. 11:10 am.-12:25 pm.	15.200	DJB	BERLIN, GERMANY, 19.74 m., Addr. (See 15.280 mc.) 12:05-11 am., 4:50-10:50 pm. Also Sun. 11:10 am.-12:25 pm.
15.195	TAQ	ANKARA, TURKEY, 19.74 m., 5:30-7 am., 9:30-11 am., Relays 2RO irregularly Affs.	15.195	TAQ	ANKARA, TURKEY, 19.74 m., 5:30-7 am., 9:30-11 am., Relays 2RO irregularly Affs.
15.190	OIE	LAHTI, FINLAND, 19.75 m. Addr. (See OFD, 9.5 mc.) 1:05-4 am., 9 am.-5 pm.	15.190	OIE	LAHTI, FINLAND, 19.75 m. Addr. (See OFD, 9.5 mc.) 1:05-4 am., 9 am.-5 pm.
15.190	—	CHUNGKING, CHINA, 19.75 m. Irreg. 8-9:30 pm.	15.190	—	CHUNGKING, CHINA, 19.75 m. Irreg. 8-9:30 pm.
15.190	ZBW4	HONGKONG, CHINA, 19.75 m., Addr. P. O. Box 200. Irregular. 11:30 pm. to 1:15 am., 3-10 am.	15.190	ZBW4	HONGKONG, CHINA, 19.75 m., Addr. P. O. Box 200. Irregular. 11:30 pm. to 1:15 am., 3-10 am.
15.180	GSO	DAVENTRY, ENG., 19.76 m., Addr. (See 17.79 mc.) 4:15-6 pm., 1:30-3:50 am., 9-11 am.	15.180	GSO	DAVENTRY, ENG., 19.76 m., Addr. (See 17.79 mc.) 4:15-6 pm., 1:30-3:50 am., 9-11 am.

(Continued on page 24)

All Schedules Eastern Standard Time

# RIGA LATVIJA

To: Joseph H. Miller, Dk Editor for Short Wave & Television Magazine, Brooklyn, N.Y.

## YL2CD

wkd 12.1939 at 157 GMT 28 Mc RST

ECO-FD-PPA 40w T.R.F.  
Confirmed 10 meter fone reception of  
the I.D.A. Special Broadcast.  
ARRL Thanks for my fb report 13 de y12cd  
ARVIDS VITOLINS / MIERA IELA 52-5 *Arvis*

# Let's Listen In with

*Joe Miller*

"DX" Editor

YL2CD—Latvia. An unusual, neat QSL in red print from this "hard-to-get" country.

● IT is mid-March as this is written, and conditions up to this time have not been as promising as expected. However, in the last few days DX reception is looking up, and the "band" should really "open up" shortly.

If you OM's want to "clean up," get going now, as April is one of the best months to get the DX, especially Asiatics on 20, when these much-sought-after signals will be heard up to as late as 10 a.m. on East Coast. Also, Asiatic SW BC and commercial phones are at one of their highest signal peaks during April and QRN permitting, one may go after a number of the rare 'uns with some assurance of success.

There has been considerable delay in answering mail from readers, and we would like to make our apologies to those of our readers who have written, and not received a reply within a reasonable time. Delays were due to pressure of business.

Our endeavor will be to answer all letters same week as received, in the future, but we must require a stamped self-addressed envelope for all requested replies.

And now for DX:

### AFGHANISTAN

YAA, 4.195 mc., Kaboul, and YAH, 5.17 mc., Herat, heard here last March, were confirmed in a letter from Mr. M. Said, the Director of International Comm.

We had written reports of these fine DX catches last year, when heard, but received a reply from Mr. Said, informing us we had our frequencies reversed, for each station, and not in any way mentioning whether we had heard these stations or not! This "refusal" was registered, as was the veri; nice service!

Not in the least discouraged, again we wrote, giving each call its correct frequency, and back came one of our most prized veris, and were we happy!

These stations often keep a schedule at 8:30 a.m., when we heard them, and the veri states aerial input is only 250 watts.

QRA (address) is, briefly: Mr. Said, Ministere des P. T. T., Kaboul, Afghanistan.

### STRAITS SETTLEMENTS

ZHP, 9.69 mc., at Singapore, is coming in very nicely these mornings, and all you fellers should go get this nice DX catch, and (for most) new country, verified right away, while ZHP is still so FB. This station sends a handsome QSL card, too. The morning skeds are daily: 4:40-9:40 a.m. and Suns.: 5:40-9:40 a.m. On the East Coast, ZHP should be easiest to log around 6-6:30 a.m. in April, but even 5:30 a.m. will be OK, with perhaps less QRN. Let's see how many of you DXers can verify this easy ace!

QRA: Radio ZHP, Broadcasting House, Thomson Road, Singapore, Straits Settlements.

### CHINA

XGOX, 15.185 mc., Chungking, has been heard several evenings during their irregular transmissions from 9-11 p.m. Also, occasionally reported as beginning program at 8 p.m. Though this station is not very well heard, at this rather difficult time for Asiatics, it is certainly worth a try, and will be heard still better in April, as the higher frequencies stay "open" longer into the evening, benefiting from the increasing length of day in the Northern Hemisphere. This station is also known as XGRV.

Then, XGRV on 11.42 mc., also at Chungking, is continuing daily BCs, as given in last issue, but during other times in a.m. Outside sked is used for communication work, and heard here using inverted speech, with a FB signal at 7:10 a.m., then later during their regular broadcast. H. C. Rufner and Max P. Fisher, W6, report XGOX, 15.185 mc.

Though no QRA is available, it is believed reports sent to Chinese Radio Administration, Chungking, China, will be verified.

### JAVA

YBF, 9.93 mc., Medan, Sumatra, a rarely heard station, was heard recently at 6 a.m. after vainly being called by what must have been a new Javanese commercial phone, just to the L.F. side of VK3ME, or about 9.48 mc. This latter station had called "allo Medan" at 5:55 a.m. and repeatedly thereafter, but, after trying for YBF, and finding no carrier on, we tried 9.93 mc., and were agreeably surprised to find YBF's carrier. However, the only reply YBF made was to put on a weak recording of native Javanese music, though, as we did not hold YBF, they may have answered later. YBF had a FB R8 carrier signal. All these Javanese phones contact one another, usually between 5:30-6:30 a.m.

PLE, 18.825 mc., Bandoeng, heard by G. C. Gallagher working KWE, Dixon, at 10:30 p.m.

PMC, 18.135, and PLE broadcast on Feb. 25, 7-8 p.m. via KQG, in a special program dedicating the Java Pavilion at the Golden Gate Exposition, and were heard R7-9 by Max Fisher and Mr. Gallagher, W6.

### JAPAN

OM G. C. Gallagher sends in a fine list of reliable Japanese phones, which now QSL in 2 months, and should be "cleaned up" by all of you OM's, they're so easy.

JVE, 15.66 mc., midnight; JVD, 15.86 mc., 10 p.m.; JVG, 14.91 mc., 8 p.m.; JVH, 14.60 mc., broadcasting all hours irreg., noon-9 p.m.; JVV3, 11.725 mc., broadcasting once 1:30-2:30 a.m.; an unknown on 15.12 mc., once hrd. BCing at 6 p.m. Also JIB, 10.53 mc., Taiwan (Formosa), a separate country, at 7 a.m., this one heard very often 4-8 a.m., as are others mentioned. JIB also verified by Jap phone QRA. Thanks for data. OM!

### SIAM

HSP, 17.74 mc., Bangkok, heard by G. C. Gallagher at unusual time of 11:30 p.m. phoning. HSP sometimes, but rarely, heard on East Coast near 7-8 a.m.

HS4PJ, 6.11 mc., the call of the unidentified Siamese phone previously reported on 6 mc., was verified by OM Gallagher, and letter stated that this station was operated by staff of HS8PJ, and intended for local reception only. Power was 2.5 kw. HS4PJ is no longer being used. FB DX. OM!

### MORE FROM ASIA

#### MANCHUKUO

MTCY, 6.00 mc., believed in this Japanese-dominated state, reported around 5 a.m. by C. D. Platner, W6.

### FRENCH INDO-CHINA

#### Boy-Landry, Inc., at Saigon,

in a recent veri of their 9.76 mc. transmissions, lists 3 transmitters on schedule, including one on 6.18 mc., but this transmission is heard on 6.21 mc.

Radio Saigon, 6.16 mc., a new station heard BCing a test program at 7 a.m. recently by Mr. Platner. The schedule is stated to be 6:30-7:10 a.m., and the QRA that of the Indo-Chinese commercial phones, P. O. Box 238, Saigon.

● VS2AS—Malay. A plain but much valued card—red call letters. OM John sent this air mail all the way via the "China Clipper"!

### JAPAN

JVW3, or JLG3, 11.71 mc., in test broadcasts, 12:30-1:30 a.m. irregular, by OM Gallagher.

### CHINA

XMMA, 11.94 mc., Shanghai, reported by C. D. Platner, signing off at 11 a.m. We wonder if this station is connected with XMHA, 12.23 mc., which is reported by I.D.A. as relaying the BCB XMHA from 4-7 a.m. XMHA has an interval chime signal, and every half-hour gives announcements. QRA for XMHA is "The Call of the Orient," 445 Race Course Road, Shanghai.

### INDIA

VUD4, 15.29 mc., Delhi, has now replaced VUD3, 15.16 mc., on the nightly transmissions, 9:30-11:30 p.m., and also being heard 1:30-3:45 and 7:30 a.m.-12:30 p.m. VUB2, 9.55 mc., Bombay, is being well heard 9:30-10:30 p.m. daily, though with complaints of QRN from NEFT. VUB2 is better heard with less QRN, from midnight-3:30 a.m., also being on 4:30-7 a.m., and up to 12:30 p.m. OM Gallagher reports VUB2 at 9 p.m.

The 4.8-4.9 mc. VU BCers have passed away till another Winter DX season makes possible reception on such low frequencies.

### OTHER DX

In a veri of EA9BJ, 7.10 mc., Radio Alcararquivir, Spanish Morocco, a list of Spanish Moroccan broadcasters are given, a valuable list.

EA9AH, 14.004 mc., Tetuan, listed at 8 p.m., broadcasting; EA9AH, 7.002 mc., EA9ME, 7.14 mc., De Villa Sanjurjo; EA9AI, 7.138 mc., De Melilla; F.E.T.-11, 7.135, Tetuan; and F.E.T.-8, Melilla, on 7.255 mc.

These are all war stations, and broadcast, or contact other Spanish stations, at all hours. Most are very well heard in evenings and early mornings.

### ALBANIA

Radio Tirana, 6.085 mc., heard by Ian Jamieson, England, at 2:15 p.m. testing, with a woman announcing in perfect English, and a man announcing in French, Italian and other languages. Reports to be sent to Radio Tirana, Tirana, Albania.

### NORWAY

From the West Coast where Europe is real DX, OM Gallagher reports LKQ, 11.72 mc., at 8 p.m., veri received; LIG, 9.61 mc., and another on 10.753 mc., broadcasting simultaneously, 11-12 p.m., and LKV, 15.17 mc., at 1 p.m.

(Continued on page 54)

**MALAYA.**

*Joe Miller*  
Transmitter. *confirming your Report on Receiver.*  
*my transmission on 4 April 1938 at 11:30 hrs 4.09.7.*  
*thanks a lot will*

E.C.O.—Pent. P.A. Sup. Gr. Mod. Input—30 Watts Aerial Full Wave Dipole North—South.	GEC. 8V. Mains. Super Het.
--	----------------------------------

To Radio *W2XJM* Ur Sigs. *W* T. *W* QSA. *R*

Q.T.R. *6.5.40* Malayon Time (i.e. 7 hours 20 mins ahead of G.M.T.)

Q.R.N. *Q.R.M.* Q.S.B. *Q.S.O.*

Q.R.G. *14.330 Kc.* Q.R.A. **J. FORD.**

W.X. *Gene* EVATT & Co.  
KUALA LUMPUR.  
SELANGOR, F.M.S.



Mc.	Call		Mc.	Call		Mc.	Call	
15.175	RV96	MOSCOW, U.S.S.R., 19.76 m. Mon., Tues., Fri., Sat. 2.30-3.30 pm. Daily 3-4 am. Mon., Wed., Thurs. 7-9.15 pm.	11.910	CD1190	VALDIVIA, CHILE, 25.2 m., P. O. Box 642. Relays CB69 10 am.-1 pm., 7-10 pm.	11.750	6SD	DAVENTRY, ENG., 25.53 m., Addr. B.B.C., London, 1.30-3.50 am., 10.45 am.-noon, 12.25-6 pm., 6.20-8.30 pm., 9.20-11.30 pm.
15.170	TGWA	GUATEMALA CITY, GUAT., 19.77 m., Addr. Minist're de Fomento. Daily 12.45-1.45 pm.; Sun. 12.45-5.15 pm.	11.900	—	HANOI, FRENCH INDO-CHINA. 25.21 m. "Radio Hanoi", Addr. Radio Club de l'Indochine. 3.45-4.15 am., 7-9.30 am., 150 watts.	11.740	SP25	WARSAW, POLAND, 25.55 m., 6-9 pm.
15.166	LKC	OSLO, NORWAY, 19.78 m. Reported Suns. 10.30 am. on.	11.900	XEWI	MEXICO CITY, MEXICO, 25.21 m., Addr. P. O. Box 2874. Mon., Wed., Fri. 3-4 pm., 9 pm.-12 m. Tues. and Thur. 7.30 pm.-12 m., Sat. 9 pm.-12 m., Sun. 12.30-2 pm.	11.740	COCX	HAYANA, CUBA, 25.55 m. P. O. Box 32. Daily 8 am.-1 am. Sun. 8 am.-12 m. Relays CMX.
15.160	XEWX	MEXICO CITY, MEXICO, 19.79 m., 12 n.-12 m., irregular.	11.895	2RO	ROME, ITALY, 25.23 m. Irregular 6-9 pm.	11.740	HVJ	VATICAN CITY, 25.55 m. Testing irregular. Wed. 8.30-9 am.
15.155	SM5SX	STOCKHOLM, SWEDEN, 19.79 m., Daily 11 am.-5 pm., Sun. 9 am.-5 pm.	11.885	TPA3	PARIS, FRANCE, 25.24 m., Addr. (See 15.245 mc.) 1-4 am., 10.15 pm.-5 pm.	11.730	PHI	HUIZEN, HOLLAND, 25.57 m., Addr. N. Y. Philips' Radio.
15.150	YDC	BANDOENG, JAVA, 19.8 m., Addr. N. 1. R. O. M. 6-7.30 pm., 10.30 pm.-2 am., Sat. 7.30 pm.-2 am., daily 4.30-10.30 am.	11.885	TPB7	PARIS, FRANCE, 25.24 m. (See 15.245 mc.) 6-8.15, 8.30-11 pm., 12.15-2 am. Irregular.	11.730	WIXAL	BOSTON, MASS., 25.57 m., Addr. World-Wide Broadcast'g Foundation, University Club. Daily exc. Sat. and Sun. 9.15-11.30 pm.
15.140	GSF	DAVENTRY, ENG., 19.82 m., Addr. (See 17.79 mc.) 1.30-3.50 am., 5.45-8.50 am., 9 am.-noon, 4.20-6 pm.	11.880	VLR3	MELBOURNE, AUST., 25.25 m., 3.30-7.15 pm., 9 pm.-3 am. week-days. Suns. mid.-3 am.	11.730	LKQ	OSLO, NORWAY, 25.58 m. 4.30-9 am., Suns. 2.30-9 am.
15.130	TPB6	PARIS, FRANCE, 19.83 m., Addr. "Paris Mondial," 98 Bis Blvd. Haussmann, 1-4 am.	11.870	W8XK	PITTSBURGH, PA., 25.26 m., Addr. (See 21.540 mc.) 1-11 pm.	11.720	CJRX	WINNIPEG, CANADA, 25.6 m., Addr. James Richardson & Sons, Ltd. Daily 6 pm.-12 m., Sat. 6 pm.-Sun. 4 am.
15.130	WIXAL	BOSTON, MASS., 19.83 m., Addr. World-Wide Broadcast'g Foundation, University Club. Sun. 10 am.-12.30 pm.	11.870	W8XK	PITTSBURGH, PA., 25.26 m., Addr. (See 21.540 mc.) 1-11 pm.	11.720	ZP14	VILLARICA, PARAGUAY, 25.60 m. 7.07-9.07 pm.
15.120	SP19	WARSAW, POLAND, 19.84 m., 6-9 pm.	11.865	—	BERNE, SWITZERLAND, 25.28 m. Irreg. 8-9 pm. to No. Amer.	11.718	CR7BH	LAURENCO MARQUES, PORTUGUESE E. AFRICA, 25.6 m. Daily 12.05-1, 4.30-6.30, 9.30-11 am., 12.05-4 pm., Sun. 5-7 am., 10 am.-2 pm.
15.120	HVJ	VATICAN CITY, 19.83 m., 10.30-10.45 am., Tues., Sun. 1.1-3.0 pm.	11.860	GSE	DAVENTRY, ENG., 25.30 m., Addr. (See 11.75 mc.) 5.45 am.-12 n., 12.25-3, 6.20-8.30 pm. (Sun. 6-8.30 pm.)	11.715	TPA4	PARIS, FRANCE, 25.61 m., (See 15.245 mc.) 6-8.15 pm., 8.30-11 pm. to No. America.
15.110	DJL	BERLIN, GERMANY, 19.85 m., Addr. (See 15.280 mc.) 12.05-2, 9 am., 10.40 am.-4.25 pm.	11.855	DJP	BERLIN, GERMANY, 25.31 m., Addr. (See 15.280 mc.) Irregular.	11.710	YSM	SAN SALVADOR, EL SALVADOR, 25.63 m., Addr. (See 7.894 mc.) 1-2.30 pm.
15.080	RK1	MOSCOW, U.S.S.R., 19.87 m. Works Tashkent near 7 am. Broadcasts Sun. 12.15-2.30 pm. Daily 7-9.15 pm.	11.850	OAX2A	TRUJILLO, PERU, 25.32 m. Testing on this freq. (See 12.200).	11.710	—	SAIGON, FRENCH INDO-CHINA, 25.62 m., Addr. Boy-Landry, 17 Place A. Forey. 7.30-9.15 am.
<b>End of Broadcast Band</b>			11.840	KZRM	MANILA, P. I., 25.35 m., Addr. Erlanger & Gollinger, Box 283. 9 pm.-10 am. Irregular.	11.705	JLG3	TOKYO, JAPAN, 25.63 m. 2.30-4 pm.
14.960	—	MOSCOW U.S.S.R., 20.25 m., 1st of month, 6 pm. Dutch program.	11.840	CSW	LISBON, PORT., 25.35 m. Nat'l Broad. Station. 11.30 am.-1.30 pm. Irregular.	11.705	SBP	MOTALA, SWEDEN, 25.63 m., 1.20-2.05, 6-9 am., 11 am.-1 pm., Sat. 1.20-2 am., 6 am.-1.30 pm., Sun. 3 am.-1.30 pm. Wed. and Sat. 8-9 pm.
14.940	PSE	RIO DE JANEIRO, BRAZIL, 20.08 m., Broadcasts Wed. 3.45-4.15 pm.	11.840	OLR4A	PRAGUE, BOHEMIA, 25.34 m., Addr. Czech Shortwave Sta., Praha XII, Fochova 16. Daily 12.45-6.30, 7.55-11.20 pm. Sun. Also 8.25-10.05 am.	11.700	HP5A	PANAMA CITY, PAN., 25.65 m., Addr. Radio Teatro, Apartado 954. 10 am.-1 pm., 5-10 pm. Sun. 6-10 pm.
14.920	KQH	KAHUKU, HAWAII, 20.11 m. Sets. 1-1.30 am., 11-11.30 pm.	11.830	W9XAA	CHICAGO, ILL., 25.36 m., Addr. Chicago Federation of Labor. Irregular 7 am.-6 pm.	11.700	CB1170	SANTIAGO, CHILE, 25.65 m., Addr. P.O. Box 706. Relays CB69 10 am.-2 pm., 3.30-11 pm.
14.600	JVH	NAZAKI, JAPAN, 20.55 m. Broadcasts irregularly 5-11.30 pm. Works Europe 4-8 am.	11.830	W2XE	NEW YORK CITY, 25.36 m., Addr. Col. Broad. System, 485 Madison Av., N.Y.C. Mon.-Fri. 3.30-6, 6.30-10 pm. Sat., Sun. 3-6, 6.30-11 pm.	<b>End of Broadcast Band</b>		
14.535	HBJ	GENEVA, SWITZERLAND, 20.64 m., Addr. Radio Nations. Broadcasts Sun. 10.45-11.30 am., Mon. 4-4.15 am.	11.826	XEBR	HERMOSILLA, SON., MEX., 25.37 m., Addr. Box 68. Relays XEBH. 9.30-11 am., 1-4 pm., 9 pm.-12 m.	11.676	IQY	ROME, ITALY, 25.7 m. News in Russian 5-5.15 am. ex. Sun., Daily 3-3.35 pm.
14.440	—	RADIO MALAGA, SPAIN, 20.78 m. Relays Salamanca 5.40-8.40 am. Sometimes 2-4 pm.	11.820	GSN	DAVENTRY, ENG., 25.38 m., Addr. (See 11.75 mc.) Irregular.	11.535	SPD	WARSAW, POLAND, 26.01 m., Addr. 5 Mazowiecka St. 6-9 pm.
14.430	HC1JB	QUITO, ECUADOR, 20.79 m. 10-10.30 pm. except Mon. 9-9.30 pm. and irreg.	11.810	2RO4	ROME, ITALY, 25.4 m., Addr. E.I.A.R., Via Montello 5. Daily 4.30-8.45 am., 10 am.-2.30 pm., 6-9 pm.	11.402	HBO	GENEVA, SWITZERLAND, 26.31 m., Addr. Radio Nations. Sun. 7-7.45 pm., Mon. 1-1.15 am., 7-8.30 pm.
14.166	PIIJ	DORDRECHT, HOLLAND, 21.15 m., Addr. (See 7.088 mc.) Sat. 12 n.-12.30 pm.	11.805	OZG	SKAMLEBAK, DENMARK, 25.41 m., Addr. Statsradiofonien. Irreg.	11.400	—	CHUNGKING, CHINA, 26.31 m. 8-8.30 am., 8-9.30 pm.
13.997	EA9AH	TETUAN, SPANISH MOROCCO, 21.43 m. Apartado 124. 5.15-6.15 pm., 6.30-7.30 pm., 9-10 pm. Relays Salamanca from 5.40 pm.	11.801	DJZ	BERLIN, GERMANY, 25.42 m. 4.50-10.50 pm.	11.040	CSW2	LISBON, PORTUGAL, 27.17 m., Addr. Nat. Broad. Sta. 9.30 am.-Noon. 2-5.30 pm.
13.635	SPW	WARSAW, POLAND, 22 m. Daily 6-8 pm. Sat. & Sun. 6-9 pm.	11.800	COGF	MATANZAS, CUBA, 25.42 m., Addr. Gen. Betancourt 51. Relays CMGF. 2-3, 4-5, 6 pm. Mid.	11.000	PLP	BANDOENG, JAVA, 27.27 m. Relays YDB. 6-7.30 pm., 10.30 pm.-2 am., 4.30-10.30 or 11 am. Sat. until 11.30 am.
12.862	W9XDH	ELGIN, ILL., 23.32 m. Press Wireless, Tests 2-5 pm.	11.800	JZJ	TOKYO, JAPAN, 25.42 m., Addr. Broadcasting Co. of Japan, Overseas Division. 7-7.30, 8-9.30 am., 2.30-4, 4.30-5.30 pm., 12.30-1.30 am.	10.950	—	TANANARIVE, MADAGASCAR, 27.40 m., Addr. (See 9.38 mc.) 12.30-45, 10-11 am., 2.30-4 am., exc. Sun.
12.486	HIN	TRUJILLO CITY, DOM. REP., 24.03 m. 7-10-10.10 pm.	11.795	DJO	BERLIN, GERMANY, 25.42 m. 4.50-11 am. (See 15.280 mc.) Irreg.	10.670	CEC	SANTIAGO, CHILE, 28.12 m. Irregular.
12.460	HC2JB	QUITO, ECUADOR, 24.08 m. Daily exc. Mon. 8-10.30 pm.	11.790	WIXAL	BOSTON, MASS., 25.45 m., Addr. (See 15.250 mc.) Daily 3.15-6.30 pm., Sat. 1.30-6 pm., Sun. 1-6.30 pm.	10.660	JVN	NAZAKI, JAPAN, 28.14 m. Broadcasts daily 1.50-7.40 am. Works Europe irregularly at other times.
12.235	TFJ	REYKJAVIK, ICELAND, 24.52 m. Works Europe mornings. Broadcasts Sun. 1.40-2.30 pm.	11.780	HP5G	PANAMA CITY, PAN., 25.47 m., Addr. Box 1121. 6-10 pm.	10.600	ZIK2	BELIZE, BRIT. HONDURAS, 28.30 m., Tue., Thurs., Sat. 1.30-2, 8.30-9 pm.
12.200	—	TRUJILLO, PERU, 25 m., "Rancho Grande." Address Hacienda Chiclin. Irregular.	11.780	OFE	LAHTI, FINLAND, 25.47 m., Addr. (See OFD, 9.5 mc.) 1.05-3 am., 5-6.20, 10 am.-12.30 pm.	10.535	JIB	TAIHOKU, TAIWAN, 28.48 m. Works Japan around 6.25 am. Broadcasts, relaying JFAK 9.05-10 am., 1-2.30 am. Sun. to 10.15 am.
12.000	RNE	MOSCOW, U.S.S.R., 24.88 m. Daily 6-7 am., 12 n.-2 pm., 3-6, 10.15-11 pm., also Tues., Thurs. 8.30-9 pm., also Sun. 6-10.30 am., 12 n.-5 pm., 6-6.30, 8.30-9, 10.15-11 pm.	11.770	DJD	BERLIN, GERMANY, 25.49 m., Addr. (See 15.280 mc.) 11.30 am.-4.25 pm., 4.50-11 pm.	10.400	YSP	SAN SALVADOR, EL SALVADOR, 28.85 m., 1-3, 6.30-11 pm.
11.990	CB1180	SANTIAGO, CHILE, 25.02 m. 7-11 pm.	11.760	TGWA	GUATEMALA CITY, GUAT., 25.51 m. (See 17.8 mc.) Irregular 10-11.30 pm. Sun. 6-11.30 pm., irregular.	10.350	LSX	BUENOS AIRES, ARG., 28.98 m., Addr. Transradio International. Tests irregularly.
11.970	H12X	CIUDAD TRUJILLO, D. R., 25.07 m., Addr. La Voz de Hispaniola. Relays HIX Tue. and Fri. 8.10-10.10 pm.	11.760	XETA	MONTEREY, MEX. 25.51 m., Addr. Box 203. Relays XET, n.-3.30 pm. and evenings.	10.330	ORK	RUYSSELEDE, BELGIUM, 29.04 m. Broadcasts 12.30-2 pm. Works OPM 1-3 am., 3-5 pm.
<b>25 Met. Broadcast Band</b>			11.760	OLR4B	PRAGUE, BOHEMIA, 25.51 m., Addr. (See 11.840 mc.) Daily exc. Sun. 8.25-10.05 am.	10.290	TIEMT	SAN JOSE, COSTA RICA, 29.15 m., 4.30-8 pm.
11.935	T12XD	SAN JOSE, COSTA RICA, 25.12 m. La Voz del Pilot. Apartado 1729. 10 am.-n., 4-10 am.				10.290	DZC	ZEESEN, GERMANY, 29.16 m., Addr. (See 15.360 mc.) Irregular.

(Continued on page 26)

All Schedules Eastern Standard Time



George P. Huntley, Hollywood movie star, finds time to operate this swell "ham" station. His call letters are W6LIP (ex-W2GIU). Many famous movie stars have visited and talked over Mr. Huntley's station.

## 11th SILVER TROPHY Award

For Best HAM Station Photo of the Month

Awarded to *George P. Huntley, W6LIP*  
Beverly Hills, Calif.



This beautiful silver trophy stands 11 $\frac{3}{4}$ " high and one is awarded monthly by RADIO & TELEVISION magazine for the best photo of a Ham station. The silver statue stands on a handsome bakelite base on which is a silver plate. The name of the winner will be engraved on this plate before the trophy is sent to him.

Editor:

Here are the technical details of my station. W6LIP (ex-W2GIU of N. Y. City).

Transmitter:—6L6, Xtal osc.; RK49 1st doubler; 807 2nd doubler.

Push-pull HK54's final amplifier; 240 watts input.

Receiver:— RME 69 Monitor, Freq. Meter, VI. and card index file of all names of stations worked, with "handles."

W6LIP Speech equipment:—Thordarson universal amplifier 500 ohm line to TZ40, Class B modulators.

All equipment here built by myself. 32 Xntrs. built in last two years. Three element rotary beams on 10 and 20 meters. End-fed ant. for 75 m. and 40 m. (CW.) 75, 40, 20, 10 m. worked, on fone and CW. Worked all continents fone and CW, worked all states.

Operate mainly on 10 meters. Contemplate going to 2 $\frac{1}{2}$  meters. Hold skeds with New Zealand chiefly.

Never run over  $\frac{1}{2}$  kw. Most W.A.C. done with 25 watts input. Hi! Operated in N.Y.C. 40 cw. under call W2GIU. Listen or operate approx. 16 hours daily, unless working on picture. Handle lots of traffic, like "rag chewing," or anything pertaining to radio. QSL 100% to all stations sending cards or to SWL's. Appreciate SWL reports from near or far. Air handle is "Tinn." Always

glad to contact any Hams who may want checks on their Xntrs. or antennas.

Like your magazine very much, although not a subscriber at the minute, and I find valuable information when I do read it.

ARRL member and also support the West Coast, Hi!

73 to you and hope you like the photos.

Geo. P. Huntley,  
602 No. Maple Drive,  
Beverly Hills, Calif.

● **GEORGE P. HUNTLEY** is on the air an average of two hours a day, generally in the evening, holding long conversations with amateurs in South Africa, Manila, Singapore, Greenland, South America, New Zealand, and other far-away countries.

Most frequent users of Huntley's transmitter, next to Huntley himself, are members of Hollywood's large English colony. Many of them, including Patricia Morison, E. E. Clive, and Melville Cooper, have made trips to Huntley's microphone to talk to friends and relatives in England.

Most of the amateurs with whom Huntley talks, regardless of whether they reside in the United States or on a South Sea atoll, want to know about movies and ask his advice on which pictures to see.

"And, of course, when they ask which pictures are good and bad, I'm obliged to tell them the pictures I appear in are always good," says Huntley.

### Silver Trophy Award

Note These Important Rules

The photos must be sharp and clear and preferably not less than 5" x 7".

The pictures will be judged for the general layout of the station, the quality of workmanship exhibited, and the appearance of the photograph itself. The judges will also consider neatness as an important point.

When you submit the photograph of your Ham station, send along a brief description not longer than 300 words, describing the general line-up of the apparatus employed, the size, type and number of tubes, the type of circuit used, name of commercial transmitter—if not home-made, watts rating of the station, whether for c.w. or phone or both, etc., also name of receiver.

State briefly the number of continents worked, the total number of stations logged or contacted, and any other features regarding the station which

(Continued on page 45)



Mc.	Call	Mc.	Call	Mc.	Call
10.260	PMN	BANDOENG, JAVA, 29.24 m. Relays YDB 6-7.30 pm., 10.30 pm.-2 am., 4.30-10.30 or 11 am., Sat. to 11.30 am.	9.630	HJ7ABD	BUCARAMANGA, COL., 31.14 m. 5.45-6.30, 11.30 am.-7 pm., 6-11 pm.
10.220	PSM	RIO DE JANEIRO, BRAZIL, 29.35 m., Addr. Box 709. Broadcasts 6-7 pm., Mon. 8-8.30 pm.	9.618	HJIABP	CARTAGENA, COL., 31.20 m., Addr. P. O. Box 37. Daily 9 am.-1.30 pm., 4.30-10.15 pm., Sun. 4.30-9 pm.
10.100	—	DEUTSCHE FREIHEITS SENDEK, 29.70 m., loc. in Germany, under-cover. 4-5 pm.	9.615	ZRL	KLIPHEUVAL, SOUTH AFRICA, 31.2 m., Addr. P. O. Box 4559, Johannesburg. Daily, exc. Sat. 11.45 pm.-12.50 am. Daily exc. Sun. 3.20-7.20, 9-11.45 am., Sun. 3.30-4.30 or 4-5, 5.30-7, 9-11.45 am.
10.042	DZB	ZEESEN, GERMANY, 29.87 m., Addr. Reichspostzentralamt. Irregular.	9.607	HP5J	PANAMA CITY, PANAMA, 31.23 m. Addr. Apartado 867. 12 n. to 1.30 pm., 6-10.30 pm.
9.995	COBC	HAYANA, CUBA, 30.02 m., Addr. P. O. Box 132. Relays CMBC 6.55 am.-1 am.	9.600	RAN	MOSCOW, U.S.S.R., 31.25 m. Daily exc. Sun. 6-10 pm. Sun. 6-7, 9.15-10 pm.
9.920	JDY	DAIREN, MANCHUKUO, 30.24 m. Relays JQAK daily 7-8 am. Works Tokyo occasionally in early am.	9.595	—	MOYDRUM, ATHLONE, EIRE, 31.27 m., Radio Eireann. Irregular.
9.892	CPI	SUCRE, BOLIVIA, 30.33 m., 11 am.-n., 7-9 pm.	9.595	HBL	GENEVA, SWITZERLAND, 31.27 m., Addr. Radio Nations. Irregular.
9.860	EAQ	MADRID, SPAIN, 30.43 m., Addr. Post Office Box 951. 7.30-8, 8.40-9 pm.	9.590	VUD2	DELHI, INDIA, 31.28 m. Addr. All India Radio, 1.30-3.30 am., 7.30 am.-12.30 pm., 8.30-10.30 pm.
9.830	IRF	ROME, ITALY, 30.52 m. Works Egypt afternoons. Relays ZRO, 12-12.25 pm. Thurs. Daily 12.40-1, 1.37-3.35 pm.	9.590	PCJ	HUIZEN, HOLLAND, 31.28 m., Addr. (See 15.220 mc.) Sun. 2-3, 7.9-25 pm., Tues. 1.45-3.40, 7.15-8.45, 9-10.30 pm., Wed. 7.15-8.30 pm., Fri. 8-9 pm.
9.805	COCM	HAYANA, CUBA, 30.60 m. Addr. Transradio Columbia, P. O. Box 33. 8-1 am. Relays CMCM.	9.590	VK6ME	PERTH, W. AUSTRALIA, 31.28 m., Addr. Amalgamated Wireless of Australasia, Ltd. 6-9 am. exc. Sun.
9.760	—	SAIGON, INDO-CHINA, 30.72 m., Addr. 17, Place A. Foray. "Radio Boy-Landry." Heard 6-9.15 am.	9.590	VK2ME	SYDNEY, AUSTRALIA, 31.28 m., Addr. Amalgamated Wireless of Australasia, Ltd., 47 York St., Sun. 1-3 am.; 5-11 am.
9.753	ZRO	DURBAN, SOUTH AFRICA, 30.75 m. Addr. S. A. Broadcasting Corp., P. O. Box 4559, Johannesburg. Daily exc. Sat. 11.45 pm.-12.50 am. Daily exc. Sun. 3.30-7.30, 9-11.45 am., Sun. 5.30-7, 9-11.30 am., also 4-5 am. on 3rd Sun. of month.	9.590	W3XAU	PHILADELPHIA, PA., 31.28 m. (Addr. See 21.52 mc.) Mon. and Thurs. 7.30-11.30 pm. Sat. 7.30-10.45 pm.
9.735	CSW7	LISBON, PORTUGAL, 30.82 m. Addr. Nat. Broad. Sta. n.-2 pm., 6-9 pm. for No. Amer.	9.580	GSC	DAVENTRY, ENGLAND, 31.32 m., Addr. B. B. C., Portland Pl., London, W. 1., 12.20-4, 4.20-6, 9.20-11.30 pm.
9.708	COCQ	HAYANA, CUBA, 30.90 m. Addr. 25 No. 445, Vedado, Havana, 7-1 am. Sun. 6.55 am.-1 am.	9.580	VLR	MELBOURNE, AUSTRALIA, 31.32 m. Addr. Box 1686, G. P. O. Daily 3.30-8.30 am. (Sat. till 9 am.) Sun. 12.01-7.30 am. Also daily exc. Sat. 9.25 pm.-2 or 2.15 am. Sat. 5-10.30 pm.

### 31 Met. Broadcast Band

9.705	—	FORT DE FRANCE, MARTINIQUE, 30.92 m., Addr. P. O. Box 136.	9.570	KZRM	MANILA, P. I., 31.35 m., Addr. Erlanger & Galinger, Box 283. Sun. 3-10 am. Daily exc. Sat. 4.30-7 pm., 11.15 pm.-12.15 am. Daily exc. Sun. 4-10 am.
9.690	T14NRH	HEREDIA, COSTA RICA, 30.94 m., Addr. Amando C. Marin, Apartado 40. Sun. 7-9 am., Tues., Thurs., Sat. 9-10 pm.	9.570	WIXK	BOSTON, MASS., 31.35 m., Addr. Westinghouse Electric & Mfg. Co. 7 am.-1 am. Sun. 8 am.-1 am.
9.690	LRA	BUENOS AIRES, ARG., 30.94 m., 6-9 pm. Mon-Thurs., 4-9 pm. Fri., 7-9 pm. Sat.	9.560	XGAP	PEKING, CHINA, 31.38 m., 9 am.-2 pm.
9.685	TGWA	GUATEMALA CITY, GUAT., 30.96 m. Daily 10-11.30 pm.; Sun. 7-10.45 pm.	9.560	DJA	BERLIN, GERMANY, 31.38 m., Addr. Broadcasting House. 6.30-10.50 pm.
9.680	ZHP	SINGAPORE, MALAYA, 30.98 m. Sun. 5.40-9.40 am., Wed. 12.40-1.40 am., Mon.-Fri. 4.40-9.40 am., Sat. 12.25-1.40 am., 4.40-9.40 am., 10.40 pm.-1.10 am. (Sun.)	9.550	HVJ	VATICAN CITY, 31.41 m. Sun. 5-5.30 am., Wed. 2.30-3 pm.
9.675	DJX	BERLIN, GERMANY, 31.01 m., Addr. (DJD, 11.77 mc.) 10.40 am.-4.25 pm.	9.550	TPB11	PARIS, FRANCE, 31.41 m. Addr. (See 15.245 mc.) Irregular.
9.670	W3XAL	BOUND BROOK, N. J., 31.03 m. Addr. NBC, N. Y. C. 5 pm.-1 am.	9.550	W2XAD	SCHENECTADY, N. Y., 31.41 m., General Electric Co., 6.15-9 pm. to So. Amer.
9.665	2RO9	ROME, ITALY, 31.04 m. 12.40-1, 1.37-5.30 pm.	9.550	OLR3A	PRAGUE, BOHEMIA, 31.41 m. (See 11.840 mc.) Irreg. 4.40-5.10 pm.
9.660	LRX	BUENOS AIRES, ARG., 31.06 m., Addr. El Mundo, Relays LRI, 7-7.45 am., 10.15 am.-11.05 pm.	9.550	XEFT	VERA CRUZ, MEX., 31.41 m. 10.30 am.-4.30 pm., 10.30 pm.-12.30 am.
9.660	HVJ	VATICAN CITY, 31.06 m. Irreg.	9.550	YDB	SOERABAJA, JAVA, 31.41 m., Addr. N.I.R.O.M. Daily exc. Sat. 6-7.30 pm., 4.30-10.30 am. Sat. 4.30-11.30 am.
9.650	W2XE	NEW YORK CITY, 31.09 m. (See 21.570 mc. for addr.) 10.30-11.30 pm. exc. Sat. and Sun.	9.550	VUB2	BOMBAY, INDIA, 31.41 m. Addr. All India Radio. 9.30-10.30 pm., 1-3.30 am.
9.650	CS2WA	LISBON, PORTUGAL, 31.09 m., Addr. Radio Colonial. Tues., Thurs. and Sat. 4-7 pm.	9.540	DJN	BERLIN, GERMANY, 31.45 m., Addr. (See 9.560 mc.) 12.05-11 am. 4.50-10.50 pm. to So. Amer.
9.645	HH3W	PORT-AU-PRINCE, HAITI, 31.1 m., Addr. P. O. Box A117. 1-2, 7-9 pm.	9.540	HJ5ABD	CALI, COLOMBIA, 31.45 m., Addr. La Voz de Valle. 12 n.-1.30 pm., 5.10-9.40 pm.
9.640	GXA8	COLONIA, URUGUAY, 31.12 m., Addr. Belgrano 1841, Buenos Aires, Argentina. Relays LR3. Buenos Aires 7 am.-m., Sat. to 2.15 am.	9.538	VPD2	SUVA, FIJI ISLANDS, 31.46 m., Addr. Amalgamated Wireless of Australasia, Ltd. 5.30-7 am., exc. Sun.
9.636	JFO	TAIHOKU, TAIWAN, 31.13 m. Relays JFAK irreg. 4-10.30 am.	9.535	ZJI	TOKYO, JAPAN, 31.46 m., Addr. (See 11.800, JZJ) 2.30-4, 4.30-5.30 pm. 8-9.30 am.
9.635	2RO3	ROME, ITALY, 31.13 m., Addr. (See 11.810 mc.) 1-3 pm., 5.30-9 pm., also Mon. 3.50-4.05 pm., Fri. and Sat. 4-4.20 pm.	9.535	—	BERNE, SWITZERLAND, 31.46 m., 1-2 pm. exc. Mon. and Tues.

9.530	W2XAF	SCHENECTADY, N. Y., 31.48 m., Addr. General Electric Co. 4 pm.-12 m. Sat. 1 pm.-12 m.
9.530	VUC2	CALCUTTA, INDIA, 31.48 m. Addr. All India Radio. 2.06-4.06 am.
9.526	XEDQ	GUADALAJARA, GAL., MEXICO, 31.49 m., n.-4.30 pm., 8-11.30 pm.
9.526	Z8W3	HONGKONG, CHINA, 31.49 m., Addr. P. O. Box 200. 11.30 pm.-1 am., 3-10 am.
9.525	LKC	JELOY, NORWAY, 31.49 m., 4.30-10.30 am., Sun. 2.30-10.30 am.
9.523	ZRG	ROBERTS HEIGHTS, S. AFRICA, 31.5 m., Addr. (See ZRK, 9.606 mc.) Daily exc. Sun. 5-7.30 am.; Sun. 5.30-7 am.
9.520	XGOY	CHUNGKING, CHINA, 31.51 m. 3-5 pm.
9.520	OZF	SKAMLEBOAEEK, DENMARK, 31.51 m., Addr. Statsradiofonien, Heibergsgade 7, Copenhagen, 8-9.30, 9.30-11 pm. to No. Amer.
9.520	YSH	SAN SALVADOR, EL SALVADOR, 31.51 m., Addr. (See 7.894 mc.) Irregular 6-10 pm.
9.510	GSB	DAVENTRY, ENGLAND, 31.55 m., Addr. (See 9.580 mc.—GSC) 1.30-3.50 am. 3-4, 4.20-6, 6.20-8.30, 9.20-11.30 pm.
9.510	HJU	BUENAVENTURA, COLOMBIA, 31.55 m., Addr. National Railways. Mon., Wed. and Fri. 8-11 pm.
9.510	HS6PJ	BANGKOK, SIAM, 31.55 m. Thursday, 8-10 am.
9.510	—	HANOI, FRENCH INDO-CHINA, 31.55 m. "Radio Hanoi", Addr. Radio Club de L'Indochine. 12 m.-2 am., 6-10 am. 15 watts.
9.503	KZIB	MANILA, PHIL. ISL., 31.57 m., 7-9.05 am.
9.503	XEWW	MEXICO CITY, MEX., 31.57 m. Addr. Apart. 2516. Relays XEW. 9 am.-12.30 am.
9.500	VK3ME	MELBOURNE, AUSTRALIA, 31.58 m., Addr. Amalgamated Wireless of Australasia, 167 Queen St. Daily except Sun. 4-7 am.
9.500	OFD	LAHTI, FINLAND, 31.58 m., Addr. Finnish Brct. Co., Helsinki. 12.15-5 pm.
9.490	OAX5C	ICA, PERU, 31.61 m., Radio Universal, 8-11.30 pm.
9.488	EAR	MADRID, SPAIN, 31.6 m., Addr. (See 9.860 mc.) 7.30-8.30 pm. Mon., Tues., Thur., Sat. at 9.30 pm. also.

### End of Broadcast Band

9.465	TAP	ANKARA, TURKEY, 31.70 m., 1.20-5 pm. Irreg.
9.445	HCODA	GUAYAQUIL, ECUADOR, 31.77 m., 8.15-10.15 pm., exc. Sun.
9.437	COCH	HAVANA, CUBA, 31.8 m., Addr. 2 B St., Vedado. 8 am.-9.30 pm. Sun. 8 am.-12 m.
9.380	—	TANANARIVE, MADAGASCAR, 31.96 m. Addr. Le Directeur des PTT, Radio Tananarive, Administration PTT. 12.30-12.45, 10-11 am., 2:30-4 am., exc. Sun.
9.370	XOY	CHENG TU, CHINA, 32.02 m., 9.45-10.30 am.
9.355	HCIETC	QUITO, ECUADOR, 32.05 m., Addr. Teatro Bolivar, Thurs. until 9.30 pm. 8-11 pm. Sats.
9.350	COCD	HAVANA, CUBA, 32.08 m., Addr. Box 2294. Relays CMCD 10 am.-11.30 pm. Sun. 10 am.-9 pm.
9.345	HBL	GENEVA, SWITZERLAND, 32.11 m., Addr. Radio Nations. Sun. 8-8.45 am., Mon. 6.45-8.30 pm.
9.340	OAX4J	LIMA, PERU, 32.12 m., Addr. Box 1166, "Radio Universal." 12 n.-3 pm., 5 pm.-1 am.
9.300	XGX	SHANGHAI, CHINA, 32.26 m., 8-9.05 am. Varies between 9.180-9.300.
9.300	HIG	CIUDAD TRUJILLO, D. R., 32.28 m. 7.10-9.40 am., 11.40 am.-2.10 pm., 3.40-9.40 pm.
9.200	COBX	HAVANA, CUBA, 32.59 m. Addr. San Miguel 194, Altos. Relays CMBX 7 am.-12 m.
9.165	HC2CW	GUAYAQUIL, ECUADOR, 32.74 m., 7-11.30 pm. Sun. 3.30-6 pm.
9.125	HAT4	BUDAPEST, HUNGARY, 32.88 m., Addr. "Radiolabor," Gyall-ut, 22. Daily 7-8 pm., Sat., 6-7 pm.

(Continued on page 28)

All Schedules Eastern Standard Time

# The Short Wave League



## On the Ham Bands

(with the "Listening Post" Observers)

Edited by Elmer R. Fuller

### HONORARY MEMBERS

Dr. Lee de Forest  
D. E. Replogle  
John L. Reinartz  
Manfred von Ardenne  
E. T. Somerset  
Hollis Baird  
Hugo Gernsback, Executive Secretary

● CONDITIONS during the past month improved several fold over the previous months, according to the reports which have been sent to me. At times, during February, the twenty-meter band provided better results than any other time this winter. The VK's are again being heard, and several were reported not only on the twenty-meter band, but also on the forty-meter band. Another new call to make its appearance during February was the EA's. These have been heard to some extent in the past, but now they are operating in large numbers. Instead of operating as commercial stations and giving news of war, they are now amateurs and are running their stations as such.

Many, many thanks for the help which you have shown in sending information on certain rare calls, for which I have advertised in several issues. From Roger Legge of Binghamton, New York; Ernest W. Lang, Observer for Washington; and Raymond Fehr, W6QVY, the correct QRA (address) of CR7AY has been learned. It is: Mario De C. Pereira, P. O. Box 264, Lourenco Marques, Mozambique, Africa. Ray Fehr says that he will answer all SWL and QSL cards. Mr. Fehr also tells me that V1RKTB will QSL 100%.

Reports were received from twenty-eight observers for the month of February, and they were certainly FB reports. However, several observers have been appointed who are not sending in regular reports, and this is going to count against them when it comes time for reappointment. After some deliberation, it has been decided that our year will start on the first of September, since this is about the beginning of the dx season. Therefore, all observers will be subject to reappointment at that time. The names of the observers for the coming year will be published in a following issue, and new certificates will be issued to them. Records are kept of the reports and activities of the several observers, and these records will be the main basis for reappointment. It will not be necessary for any observer to apply for reappointment, as all observers for this year will automatically be considered for next year.

For February reports were received from observers representing the following locations:—

Alabama ..... Wells, Jack  
Arkansas ..... Henderson, Bill  
Colorado ..... Wallen, Dan T.  
Connecticut ..... Kemp, Howard G.  
England ..... Spencer, Kenneth  
Florida ..... Lester, Major  
Illinois ..... Carling, Len M.  
Kansas ..... Hegler, Burns E.  
Kentucky ..... Taglauer, Bob  
Maine ..... Barker, Elwyn L.  
Maryland ..... Wilkes, Cecil A.  
Massachusetts ..... Lendzioszek, Edward  
Missouri ..... Fleming, R. B.  
Nebraska ..... Noyes, William Dean  
New Hampshire ..... Montgomery, Alex  
New Jersey ..... Fitzpatrick, John

New York ..... Fuller, Charles H.  
New Zealand ..... Herzog, W. F.  
Ontario ..... Sibbin, J. C.  
Oregon ..... Clarke, Stanley  
Pennsylvania ..... Trueman, Elwood C.  
South Africa ..... Jordan, Tom  
South Carolina ..... Westman, Oscar  
South Dakota ..... Halliday, Ray  
Texas ..... Hutchinson, Robert  
Utah ..... Slaughter, Edward C.  
Washington ..... Parker, Robert  
Lang, Ernest W.

Asiatics seem to be coming in much better than they have before this season. Several were reported for February.

Call	Freq.	R	S	Where Heard
J2KG	14.	4	7	New Zealand
J2CS	14.	4	6-7	New Zealand
J2MI	14.	3-4	6	New Zealand
J3FJ	29.9	4	6	New Hampshire
J7CB	14.	5	5	Ore.
J7CD	14.063	4	6	Utah
VU2BG	14.25	4	7	Fla.
VU2EG	14.	5	8	South Africa
VU2FU	14.	5	7	South Africa
VU2CO	14.3	5	5	N. Y.
XZ2DX	14.06	4	6	Wash.
XZ2DY	14.3	5	6	N. Y.
Y1JYL	14.28	5	6	N. Y.
CN8BA	14.06	4	7	N. J.
	28.11	4	6	Neb.
CN8AV	14.065	4	7	N. J.
	28.06	4	7	N. J.
CN8MI	14.03	4-5	7	Ontario, Conn.
CN8MB	14.045	5	7	N. J.
CN8MY	14.07	4	7	N. J.
CN8AV	14.115	4	6	Mass.
EA8AS	7.27	5	7	Ala.
EA9AH	7.0	5	9	Ala.
EA9BJ	7.12	5	9	Ala.
SU1MV	28.367	4-5	7	Neb., N. J.
SU1CH	28.38	5	7-8	Ky.
SU1AM	14.	5	7	South Africa
VQ2PL	14.1	4	5	Tex.
VO8AE	14.	5	7	South Africa
ZE1JN	14.252	4	7	Ill.
ZE1JX	14.021	4	7	Ill.
ZE6EC	14.	4	7	South Africa
ZS1BV	14.017	3	6	Neb., Conn.
ZS1AX	14.07	4	5	Conn.
ZS1BL	14.2	5	6	N. Y.
ZS2N	14.008	4-5	6-8	Ill., Kan.
ZS2X	14.03	4-5	5-8	Tex., Neb., Kan., Ill., Ark., Conn.
ZS2AZ	14.07	4-5	5-8	Ill., Tex., N. Y., Neb., England, Kan., Ontario, Ore., Ark., N. Y., Colo., Ill., Neb., Kan., Conn.
ZS4II	14.06	4-5	5-9	Ill., England, N. Y.
ZS5BE	14.047	3	6	Ill.
ZS5CO	14.3	5	6	N. Y.
ZS5AS	14.347	5	9	Fla.

Call	Freq.	R	S	Where Heard
ZS5J	14.055	4	5-7	Conn., Ill.
ZS5T	14.05	5	7	Ark.
	28.035	4	7	Neb.
ZS5CJ	14.13	5	5-7	Kan.
ZS5AW	28.197	5	7	Neb.
ZS5CL	14.1	5	6-9	Tex., Pa., Ark., Ill., Conn.
ZS6DW	14.09	3-4	5-7	Col., Kan., Ill., Mo.
ZS6S	14.11	5	5-9	Col., Kan., N. J., Fla., Ore., N. Y., Ark., Ill.
ZS6AJ	14.12	4-5	5-9	Tex., Neb., Ore., Ill.
ZS6CN	14.035	4-5	5-8	Neb., Conn.
ZS6CT	28.176	3	5	Neb.
ZS6W	28.24	4	6	Neb.
ZS6BB	14.09	3-4	4-5	Wash., Conn., Ill.
ZS6BR	14.035	5	6-7	Kan., N. Y., Ill.
ZS6EF	14.11	4	7	Kan., N. J.
ZS6DY	14.11	5	6-7	Kan., Ontario, Ark., Ill.
	28.2	5	8	Ontario
ZS6DL	14.064	5	5-7	Ore., Ill.
ZS6BW	28.105	5	9	Ky.
ZS6Q	28.24	5	7	Ky.
ZS6CK	14.03	3	4-5	Conn.
ZS6AK	14.2	5	6	N. Y.
ZS6BY	14.1	5	6	N. Y.

From our observers in other countries we have the following United States hams, and several other North American amateurs being heard locally.

CO2GL	14.055	4	8	Utah
CO2AM	14.066	4	7	Utah
CO2MA	14.1	5	6	Col., Wash.
CO2RR	14.09	5	7	Col., Wash.
CO2II	14.13	5	7	Col.
CO2SH	14.09	5	6	Col.
CO2SV	14.09	4-5	6-7	Col., Ore., S. D.
CO2WV	14.15	5	7-8	Col., Wash., England
	28.045	5	7	N. J.
CO2LY	14.1	5	8	Col., Wash.
CO2RG	14.13	5	5	Col.
CO2GY	14.12	5	8	Col., Wash., N. Y.
CO2LL	14.025	5	7	Wash.
CO2OY	14.08	5	7	Wash.
CO2CR	28.1	5	8	N. J.
CO2OK	14.45	5	8	Fla.
CO2HY	14.32	5	9	Fla.
CO2RD	14.07	5	2	N. Y.
CO2BD	14.065	4	4	N. Y.
CO2VW	14.072	2-5	3-5	N. Y., S. D.
CO2JJ	14.11	5	6	England
CO2WV	14.01	3	5	S. D.
CO2WL	14.24	3	6	S. D.
CO2SE	14.22	4	7	S. D.
CO7CX	14.04	5	6	Col.
CO8BC	14.061	5	8	Utah
HH2B	14.00	5	8-9	Me., N. J., Conn., England, N. Y.
HH2PB	14.35	5	8	N. Y.
HH5PA	14.05	5	9	Me., N. J., N. Y.

(Continued on page 60)

XII-OLYMPIAD TOKYO JAPAN  
24. SHIMMEICHO HONGO

A.R.R.L.  
J.A.R.L.  
VY 104 FB  
28 MC.  
FONE RDM  
50 P. 100  
DATE 25L  
QSL INX!

RADIO HATCHER HP 28 MC. LINE SIGS  
R 2500 T WTB HRON 26 MARCH 38  
AT 12 30 P.M. C. T. 241 2411 100 50 243 50 57.  
XMTR: C.C. 2A2 6L6 6L6 210 210W INPUT (MAKE)  
RCVR: HOME MADE 11 TUBES SUPERHET.  
O.V.: W.A.C. 6L6 COUNTRIES W. 22 Z.  
A.N.T.: HERTZ 8th HEAD USEP.

**Q2RN**

THE ABOVE IS BY E-mail  
THE ABOVE IN E-mail

VY 73 AND GUD LUCK FM OWNER AND OPR TADASHI OKUYAMA

THE CORPS US ARMY

**K5AF**

ALBROOK FIELD  
PANAMA, C. Z.

Left—Interesting QSL card sent Robert Hatcher, Richmond, Va. from J2KN, Tokyo, Japan. Right—Veri card from Army amateur station K5AF, Canal Zone.



Mc.	Call	Location, Frequency, and Schedule	Mc.	Call	Location, Frequency, and Schedule	Mc.	Call	Location, Frequency, and Schedule
9.100	COCA	HAYANA, CUBA, 32.95 m., Addr. Galiano No. 102. Relays CMC 9 am.-12 m.	6.720	PMH	BANDOENG, JAVA, 44.64 m. Relays N.I.R.O.M. programs. 4.30-11 or 11.30 am. Also Sat. 9.30 pm.-1.30 am.	6.243	HIN	CIUDAD TRUJILLO, D. R., 48 m., Addr. "La Voz del Partido Dominicano." 12 n.-2 pm., 6-10 pm.
9.091	PJC2	CURACAO, D. W. INDIES, 33 m., 6.36-8.36 pm., Sun. 10.36 am.-12.36 pm.	6.690	TIEP	SAN JOSE, COSTA RICA, 44.82 m., Addr. Apartado 257, La Voz del Tropico. Daily 7-11 pm.	6.235	HRD	LA CEIBA, HONDURAS, 48.12 m., Addr. "La Voz de Atlantida." 8-11 pm.; Sat. 8 pm.-1 am.; Sun. 4-6 pm.
9.020	COBZ	HAYANA, CUBA, 33.32 m., Radio Salas Addr. P. O. Box 866. 7.45 am.-1.15 am. Sun. 7.45 am.-12 m. Relays CMBZ.	6.675	HBQ	GENEVA, SWITZERLAND, 44.94 m. Addr. Radio-Nations. Off the air at present.	6.225	YVIRG	VALERA, VENEZUELA, 48.15 m. 6-9.30 pm.
8.935	COKG	SANTIAGO, CUBA, 33.44 m. Addr. Box 137. 9-10 am., 11.30 am.-1.30 pm., 3-4.30, 5-6, 10-11 pm., 12 m.-2 am.	6.672	—	44-94 m., relays Salamanca, Spain, 7-9.45 pm.	6.210	—	SAIGON, INDO-CHINA, 48.28 m., Addr. Radio Boy-Landry, 17 Place A. Forey. 4.30 or 5.30-9.15 am.
8.841	HCJB	QUITO, ECUADOR, 33.5 m., 7-8.30 am., 11.45 am.-2.30 pm., 5-10 pm., except Mon. Sun. 12 n.-1.30 pm., 5.30-10 pm.	6.672	YVQ	MARACAY, VENEZUELA, 44.95 m. Irregular.	6.205	YV5RI	CORO, VENEZUELA, 48.32 m., Addr. Roger Leyba, care A. Urbina y Cia. Irregular.
8.700	HKY	BOGOTA, COLOMBIA, 34.46 m. Tues. and Fri. 7-7.20 pm.	6.635	HC2RL	GUAYAQUIL, ECUADOR, S. A., 45.18 m., Addr. P. O. Box 759. Sun. 5.45-7.45 pm., Tues. 9.15-11.15 pm.	6.200	HI8Q	CIUDAD TRUJILLO, D. R., 48.36 m. Irregular.
8.665	COJK	CAMAGUEY, CUBA, 34.64 m., Addr. Finlay No. 3 Altos. 5.30-6.30, 8-11 pm., daily except Sat. and Sun.	6.630	HIT	CIUDAD TRUJILLO, D. R., 45.25 m., Addr. "La Voz de la RCA Victor." Apartado 1105. Daily exc. Sun. 12.10-1.40 pm., 5.40-8.40 pm.; also Sat. 10.40 pm.-12.40 am.	6.190	HVJ	VATICAN CITY, 48.47 m. Mon., Wed., Thur., Sat. 2-3.30 pm., Tues. Fri. 2-3 pm. Thur. also 3-3.30 pm.
8.665	W2XGB	HICKSVILLE, N. Y., 34.64 m., Addr. Press Wireless, Mon. to Fri. News at 9 am. and 5 pm.	6.625	PRADO	RIOBAMBA, ECUADOR, 45.28 m. Thurs. 9-11.45 pm.	6.190	TG2	GUATEMALA CITY, GUAT., 48.4 m., Addr. Dir. Genl. of Electr. Commn. Relays TGI Mon.-Fri. 6-11 pm., Sat. 6 pm.-1 am. Sun. 7-11 am., 3-8 pm.
8.580	YNPR	MANAGUA, NICARAGUA, 34.92 m. Radiodifusora Pilot.	6.610	YNLG	MANAGUA, NICARAGUA, 45.39 m. Emisora Ruben Dario. 1.30-2.30, 6-10.15 pm.	6.185	HIHA	SANTIAGO, D. R., 48.5 m., Addr. P. O. Box 423. 7 am.-5 pm.
8.090	YDX	MEDAN, SUMATRA, N. E. I., 37.08 m. Daily exc. Sat., 10.30 pm.-2 am. Sat. 7.30 pm.-1.30 am.	6.558	H14D	CIUDAD TRUJILLO, D. R., 45.74 m. Except Sun. 11.55 am.-1.40 pm.			
7.894	YSD	SAN SALVADOR, EL SALVADOR, 37.99 m., Addr. Dir. Genl. Tel. & Tel. 7-10.30 pm.	6.550	X8C	VERA CRUZ, MEX., 45.8 m. 8.15-9 am.			
7.870	HCIRB	QUITO, ECUADOR, 38.1 m. La Voz de Quito. 8.30-11.30 pm.	6.550	TIRCC	SAN JOSE, COSTA RICA, 45.8 m., Addr. Radioemisora Catolica Costarricense. Sun. 11 am.-2 pm., 6-7, 8-9 pm. Daily 12 n.-2 pm., 6-7 pm., Thurs. 6-11 pm.			
7.854	HC2J5B	GUAYAQUIL, ECUADOR, 38.2 m. Evenings to 11 pm.	6.545	YV6RB	BOLIVAR, VENEZUELA, 45.84 m., Addr. "Ecos de Orinoco." 6-10.30 pm.	6.156	YV5RD	CARACAS, VENEZUELA, 48.71 m. 11 am.-2 pm., 4-10.40 pm.
7.797	HBP	GENEVA, SWITZERLAND, 38.48 m., Addr. Radio-Nations.	6.520	YV4RB	VALENCIA, VENEZUELA, 45.98 m. 11 am.-2 pm., 5-10 pm.	6.153	HI5N	MOCA CITY, D. R., 48.75 m. 6.40-9.10 pm.
7.614	CR6AA	LOBITO, ANGOLA, 39.39 m., Mon., Wed., Sats. 2.45-4.30 pm. Also 7.177.	6.516	YNIGG	MANAGUA, NICARAGUA, 46.02 m., Addr. "La Voz de los Legos." 1-2.20, 8-10 pm. Except Sundays.	6.150	VPB	COLOMBO, CEYLON, 48.78 m., 7-11 am.
7.510	JVP	NAZAKI, JAPAN, 39.95 m., 8-9.30 am.	6.500	HIL	CIUDAD TRUJILLO, D. R., 46.13 m. Addr. Apartado 623. 12.10-1.40 pm., 5.40-7.40 pm.	6.150	CJRO	WINNIPEG, MAN., CANADA, 48.78 m., Addr. (See 11.720 mc.) Daily 6 pm.-12 m., Sun. 5-10 pm.
7.450	TI2R3	SAN JOSE, COSTA RICA, 40.27 m. "Radioemisora Athena." 9.30-11 pm., exc. Sun.	6.490	TGWB	GUATEMALA CITY, GUAT., 46.2 m. La Voz de Guatemala. Daily 7.45-9 am. 12.45-3.45 pm., 7.30 pm.-12.15 am. Sun. 10.30 am.-5.15 pm., 7 pm.-12 m.	6.150	ZPI4	VILLARRICA, PARAGUAY, 48.78 m., 4-6 pm.
7.410	HCJ84	QUITO, ECUADOR, 40.46 m., 7-9.30 pm. irregularly.	6.480	HIIL	SANTIAGO DE LOS CABALLEROS, D. R., 46.28 m., Addr. Box 356. 9.40-11.40 am., 7.40-9.40 pm.	6.147	ZEB	BULAWAYO, RHODESIA, S. AFRICA, 48.8 m. Mon., Wed., and Fri. 1.15-3.15 pm.; Tues. 11 am.-12 n.; Thurs. 10 am.-12 n. Sun. 3.30-5 am.
7.410	YDA	TANDJONGPRIOK, JAVA, 40.46 m., Addr. N.I.R.O.M., Batavia, 10.30 pm.-2 am.; Sat. 7.30 pm.-2 am.	6.470	YNLAT	GRANADA, NICARAGUA, 46.36 m., Addr. Leonidas Tenorio, "La Voz del Mombacho." Irregular.	6.145	HJ4ABG	MEDELLIN, COL., 48.79 m. 11 am.-12 n., 6-10.30 pm.
7.380	XECR	MEXICO CITY, MEX., 40.65 m., Addr. Foreign Office. Sun. 7-8 pm.	6.465	YV3RD	BARQUISIMETO, VENEZUELA, 46.37 m. Radio Barquisimeto, irregular.	6.140	W8XK	PITTSBURGH, PA., 48.83 m., Addr. Westinghouse Electric & Mfg. Co. Relays KDKA 11 pm.-12 m.
7.220	HKE	BOGOTA, COL., S. A., 41.55 m. Tues. and Sat. 8-9 pm. Mon. and Thurs. 6.30-7 pm.	6.450	HI4V	SAN FRANCISCO DE MACORIS, D. R., 46.48 m. 11.40 am.-1.40 pm., 5.10-9.40 pm.	6.137	CR7AA	LAURENCO MARQUES, PORT. E. AFRICA, 48.87 m. Daily 12.05-1, 4.30-6.30, 9.30-11 am., 12.05-4 pm., Sun. 5-7 am., 10 am.-2 pm.
7.200	YNAM	MANAGUA, NICARAGUA, 41.67 m. Irregular at 9 pm.	6.400	TGQA	QUEZALTENANGO, GUATEMALA, 46.88 m., Mon.-Fri. 9-11 pm. Sat. 10 pm.-1 am. Sun. 1-3 pm.	6.133	XEXA	MEXICO CITY, MEX., 48.93 m., Addr. Dept. of Education. Daily 8-11 am., 2.30-4 pm., 7.30 pm.-12.45 am. Sun. 1.30 pm.-12.45 am.
7.177	CR6AA	LOBITA, ANGOLA, PORT. WEST AFRICA, 41.75 m., Mon., Wed., and Sats. 2.45-4.30 pm. Also see 7.614 mc.	6.384	ZIZ	BASSETERRE, ST. KITTS, W. INDIES, 46.99 m. 4-4.45 pm. Wed. 7-7.30 am.	6.130	TIEM	SAN JOSE, COSTA RICA, 48.94 m. "El Mundo." Apartado 1049. 11 am.-11 pm., Sun. 10 am.-6 pm.
7.100	FO8AA	PAPEETE, TAHITI, 42.25 m., Addr. Radio Club Oceanique. Tues. and Fri. 11 pm.-12.30 am.	6.340	HIIX	CIUDAD TRUJILLO, D. R., 47.32 m., Sun. 7.40-10.40 am., daily 12.10-1.10 pm., Tues. and Fri. 8.10-10.10 pm.	6.130	CHNX	HALIFAX, N. S., CAN., 48.94 m., Addr. P. O. Box 998. Mon.-Fri. 7 am.-11.15 pm., Sat. 11 am.-11 pm., Sun. 12 n.-11.15 pm. Relays CHNS.
7.088	PIIJ	DORDRECHT, HOLLAND, 42.3 m., Addr. Dr. M. Hellingman, Technical College. Sat. 11.10-11.50 am.	6.335	OAXIA	ICA, PERU, 47.33 m., Addr. La Voz de Chiclayo, Castilla No. 9. 8-11 pm.	6.130	LKL	JELOY, NORWAY, 48.94 m. 11 am.-6 pm.
7.050	FG8AA	POINT-A-PITRE, GUADELOUPE, F.W.I., 42.55 m., 6-7 pm., also 9-10.30 pm. Irregular. P.O. Box 125.	6.324	COCW	HAVANA, CUBA, 47.4 m., Addr. La Voz del Radio Philco, P. O. Box 130. 6.55 am.-12 m. Sun. 9.55 am.-10 pm.	6.125	CXA4	MONTEVIDEO, URUGUAY, 48.98 m., Addr. Radio Electrico de Montevideo, Mercedes 823. 8 am.-Noon. 2-10 pm.
6.990	XEME	MERIDA, YUCATAN, 42.89 m., Addr. Calle 59, No. 517, "La Voz de Yucatan desde Merida." Irregular.	6.310	HIZ	CIUDAD TRUJILLO, D. R., 47.52 m. Daily except Sat. and Sun. 11.10 am.-2.25 pm., 5.10-8.40 pm. Sat. 5.10-11.10 pm. Sun. 11.40 am.-1.40 pm.	6.122	HJ3ABX	BOGOTA, COL., 49 m., Addr. La Voz de Col., Apartado 26-65. 12 n.-2 pm., 5.30-11 pm.; Sun. 6-11 pm.
6.977	XBA	TACUBAYA, D. F., MEX., 43 m. 9.30 am.-1 pm., 7-8.30 pm.	6.300	YV4RD	MARACAY, VENEZUELA, 47.62 m. 6.30-9.30 pm. exc. Sun.	6.122	HP5H	PANAMA CITY, PAN., 49 m., Addr. Box 1045. 10 am.-1 pm., 5-11 pm.
6.805	HI7P	CIUDAD TRUJILLO, DOM. REP., 44.06 m., Addr. Emisora Diaria de Comercio. Daily exc. Sat. and Sun. 12.40-1.40, 6.40-8.40 pm. Sat. 12.40-1.40 pm. Sun. 10.40 am.-11.40 am.	6.295	OAX4G	LIMA, PERU, 47.63 m., Addr. Apartado 1242. Daily 7-10.30 pm.	6.122	FK8AA	NOUMEA, NEW CALEDONIA, 49.00 m., Radio Noumea, Addr. Charles Gaveau, 44 Rue de l'Alma., Wed. & Sats. 2.30-3.30 am.
6.790	PZH	PARAMIRABO, SURINAM, 44.16 m., Addr. P. O. Box 18. Daily 6.06-8.36 am., Sun. 9.36-11.36 am. Daily 5.36-8.36 pm.	6.280	HIG	TRUJILLO CITY, D. R., 47.77 m., 7.10-9.40 am., 11.40 am.-2.10 pm., 3.40-9.40 pm.	6.117	XEUZ	MEXICO CITY, MEX., 49.03 m., Addr. 5 de Mayo 21. Relays XEFO 9 am.-1 pm., 7 pm.-2 am.
6.775	HIH	SAN PEDRO DE MACORIS, DOM. REP., 44.26 m., 12.10-1.40 pm., 7.30-9 pm., Sun. 3-4 am., 4.15-6 pm., 4.40-7.40 pm.	6.270	YV5RP	CARACAS, VENEZUELA, 47.79 m., Addr. "La Voz de la Philco." Daily to 10.30 pm.	6.115	OLR2C	PRAGUE, BOHEMIA, 49.05 m. (See 11.40 mc.)
6.750	JVT	NAZAKI, JAPAN, 44.44 m., Addr. Kokusai-Denwa Kaisha, Ltd., Tokyo. Irregular.	6.255	YV5RJ	CARACAS, VENEZUELA, 47.18 m. 5.30-8 pm.			
6.730	HI3C	LA ROMANA, DOM. REP., 44.58 m., Addr. "La Voz de la Feria." 12.30-2 pm., 5-6 pm.						

### 49 Met. Broadcast Band

(Continued on page 58)

All Schedules Eastern Standard Time

# The "Bauer" T-R-F Four

Francis J. Bauer, Jr., W6FPO

A four tube T.R.F. receiver performing as well as many a small super-het. A novel circuit is employed, combining "link" and "capacity" coupling in a tuned plate circuit for the r.f. amplifier.

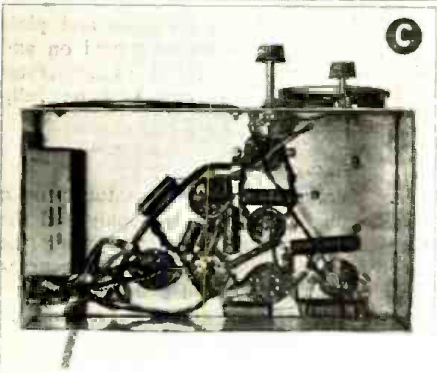
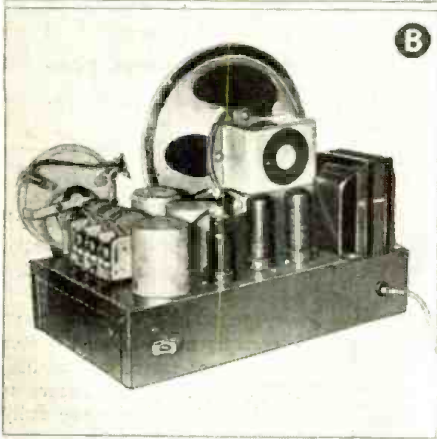
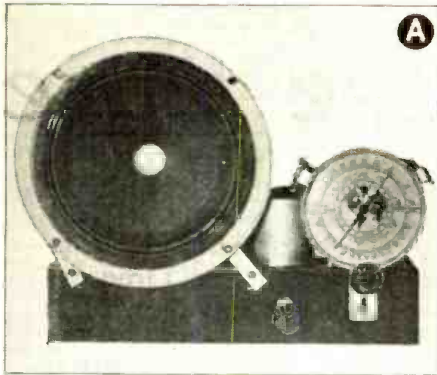

• ANYONE who has used or built the conventional four tube T.R.F. receiver is familiar with the limitations of such equipment. The selectivity is usually none too good and in addition there is regeneration that supposedly gives greater sensitivity but actually reduces the amplification because the receiver breaks into oscillation before the full gain of the r.f. tube can be realized. Another common defect in this type of receiver is a characteristic drop in gain toward the low frequency end of the broadcast band.

These obvious deficiencies are remedied to a surprising extent in the simple receiver described in this article. In the writer's opinion, the performance of the High Efficiency Four compares very favorably with that of many a small super-het, with the added advantage of lower noise-level and no oscillator hiss.

### New Coupling System Used

An examination of the wiring diagram will reveal a circuit that is standard in every

respect except for the unique coupling system between the r.f. and detector tubes. This, together with the tuned plate circuit in the r.f. stage, is the heart of the receiver and accounts for the tremendous gain with stability that this receiver is capable of.

A combination of link and capacity coupling is used so as to provide uniform gain throughout the tuning range. At high frequencies condenser "c" is the most effective coupling medium. As the frequency is lowered "c" becomes less and less effective because of its increase in reactance but the link circuit, on the other hand, becomes more efficient. In other words, "c" works best at high frequencies and the link circuit works best at low frequencies, provided both "c" and the link circuit are properly phased as explained later on in the text.

### Set Easy to Build

The construction of this receiver presents no unusual difficulties as long as the chassis layout is adhered to, particularly in the r.f. (Continued on page 51)

Left—Photos of the T.R.F. Four. Below—Wiring diagram. The improved tuning is due to the "link" circuit connecting the R.F. and detector tubes.

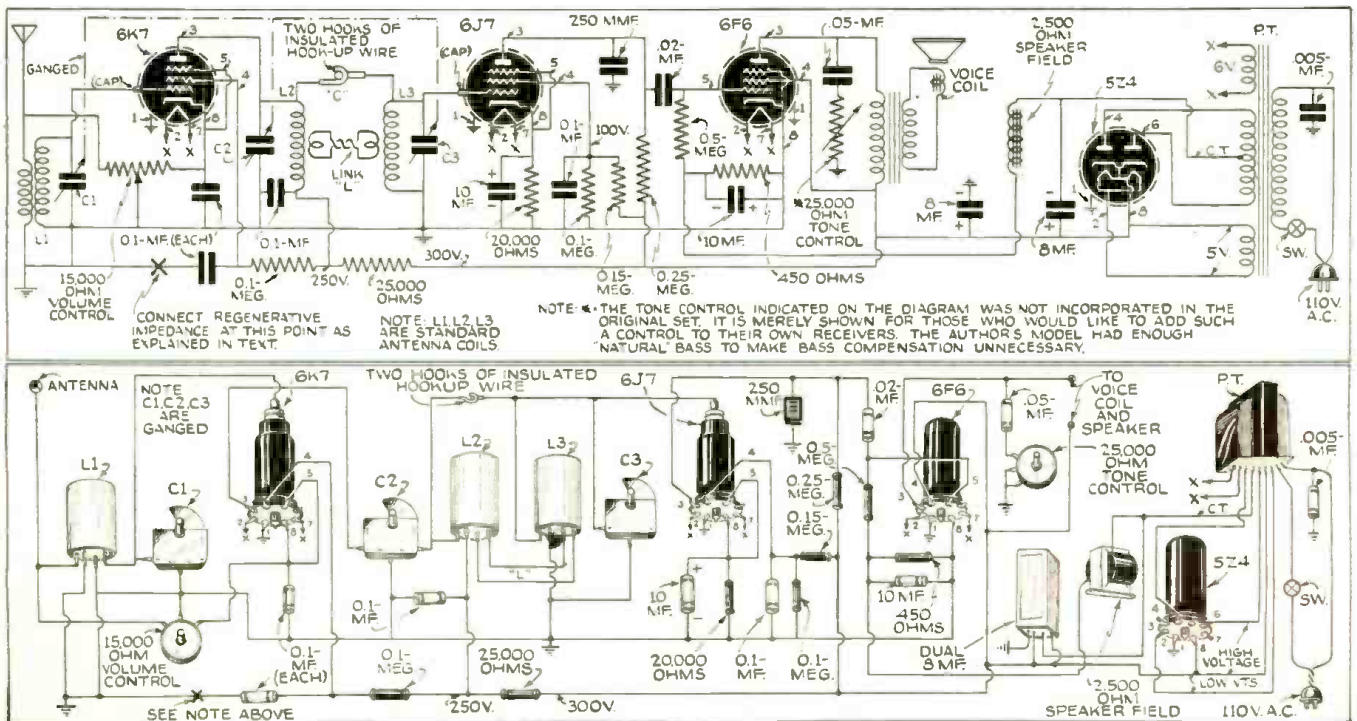



# De Luxe

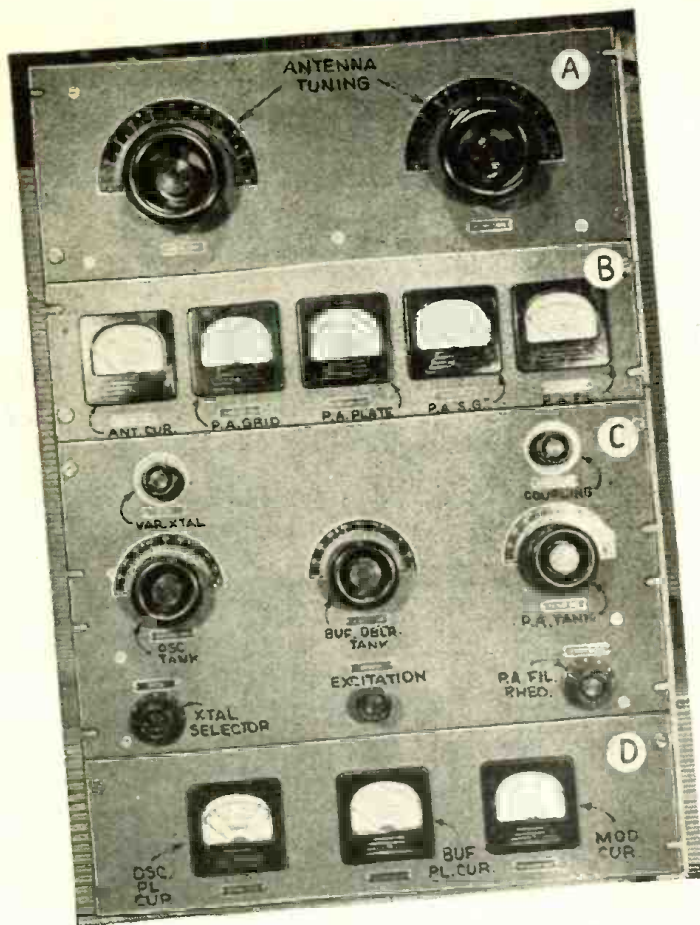

Front view of the De Luxe Transmitter using beam power tubes—a handsome smooth-working "rig."

## The R.F. Unit

● THE R.F. section of this transmitter is composed of three beam power tubes, hence the name. In addition to the usual 6V6 and 807 beam tubes, the power amplifier is one of the new

This is the first of a series of articles describing a swell transmitter. The "radio frequency" section is explained in this part. This unit employs three beam power tubes. The power output on both phone and CW is about 200 watts. Remote control is provided for, as are both over- and underload protection. Bands—80, 40, 20 and 10 meters.

813 tubes, which is one of the most efficient types ever designed. The power output on both phone and CW is around 200 watts, which will do respectable work even on the present overcrowded bands.

Besides the new 813, several other recent developments have been incorporated. One of these is the recently announced 40-meter variable crystal. Provision is made for two of them, and adjustment of both is made from the front panel. Another feature is the kit-type speech amplifier which will be described more fully in a subsequent article.

Remote control is provided for, and the filaments and plate power as well as the exciter alone may each be turned on and off from a remote position. This control system also incorporates complete over- and underload protection, and will be fully described in the next article.

## Clickless Keying

The R.F. unit is complete, except for the antenna tuner, on a single chassis. This includes low voltage power supply and the keying relay. *Clickless keying* is accomplished by breaking the cathode circuit of the 6V6 oscillator. A small amount of regeneration in the oscillator circuit lowers crystal and plate current and allows rapid keying even with rather poor crystals. Self-bias on

Wiring diagram of the R.F. section of the De Luxe Transmitter.

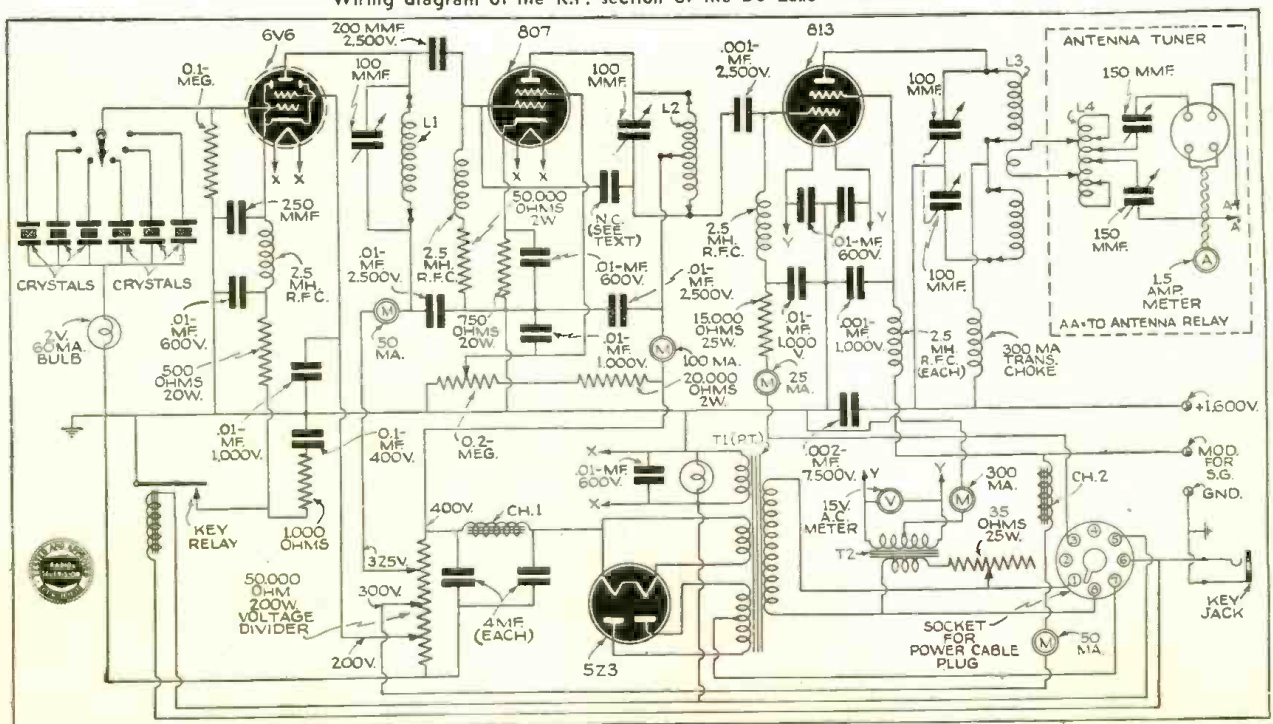



# "Beam Power 3"



PART I

Howard G. McEntee, W2FHP

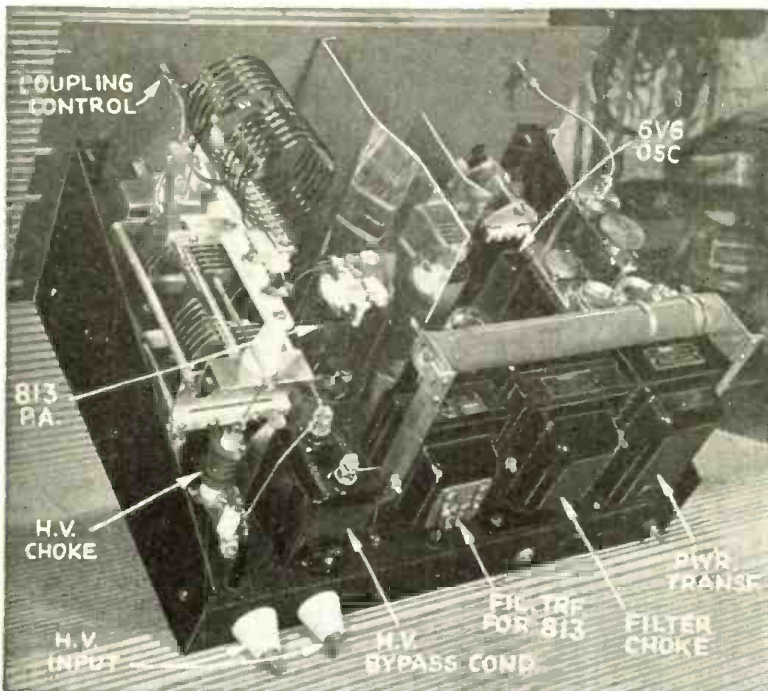

A close-up rear view of the transmitter's R.F. unit.

the coil from the plate end, giving a more balanced arrangement and less of a capacity load on L1, since the plate to filament capacity of the 807 and the grid to filament of the 813 are both rather high.

### 813 Plate Circuit Unusual

The 813 plate circuit is rather unusual, but the arrangement used lessens the effect of the high output capacity on the tuned circuit, and at the same time permits the use of a ready-made variable link unit. The latter permits variation of coupling from the front of the panel which is a decided convenience, especially with some types of antennas. This transmitter is used with an 8JK beam, which is quite susceptible to changes in weather such as rain or heavy fog. It is a great convenience to be able to vary coupling from the front panel.

The two variable crystals plug in on a shelf above the chassis, and this shelf is supported by the side brace: brass pillars are run from the two free corners to the base to form a solid mounting. The crystal variation control is operated by a flexible shaft from the front panel. A strip of aluminum  $\frac{1}{2}$ " x  $\frac{3}{8}$ " mounted above the crystal shelf on pillars supports the two shafts which are geared together. The gears are standard  $\frac{1}{2}$ " diameter units with  $\frac{1}{4}$ " shaft holes. Clips to slip over the knobs on the crystal holders are soldered on the lower ends of the gear shafts. When changing these crystals, the gears and shafts may be raised to permit removal. Ordinary  $\frac{1}{4}$ " shaft bushings serve as bearings for the shafts.

Sockets for four other crystals are mounted in the side bracket, so that the crystals project outward. They keep cooler in this position and such mounting reduces crowding on the chassis.

The crystal selector switch is mounted under the chassis, with a large hole over it for the leads to pass through. A 60 ma., 2 V. pilot lamp is mounted in series with the common lead from the crystal holders. It is only needed during preliminary adjust-

(Continued on page 41)

the 807 and partial fixed-bias on the 813 make this type of keying practical. A single 45-volt battery holds the latter tube down when excitation stops, and is the simplest possible bias means. A single battery will last practically as long as its shelf life in this circuit, since the grid current is only about 10 ma. or so.

The fact that such low excitation is required by the 813 allows us to run all the components at relatively low ratings, so that life of all parts is very long, and everything runs cool and without strain.

The 6V6 always runs on fundamental frequency, while the 807 can be run on fundamental, or double, or quadruple, as required. The transmitter was designed primarily for 40, 20 and 10 meters, which is the reason for the selection of the 40-meter crystals. However 80-meter operation is entirely feasible and may be accomplished with an 80-meter crystal. Either 80- or 40-meter crystals will cover three bands, doubling or quadrupling in the 807 as required, with plenty of drive to the 813. The drive is so high in most cases that it is best to reduce it, as it is quite easy to overdrive the 813. For this purpose a variable screen grid resistor for the 807 acts as excitation control and reduces the drive smoothly and without detuning effects.

### 807 Is Neutralized

It was found advisable to neutralize the 807, so that straight-through or fundamental operation could be accomplished without fear of self-oscillation. If the neutralization is not used, considerable extra shielding is required. Of course, complete stability is had when the 807 is doubling.

The neutralizing capacity required is very small, and the condenser may be seen on the underside view. It consists of pieces of No. 10 tinned copper wire run about  $\frac{3}{8}$ " apart for 1". The wires are held rigidly spaced by clamping between two "butt-in" insulators which are about  $\frac{1}{2}$ " in diameter. The spacing of the wires is varied until stable operation is secured when either 40- or 80-meter coils are used at both L1 and L2.

The output of L2 is taken off at the opposite end of

Another view of the R.F. section. Note the sturdy construction.

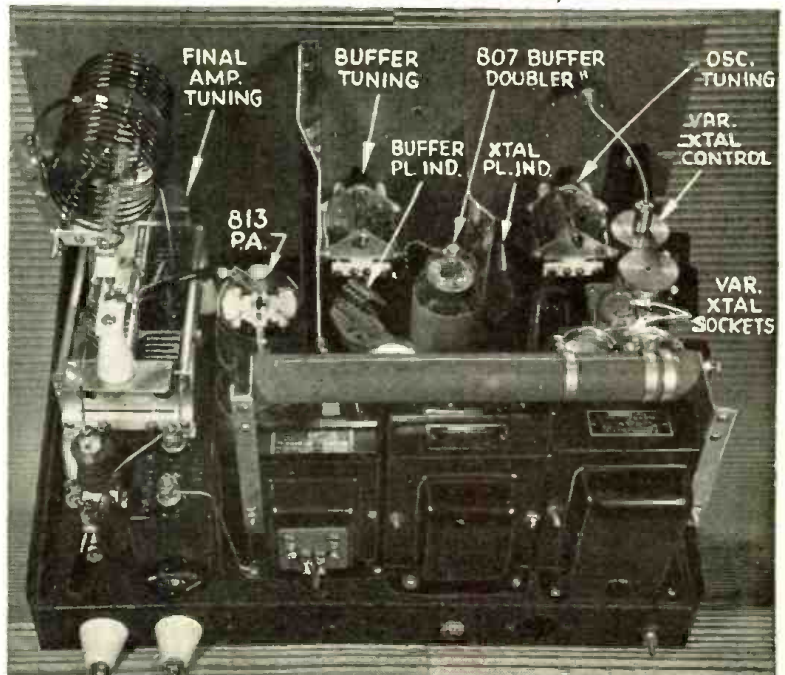



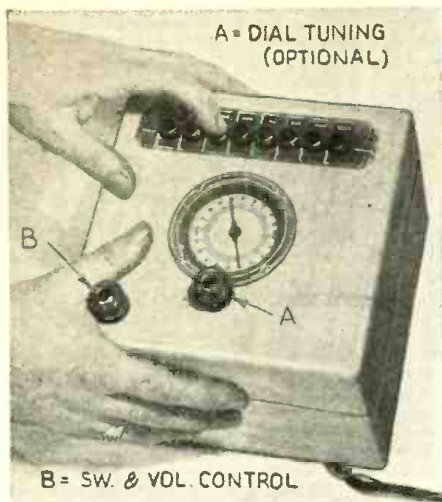

This "Remote Control" box will tune any broadcast receiver automatically to seven different stations.

● THERE is an old saying that "necessity is the mother of invention," but even more true, perhaps, would be one reading—"laziness is the reason for many inventions." And being inclined to laziness—especially with spring weather here—the thoughts of a "gadget" which would permit tuning from one station to another and, if desired, changing the volume of the programs, without leaving that comfortable easy chair, sounded awfully interesting.

So with an effort the easy chair was relinquished for a few evenings while an arm-chair remote control unit was designed and constructed.

And with the thought that there might be other lazy folk who might resent leaving their easy chairs to tune in the radio entertainment they want to hear, the details of this unit, which is no more difficult to construct and no more costly than a small A.C.-D.C. midget superhet, are here given. It can be used with any broadcast receiver without making any changes in the receiver or connecting any wires to it.

#### How "Remote Control" Unit Works

The principle of operation is quite simple. The remote tuner contains the first-detector, oscillator and two I.F. amplifier stages of a super-heterodyne receiver, plus a radiating coil which re-transmits the programs received on the remote tuner to the regular radio receiver where they are amplified again, detected and heard through the loudspeaker.

In other words, the remote tuner is a tiny radio transmitter which changes the frequency of the broadcast stations to a frequency of 1560 kc. The broadcast receiver is tuned to this frequency and not touched further. All stations within the broadcast band are picked up by the remote tuner and changed to this same frequency.

The remote tuner is contained in a small box about 7½ inches square and 5½ inches high. The photos on this page show its convenient size as well as the general layout of parts and construction.

#### Circuit Is Simple

The circuit is less complicated than most broadcast sets. The 6K8 tube is the first detector and oscillator. A two-gang con-

# REMOTE CONTROL Selects Stations Spot—Just



denser tunes the aerial and oscillator circuits. A 6K7 tube is the first I.F. amplifier stage, which is tuned to a frequency of 1560 kc. The 6B8 is used as second I.F. stage and as A.V.C. diode. The coil in the plate lead of this 6B8 tube is 3 inches in diameter and is not shielded like the other coils in the set. This coil is a loop aerial which sends the signals to the regular receiver.

Incidentally, it was found that by coupling the aerial wire to this coil loosely (the aerial wire is twisted around the A.C. line cord and the two are wrapped once around this 3-inch coil) the remote tuner could be removed about 100 feet from the receiver and still provide complete control over the station selection and volume of the radio set.

#### Plate Supply "Built-In"

The filament and plate voltages for the tuner are obtained in conventional A.C.-D.C. manner by means of a 25Z6 tube and a series connection of the filaments. Two 40 m.f. electrolytic condensers and a wire-wound resistor provide adequate filtering of the plate voltage supply.

Actual layout of the parts can be seen in the photos and accompanying drawings. The aerial coil and the two I.F. coils are Meissner coils which are readily obtained. The oscillator coil is a Meissner type 14-7560 adjustable oscillator coil which is doctored up as follows. The plate winding is completely unwound and 35 turns are removed from the grid or

## New! Exclusive!

This easily built Remote Control box, plugged into any electric light outlet in your home, permits any one of seven stations to be "tuned in" by simply pushing a button! It also controls volume and provides "remote" dial tuning of your broadcast receiver. Four tubes are used, together with standard parts.

tuned winding. The plate winding is then rewound, as a straight solenoid directly over the grid winding, after having replaced the layer of varnished cloth which was originally between the two coils. Wind 30 turns of the plate coil and connect the ends back to the terminals on the coil base. Then replace the shield and the powdered iron core.

The radiating coil consists of 28 turns of No. 30 enamelled wire on a 3-inch bakelite form. This coil must be close-wound. The position of this coil in the tuner can be seen in the photos.

#### Image Trap Coil

One other coil is shown in dotted line. This coil was not required in the original set. It is an image trap coil and is tuned to the I.F. of 1560 kc. to prevent signals tuned to 1560 kc. from being heard through the I.F. channel. It consists of a coil and condenser connected in series and tuned to 1560 kc. A small broadcast coil and a 225 mmf.

Close-up rear view of Control unit.





# BOX from any push button!

C. W. Palmer, E.E.

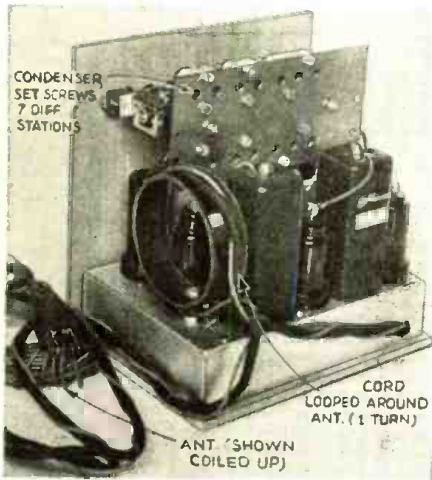

This view shows coil antenna used on Remote Control unit.

mica trimmer condenser will serve nicely. If no I.F. or image interference is encountered, this coil and condenser can be omitted.

### Adjustments

The adjustments of the I.F., oscillator and the push-button tuner, which permits stations to be tuned by simply pushing buttons on the remote tuner, are quite easy.

First, tune your broadcast receiver accurately to 1560 kc., preferably by means of a calibrated service oscillator. Remove the aerial wire from the aerial binding post of

### See Diagram on page 47

the set and replace this with a wire about 5 to 10 feet long, laid on the floor.

Place the remote tuner near the receiver, with the aerial wire (a 30 ft. length of insulated flexible wire) placed conveniently under a rug or around the edge of the room. Plug in the tuner and turn the radio set on. Set the volume controls on both units on high. Adjust the I.F. of the tuner to 1560 kc. with a signal generator, picking up the signal in the receiver and using a tuning meter in the set or the "sound" as indicating means. Next, with the "manual-tuning" button of the Meissner 10-7554 tuner pushed in, adjust the trimmers on the condensers at a frequency of about 1400 kc., again using the service oscillator. Follow this with an adjustment of the padder condenser in the oscillator of the tuner unit at a frequency of 550 kc.

After the tuning dial of the set has been "tracked," the tuning buttons can be set-up by pushing the buttons one at a time and  
(Continued on page 46)

*the*

# RUSH IS ON!!

for the

# HQ-120

**T**HE NEW HAMMARLUND "HQ-120-X" is radio's most outstanding communications type receiver. Hams and short wave listeners everywhere are amazed with its remarkable performance. The ability of the "HQ-120-X" to pull in weak, distant stations is providing new thrills for the DX'er. The reason for this is the fractional microvolt sensitivity throughout the entire range of the receiver. In order to derive full benefit of extreme sensitivity a receiver must have a widely variable selectivity characteristic, since most short wave bands are considerably crowded. The new Ham-

marlund developed variable selectivity crystal filter, incorporated in the "HQ-120-X," allows the operator to select the proper band width for best results. This new filter works as well on phone reception as CW. Crowded phone bands are more than doubled in effective width when using the "HQ-120-X" crystal filter. In other words, there are more than twice as many usable channels made available for perfect reception. There are many other features thoroughly described in a 16-page booklet available without charge. "The rush is on!" Try the "HQ-120-X" and judge for yourself.

Write Department RT-5 for free 16-page booklet.

## HAMMARLUND MFG. CO., INC.

424-438 WEST 33rd ST., NEW YORK

CANADIAN OFFICE: 41 WEST AVE., NO., HAMILTON, ONT.

**FEATURES**

- SIMPLICITY
- PERFECT CONTROL
- SEMI-AUTOMATIC
- EASE OF OPERATION

## MARTIN FLASH

The greatest VALUE ever offered

**STURDY CONSTRUCTION**

Single lever. Two pairs of coin silver contact points... one for dots, the other for dashes.

Designed especially to meet the demands of amateur operators. Beautiful black crackle finish. This key is a "winner." Weight, 2 pounds. Base, 6x3x3/8. New low list, each **\$6.95**

Ask your dealer to show you the FLASH Key. If he cannot supply you, send your order direct to us.

Write for complete catalog illustrating and describing all models.

**MARTIN RESEARCH & MFG. CORP.**  
98 PARK PLACE      Dept. RT-5      NEW YORK CITY



# Tune In TELEVISION SOUND Converter for 2½, 5 and

Herman Yellin, W2AJL

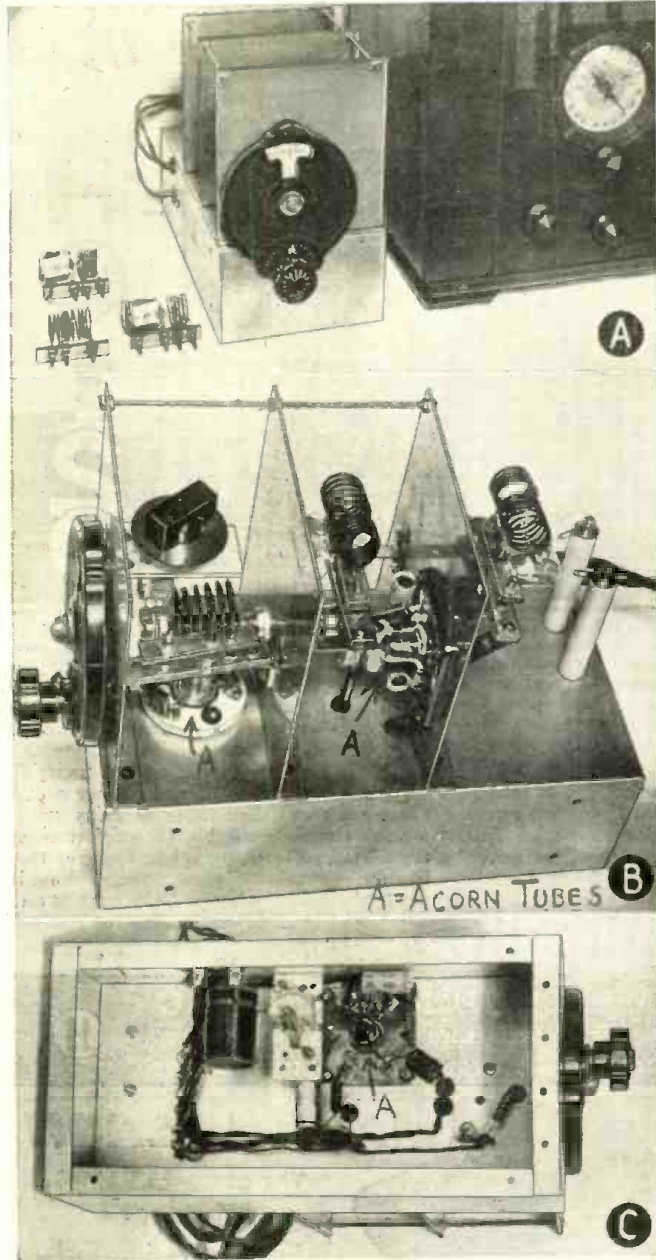

Top—Converter with all-wave superhet (must tune to 3400 kc. or 88 meters). Center—Close-up side view. Bottom—a peek at the underside. One shield tie-rod removed for photo.

● THE recent forced use of stable five meter transmitters has made entirely practicable the use of superheterodyne receivers on this high frequency. Not only have they become practical, but as many of the old possessors of wobbled transmitters are returning to the fold with crystal-controlled rigs, the use of a highly selective receiver will soon become a necessity. The appearance of stable transmitters and receivers has already resulted in a number of stations using cw transmissions on 5 meters.

For many amateurs, the construction of a separate five meter receiver offers a serious financial problem. However, it is possible to build a small converter at a comparatively low cost and couple this to the regular station receiver, using this receiver as the intermediate frequency amplifier. If the receiver is a superhet we will have a super with a double I.F. and it will give much better selectivity than a super using but a single I.F. Thus, strange as it may seem, a simple converter added to a good receiver will furnish us with a much better receiving system than an ordinary complete superhet. For best results the regular station super should have an R.F. stage with plenty of "soup."

### All Tuning Done with "Converter"

In the converter whose description follows, the I.F. of 3400 kc. is one at which practically all short-wave receivers have plenty of gain. Unlike the lower frequency supers, the oscillator is operated at a lower frequency than the detector in order to increase oscillator stability. In use the converter is adjusted so that the frequency difference between the oscillator and detector is 3400 kc. (88 meters) and the regular s-w receiver tuned to this frequency. Subsequent tuning is done only with the converter. By means of plug-in coils, reception is also possible on the 2½- and 10-meter bands. On 2½ meters it will be rather difficult to receive

Wiring diagram of the converter.

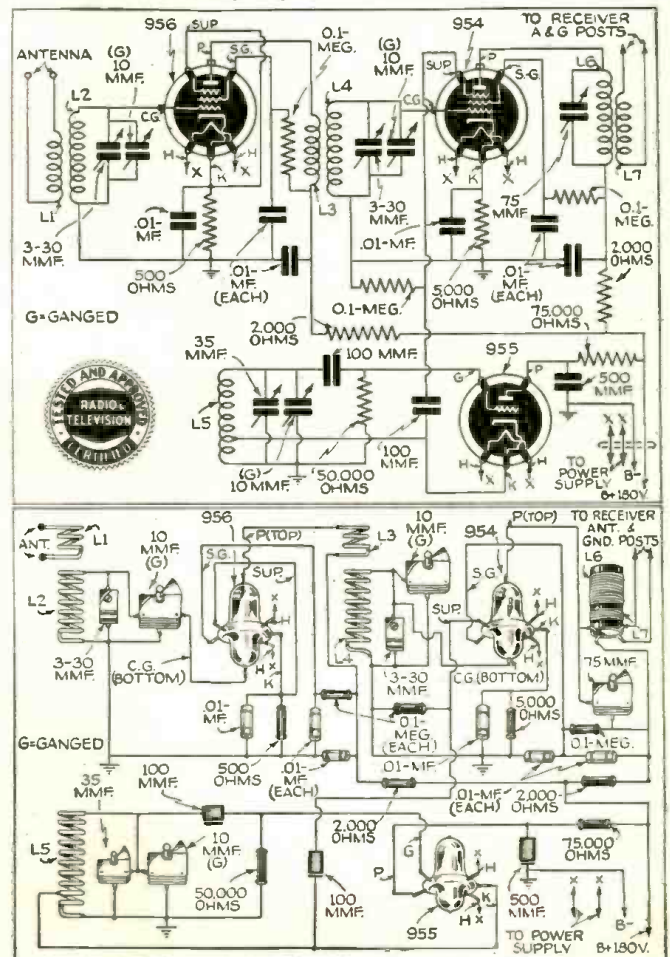

# On This 10 Meters



signals from modulated oscillator transmitters, but since more and more hamis are using their 5-meter crystal-controlled rigs on 2½ meters there will be plenty of stations to listen to. Too, one might as well start off on 2½ with a good receiver.

Because of the desirability of using the converter on 2½ meters, acorn tubes were employed, a 956 for the r.f. stage, a 954 for the first detector and a 955 for the high frequency oscillator. The sensitivity on 2½ as well as on the other two bands was much greater than with receivers using ordinary

Highly sensitive acorn tube converter, capable of exceptional selectivity when used with a superhet tuning to 88 meters. Particularly useful for intercepting Television Sound channels.

tubes. Also, the use of the small acorn tubes resulted in a much more compact layout with extremely short leads. At the ultra-high frequencies, r.f. leads should be conspicuous by their absence, with wires concentrated in the coils.

### Tuning Condensers Ganged

As the photos show, the converter is mounted on a standard 5x10x3 inch chassis to which are bolted three aluminum interstage shields. On these shields are mounted the three ganged tuning condensers. Figures 1 a, b, c and d show the necessary holes which should be drilled quite accurately in order for the different units to fit together.

The shield closest to the tuning dial mounts the oscillator tuning condenser and immediately above this condenser is the oscillator padding condenser, which is of the air-dielectric type since its capacity must be quite constant in order for the converter to hold its calibration. The tuning condensers have a capacity of 15 mmf. which must be changed to 10 mmf. This can be done by moving the rear stator plate so that the distance between the two stator plates is doubled. The 955 socket, of isolantite, is mounted about ¼" off the chassis. Holes are drilled through the chassis under the filament, cathode and plate terminals for connecting leads to these terminals. Also a small hole (¼") should be drilled through the chassis under the center of the socket to allow the small projection of the 955 tube to protrude through the chassis. The oscillator coil jack bar is mounted at an angle in order to keep the leads as short as

possible. All the coil mounting strips and receptacles were made from sheet victrol. The writer used 3/16" sheet for the bars holding the coil jacks and ¼" sheet for the coil strips. Miniature banana plugs and jacks were used for the contacts. The constructor should make up a metal drilling template for drilling the jack bars and coil strips so that the coil plugs will line up with the jacks. Attempts at forcing the plugs into the jacks when they don't line up will result in a broken coil strip.

On the center shield is mounted the detector tuning condenser, while the detector coil (L<sub>3</sub>, L<sub>4</sub>) is supported between this shield and the rear shield with metal brackets. The 954 tube socket is mounted underneath the chassis, so that when the tube is inserted into its socket, the end of the tube containing the grid terminal will be above

(Continued on page 49)

### Coil Data

	5 meter band (and Television Sound Chan.)	2½ meter band
L <sub>1</sub>	10 meter band 6 turns No. 18 enameled ¾" dia. wound at end of L <sub>2</sub>	4 turns No. 14 enameled ¾" dia. ¾" dia.
L <sub>2</sub>	11 turns No. 18 enameled ¾" dia.	4 turns No. 12 enameled ¾" dia. ¾" long
L <sub>3</sub>	8 turns No. 18 wound at end of L <sub>1</sub>	5 turns No. 14 enameled ¾" dia. ¾" long
L <sub>4</sub>	12 turns No. 18 ¾" dia. 1" long tapped at 3rd turn from ground	4 turns No. 14 enameled ¾" dia. ¾" long Tap 2 T. from G
L <sub>5</sub>	46 turns No. 24 enameled, close wound on 1" dia. form	4 turns No. 12 enameled ¾" dia. ¾" long Tap 1½ T. from G
L <sub>7</sub>	8 turns No. 24 enameled, wound at end of L <sub>4</sub> (number of turns can be varied for optimum output). T=Turns; G=Ground.	

### PARTS LIST

- NATIONAL CO.**  
3-15 mmfd. tuning condensers, type STHS-15E (altered)  
1-35 mmfd. condenser, type UM-35  
1-75 mmfd. condenser, type UM-75  
2-Metal acorn sockets, type XMA  
1-Isolantite acorn socket, type XCA  
1-Flexible shaft coupling, type TX-9  
1-Can victrol coil dope and ¼" and 3/16" sheet victrol  
1-XR-2 coil form for L<sub>4</sub>, L<sub>7</sub>  
6-3-30 mmf. mica trimmers, type M-30  
2-Stand-off insulators, type GS-2  
1-Type "B" vernier dial  
1-HRO dial "0-10"

- RCA MFG. CO.**  
1-954; 1-955; 1-956 (Acorn tubes)

- I.R.C.**  
1-500 ohms; 2-2000 ohms; 1-5000 ohms; 1-50,000 ohms; 1-75,000 ohms; 3-100,000 ohms; all ½ watt, type BT½

- SOLAR MFG. CORP.**  
6-.01 mfd. 400 volt paper tubulars, type SO219  
2-.0001 mf. mica, type MO1416  
1-.0005 mf. mica, type MT1322

- PAR-METAL**  
1-5" x 10" x 3" Cadmium plated chassis, type C-4508

- AMERICAN RADIO HARDWARE CO.**  
11-No. 394 midjet jacks  
33-No. 392 midjet plugs

Dealers! Servicemen! Amateurs!  
Soundmen! Builders!

**FREE**

**ALLIED'S Spring  
RADIO CATALOG**  
JUST OUT—SEND COUPON!

**EVERYTHING IN RADIO  
AT LOWEST PRICES**



### NEW SETS!

New KNIGHT Radios, with Push-Buttons, built-in "Air-Market" aerials—at new low prices! 40 models—Portable, A.C. AC DC, 1½, 5, and 32 volt, etc., as low as \$5.95!—and radio's biggest line of record players, phonographs, phono-radios!



### NEW SOUND!

New P.A. values for every purpose, 8-65 watts—Monitor Speakers, Remote Control, de luxe standard models—permanent, portable, and mobile—and complete line of recording equipment, discs, etc.!

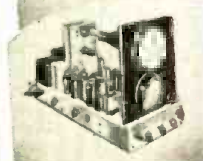

### NEW KITS—PARTS!

More than 14,000 parts! New Build-Your-Own Kits: Meissner 1, 2, 3 tube, new "Pee-Wees"; Television; Mystery Phono and Mike Kit, and many others. Write for Free Parts Lists, New Builders' Handbook for beginners, only 10c.



### NEW HAM GEAR!

Giant new Ham section—all new station-checking equipment to meet F.C.C. regulations, Rotary Ham Antenna Gear, Television Kit, new Hallcrafters, Howard, R.M.E. Models—all leading lines at lowest prices! See what's new!



### NEW TESTERS!

All leading lines! See new equipment with provision for new Loctal Tubes, etc.—Tube Checkers, Set Testers, Analyzers, Oscilloscopes, Meters—and over 14,000 parts at lowest prices!

Fastest Service,  
Highest Quality,  
Lowest Prices al-  
ways! Write for ALLIED'S  
new Spring Catalog!

**Free!**  
SEND COUPON



**ALLIED Radio  
Corporation,  
Dept. 3-E-9  
833 W. Jackson  
Blvd.,  
Chicago, Ill.**

- Send me your new FREE Spring Catalog.  
 Enclosed find 10c (plus 3c postage) for Builders' Handbook.

Name .....  
Address .....  
City ..... State .....



# Question Box

## Simple C.W. Transmitter Rig

? Please show diagram for a C.W. rig using six 6L6's for an output of about 100 watts.

A. The diagram you request is given herewith, and a member of the Galveston (Tex.) Amateur Radio Club built this transmitter (designed by Louis Huffert), at a total cost of \$20.00, which included crystal, tubes, chassis, three low-priced meters

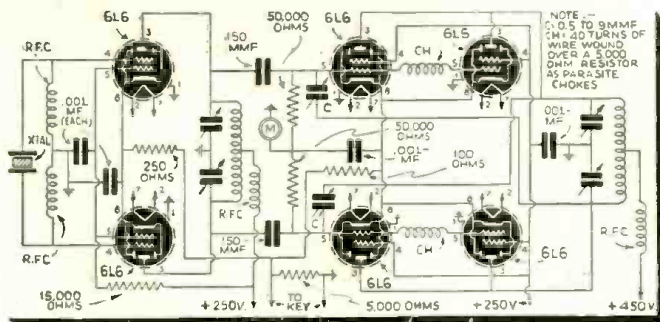

Hook-up for C.W. Ham transmitter using six 6L6's. No. 1177.

and hardware. The set is easily constructed and requires but little space; it can be operated from two low-priced power packs. The original model, in fact, operated satisfactorily with an old Majestic receiver powerpack for the final stage, and an R.C.A. receiver pack for the oscillator.

## Size of Grid Resistor

? Please publish the correct value of the grid resistor for an 809 tube when used as a class C, plate modulated R.F. amplifier. —Melvin Roppelt, Baltimore, Md. (W3HRY).

A. According to the tube booklet, a 5000 ohm grid resistor should be employed when this type tube is used as a Class C R.F. amplifier.

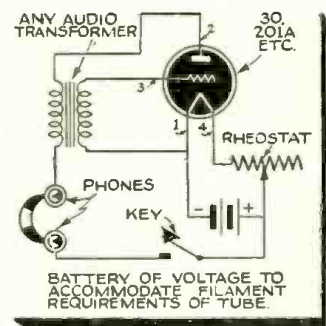

A very simple code practice oscillator. No. 1178.

A filament is needed only when the battery voltage is higher than the filament rating of the tube. The audio transformer may be any one available, and if the circuit does not oscillate at the first try, reverse the connections to one of the transformer windings.

## Television Query

A. In answer to numerous queries we wish to point out that with television about to break, there is no simple attachment which can be added to your present broadcast or all-wave receiver for picking up the images. The sound channel may be intercepted in this way, however, and converters for tuning in waves of 6 to 7 meters will be available on the market: some all-wave receivers tune to this channel as they stand and, in that case of course, no other attachment for receiving the sound is necessary. For picking up the image, a special wide-bandpass receiver will be required and a small dipole aerial, with its broad-side facing toward the television transmitter, should be used.

## Adding Amplifier Stage

? Please show how to add a 56 audio stage to a 58 detector. —Frank D'Arcy, Saskatoon, Sask., Can.

A. Diagram herewith shows how to connect a 56 audio stage, as you request. The use of an iron core audio choke for coupling results in a much better impedance match and allows a greater effective plate voltage to be applied to the plate of the 58 tube.

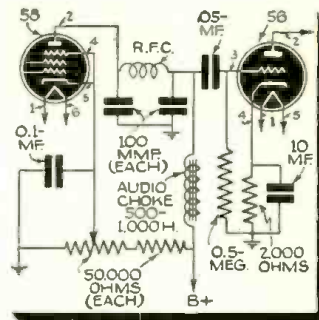

How to add an audio amplifier stage to a 58 detector. No. 1179.

## Improving a 3-Tube A.C. Receiver

? On page 480 of your December issue, there is described a 3-tube A.C. receiver, by J. R. Wilcox. Show in diagram how to add one stage of audio frequency amplification so as to increase the strength of signal on the loud speaker, and also indicate the best place to plug in a pair of headphones. —A. Robert Levett, New Haven, Conn.

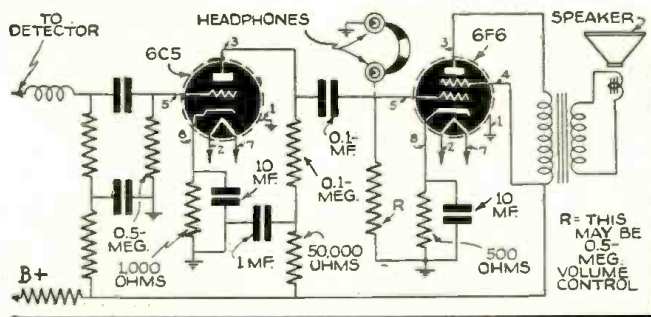

How to connect an amplifier stage to the 3-tube receiver described in the December issue, with the connection of headphones indicated. No. 1180.

A. The best method for adding an audio amplifier stage to the 3-tube receiver is shown herewith—note that a new tube, a 6C5, is placed between the 6K7 and the 6F6 in the old hook-up. The connection for headphones is also indicated.

## Half-Wave Rectifier

? Please diagram the connections for a half-wave rectifier for use with a transformer which does not have a center-tapped secondary. —Horace Hill, Stevens Point, Wis.

A. Here is the diagram you want. A full-wave rectifier tube, such as an 80, 5Z3, 82 or 82, can be used by connecting the two plate terminals of the tube in parallel. This is a popular circuit and uses standard components.

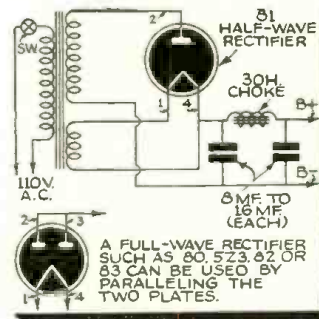

How to hook up a half-wave rectifier; with a full-wave tube the two plates are joined together. No. 1181.

A fee of 25c (stamps, coin or money order) is charged for letters that are answered by mail. This fee includes only hand-drawn schematics. We cannot furnish full-size working drawings or picture layouts. Letters not accompanied by 25c will be answered on this page. Questions involving considerable research will be quoted upon request. Names and addresses should be clearly printed on each letter.

# Transoceanic Radio Telephony on Short Waves

FRANK B. JEWETT

(Continued from page 5)

tube; and its advent, as is well known, came with the invention of a method of making vacuum tight seals between metal and glass envelopes.

In searching for the most efficient way of applying the power made available by water-cooled tubes, telephone engineers were led to the employment of a method which had already been used successfully in high-frequency wire telephony. This method, now well known to radio engineers, is called *single side-band suppressed-carrier transmission*. As compared with the ordinary modulated carrier transmission, it increases the effectiveness of a radio telephone system by about *ten-to-one* in power. This accrues partly because none of the power capacity of the transmitter is used up in sending the non-communication bearing carrier frequency and partly because the narrower band width permits greater selectivity and noise exclusion at the receiver.

A final element, and a very important one, was then necessary to permit the effective utilization in a combined wire and radio system of the potential power capacity provided by water-cooled transmitters employing the single side-band principle. The difficulty that remained to be overcome was that of *singing*. By associating and electrically interlocking several of the voice-current operated switching devices which had already been developed for suppressing echoes on long wire lines, an arrangement now commonly known as a "vodas" was perfected. When the subscriber talks, his own speech currents, acting on the vodas, cause it to connect the radio transmitter to the wire line and at the same time to disconnect the radio receiver. When the subscriber listens, the connection automatically switches back to the receiver. No singing path ever exists. The amounts of amplification in the two oppositely directed paths can be adjusted substantially independently of each other, and constant full load output from the radio transmitters is permitted. With this device it became possible to connect almost any telephone line to a radio system and to adjust amplification so that a weak talker over a long wire line could operate the radio transmitter as effectively as a strong local talker.

Although the first long distance radio telephone circuit operated, and still operates, between the United States and England on a long wave-length of about 5,000 meters we did not then, and we do not today, know how any considerable amount of intercontinental radio telephony could be accomplished using such low frequencies. The discovery that *short waves* can be transmitted to the greatest terrestrial distances and can be satisfactorily received in the tropics came, therefore, at a most opportune time. In addition to removing physical barriers, short waves further encouraged the growth of radio telephony by making it possible to construct directive antennas of moderate size, as is now well known. These increased the effectiveness of transmission many times, thereby reducing the transmitter power required for a given reliability of communication.

In view of the limitations of our knowledge, or perhaps the limitations with

which Nature has circumscribed radio transmission, short waves are the indispensable element without which substantial growth of overseas radio telephony could not have occurred. Other contributions, now to be briefly mentioned, have played a significant part in this development.

A well-nigh fundamental requirement of telephony is *privacy*—and radio telephone communication would have been severely hampered if means had not been invented to prevent eavesdropping. The first method developed, and applicable to systems in which the carrier wave is transmitted, was the simple inverter. Single side-band transmission presented a more difficult problem, but one which has of course been solved.

Another item of great aid in promoting growth was the development of methods of accurate stabilization of transmitted frequencies. The first effect of this was to eliminate the extreme distortion which characterized early short-wave telephone transmission and which was found to be due to parasitic phase or frequency modulation effects in the transmitters. As the number of radio communication facilities, both telegraph and telephone, grew, accurate stabilization of frequency became a necessity in order to permit effective utilization of the available frequency space without mutual interference between stations.

While space will not permit mention of all the methods and devices which have been introduced to facilitate or to lessen the cost of radio telephony, I should like to close with a few words regarding the *musa*. This new type of antenna utilizes the fact that in long distance short-wave transmission, the received waves come at any one instant slanting down to the receiver from different angles of elevation. In continuous-wave sending the energy reaches the receiver in distinct streams from different vertical angles which remain comparatively stable. As might be expected, the component coming at a low angle has taken less time in its trip from the transmitter than a high-angle component. The ordinary directive antenna is blunt enough in its vertical receiving characteristic to receive all these components and merge them together. Because of phase differences which tend to vary from moment to moment, the result is greater or less destructive interference, which shows up as selective fading or distortion.

The *musa*, by providing extremely sharp selectivity in a vertical plane, enables the phase differences between the various vertical components to be equalized and thus removes the root of the trouble. The system of antennas can be aimed or steered electrically, so as to pick out separately the individual radio beams. Having accomplished this, its second function is to correct phase differences between the beams so that they may be combined smoothly into a replica of the original signal. Fortunately, it is found that the directive selection and the delay compensation adjustments correct for one frequency are satisfactory for a considerable band of frequencies adjacent thereto. This permits receiving a number of grouped channels through one system.

PUT  
**POWER**  
BEHIND YOUR  
SIGNALS  
with these RCA  
Rectifiers!



Outstanding in performance, low in cost—these fine RCA Rectifiers put real pep and power behind your signals.

The RCA-866 illustrated and the 866-A are half-wave, mercury-vapor tubes extremely popular for many amateur uses. Look at the characteristics of these tubes and you'll see that they are real values at their current low prices.

### CHARACTERISTICS

	RCA-866	RCA-866A
Filament volt. (AC)	2.5 volts	2.5 volts
Filament current	5 amperes	5 amperes
Peak inverse voltage	7500 volts max.	10,000 volts max.
Peak plate current	1.0 amp. max.	1.0 ampere max.
Aver. plate current	0.25 amp.	0.25 ampere max.
Tube voltage drop (approx.)	15 volts	10 volts

PRICE

REDUCTION!

Here's good news! The price of the RCA-866A has been reduced from \$4 to \$2.50. Listen to the "Magic Key of RCA" every Sunday, 2 to 3 P. M., E. S. T., on the NBC Blue Network.

First in Metal . . . Foremost in Glass . . . Finest in Performance



Radio Tubes

RCA Manufacturing Co., Inc., Camden, N. J.  
A Service of the Radio Corporation of America



# H. G. CISIN'S FAMOUS KITS

## 1939 Senior Metal Tube SPACE EXPLORER

All-Wave All Electric Beam Power 5 Tube Communications Receiver



SEVEN NON-SKIP OVERLAPPING BANDS—8 1/4 to 2000 meters. Professional Band Spread. Beam Power. Communications Set.

POWERFUL, SENSITIVE, SELECTIVE—Ultra-Modern Features include: Beam Power Output; Built-in Full Toned Electro-Dynamic Speaker; Patent Pending A.C. D.C. Circuit; Low-loss Air Dielectric

Band Spread on all bands, Self-Contained Power Supply Precision Filtered to eliminate hum, Full Vision Dial, Antenna Control, Headphone Jack, Dual Regeneration Control, Beam Power tube furnishes over 2 watts undistorted power to dynamic speaker giving Full Loud Speaker Volume. Studio Tone Quality. Sturdy drilled metal chassis. Verified foreign reception reported by many owners. Gives professional results, but plans are so clear anyone, even a novice, can build this set successfully.

Uses 100% Metal Tubes rather than low-priced "g" type tubes in carefully engineered circuit as follows: one metal tube 6J7, one metal tube 6C5, one metal tube 25L6, one metal tube 25Z6, one metal tube K-55-A; as tuned screen grid pentode regenerative detector, powerful 1st audio amplifier, 2nd audio two-watt Beam Power Output, Half-wave rectifier and automatic ballast stage.

Complete Senior Space Explorer Kit of all chassis parts, Power Supply and clear, simplified wiring diagram (unwired, less tubes, coils and speaker) **\$5.95**

Five Matched Metal Tubes \$3.75; Four S.W. Coils 8 1/4 to 200 meters \$1; Two B'cast Coils 200 to 625 m. \$1; Long Wave Coil 550 to 2000 meters \$1; Full Toned Dynamic Speaker \$1.95; Attractive two-toned wood cabinet \$1.50; Wired and tested \$2.25 extra. Shipping weight 7 lbs. Send stamp for circular. 25% deposit on all C.O.D. orders.

**SPECIAL**—Senior Space Explorer, Complete Assembled, Wired, Factory Tested Chassis, with all coils \$2 1/2 to 625 meters set of matched metal tubes built-in dynamic speaker, ready to use **\$15.35**

## '39 JR. SPACE EXPLORER 4-TUBE RECEIVER



SEVEN BANDS—10 to 2000 meters. Junior Band Spread Professional Communications Set.

MODERN, SENSITIVE AND SELECTIVE Amplify Volume. Reception from as many as 39 foreign stations in a single evening reported and verified by many owners.

amplifier, half-wave rectifier and automatic ballast stage. Self-contained power supply operates on 105-120 volts, any frequency A.C. or D.C. interchangeably. Built-in Chromatic Speaker, phone jack, antenna control, full vision dial, band spread variable, dual regeneration control, sturdy drilled metal chassis. Clear explanatory diagram simplifies wiring for the beginner.

Uses one 6C6, one 76, one 2A7 (Twin-Tube) and one metal K-105-A; as tuned screen grid regenerative detector, powerful two-stage pentode audio

COMPLETE JUNIOR SPACE EXPLORER KIT of all chassis parts, Power Supply and Pin Diagram (unwired, less tubes, coils and speaker) **\$4.95**

Four Matched Tubes \$2.45, Four Short Wave Coils 10 to 200 m. \$1, Two B'cast Coils 200 to 600 meters \$1, Long Wave Coil 550 to 2000 meters \$1, Tru-Fidelity Chromatic Midget Speaker \$1.45, Tru-Fidelity Chromatic P.M. Dynamic Speaker \$1.95, Attractive Two-toned Wood Cabinet \$1.50. Wired and factory tested \$2 extra. Shipping weight 8 lbs. No circulars available on this model.

**SPECIAL**—Junior Space Explorer, Complete Assembled, Wired, Factory-tested Chassis, with all coils 10 to 2000 meters set of matched tubes, built-in Chromatic P.M. Dynamic Speaker, ready to use **\$13.95**

## H. G. CISIN'S All-Wave Air Scout Jr. THREE-TUBE All Electric All Wave Model 3AE Receiver



A powerful sensitive all-wave set. Holds wonderful records for foreign reception. Also brings in police calls, amateur, code, Transatlantic phone and broadcast entertainment. Excellent volume. Works from any A.C. or D.C. house current. Easiest set to build. Employs newest metal ballast tube as one of the tubes. Speaker mounts on attractive panel. Range 9 1/2 to 610 meters or to 1500 meters with special long wave coil. Complete Kit includes: Earphone, broadcast coil, 10 to 200 meter coil. Panel, Chassis, High Grade Variable Condenser, Potentiometer, Antenna Trimmer, Dial, Sockets, Knobs, Speaker, and all other required parts including instructions and diagram. **\$3.20** With Phone (Less tubes, unwired)

MODEL 3AE Pat. No. 2,086,256 Wire, Resistors, Condensers, and all other required parts including instructions and diagram. **\$3.20** With Phone (Less tubes, unwired)

Following Auxiliary Parts are available: 9 1/2 to 20 meter coil (foreign) 25c; 15 to 65 meter coil (foreign) 25c; 40 to 80 meter coil (foreign) 25c; 5" Find-all Loud Speaker \$1.25; Complete Antenna Kit 50c; Wood Screw Kit 10c; Tubes for Model 3AE each 30c; Earphone Unit and coil \$1; Double Earphones \$1.30; Handspread Attachment 75c; Air Scout Jr. model 3AE wired extra \$1.00. NOTE: If you already have earphones, two extra foreign coils may be substituted in model 3AE.

H. G. CISIN, CHIEF ENGINEER Allied Engineering Institute, Dept. S-55 98 Park Place, New York, N. Y.

# Improved McMurdo Silver Diversity Coupler

Irvin L. Glorum

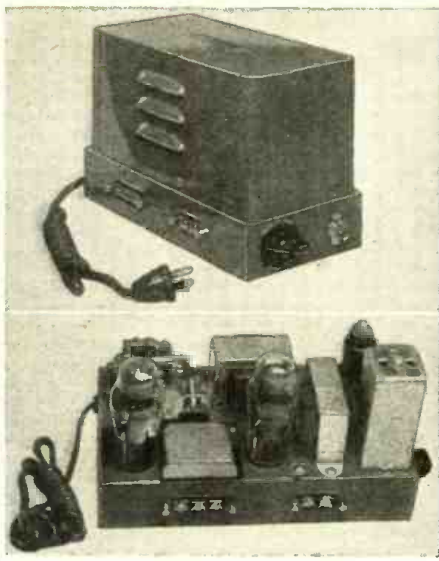

Two views of the improved diversity coupler and diagram below.

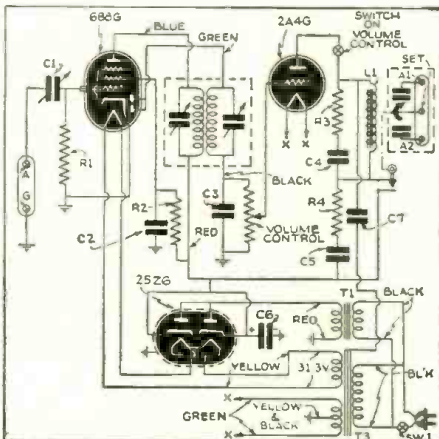

● A METHOD of dual diversity reception recently disclosed by McMurdo Silver retains the advantages of the multiple receiver diversity systems and eliminates the extra cost, noise and bulk due to shielding usually associated with this type of receiver. This new method may be reduced in practice to a simple unit which will operate with any receiver of the superheterodyne type having an I.F. of 450 to 480 kc., either with or without A.V.C. Such a unit need not be discarded with receiver changes, and insures the advantages of dual diversity reception with any receivers now in use, and any which may be designed in the future.

Working from the hypothesis that a fading signal does not always fade equally on two different antennae and that usually the signal can be found on one of two antennae in the same plane if they are a wavelength apart, or on one of two antennae when one is in a vertical plane and one in a horizontal plane, a method was developed of automatically switching from one to the other, this change following the signal phase shift or fading. In the initial experimental unit a single-pole, double-throw switch operated by the fading signal was used. This proved not wholly satisfactory inasmuch as the phase shift was not always exactly 180 degrees, but usually fractions of this amount, although the shift did usually complete a 360 degree cycle. However, this direct antennae switching system worked and indicated the soundness of the fundamental concept.

A means of antenna switching capable of combining in varying degree the voltages from the two antennae, as well as simply selecting either of them, was obtained by the use of a differential variable condenser having two stator sections and a common rotor. The rotor section was connected to the receiver antenna terminals, a horizontal antenna connected to one stator and a vertical antenna to the other stator section.

Further developments indicated that the same relay operated successfully in conjunction with a 2A4G tube used in the early direct switching system, together with suitable amplifier system. A

relay having a rotating shaft, which was connected by means of bakelite gears to the condenser shaft, the relay action being transmitted to the shafts by means of a ratchet, was selected as the simplest means of accomplishing the desired antenna selecting action. This ratchet having eight teeth, permitted simulation of the condition of five distinct antenna angles, the eight-tooth ratchet giving 45 degrees of rotation for each relay impulse.

Sometimes one antenna will have a better signal-to-noise ratio than the other, when the coupler will locate on the antenna having the best signal-to-noise ratio. This is because the noise impulses, being of short duration, do not create sufficient voltage at the grid of the coupler amplifier tube to control the 2A4G. The antenna selecting condenser will then continue to rotate until sufficient control voltage is obtained at the grid of the 2A4G from one antenna or the other to temporarily "lock" it.

As the rotation of the antenna selecting condenser is dependent upon the ratchet for positioning it can readily be understood that, as the signal fades, the relay being actuated by the 2A4G which in turn is controlled by its amplifier and signal voltage from the receiver, the condenser will rotate until it automatically finds a signal sufficiently strong to prevent the 2A4G from ionizing and operating the relay.

In receivers with no A.V.C. systems, a small amount of the I.F. signal voltage is taken from the receiver's I.F. amplifier at the plate of the last I.F. tube, through a small variable coupling condenser located in the diversity coupler, and impressed on the grid of a 6B8 pentode-duo-diode tube. An intermediate frequency transformer is used to couple the plate of this tube to its diodes. The amplified voltage developed across the diode load resistor is then used to control the 2A4G grid. The diversity coupler amplifier having a voltage gain of one hundred times the minimum voltage required to prevent the 2A4G from ionizing being nine volts, it is only necessary to supply the grid of the 6B8 tube with less than one tenth of a volt for control. If the voltage at the grid of the 2A4G tube drops below nine volts the tube ionizes, increasing its plate current suddenly sufficiently to actuate the relay.

In order to get smooth control of this grid voltage a potentiometer having a reverse "audio volume control" taper and a resistance of 1/2 megohm is used as the diode load resistor. This allows a very critical set-up adjustment so that extremely small decreases in signal level below a level determined by the setting of this potentiometer cause the coupler to function.

When used with receiver having six or more tuned circuits (2 I.F. stages) the 6B8 grid coupling capacity is adjusted to about ten mmf. while for receivers having less than six tuned circuits (1 I.F. stage) the capacity is set to approximately twenty mmf.

The I.F. transformer of the coupler unit is tuned to the I.F. of the receiver.

In operation it is merely necessary to tune the receiver to the desired signal and adjust the potentiometer of the coupler so that the unit begins to function when the signal starts to fade. The coupler should be so adjusted so that it operates only when the downward signal level fade is greater than can be taken care of by the A.V.C. system in the receiver.—Photos and diagram courtesy E. I. Guthman & Co.

### Parts for Diversity Coupler

- GUTHMAN**  
1—No. N89 Chassis; 1 No. M90 Chassis Cover; 1 No. M91 Chassis; Bottom Plate  
1—Antenna selecting Condenser, 876 Shield and R5 relay  
1—6 ft. Cord and Plug  
1—2-screw terminal strip, A-G  
1—No. 905 Pure Gum Grommet  
T1, 1—No. 5328 Transformer, plate  
T3, 1—No. 5427 Transformer, fil  
T1 (I.F. Trans.), 1—No. 3388—OUT I.F. Transformer  
C1, 1—No. C45 Trimmer Condenser  
MTG. 1, 2, 3, 4, 5—No. B145—2-lug mounting strips
- CORNELL-DUBILIER**  
C5, 1—1/2 mf. 200 volt condenser  
C2, 1—1/10 mf. 200 volt condenser  
C7, 1—1/10 mf. 400 volt condenser  
C8, 1—500 mmf. mica condenser
- I.R.C.**  
R3, R4, 2—BT 1/2 resistors, 150 ohm  
R1, 1—BT 1/2 resistors, 1 megohm  
R2, 1—BT 1/2 resistors, 100,000 ohm
- CROWE**  
1—No. 561 Sensitivity Plate  
**MALROY**  
C6, 1—No. BB42, 10 mfd. 300 volt condenser  
C4, 1—No. B135, 20 mmf. 250 volt condenser
- CENTRALAB**  
P1, 1—1/2 meg. Volume Control with switch and lock washer
- AMPHENOL**  
3—SR sockets with No. 6 ring  
7—UN800 grommets
- ARROW**  
SW1, 1—H. & H. Toggle Switch No. 20994 N.P. with ON-OFF plate
- KURZ-KASCH**  
1—8292-1L black knob, Hardware.



# NEWEST RADIO APPARATUS

## Toy Kits by RCA

- THE RCA Manufacturing Company is now producing two kits of toys, the first of which—a radio sound-effects laboratory for the youngsters



to play with—is pictured here. It will be sold not only through regular radio stores handling other items in the line, but also through mail order houses and toy shops. The sound effects include surf breaking on the beach, train collision, the NBC chime tones, siren whistle, rain effect, cow moo, etc. The entire outfit is affixed to a sturdy table with removable legs, so it can be set up for play in a few moments. The kit includes two complete program scripts which call for a wide range of different sound effects. There is also available an auxiliary microphone outfit to be used with the kit. The mike connects to the radio receiver by means of a simple oscillator packed with it.

The RCA electronic kit, not shown, contains complete parts and instructions for building a telegraph code practice set, a public address system, a capacity relay for automatic control of electrical mechanisms, and a small radio receiver. There are condensers, inductance coils, resistors, a radio tube, a microphone, an earphone, a relay, and soldering equipment. The instruction booklet explains the nature and function of each part and contains diagrams for wiring the devices.

## New Line of Volume & Tone Controls

- FILLING the requirements for 90% of replacements, a new line of volume and tone controls has been announced by Consolidated Wire & Associated Corps. The line includes resistances from 5,000 to 1,000,000 ohms in 5 types—without switch or intermediate tap; without switch, but with intermediate tap; with single-pole, single-throw switch, without intermediate tap; with



single-pole, single-throw switch and intermediate tap; and with double-pole, single-throw switch without intermediate tap. The unit illustrated is Model VTC—with S.P., S.T. switch, without intermediate tap.

## Handy Kits of Midget Dry Electrolytics

- HANDY kits containing six or twelve midget dry electrolytics have recently been introduced by the Sprague Products Company as a quick and highly economical solution to countless condenser replacement problems.



Because these "Atoms" are available in all capacities and voltages, including a complete line-up of dual combinations, a comparatively small stock of these condensers will equip the serviceman for almost any job. In addition to being exceedingly small dry electrolytics, Atoms are self-supporting and can be mounted in exactly the same manner as paper tubular condensers.

## Bud's New Devices

- ANNOUNCING a new 500 watt radio-frequency amplifier kit, Bud Radio, Inc., introduces many other interesting devices. Among these are an Auto Link Control which provides electrical control of the link circuit in five definite steps and eliminates the necessity of mechanically controlled link coils.

There is also a new line of Tiny-mite tuning condensers in sizes ranging from 6 to 140 mmf. maximum capacity. All models are adapted to single hole panel mount, insulated panel mount and insulated base mount, without need for extra fittings, and require but 1½" x 1¼" panel mounting space.

Also shown is a line of sloping panel cabinets which may be used for housing frequency meters, modulator indicators, field strength meters, etc. The entire front panel is removable.

Similar to these but without the removable panel are the sloping panel meter cases which are furnished with two ceramic feed-through insulators.

A removable-top chassis is also featured in the line, as is a transmitter rack dolly for moving heavy transmitters.

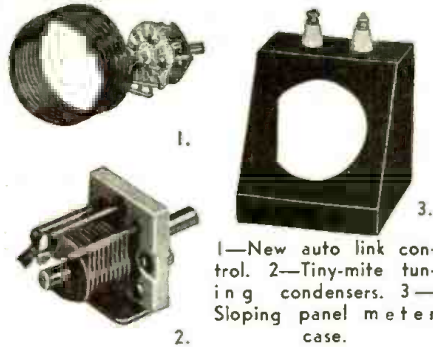

1—New auto link control. 2—Tiny-mite tuning condensers. 3—Sloping panel meter case.

## Amateur Speech Amplifier

- A FOUNDATION kit for the construction of a modern amateur speech amplifier with over-modulation control is designed to meet the specialized and exacting requirements of the amateur and commercial transmitter. An outstanding feature is the improved automatic over-modulation control circuit. Push-pull 2A3's are used with a

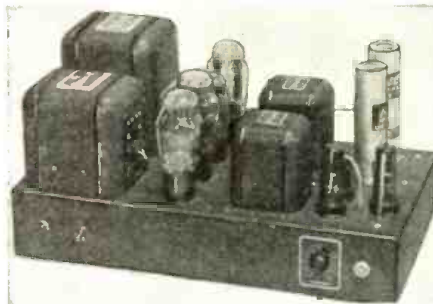

choice of either a 500 ohm output transformer for remote control operation or one of the new Multi-Match or Universal driver transformers for use where this new Thordarson amplifier is closely adjacent to the modulator. The output is sufficient for driving any class B stage up to 500 watts output.

## Band-Switch

- A NEW turret band-switch has been developed for amateur transmitter applications. It utilizes a five-gang three-position switch equipped with mounting bars to accommodate any three Coto "Pee-Wee" inductors. This permits the choice of any three bands without removing coils. Two or more band-switches may be coupled for unit control.

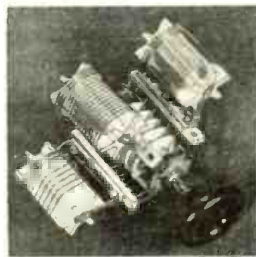

The inductors are wound on threaded Alsimag 196 forms and are available for all bands with end link, center link, and center tapped without link. Mounting bases may be had for regular plug-in operation where band-switching is not desired. The inductors and switch are rated at 50 watts capacity.

Names and addresses of manufacturers supplied upon request.



# MILLION VOLT RESISTORS...

Maybe you don't need million volt resistors . . . yet it is worth knowing that the same famous IRC Metallized resistance principle, best known in the little ½-, 1- and 2-watt Insulated Resistors for radio use, has now made possible outstanding advances in both high voltage and ultra high frequency resistors for advanced scientific research purposes.

10,000 ohms at ½ watt—100,000 volts at 150 watts—1,000 megohms at 150 volts . . . regardless of the need, the IRC Metallized element can supply them all, dependably and economically.

"Metallized" Resistors are made under IRC patents in eight countries. The Metallized type of element is the most adaptable yet produced. No other resistance material holds such an outstanding record of past success. None holds such broad possibilities for future development. Whatever your need—insist on the best!



"They Stay Put"



INSULATED

"Metallized"

RESISTORS

TYPE BT

INTERNATIONAL RESISTANCE CO

401 N. Broad St., Phila., Pa.



# YOU CAN'T GO WRONG ON A DEAL LIKE THIS!

## The 5 Famous EAGLE KITS

Every one a Winner



### The EAGLE R9 \$5.95

All-Wave Receiver Kit. Designed to operate on all amateur and foreign bands. Is very well adapted for those who

desire an efficient receiver which is compact and easy to construct. All chassis holes are punched and no drilling is necessary. By using the same power supply for both the receiver and the FB-25 transmitter it is possible to build a complete station at extremely low cost.

including set of 4 coils 15 to 225 meters

**ACCESSORIES**  
 10 meter or broadcast coil . . . . .50c  
 Set of 2 Tubes, 6F7, 6C5 . . . . . \$1.08  
 Extra audio stage (optional) . . . . . \$1.00  
 6F6 tube for audio stage . . . . .59c  
 Black cracked cabinet for R9 receiver with speaker grille . . . . .75c  
 5 inch loud speaker for above . . . . .95c  
 The R9 receiver wired, ready to operate . . . . . \$4.50  
 Wiring for extra audio stage . . . . .50c

### Economical 25-Watt TRANSMITTER



### The New EAGLE FB-25

An efficient, economical transmitter, using the 6L6 metal tube. The kit is furnished complete with essential parts, fully mounted on black cracked Bud chassis. No drilling necessary. See description Page 480 December R & T.

**\$6.95**

We furnish a ready-wound plug-in coil for your particular band. Your choice of 160-80-40 or 20 meters. Complete kit ready to wire.

**ACCESSORIES**  
 6L6 Power Tube—88c. High Grade Crystal and Holder—\$2.50. Ready-wound plug-in coils for extra bands—50c ea. Wiring (optional) \$2.00.  
 Power Supply Kit for FB-25, Eagle R9 or Minuteman \$3.95  
 5Z3 or 80 Tube for power supply . . . . .29c  
 Power Supply Wired (Optional) . . . . .75c

**FEATURES**  
 ● Versatility ● Economy  
 ● Quality parts ● 2 band operation with one Crystal  
 ● 25 watts of power ● Easily Cracked  
 ● Simple to Operate. ● An ideal transmitter or Exciter.

### EAGLE Minuteman

2 1/2-5-10 METERS  
 Amateur Band Receiver for Consistent reception on the loudspeaker.  
**MINUTEMAN KIT**  
 Complete with 3 Coils **\$4.75**  
 2 Tubes 6C5 & 42 **\$1.25**



**WIRING \$1.25**  
**CHARGE OPTIONAL**  
 Just the receiver for duplex work. The most sensitive and selective super regenerative receiver known. Uses metal and glass tubes. The 1st 2 1/2 to 10 meter receiver ever offered to the amateur at such ridiculously low price. No license necessary to operate it.

### The EAGLE Quadrodyne

All-Wave A.C.-D.C. Receiver Loudspeaker Volume on 2 Tubes

The Eagle Quadrodyne is an AC-DC all-wave receiver giving the equivalent operation of four tubes, and capable of working a magnetic or permanent dynamic speaker. The tubes used are a 6F7 and a 12AT. Both tubes are pentodes and of the dual operation type.



2 Guaranteed tubes 6F7 & 12AT . . . . . \$1.65  
 5 inch loud speaker . . . . .95c  
 Black cracked cabinet . . . . .50c  
 Wired \$2 extra.

### THE EAGLE WIRELESS PHONO CONTROL



Complete Phono Kit **\$2.95**

Will play your records or transmit your voice through your broadcast receiver from distances up to 500 ft., without wires or any attachments to your radio. No aerial required. Your transmission will be received clearly and with ample volume. No government license necessary. Satisfy your friends with this amazing invention.

Self powered A.C.-D.C. 2 Tubes—50c each  
 Wiring \$1.00 extra

MAIL ORDERS FILLED PROMPTLY.  
 \$1.00 Deposit. Check or Money Order. Balance C.O.D.  
**EAGLE RADIO CO.**  
 84 Cortlandt Street, Dept. W, New York City

### New Filter Unit

● ADDITIONS to the "Quietone" filter line have been announced by the Cornell-Dubilier Electric Corp. These new units have a wide range of application. The Type IF-8 All Wave Quietone Filter, replacing the old CD Type IF-1, can successfully be used between the radio receiver and power line, to prevent line noises from entering set. A metal case effectively shields unit which is equipped with binding post for ground connection. For use on 110 V. A.C. or D.C., 5 amp., maximum capacity.



New Line Noise Filter.

### New V T Voltmeter

● A NEW vacuum tube voltmeter has been announced by Million Radio & Television. It features a push-button range from 3 to 3,000 volts on A.C. or D.C., and as it has an input impedance of 24 megohms, it will not disturb the circuit under test. The instrument, which uses co-axial cable, is A.C. operated. It needs but one adjustment for all ranges, making it simple to use. The range of frequencies covered is from 30 cycles to 40 megacycles.



## NEWEST CATALOG

### Thordarson Catalog

Thordarson Complete Transformer Catalog No. 400-CX. Twenty-three pages, size 8 1/2" x 11".

The Spring and Summer edition of this manufacturer's new catalog includes several new transformers particularly adapted for use by the serviceman, public address engineer, amateur and experimenter. Extremely interesting is the section devoted to the instructions as to what type of transformer is best suited for use with specific tubes in various circuits.

### New RCA Tube Book

Characteristic Chart and Socket Connections of RCA Receiving Tubes. Sixteen pages, size 8 1/2" x 5 1/2". More than 200 types of receiving tubes are covered in this new booklet, which is an absolute necessity for every one who is interested in radio. While not as complete as RCA receiving tube manual No. RC-13, which contains 192 pages, this 16-page booklet does give the fundamental information, such as type number, designation, dimensions, socket connections, cathode type and rating, use, plate voltage, plate bias, screen voltage, screen current, plate current, A-C plate resistance, transconductance, amplification factor, load for stated power output and power output in watts.

### Wholesale Radio Service Co., Catalog No. 76

The first 152 pages of this new catalog are devoted to radio equipment, while cameras and

photographic supplies fill the pages from 157 to 184, those lying between being devoted to an index, instructions, etc.

Among the new items offered is a battery-powered portable Lafayette receiver in a variety of price ranges. Also in the line is a 5-tube "three-in-one" superhet., which will operate on 6 volt battery or on 110 volts. A.C. or D.C.

Prices of sets shown in the catalog range from \$2.75 for a one-tube battery-operated model to \$199.50 for the 16-tube radio-phonograph.

As always, the catalog contains a wide variety of P.A. equipment, record players, microphones, set components, test instruments, communications receivers produced by various leading manufacturers, build-your-own kits, tools, and everything else that the SWL, Ham or Experimenter might desire. The new catalog is bigger and better than ever before.

### Hammarlund Catalog

The Hammarlund Manufacturing Company, Inc., has published a 20-page 1939 second edition catalog, containing many items which have been added recently to the line. Foremost among these are variable condensers of improved design, transmitting foundation units, and many other new and interesting short wave components for both transmitting and receiving. Complete technical details, mechanical as well as electrical, are given for the various parts. There are over 75 illustrations.

More "Newly Licensed Hams"—names and address in Next Issue.

## Electronic Television Course

(Continued from page 21)

flection type tubes the current through the deflection yoke must be of this shape in order to deflect the beam of electrons both in the vertical and horizontal directions.

scanning frequencies (13,200 cycles horizontal line frequency and 60 cycles vertical frame frequency).

### How Synchronism Is Maintained

In the previous chapter of this course, it was stated that the synchronizing pulses transmitted at the end of each line and frame represented the highest modulation percentage capabilities of the television transmitter. These synchronizing impulses (see Fig. 1-C) are used to "trigger off" the saw-tooth oscillators at the proper time and consequently keep the picture synchronized with that of the transmitter. At the receiver, these impulses are first separated from the picture signals, and finally the line frequency impulses (13,200 cycles) are separated from the frame frequency impulses (60 cycles) and "fed" or injected into the grid circuit of the low frequency and high frequency saw-tooth oscillators. These oscillators are adjusted slightly lower in frequency and the synchronizing impulses trigger them at their respective

### D.C. Background Level

In addition to the picture and synchronizing signals, as described in the preceding paragraphs, there is another component transmitted of which no mention has been made as yet. This is the D.C. or background pedestal level. (See Fig. 1-C.) This pedestal establishes the relative intensity of the received picture. Where direct coupling is employed from the second detector to the grid of the cathode ray tube, this D.C. component would automatically regulate the pedestal or background level. However, in some circuits, direct coupling between the grid of the cathode ray tube and the detector would be impractical and, therefore, the pedestal or background level must be established by a manual control unless some means is found to couple the grid of the cathode ray tube to the detector by a direct current path. This we will take up in detail in a subsequent chapter on receiving circuits.



# De Luxe Beam Power Xmitter

(Continued from page 31)

ments and only rarely even then, but is good insurance.

The shield for the 813 is cut down from a larger size, as it need be only 2" high. The stubby construction of the 813 certainly permits short leads and compact design, one of the reasons, no doubt, for its fine operation on 10 meters.

The keying relay is mounted just in front of the filter choke and next to the filter condensers. It is fastened to a piece of 1/2" thick sponge rubber to afford quiet operation.

### Meters Have Panels of Their Own

The meters are all mounted on separate panels and the connections to the R.F. chassis are made by means of plugs and sockets. The latter are fastened to the panel side brace under the final tank condenser. An eleven prong socket is used for the upper meter panel and a six prong for the lower, with two leads in each case carrying 6.3 V. for the meter lamps.

The variable link unit is removed from the mounting plate supplied with it, and fastened on aluminum brackets to the final plate tuning condenser.

Although the final amplifier coils are used as they come, the exciter coils L1 and L2 must have a few turns removed from each to hit the required hands. About 20 per cent of the turns are removed, and it is best to do this a few at a time until the tuning condenser reaches resonance about 1/3 of full capacity. The turns on L2 must be removed evenly from each end so that the center tap will not be upset.

Preliminary tune up follows the usual procedure. The 813 should not be placed in its socket until the exciter section is working properly. This may be checked by temporarily connecting a 25 watt lamp in series with a 50 mmf. variable condenser from grid of the 813 socket to ground. Next insert the 813 and leave off plate and screen

voltage. If between 10 and 15 ma. grid current can be obtained on all bands, the exciter may be considered satisfactory.

The antenna coupling unit follows standard practice, and by use of clips on L4 practically any circuit or band may be used. The antenna relay is on this section for convenience. The relay is not shown in the schematic, as connections to its coil come from the control circuit to be described next month.

### List of Parts

#### THORDARSON

- 1—Power Transformer No. T92R21 (T1)
- 1—Choke No. T64C09 (CH1)
- 1—Choke No. T43C92 (CH2)
- 1—Filament Transformer, 10 V. at 5 A. No. T64F14 (T2)

#### BLILEY

- 2—40 M. variable crystals, Type VF1

#### R.C.A.

- 1—6V6. V1
- 1—807. V2
- 1—813. V3
- 1—5Z3. V4
- 1—No. UT 104 socket

#### TRIPLETT

- 1—1.5 A.R.F. meter, Model 347A
- 1—25 ma. meter, Model 327A
- 2—50 ma. meter, Model 327A
- 1—100 ma. meter, Model 327A
- 1—300 ma. meter, Model 327A
- 1—15V A.C. meter, Model 337A
- All with rear illumination

#### PAR-METAL

- 1—No. 15212 chassis 17 x 13 x 2"
- 1—No. SB713 brackets (pair)
- 1—MG33 panel 19 x 5 1/4"
- 1—MG53 panel 19 x 5 1/4"
- 1—G3603 panel 19 x 7"
- 1—G3605 panel 19 x 10 1/4"

#### NATIONAL

- 1—TMC 100 D split stator condenser
- 2—TMS 100 condensers (driver)

(Continued on following page)

# BUILD YOUR OWN FACSIMILE RADIO PRINTER

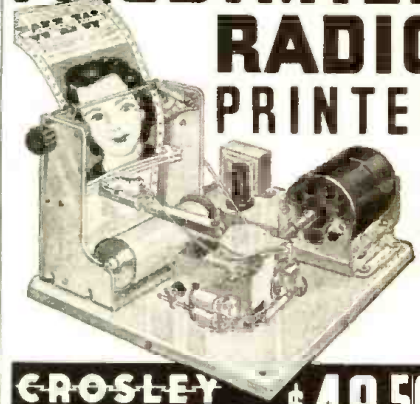

**CROSLY READO KIT \$49.50**

GET IN ON THE GROUND FLOOR WITH RADIO'S MOST PROMISING DEVELOPMENT

Already daily broadcasting experiments from leading radio stations offer fascinating study and fun. This new art holds promise of a great future, and another chance to grow up in a field as prolific of personal profit and satisfaction as radio was 20 years ago. Time is not far distant when radio facsimile printers may constantly deliver into American homes an exciting stream of pictures of events as they happen together with visual reports, vital information and news. Already the progress provides much of interest and for study in the early morning broadcasts of news and pictures with many stations operating on ultra high frequency during daylight hours.

BUILD AND ATTACH TO YOUR OWN RECEIVER

The Crosley "Reado" radio printer is a development of the Finch method and is being used in many spots throughout the country today. When you have built the printer it is easily attached to your own radio receiver. We provide all the necessary parts carefully precision machined ready to build, packed in a special kit. Most Crosley dealers will display them. If none are convenient to you, write us.

## THE CROSLY CORPORATION

READO DEPARTMENT POWEL CROSLY, Jr., Pres.  
106 ARLINGTON STREET CINCINNATI, OHIO

Please send me literature about the Crosley READO, all facsimile broadcasting activities and list of stations now doing experimental broadcasting. Also, the name of my nearest Crosley dealer to carry the Reado Kit.



NAME.....

ADDRESS.....

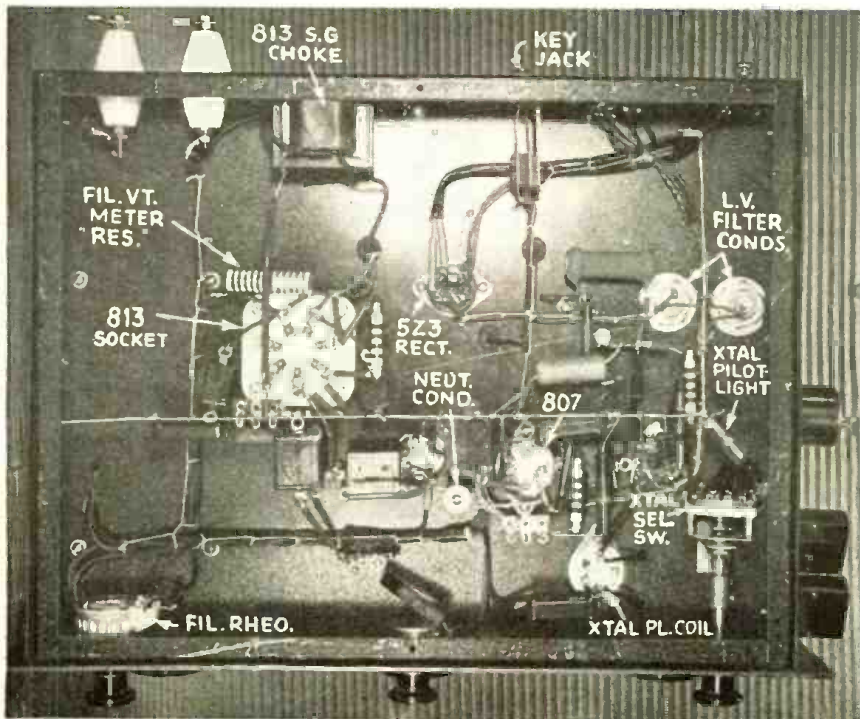

Bottom View of Transmitter.

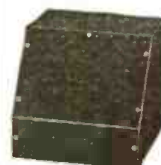

## SLOPING PANEL CABINETS

Here's a NEW housing for receiver, monitor, testing meter, etc., that is both attractive and convenient.

Controls on sloping panel easily viewed from any position. Entire front panel removable. Sizes: 7" deep, 6 1/2" high, and 7", 9" and 11" wide. Very reasonable prices. Your BUD jobber has them. For new folder RT59 write—

## BUD RADIO, INC.

5205 Cedar Ave. Cleveland, O.



# THIS IS THE WIND-UP!

Out of 1000 Coil Winding Machines Recently Purchased from The Atwater Kent Mfg. Co. we offer the following, subject to prior sale.



**38 Power Transformer Coil Winding Machines Paper Layer Type.** Paper is Automatically Fed in to Coil at end of each Layer of Wire with Signal Lights attachments for START, TAP, STOP. Also Automatic Winding Spindle Holder. Machine will wind wire from 18 to 40 gauge. Size of wire controlled by change of 3 outside gears. Winding traverse controlled by Cam action. Will wind package of coils up to 12" long x 3" dia. Cork Friction Clutch. Belt Drive. Size of machine 31" long x 14" wide x 8" high. **\$75.00**  
Weight 100 pounds. Price each  
12 machines are 35" long. Will wind package of coils up to 13 1/2" length.

**65 Power Transformer Winding Machines Winding Construction and frame same as Cut and description above, complete with Automatic Paper Feed.** **\$25.00**  
Size and weight same as above. Price each. Less Signal Lights and Automatic Winding Spindle Holder.

**12 Audio and Choke Winding Machines. Paper Layer Type.** Complete with Automatic Paper Feed. Machine same as cut and description in item No. 38, only smaller in construction. Size 22" long x 14" wide x 6" high. Weight 60 pounds. Less Signal Lights and Automatic Spindle Holder. Cork Friction Clutch Belt Drive. Price each **\$20.00**  
Will wind package of coils 5 1/2" long x 2" Dia.

**21 Small Paper Layer Winding Machines same as described in item No. 3.** Will wind package of coils up to 3 1/2" long x 1 1/2" Dia. Size of machine 14" long x 9" wide x 5 1/2" high. Weight **\$15.00**  
30 pounds. \*Price each  
\*Note we can furnish Gears, Cams, winding spindles, and spare parts for all of the above machines. Price of Gears and Cams each. . . . .50c



**95 IF & RF Coil Winding Machines** Arranged for straight winding, the wire feed guide is controlled by lead screw for number of turns per inch, equipped with Automatic Stop, and Turn Counter. Size 10" long x 7" wide x 6" high. Weight 30 **\$11.50**  
pounds. Cork Friction Clutch Belt drive. Price ea.

**61 Resistor Coil Winding Machines** arranged for straight winding and winding traverse controlled by Lead Screw for number of turns per inch. We furnish 3 additional Lead Screws free with assorted Thread Size with each machine. Size 15" long by 8" wide x 6" high. Weight 25 lbs. Cork **\$10.50**  
Friction Clutch Belt Drive. Price each

**83 Field Coil Winding Machines.** Will wind coil up to 3 1/2" Dia. x 2 1/2" wide equipped with Automatic Stop. Size 16" long x 10" wide x 6" high. weight 30 **\$7.50**  
lbs. Price each



**55 Filament Coil Winding Machines** for winding on Power Transformer Coils, has winding Spindle 7" long x 1/2" Dia. Turn Counter attached. Cork friction clutch, belt drive. Weight 26 lbs. **\$9.50**  
Price each

**20 Hand Coil Winding Machine 1 1/2" Dia.** Spindle x 3" long. can be changed to any length required. Turn Counter Attached. Weight 13 pounds. **\$6.50**  
Price each



**11 Logan Hydraulic Air Presses** used by Atwater Kent Mfg. Co. to form Paper Speaker Cones, also applying Silk on Card Board and Wood for Radio Grills. We furnish the Aluminum Form for making the Speaker Cones on each Press. Machine is equipped with Automatic Lock and releasing attachment. Hand Control, and Electric heating elements, on each Press. Size 25" x 16" at base, 45" h. w. h. Weight 450 lbs. Price each **\$95.00**

All machines are overhauled and are in excellent working condition. All machines have been in current use at the Atwater Kent Mfg. Plant until the factory was closed down. We guarantee every machine for 30 days. Money refunded if not satisfactory. Terms 1/3 cash with order balance 5D/6L.

**M. M. LEVINE**

84 Warren St. Tel. Worth 2-8655 New York City

Rear view of Antenna Tuning Panel.

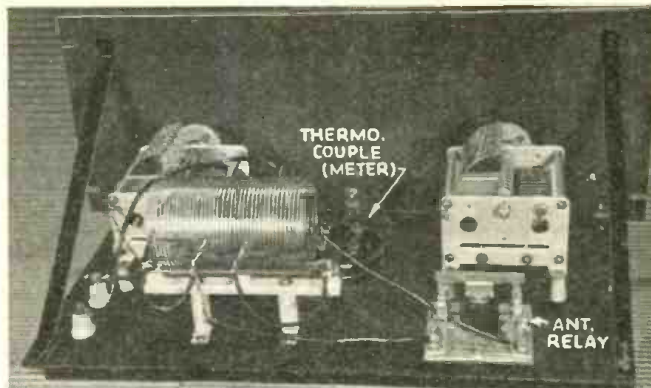

## NATIONAL (Cont'd.)

- 2—TMC 150 condensers. (antenna)
- 4—CHS crystal holders
- 4—R-100 chokes
- 1—R-154 choke
- 2—TX13 flexible couplings
- 2—XS-1 feed through insulators
- 4—GS-5 insulators
- 14—GS-10 insulators
- 2—TX-9 couplings
- 1—TX-1 coupling
- 6—SB panel bushings
- 1—J-30 shield
- 1—B-30 shield

## I. R. C.

- 1—20,000 ohm BT2
- 1—100,000 ohm BT2
- 1—50,000 ohm BT2
- 1—1,000 ohm BT1
- 1—750 ohm Type DG
- 1—500 ohm Type DG
- 1—15,000 ohm Type DG
- 1—50,000 ohm Type HOA (3 bands)
- 1—2 meg. variable No. 11-129
- 1—Rheostat 35 ohm No. PR25

## CORNELL DUBILIER

- 1—250 mmf. midget mica
- 1—1 mf. 400 V. paper
- 6—.01 600 V. mica
- 1—200 mmf. 2500 V. mica
- 1—.001 mf. 2500 V. mica
- 1—.001 mf. 1000 V. mica
- 3—.01 mf. 1000 V. mica
- 1—.002 mf. 7000 V. mica
- 2—4 mf. 600 V. paper

## AMPHENOL

- 1—Super MIP octal socket
- 9—5 prong steatite sockets

- 1—MIP4 socket 4 prong
- 1—MIP6 socket 6 prong
- 1—MIP8 socket 8 prong
- 1—MIP11 socket 11 prong
- 1—Plug 6 prong
- 1—Plug 8 prong
- 1—Plug 11 prong

## BARKER AND WILLIAMSON

- 1—80 TVL coil. L3
- 1—40 TVL coil. L3
- 1—20 TVL coil. L3
- 1—10 TVL coil. L3
- 1—TV base
- 1—TA antenna coil (6 clips), L4
- 1—80 M coil. L1
- 1—40 M coil. L1
- 1—80 MC coil. L2
- 1—40 MC coil. L2
- 1—20 MC coil. L2
- 1—10 MC coil. L2

## GORDON

- 3—No. 301 dials
- 2—No. 300 dials
- 5—No. 314 knobs
- 12—1/2" grommets
- 18—Name plates (standard size)
- 2—No. 262 dial plates

## CENTRALAB

- 1—6 point isolantite switch

## WARD LEONARD

- 1—Keying relay No. 507-507
- 1—Antenna relay No. 507-531

## MISCELLANEOUS

- 1—60 ma. pilot lamp and socket
- Aluminum for shields
- 2—Brass gears 1 1/2" diameter

# I Cover the Pacific Coast!

LYLE M. NELSON

Reports of reception will be greatly appreciated. Address them to the author in care of **RADIO & TELEVISION, 99 Hudson St., New York, N. Y.**

● AS the long days of summer begin to approach, reception on the 49 meter band during the late evenings is gradually fading out and listeners on the Pacific Coast are turning to early morning 31 meter stations in the Far East and to daytime European broadcasters.

Surprising reception from China's XGOY on 9.50 mc. has been reported during the past few weeks. XGOY is now reaching here with tremendous volume from 4 to 4:30 and 6 to 7:50 a.m. daily. It can easily be picked up just on the low frequency side of Tokyo's JZI, which is on the air at the same time. XGOY is also well received on 15.19 mc. from 6:30 to 8:30 p.m.

As this column is being written, the new Irish short wave station is testing on 17.84 mc. As yet all broadcasts are irregular, but the station can usually be picked up in the afternoons with fair volume. Mr. Kendall Walker of Yamhill, Oregon, reports that this station is heard during the afternoons on 6.19, 9.595, 11.74, 15.12 and 17.74 mcs. announcing as "Radio Eireann." The station is located near Athlone.

A new station announcing as "Radio Noumea" in Noumea, New Caledonia, has been reported on 6.12 mc. from 11:30 to 1 a.m. Tuesdays to Fridays. The call letters are given as FK8AA.

As predicted in this column last month the new Soviet stations on 6.00, 6.03 and 9.52 mcs. were not RV15 as many have believed. Recent word received from Moscow authorities by T. S. Hite of Los Angeles brings the information that these stations are RV96 (6.03 and 9.25) and RV59

(6.00). According to this report all three stations are now broadcasting an English program from 7 to 8 a.m. daily.

Hawaii's popular transmitters continue to reach here with the volume of local stations. KHE on 17.8 mc. and KQH on 14.9 mc. are on the air from 5:30 to 6:30 p.m. Saturdays and Sundays.

Reception of the North American hour from Italy has greatly improved and the Rome stations are now coming through with excellent strength on 9.64, 9.83 and 11.81 mcs. from 4:30 to 6 p.m. Best reception is usually from the 9.83 mc. station, but occasionally 2RO4 on 11.81 mc. is the loudest.

Amateur station PK6XX in Hollandia, New Guinea, has been reported by several listeners. This station can be heard on the 20 meter amateur band (approximately 14.02 mc.) during the early morning hours.

The new Oslo station on 9.60 mc. is well received here during test transmissions from 8 to 9 p.m. daily. Mr. G. Goehring, Jr., of Fresno, states that the station may also be heard on 11.72 mc. in the early a.m. and on 15.19 mc. during the afternoon until sign off at 4:10 p.m.

Round 'n' About—from listeners' reports—TPA, new station in Turkey, heard on 9.46 mc. from 7 to 9 a.m. Station is very weak. . . . Address of New Zealand station on 6.95 is Station ZL2ZB. Hope Gibbons Building, Dixon Street, Wellington, C1. . . . JDY on 9.92 mc. in Dairen, is heard giving Japanese side of news daily at 4:50 a.m.

. . . . W6XBE, new Golden Gate exposition station on 15.33 mc., is testing from 4 to 8 p.m. irregularly. . . . ZRD of Durban on 9.72 is heard between 7 and 8 a.m. . . . YL2CB of Latvia is sending weak signal through on 28.81 mc. from 6:30 to 7:15. . . . ZRK is very well received on 9.61 mc. from 8:45 to 9:45 p.m. and 6 to 7:30 a.m.



## New Cathode-Ray Tube

(Continued from page 9)

This sounds simple, but there still remain two problems to be explained. First, how does a screen operate with as many "doors" as one required to produce a television image full of detail? Second, how are these doors to be open or closed?

If we keep in mind that an unbelievably large number of doors is required to produce a really good television image, it may seem that the new system is "not so hot," and that it belongs in that class generally termed as "theoretical dreams." This is not the case, according to German technical magazines.

### How Translucence Is Changed

There is an interesting physical phenomenon which is obtainable with certain crystals and liquids. They act like variable doors as far as the passage of light is concerned. The variation of their translucence varies with the voltage which is applied to them in a suitable manner.

This possibility of varying translucence by means of an electric current is known as the *Kerr effect*. It is obtained by placing a crystal between the plates of a condenser, into the terminals of which a high voltage is fed. There are a number of variations of design. Liquids may be used instead of crystals, and coils instead of the condenser plates, and so on.

Although this system may seem brand new, the fundamental principle is already used in certain television systems, and also in some facsimile transmission devices. But all present systems operates with one single "electric door" only. That is the reason for certain limitations of contemporary television systems of this design.

### New Crystal Screen Used

Von Ardenne applies the Kerr effect in a completely different manner. How he does it is explained in detail in the schematic diagram. Instead of the customary fluorescent screen (a fundamental part of every present cathode-ray tube), he uses a cathode-ray tube equipped with a screen consisting of many tiny crystals. After all that has been said above, it is not necessary to stress that each of these crystals acts as an "electric door"—or, to say it more precisely, as a *light valve*.

The cathode-ray beam, playing over the screen consisting of many tiny crystals, varies the translucence of the crystals, an application of the Kerr effect already described. Thus the light of the lamp (shown to the left of the crystal screen) may pass either uninterrupted or partly reduced, or is perhaps blocked out entirely.

### Large Image Obtainable

In short, the crystal screen takes the place of a lantern slide, or rather that of a movie film. By placing a projection lens in front of the crystal screen, the images obtained may be reproduced in large size on a wall.

But that is not the only advantage of this system of television reception. In fluorescent screen receivers, the dots of light which constitute the television image fade away shortly after the beam has generated the dot of fluorescent light, thus causing, among other phenomena, the flicker effect. The new crystal screen of von Ardenne's operates practically without flicker, because of a so-called storage effect, the German publications state. The openings of the tiny crystal doors do not change until the beam returns for a second adjustment.

## The New 1939 RACO PORTABLE CLIPPER

Ideal for use in automobile, boat, beach, farm, picnics, etc.

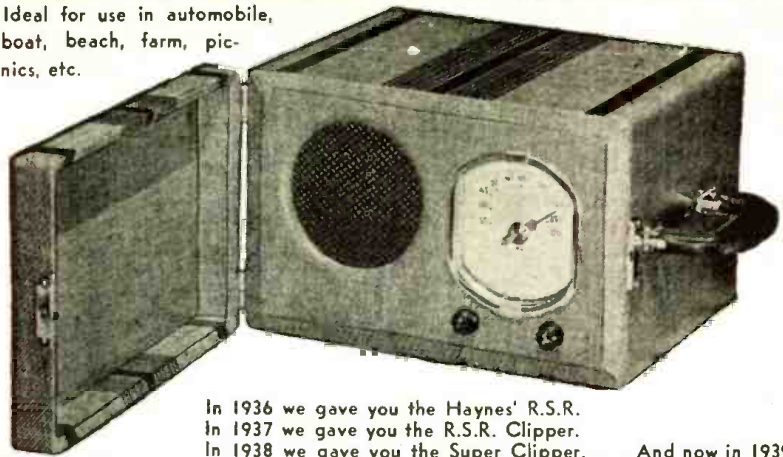

In 1936 we gave you the Haynes' R.S.R.  
In 1937 we gave you the R.S.R. Clipper.  
In 1938 we gave you the Super Clipper.

And now in 1939, we proudly present this new sensational super value, the 1939 RACO PORTABLE CLIPPER

An efficient battery operated Superheterodyne housed in a beautiful striped airplane fabricoid case and engineered in the world famous RACO Laboratories. Remember this isn't just another portable radio, but represents all the resources and knowledge of radio technique acquired over an extended period of years by a company that has always catered to the radio experimenter who demands better than the average radio performance. Our policy of selling direct to the consumer is responsible for the unbelievably low price and our determination to always maintain our reputation for producing only custom built equipment assures high quality performance.

- R.C.A. Licensed
- Noise Suppression
- Vernier Drive-Dial
- No Aerial Necessary
- Automatic Volume Control
- Weight, including batteries, 15½ lbs.
- Four high-efficiency, multi-purpose tubes equivalent to a seven-tube set.
- Full Over-size Dynamic Speaker.
- Six Tuned Circuits for Sensitivity and Fidelity.

Please note the Clipper Portable features a hinged cover which affords complete protection when receiver is not in actual use. This feature will be found only in these portable radios selling for \$50 or more.

THE NEW 1939 RACO PORTABLE CLIPPER, complete with tubes and batteries, ready to play ANYWHERE—Only

**\$16.45**

**RADIO CONSTRUCTORS LABS • 136 Liberty St., NEW YORK, N.Y.**



## The 1 and ONLY

### SHORT WAVE COIL DATA BOOK

Every experimenter knows that the difference between a good and a poor radio set is usually found in the construction of short-wave coils. Coil winding information is vitally important and in this new coil book all "dope" appears. There're illustrations which give instructions on how to wind coils, dimensions, sizes of wire, curves and how to plot them. Every experimenter needs this book—it also contains complete data on all types of receiving coils, together with many suitable circuits using these coils. Also complete data on various types of transmitting coils with many transmitting circuits such as exciters and amplifiers using the various coils described.

#### Contents Briefly Outlined

- S-W Tuning Inductance Charts • Coil Data for T. R. F. Receivers • One Tube Oscillodyne • Two Tube Bandspreeder • The Mono-Coil • 2-Tube Old Reliable • 2-Tube Globe Triter • 2 Winding Coils—10-500 Meters • Doerle 3-Tube "Signal Gripper" • Electrified • 3-Tube Bandspreeder for the Ham • General Coverage Coils on Ribbed Forms • Coil Data for Superhet or S-W Converter • Ultra S-W Coils • Switch Coils for S-W Superhets • Experimental Coils • S-W Antenna Tuner • Most Popular S-W Tuning Circuits • Self-Supporting Transmitting Circuits Employing Coils Described • All Band Antenna Tuner for Transmitting • Plug-in Coils for Exciters • Frequency-Wavelength Conversion Chart.

**PRICE 25c PREPAID**

For a copy of this handy book, send 25c in U.S. Coin or stamps to

**RADIO PUBLICATIONS**  
97 HUDSON STREET NEW YORK, N. Y.

## ASSURED STABILITY

WITH

### BLILEY CRYSTAL UNITS

10-20-40-80-160  
Meter Bands



**TYPE B5**—This outstanding crystal unit sets new standards for high-frequency low-drift crystals. Price 40 meters, \$4.80; 20 meters, \$7.50.

**TYPE LD2**—A precision low-drift crystal unit that is reliable, efficient and powerful. Price, 80 or 160 meters, \$4.80.

**TYPE HF2**—Simplifies the construction of 5-10- and 20-meter transmitters. Price, 10 or 20 meters, \$5.75.

**TYPE BC3**—A moderately priced mounted crystal with unusual activity and power output. Price 40, 80 or 160 meters, \$3.35.

**BLILEY ELECTRIC CO. • ERIE, PA.**

## BRUSH HIGH LEVELER SERIES MICROPHONES



Range in price from \$22.50 to \$32.50

NEW BRUSH HEADPHONES

Write for your Brush catalog today.

### THE BRUSH DEVELOPMENT CO.

3326 PERKINS AVE. CLEVELAND, OHIO



# I assure You

that a fair and square deal, every time, is the only way to keep up a successful business. That must be right, because since 1925 more and more men have been buying their radio equipment from me.

You, too, will find it to your advantage to deal with me whenever you want to buy a new receiver, transmitter, or any other equipment.

My personal attention to your wishes, fair trade-in allowances, reasonable terms for your convenience, prompt safe delivery, and above all—a sincere desire to give you full co-operation—is your assurance of complete and lasting satisfaction.

Be sure to write to me.

73

**Bill Harrison, W2AVA**

## TIME PAYMENTS?

Check these easy terms—

Receiver	Cash Price	Down Payment	Monthly Payments 8 OR 12
NC-101-X			
HC-120-X	\$129.00	\$19.96	\$14.21 \$9.66
NC-100A	120.00	18.48	13.22 9.00
S-16, Breting 49, NC-81-X, NC-80-X	99.00	15.34	10.90 7.41
New SX-23, speaker	127.50	19.40	14.08 9.58
SX-16, speaker	123.00	19.60	13.47 9.16
SX-17, speaker	149.50	22.60	16.53 11.25
RME-69	152.85	24.10	16.78 11.41
RME-70	138.60	21.10	15.31 10.41

I can change these terms to suit your convenience.

Also terms on all Hallicrafters, Hammarlund, National, RME, Howard, Sargem, Bretings, Patterson, Temco, RCA, Thordarson, Utah, etc., Receivers, Transmitters and Kits.

### OUR USED DEPT

has many good reconditioned and guaranteed trade-in Receivers and Transmitters at attractive prices. Good values! Send stamp for list.

**HARRISON RADIO CO.**  
12 West Broadway, New York City

## PAR-METAL RACKS—PANELS—ACCESSORIES

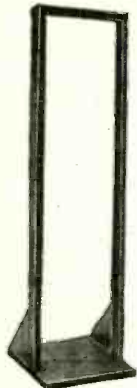

PAR-METAL offers you a uniform line of standardized metal products that enables you to quickly build up an amateur transmitter that is professional both in construction and appearance.

THE RACKS, cabinets, panels, etc., are the result of many years' experience in making similar equipment for the sound industry. All of these products have been designed and made by a modern plant that has fabricated about everything from a chassis to the metal work on a broadcast station.

All of the parts are available in various standard sizes—a complete line that will meet almost every requirement.

WRITE FOR COPY OF FREE CATALOG NUMBER 39T  
**PAR-METAL PRODUCTS CORP.**  
35-27 41st ST., LONG ISLAND CITY, N. Y.

## Whatever YOU WANT In A HEADSET



Scientifically Built Heavy bar magnets greatly increase their efficiency.

You'll find in a Cannon-Ball Guaranteed Headset: Sensitivity. Clarity of tone. Dependable performance. Quality at fair prices. Folder T-6 illustrates complete line. Write Headset Headquarters.

**C. F. CANNON COMPANY**  
SPRINGWATER, N. Y.

## What About That Television Antenna?

(Continued from page 17)

effect to be of less importance than multiple path transmission. He recommends, therefore, that the television experimenter move the aerial closer to, as well as farther from, the building wall in order to ascertain the exact point where the best signal is to be obtained. The best signal, in this case, may not be the strongest, but it will be the one which is sufficiently strong, and the one which is free of multiple image effects from adjacent steel structures. It must also be free of the veritable "hash" of signals received in various portions of the building occupied by the receiver and transmitted along the framework to the immediate vicinity of the receiving antenna. This composite may cause the very slightly displaced multiple images that result in blurred reproduction. This problem is distinct from that resulting in direct reflection of the signal from the portion of the steel framework of the building immediately behind the receiving antenna.

Fig. 4 shows another point brought out by Mr. Hanson—the use of a single receiving aerial for television on an apartment house or hotel. The various apartments throughout the building will be able to receive television signals through a central amplifying and distributing system, as shown in the diagram. An alternative method for hotels would be for an expert operator to tune in a television signal on a good set, and then distribute the amplified video signal over co-axial lines to the various rooms.

Fig. 5 shows a simple television receiving aerial, and it is best to erect this on a wooden pole if possible. The arrow shows the direction of maximum reception, the doublet in each case being placed broadside to the transmitting station.

In Fig. 6, a television receiving doublet with a reflector is shown, the space between the legs of the doublet and the reflector being one-quarter wavelength.

A more elaborate receiving antenna is shown in Fig. 7, and here the aerial is provided with a director as well as a reflector. The arrow indicates the direction of the transmitting station.

By means of the so-called turnstile antenna, 360 degree coverage may be obtained and Fig. 8 shows how the two doublets are arranged in this case.

Fig. 9 shows how the ultra short television waves may be reflected back and forth many times between tall buildings, before they finally reach the receiving aerials of some of the television receivers. In one case, cited by Mr. Hanson, television reception was successful where the space between the transmitting and receiving aerials was not entirely clear, but was obstructed by a building, as shown in Fig. 10. In such a case, the received waves undoubtedly reflected from some other building or object off the line of direct transmission.

Fig. 11 shows how waves may be changed in their polarization plane so that the receiving aerial may have to be tilted at some angle, different than that of the transmitting antenna, in order to ensure maximum signal strength.

In one case, mentioned in an English report several years ago, a change in the polarization as great as 90 degrees was noted; i.e., where the transmitting double was vertical, the horizontal doublet had to be placed horizontal for maximum received signal strength.

## Westinghouse Power Generator

Manufactured for U. S. Signal Corps  
200 Watt. 110 V. AC

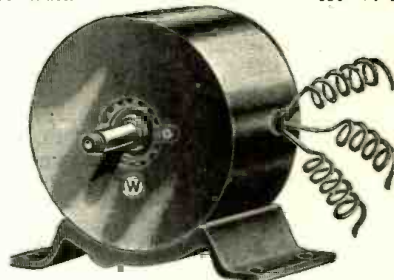

### A. C. ELECTRICAL POWER

from a Windmill, from available Waterpower, from your Automobile, from your Motorcycle, from your Bicycle, Foot-pedals or Handcrank (for transportable Radio Transmitters, Strong Floodlights, Advertising Signs); do you want to operate AC Radio sets from 32 V. DC farm light systems; operate two generators in series to get 200 V. AC; obtain two phase and three phase AC, etc., etc.

There Are Over 25 Applications  
Some of which are:

A.C. Dynamo lighting from eight to ten 20 Watt 110 Volt lamps. Short Wave Transmitter supplying 110 Volts AC for operating "Ham" transmitter. Operating 110 V. AC 60 Cycle Radio Receiver in DC districts. Motor Generator. Public Address Systems. Electric Sirens on motor boats, yachts, etc. Camp Lighting. Short Wave artificial "feter" apparatus. Television. Pelton Waterwheel for lighting or other purposes. Airplane: for lighting strong searchlights or electric signs. Laboratory work, etc., etc. 1/4 to 1/2 H.P. needed to run generator.

BLUE-PRINT 22 x 28 in. and Four-Phase 8 1/2 x 12 in. INSTRUCTION SHEETS FREE with Generator.

Generator, as described, including four replacement carbon brushes. Blue-print and instructions \$7.90

Send \$2.00 deposit, balance C.O.D.

Shipping weight 18 lbs.  
(Replacement carbon brushes bought separate \$1.50 per set of four. Set of instructions bought separate \$1.00.)  
MONEY-BACK GUARANTEE

### WELLWORTH TRADING COMPANY

560 West Washington Blvd., Dept. RT-539, Chicago, Ill.

# FREE!

Our new Catalog describing over thirty-two books in the "How to Make More Money" field has just come off the press. This catalog describes each book in detail. It enables you to select one or more books which will meet your requirements in an attempt to improve yourself financially.

Many of the books in the NATIONAL PLANS INSTITUTE catalog tell you how to start a spare- or full-time business of your own.

Write today for your FREE copy of the "NPI" Book Catalog—address a one-cent postcard to Dept. RT-539—and mail it today.

**NATIONAL PLANS INSTITUTE**  
246-T FIFTH AVENUE, NEW YORK, N. Y.

## SAVE MONEY! ON RADIO SETS AND PARTS

Send for our FREE GIANT Spring Catalog illustrating and describing over 1,000 money saving items.

**UNITED RADIO COMPANY**  
DEPT. S.W. NEWARK, N. J.



# New S-W Receiver

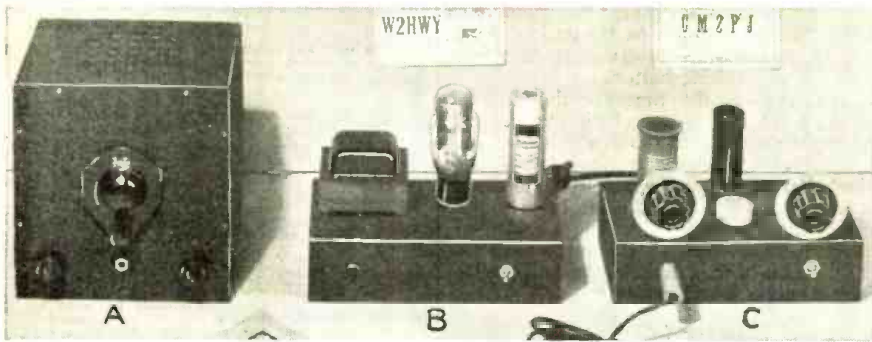

R-9 Receiver at A; power supply at B; transmitter at C.

● A NEW receiver, designed to operate on the amateur and foreign broadcast bands, has been designed by the engineers of the Eagle Radio Company. Known as the R-9, the receiver is efficient, compact and easy to construct. In its basic form it consists of a regenerative detector, and a single stage audio employing a 6J7 and a 6C5, respectively. An extra audio stage using a 6F6 is available, if loud speaker reception is desired. The receiver proper is shown in Fig. 1A; the additional audio stage in Fig. 1B. Also available is a simple power supply, which may be used alternatively on either the receiver or the 25 watt

transmitter which was described in the December, 1938, issue of RADIO & TELEVISION. The power supply is shown in Fig. 2A and its method of connection in Fig. 2B. A single-pole, double-throw switch permits power to be fed into either the send or the receive circuit, the switch being placed in the positive B lead in the supply chassis. The transmitter filaments are connected in parallel and remain "on" at all times, only the "B" being transferred. The "B" negative of all three units is common and a 20 watt, 25,000 ohm bleeder resistor is connected from "B" positive to "B" negative of the power supply. A 5Z3 is used as the rectifier.

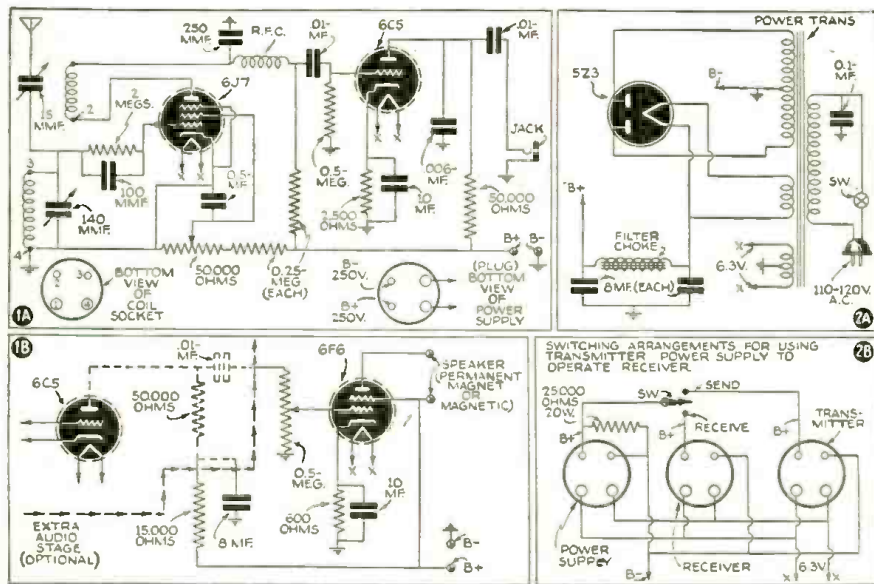

Hook-up of receiver, power-supply and additional stage of audio for loud-speaker operation.

## Silver Trophy Award

(Continued from page 25)

you think will be of general interest to the reader. Mention the type of aerial system used, especially any unique or new features about it, and which type of aerial you use for transmitting and receiving; also what type of break-in relay system, if any, is used.

Important—Don't forget to send along a good photograph of yourself, if your likeness does not already appear in the picture!

Note that you do not have to be a reader of RADIO & TELEVISION in order to enter the contest. Pack all photographs carefully and the description had best be mailed in the same package with the photos. The Editors will not be responsible for photos lost in transit.

Do not send small, foggy-looking photos because they cannot be reproduced properly in the magazine. If the picture you have or may take of your station is not thoroughly sharp and clear and at least 5" x 7", it would be best to have a commercial photographer take a picture of your station. If you cannot do this, you most probably have a friend who owns a good camera and who can arrange to take the photograph. You are not limited to one picture, but may submit as many different views as you like.

Address all photos and station descriptions to Editor, Ham Station Trophy Contest, c/o RADIO & TELEVISION, 99 Hudson Street, New York, N. Y.

Don't miss the June "Television" Issue!

**TAKE A LOOK!**  
**BIG SAVE-MONEY BOOK FREE**

Yes, yours for the asking. Whether you build or buy, you need this amazing catalog. Brand new, up-to-the-minute and crowded to the covers with important savings in radio. Not just a scattering of bargains to deceive you, but page after page of genuine values — all nationally advertised parts, tubes, build-your-own kits and test equipment — the remarkable Lafayette line of receivers, significantly rated "best buys" by consumer groups — new P.A. streamlined for Sell — and on everything you buy, prices consistently lower. It's a grand guide to savings this book. Tear off coupon and mail at once for your FREE copy of catalog 76.

**LAFAYETTE RADIO CORP.**  
**AND WHOLESALE RADIO SERVICE CO. INC.**  
NEW YORK, N. Y. • CHICAGO, ILL. • ATLANTA, GA.  
100 SIXTH AVENUE • 901 W. JACKSON BLVD. • 265 PEACHTREE ST.  
BOSTON, MASS. • BRONX, N. Y. • NEWARK, N. J. • JAMAICA, L. I.

Rush New FREE Radio Catalog No. 76.

Name..... PLEASE PRINT  
Address.....  
City..... State.....

LAFAYETTE RADIO CORP.  
Dept. 4E9—100 Sixth Ave., New York, N. Y.

PASTE COUPON ON PENNY POSTCARD

## New Performance Features at Amazing Low Cost!



**Two New TURNER Microphones—Dynamic 88, Crystal 66**

YOU get new advanced engineering and design—at no increase in cost—in these handsome new Turner mikes. Ruggedness that assures tops in performance under severe operating conditions—weighted frequency response—inertia mounted cartridges—narrow beam pick-up of all frequencies—absolute wind and blast proofing, are exclusive features of these matchless new Turner models.

MODEL 66  
Get praise-winning "studio quality" with this professional mike. Order now.

**\$25.00 LIST**

**The TURNER CO.**

Cedar Rapids, Iowa  
Licensed Under Patents of the Brush Development Co.

**SOLAR**  
gives you **MORE** for your money  
**MINICAP**  
MINICAP +  
DRY ELECTROLYTIC CAPACITORS

Catalog upon request  
SOLAR MFG. CORP., 599 Broadway, New York



## RADIO INSTRUCTION

### It's EASY to LEARN CODE The CANDLER WAY!

If you are having trouble learning code—if you can't make the speed you need for your license—if you want to develop your code so that you can get more real fun out of CW—write Candler! You'll make real progress with the Candler system—you'll learn the correct fundamentals and mental co-ordination—you'll develop sound consciousness—and in a few weeks you'll make more real progress than you will in months of undirected practice. You'll be amazed to find you can read code as easily as you read print, without strain or conscious effort, an accomplishment well worth the low cost of Candler Training. Write today for the FREE "Book of Facts." See what others say about the Candler System of learning code—including such Candler-trained operators as T. R. McElroy, World's Record Holder and Champion. Do it today—take the first step toward real code proficiency!



**FREE! Book of Facts!**

### CANDLER SYSTEM CO.

Box 331, Dept. S-5  
ASHEVILLE, NO. CAROLINA, U. S. A.  
British Address: Room 56, CRAVEN HOUSE  
Kingsway, London, W. C. 2

## RADIO ENGINEERING

Complete Radio Engineering Course in 96 weeks. Bachelor of Science Degree. Radio (television, talking pictures and the vast electronic field) offers unusual opportunities for trained radio engineers. Courses also in Civil, Electrical, Mechanical, Chemical, Aeronautical Engineering; Business Administration and Accounting. Tuition, living costs low. World famous for technical two-year courses. Special preparatory department for those who lack required high school work. Students from all parts of the world. Enter June, September, January, March. Write for catalog.

2459 COLLEGE AVE. ANGOLA, IND.

### TRI-STATE COLLEGE

### YOUR FUTURE IN

These growing industries need trained men for sales, service, operation. Your chance for employment and advancement depends on thorough training. National Schools offer you time-tested training. Complete, modern facilities and equipment in the largest trade school in the West. Est. 1905.

**NATIONAL SCHOOLS**  
4000 S. Figueroa Street, Los Angeles

NATIONAL SCHOOLS, Dept. B-RT, Los Angeles  
Please send free Radio and Television Booklets.

NAME \_\_\_\_\_ AGE \_\_\_\_\_  
ADDRESS \_\_\_\_\_  
CITY \_\_\_\_\_ STATE \_\_\_\_\_

### EASY TO LEARN CODE

It is easy and pleasant work to learn the modern way—with an INSTRUCTOGRAPH CODE TEACHER. Ideal for the beginner or advanced student. Always ready—No GRMs—beats having some one send to you. Many tapes available ranging from alphabet for beginners to typical messages on all subjects. Speed range 5 to 40 WPM.

**FOR SALE OR RENT**  
Standard with 10 tapes and book of instructions . . . \$20.25  
Junior with 5 tapes and book of instructions (not rented) . . . \$12.00  
RENTAL Standard with 10 tapes and book of instructions \$2.00 first month, \$2.25 each additional month.

### INSTRUCTOGRAPH COMPANY

Dept. SW-5, 912 Lakeside Place, Chicago, Ill.  
Representatives for Canada:  
Radio College of Canada, 863 Bay St., Toronto



## Remote Control Selects Stations

(Continued from page 33)

adjusting the trimmers on the button unit for best signal strength on the desired local stations. Seven stations can thus be tuned in simply by pushing buttons!

Next, remove the tuner to the desired remote point and try out both the manual and button tuning, making any slight readjustments for correct tuning. It will be found that the volume control on the radio receiver can be set at a point to give the desired maximum signal strength and then the correct strength of the music can be set by means of the remote control tuner. See diagram on opposite page.

### LIST OF PARTS

#### MEISSNER

- 1—Type 10-7554 push-button tuner
- 1—Type 14-1496 antenna coil, L1
- 1—Type 14-7560 oscillator coil, L2 (modified)
- 1—Type 16-8091 1500 kc. i.f. coil, L3
- 1—Type 16-8095 1500 kc. i.f. coil, L4
- 1—Type 18248 dial
- 1—Type 21-5214 2-section 365 mmf. condenser, C1, C2
- 2—Type 22-7028 mica semi-var. cond. 80-225 mmf. C3, C14

#### CORNELL-DUBILIER

- 1—Mica cond. 50 mmf. C4
- 1—Mica cond. 250 mmf. C5
- 5—Paper cond. .05 mf. 300 V., C6, C7, C8, C9, C10
- 1—Mica cond. 50 mmf. C11
- 2—Electrolytic conds. 40 mf. 200 V. C12, C13

#### RCA

- 1—Type 6K8 tube, V1
- 1—Type 6K7 tube, V2
- 1—Type 6B8 tube, V3
- 1—Type 25Z6 tube, V4

#### PAR-METAL PRODUCTS

- 1—Chassis 5" x 7" x 1 1/2" deep

#### I.R.C.

- 1—Resistor, 50,000 ohms, 1/2 W., R1
- 1—Resistor 200 ohms, 1 W., R2
- 1—Resistor 1250 ohms, 1 W., R3
- 1—Resistor 3000 ohms, 1 W., R5
- 2—Resistors .25 meg., 1/2 W., R6, R7
- 1—Type AB resistor, 1000 ohms, R8

#### CENTRALAB

- 1—Volume control with switch, 500,000 ohms, R4

#### OHMITE

- 1—225 ohm resistor line cord, R8

#### EBY

- 4—Wafer octal sockets

#### MISCELLANEOUS

- 3/16" wood for cabinet, screws, nuts, washers, grid caps, and wire for connections and aerial.

The following average socket voltages made with a 1,000 ohm/volt meter: on the control unit—volume control full on—will indicate whether all tubes are receiving correct voltages when trying out the new unit.

Tube	Cathode V.	Osc. Plate V.	Screen V.	Plate V.
V1	2 1/2	112	112	112
V2	8	—	112	112
V3	10	—	112	112

A variation of 10 to 15% is permissible from the above figures without indicating a defect.

## BOOK REVIEW

SPRAYBERRY DICTIONARY OF RADIO. 94 pages, size 5 1/2" x 8".

A very complete glossary of radio items is offered in this newly printed book. The first 81 pages are devoted to a table of contents and definitions on everything from A1 Emission to Z Signals. The balance of the book is given over to explanations of abbreviations; of the Greek letter Pi as used in radio; conversion tables; Greek symbols used in radio; a chart of standard symbols (which is printed through the courtesy of Gernsback Publications); an International Morse Code chart (printed through the courtesy of the same organization); a parallel resistance chart; analyses of radio set troubles, a resistor chart, and a decibel level chart.

The book will be useful to anyone engaged in the study, hobby or business of radio.

## RADIO INSTRUCTION

### LEARN TO SEND AND RECEIVE CODE

Learn to send and receive code signals. Like operators on ships at sea and at commercial and amateur land stations. Interpret distress signals, news flashes, bulletins, and dozens of other kinds of interesting radio communications.

MASTER TELEPLEX teaches you to receive code exactly the way the world's best operators do—by sound. A heavy waxed paper tape, running through a machine, operates an automatic key which sends messages to you, at any speed you desire. As you improve in speed, the machine sends faster, gradually preparing you for top-speed amateur and commercial signals. With the new All Electric MASTER TELEPLEX you learn to send by sending and the signals you send are repeated back to you, exactly as you sent them, thus enabling you to correct your own errors. We furnish a complete course, lend you the improved All Electric MASTER TELEPLEX and give you personal instruction with a MONEY BACK GUARANTEE. Send for TELEPLEX FOLDER 8-5 today. IT'S FREE!



### TELEPLEX COMPANY

67-69 Park Place, New York  
In Canada write:  
CANADIAN ELECTRONIC INST., TORONTO, ONT.

## LEARN TELEVISION NOW

1939 to be Television Year. NEW Opportunities. Amazing new training covers latest Radio Television Practices, etc. Over 100 lessons, as low as \$39.50, easy payments.



### FREE TRIAL—

10 Lessons sent on Free Trial by return mail. Write today to see for yourself.

S. Q. Noel, Pres.  
Universal System, 630 Candler Bldg., Kansas City, Mo.

## BE A RADIO SERVICE EXPERT

Modern receivers require men with modern training for service work. **LEARN AT HOME** Our home instruction method and service equipment offer starts you earning money almost at once. Up to \$3 an hour easy in a short time. Write for free book. Radio Training Ass'n of America Dept. RT-95 4525 Ravenswood Ave., Chicago

## RADIO ENGINEERING

RCA Institutes offer an intensive course of high standard embracing all phases of Radio and Television. Practical training with modern equipment at New York and Chicago schools. Also specialized courses and Home Study Courses under "No obligation" plan. Catalog Dept. SW-39.

**RCA INSTITUTES, Inc.**  
A Radio Corporation of America Service  
75 Varick St., New York. 1154 Merchandise Mart, Chicago

## LEARN RADIO TELEVISION

500 LICENSED graduates placed in past 7 years in shipping, broadcasting, aviation, police, etc.; we also teach radio servicing and repairing; new beginners' class now forming; 60-page catalog free; oldest, largest and best equipped.

**MASS. RADIO SCHOOL**  
18 BOYLSTON ST., BOSTON Est. 1899

## AMATEUR RADIO LICENSES

Day and evening classes in code and theory  
**Home Study Courses**

Hundreds of students now on the air. Results guaranteed. Reasonable, efficient and thorough.

**AMERICAN RADIO INSTITUTE**  
1123 BROADWAY NEW YORK, N. Y.

## RADIO ENGINEERING

broadcasting, aviation and police radio, servicing, marine radio telegraphy and telephony, Morse telegraphy and railway accounting taught thoroughly. 48 weeks' Engineering course equivalent to 3 years of college radio work. All expenses low. Catalog free. School established 1874.

Dodge's Institute, Turner St., Valparaiso, Ind.



## Hook-up of Remote Control Unit

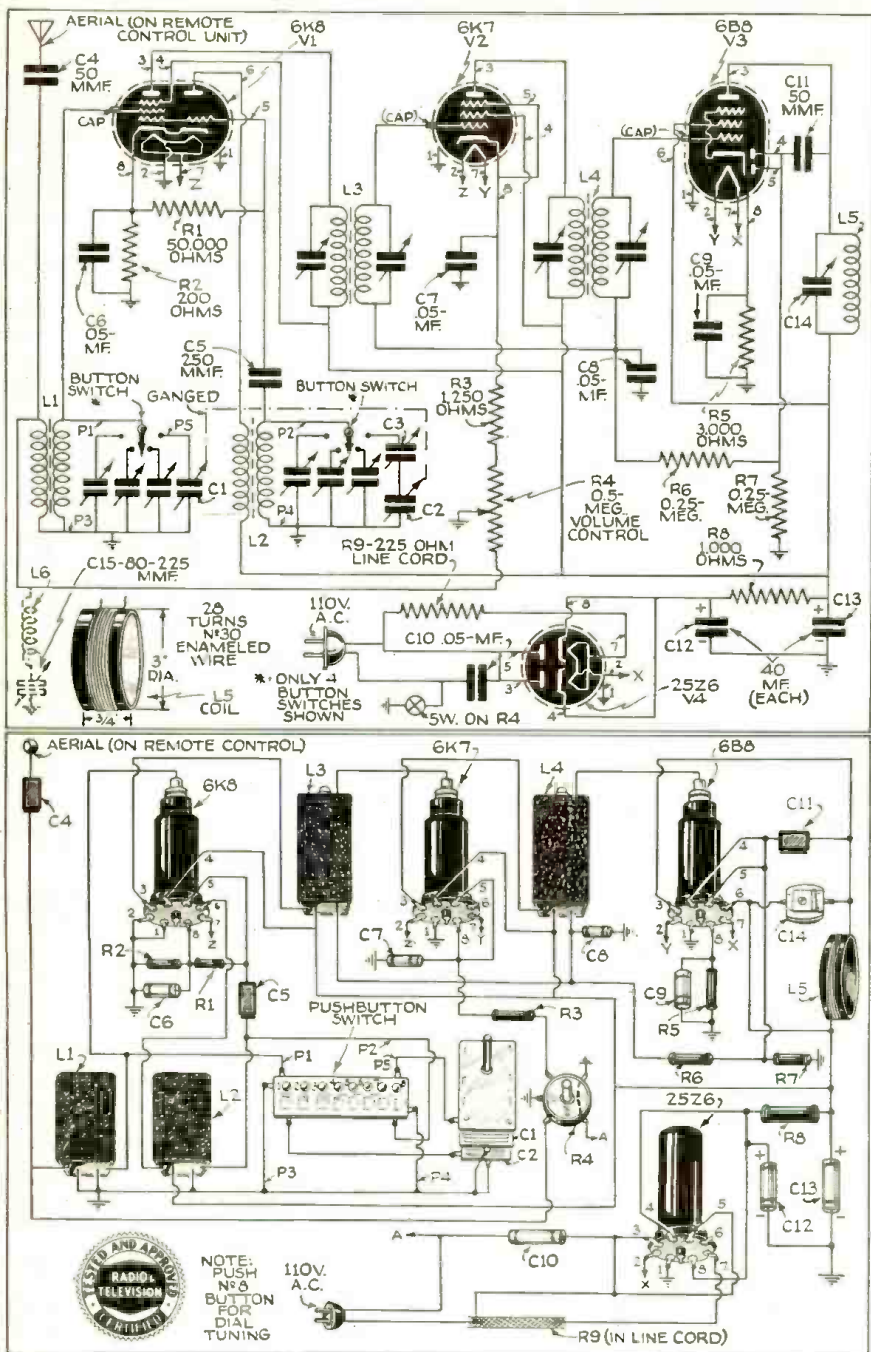

## An Interview with F.C.C.'s Chief

(Continued from page 3)

Commissioner McNinch then pointed out one flaw in the present radio law which holds that if a candidate for any office in a major political party is given time on the air, his opposing candidates must be given equal facilities. However, the law does not state anything about friends or advocates of the various candidates, and it would be possible for a station to put on ten men who urge that you vote for Senator Blank, and refuse to put on those who insist that Senator Dash would make the better legislator.

Summing up, Mr. McNinch said that he was in favor of a smaller F.C.C. because a group of fewer men would be subject to less political pressure than would a larger

body, and because a smaller body could act more quickly and with greater harmony than a larger group. He added that if applications for commercial television stations do go through, he will give them full consideration, although it is not probable that there will be much demand for such licenses at the present time.

Next Issue!  
How To Build a  
TELEVISION RECEIVER

## RADIO INSTRUCTION

# RADIO made EASY

with Ghirardi's Home Training Course  
**COMPLETE IN 7 BIG BOOKS**

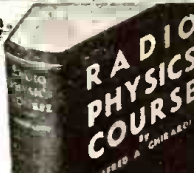

Fit yourself at home, in spare time, for a good-paying radio job. You'll learn all that's really essential in Ghirardi's world-famous self-training course, complete in this big 872-page volume—including Television, Sound, Cathode-Ray Tubes, as well as Radio and Electricity, all here, clearly explained, fully illustrated, easy to grasp!

### Quick Way to Learn

Ghirardi's simplified method is the quickest way to get your radio education. No "background" study—no math—no lectures. Easy as 1-2-3.

**36 Volumes in 1—972 pp. 508 Illus.**

1. Radio Broadcasting System. 2. Sound. Speech, Music. 3. Electron Theory. Elec. Current. 4. Elec. Units: Ohm's Law; Resistance. 5. Elec. Circuits; Batteries. 6. Magnetism. 7. Electromagnetism. 8. Electromagnetic Induction. 9. Inductance. 10. Capacitance; Condensers. 11. A.C. Circuits. 12. Filters. 13. Measuring Instruments. 14. Radio Waves. 15. Broadcasting. 16. Receiving. 17. Vacuum Tube Principles. 18. Vacuum Tube Characteristics. 19. Vacuum Tube Construction. 20. Vacuum Tube Detector and Amplifier Action. 21. Radio Frequency Amplification. 22. "Superhets". 23. R.F. Amplifiers; Tuning Coils. 24. Audio Amplifiers. 25. Speakers. 26. Battery Operated Receivers. 27. Power Supply Units. 28. Elec. Receivers. 29. Automobile and Aircraft Radio. 30. Phono Pickups; Sound Systems. 31. Short-Wave. 32. Photoelectric Cells; Cathode-Ray Tubes. 33. Television. 34. Antennas; Grounds. 35. Testink; Servicing. 36. Sound Films. . . . 856 Review Questions!

### USE IT 5 DAYS—OUR RISK!

Get it!—Read it!—Use it! If not completely satisfied, return the book within 3 days and get your money back. You risk nothing—but you'll lose your great opportunity, unless you TRY IT!

### MAIL COUPON TODAY!

**RADIO & TECHNICAL PUBLISHING CO.**  
45 Astor Place, New York, Dept. R47-59  
 Here's my \$4. Please send RADIO PHYSICS COURSE postpaid, with money-back guarantee.  
NAME .....  
ADDRESS .....  
CITY ..... STATE .....  
 Send free descriptive literature.

## YOU CAN BECOME A MONEY-MAKING RADIO EXPERT

WITH THE  
**New SPRAYBERRY**  
Personalized  
**HOME TRAINING in**

You Learn Easily in Your Spare Hours . . .  
By Doing Many Experiments with Up-To-Date Equipment

Here's a really fine, up-to-the-minute Radio and Television Training that's specially designed to give you quick results. **TRAINING PREPARES YOU FOR GOOD RADIO JOBS . . . AT EXCELLENT PAY.** My training starts right at the beginning of Radio . . . unfolds each subject in a simplified, logical, understandable style. You easily learn Television, Electronics, Facsimile Radio, Radio Set Repair and Installation Work, etc.

**NO PREVIOUS EXPERIENCE NEEDED!** It makes no difference what your education has been. I can fit you for a good-paying Radio job. Your success is my full responsibility.

### YOU GET EXPERIMENTAL TEST EQUIPMENT PLUS EXPERIMENTAL OUTFITS

. . . Includes 11 Radio Parts (to build complete Receiver), Tools, All-Wave, All-Purpose Analyzer, and Experimental Outfits for conducting actual experiments with your own hands.

### I Supply

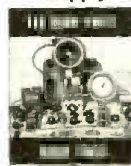

**EARN WHILE YOU LEARN!** My **BUSINESS BUILDERS** show you how to put your equipment to practical use in handling actual money-making Radio Service Jobs shortly, after you begin training.

### SERVICEMEN

I offer Advanced Training for those already in Radio. Get complete details in my FREE 52-page Book. **The Sprayberry Course is Sold Under a Money-back Agreement!**

### RUSH COUPON for BIG FREE BOOK

**SPRAYBERRY ACADEMY OF RADIO**  
F. L. Sprayberry, Pres.  
245-E University Place, N.W.,  
Washington, D. C.

Please send me FREE copy of "HOW TO MAKE MONEY IN RADIO."

Name ..... AGE .....

Address .....

City ..... State .....

Tear off this coupon, mail in envelope or paste on penny postcard. Servicemen—Check here



# "Wireless" Oscillator for Phono and Mike

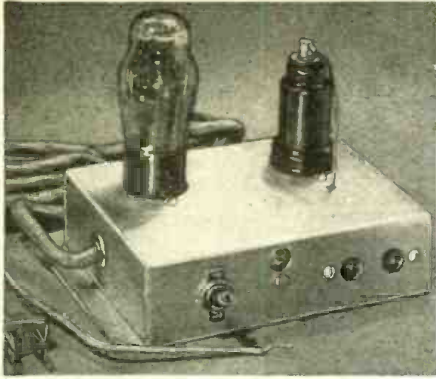

The "wireless" oscillator here described is very easy to build. It enables one to play phonograph records on a regular radio receiver, without direct connection to the set itself. It can also be used with a "mike."

● THE use of a small modulated oscillator will permit you to carry on remote point phono and mike transmission at any distance up to 25 feet, and without direct connection to the radio receiver.

The general theory of *wireless* type phono oscillators has been covered by several articles, but it is well to review briefly the operation of such units. The oscillator is designed to produce oscillations in the broadcast band. Usually the carrier signal is adjustable over 100 or 200 kc. to permit the reception of the oscillator's signal at a

point where no broadcast station is present. The carrier is modulated by the electric impulses generated by the phono pickup. While a separate modulator type tube can be used, because the input audio signal is of sufficiently high intensity and for simplicity, a single tube is utilized for a dual purpose and electron-modulation is employed, in the apparatus described here.

Notice in the circuit diagram the connections leading to the 6A8 tube. Considering for the moment the function of this tube with the control grid G-1 remaining at a small negative constant potential, we see the equivalent autodyne tetrode in a modified oscillator.

This circuit is not standard, for while the grid coil tuning condenser is sometimes omitted and the plate coil tuned circuit is used for frequency adjustment, this procedure normally is not reversed, for the variation only of the grid coil condenser has but little effect on the oscillating frequency. This arrangement has the advantage of offering better vernier adjustment and keeping the carrier frequency constant for any one setting.

The control grid G-1 is in the electron path and will modulate the resulting plate current with the audio signal produced by the phono pickup. The antenna radiator is capacity coupled (through a 50 mmf. condenser) to the plate of the tube. The antenna wire is incorporated in the line cord, but usually an additional length of wire

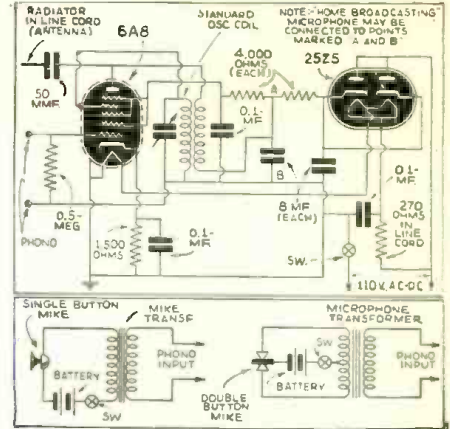

The "oscillator"—really a miniature transmitter—uses but 2 tubes, a 6A8 and a 25Z5. Connections for single- and double-button mikes are shown. The radiator may be separate from the line cord.

will have to be connected if the oscillator is at a considerable distance from the associated radio receiver.

For the power supply, a 25Z5 tube in a half-wave rectifier circuit is used. The needed filtering is obtained with a dual 8 mf. electrolytic condenser and a 4,000 ohm resistor. The second 4,000 ohm resistor serves to reduce the voltage to supply the  
(Continued on page 50)

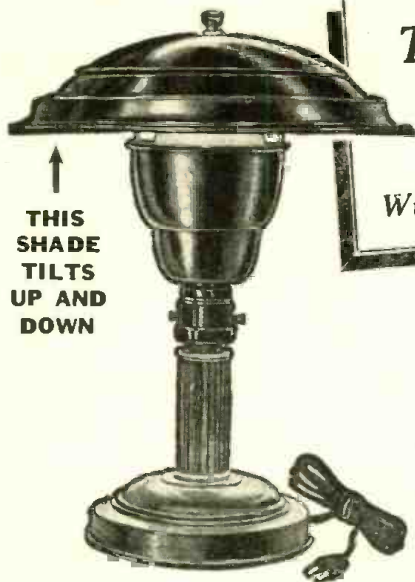

↑  
THIS SHADE TILTS UP AND DOWN

This **MODERN DESK LAMP** Is Yours Absolutely **FREE** With a Year's Subscription to **RADIO & TELEVISION**

JUST THINK OF IT—you can get absolutely FREE, the beautiful desk lamp shown at the left. This attractive desk lamp is suitable for home, desk, den, office, laboratory, studio or workshop. It is sent to you by the publishers with their compliments for a one-year subscription to RADIO & TELEVISION. Look at the many fine features which this handsome desk lamp has. Read the list below.

### LOOK AT THESE FEATURES!

- ⊗ Constructed of metal with attractive bronzed finish.
- ⊗ Scientifically constructed to give glareless, diffused light.
- ⊗ Helmet-type shade can be tilted to any convenient angle.
- ⊗ Stands 13" high and has 10" metal shade.
- ⊗ 5-foot rubber insulated cord and plug.
- ⊗ Constructed to last for many years.

Clip Coupon Today — and Mail!

Send your subscription today to RADIO & TELEVISION for One Year (12 issues) and receive absolutely FREE one of these truly remarkable desk lamps. New subscribers are accepted or you may extend your present subscription another twelve months under this offer. Mail your remittance of \$2.50 (Plus 25c for shipping charges on lamp) to the publishers of RADIO & TELEVISION. (Canada and foreign \$3.25) You will promptly receive your FREE DESK LAMP by return mail. Use the coupon at the right to order your subscription.

**RADIO & TELEVISION**  
99 Hudson Street      New York, N. Y.

**RADIO & TELEVISION, 99 HUDSON ST., NEW YORK, N. Y.**

Gentlemen: Enclosed you will find my remittance of \$2.50 for which enter my subscription to RADIO & TELEVISION for One Year (12 issues). Send me promptly my FREE DESK LAMP. (Canada and foreign \$3.25.) In U. S. add 25c additional to cover shipping charges of lamp.

( ) NEW SUBSCRIBER      ( ) EXTEND PRESENT SUBSCRIPTION

Name .....

Address .....

City ..... State .....

(Send remittance by check, money order or unused U. S. Postage stamps. Register letter if you send cash or stamps.)

R&T-5-30

## 2½, 5 and 10 Meter Converter

(Continued from page 35)

the chassis and very near to the tuning condenser. On the rear shield is mounted the R.F. stage tuning condenser and R.F. coil ( $L_1$ ,  $L_2$ ) jack bar. Also mounted on this shield is the 956 tube socket which is mounted on the side of the shield nearest the center shield so that when the 956 is inserted in its socket, its grid terminal will protrude through the shield and be very close to the stator terminal of the R.F. stage tuning condenser.

### New Type "Acorn" Tube Sockets Used

A few words concerning the R.F. and detector tube sockets might not be amiss. These are special National acorn tube sockets made of sheet copper, with the tube contacts mounted on but insulated from this plate by a sheet of mica. The socket is insulated from the chassis by a sheet of mica also. This type of assembly results in a capacity between each contact and base of about 40 mmf. and between base and chassis of 500 mmf. When the cathodes of the 954 and 956 are connected to the socket plate, quite effective by-passing is had right at the socket terminals. At very high frequencies, this is all the by-passing needed, but at 5 and 10 meters a little more is necessary so .01 mf. condensers were added. Incidentally, care should be exercised not to allow the socket contacts other than the cathode to short to the socket plate.

The detector plate coil ( $L_3$ ) and its air-trimmer condenser are mounted beneath the chassis next to the 954 tube socket. The shaft of this condenser is slotted and projects above the chassis so that it can be readily adjusted. Make certain that the

shaft doesn't short to the chassis.

As the photo shows, a pair of threaded 6/32 rods bolted at the upper corners of the three shields make the assembly extremely rigid.

Since air trimmers were not necessary across the R.F. and detector coils, mica compression trimmers were used, thereby enabling us to use individual trimmers for each coil. They are mounted on each one of the R.F. and detector coils with short lengths of heavy wire and adjusted for each band, so that when changing to another band, it is only necessary to readjust the oscillator padding condenser besides changing the coils.

With the converter all wired up, the output from the pickup coil  $L_1$  is connected through a pair of twisted wires to the antenna and ground terminals of the regular short wave receiver, which should be tuned to approximately 3400 kc. (88 meters) and its gain control placed at maximum. The converter detector plate trimmer condenser should now be adjusted to a position where the noise level heard in the receiver peaks up. Now with an antenna connected to the converter and the tuning condensers at their half capacity setting and mica trimmers at their minimum capacity, adjust the oscillator padding condenser until signals in the desired band are heard. Remember the oscillator frequency will be 3400 kc. lower than the detector frequency. The detector and R.F. coil trimmers are then successively adjusted for maximum signal in the receiver. If the receiver has an "R" meter, adjustments will be greatly facilitated. An output meter can also be used. By the proper set-

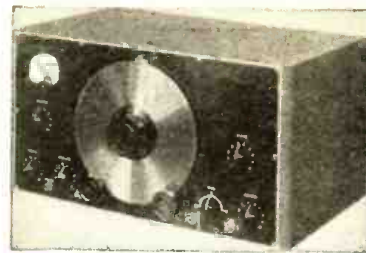

## NOT AT twice ITS PRICE

THE new GUTHMAN U17 "Silver-Super" gives you combined features you can't buy in any other communication receiver at twice its price.

Calibrated 3" S-Meter  
Six Low-C Wave Bands, 5 through 612 Meters  
New Noise Suppressor System  
Continuously variable selectivity from single-signal c.w. to High-Fidelity  
Automatically stabilized B Voltage  
Terminals for extra external S-R switch and for anti-fading Dual-Diversity Coupler

Priced at only \$49.50 net from all leading jobbers, this outstanding buy comes completely assembled, ready to wire, with every wire color-coded, cut to length and with ends skinned. By wiring it yourself, following complete instructions you learn while you save many dollars.

Send for full details of this new receiver, which brinks you features you can't buy at twice its price. And for the P.A. specialist, we have something equally new and startling in U21 P.A. Tuner and 8, 15 and 30 watt power amplifiers. For the amateur, the famous U-10 Frequency Meter-Monitor, U14 Visual Frequency Deviation Meter and modern parts including compact stable H.F. variable condensers and r.f. chokes of design that will surprise you.

SEND TO DEPT. RT2 TODAY FOR DETAILS

EDWIN I. *Guthman* & CO., INC.

400 S. PEARIA ST. CHICAGO, U. S. A.

CABLE ADDRESS: GUTHCO-CHICAGO

## Your Inquiries Invited

When you need amateur equipment it is to your advantage to write to me. You get personal attention; 6% terms financed by myself so you buy with less cost and more convenience; fair trade-in value for your equipment; ten day trial of all receivers; and my cooperation in every way to see that you are 100% satisfied. For any equipment, the latest information and technical help, write to W9ARA.

### Compare My Terms with Others

Model and Receiver	Cash Price	Down Payment	12 Monthly Payments
RME-70	\$138.60	\$27.72	\$9.79
HQ-120X & NC101X	129.00	25.80	9.11
NC100A	120.00	24.00	8.48
NC80X & NC81X	99.00	19.80	6.99
Brefing 49 & S16	99.00	19.80	6.99
Howard 438	49.95	9.99	3.53
NC-44 & S-20	49.50	9.90	3.49
The New SX-23	115.50	23.10	8.15
Sky Buddy	29.50	5.90	2.08

Also HRO, Breting 9, Howards, Sargents, all others

Similar terms on Hallicrafters, National, Harvey, RCA, RME, Temco transmitters and Thordarson, National, U.T.C., Utah, Kits.

All orders and inquiries attended to by Bob Henry, W9ARA; active amateur for 14 years; graduate M.I.T.E.E.; owner of Henry Radio Shop selling amateur supplies for ten years.

*Bob Henry*  
W9ARA

BUTLER,

MISSOURI

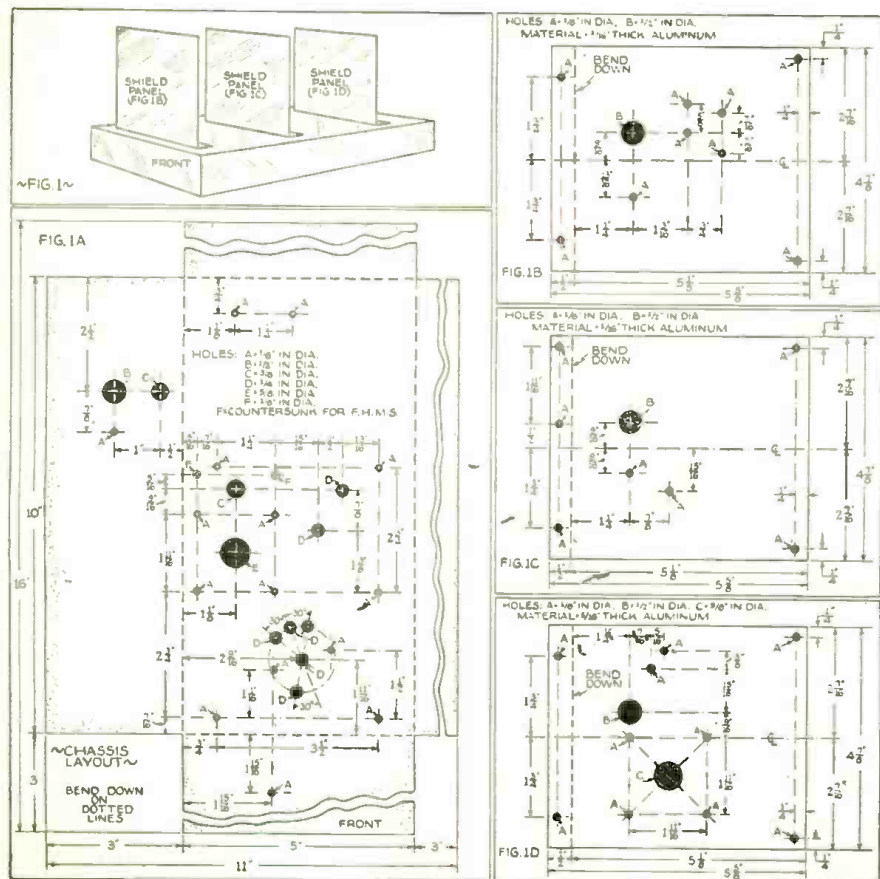

Details of Chassis and Shields.







# The "Bauer" T-R-F Four

(Continued from page 29)

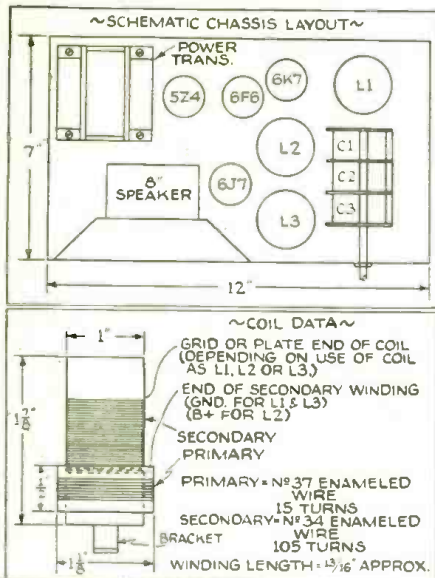

end. Several layouts were tried and the one shown was finally adopted since the r.f. amplifier did not oscillate and the circuits tracked perfectly. It is important that good shielded coils be employed in order to realize full performance from this circuit. Regeneration, when properly controlled, can be used to advantage on weak signals as explained later, but regeneration caused by poor parts or sloppy wiring is nothing but a detriment and a nuisance marring the performance of an otherwise good receiver.

The usual common-sense rules of wiring apply to this receiver as they do to any other. Keep the r.f. leads short and install the various by-pass condensers and resistors as close as possible to their respective points in the circuit. The photograph of the underside of the chassis gives the general idea to be followed. It does not result in a very pretty appearing job, perhaps, but it is efficient—and efficiency is what we want after all. Confine all of your artistic ability to the top of the chassis. For instance, the author sprayed his chassis with lacquer after cutting and drilling it and placed the necessary wire holes for condenser and speaker leads so that they would be as unobtrusive as possible. The dark green chassis produced a very pleasing contrast with the aluminum coil shields and black metal tubes.

Getting back to the circuit once more, it will be noticed that a separate bleeder is used for the screen voltage supply of the detector tube. There are two important reasons for this. Since this is not a production model radio, we can afford to spend an extra dime for two carbon resistors and another dime for an extra by-pass condenser, resulting in constant screen voltage on the detector when the volume control is operated.

The 25,000 ohm resistor in the plate circuit of the r.f. tube was inserted because the n.c. voltage of the author's power supply was higher than was deemed safe for the r.f. tube. If the voltage output of your power transformer speaker system is no more than 250 V., this resistor can be omitted.

### Adjusting the "Link" Circuit

After the receiver has been completely assembled, wired, and checked, it is ready for adjustment. Leave one side of the "link" circuit open and make sure that the antenna primaries on L<sub>2</sub> and L<sub>3</sub> that make up the link circuit are as far from L<sub>2</sub> and L<sub>3</sub> as

possible. Condenser "c" should be left permanently wired in since there is no need to experiment with the value of "c." It was found that the very small value of "c" as indicated on the diagram was adequate.

Now turn on the receiver and let the tubes warm up. It would be a good idea to check the voltage at this point. If the suggestions outlined in this article have been closely followed, the receiver will play immediately upon connecting an antenna to it. Tune in a local station and make a rough adjustment on the tuning condenser trimmers.

Now tune the receiver to the high frequency end of the band and pick out a fairly weak station. Readjust the condenser trimmers carefully and test the receiver over the whole band.

If any powerful locals on the dial appear as "double spots," it is an indication that the capacity of "c" must be reduced by cutting the wire loops shorter. Make sure that you followed the directions on the diagram properly when you made "c."

With the correct value of "c" in the circuit—and not until then—you may now proceed to adjust the link circuit properly. This is the most important adjustment of all. Upon it depends the successful operation of the "High Efficiency Four." Too much emphasis cannot be placed upon it.

Tune in a fairly weak station at the high frequency end of the dial with the link circuit open. Now close the link, retune with the dial if necessary, and note if the volume is increased or decreased. If the volume is decreased, solder the link circuit permanently. If the volume is increased, or there is no noticeable change in volume, it indicates that the link coupling is in phase with the capacitive coupling of "c" and the leads to one of the link coils must be reversed.

It is very important that the link circuit be out of phase with the coupling condenser "c." If it isn't, serious audio distortion will result, together with double-spot tuning, in spite of the loose coupling and the gain will not be uniform throughout the tuning range. When the circuit is properly adjusted, opening the link should result in weaker signals at the low frequency end of the band and at the high frequency end there should be little or no difference in volume. There will be a difference in fidelity, however.

The circuit developed in this article is really what is known as a "hand-pass" amplifier. However, in this receiver the coupling is purposely adjusted below the critical value. If more than one stage of r.f. is used, the coupling may be tightened and the result is a remarkable high gain, high fidelity band-pass amplifier either for p.a. work or for use in the home of the discriminating listener. Such a unit, complete with a volume expander in the audio system, will be described by the author in the near future, if the Editor is satisfied there is sufficient reader interest. If you want this article, tell the Editor.

### Coil Data

The coils illustrated are for the broadcast band and are designed for use with a standard .000365 mf. tuning condenser. All three coils (L<sub>1</sub>, L<sub>2</sub> and L<sub>3</sub>) in this receiver are exactly alike: as a matter of fact, three standard commercial antenna coils can be used in place of this home-constructed design, provided the coupling to the primary is adjustable.

When this coil is used as L (in the diagram): PRI=antenna coil; SEC=R.F. grid coil.

(Continued on page 53)

## space saving money saving DYKANOL CAPACITORS



New TYPE TQ

### FEATURES

Hi-Purity Aluminum Foil: Makes possible lower R.F. resistance.

Hi-Purity Multi-Laminated Kraft Tissue: Assures higher voltage breakdown; minimum leakage.

Dykanol (Chlorinated Diphenyl) Impregnated and Filled: Gives long life; small size;

lower power-factor; fire-proof.

Vacuum Dried and Impregnated: For lower equivalent series resistance.

Hermetically Sealed: Not affected by moisture, time or temperature.

Universal Mounting Strap: Allows mounting unit in any position.

Available in all popular capacities from 1 mfd. 600 v. to 2 mfd. 2,000 v. Completely described in NEW CATALOG NO. 161. Send for your copy today.

Product of the world's largest manufacturer of capacitors

MICA • PAPER • DYKANOL WET and DRY ELECTROLYTICS

**CORNELL-DUBILIER ELECTRIC CORPORATION**  
1027 Hamilton Blvd., So. Plainfield, N. J.  
Cable Address: "CORDU"

## MIDWEST FACTORY SALE!

SAVE 48-50% NEW!

30 DAYS TRIAL

PUT THIS NEW 14-TUBE WORLD WIDE CHASSIS IN YOUR CABINET

Only \$19.95 COMPLETE WITH TUBES AND SPEAKER

Prices start as low as \$10.95. As Much As

**\$40 TRADE-IN ALLOWANCE** on the beautiful 17-tube, 5-band Model "D" shown on left. Money-back guarantee. Write for new FREE 1939 catalog.

MIDWEST RADIO CORP., Dept. 14-MM, Cincinnati, O.

## Do you need BINDING POSTS?

The XL PUSH POST with its Spring Action assures Constant Contact and quick connection.

Manufactured in All Aluminum Type M at 40c each  
Aluminum Body, Bakelite Top Type B1 at 15c each

Type B1 completely insulated with Bakelite Insulating Shell type C1 at 20c each and proven by 240 hr Salt Spray Test AS NON-CORROSIVE our Types CP or NP at 28c each.

Manufacturers and Dealers Liberal Discounts

**X. L. RADIO LABORATORIES**  
420 West Chicago Ave., Chicago, Ill.



# FREE-FIFTEEN 10¢ PUBLICATIONS

featuring construction of the most popular short-wave receivers and transmitters with a One-Year's Subscription to Radio & Television

THESE publications are large printed sheets which average in size about 11"x17", the majority of them printed on both sides. All have photographic reproductions of the complete project, as well as detail illustrations. In addition, there are complete wiring diagrams and various technical details to assist the experimenter and builder in constructing the set. Full parts lists are always given, and the printed text runs anywhere from 500 to 3,000 words, depending on the complexity of the radio project. ALL RECEIVERS AND TRANSMITTERS ARE STRICTLY UP-TO-DATE: THERE ARE NO ANTIQUES OR OUT-OF-DATE PUBLICATIONS IN THIS

LIST. These projects are particularly valuable to the experimenter and constructor who builds "his own". Indeed, the 50 publications shown on this page represent the cream of recent radio construction by the master radio builders of America. Designs of this kind usually are sold for 25c to \$1.00 apiece, and frequently you do not get half the technical information we give you. When mailing us your subscription, use the special coupon on this page. Select your 15 projects by their serial numbers. We accept money orders, cash, checks or new U.S. stamps (no foreign stamps or currency accepted). If you send cash or stamps register your letter against possible loss.

**THESE 15 PROJECTS, IF BOUGHT SINGLY, WOULD HAVE COST YOU \$1.50. YOU CAN NOW GET THEM ABSOLUTELY FREE!**

**HOW TO BUILD THE SWITCH BAND-2 RECEIVER.** A low-cost receiver for 6 volt battery or A.C. operation which enables the short-wave fan to hear stations in all parts of the world. No. 1

**HOW TO MAKE A 2-TUBE RECEIVER FOR THE BEGINNER.** This receiver consists of detector and two audio stages. A double purpose tube is used to secure the 2 audio stages. Tubes are for 1 1/2 volt battery operation. No. 2

**HOW TO MAKE THE PORTABLE SUPERHET 4.** An ace all-wave superhet for battery operation. This receiver features band-spread and has a built-in beat oscillator. No. 3

**HOW TO BUILD A 4-BAND 3-TUBE SUPERHET.** A 3-tube receiver giving 4-tube results. Rack and panel type construction is employed. It has a regenerative second detector. No. 4

**HOW TO MAKE A FIXED-BAND 8-TUBE SUPERHET.** This short-wave "fan" receiver tunes over a wide band of frequencies without coil switching or changing. It's a real performer. It operates directly from 110 V. A.C. and has band-spread. No. 5

**HOW TO BUILD A 5-TUBE SUPERHET FOR FAN AND HAM.** A sure-fire receiver for all short-wave enthusiasts. It uses plug-in coils and iron core A.F. transformers which assure plenty of gain. No. 6

**HOW TO MAKE A TWIN-PENTODE RECEIVER.** This receiver, especially designed for the beginner, employs but one dual purpose tube which gives results equivalent to a 2-tube receiver. It is for 2-volt battery operation with headphones. No. 7

**HOW TO BUILD AN EFFECTIVE SHORT WAVE PRESELECTOR.** A signal-booster that will greatly improve reception on any short-wave super. It employs two 6KT tubes in parallel in a highly efficient circuit in which both input and output are tuned. No. 8

**HOW TO BUILD A REGENERATIVE 2-TUBE.** This unusual receiver has the tickler coil in the screen grid circuit of the detector. The receiver tunes from 9-250 meters; band-spread is included; metal or glass tubes may be employed. No. 9

**HOW TO MAKE THE S.W.&T. COMMUNICATIONS RECEIVER.** An unusually fine receiver for the critical Ham and Fan, incorporating many exceptional features. Regeneration is employed in the first detector stage which makes use of an acorn tube. The receiver also incorporates a noise-control circuit, variable selectivity control and a tuning meter. No. 10

**HOW TO MAKE A BAND-SWITCHING 2-VOLT RECEIVER.** This fine receiver for battery operation employs a band-switching arrangement, enabling the builder to tune from 16-550 meters by flipping a switch. No. 11

**HOW TO BUILD THE MULTI-BAND 2 RECEIVER.** A receiver for the short-wave beginner. It has a remarkable tuning range of 2 1/2-270 meters with band-spread on all bands. Plug-in coils are used and complete data for an A.C. power supply is given. No. 12

**HOW TO MAKE THE VS-5 METAL TUBE SUPERHET.** This complete all-wave receiver boasts, among other things, variable selectivity, metal tubes, AVC and band-spread. The tuning range is from 17-550 meters. No. 13

**HOW TO BUILD A BEGINNERS 2-TUBE SUPER.** A simplified superhet using 2 volt battery tubes which is just the thing for the beginner. It employs plug-in coils which cover a tuning range from 15-200 meters. No. 14

**HOW TO MAKE A T.R.F.-3 FAN RECEIVER.** This is an all-around receiver employing 2 volt tubes. A T.R.F. stage ahead of the regenerative detector insures good selectivity and sensitivity. Band-spread is provided by a two-speed dial. No. 15

**HOW TO BUILD THE FORTY-NINER—A RECEIVER FOR LEAN PURSES.** This novel receiver features a spare-change detector and requires only 12 volts of B battery. It uses 2-49 tubes which may be operated from any 2 volt A battery. No. 16

**HOW TO MAKE A REAL 5-METER SUPERHET.** This carefully designed receiver for ultra-short-wave reception employs a straightforward circuit. Careful placement and high quality parts insure fine results. No. 17

**HOW TO BUILD THE 2-VOLT SUPER DX-4.** This superhet, though small in size is big in performance. Using battery type tubes, it features continuous band-spread, and automatic volume control, which may be cut in or out as desired. No. 18

**HOW TO MAKE THE ULTRA-HIGH FREQUENCY WIZARD-6.** This is a first-class 5-meter super-regenerative receiver, using acorn tubes in the R.F. and detector stages. The other tubes are of the metal type. The use of the acorn tubes insures exceptionally fine results. No. 19

**HOW TO BUILD A HIGH-GAIN METAL-TUBE RECEIVER.** This little receiver is a real performer, tuning from 10-200 meters. Continuous band-spread is provided. No. 20

**HOW TO BUILD THE WORLD-WIDE 10-METER CONVERTER.** Many enthusiastic reports have been received from the builders of this unit, which may be attached to your present receiver for picking up 10 meter signals from all parts of the world. Only 2-tubes are used. No. 21

**HOW TO BUILD A DE LUXE 3-TUBER.** This is the receiver for the Ham or Fan who wants a really high class receiver of simple design. It employs an unusual band-spreading dial. The circuit, employing metal tubes, has a stage of T.R.F. followed by a regenerative detector and a stage of audio. No. 22

**HOW TO BUILD THE OCTODE METAL TUBE-3.** This receiver is capable of excellent performance on the short waves. It requires only one plug-in coil for each band as a stage of untuned R.F. precedes the detector. It also has an A.F. stage for boosting the volume to comfortable headphone level. No. 23

**HOW TO MAKE THE 3-IN-1 REFLEX SET.** A 2-tube giving 4-tube performance is this receiver which does its work with a minimum of tubes. A 6F7 is used as a combined R.F. amplifier, detector and first audio stage; a 6CS is used as second audio stage. No. 24

**HOW TO BUILD THE 100 WATT QRM DODGER—A COMPACT 5-METER TRANSMITTER.** This M.O.P.A. rig puts out a hefty signal and by use of a calibrated vernier oscillator control will overcome the QRM problem on 5 meters. No. 25

**HOW TO BUILD A DE LUXE 5-METER MOBILE STATION.** A really fine M.O.P.A. mobile transmitter which will work real DX on portable location. It employs five metal tubes. No. 26

**HOW TO BUILD THE H-G-M MEDIUM POWER TRANSMITTER.** A crystal control set with an output of 90 watts. Band-switching is employed for operation on the 80, 40, 20 and 10 meter Ham bands. It gave excellent results under test. No. 27

**HOW TO MAKE THE 806 ALL-BAND TRANSMITTER.** An unusual transmitter delivering 400 watts output from an 806 final amplifier. A crystal pen-test oscillator is used, followed by a driver stage. Real DX has been worked on 10, 20, 40 and 80 meters with this smooth working job. No. 28

**HOW TO BUILD A 125-WATT MODULATOR USING 35T's.** This is an ideal unit for the amateur and will modulate any transmitter with a power input up to about 400 watts. A total of 10 tubes are used including the power supply unit. No. 29

**HOW TO BUILD THE C-O-M 150 WATT TRANSMITTER.** An unusual crystal oscillator, multiplier with but one tuned circuit. It uses a pair of RK33 in parallel with a RK39 driver. The crystal oscillator circuit uses a 616. No. 30

**A LONG-LINES TRANSMITTER FOR 1-METER TRANSMISSION, AND A COMPANION RECEIVER.** A really special job for the seriously minded experimenter. This outfit permits short distance contacts in this interesting band. No. 31

**HOW TO BUILD A 200 WATT XMITTER WITH PEN-TEST EXCITER.** This transmitter will really go to town. The use of the Pen-Test crystal oscillator and frequency multiplier circuit eliminates many headaches from cracked crystals. No. 32

**HOW TO BUILD A 10 AND 20 METER TRANSMITTER.** A 200 watt transmitter which worked world-wide DX on test. Although compact, it is highly efficient in the 10 and 20 meter bands. Five tubes are used. No. 33

**HOW TO MAKE THE WIZARD 1-TUBE 50-WATT TRANSMITTER.** An amateur, crystal-controlled c.w. transmitter using the RK20 screen grid pentode. In tests, it compares with 250-watters. No. 34

**HOW TO MAKE THE "OSCILLODYNE" 1 TUBE WONDER SET.** One of the most sensitive short-wave sets designed, employing a really new circuit for the first time. Battery operated. No. 35

**HOW TO MAKE THE "19" TWINPLEX (ONE TUBE PERFORMS AS TWO) RECEIVER.** One of the most sensitive 1-tube sets ever designed and very popular. No. 36

**HOW TO MAKE THE IMPROVED 3-TUBE DOERLE SET FOR BATTERY OPERATION.** One of the finest of the Doerle series, by the famous short-wave inventor. No. 37

**HOW TO MAKE THE "GO-GET-EM 2" RECEIVER FOR THE BEGINNER.** This unusual 2-tube circuit gives 3-tube results. Battery operated. Excellent for beginners. No. 38

**HOW TO MAKE THE 1-TUBE ALL-ELECTRIC OSCILLODYNE.** This is the famous electrified short-wave receiver. Easy to build for little money. Operates on A.C. and D.C. No. 39

**HOW TO MAKE THE 2 TO 5 METER TWO-TUBE LOUDSPEAKER SET.** This receiver may be used with batteries or with an A.C. power pack. Packs a big wallop. No. 40

**HOW TO MAKE THE 3-TUBE BATTERY SHORT-WAVE RECEIVER.** This receiver was a prize winner in SHORT WAVE CRAFT. An unusual short-wave receiver, easy to build. No. 41

**THE BRIEF-CASE SHORT-WAVE RECEIVER AND HOW TO BUILD IT.** So small that the entire set, batteries, head set, aerial and everything, goes into a brief-case. Stations from Europe are often received. By Hugo Gernsback, Clifford E. Denton. No. 42

**HOW TO BUILD THE POCKET SHORT-WAVE RECEIVER.** One of the smallest, pocket-size, battery receivers ever designed by Hugo Gernsback and Clifford E. Denton. A marvelous set that brings in European stations. No. 43

**HOW TO BUILD THE CIGAR-BOX 1-TUBE "CATCH ALL" RECEIVER.** An effective short-wave battery set which fits into a small cigar box, insuring high portability yet great efficiency. No. 44

**HOW TO BUILD THE "DUAL-WAVE" SHORT-WAVE BATTERY RECEIVER.** With this set, you can hear both ends of radiophone talk, on one set of phones. In other words, you can listen to a ship at sea and the land station communicating with it, simultaneously, by means of this double receiver. No. 45

**HOW TO BUILD THE 1-TUBE "53" TWINPLEX RECEIVER.** The twinplex, although it has only one tube, works as if it had two. Marvelous in efficiency. Uses either batteries or A.C. power pack for "B" supply. No. 46

**HOW TO BUILD THE PORTABLE MINIDYNE SHORT-WAVE BATTERY SET.** Uses no aerial, no ground. The total weight is 3 1/2 lbs. and measures 6x5x6 inches. Self-contained batteries, tube, condensers, and loop. Highly sensitive circuit. No. 47

**HOW TO BUILD THE HAM-BAND "PEE-WEE" 2-TUBE.** A dandy receiver with high efficiency and band-spread tuning. Works a loudspeaker. Yet the entire receiver is no larger than your hand. Works with either batteries or an A.C. power pack. No. 48

**HOW TO BUILD THE DUO-AMPLIDYNE.** The ideal 1-tube set for the beginner. One of the finest 1-tube sets; it really gives 2-tube performance. Made for battery operation. With only ten-foot antenna brings in the good European stations. No. 49

**HOW TO BUILD THE "MONO-COIL 2".** No more "plug in" coils. This set eliminates bothersome coils and is made to cover short-wave bands. Works with either batteries or A.C. power pack. No. 50

**RADIO & TELEVISION, 99 Hudson Street, New York, N. Y.**

Gentlemen: Enclosed you will find my remittance of \$2.50 for which enter my subscription to RADIO AND TELEVISION for One Year (12 issues). Send me promptly, absolutely FREE and POSTPAID, the 15 publications I have circled at the right. (CANADA AND FOREIGN \$3.15.)

NEW SUBSCRIBER  EXTEND PRESENT SUBSCRIPTION

Name .....  
Address .....  
City ..... State ..... R&T-5-39  
Send remittance by check or money order. Register letter if you send cash or unused U. S. Postage Stamps.

1	2	3	4	5
6	7	8	9	10
11	12	13	14	15
16	17	18	19	20
21	22	23	24	25
26	27	28	29	30
31	32	33	34	35
36	37	38	39	40
41	42	43	44	45
46	47	48	49	50

**RADIO & TELEVISION**  
99 HUDSON STREET  
NEW YORK, N. Y.



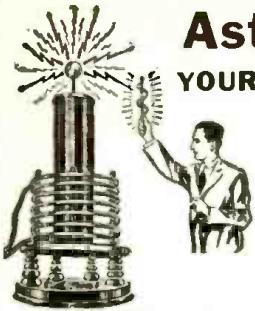

# Astonish

**YOUR FRIENDS!**

Pass  
500,000 Vts.  
Thru the  
Body!  
Light  
Lamps, etc.

## DATAPRINTS

**SHOW YOU HOW!**

**20c Each in Order for 10**

**TESLA-ODUDIN HI-FREQ. COILS**

(Data and Drawings only)

- 36" Sp'k Tesla-Oudin Coil.....40c  
(1 K.W. Exc. Trf. Data. Included FREE!)
  - 8" Sp'k Tesla-Oudin Coil.....40c  
(1/4 K.W. Exc. Trf. Data. Included FREE!)
  - 3" Sp'k Oudin; 110 Vt. "Kiek Coil" type.....40c
  - 3" Sp'k Tesla Works on Ford Sp'k Coil.....40c
  - 1" Sp'k Violeta Hi-Freq. Coil.....40c
- FREE with order for \$1.00 or more—20 Tricks with  
Hi-Freq. Coils\* (40c separate)

Television Hook-ups "Sight & Sound" . . .40c

**20 ELECTRIC TRICKS  
AND LODGE TRICKS!**



Lands of Fun!  
How to Shock 'em!.....40c  
Order with other prints; see  
special Price below and save.

**Solenoid & Magnet Data—Get Our List!**

**20 Telephone Hook-ups—Build Your Own . . .40c**



**RADIO CONTROL  
FOR MODEL BOATS,  
PLANES, ETC.**

Circuit data .....40c

**S-W DIATHERMY**  
(Artificial Fever)

Dataprint giving Constructional  
data for Small, Medium and  
Large size App. (All 3).....40c



**Induction PIPE &  
ORE LOCATOR**

Construction Data .....40c

**You NEED these DATAPRINTS !!**  
40c Each.

- 20 Telephone Hook-ups. Rewinding Armatures.
- 100 Mechanical Movements. Einthoven String Galvanometer.
- 20 Motor Hook-ups.
- 20 Simple Bell Circuits. Resistance Measuring Bridge.
- 2 K.W.

Special Prices: 4 prints \$1.00; 10 for \$2.00;  
40c each, single orders.

**The DATAPRINT Co.**

Lock Box 322A RAMSEY, N. J.

## LAST CALL! STOPPANI COMPASS

Out of 3,000 we had originally, only a few are  
now available. We are not taking advantage of  
this condition by boosting the price. In our catalog  
we list Stoppani Compass at \$7.50. In our  
recent advertisements at \$4.50.

A Precision Instrument  
made in Belgium. Purchased by the U. S.  
Government at more than  
\$30.00 each. Ideal for Radio Ex-  
perimenters Laboratory, also may be  
used as a Galvanometer for detect-  
ing electric currents in  
radio circuits. Ruby  
jewel, solid bronze.  
4 inches square, fitted in  
a hardwood case.



Also used by hunters  
and surveyors.

Our price prepaid \$4.50  
each

Send for catalog containing full descriptions of these  
and many other interesting items.

**GOLD SHIELD PRODUCTS**

Dept. RT-5-9 350 Greenwich St. New York

## The "Bauer" T-R-F Four

(Continued from page 51)

When this coil is used as L2 (in the dia-  
gram): PR1=link coil; SEC=R.F. plate  
coil.

When this coil is used as L3 (in the dia-  
gram): PR1=link coil; SEC=detector  
grid coil.

The amount of coupling indicated on the  
drawing is approximately correct for the  
link circuit. Antenna coils usually have  
closer coupling, so when using commercial  
antenna coils in this receiver, the primary  
coupling will have to be reduced on those  
coils used as L2 and L3, as already ex-  
plained in the text.

The reason that this reduction in  
coupling is necessary is because in L2 and  
L3 we no longer are coupling an aperiodic  
(antenna) circuit to a tuned circuit, but  
are actually coupling two tuned circuits  
(i.e., L2 and L3).

We are all familiar with the use of *link*  
*coupling* in transmitters. It so happens that  
properly adjusted link coupling in receivers  
is just as efficient, although physical ex-  
amination of the coils makes one wonder  
how the diminutive link coil is capable of  
transferring the energy so completely. Well,  
the point is that it does and in some cases it  
may be necessary to decrease the coupling  
even more than indicated in the drawing.  
The experimenter can readily determine the  
proper amount of coupling. The disappear-  
ance of "double spots" on the dial, as ex-  
plained in the text, is the best check.

### SHORT-WAVE COIL DATA (TENTATIVE)

L1 AND L2		L3 AND L4		L5
1.500KC-4600KC	44 TURNS N° 22 DCC	3 TURN LINK	5T	
3000KC-11600KC	15 TURNS N° 22 DCC SPACED DIA. OF WIRE	1 TURN LINK	3T	
6000KC-27,000KC	6 TURNS N° 22 DCC SPACED TO COVER 1"	1 TURN LINK	2T	

THESE SPECIFICATIONS ARE FOR USE WITH STANDARD  
365 MMF TUNING CONDENSER. COILS ARE WOUND  
ON 1/4" DIAMETER RIBBED FORMS, WITH THE  
WINDINGS ARRANGED AS SHOWN:

GRID OR PLATE END  
OF WINDING. GROUND OR B+ END

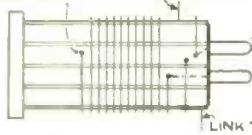

LINK TURN (L3)

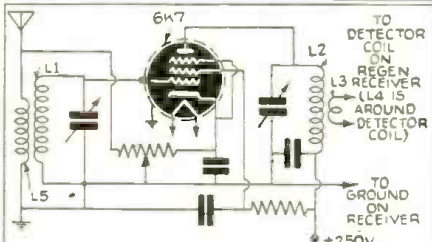

TO USE THE FRONT END OF THE RECEIVER AS A  
SUPER PRE-SELECTOR, MERELY CONNECT ONE  
SIDE OF L3 TO THE ANTENNA POST OF THE  
SUPER AND GROUND THE OTHER SIDE OF L3 TO  
THE CHASSIS OF THE SUPER.  
THE ANTENNA PRIMARY OF THE SUPER THEN  
BECOMES A LINK COIL AND IT MAY BE  
NECESSARY TO REDUCE COUPLING FOR  
SATISFACTORY OPERATION.

Hook-up and coil data for use as S-W  
converter.

## "The Radio Beginner"

will continue

next month—SUBJECT:

"How the Superheterodyne  
Works"

## HERE IT IS.... HAMS

A New  
A.C. AND D.C.  
Pocket  
Volt-Ohm-  
Milliammeter



with Ranges  
to 5000 Volts  
Self-Con-  
tained.

Size:  
3 1/16" x  
5 5/8" x  
2 5/8"

MODEL  
666-H

Will handle all  
Amateur Requirements

**\$14.50**

Net Price



Model 666 — uses  
same case as 666-II  
... Reads to 1000  
volts at 1000 ohms  
per volt  
Net  
Price **\$14.00**

Thermo-Ammeters  
Prices greatly re-  
duced. For a more  
efficient antennae  
circuit, investigate  
Triplet Thermo-  
Ammeters at your  
parts jobber.

Now, a new Triplet AC  
and DC Pocket Volt-Ohm-  
Milliammeter that will  
handle voltages to 5000 volts  
without external multi-  
pliers. It will check the  
high voltages and circuits  
of transmitters and re-  
ceivers—just the instrument  
for amateur use.  
Ranges: AC-DC Voltage at  
1000 Ohms per volt 0-10-  
50-250-1000-5000; DC Milli-  
amperes 0-10-100-500; Re-  
sistance 0-300 shunt type  
10 ohm reading at center  
scale; 0-250,000 series type,  
3700 ohms at center scale.

WRITE FOR CATALOG!

THE TRIPLET ELECTRICAL INSTRUMENT CO.  
Section 285 Harmon Ave., Bluffton, Ohio



## ALL METAL UTILITY CABINETS

NOW READY FOR DELIVERY

Indispensable for keeping under lock and key all  
VALUABLE parts including your QSL or SWL  
cards. Top drawer has 10  
compartments for small  
parts. In the 6 and 8 drawer  
cabinets, the two lower ones  
are made into one unit to  
hold tubes, crystals, meters,  
pick-ups, camera lenses,  
films, micrometers,  
slide rules, etc. In the  
smaller compartments  
you can keep resistors,  
condensers, bolts, nuts,  
washers, etc., from be-  
ing "borrowed".

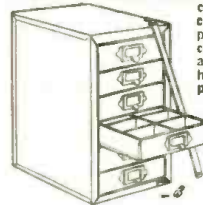

	Height	Depth	Width	List
6 drawers	9"	8 1/2"	6"	3.50
8 drawers	11 1/2"	8 1/2"	6"	4.50

Bar with lock and key .....50

Finished in wrinkle, olive green.  
Amateur's Discount, 40%. Write for complete catalog.  
Ask your dealer to show you a sample. If he has  
none, send your order direct.

**KORROL RADIO PRODUCTS CO.**

350 Greenwich St., Dept. 539, New York City

## HALLICRAFTERS

New S-19-R  
**SKY BUDDY**

The new SKY BUDDY has sensitivity, im-  
age ratio, signal-to-noise ratio and fine all-around  
performance. It has all essential controls for  
communications reception, built-in speaker and  
covers from 44 mc. to 545 kc. Latest design and  
following features—6 tubes, 4 bands, covers 10-  
meter band, Electrical band spread, Separate  
band spread dial, B.F.O., Pitch control, Send-  
receive switch, Band switch, Phone jack and  
AVC switch.

Amateur price \$29.50 net complete

**CAMERADIO**

963 LIBERTY AVE. 30 TWELFTH ST.  
PITTSBURGH, PA. WHEELING, W. VA.

Established 1919



# PRICED FOR CLEARANCE

Rockbottom Prices on Overstocked New and Rebuilt Merchandise

When prices are low we buy! They're low now—LOWER THAN THEY EVER WILL BE—hence this sale. Most of the merchandise is new—never used; some of it reconditioned. 100% satisfaction on each transaction or your money refunded.

**ORDER FROM THIS PAGE.** Use the convenient coupon below. Be sure to include sufficient extra remittance for parcel post charges, else the order will be shipped express, charges collect. Any excess will be refunded. C.O.D. shipments require a 20% deposit. If full remittance accompanies order deduct 2% discount. Send money order—certified check—new U. S. stamps. No C.O.D. to foreign countries.

**ORDER TODAY QUANTITIES LIMITED QUICK SHIPMENTS ASSURED**

## VARIABLE SPEED UNIVERSAL MOTOR

FOR 110 VOLTS, A.C. OR D.C.

Made for Dictaphone machines by American Gramophone Co. Used, but in excellent condition. Special level control permits variable speeds up to 3000 r.p.m. 1/2" shaft extends from both sides of motor. Measures 7 1/2" x 3 1/2" diam. overall. Shp. Wt. 6 3/4 lbs.

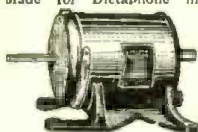

ITEM No. 11  
Your Price ..... \$2.55

## NEW FUEL PUMPS

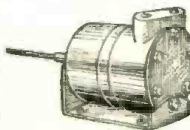

Brown & Sharpe pumps. Brand new; never been used. Can be used for gasoline, oil, kerosene and other fuels. Not good for water. Takes standard thread 1/2" input and output pipes. Has 1/2" drive shaft. Measures 4 x 3 3/4 x 3 1/4" diam. overall. Shp. Wt. 8 1/2 lbs.

ITEM No. 24  
Your Price ..... \$4.45

## SPERRY GYROSCOPE LIQUID COMPASS

Made for U.S. Signal Corps; sensitive and accurate. Quick readings easily made from top; accurate readings of graduations through focusing magnifying lens on side of instrument. Complete with level sights and ratchet leather carrying case. Excellent for boats, boy scouts, campers, hikers, etc. A few turns of wire around its case makes it usable as a galvanometer. Shp. Wt. 3 lbs.



ITEM No. 12  
Your Price ..... \$1.85

## STURDY 8" BENCH SAW

For use in workshops, shipping rooms, repair shops, etc. Experimenters will find it a tremendous time and labor saver. 12 x 14 in. table with 45° tilt. 60° calibrated protractor and adjustable rip fence. Saw blade is adjustable up or down and has automatic drop gear. Weighs 37 lbs. Sold without blade and motor. Shp. Wt. 42 lbs.

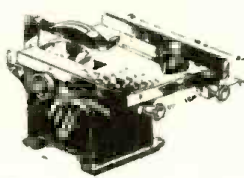

ITEM No. 42  
Your Price ..... \$11.65

## ADJUSTABLE ANGLE VISE

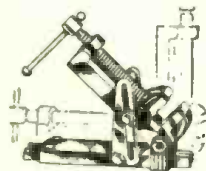

This tool regularly sells for about \$15. A handy tool for use when drilling, filing, marking, grinding, milling, cutting and fitting at tough angles where jigs would ordinarily be used but are not available. Its 2 1/2" jaws open 9° wide and tilt to a 90° angle. Has sturdy end slots for bolting to machine table. Strong screw with steel handle, accurately machined. Jaws are grooved for holding round objects. Measures 8" long. Shp. Wt. 12 lbs.

ITEM No. 43  
Your Price ..... \$5.61

## POWER JIG SAW

A trouble-proof powerful tool with self-contained power unit. Cuts 7200 strokes per minute, leaving smooth edges. An ideal machine for wood-crafters, model makers, handymen, etc. Has 10" square table and gray iron frame mounted on rubber to absorb vibration. Arm blade depth 13 1/2". Designed for 110-120 V. AC use. Measures 9 1/2" x 19 1/2". Adjustable guide and stroke. Sold complete with 8 ft. approved cord and plug, ready to use. Shp. Wt. 12 lbs.

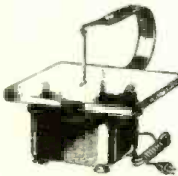

ITEM No. 45  
Your Price ..... \$9.96

## 1/75 HP AC MOTOR

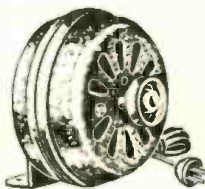

Here indeed is a real bargain in a small quiet powerful motor which every experimenter and home workshop owner will be pleased to own. Develops 1/75 HP at 3000 RPM. The entire motor is only 3 1/2 inches in diameter. 7/8" shaft. Inductor type motor with shaded pole for self starting. Speed can be varied with suitable rheostat. Complete with cord, plug and base, but less pulley. For use on 110 V. 60 cycle AC line. Shp. Wt. 8 lbs.

ITEM No. 44  
Your Price ..... \$1.75

## 20,000 RPM HAND GRINDER

Save 50% on a tough little hand grinder that is extremely useful to radio servicemen, experimenters, jewelers, dental mechanics, etc. Develops 20,000 RPM. Fits solidly in the palm of the hand. Operates on 110 V. AC or DC. 25 or 60 cycles. Its features are: high torque, oilless bearings, sturdy thrust, cool running, handy switch, collet chuck, for 1/8" and 3/32" wheels, finger support for precision work. Its high speed adapts it to all types of jobs including coarse and delicate work. Shp. Wt. 6 lbs.

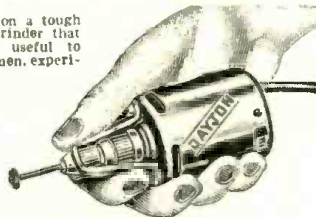

ITEM No. 48  
Your Price ..... \$7.62

## COMPLETE ELECTRIC SPRAYER OUTFIT



Consists of a sturdy compressor 110 V. 1/4 HP, 1750 RPM motor, 10 ft. hose, efficient spraying gun and all necessary mounting accessories. Costs only 2 cents per hour to operate. Delivers considerable air pressure. Positively will not bump oil. Few working parts to wear. Sprays practically anything. Shp. Wt. 40 lbs.

ITEM No. 46  
Kit less motor, but with gun  
Your Price ..... \$6.36

ITEM No. 47  
The complete kit including 1/4 HP motor  
Your Price ..... \$14.53

**WE HAVE NO CATALOG. ORDER DIRECT FROM THIS PAGE.**

**HUDSON SPECIALTIES - 40-T West B'way - N.Y.C.**

**IT'S EASY TO ORDER—CLIP COUPON—MAIL NOW**

HUDSON SPECIALTIES CO., 40-T West Broadway, New York, N. Y. RT-539

I have circled below the numbers of the items I'm ordering. My full remittance of \$..... (include shipping charges) is enclosed.

OR my deposit of \$..... is enclosed (20% required), ship order C.O.D. for balance. (New U.S. stamps, check or money order accepted.)

Circle Item No. wanted: 11 12 24 42 43 44 45 46 47 48

Name ..... Address .....

City ..... State .....

Send remittance by check, stamps or money order; register letter if you send cash or stamps.

Let's Listen In with  
Joe Miller

(Continued from page 23)

## HAM STARDUST

Writing during middle of A.R.R.L. Contest, we are still awaiting the Spring "opening" of bands, but at present in vain. But much better things are in store, so let's see what we can hear, listed here, and then pray that a few of these luscious calls fall prey to our straining ears!

### ASIA

This is the continent we all want to hear in particular, no guess work there! We will mention DX reported for each country, then list others on 20 fone also operating in that particular land.

### BURMA

XZ2EX, 14060, by Mario Bruscia, W2, FB DX OM, at 9:40 a.m.! Others on fone are XZ2DY, 14100, 210, 375; XZ2DX, 14040; XZ2PB, 14040; and 2DY also reported on 332, using 100 watts (I.D.A.-A.T.).

### FRENCH INDIA

FNIC, Chandernagore, a district within the city of Calcutta, but under French rule, is reported on a number of frequencies, from 14075, 14150, 14210 and again to 14040! This would count a separate country.

### JAVA

PK1RI, 14030; PK2AY, 14020; PK2WL, 14130; PK3WI, 14040, and PK4KS, 14320, all by Rog Legge, W8, I.D.A. Ama-touring Editor, who's doing a FB job on A.T. and DX, too. PK3WI and 4KS also here. Others are: PK1VY, 14270, 060, 100; PK1DB, 14300; PK1RL, 14030, 280; PK1BN, 14260; PK1ZZ, 14280, 320; PK1VM, 14100; PK1SK, 14070; PK2RN, 14320; PK2JN, 14320; PK2DF, 14040; PK3AA, 14300, 360. In Sumatra are: PK4JD, 14100, reported by Ian Jamieson, G; PK4VR, 14375.

### CHINA

XU3AA, 14075, reported by Carl Weber, W2 (I.D.A.) at 10:45 a.m. XU8RB, soon to be on with 500-600 watts, has his license again. FB news for "Reg." and will be on 14084 and 14212 (I.D.A.). Other Chinese are XU6TL, 14056, 120; XU8MC, 14000, 090; XU8ET, 14050; XU8HW, 14080; XU9CS, 14280; XU2HL, 14035; XU8RL, 14310; XU8JR, 14130; XU8MT, 14030, 135.

### JAPAN

J7CB, J8CB, J2MI are reported by Max Fisher, W6, but no frequencies. J8 is Korea, a new country, and now called Chosen by the Japanese. Heard by Max near midnight. E.S.T. Other Japs are: J2MK, 14080; J2LL, 14010; J2KJ, 14260; J2KN, 14400; J2QJ, 14250; J2CR, 14035; J5CC, 14400, 280. And in Korea, J8CA, 14260; J8CG, near 14400.

### PHILIPPINES

KA1FH, 14130, KA1PI, 14140, reported by Rog Legge. Other KA's heard here are KA1FH, KA1LB, KA1ME, KA1CS, all on low end of the American fone band, vicinity of 14150, and KA1ME, also around 14280. Other KA's are: KA1MG, 14280, 140; KA1JZ, 14300; KA1BH, 14140; KA1CW, 14270; KA1AP, 14300; KA3BW, 14176; KA7EF, 14120, 150, 290. Ian Jamieson reports KA1ME, KA1PI and KA1FH.

### INDIA

VU2FU, 14200, by OM Ian. Others are: VU2BG, 14140; VU2CO, 14140; VU2DR, 14120; VU2LL, 14370, 340; VU2FU, 14240; VU2JK, 14030; VU2FQ, 14060, 190. VU2FQ, QSL'd to Murray Buitkant, W2, for reception at 3 p.m., on 14190, in midst of American fone band! How do you do it, Murr?

### STRAITS SETTLEMENTS

VS1AB, 14250; VS1AF, 14070, are on fone in Singapore.

### FED. MALAY STATES

VS2AE, 14100, 320, 370; VS2AR, 14040, 310, 370 are on fone.

### HONG KONG

VS6AF, 14300; VS6AB, 14080, are on fone.

### CEYLON

VS7GJ, 14060; VS7RF, 14336; VS7JW, 14350; VS7RP, 14255, are on fone.

### PALESTINE

ZC6EC, 14300; ZC6AP, 14210; ZC6AC, 14250, are reported on fone, but unlicensed, under cover.



# G.E. PHONOGRAPH MOTOR

Formerly Sold for \$15.00

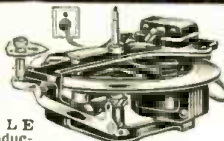

Only \$4.95

**VARIABLE** speed induction type self-starting, 110 volt, 25 to 60 cycle, A.C. with speed control. Plug and cord. Speed range from 5 to 200 R.P.M. Can be installed in place of old-fashioned, hand-winding speed motor. Also ideal for display turn table, and a hundred other uses. These General Electric Motors are brand new, in original factory cartons. **\$4.95** G. E. Electric Phonograph motor as described

Shipping Weight—12 lbs.

## MICROPHONE and RECEIVER

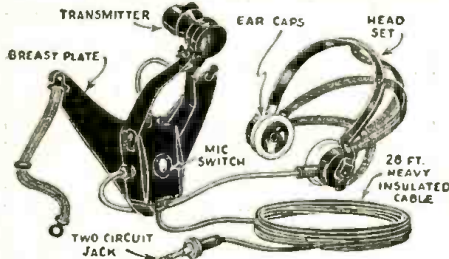

**THIS** Microphone and telephone headset outfit was built especially for the U. S. Navy Aviation Corps.

The Holtzer-Cabot Electric Company constructed the outfit to Government specifications.

The outfit consists of low-impedance carbon microphone (transmitter), securely fastened to a metal breast-plate, and a set of heavy-duty, low-impedance earphones. A specially constructed switch on the back of the breast-plate controls the microphone circuit. The earphones are U.S.N. "C" type, attached to adjustable headband. Twenty-eight feet of very heavy, and waterproof conductor cable is furnished. Current of not more than 10 volts should be used. A storage battery is the most satisfactory current supply.

U. S. Navy Airplane-type Microphone and Receiver as described. **\$4.96**

Shipping Weight—9 lbs.

We will forward Shipments by Express Collect if sufficient postage is not included.

**WELLWORTH TRADING COMPANY**  
560 W. Washington Blvd., Dept. RT-539, Chicago, Ill.

## Just Published . . . a NEW RADIO AND ELECTRONIC DICTIONARY Containing 3,800 Definitions . . . . .

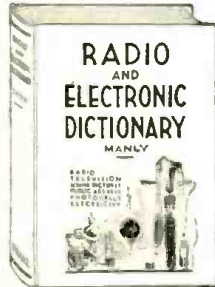

**THIS RADIO AND ELECTRONIC DICTIONARY**, written by Harold P. Manly, explains the meaning of 3,800 terms used in radio, electronics and other closely allied fields. It includes new terms used in radio transmission, sound pictures, television, public address, aviation radio, navigation and industrial control, photo-electricity, photo-cell application, telephotography, etc. This dictionary permits learning every new expression whether you hear it or read it. Alphabetically arranged for quick reference. 355 illustrations augment definitions in the text.

The book is recommended for students, instructors, engineers, service men, experimenters, salesmen and everyone in any way associated with radio. **ONLY \$2.50**

**THE RADIO AND ELECTRONIC DICTIONARY** is new, authentic and printed in a single volume of 300 pages, size 6 x 9 inches. The book weighs two pounds, and bound in durable cloth. **SHIPPED ANYWHERE \$2.50** IN U. S. A. POSTPAID . . . Price

Mail remittance by check or money order to **RADIO PUBLICATIONS**  
99 HUDSON STREET NEW YORK, N. Y.

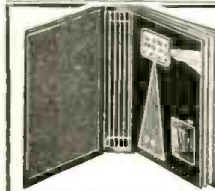

### "JIFFY" Magazine Binders

Sturdily built and covered with black fabricoid. Has two stamped metal ends with 12 spring wire separators. Magazines can be inserted and removed in a jiffy. No fuses—no lost time—no labor.

- No. 1. 12 1/2" x 9 1/2", with 2-inch back for R.T., Radio-Craft, Radio News, etc. **\$1.00**
- No. 2. 10 1/2" x 7 1/2", with 3-inch back for QST, Radio, Popular Mechanics, etc. **\$1.00**
- No. 3. 8 1/2" x 6 1/2", with 3-inch back for Reader's Digest, etc. **\$1.00**

De Luxe Models, Above sizes—**\$1.50**  
P.P. Prepaid in U.S. and Canada  
Send for catalog containing full descriptions of many other interesting items.

**GOLD SHIELD PRODUCTS**  
Dept. RT-5-9 350 Greenwich St. New York

**AFRICA**  
**MOZAMBIQUE**  
CR7MD, 14400+, heard here at 12:25 a.m., but faded out suddenly.

**MADEIRA**  
CT3AN, 7.09 mc. on 40-meter band, heard at 1:25 a.m., recently.

**EGYPT**  
SU1MW, 14145; SU1CR, 14055, SU1RD, 14300; SU1RH, 14020, reported and heard here.

**TANGIERS**  
EK1AF, 14020, 14135, new call prefix of CN1AF, heard by many.

**MADAGASCAR**  
FB8AH, 14380, reported by many, with a usual R8-9 signal.

**FRENCH MOROCCO**  
CN8MT, 14080; CN8AI, 14110; CN8AW, 14030; CN8MI, 14030; CN8MB, 14030; CN8MV, 14060, reported and heard here. CN8AC, 7.07 mc., here at 2:15 a.m.  
South Africans still coming in, but dying off.

**EUROPE**  
**LITHUANIA**  
LY1S, 14020; LY1KK, 14080, heard and reported. LY1BF, 14140.

**POLAND**  
SP1MR, 14015, 3:40 p.m. here

**LUXEMBURG**  
LX1TW, 14050; LX1AY, 14060, 220; LX1GI, 14100, by Ian Jamieson.

**JUGO-SLAVIA**  
YU7VX, 14020; YU7XU, 14150, by Ian.

**SWITZERLAND**  
HB9DB, 14060; HB9S, 14170, 110, by Ian.  
Others by Ian are: OH8NW, 14080, Finland; ZA1CC, 14135, Albania; TF3C, 14060, Iceland.  
We regret leaving on 10-meter DX, but will have a space reserved for it next month. Europe and Africa come in FB now from 8 a.m.-2 p.m., and Oceania, occasionally on Asiatic, heard near 6-7 p.m. on East Coast.  
Good DX hunting to all!

## Television and Ultra Short Wave Antennas

(Continued from page 8)

casting System's television aerials mounted on the spire of the Chrysler Tower, New York City. The video antenna is 937 feet above the street, and the audio or voice antenna 965 feet above the street. There are sixteen dipoles in the complete antenna system, and the television transmitter is mounted in the tower, directly beneath the antennas. The transmitter is connected by means of a co-axial cable with large television studios located nearby, at Grand Central Terminal.

Fig. 7 shows the U.S.V. antenna for 11.4 meter (26,150 kc. or 26.1 mc.) broadcasts erected by station W9XUP, owned by broadcast station KSTP, St. Paul and Minneapolis. (Power is 1000 watts.)

The antenna system shown in Fig. 7 is mounted on top of a 175 foot steel tower. A small platform, 4 feet by 4 feet, was constructed on top of the tower to be used in the installation of the antenna, for tuning the antenna, and for use in the contemplated research on high frequency antenna design. The antenna is of three inch steel seamless tubing 3/4 wave length long, of which approximately 1/2 wave length is now being used as the actual radiator. It is mounted in a sleeve fastened to the steel tower so that the tube may be easily adjusted to any desired height of radiator up to 3/4 wave length. The antenna is fed by means of a concentric line which is coupled to the antenna by means of the condenser-slant wire method in the manner of the shunt feed method used in some broadcast installations. This method was used due to its flexibility—it combines ease and accuracy (Continued on page 57)

# COILS



- Ideal for construction or replacement use.
- Complete Line.
- I.F. Transformers.
- Antenna, R.F., and Oscillator coils.
- Iron Core or Air Core Types
- Mica trimmed and permeability tuned types.
- Litz wire wound.
- Special types for amateurs.
- Fully guaranteed.

Consolidated coils are made uniform by rigid manufacturing control plus prealigning and checking on special testing equipment. Each coil treated carefully with special compound to exclude moisture and assure permanency of original adjustment.

See Them at Your Parts Jobber's Today!

**CONSOLIDATED**  
WIRE AND  
**CORPORATIONS**  
528 S. PEORIA ST. CHICAGO, ILL.

## A PROFESSIONAL SLIDE RULE

PRACTICAL, EDUCATIONAL, TIME SAVER

Features: Nickel Silver framed indicator with integral friction springs. Scales calibrated directly on well-seasoned wood. Retains accuracy regardless of temperature or humidity changes. Instructions and illustrations of primary operations clearly printed on reverse side of rule for ready reference or teaching. Each rule with a durable pocket carrying case for convenience and protection.

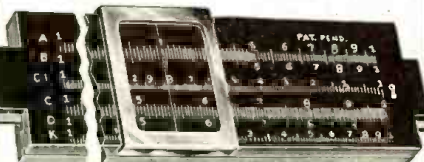

We offer an eight inch, white wood, accurate slide rule with A, B, C, D, CI and K Scales, a 20-page Book of Instructions, How to Use a Slide Rule, a 30-page Book of 300 Examples and Answers, a two-toned Facsimile of the Declaration of Independence, suitable for framing, and an 8-page catalog illustrating and describing indoor games and many unusual items. All five prepaid anywhere in the United States and Canada for **50c**

Send for catalog containing full descriptions of these and many other interesting items.

**GOLD SHIELD PRODUCTS**  
Dept. RT-5-9 350 Greenwich St. New York



### UNIVERSAL 15MM. "Streamliner"

Highest quality sound pickup for p. a., recording and amateur. Crystal or dynamic in any impedance. Modern in design. Inel. loop, flex. tube, screw plug and 25 ft. cable. In De Luxe package. At your jobber's now.

**UNIVERSAL MICROPHONE CO., LTD.**  
424 Warren Lane, Inglewood, Calif.



## EVERYTHING IN RADIO!

A COMPLETE SOURCE FOR YOUR RADIO NEEDS  
Our immense stock of radio sets, parts and supplies enables you to purchase your entire needs on one order. You will find all your Nationality Known Favorites in this big book which is FREE for the asking. Practically every order is shipped the same day it is received.  
WRITE FOR BIG NEW CATALOG

**BURSTEIN-APPLEBEE CO.**  
1012-14 McGee St. Kansas City, Mo.



# Getting Started in Amateur Radio

(Continued from page 19)

adapted to several frequencies and is easier to build and adjust. The feeder wires of the transmission line should be close to a multiple of a quarter wavelength. Differences in the exact length can be compensated for in the coupling and tuning arrangement. The two wires of the feed should be from 3 to 12 inches apart and be held at that spacing by means of insulators spaced every foot or two along the length of the transmission line.

The most popular type of Hertz antenna used by amateurs is the "Zepp" antenna, so-called because it was first used on Zeppelin airships. This antenna consists of a horizontal wire of any desired number of half-wavelengths, computed by the method given above and a tuned feeder, one wire of which is connected to the aerial and the other is left floating. The feeder is an odd number of quarter wavelengths long. Series tuning can be used with feeders having a length between  $\frac{1}{4}$  and  $\frac{3}{8}$  of a wavelength. For feeders shorter or longer than these limits, parallel or current feed is desirable.

Since this type of aerial is particularly suited to the transmitter that was described in Part 2, some exact details will be given for making such an antenna and coupling arrangement.

Figure 3 shows the makeup of the antenna. The length L is figured from the method given at the beginning of this article. The length of the feeders and the method of tuning the coupling coil is given in the chart below, for the wavebands cov-

ered by the X-mitter described in Part 2.

Length of each wire F in feet	Waveband and Tuning Arrangement			
	1750 Kc.	3500 Kc.	7000 Kc.	14000 Kc.
120	Series	Parallel	Parallel	Parallel
90	Parallel	Series	Series	Parallel
60	Parallel	Series	Parallel	Parallel
30	Not recommended	Parallel	Series	Parallel

In tuning the Zepp antenna with series tuning, the condensers should be turned to the maximum capacity position, while with parallel tuning the condenser should be at minimum capacity. After the transmitter has been tuned to the desired frequency, following the methods given in Part 2, the antenna coupling coil should be placed near the output tank coil in the transmitter and the series condensers tuned simultaneously until the radio-frequency ammeter shows maximum current and the plate current milliammeter in the X-mitter shows normal current.

The procedure with parallel tuning is the same as above, except that the condenser is set at minimum capacity and is increased for maximum indication in the R.F. ammeter. Only one meter is needed as it can be shifted from one line to the other. The readings on both lines should be the same.

The coil for coupling the transmitter to the feeder line is made identical to the tank coil used in the plate circuit of the 46 tube. Two clips should be provided as shown in Fig. 4, to reduce the over-all inductance for the higher frequency bands. The coil and

the two condensers with the R.F. ammeter should be mounted on a suitable chassis or panel to permit the coil to be coupled to the tank coil in the X-mitter.

In addition to the simple Marconi and Hertz antennas, of which the Zepp is a representative type, there are many other types. The feed can be connected to the center of the single wire span, making what is called a "doublet." Then the feeder line can be made in the form of heavy aluminum or copper rods tuned to  $\frac{1}{4}$  wavelength and this becomes the "Q" antenna. Many other modifications have been made, each with some characteristic to fit an individual need.

To increase the radiation in a given direction, many hams have tried the various forms of directive arrays, such as the rotatable doublet with a reflector, and the "V" type or diamond type long wire directive systems. However, these are highly specialized types of transmitting antennas and do not lend themselves well to the beginner's needs. These special types of aerials can be studied later when the new ham has tried the more conventional types.

In the next part of this series, we will discuss the design of power-supply units, with some references to the various types of rectifier and filter systems commonly used in amateur stations. This includes the brute-force, tuned and swinging types of filters, each of which has some application in supplying the high voltage to the elements of the tubes in a phone or C.W. transmitter.



## TELEVISION'S Stride Today Makes It Essential for You to Read—"ABC of TELEVISION"—

WITH important progress being made in Television every day—and with developments satisfactory to Television engineers that consistent programs will be broadcast shortly, it is important that principles be understood quite thoroughly.

The publishers of RADIO AND TELEVISION give you the opportunity to add "ABC OF TELEVISION" or two other books to your technical library. They make the offer even more attractive by giving these books to you absolutely FREE. A subscription to RADIO AND TELEVISION for seven months at the cost of One Dollar gives you a choice of either of the three books shown in this advertisement. For Two Dollars you receive RADIO AND TELEVISION for fourteen months and you receive any two books of your choice absolutely FREE. To get all three books FREE, enter your subscription for twenty-one months for only Three Dollars. ANOTHER SAVING FOR YOU—THE PUBLISHERS PAY POSTAGE ON THE BOOK OR BOOKS YOU CHOOSE.

### Partial Contents of ABC of Television

**CHAPTER 1**—The simplest television receiver; how the eye sees; its likeness to television equipment.  
**CHAPTER 2**—Theory of scanning; the Nipkow disc and its relation to television; the photo-electric cell; neon lamps; brief description of several modern mechanical systems.  
**CHAPTER 3**—Need for a large number of picture elements; need for broad channel width in transmission of high-fidelity television signals.  
**CHAPTER 4**—The use of the cathode ray tube in television receivers; necessary associated equipment used in cathode-ray systems.  
**CHAPTER 5**—How a television station looks and how the various parts are operated.

**CHAPTER 6**—The Iconoscope as used for television transmission in the RCA system.  
**CHAPTER 7**—The Farnsworth system of television transmission.  
**CHAPTER 8**—The future of television; Probable cost of receivers; some expressions of opinion by prominent men; list of present television transmitters.

64 PAGES—100 ILLUSTRATIONS  
 Stiff, Flexible Covers, 5½x8¼ INCHES

## Get One or All of These Books

# FREE!!

RADIO AND TELEVISION, 99 Hudson Street, New York, N. Y. R&T-5-39

Gentlemen: Enclosed you will find my remittance of \$..... for which enter my subscription to RADIO AND TELEVISION as checked below; also send me, postpaid, the book or books which I have marked below.

- ABC OF TELEVISION  
 S.W. RADIO QUIZ BOOK AND KINKS  
 SHORT WAVE GUIDE
- 7 months—\$1.00—choice of any one of three (3) books. (Canadian and foreign—\$1.30)  
 14 months—\$2.00—choice of any two (2) of the three (3) books. (Canadian and foreign—\$2.60)  
 21 months—\$3.00—all three books. (Canadian and foreign—\$3.90)  
 If you are a subscriber now, we will extend your present subscription.  
 New subscriber  Old subscriber

Name..... Address.....  
 City..... State.....

Send your remittance by check or money order. If you send cash or unused U.S. postage stamps, please be sure to register your letter for your own protection.

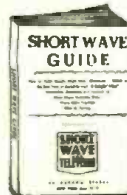

**SHORT WAVE GUIDE**  
 Covers hundreds of short-wave questions and answers; illustrates popular short-wave kinks; gives explicit instructions for building simple short-wave receivers; instruction on the best type of antenna installation; diagram and construction details for building transmitters.

### S. W. RADIO QUIZ BOOK

This book covers questions and answers on transmitters, short-wave receivers, ultra short-wave receivers; practical hook-ups for experimenters; how to "hook-up" converters, noise silencers, power supplies, modulators, beat oscillators, antennas, pre-selectors and 5-meter receivers.

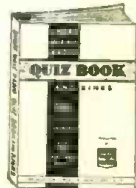



## Television and Ultra Short Wave Antennas

(Continued from page 55)

of tuning with speed of tuning, which is very advantageous for any experiments on the antenna.

The program material for W9XUP up to the present time has been either the regular KSTP programs or the NBC Red Network programs. Special programs of interest primarily to the amateur have been contemplated for the near future in addition to special programs of common interest. The station is on the air from 7:00 A.M. to 12 o'clock midnight CST every day. Reports of reception will be acknowledged by card.

## Why NOT "Commercial" Television?

(Continued from page 8)

casting field, that the earlier these licenses are issued, so that television can "get going," the sooner television will become a strong factor in helping to revitalize the country's business.

One radio manufacturer told the writer the other day that he has been getting inquiries daily from broadcasters all over the country, for prices and delivery dates on television transmitters; but in the same breath, many of them mentioned that they are still worried about the fact that they will be under a heavy expense so far as producing programs is concerned because they cannot solicit sponsors!

I am sure that the radio industry and the readers of RADIO & TELEVISION would highly appreciate an opinion from you as to how soon commercial television licenses may be issued.

Cordially yours,

**RADIO & TELEVISION**  
(Signed) H. W. Secor  
Managing Editor

Commissioner McNinch's Reply Follows  
Federal Communications Commission  
Washington, D. C.  
March 16, 1939

Mr. H. W. Secor, Managing Editor,  
RADIO & TELEVISION,  
99 Hudson Street,  
New York, N. Y.

Dear Mr. Secor:

After careful consideration of your request in your letter of March 4, I have reached the conclusion that it would not be advisable for me to respond to your invitation to venture expression of an opinion as to the present status of television, and as to how soon I think commercial licenses may be issued for radio facsimile stations.

For numerous reasons, which are to the Commission entirely satisfactory, the Commission has not deemed it advisable to grant commercial licenses for either facsimile or television, and because I could not forecast accurately the time or the character of future Commission action touching these subjects, it seems unwise for me to enter the dubious field of prophecy.

Sincerely yours,

**FRANK R. MCNINCH,**  
Chairman.

## Radio-Craft

\$4,000 Public Address Contest.  
5-Tube Superhet. Weighs 2 3/4 Lbs.!  
Breaking into Coin-Phonograph Servicing  
—Part I.  
Building an A.C.-D.C. Set in a World's Fair Theme.  
Double-Tracing Your Oscilloscope.  
A Switchless 2-Way Interphone!  
The current, May issue of RADIO-CRAFT on all newsstands April 1.

# Complete RADIO TRAINING for \$1.95

## Regular \$39.00 RADIO TECHNICAL INSTITUTE Course



### AN UNUSUAL OFFER

A limited quantity of R.T.I. \$39.00 radio servicing courses have been reprinted and are offered to you at only \$1.95. These are the latest 1937 courses, complete in every detail with all supplementary material, and exactly

the same as the originals.

Radio is the present-day opportunity field. Hundreds of men with no special talents have studied Radio Servicing for a short time and are now making twice and three times as much money. R.T.I. unique radio training brings rich rewards; you can get ready quickly, inexpensively, easily, and in your spare time for a good job in radio.

### ACCEPTED BY INDUSTRY

Forty large radio manufacturers have helped to prepare the R.T.I. course. Just think what this backing by the radio industry means to you. R.T.I. practical training will give you facts and real data you will need on the job. Hundreds of diagrams and illustrations will help you. You will pass quickly from lesson to lesson and in a surprisingly short time will be ready to do real radio servicing.

### COMPLETE IN ALL DETAILS

No special previous education or experience is needed. R.T.I. course will give you all the training you need. The lessons are clear, interesting, easy to master and use. Fellows who knew nothing about radio before taking the R.T.I. course are now the leading servicemen in their communities. This is your chance to obtain this excellent course for only \$1.95.

From the very start you are introduced to practical servicing equipment and practices. You are told how to open your own shop or radio store. Lesson 15, "The Radio Servicink Business," will give you many practical ideas and hints. The course is so planned that you will be able to earn spare-time money before you have reached your tenth lesson. The special \$1.95 price of the complete course can be earned in a single evening's work.

### YOUR GUARANTEE

You are completely protected. We guarantee these courses to be exactly as the original \$39.00 Radio Technical Institute courses. Money back guarantee. References: Liberty National Bank, Chicago.

### THREE COURSES IN ONE

R.T.I. course is really three complete essential courses combined. You get training in (1) Practical and Applied Radio; (2) Fundamentals of Radio Principles; and (3) Advanced Specialized Training. This is the training that will place you above the average radio servicemen—and you get this training for only \$1.95.

There are over 32,000,000 radio sets in use. Over 4,500,000 auto radios alone. You should cash in on this gigantic money market. The R.T.I. easy practical course will pave the way to your success in Radio work.

### TELLS HOW TO USE INSTRUMENTS

The training is complete. Everything from simple facts to complex alignment problems. Many servicemen have found that R.T.I. training is excellent for brush up and study of modern servicing methods. This is the best buy in a radio education. Take advantage of the bargain price today.



### LATEST DATA

Yes, in the R.T.I. course you will find a complete explanation of A.V.C., how to use an oscilloscope, sound feed-back, resonance phenomenon . . . every possible fact you must know to be the best servicemen. You get a real radio training. One of the BEST radio courses is yours for only \$1.95.

### LIMITED QUANTITY

Hurry your order to us today. There is but a small quantity of the courses left at the special price. You are completely protected with our guarantee. Send total remittance with order, or we will ship C.O.D. Postal money orders, checks, currency, unused stamps accepted. Answer today.

### SUPREME PUBLICATIONS, Agents 3729 W. 13th Street, Chicago, Ill.

Please send the complete R.T.I. radio course at the special \$1.95 price.

- I am enclosing \$1.95, send prepaid.  
 Send C.O.D. I will pay mailman \$1.95, plus a few cents postage.

NAME .....

ADDRESS .....



## U. S. ARMY SIGNAL CORPS LAMPS

The lamp of 100 uses

Scout Signalling  
Night Bowling Alleys  
Trailer Lamp  
Night Motor Boat Races  
Auto. Truck and Trailer Camps  
Tractor Light  
Camp Light  
Barnyard Lighting  
Night Fishing  
Radio Shafts  
Bungalows  
Picnics, etc.



Scouts Signalling

Lamp size—12 1/2" wide, 5 1/2" deep, 1 1/2" high including socket, fitted with 10" silver plated reflector (no glass, nothing to break). Packed in portable wooden carrying case, with hinged cover, hump and handles. Every case contains weatherproof extension cord and plug, 2 extra bulbs, flashlight signalling key and 16 page U.S. Army Instruction Manual. Shipping weight 18 lbs. Price \$25.00. (Cost to the Government about \$25.00)

**\$2.50**  
F.O.B. N. Y.

Same size lamp without wooden case or extra fittings \$1.50  
Small lamps, 6" ..... \$1.00  
Send for catalog containing full descriptions of this and many other interesting items.

### GOLD SHIELD PRODUCTS

Dept. RT-5-9 350 Greenwich St. New York

## NEW—LUMINOUS PAINT.. that SHINES ALL NIGHT

Used on keyholes, wall switches, "Ham" radio dials, etc. Easily applied to any surface. Harmless. Now available in 25c, 50c, & 75c sizes. 10c for sample bottle and 50 applications. Dealers and agents wanted.  
**EASTERN MFG. CO.,** Dept. R5, 656 Broadway New York City

## Radio Men find This Book Handy

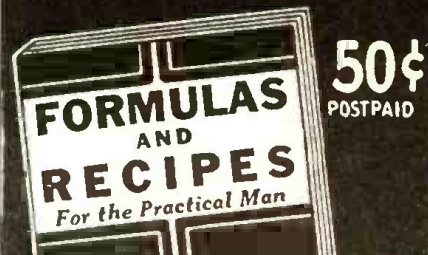

**50¢**  
POSTPAID

### Here Is the Contents of the Book

1. Adhesives. Glues. Cements. Gums. Mucilages. Lubricants. 2. Cleaning: Stain Removers. Paint Removers. Bleaches. Cleaning Fluids. 3. Metal Craft: Coloring. Oxidizing. Plating. Repairing. Welding. Polishes. Alloys. Solders. Amalgams. 4. Paints: Colors. Stains. Varnishes. Enamels. Luminous Paint. Washable Paint. Paint-Removing. Waterproofing. Fireproofing. 5. Glass-Working: Cutting. Drilling. Boring. Bending. Blowing. Etching. Engraving. Frosting. Silvering, etc. 6. Wood-craft: Fillers. Fireproofing. Anti-proofing. Waterproofing. Furniture Polishes. Finishes, etc. 7. Inks: Recipes. Eradicators. Ink Stain Removers. Special Inks. Colored. Indelible. Sympathetic. Invisible. Hectograph. 8. Photography: Developers. Emulsions. Fixers. Sensitizing. Toning. Printing. Photograph Paper. Blueprint Paper. 9. Antidotes for Poisons. Remedies for Burns and Scalds. Disinfectants. First-Aid in Accidents. Emergency Remedies. Home Remedies. 10. Preparation. Manipulation. Handling. Mixing. Measuring. Weighing. Filtering. Straining Solutions: List of Technical Substances. Emulsifying: Use of Hydrometer. Use of Thermometer; Tables of Weights and Measures. Decimal Systems. Useful Tables.

### TECHNIFAX, Division RT-539 560 W. Washington Blvd., Chicago, Illinois

TECHNIFAX, Division RT-539  
560 W. Washington Blvd., Chicago, Illinois  
Gentlemen: Enclosed please find 50c (check, money order, coin or unused U.S. stamps accepted) for which send me POSTAGE PREPAID, One Copy of FORMULAS AND RECIPES for the Practical Man.

Name .....

Address .....

City ..... State .....



# COMMERCIAL NOTICES 10¢ A WORD

Under this heading only advertisements of a commercial nature are accepted. Remittance of 10¢ per word should accompany all orders. Copy should reach us not later than the 10th of the month for the second following month's issue.

## AGENTS WANTED

300% PROFIT SELLING GOLD Leaf Letters for Store Windows; Free samples. Metallic Co., 446 North Clark, Chicago.

## CORRESPONDENCE COURSES

**CORRESPONDENCE COURSES** and educational books, slightly used. Sold. Rented. Exchanged. All subjects. Satisfaction guaranteed. Cash paid for used courses. Complete details and bargain catalog. Free. Send name. Nelson Company, E-210 Manhattan Building, Chicago.

## INSTRUCTION

**RADIO ENGINEERING. BROADCASTING, aviation and police radio, servicing, marine and Morse telegraphy taught thoroughly.** All expenses low. Catalog free. Dodge's Institute, Colt St., Valparaiso, Ind.

**COMPLETE RADIO CODE COURSE** on Three Records. Dealer's Net Price \$3. Poinsettia, Inc., Pittman, N. J.

## MISCELLANEOUS

**FOR SALE, 18" SHIP MODELS.** Colob. East Harvey St., Ely, Minn.

**7 MILLIAMMETER, HEAVY RUBBER insulation, high voltage lacquered cable, suitable for transmitter, 2¢ per foot.** Gold Shield Products, 350 Greenwich St., New York City.

## PATENT ATTORNEYS

**INVENTORS—PROTECT YOUR rights before disclosing your invention to anyone.** Form "Evidence of Conception"; "Schedule of Government and Attorneys' Fees" and instructions sent free. Lancaster, Alwine & Rommel, 436 Bowen Building, Washington, D. C.

## QSL-CARDS-SWL

**100 NEAT SWL CARDS PRINTED** with your name and address sent post-paid for \$1. Bunch of samples and R-T Chart for five cents in stamps. WBEF, 16 Stockbridge Ave., Lowell, Mass.

**QSL-SWL CARDS, 200 FOR \$1.** Quality Printing. Send stamp for Free Samples. Miller Printing Co., 399 Thirteenth Ave., Columbus, Ohio.

## RADIO

**STOP—BEFORE YOU BUY A** short wave receiver, send dime for our

24-page catalog containing circuit diagrams and information on over 25 Doerle short wave receivers and transmitters. See Dec. 1938 issue for details describing a few of our models. Oscar B. Kusterman, 297 DeKalb Ave., Brooklyn, N.Y.C.

**PLANS 18 TESTED CRYSTAL sets.** SW record 4250 miles, with "radiobuilder" year. 25¢. Laboratories, 7100-A East 14th, Oakland, California.

**3,000 MI. CRYSTAL-PLANS 10¢.** Kit \$1.00. World-wide metal tube receiver \$1.95. Information free. Call radio, B.94H, Saugus, Calif.

## SHORT WAVE RECEIVERS

**WE STILL HAVE A FEW USED** Doerle receivers Models D-38, B85 and 7C, reconditioned by factory, at 40% off. See Dec. 1938 Radio and Television for description. Oscar B. Kusterman, 297 DeKalb Ave., Brooklyn, N.Y.C.

## SONG POEMS WANTED

**WANTED ORIGINAL POEMS,** songs for immediate consideration. Send poems to Columbia Music Publishers, Ltd., Dept. K49, Toronto, Can.

# FOR SALE (NON COMMERCIAL) 3¢ A WORD

Under this heading we accept advertisements only when goods are offered for sale without profit. Remittance of 3¢ per word should accompany all orders. Copy should reach us not later than the 10th of the month for the second following month's issue.

**FOR SALE, NATIONAL 1-10** slightly used, complete with tubes, coils and power pack. No speaker. \$25. Harold Mendel, 2474 Marlon Ave., New York City.

**MASTER TELEPLEX \$25.** HAM special \$13. Instructor-aided, complete \$18. James Rush, 14 Madison Ave., Pleasantville, New York.

**SKY BUDDY, \$15.00.** EDW. BIRD, 4340-6th N.E., Seattle, Wash.

**50 WATT XMITTER COMPLETE \$21.00.** WBLIT, Busselville, Ark.

**BEST CASH OFFER TAKES** three tube T.R.F. receiver with separate power supply. Write for full particulars. Richard Briggs, 848 Belmont Street, Watertown, Mass.

**811 ELEVEN TUBE SUPER-** Sky Rider \$49.00. ACI-136 \$20.00. Silver 5C \$24.00. Sky Buddy \$13.00. WBARA, Butler, Missouri.

**RECONDITIONED RECEIVERS.** Have several good, reconditioned communication receivers. Send stamp for list. W2AVA, 12 West Broadway, New York.

# BARTER AND EXCHANGE—FREE!

NO ADVERTISEMENT TO EXCEED 35 WORDS, INCLUDING NAME AND ADDRESS

Space in this department is not sold, it is intended solely for the benefit of our readers, who wish to buy or exchange radios, parts, photographs, cameras, bicycles, sporting goods, books, magazines, etc. As we receive no money for these announcements, we cannot accept responsibility for any statements made by the readers. Use these columns freely. Only one advertisement can be

accepted from any reader in any one issue. All dealings MUST be above board. Remember you are using the U. S. mail in all these transactions and therefore you are bound by the U. S. Postal Laws. Describe anything you offer accurately and without exaggeration. Treat your fellow members the way you wish to be treated. We welcome suggestions that will help to make this department interesting and helpful to our readers. Copy should reach us not later than the 10th of the month for the second following month's issue.

**HAVE NEW AMPERITE MIKE.** Silver-Marshall 6 tube A.C. receiver complete, electric shaver, radtoplan, field glasses, other items. Your list for mine. M. Epstein, 2953 Ruckie, Indianapolis, Ind.

**TRADE INSTRCTOGRAPH COMPLETE** with ten tapes, with built-in Mac electric oscillator. Also Speed-X key. Jewell R.F. meters for what have you? Write W9JML, 616 N. Central, Chicago.

**WANTED: LARGE STAMP COL-** lections (none too large to consider). Send full description and what you want. Swap list. R. D. Dawson, 1208F, The Dalles, Oregon.

**WANTED: SUPREME 89 OR** similar Supreme's. Rider's Manuals. Like to trade with person near. Have Alimeters, Triplett oscillator, Sky Buddy and other things. Have 125 radio magazines also. Bill Eslick, Norwich, Kans.

**ALL WAVE 16 MIDWEST 175 TO** 9 meters, fine shape, need PA with crystal or ribbon 2250 or what, also OCA. CH see like new cost \$39.00. A. Jonas, 1019 Wood, Flint, Mich.

**HAVE MARINE HARDWARE AND** parts, also have radio parts of every description, want rifles, shot guns, sporting goods. J. A. Bakinis, P. O. Box 51, Sta. A, New Haven, Conn.

**WANT CORRESPONDENCE FROM** all over the world. Will trade anything. I will answer all mail promptly. 738. Bob Burch, 3135 Kedzie, Chicago, Ill. U.S.A.

**RADIO MAGAZINES SINCE 1930** including SWC, Radio News, Radio-Craft, over 50 to trade for photographic enlarger, record changer, phono-motor. Will pay cash difference. William Chrusch, 152 Fifth St., Filadelfia, N. J.

**WANTED—CORRESPONDENCE** with fellows interested in aviation radio, photography or stamps in all parts of the world. Harry Jamieson, 94 Raglan Avenue, Toronto, Ontario, Canada.

**HAVE BUTTERFLIES AND** many other insects, old coins, bills, magazines. Wanted car radio, old stamps, antiques. Also have many fine covers. L. Signor, Dover, Fla.

**HAVE 3 2 1/2 METER RECEIVERS** work fine, also set of coils for SW4, 1 low loss 40 meter coil banana plug type, 1 pr. Baldwin phones. WILDD, Roxbury, (19), Mass.

**HAVE LARGE SELECTION OF HI** class s.w. parts, last set was H.R.O. Want something not in electrical or radio line, or stamps or coins. John Dudarevich, 1808 Pitkin Ave., Brooklyn, New York.

**SWAP-NATIONAL SW3, COMPLETE,** good condition, 40, 160 meter coils, for candle camera. Argus preferred. Seymour Bokdonoff, Box 652, Bridgeport, Conn.

**HAVE CHARLES ATLAS** strength course, fine .22 rifle A.C. power packs, Diesel Power magazines, radio parts, books, portable phonograph. Want modern radio parts, short wave receiver, testing equipment. Wallace Freeman, Box 466, Barre, Mass.

**HAVE "HAM" COMMUNICATION** receiver. Tunes all bands 5 tubes. Speaker incorporated. Complete with tubes. To trade for J. Weiss, 547 E. 105 Street, Cleveland, Ohio.

**BRITISH COLONIES AND FOREIGN** airmail stamps duplicates, mixed wanted for same of old and new U.S. stamps or foreign in lots, also have radio parts, tubes, books, magazines. W2IAG, 2907 Clifton Ave., New York, N. Y.

**TRADE KEYSTONE PROJECTOR.** Eastman developing outfit 3 1/2 x 4 1/2 frame and 3 1/2 x 5 1/2 box camera for 250 volt generator 6 volt input. Want 1/2 H.P. air cooled gas engine. J. O. S. Hunter, Box 163, Kensington, P.E.I.

**WANTED 16MM PROJECTOR OR** camera. Have amplifier, telescope camera outfit. What have you to swap? Walter Carmichael, 135 Marcella St., Boston, Mass.

**HAVE CORONA PORTABLE RADIO** Physists, Modern Radio, Belden double-doublet. York bar dumbbell course, mags., Diesel mags., U.S.N. photos. Want Piezo calib., pre-selector. Spider-web ant., head-phones, radio parts. John S. Praszynski, St. Martinville, La.

**25 CAL. REPEATING RIFLE,** new gauntlet fur mittens and seat, size 44, ladies medium size calf skin fur coat. Want car radio Leica camera, binoculars, outboard motor. Leo Herberport, 3007 Jay Ave., Sioux City, Iowa.

**WANTED STANDARD SHORT** wave receiver. Have Vitoreen superhet battery chassis, Sparton 11 tube chassis, refrigerator compressor, Crosley Dynacone speaker, radio parts. Trade for what have you? Ernst Albrecht, 1454 West 14th St., Davenport, Iowa.

**WILL SWAP GILBERT ERECTOR** sets Nos. 6 and 7 1/2 complete with 2 motors AC and DC for meters and test equipment. Frank M. Masters, Jr., River Road RD No. 2, Harrisburg, Penna.

**WHAT HAVE YOU TO SWAP FOR** a 5 meter receiver or bicycle. Photo equip. pref. Hyman Baikien, 65 Weston St., Boston, Mass.

**SWAP FOREIGN U.S. STAMPS,** books, large lenses from plate cameras, bellows, boxing gloves, Denker punching bag, fresh water fishing pole, S&D mint pennies. Want cameras, enlargers, photographic equipment. E. Lorenzo, 356 Carpenter St., Prov., R. I.

**TRADE—6 FT. SPLIT BAMBOO** rod, heavy, large Pfleuger reel, good condition, suitable for tuna, muskie fishing. Want Howard 409, Sky Buddy. Also 22 rifle electric razor. Forrest F. Wilson, 107 E. North St., Marshalltown, Iowa.

**WANTED ANSCO MEMO 35MM** camera, good lens. What do you want in trade or cash? All letters answered. Harvey E. McDowell, Ft. Defiance, Arizona.

(Continued on opposite page)

# World S-W Stations

(Continued from page 28)

- Mc. Call
- 6.110 GSL DAVENTRY, ENGLAND, 49.1 m.
- 6.110 XEGW MEXICO CITY, MEX., 49.1 m.,  
Addr. La Voz de Aguila Azteca desde Mex., Apartado 8403. Relays XEJW 11 pm.-1 am.
- 6.108 HJ6AB MANIZALES, COL., 49.14 m., Addr. P. O. Box 175. Mon.-Fri. 12.15-1 pm.; Tue. and Fri. 7.30-10 pm.; Sun. 2.30-5 pm.
- 6.100 YUA BELGRADE, JUGOSLAVIA, 49.18 m. 1-3, 6.30-8.30 am., Noon-6.30 pm.
- 6.100 W3XL BOUND BROOK, N. J., 49.18 m., Addr. Natl. Broad. Co. 9 pm.-1 am.
- 6.097 ZRK KLIPHEUVEL, S. AFRICA, 49.2 m., Addr. S. African Broad. Co., Johannesburg. Daily 12 n.-4 pm., Sun. 12 n.-3.20 pm.
- 6.097 ZRJ JOHANNESBURG, S. AFRICA, 49.2 m. Addr. S. African Broad. Co. Daily exc. Sat. 11.45 pm.-12.50 am.; Daily exc. Sun. 3.15-7.30, 9.11-30 am. (Sat. 8.30-11.30 am.) Sun. 3.30-4.30 or 4-5 am., 5.30-7, 9-11.30 am.
- 6.095 JZH TOKYO, JAPAN, 49.22 m., Addr. (See 11.800 mc., JZJ.) Irregular.
- 6.090 CRCX TORONTO, CAN., 49.26 m., Addr. Can. Broadcasting Corp. Daily 7.45 am.-5 pm., Sun. 10.30 am.-12 n.
- 6.090 ZBW2 HONGKONG, CHINA, 49.26 m., Addr. P. O. Box 200. Irregular.
- 6.083 VQ7LO NAIROBI, KENYA, AFRICA, 49.31 m., Addr. Cable and Wireless, Ltd., Mon., Fri. 5.30-6 am., 11.15 am.-2.15 pm., also Tues. and Thurs. 8.15-9.15 am.; Sat. 11.15 am.-3.15 pm.; Sun. 10.45 am.-1.45 pm.
- 6.081 YVIRD MARACAIBO, VEN., 49.32 m. 6-11 pm.
- 6.080 W9XAA CHICAGO, ILL., 49.34 m., Addr. Chicago Fed. of Labor. Relays WCFL irregular.
- 6.079 DJM BERLIN, GERMANY, 49.34 m., Addr., Broadcasting House. Irregular.
- 6.077 OAX4Z LIMA, PERU, 49.35 m. Radio National 7 pm.-1.30 am. Except Sun.
- 6.075 VP3MR GEORGETOWN, BRI. GUIANA, 49.35 m. Sun. 7.45-10.15 am.; Daily 4.45-8.45 pm.
- 6.070 CFRX TORONTO, CAN., 49.42 m. Relays CFRB 7.30 am.-12 m., Sun. 10 am.-12 m.
- 6.070 VE9CS VANCOUVER, B. C., CAN., 49.42 m. Sun. 1.45-9 pm., 10.30 pm.-1 am.; Tues. 6.30 pm., 11.30 pm.-1.30 am. Daily 6-7.30 pm.
- 6.069 — TANANARIVE, MADAGASCAR, 49.42 m., Addr. (See 9.53 mc.) 12.30-12.45, 3.30-4.30, 10-11 am. Sun. 2.30-4.30 am.
- 6.065 SBO MOTALA, SWEDEN, 49.46 m. Relays Stockholm 4.15-5 pm.
- 6.060 — TANANARIVE, MADAGASCAR, 49.5 m., 12.30-12.45, 3.30-4.30, 10-11 am.
- 6.060 WBXL CINCINNATI, OHIO, 49.5 m., Addr. Crosley Radio Corp. Relays WLW Tues., Fri., Sun. 5.45 am.-12 n., 11 pm.-2 am.; Wed. 5.45 am.-12 n., 9 pm.-2 am.; Mon., Thurs., Sat. 5.45 am.-2 am.
- 6.060 W3XAU PHILADELPHIA, PA., 49.5 m. Relays W2XE Wed., Fri., Sun. 7.30-11 pm., 11.30 pm.-1 am., Mon. and Thur. 12 m.-1 am. Tues. 7.30-11 pm., 12 m.-1 am. Sat. 11 pm.-2 am.
- 6.057 ZHJ PENANG, FED. MALAY STATES, 49.51 m. 6.40-8.40 am., except Sun., also Sat. 11 pm.-1 am.
- 6.054 HJ6ABA PEREIRA, COL., 49.52 m. 9.30 am.-12 n., 6.30-10 pm.
- 6.050 GSA DAVENTRY, ENGLAND, 49.59 m.,
- 6.050 HJIABG BARRANQUILLA, COL., 49.65 m., Addr. Emisoras Atlantico. 11 am.-11 pm.; Sun. 11 am.-8 pm.
- 6.050 HP5F COLON, PAN., 49.59 m., Addr. Carlton Hotel. Irregular.
- 6.045 RV15 KHABAROVSK, U.S.S.R., 49.63 m. 2-11 am.
- 6.045 XETW TAMPICO, MEXICO, 49.6 m. Irregular 7-11 pm.



Mc. Call  
6.040 W4XB MIAMI BEACH, FLA., 49.65 m. 1-3 pm., 9 pm.-12 m. Relays WIOD.

6.040 W1XAL BOSTON, MASS., 49.85 m., Addr. University Club, 7-9 pm. exc. Sat. & Sun.

6.033 HPSB PANAMA CITY, PAN., 49.75 m., Addr. P. O. Box 910, 10.30 am.-2, 6-10 pm.

6.030 VE9CA CALGARY, ALTA, CAN., 49.75 m. Thur. 9 am.-1 am.; Sun. 12 n.-12 m.

6.030 RV59 MOSCOW, U.S.S.R., 49.75 m. 5-6, 10-11 pm. Irregular.

6.030 OLR2B PRAGUE, BOHEMIA, 49.75 m. (See 11.875 mc.) Off the air at present.

6.028 XEUV VERA CRUZ, MEX., 49.82 m., Addr. Av., Independencia 98. 10 pm.-1 am.

6.070 DJC BERLIN, GERMANY, 49.83 m., Addr. (See 6.079 mc.) 11.30 am.-4.30 pm.

6.017 H13U SANTIAGO DE LOS CABALLEROS D. R., 49.85 m. 7.30-9 am., 12 n.-2 pm., 5-7 pm., 8-9.30 pm.; Sun. 12.30-2, 5-6 pm.

6.018 PRA8 PERNAMBUCO, BRAZIL, 49.84 m., Radio Club of Pernambuco, 4-9 pm.

6.010 OLR2A PRAGUE, BOHEMIA, 49.92 m., Addr. (See OLR, 11.84 mc.) Irreg.

6.010 COCO HAVANA, CUBA, 49.92 m., Addr. P. O. Box 98. Daily 7.55 am.-12 m., Sun. until 11 pm.

6.010 VK9MI S. S. KANIMBLA, 49.92 m. (Travels between Australia and New Zealand). Sun., Wed., Thurs. 6.55-7.30 am.

6.010 CJCX SYDNEY, NOVA SCOTIA, 49.92 m. Relays CJC8 7 am.-1 pm., 4-8 pm. 1.30 pm. 8.30 pm.

6.007 ZRM ROBERTS HEIGHTS, S. AFRICA, 49.94 m., Addr. (See ZRK, 9.606 mc.) Daily exc. Sun. 10 am.-3.30 pm.; Sun. 9 am.-12 n., 12.15-3.15 pm. Daily exc. Sat. 11.45 pm.-12.50 am.

6.009 ZRJ JOHANNESBURG, S. AFRICA, 49.94 m., Addr. S. African Broadcast. Co. Irregular.

6.008 HPSK COLON, PAN., 49.96 m., Addr. Box 33, La Voz de la Victor. 7-9 am., 10.30 am.-1 pm., 5-11 pm.

6.008 CFCX MONTREAL, CAN., 49.96 m. Can. Marconi Co. Relays CFC6 6.45 am.-12 m.; Sun. 8 am.-10.15 pm.

6.008 VE9DN DRUMMONDVILLE, QUE., CAN., 49.96 m., Addr. Canadian Marconi Co.

6.008 CXA2 MONTEVIDEO, URUGUAY, 49.98 m., Addr. Rio Negro 1631. Relays LS2, Radio Prieto, Buenos Aires. 7.30-10.30 pm.

6.008 ZRA SALISBURY, RHODESIA, S. AFRICA, 50 m. (See 6.147 mc., ZEB.) Also Sun. 3.30-5 am.

6.008 XE977 MEXICO CITY, MEX., 50 m., Addr. P. O. Box 79.44. 8 am.-1 am.

**End of Broadcast Band**

8.977 CS2WD LISBON, PORTUGAL, 50.15 m., Addr. Rua Capelo 5. 3.30-6 pm.

8.978 OAX4P HUANCAYO, PERU, 50.16 m. La Voz del Centro del Peru. 8 pm. on.

8.970 YV8RC CARACAS, VEN., 50.26 m., Addr. Radio Caracas. Sun. 7 am.-10 pm. Daily 7-8 am., 1-1.45 pm., 4-9.30 or 10 pm.

8.968 HVJ VATICAN CITY, 50.27 m. Off the air at present.

8.980 HH2S PORT-AU-PRINCE, HAITI, 50.37 m., Addr. P. O. Box A103. 7-9.45 pm.

8.935 YV1RL MARACAIBO, VEN., 50.52 m., Addr. Radio Popular, Jose A. Higuera M. P. O. Box 247. Daily 11.43 am.-1.43 pm., 5.13-10.13 pm.; Sun. 9.13 am.-3.13 pm.

8.970 YV4RH VALENCIA, VEN., 50.68 m. 5-9.30 pm.

8.970 ZNB MAKEKING, BRI. BECHUANALAND S. AFRICA, 50.84 m., Addr. The Govt. Engineer, P. O. Box 106. 6-7 am. 1-2.30 pm. Ex. Suns.

8.970 TILS SAN JOSE, COSTA RICA, 50.85 m. 8-10 pm.

(Continued on following page)

**BARTER AND EXCHANGE FREE ADS (continued)**

WANTED—110 VOLT A.C. GASOLINE generator. or? Will trade Western Electric sound system and recording amplifiers, volume indicator, common battery P.B.N. analytical balances, standard weather bureau anemometer, pen recorder, etc. A. H. Dreesen, Mansfield Centre, Connecticut.

WILL TRADE ONE TRIPLETT Master four unit tester, Meissner 8 tube receiver (Traffic Scout) for Clough-Brenkle 105 oscillograph 85A Unitmeter, 81-A modulator, John Sullivan, 99 Aldrich St., Roslindale, Mass.

WANTED—USED RADIO SERVICE equipment, such as tube tester, signal generator, V.T. voltmeter, etc. Will pay cash. Send description and price in first letter. Thank you, J. Karkus, 1122 Heaver Ave., Pittsburgh, Pa.

TRADE—4 TUBE A.C. D.C. RADIO in perfect condition for a s.w. receiver or portable typewriter. Will add cash or 15 jewel wristwatch if necessary. What say? R. Mfner, Oakdale, Iowa.

WILL PAY CASH OR TRADE radio parts for any kind of radio service equipment. All inquiries will be answered. James C. Gates, 64 Hyatt St., Prov., R. I.

WILL TRADE CP MARTIN guitar and case style C-1. Purchase price \$101.60 in April, 1936, in A1 condition, for good SW receiver 10-160M in 5 bands. John J. Clemens, 4406 2nd St., Ecorse, Mich.

SWAP 1 TRANSFORMER, 1500 or 3000 volt D.C. at 350 MA 300 V. A.C. each side, center tap, 110 or 250V input, 1 pair WE211's, one Cardwell XT2101D split-stator condenser. James Dolan, Box 655, Woonsocket, R. I.

I HAVE A SET OF CZECHOSLOVAKIAN stamps, catalog value \$15. I would like to trade these for a 1/2 watt resistor. John Krupa, 17 W. Ridge St., Natick, Mass.

HAVE ELECTRICAL EXPERIMENTAL kit, contains two-way phone, hand driven (75-125 volts) generator; polarized bell ringer, etc. Want photographic materials or what have you? Send swap list, George Honer, 1305 Harrison St., Chicago, Ill.

WILL SWAP BOWLING BALL and shoes size 8 1/2 with bag, three matched Hagen woods, five irons, golf bag, ice skates size 9. Packard electric razor. Want test equipment, etc. Leslie Merz, 132 Millbank St., Rochester, N. Y.

WANTED—RIDER MANUALS: from vol. three up to date. State Price, C. E. Laler, Neperce, Idaho.

WANTED: 35 and 16MM MOVIE cameras, also camulid types, 110v. SW2 national meters, test equip., 22 automatic rifle, power transformers, gas engine, Gus W. Deuchler, No. 1 Florence Station, Omaha, Nebraska.

WANTED CARBON OR CRYSTAL nuke, have radio parts, variable cond. power banks, also Bakelite trickle charger, operates on 110 volts, charges from 4 to 6 volts, etc. Albert Bellfuss, Jr., R. 1, Box 94, Harnis Rd., Glenview, Ill.

WANTED—PICK UP SLIDE trombone, any type of trombone music and records, and complete orchestras. Have radio and bike parts. Joseph Gerard, Jr., 3338 E. 132, Cleveland, Ohio.

FIRST DAY COVERS TO EXCHANGE for U.S. commemoratives. Newspaper for ten cents. World War covers, gov't. postals, T.B. seals for coins. Ten unused purple stamps for old Duck stamps. Mervyn Reynolds, Jefferson, Maine.

WILL TRADE BUILDING instructions, fuselage, wing spars, enough wood to finish Flying Flea airplane for printing press or what have you. H. Earl Tremain, 916 Park, Salina, Kansas.

WANTED: RADIO COURSE. Have stamps, tennis racket and roller skates. Want to exchange stamps with foreign correspondents; stamp for stamp. Donald C. Weber, Archbold, Ohio, U.S.A.

TRADE HEADRIDE 0-60-300 D.C. voltmeter, net \$2.65, 0-10 D.C. voltmeter, zero adjustment, 1938 Radio Handbook, for Radio Physics Course. Write, stating condition, Glenn Coffey, 103 Woodbury Road, Altadena, California.

HAVE CYLINDER EDISON phonograph, 37 records, stamps, 75 lbs. U.S. stamps on paper. Want long or short wave single battery receiver, good 32 or 110V generator or battery unit, tools, stamps, or? Frank Schmidt, Washington, Vermont.

954-955-956 TUBES, WILL EXCHANGE 4 tube, 2 band, receiver for any one of them. Or what have you? All letters answered. G. E. Boldman, 317-7th St., Rawlins, Wyo.

HAVE SW-3, HOME BUILT TRF and Parts. Want phonograph parts such as record changers, pickups, etc. Bill Sanderson, Jr., 2208 Floyd Avenue, Richmond, Virginia.

WANTED, GOOD STAMP COLLECTION from someone who wants to get rid of entire collection. Have radio parts to trade for same or what? Write Philco Layden, RFD No. 2, Box 21, Hertford, N. C.

WANTED: 20 METER CRYSTAL and bug. Have cash, 100 power microscope, radio mags. and parts. QRA: Al Hobling, 1725 Putnam Ave., Ridgewood Station, Brooklyn, New York City.

WANTED—AUTO RADIO, PICK UP or? Have speaker, radio parts, stamps, etc. Send for list. Want to correspond with 18 year old YL's or SWL's. R. Hower, R.D. No. 3, Bloomsburg, Penna.

SWAP—NEW PORTABLE PHONO spring driven—small A.C. electric motor, 12" Majestic speaker in case. 25 novel books, for typewriter or what have you. All letters ans. Charles Bailey, Box 187, Draper, N. C.

SWAP SCHICK RAZOR USED mechanical drawing set 896 3/4, Keuffel & Esser A-1, cost \$22.50, Eby eye, 3 inch PM spkr., other parts. Want scope, record changer, xmitter parts. Harold Cook, 307 So. Elm St., Shenandoah, Iowa.

SIGNAL GENERATOR WANTED! type using batteries. Must be in A-1 condition and priced reasonable. Will pay cash. Please send full details in first letter. Elmo Brekhuis, Dawson, Minnesota.

I HAVE SIX 4 MFD. 2000 VOLT oil filled condensers with insulated standoffs. Want ohmmeter, transmitting tubes, parts, manuals, etc. Will consider any swap. WOLM, Natrona, Pa.

HAVE GUITAR NEW METAL glass tubes, many modern parts, trans. formers, midge speaker cabinet, pickup, turntable, motor, spark coils. Want banjo, flyrod, N. Hansen, 826 S. 4th St., Aurora, Ill.

WANTED CRYSTALS MOUNTED or unmounted, or what have you. Have meters, new, slightly used transmitting tubes, RK50's, 809's, RK36's, mikes, other miscellaneous parts to swap. Radio W80QI, Wellsville, N. Y.

WILL SWAP 6-350 DYNAMOTOR nearly new, a 6 tube Philco car radio and a Kodak need a good SW receiver or what have you? WBFEL, Delphos, Kansas.

TRADE FOR RADIO EQUIPMENT, U.S. regulation bugle, and single shot Remington 22 rifle. Both in good condition. Trade for 6 volt broadcast receiver, 5 meter transceiver or car radio. Eugene Wright, Box 1794, Vernon, Texas.

SWAP GIANT OIL FILLED CONDENSER, 15"x6"x6" rated 3700 volts will stand 5000. Want transmitting tubes and any radio parts. Will consider any swap. Write, please use anything, J. H. Zillins, 37 River Ave., Natrona, Pa.

SWAP 15 WATT PHONO RIG complete with mtal. tubes, mike, power supply. Uses 80, 57, 6L6, 6L6. Works on 160M and 80M for what have you? W2HAP, 804 Lanet Ave., Far Rockaway, L. I., N. Y.

HAVE MOTOR EFFICIENCY guide, cartooning course, phones, practice of printing manual. Want inductor, short wave parts, A.C. D.C. code oscillator or what have you. H. Patcien, 23 Grand Street, Sidney, N. Y.

WANTED RECORD CHANGER, Rider's Manuals and oscilloscope. Have photo-enlarger, cameras, latest Victor and Bluebird dance records (new), back issues of Fortune and Esquire and cash. Write to Itay Kilne, Box 273, Coraopolis, Pa.

HAVE WESTON SIGNAL GENERATOR, 8 inch millimeter, condenser analyzer, Triplett kit, other equipment. My list for yours. Am interested in recording instrument. P. J. Wagner, 647 Seagriff St., Pittsburgh, Pa.

WILL SWAP OLD BOTTLES, POSTALS, Indian relics, for headphones for 1 tube radio, \$ size silver coins. Eldor Haskard books, E. Beam, Mt. Orale, O.

SWAP 6 METAL TUBE SUPER-Gainer with 8" dynamic spkr. Also 4 tube 5 meter rev with 6" dynamic. Want F1B7A or? All replies answered. WILD2D, 3818 N. Ridgeway Ave., Chicago, Ill.

HAVE ONE \$1.50 ICS RADIO operating and servicing course; want good camera or small xmitter, or what have you. QRA John Ferris, Sussex, New Brunswick, Canada.

HAVE SAXOPHONE, VIOLIN, microscope, telescope, field glasses, movie camera, with projector, Kodak camera, electric dry shaver, watch. Want coins, medals, old bonds, fine old U.S. stamps, covers, autographs, prints, relics. J. Settel, 24 Crosby Ave., Brooklyn, N. Y.

STAMP COLLECTORS: EXCHANGE stamps with collectors in foreign countries, appreciate covers with commemorative stamps for my cover collection. All letters answered. Will pay Myers, 317 Putnam St., Sulphur Springs, Texas, U.S.A.

HAVE LATEST MODEL 27, SLIDE action Marlin repeater, caliber .25-20, perfect condition. Want high grade 3 power binoculars or? C. Moore, 211 East 108 Street, Los Angeles, Calif.

SWAP BRAND NEW MAC BUG for ham receiver in A-1 condition. Prefer one with electrical band spread but others considered. Frank Courtney, W4FDN, 616 Greene St., Augusta, Ga.

NEED CRYSTAL MICROPHONE, typewriter. Trade Thordarson 500, 7 1/2 fl. Motor generator 110 AC, 500 DC, Jevell 15 VAC, 150 mill DC, one amp 1R, Weston 50 and G1, 500 mill DC, W6DXA, 206 S. E. Blvd., San Anselmo, Calif.

DN'ERS, YL'S, XYL'S, I'll trade you stamp for stamp. Send one or more. I'll send equal number by return mail. Also a few Fada parts to trade for stamps. Arlene Horton, 16 Auburn Place, Athol, Mass.

HAVE SHORT WAVE CRAFT, SW & T., Radio News, Popular Science, Pop. Mechanics, Modern Mechanix, and Life Magazines for what have you. Will answer all mail. I exchange QSL's. Bill Basins, 6611 S. Lockwell St., Chicago, Illinois.

HAVE 1/2 HORSE B. & S. ENGINE, '33 Willys sedan, Nickledeon Plano, C-2 Akrus and all accessories. Want factory built car, American Bob Forman, Box 127, Monmouth, Illinois.

TRADE \$14.95 SILVERTONE RECORD player for a good used Sky Buddy receiver, also have many radio parts, have \$2.00 worth of popular dance records. Want headphones. Write, Howard Perkins, 11814 Pepper Avenue, Cleveland, Ohio, U.S.A.

SWAP GOOD CONDITION Winchester 22 long rifle, lever action army type, wind gauge, front, back sights, arm straps, weight 10 lbs., 30 inch barrel, approx. value \$45, for what have you. Milton Benson, So. Hadley Falls, Mass.

WILL TRADE ONE G.E. HI-voltage sign transformer, Prim, H10-150 A.C. sec. 15,000 volt, almost new, for a good SW receiver. M. F. Mattem, Del Norte, Colo.

HAVE COMBINATION TATTOOING machine, tattoo designs, inks, needles, secrets fire eating, glass walking, Hindu rope escape trick and many other secrets to trade for instruction books, 22 E. Dye, 321 East State St., Kennett Square, Pa.

SWAP FISHING FLIES, PLUGS, lines, leaders, reels; handball glove, Taylor barometer, Hodgman poncho, hunting knives, new briar pipes for sleeping bag, 22 rifle, binoculars, outdoor equipment, U. S. Stamps, Waltz, 1211 Transverse, Pittsburgh, Pa.

WILL SWAP A 4 TUBE BATTERY operated SV receiver with 40 and 80 meter coils for 10 meter transceiver or what have you? Harold Lantow (W9SEF), Renwick, Iowa.

WILL TRADE 1,000 DIFFERENT, unused postcard views of the U. S., \$4.00 credit on used correspondence course, etc., for Sky Buddy or Howard 430, Joseph McGuire, 5022 So. 38th St., Omaha, Neb.

TRADE MOTOR GLIDER SCOOTER, cost new \$129.00, four cycle motor 1 1/2 h.p. for fast miniature camera, photo equipment, photographic supplies. Scooter worth at least half new price. Joseph Piotrowski, 1119 St. John St., Toledo, Ohio.

VIKING CAMERA F.3-5 REFLEX auto focusing also Oliver typewriter, good condition and 110v. after 8ky Chief, also \$20. Would like Hallcrafters SX17 or what have you. Samuel Brodsky, 365 Grand St., New York City, New York.

WANTED—80 METER CRYSTAL with holder for 3800.5 meter crystal and cash to boot. Trade 20 volt transformer for Johnson dial as plate. Other parts. Write to Bob Louis, 112-4 Avenue East, Calgary, Alberta, Canada.

SWAP CHARLES ATLAS \$35.00 (Dynamic Tension) course for a reasonably good SW receiver, radio courses, or what have you. J. Maslek, 515 Grand St., Trenton, N. J.

WOULD LIKE TO HEAR FROM stamp collectors in Canada and Newfoundland. Will exchange only good copies of Australian stamps, also 1st day covers. F. Ryan, 281 Bell St., West Coburg, N13, Victoria, Australia.

WANTED—TRIPLETT 0-300 AND 0-150 meters, test analyzer, oec., tube checker, 0-5 R.F. ammeter. Have Stewart Warner 2nd converter, American F-1 mike, Stromberg Carlson Pickup, etc. Don Hutchinson, Jr., 622 Blvd. E., Weehawken, N. J.

HAVE A CROSLLEY 5 TUBE AUTO radio. Will swap for typewriter, shortwave receiver, or what? Will also swap S.W.L. cards, 1 QSL 100%. QRA—Victor Charis, 14 Union St., Methuen, Mass.

I HAVE 50 MAGAZINES S.W. & T., 1934-1938. Will swap for what have you. Have a 5 meter transceiver, Joe Hiblinski, 219 Nepperhan Ave., Yonkers, N. Y.

(Continued on following page)



# BARTER and EXCHANGE FREE ADS (continued)

**HAVE 5 CELL FLASHLIGHT.** Junior International album. 1937. 1500 foreign. U. S. stamps, transformer delivering 4.5 volts, copies Short Wave Craft, Radio & Television. Trade for complete N. R. I. course. See Friedman, 500 W. 182 St., New York, N. Y.

**TRADE—150 VARIETIES U. S.** stamps mounted in stock-book. No junk. Wanted—Muselman hub brake model M in good condition. Gale Pasley, Jr., 1834 Monroe St., Chicago, Ill.

**WANT OLD PHONO-RECORDS** before 1920. Classical or jazz. Singers, orchestras. Must be fairly clear, not badly scratched. Send list. Will trade other records. cash. Jim Palmer, 4832 Caroline Street, Houston, Texas. Want for collection.

**WILL PAY \$2.00 FOR A 1,100-0-1,100 volt, 150 ma. power transformer,** which was advertised for \$1.69 in the barkan section of Wholesale Radio's catalog. Dean Cooper, 17 So. 11th St., Fort Dodge, Iowa.

**TRADE LONGINES \$100 WRIST** watches. One into yours, one 14k solid gold, brand new, never worn. John Elliott, 412 Seneca Ave., Oil City, Penna.

**WANT TO TRADE OR WILL PAY** some cash for barometers, or other weather instruments in good condition. Thad E. Gressley, 1819 Trinity Dr., Toledo, Ohio.

**CASH FOR NATIONAL TYPE** drum dial, new or used, counter clockwise rotation. Also exchange 140 nmf dual condenser for 100 nmf singles. K. Johannes, Old Hickory, Tenn.

**I HAVE 20 CANDY MACHINES** and 4 peanut machines. Will trade for testing equipment, good receiver, such as National, Hallicrafter, etc. All letters answered. Whately, Jack Butler, 508 Whitley Ave., Joliet, Illinois.

**WANTED: GOOD 1631 PROJECTOR** films. Also Jewell Weston test equipment, meters. Trade code machine, code course, velocity, mike, amateur sets, ham parts, radio books course, etc. Write S. J. Niewicz, 79 Church St., Broad Brook, Conn.

**HAVE ONE TUBE RADIOS,** crystal sets. Parts, skin painter letter patterns. Want radio parts, books. John Hayes, Doe Inn, Missouri.

**OFFER—TELEPLEX SPRING** wound model in good condition. Want meters and power supplies for transmitter. Write W31YU, Albert Port, 165 W. 7 Ave., Onashohocken, Penna.

**HAVE LIONEL O GAUGE ELECTRIC** trains transformer, tracks in fair condition. Keystone postcard projector practically unused for good typewriter. Have good 33 tube for good 34. Arthur Waddler, 29 Day Street, Fall River, Mass.

**WANTED RIDER'S MANUALS OR** tube tester, or what have you. Have radio parts, B-Eliminator, ice skates size 11, etc. S. J. Battery, 35 Potter Pl., No. Adams, Mass.

**WANT A STRONG POWERFUL** camera, phonograph, oscillator, 1938 Ultra Stratosphere "10" or other similar sets. Have an old bazonet, Falcon camera and radio parts. Interested in everything. Stanley Majewski, 165 Norman Ave., Brooklyn, N. Y.

**WANT CAMERA, ENLARGER,** etc. Have radio parts, ham equipment. Send your list for mine. Tom B. Tolson, W3ZME, 260 Maria Ave., St. Paul, Minn.

**HAVE PHONOGRAPH MOTOR, 8** inch dynamic speaker and U. S. and foreign stamps for short wave receiver, factory or home assembled, or what have you. Clare Seaman, 125 S. St. S. E., Rochester, Minn.

**SWAP NEW WEBSTER UN-** abridged Dictionary, two large volumes, latest edition. Jack Ramon, 412 Seneca Street, Oil City, Pa.

**WANT OLD AND LATE RECORD-** ings by Bing Crosby, must be in playable condition and not badly scratched. Will pay cash or trade if ok. Howard Hoyer, Box W, Lenon Grove, Cal.

**CORRESPONDENCE WANTED** with English speaking young man in Palestine, Leslie E. Collins, West Pine Street, Plaistow, New Hampshire, U.S.A.

**WOULD LIKE A SW SET OR** what have you. Have Windcharger, B-Eliminator, speaker, phono-pickup, etc. Edward Sherman, R.F.D. 2, Amanda, Ohio.

**WILL SWAP OR TRADE ONE** American Code Reader slightly used with two rolls of tape for what have you? Will consider a set of Riders Manuals. Eugene Cheney, Box 88, Rudd, Iowa.

**WANT COM RECEIVER, 54 TO** 20 MC and V-O-M meter. Have instragramph with ten tapes. Browning automatic 16 Ga. shotgun with two barrels, single barrel 20 ga. gun, cash. G. M. Bettis, Swatwater, Texas.

**POSTAL CARD COLLECTORS,** I will exchange a card with my locality for one from yours. Please autograph face of card. Address to Leon F. Ostroski, 527 S. 15 1/2 St., Reading, Pa., U.S.A.

**HAVE BENJAMIN AIR PISTOL,** single shot with safety catch and adjustable shooting force. Want D.C. volt-ohm-milliammeter or small signal generator. Arthur B. James, 2405 W. Oakdale St., Tulsa, Pa.

**SWAP HAM PARTS, ALL KINDS** meters, transformers, chokes, tubes 212D, 203A, 807, 860, etc. 5 meter receiver, transmitter for all bands, many other parts. State your wants. W8JXV, 412 Seneca St., Oil City, Penna.

**WANTED—TUBE TESTER, OS-** cilloscope or oscillator or any test instruments. I have superhet, radio, volt ohmmeter for testing instruments or something else. D. Carlson, 217-02 38th Ave., Bayside, L. I. N. Y.

**TRADE: ARGUS-A, CAMERA,** case. Don focusing mount, Maxim exposure meter and wrist loop. For Asatole D-104 mike. National CHM oscilloscope with tube, or? All letters answered. C. Raski, 272 E. Poplar, E. Plymouth, Penna.

**SWAP—5, 10 METER EXCITER-** xtr.; 10 meter mobile receiver; Carter 250 volt, 50 mills Generator; portable 10 meter c.w. rig; 10 meter mobile transmitter, mobile pwr. supply. W10M, 40 Wayland St., Boston, Mass.

**WOULD LIKE TO BUY OR** trade for books and information on how to become an Amateur and operating a transmitter. Billy Gyles, Haileyville, Okla.

**WANTED 3 TUBE ALL ELECTRIC** short wave receiver less tubes and coils. Have large 9 inch super dynamic speaker, also have 7 tube Majestic chassis less tubes, speaker and power pack. George Moeller, Finley Park, Ill.

**WANT OIL COINS, CAMERA,** lenses, photo equipment, drawing instruments, or? Have mechanics' tools, carpenter's tools, hobby or workshop equipment and fine table lamp. D. L. Snyder, 1140 Walnut St., Allentown, Pa.

**WANTED ROLLEICORD OR ANY** other reflex type camera in exchange for trumpet, miniature camera with 2.9 lens, enlarger, and other photographic equipment or cash. Address, John Baber, 802 So. Third Avenue, Maywood, Ill.

**WANT CODE TEACHING MA-** chine. Have 600 volt power pack, 1 1/2 tin with tubes, Robert Woske, West Fifth St., Marion, Indiana.

**WANTED 2 CODE PRACTICE** keys in good condition, also 6 volt storage battery 'B' eliminators. Will answer all letters. Herbert McKay, Donald, Alta., Canada.

**WILL SWAP COMPLETE C-W** transmitter, new receiver, 5 volt transformers, xmitting tubes, etc. Want phone transmitter less power supply. Will answer all correspondence. Send list. Maurice Twilley, Del. Road, Pittsville, Md.

**TO TRADE: WAT HELIAGF** comparator (Hydrogen ion apparatus) in perfect condition. Want 4-5-6 tube, communication type rev., 10 to 530 meters. All inquiries answered. Write Arthur Cape, P.O. Box 163, Desloge, Missouri.

**SWAP—2 TUBE AC-DC SHORT** wave set with 1 coil (others lost) with tubes. Want bicycle or portable battery set (1 to 3 tubes). Walter Graham, 6500a Olive St. Rd., St. Louis, Mo.

**WANTED: USED CANDLE JIN-** for course. State lowest cash price in letter. Best offer accepted. Write Arthur Harris, 216 E. Madison St., Easton, Pa.

**SWAP: ALL KINDS RADIO** parts, test equipment, books on radio and photography. S.W. magazines, writers magazines, U.S. and foreign stamps. Want: Stop-watch, stapling machine, Hektograph machine. John J. Wilkas, 1517 So. 49th Court, Cicero, Ill.

**WANTED: TO EXCHANGE COR-** respondence with anyone, either sex, in England and U.S.A. I won't fail you. Ernest W. Meyer, R.1, Girard, Kans., U.S.A.

**ENGLAND CALLING: I HAVE** several duplicates in my stamp collection. I should like to exchange. What have you and what do you want? No dealers please. George Blowers, 74 Camphore Road, Oulton Broad, Lowestoft, England.

**CORRESPONDENCE WITH IN-** teresting people desired. Want to exchange letters, photos, etc., with you whether you are in the U.S. or a foreign country. Write me, John Parvuk, 1885 Hazard Ave., Los Angeles, Calif.

**WANTED: 5 METER TRANS-** ceiver. Pay cash for best offer. State price and particulars. J. Bertolis, 516 W. Hamilton, Gillespie, Ill.

**HAVE 1000 COPIES CHICAGO** Fair songs. Very beautiful souvenirs. Battery radio and old fashioned high wheel bicycle, minus big wheel, for what have you? W. E. Shelton, 43 W. Cuyahoga Falls Ave., Akron, Ohio.

**2 TUBE DC SET WITH AMPLI-** fier and speaker unit, Indian head cents, approval stamps, postmarks, sharp tuner dial, auto-tune, auto safety lighter, headphones. Want microphone. R. Lewis, Griffithville, Ark.

**SWAP \$110 N. R. I. RADIO COURSE** for superhet communications receiver or what. Norman Niemiller, 230 Paradise St., St. Marys, Pa.

**SWAP QST'S FOR PHOTO-** graphic equipment:—May, June, Aug. 1925; Feb.-Dec. '26; '27-Jan. '29; June '29; Aug.-Nov. '29; Jan. '30-April '31; Nov., Dec. '31; Jan.-Oct. '32. Herman Yelkin, 351 New Lo. S. Ave., Brooklyn, N. Y.

**USED HAWAIIAN GUITAR, CASE** and lessons, cost \$35.00 two years ago. Swap for high speed key, code course or what have you. Also have plate camera. Everett Schauf, Wellman, Iowa.

**TRADE: LUDWIG ORCHESTRA** snare drum which is practically new and in fine condition for SW3. A. M. Hinds, Jr., Box 1, Tye, Texas.

**WANTED: 5 OR 4 BAND A.C.** short wave, 5, 6- or 7-tube receiver, working condition, with-out tubes. Trade 2-30-0-30, 2-0-60 Weston DC ammeters, never used for receiver. R. W. Dieter, R. 2, Box 109, Blue River, Wis.

**WANTED: SUPERHET, AT LEAST** 1 stage R.F. cover, 10 meters, code oscillator. Have E.C. 0-50-45 amp. 25 watt xmitter, 7T clipper, 750 volt xformer, 210 tube, A.C. motor, power supply for xmitter. Victor Samardzi, 104 Longview Ave., Bronx, N. Y.

**SWAP—TRANSMITTER, PARTS,** radios, books. Wanted field glasses, movie camera or what have you in trade. Samuel Schlecker, 326 East 46th St., Brooklyn, N. Y.

**WANTED: USED TEST EQUIP-** ment in usable condition. Will trade radio parts or cash for same. Billy Diggs, 3000 Wilbarger St., Vernon, Texas.

**TRADE FOR PHOTO SUPPLIES:** or? Triplet 1232 signal generator; 1200-A volt-ohm-milliammeter; 1220-A checker; 1295 modulation monitor. Clough-Brenke OMA frequency modulated signal generator. Guaranteed new. M. L. Potter, 233 East Ave., Park Ridge, Ill.

**WANT BASEBALL CATCHER'S** equipment, music and phonograph equipment, or? Have great variety of canceled stamps, violin, magazines, Mah Jongg game, etc. Victor Lurski, 13 Grove Terrace, Irvington, N. J.

**HAVE EARPHONES, TONE ARM,** fossils, minerals, guitar, mandolin, ukelele, banjo and taxidermy courses, old prints, records, list. Want midset radio, perennials, coins, Indian pottery, relics, vases, etc. Stanley Bytel, 5025 Olden Ave., Cicero, Ill.

**WANTED: SCIENCE FICTION** story magazines. I have other magazines, papers, stamps, course in physical culture, etc. I will trade for them. Write H. A. Pitman, London, New Hampshire.

**DETA WOOD LATHE, 38 INCH** stroke, 100 speeds. Want communication receiver, gasoline power generators, meters, rifle, relays, camera, crystal microphone, or what? E. H. Lyle, Box 936, Wink, Texas.

**WOULD LIKE TO EXCHANGE** badges, pins, medals, etc., from other states and countries. Will send something for your hobby from here. Write 906 Russell, Febr., 2018 South 7th East, Salt Lake City, Utah.

**BREAKING UP MY LABORA-** tory. Tube tester, meters, outlets, switches, power trans, tubes, radio magazines, motors, generators, panel lights, condensers, resistors, radio cabinets and chassis. Russ Furman, 611 Franklin Ave., Hartford, Conn.

**HAVE ALL KINDS OF RADIO** parts. Am interested in trading for golf clubs. Give type of clubs and what you want in trade in first letter. Herman Buehrle, Jr., 722 Penn. St., Gary, Indiana.

**CANADIANS—HAVE NUMEROUS,** new and used radio parts to exchange for radio parts or test equipment. Inquiries appreciated and answered. Harvey Zellen, 444 Crawford St., Toronto, Ont., Canada.

**HAVE 800 DIFFERENT STAMPS.** Trade for R&T, double button mike, key, isolantite sockets, plug-in coils, vernier dials, 130 nmf, variable condensers, 2 1/2 MH. R.F. choke, power transformer. Thomas Shragoin, 50 Steuben Street, Providence, Rhode Island.

**WILL SWAP 3 TUBE AMPLI-** fier, complete with tubes, speaker amp. Any trade offers? Harry Campbell, Jr., 28 Con's St., Portland, Me.

**CODE MACHINE INSTRUCTO-** graph with oscillator, key, photos and tapes 1 & 2. Also Weston analyzer plug and adaptors. Will exchange for short wave parts or what have you. Andrew Dunn, 1462 W. Hubbard St., Chicago, Ill.

(Continued on opposite page)

Mc.	Call	Barter	Exchange
5.898	YV3RA	BARQUISIMETO, VEN., 50.86 m., Addr. La Voz de Lara, 12 n.-l pm., 6-10 pm.	
5.885	H198	SANTIAGO, D. R., 50.95 m. Irregu- lar 6-11 pm.	
5.875	HRN	TEGUCIGALPA, HONDURAS, 50.06 m., 1.15-2.16, 8.30-10 pm.; Sun. 3.30-5.30 pm., 8.30-9.30 pm.	
5.855	H11J	SAN PEDRO DE MACORIS, D. R., 51.25 m., Addr. Box 204, 12 n.- 2 pm., 6.30-9 pm.	
5.845	YV1RB	MARACAIBO, VEN., 51.3 m., Addr. Apartado 214, 8.45-9.45 am., 11.15 am.-12.15 pm., 4.45- 9.45 pm.; Sun. 11.45 am.-12.45 pm.	
5.825	TIGPH	SAN JOSE, COSTA RICA, 51.5 m., Addr. Alma Tica, Apartado 800, 11 am.-1 pm., 6-10 pm. Relays TIX 9-10 pm.	
5.813	TIGPH2	SAN JOSE, COSTA RICA, 51.59 m., Addr. Senor Gonzalo Pinto, H.	
5.790	TGS	GUATEMALA CITY, GUAT., 51.75 m., Casa Presidencial, Senor J. M. Caballeroz, Irregular.	
5.758	YNOP	MANAGUA, NICARAGUA, 52.11 m., 8-9.30 pm.	
5.740	YV2RA	SAN CRISTOBAL, VENEZUELA, 52.23 m., Addr. La Voz de Tachira, 11.30 am.-12 n., 5.30-9 pm., Sun. 11 to 10 pm.	
5.735	HC1PM	QUITO, ECUADOR, 52.29 m. Ir- regular 10 pm.-12 m.	
5.190	YDX	MEDAN, SUMATRA, N. E. I., 57.97 m., 8.30-11.30 am.	
5.145	OK1MPT	PRAGUE, BOHEMIA, 58.31 m., Addr. (See OLR, 11.84 mc.) Irregular.	
5.145	PMY	BANDOENG, JAVA, 58.31 m. 5.30- 11 am.	
4.960	VUD2	DELHI, INDIA, 60.48 m., Addr. All India Radio, 7.30 am.-12.35 pm.	
4.920	YUM2	MADRAS, INDIA, 60.93 m., Addr. All India Radio, 6.30 am.-12.10 pm.	
4.900	HJ3ABH	BOGOTA, COL., 61.19 m., Addr. Apartado 565, 12 n.-2 pm., 6-11 pm.; Sun. 12 n.-2 pm., 4-11 pm.	
4.830	VUB2	BOMBAY, INDIA, 61.8 m., Addr. All India Radio, 7.30 am.-12.30 pm.	
4.880	HJ4ABP	MEDELLIN, COL., 61.44 m. 8-11 pm.	
4.875	ZTD	DURBAN, SOUTH AFRICA, 61.5 m., Addr. (See ZRK, 9.606 mc.) Daily 12 m.-3.45 pm., Sat. till 4 pm., Sun. till 3.20 pm.	
4.842	HJ3ABD	BOGOTA, COL., 61.95 m., Addr. La Nueva Granada, Box 509, 12 n.- 2 pm., 7-11 pm., Sun. 5-9 pm.	
4.840	YUC2	CALCUTTA, INDIA, 61.98 m., Addr. All India Radio, 6.30 am.-12 n.	
4.800	HJ1A8E	CARTAGENA, COL., 62.46 m., La Voz de los Laboratorios Fuentes, Addr. Box 31, Daily 8.30 am.-11 pm., Sun. 10 am.-9 pm.	
4.780	HJ1ABB	BARRANQUILLA, COL., 62.72 m., La Voz de Barranquilla, Addr: P. O. Box 715, 11.30 am.-1 pm., 4.30-10 pm.	
4.772	HJ1ABJ	SANTA MARTA, COL., 62.85 m., 11.30 am.-2 pm., 5.30-10.30 pm., except Wed.	
4.740	HJ6ABC	IBAGUE, COL., 63.25 m. 7 pm.-12 m.	

## On the "Ham" Bands

(Continued from page 27)

Call	Freq.	R	S	Where Heard
H1AN	14.71	5	9	N. J., South Africa
H15X	14.165	5	9	N. J.
H17G	14.2	5	9	N. J.
	28.25	4-5	7-9	Ontario, Me., N. J.
H17I	14.035	5	2-8	Conn., N. Y.
H1A	14.5	5	7	Fla.
HR2A	14.27	5	8	Kan.
HR5RG	14.05	5	5	Ore.
HR5C	14.115	5	8	Conn.
K4EEE	27.02	5	6	N. H.
K4EJF	14.115	5	4-9	N. H., N. J., N. Y., Fla.
K4FTC	28.125	4	8	N. J.
K4EZR	28.02	5	8	N. J.
K4EMG	14.11	5	8	N. J.
K4EJR	14.11	5	8	N. J.
K4FAY	14.219	3-5	6-8	N. J., Fla., S. D.
K5AF	29.38	5	6	Ky.
K5AN	28.8	5	8	Ontario
K7GSC	28.52	5	8	Ky.
K7GDP	28.62	5	7	Ky.
K7AOC	14.213	5	9	Utah
OX7ZL	14.04	5	7-8	Col., Kan.



# BARTER and EXCHANGE FREE ADS (continued)

Call	Freq.	R	S	Where Heard
TG9AA	14.095	4-5	6-9	Wash., N. J., Conn.
TG9BA	14.29	3-5	5-9	Col., Me., N. J., New Zealand
TI2AC	14.15	5	8-9	Me., N. J.
VE1ET	28.3	3	3	England
VE2BG	14.1	5	8-9	England
VE2CP	14.15	5	8-9	England
VE2AA	14.15	5	7	England
VE3LL	14.19	5	8-9	England
VE5AHU	14.11	5	5	England
VO1B	14.25	4	7	Fla.
VO2N	14.02	3	4	N. Y.
VO2Z	14.137	5	4	N. Y.
VO6B	14.28	5	7	Ontario
VPIBA	14.095	4-5	6-9	Col., Conn., Wash., Ill., Me., N. J., Col., N. Y., Wash., Ore., Me.
VP1WB	14.09	4-5	6-9	N. J.
VP2LC	14.13	4	8	N. J.
VP5TR	14.21	4	7	Me.
VP6FO	14.105	5	5-9	Ore., N. J., N. Y.
VP6LN	14.15	5	9	Me., N. Y.
VP6YB	14.1	5	9	N. J.
VP6MY	14.135	5	8	N. J.
VP6LO	14.075	4	7	Conn.
VP6MR	14.145	5	7	Conn., South Africa
VP7NS	14.11	5	6-8	Col., Me., N. J.
VP7NW	14.2	5	7	Me.
VP9L	14.06	4-5	6-9	Wash., Me., Conn., Ill.
VP9G	14.105	5	8-9	N. J., Conn., N. Y., Ill.
VP9R	14.165	4	8	N. J., N. Y.
VP9Z	14.34	3	5	N. Y.
VP9LS	14.12	2	2	S. D.
WI1ATY	14.1	4	6-7	New Zealand
WI1Z	14.1	5	8	South Africa
WI1QM	28.4	5	7	England
WI1KL	28.42	5	3	England
WI1HYZ	29.06	5	5	England
WI1KEN	29.08	5	6	England
WI1AUR	28.82	5	6	England
WI1KDX	29.0	5	6	England
WI1FBX	28.86	5	4	England
WI1JIS	28.62	5	4	England
WI1BDS	28.6	5	5	England
WI1PV	28.8	5	4	England
WI1HON	28.8	5	4	England
WI1KTF	28.8	5	5	England
WI1HPO	14.23	5	8	England
WI1KPK	14.1	5	9	England
WI1BUZ	14.25	5	8	England
WI1COI	14.23	5	7	England
WI1FD	4.4	2	5	S. D.
WI1TNT	3.95	4	7	S. D.
WI1DOA	4.0	4	7	S. D.
W2JOY	28.28	5	7	England
W2HTW	28.3	5	6	England
W2GIZ	28.33	4	4	England
W2IYX	28.32	4	6	England
W2BFH	29.4	3	3	England
W2GFH	28.8	5	8	England
W2JWN	14.19	5	9	England
W2AQK	14.19	5	8	England
W2CXP	14.22	5	8	England
W2BRI	14.21	5	9	England
W2ELJ	4.12	4	8	S. D.
W3GKM	14.1	5	8	South Africa
W3EOZ	14.28	5	7-8	South Africa, England
W3F1L	28.35	5	6	England
W3BDV	29.1	5	4	England
W3C1A	29.0	4	3	England
W3AST	28.8	5	5	England
W3BBO	28.8	5	6	England
W3HKM	28.74	4	4	England
W3FRE	14.22	5	9	England
W3F1U	14.25	5	5	England
W3EWW	4.4	4	3	S. D.
W4OC	14.25	5	7-8	South Africa, England
W4EEV	14.1	5	8	South Africa
W4EPX	28.62	5	4	England
W4EGN	29.6	5	5	England
W4ERX	28.6	4	4	England
W4ECZ	14.21	5	9	England
W4AMR	14.21	5	6	England
W5ZS	28.7	4	4	England
W6IKY	14.1	5	8-9	New Zealand
W8DBC	14.1	5	8	South Africa
W8AFO	28.96	5	5	England
W8C1R	28.8	5	3	England
W8AHC	28.7	4	3	England
W8QWT	28.8	5	6	England
W8OKS	14.22	5	8	England
W9ARA	14.1	4	6-7	New Zealand
W9T1Z	14.1	5	8	South Africa
W9RGH	14.1	5	8	South Africa
W9MEL	14.1	5	8	South Africa
W9OFL	28.65	5	5	England
W9W1P	28.8	5	6	England
W9OLY	28.6	5	5	England
W9RUK	14.24	5	8	England
XE1AA	14.12	5	6	Wash.
XE1GE	28.45	5	7	Ontario
XE1CJ	14.1	5	7	Me.
XE2JR	14.13	5	9	Wash.
XE2FA	14.05	5	8	Wash.
XE2GM	14.115	5	8	Wash.
XE3AX	14.3	5	8	Ontario
YV3BG	28.4	4	6	Me.
CE1YO	14.12	5	7	Wash.
CE1AO	14.1	4-5	6-8	Ore., Fla., Ill.
CE2BX	14.13	3-5	5-7	Col., Ill., Mass., S. D., Fla., New Zealand

(Continued on page 63)

**WANTED: USED INSTRUCTOGRAPH** tapes; continental only, state number, price, and condition. Write: John R. Kane, 1718 Martha Washington Dr., Wauwatosa, Wis.

**HAVE 6 INCH REFLECTING** telescope, factory ground mirror, metal tube. Want oscilloscope or what have you. Claude Smith, Wink, Texas.

**WANTED: "SKY BUDDY"** SW receiver. Will give \$11.00 in cash or Argus camera, filter and sunshade (retail value is \$15.50) and \$3.00 cash. B. Rosenbaum, 1606 North Shore Rd., Revere, Mass.

**I HAVE 8 SETS REDUCTION** gears suitable for rotary antennas. Need meters and dials, variable condensers. Send list and I will send full data. Will answer 100%. Martha E. White, Pittsfield, Md.

**CANADIANS: 65 POPULAR** Mechantes, 20 Modern Mediant and Invention. Trade for folding Kodak camera or 8 mm. movie camera. A. E. Martsch, Box 101, Madison, Sask., Canada.

**SWAP NEEDHAM UPRIGHT** concert grand piano, needs retuning and polishing, inside in perfect condition, never been used. Will deliver around Boston. Want transmitter or receiver. S. Swetoff, 33 Wabon St., Roxbury, Mass.

**WANTED: SMALL XMITTER,** A.C. transmitter or photo equip. Will trade test equip., meters, etc. for parts. Write—Charles Steiner, 634 Delaware Street, Harrisburg, Pa.

**WILL SWAP A SUNBEAM** Electric razor A-1 condition. Also hand grinder brand new with 8 steel cutting emery mounted wheels. For Hatter crafters, Sky Buddy or what? Marcel Lechance, 26 Howard St., Lewiston, Maine.

**WILL SWAP 1 LIONEL** TRAIN set, reversible engine, for short wave receiver. Will swap SWL cards. (QRA: E. F. Diehl, Jr., 309 S. 17th St., Camp Hill, Pa., U.S.A.)

**I HAVE 120 COPIES OF SATUR-** day Evening Post. Also Time, Forum, National Geographic and others. Want good radio parts, recvr., xmitter, or? QRA—Bob Davis, 363 Westland Ave., Berley, Ohio. QSL 100%.

**HAVE 4 VOLUME SET OF** Audel's Plumbers' and Steamfitters' Guide, cost \$8, good condition. Will swap for radio book or books of equal value. William H. Cohn, Box 177, Vivian, W. Va.

**TO TRADE SUPERIOR** ALL-meter, Triplet tube tester, model 1210, and Triplet signal generator, model 1230, also Hammond coils S.W.K.-4 and S.W.K.-6 kit. R. I. Gardner, 2689 L St., San Diego, California.

**SWAP NEW EASTMAN** ADJUST-able aluminum developer tank and radio parts for phono motor, pickup, equipment or what? Send list of swap-page to Emmett Sullivan, 2829 N. Chamber St., Milwaukee, Wis.

**HAVE 12 ISSUES RADIO NEWS** Dec. '37 to Dec. '38, old Amateur call book, 2 or 3 SWL QSL lists. Want 10 meter converter, small battery radio or? (Chas. A. Spielman, 413 1/2 S. Barstow St., Eau Claire, Wis.)

**WANTED: UTAH KIT NO. 2** OR modulator. Must be in good condition. All letters answered. Burns E. Heiler, 310 N. "A" St., Arkansas City, Kans.

**40 WATT-PHONE AND C.W.** "Hi-Tush" all band transmitter. Complete. Factory assembled. What have you to trade? H. G. Gwinn, 835 W. 21, Anderson, Ind.

**SWAP DYNA PUSH EXCITER,** complete with power supply, crystal and coils, for good used receiver or transmitting parts. Swap 2 stage postal preselector for amplifier system or code machine. Steve Vargo, Jr., 2338 Rivershore Ave., Dayton, Ohio.

**TRADE BRUNO VELOCITY MIKE** A-1 with 10 cable, telegraph key and sander, for crystal mike, pickup, turntable or what have you? I'll answer all inquiries. B. L. Fisher, 808 Farmer St., Petersburg, Va.

**WANTED: GOOD 6 VOLT** GENER-ator with about 200V output. Have A-1 condition. Wollensak 15 power telescope to trade. All letters answered. Billy Sellman, R.R. 3, Greenville, Ohio.

**WANTED: 2-4 TUBE AC-DC** SW receiver, small printing press or Call Book Have 2-30, 2-32, 1-22 tubes, 8" Utah speaker, phones. Homer Davidson, 322 E. 10th St. S., Newton, Iowa.

**HAVE NEW MAC DE LUXE** BIG key and late Cadillac Junior code course. 0-1 DC "Triplet" milliamper-eter meter "new." Want good complete short wave receiver. Must be A-1 shape. John Strang, 332 N. Jefferson, Peoria, Ill.

**SWAP CORONA PORTABLE** WITH case, golf clubs, G.E. two-band super-het, books, test tubes. Want phono-rick, frequency meter, radio servicing instruments. Donald Watson, 17 Lake Street, Cooperstown, N. Y.

**WILL TRADE MAGAZINES, TEL-**escape, books and motor for small transmitter, 46 magazines in all. Motor in good condition. Also have many stamps, etc. Write for list, Warren Brown, 616 1/2 Com'l Ave., Anacortes, Wa.

**SWAP: ANALYZER, P.E. CELL** unit, Motorola car set, vibrator power supply, 211-E transmitting tube. What have you? Jack E. Fry, Box 151, Denver, Colo.

**WANTED: AUTOMATIC** CODE machine or small multimeter, must test A.C. volts. Have Riders No. 3 and other radio equipment. Address: James H. Finney, 45 River Street, Cambridge, Mass.

**SWAP 110 VOLTS UNIT DC 15** watts output name Racon, horn 3 feet long, brand new, converter D.C. to A.C. deliver 3.0 watts, for rifle, gauge 12 or 16, good condition. M. Bayoua, 54 Henry St., N. Y. C.

**HAVE TELEPLEX** CODE Ma-chine, complete, built-in oscillator, phones, key and instructions. Will trade for good preselector 10 to 160 volts, give particulars, or what have you? William Tietz, 1610 Mahan Ave., Bronx, N. Y. C.

**TRADE "EILEN 3B" THIR-**ee-tube, all-wave battery receiver, works magnetic speaker, very economical operation, in perfect working condition. Want a balloon tire bicycle in perfect working condition. Alexander Gwynn, 217 Pine St., Phila., Penna.

**WANT 300 WATT FINAL** AMPLI-fier, modulator for same and power supplies, or parts. Have C. Melody Sax, searchlight, power circular and jik saw, miscellaneous parts. Jimmy Gwinn, 935 W. 21st, Anderson, Indiana.

**WANT TO BUY USED** FACTORY built short wave receiver and code machine. A. F. Jensen, 6939 Inlay St., Chicago, Ill., Nor. Pk.

**WANTED: HAWAIIAN** GUITAR, enlarger, stamp collections, 40 meterials, chassis, educational books, or? Have: 16 mm projector, films, radio parts, D.B. mike, QST, Radio, science magazines and charger, etc. Stan, 2748 Michigan St., Detroit, Mich.

**WANTED: SKY BUDDY, SIM-**ilar receiver, low power phono xmitter, meters, pickups, record changers. Have xmitter key, candle camera, radio course, records, high ratio tuning dial, phono oscillator. Bill Godden, Box J, Emmetsburg, Iowa.

**HAVE 5-TUBE S.W. RADIO,** A.C. D.C. model. Will trade for "U.I.F. Products Co." portable trans. recvr., 2 1/2 or lower, 4,000 M, or higher. Emory Toon, 300 Highland Ave., Johnson City, Tenn.

**HAVE ARGUS** CAMERA AND EN-larger, exposure meter, photo light, standard vertical enlarger complete. 275 course in photography, to trade for amateur radio and parts. Paul Reed, Hilltop, N. Y.

**HAVE BRAND NEW NATIONAL** SW-3 with 20-, 40-, 160-meter band-spread coils, tubes and Prost head-phones. It is the 2 volt model. Want photograph equipment. R. Rhett, Byrd St., Raleigh, N. C.

**HAVE PRACTICAL WIRELESS** Telegraph by E. Drew, and Radio Tele-phony for Amateurs by Ballant. Want radios, parts, code machine or what have you? I. Kubik, 37 Pine St., G. Harrington, Mass.

**WANTED: 6-TUBE SUPERHET,** must have "R" meter. Have 360 feet 16 mm sports film in perfect shape, microscope, books and magazines to swap for what? All letters answered. Maylan Wilbur, Weld, Maine.

**HAVE LADY'S WHITE** GOLD wrist watch, seventeen jeweled, East-man 3A folding Kodak, National Geographic, Popular Meeluanes, others, two tube Kadette, Sky Buddy radio, Want larger radio, instruments, oscillator or what offered. C. Pollock, Chamite, Kans.

**SWAP: SHORT WAVE** SET builders' parts 2 volt tubes, 48 lesson N.R.I. course, value \$20. Trade for field classics, auto radio or .22 caliber automatic rifle. Oscar E. Nelson, Route 1, Oslo, Minn.

**WANTED TO BUY—A** CAMERA, prefer Argus, but will consider any kind. Price must be cheap. Have rifle, telescope, books and magazines to swap for what? All letters answered. Maylan Wilbur, Weld, Maine.

**WANTED—RIDERS, GERNSBACH** Manuals. Have three meter Redrite tester. L. M. Schlaechter, Gettysburg, S. D.

**SWAP ONE COMPLETE** NRI radio course complete with code lessons for a Sky-Buddy or like receiver. John H. Schulken, 3 Warren St., Charleston, S. C.

**HAVE 150 WATT A.C. GENER-**ator, Cost \$42.50. New power rack model A-1 shape. Trade for 5 meter trans-mitter or 2-tube loudspeaker set with batteries. Robert L. Smith, 33 Erwin St., Duquesne, Pa.

**SWAP NEW ECLIPSE** ELECTRIC outboard (cost \$40), 1922 Harley motorcycle in A-1 condition. Gender code and typing course, N.P.I. Poultry course, for Grafex, Rolleicord or similar camera or good S.W. receiver. Richard Loughton, Littleton, Mass.

**HAVE 32 CAL. RIFLE** WILL swap for guitar and rifle for 30/40 Krag. Have 11 shells to fit rifle. Harold parts, etc. What have you? Michael Foster, R.D. No. 1, Salina, Pa.

**WANTED: HALLICRAFTER** NO or Howard short wave receiver. Will pay cash or trade, list the exchange lists. John C. Noonan, 620 8th Ave., Brook-ings, S. D.

**HAVE LOTS OF RADIO** PARTS, over 1,000 foreign and U. S. stamps, good Sulfur cases, small turning lathe. Write for list. Want xmitter and view equipment. Arnold Odden, Battle View, No. Dak.

**SWL EXCHANGE**

**GREETINGS FROM THE** SOUTH-land, SWLs! Would like to swap cards with you. Also newspapers and photos. Foreign readers, 1 QSL 100%, so come ahead with your cards. Edward Owens, Wellington, Ala.

**SHORT WAVE LISTENERS** IN U.S.A. and foreign countries. Would like to exchange SWLs. We QSL 100%. (Hest. W. C. Parkinson, Box 884, Texas City, Texas, U.S.A.)

**I AM AN SWL. I WILL QSL** 100% anywhere in the world. Ernest Sawyer, R.S.S.L. W3F84, 46 Highland St., West Medway, Mass.

**SWLs IN THE U.S.A. AND** foreign countries, let's swap SWL cards. Send me your card and I will promptly send you mine. 1 QSL 100%. QRA: Vernon Lockett, 229 S. Bonner Ave., Tyler, Texas, U.S.A.

**CQ SWLs, WOULD LIKE** TO swap QSLs with SWLs and hams. YL's included, in any part of the world. 1 QSL 100%. QRA: Arnold L. Berger, G75, 33 Warrender Park Road, Edinburgh, 9, Scotland.

**SWLs EVERYWHERE IN THE** world, or ed wud b appreciated. 1 QSL 100%. What say someone else. Robert Guert, 350 N. Charlotte St., Pottstown, Penna.

**ATTENTION SWLs IN U.S.A.** and foreign countries. I would like to swap my SWL card for one of yours. 1 QSL 100%. Ian M. Perkins, Tara-dale, Napier, New Zealand.

**WOULD LIKE TO EXCHANGE** cards with any ham, U.S. or foreign. 1 QSL 100%. Al Letcher, 528 E. Main St., Medford, Oregon, U.S.A.

**CQ YL's ES OM's, WILL COME** back for anybody by return mail. Vy 73 ex DX. QRA: "PYGOK", Ary Blaustein, 699 Alameda Ytu, Sao Paulo, Brazil, South America. K pae.

**SWLs AND HAMS ANYWHERE,** Anybody sending me one of their SWLs will get one of mine in return. 1 QSL 100%. Harold C. Chapman, 106 Mill St., Lodi, Ohio, U.S.A.

**CQ K6 SWLs, WOULD LIKE** very much to correspond with future K6 or other Oceania Hams. I will answer all mail. Millard Fortner, Route No. 1, Box 20, Cerefo, W. Va.

**OM's, YL's, SWL's, WOULD** like to exchange correspondence with you, what say someone, please? QRA: R. C. Norton, Jr., R.R. 5, Hamilton, Ontario, Canada.

**HELLO SWLs ANYWHERE,** Let's swap cards. QSL, Jr. Vy 73 ex DX. QRA: "The Listener in the Ranges", M. N. Wicks, Ralhamah, South Australia.

**ATTENTION SWLs ALL OVER** the world, I will swap cards 100% with anyone. Also, I will swap stamps or correspondence. Harold L. Knauft, 34 Wilmington Street, Rochester, New York, U.S.A.

**SHORT WAVE LISTENERS** IN all countries. Would like to exchange SWL cards, postcards and photos and would like to correspond with anyone. 1 QSL 100%. Ed. Hoffman, 1744 Wilmot Avenue, Chicago, Illinois, U.S.A.

**WISH TO EXCHANGE** SWL cards and correspond with anyone in the world. Come, YL's and OM's. Lavoyl Kinney, Fayette, Ohio.

**WOULD LIKE TO EXCHANGE** postcard views and letters with foreign SWL's. Prefer ones interested in radio. If you like long letters, write —I will answer all. Mrs. Lucy Jennings, R.F.D. No. 1, Gladys, Va., U.S.A.

**CALLING CQ SWL YL's** and Hams, would like to swap SWL cards with you. QRA: Ray Davis, Co. 773 CCC, Drakesville, Ia.

**SWAP SWLs AROUND THE** COR-ner or around the world, 100%. QRA: Bob Litzert, 824 Passmore St., Philadelphia, Penna.

**ATTENTION YL's ES OM's,** "The Voice of the Windy City" calling all SWL's throughout the world. Have new card. Will swap and correspond 100%. QRA: Charles Boxa, 2678 N. Halsted St., Chicago, Ill., U.S.A.



# ... THESE OUTSTANDING SHORT WAVE BOOKS ARE Now Available AT YOUR DEALER!

YOU buy parts, tubes, kits, accessories from your local radio dealer—that's what countless thousands of short-wave fans do. Now through a nation-wide distribution service our numerous books are available at your favorite radio dealer—right where you buy other radio equipment. It's more convenient, saves time and you can inspect the books before you buy. Ask your dealer to show you all the books advertised on this page—they're always in stock.

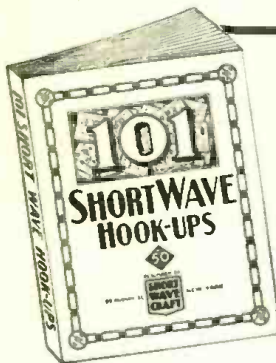

### 101 SHORT WAVE HOOK-UPS

Compiled by the Editors of  
RADIO & TELEVISION

Here is a worthwhile book that every short wave listener, every short wave fan, and every short wave amateur has wanted for a long time. It gives you the 101 best short wave hook-ups which have appeared heretofore.

100 Illustrations  
72 Pages

50c

### HOW TO BUILD AND OPERATE SHORT WAVE RECEIVERS

This is the best and most up-to-date book on the subject. It is edited and prepared by the editors of RADIO & TELEVISION and contains a wealth of material on the building and operation, not only of typical short wave receivers, but short wave converters as well.

150 Illustrations  
72 Pages

50c



### TEN MOST POPULAR SHORT WAVE RECEIVERS

HOW TO MAKE AND WORK THEM

The editors of RADIO & TELEVISION have selected ten outstanding short wave receivers and these are described in the new volume. Each receiver is fully illustrated with a complete layout, pictorial representation, photographs of the set complete, hook-up and all worthwhile specifications.

75 Illustrations  
40 Pages

25c

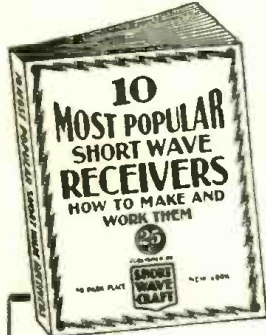

### HOW TO GET BEST SHORT WAVE RECEPTION

M. HARVEY GERNSBACK tells you everything you have ever wanted to know about short wave reception. The author, a professional radio listener and radio fan for many years, gives you his long experience in radio reception and all that goes with it.

40 Illustrations  
72 Pages

50c

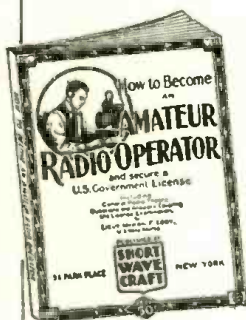
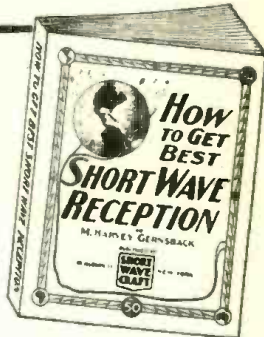

### HOW TO BECOME AN AMATEUR RADIO OPERATOR

By Lieut. Myron F. Eddy, whose experience in the amateur field has made him pre-eminent in this line.

If you intend to become a licensed code operator, if you wish to take up phone work eventually—this is the book you must get.

150 Illustrations  
72 Pages

50c

### THE SHORT WAVE BEGINNER'S BOOK

Here is a book that solves your short wave problems—leading you in easy stages from the simplest fundamentals to the present state of the art as it is known today. It is the only low-priced reference book on short waves for the beginner.

75 Illustrations  
40 Pages

25c

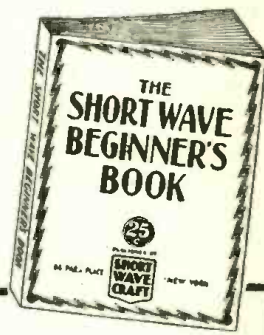

### LOOK FOR YOUR NEAREST DEALER

For convenience the publishers list below dealers in all parts of the world where our books are available. On your next shopping trip be certain to examine these volumes. You're sure to want them for your technical library.

- ALABAMA  
Walther Bros., Montgomery
- ARIZONA  
Sam's Cigar Store, Phoenix
- CALIFORNIA  
Electric Supply Co., Oakland  
Radio Supply Company, Los Angeles  
Radio Television Supply Co., Los Angeles  
Pacific Radio Exchange, Inc., Los Angeles  
Western Auto Supply, Los Angeles  
Zack Radio Supply Co., Los Angeles  
Vroman's Book Store, Pasadena  
Western Radio & Elec. Co., San Diego  
Offenbach Electric Co., San Francisco  
Technical Book Co., San Francisco  
Zack Radio Supply Co., San Francisco  
Radio Specialties Co., San Jose
- COLORADO  
Auto Equipment Co., Denver  
Interstate Radio Supply, Denver
- CONNECTICUT  
The Edward P. Judd Co., New Haven
- DELAWARE  
Wilmington Elec. Spec. Co., Inc., Wilmington
- FLORIDA  
Radio Accessories Co., Orlando
- GEORGIA  
Wholesale Radio Service Co., Inc., Atlanta
- ILLINOIS  
Allied Radio Corporation, Chicago  
Walter C. Braun, Inc., Chicago  
Chicago Radio Apparatus Co., Chicago  
A. C. McClurg & Co., Chicago  
Midwest Radio Mart, Chicago  
Newark Electric Co., Chicago  
Sears, Roebuck & Co., Chicago  
Max Stein & Co., Chicago  
Montgomery Ward & Co., Chicago  
Wholesale Radio Service Co., Inc., Chicago

- INDIANA  
Van Sickle Radio, Indianapolis
- MASSACHUSETTS  
DeWolfe & Fiske Co., Boston  
The Personal Book Shop, Boston  
Wholesale Radio Service Co., Inc., Boston  
Library Book House, Springfield  
Tremont Elec. Supply Co., Boston
- MICHIGAN  
Rissi Brothers, Detroit
- MINNESOTA  
St. Paul Book & Stat. Co., St. Paul
- MISSOURI  
Bursteln-Applebee Co., Kansas City  
Radio Lab., Kansas City  
Walter Ashc Radio Co., St. Louis  
Van Sickle Radio Co., St. Louis
- NEW JERSEY  
Radio Apparatus Co., Newark  
United Radio Co., Newark  
Wholesale Radio Service Co., Inc., Newark
- NEW YORK  
Fort Orange Radio Dist. Co., Albany  
Wholesale Radio Service Co., Inc., Bronx  
Wholesale Radio Service Co., Inc., City  
Harrison Radio Co., New York City  
Jamaica, L. Co., New York City  
American News Co., New York City  
Baker & Taylor Co., New York City  
Blum, the Radio Man, New York City  
David Bogen & Co., New York City  
Federated Purchaser, Inc., New York City  
Radio Circular Co., New York City  
E. E. Stecher & Co., New York City  
The Steiker Co., New York City  
Sun Radio Co., New York City  
Thor Radio Corp., New York City  
Try-Mo Radio Co., New York City  
Van Riemsdyck Book Stores, New York City  
Wholesale Radio Service Co., Inc., New York City  
H. W. Wilson Co., New York City  
Radio Parts & Equipment Co., Rochester  
M. Schwartz & Son, Schenectady

- OHIO  
College Book Exchange, Toledo
- OREGON  
J. K. Gill Co., Portland
- PENNSYLVANIA  
Radio Electric Service Co., Philadelphia  
Comeradio Co., Pittsburgh
- WASHINGTON  
Seattle Radio Supply Co., Seattle  
Wedel Co., Inc., Seattle  
Spokane Radio Co., Spokane
- WISCONSIN  
Radio Parts Co., Milwaukee
- ARGENTINA  
Radio Revista, Buenos Aires
- AUSTRALIA  
McGill's Authorized Agency, Melbourne
- BELGIUM  
Emil Arens, Brussels
- CANADA  
T. Eaton & Co., Winnipeg, Man.  
Electrical Supplies, Ltd., Winnipeg, Man.  
Wholesale Radio Supply, Winnipeg, Man.  
Canadian Electrical Supply Co., Ltd., Toronto, Ont.  
Radio Trade Supply Co., Ltd., Toronto, Ont.  
Canadian Electrical Supply Co., Ltd., Montreal, P. Q.
- BRAZIL  
Agencia Soave, Sao Paulo
- CHINA  
China News Co., Shanghai  
International Booksellers, Ltd., Shanghai
- CUBA  
Diamond News Co., Havana
- ENGLAND  
Gorrings Amer. Wholes Agency, London
- FRANCE  
Toute La Radio, Paris
- GERMANY  
Rehr G.M.B.H. SW13, Berlin NW No. 7

- HOLLAND  
Radio Peeters, Amsterdam, Z.
- INDIA  
Empire Book Mart, Bombay
- MEXICO  
American Book Store, Mexico, D. F.  
Central De Publicaciones, S. A., Mexico, D. F.  
Jaques Salvo, Mexico, D. F.
- NEW ZEALAND  
Johns, Ltd., Auckland  
James Johnston, Ltd., Dunedin  
Te Aro Book Depot, Ltd., Wellington
- SOUTH AFRICA  
Technical Book Co., Cape Town  
Central News Agency, Johannesburg  
International House, Johannesburg  
South African Radio Publications, Johannesburg

IF YOUR DEALER DOES NOT CARRY THESE BOOKS, ORDER DIRECT FROM US. FILL OUT COUPON BELOW. SHIPMENT WILL BE MADE IMMEDIATELY.

POPULAR BOOK CORP. R&T-5-39  
99 Hudson Street, New York City.

Gentlemen: I enclose herewith my remittance for for which please send me the following books:

.....

.....

.....

Name .....

Address .....

City ....., State .....

(Send remittance in form of check or money order. If letter contains cash or unused U. S. postage stamps, register it.)

POPULAR BOOK CORPORATION • Publishers • 99 HUDSON STREET • NEW YORK, N. Y.



# On the "Ham" Bands

(Continued from page 61)

Call	Freq.	R	S	Where Heard
CE3BM	14.04	4	5	Col.
CE3CG	14.11	5	6	Ark.
CE3AS	14.025	4	6	N. J.
CE4AC	14.09	4-5	6-7	Col., Ill.
CX2AK	14.034	5	7	Pa.
CX2CO	14.072	4	8	Ill.
CX3CL	14.01	4	7	N. J.
HC1FG	14.26	5	7	Wash.
HC2CC	14.1	4	5	Conn.
HC2HP	14.3	5	7	N. Y.
HJ1AG	14.02	4	3	Wash.
HK1AG	14.015	4-5	6-8	Md., Ore., N. J., Conn.
HK3CL	14.05	5	4-6	Col., Wash., N. J., N. Y.
HK3CC	14.25	4-5	6-7	Md., Ontario
HK3CO	14.2	5	5	Ore.
HK3CR	14.	5	7	Ore.
HK3CG	14.07	4-5	6-7	Conn., Ill.
HK3CZ	14.3	5	6	N. Y.
HK3CW	14.25	5	7	Ill.
HK4DF	14.025	3	7	Mass.
HK4DL	14.1	5	8	N. J.
HK4AS	14.18	5	7	N. J.
HK5EE	14.	4	6	New Zealand
LU1DA	14.07	4-5	4-8	Col. Pa., Me., Mass.
LU1DF	28.1	5	9	Ark., S. C.
LU1QA	28.05	5	8	Ark.
LU2VG	28.215	4	8	Mass.
LU4AH	14.287	4	8	Fla.
LU4CZ	14.08	4	5	N. Y.
LU5CZ	14.07	5	5-7	Col.
LU7BK	14.11	5	6-8	Col., Me., Wash., Pa., Ark.
LU7BH	14.1	5	5	Wash., Me., N. J.
LU7BR	14.065	5	6	Ore.
LU8EC	14.035	4-5	4-7	Pa.
OA4C	14.19	5	6	Wash., Ore., Ark.
OA4AW	14.137	4-5	2-8	Ark., New Zealand, N. Y., Ill.
PY2PP	14.175	5	7	Me.
PY2JC	14.1	4	6	Conn.
PY2FY	14.	5	7-8	New Zealand
PY2AK	14.25	5	8	N. Y.
PY4BI	14.21	5	6	England
PY5BF	14.	5	7	South Africa
PY7GA	14.	5	9	South Africa
VP3AA	14.1	4-5	7-9	N. J., Conn., N. Y., Ill.
VP4TK	14.125	4-5	4-9	N. J., N. Y.
YV's reported from				Col., Md., Wash., N. J., Eng. land, Mass., Conn., Mo., New Zealand and Fla. Too many to publish.
CT1AY	14.11	5	7-9	Md., Ky., N. J., Ontario, Conn.
CT1FU	7.24	5	8	Ala.
CT1ZA	14.12	5	9	Me., Conn.
CT1PK	14.095	4	8	Mass.
CT1QG	14.	3-4	5-7	New Zealand
EA7BA	14.29	4-5	6-9	Ontario, Conn.
E19J	28.205	5	7-8	Neb., Mass.
E12L	28.4	4-5	3-7	Ontario, N. Y.
F3 and F8 reported by				N. H., Me., Mass., N. Y., Neb., Ark., Ky., Ontario and Conn.
G2, G3, G5, G6 and G8 reported by				Neb., Ark., S. C., Mass., Ontario, N. J., Me., Conn., Fla., N. Y., Md., Ky., Pa., and N. H.
G12LW	28.06	5	8	Ark.
G15J	28.3	4	5	S. C.
GM2MB	14.085	3	6	Ill.
GM6RG	28.445	5	9	Neb., Ky., N. J., S. C.
GM6VD	14.095	5	9	Ark.
GM8MN	14.15	5	8	N. Y.
GW reported by				Ontario, Ark., Me., Mass., N. Y., and Conn.
I11T	28.04	5	7	Ky.
I1TKM	28.065	5	8	Neb.
ON4NO	28.115	5	9	Neb.
ON4BK	14.11	5	5	Wash.
ON4RI	14.16	5	8	Me.
ON4PA	28.16	5	8-9	Me., Mass.
ON4ZA	14.	5	8	South Africa
OZ2HN	14.15	3	4-5	Mass.
PA0AD	28.212	4	7	Neb.
PA0FB	28.005	4	6	Neb.
PA0MZ	14.075	5	7-8	Ontario, Ark., South Africa, Ill.
K6 reported by				Utah, Kan., New Zealand, Col., Ill., South Africa, Ore., Ky., S. D., Pa., N. J., Wash., Mass., and S. C.
KA reported by				Utah, Wash., Kan., Neb., South Africa, New Zealand.
PK1RL	14.	4	7	New Zealand
PK2AY	14.05	5	5	N. Y.
PK3WI	14.05	5	8	Wash.
PK4KS	14.315	3-5	6-7	Kan., Ontario, New Zealand
PK6NX	14.02	4-5	6-9	Wash., N. Y., Kan., Ontario, New Zealand
VK has made a comeback				and about forty were reported by Neb., Ala., New Zealand, Wash., Kan., Me., Mo., N. Y., and South Africa.
VR6AY	14.	4	6	South Africa
ZL3IF	28.45	3	4	Ontario
ZL2BE	28.5	5	8	Ark.

Well, that finishes the reports for this month, and it is hoped that they will be as good next month. If conditions remain as favorable as they have been for the last two weeks, some extra good DX should be heard.

# FREE CATALOGS and INFORMATION

By carefully reading the advertising columns, you will find many offers to furnish literature containing valuable technical information that will help you in your work. Use this list freely.

Firm	Business	Offer	No.	Cost	Adv. Page
Allied Engineering Inst.	Kit Mfr.	Circulars		Free	38
Allied Radio Corp.	Mail Order	Spring Radio Catalog		Free	35
		Builder's Handbook		10c	
American Radio Institute	Radio School	Booklet		Free	46
Andrea Radio Corp.	Television Kit Mfr.	Information		Free	B.C.
Bliley Electric Co.	Parts Mfr.	Engineering Bulletin	E-6	10c	43
		Circular	A-6	Free	
Brush Development Co.	Parts Mfr.	Catalog		Free	43
Bud Radio, Inc.	Parts Mfr.	Folder	RT59	Free	41
		Station Log & Data Ek.		10c	
Burstein-Applebee Co.	Mail Order	Catalog		Free	55
Cameradio Co.	Mail Order	1939 Catalog		Free	53
Candler System Co.	Code Course	Book of Facts		Free	46
Cannon, C. F., Co.	Parts Mfr.	Folder	T-6	Free	44
Consolidated Wire & Associated Corporations	Parts Mfr.	Information		Free	55
Cornell-Dubilier Elec. Corp.	Parts Mfr.	Catalog	161	Free	51
Coyne Electrical School	Trade School	Electrical Catalog		Free	3
		Radio Catalog		Free	
Crosley Corporation, The	Set Mfr.	Literature		Free	41
Dodge's Institute	Radio School	Catalog		Free	46
Eagle Radio Co.	Kit Mfr.	S. W. Diagrams		Free	40
Eastern Mfg. Co.	Mfr.	Circular		Free	57
Gold Shield Products	Mail Order	Catalog		Free	53,55,57
Guthman, Edwin I., & Co.	Set & Parts Mfr.	Information		Free	49
Hammarlund Mfg. Co.	Set & Parts Mfr.	1939 Catalog		Free	33
		16 page Booklet		Free	
Harrison Radio Co.	Mail Order	Information		Free	44
Henry, Bob	Mail Order	Information		Free	49
Instructograph Company	Code Machine	Information		Free	46
International Resistance Co.	Parts Mfr.	Literature		Free	39
Korrol Radio Products Co.	Parts Mfr.	Catalog		Free	53
Lafayette Radio Corp.	Set Mfr.	Radio Catalog	76	Free	45
Levine, M. M.	Coil Machines	Information		Free	42
Martin Research & Mfg. Corp.	Radio Keys	Catalog		Free	33
Mass. Radio School	Radio School	60-page Catalog		Free	46
Midwest Radio Corp.	Set Mfr.	1939 Catalog		Free	51
National Company, Inc.	Set & Parts Mfr.	Catalog		Free	I.B.C.
National Plans Institute	Publisher	Book Catalog		Free	44
National Radio Institute	Radio School	64-page Book		Free	1
National Schools	Radio School	Radio & Television Bklt.		Free	46
Par-Metal Products Co.	Parts Mfr.	Catalog	39T	Free	44
Radio & Technical Publ. Co.	Radio Textbooks	Circulars on each Book		Free	47
Radio Constructors Lab.	Set Mfr.	Catalog		Free	43
Radio Train. Assn. of Amer.	Radio School	Book		Free	46
RCA Institutes, Inc.	Radio School	Catalog		Free	46
RCA Manufacturing Co., Inc.	Set & Parts Mfr.	Literature		Free	37
Remington Rand, Inc.	Typewriter Mfr.	Catalog		Free	64
Solar Mfg. Corp.	Parts Mfr.	General Parts Catalog	9S	Free	45
		Transmitting Catalog	2X	Free	
		Condenser Testers Cat.	CBCC-1	Free	
Sprayberry Acad. of Radio	Radio School	52-page Book		Free	47
Superior Instruments Co.	Test Equipment	Catalog		Free	I.F.C.
Supreme Publications	Publisher	Information		Free	57
Telex Co.	Code Machine	Booklet	S-5	Free	46
Triplet Electrical Inst. Co.	Parts Mfr.	Catalog		Free	53
Tri-State College	Radio School	Catalog		Free	46
Turner Co., The	Parts Mfr.	Bulletin	41-A	Free	45
United Radio Company	Mail Order	Spring Catalog		Free	44
Universal Microphone Co.,	Parts Mfr.	Information		Free	55
Universal System	Television School	Literature		Free	46
Wholesale Radio Service Co.	Mail Order	Radio Catalog	76	Free	45
X. L. Radio Laboratories	Parts Mfr.	Information		Free	51



# GREATEST BARGAIN

in 10 years



as little as

**Remington  
NOISELESS  
Portable**  
NOW AS LITTLE AS  
**10c a day**

**10c  
A  
DAY**

Imagine a typewriter that speaks in a whisper! You can write in a library, a sick room, a Pullman berth, without disturbing others. And superb performance that literally makes words flow from the machine. The Remington Noiseless Portable is equipped with all attachments that make for complete writing equipment—it manifolds and cuts stencils perfectly. Furnished in black with chromium fittings.

### SPECIFICATIONS

Standard keyboard. Takes paper 9.5 inches wide. Standard size, 12 yard ribbon. Makes up to 7 legible carbons. Back spacer. Paper fingers. Roller type. Black key cards with white letters. Double shift key and shift lock. Right and left carriage release. Right and left cylinder knobs. Large cushion rubber feet. Single or double space adjustment. A brand new NOISELESS typewriter, right off the assembly line.

### 10-DAY FREE TRIAL

For the first time in history you can own a genuine Remington Noiseless Portable for as little as 10c a day or \$3.00 a month. Think of it! The finest Remington Portable ever built at the lowest terms we have ever offered. And you don't risk a penny! We will send this brand new Remington Noiseless Portable for a TEN DAYS' FREE TRIAL! If you are not satisfied, send it back. We pay all shipping charges.

## FREE TYPING COURSE

With your Remington Noiseless Portable—absolutely free—a 19-page course in typing teaching you the Touch System, always used by experts. With the help of this course you will find typing the most enjoyable way you ever wrote.



## SPECIAL CARRYING CASE

Carrying Case, handsomely covered in DuPont fabric is included with your purchase. The case makes it easy to take your machine anywhere. You can use it on trains, or on your knees at home. Don't delay. Mail the coupon.



**MAIL NOW**  
Remington Rand Inc. Dept. 300-5  
465 Washington St., Buffalo, N. Y.

Tell me, without obligation, how to get a Free Trial of a new Remington Noiseless Portable, including Carrying Case and Free Typing Course for as little as 10c a day Send Catalog.

Name .....  
Address .....  
City ..... State .....

## How a Television Receiver Is Born

(Continued from page 7)

ling dozens of such tubes each working day. The cost is said to have been reduced to a level well within reach of the television enthusiast.

Finished tubes are thoroughly tested for deflection sensitivity, image brilliance, positioning and other characteristics, before being released for use in Du Mont television receivers or otherwise.

These tubes, the largest yet made available to American television workers and enthusiasts, will provide, it is claimed, a full 8 x 10 inch screen image, with all the brilliancy, sharpness and flickerless characteristics of home movies, when properly operated.

## Most Powerful Television Transmitter

(Continued from page 7)

new design, will be utilized in the complete television transmission equipment, which is five times as many as now used for voice broadcasting. The antenna will resemble a cube of wires as strung from the three 100-foot poles.

Images transmitted will conform to the usual United States standard of 441 lines per frame, 30 frames (60 fields) per second, with an aspect ratio of 4:3.

In addition to the Indian Ladder transmitter, G-E is said to have a license for another 10 kw. transmitter to be erected at Bridgeport, Conn., at an estimated cost of \$195,000.

Last year General Electric sent radio engineers abroad to investigate and study television in England, Germany and Holland, so that this station might incorporate the very latest known to the art.

C. A. Priest, engineer in charge of radio for G-E, announced: "We will not use the new coaxial cable between our studio and the station but an ultra high-frequency sharp directional transmitter, feeling this will also produce better results because the cable cannot carry the 3-4-million cycle frequencies which will be used in television."

## Answers to QUIZ on page 16

1. b
2. c
3. aC, bA, cB
4. b, c & d
5. c
6. a, farthest; b, nearest
7. b & c
8. b
9. c
10. d (Slightly over 51,000)
11. Ac, Bg, Ch
12. e
13. b
14. b
15. d
16. b
17. c (He painted "September Morn.")  
Caruso, who probably fooled you, broadcast over the de Forest station in New York in 1910.

*Special*  
**TELEVISION FEATURES**  
in  
June Number

## Index to Advertisers

A	
Allied Engineering Institute.....	38
Allied Radio Corporation.....	35
American Radio Institute.....	46
Andrea Radio Corp.....	Back Cover
B	
Barter & Exchange Free Ads.....	58-61
Bliley Electric Co.....	43
Brush Development Co., The.....	43
Bud Radio, Inc.....	41
Burstein-Applebee Co.....	53
C	
Cameradio Co.....	53
Candler System Co.....	46
Cannon, C. F. Company.....	44
Commercial Notices.....	58
Consolidated Wire and Associated Corporations.....	55
Cornell-Dubilier Electric Corp.....	51
Coyne Electrical School.....	3
Crosley Corporation, The.....	41
D	
Dataprint Company.....	53
Dodge's Institute.....	46
E	
Eagle Radio Co.....	40
Eastern Mfg. Co.....	57
F	
For Sale Ads.....	58
G	
Gold Shield Products.....	53, 55, 57
Guthman, Edwin I., & Co., Inc.....	49
H	
Hammarlund Manufacturing Co., Inc.....	33
Harrison Radio Co.....	44
Henry, Bob.....	49
Hudson Specialties Company.....	54
I	
Instructograph Company.....	46
International Resistance Co.....	39
K	
Korrol Radio Products Co.....	53
L	
Lafayette Radio Corp.....	45
Levine, M. M.....	42
M	
Martin Research & Manufacturing Corp.....	33
Mass. Radio School.....	46
Midwest Radio Corporation.....	51
N	
National Company, Inc.....	Inside Back Cover
National Plans Institute.....	44
National Radio Institute.....	1
National Schools.....	46
P	
Par-Metal Products Co.....	44
R	
Radio Amateur Course.....	4
Radio & Technical Publ. Co.....	47
Radio Constructors Labs.....	43
Radio Publications.....	43, 50, 55
Radio Training Assn. of America.....	46
RCA Institutes, Inc.....	46
RCA Manufacturing Co., Inc.....	37
Remington Rand, Inc.....	64
S	
Solar Mfg. Corp.....	45
Sprayberry Academy of Radio.....	47
Superior Instruments Co.....	Inside Front Cover
Supreme Publications.....	57
T	
Technifax.....	57
Teleplex Co.....	46
Triplet Electrical Instrument Co.....	53
Tri-State College.....	46
Turner Co., The.....	45
U	
United Radio Company.....	44
Universal Microphone Co., Ltd.....	55
Universal System.....	46
W	
Wellworth Trading Company.....	44, 55
Wholesale Radio Service Co., Inc.....	45
X	
X. L. Radio Laboratories.....	51

(While every precaution is taken to insure accuracy, we cannot guarantee against the possibility of an occasional change or omission in the preparation of this index.)



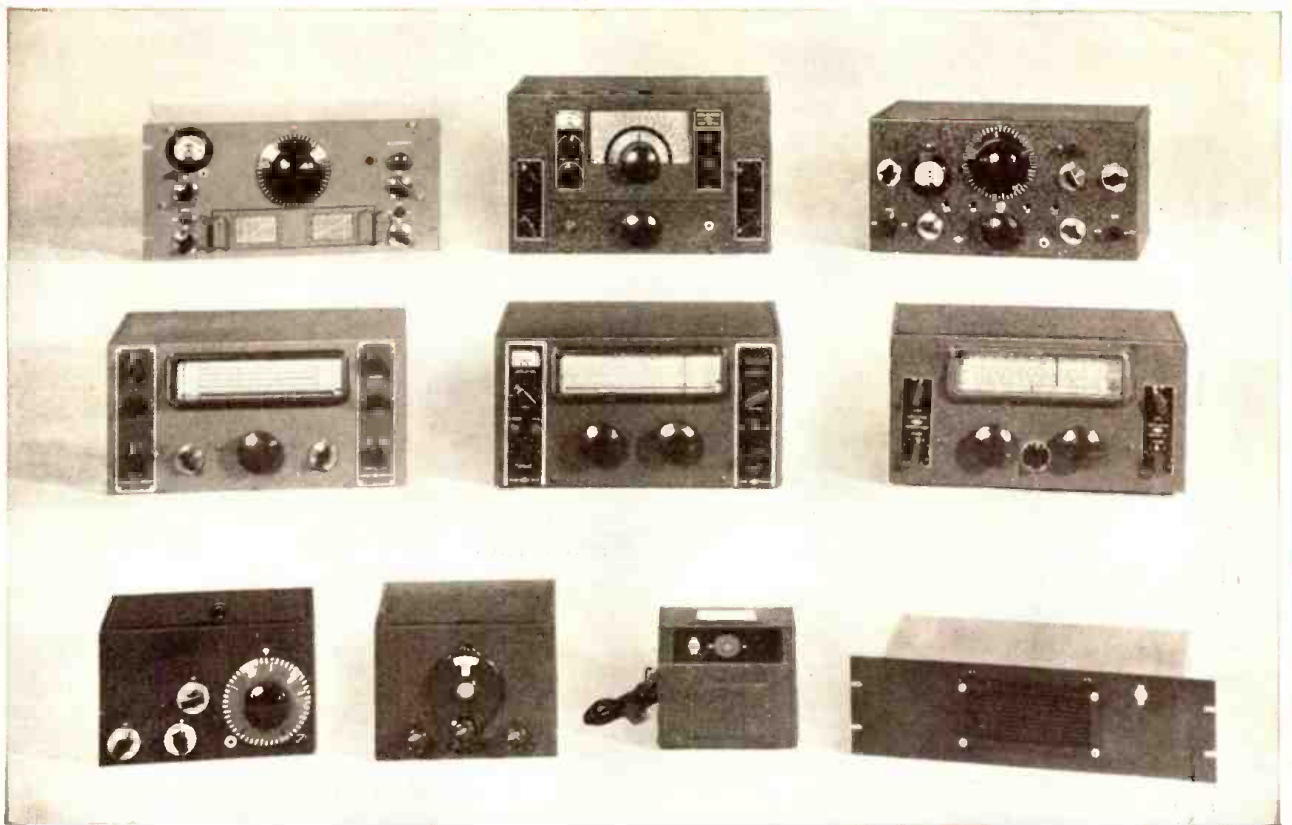

## A FINE RECEIVER FOR EVERY PURPOSE

**HRO** A professional receiver, designed for maximum performance. Features include two high-gain preselector stages giving exceptional signal to noise ratio, crystal filter, micrometer dial, S meter, AVC, Beat Oscillator. Approximate List Price \$350\*. (Top row, left.)

**NC-100A & NC-101X** Fine Communication Receivers with splendid tone. These 11 tube superheterodynes are self-contained except for the speaker. The NC-100A series (Top row, center) is ideal for broadcast reception as well as communication work. The NC-101X (Top row, right) covers only the amateur bands. Features include one stage of preselection, as well as complete communication equipment. Approximate List Price \$200\*.

**NC-80 & NC-81** Excellent Communication Receivers at a moderate price. This inexpensive 10 tube receiver uses a 1560 KC IF amplifier, giving excellent image suppression. Features include crystal filter and communication equipment. The NC-80 is for general coverage. The NC-81 covers only the amateur bands. (Middle row, left.) Approximate List Price \$165\*.

**NC-44** For capable performance at a very low price. A seven tube superheterodyne with continuous coverage from 550 KC to 30 MC. A CW Oscillator is provided. (Middle row, right.) Approximate List Price \$83\*.

**NC-510** A specialized superheterodyne covering 28 to 64 MC. The NC-510 (Middle row, center) is strictly a communication receiver, embodying all the features commonly needed in such work, but is specialized to give maximum performance in the range from 28 to 64 MC. Acorn tubes are used. Approximate List Price \$250.

**ONE-TEN** A specialized receiver for the range from 1 to 10 meters. (Bottom row, left.) The ONE-TEN Receiver is intended primarily for the Experimenter. It is a thoroughly satisfactory receiver for the ultra-high frequencies. Four tubes are used: RF, Super-regenerative Detector, 1st Audio, and Output Audio.

**SW-3** A dependable regenerative receiver. (Bottom row, second from left.) The SW-3's seven year reputation for performance and dependability gives it preference for many classes of work. It uses three tubes in a highly developed circuit that provides maximum sensitivity and flexibility.

**POWER SUPPLIES** National Power Supplies are specially designed for powering high frequency receivers, and include efficient filters for RF disturbances as well as hum frequencies. They are made in a variety of types.

★ The List Prices given above are approximate only, and are intended only to show the price range in which each receiver falls. Complete specifications and prices will be given on request.

**NATIONAL COMPANY, INC., MALDEN, MASS.**



BUILD YOUR OWN

1000  
 Frank M. Johnson  
 S.A. X-ray

# TELEVISION

SIGHT and SOUND RECEIVER!

TELEVISION IS HERE!

It's an accomplished fact today. May, 1939, marks the beginning of broadcasting in New York and in many population centers of America transmitters are building. Television is a billion dollar industry with wonderful opportunities for those who know the art. Get in on it now—and qualify as an expert.



Andrea KT-E-5 Television Sight and Sound Construction Kit, front view, assembled **\$79<sup>95</sup>** less tubes

*F. A. D. ANDREA, who led the industry with radio kits in 1923 now leads with a television kit you can easily assemble in your own home*

Of course you want television reception in your home—and, of course, you want the added fun and satisfaction of building your own. That's the way to know the "ins and outs" of this fascinating new art. You become an expert authority quickly. No one in America has the experience that F. A. D. ANDREA has in producing kits that assemble properly and work like a factory-built job. Every radio fan who remembers the early days, recalls the success of his famous Neutrodyne radio kits. Complete, step-by-step, illustrated instructions with every kit.

At right: A complete, factory-built table model television receiver, if you prefer it. Andrea "Sharp Focus" receiver MODEL I-F-5, complete with tubes \$189.50.

Andrea Teleceptor ..... \$9.50  
 Antenna specially designed for television reception

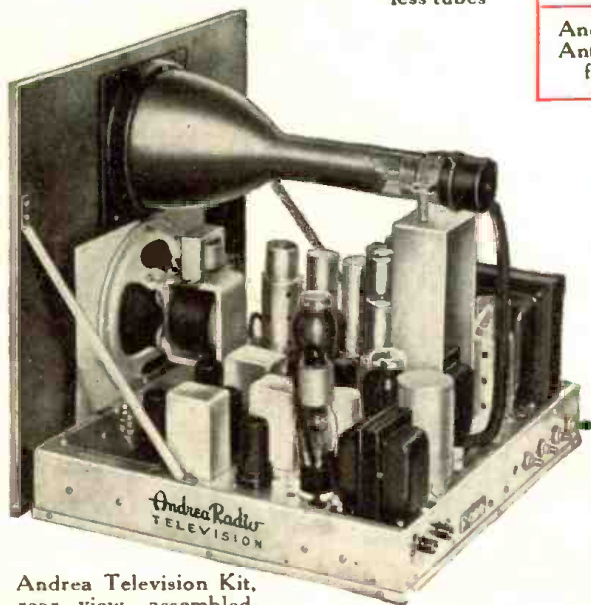

Andrea Television Kit, rear view, assembled.

- Complete Wiring Diagrams and Step-by-Step Instructions supplied free with every Andrea KT-E-5 Kit.

Or send \$1 for diagrams and instructions alone—authoritative, detailed, profusely illustrated.

**DISTRIBUTORS:**

- A limited number of territories are still open. Write for full information.

**IMMEDIATE DELIVERY:**

We're supplying dealers with Andrea "Sharp Focus" television Kits and complete receivers as fast as possible. If your dealer hasn't ordered his yet, we'll supply you direct. Write or phone



**"SHARP-FOCUS" TELEVISION**

ANDREA RADIO CORP. 48-35 48th Ave. Woodside, L.I., N.Y.  
 Telephone: Stillwell 4-4754