

# SHORT WAVE AND TELEVISION

WORLD'S LARGEST SHORT WAVE CIRCULATION

FEBRUARY

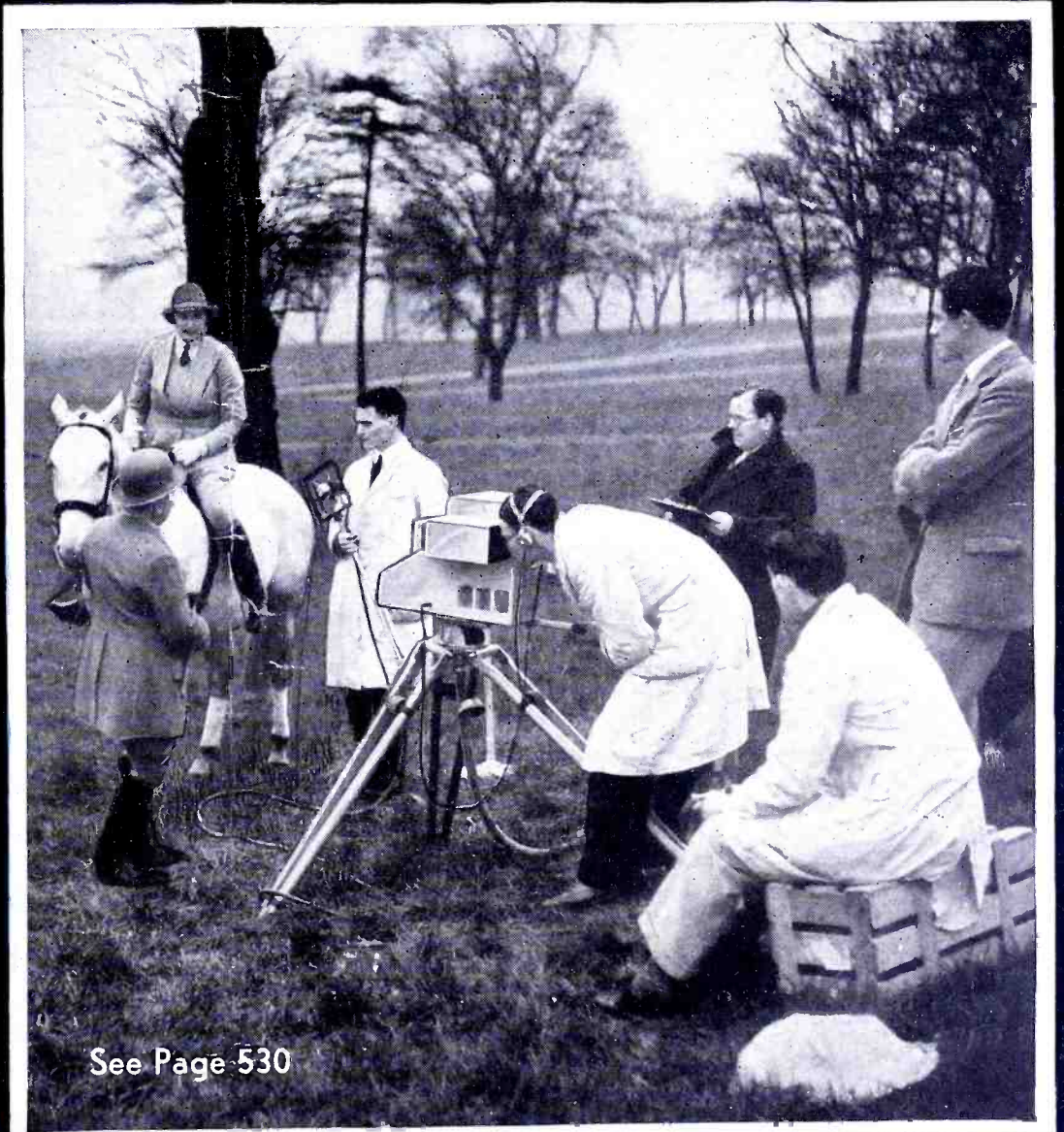

See Page 530

25¢  
IN U.S. AND  
CANADA

FEB 38

HUGO GERNSBACK,

Editor

# The Radio Experimenter's Magazine



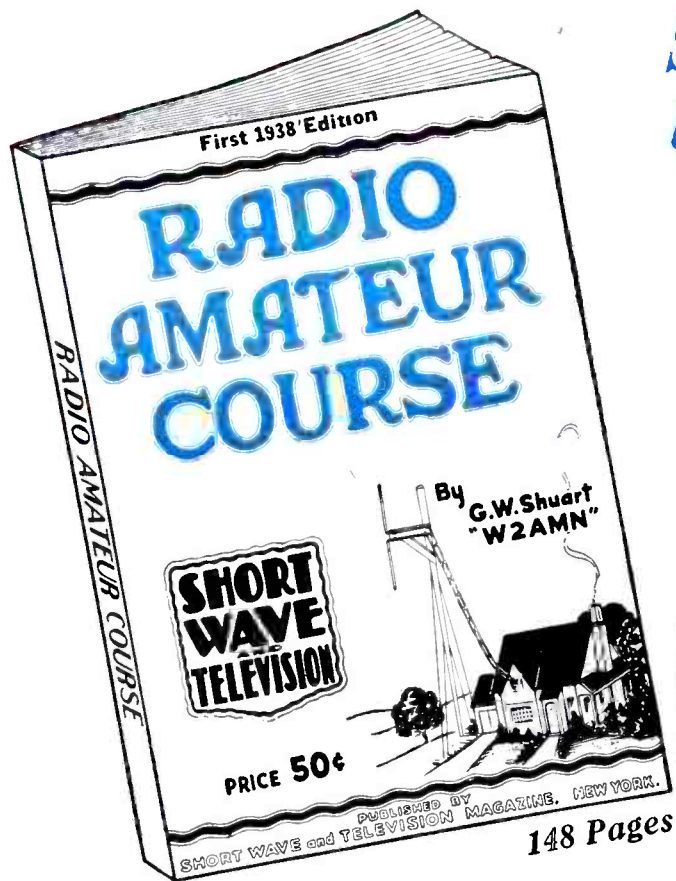

# SEE this remarkable book at your dealer

Glance over its 148 pages containing over 150 *diagrams* and halftone cuts. Read *step by step* how you can obtain the foundation of a *short wave radio education*

This book represents the *biggest value* you ever received for 50¢

Written by Geo. W. Shuart, W2AMN—  
the authority on short waves

Your library is not complete without it

A new book that will appeal to tens of thousands—  
An essential book for all beginners—

## ON SALE AT THE FOLLOWING DEALERS

### ARIZONA

Sam's Cigar Store,  
127 N. First Ave.,  
Phoenix.

### CALIFORNIA

Scott Wholesale Radio Co.,  
341 E. Fourth Street,  
Long Beach.  
Offenbach Electric Co., Ltd.,  
1452 Market Street,  
San Francisco.  
Zack Radio Supply Co.,  
1426 Market Street,  
San Francisco.

### COLORADO

Auto Equipment Co.,  
14th at Lawrence,  
Denver.

### CONNECTICUT

Radio Inspection Service Co.,  
227 Asylum Street,  
Hartford.  
Stern Wholesale Parts, Inc.,  
Stern Bldg., 210 Chapel St.,  
Hartford.

### GEORGIA

Wholesale Radio Service Co., Inc.,  
430 W. Peachtree St., N.W.,  
Atlanta.

### ILLINOIS

Allied Radio Corporation,  
833 West Jackson Blvd.,  
Chicago.  
Newark Electric Company,  
226 W. Madison St.,  
Chicago.  
Wholesale Radio Service Co., Inc.,  
901 W. Jackson Blvd.,  
Chicago.

### INDIANA

Van Sickle Radio, Inc.,  
34 West Ohio Street,  
Indianapolis.

### MASSACHUSETTS

Greater Boston Distributors,  
40 Waltham St.,  
Boston.  
H. Jappe Co., 46 Cornhill,  
Boston.  
Wholesale Radio Service Co., Inc.,  
110 Federal Street,  
Boston.  
Springfield Radio Co.,  
397 Dwight St.,  
Springfield.  
H. Jappe Co., 37 Mechanic St.,  
Worcester.

### MICHIGAN

Rissl Brothers, Inc.,  
5027 Hamilton Ave.,  
Detroit

### MISSOURI

Modern Radio Company,  
409 No. Third St.,  
Hannibal.  
Hurstin-Applebee Co.,  
1012-14 McGee St.,  
Kansas City.  
Van Sickle Radio Co.,  
1113 Pine St.,  
St. Louis.

### NEBRASKA

Radio Accessory Company,  
2566 Farnam Street,  
Omaha.

### NEW HAMPSHIRE

Radio Service Laboratory,  
1187 Elm Street,  
Manchester.

### NEW JERSEY

Arco Radio Co.,  
227 Central Avenue,  
Newark.  
Wholesale Radio Service Co., Inc.,  
219 Central Avenue,  
Newark.

### NEW YORK

Wholesale Radio Service Co., Inc.,  
542 E. Fordham Rd.,  
Bronx.  
Wholesale Radio Service Co., Inc.,  
90-08 166th Street,  
Jamaica, L.I.  
Blair, The Radio Man, Inc.,  
64 Dey Street,  
New York City.  
Federated Purchaser, Inc.,  
23-25 Park Place,  
New York City.  
Harrison Radio Co., Eagle Radio Co.,  
12 West Broadway, 84 Cortlandt Street,  
New York City. New York City.  
Terminal Radio Corp.,  
80 Cortlandt Street,  
New York City.  
Thor Radio Corp., Sun Radio Co.,  
65 Cortlandt St., 227 Fulton Street,  
New York City. New York City.  
Try-Mo Radio Co., Inc.,  
85 Cortlandt St.,  
New York City  
Wholesale Radio Service Co., Inc.,  
100 Sixth Avenue,  
New York City.  
Radio Parts & Equipment Co.,  
244 Clinton Avenue No.,  
Rochester.  
M. Schwartz & Son,  
710-712 Broadway,  
Schenectady.

### OHIO

News Exchange,  
51 So. Main St.,  
Akron.

Canton Radio & Supply Co.,  
1140 Tuscarawas St., W.,  
Canton.

United Radio, Inc.,  
1103 Vine St.,  
Cincinnati.

The Hughes-Peters Electric Corp.,  
178-180 N. Third Street,  
Columbus.

Standard Radio Parts Co.,  
135 East Second Street,  
Dayton.

### OREGON

Portland Radio Supply Co.,  
1300 W. Burnside St.,  
Portland.

### PENNSYLVANIA

Radio Distributing Co., Cameradio Co.,  
1124-26 Market St., 963 Liberty Ave.,  
Harrisburg. Pittsburgh.  
M & H Sporting Goods Co.,  
512 Market St.,  
Philadelphia

### RHODE ISLAND

W. H. Edwards Co.,  
32 Broadway  
Providence, R.I.

### UTAH

O'Loughlin's Wholesale Radio Supply,  
315 South Main Street,  
Salt Lake City.

Radio Supply, Inc.,  
46 Exchange Place,  
Salt Lake City.

### WASHINGTON

Spokane Radio Company, Inc.,  
611 First Avenue,  
Spokane.

### WISCONSIN

Radio Parts Co., Inc.,  
536-538 W. State St.,  
Milwaukee.

### TEXAS

Amarillo Electric Co.,  
111 East 8th Ave.,  
Amarillo.

### AUSTRALIA

McGill's Agency,  
183-184 Elizabeth St.,  
Melbourne.

### CANADA

The T. Eaton Co., Ltd.,  
Winnipeg,  
Man.  
Canadian Electrical Supply Co., Limited,  
285 Craig Street W.,  
Montreal, Que.  
Metropolitan News Agency,  
1248 Peel Street,  
Montreal, Que.

### CUBA

The Diamond News Co.,  
Palacio Asturiano, Por San Jose,  
Habana.

### ENGLAND

Gorrings's American News Agency,  
9a. Green Street, Leicester Square,  
London, W.C.2.

### INDIA

Empire Book Mart,  
Box 631,  
Bombay.

### MEXICO

American Book Store, S. A.,  
Avenida Madero 25,  
Mexico City.  
Central De Publicaciones,  
Avenida Juarez, 4, Apartado 2430,  
Mexico, D. F.

### NEW ZEALAND

Te Aro Book Depot Ltd.,  
64 Courtenay Place,  
Wellington.

### SOUTH AFRICA

Technical Book Co.,  
147 Longmarket St.,  
Cape Town.

IF NOT AT YOUR DEALER'S, PLEASE SEND HIS NAME AND ADDRESS AND WE WILL CREDIT HIM WITH YOUR ORDER. PLEASE FILL OUT COUPON BELOW.

SHORT WAVE & TELEVISION, 99 Hudson Street, New York City. SW-2-38

Gentlemen: I enclose herewith my remittance for 50¢, for which please send me my copy of the "RADIO AMATEUR COURSE" postpaid.

Name .....

Address .....

City ..... State .....

Dealer's Name and Address.....

(Send remittance in form of check or money order. If letter contains cash or unused U. S. postage stamps, register it.)

Be sure to see future copies of Short Wave & Television for additional names of dealers handling this book.

SHORT WAVE & TELEVISION, 99 HUDSON ST., NEW YORK CITY





# Be a Radio Expert

## Many make \$30 \$50 \$75 a week

### I will train you at home for many Good Spare Time and Full Time Radio Jobs

J. E. SMITH, President, National Radio Institute  
Established 1914

The man who has directed the home study training of more men for the Radio Industry than any other man in America.



#### Set Servicing

Spare time set servicing pays many \$5, \$10, \$15 a week extra while learning. Full time servicing pays as much as \$30, \$50, \$75 a week.

#### Broadcasting Stations

Employ managers, engineers, operators, installation and maintenance men for fascinating jobs and pay up to \$5,000 a year.



#### Loud Speaker Systems

Building, installing, servicing, operating public address systems is another growing field for men well trained in Radio.

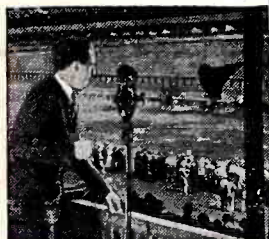

## HERE'S PROOF THAT MY TRAINING PAYS



#### \$80 Monthly in Spare Time

"I work on Radio part time, still holding my regular job. Since enrolling seven years ago, I have averaged around \$80 every month." JOHN B. MORISSETTE, 809 Valley St., Manchester, N. H.

#### Makes \$50 to \$60 a Week

"I am making between \$50 and \$60 a week after all expenses are paid, and I am getting all the Radio work I can take care of, thanks to N. R. I." H. W. SPANGLER, 126 1/2 S. Gay St., Knoxville, Tenn.



#### Operates Public Address System

"I have a position with the Los Angeles Civil Service, operating the Public Address System in the City Hall Council. My salary is \$170 a month." R. H. ROOD, R. 136, City Hall, Los Angeles, Calif.



#### Lesson on Radio Servicing Tips—FREE

I'll prove that my Training gives practical, money-making information, that it is easy to understand—that it is just what you need to master Radio. My sample lesson text, "Radio Receiver Troubles—Their Cause and Remedy" covers a long list of Radio receiver troubles in A.C., D.C., battery, universal, auto, T. R. F., superheterodyne, all-wave, and other types of sets. And a cross reference system gives you the probable cause and a quick way to locate and remedy these set troubles. A special section is devoted to receiver checkup, alignment, balancing, neutralizing and testing. Get this lesson FREE. No obligation. Just mail coupon.



Do you want to make more money? Radio offers you many opportunities for well-paying spare time and full time jobs. You don't have to give up your present job, leave home or spend a lot of money to become a Radio Expert.

#### Many Radio Experts Make \$30, \$50, \$75 a Week

Radio broadcasting stations employ engineers, operators, station managers and pay up to \$5,000 a year. Spare time Radio set servicing pays many \$200 to \$500 a year—full time jobs with Radio jobbers, manufacturers, dealers, as much as \$30, \$50, \$75 a week. Many Radio Experts operate their own full time or part time Radio sales and service businesses. Radio manufacturers and jobbers employ testers, inspectors, foremen, engineers, servicemen, paying up to \$6,000 a year. Radio operators on ships get good pay, see the world besides. Automobile, police, aviation, commercial Radio and loud speaker systems are newer fields offering good opportunities now and for the future. Television promises to open many good jobs soon. Men I trained have good jobs in these branches of Radio. Read their letters in "Rich Rewards in Radio." Mail the coupon.

#### There's a Real Future in Radio for Well-Trained Men

Radio already gives good jobs to more than 300,000 people. In 1936 Radio enjoyed one of its most prosperous years. More than \$500,000,000 worth of sets, tubes and parts were sold—an increase of more than 60% over 1935. Over a million Auto Radios were sold, a big increase over 1935. 24,000,000 homes now have one or more Radio sets. More than 4,000,000 autos are Radio equipped. Every year millions of these sets go out of date, are replaced with newer models. More millions need servicing, new tubes, repairs, etc. A few hundred \$30, \$50, \$75 a week jobs have grown to thousands in 20 years. And Radio is still a new industry—growing fast!

#### Many Make \$5, \$10, \$15 a Week Extra in Spare Time While Learning

Almost every neighborhood needs a good spare time serviceman. The day you enroll I start sending you Extra Money Job Sheets. They show you how to do Radio repair jobs, how to cash in quickly. Throughout your training I send you plans and ideas that

have made good spare time money—from \$200 to \$500 a year—for hundreds of fellows. I send you special Radio equipment and show you how to conduct experiments and build circuits, which illustrate important Radio principles. My Training gives you PRACTICAL EXPERIENCE while learning.

#### I Give You a Professional Servicing Instrument

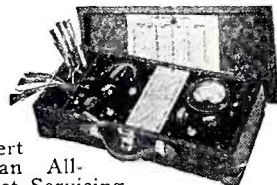

Here is the instrument every Radio expert needs and wants—an All-Wave, All-Purpose Set Servicing Instrument. It contains everything necessary to measure A.C. and D.C. voltages and current; test tubes, resistance; adjust and align any set, old or new. It satisfies your needs for professional servicing after you graduate—can help you make extra money servicing sets while training.

#### You Get a Money-Back Agreement

I am sure I can train you successfully. I will agree in writing to refund every penny you pay me if you are not satisfied with my Lessons and Instruction Service when you finish. I'll send you a copy of this agreement with my Free Book.

#### Find Out What Radio Offers You

Act Today. Mail the coupon now for "Rich Rewards in Radio." It's free to any fellow over 16 years old. It points out Radio's spare time and full time opportunities and those coming in Television; tells about my training in Radio and Television; shows you letters from men I trained, telling what they are doing and earning. Find out what Radio offers YOU! MAIL THE COUPON in an envelope, or paste on a postcard—NOW!

J. E. SMITH, Pres., National Radio Institute

Dept. 8BB3  
Washington,  
D. C.

THIS FREE BOOK HAS HELPED HUNDREDS OF MEN MAKE MORE MONEY



## This Coupon is Good for ... One FREE Copy of My Book

J. E. SMITH, President, Dept. 8BB3  
National Radio Institute, Washington, D. C.

Dear Mr. Smith: Without obligation, send me free the Sample Lesson and your 64-page Book "Rich Rewards in Radio," telling about spare time and full time Radio opportunities, and how I can train for them at home in spare time. (Please write plainly.)

NAME ..... AGE.....

ADDRESS .....

CITY ..... STATE.....

14-X1





The Next issue comes out February 1st

HUGO GERNSBACK, Editor
H. WINFIELD SECOR, Manag. Editor
M. HARVEY GERNSBACK, Assoc. Editor

FEATURE AUTHORS. THIS MONTH:

- Donald McNicol
DeWitt R. Goddard
George F. Huether, W2IHO
George W. Shuart, W2AMN
Raymond P. Adams
P. M. Ohlinger
Joe Miller

IN THE MARCH ISSUE:

- The "S.W. & T." 441-line Television Receiver—How To Build It, C. W. Palmer.
300-Watt R.F. Amplifier Using T-125 Tube, Art Gregor.
S-W Superhet Using New H.F. Intermediates, Raymond P. Adams.
Short Waves Guide Planes Between Europe and South America.
An Up-To-Date 5-Meter Transmitter.

OUR COVER

The front cover illustration this month shows an outdoor scene being televised in England by BBC experts. (By Courtesy B.B.C.)



Certified Circuits

When you see this seal on a set it is a guarantee that it has been tested and certified in our laboratories, as well as privately in different parts of the country. Only constructional—experimental sets are certified. You need not hesitate to spend money on parts because the set and circuit are bona fide. This is the only magazine that renders such a service.

IN THIS ISSUE:

NEW DEVELOPMENTS

Table listing new developments with page numbers: Television—How Soon?, Donald McNicol (533), Television "Piped" from New York to Philadelphia (534), 9 People Can Talk 2-Way on One U.S.W. Circuit (535), Ultra-Short Waves Connect Institute to Observatory 90 Miles Distant, Austin Bailey (536), Trans-Atlantic Television, DeWitt R. Goddard (536)

S-W STATIONS—HOW TO FIND THEM

Table listing S-W stations with page numbers: Let's Listen In with Joe Miller (552), World S-W Stations (554), How To Identify S-W Stations (557), S-W League—When To Listen In, M. Harvey Gernsback (559)

TELEVISION

Table listing television articles with page numbers: Television "Piped" from New York to Philadelphia (534), Trans-Atlantic Television (536), Television Sweep-Circuit Data for new RCA C-R Tubes (551)

LATEST SHORT WAVE APPARATUS

Table listing latest short wave apparatus with page numbers: New Machine Makes It Easy to Learn Code (549)

CONSTRUCTOR

Table listing constructor projects with page numbers: New Experiments with Radio Apparatus (538), How To Make A Simple Induction Phone, G. F. Huether, W2IHO (540), The Switch-Band-2 Receiver, George W. Shuart, W2AMN (544), U. H. F. Converter Brings In 5 and 10 Meter Stations, Raymond P. Adams (546), How To Make a Peak Voltmeter, P. M. Ohlinger (548), Building Sweep-Circuit Coils for new RCA Television C-R Tubes (551), A 40-Meter Band-Switching Transmitter, George W. Shuart, W2AMN (562)

MISCELLANEOUS

Table listing miscellaneous items with page numbers: How Can I Obtain A Practical Education in Radio and Television? H. W. Secor (537), Uncontrolled Oscillations (542), World-Wide S-W Review, C. W. Palmer (550), Question Box (555), Can You Answer These Questions? (557), Short Wave Kinks (561), Short Wave Scout Trophy Award (568), Book Review (583)

SHORT WAVE & TELEVISION—Published monthly on the first of the month, 12 numbers per year. Entered as second-class matter May 7, 1930, at the post office at Mount Morris, Illinois, under the act of March 3, 1879. Trademarks and copyrights by permission of H. Gernsback, 99-101 Hudson St., N. Y. C. Text and illustrations are copyright and may not be reproduced without permission. Address all contributions to Editor, SHORT WAVE & TELEVISION, 99 Hudson St., N. Y. C. We are not responsible for lost manuscripts. Contributions cannot be returned unless authors remit full postage. Subscription price \$2.50 a year in the United States and possessions and Canada. \$3.00 in foreign countries. Single copies 25c, on sale at principal newsstands in the United States and Canada. Make all subscription checks payable to Popular Book Corporation. Printed in U. S. A.

SHORT WAVE & TELEVISION
Copyright 1938, by H. Gernsback
Published by Popular Book Corporation
Publication Office—404 N. Wesley Avenue, Mount Morris, Ill. Editorial and Executive Offices—99 Hudson St., New York, N.Y. HUGO GERNSBACK, President; H. W. SECOR, Vice President; EMIL GROSSMAN, Director of Advertising. European Agents: Gorrings American News Agency, 9A Green St., Leicester Square, London W.C. 2. Brentano's—London and Paris. Australian Agents: McGill's Agency, 179 Elizabeth St., Melbourne.



**By Doing Actual Jobs—Not Correspondence—On Modern Radio Equipment**

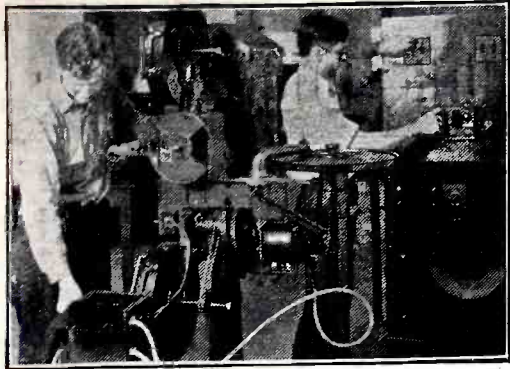

View of Students operating our Television Camera and Scanning Unit

# TRAIN IN 12 WEEKS

In the Big Chicago Shops of **COYNE**



Students operating our modern Transmitter

**TELEVISION**

# FOR RADIO

**TALKING PICTURES**

**No Advanced Education or Previous Experience Needed to Master Thorough, Practical Coyne Training**

“Learn by Doing” methods train you for **RADIO, TELEVISION and SOUND EQUIPMENT—NOT A CORRESPONDENCE COURSE—NO BOOK STUDY—YOU DON’T HAVE TO RECITE LESSONS IN A CLASSROOM—you DON’T NEED advanced education or previous Radio Experience.** You are trained right in modern, daylight shops on Radio, Sound and Television equipment under the personal supervision of expert instructors on the sort of similar work you will meet out in the field on a real job. That’s why Coyne Practical Training is able to prepare you in such a short time. **SPEND ONLY 12 WEEKS DOING ACTUAL WORK AT COYNE,** and you should be ready for your start to a better job and a real future. Do radio wiring and testing, trouble shooting, repairing and servicing. Work on a wide variety of Superheterodyne sets, oscillators, analyzers and test instruments. Learn how to operate television receiving and transmitting equipment; to install, test and service public address systems and sound picture equipment. Prepare to qualify for a government license examination as Amateur, Broadcast, or Telegraph Radio Operator and to know code and Dept. of Commerce rules.

## Amazing Offer!

# PAY FOR YOUR TRAINING AFTER YOU GRADUATE in Small Monthly Payments!

Don't let lack of money stop you from sending in the Coupon. Learn how you can get your training first—Then take over one year to pay tuition after you graduate. Make your first payment 60 days after your regular 12 Weeks Training period ends. Then take over a year to pay the

balance in small monthly payments. This plan has enabled hundreds of ambitious fellows to get Coyne Training with very little money. It can do the same for you. Many of our graduates have found their extra earnings more than enough to cover the small monthly payments.

### Earn Living Expenses While You Are Training!

If you need part-time work to help pay your living expenses while training, my free employment service will help you get it. The Free Service of our Employment Department has enabled hundreds of deserving students to get part time jobs and earn part or all of their room and board while training in the great Coyne Chicago Shops.

### Electric Refrigeration

#### Training Included Without Extra Cost

This combination Training (Radio and Refrigeration) can be of great value to you. Whether you go into business for yourself or get a job working for a Radio Sales and Service organization, the fact that you are trained in servicing Electric Refrigerators will be profitable to you. Many Radio Manufacturers also make Electric Refrigerators and men with this combination training are much more valuable to these employers. You can NOW get this training without extra cost.



### You Get Employment Service After You Graduate

Our Graduate Employment Service will give you employment service as often as you need it. You will also get free consultation service and advice whenever you want it.

### Mail The Coupon

Get the new “Coyne Opportunity Book” giving all facts about Coyne Training. Photographs of Shops showing students at work on modern Radio equipment under the personal supervision of Coyne Expert Instructors. Also details of our Part Time Employment Service, Pay After Graduation Plan and Graduate Employment Service. Yours without cost. Simply mail the coupon.

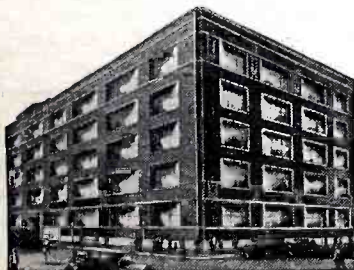

#### Home of Coyne Shops

This is our fireproof modern building wherein is installed thousands of dollars worth of Radio equipment of all kinds. Every comfort and convenience has been arranged to make you happy and contented during your Training.

**COYNE**

**RADIO DIVISION  
ELECTRICAL SCHOOL  
500 S. Paulina St., Dept. 28-2K, Chicago, Ill.**

**H. C. LEWIS  
President**

H. C. LEWIS, President—RADIO DIVISION  
Coyne Electrical School, Dept. 28-2K  
500 S. Paulina St., Chicago, Ill.

Send me your Big Free Book about Coyne Training and give me all details regarding your Part Time Employment Service and Pay After Graduation Plan of easy, monthly payments.

NAME.....AGE.....

ADDRESS.....

CITY.....STATE.....

Mail in envelope or paste on postcard

Please mention SHORT WAVE & TELEVISION when writing advertisers



# ... THESE OUTSTANDING SHORT WAVE BOOKS ARE Now Available AT YOUR DEALER!

YOU buy parts, tubes, kits, accessories from your local radio dealer—that's what countless thousands of short-wave fans do. Now through a nation-wide distribution service our numerous books are available at your favorite radio dealer—right where you buy other radio equipment. It's more convenient, saves time and you can inspect the books before you buy. Ask your dealer to show you all the books advertised on this page—they're always in stock.

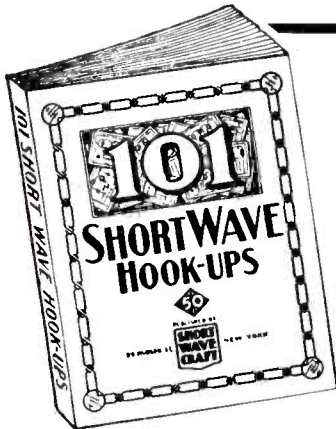

### 101 SHORT WAVE HOOK-UPS

Compiled by the Editors of SHORT WAVE and TELEVISION

Here is a worthwhile book that every short wave listener, every short wave fan, and every short wave amateur has wanted for a long time. It gives you the 101 best short wave hook-ups which have appeared heretofore.  
100 Illustrations  
72 Pages

50c

### HOW TO BUILD AND OPERATE SHORT WAVE RECEIVERS

This is the best and most up-to-date book on the subject. It is edited and prepared by the editors of SHORT WAVE and TELEVISION and contains a wealth of material on the building and operation, not only of typical short wave receivers, but short wave converters as well.

150 Illustrations  
72 Pages

50c



### TEN MOST POPULAR SHORT WAVE RECEIVERS

HOW TO MAKE AND WORK THEM  
The editors of SHORT WAVE and TELEVISION have selected ten outstanding short wave receivers and these are described in the new volume. Each receiver is fully illustrated with a complete layout, pictorial representation, photographs of the set complete, hook-up and all worthwhile specifications.

75 Illustrations  
40 Pages

25c

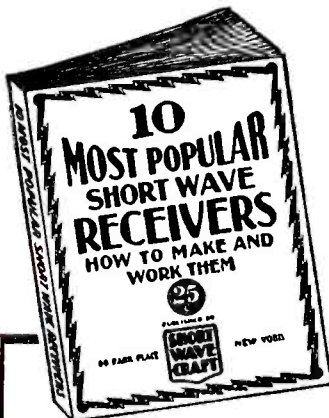

### HOW TO GET BEST SHORT WAVE RECEPTION

M. HARVEY GERNSBACK tells you everything you have ever wanted to know about short wave reception. The author, a professional radio listener and radio fan for many years, gives you his long experience in radio reception and all that goes with it.

40 Illustrations  
72 Pages

50c

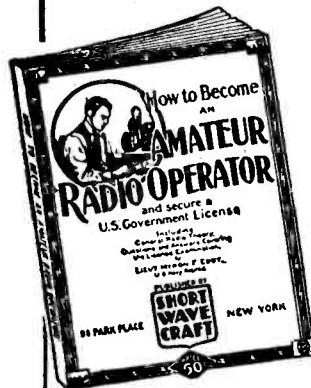
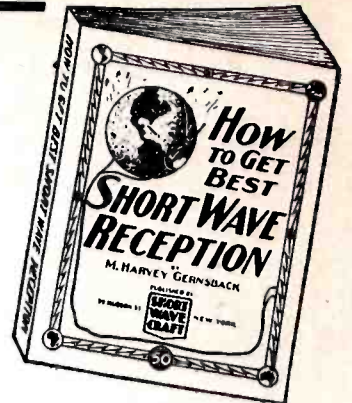

### HOW TO BECOME AN AMATEUR RADIO OPERATOR

By Lieut. Myron F. Eddy, whose experience in the amateur field has made him pre-eminent in this line.

If you intend to become a licensed code operator, if you wish to take up phone work eventually—this is the book you must get.

150 Illustrations  
72 Pages

50c

### THE SHORT WAVE BEGINNER'S BOOK

Here is a book that solves your short wave problems—leading you in easy stages from the simplest fundamentals to the present stage of the art as it is known today. It is the only low-priced reference book on short waves for the beginner.

75 Illustrations  
40 Pages

25c

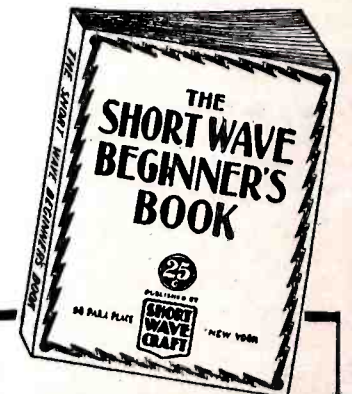

### LOOK FOR YOUR NEAREST DEALER

For convenience the publishers list below dealers in all parts of the world where our books are available. On your next shopping trip be certain to examine these volumes. You're sure to want them for your technical library.

**ALABAMA**  
Walther Bros., Montgomery

**ARIZONA**  
Sam's Cigar Store, Phoenix

**CALIFORNIA**  
Electric Supply Co., Oakland  
Radio Supply Company, Los Angeles  
Radio Television Supply Co., Los Angeles  
Pacific Radio Exchange, Inc., Los Angeles

Western Auto Supply, Los Angeles  
Zack Radio Supply Co., Los Angeles  
Vroman's Book Store, Pasadena  
Western Radio & Elec. Co., San Diego  
Offenbach Electric Co., San Francisco  
Technical Book Co., San Francisco  
Zack Radio Supply Co., San Francisco  
Radio Specialties Co., San Jose

**COLORADO**  
Auto Equipment Co., Denver  
Interstate Radio Supply, Denver

**CONNECTICUT**  
The Edward P. Judd Co., New Haven

**DELAWARE**  
Wilmington Elec. Spec. Co., Inc., Wilmington

**FLORIDA**  
Radio Accessories Co., Orlando

**GEORGIA**  
Wholesale Radio Service Co., Inc., Atlanta

**ILLINOIS**  
Allied Radio Corporation, Chicago  
Walter C. Braun, Inc., Chicago  
Chicago Radio Apparatus Co., Chicago  
A. C. McClurg & Co., Chicago  
Midwest Radio Mart, Chicago  
Newark Electric Co., Chicago  
Sears, Roebuck & Co., Chicago  
Max Stein & Co., Chicago  
Montgomery Ward & Co., Chicago  
Wholesale Radio Service Co., Inc., Chicago

**INDIANA**  
Van Sickle Radio, Indianapolis

**MASSACHUSETTS**  
DeWolfe & Fiske Co., Boston  
The Personal Book Shop, Boston  
Wholesale Radio Service Co., Inc., Boston

**MICHIGAN**  
Library Book House, Springfield  
Tremont Elec. Supply Co., Boston

**MINNESOTA**  
Rissl Brothers, Detroit

**MISSOURI**  
St. Paul Book & Stat. Co., St. Paul

**MISSOURI**  
Burststein-Applebee Co., Kansas City  
Radio Labs., Kansas City  
Walter Ashe Radio Co., St. Louis  
Van Sickle Radio Co., St. Louis

**NEW JERSEY**  
Radio Apparatus Co., Newark  
United Radio Co., Newark  
Wholesale Radio Service Co., Inc., Newark

**NEW YORK**  
Fort Orange Radio Dist. Co., Albany  
Wholesale Radio Service Co., Inc., Albany

**NEW YORK**  
Wholesale Radio Service Co., Inc., Jamaica, L. I.

**NEW YORK**  
American News Co., New York City  
Baker & Taylor Co., New York City  
Blair, the Radio Man, New York City  
David Bogen & Co., New York City  
Federated Purchaser, Inc., New York City

**NEW YORK**  
Harrison Radio Co., New York City  
Radio Circular Co., New York City  
G. E. Stechert & Co., New York City  
The Stolzer Co., New York City  
Sun Radio Co., New York City  
Thor Radio Corp., New York City  
Try-Mo Radio Co., New York City  
Van Riemsdyck Book Stores, New York City

**NEW YORK**  
Wholesale Radio Service Co., Inc., New York City

**NEW YORK**  
H. W. Wilson Co., New York City  
Radio Parts & Equipment Co., Rochester  
M. Schwartz & Son, Schenectady

**OHIO**  
College Book Exchange, Toledo

**OREGON**  
J. K. Gill Co., Portland

**PENNSYLVANIA**  
Radio Electric Service Co., Philadelphia  
Cameradio Co., Pittsburgh

**WASHINGTON**  
Seattle Radio Supply Co., Seattle  
Wedel Co., Inc., Seattle  
Spokane Radio Co., Spokane

**WISCONSIN**  
Radio Parts Co., Milwaukee

**ARGENTINA**  
Radio Revista, Buenos Aires

**AUSTRALIA**  
McGill's Authorized Agency, Melbourne

**BELGIUM**  
Emil Arens, Brussels

**CANADA**  
T. Eaton & Co., Winnipeg, Man.  
Electrical Supplies, Ltd., Winnipeg, Man.

**CANADA**  
Wholesale Radio Supply, Winnipeg, Man.

**CANADA**  
Canadian Electrical Supply Co., Ltd., Toronto, Ont.

**CANADA**  
Radio Trade Supply Co., Ltd., Toronto, Ont.

**CANADA**  
Canadian Electrical Supply Co., Ltd., Montreal, P. Q.

**BRAZIL**  
Agencia Soave, Sao Paulo

**CHINA**  
China News Co., Shanghai  
International Booksellers, Ltd., Shanghai

**CUBA**  
Diamond News Co., Havana

**ENGLAND**  
Gorringer's Amer. News Agency, London

**FRANCE**  
Toute La Radio, Paris

**GERMANY**  
Rehr G.M.B.H. SW15, Berlin NW No. 7

**INDIA**  
Empire Book Mart, Bombay

**MEXICO**  
American Book Store, Mexico, D. F.  
Central De Publicaciones, S. A., Mexico, D. F.  
Jaques Salvo, Mexico, D. F.

**NEW ZEALAND**  
Johns, Ltd., Auckland  
James Johnston, Ltd., Dunedin  
Te Aro Book Depot, Ltd., Wellington

**SOUTH AFRICA**  
Technical Book Co., Cape Town  
Central News Agency, Johannesburg  
International House, Johannesburg  
South African Radio Publications, Johannesburg

IF YOUR DEALER DOES NOT CARRY THESE BOOKS, ORDER DIRECT FROM US. FILL OUT COUPON BELOW. SHIPMENT WILL BE MADE IMMEDIATELY.

POPULAR BOOK CORPORATION SW-2  
99 Hudson Street, New York City.  
Gentlemen: I enclose herewith my remittance for \_\_\_\_\_ for which please send me the following books:

Name \_\_\_\_\_  
Address \_\_\_\_\_  
City \_\_\_\_\_ State \_\_\_\_\_  
(Send remittance in form of check or money order. If letter contains cash or unused U. S. postage stamps, register it.)

POPULAR BOOK CORPORATION • Publishers • 99 HUDSON STREET • NEW YORK, N. Y.





HUGO GERNSBACK, EDITOR

H. WINFIELD SECOR, MANAGING EDITOR

# TELEVISION—How Soon?

Donald McNicol, past-president of the Institute of Radio Engineers, discusses the various problems to be solved in order to realize commercial television in this country.

● IN files of scientific literature of ten years ago there are advertisements which announced the perfection of television. In the year 1937, in clubs, in newspaper offices, on trains, on street corners, radio engineers are still being asked the question, "When are we to have television?" What there is available at the moment in the way of television service has cost, it is said, some fifty million dollars, and when the public views present television performance, the question still is asked, "When are we to have television?"

Apologists say that television is making as rapid progress toward perfection as was that made by radio. There is substance in this argument if radio's beginning is dated from the year 1894 and its profitable employment from 1923—a span of twenty-nine years. But, if the period of radio's development encompasses the evolution of radio-telephony—radio broadcasting, then the radio period shortens to 1915-1923, a span of eight years. The logic of the separation lies in the assumption that spark-gap wireless telegraphy, and vacuum tube transmitters for radio-telephony were concurrent developments mainly in the hands of the same experimenters, fathered by a common objective, but nonetheless separate arts.

Television has been a laboratory baby since 1920. Long before that year however, thought was given the subject and experimental systems tinkered with, but the year 1920 may be taken as a date when what we have today in the way of television took form. That is a span of seventeen years, compared to an equivalent span of eight years for radio broadcasting—and still the question, "When are we to have television?"

*Engineering Progress*—There are engineers who say that we shall have television just as soon as someone invents it, by which is implied that a television system to which the public will take, as it took to radio sound broadcasting in 1922, will be the fruition of discoveries or inventions yet to be made. As to this it is not likely that the fifty million dollars so far expended has been wasted. What has gone before in association with what is to come will in some degree bear the relation of concurrent arts, as in the case of radio-telephone development.

Television's ultimate attainments have been

set for it by moving pictures on large screens, and the task rendered more difficult with the perfection of talking pictures. The public has its own ideas of what will be acceptable in television service. There is a parallel in air transport: An airplane that would carry as many as fifty passengers across the Atlantic, bears some relation to a great ship that carries thousands of passengers, but as a means of transport there is an impressive difference. Could the *Normandie* be equipped with wings that would carry her across the

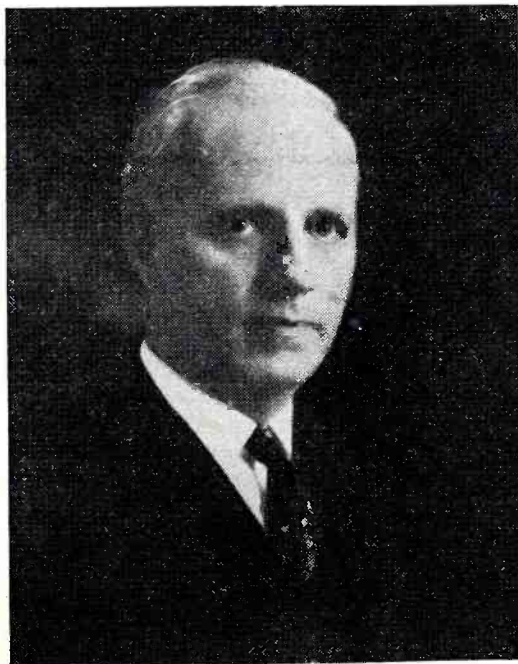

Donald McNicol, who has held many important positions, has been an active worker in the field of electrical and radio engineering.

Atlantic in a day and a half, that would be something! If a citizen, on a wall in his living room had a 3-foot, or 4-foot square screen upon which he could view "pictures" as in the movies, that would be television, as the public which pays for services desires television.

There are two factors in the television situation which are of creditable significance; creditable to the engineers and to the com-

mercial organizations likely to exploit and promote television when it arrives. In the promotion of television the operating organizations, heirs to what the engineers may accomplish, have avoided premature, sensational exploitation. This is salutary and commendable. On the part of the host of engineers and experimenters who are devoting their lives and talents to the development of television, there is a determination to succeed which can have only a satisfactory outcome.

*Channels for Television*—As has been the entire history of radio, experimentation and research in the engineering of television have profited from inventions and discoveries in collateral departments of science. The explorations of radio amateurs into the realms of high-frequency (short-wave) radio transmission, and the work of promoters of new services such as police radio, in the ultra-high frequency bands, have contributed measurably.

As matters stand at the moment, the conclusion of television engineers is that a swath six megacycles (6,000,000 cycles) wide is satisfactory for picture and sound transmission, and it has been proposed that—excluding the amateur band between 56 and 60 megacycles—the frequencies between 42 and 90 megacycles be assigned to television. In view of the notion held by laymen as to the immense number of channels made available by utilization of ultra-high frequencies, it is of interest to note that in the band recommended for television there are but seven channels of 6 megacycles width. Even with the limited range or coverage of a television transmitter as at present contemplated, large cities like New York and Chicago might have not more than three or four television transmissions. The present high cost of television studios and transmitters, with particular respect to the high cost of suitable entertainment material for transmission, renders quite remote the likelihood that television service to rural areas will be available by direct transmission until relaying at commercial costs is practicable.

*New York, Then Hollywood*—In view of what the public is likely to expect from television it is realized that New York and Hollywood constitute the two most dependable sources of talent. It would appear that New York is to be the (Continued on page 570)

Fourteenth of a Series of  
"Guest" Editorials.



# Television "Piped" from New York to Philadelphia

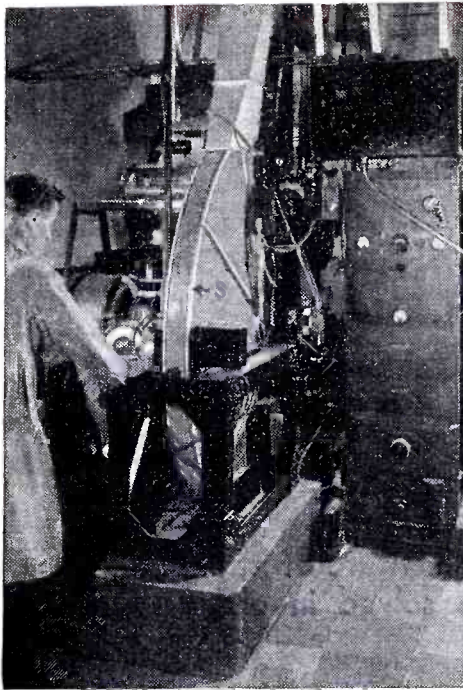

Enclosed lens scanning disc at transmitter is indicated at S.

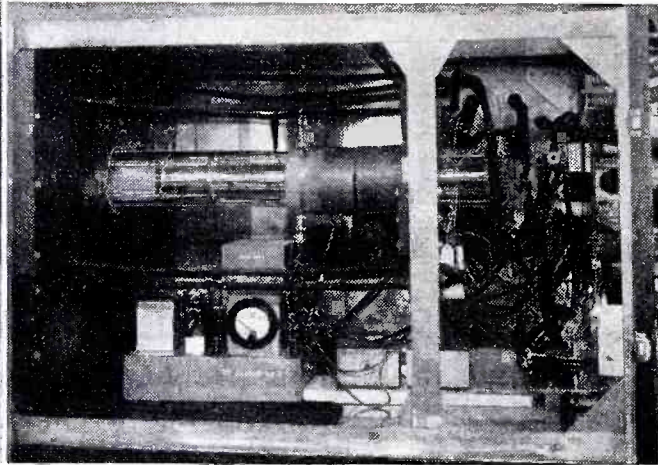

A close-up of the large cathode ray tube which reconstructs the images.

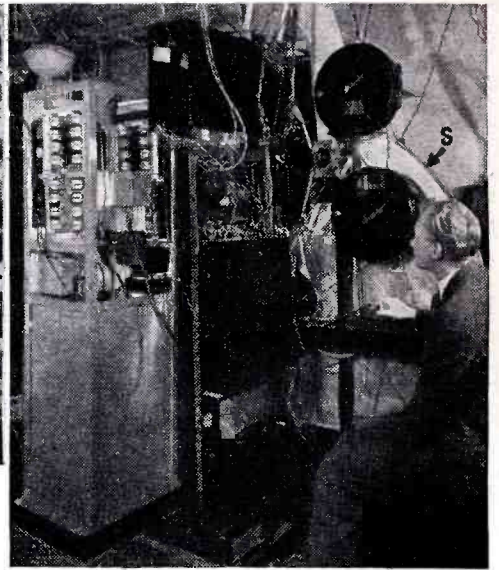

Photos courtesy of Bell Telephone Lab. Another view of the television transmitter at New York.

● IN the Bell Telephone Laboratories in New York recently a sound-picture film was run through a transmitter and its two records—sound and scene—were converted into electric currents and transmitted to Philadelphia, 90 miles distant. There the picture was reproduced on a glass screen large enough for a group of ten people to see easily, while the accompanying sound came from a loud-speaker. The sound picture described, by voice and animated diagrams, the coaxial cable system and explained briefly the operation of the picture transmitter and receiver. Some films typical of the news-reel theatre were also transmitted. The film itself told the story of the experiment.

Between the Long Lines offices in New York and Philadelphia there extends a cable which contains two coaxial-conductor units. Each unit is formed by a flexible copper tube and a single wire enclosed by the tube and held at its center by thin disks of hard rubber. Along the route are unattended installations of special amplifying equipment

which receive their power over the inner wires of the two coaxials. The cable with its amplifiers and with its terminal equipment is an experimental installation for the development of broad-band transmission.

**Motion pictures were recently transmitted a distance of 90 miles between New York and Philadelphia by the Bell Telephone Labs., over their new coaxial cable system. 240 line definition was used and the images were surprisingly steady and clear.**

Each coaxial conductor unit with its associated one-way amplifiers is capable of transmitting simultaneously the currents of two hundred and forty different telephone

transmitters. Using separate units for transmission in opposite directions, the system provides for two hundred and forty simultaneous conversations. The million-cycle range of each unit is utilized by carrier-current methods. In the present arrangement the transmitters are formed into twenty groups of twelve each. Each transmitter is limited to a frequency band of four kilocycles; and the bands from the twelve transmitters of each group are raised to successive positions between sixty and one hundred and eight kilocycles. Twenty complicated currents are thus obtained. These currents, by another modulation, are spaced in the range from sixty to one thousand and twenty kilocycles. This system of multi-channel telephony was recently tested over a looped back circuit equivalent to thirty-eight hundred miles; and transmission was satisfactory.

Another question remained: Can the system transmit satisfactorily a single message the frequency components of which occupy its entire range, that is, a current of the kind required in television programs. To study that possibility there were constructed in the Bell Telephone Laboratories a transmitter to originate a signal of that wide range of frequencies and a suitable receiver, both of which utilize some of the present techniques of television.

## Lens Disc Scans Film Images

For a signal which can be repeated over and over a motion picture is used; it moves uniformly past a picture gate where lenses in a large rotating disc sweep across it a light beam three-thousandths of an inch square! The light passing through the film enters an electron multiplier. The resulting current contains frequencies between zero and about eight hundred kilocycles. Before transmission it is raised by modulation about one hundred kilocycles higher.

High Frequencies—Sharpness of detail in a picture implies a rapid change from light to  
(Continued on page 574)

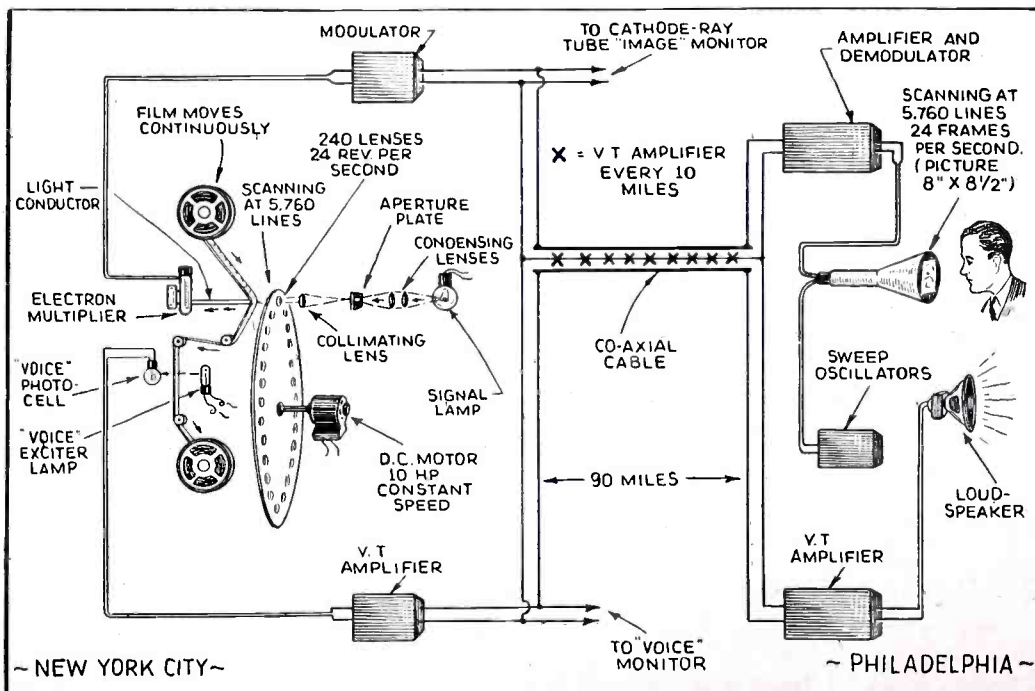
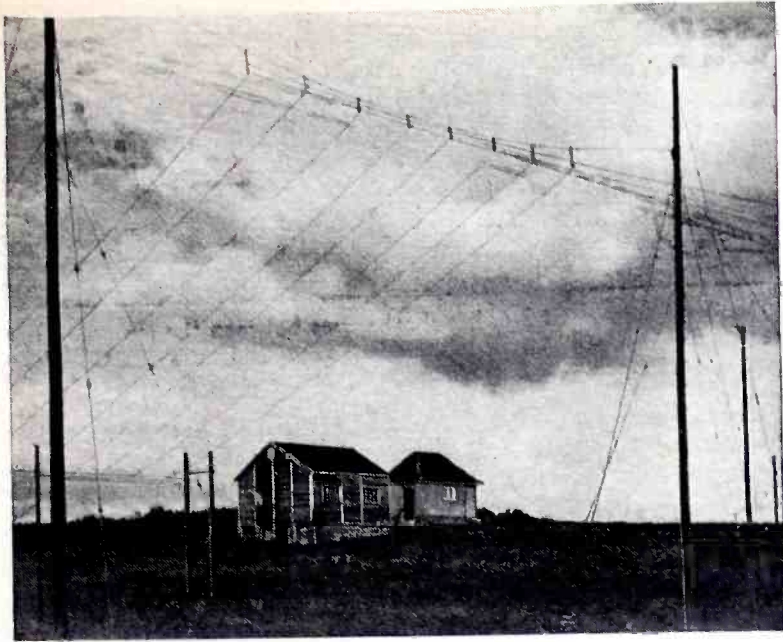

Diagram shows in simplified fashion the set-up for transmitting television over the coaxial cable between New York and Philadelphia.





Receiving and transmitting aerials at Portpatrick (Stranraer) Scotland.

# 9 People Can Talk 2-Way on 1 U.S.W. Circuit

Ireland and Scotland now joined by forty-one-mile 3.6 meter U.-S.W. link carrying nine 2-way conversations.

● THE inauguration by Sir Walter J. Womersley, M.P., Assistant Postmaster General, of the Belfast-Stranraer 9-channel *ultra-short wave* radio telephone link recently marks one of the most outstanding achievements of today in the world of communications.

Although the use of *ultra-short waves* for commercial telephony is by no means new—an experimental service having been operated by the British Post Office as long ago as 1932—this is the first application in Great Britain, or in fact in the world, of a system wherein as many as nine telephone channels are passed simultaneously over a single radio link.

This system is the outcome of many years of research by engineers into the technique of *ultra-short wave* communication, coupled with long and arduous field trials. It is interesting to note, too, that the *ultra-short wave* is by no means the limit of wavelength for communication purposes and that the researches of Standard Radio engineers into *microrays* resulted in the design and installation as long ago as 1933 of the Lympne-St. Inglevert *micro-ray* link used by the Air Ministry, which operates on a wavelength of 17.4 cms. (6.9 inches) over an optical distance of 21.7 miles (35 km).

Foremost among the virtues of the *ultra-short waves* is the possibility of transmitting *wide bandwidths*. The width of the band that can be transmitted increases as the wavelength is shortened, and it is for this reason mainly that high definition television

stations all operate in this region, as they require a total bandwidth of as much as six megacycles.

### Apparatus Is Automatic in Operation

The equipment is designed for unattended operation and is capable of complete re-

ting and receiving equipments derive their whole power supply from the public supply mains, the only battery used in the equipment being that for the operation of the relay system. A Diesel-electric power plant is arranged so that in the event of failure of the public electricity supply, it will take over the load automatically approximately

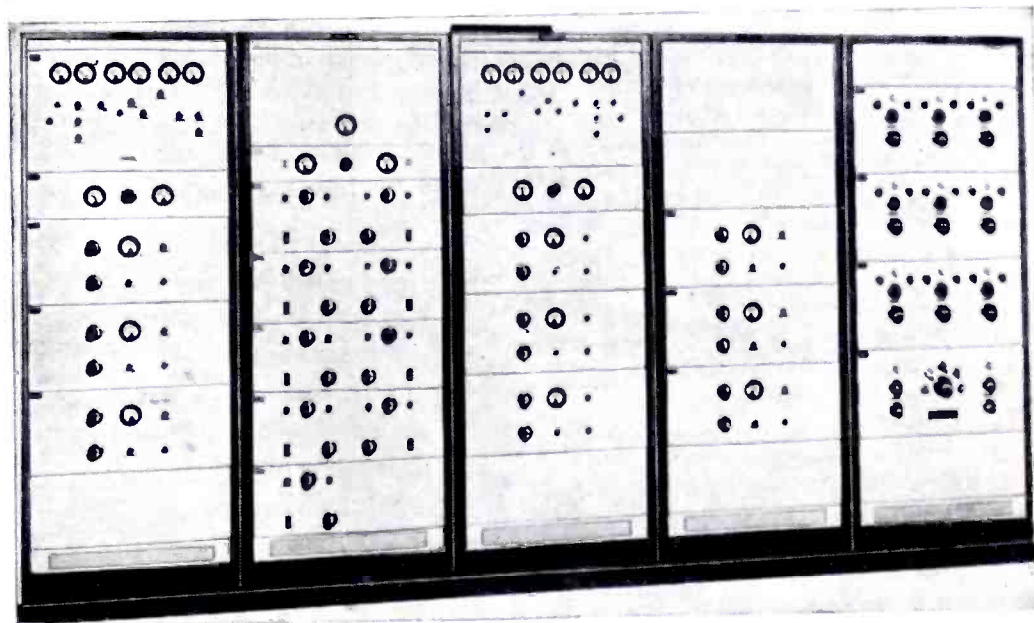

Transmitter of the type used at Belfast and Stranraer for the 9-Channel U.-S.W. radio link across the Irish Sea.

ote control from the nearest telephone exchange. In addition it is provided with spare equipment, part of which is brought automatically into operation on the occurrence of any abnormal condition. Both transmit-

one minute after such failure and thus avoid serious interruption of the service.

*Transmitter:* Let it be assumed that the input of channel No. 1 is supplied with  
(Continued on page 578)

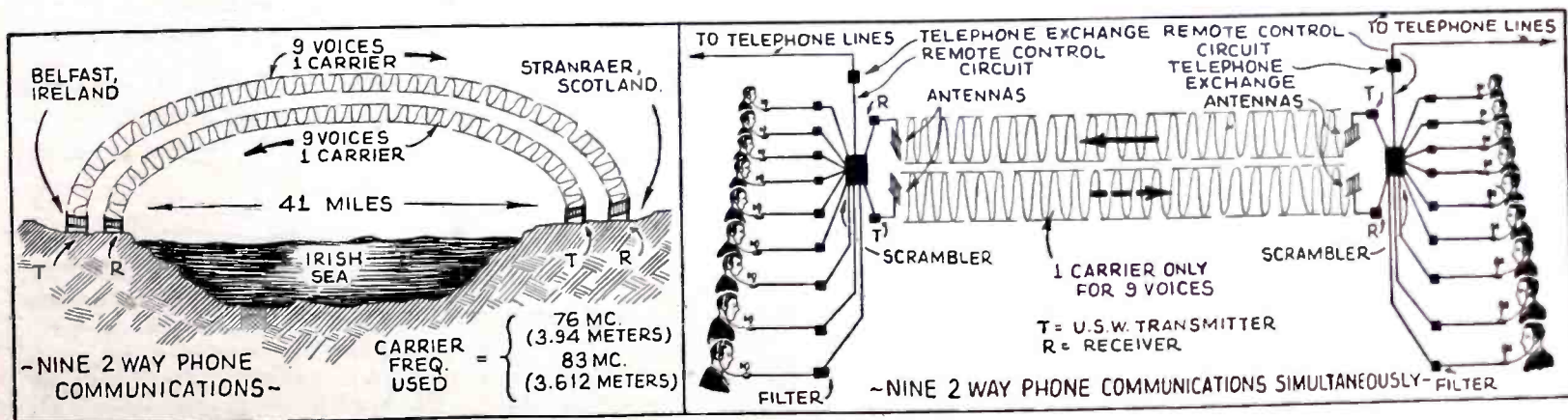

One of the latest and cleverest developments in *ultra-short-waves* for the 41-mile link joining Ireland and Scotland—18 people may talk over this 2-way 9-channel system. One carrier uses a 3.94-meter (76 mc.) carrier, while the second carrier, for transmission in the opposite direction, uses a 3.61 meter (83 mc.) carrier wave.



# Ultra-Short Waves Connect Institute to Observatory

## 90 Miles Distant

AUSTIN BAILEY

Transmission Development, Bell Telephone Laboratories

● THERE is under construction on the top of Palomar Mountain, in Southern California, a new astronomical observatory in which the world's largest telescope is to be installed. The establishment of the observatory represents a major construction project, for which a telephone "order wire" is required between the mountain top and the headquarters at the California Institute of Technology, which is situated about ninety miles away.

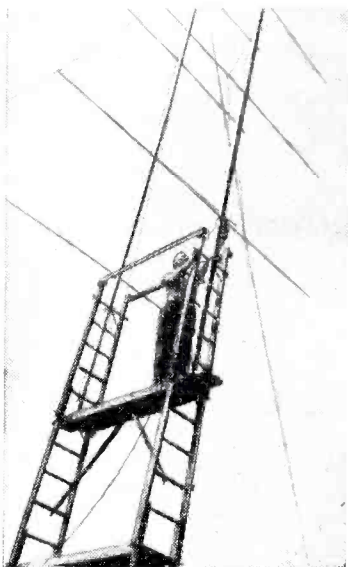

One of the antenna structures used for ultra-short wave experiments.

Members of the staff of the California Institute proposed establishing the desired telephone connection by means of an *ultra-short wave radio link*. As this seemed to be a favorable opportunity to try out ultra-short waves for telephone purposes over an unusual and difficult transmission path, the engineers of the Laboratories became interested in it, and the project

was undertaken on a cooperative basis. The Bell System agreed to contribute the apparatus and the Institute to carry out the work of setting up the circuit and operating it for their purposes, while both have joined in the experimental study of the propagation path. The transmission path is characterized by its considerable length, ninety miles, and the fact that the peaks of an intervening range of mountains protrude into it. The situation is illustrated by the profile chart where the solid line indicates the shortest path and the dashed one represents the mean path which the ultra-short waves would be

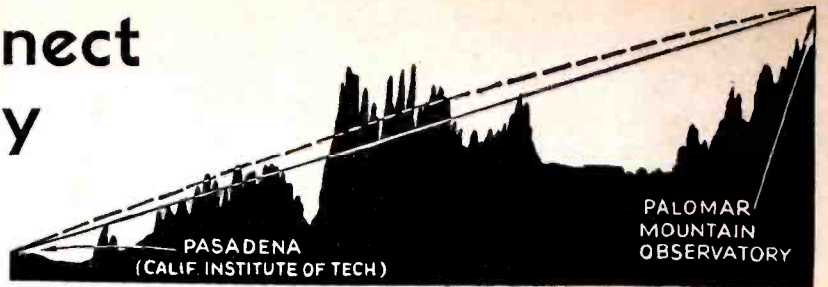

The 90-mile gap spanned by ultra-short waves between the mountain top, where the world's largest telescope is to be erected, and the California Institute of Technology is shown above.

The transmission path is characterized by its considerable length, ninety miles, and the fact that the peaks of an intervening range of mountains protrude into it. The situation is illustrated by the profile chart where the solid line indicates the shortest path and the dashed one represents the mean path which the ultra-short waves would be

(Continued on page 571)

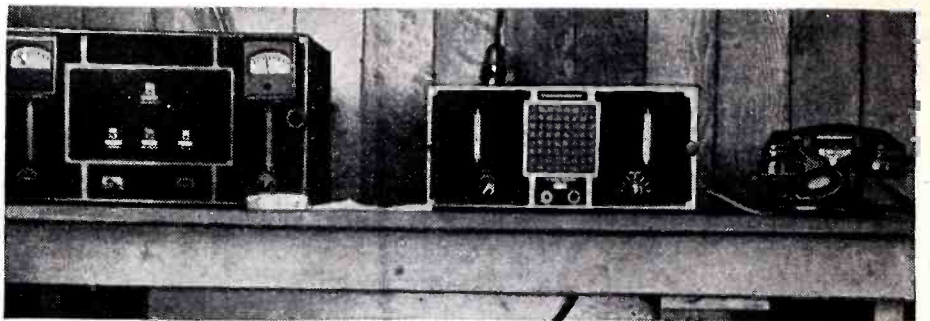

Interior of the radio shack at Palomar, showing the ultra-short wave receiver and transmitter.

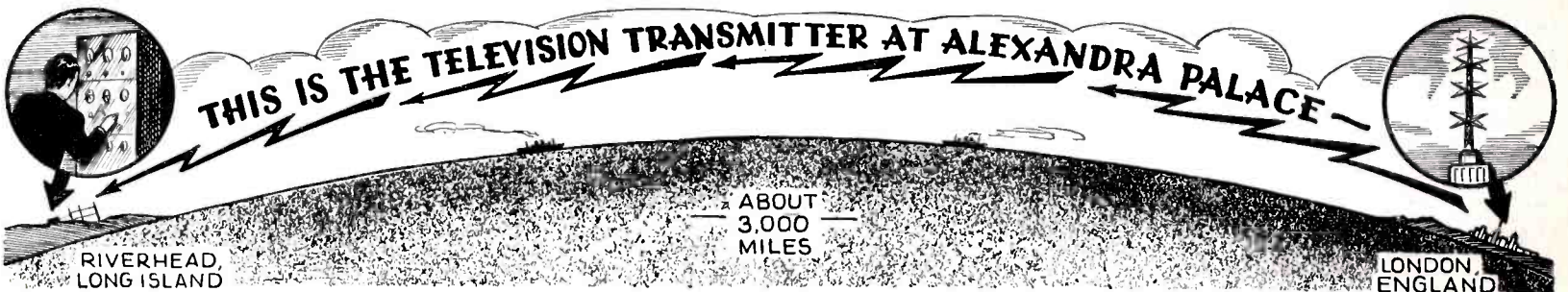

# TRANS-ATLANTIC TELEVISION?

Report on English Vision Signals Picked Up Here

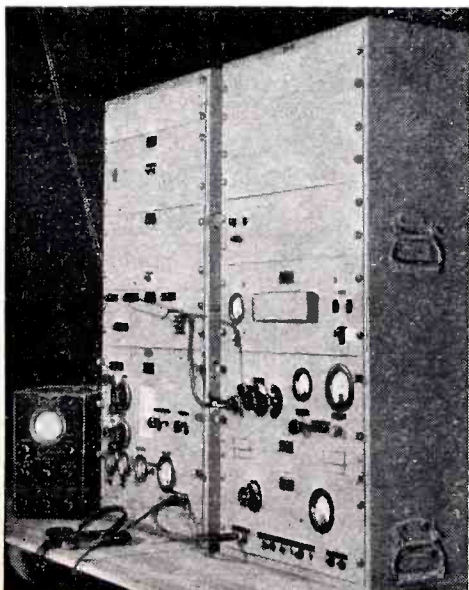

Fig. 1—Receiver used to pick up European television signals at Riverhead, Long Island.

DeWitt R. Goddard

R.C.A. Communications, Riverhead, L.I.

● ON January 21, 1937 one of our engineers at the Frequency Measuring Laboratory at Riverhead, N.Y., was making his usual routine "Cruise of the ether" in the neighborhood of 40 megacycles when to his surprise he heard a carrier modulated with a voice having a distinct English accent. A hurried check of the frequency showed the carrier to have a frequency of 41.5 megacycles per second, (7.22 meters) the assigned frequency of the voice channel of the Alexandra Palace television transmitter. A few minutes later the transmitter's identity was confirmed as the announcer said: "this is the television transmitter at Alex-

andra Palace, London." Imagine the operator's surprise!

This was the start of a series of observations and measurements on the English and German *television* transmissions. Fig. 1 shows the ultra-high frequency receiver used. The lower panel of the further rack is the receiver proper, while just above it is a low capacity antenna switch used to connect the receiver to either the incoming transposed

(Continued on page 577)

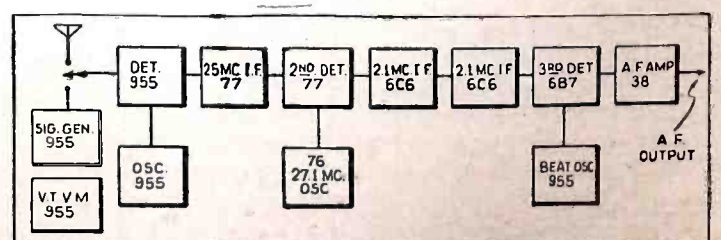
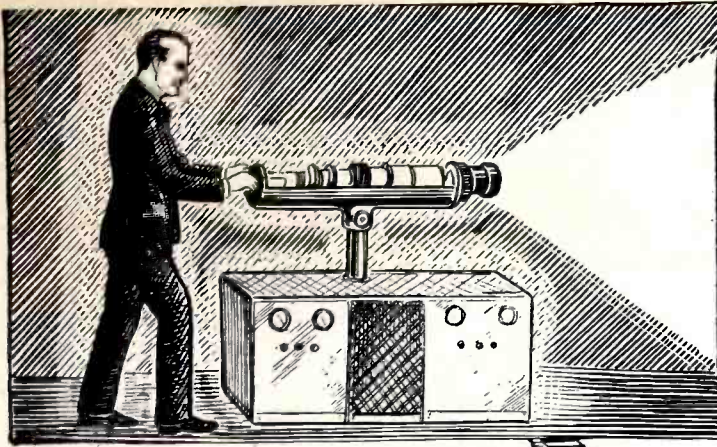

Fig. 2—Block diagram of the U.-H.F. receiver, showing types of tubes used.





# How Can I Obtain A Practical Education in RADIO & TELEVISION?

—H. W. Secor

● TELEVISION is rapidly becoming such an important subject that young men everywhere are beginning to ask the question as to how and where they can obtain a thorough training in this subject. In the first place a television expert does not grow overnight, as the general public is often prone to think, but he is the product of many months, even years, of careful training and laboratory research. A television expert is nothing more, nor less, than a person with electrical or radio training who has specialized in the latest developments in electronics, so that he has become an expert in the more restricted branches of the radio art dealing with television.

In other words, when a good television expert emerges from his studies he has a first class education in mathematics and the elements of electricity, including a thorough study of dynamos, batteries, magnets, chemistry, etc. All modern radio and television courses, as a study of the various schools will disclose, provide for this thorough basic training in electrical subjects including mathematics. There are a few specialized television courses which have been arranged for the more advanced students, who may have had a good basic training in technical or electrical subjects.

One may gather from what has been said thus far, that a man who is a first-class radio expert, may easily step over into the realm of television operation and design. Relatively speaking this is true, providing that he has kept pace with the recent technical developments in television. Another plan would be for such a radio expert to take one of the modern specialized courses in television offered by various schools which will enable the ambitious student to bring his radio education right up-to-date.

Short-wave hams make very excellent television course students, as they usually have acquired a good practical knowledge of radio matters in general. The ham's knowledge of the radio code will always stand him in good stead, as code signals are frequently useful in checking up between television stations. Those who intend to become television announcers, and there will be plenty of demand for them in the coming decade, will do well to study a foreign language or two, and they should also take a course in public speaking and debating. A specialized short course in television technique should also be taken by those aspiring to be television announcers, as a certain amount of technical knowledge will always prove extremely useful.

Resident instruction is desirable in radio and television work, as it is in many other subjects, but all of us cannot afford the time and money required to attend resident schools. Very excellent courses have been prepared and are now offered by a number of radio schools, whereby most, and in some cases all, of the instruction can be carried on by home-study.

Only trained men can and will operate television cameras and projectors.

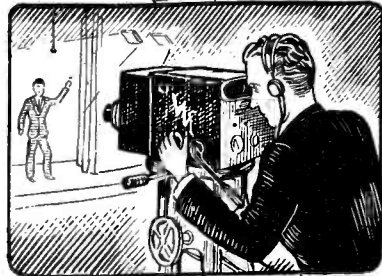

Television operators will be in great demand tomorrow.

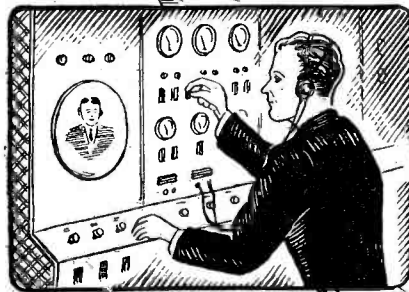

The student will do well to obtain a position in the radio-television field.

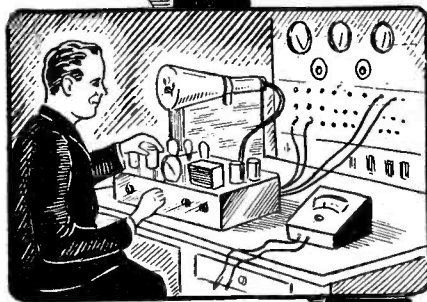

Below—The student should always check theory with practical experiments.

One of the weakest points about home-study courses has always been that the student may not be occupied daily in work of the same type as he is studying and, so, acquires only a theoretical knowledge of the subject. This has now been remedied by the fact that quite elaborate experimental apparatus is often furnished with the home-study course, and the student has to construct a number of different types of sets and make a report on them to his instructor. It is best, but not always essential, that the student of a home-study course endeavor to obtain a position with some company in the radio or television field, so as to gain practical experience.

Television set-servicing is a new branch of the radio industry which will before long demand

the earnest attention of students everywhere. Television receivers are far more complicated than even the largest broadcast receiving sets and only those servicemen who have received special training will be able to make satisfactory adjustments or repairs on the modern electronic television receivers. One of the peculiar things about this whole subject of television training, whether it is from the servicemen's point of view or the technician's, is that in any event the best men in the respective branches of the television art, will always be those who have a thorough basic training in electricity, mathematics and the subject of electronics. Rome wasn't built in a day, neither are television experts made over night! Forever and a day the television expert must be a student.

One of the modern courses offered in television starts the student off with a short history of the subjects and then provides an elementary study of the electron theory. Fundamental electrical terms are then discussed and next the student receives instruction in mathematics, alternating currents and the theory of vacuum tubes. Just why and how vacuum tubes do the things they do constitutes one of the main subjects in any radio or television course of study.

Other important topics taken up in one of these typical modern courses are: how to plot graphs, study of electro-

magnetism and the action taking place in magnetic circuits, studies in magnetic induction and how transformers work. The action occurring in condensers is then studied and the calculation of capacity with series and parallel

(Continued on page 566)





# New Experiments with Radio Apparatus

The experimenter has at his command today, many new devices which were not available yesterday. See if you can adapt some of these radio parts to non-radio applications—we offer cash prizes for ideas accepted and published.

## Loudspeaker Used As Microphone

When cone loudspeakers first came into use it was soon discovered that if a person spoke in proximity to one of these speakers, that the voice could be picked up and transmitted through an amplifier. The modern type small loudspeakers, particularly the 3" and 4"

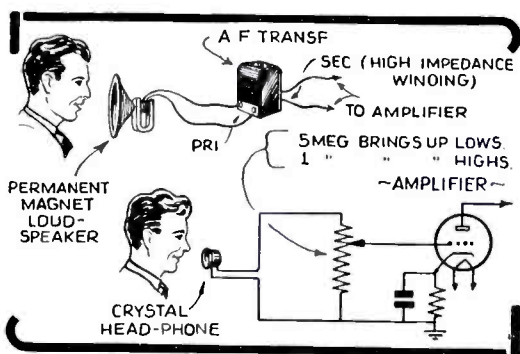

Here is a very useful idea—how to use a loudspeaker as a microphone.

diameter sizes having a permanent magnet field, are very useful as "mikes," and they develop their own voice currents as the diaphragm moves back and forth. They should be used in connection with a matching transformer; a little experimenting may be necessary to match the impedance for best results. An output transformer will usually serve the purpose of matching the speaker to the input of an amplifier.

A very good substitute for a mike is to use a crystal type headphone. These have quite a high impedance and they also develop their own voice currents in the form of piezo-electricity. The hook-up is shown for using a crystal headphone as a *mike*. The arm of the potentiometer enables the input to the amplifier to be adjusted as desired. The crystal phone has a very high output as a microphone.

If the potentiometer has about 5 megohms resistance this will bring up the low frequency

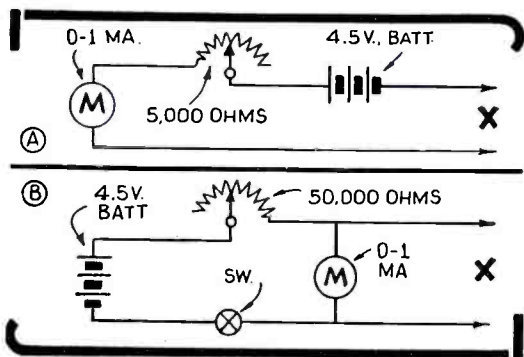

The two circuits shown above for a home-made ohmmeter, will prove valuable to both the radio and electrical experimenter. The advantages of each circuit are explained in the text.

components of the speech or music, while if the potentiometer has about 1 megohm resistance it will be found that the high-frequency speech components are brought out.

## A Simple Ohmmeter

If a low-range milliammeter is at hand, one having a scale reading say 0-1 ma., then it is a simple matter to arrange for the direct measurement of resistance. In the simpler form of ohmmeter circuit shown at A, a variable resistance of about 5,000 ohms is connected in series with a flashlight or other battery of say 4.5 volts potential, while the unknown resistance is connected across the terminals X.

In such a set-up the resistance may be judged relatively by comparing the readings on the milliammeter scale for a series of known resistances; a paper scale calibrated in ohms, may be pasted over the milliammeter dial. Even without such a calibrated scale, the relative value of a resistance may be judged by the difference in readings on the

## MONEY FOR YOUR IDEAS!

Each month we will award 2 prizes, the first of \$10, the second \$5, for the best NON-RADIO uses of ordinary radio parts and radio instrumentalities. Hundreds of different ideas may be adapted for this contest; the editors will be grateful for your ideas.

meter. Before making any measurements the variable resistance in series with the battery is adjusted until the meter reads full scale (with the terminals XX shorted together), in this way variations in voltage as the battery gets older are compensated for. The higher the voltage of the battery, the higher the resistance must be to compensate for it, and the higher the ohmmeter will read on its scale.

Fig. B shows an improved form of ohmmeter, employing a milliammeter with a scale of about 0-1 ma. This set-up is particularly useful for measuring resistances below 300 ohms. This shunt circuit type of ohmmeter will enable resistance values to be read within about  $\frac{1}{2}$  ohm. This feature is of great merit when testing low-resistance coils, such as those in R.F. and I.F. transformers. In this circuit whenever the battery switch is closed, the meter reads full scale at all times, until you connect an unknown resistance across the

terminals. When through making the test the battery switch is, of course opened. The lower the unknown resistance, the farther the meter needle will move toward the left.

## Balanced Burglar-Alarm Circuit

If you have several potentiometers of about the same resistance lying around, then you can make a bridge for one end of the circuit, as shown in the diagram. These potentiometers may be of 1,000 ohms value, or several thousand ohms, depending upon the resistance and sensitivity of the relay. If the relay is only a few hundred or possibly 1,000 ohms

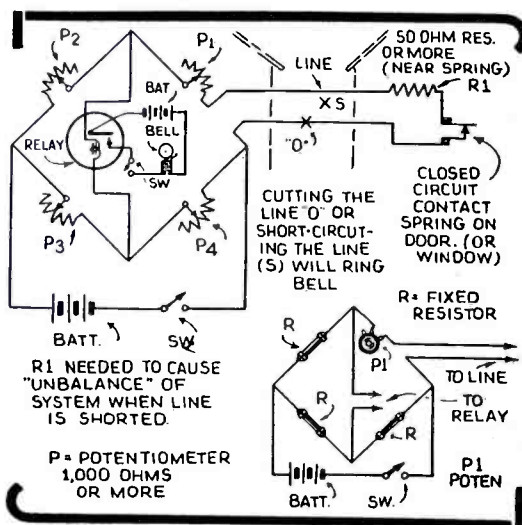

A simple balanced burglar alarm circuit.

resistance, then the potentiometers should not greatly exceed this, or an excessive battery current will be required to operate the relay.

As the system is balanced by adjusting the resistance of the four arms of the bridge until no current passes through the relay, it will be seen that if one of the wires constituting the circuit between a house and garage, for instance, is disturbed one arm of the bridge will be unbalanced and the relay will receive sufficient current to close an armature and ring a bell, etc. If a resistance, R1, of 50 ohms or so were not placed close to the closed-circuit contact on the garage door, for example, a piece of wire placed across the external line between the two buildings, would allow the thief to open the door without sounding an alarm.

One of the diagrams shows an optional and cheaper method of rigging up the resistance bridge. Here three of the arms are formed of ordinary fixed resistors, about 1,000 ohms each, and a variable resistor or potentiometer of 1,000 ohms is used in the fourth arm to balance the line resistance and also that of R1. The battery used across the bridge may be an Edison primary cell, dry cells or rectified A.C.



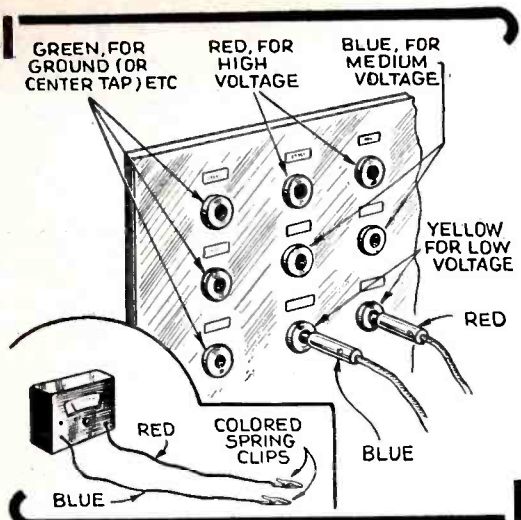

Colored jacks and plugs will save a lot of time and burned out instruments in the experimental laboratory.

### Colored Jacks and Plugs for Test-Boards

The accompanying picture shows how the brightly colored jacks and plugs now available in radio-supply stores may be used to good advantage for test switchboards in the home laboratory or service shop. Red is usually assigned to high voltage plus, while blue or yellow might be used to indicate medium voltage, and green or blue for B minus or ground lines.

We have seen many home-made testing instruments built up in neat cabinets by servicemen and radio experimenters in general, but we have been surprised to note that very little use has been made of the handsome colored pin-jack terminals and plugs now available on the market. By using colored wires in connection with these colored terminals, of the pin-jack or other variety, tests can be much more quickly and accurately carried out.

### Phono Pick-Up Made from Headphone

After all, phonograph pick-ups cannot be bought for a song, and every once in a while the experimenter may desire to make use of such a device, without caring to spend several dollars for one of these pick-ups. A Baldwin type phone makes a very good phonograph pick-up when rebuilt in the manner shown in the picture.

In some cases the lever and bearing supports for it may be procured from a local radio and phonograph shop, an old sound-box being sometimes available at slight cost. The lever and supports are mounted on the cap

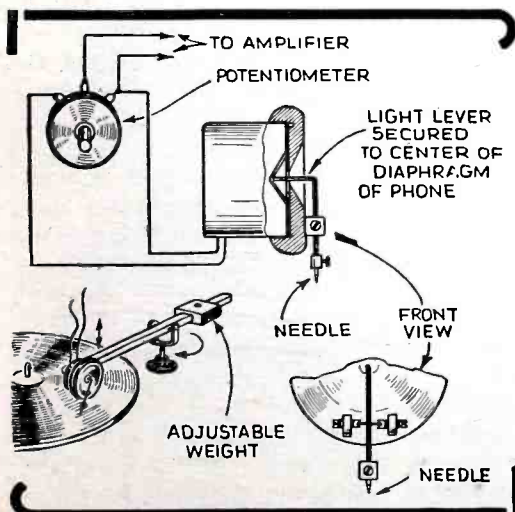

A good phonograph can be made from a headphone, especially one of the Baldwin type.

of the phone or the old phonograph sound-box frame may be screwed or clamped to the headphone. A small piece of stiff wire may be cemented in place from the center of the phone diaphragm to the top of the balanced pick-up lever; on the lower end mount the needle-holder. The ingenious experimenter can also easily rig up a balanced arm to carry the magnetic pick-up as shown in the sketch. As will be seen the arm must have two motions, up and down and also sidewise.

A balance weight can be placed on the outer end, and by putting a thumb-screw on this so that it can be slid along the arm, any amount of pressure can be exerted on the phonograph needle. Hill and dale records may be played by turning the pick-up into the proper position.

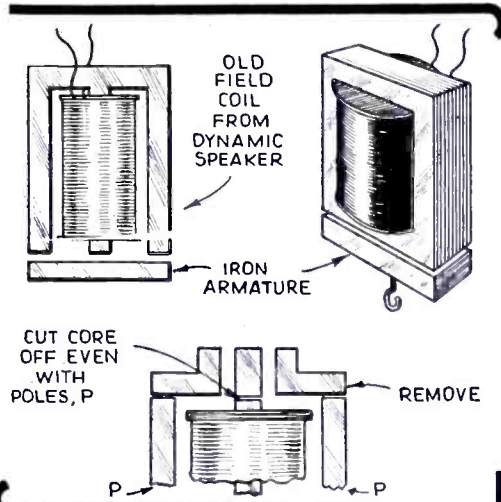

A powerful magnet can easily be built from an old loudspeaker unit. Many other variations of the idea shown in the picture will suggest themselves to the live-wire experimenter, such as heavy-duty relays constructed from the magnet frame and coil, etc.

### Powerful Magnet from Old Speaker Unit

The illustration shows how a strong electromagnet may be made from an old loudspeaker frame. In some of the older type speakers the field coil was wound for 6 volts and if you happen to run across one of these, it should make a very strong battery magnet.

In any event a new iron armature will have to be provided and this may be made by riveting together a bunch of transformer punchings or else formed from a piece of wrought iron or mild steel about  $\frac{1}{2}$ " or  $\frac{3}{4}$ "

A radio piano on which different tunes can be played is shown in the diagram below, and in the detailed drawing of one of the "key" condensers, at the right.

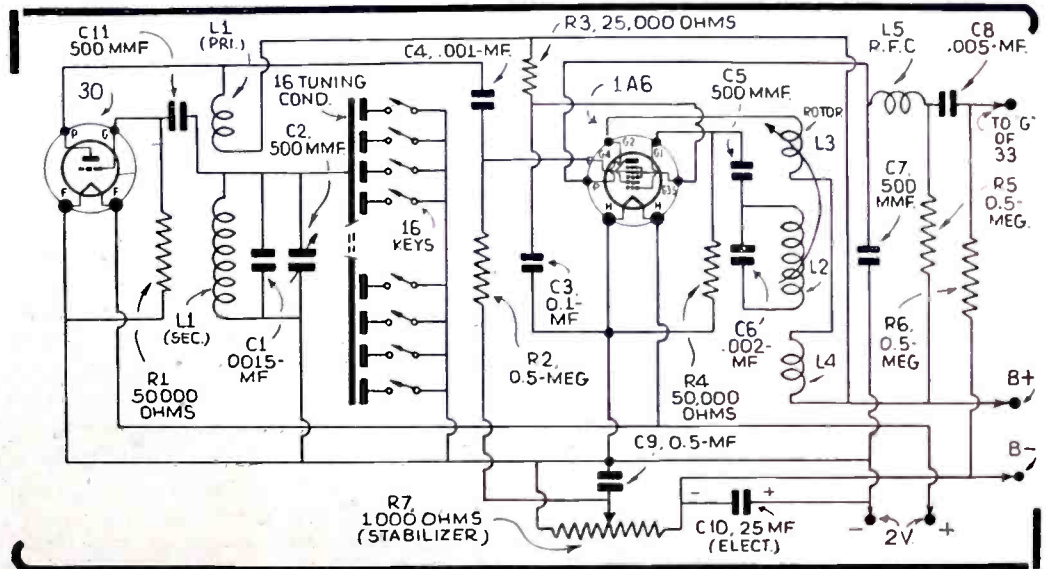

square. The pole-pieces are best removed from the outer frame of the magnet and, if necessary, the central core cut off so as to be flush with the outer iron ring, as shown in the drawing.

For maximum results with any magnet it is very essential that the pole-pieces be very carefully and accurately smoothed off with a file or with the help of a grinding machine. If the magnet is to be used for any length of time and should heat up, simply connect a 110 volt lamp (about 50 watt size) in series with it.

### Radio Piano from Odd Parts

Electronic music with flute-like notes can be produced by means of oscillators connected in a circuit like that shown. The primaries and secondaries, L1, may be wound on a single piece of insulating tube, while the coil L3 is arranged on a small shaft with a knob, so that it can be turned at different angles to the stationary coil, L2. L4 is wound below L2 on the bottom of a piece of tubing. For L1, any 2-circuit broadcast tuner may be used, while a 3-circuit coupler may be used as L2, 3 and 4.

The different tones will have to be calibrated with the aid of a piano, unless one has a trained musical ear or a set of pitch-pipes. The 16 tuning condensers are small affairs and comprise brass or other metal plates, measuring about  $\frac{3}{8}$ " x  $1\frac{1}{4}$ " long, with several thicknesses of insulating paper placed between these note condensers and a common condenser plate. The small note plates are moved in or out until all the respective notes for the scale are obtained. The keys may be made from wood. The output may be fed into the grid of a 33 tube, whose plate is connected to a permanent magnet loudspeaker.

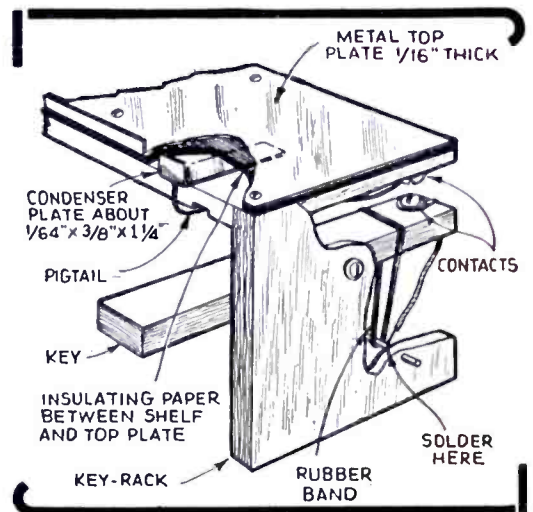





# How to Make

The induction phone transmitter with 1-stage A.F. amplifier, the second tube being a rectifier. Only the mike on the handset is being used in this case.

• A NEW dress for an old idea is brought forth in this apparatus. It is a "wireless" telephone based on the principle of electro-magnetic induction.

It should be understood that a small radio transmitter and receiver could accomplish the same results over much longer distances than this device. The use of ultra-short waves could very nicely do this. However the apparatus described is not intended as a substitute for radio. It is to the general student and experimenter that this is offered as a novel and interesting experiment.

Briefly the idea is this. When a varying current flows through a coil, electro-magnetic lines of force are set up. When another coil is placed in the field of the first coil, a current similar to the original current is set up in the second coil; this is called electro-magnetic induction.

In this apparatus large coils or loops are used in conjunction with audio amplifiers. When a person talks into the microphone, his voice is amplified by a one tube pentode amplifier of simple design. The output of this amplifier is connected through a transformer to a coil of about 50 turns. Electro-magnetic lines of force are set up and these in turn cut across the turns of the receiving loop of about 100 turns. These coils may be spaced with this model, a maximum distance of about 20 feet. The weak current set up in the receiving coil is in turn amplified to bring up the signals to an audible strength.

Numerous applications will suggest themselves to the experimenter with ingenuity and imagination.

Those who are also interested in amateur magic will find a practical use for this outfit. Here is one suggestion by which a very clever illusion of telepathy and clairvoyance can be created. A confederate, walking through the aisle, solicits questions from the audience. When he receives a question, he apparently transmits it telepathically to the performer on the stage, who answers it apparently without having heard the question or seen the questioner!

The confederate in this act carries a portable, battery-operated model with the coil sewed into the back of his coat. He can use a lapel or chest microphone so that when the person asks a question, it will be picked up and transmitted to the performer on the stage. The performer carries a similar apparatus using a small head set concealed in his turban or in any other way that might suggest itself. In this way he can hear the question asked

and give whatever answer he thinks will suit the occasion. This is but one of many practical variations to which this induction telephone can be put.

Of course, the apparatus required would be of necessity extremely portable and easily concealed. The principle of operation, however, is the same.

## Circuit Data

The transmitting amplifier uses a type 42 tube. This is coupled to the loop through an output transformer designed to match a ten ohm voice coil. The loop is connected across the ten ohm winding. Any suitable power-supply can be used.

The receiving amplifier uses a 6C6 tube, resistance-coupled to a 76. The loop is coupled to the 6C6 grid through a 50 ohm to grid transformer. (A single-button mike transformer to grid can be made to pinch hit if this is not available.)

For those desiring battery operation, the following layout is suggested. In the transmitter, a single 33 is used. The filament of this tube has a comparatively low current drain and the required 2 volts can be supplied by 2 flashlight cells in series. Three small size 45 volt B batteries will supply the required 135 volts on the plate. The transformer and loop are the same as for the A.C. model.

The receiver uses a 34 tube resistance-coupled to a type 30. Here again flashlight cells can be used for the filament. The plate voltage can be supplied by the same type B supply. The transformer and loop are similar to those used on the A.C. model.

The loops are the really important part of this outfit. They are set up on a

The voice waves are picked up by magnetic induction on the loop aerial here shown and amplified by the 2-stage A.F. amplifier observed in the picture. Distances up to 10 ft. were bridged by this system.

framework of 2 pieces of 1 inch square pine. One piece 2 feet long crosses a 3-foot section at right-angles 1 foot from the top. This forms a cross around the outside of which the wire is wound, making a loop that looks very much like the once-famed indoor loop of a by-gone era. The whole is set on a base so that it stands upright. Complete construction details are given in the accompanying sketch. The only difference between the two coils is in the number of turns used. The transmitter end uses 50 turns of number 22 double-silk covered wire, while the receiver uses 100 turns of number 32 double-silk covered wire.

While operating, the coils should face one another so that they will be exactly in each other's field. If placed at right-angles no current will be set up in the receiving end.

If the directions as presented here are followed, the experimenter can be assured of surprising and interesting results. As this is only a simple model, the experimenter who is interested can develop as elaborate an apparatus as he may desire. Increasing the number of turns and diameter of the loop will increase the strength of the field and greater coverage can be expected. Increasing the number of stages of amplification on both the transmitting and receiving ends will also accomplish this result. Of course the number of stages used at the receiving end will be limited only by tube noise.

As no experiments have been conducted with multi-stage apparatus, the author would appreciate comments from anyone conducting experiments with this apparatus.

Interesting Tests Made by the Editors  
A number of experiments were carried on

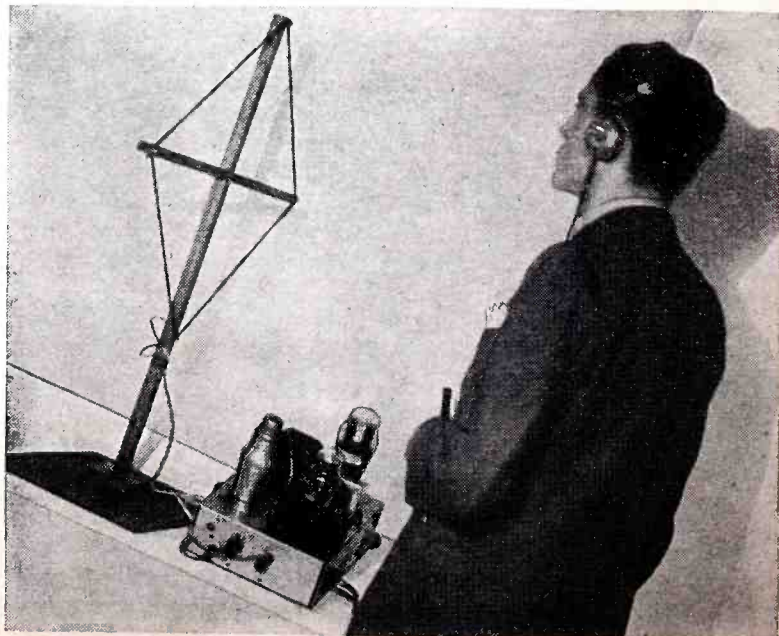



# A Simple Induction Phone

George F. Huether, W2IHO

Mind-reading acts, party stunts and many other uses will suggest themselves for the application of this induction-type phone. Under ordinary conditions no interference with radio sets is caused by this simple phone system.

by the editors with this interesting loop induction phone and some of them are described herewith for the benefit of those desiring to try them.

In the original induction phone no vacuum tube amplifiers were used and this set-up was tried with the loop aeriels. An ordinary carbon microphone was connected in series with a 4½ volt battery (three dry cells) with a loop, as shown in one of the diagrams; at the receiver the loop aerial was simply connected to a pair of headphones. Even when a pair of 2,000 ohm phones were used the results were quite good and the loops could be separated about 3 ft., and the voice still clearly understood.

With this simple set-up of the induction phone, the transmitter may be improved by connecting a telephone induction coil between the microphone and battery and the loop

aerial as shown. A microphone transformer may also be tried and, in any event, the secondary should have a very low impedance so as to match the loop as nearly as possible.

At the receiving end better results will be obtained if a pair of 75 ohm headphones are used in connection with the loop, as they will nearly match the impedance of the loop. If a single pentode output transformer is at hand, this will provide a closer matching of the impedance, the loop being connected to the voice coil winding on the transformer and the 2,000 ohm phones to the high impedance winding.

The next experiment involved a set-up shown in fig. 2, and here the microphone and 4½ volt battery were simply connected to the loop as in the first experiment. For this test, however, the advantage of a 2-stage audio frequency amplifier connected to the receiv-

ing loop was tried, and the distance separating the two loops could now be increased from 2 to 2½ times, or about 5 to 6 ft., with the voice still strong and clear in the phones. For certain requirements for those problems where an induction phone system of this type might be desirable or useful, another way to increase the range is, of course, to use an audio frequency amplifier of several stages so as to more highly magnify the currents induced in the receiving loop.

The third experiment tried and shown in fig. 3, involved the transmission of radio programs from one loop to the other. The transmitting loop was connected across the terminals of the low impedance output transformer and the voice coil of the loudspeaker in the radio set disconnected. The 2-stage A.F. amplifier described in the present article was used in connection with the receiving

(Continued on page 592)

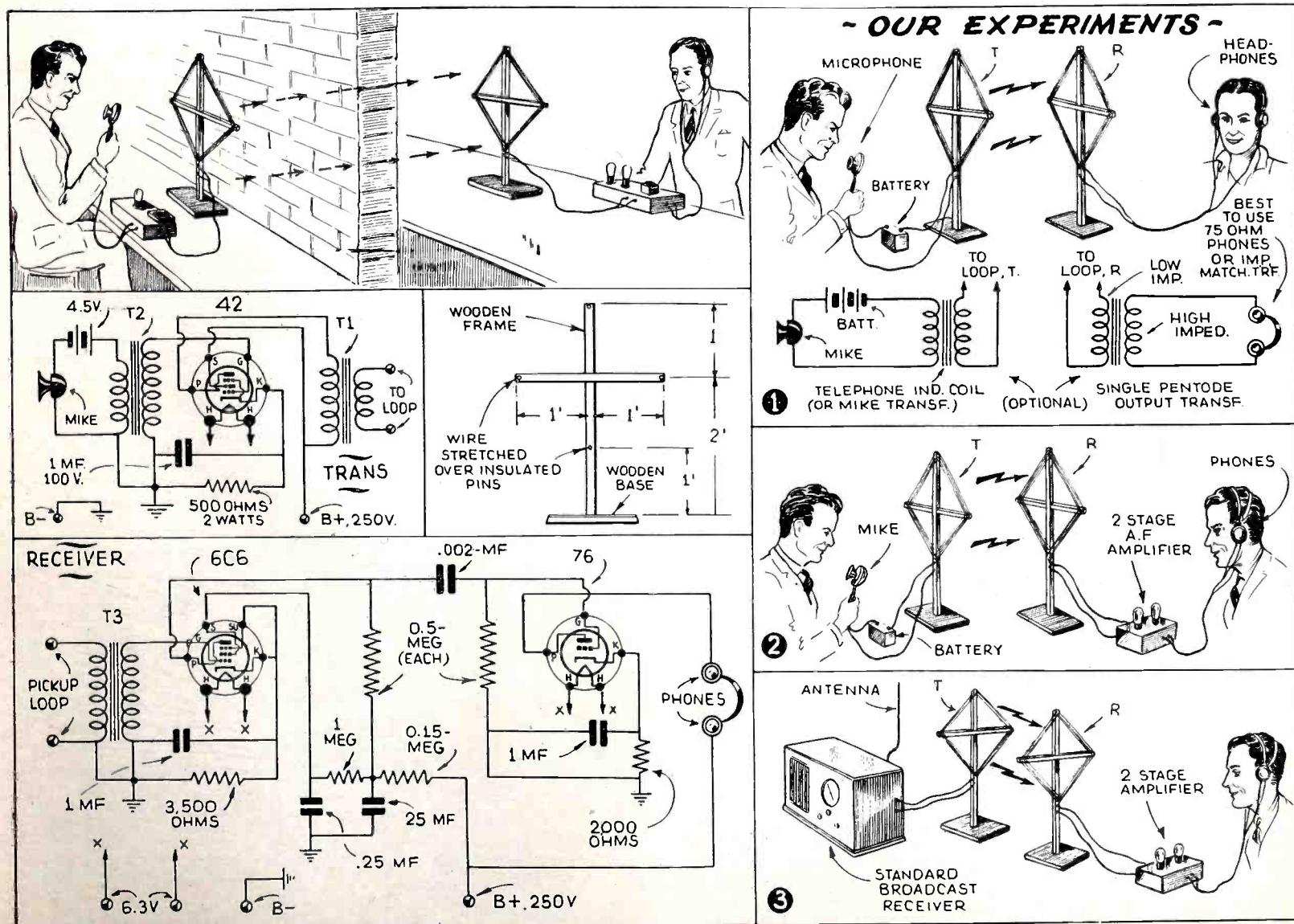

Diagrams above show 1-tube A.F. amplifier used at the transmitter, and 2-stage A.F. amplifier used at the receiving loop. Also hook-ups for duplicating the editors' tests, made without amplifiers.



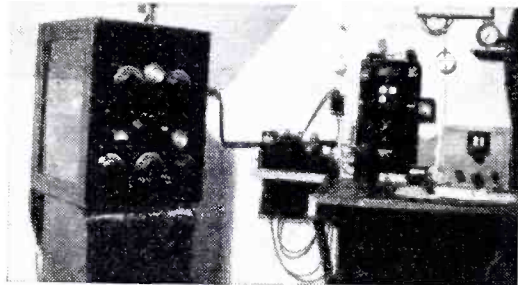

Photo above shows a dandy "rig" in Copenhagen. The station call letters are OZ3U. The address of the station is Alhambrave 3, Copenhagen, Denmark.

### Has 2,500 Veris!!!

Editor,

Ever since the time when I was building crystal sets to listen to the "yokel" a few miles away I have been more or less an "ole" DX hound. A year ago my log was well over 5,000 but at that time my only interest concerning DX was the logging of distance. Since then I have decided to obtain a veri for every station logged and to date I have over 2,500 veris, most of those being QSL cards from 20 meter "hams" in 51 countries.

I am sending you one of my old QSL cards. I would like to hear from other SWLs and if anyone is interested in obtaining a list of some real DX stations on 20 meters, I will be glad to pass it on to them.

I hope "S. W. & T." will continue to be the "mag." it always has proved to be.

MATTY WILLIAMS,  
703 Asbury Ave.,  
Asbury Park, N.J.

### He Deciphered Message from Mars!

Editor,

The article on the possibility of establishing communication with Mars in the current issue of *Short Wave & Television* was very interesting.

This is the first time I ever heard that a signal had actually been received from that planet, so I immediately assumed the task of deciphering the message.

So Mickey Mouse comes from Mars!

Very truly yours,  
PAGE TAYLOR,  
14717 Detroit Ave., Lakewood,  
Cleveland, O.

### How to Signal Mars

Editor,

After reading "Can We Signal Mars?" in the December, 1937 issue of *Short Wave and Television*, I offer the following:

As a possible means of signalling Mars, why not employ a narrow concentrated beam against the moon? This beam could be reflected from the surface of the moon at a proper angle, so as to obtain a suitable spread

# UNCONTROLLED

## Bouquets and Brickbats

akin to the X-ray tube. This reflection occurring in space should materially reduce losses that are ordinarily encountered in our atmosphere. It is possible that we may produce in effect a secondary emission of higher frequency, that would further aid the beam in bridging the gap.

Very truly yours,  
EDWARD L. SCHLAVONE,  
3410 13th St., N.W.,  
Washington, D.C.

(Attoboy, Edward! Let's have some more ideas on this Martian problem.—Editor.)

### A Boost from India!

Editor,

I am a regular subscriber and reader of *Short Wave & Television* for the last year. I just want to convey to you my impressions about this magazine. It is absolutely indispensable for all radio enthusiasts, because it gives theoretical as well as practical information regarding this highly popular subject of modern times.

Even to an amateur like me, this magazine has helped tremendously. With its aid I have secured verifications from more than twenty foreign countries—including the far away, short-wave stations of the U.S.A.

I am a member of the *Short Wave League* and justly very proud of it. I am also a member of the *British Long Distance Listeners' Club* of London.

MR. N. G. MUJUMDAR,  
187, Kasaba Peth,  
Poona City, India.

### An Elaborate English S-W Listening Post

Editor,

I have been a reader of your magazine for just two years, and thought perhaps my fellow readers would like to see a photo of a British receiving station (I have it in the attic of my house).

My main receiver in the center of the photo is a 3 tube 0-V-2 pentode output, using an all-wave coil 10-2000 meters, working from "B" eliminator power-supply and "A" storage battery, that I keep trickle-charged.

The receiver to the left is a small 2-tube bandspread Short-Waver, with plug-in coils to tune 12.5-180 meters. This receiver also works from another "B" eliminator supply, etc. I use it more as a *stand-by* receiver for European and local ham listening.

Directly above this set is my 5, 7 and 10 meter RX, a 3-tube superregenerative with interchangeable coils. This also works from the same type of "A" and "B" supplies.

Continuing along this shelf on right of loudspeaker, is a 5-7 meter test-oscillator, and a 80-175 meter converter adaptor, together with a 10-80 meter beat-oscillator. The switches below the loudspeaker are used for switching in phones or speakers, while the meter checks the current taken by the receiver.

Down onto the bench again, next to the receiver, is an all-electric A.F. amplifier, employing 2-76's, coupled to two 42's working in push-pull, and one 80 rectifier, and this circuit, I am pleased to say was taken from a copy of *Short Wave & Television*, and is working very well.

I can, by turning a switch on the panel of the short-wave receiver, switch out the pentode output tube, and connect the first two tubes onto the amplifier, and it sure "punches it out"! To make a change from DXing, I can switch in a phonograph turn-table and pickup for recorded music.

Well this letter has developed into quite a budget, but when one is writing or talking about such a grand hobby as radio, I find there is no limit, so with wishing your magazine every success, and 73 to all my fellow readers,

I am, yours sincerely,

R. ALLEN,  
R.S.G.B., B.R.S. 3028.  
37 Highfield Road,  
Bognor Regis, England.

### He Wants Reports—Did You Hear Him?

Editor,

I would be very pleased if you would insert a notice in your magazine to the effect that I would like DX reports on my C.W. trans-

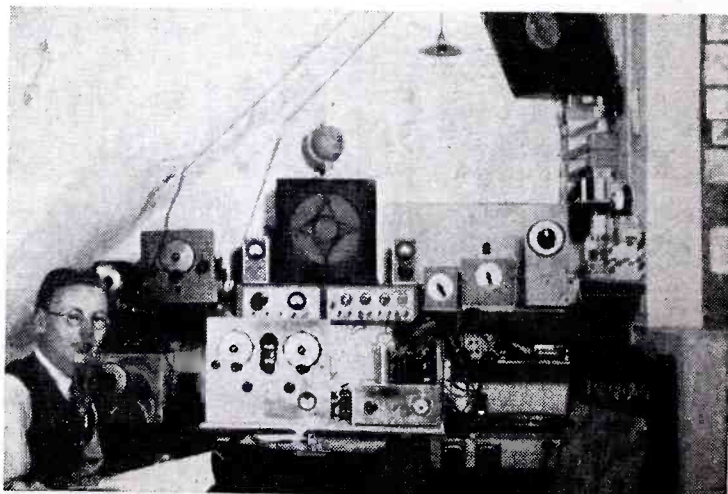

Above—Listening post of R. Allen, Sussex, England.



# OSCILLATIONS

## from Our Readers

missions on 20 and 40 meters. All reports will be answered with QSL and reports must contain the following particulars: QSA-R & T, report or RST. Freq., time and date of reception. Type receiver, number tubes, type of tubes. Type aerial, any other DX audible at same time as my sigs. What was type of communication by me (CQ, etc.).

Any other particulars considered of interest may be added. Listeners can depend on me that all reports received will be QSL'd within 24 hours of receipt. My call sign is VK2ABL.

Hope your listeners, that is readers, Hi! will find this of interest in your valuable paper. Reports are requested from any country.

Yours faithfully,  
LES TANNER, VK2ABL,  
Delamere Street,  
Canley Vale, N. S. W.,  
Australia.

### Great Results With His 23-Tube Scott Editor,

Not to be outdone in appreciation by friend and co-enthusiast, Theodore Domby, I thought I would drop you a line myself. I started along the S-W road about the end of last January with the arrival of my Scott 23 tuber—and then—the old rocking chair got me!

My antenna is a Scott double-doublet, running NE-SW, elevated about 60 ft., between two tall trees. I use a Visa-glow arrester to avoid signal loss. I do not have any special den, but I use my headphones most of the time so as not to annoy the XYL, also for sitting up nights—and mornings!

Yours was the first short-wave magazine I used, and I am a member of the I.S.W.C., the N.N.R.C., and Rueda del Oeste (WA3F), and it is all I can do to find time to listen, QSL and report to I.S.W.C. and N.N.R.C. I buy regularly and greatly value *Short Wave & Television*, and I often find valuable data not given in other magazines I receive.

I am quite impartial in my search for good catches; sometimes I fish for the phone stations only, and as the result I have logged LSY, OPL, GAU, FZS, GAS, GAW, IAC, GBC, TYA, GBS, DZE, TPZ2, KKO, FZE8, KIO, GBP, OPM, LSN, ICK, KEE, KEJ, DAF, KKJ, RKI, ZFA, JVH, JDY, JYS, TYC, FNSK, DOA1, PMC, W2XGB, ITK, IUG, KWU, RIM, IQA, DZH, GBW, IDU.

On other occasions I go for the broadcasters, sometimes sticking to the bands from 6.00 to 10.00 mc. and at other times working from 10.00 upwards to 15.00 mc. Some star catches have been KZRM, YDC, SM5SX, VPDZ, VK6ME, ZMBJ, EA6AH, EAJ43, OAX4G, ORK, LSX, ZTJ, YSD, CR7RH, PMN, and a considerable number of others more easily caught.

I sometimes devote whole evenings to the

40 and 20 meter amateur bands, and among some of my better catches have been K7FST, K7FBE, CE3DW, KA1ME, J2MI, 4 PK's, 8 VK's, ZM2DI, FTE8 (St. Pierre Miquelon) ZE1JR, SU1CH, SU8KG, OX2QY, several XU's, ZU6AF, ZL4BR, and very many others too numerous to mention. (Why is it so hard to get New Zealanders?)

So far my verified log for nine months includes 190 cards from 58 countries in all continents.

I like the make-up of your magazine, especially the *dope* on verifying stations. This data and Joe Miller's department and the "When To Listen In" articles are my favorites. I also find it very interesting to see pictures of rare QSL cards, some of which I myself have received.

NEVILLE C. SEYMOUR,  
Insuranshares Certificates Incorporated,  
401 Keyser Bldg.,  
Baltimore, Md.

P.S.—While in England this spring, I saw copies of your magazine in several "shacks" I visited—and they are the *bible* to those boys!

### Constructive Criticism—And How!

Editor,

Taking the editorials, this is considered a good feature, one of interest to all radio-

---

● **The Editors would like to see more letters of a controversial nature. If you are displeased with anything in the radio field, or if you disagree with the viewpoints of authors of articles published in this magazine, write us giving an exposition of your feelings on the matter. We will endeavor to publish all such letters on these pages.**

---

minded persons. The idea of having "Guest" editorials occasionally by leaders in the field of S.W. radio is a good one.

The usual articles describing technical advances in S-W's and Television are interesting, doubtless, but from my own experience, these are rarely read through, usually being only glanced at, to ascertain whether there is any new data to be gleaned of possible value in radio reception.

The point is here made that there is a decided lack of helpful articles for the SWL in getting the most out of his present apparatus, or in improving his results, through inexpensive alterations in his listening set-up.

A remark is appropriate here concerning the make-up of these articles. At present, in most



Miss Beatrice Holman, WIKTG, of Belmont, Mass., who won this Hallicrafter communications receiver at a recent "hamfest" held in Boston.

articles that have appeared of this nature, not enough data was given to each item, at least from my viewpoint. Consideration is given to the inevitable necessity for conservation of space, but it seems to me that it would be better to take one or two items each month and treat them *fully*, with all angles fully discussed in your usual clear, layman's language.

For instance, at present, antennas are now considered more important than ever before. Articles describing various types of antennae with directional effects would be found to be of much interest among DXers. For myself, wanting to log Africans to help my DX log, I undertook the erection of a diamond rhombic beam aimed at the heart of South Africa. With the help of three other enthusiasts, therefore, it was erected, and the results were most interesting.

All data should not be dealt with in one article, but should be taken and made up into a number of fully detailed articles, published monthly, until all types were fully covered.

Though undoubtedly it is considered to make the magazine more colorful and "eye-catching," the abundance of illustrations seem to me to detract from the publication's effectiveness.

More attention should be accorded to articles dealing with S.W. DX reception. Articles for S.W. beginners (in DXing) dealing with the method of logging of stations, of writing for veris, of how to tell different stations by the sound of their carriers, of how to mount veris and how to care for them, of other small, but to the DXer, important items should be fully discussed in articles every month; one or two items each month being treated, and most completely covered so that the merest beginner will be able to learn the fascinating game within a short period.

Regarding the Scout Trophy, given monthly, that is a good attraction but doesn't seem to bring as great a response as it should.

Descriptions of the more elementary types of transmitters is of much interest, as many DXers are potential "hams" and plan to some day erect their own station.

Sincerely yours,

J. MILLER,  
New York City.



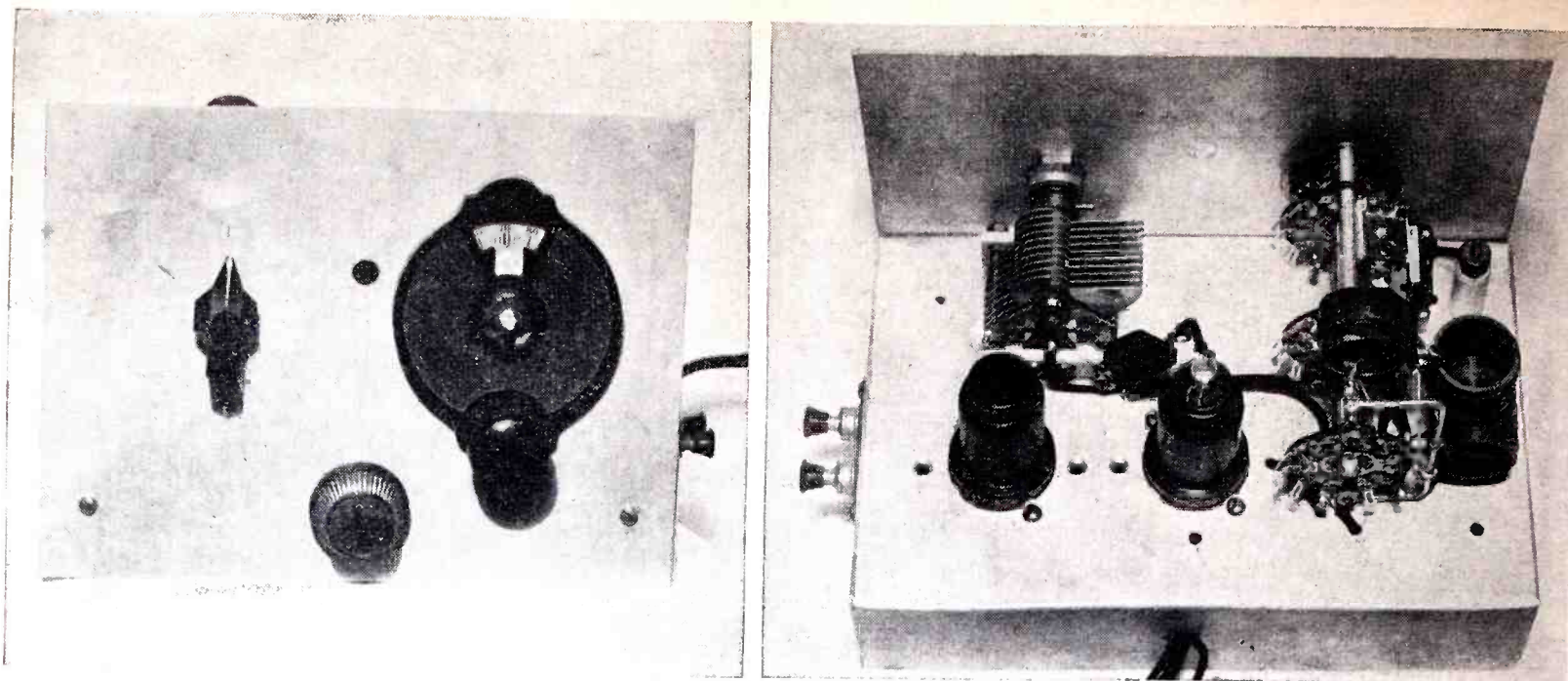

A front view of the receiver and view behind the panel; note how the coils, condensers and tubes are arranged.



# The SWITCH BAND-2 Receiver—for the S-W FAN

George W. Shuart, W2AMN

● BAND-SWITCHING is here to stay so we might just as well use it in our smaller receivers and make use of its many desirable features. There are probably two reasons why the beginner in the art of short-wave set building does not use *band-switching* and they are—one, that the first set is by no means a permanent affair and the plug-in

coils used in it can be used in another set without breaking down the first one—too, band-switching sounds terribly complicated to the beginner.

### Switching Scheme Simple

Neither of the above should prevent the newcomer from using band-switching, because

in the first place the switching mechanism can be made in a unit that may be changed from one receiver to another, although not as rapidly as can plug-in coils. And in the second place the switching unit is not at all complicated and can be made by the newest of newcomers. The inductance switches that are now on the market are very efficient and

Wiring diagram for the "Switch band-2" receiver.

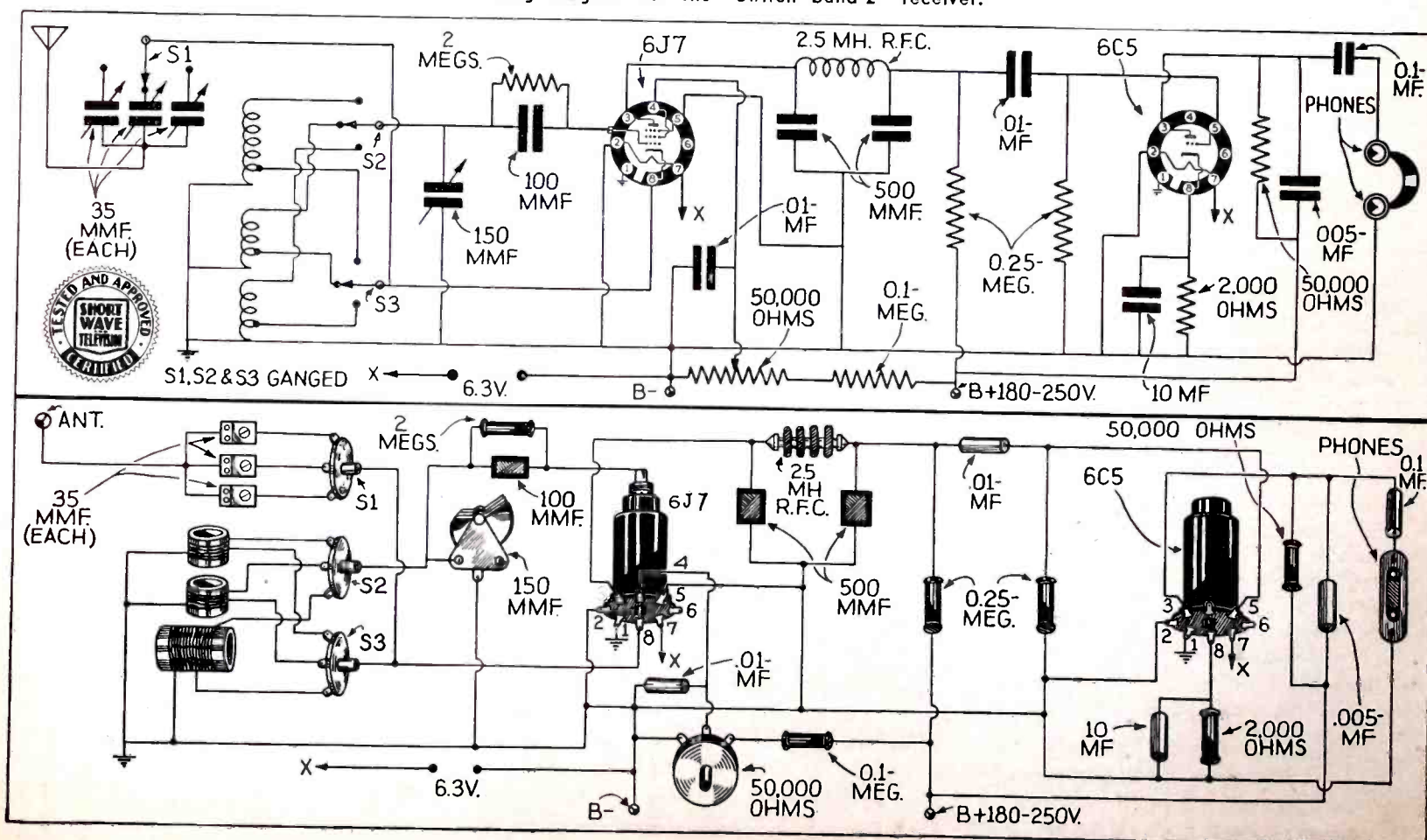



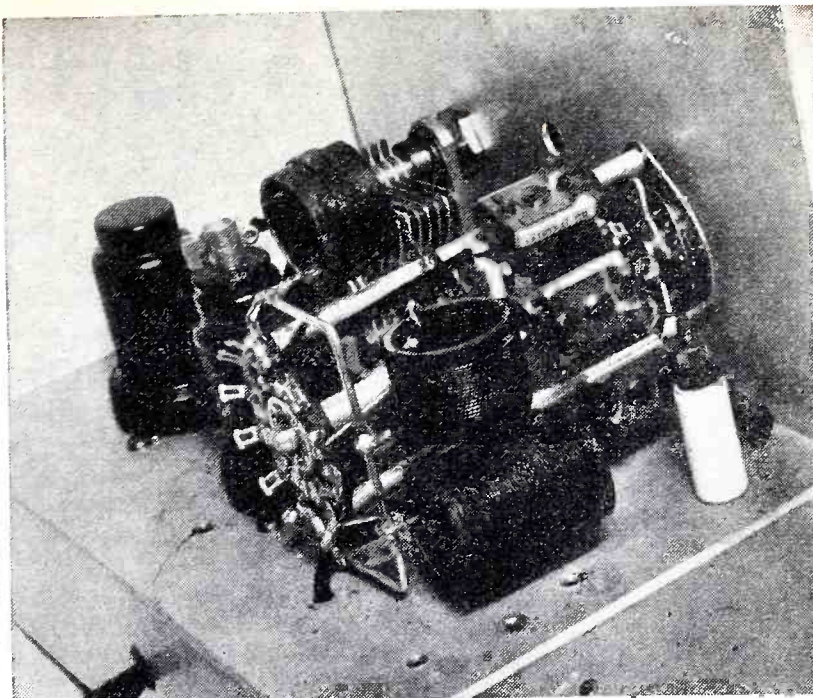
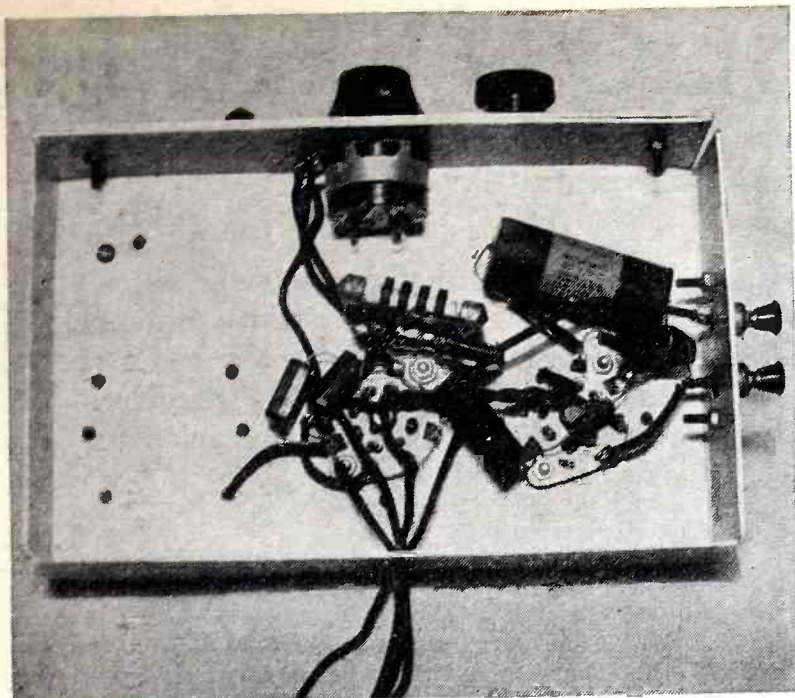

Bottom view of the receiver, showing the few essential parts required. Close-up of the hand-wound coils, data for which is given.

not at all expensive. Winding the coils is a very simple matter, just as simple in fact as making the plug-in coils. Choosing the design or method of construction of the unit is the only item requiring the slightest mental strain.

In the band-switching unit used in the two-tube set shown in the photos we have used a three-gang rotary inductance switch of standard manufacture. This switch, as it happens, has eleven positions for each rotor. These are not all necessary of course, but we advise the reader to obtain a switch with more contacts than necessary for two reasons, first, because he may wish to add more bands or circuits to the unit at a later date and, second, because it is advisable to leave some space between the used contacts. For instance we have used every other contact on the stationary plate in order to reduce as much as possible the coupling between any two leads of the coil assembly.

#### Range Easily Increased

In our case we have divided the most popular short-wave range into three parts by employing three coils. There is no reason why the range of the receiver could not be increased to suit the builder. Adding coils for an increased tuning range will in no way impair the performance of the receiver. The only important point is to keep the coils at a reasonable distance from each other, avoiding crowding and placing each coil at right-angles to the coil nearest to it. If this is done there will be no dead-spots in the tuning range caused by the unused coils.

The diagram shows that the common ground or B— ends of the coils are all connected together to a common lead. These need not be switched. There are only two leads on each coil that are switched, the cathode tap and the grid lead. Using the cathode method of obtaining regeneration simplifies the switching arrangement considerably.

#### Antenna Condensers Switched Also

By this time the reader will be wondering why we have used a three-gang switch. Well so long as a switch is employed to simplify

With this low-cost receiver the short-wave fan may hear stations in all parts of the world on a pair of headphones. The different bands are switched in or out quickly and proper antenna condenser adjustment is automatically made for each band. A smooth working set with a real kick in it!

the receiver, we might as well do the job right. In small receivers where the antenna is coupled to the input of a regenerative stage the degree of coupling must be changed as the frequency to which the receiver is tuned is increased. We can, however, find an optimum adjustment for any one of the various bands into which the range has been divided. This means that every time we change bands we also have to change the antenna coupling. The third section on the switch in this assembly does just that for us. We have employed three antenna coupling condensers and each is set, by trial and error, to give best results in the particular band in which we are tuning. Then as we switch bands we also switch preadjusted antenna coupling condensers. This gives us real switch-band performance without the necessity for fiddling with adjustments every time we change from one band to another.

#### Coil Winding Data

The coils are wound on one-inch diameter bakelite tubing with No. 24 double-silk cov-

ered copper wire. These coils are all close wound. The largest coil has 36 turns and the cathode tap is at the 8th turn from the B minus end; the next largest coil has 14 turns and is tapped at the 3rd turn for the cathode; the

smallest coil has 7 turns and is tapped at the 2nd turn from the cathode. These coils cover a range of from 2600 kc. to 15,000 kc. This range can, as said before, be altered to fit the readers' requirements.

Mounting the coils has been done in the simplest manner but any other convenient method may be used. When winding the coils leave leads about six inches long at the start and finish. After the coils are wound, given a heavy coat of coil dope and thoroughly dried, these leads are looped several times through the hole where the coil is started. These loops are about an inch long and are twisted to form a heavy lead which will support the coil and also serve as the connecting leads to the switch.

The tap on the coil is formed in a conventional manner, by making a small loop in the wire as the coil is wound. A glance at the rear view of the receiver will show the reader just how the coils are supported and mounted on the switch. Under each supporting screw at the end of the switch plate place a soldering lug. A piece of No. 12 busbar is formed in a manner to support one end of the three coils and also to serve as the common B— lead. The other ends are supported by the heavy twisted leads, mentioned before, which are soldered directly to the terminals of the switch.

#### Screen-grid Regen. Control

The rest of the receiver is more or less the same as any other two-tuber. It employs a 6J7 detector and a 6C5 A.F. Amp. Any similar tube combination may be used with equal results. No band-spread is provided other than the use of a 270 degree tuning condenser which helps to spread out the tuning. Band-spread may be added or the receiver may be made to operate in narrow bands such as the ham bands, by using small  
(Continued on page 584)

## NEXT ISSUE!!

### Part I—

### The "S. W. & T" 441-Line

### CATHODE-RAY

### Television Receiver

### For "Sight and Sound" Reception.

### Designed by—

**C. W. Palmer, E.E.**



# UHF CONVERTER

Raymond P. Adams

This specially designed 5 and 10 meter converter employs inexpensive metal tubes in a new circuit. It has a regenerative mixer, a very stable oscillator, A.C. power-supply, and a special arrangement for matching the output to any receiver. This converter will bring in high-fidelity BC. transmissions, also television "sound" channels.



John Ledden, Hollywood personality and former New Jersey newspaper publisher, looks over the "upstairs" layout. Note the output coil with shield removed.

● A LITTLE while ago—when 5 meter and general UHF communication was something new and the average transmitter working at extreme frequencies was a single-tube, self-excited affair putting out a signal both broad and uncertainly located in frequency, our best and perhaps only receiving bet was the familiar super-regenerator, which featured good sensitivity on the one hand and a wide acceptance on the other. Superhets were as a rule quite out of question, as they generally provided us with far more noise than signal, involved large constructional cost, and were altogether too selective to hold creeping signals and to afford a band-width sufficient for amplification of much more than the intelligible voice frequencies.

But times, conditions, and transmitting practices have changed. While a great many transceivers are still in existence, the average mobile job employs a M.O.P.A. transmitting set-up; and an increasingly large number of amateurs are on the 56 mc. band with quite stable, crystal-controlled signals (Broadcasters, of course, hold frequency exactly). And however much the superregenerator remains a widely accepted type of receiver by reason of its simplicity, low cost, sensitivity, and broad tuning—more and more listeners are turning to the superhet for UHF signal interception (an expected and paralleling trend, of course); the more modern superhets, frankly, perform in a distinctly acceptable manner, noise being minimized and band-width extended through proper design and the use of the now-available I.F. components in the higher frequency ratings.

UHF broadcast signals, as we have noted, are very well controlled and show so little drift that they may be held on any superhet, whatever the I.F. This does not mean to say that any superhet will afford a wide enough acceptance for the high-fidelity pick-up of these signals, which are generally characterized by extremely wide modulation range, or

that it will do a good job on audio modulation tracks related to *video* (picture) transmissions for television; nor does it say that any superhet will afford proper image reactivity with UHF inputs. But it does make it clear that the conventional-modern day receiver will at least permit the intelligible reception and logging of the transmissions, which is something of an experience whether full modulation is passed or not.

Amateur phone transmissions, being similarly well controlled on the whole, may also be held and logged—within limits of course. Then, amateurs, today, don't spend much time seeking modulation-system fidelity; frankly, they deliberately hold modulation width to the intelligible voice frequencies, and for very obvious reasons; and if the I.F. portion of a receiver will accept these frequencies—if the receiver has say a normal 8 to 10 kc. band-pass characteristic or means of varying the selectivity through the overcoupling of coils in I.F. components—then very satisfactory reception may be expected on all but broad and creeping transmissions, matters of proper image reactivity not being considered.

Those matters of image, however, are important to the critically-minded amateur and experimenter. They depend upon input range, input acceptance, dial coverage, and the frequency of the I.F. For good image reactivity on 10 meters, the I.F. should be at least 1500 kc.; for similar reactivity on 5 meters the I.F. should be from 3,000 to 5,000 kc. in value; and from this it is apparent that where *any* I.F. will be at least acceptable for signal pickup, logging, and intelligible reception—a very definite I.F. is in order where image selectivity *must* be considered. A UHF superheterodyne logically should have an I.F. tuned some-

where in the 5,000 kc. to 1500 kc. range—the value being such as to give best image reactivity with a certain R.F. coverage—or compromise reactivity where the coverage is extended over several plug-in coil ranges.

This brings us to a consideration of the practicality of a *converter* tunable over UHF wavelengths and designed to feed its output into an available receiver (TRF or Superhet.) If an ordinary super with any I.F. will do the trick providing its *front end* coverage extends to and through ultra-high frequencies, then very certainly a *converter-receiver* assembly will work out satisfactorily. If the receiver is a *broadcast-band* job, then we may convert to 1500 kc. and provide for a fairly good compromise image reactivity with 60 to 30 mc. input; if the receiver is an *all-wave super*, then we may convert to any initial I.F. which seems most satisfactory, tuning the receiver to that frequency. If the broadcast-band receiver is of the TRF or variable selectivity superhet type, a fairly good acceptance may possibly be provided, particularly suitable in any event for 10 meter reception. If the all-wave receiver is properly designed, it will provide for proper image selectivity whatever the converter tun-

(Continued on page 585)



Mr. Ledden, who is a short-wave enthusiast, examining the "power-supply," which has been removed from the converter cabinet.







# How To Build A Peak Voltmeter

P. M. Ohlinger

A peak voltmeter is useful to every radio experimenter. Here's how to make one simply and cheaply.

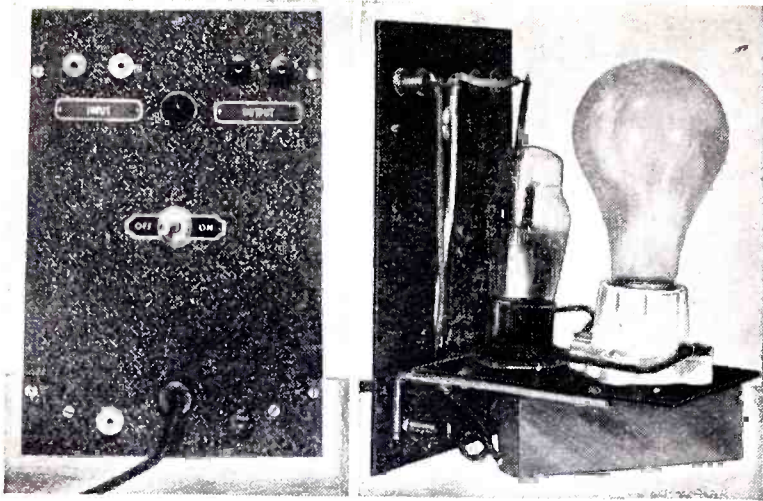

Front and rear views of peak voltmeter.

● A PEAK voltmeter is a handy piece of equipment for the experimenter or serviceman to have about. The unit to be described will allow any external D.C. voltmeter to be used to measure peak A.C. voltages. Ordinary voltmeters and ammeters measure the effective or R.M.S. (root mean square) voltage only.

For alternating voltages and currents of true sine wave variation, the RMS voltage, multiplied by 1.41 gives the peak A.C. voltage. For instance; A voltage of 110 volts A.C. multiplied by 1.41 gives us 155, the peak A.C. voltage. The peak voltage multiplied by .707 gives us the RMS voltage. A peak voltage of 140 multiplied by .707 gives the RMS voltage of 98.9. These formulas hold true only for a true sine wave, and values of waves other than this must be found with a peak voltmeter.

Keep in mind the fact that although the ordinary voltmeter readings in RMS values may indicate that the current and voltage rating of chokes and filter condensers is high enough, the insulation must be able to stand the *peak voltage* in A.C. circuits and this *twice* in every cycle.

A few of the uses this peak voltmeter unit may be put to are:

1. Measuring peak voltages, especially across the first filter condenser, as this condenser must have a voltage rating slightly higher than the peak voltage.

2. As an output meter when connected from plate to plate or plate to chassis. Also connections may be made directly across the voice coil of the speaker and readings taken when a low meter range is used.

3. To find transformer ratios, open circuits, noisy or incorrectly center-tapped transformers, apply the 110 V. A.C. line voltage to one winding of a transformer and measure the voltage developed across the other winding with a peak voltmeter. Dividing the one voltage into the other will give the approximate ratio of step-up or step-down.

4. To measure the peak A.C. voltage across the high voltage winding of the power transformer.

5. To determine the efficiency of the filtering in power supplies. Measure the peak voltage across the first filter condenser. Now measure the RMS voltage. The difference between the two voltages is the A.C. ripple voltage. The decrease of the A.C. ripple across the succeeding chokes and filter condensers will determine the efficiency of

the filtering network system.

6. Vibrator units and power packs of auto and 6 volt farm radios can be efficiently tested by this unit because it draws little current.

Peak voltages from ten or twenty volts on up can be measured with a good degree of accuracy. The accuracy is dependent on the type meter used, the 1000 ohms per volt type being preferable, using a scale of 100 volts and more. It is important also to use the paper condenser specified, as this affects the accuracy of the unit in that if there is much current

drain through the condenser, the meter readings will be inaccurate and low in value.

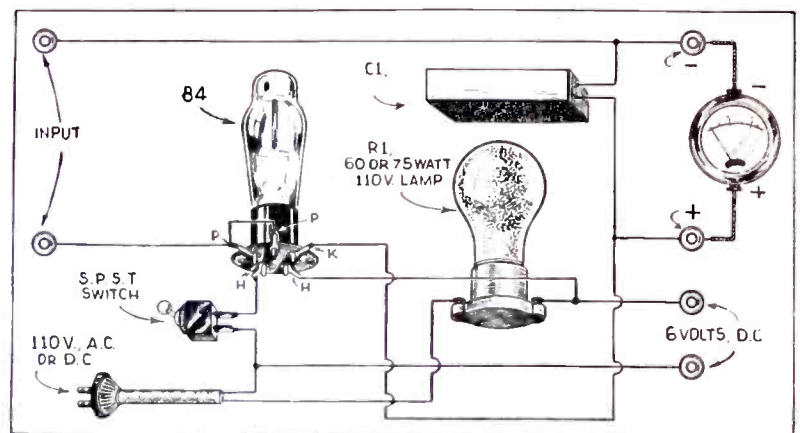

Wiring diagram for the constructor.

The unit is housed in a shield box finished in black crackle enamel, dimensions of the box being  $4\frac{1}{2} \times 7\frac{1}{2} \times 5$  inches high. The front panel fastens to the extended flange of the shield box, making the unit ideal for panel mounting.

Insulated tip jacks are used on the metal front panel and name plates mark the jacks INPUT and OUTPUT. Of the two Input jacks, the lead from one connects to the plate of the type "84" tube and that of the other to the lead of the condenser. One lead from the output jack connects to the cathode of the tube and the remaining lead of the condenser. The lead from the other output jack goes to the input jack which is connected to the condenser.

The external voltmeter is plugged into the output jacks, which are color-coded as the correct polarity must be observed in the meter connection. Test leads are connected to the input jacks and the voltage to be measured.

The filament circuit has been arranged so that this instrument may be used on either 110 Volts A.C. or D.C. or 6 volts battery. Leads to two insulated jacks are brought to the front panel for the battery connections.

The current drain of the type "84" tube differs with the tube brand but a 60 watt, 110 volt lamp will drop the 110 AC-DC volts to a filament voltage suitable for operating the tube specified.

## PARTS LIST

CORNELL-DUBILIER  
RM6200—2 mf. 600 W.V. Capacitor.  
(Continued on page 592)

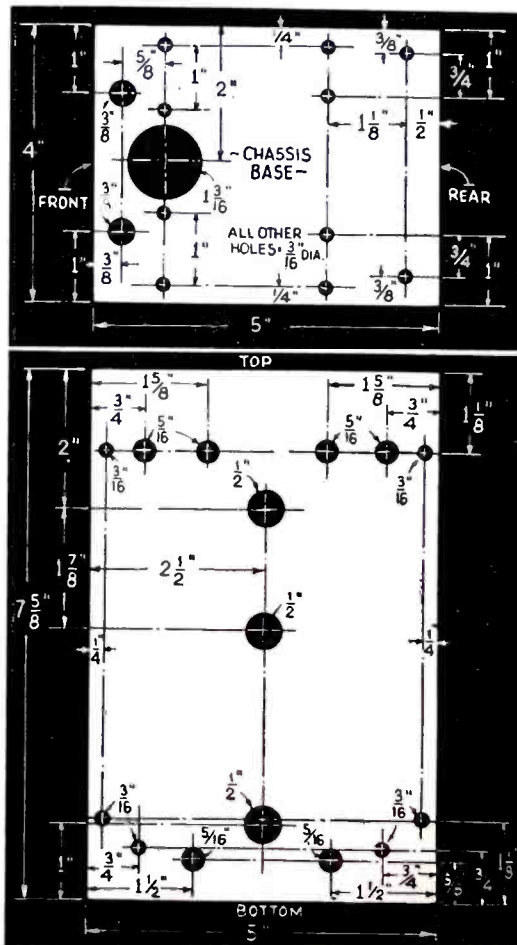

Chassis layout details.



# LATEST in Short-Wave APPARATUS

## Machine Makes Learning Code Easy

● THE dits and dahs that mean radio code have prevented thousands of people from enjoying the most fascinating of all modern hobbies—Amateur Radio. As a matter of fact, learning to send and receive the code is very simple. The process is relatively slow and one cannot see from day to day that he is making any progress. For that reason many beginners become discouraged and give it up.

For the past fifteen years R. G. Miller has been making code-teaching instruments to aid beginners in mastering the dits and dahs. He recently said, "Any one could learn the code with my first code instructor. But that is not enough; I must provide a method whereby one will thoroughly master the code."

In the old days when students used the teleplex to learn American Morse, it meant a living to them, and they worked hard to learn, because it meant a job. With the advent of amateur radio beginners were not faced with the urge of necessity and frequently became discouraged and quit. It was then that Mr. Miller started bending all of his efforts toward finding a way to make the study of code more interesting so that the student would actually want to practice.

The new Master Teleplex is practically a perfect code instructor. This instrument does not send mechanical signals; it is a mechanical means of sending actual code signals that are made by hand or with a "bug."

The device comes complete with everything that is necessary for a beginner to thoroughly master the code, or for an experienced operator to speed up his sending and receiving. It operates on 110 volts A.C.; just plug it in and it is ready to go.

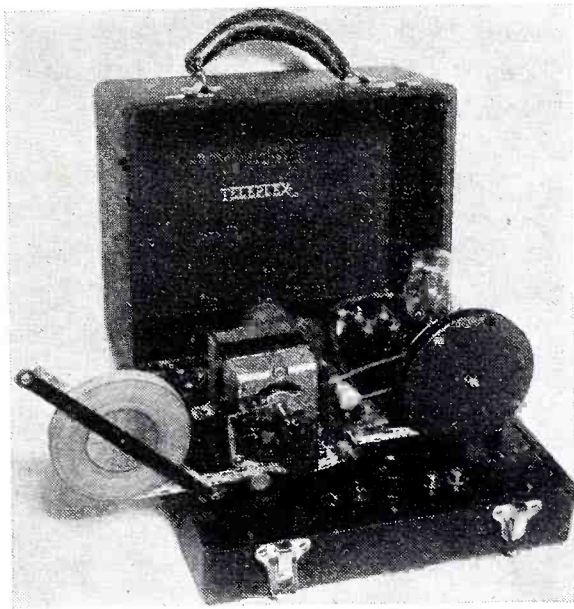

This tape-operated machine teaches you code, or it may be used to record code signals. (No. 678)

The new code teacher will accurately record your own sending so that you can see exactly how you make your characters. It will then repeat them back so that you can hear how your signals sound. This is an extremely important and valuable feature, because the U. S. Government requires you to pass a test in sending as well as receiving. Most people are of the erroneous opinion that learning to send is easy. As a matter of fact, learning to send properly is much more difficult than learning to receive. Even among professional operators we find exceedingly few good senders. Sending is very much like handwriting. Everyone sends differently—everyone has his own peculiar characteristics. An experienced operator learns to recognize the sending of another operator just as one recognizes another's hand writing. No operator really knows what his sending sounds like—he doesn't know whether he is a good sender or not—unless he has some means of recording it. Just try writing a few words blind-

folded and then see how much better you can do with your eyes open. That will give you a clear idea of what it means to be able to see your own signals.

As every operator sends differently a person must be able to read all of them if he expects to get the full enjoyment from amateur radio. An ingenious scheme has been worked out for exchanging tapes, so that students using this machine will have the advantage of unlimited practice material. When a student is convinced that he can send readable signals, not necessarily perfect signals, he submits a sample of his sending. If the signals are found to be readable, he is given a list of other students who (Continued on page 591)

## Ultra-Hi Freq. Oscillator

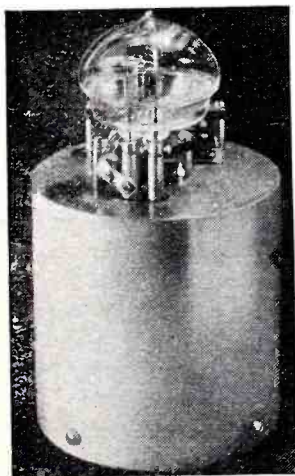

A new U.H.F. oscillator (No. 679)

the "Q" of the resonant circuit is approximately 2500. This oscillator fulfills laboratory requirements which demand a high degree of frequency stability under varying external conditions. A confined electro-magnetic field, ample output for use as a source for high-frequency measurements, and finally a convenient physical size. The complete oscillator as shown in the photo herewith has

● THE photos at the left and at the bottom of the center column, show an interesting new ultra-high-frequency oscillator intended for measurement making applications. This oscillator uses one of the new U.H.F. tubes and it operates at frequencies as high as 100 megacycles or 3 meters; at this frequency

an overall height of but 7". Referring to the photo in which the tank circuit is shown in disassembled form, the outer brass shell is shown on the left, the inner copper cylinder on the right. The brass disc in the foreground closes the brass cylinder after the copper insert has been placed in position. The small copper cylinder, located eccentrically on a shaft passing through the disc, is used in conjunction with the large copper cylinder to form a small, variable condenser for the adjustment of the frequency to a particular (Continued on page 591)

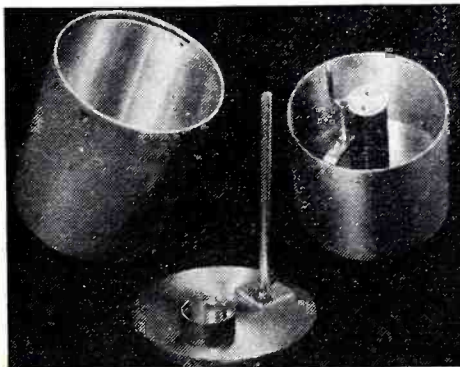

The concentric-element oscillator tank circuit disassembled.

## New Beam Xmitter Tube

● HERE is one of the newest tubes of interest to short-wave hams, a transmitting beam-power amplifier, known as the RCA 814. This tube is particularly suited for use as an R.F. power amplifier, oscillator and frequency multiplier. In class C service it is capable of giving a power output of 130 watts, or better with a driving power of only 1.5 watts. The tube has top cap plate connection to insure high insulation and low grid-plate capacitance, with effective shielding to minimize the need for neutralization. A ceramic base is provided also and the tube is of the filament type. The screen absorbs little power (Continued on page 591)

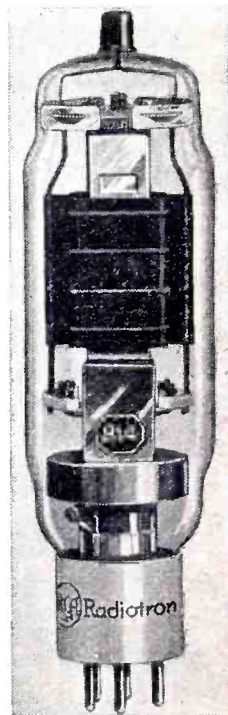

Names and addresses of manufacturers of apparatus furnished upon receipt of postcard request; mention No. of article.



# World-Wide Short-Wave Review

—Edited by C. W. Palmer

## A German Television Receiver

● IN the latest issue of *Popular Radio* (Copenhagen) an interesting view of the latest model Telefunken image receiver was shown.

This set, shown in the photo here, is a combination image and sound receiver using 36 tubes and built to receive 441 line images on the waveband between 4 and 7 meters.

The positions of the parts, especially the cathode-ray tube, which tilts back against the edge of a mirror is interesting to the television-minded short-wave fan. This vision tube, incidentally, operates with a potential on the focusing electrodes of 12,000 volts and produces images of approximately 8 x 10 inches.

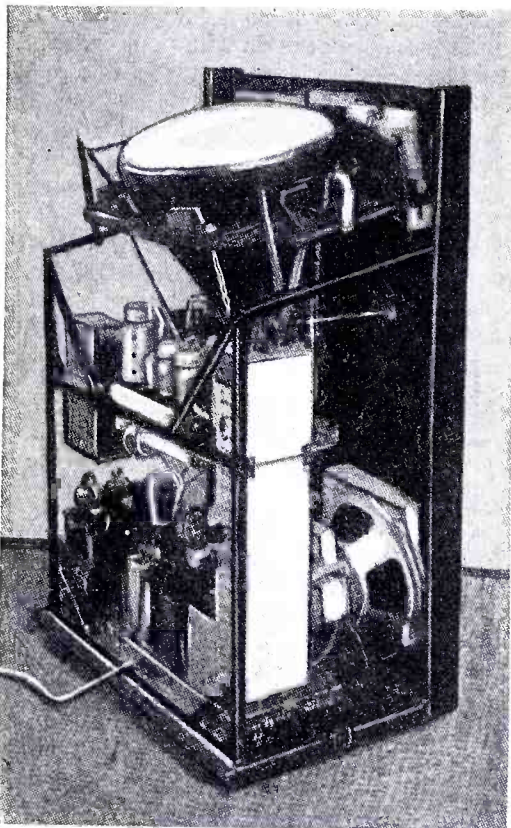

The latest model Telefunken television receiver for both image and sound. It uses 36 tubes and will pick up the new 441 line images.

## C.W. On a Superhet

● IT is usually considered necessary to couple a separate oscillator to the I.F. amplifier of a superheterodyne receiver in order to receive continuous wave signals. This necessitates changes in the wiring and an additional tube which cannot always be fitted onto the chassis of the set.

Another way to produce this oscillation was described in a recent issue of *Practical and Amateur Wireless* (London). It consists of providing feedback in one of the I.F. amplifier tubes so that this tube will oscillate

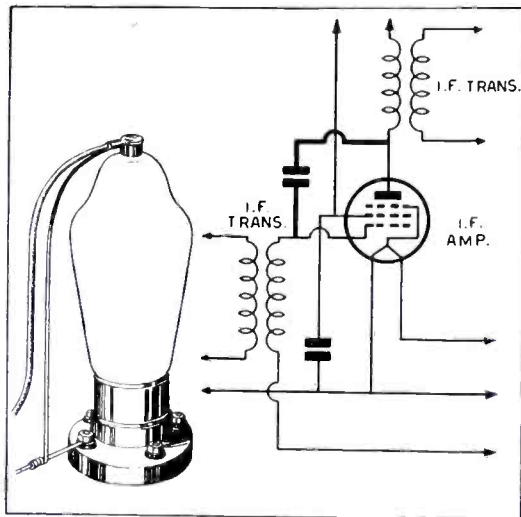

A clever way in which to receive C.W. signals on a superhet receiver. This circuit provides feed-back in one of the I. F. amplifier stages, thus causing the oscillations necessary for C.W. reception.

and thus produce the interfering voltage which makes the C.W. signal audible.

A very simple method of introducing regeneration in the I.F. amplifier is to couple a wire from the control grid to the plate, as shown in the sketch. As shown in the circuit this wire, which is connected to the grid and is insulated from but wrapped around the plate wire, is the same as a small condenser connected between the grid and plate.

It may be necessary to readjust the trimming condensers on the I.F. transformers to permit high efficiency.

## Differential Regeneration Control

● IN Europe, the regeneration in the detector circuit of regenerative receivers is often controlled by means of a "differential

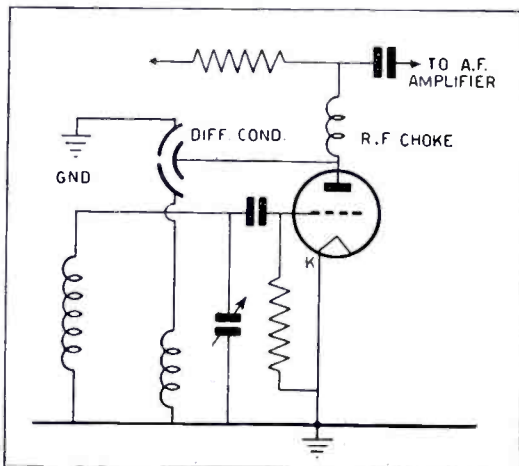

By using a differential condenser as described in the article, superior reception in regenerative circuits is made possible.

condenser" which consists of two small variable condensers on a single shaft. In its usual form this condenser consists of two stators with a single rotating group of plates which shift from one set of stator plates to the other.

This condenser has never become popular in the U.S., but it actually has certain advantages over the usual condenser or resistance control of feedback.

The circuit shown here is a part of the usual type of regenerative circuit found in English radio magazines. When the differential condenser is in the lower position, the condenser acts in the usual manner to control the reactance of the plate coil, so that the regeneration can be adjusted just below the oscillation point.

However, on those parts of the bands where very little regeneration is needed, and a very small capacity is used, the plate bypass, which is provided by the regeneration condenser, is so small that instability often results. This difficulty is overcome by the second set of plates connected to ground which provides the needed bypass to ground, at the same time allowing the desired small feedback capacity.

While differential condensers are not available in the U.S., two small trimmer condensers can be connected on the same shaft with the stators opposite so that one condenser increases in capacity as the other decreases. The two rotors are then connected together and replace the single rotor of the differential condenser.

## An Automatic Sender For C.W. Work

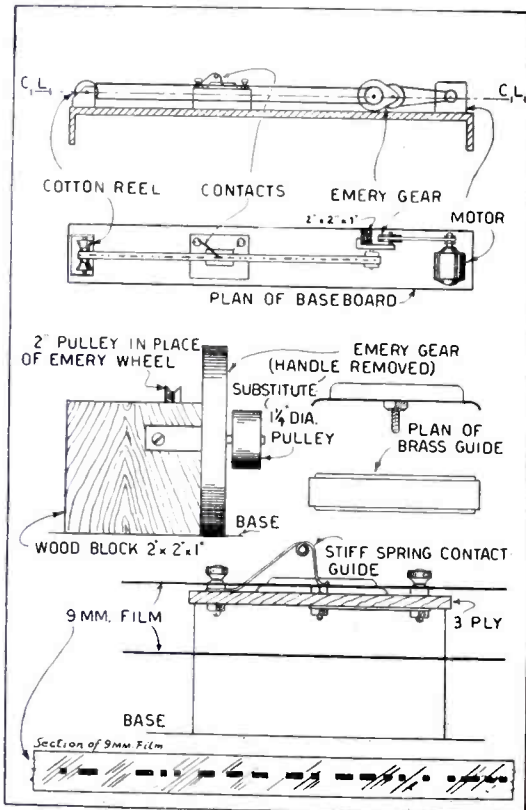

In this automatic code transmitter the signal is recorded on a strip of celluloid in the form of slots, which cause contacts to open and close the transmitter circuit.

● EVER since the early days of amateur radio "Rube Goldberg" gadgets have been made to automatically send CQ signals, test signals, and the many other long repeated signals that hams must otherwise pound out  
(Continued on page 578)



# TELEVISION Sweep Coil Data

Complete constructional data is given here for building the oscillators and magnetic scanners for use with the new RCA cathode-ray television tubes.

● **INTEREST** in television reception is increasing at a great rate, due for one thing to the recent introduction to the experimental fraternity of the new 5" and 9" diameter cathode-ray tubes by RCA. These tubes are

The picture below shows various circuits necessary for exciting the magnetic scanning device used with the new experimental television tubes. Complete data on the circuits is given in the accompanying article.

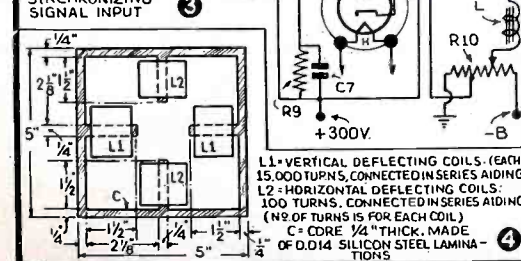
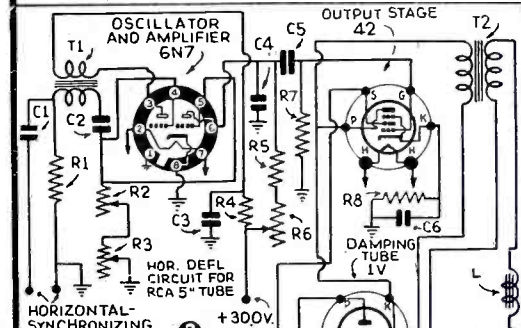
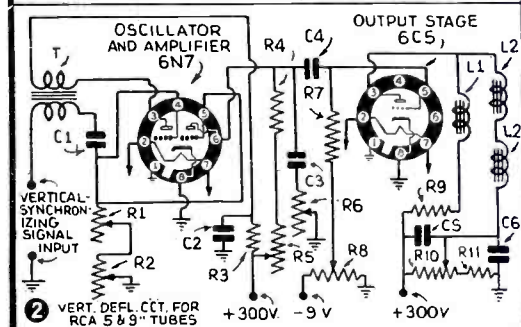
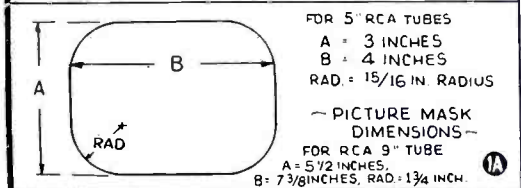
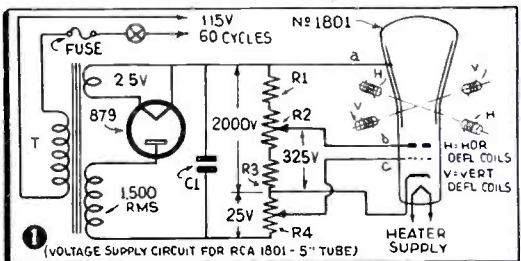

specially designed for experimental television reception and are for use with electromagnetic scanning. Data for building the scanning or sweep coils is given here.

Kinescope RCA-1801 is a cathode-ray tube designed primarily for the reproduction of television pictures. It is being used by the amateur and experimenter for the reception of experimental television transmissions. This tube is intended for use with electromagnetic deflection and has a bulb-end 5 inches in diameter. The screen, which fluoresces brightly with a yellowish hue, accommodates a picture 3 inches by 4 inches in size.

### Five-Inch Electromagnetic-Deflection Type with Medium-Persistence Screen

The electrodes in the 1801 provide a focused beam of electrons. These electrons impinge on the fluorescent screen and produce a spot of light. The brightness of this spot can be controlled by a modulating voltage applied to the grid. The position of the spot can be controlled by means of two sets of electromagnetic-deflecting coils, one of which is used to control the horizontal movement of the spot; the other, the vertical movement of the spot.

In the use of the RCA-1801 for television reception, currents of sawtooth waveform are supplied to the vertical-deflecting coils and to the horizontal-deflecting coils. The resultant deflections cause the spot to scan the rectangular picture area on the screen. At the same time, the television picture signal is applied to the grid to modulate the brightness of the spot. As a result of the modulation and motion of the spot, the spot traces on the screen of the Kinescope a reproduction of the scene being transmitted.

### Tentative Characteristics and Ratings

Heater Voltage (A.C. or D.C.)	2.5 Volts
Heater Current	2.1 Amperes
Fluorescent screen:	
Material	Phosphor No. 3
Color of Fluorescence	Yellow
Direct Interelectrode Capacitance:	
Grid to all other electrodes	12 max. mmf.
Overall Length	15 3/4" (plus or minus 3/8")
Maximum Diameter	5 1/8"
Bulb	J-40
Cap	Medium Metal
Base	Medium 5-Pin

### Maximum Ratings and Typical Operating Conditions

High-Voltage Electrode (Anode No. 2) Voltage	3000 max. Volts
Focusing Electrode (Anode No. 1) Voltage	1000 max. Volts
Control Electrode (Grid) Voltage	Never Positive
Grid Voltage for Current Cut-off	-35 approx. Volts
Fluorescent-Screen Input Power per Sq. Cm.	10 max. Milliwatts
Typical Operation:	
Heater Voltage	2.5 Volts

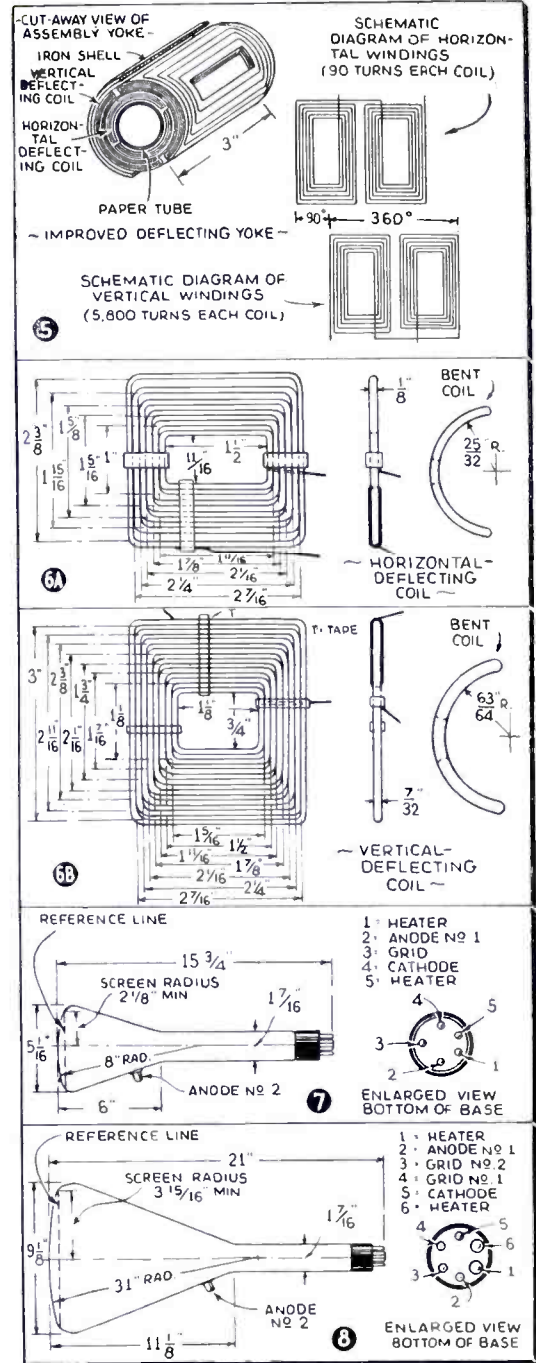

The diagrams above provide further details of the sweep oscillator circuits and magnets to be used with the new tubes.

Anode No. 2 Voltage ..... 2000 Volts  
Anode No. 1 Voltage (Approx.) ..... 325 Volts  
Grid Voltage adjusted to give suitable luminous spot  
Grid Signal-Swing Voltage (Approx.) \*\* ..... 15 Volts  
\*With approximately 500 volts on Anode No. 1 and 3000 volts on Anode No. 2.  
\*\*Peak-to-peak value for optimum contrast.

### Installation

The handling of RCA-1801 in transportation and storage requires great care, because the tube may be broken or permanently damaged if subjected to sudden jars or excessive strains. Each 1801 is supported within its shipping carton so that it will not come in contact with the sides of the carton during shipment. When the 1801 is stored or transported, the tube should be protected from moisture and should be in an upright position with the large end of the bulb (viewing screen) always up. In no case should the tube be placed on or slid across a hard surface, such as a table or a laboratory work bench. Such practice may result in scratches at the rim of the conical portion of the bulb, where the viewing screen merges into the bulb flare. Scratches on the bulb, especially on this por-

(Continued on page 576)



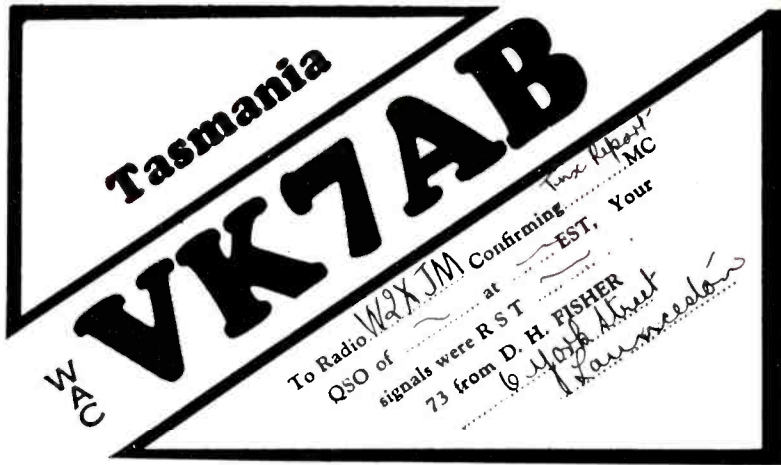

VK7AB, Tasmania—A neat card with black letters contrasting beautifully on a white card.

Let's Listen In

Winner of the 30th

● CONDITIONS for the month of November have been quite profitable in the matter of accumulating a good log of new DX stations, although as usual, the amateurs have supplied most of the activity.

Up to about the last week in November conditions had been fairly good on all bands, but during the last week, a universal plaint has been raised by amateur and SWL alike, regarding the noticeable let-down in DX reception, most marked on the 20 meter band, which generally serves as a reliable gauge of conditions best suited to long distance reception.

At the time of this writing, poor conditions still persist, but we feel certain that "the band" will open up again, to help us to further enrich our log book with jottings on good DX catches.

What Is a Veri?

We have been requested by the Golden Gate Chapter of the International DXer's Alliance, San Francisco, through Ashley Walcott, Secretary, to state our opinion in regard to the matter of so-called "artificial verifications," and, as our opinion coincides with that of the findings of a referendum made at a meeting of the G. G. Chapter, we are glad to clear up the matter here.

The above is in regard to the issuance of unauthorized verifications of reception for transmissions from Daventry, and also from HRN, Honduras, and perhaps other stations.

It is our opinion that such confirmations are worthless, and as such, will not be accepted for any contests in which verifications need be entered. It is to be noted that the practice of verifying reports of reception of the above mentioned stations has in no way been authorized by these stations!

Furthermore, this practice will have a most harmful tendency in regards to the grand hobby of QSL collecting.

If continued, such procedure will eventually be regarded by a goodly number of stations as sufficient excuse to discontinue their own verification work, something perhaps unforeseen when this practice was begun by several Eastern DX fans. We must give a little credit to these fans for their good intentions, as they sacrificed their time to "monitor" programs, and conducted the system on a "cost" basis, but we feel certain these parties did not foresee into what a muddle they would lead the verification hobby, if such a practice spread, and was accepted by more and more stations.

In general, the above opinion has been

found to be in accord with that of other leading radio publications, and with that of the leading DX Clubs in the U.S.A.

Therefore, we hereby request of the authors of this "artificial verification" system that they realize the bad effects the hobby will eventually suffer, and that they discontinue further activity along this line. We hope to see this practice cease.

And now to DX:

MADAGASCAR

Radio Tananarive, located in the city of Tananarive, is now being heard on three frequencies on the West Coast, by Ashley Wolcott, our Pacific Coast correspondent.

● **If you have logged a new station be sure to write the DX Editor, c/o Short Wave & Television, and give him this information for the benefit of other listeners.**

Ashley received a veri of the 9 mc. frequency, and data in the letter states that Tananarive now operates on the following freqs.: 10.96, 9.503, and 6.069 mc. However, Ashley hears Tananarive on these freqs.: 10.95, 9.38, and 6.06 mc.!

The 10.95 mc. freq. is reported as the best signal, 9.38 mc. next best, and 6.06 mc. is heard only on good mornings, all these heard from 10-11 a.m., E.S.T. on the coast.

However, for Eastern DXers the best time is daily from 3:30-4:30 a.m., and on Sundays from 2:30-4 a.m., this being the latest schedule received.

Having already verified Tananarive on 6 mc., we are going to try for the two other freqs., and hope to be able to report favorable results on at least one of the two, as we have just received the new '38 Skyrider, which we feel is fully capable

ZU6E, South Africa —Green letters on a light tan background make this a striking QSL.

of receiving these faint, rare, signals, judging from our brief tests for a few days. Next month we will give the results of our tests on this fine receiver.

Back to Madagascar! This station usually tests for about 15 minutes before each broadcast, ordinarily playing one record over and over, the well-known "Over the Waves" waltz. Of course, all frequencies transmit simultaneously. Opening announcement is "Allo, allo, ici Station Radio Tananarive." To be mentioned is the fact that Tananarive's freqs. are inclined to be unstable, but should be found somewhere near freqs. listed. Full QRA are given in a previous column.

ANGOLA

CR6AA, 7.177 mc., at Lobito, was logged the other day at 3:30 p.m., inside their regular schedule of 2:45-4:30 p.m., on Weds. and Sats.

This rare catch is a regular visitor around the holiday season, as conditions are best at this time of the year for the rare African SW-Broadcasters. CR6AA is rather difficult to log on the 7 mc. frequency, due to the at times terrific code QRM, being located in the middle of the 40 meter amateur band, which is nothing but a "mess" of code signals, mostly of terrific strength, to which our sore ears will amply attest, hi!

CR6AA also operates on 9.666 mc., and should be easier to receive on that wave, if only due to the absence of the "C.W." Q.R.M. It is reported that above schedule applies only to 7.177 mc., and that the 9.666 mc. freq. is used irregularly. QSL card previously published.

The full QRA is: Alvaro de Carvalho, Director, CR6AA, P. O. Box 103, Lobito, Angola, Port West Africa. W. S. Wade, W7, reports CR6AA on 9.666 mc.

TAX FOR REPORT  
STATION **W2SWL** **South Africa** **SARRL**  
THIS CONFIRMS QSO ON 14 MCGREATDAYS HOURS GMT DATE **8. 11. 36**  
Your Signal **RECEPTION VERIFIED** Clean Steady  
**ZU6E**  
RECEIVERS SIX TUBE 35 AND MURDOCK SILVER EIGHT 80. WITH XTAL FILTER.  
48W TRANSMITTER 6L OSC 6L BUFFER 6L7B AMPLIFIER 6E CLASS B MODULATOR  
500V 95 MA  
W. H. BROWNING. Box 745 JOHANNESBURG, SOUTH AFRICA  
Wallechs, Pty.—10528



With  
*Joe Miller*

## S.W. Scout Trophy

### EGYPT

SUZ, 13.83 mc., Cairo, was heard at the most unusual hour of 4:05 a.m. recently, in contact with GBB, 13.58 mc., Rugby, England, as usual. This is far off their regular daily (ex. Sun.) sked of 11 a.m. SUZ can easily be logged if one tries for a week or so, at 11 a.m. E.S.T., as they clearly announce their call and location when contacting Rugby.

QRA: Marconi Radiotelegraph Co., P. O. Box 795, Cairo, Egypt.

### SOUTH AFRICA

The Klipheuvell station which takes its programs from Capetown, on 9.615 mc., is holding up very well, a fine, consistent signal, judging from reports throughout the U.S. and Canada. As reports are requested to be sent to ZTJ's QRA: P. O. Box 4559, Johannesburg, we assumed this to be ZTJ on a higher freq., perhaps we have erred. This station is on every day but Saturday, from 11:45 p.m.—12:45 a.m.

### ITALIAN AFRICANS

ITK, 16.385 mc., Mogadiscio, Italian Somaliland, heard recently at 9:15 a.m., fair signal.

A new Italian African, we believe, is the signal heard just to the high freq. side of IAC, 17.70 mc., Pisa, Italy, and we place the unknown's freq. as 17.73 mc. Time heard has been 9:15 and 10:30 a.m. Signal, of course, does not compare with IAC's tremendous power.

### CANARY ISLANDS

EAJ43, 10.37 mc., Santa Cruz de Tenerife, is now operating daily on a new, announced "sked" of 2-3 a.m., "Canary Island Time," or 9-10 p.m., E.S.T. They should be very

well heard on this new schedule.

Regarding EAJ43, we've a story to relate. When first we heard EAJ43, we sent them a report, along with the rest of our immediate DX friends. When one after another got their QSL cards back, but not us, we repeated our report again and again, but in each instance heard nothing from the station. Being persistent, and perhaps a bit "mad," we came to the situation where we had *five* reports out to EAJ43, *and still no answer!*

About two months after mailing our last report, we finally—great day!—received our QSL, the one recently pictured, this confirming our most recent report! Oddly, we got a second QSL later, this confirming our next most recent report, the third and fourth reports the same, and the fifth, a report of last October, '36, came in, being last to be answered, hi! It seems they work in reverse as far as QSL's are concerned! We can't complain, however, we certainly got our QSL's, all five of them, hi!

### SPANISH MOROCCO

EA9AH, 14.01 mc., Tetuan, sends a card which is slightly different from one recently pictured, to Gilbert B. Devey, W8, stating that they transmit war news in English from 11:05-11:15 p.m., E.S.T., and from 1:30 a.m., on, daily. Power is increased to 500 watts. Anyone can hear this station's strong signal,

and a handsome card awaits all correct reports to: Fernando Diaz Gomez, EA9AH, P. O. Box 124, Tetuan, Spanish Morocco.

Outside of above schedule, this station operates irregularly throughout the evening hours, often calling and working North and

South American amateurs, using either English or Spanish, upon occasion.

### SIAM

Through information received from Indo-China and Siam, we have news on several radiophone stations heretofore unlisted in any publication. Firstly, however, in a letter from Sangiem, Powtongsook, Bangkok, we learn that HSJ, 7.955 mc., Bangkok, occasionally contacts ZGB, 13.642 mc., Kuala Lumpur, FMS, and with FRS3, 5.00 mc., Saigon, Indo-China.

HSG, 10.957 mc., has a daily (except weekends) schedule with ZGB at 9:40 p.m., and 1:40 a.m., E.S.T., rather poor times for reception in the U.S. In case of unfavorable conditions for HSG, HSJ will be used instead.

### INDO-CHINA

A letter from Saigon gives us the following data: FZS3, 9.62 mc., is an unlisted radiophone usually employed for telegraphy, but occasionally is used as a radiophone transmitter.

Also, the correct call of FZS on 11.991 mc., is FZS4. The other Saigon station unlisted is already mentioned, FRS3, operating on 5.00 mc.

### INDIA

VWY2, 17.48 mc., Poona, India, heard lately at 7:45 a.m., using inverted speech. A very good signal.

### JAPAN

JVE, 15.66 mc., Nazaki, heard at 7:45 a.m., JVK, 12.02 mc., at 7:55 a.m.

JZJ, 11.80 mc., will broadcast the Overseas program from 12:30-1:30 a.m. from Nov. 10. JZK, now broadcasting above feature, will cease doing so on Nov. 14. This from Harry Honda, W6. Harry also mentions that JVE phones KWO, 15.41 mc., Dixon, Cal., irregular between 10:30-11:30 p.m., using man and lady announcers.

### BURMA

VVS, 12.87 mc., Mingaladon, heard recently phoning VVN, 13.26 mc., Fort Madras, India.

(Continued on page 580)

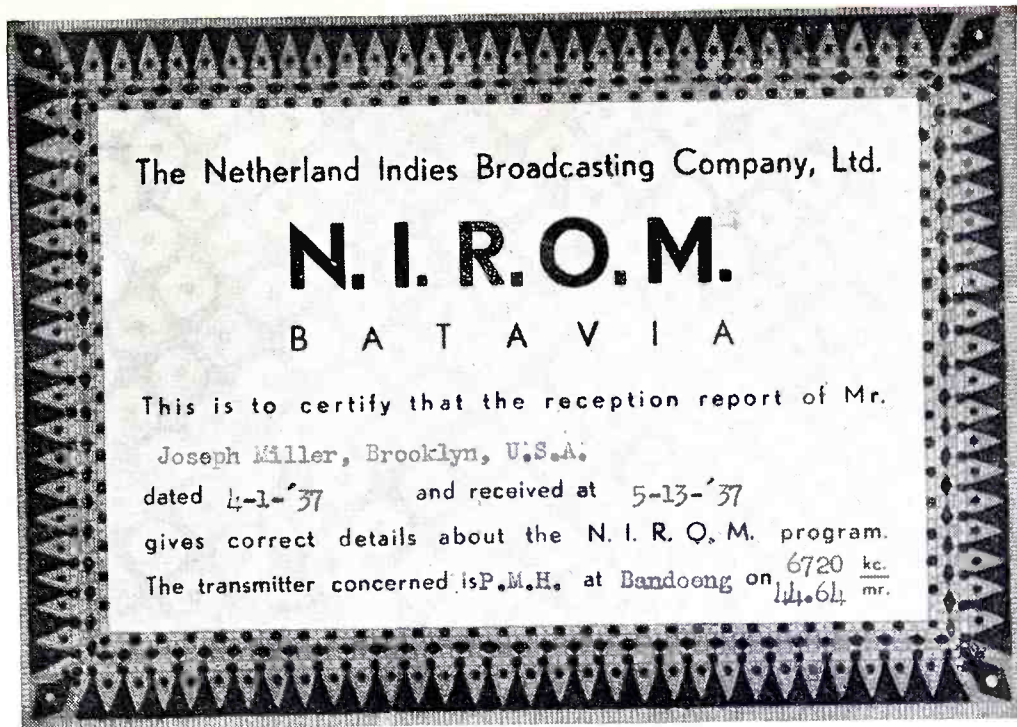

PMH—N.I.R.O.M. Java—This handsome QSL is the verification card for all Javanese S.W. broadcasters.

I certify herewith ~~contact with you~~ on the *2*th of *October* 193*7* your observation

I heard your signals *W* *qrk* *—* quality *—*

*HA4A*

Input *200W*  
Ant. *of dip*  
Wx

QRM. *0 74140*

QRA Budapest, I. Györi-út 12  
PSL QSL

Op *Dénes v. Bibó*  
Vice-president of the National Union of the Hungarian Shortwave Amateurs  
Chairman of the Technical Committee

HA4A, Hungary—Unusual card with black letters on a reddish-buff card.



# World Short-Wave Stations

*Revised Monthly*

Broadcasters Calls in bold type  
Phones in light type

Reports on station changes are appreciated.

↓ S.W. BROADCAST BAND ↓			↓ S.W. BROADCAST BAND ↓			↓ S.W. BROADCAST BAND ↓		
Mc.	Call		Mc.	Call		Mc.	Call	
31.600	W3XEY	BALTIMORE, MD., 9.494 m., Relays WFBR 4 pm-12m.	19.600	LSF	BUENOS AIRES, ARG., 15.31 m., Addr. (See 20.700 mc.) Tests irregularly.	17.850	XGM	SHANGHAI, CHINA, 17 m. Works London 7-9 am.
31.800	W2XDV	NEW YORK CITY, 9.494 m., Addr. Col. Broad. System, 485 Madison Ave. Daily 6-11 pm.; Sat. and Sun. 1.30-6, 7-10 pm.	19.480	GAD	RUGBY, ENG., 15.4 m. Calls VQG4 7.30-8 am.	17.520	DFB	NAUEN, GERMANY, 17.12 m. Works S. America, near 9.15 am. Works Siam 3-5 am., 8-9 pm.
31.800	W3XKA	PHILADELPHIA, PA., 9.494 m., Addr. MBC. Relays KYW 12 n-10 pm.	19.355	FTM	ST. ASSISE, FRANCE, 15.5 m. Calls S. America mornings.	17.480	VWY2	KIRKEE, INDIA, 17.16 m. Works London 7.30-8.15 am.
31.600	W5XAU	OKLAHOMA CITY, 9.494 m., Sun 12 n-1 pm., 6-7 pm. Irregular other times.	19.345	PMA	BANDOENG, JAVA, 15.51 m. Works Holland 5.30-11 am.	17.310	W2XGB	HICKSVILLE, L. I., N. Y., 17.33 m., Addr. Press Wireless, Box 200. Tests 9.30-11.30 am. except Sat. and Sun.
31.600	W4XCA	MEMPHIS, TENN., 9.494 m., Addr. Memphis Commercial Appeal. Relays WMC.	19.280	PPU	RIO DE JANEIRO, BRAZ., 15.58 m., Addr. Cia. Radiotel. Brasileira. Works France mornings.	17.120	WOO	OCEAN GATE, N. J., 17.52 m., Addr. A. T. & T. Co. Works ships irregularly.
31.600	W8XAI	ROCHESTER, N. Y., 9.494 m., Addr. Stromberg Carlson Co. Relays WHAM 7.30-12.05 am.	19.220	WKF	LAWRENCEVILLE, N. J., 15.6 m., Addr. A. T. & T. Co. Calls London and Paris daytime.	17.080	GBC	RUGBY, ENG., 17.50 m. Works ships irregularly.
31.800	W8XWJ	DETROIT, MICH., 9.494 m., Addr. Evening News Ass'n. Relays WWJ 6-12.30 am., Sun. 8 am-12 m.	19.200	ORG	RUYSSELEDE, BELGIUM, 15.62 m. Calls OPL mornings.	18.835	ITK	MOGADISCIO, ITAL. SOMALILAND, 18.32 m. Calls IAC around 9.30 am.
31.800	W9XPD	ST. LOUIS, MO., 9.494 m., Addr. Pulitzer Pub. Co. Relays KSD.	19.180	GAP	RUGBY, ENG., 15.60 m. Calls Australia 1-8 am.	18.270	WLK	LAWRENCEVILLE, N. J., 18.44 m., Addr. A. T. & T. Co. Works S. Amer. daytime.
26.400	W9XJL	SUPERIOR, WIS., 11.36., Relays WEBC daily.	19.020	H88PJ	BANGKOK, SIAM, 15.77 m. Mondays 8-10 am.	18.270	WOG	OCEAN GATE, N. J., 18.44 m., Addr. A. T. & T. Co. Works England Late afternoon.
26.400	W9XAZ	MILWAUKEE, WIS., 11.36 m., Addr. The Journal Co. Relays WTMJ from 1 pm.	18.970	GAQ	RUGBY, ENG., 15.81 m. Calls S. Africa mornings.	18.240	KTO	MANILA, P. I., 18.47 m., Addr. RCA Comm. Works Japan and U. S. 5-9 pm. irregularly.
26.100	GSK	OAVENTRY, ENG., 11.49 m., Addr. B. B. C., London. Operates irregularly	18.890	ZSS	KLIPHEUVEL, S. AFRICA, 15.88 m., Addr. Overseas Comm. of S. Africa, Ltd. Calls GAQ 9-10 am.	18.233	FZR3	SAIGON, INDO-CHINA, 18.48 m. Calls Paris early morning.
25.950	W6XKG	LOS ANGELES, CAL., 11.56 m., Addr. B. S. McGlashan, Wash. Blvd. at Oak St. Relays KGFJ 24 hours daily.	18.680	OCI	LIMA, PERU, 16.06 m. Tests with Bogota, Col.	18.030	KKP	KAHUKU, HAWAII, 18.71 m., Addr. RCA Comm. Works Dixon 3-10 pm.
21.550	GST	DAVENTRY, ENG., 13.92 m., Addr. (See 26.100 mc.) Irregular at present.	18.620	GAU	RUGBY, ENG., 16.11 m. Calls N. Y. daytime.	18.880	FTK	ST. ASSISE, FRANCE, 18.9 m. Works Saigon 8-11 am.
21.540	W8XK	PITTSBURGH, PA., 13.93 m., Addr. Grant Bldg. Relays KDKA 6.45-9 am. Exc. Sun.	18.450	HBF	GENEVA, SWITZERLAND, 16.26 m., Addr. Radio Nations. Tests irregularly.	18.865	CEC	SANTIAGO, CHILE, 18.91 m. Calls Peru daytime irregular.
21.530	GSJ	DAVENTRY, ENG., 13.93 m., Addr. (See 26.100 mc.) 5.45-8.55 am.	18.345	FZS	SAIGON, INDO-CHINA, 16.35 m. Works Paris early morning.	18.810	LSL	BUENOS AIRES, ARG., 18.08 m., Addr. (See 21.020 mc.) Works London mornings and Paris afternoons.
21.520	W2XE	NEW YORK CITY, 13.94 m., Addr. Col. Broad. Syst., 485 Madison Ave. 7.30-10 am., Sat. and Sun. 8 am-1 pm.	18.340	WLA	LAWRENCEVILLE, N. J., 16.36 m., Addr. A. T. & T. Co. Calls England daytime.	18.660	JVE	NAZAKI, JAPAN, 19.10 m. Works Java and Siam 3-5 am.
21.470	GSH	DAVENTRY, ENG., 13.97 m. (See 26.100 mc.) 5.45 am-12 n	18.310	GAS	RUGBY, ENG., 16.38 m. Calls N. Y. daytime.	18.620	JVF	NAZAKI, JAPAN, 19.2 m. Works Cal. near 5 am. and 8 pm.
21.420	WKK	LAWRENCEVILLE, N. J., 14.01 m., Addr. Amer. Tel. & Tel. Co. Calls S. Amer. 7 am-7 pm.	18.299	YVR	MARACAY, VENEZ., 16.39 m. Works Germany mornings.	18.650	CO9XX	TUINICU, ORIENTE, CUBA, 19.29 m., Addr. Frank Jones, Central Tuinicu, Tuinicu, Santa Clara. Broadcasts irregularly evenings.
21.080	PSA	RIO DE JANEIRO, BRAZ., 14.23 m., Calls WKK daytime.	18.250	FTO	ST. ASSISE, FRANCE, 16.43 m. Works S. America daytime.	18.450	IUG	ADDIS ABABA, ETHIOPIA, 19.41 m. Works Rome 9.15-10.30 am.
21.080	WKA	LAWRENCEVILLE, N. J., 14.25 m., Addr. (See 21.420 mc.) Calls England morning and afternoon.	18.200	GAW	RUGBY, ENG., 16.48 m. Works N. Y. C. daytime.	18.440	XEBM	MAZATLAN, SIN., MEX., 19.43 m., Addr. Flores 103 Alto. "El Pregonero del Pacifico." Irregularly 7 am-10 pm.
21.020	LSN6	BUENOS AIRES, ARG., 14.27 m., Addr. Cia. Internacional de Radio. Works N. Y. C. 7 am-7 pm.	18.135	PMC	BANDOENG, JAVA, 16.54 m. Works Holland mornings.	18.415	KWO	DIXON, CAL., 19.46 m., Addr. A. T. & T. Co. Works Hawaii 2-7 pm.
20.880	EHY-EDM	MADRID, SPAIN, 14.38 m., Addr. Cia. Tel. Nacional de Espana. Works S. Amer. mornings.	18.115	LSY3	BUENOS AIRES, ARG., 16.56 m., Addr. (See 20.700 mc.) Tests irregularly. Broadcasts 4-5 pm. Friday.	18.370	HAS3	BUDAPEST, HUNGARY, 19.52 m., Addr. Radiolabor, Gyali Ut 22. Sun 9-10 am.
20.700	LSY	BUENOS AIRES, ARG., 14.49 m., Addr. Transradio Internatl. Tests irregularly	18.040	GAB	RUGBY, ENG., 16.83 m. Works Canada morning and afternoon.	18.380	DZG	ZEESEN, GERMANY, 19.53 m., Addr. Reichspostzentramt. Tests irregularly.
20.380	GAA	RUGBY, ENG., 14.72 m. Calls Arg., Brazil mornings.	17.810	PCV	KOOTWIJK, HOLLAND, 16.84 m. Works Java 6-8 am.	18.355	KWU	DIXON, CALIF., 19.53 m., Addr. A. T. & T. Co. Phones Pacific Isles and Japan.
20.040	OPL	LEOPOLDVILLE, BELGIAN CONGO, 14.97 m. Works ORG mornings.	↓ S.W. BROADCAST BAND ↓			18.340	DJR	BERLIN, GERMANY, 19.50 m., Addr. Broadcast'g House, 8-9 am.
20.020	DHO	NAUEN, GERMANY, 14.99 m., Addr. Reichspostzentramt. Works S. Am. mornings.	17.800	TGWA	GUATEMALA CITY, QUAT., 16.84 m., Addr. Ministre De Pomento. Irregular.	18.330	W2XAD	SCHENECTADY, N. Y., 19.56 m., Addr. General Electric Co. Relays WGY 11 am. to 9 pm.
19.800	LSG	BUENOS AIRES, ARG., 15.08 m., Addr. (See 20.700 mc.) Tests irregularly.	17.790	GSG	DAVENTRY, ENG., 16.86 m., Addr. B. B. C., London. 3.15-5.30 am., 5.45 am-12 n., 12.20-3.45 pm.	18.310	GSP	OAVENTRY, ENG., 19.6 m., Addr. (See 26.100 mc.) 1.45-3.45 pm.
19.820	WKN	LAWRENCEVILLE, N. J., 15.14 m., Addr. A. T. & T. Co. Calls England daytime.	17.785	JZL	TOKIO, JAPAN, 16.87 m. Tests irregularly.	18.290	LRU	BUENOS AIRES, ARG., 19.62 m., Addr. El Mundo. 6-8 am.
19.680	CEC	SANTIAGO, CHILE, 15.24 m., Addr. Cia. Internacional de Radio. Calls Col. and Arg. daytime.	17.780	W3XAL	BOUND BROOK, N. J., 16.87 m., Addr. Natl. Broad. Co. 8.55 am-9 pm.	18.280	H13X	CIUDAD TRUJILLO, D. R., 19.63 m. Relays H1X Sun. 7.40-10.40 am. Week-days 12.10-1.10 pm.
19.550	LSN5	BUENOS AIRES, ARG., 15.27 m., Addr. (See 21.020 mc.) Calls Europe daytime	17.770	PHI	HUIZEN, HOLLAND, 16.88 m., Addr. (See PHI, 11.730 mc.) Daily except Wednesday, 8.25-10 am., Sun. 7.25-10.25 am.	18.280	DJQ	BERLIN, GERMANY, 19.63 m., Addr. Broadcasting House. 12.05-10 am.; also Sun. 11.10 am-12.25 pm.
19.820	VQG4	NAIROBI, KENYA, 15.28 m., Addr. Cable and Wireless, Ltd. Calls London 7.30-8 am.	17.760	W2XE	NEW YORK, N. Y., 16.89 m., Addr. Col. Broad. System, 485 Madison Ave. Daily 6.20 pm-12 m.	18.270	W2XE	NEW YORK CITY, 19.65 m., Addr. (See 21.520 mc.) Daily except Sat and Sun., 1-2.15 pm.
			17.755	ZBW5	HONGKONG, CHINA, 16.9 m., Addr. P. O. Box 200. 4-10 am. irregular.			
			17.741	HSP	BANGKOK, SIAM, 16.91 m. Works Germany 3-5 am., 8-9 pm. Works JVE 11 pm-6 am.			

(Continued on page 556)



# Question Box

A fee of 25c (stamps, coin or money order) is charged for letters that are answered by mail. This fee includes only hand-drawn schematics. We cannot furnish full-size working drawings or picture layouts. Letters not accompanied by 25c will be answered on this page. Questions involving considerable research will be quoted upon request. Names and addresses should be clearly printed on each letter.

## 30 WATT MODULATOR

Will you please print the diagram for a modulator suitable for use with the crystal-controlled 5 and 10 meter transmitter appearing in the April 1937 issue.—Glenn Attrill, Poenta, Calif.

**A.** We have shown a modulator which should be quite satisfactory for use with this transmitter. It is for crystal mike input and employs a pair of 6L6 beam tubes in a push-pull output stage operating in class AB. It is capable of supplying about 30 watts of audio output, depending on the design of the power transformer and filter chokes. To realize maximum output, it is important that the D.C. resistance of the 200 ma. chokes be as low as possible. It is also important that the power transformer have very good regulation.

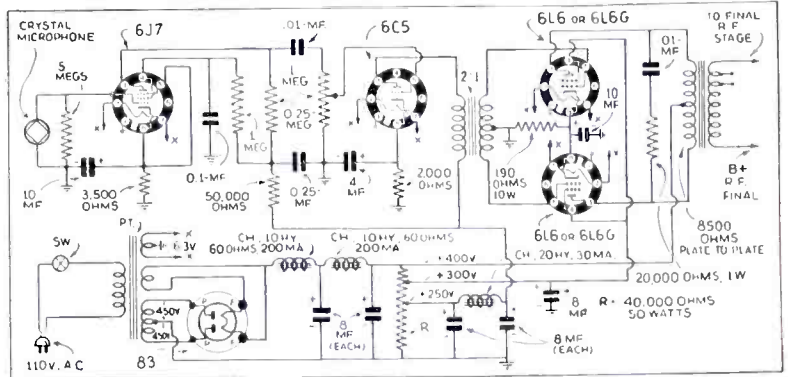

Modulator for 5 and 10 Meter Rigs—1108

**A.** The 4-tube receiver illustrated should meet your requirements. Metal tubes are used throughout; 6K7 pentodes are used in the R.F. and detector stages, and a 6J5 high-gain general-purpose triode is used for the first audio. A 6F6 power pentode comprises the output stage. The detector uses electron coupling. A simple power pack similar to those which have appeared on this page in the past issues will be satisfactory for use with the receiver, providing that a B supply of 250 Volts at a drain of about 60 ma. is available. A center-tapped filament winding delivering 6.3 volts at 3 amperes will take care of the heaters. The center tap should go to B—.

## AN IMPRACTICAL CIRCUIT

Please print a diagram of a 4-tube A.C.-D.C. short-wave set using a 56, 57, 58, 2A5 and an 80 tube.—Sidney Yaffe, Brooklyn, N.Y.

**A.** The circuit you request is impractical. The tubes you have are for 2.5 Volt filament operation and require quite a high amperage. To use them in an A.C.-D.C. circuit would mean that the current consumption from the 110 V. line would be very high. Further, it is probable that a considerable amount of hum would be noticeable when using this type of tube in such a circuit.

An 80 tube is designed for use only with a power transformer and could not be used satisfactorily in an A.C.-D.C. circuit. We suggest you either build an A.C. set using a power transformer or secure

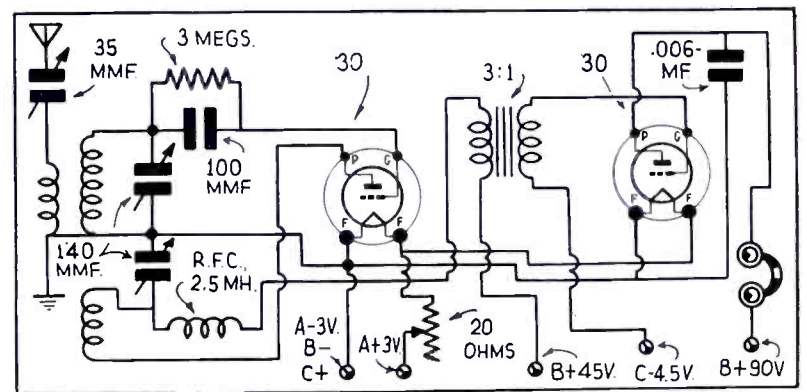

Battery Set Using 30-type Tubes—1110

6.3 V. tubes suitable for use in A.C.-D.C. designs. Numerous circuits for A.C.-D.C. operation have been published in the magazine.

## POWER SUPPLY PROBLEM

I am going to build a power supply which must supply the "B" voltage for a 2 tube set and a 6 tube set. What should the current rating of the power transformer be to cover this wide range?—George Black, Beaumont, Tex.

**A.** If the available voltage is correct, the current rating of the power supply is not important so long as the rating is equal to, or greater than, the requirement of the receiver. A large power supply will operate a small receiver satisfactorily, but a small power supply will not operate a large receiver.

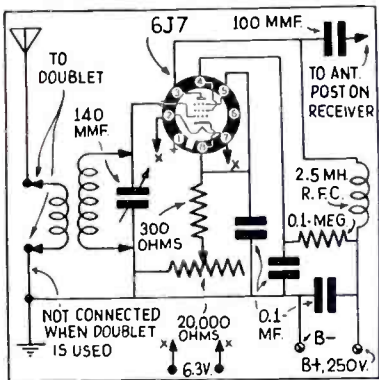

R. F. Amplifier—1109

both terminals of the antenna coils and there is no connection between this coil and ground. Sensitivity in this circuit is controlled by a 20,000 ohm potentiometer in the cathode circuit. If a common B supply is employed there will be no need for a separate connection between the B negative of the pre-amplifier and the receiver. Note that although the diagram shows a 6J7, a 6K7 is proper. Connections are the same for either tube.

## 6K7 R.F. AMPLIFIER

Please print a diagram of a tuned R.F. amplifier using a 6K7 tube. This amplifier should use regular four prong plug-in coils with the tickler portion as the antenna coil.—Charles Mourmouris, Denver, Colo.

**A.** We have shown the diagram requested employing a 6K7 as a R.F. amplifier. We have shown connections for both the doublet and straight antenna and ground. When the doublet is used, the antenna connects to

## 2-TUBE BATTERY SET

I would like you to publish a diagram of a receiver employing 2 type 30 tubes in a simple circuit.—Mack Mckenzie, Frostburg, Md.

**A.** A 2-tube receiver consisting of a regenerative detector and a stage of audio is reproduced on this page. The coils are of the 3-winding, 6-prong type. The primary winding, that is the coil which is interwound with the grid coil, is used for antenna coupling.

## UNTUNED TRF RECEIVER

Please publish the diagram for a set employing high-gain tubes and consisting of an R.F. stage inductively coupled to a regenerative detector, which in turn is resistance coupled to the first audio stage, driving a pentode output tube. The set should also have a phone jack, band-spread, and volume and tone controls, as well as a regeneration control.—Charles Dickson, Belle Vernon, Pa.

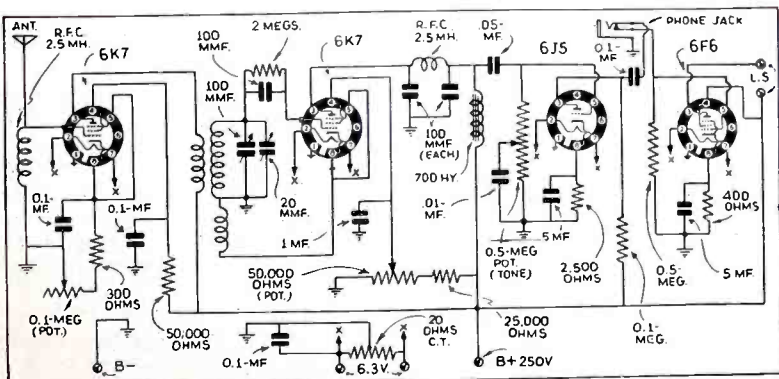

TRF Receiver—1111



Mc.	Call		Mc.	Call		Mc.	Call	
15.280	GSI	DAVENTRY, ENG., 19.66 m., Addr. (See 26.100 mc.) Irreg. 12.20-3.45 pm.	14.500	—	ASmara, ERITREA, AFRICA, 20.69 m. Works Rome and Addis Ababa 6.30-7.30 am	12.120	TPZ2	ALGIERS, ALGERIA, 24.75 m. Calls Paris 12 m.-6.30 am.
15.252	RIM	TACKENT, U.S.S.R., 19.67 m. Works RKL near 7 am.	15.500	LSM2	BUENOS AIRES, ARG., 20.69 m., Addr. (See 21.020 mc.) Works RIO and Europe daytime.	12.060	PDV	KOOTWIJK, HOLLAND, 24.88 m. Tests irregularly.
15.250	W1XAL	BOSTON, MASS., 19.67 m., Addr. University Club. Daily 2.15-4 pm., Sun. 10.15 am.-12 n.	14.485	TIR	CARTAGO, COSTA RICA, 20.71 m. Works Central America and U. S.A. daytime.	12.000	RNE	MOSCOW, U.S.S.R., 25 m. Daily 6-7 am., 12.15-1 pm., 8.30-11 pm., also Sun. 6 am.-1 pm.
15.245	TPA2	PARIS, FRANCE, 19.68 m., Addr. 98 bis. Blvd. Haussmann. "Radio Colonial." 6-11 am.	14.485	YSL	SAN SALVADOR, SALVADOR, 20.71 m. Irregular.	11.991	FZS2	SAIGON, INDO-CHINA, 25.02 m. Phones Paris mornings.
15.230	HS8PJ	BANGKOK, SIAM, 19.32 m. Irregularly Mon. 8-10 am.	14.485	HPF	PANAMA CITY, PANAMA, 20.71 m. Works WNC daytime.	11.960	HIX	CIUDAD TRUJILLO, D. R., 25.08 m., Addr. La Voz de Hispaniola. Relays HIX Tue. and Fri. 8.10-10.10 pm.
15.230	OLR5A	PRAGUE, CZECHOSLOVAKIA, 19.32 m., 6-7.30 am.	14.485	TGF	GUATEMALA CITY, GUATEMALA, 20.71 m. Works WNC daytime.	11.955	IUC	ADDIS ABABA, ETHIOPIA, 25.09 m. Works IAC around 12 midnight.
15.220	PCJ	HUIZEN, HOLLAND, 19.71 m., Addr. N. V. Philips' Radio, Hilversum. Tues. 3.30-5 am., Wed. 9 am.-12 n.	14.485	YNA	NICARAGUA, MANAGUA, 20.71 m. Works WNC daytime.	11.950	KKQ	BOLINAS, CALIF., 25.1 m. Tests irregularly evenings.
15.210	W8XK	PITTSBURGH, PA., 19.72 m., Addr. (See 21.540 mc.) 9 am.-7 pm.	14.485	HRL5	NACAOME, HONDURAS, 20.71 m. Works WNC daytime.	11.940	FTA	STE. ASSISE, FRANCE, 25.13 m. Works Morocco mornings and Argentina late afternoon.
15.200	DJB	BERLIN, GERMANY, 19.74 m., Addr. (See 15.280 mc.) 12.05-11 am. Also Sun. 11.10 am. to 12.25 pm.	14.485	HRF	TEGUCIGALPA, HONDURAS, 20.71 m. Works WNC daytime.	↓ S.W. BROADCAST BAND ↓		
15.190	ZBW4	HONGKONG, CHINA, 19.75 m., Addr. P. O. Box 200. Irregular. 11.30 pm. to 1.15 am., 4-10 am., Sat. 9.15 pm.-1 am., Sun. 3-9.30 am.	14.470	WMF	LAWRENCEVILLE, N. J., 20.73 m., Addr. A. T. & T. Co. Works London and Paris daytime.	11.910	CB1190	VALDIVIA, CHILE, 25.2 m., P. O. Box 642. Relays CB69 11 am.-11 pm.
15.180	GSO	DAVENTRY, ENG., 19.76 m., Addr. (See 26.100 mc.) 3.15-5.30, 5.45-8.55 am, 4-6 pm.	14.460	DZH	ZEESEN, GERMANY, 20.75 m., Addr. (See 15.360 mc.) Irregular.	11.900	XEWI	MEXICO CITY, MEXICO, 25.21 m., Addr. P. O. Box 2874. Tues. and Thurs. 7.30 pm.-12 m., Fri. 9 pm.-12 m. Sunday 12.30-2 pm.
15.170	TGWA	GUATEMALA CITY, GUAT., 19.77 m., Addr. (See 17.8 mc.) Irregular 11.30 am.-2 pm.	14.440	GBW	RUGBY, ENG., 20.78 m. Works U. S. A. afternoons.	11.895	HP5I	AQUADULCE, PANAMA, 25.22 m. Addr. La Voz del Interior. 7.30-9.30 pm.
15.165	XEWW	MEXICO CITY, MEXICO, 19.78 m. 12 n.-12 m. irregular.	14.200	EA9AH	TETUAN, SPANISH MOROCCO, 21.13 m. Daily except Sun. 2.15-5.7 and 9 pm.	11.880	TPA3	PARIS, FRANCE, 25.23 m., Addr. (See 15.245 mc.) 2-5 am., 12.15-6 pm.
15.160	JZK	TOKIO, JAPAN, 10.79 m. Irregular.	14.164	P11J	DORDRECHT, HOLLAND, 20.52 m., Addr. (See 7.088 mc.) Sat. 12 n.-12.30 pm.	11.870	W8XK	PITTSBURGH, PA., 25.26 m., Addr. (See 21.540 mc.) 7-10 pm.
15.150	YDC	SANDOENG, JAVA, 19.8 m., Addr. N. I. R. O. M. 6-7.30 pm. 10.30 pm.-2 am., Sat. 7.30 pm.-2 am., 5.30-10.30 am.	13.990	GBA	RUGBY, ENG., 21.44 m., Works Buenos Aires late afternoon.	11.860	YDB	SOERABAJA, JAVA, 25.29 m., Addr. N. I. R. O. M. Sat. 7.30 pm. to 2.30 am., daily 10.30 pm. to 2 am.
15.140	G8F	DAVENTRY, ENG., 19.82 m., Addr. (See 26.100 mc.) 5.45 am.-12 n.	13.820	SUZ	ABOU ZABAL, EGYPT, 21.71 m. Works with Europe 11 am. to 2 pm.	11.860	G8E	DAVENTRY, ENG., 25.29 m., Addr. (See 26.100 mc.) Irregular.
15.120	HVJ	VATICAN CITY, 19.83 m., 10.30-10.45 am., except Sun., Sat. 10-10.45 am.	13.690	KKZ	BOLINAS, CALIF., 21.91 m., Addr. RCA Communications. Irregular.	11.855	DJP	BERLIN, GERMANY, 25.31 m., Addr. (See 15.280 mc.) Irregular 11.35 am. to 4 7-10.45 pm.
15.110	DJL	BERLIN, GERMANY, 19.85 m., Addr. (See 15.280 mc.) 12 m.-2, 8-9 am., 10.40 am. to 4.30 pm. Sun. also 6-8 am.	13.635	SPW	WARSAW, POLAND, 22 m., Mon., Wed. Fri. 12.30-1.30 pm., Daily 6-7 pm.	11.840	KZRM	MANILA, P. I., 25.35 m. Addr. Erlanger & Gallinger, Box 283. 9 pm.-10 am. irregular.
15.055	WNC	HIALEAH, FLORIDA, 19.92 m., Addr. A. T. & T. Co. Calls Central America daytime.	13.585	GBB	RUGBY, ENG., 22.08 m. Works Egypt and Canada afternoon.	11.840	CSW	LISBON, PORT., 25.35 m. Nat'l Broad. Stat. 11.30 am.-1.30 pm. Irreg.
15.038	RKI	MOSCOW, U.S.S.R., 19.95 m. Works Tashkent near 7 am. Broadcasts Sun. 12.15-2.30 pm.	13.415	GCJ	RUGBY, ENG., 22.36 m. Works Japan and China early morning.	11.840	OLR4A	PRAGUE, CZECHOSLOVAKIA, 25.35 m. Addr. Czech Shortwave Sta., Praha X11, Fochova 16. Daily 2-2.15 pm.
14.980	KAY	MANILA, P. I., 20.03 m., Addr. RCA Comm. Works Pacific Islands.	13.410	YSJ	SAN SALVADOR, SALVADOR, 22.37 m. Works WNC daytime.	11.830	W8XAA	CHICAGO, ILL., 25.36 m., Addr. Chicago Federation of Labor. Irregular 7 am.-6 pm.
14.970	LZA	SOPHIA, BULGARIA, 20.04 m., Addr. Radio Garata. Mon., Tues., Thurs., Fri. 11.30 am.-2.45 pm., Wed. 11.30-am 4.45 pm., Sat 11.30 am.-5 pm., Sun. 2 am.-5 pm., Daily except Sun. 5-6.30 am.	13.390	WMA	LAWRENCEVILLE, N. J., 22.4 m., Addr. A. T. & T. Co. Works England morning and afternoon.	11.830	W2XE	NEW YORK CITY, 25.36 m., Addr. Col. Broad. System, 485 Madison Av., N.Y.C. Daily 2.30-6 pm.
14.960	PSF	RIO DE JANEIRO, BRAZIL, 20.43 m. Works with Buenos Aires daytime.	13.380	IDU	ASmara, ERITREA, AFRICA, 22.42 m. Works Rome daytime.	11.820	XEBR	HERMOSILLA, SON., MEX., 25.38 m., Addr. Box 68. Relays XEBH. 2-4 pm., 9 pm.-12m.
14.960	HJB	BOGOTA, COL., 20.07 m. Calls WNC daytime.	13.345	YVQ	MARACAY, VENEZUELA, 22.48 m. Works WNC daytime.	11.820	G8N	DAVENTRY, ENG., 25.38 m., Addr. (See 26.100 mc.) Irregular.
14.940	H11	CIUDAD TRUJILLO, D. R., 20.08 m., Phones WNC daytime.	13.285	CGA3	DRUMMONDVILLE, QUE., CAN., 22.58 m. Works London and ships afternoons.	11.810	ZRO	ROME, ITALY, 25.4 m., Addr. E.I.A.R., Via Montello 5. Daily 5-8.30 am., 10.30 am.-12.20 pm.
14.940	HJA3	BARRANQUILLA, COL., 20.08 m. Works WNC daytime.	13.330	IRJ	ROME, ITALY, 22.69 m. Works Tokio 5-9 am. irregularly.	11.805	OZG	SKAMLEBOAEK, DENMARK, 25.41 m. Addr. Stataradiophonien. Irregular.
14.845	OCJ2	LIMA, PERU, 20.21 m. Works South American stations daytime.	13.075	VPD	SUVA, FIJI ISLANDS, 22.94 m. Irregularly.	11.800	JZJ	TOKIO, JAPAN, 25.42 m., Addr. Broadcasting Co. of Japan, Overseas Division. 8-9 am, 3-4, 4.30-5.30 pm.
14.790	ROU	OMSK, SIBERIA, U.S.S.R., 20.28 m. Works Moscow irregularly 7-9 am.	12.840	WOO	OCEAN GATE, N. J., 23.36 m., Addr. A. T. & T. Co. Works with ships irregularly.	11.800	OER3	VIENNA, AUSTRIA, 25.42 m. Daily 10 am.-5 pm. Sat. until 5.30 pm.
14.730	IQA	ROME, ITALY, 20.37 m. Tests irregularly.	12.825	CNR	RABAT, MOROCCO, 23.39 m., Addr. Director General Tele. & Teleg. Stations. Works with Paris irregularly.	11.795	DJO	BERLIN, GERMANY, 25.43 m., Addr. (See 15.280 mc.) Irregular.
14.653	GBL	RUGBY, ENG., 20.47 m. Works J VH1-7 am.	12.800	IAC	PISA, ITALY, 23.45 m. Works Italian ships mornings.	11.795	OAX5B	ICA, PERU, 25.43 m., Addr. Radio Universal. 11 am.-12 n, 4-11.15 pm.
14.640	TYF	PARIS, FRANCE, 20.49 m. Works Saigon and Cairo 3-7 am, 12 m.-2.30 pm.	12.780	GBC	RUGBY, ENG., 23.47. Works ships Irregularly.	11.790	COGF	MATANZAS, CUBA, 25.45 m., Addr. Gen. Betancourt 51. Relays CMGF. 2-3, 4-5, 6-11 pm.
14.600	JVH	NAZAKI, JAPAN, 20.55 m. Broadcasts irregularly 5-11.30 pm. Works Europe 4-8 am.	12.325	DAF	NORDEICH, GERMANY, 24.34 m. Works German ships daytime.	11.790	W1XAL	BOSTON, MASS., 25.45 m., Addr. (See 15.250 mc.) Daily 4.45-6.30 pm., Sat. 1.45-5.15, 6-6.30 pm., Sun. 3-6.30 pm.
14.590	WMN	LAWRENCEVILLE, N. J., 20.56 m., Addr. A. T. & T. Co. Works England morning and afternoon.	12.300	CB615	SANTIAGO, CHILE, 24.39 m., Addr. Louis Desmaras, Casilla, 761. 11 am.-1 pm., 4-8 pm., Sun. 4-10 pm.	11.770	DJD	BERLIN, GERMANY, 25.49 m., Addr. (See 15.280 mc.) 10.40 am.-4.30 pm., 4.50-11 pm.
14.535	HBJ	GENEVA, SWITZERLAND, 20.64 m., Addr. Radio Nations. Broadcasts Sat. 6.45-8 pm.	12.290	GBU	RUGBY, ENG., 24.41 m. Works N. Y. C. evenings.	11.760	TGWA	GUATEMALA CITY, GUAT., 25.51 m. (See 17.8 mc.) Tues. and Thurs. 8 pm.-12 m.
14.530	LSN	BUENOS AIRES, ARG., 20.59 m., Addr. (See 20.020 mc.) Works N. Y. C. afternoons.	12.250	TYB	PARIS, FRANCE, 24.49 m. Irregular.			
			12.235	TFJ	REYKJAVIK, ICELAND, 24.52 m. Works Europe mornings. Broadcasts Sun. 1.40-2.30 pm.			
			12.215	TYA	PARIS, FRANCE, 24.56 m. Works French ships in morning and afternoon.			
			12.150	GBS	RUGBY, ENG., 24.69 m. Works N. Y. C. evenings.			
			12.130	DZE	ZEESEN, GERMANY, 24.73 m., Addr. (See 15.360 mc.) Tests irregular.			

(Continued on page 558)

(All Schedules Eastern Standard Time)



# How To Identify S-W Stations

Keep These Lists for Future Reference

## WORLD-WIDE STATION IDENTIFICATION LIST

### Part Eight

#### FREQ. CALL TYPE LOCATION

- 6.69 TIEP—B—San Jose, Costa Rica.  
Slogan "La voz del Itmo," "the voice of the Isthmus."
- 6.65 YNLG—B—Managua, Nicaragua.  
See 8.505 mc. Signs off with selection "Good night, ladies."
- 6.65 JFZC—C—"S. S. Chichibu Maru".  
N.Y.K. liner See JFZC, 17.70 mc.
- 6.635 HC2RL—B—Guayaquil, Ecuador.  
Opens and closes with the Ecuadorian National Anthem. Announces every 15 minutes in English and Spanish, prefacing English announcements with "Hello America, this is station HC2RL, Guayaquil, Ecuador."
- 6.63 HIT—B—Trujillo, Dom. Rep.  
"La voz de la Victor," announces as "HIT—T as in Texas." Opens, closes, with "Anchors Aweigh."
- 6.625 PRADO—B—Riobamba, Ecuador.  
Announces "Estacion Prado, en Riobamba, Ecuador." Opens with chimes.
- 6.555 HI4D—B—Trujillo, Dom. Rep.  
Slogan "La voz del Quisqueya."
- 6.55 TIRCC—B—San Jose, Costa Rica.  
Slogan "Radioemisora Catolica Costarricense."
- 6.545 YV6RB—B—Bolivar, Venezuela.  
"Ecos del Orinoco."
- 6.54 YNIGG—B—Managua, Nicaragua.  
"La voz de los Lagos"
- 6.52 YV4RB—B—Valencia, Venezuela.  
"La voz de Carabobo." Uses dual call "YV4RA y YV4RB."
- 6.50 HIL—B—Trujillo, Dom. Rep.  
Gives call, saying "L—as in London," in English.
- 6.50 J2AA—C—Haneda Airdrome.  
Tokyo, Japan. Announces as "Kochira wa J2AA, Haneda." Phones aircraft.
- 6.485 HIIL—B—Santiago de los Caballeros, Dom. Rep.  
"Emisora Nacionales."
- 6.485 Radio Guardia Civil, Tetuan, Spanish Morocco.  
Announces "Atencion, atencion, aqui es Radio Guardia Civil, en Tetuan, Marruecos Espanol."
- 6.479 HI8A—B—Trujillo, Dom. Rep.  
"La Fa-doc en el Aire, Ciudad Trujillo."
- 6.46 KZGF—C—Manila, Philippines.  
See KZGF, 7.855 mc. Address: Philippine Long Distance Telephone Company, Box 444, Manila, Philippines. (Radiophone Dept.).
- 6.45 HI4V—B—San Francisco de Macoris, Dom. Rep.  
"La voz de la Marina."
- 6.42 HIIS—B—Santiago de los Caballeros, Dom. Rep.  
"La voz de la Hispaniola."
- 6.416 YV6RC—B—Bolivar, Venezuela.  
"Radio Bolivar."
- 6.41 TIPG—B—San Jose, Costa Rica.  
"La voz de la Victor." Closes with "Parade of the Wooden Soldiers."
- 6.40 YV5RH—B—Caracas, Venezuela.  
"Ondas Populares." Uses dual call "YV5RG y YV5RH."
- 6.38 YV5RF—B—Caracas, Venezuela.  
"Ecos de Caribe." Uses dual call "YV5RE y YV5RF." Closes with "Blue Danube" organ recording.
- 6.365 YVIRH—B—Maracaibo, Venezuela.  
"Ondas del Lago," then a burst of music. Then announces "Emisora Philco, YV1RF y YV1RH."
- 6.357 HRPI—B—San Pedro Sula, Honduras.  
"El Eco de Honduras." Announces frequency as "6,350 kc."
- 6.34 HIIX—B—Trujillo, Dom. Rep.
- 6.335 OAXIA—B—Chiclayo, Peru.  
Slogans—"Radio Delcar," and "la voz de Chiclayo." Also "la voz de Ica," and "Radio Philco." Signs off with Good Night song by Ted Lewis.
- 6.33 JZG—C—Nazaki, Japan.  
When relaying JOAK's program follows same outline as JVN, 10.66 mc. When phoning ships, usually calls in code and follows with inverted speech.
- 6.31 HIZ—B—Trujillo, Dom. Rep.  
"Broadcasting Nacional." Uses dual call "HIZ y HIJ." Also uses slogan "La voz de los Muchachos."
- 6.31 TG2—B—Guatemala City, Guatemala.  
Uses dual call "TG1 y TG2."

## Have You Heard These South American Artists?



Left—ISABEL MAR- ENGO, Argentine Soprano, who is a featured artist at Radio El Mundo.

Right—MAESTRO JULIO DE CARO, composer and orchestra leader, whose distinctive style and remarkable orchestrations are one of the most interesting features of radio El Mundo programs.



## Can You Answer These Radio Questions?

1. What type of scanning was used at the transmitter in the recent Bell Telephone Labs. television demonstration? See page 534.
2. How long ago and between what points was micro-ray transmission established commercially? See page 535.
3. In the recent reception by RCA engineers of Trans-Atlantic television signals, was the image picked up, or only the station carrier and voice? See page 536.
4. What is the name of the Observatory connected with Pasadena by ultra-short waves? See page 536.
5. Can you name five important subjects which every radio and television expert should master thoroughly? See page 537.
6. Do you know how to connect a loudspeaker so it can be used as a microphone? See page 538.
7. What are the limitations of the induction phone and can its range be increased indefinitely? See page 540.
8. Is there any special manner in which the tuning coils in a switch-band receiver should be arranged to avoid interaction? See page 544.
9. Is there any advantage in being able to match the output of an S-W converter to the input of the receiver, and how would you accomplish it? See page 546.
10. What are some of the uses of a Peak Voltmeter? See page 548.
11. Where are the "sweep coils" placed on a cathode ray television tube? See page 551.
12. What short-wave broadcast station is aboard a steamship? See page 581.



Mc.	Call		Mc.	Call		Mc.	Call	
11.760	OLR4B	PRAGUE, CZECHOSLOVAKIA, 25.51 m., Addr. (See 11.875 mc.) Irregular.	10.520	VLK	SYDNEY, AUSTRALIA, 28.51 m., Addr. Amalgamated Wireless of Australasia Ltd. Works England 1-6 am.	9.760	VLJ-VLZ2	SYDNEY, AUSTRALIA, 30.74 m., Addr. Amalgamated Wireless of Australasia Ltd. Works Java and New Zealand early morning.
11.760	QSD	DAVENTRY, ENG., 25.53 m., Addr. B. B. C., London. 3.15-5.30, 8.55 am.-12 n., 12.20-6.00 pm., 9.15-11.15 pm.	10.430	YBG	MEDAN, SUMATRA, 28.76 m. 5.30-6.30 am., 7.30-8.30 pm.	9.760	WOF	LAWRENCEVILLE, N. J., 30.77 m., Addr. A. T. & T. Co. Works London and Paris night time.
11.730		SAIGON, INDO CHINA, 25.57 m., Addr. Radio Phileo. 11pm.-1am., 5.30-9.30am.	10.420	XGW	SHANGHAI, CHINA, 28.79 m. Works Japan 12 m.-3 am.	9.740	COCQ	HAVANA, CUBA, 30.78 m. Addr. 25 No. 445, Vedado, Havana. 6.55 am.-1 am. Sun. till 12 m.
11.730	PHI	HUIZEN, HOLLAND, 25.57 m., Addr. N. V. Philips' Radio.	10.410	PDK	KOOTWIJK, HOLLAND, 28.8 m. Works Java 7.30-9.40 am.	9.710	GCA	RUGBY, ENGLAND, 30.9 m. Works S. A. evenings.
11.720	CJRX	WINNIPEG, CANADA, 25.6 m., Addr. James Richardson & Sons, Ltd. 4-10pm.	10.410	KES	BOLINAS, CALIF., 28.8 m., Addr. RCA Communications. Irregular.	9.685	TGWA	GUATEMALA CITY, GUAT., 30.96 m. Irregular.
11.718	CR7BH	LAURENCO MARQUES, PORTUGESE, E. AFRICA, 25.6 m. Daily 12.05-1, 4.30-6.30, 9.30-11 am., 12.05-4 pm., Sun. 5-7 am., 10 am.-2 pm.	10.370	JVO	NAZAKI, JAPAN, 28.93 m. Broadcasts around 5 am.	9.680	FZF6	FORT de FRANCE, MARTINIQUE, 30.97 m., Addr. P. O. Box 136. 11.30 am.-12.30 pm., 6.15-7.50 pm.
11.715	TPA4	PARIS, FRANCE, 25.61 m., (See 15.245 mc.) 6.15-8.15 pm., 10 pm.-1 am.	10.370	EHZ	TENERIFFE, CANARY ISLANDS, 28.93 m., Relays EAJ43 2.15-3.15, 6.15-8.55 pm. Relays Salamanca, Spain 8.55-10 pm.	9.675	DZA	ZEESSEN, GERMANY, 31.01 m., Addr. (See 10.042 mc.) Irregular.
11.710	SBG	MOTALA, SWEDEN, 25.63 m., 1.20-2.05, 8-9 am., 11 am.-1.30 pm.	10.350	LSX	BUENOS AIRES, ARG., 28.98 m., Addr. Transradio International. Broadcasts 5-6 pm. Mon. and Fri. Tests irregularly at other times.	9.670	TI4NRH	HEREDIA, COSTA RICA, 31.02 m., Addr. Amando C. Marin, Apartado 40. 8.30-10 pm., 11.30 pm.-12 m.
11.710	XEWB	GUADALAJARA, MEX., 25.63 m., Addr. Juarez 289. Irregular.	10.330	ORK	RUYSSELEDE, BELGIUM, 29.04 m. 2.30-4 pm.	9.660	LRX	BUENOS AIRES, ARG., 31.06 m., Addr. El Mundo. 8.30 am.-10.30 pm.
11.710	YSM	SAN SALVADOR, EL SALVADOR, 25.63 m., Addr. (See 7.894 mc.) Irregular 1.30-2.30 pm.	10.300	LSL2	BUENOS AIRES, ARG., 29.13 m., Addr. Cia. Internacional de Radio. Works Europe evenings.	9.650	CS2WA	LISBON, PORTUGAL, 31.09 m., Addr. Radio Colonial. Tues., Thurs. and Sat. 4.30-7 pm.
11.700	HP5A	PANAMA CITY, Pan., 25.65 m. Addr. Radio Teatro, Apartado 954. 10 am.-10 pm.	10.290	DZC	ZEESSEN, GERMANY, 29.16 m., Addr. (See 15.360 mc.) Irregular.	9.650	DGU	NAUEN, GERMANY, 31.09 m., Addr. (See 20.020 mc.) Works Egypt afternoon.
11.700	CB1170	SANTIAGO, CHILE, 25.65 m., Relays CB89 6 pm.-12 m.	10.260	PMN	BANDOENG, JAVA, 29.24 m., Relays YDB 5.30-10.30 or 11 am., Sat. to 11.30 am.	9.645	HH3W	PORT-AU-PRINCE, HAITI, 31.1 m., Addr. P. O. Box A117. 1-2, 7-8 pm.
11.680	KIO	KAHUKU, HAWAII, 25.68 m., Addr. RCA Communications. Irregularly.	10.260	LSK3	BUENOS AIRES, ARG., 29.27 m., Addr. (See 10.310 mc.) Works Europe and U.S.A. afternoons and evenings.	9.645	YNLF	MANAGUA, NICARAGUA, 31.1 m. 8-9 am., 12.30-2.30, 6.30-10 pm.
11.596	VRR4	STONY HILL, JAMAICA, B. W. I., 25.87 m. Works WNC daytime.	10.230	CED	ANTOFAGASTAN, CHILE, 29.33 m. Tests 7-9.30 pm.	9.640	CX48	COLONIA, URUGUAY, 31.1 m., Addr. Belgrano 1841, Buenos Aires, Argentina. Relays LR3, Buenos Aires 6 am.-11 pm.
11.580	VIZ3	FISKVILLE, AUSTRALIA, 25.95 m., Addr. Amalgamated Wireless of Australasia Ltd. Tests irregularly.	10.220	PSH	RIO DE JANEIRO, BRAZIL, 29.35 m. Broadcasts 7-9 pm.	9.635	2RO	ROME, ITALY, 31.13 m., Addr. (See 11.810 mc.) Daily 12.30-9 pm.
11.530	SPD	WARSAW, POLAND, 26 m., Addr. 5 Mazowiecka St. Testing daily 6-7 pm.	10.170	RIO	BAKOU, U.S.S.R., 29.15 m. Works Moscow 10 pm.-5 am.	9.630	HJ7ABD	BUCARAMANGA, COL., 31.14 m. 10 am.-12 n., 4-11 pm.
11.500	XAM	MERIDA, YUCATAN, 26.09 m. Irregular 1-7.30 pm.	10.140	OPM	LEOPOLDVILLE, BELGIAN CONGO, 29.59 m. Works Belgium around 3 am. and from 1-4 pm.	9.625		TAIHOKU, TAIWAN, 31.16 m., Relays JFAK irreg. 8-10.25 am., 1-2.30 am., Sun. 8-10.15 am.
11.500	PMK	BANDOENG, JAVA, 26.09 m. Tests irregularly.	10.080	RIO	TIFLIS, U.S.S.R., 29.76 m. Works Moscow early morning.	9.620	HJ1ABP	CARTAGENA, COL., 31.19 m., Addr. P. O. Box 37. 11 am.-1 pm., 5-11 pm. Sun. 10 am.-1 pm., 3-6 pm.
11.435	COCX	HAVANA, CUBA, 26.21 m. P. O. Box 32. 6.55 am.-1 am. Sun. till 12 m. Relays CMX.	10.070	EDM-EHY	MADRID, SPAIN, 29.79 m. Works S. A. evenings.	9.615		KLIPHEUVAL, SOUTH AFRICA, 31.22 m., Addr. P. O. Box 4559, Johannesburg. Daily, exc. Sat. 11:45 pm.-12.40 am., Daily exc. Sun. 3.20-7.15, 9-11:40 am., Sun. 4-5:30, 8-11.40 am.
11.413	CJA4	DRUMMONDVILLE, QUE., CAN., 26.28 m. Tests irregularly.	10.065	JZB-TDB	SHINKYO, MANCHUKUO, 29.81 m. Works Tokio 6.30-7 am.	9.615	HP5J	PANAMA CITY, PANAMA, 31.22 m. Addr. Apartado 867. 12 n. to 1.30 pm. 6-10.30 pm.
11.402	HBO	GENEVA, SWITZERLAND, 26.31 m., Addr. Radio Nations. Sat. 6.45-8 pm.	10.055	ZFB	HAMILTON, BERMUDA, 29.84 m. Works N. Y. C. irregular.	9.600	RAN	MOSCOW, U.S.S.R., 31.25 m. Daily 7-9.15 pm.
11.280	HIN	CIUDAD TRUJILLO, D. R., 26 m., Addr. La Voz del Partido Dominicano. Irregular.	10.055	SUV	ABOU ZABAL, EGYPT, 29.84 m. Works Europe 1-6 pm.	9.595	HBL	GENEVA, SWITZERLAND, 31.27 m., Addr. Radio Nations. Sat. 5.30-6.30 pm.
11.060	ZLT4	WELLINGTON, NEW ZEALAND, 27.15 m. Works Australia and England early morning.	10.042	DZB	ZEESSEN, GERMANY, 29.87 m., Addr. Reichspostzenstralamt. Irregular.	9.590	PCJ	HUIZEN, HOLLAND, 31.28 m., Addr. (See 15.220 mc.) Sun. 2-3, 7-9.15 pm., Mon. 9-10.30 pm., Tues. 5.30-8 am., 2-3.30 pm., Wed. 8-9.30 pm., Thurs. 7-8.30, 9-10.30 pm.
11.040	CSW	LISBON, PORTUGAL, 27.17 m., Addr. Nat. Broadcasting Sta. 1.30-5 pm.	9.990	KAZ	MANILA, P. I., 30.03 m., Addr. RCA Communications. Works Java early morning.	9.590	VK6ME	PERTH, W. AUSTRALIA, 31.38 m., Addr. Amalgamated Wireless of Australasia, Ltd. 6-8 am. exc. Sun.
11.000	PLP	BANDOENG, JAVA, 27.27 m. Relays YDB. 5.30-10.30 or 11 am. Sat. until 11.30 am.	9.950	COCU	HAVANA, CUBA, 30.15 m., Addr. (See 6.590 mc., COCU). Relays CMCU 7 am.-12 m.	9.590	VK2ME	SYDNEY, AUSTRALIA, 31.38 m., Addr. Amalgamated Wireless of Australasia, Ltd., 47 York St., Sun. 1-3 am., 5-11 am.
10.970	OCI	LIMA, PERU, 27.35 m. Works Bogota, Col. evenings.	9.950	GCU	RUGBY, ENGLAND, 30.15 m. Works N. Y. C. night time.	9.590	W3XAU	PHILADELPHIA, PA., 31.28 m. Relays WCAU Sun., Tues., Wed., Thurs. 12 n-7 pm., other days to 8 pm.
10.960		TANANARIVE, MADAGASCAR, 27.36 m., Addr. (See 9.53 mc.) 12:30-45, 3:30-4:30, 10-11 am.	9.930	HKB	BOGOTA, COL., 30.21 m. Works Rio evenings.	9.580	GSC	DAVENTRY, ENGLAND, 31.32 m., Addr. B. B. C., Portland Pl., London, W. 1. 4.15-6, 6.20-8.30, 9.15-11.15 pm.
10.840	KWV	DIXON, CALIF., 27.68 m., Addr. A. T. & T. Co. Works with Hawaii evenings.	9.930	CSW	LISBON, PORTUGAL, 30.31 m., Addr. Nat. Broad. Station. 5-7 pm.	9.580	VLR	MELBOURNE, AUSTRALIA, 31.32 m. Addr. Box 1686, G. P. O. Daily 3.30-8.30 am. (Sat. till 9 am.) Sun. 3-7.30 am. Daily exc. Sat. 9.35 pm.-2.15 am.
10.770	GBP	RUGBY, ENGLAND, 27.85 m. Works Australia early morning.	9.925	JDY	DAIREN, MANCHUKUO, 30.23 m. Relays JQAK daily 6.50-8 am.	9.580	OAX5C	ICA, PERU, 31.32 m. 6-10 pm.
10.740	JVM	NAZAKI, JAPAN, 27.93 m. Works U.S.A. 2-7 am.	9.890	LSN	BUENOS AIRES, ARG., 30.33 m., Addr. (See 10.300 mc.) Works N. Y. C. evenings.	9.570	KZRM	MANILA, P. I., 31.35 m., addr. Erlanger & Galinger, Box 283. 4.30-6 pm., 5-9 am., Sun 4-10 am.
10.675	WNB	LAWRENCEVILLE, N. J., 28.1 m., Addr. A. T. & T. Co. Works with Bermuda irregularly.	9.870	WON	LAWRENCEVILLE, N. J., 30.4 m., Addr. A. T. & T. Co. Works England nights.	9.570	W1XK	SPRINGFIELD, MASS., 31.35 m., Addr. Westinghouse Electric & Mfg. Co. Relays WBZ 7 am. to 1 am. Sun. 8 am. to 1 am.
10.670	CEC	SANTIAGO, CHILE, 28.12 m. Daily 7-7.15 pm.	9.860	EAQ	MADRID, SPAIN, 30.43 m., Addr. Post Office Box 951. Daily 5.15-7.30 pm., Sat. also 12 n.-2 pm.			
10.660	JVN	NAZAKI, JAPAN, 28.14 m. Broadcasts daily 2-8 am. Works Europe irregularly at other times.	9.833	COCM	HAVANA, CUBA, 30.51 m. Addr. Transradio Columbia, P. O. Box 33. 7 am.-12 m. Relays CMCU.			
10.600	ZIK2	BELIZE, BRIT. HONDURAS, 28.25 m., Tues., Thurs., Sat. 7:30-7:45 pm.	9.830	IRM	ROME, ITALY, 30.52 m. Works Egypt afternoons.			
10.550	WOK	LAWRENCEVILLE, N. J., 28.44 m., Addr. A. T. & T. Co. Works S. A. nights.	9.800	XGOX	NANKING, CHINA, 30.61 m., Relays XGXA 6-10 am.			
10.535	JIB	TAIHOKU, TAIWAN, 28.48 m. Works Japan around 6.25 am. Broadcasts, relaying JFAK 9-10.25 am. 1-2.30 am. Sun. to 10.15 am.	9.800	LSI	BUENOS AIRES, ARG., 30.61 m., Addr. (See 10.350 mc.) Tests irregularly.			
			9.790	GCW	RUGBY, ENGLAND, 30.64 m. Works N. Y. C. evenings.			

↓ S.W. BROADCAST BAND ↓



# Short Wave League

## HONORARY MEMBERS

Dr. Leo de Forest      Marjorie von Ardenne  
 D. E. Replogle        E. J. Sommers  
 John L. Reinartz        Hollis Baird  
 Hugo Gernsback, Executive Secretary



Broadcasting a play at VLR, Melbourne, Australia.

## WHEN TO LISTEN IN

by  
 M. Harvey Gernsback

All Schedules in Eastern Standard Time

**JAPAN . . .** The broadcasts from Japan now take place on JZJ, 9.51 mc and JZJ, 11.8 mc. The schedule is 12:40-1:40 am, 4:9 am, 1-4 and 4:40-5:40 pm., daily. At present JZJ is being heard very well in New York from 4:40-5:40 pm. Wonders of short-waving are never-ending. While listening to Japan one Sunday afternoon recently, we heard strangely familiar sounds emanating from the loud-speaker. It turned out to be "The Music Goes Round and Round"! The pay off came when the vocal chorus was sung in Japanese! The effect was quite startling.

**ROME . . .** ZRO has announced an enlarged schedule of operations effective December 1st. The new schedule is from 5:8-10 am., and 10 am.-12:20 pm. on 11.81 mc. From 12:40 to 9 pm ZRO broadcasts on 9.615 mc. This schedule is daily including Sunday. From 6:7-7:40 pm. a program for South America is broadcast and from 7:45-9 pm. there is a program for North America. Note that these are now a daily feature. The station also announces that it is putting into operation two new experimental transmitters having a power of 2 kw. These transmitters will operate on three frequencies, 17.17, 15.23, 15.29 mc., and will send out the same programs as ZRO. They will be put into regular service by February 1st.

**CZECHOSLOVAKIA . . .** The Prague short-wave station has also announced a new schedule of operations. A program is broadcast for

North America over OLR3A, 9.55 mc. on Monday, Wednesday and Friday from 8-11:35 pm. A program for South America is broadcast on Sundays from 6:15-8:55 pm. on the same frequency. For Europe programs are heard daily from 12:55-4:40 pm. on 9.55 mc. For Asia a program is broadcast daily from 6:25-7:40 am. on OLR3A, 15.23 mc. A second program for Asia is broadcast daily except Sunday from 9:25-10:10 am. on 9.55 mc. However, judging by past performance of the station it is quite possible that this schedule will not be adhered to exactly.

**ENGLAND . . .** Daventry has returned to the 6 megacycle beam. GSI, 6.11 mc. is now on from 6:20-8:40 pm. and from 9:15-11:15 pm. for North America. Other transmissions for North America are GSP, 15.31 mc., 1:45-4 pm., GSC, 9.58 mc., 4-6 pm., GSC, 9.58 mc., 6:20-8:40 and 9:15-11:15 pm., GSB, 9.51 mc., 6:20-8:40, 9:15-11:15 pm.

**AUSTRALIA . . .** VK3LR, the Melbourne station on 9.58 mc. informs us that the call letters of the station have been changed to VLR.

**OFFICIAL OBSERVERS . . .** for PCJ are requested by N. V. Philips' Radio of Eindhoven, Holland. Since the inauguration of their new 60 kw transmitter, the operators are anxious to secure comprehensive reception reports from all over the world on their station's performance. They have informed us that listeners who send in regular reports for a period of one year will be rewarded with a souvenir from the station. A few observers in each country of the world are requested. Observers in the United States have already been appointed so that any of our readers outside the United States interested in co-operating with PCJ should write directly to the station. Special log forms have been prepared for observers.

**KLIPHEUVAL . . .** Thanks to several South African readers, we are able to give the complete story on the Klipheupal station. This station has been put into service to provide an alternative program service for South

African listeners. Up to the present the only Cape Town station has been one operating on the broadcast band. The new short-wave station will be principally for the benefit of Afrikaans and most announcements from this station will be made in Afrikaans, which is a language of Dutch origin. During the daytime hours in South Africa this station operates on 9.615 mc. but during their evening hours it shifts to 6.097 mc. which is the same frequency as the Johannesburg station. Under the new set-up the Johannesburg station operates on 6.097 mc. during the day but signs off when Klipheupal comes into operation on this frequency. So now there are actually two stations on 6.097, one in Klipheupal and one in Johannesburg.

The Klipheupal station has a power of 2 kw., Johannesburg's is much less than this. For complete schedule see the station list.

ZNB, at Mafeking, Bechuanaland, on 5.9 mc. is no longer operating regularly according to a dispatch we have just received from a listener in Natal. The station got into a dispute over the payment of royalties for playing phonograph records on the air so that at present the station operates on Sunday only at 1:40 pm. when it broadcasts a news bulletin in English. It is used for general experimental work, however, irregularly at other times.

**PORTUGAL . . .** The call letters of CT1AA at Lisbon have been changed to CS2WA. There is a new station in Lisbon on 5.977 mc., this is CS2WD. The station generally operates from 3:30-6 pm. Address is Rua Capelo 5.

**MOSCOW . . .** RNE on 12 mc. has enlarged its schedule considerably. Full details may be found in the station list. RNE is also operating on 6 mc. daily from 3-6 pm. The schedules of RAN and RKI remain the same as last month.

**FRANCE . . .** The long heralded expansion of Radio Coloniale has at last occurred. Regularly about once every six months for the last three years we have received notices that Radio Coloniale had its new high powered (Continued on page 590)

### Additions to Station List

MHz	Call	Location
31.000	W3ERA	PHILADELPHIA, PA.
31.000	W3IAO	OKLAHOMA CITY, OKLA.
15.170	TOWA	GUATEMALA CITY, GUAT.
10.500		TANANARIVE, MADAGASCAR
10.500	DKZ	BELIZE, BRIT. HONDURAS
7.800		QUADALAJARA, JALISCO, MEX.
6.800	NYEJ	LA VEGA, D. R.
6.807		KLIPHEUVAL, S. AFRICA
6.811		PERNAMBUCO, BRAZIL
6.810	YMH	S. S. KANIMELA
5.977	CS2WD	LISBON, PORTUGAL



Mc.	Call		Mc.	Call		Mc.	Call	
9.560	DJA	BERLIN, GERMANY, 31.38 m., Addr. Broadcasting House. 12.05-11 am., 4.50-10.45 pm.	9.170	WNA	LAWRENCEVILLE, N. J., 32.72 m. Works England evenings.	7.520	KKH	KAHUKU, HAWAII, 39.87 m. Works with Dixon and broadcasts irregularly nights.
9.550	OLR3A	PRAGUE, CZECHOSLOVAKIA, 31.41 m. See 11.840 mc. Daily exc. Sun. 9.25-10.10 am., Daily 12.55-4.40 pm. Sun. 6.15-8.55 pm. Mon., Wed., Fri. 8-10.35 pm.	9.160	YVR	MARACAY, VENEZUELA, 32.79 m. Works with Europe afternoons.	7.520	RKI	MOSCOW, U. S. S. R., 39.87 m., Relays RAN 7-9.15 pm. Works RIM early am.
9.550	XEFT	VERA CRUZ, MEX., 31.41 m. 11.30 am.-4 pm., 7 pm.-12 m.	9.125	HAT4	BUDAPEST, HUNGARY, 32.88 m., Addr. "Radiolabor," Gyali-ut, 22. Sun. and Wed. 7-8 pm., Sat. 6-7 pm.	7.510	JVP	NAZAKI, JAPAN, 39.95 m. Irregular.
9.550	YDB	SOERABAJA, JAVA, 31.41 m., Addr. N.I. R.O.M. Daily exc. Sat. 6-7.30 pm., 5.30 to 10.30 or 11 pm. Sat. 5.30-11.30 am.	9.090	COBC	HAVANA, CUBA, 32.98 m. Addr. P.O. Box 132. Relays CMBC. 6.55 am.-12.30 am	7.390	ZLT2	WELLINGTON, N. Z., 40.6 m. Works with Sydney, 3-7 am.
9.540	DJN	BERLIN, GERMANY, 31.45 m., Addr. (See 9.560 mc.) 12.05-10 am., 4.50-10.45 pm.	9.080	TFK	REYKJAVIK, ICELAND, 33.11 m. Works London afternoons.	7.380	XECR	MEXICO CITY, MEX., 40.65 m., Addr. Foreign Office. Sunday 6-7 pm.
9.540	VPD2	SUVA, FIJI ISLANDS, 31.45 m., Addr. Amalgamated Wireless of Australasia, Ltd. 5.30-7 am.	9.030	COBZ	HAVANA, CUBA, 33.2 m., Radio Salas Addr. P. O. Box 866, 7.45 am.-12.10 am. Irreg. 12.30-2 am. Relays CMBZ	7.220	HKE	BOGOTA, COL., S. A., 41.55 m. Tues. and Sat. 8-9 pm. Mon. and Thurs. 6.30-7 pm.
9.535	JZI	TOKIO, JAPAN, 31.46 m., Addr. (See 11.800, JZJ) 12.30-1.30, 8-9 am., 3-4, 4.30-5.30 pm.	9.020	GCS	RUGBY, ENGLAND, 33.26 m. Works N. Y. C. evenings.	7.200	YNAM	MANAGUA, NICARAGUA, 41.67 m. Daily at 9 pm.
9.535	HB9D	ZURICH, SWITZERLAND, 31.46 m., Addr. Radio Club of Zurich, Post Box Zurich 2. Sun. 9-11 am., Thur. 1-3 pm.	9.010	KEJ	BOLINAS, CAL., 33.3 m. Relays NBC and CBS programs in evening irregularly.	7.100	FO8AA	PAPEETE, TAHITI, 42.25 m., Addr. Radio Club Papeete. Tues. and Fri. 11 pm.-12 m.
9.530	W2XAF	SCHENECTADY, N. Y., 31.48 m., Addr. General Electric Co. 4 pm.-1 am.	8.967	VWY	KIRKEE, INDIA, 33.43 m. Works with England in morning.	7.090	---	GUADALAJARA, JALISCO, MEX., 42.29 m., La Radiodifusora del Pueblo. 9-11 pm.
9.530	---	TANANARIVE, MADAGASCAR, 31.48 m., Addr. Le Directeur des PTT, Radio Tananarive, Administration PTT. 12.30-12.45, 3.30-4.30, 10-11 am.	8.960	TPZ	ALGIERS, ALGERIA, 33.48 m. Works Paris afternoons.	7.088	PI1J	DORDRECHT, HOLLAND, 42.3 m., Addr. Dr. M. Hellingman, Technical College. Sat. 11.10-11.50 am.
9.525	ZBW3	HONGKONG, CHINA, 31.49 m., Addr. P. O. Box 200. 11.30 pm. to 1 am., 4-10 am., Sat. 9 pm.-1 am., Sun. 3-9.30 am.	8.920	COKG	SANTIAGO, CUBA, 33.61 m., Addr. Box 137. 9-10 am., 11.30 am.-1.30 pm., 3-4.30, 5-6, 10-11 pm., 12 m.-2 am.	6.998	PZH	PARAMIRABO, DUTCH GUIANA, 42.88 m., Addr. P. O. Box 18. Daily 6.06-8.36 am., Sun. 9.36-11.36 am., Daily 5.36-8.36 pm.
9.525	LKJ1	JELOY, NORWAY, 31.49 m. 5-8 am.	8.775	PNI	MAKASSER, CELEBES, N. I., 34.19 m. Works Java around 4 am.	6.977	XBA	TACUBAYA, D. F., MEX., 43 m. 9.30 am.-1 pm., 7-8.30 pm.
9.520	HJ6ABH	ARMENIA, COLOMBIA, 31.51 m. 8-11 am., 6-10 pm.	8.765	DAF	NORDDEICH, GERMANY, 34.23 m. Works German ships irregularly.	6.976	HCETC	QUITO, ECUADOR, 43m., Addr. Teatro Bolivar. Thurs. till 9.30 pm.
9.520	OZF	SKAMLEBOAEK, DENMARK, 31.51 m., Addr. Statsradionfoni, Copenhagen. 2-6.40 P.M.	8.760	GCQ	RUGBY, ENGLAND, 34.25 m. Works Africa afternoons.	6.905	GDS	RUGBY, ENG., 43.45 m. Works N.Y.C. evenings irregularly.
9.520	YSH	SAN SALVADOR, EL SALVADOR 31.51 m., Addr. (See 7.894 mc.) Irregular 6-10 pm.	8.750	FZE8	DJIBOUTI, FR. SOMALILAND, AFRICA, 34.29 m. Works Paris around 2.30 am.	6.880	KEL	BOLINAS, CALIF., 43.70 m. Tests irregularly. 11 am.-12 n., 6-9 pm.
9.520	XEDQ	GUADALAJARA, GAL., MEXICO, 31.51 m. Irregular 7.30 pm. to 12.30 am.	8.730	GCI	RUGBY, ENGLAND, 34.36 m. Works India 8 am.	6.850	XGOX	NANKING, CHINA, 43.8 m. Daily 6.40-8.40 am., Sun. 4.40-6.05 am.
9.510	VK3ME	MELBOURNE, AUSTRALIA, 31.55 m., Addr. Amalgamated Wireless of Australasia, 167 Queen St. Daily except Sun. 4-7 am.	8.720	VPD3	SUVA, FIJI ISLES, 34 m., Addr. (See 9.540 mc., VPD2). 5.30-7 am.	6.800	HITP	CIUDAD TRUJILLO, DOM. REP., 44.12 m., Addr. Emisoría Diaria de Comercio. Daily exc. Sat. and Sun. 12.40-1.40, 6.40-8.40 pm. Sat. 12.40-1.40 pm. Sun. 10.40 am.-11.40 am.
9.510	GSB	DAVENTRY, ENGLAND, 31.55 m., Addr. (See 9.580 mc.—GSC) 3.15-5.30 am., 12.20-6 pm., 6.20-8.30, 9-11 pm.	8.700	HKV	BOGOTA, COLOMBIA, 34.46 m. Tues. and Fri. 7-7.20 pm.	6.770	HIH	SAN PEDRO DE MACORIS, DOM. REP., 44.26 m. 12.10-1.40 pm., 7.30-9 pm. Sun. 3-4 am., 4.15-6 pm., 4.40-7.40 pm.
9.510	H88PJ	BANGKOK, SIAM, 31.55 m. Thursday, 8-10 am.	8.680	GBC	RUGBY, ENGLAND, 34.56 m. Works ships irregularly.	6.775	WOA	LAWRENCEVILLE, N. J., 44.41 m., Addr. A. T. & T. Co. Works England evenings.
9.505	HJ1ABE	CARTAGENA, COLOMBIA, 31.57 m. Addr. P. O. Box 31. 5-10.30 pm.	8.665	COJK	CAMAGUEY, CUBA, 34.62 m., Addr. Finlay No. 3 Altos. 5.30-6.30, 8-11 pm., daily except Sat. and Sun.	6.750	JVT	NAZAKI, JAPAN, 44.44 m., Addr. Kokusai-Denwa Kaisha, Ltd., Tokio. Irregular.
9.500	XEWW	MEXICO CITY, MEX., 31.58 m. Addr. Apart. 2516. Relays XEW. 6 pm.-12 m.	8.580	YNLG	MANAGUA, NICARAGUA, 34.92 m. 7.30-9.30 pm.	6.730	HI3C	LA ROMANA, DOM. REP., 44.58 m., Addr. "La Voz de la Feria." 12.30-2 pm., 5-6 pm.
9.500	HJU	BUENAVENTURA, COLOMBIA, 31.58 m., Addr. National Railways. Mon., Wed. and Fri. 8-11 pm.	8.400	HC2CW	OCEAN GATE, N. J., 35.05 m. Works ships irregularly.	6.720	PMH	BANDOENG, JAVA, 44.64 m. Relays NIROM programs. 5.30-9 am.
9.500	PRF5	RIO DE JANEIRO, BRAZ., 31.58 m. Irregularly 4.45 to 5.45 pm.	8.380	IAC	QUAYAQUIL, ECUADOR, 35.71 m. 11.30 am.-12.30 pm., 8-11 pm.	6.710	TIEP	SAN JOSE, COSTA RICA, 44.71 m., Addr. Apartado 257, La Voz del Tropico. Daily 7-10 pm.
9.478	EAR	MADRID, SPAIN, 31.65 m., Addr. (See 9.860 mc.) 7.30-9.30 pm.	8.190	XEME	PISA, ITALY, 35.8 m. Works Italian ships irregularly.	6.672	YVQ	MARACAY, VENEZUELA, 44.95 m. Sat. 8-9 pm.
9.460	ICK	TRIPOLI, N. AFRICA, 31.71 m. Works Rome, 5.30-7 am.	8.185	PSK	MERIDA, YUCATAN, 36.63 m., Addr. Calle 59, No. 517, "La Voz de Yucatan desde Merida." 10 am.-12n., 6 pm.-12 m.	6.670	HC2RL	QUAYAQUIL, ECUADOR, S. A., 44.95 m., Addr. P. O. Box 759. Sun. 5.45-7.45 pm., Tues. 9.15-11.15 pm.
9.440	HC2RA	QUAYAQUIL, ECUADOR, 31.78 m. Irregularly till 10.40 pm.	8.038	CNR	RIO DE JANEIRO, BRAZIL, 36.65 m. Irregularly.	6.650	IAC	PISA, ITALY, 45.11 m. Works ships irregularly.
9.428	COCH	HAVANA, CUBA, 31.8 m., Addr. 2 B St., Vedado. 7 am.-1 am.	7.975	HC2TC	RABAT, MOROCCO, 37.33 m. Sun. 2.30-5 pm.	6.630	HIT	CIUDAD TRUJILLO, D. R., 45.25 m., Addr. "La Voz de la RCA Victor." Apartado 1105. Daily exc. Sun. 12.10-1.40 pm., 5.40-8.40 pm.; also Sat. 10.40 pm.-12.40 am.
9.415	PLV	BANDOENG, JAVA, 31.87 m. Works Holland around 9.45 am. Broadcasts 5.30-9.30 am., 6-6.30 pm.	7.901	LSL	QUITO, ECUADOR, 37.62 m. Thurs. and Sun. at 8 pm.	6.625	PRADO	RIOBAMBA, ECUADOR, 45.28 m. Thurs. 9-11.45 pm.
9.330	CGA4	DRUMMONDVILLE, CANADA, 32.15 m. Works England irregularly.	7.894	YSD	HURLINGHAM, ARGENTINA, 37.97 m. Works Brazil at night.	6.590	COCU	HAVANA, CUBA, 45.52 m., Addr. Estrada Palma 25, Vibora, Havana. Relays CMCU 7 am.-12 m.
9.330	OAX4J	LIMA, PERU, 32.15 m., Addr. Box 1166, "Radio Universal." 12 n.-3 pm., 5 pm.-1 am.	7.860	SUX	SAN SALVADOR, EL SALVADOR, 37.99 m., Addr. Dir. Genl. Tel. & Tel. Irregular 7-11 pm.	6.558	HI4D	CIUDAD TRUJILLO, D. R., 45.74 m. Except Sun. 11.55 am.-1.40 pm.
9.300	YNGU	MANAGUA, NICARAGUA, 32.26 m. 12 n.-2 pm., 6-7 pm.	7.854	HC2J8B	ABOU ZABAL, EGYPT, 38.17 m. Works with Europe, 4-6 pm.	6.550	XBC	VERA CRUZ, MEX., 45.8 m. 8.15-9 am.
9.280	GCB	RUGBY, ENGLAND, 32.33 m. Works Canada and Egypt evenings and afternoons.	7.797	H3P	QUAYAQUIL, ECUADOR, 38.2 m. Evenings.	6.550	TIRCC	SAN JOSE, COSTA RICA, 45.8 m., Addr. Radioemisora Catolica Costarricense. Sun. 11 am.-2 pm., 6-7, 8-9 pm. Daily 12 n.-2 pm., 6-7 pm., Thurs. 6-11 pm.
9.275	HIG	CIUDAD TRUJILLO, D. R., 32.33 m. 7.10-8.40 am., 12.40-2.10, 8.10-9.40 pm.	7.715	KEE	GENEVA, SWITZERLAND, 38.48 m., Addr. Radio-Nations. Sat. 5.30-6.30 pm.			
9.200	COBX	HAVANA, CUBA, 32.59 m., Addr. San Miguel 194, Altos. Relays CMBX 7 am.-12 m.	7.626	RIM	BOLINAS, CAL., 38.89 m. Relays NBC and CBS programs in evening irregularly.			
			7.610	KWX	TACHKENT, U.S.S.R., 39.34 m. Works with Moscow in early morning.			
			7.550	T18W8	DIXON, CAL., 39.42 m. Works with Hawaii, Philippines, Java and Japan, nights.			
					PUNTA ARENAS, COSTA RICA, 39.74 m., Addr. "Ecos Del Pacifico", P. O. Box 75. 6 pm.-12 m.			

(Continued on page 564)



# Short Wave Kinks

Each month the Editor will award a 2 year subscription for the best short-wave kink submitted. All other kinks published will be awarded eight months' subscription to **SHORT WAVE & TELEVISION**. Look over these 'kinks'; they will give you some idea of what is wanted. Send a typewritten or ink description, with sketch, of your favorite to the "Kink" Editor.

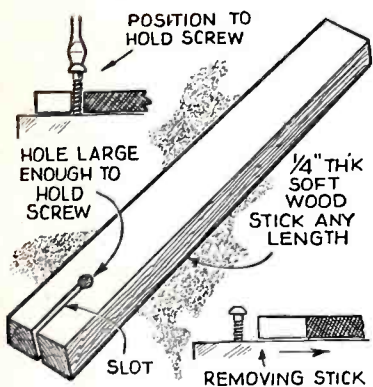
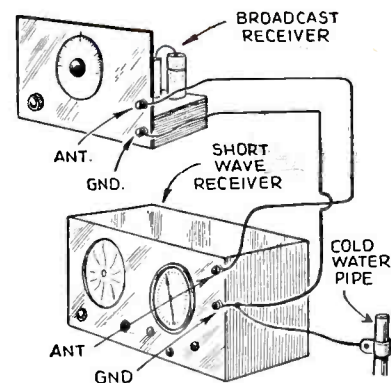

## SCREW HOLDER

A handy gadget is this screw holder made from a piece of soft wood  $\frac{1}{4}$ " thick. Cut an  $\frac{1}{8}$ " slot in the wood for a distance of about  $\frac{1}{4}$ " from the end; then drill a hole through the wood large enough to pass a  $10/32$ " screw (see illustration). The gadget can then be used as a screw holder to get screws into holes which are in awkward positions. The slot permits the stick to be withdrawn from the screw after it has been secured.

Another use for the stick is to hold the screw while it is being turned into position by a screwdriver.—*W9WLE*.

## AN ECONOMICAL DIAL

To make a dial cheaply remove the dial from a clock or watch and secure it to the panel of your receiver as shown in the illustration. A pointer knob is attached over the control shaft, covering all of the dial except the numerals. A large clock-face dial can be used for the main tuning condenser dial, whereas a watch dial is ideally suited to a volume or regeneration control. The hole in the center of the dial through which the hands passed should be enlarged slightly to pass the shaft of the control.—*Robert Jones*.



## SIGNAL LIMITER

A circuit is shown in the diagram for reducing the effect of noises and fading on C-W reception. This signal limiter is employed as one of the audio amplifier stages in a receiver. The 50,000 ohm potentiometer is adjusted so that all signals above a certain level are reproduced at the same volume. This arrangement, of course, will result in poor quality of reproduction on music because any loud passages of music will be similarly limited. It will, however, greatly reduce the annoyance of static crashes. When the potentiometer is set at the high voltage end of its range, this circuit will function as a normal amplifier.—*David McKinney*.

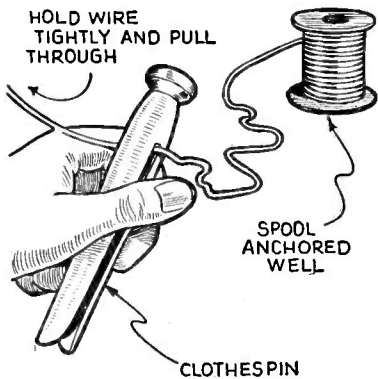
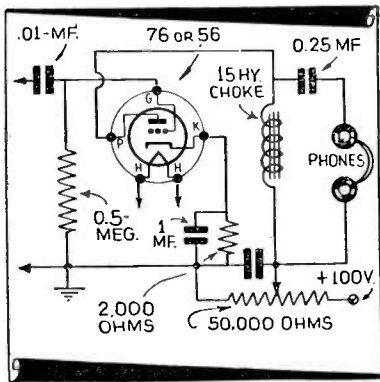

## KINK FOR UNKINKING

The humble clothespin comes to the rescue of the experimenter once more. In this case it is used to straighten out the kinks in wire used for coil winding.

Pass the wire through the slot in the clothespin and pull the wire through, at the same time squeezing the clothespin to compress the slot. This will straighten out the kinks in the wire very nicely. (See sketch.)—*Victor Galka*.

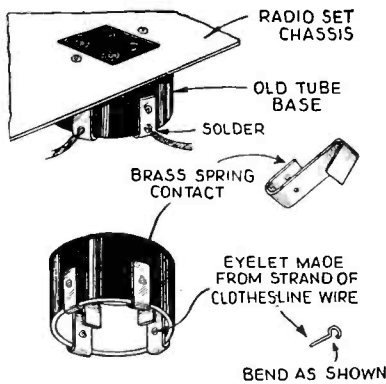

## HOME-MADE TUBE SOCKET

For those who make their own sockets, or for emergency use, all that is necessary is an old tube-base, some old brass condenser plates, a strand of clothesline wire, and some small bolts. The prongs of the tube-base are drilled out from the inside with bits that correspond in thickness to the respective prongs. Cut several brass strips from the condenser plates and bend as shown in the sketch. Drill a small hole through the strips and wall of tube-base and secure with eyelets as shown. Two small screws fasten the socket under the panel of the set. Contact is just as sure as in ready-made sockets.—*Mervyn Chappell*.

## AN EMERGENCY GRID CAP

How many times have you wired up a receiver and discovered at the last moment that there were no more grid clips in the junk box?

Here is a kink which will take the place of a standard grid cap very nicely.

Take an ordinary pencil clip and bend the clamps so that they will slide over the grid cap of the tube easily. Solder the lead to the other end of the clip as shown in the drawing.—*Bob Wachter*.

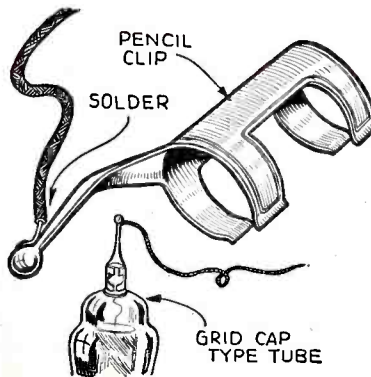

## CALIBRATING S-W SETS

### 1st Prize Winner

If you have a small regenerative receiver that covers the B.C. band and wish to calibrate a larger S.W. receiver, read on. The first thing to do is to tune the B.C. receiver to zero beat with, let us say, WLW on 700 kilocycles. This, of course means that it must be in an oscillating condition. Now let your short-wave receiver warm up thoroughly and then tune for the harmonics of the B.C. receiver, which will appear at multiples of 700 kc., that is 7,000 kc., 7,700 kc., 8,400 kc., etc. By putting down this information on calibration charts for every harmonic of every B.C. station you can hear, you will have an extremely accurate set of calibration charts. As B.C. stations do not vary more than 50 cycles, the most you can be off at the tenth harmonic is one half a kilocycle, although you may not be able to record this accurately on the chart.—*Edward W. Karpen*.

## SIMPLE POWER-SUPPLY

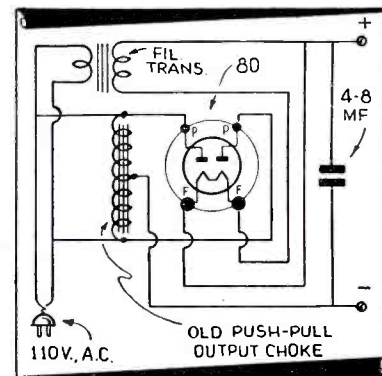

A low-cost power-supply can easily be made from parts around the average junk-box as shown in the accompanying diagram. Parts required are a tube socket, an old push-pull choke, a 5-volt filament transformer and an electrolytic condenser. Approximately 120 volts will be delivered by the unit. The current drain must be kept very low in this unit, however. It should make an ideal source of C-bias supply. An ordinary filter may be attached to the output.

When using this unit it should be remembered that the B- is connected directly to the power line. The receiving equipment must be grounded through a .5 mf. paper condenser instead of directly to prevent short circuits.—*Robert C. Hurson*.



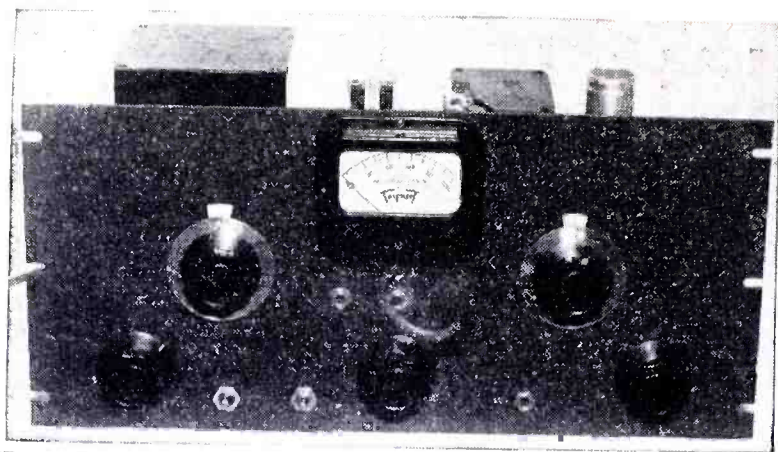

Front view of the 40-watt band-switching exciter, which may also be used as a transmitter if desired.

# Forty-Watt Exciter Or

George W.

● IN order to simplify the operation of our own all-band transmitter, we decided to build an all-band *exciter unit* which did not use plug-in inductances. This *band-switching exciter* turned out so successfully that we thought other hams, facing similar problems, would be interested in this particular unit.

Where an amateur station is operated on two or more of the *ham* bands, the old style transmitter, with its plug-in coils is outmoded. The many extra coils around the shack, not to mention the time and labor necessary in changing bands, are inconvenient to say the least.

The average amateur transmitter, as far as we have been able to determine, has an output of around 100 to 200 watts. This means that the exciter unit must have an output of around 15 to 25 watts, unless of course, the transmitter uses one of the pentode or tetrode tubes in the *final*, which requires much less excitation than the average triode. This exciter will supply about 40 watts of power and is capable of driving the average final amplifier, using well known standard

tubes, to an input of from 200 to 400 watts with no trouble at all. In fact the input to our final with this exciter is slightly less than 400 watts in the 20 meter phone band.

### Serves as 40-watt CW Xmitter Also

Besides being an efficient exciter unit this little rig will serve as a modern up-to-the-minute 40-watt CW transmitter for the *brass-pounder* who likes to work all bands in a single evening.

The genesis of this unit is the all-band *desk-type* transmitter described in the Dec. '37 and Jan. '38 issues. The latter proved that it is more than convenient to have a complete unit, that is, the power-supply and all accessories as well as band-switching on the same chassis. In the new exciter we start out with a 6V6-g oscillator tube, followed by the old faithful 6L6, and ending with one of the new 807's with the increased ratings. With this tube line-up it is possible to work on four bands with a *single* crystal. On 80, 40 and 20 meters the 807 is operated as a straight amplifier, and on 10 meters it

functions as a *frequency doubler*.

The output on the first three bands is a good forty watts, and on ten meters it is only slightly less.

In order to avoid complication in the band-changing arrangement we have resorted to rather large tuning capacitors. The tuning condensers for both the oscillator and the multiplier stages are 200 mmf. midgets and will take in any two bands with the same inductance in the circuit. In the case of the oscillator there is only one coil and that serves for either an 80 or 40 meter crystal.

The 40 meter crystal is not needed but the circuit is designed to accommodate it in case one is used, in order to make available another frequency in the three higher frequency bands covered by the unit. The output from the oscillator plate tank is taken from a point at about the center of the inductance. This is done to lighten the load on the circuit in order that it will start oscillation easily when the power is turned on. Also the full output of the oscillator is not needed to drive the multiplier tube.

How to wire the 40-watt Exciter-Transmitter.

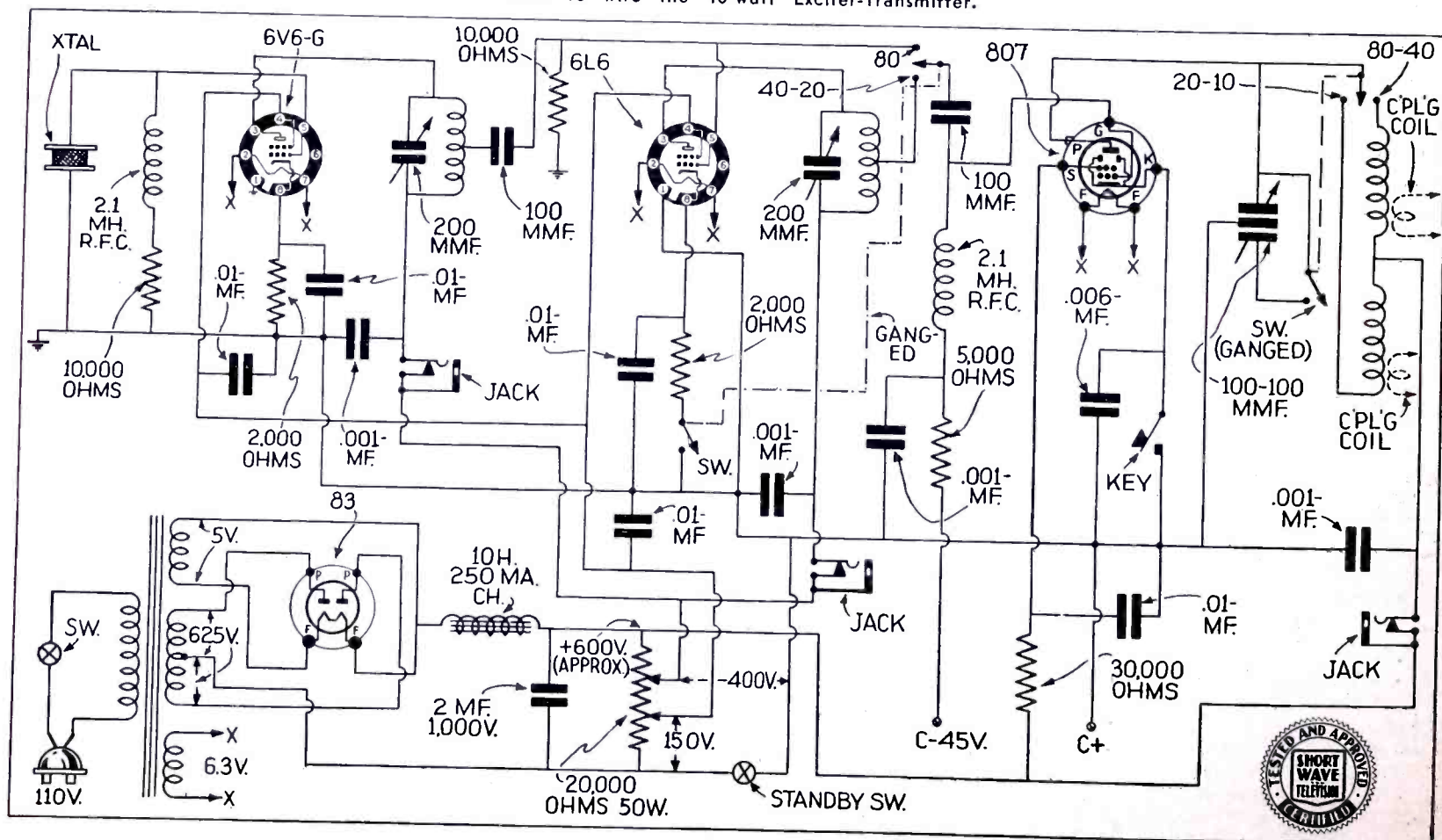



# Band-Switching Transmitter

Shuart, W2AMN

When working on 80 meters the oscillator drives the 807 direct and the 6L6 is switched out of the circuit. If the output was taken directly from the plate of the oscillator the above arrangement for 80 meter operation would not be possible without some difficulty.

## 6L6 Multiplier Stage

The 6L6 multiplier stage also has only a single coil. This stage is used for operation on only the three higher frequencies. It tunes to either 40 or 20 meters. In the latter case it is a frequency quadrupler and provides good excitation for the output tube. This plate tank circuit is also tapped at about the center of the coil. This allows better efficiency in this stage and here also the full output is not needed.

The final stage employs two inductances, one for 40 and 80 meters, which is permanently mounted on the chassis, and another which is plug-in for 20 meters. This coil is plug-in because for 10 meter operation a separate coil must be used for best results. Remember that the last tube is a *doubler* and a tap on the 20 meter coil would not work out so well. A separate coil could be mounted on the chassis and connected to the switch or the 20 meter coil might have been made small enough to tune to both 10 and 20 with the large capacitor. This last method would result in poor efficiency, due to the very high C in the circuit for 20 meter operation. The separate coil, whether connected to the switch or not, is the best arrangement. The tuning condenser in this stage is of the split stator type; both stators are connected in parallel for 80 and 40 meter operation, while on 20 and 10 the switch opens the circuit, leaving only one stator in use. The capacity of each section is 100 mmf.

Going back to the multiplier stage we find that the band-switch there only connects the grid or input of the 807 to the proper driving stage, and at the time it is connected to the oscillator for 80 meter operation, the switch opens the cathode circuit of the 6L6, thus putting it out of operation.

## Coil Data

The coils for the oscillator and multiplier stages are very compact, being only one inch in diameter. They are wound with No. 22 double silk covered wire. The oscillator coil has 24 turns and is tapped at the exact center, while the multiplier coil has 10 turns and is tapped at the 4th turn from the *cold* end. Both coils are close-wound and are

self-supporting, being first wound on a one-inch dia., form, given a coat of coil dope and later removed. Winding them on a bakelite tube should make it easier to mount them and is probably the simplest method.

Coils for the output stage are constructed with No. 16 silk covered wire and are of the space wound type using celluloid strips for support. The 80-40 meter coil has 18 turns, is  $1\frac{3}{4}$  inches inside diameter and  $2\frac{1}{4}$  inches long. The 20 meter coil is of similar construction and has 8 turns,  $1\frac{3}{4}$  inches in diameter and  $1\frac{3}{4}$  inches long. For ten meters the coil has 5 turns,  $1\frac{1}{8}$  inches in diameter and 2 inches long.

**Hams will find this band-switching exciter a very valuable asset to their station; this rig may also be used as a modern 40 watt C.W. Xmitter. The 80, 40, 20 and 10 meter bands are covered.**

## Power-Supply

The power-supply uses a 625 volt transformer which, after rectification and filtering results in nearly 600 volts under full load. A voltage divider is used to obtain the lower voltages except for the screen voltage on the 807 which is supplied through a series resistor and is to be recommended in all cases. The various voltages under operation are indicated on the diagram. Combination grid leak and cathode resistor bias is used on the first two stages while both grid-leak and fixed, external, bias is used on the 807. The entire combination is necessary for good stability. The oscillator operates more smoothly with this

Bottom view of the unit. Note the neat arrangement.

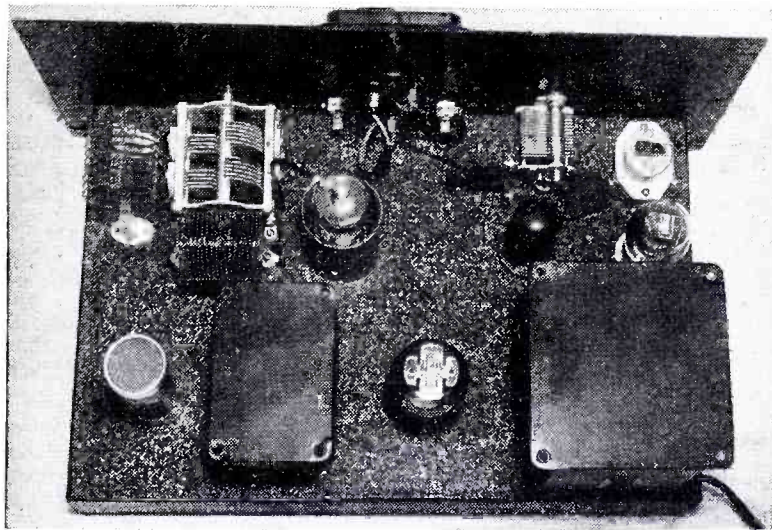

Rear view of the exciter.

arrangement, while the multiplier operates more efficiently. The *final* uses external bias so that when and if the excitation is removed the tube will not be destroyed.

Tuning is a matter of experience, of course, but a few suggestions are in order: First tune everything for peaks and dips the same as in any transmitter. Then you will probably find that on the two lowest frequency bands, 80 and 40, the excitation will be too great for the final 807. Returning to the oscillator, detune it until the 807 functions properly. The oscillator control can be varied considerably and has a great effect on its output. This will serve as an excitation adjustment. If further reduction is necessary the multiplier *tank circuit* may be detuned. None of these detuning adjustments will impair the performance of the transmitter in the least.

## Parts List

### HAMMARLUND

(condensers and sockets)  
2—200 mmf. var. cond. MC-200-M  
1—100-100 mmf. var. cond. MTCD-100-C  
2—2.1 mh. rfc. CHX  
2—8-prong sockets S8  
2—5-prong sockets S5  
1—4-prong socket S4

### CORNELL-DUBILIER

(condensers)  
2—.0001 mf. mica cond. 1,000 v.  
5—.01 mf. mica cond. recv. type  
4—.001 mf. mica cond. 1000 v.  
1—.006 mf. mica cond. 600 v.  
1—2 mf. oil filter cond. 1000 v.

### I. R. C.

(Resistors)  
1—30,000 ohm 20 watt resistor

(Continued on page 591)

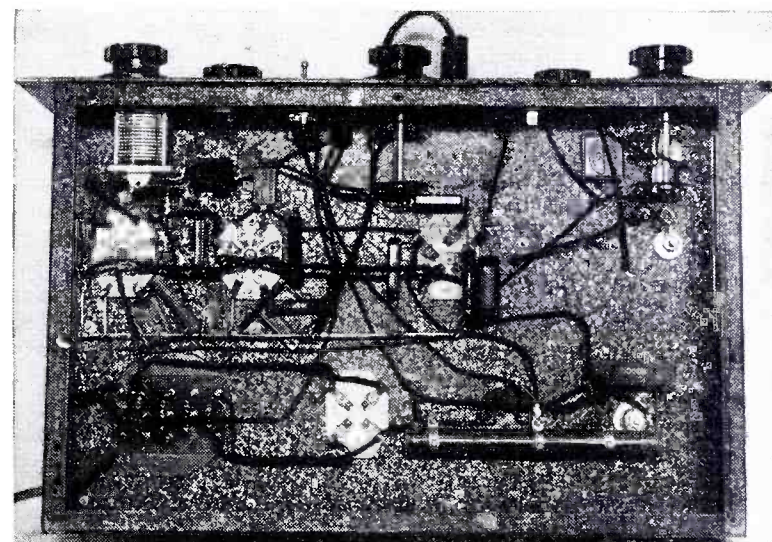



Mc.	Call	Mc.	Call	Mc.	Call
6.545	YV6RB	6.160	VPB	6.095	JZH
6.530	YN1GG	6.150	CSL	6.092	OAX4Z
6.520	YV4RB	6.150	CJRO	6.090	HJ4ABC
6.500	HIL	6.147	ZEB	6.090	CRCX
6.500	T1OW	6.145	HJ4ABU	6.090	XEBF
6.490	H11L	6.140	W8XK	6.090	ZBW2
6.477	H14V	6.137	CR7AA	6.085	HJ5ABD
6.470	YNLAT	6.135	HJ1ABB	6.083	VQ7LO
6.420	H11S	6.135	H15N	6.080	ZHJ
6.410	TIPG	6.130	TGXA	6.080	W9XAA
6.400	YV5RH	6.130	VP3BG	6.079	DJM
6.396	COX4S	6.130	COCD	6.070	VP3MR
6.380	H18J	6.130	VE9HX	6.070	HJ3ABF
6.380	YV5RF	6.130	ZGE	6.070	CFRX
6.360	HRP1	6.130	LKL	6.070	YV1RE
6.360	YV1RH	6.125	CXA4	6.070	VE9CS
6.350	HRY	6.125	OAX1A	6.069	—
6.340	H11X	6.122	OAX4P	6.065	HJ4ABL
6.330	COCW	6.122	HP5A	6.065	SBG
6.318	H1Z	6.122	HJ3ABX	6.060	W8XAL
6.310	TG2	6.120	W2XE	6.060	W3XAU
6.300	YV4RG	6.120	XEUZ	6.050	HP5F
6.280	COHB	6.115	OLR2C	6.050	GSA
6.270	YV5RP	6.110	XEPW	6.045	H19B
6.243	H1N	6.110	VUC	6.042	HJ1ABG
6.235	HRD	6.110	GSL	6.040	W4XB
6.230	YV1RG	6.110	YUA	6.040	W1XAL
6.230	OAX4G	6.105	HJ4ABB	6.040	YDA
6.220	—	6.100	W3XAL	6.030	HJ4ABP
6.210	YV5RI	6.100	W9XF	6.030	HP5B
		6.100	HJ4ABE	6.030	VE9CA
		6.097	—	6.030	OLR2B
		6.097	ZTJ	6.025	HJ1ABJ
				6.020	DJC
				6.020	XEUW

↓ S.W. BROADCAST BAND ↓

6.190	H18Q	CIUDAD TRUJILLO, D. R., 48.47 m. 11.45 am.-1 pm., 4.45-6.45 pm.
6.185	H11A	SANTIAGO, D. R., 48.5 m., Addr. P. O. Box 423. 7 am.-5 pm.
6.171	XEXA	MEXICO CITY, MEX., 48.61 m., Addr. Dept. of Education. 7-11 pm.
6.160	YV5RD	CARACAS, VENEZUELA, 48.7 m. 11 am.-2 pm., 4-10.40 pm.

6.160	VPB	COLOMBO, CEYLON, 48.7 m. Daily exc. Thurs. and Fri., 6.30 am.-12.30 pm.; Sun. 7-11.30 am.
6.150	CSL	LISBON, PORTUGAL, 48.78 m. Irregular. 7-8.30 am., 2-7 pm.
6.150	CJRO	WINNIPEG, MAN., CANADA, 48.78 m., Addr. (See 11.720 mc.) 4-10 pm.
6.147	ZEB	BULAWAYO, RHODESIA, S. AFRICA, 48.8 m. Mon., Wed. and Fri. 1.15-3.15 pm.; Tues. 11 am.-12 n.; Thurs. 10 am.-12 n.
6.145	HJ4ABU	PEREIRA, COL., 48.8 m. 9.30 am.-12 m., 6.30-10 pm.
6.140	W8XK	PITTSBURGH, PA., 48.86 m., Addr. Westinghouse Electric & Mfg. Co. Relays KDKA 10 pm.-1 am.
6.137	CR7AA	LAURENCO MARQUES, PORT. E. AFRICA, 48.87 m. Daily 12.05-1, 4.30-6.30, 9.30-11 am., 12.05-4 pm., Sun. 5-7 am., 10 am.-2 pm.
6.135	HJ1ABB	BARRANQUILLA, COL., 48.9 m., Addr. P. O. Box 715. 11.30 am.-1 pm., 4.30-10 pm.
6.135	H15N	SANTIAGO, D. R., 48.9 m. 6.40-9.10 pm
6.130	TGXA	GUATEMALA CITY, GUAT., 48.94 m., Addr. Giornal Liberal Progressista. Irregularly.
6.130	VP3BG	GEORGETOWN, BRIT. GUIANA, 48.94 m. From 5 pm. on.
6.130	COCD	HAVANA, CUBA, 48.94 m., Addr. Box 2294. Relays CMCD 7 am-1 am.
6.130	VE9HX	HALIFAX, N. S., CAN., 48.94 m., Addr. P. O. Box 908. Mon.-Fri. 9 am.-1 pm., 5-11 pm. Fri.; 1-3 pm., Sat.; Sun. 9 am.-1 pm. 2-11 pm. Relays CHNS.
6.130	ZGE	KUALA LUMPUR, FED. MALAY ST., 48.94 m. Sun., Tue. and Fri. 6.40-8.40 am.
6.130	LKL	JELOY, NORWAY, 48.94 m. 11 am.-6 pm.
6.125	CXA4	MONTEVIDEO, URUGUAY, 48.98 m., Addr. Radio Electrico de Montevideo., Mercedes 823. 10 am.-12 n., 2-8 pm.
6.125	OAX1A	CHICLAYO, PERU, 48.98 m., Addr. La Voz de Chivlayo, Casilla No. 9. 8-11 pm.
6.122	OAX4P	HUANCAYO, PERU, 49 m. La Voz del Centro del Peru. 8 pm. on.
6.122	HP5A	PANAMA CITY, PAN., 49 m. Addr. Box 58. 12 n-1 pm., 8-10 pm.
6.122	HJ3ABX	BOGOTA, COL., 49 m., Addr. La Voz de Col., Apartado 2665. 12 n.-2 pm., 5.30-11 pm.; Sun. 6-11 pm.
6.120	W2XE	NEW YORK CITY, 49.02 m., Addr. Col. B'cast. System, 485 Madison Ave. Irregular.
6.120	XEUZ	MEXICO CITY, MEX., 49.02 m., Addr. 5 de Mayo 21. Relays XEFO 1-3 am.
6.115	OLR2C	PRAGUE, CZECHOSLOVAKIA, 49.05 m. (See 11.875 mc.)
6.110	XEPW	MEXICO CITY, MEX., 49.1 m., Addr. La Voz de Aguila Azteca desde Mex., Apartado 8403. Relays XEJW 11 pm.-1 am.
6.110	VUC	CALCUTTA, INDIA, 49.1 m. Daily 3-5.30 am., 9.30 am.-12 m.; Sun 7.30 am.-12 m.
6.110	GSL	OAVENTRY, ENGLAND, 49.1 m., Addr. (See 26.1 mc.) 6.20-8.30, 9.15-11.15.
6.110	YUA	BELGRADE, JUGOSLAVIA, 49.18 m., 12.45-2.30, 4-8 am., 1-6 pm.
6.105	HJ4ABB	MANIZALES, COL., 49.14 m., Addr. P. O. Box 175. Mon.-Fri 12.15-1 pm.; Tue. and Fri. 7.30-10 pm.; Sun 2.30-5 pm.
6.100	W3XAL	BOUND BROOK, N. J., 49.18 m., Addr. Natl. Broad. Co. 9.15 pm.-1 am.
6.100	W9XF	CHICAGO, ILL., 49.18 m., Addr. N.B.C. 8 am.-9.10 pm., 1.05-2 am.
6.100	HJ4ABE	MEDELLIN, COL., 49.18 m. 11 am.-12 m., 6-10.30 pm.
6.097	—	KLIPHEUVAL, S. AFRICA, 49.2 m., Daily 12 n.-4 pm., Sun. 12 n.-3:05 pm.
6.097	ZTJ	JOHANNESBURG, S. AFRICA, 49.2 m., Addr. African Broad. Co. Daily exc. Sat. 11.45 pm.-12.40 am.; Daily exc. Sun. 3.20-7.15, 9-11.40 am.

6.095	JZH	TOKIO, JAPAN, 49.22 m., Addr. (See 11.800 mc., JZJ.) Irregular.
6.092	OAX4Z	LIMA, PERU 49.25 m. Radio National 7-11 pm.
6.090	HJ4ABC	IBAGUE, COL., 49.26 m. 7 pm.-12 m.
6.090	CRCX	TORONTO, CAN., 49.26 m., Addr. Can. Broadcasting Corp. Daily 5.30-11.30 pm.; Sun. 5-11.30 pm.
6.090	XEBF	JALAPA, MEXICO, 49.26 m., Addr. Insurgentes 34. Testing.
6.090	ZBW2	HONGKONG, CHINA, 49.26 m., Addr. P. O. Box 200. Irregular.
6.085	HJ5ABD	CALI, COLOMBIA, 49.3 m., Addr. La Voz de Valle. 12m.-1.30 pm., 5.10-9.40 pm.
6.083	VQ7LO	NAIROBI, KENYA, AFRICA, 49.31 m., Addr. Cable and Wireless, Ltd. Mon.-Fri. 5.30-6 am., 11.15 am.-2.15 pm., also Tues. and Thurs. 8.15-9.15 am.; Sat. 11.15 am.-3.15 pm.; Sun. 10.45 am.-1.45 pm.
6.080	ZHJ	PENANG, FED. MALAY STATES, 49.34 m. 6.40-8.40 am., except Sun., also Sat. 11 pm.-1 am.
6.080	W9XAA	CHICAGO, ILL., 49.34 m., Addr. Chicago Fed. of Labor. Relays WCFL irregular.
6.079	DJM	BERLIN, GERMANY, 49.34 m., Addr. Broadcasting House. Irregular.
6.070	VP3MR	GEORGETOWN, BRI. GUIANA, 49.42 m. Sun. 7.45-10.15 am.; Daily 4.45-8.45 pm.
6.070	HJ3ABF	BOGOTA, COL., 49.42 m. 7-11.15 pm.
6.070	CFRX	TORONTO, CAN., 49.42 m. Relays CFRB 6.30 am-11 pm. Sun. 9.30 am.-11 p. m.
6.070	YV1RE	MARACAIBO, VEN., 49.42 m. 6-11 pm.
6.070	VE9CS	VANCOUVER, B. C., CAN., 49.42 m. Sun. 1.45-9 pm., 10.30 pm.-1am.; Tues. 6-7.30 pm., 11.30 pm.-1.30 am. Daily 6-7.30 pm.
6.069	—	TANANARIVE, MADAGASCAR, 49.42 m., Addr. (See 9.53 mc.), 12.30-12.45, 3.30-4.30, 10-11 am., Sun 2.30-4.30 am.
6.065	HJ4ABL	MANIZALES, COL., 49.46 m. Daily 11 am.-12 m., 5.30-7.30 pm.; Sat. 5.30-10.30 pm.
6.065	SBG	MOTALA, SWEDEN, 49.46 m. Relays Stockholm 1.30-5 pm.
6.060	W8XAL	CINCINNATI, OHIO, 49.6 m., Addr. Crosley Radio Corp. Relays WLW 6.30 am.-8 pm., 11 pm.-2 am.
6.060	W3XAU	PHILADELPHIA, PA., 49.5 m. Relays WCAU 8-11 pm.
6.050	HP5F	COLON, PAN., 49.59 m., Addr. Carlton Hotel. 11.45am.-1.15 pm., 7.45-10 pm.
6.050	GSA	DAVENTRY, ENGLAND, 49.59 m. Addr. (See 26.1 mc.) 12.20-4 pm.
6.045	H19B	SANTIAGO, D. R., 49.63 m. Irregular 6-11 pm.
6.042	HJ1ABG	BARRANQUILLA, COL., 49.65 m., Addr. Emisora Atlantico. 11 am.-11 pm.; Sun. 11 am.-8 pm.
6.040	W4XB	MIAMI BEACH, FLA., 49.65 m. Relays WIOD 12m.-2 pm., 5.30-6 pm., 10 pm.-12 m.
6.040	W1XAL	BOSTON, MASS., 49.65 m., Addr. University Club Exc. Sat. 7-9 pm.
6.040	YDA	TANDJONGPRIOK, JAVA, 49.65 m., Addr. N.I.R.O.M., Batavia. 10.30 pm.-2 am.; Sat. 7.30 pm.-2 am.
6.030	HJ4ABP	MEDELLIN, COL., 49.75 m. 8-11 pm.
6.030	HP5B	PANAMA CITY, PAN., 49.75 m., Addr. P.O. Box 910. 12m.-1 pm., 7-10.30 pm.
6.030	VE9CA	CALGARY, ALTA., CAN., 49.75 m. Thur. 9 am.-2 am.; Sun 12 m.-12 m.
6.030	OLR2B	PRAGUE, CZECHOSLOVAKIA, 49.75 m. (See 11.875 mc.)
6.025	HJ1ABJ	SANTA MARTA, COL., 49.79 m. 11.30 am.-2 pm., 5.30-10.30 pm. except Wed.
6.020	DJC	BERLIN, GERMANY, 49.83 m., Addr. (See 6.079 mc.) 10.40 am.-4.30, 4.50-10.45 pm.
6.020	XEUW	VERA CRUZ, MEX., 49.83 m., Addr. Av. Independencia 98. 8 pm.-12.30 am.

(Continued on page 581)

(All Schedules Eastern Standard Time)



# ALLIED OFFERS RADIO'S GREATEST VALUES!

*Everything*  
**IN RADIO**  
AT  
**LOWEST PRICES!**



DOZENS OF KITS—OVER 12,000 PARTS!  
Radio's largest selection of Kits—from beginner's One-Tube to 14 Tube Superhet, and over 12,000 exact duplicate and replacement parts for building or repairing any circuit—all shown in ALLIED'S great Catalog.

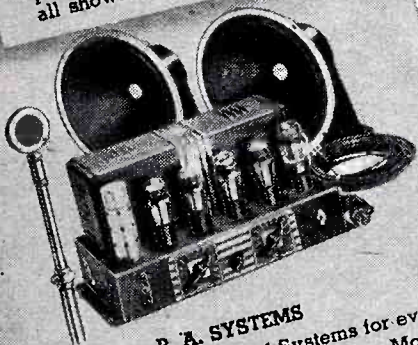

**P. A. SYSTEMS**  
KNIGHT Integrated Sound Systems for every P.A. need—8 to 60 Watts—Portable, Mobile and Permanent—and Inter-Com Systems—2 way, Selective and Super-Selective.

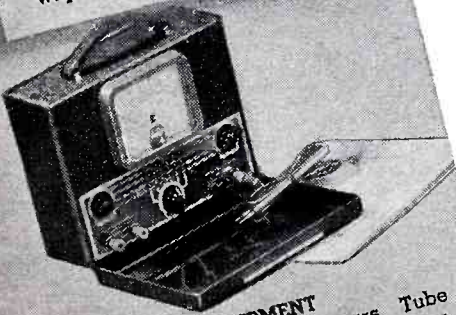

**TEST EQUIPMENT**  
Testers of every type—Analyzers, Tube Checkers, Set-Testers, Meters, Signal Generators—all nationally known brands. See them at lowest prices in ALLIED'S 1938 Catalog.

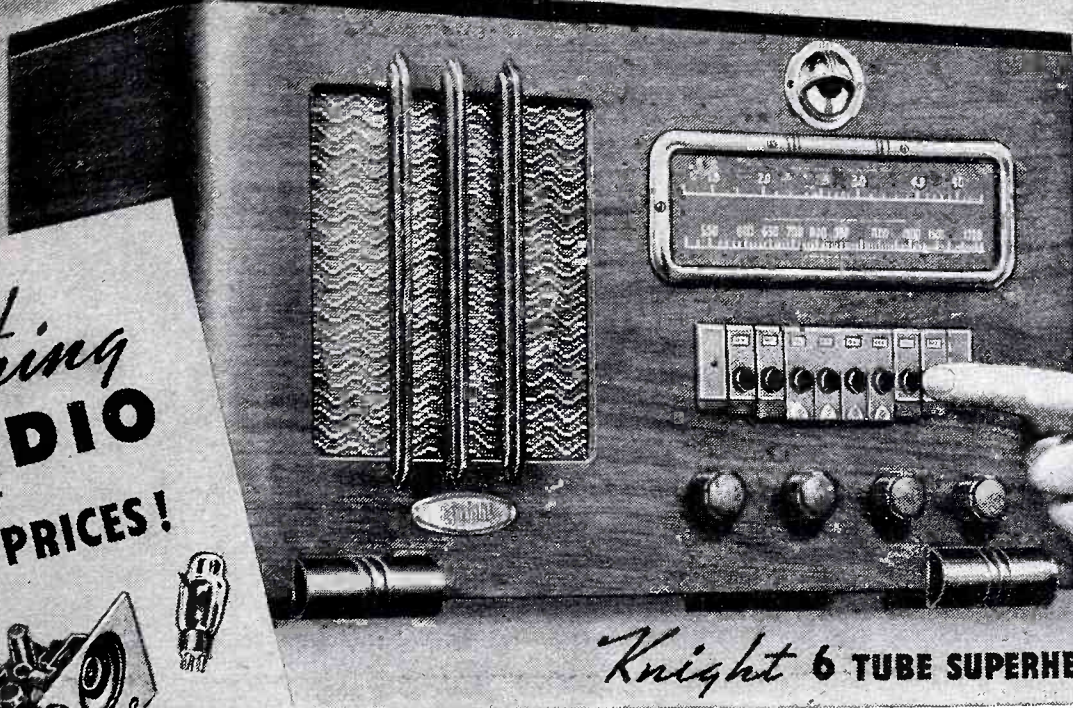

*Just touch  
a button...  
THERE'S  
YOUR STATION!*

*Knight 6 TUBE SUPERHET only \$23.95*

## KNIGHT PUSH-BUTTON TUNING MODELS AT STARTLING LOW PRICES!

KNIGHT Radios bring you Push-Button Tuning and every newest feature at prices that fit EVERYBODY'S purse. Here are radio's supreme values! The beautiful 6 Tube AC 2-Band Superhet shown above, offers an R.C.A. and Hazeltine licensed circuit with Push-Button Tuning, new Slide-Rule Type Dial, Electric Eye, Tone Control, A.V.C., Electro-Dynamic Speaker, and 3 Watts power output—all for only \$23.95. In the 60 other KNIGHT models, you'll find values equally astonishing—made possible only by ALLIED'S volume and low distribution costs—prices that make the KNIGHT Radio's Greatest Value, offering biggest profits for you. 61 KNIGHTS to choose from—a set for every purpose—5 to 16 tubes, for AC, AC-DC, 6 Volt, 32 Volt, Battery, and Auto operation. See all 61 models in ALLIED'S Catalog. Send coupon now.

## DEALERS! • SERVICE MEN! • SOUND MEN! AMATEURS! • SET BUILDERS!

You all need ALLIED'S Catalog. Everything in radio in one great book, at lowest prices—160 pages of Sets, Parts, Kits, Sound Systems, Amateur Gear, Test Equipment, Books, Tools, etc.—every Radio requirement at your finger-tips for instant reference—easy to use and profitable to order from. For ALLIED'S low prices save you money. Send coupon today for ALLIED'S free 1938 Catalog—radio's complete supply guide!

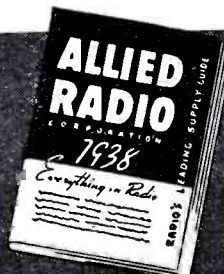

**FREE** *Catalog*

## ALLIED RADIO CORP.

833 WEST JACKSON BLVD., CHICAGO  
Dept. 3-B8

Send your Free 1938 Catalog

Send Free Parts Lists for.....

Name .....

Address .....

City ..... State .....



**THE  
WORLD'S GREATEST  
RADIO VALUE!**

**THE DE LUXE  
CROSLEY  
FIVER**

**AMERICAN  
AND  
FOREIGN  
RECEPTION**

**FOR ONLY \$24.95**

### FIVER DE LUXE TABLE MODEL



The famous Crosley Fiver with striking advanced cabinet styling and featuring sensational Foreign reception. Incorporates Crosley Mirro-Dial and all other famous features that have made and kept the Fiver "The World's Greatest Radio Value." Dimensions: 12½" high, 10¾" wide, 6¼" deep.

### FIVER DE LUXE COMPACT

The same Crosley Fiver housed in an unusually attractive compact type cabinet. Offers the same outstanding features and brilliant American and Foreign reception found in the regular Fiver.

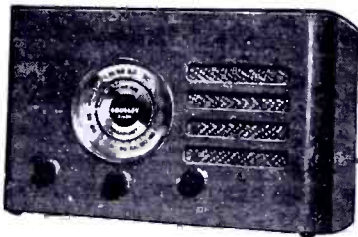

Dimensions: 8⅞" high, 13⅞" wide, 6¼" deep. 5 tubes superheterodyne; 2 bands, 540-1720 Kc. and 5800-15,400 Kc.; full floating, moving coil electrodynamic speaker; full vision, illuminated, 3-dimensional Mirro-Dial; automatic volume control; power supply noise filter.

(Prices slightly higher in South and West)

**THE CROSLEY RADIO CORPORATION**  
POWEL CROSLEY, Jr., Pres. CINCINNATI  
Home of "the Nation's Station"—WLW—  
500,000 Watts—70 on your dial.

**YOU'RE THERE  
WITH A  
CROSLEY**

## How Can I Obtain a Practical Education in Radio & Television

(Continued from page 537)

connection of condensers, losses and breakdowns in condensers, etc., come up for consideration. Under vacuum tubes, such technical aspects as the static and dynamic characteristics, the amplification factor, how to choose amplifier tubes, etc., are studied.

The student's interest is kept alive with experiments and carefully prepared theoretical studies on such subjects as filters, rectifier circuits, and audio and radio frequency amplifiers, to mention a few.

Radio subjects which every good television expert must be thoroughly familiar with include—oscillators and how to adjust and calibrate them, the use of cathode ray oscilloscopes for testing, shooting trouble on all-wave superheterodynes, crystal control oscillators, various types of modulation, etc.

Of course, every radio and television technician must have absorbed a goodly amount of knowledge with regard to the design and operation of radio transmitting stations, for he may some day find himself in charge of such a station and he must know exactly what is going on and the use of the different apparatus. Thus we find that the up-to-date television or radio course includes plenty of material on the different classes of modulators and amplifiers, with a great deal of study assigned to speech or video amplifying systems, microphones, transmitter circuits in general, including various types of relays, monitors, etc., and most important—different types of antennas and how they work.

After the student, whether he is pursuing a home study or resident course, has, in the estimation of his instructor's judgment been given a sufficient amount of basic training in electricity, mathematics and electronics, he will then be ready for the more advanced subjects in television, which include a study of the various principles of scanning, optics, photo-electric cells, television cathode ray tubes, television receiver circuits, synchronization and television sound receivers.

Before the student receives his diploma, at least one school requires that he must also qualify in the following subjects, which are offered in one form or another in the various courses offered today. The student must have qualified and either answered questions, or written reports on his knowledge of how to install television receivers, how to test cathode ray tubes, the action of television cameras, the best methods of lighting television studios and arranging the best sound pick-up, the technique of transmitting motion picture films by television and also the transmission of photos by wire or radio (facsimile or telephotography).

### Why Television and Radio Experts Need to Have a Broad Education

Perhaps it is rather difficult for a young student of television or radio subjects to fully realize just why he should, if possible, learn at least one foreign language, or why he should study general philosophy, rhetoric, etc. The writer has known many cases where those engaged in radio and television work have suddenly been asked to fill in as announcers, or are perhaps called upon to give a talk before a group of men, so that he cannot too strongly recommend that the student endeavor to make his education just as broad as he possibly can.

The ability to make even a brief speech in a pleasing and forceful manner in public is

one of the attributes of the average college-bred man, but we all cannot have the benefits of a resident school education. The recommendation is made, therefore, that students taking a home-study course endeavor at every turn to broaden themselves as much as possible, by becoming members of local debating clubs, or, at least some local organization which will give them the opportunity for self-expression.

Now let us examine for the moment the more technical subjects with which the radio course student is expected to be familiar. Sometimes the student will tire of a course and find that he is making a pretty good amount of money from radio servicing, let us say, but the writer would most urgently advise that at every opportunity the young man endeavor to study every important branch of the subject, as outlined in the various school catalogs.

Here is an example of the indifferent manner in which some students take up a course of study. The writer has talked with many students and has been surprised to note that quite a number of them had, apparently, paid but scant attention to such subjects as dynamos, motors, storage batteries, transformers, etc., when they were taking their courses. Another weak spot in the education of some radio men is mathematics, and this is a tremendously important subject if you ever expect to tackle a real job in the radio and television industry.

Some students apparently simply follow the lesson paper and work out the problems as they are outlined, so that they can finish the course and get a certificate. The thorough student, however, will soon perceive that the best way to obtain a complete education on a subject is to read at least one book, and better still half a dozen, on a specific subject. You may ask the average technician how to calculate the turns ratio in a transformer, in order to convert a certain voltage to one of another value (or some similar and fairly simple question) and receive an answer. But if you ask him about vector diagrams, or how he would calculate the primary input current for a certain size transformer, with a specified load connected across the secondary, the answer is liable to be rather vague. Here the value of a thorough training in transformer theory, for example, will begin to assert itself.

If you are a self-taught reader and did not take any prescribed course, either resident or home study, one of the most important subjects to study and master as thoroughly as possible is physics. Such practical everyday phenomena as the expansion and contraction of metals, the expansion law for gases and liquids, the laws of physical optics, why certain lenses should be used for transmitting light in a given television design—all these vital points must be studied and understood by the real television and radio technician.

Today we have a new subject which the student of physics of a generation ago never heard of, that of *electron optics*. Men like Dr. Vladimir Zworykin, famous physicist of the RCA Engineering Labs., and Philo T. Farnsworth—these men know their electron optics. And if such men as Zworykin and Farnsworth had not made a very intense study of just what happens inside a cathode ray tube, we would still be waiting for the iconoscope and the oscillight.





**TAKE YOUR CHOICE**



Reading the 'want-ads' in the hope of finding just any sort of a job—

Glamour and romance in Television-Broadcasting! An action scene "on stage" in the Power and Light Building, the home of Midland Television and the base of Midland's training.

**A Lifetime of Fear ? —OR— A GOOD JOB, MORE MONEY, for the FUTURE ? —OR— A BRILLIANT FUTURE in—**

# TELEVISION

**YOU CAN BE ONE OF THE VERY FIRST TO BE TRAINED ON "ULTRA-MODERN," 441-LINE ELECTRONIC TELEVISION EQUIPMENT**

**BROADCASTING — AIRLINE OPERATING SHIP OPERATING POLICE RADIO**

Sound advice. Based on ironclad facts! If that's what you want, read on. But if you're looking for the easy, "gambling way" of winning success, you might as well stop reading right now.

This very minute you're confronted with opportunities of such magnitude that you may be inclined to doubt their existence... Yet you know how Radio skyrocketed into a giant industry almost overnight. You know that many young men have won, and are continuing to win, success in Radio—**BECAUSE THEY TRAINED THEMSELVES FOR SUCCESS...** And now we all know that TELEVISION will be another world-wide industry, rich in rewards for those who are prepared... **WILL YOU BE READY?... Yes, if you take immediate advantage of the outstanding features of Midland training!**

Midland is the **ONLY** independent school offering complete, ultra-modern training on 441-line RCA electronic television receiving and transmitting equipment. And *that* is the type of equipment that is bringing commercial television closer every day. Already perfected to a point comparable to motion pictures, "electronic scanning" is almost ready to do its part in starting America on another era of prosperity.



Midland training includes actual experience as a Television Camera Man!

To take advantage of Midland's outstanding training, you don't have to give up your present job. You complete your preliminary training *at home*—studying intensely interesting "color-coded" lessons, conducting a host of fascinating and instructive experiments, with *equipment we provide*—and then you come to Kansas City and our beautiful home in the Power & Light Building for *actual experience*. For remember, this is **NOT** a correspondence course. It is a combined extension-resident training. You study actual operation of radio and television in our resident school, in our modern laboratories—under an engineering staff of accomplished, friendly men, with years of practical experience.

If you are sincere in desiring to enter an industry that offers immediate, substantial cash rewards and a brilliant future, we invite you to send for your **FREE** copy of "Fortunes in Foresight." Just fill out, clip, and mail us the coupon below. **DO IT TODAY AND WE WILL DO THE REST.**

**Full Transportation Allowance to Kansas City**

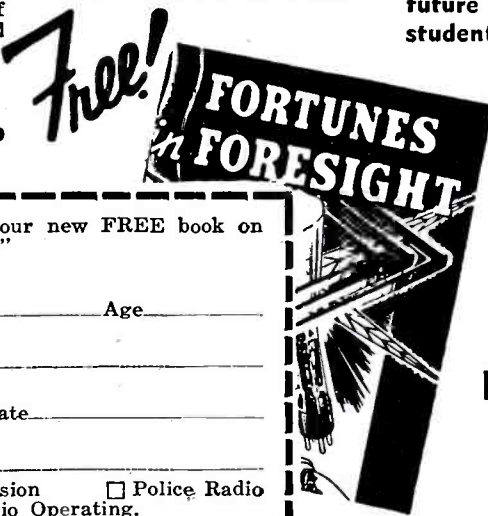

"... It was you who pointed out the vast possibilities of a radio career for me. It was Midland that made it possible."

*Orwin Middleton, employed by Earl J. Goetze, Inc., wholesale distributors RCA-Victor products.*

"... Thank you for obtaining my new position. Even though only part way through my course of study with Midland, I have already received much value for the money and time invested."

*Donald Welborn, employed by Radiolab, radio and public address sales, Kansas City, Mo.*



"... and I want to tell you and the whole wide world that I owe it all to your incomparable training and whole-hearted help!"

*Wm. Davis, Radio Operator with TWA, stationed at Amarillo, Texas.*

Midland training prepares for **TWO** Government radio operator's license exams; qualifies for immediate employment in radio, and the marvelous future opportunities in television. As a Midland student, everything will be in your favor.

**MIDLAND TELEVISION, INC.**  
Power and Light Building,  
112-B West 14th Street,  
KANSAS CITY, MISSOURI

Affiliated with  
**Columbia Network Basic Broadcast Station KMBC**

Gentlemen: Without obligating me, please send me your new **FREE** book on Radio-Television opportunities, "Fortunes in Foresight."

Name \_\_\_\_\_ Age \_\_\_\_\_

St. or R. F. D. \_\_\_\_\_

City \_\_\_\_\_ State \_\_\_\_\_

Occupation \_\_\_\_\_

I am most interested in  Broadcasting  Television  Police Radio  Ship Radio Operating  Airline Radio Operating.

(Mail in envelope or paste on postcard)



# Short Wave

The Forty-Sixth Trophy  
Presented to SHORT WAVE SCOUT  
ROBERT D. WADE

3704 Tyler Street  
Amarillo, Texas

For his contribution toward the advancement of the art of Radio  
by

SHORT WAVE and TELEVISION

Honorable Mention: Edward A. Flood, Union City, N. J.; Israel Sinofsky, Passaic, N. J.; John Pawluck, Los Angeles, Calif.

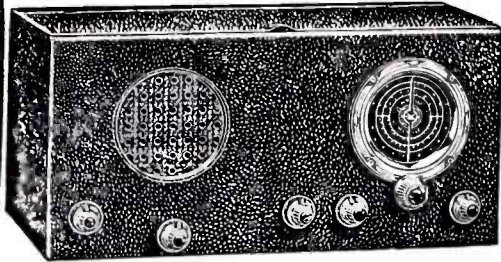

## DOERLE MODEL D-38

A. C. 171½ x 81½ x 81½

8 Tubes 4½ to 3000 Meters

The last word in short wave receivers. Before you buy send for circular D-38, an eight-page booklet containing schematic and picture diagrams, instructions, and sketches.

Read this booklet and compare with the other models you have in mind. Then send your order to the concern who in your opinion is giving you the best for your money.

Complete, with all coils, and tubes, no extras... **\$32.50**

Kit, factory assembled, but unwired, less tubes, with all coils... **\$22.50**



BS-5 Six tube Bandswitch Receiver, no plug-in-coils, select the band by a simple flip of the switch. Loudspeaker operation. 12 to 600 meters, automatic headphone jack also included. Complete, ready to use, including tubes, factory wired and laboratory tested, \$18.50. Complete kit, factory assembled ready to wire, including tubes and cabinet, \$16.50.

## 7C 5-Tube

Short Wave Receiver 8¼ to 625 meters

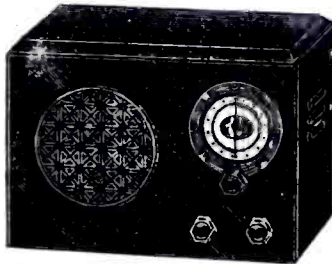

**Bigger and More Powerful Than Ever**  
**A Giant in Performance**

Uses a 6K7 radio-frequency stage, a 6F7, twin 2 in 1 tube, as regenerative detector and first audio, one 6C5, one 12A7, twin 2 in 1 tube, and one K92A. Earphone pack has been incorporated to permit the use of phone when loudspeaker operation is not desired. Operates from regular house current.

Size: 10x7½x7¼.  
Complete with all coils, 9¼ to 600 meters, and all tubes, ready to use, nothing else to buy... **\$16.50**  
In Kit form, but factory assembled, including all coils and tubes, but unwired... **\$12.95**

\*Available in battery model upon special order at same price.  
\*\*Also available in ham model with special tuning circuit to provide additional bandspread at \$1.00 additional.

## 2-Tube Electric Set



Complete with 5 coils, 2 tubes, wired and tested, 12 to 600 meters, which includes the broadcast band... **\$4.00**

In kit form, factory assembled with coils, but less tubes and unwired... **\$2.50**

Available for battery operation at the same price, if specified.

## 1938 FREE CATALOG

SEND STAMP TO COVER MAILING

## OSCAR B. KUSTERMAN

68 Barclay Street, New York City

### 39 Stations Win The North American Contest

Mr. Wade submitted a list of 43 stations in North and Central America and the West Indies, of which 39 were allowed. This marks Mr. Wade's third attempt to win the trophy. The receiver used was an Atwater Kent 1935 model with a double-doublet antenna 40 ft. high.

His listening period was from January 8 to February 7, 1937.

This contest was particularly close because the three runners-up submitted entries totaling 43, 41, and 39 veris. However, after examination of cards of each contestant a certain number were rejected as not complying with contest rules. So the final result was 39 for Mr. Wade, 37 for Mr. Flood, 35 for Mr. Sinofsky and Mr. Pawluck.

We salute you Mr. Wade and say better luck next time to the runners-up!

#### List of Stations

W8XK, 6,140 kc., Pittsburgh, Pa.  
W8XK, 11,870 kc., Pittsburgh, Pa.  
W8XK, 15,210 kc., Pittsburgh, Pa.  
W2XE, 6,120 kc., New York City  
W2XE, 11,830 kc., New York City  
W2XE, 15,270 kc., New York City  
W2XE, 17,760 kc., New York City  
W2XE, 21,520 kc., New York City  
W3XAU, 6,060 kc., Philadelphia, Pa.  
W3XAU, 9,590 kc., Philadelphia, Pa.  
W3XAL, 6,100 kc., New York City  
W3XAL, 17,780 kc., New York City  
W9XF, 6,100 kc., Chicago, Ill.  
W9XAA, 6,080 kc., Chicago, Ill.  
W9XAA, 11,830 kc., Chicago, Ill.  
W2XAF, 9,530 kc., Schenectady, N.Y.  
CFCX, 6,005 kc., Montreal, Canada  
CJRX, 11,720 kc., Winnipeg, Canada  
CJRO, 6,150 kc., Winnipeg, Canada  
TIPG, 6,410 kc., San Jose, Costa Rica  
TIRCC, 6,550 kc., San Jose, Costa Rica  
TG2X, 5,940 kc., Guatemala City  
TGW, 9,450 kc., Guatemala City  
CO9JQ, 8,668 kc., Camaguey, Cuba  
COCO, 6010 kc., Havana, Cuba  
COCX, 11,490 kc., Havana, Cuba  
COCD, 6,130 kc., Havana, Cuba  
H11X, 6,340 kc., Ciudad Trujillo, R. D.  
H11, 6,630 kc., Ciudad Trujillo, R. D.  
H11J, 5,865 kc., San Pedro de Macoris, R. D.  
XEFT, 6,000 kc., Mexico, D. F.  
XEFT, 15,300 kc., Mazatlan, Mexico  
XEFT, 9,510 kc., Vera Cruz, Mexico  
XEUW, 6,020 kc., Vera Cruz, Mexico  
XEWI, 11,900 kc., Mexico, D. F.

## First World-Wide Contest Closes January 24th

Beginning this month, the original type of contest will be run again. That is to say, there will be no restriction on the geographical location of the stations to be entered in any one contest. Each contest will be world-wide. Stations heard and verified during any

thirty-day period, regardless of their location, will be acceptable provided that at least 50% of the stations submitted are from countries other than the one in which the contestant resides. The May contest will close on February 24.

## Contest Rules

The purpose of this contest is to advance the art of radio by "logging" as many short-wave phone stations as possible.

A notarized affidavit must be sent with the veri cards.

By midnight, Jan. 24th, all entries for the April contest must be in the hands of the Editors, together with the veris and the notarized oath that the contestant personally listened to all of the stations listed.

In the event of a tie between two or more contestants, each listing the same number of stations, the judges will award a similar trophy to each contestant so tying.

Bear in mind that the veri cards should be absolute verifications, and not simply an acknowledgment

that you notified a station that you heard them. Several stations do not verify, but simply send an acknowledgment card. Note that only experimental, phone, or broadcast stations should be entered in your list. No amateur transmitters or commercial code stations can be entered.

The judges in each contest will be the Editors of Short Wave & Television and the opinion of the judges will be final.

Send veri cards with your letter and oath certificate all in one package. Use a single line for each station and list them in a regular order, such as: frequency, schedule (all time should be reduced to E.S.T., which is five hours behind G.M.T.), name of station, city, country; musical identification signal if any.



# Scouts

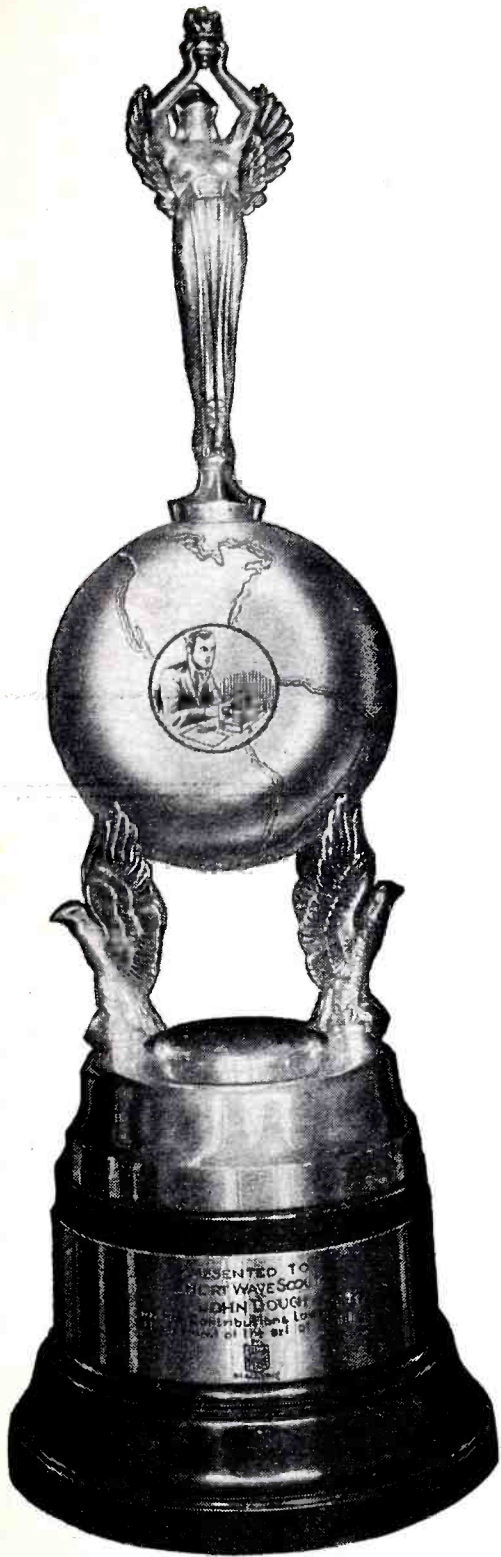

The handsome trophy which was designed by one of New York's leading silversmiths. It is made of metal throughout, except for the base, which is black Bakelite. The metal itself is quadruple silver-plated, in the usual manner of all trophies today.

It is a most imposing piece of work, and stands from tip to base 22½". The diameter of the base is 7¾". The diameter of the globe is 5¼". The work throughout is first-class. It will enhance any home, and will be admired by everyone who sees it.

The trophy will be awarded every month to that SHORT WAVE SCOUT who has logged the greatest number of short-wave stations in each contest as explained elsewhere. The winner will be announced in a subsequent issue of SHORT WAVE & TELEVISION. The winner's name will be hand engraved on the trophy.

# SUPER-CLIPPER!

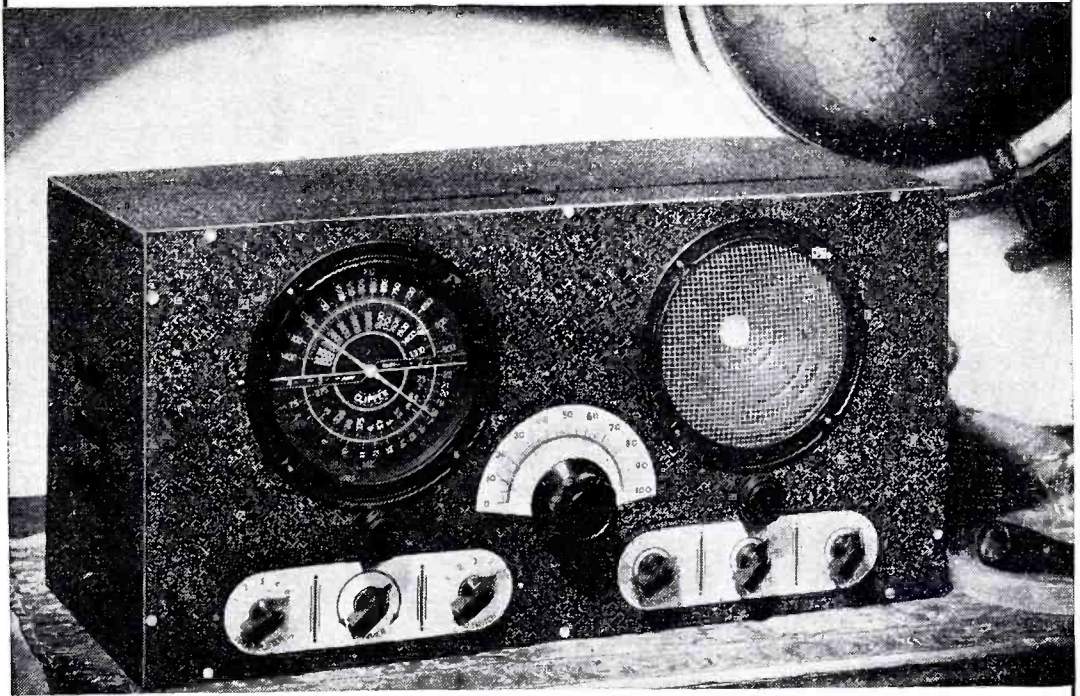

**New 7 Tube, 7 Band Receiver**  
THREE STAGES OF RADIO FREQUENCY AMPLIFICATION  
INCLUDING

**Built-in Signal Booster and Preselector!**

**H**ERE IS THE TYPE OF SHORT WAVE RECEIVER YOU HAVE ALWAYS WANTED BUT, PERHAPS, COULD NEVER BEFORE AFFORD. IT IS DESIGNED SPECIFICALLY FOR LONG DISTANCE SHORT WAVE RECEPTION AND HAS THAT EXTRA POWER AND PUNCH WHICH IS OFTEN SO VALUABLE IN BRINGING THROUGH A WEAK DX STATION.

### UNUSUAL DX RECEPTION

The SUPER-CLIPPER of course guarantees you consistent foreign reception; but it goes further than that—you can expect the *unusual* in long distance reception with this big record-breaking receiver. Its circuit utilizes both regeneration and super-regeneration combined with radio frequency amplification. The tube line-up is as follows:—6K7 RF Booster; 6K7 RF; 6K7 Ultra-high RF (separate channel); 6J5 Detector; 6J5 First audio; 6L6G Power output; 80 Rectifier.

Adjustable bandspread which may be set to *any* desired degree is a particularly useful feature. The amateur twenty meter band, for instance, may be spread over the whole 180 degrees of the large bandspread (center) dial if desired; or, if you prefer, you can even put ½ or ¼ of it over this whole dial. Think what this kind of bandspread means on the crowded foreign broadcast bands! Variable antenna matching permits proper coupling to *any* antenna, giving maximum energy transfer at all frequencies. This is a tremendous help in weak signal reception and is usually found on only a few of the most expensive custom built receivers.

### A Few of Its Many Features:

- ★ Built-in Signal Booster and Preselector which enables the crowded foreign stations to be separated and even the weak ones built up to loud-speaker volume. Covers same range as main tuner and is tuned automatically with it but may be switched out of circuit for stand-by tuning and local high fidelity reception.
- ★ Calibrated reduction drive tuning dial covering from 22 to .54 megacycles (13 to 555 meters) in four overlapping bands controlled by bandswitch (NOT plug-in coils).
- ★ Both electrical and mechanical bandspread entirely eliminating critical tuning on even the weakest foreign stations. A separate bandspread and ultra-high frequency condenser is used.
- ★ Two stages of powerful audio amplification with 6L6 beam power output.
- ★ Separate Ultra-high Frequency R.F. channel (3 to 12 meters) using airwound coils and 6K7 R.F. amplifier. (Separate antenna connection is provided for maximum efficiency).
- ★ Six inch dynamic speaker; Noise and Tone control; Earphone jack, etc.: In fact every worthwhile feature that you have told us you would like to have in your personal receiver.

### The New 1938 Super-Clipper

complete with 7 tubes, ready to plug in to any 110 v. line and operate.....  
Shipping weight 30 lbs. NOT SOLD IN KIT FORM.

**\$29<sup>75</sup>**

### WRITE FOR NEW RACO S-W CATALOG!

Kits, receivers, converters, valuable antenna information—everything you'd expect to find in a complete short-wave catalog—at prices astoundingly low. Write today for RACO'S LATEST SHORT-WAVE CATALOG—illustrating and technically describing RACO'S complete line of long distance receivers. Address Dept. SWT-238.



### RADIO CONSTRUCTORS LABS.

136 LIBERTY STREET  
Dept. SW-21 NEW YORK, N. Y.





# A NEW INSTRUMENT *by* SUPERIOR

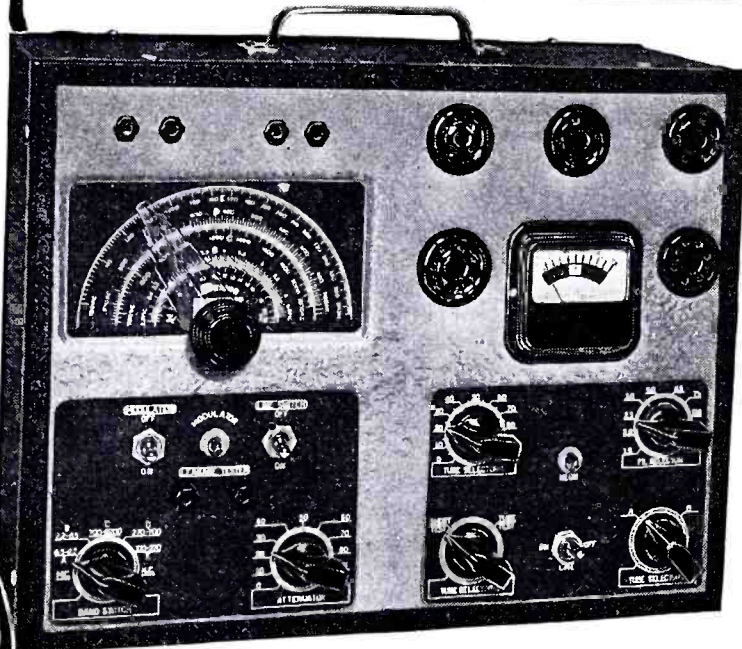

**Combination  
Instrument—  
ALL-WAVE  
SIGNAL  
GENERATOR  
PLUS  
A COMPLETE  
TUBE TESTER  
ONLY \$19.90**

● Truly the greatest value ever offered by any instrument manufacturer! There is no comparison to the COMBINATION INSTRUMENT, made by Superior, at the price of \$19.90. Consists of two fully complete units housed in a single metal cabinet of attractive design: (1) an ALL-WAVE SIGNAL GENERATOR and (2) COMPLETE TUBE TESTER. ● The Signal Generator has a range of from 110 kc to 22 mc, all fundamental frequencies, in five bands—with front panel band-switch-planetary drive is incorporated to allow for slow precise tuning adjustment. ● R.F. and AF outputs, with two AF amplitude levels. ● Accuracy 1 percent on for testing condensers, etc. ● Separate Neon leakage test circuit, neon modulator tube. ● The TUBE TESTER tests all 4, 5, 6, 7 and octal base tubes, including diode tubes. ● Incorporates separate neon short or leakage test, to determine whether tubes are bad, noisy or leaky. ● English reading meter, with "BAD-?-GOOD" scale. ● Uses minimum number of operating controls, allowing tube tests to be made quickly and accurately. ● Sturdy, reliable and foolproof emission type circuit.

Shipping weight—19 lbs.

● Write today for Superior's New Catalog—"At Your Service." It describes the complete line of Superior Test Equipment.



**SUPERIOR INSTRUMENTS COMPANY 136 LIBERTY STREET  
Dept. SWT-2, New York, N. Y.**

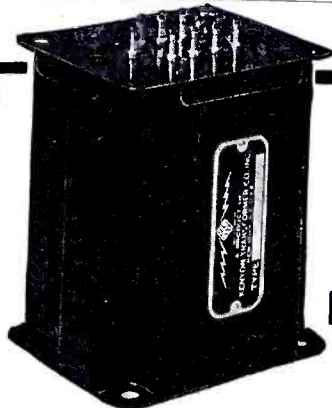

Be Wise  
and  
Kenyonize

Your  
T20, TZ20 and 809  
With

**KENYON T-378  
FILAMENT TRANSFORMER**

**Net Price \$3.00**

7.5 V. or 6.3 V.-7A C.T. 2000 V Test

See Your Local Jobber or  
Dealer for Bulletin on

**T-378**

**KENYON TRANSFORMER CO.  
INC.**

840 Barry St., New York, N. Y.

Export Dept.

25 Warren St.

New York, N. Y.



## Universal Ribbon MICROPHONES

Self energizing. No polarizing voltage. Plug in and use. Distant pickup. Semi-directional. No feedback. Unconditionally guaranteed. Incl. ten feet 2-conductor cable. Can be used on amplifiers not less than 85 db. gain.

List  
**\$22.50**  
without plug

List  
**\$24.25**  
with plug

Microphone Division  
**UNIVERSAL MICROPHONE  
CO., LTD.**

424 Warren Lane  
Inglewood Calif., U.S.A.

## Television—How Soon?

Donald McNicol

(Continued from page 533)

first beneficiary of television on a commercial, scheduled scale. Land elevations in New York are relatively low, and television coverage over the entire greater city may be obtained from transmitters radiating from the tops of skyscraper buildings. In the city proper radio shadows due to the wide use of steel in building construction introduce difficulties such as those experienced in receiving ordinary broadcasts in the same locations, but in outlying districts within range the service should be uniform and dependable.

**Quality of Television Pictures**—The engineering technique of television has been largely concerned with the term *number of lines*, the parallel and adjacent paths over which moves a spot of light which produces the television picture to be viewed. Readers doubtless are familiar with the density progress from 24 lines to the present 441. At the lower frequency the picture was but a series

of blurs, only roughly duplicating the original. In the course of experimentation to better definition 45-line and 60-line pictures were considered. Systems were developed employing 120, and then 180-line pictures.

The present accepted standard is 441 lines, with a frame frequency of 30 per second, a field frequency of 60 pictures per second, interlaced, and an aspect ratio of 4:3, as in motion-picture engineering. The size of pictures, in one system, is 7½ by 10 inches, or that practicable with a 1½ inch cathode ray tube. Employing optical projection from a kinescope, demonstrations have been given, producing a picture 8 by 10 feet. Obviously, the 7½" by 10" pictures are too small to afford anything other than makeshift entertainment.

**Economics Important**—It is probable that there is good sense in a situation wherein a spectacular scientific (engineering) development, nearing commercial status, finds itself involved in economics. Engineers in radio services in early years and who have long memories, will recall that a succession of stock-jobbers mulcted an enthusiastic, if too sanguine public out of their surplus cash in advance of the time when radio was commercially useful and a profitable field had been found for it. It is possible that the American public has, in its collective mind, become accustomed to gleaning mental peace from reading Gray's quatrains, while at the same time listening to the ebb and flow of the Battle of Cathartics. If the public has become thus mentally dextrous, possibly it can get used to reading editorials about the submerged-third while occasionally viewing the Dionne hopefuls being scrubbed with Pfenfinger's soap. The promoters of television, it appears, have little hope of financing the service from the sale of television receivers. The cost of receivers at present is several hundred dollars. Inquiry is abroad searching out possible sources of sustenance. One report on television prospects reads: "It is argued that if large governmental subsidies can be secured, better shows will become available, and eventually widespread public interest and participation can be enlisted." A spokesman for one of the radio operating organizations hoping to cash-in on television wrote: "I believe that owners of television receivers in the United States will not be required to pay a fee for television programs. This is an aspect of the television problem in which the advertising fraternity will doubtless cooperate in finding the commercial solution."

In any event there you are. That, briefly, is television at the dawn of 1938.

### Articles Wanted

Be sure to write the Editors and give them a brief description of your particular circuit; if they are interested, they will inform you promptly, so that you can prepare an article and take photos of the set. Otherwise, the set can be sent to the Editors and they will photograph it.

## 60 Words Per Minute—no Errors!

● L. R. McDONALD, W8CW, the winner of the 1937 A.R.R.L. Code Contest held in Detroit, September 8th, copied 60 words per minute without error.

Mr. McDonald, who learned the code by the Candler System, believes that practice alone will not develop a fast operator. The mental training which is part of the system taught by Mr. Candler, was in a considerable measure responsible for his success.





# THE NEW 1938 ULTRA STRATOSPHERE "10"

## 2 1/2 to 4000 METER TRANS-RECEIVER (RECEIVES 2 1/2 to 4000 METERS) (TRANSMITS 2 1/2 and 5 METERS)

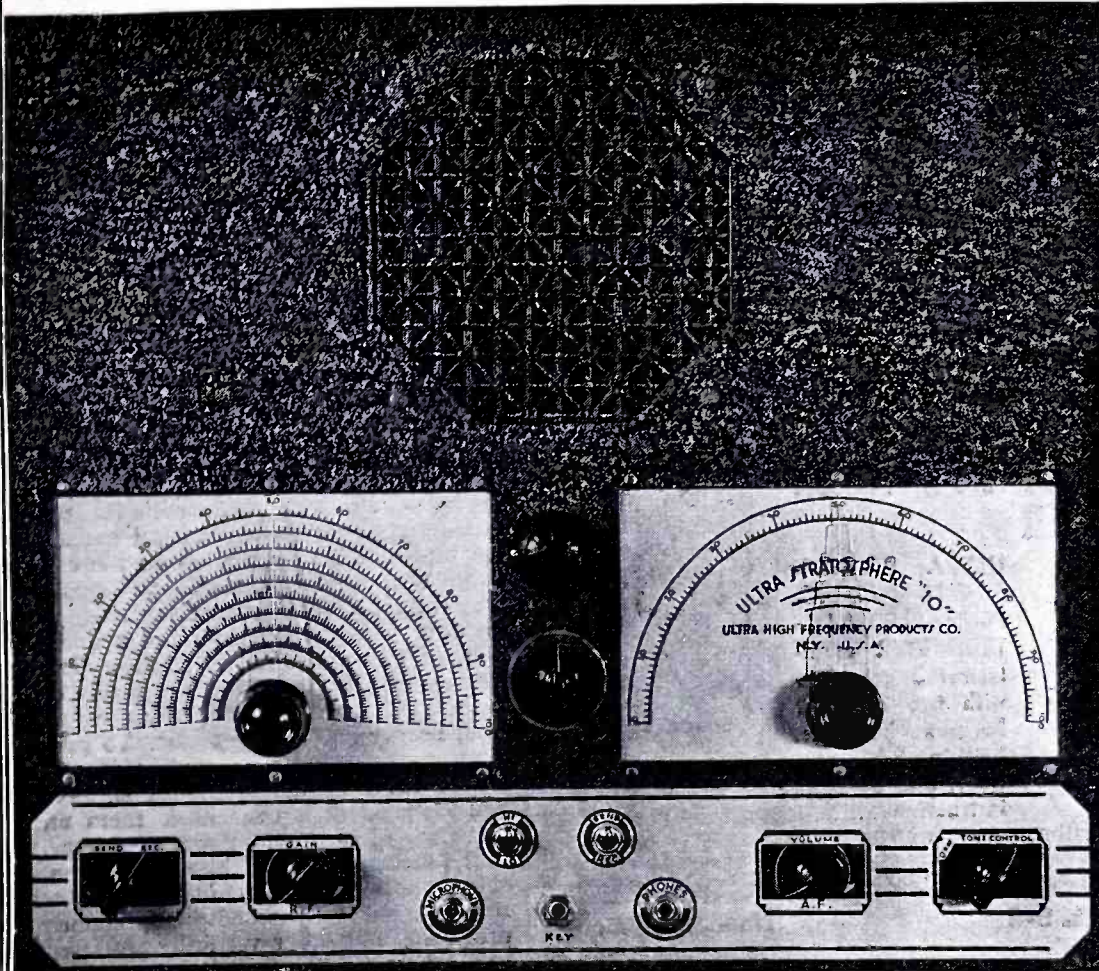

- \*Ten tubes.
- 1—6K7 Regenerative Tuned R.F. Amplifier.
- 1—6J7 Regenerative Detector.
- 1—6J5G Super Regenerative Detector & Transmitting Osc.
- 2—6C5 P.P. 1st Audio Stage.
- 2—25L6 P.P. Beam power output stage & modulators.
- 2—25Z6 Parallel Rectifiers.
- 1—6G5 Electronic tuning indicator & R meter.
- \*Receives from 2 1/2 to 4000 meters.
- \*Transmits on 2 1/2 & 5 meters.
- \*8" Dynamic Speaker.
- \*Calibrated R.F. Gain Control.
- \*A.F. Gain Control.
- \*Size—17 1/2" x 19 1/2"—16 gauge metal.
- \*Tone control.
- \*R.F. Resonator control.
- \*Separate electrical bandspread.
- \*Vernier planetary drives on tuning Cond.
- \*Large 8" tuning dials.
- \*May be used for I.C.W. and phone transmission and as a code practice oscillator. Only a key required.
- \*Standby switch.
- \*Automatic Phone jack.
- \*Built-in A.C. & D.C. Power supply.

Complete kit of parts, including 8" Dynamic Speaker, unwired, less tubes and accessories... **\$18.95**

1 Kit of 10 matched Sylvania tubes.....\$6.95  
 Set of 4 coils—2 1/2 to 15 meters......30  
 Set of 8 coils—15 to 550 meters..... 2.20  
 Set of 4 coils—550 to 4000 meters..... 2.00  
 American S. B. Handmike..... 2.95  
 Wired and tested extra..... 4.50

### SENSATIONAL ULTRA A. C. + D. C. 2-TUBE TRANS-RECEIVERS 2 1/2 to 4000 Meters

#### TRULY A SENSATION

Uses the new 6J5G super triode tube which is the equivalent of acorn types

Never before was a unit of this type available at any price. This compact and self-contained unit will receive from 2 1/2 to 4000 meters with a high degree of excellence. Will receive foreign stations, amateurs, police calls, broadcast, press, airplane and weather reports, time signals, and all ultra high frequency stations. As a 2 1/2 and 5 meter transmitter surprising results will be obtained when calling friends from afar.

- FEATURES**
- Transmits from 2 1/2 to 5 meters
  - Receives from 2 1/2 to 4000 meters (12 bands)
  - Separate electrical and mechanical bandspread
  - Loud speaker volume
  - Automatic super-regeneration from 2 1/2 to 15 meters
  - House to house communication
  - Plate modulation
  - Built-in A.C. & D.C. power supply (any cycle)

Complete kit unwired less tubes, coil cabinet	<b>\$7.15</b>
Cabinet	.95
Matched set of tubes (12A7-6J5G)	1.65
Wired and tested	2.00
Set of 4 coils (2 1/2 to 15 meters)	.30
Set of 4 coils (15-200 meters)	.95
Set of 5 coils (200 to 4000 meters)	1.75
American SB Handmike	2.95
5" Magnetic Speaker	1.25

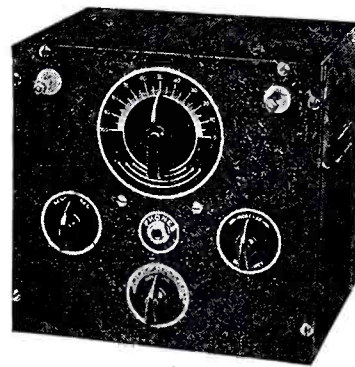

**ULTRA HIGH FREQUENCY PRODUCTS CO.,** 123 Liberty St., New York, N.Y.

expected to take under average conditions, were no barriers present. The curvature is due to atmospheric refraction which is caused primarily by water vapor in the air. It is difficult to predict results on a theoretical basis, but preliminary studies indicated that the obstruction of the mountains might insert a transmission loss of about eighteen db. The indications were that five-watt transmitters might serve if the local noise conditions were not too severe and if antennas of reasonable gain were employed.

The circuit has now been established and is used thirty or forty times on each work day. The transmission to Palomar Mountain proves to be fairly satisfactory with the five-watt transmitter and the directive antenna which were erected; but with similar equipment the transmission in the reverse direction, to the Institute, has been subject to considerable interference. This arises largely from the ignition systems of automobiles in nearby streets. For purposes of convenience and for economy the Institute desired to locate the receiving antenna on a building in Pasadena rather than in the outlying country, where greater freedom from such interference could be obtained. To over-ride this

### Ultra-Short Waves Connect Institute to Observatory 90 Miles Distant

(Continued from page 536)

noise and to fortify the circuit in general, the California Institute engineers have recently constructed forty-watt amplifiers which have

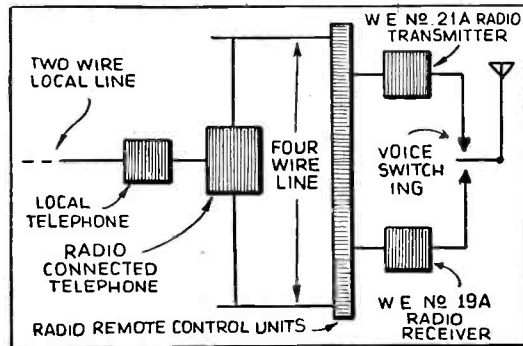

Both local and radio-connected telephones have been installed. Remote control units are provided to establish radio connection with distant telephones.

been added to the five-watt transmitters at both terminals.

The equipment provided by the Laboratories consists of modified W.E. apparatus of the type which was developed principally for mobile use and for operation in the frequency band of thirty to forty-two megacycles (9.9 to 7.13 meters). One of the requirements of the project was that the transmitters and receivers be so stable in operation that contact could be maintained between the two terminals without continual attendance. The transmitters have quartz-crystal oscillators which maintain the frequency well within 0.025 per cent of the nominal value for a temperature range of zero to sixty degrees Centigrade. Each crystal is also provided with a thermostatically controlled heater which becomes operative for temperatures below zero. The receivers are a-c operated superheterodynes with beating oscillators which are crystal-controlled. A third d-c operated receiver was provided for mobile testing.

Arrangements were provided to connect several telephone stations to the radio circuit, and code ringing features were included to enable a person at any telephone to ring any



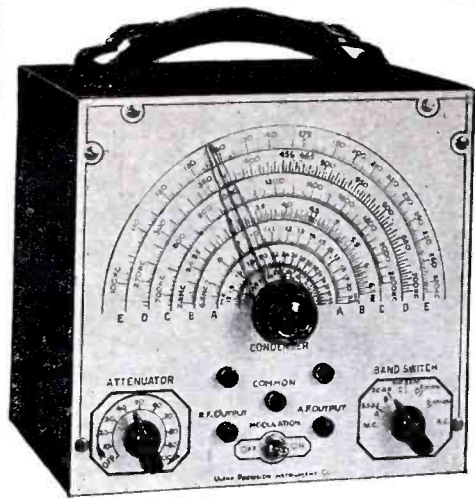

### ULTRA MODEL 1A1 Precision Signal Generator

- Wide range 100 K.C. to 66 M.C. (3000 to 4.5 meters).
- Direct reading dial accurately calibrated for entire range.
- Accuracy of calibration 1/2 of 1% on I.F. and broadcast bands, 1% on short wave bands.
- High ratio vernier dial drive with hair splitting pointer.
- Separate outputs for both R.F. and audio.
- Attenuator for both R.F. and audio channels.
- Modulated or unmodulated R.F.
- Pure sine wave audio output.
- Due to pure wave form of both R.F. and audio outputs the unit may be used in conjunction with an oscillograph.
- Tests condensers for opens and shorts by pitch method.
- Outstanding appearance. Unit has beautifully etched metal panel.
- A.C. and D.C. operation. Any cycle.
- Supplied for 110 volt A.C. and D.C. operation. May be supplied for any operating voltage from 110 volts up, on request at no extra charge.

Model 1A1 Precision signal generator supplied complete with tubes, cabinet, and operating instructions as illustrated and described

**\$12.50**

### ULTRA PRECISION A.C.-D.C. PORTABLE ALLTEST METER

- OHMETER.
- A.C.-D.C. volt millimeter (2000 ohms per volt).
- Accuracy of A.C. readings linear regardless of frequency, waveform, or temperature.
- Completely self contained for all ranges (no external batteries or plugging into power line required).
- Built-in tube rectifier.
- D'Arsonval jeweled movement (500 micro-amperes).
- Overall accuracy on A.C. or D.C. 2%.
- VOLTS—0-5, 0-50, 0-250, 0-1000.
- MILS—0-1, 0-5, 0-250, 0-1000.
- OHMS—0-200, 0-200,000, 0-2 meg.
- Large easy to read scales with knife edge pointer.
- May be used as field strength meter.

ULTRA PRECISION A.C.-D.C. PORTABLE ALLTESTMETER as illustrated complete with two 7 1/2 volt Burgess batteries, built-in tube rectifier, and operating instructions.



**\$15.95**

IF YOUR DEALER CANNOT SUPPLY YOU, ORDER DIRECT.

**ULTRA PRECISION INSTRUMENTS CO., Inc.**  
123 Liberty St., Dept. S-2 New York City

## They're all in the NEW FREE 1938 Catalog Standard Make Radio Sets

**FREE** MODELL'S catalog of Standard sets has created a sensation in the radio world. This marvelous 44 page book lists over 400 different makes and models of home electric sets, farm battery sets and auto radios, made by the leading nationally advertised manufacturers, such as RCA—Philco—GE—Zenith—Motorola—DeLoe—Grunow—Crosley—Stromberg—Carlson—Kadette—Emerson—Fada—Garod—Halsion and others. If you are interested in radios, get this Encyclopedia on Standard Radio Sets and details how you can make money in your spare or full time. **DO IT TODAY.**

Mail Coupon to address nearest you



**Modells'**  
Since 1889

- Dept. L-4,
- 58 Cortlandt St. New York, N. Y.
- 56 W. Washington St. Chicago, Ill.
- 57 Forsyth St., Atlanta, Ga.

MODELL'S, Dept. L-4,  
58 Cortlandt St., New York City, N.Y.  
 Send me Your 44-page 1938 catalog  
 How may I increase my income

NAME \_\_\_\_\_  
ADDRESS \_\_\_\_\_  
CITY \_\_\_\_\_ STATE \_\_\_\_\_  
PASTE COUPON ON PENNY POSTCARD

**WRITE** today for catalog listing in detail the world's most complete condenser line.

**MICA • DYKANOL • PAPER  
WET & DRY ELECTROLYTICS**  
CORNELL-DUBILIER ELECTRIC CORPORATION  
1027 Hamilton Boulevard, So. Plainfield, N.J.

### SHORT WAVE CONVERTERS FOR CAR RADIOS

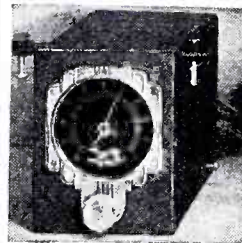

- Can be attached to any car radio. Has on and off switch and does not affect the reception on the standard broadcast band.
- MODEL 600 covers 49-31-25-20-18 and 16 meter bands. Designed for American and Foreign short wave broadcast. Distance range 5000 to 10000 miles. List Price \$24.95
  - MODEL 700 long wave covers 135 to 410 KC. Receives gov. weather reports, etc. List Price \$24.95
  - MODEL 100 with fixed condensers, covers 1600 to 2600 kilocycles. List Price \$11.95
  - MODEL 200 with variable condenser, covers 1550 to 6000 kilocycles. List Price \$17.95
  - MODEL 400 with fixed condenser, covers 5 to 10 meters. List Price \$13.95
  - MODEL 500 with variable condenser and illuminated dial. Very sensitive has two metal tubes. Exceptional distance range. List Price \$21.95

Jobs and Dealers wanted  
**ABC RADIO LABORATORIES** 3334 N. New Jersey St., Dept. S-2, Indianapolis Ind., U.S.A.

## Leadership TRIMM Presents the TRIMM COMMERCIAL HEADSET

Like its companion, Trimm Featherweight, the Trimm Commercial is destined to become the standard by which other headsets are compared. Especially suited to the discriminating amateur—built to more exacting requirements—provides a new high in sensitivity, service and clarity of sound.

Write today for catalog R 9

**TRIMM RADIO MANUFACTURING COMPANY**  
1770 W. Bertau Avenue Chicago, Illinois

### EXPERT RADIO SERVICE COURSE

**FREE WITH ANY INSTRUMENT**  
Speed tough service jobs. Make more profit. The C-B Visual Service Course gives you "know how." Designed for service men by famous Midland Television School and C-B engineers. For details, see your C-B jobber or write us. Make your time pay more. Don't delay. Write TODAY.

**The CLOUGH-BREngle CO.**  
2813-E W. 19th St. Chicago, Ill.

of the other telephones, local or distant. Other arrangements permitted connection of extra telephones to the local circuit without access to the radio circuit.

Certain telephones were provided with special features which permit them to control the radio circuit. In placing a call over the radio circuit the calling party, if he finds the circuit idle, holds his handset and operates a key to energize his radio transmitter. After pausing for a few seconds until the filaments are heated, he operates another key, which controls the carrier and sends the code of the desired telephone as a series of dashes. This causes a sequence of operations at the distant radio receiver which ends in the ringing of call bells at the distant terminal, in accordance with the transmitted code. The answering party then picks up his handset and momentarily depresses a key to start the radio transmitter so that conversation may begin. Power is automatically disconnected from the radio transmitters as soon as the respective parties replace their handsets, and a single ring on the magnetos by each party then indicates that the circuit is idle.

Experiments were made with the receiver and a simple half-wave vertical antenna on the roof of the Optics Shop on the campus. These tests showed a maximum signal with the center of the antenna sixteen feet above the roof of the penthouse, and a gratifying decrease in noise from all sources. The advantage of this location was probably due to its being somewhat shielded by the building from nearby automobile traffic. To gain this improvement, the radio equipment was removed from the Astrophysical Observatory and installed in a convenient room on the first floor of the Optics Shop. A new permanent antenna has been installed sixteen feet above the penthouse roof. This height was redetermined and checked the optimum value previously found for vertically polarized signals. A concentric conductor transmission line connects this antenna to the radio equipment. The antenna consists of two vertical half-wave driven radiators spaced twenty feet apart at right angles to the line of transmission. A quarter wavelength behind these are two parasitically excited half-wave antennas which form a reflector. A back-end null for this combination is directed toward the High-Voltage Laboratory when the two driven antennas are excited in phase. Final adjustment of this system has not as yet been completed, but considerable improvement over the previous location of the apparatus has already been realized.

Experimental antennas were also installed at Palomar Mountain. A single wire line 342 feet long was supported above the ground on thirty-foot poles down the slope in the direction of Pasadena and connected to the radio set through a quarter-wave matching section of line. This was about the proper height above ground to obtain phase reinforcement of the direct waves and waves reflected from the slope, but the length of the antenna was not the optimum required to use the maximum of the cone of receptivity. The topography of the ground prevented obtaining a wire length sufficient to place this cone correctly. The results were inferior to those obtained with a half-wave vertical and a reflector.

An eighty-five-foot water tower with a metal tank provided a location at a still higher elevation. The receiver and equipment were taken to the platform on the tower and a half-wave length vertical antenna mounted about 4 1/2 feet out from the tank, using the tank itself as a reflector. A null was found for a vertical antenna at a point about eight to nine feet from the tank. The local noise level was low and the results were so good that the antenna was located permanently on the tower. A single half-wave vertical in front of the tower is now in regular use.—Bell Laboratories Record.



# Radio—A Wide-Open Door To Opportunity



Alfred A. Ghirardi, E. E.

● **THE** radio industry has progressed with lightning-like rapidity. Each year has brought some new development to add to the wonder, convenience, and delight of the public.

There are those, both within and without the industry, who deny this and contend that the peak of radio development has been reached; but these men, too lazy and unwilling to keep up with the giant strides of radio, are indulging in a bit of wishful thinking, rather than basing their conclusions on actual, hard fact. They are the ones for whom no line of work holds opportunity, because they themselves refuse to accept opportunity even when it knocks on their very door.

Based as it always has been on a constant parade of new ideas, radio offers success only to those who are alert to progress, who are eager to fit themselves eminently for this type of endeavor, and who are interested in radio enough to devote a large amount of their time to keeping up with it. The men who made radio the great thing that it is today—both those untrained in scientific methods of research and those best prepared as to educational background and elaborate laboratory equipment—were men of that calibre.

From the initial development of A.C. tubes and A.C. line operation of radio sets these men were responsible for such rapidly following innovations as power tubes, single-dial tuning, dynamic speakers, electrolytic condensers, screen-grid and pentode type tubes, radio-phonograph combinations, single-control superheterodyne receivers, midget receivers, automatic volume control, inter-channel noise suppression, small automobile type tubes, remote tuning control devices, vibrator-type power supply units, automobile receivers, wave-band switching systems, short-wave and all-wave receivers, and push-button tuning—innovations without which radio could not have reached its present position of importance and supremacy in the industrial scene.

Radio today, far from having achieved its maximum growth, is, rather, opening on a phase of even greater development insofar as it provides a stepping stone to fields hitherto uncultivated by radio men. Radio today is the object of more research than has ever before been devoted to it! If this same spirit of advancement that characterized its early years continues, the radio industry can never become inactive. The result of all this display of initiative and study cannot be stagnation, as some would have us believe; the result can only be greater accomplishments for radio with its ensuing benefits for the radio-buying public as well as for the men connected with the innumerable branches of

one of our greatest industries.

Among the more promising of the new branches of radio is that devoted to the development of real high-fidelity with relation to both reception and transmission. And with this high-fidelity reception comes more than the mere problem of extending the range of reproduction further into the high and low frequency regions. It poses to the radio technician the more difficult questions of noise elimination, construction and servicing of receivers and set design. It even brings up the consideration of proper acoustics for the room in which the set is to be placed. The radio man who tackles these questions now will be in a very enviable position when the inevitable boom, that will accompany the development of satisfactory high-fidelity receiving equipment which can be marketed at a price suitable for mass consumption, comes. When this goal in high-fidelity research is achieved it will mean the beginning of an expansion far greater than any the radio industry has ever known, and those men who are far-sighted enough to realize this and prepare themselves for it will share in its benefits.

A branch of industry into which radio men can step right now without having to wait for a perfected development is the photo-electric field. The electric eye is continually used in industry today and other new uses for it are constantly being unfolded. How-

(Continued on page 582)



CANDLER Trained McElroy, Champion Class A. Speed 69 wpm. CHAMPION MCELROY who teaches CANDLER SYSTEM at HARVARD says: "Practice alone, of any kind, will not develop skill and speed. It takes a thorough knowledge of the fundamentals and Mind Training, taught exclusively by THE CANDLER SYSTEM."



CHAMPION JEAN, W3BAK Two months after beginning Candler training, Jean could copy 30 wpm on her "mill" easily.

## LEARN or *SPEED UP YOUR* with the New **CANDLER SYSTEM** Trains You to Meet *NEW CODE SPEED* Requirements

Those speedy operators you hear on the air are mostly Candler trained. With the Candler System you can improve your operating speed in an amazingly short time right at home. This system teaches you code by sound, the only correct and accurate way. With only a few hours of practice the Candler way, you will see an amazing development in your performance. In a few weeks' time you'll be pounding brass with the best of them.

### COSTS YOU NOTHING TO GET THE FACTS!

If you want to learn code—RIGHT—or if you are "STUCK" and want to increase your speed for that commercial license and a good job, write today for our new book, "HOW CODE CHAMPIONS ARE MADE." Contains records and pictures of the Champions, how their amazing speeds were developed through Candler Training. All questions answered. NO EXPENSIVE PRACTICE EQUIPMENT NEEDED!

## CANDLER SYSTEM CO.

Department SW-2

ASHEVILLE, NORTH CAROLINA, U. S. A.

CANDLER SYSTEM CO., Dept. SW-2, ASHEVILLE, NORTH CAROLINA  
Please mail without obligation your new book, "HOW CODE CHAMPIONS ARE MADE."

Name .....

Address .....

City ..... State.....



WALTER H. CANDLER Maker of Champions Will Train You Personally to Qualify for that Bigger, Better Job.

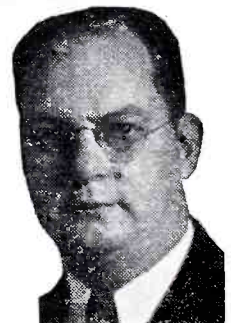

L. R. McDONALD, W3CW Winner A.R.R.L. Code Contest Detroit Convention Sept. 6, 1937 by copying 60 wpm without error. "Practice alone of any kind will not develop a fast op. Candler makes available to all ops the Mental Training formerly acquired by only a few, and then by accident. I'm not aware of a better way to acquire speed and accuracy than the training and advice Candler gave me." McDONALD, W3CW.



BUILD YOUR OWN

*Meissner*

ALL WAVE "8"

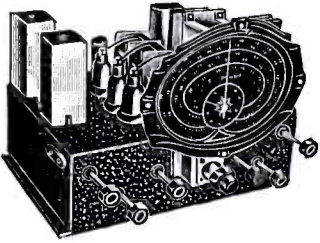

4-BAND SUPERHET

540 KC TO 43 MC

Incorporating the Exclusive  
MEISSNER

MULTI-WAVE ASSEMBLY

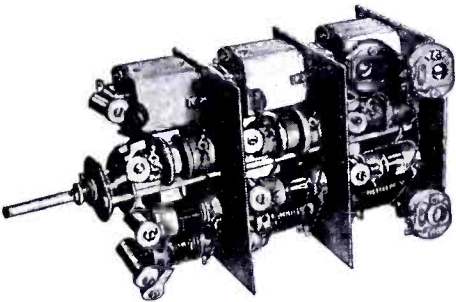

With 9 Align-Aire (air-dielectric) Trimmers  
Factory-wired and Pre-aligned  
Complete Coil and Tuning Kit including:  
4-Band Coil Assembly  
Tuning Condenser, 8" Band Spread Dial  
Ferrocart I.F. Transformers

Beat Frequency Oscillator Transformer with de-  
tailed instructions  
—Kit No. 7508-A, **\$20<sup>70</sup>**  
Net Price

Complete data on this kit (and 17 others) is  
available in the big Meissner  
112-page Instruction Book, **50c**  
Net

See your Jobber or order direct from

MEISSNER MFG. CO.  
Mt. Carmel Illinois

Department R-2  
Rush latest 32-page Complete Catalog.

Name .....

Address .....

City ..... State .....

Ask your **JOBBER**  
for the NEW

**STANCOR**

"HAMANUAL"

New Tubes . . . New Circuits

16 NEW TRANSMITTERS  
5 WATTS TO 1000 WATTS

STANDARD TRANSFORMER  
CORPORATION  
850 BLACKHAWK STREET, CHICAGO

# Television "Piped" from New York to Phila.

(Continued from page 534)

dark and vice versa. That in turn means a current from the photoelectric device that changes rapidly from strong to weak. A changing current can be shown to be a group of alternating currents whose frequencies reach higher values as the change becomes more rapid. Conversely, if the circuit suppresses some of these high frequencies, the current will seem to change more slowly. That in turn means blurred television details. Hence a high quality system is designed to handle high frequencies.

At the receiving terminal, in a cathode-ray tube, the current is supplied to a set of plates so arranged that the current corresponding to the brightest spot on the film centers the electron stream on an aperture one two-hundredth of an inch square. For less bright points the beam does not center on the aperture and fewer electrons pass. The stream then passes two more pairs of plates; one of which sweeps it back and forth fifty-seven hundred and sixty times a second; and the other up and down twenty-four times a second.

**Scanning Frequencies**—To permit the use of standard sound-film in the transmitter, the system is designed to scan 24 "frames" a second. The scanning disc contains 240 lenses and runs at 24 revolutions per second, scanning 5760 lines a second. Similarly the screen at the end of the receiving tube is scanned horizontally by the electron stream at the rate of 5760 lines a second, that is 240 lines for each of the 24 frames which are transmitted each second.

In transmission over the cable the lowest frequencies fall behind the highest, taking about twenty millionths of a second longer in travel. In that time the cathode beam can move forty times its width. The effect is the same as if the finer the picture details the more out of synchronism were scanning disc and cathode beam. For the new coaxial transmission, however, delay equalizers were developed to keep together all the components of the current to a precision corresponding to the motion of the beam for half its width, that is, a dead-heat finish between all the frequencies to within a quarter of a millionth of a second!

Amplifiers designed for a still wider band are under development, which will permit more telephone channels and more detail in a transmitted scene.

## Images Transmitted on New Single Side-band System

Dr. Frank B. Jewett, President of the Bell Telephone Laboratories, made the following statement on coaxial cable developments:

"In order properly to appraise the demonstration of television pictures transmitted over the coaxial cable from New York to Philadelphia and the semi-technical explanation of it, it is necessary to understand just what the demonstration was designed to show; what it was and was not; and what was new and an advance over the preceding art.

"The demonstration was not the first transmission of television image currents for long distances over wires. The first such demonstration was made by the Bell System in 1927 when television image currents were transmitted from Washington to the Bell Telephone Laboratories in New York and there reproduced. In that demonstration transmission was over specially conditioned telephone circuits of ordinary construction. The characteristics of such circuits were sufficiently good for the poor grade of television picture then attainable by the equip-

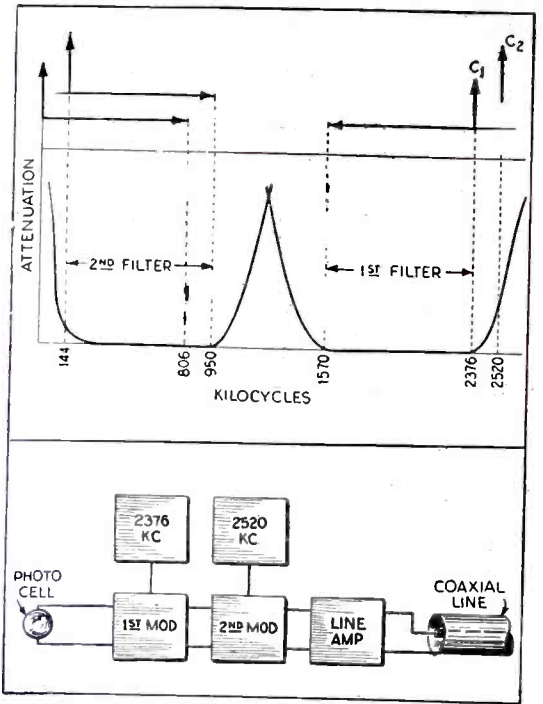

In the recent demonstration of television transmission over the coaxial cable between New York and Philadelphia a frequency band width of 806 kc. was employed. Since the coaxial cable is not designed to transmit frequencies below 60 kc., however, the original frequency band from 0 to 806 kc., had to be raised by modulations to a higher position in the frequency spectrum.

This is accomplished through double modulation. The first modulation employs a carrier of 2376 kc., and results in a lower side-band from 1570 to 2376 kc., and an upper side-band from 2376 to 3182. A filter then removes all of the upper side-band except a small section of its lower frequencies, which is passed by the sloping corner of the filter characteristic. A second modulation with a carrier of 2520 kc. results in an upper side-band from 4090 to 4896 kc., and a lower side-band from 950 to 144 kc., with the addition of a group of somewhat lower frequencies corresponding to the vestigial upper side-band passed by the first filter. A second filter easily removes the upper side-band, and is accurately designed to cut off the vestigial frequencies below 144 kc., so that the frequencies transmitted run from 144 to 950 kc.

ment for scanning and reproducing (50 lines, corresponding to a frequency band width of approximately 22,500 cycles).

"The latest demonstration was not designed to show an improved television per se. In fact the images (240 lines) were inferior in grain to those produced by the most modern

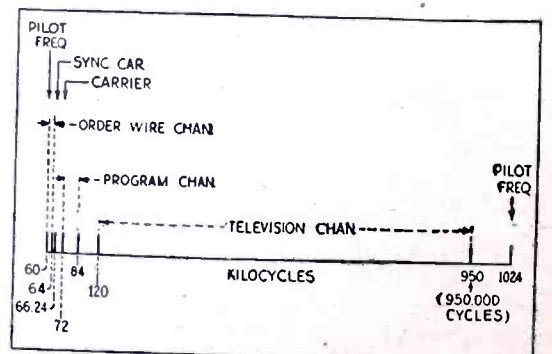
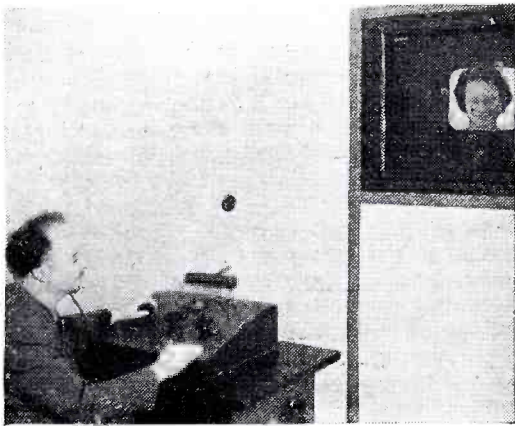

Diagram above shows television transmission band of nearly one million cycles used in the transmission of images.



television equipment (441 lines or better). This was not due to any limitation imposed by the scanning or reproducing apparatus, but to the limitations imposed by the experimental terminal and repeater equipment now on the New York-Philadelphia cable. This equipment limits the top frequency of the transmitted current to approximately 1,000,000 cycles so that a 240-line picture is about the finest grain image that can be transmitted.

"What the demonstration did show for the first time is the unique and economical utilization for television currents of the frequency band of a long coaxial cable. Instead of transmitting the television currents by the double side-band method common to radio broadcasting, a method for single side-band transmission was developed, thus utilizing to the fullest the frequency range for which the cable system was equipped. The double side-band method has been used in Europe for transmission of 180 line images over coaxial cable. In that transmission each side-band occupied only about 1/3 of the transmission range of the cable system, amounting to the television use of the available frequency range at only 33 percent efficiency. In the method which has just been demonstrated at Philadelphia a single side-band is obtained by double modulation and precise filtering; and this side-band is placed



The image control desk and the screen behind which a large cathode ray tube was mounted.

to avoid the first 100 kilocycles of the frequency range of the cable system where transmission is unsatisfactory and the various components cannot easily be amplified. There was also introduced compensation for the different velocities of transmission of different frequency components. The result is the delivery of an essentially perfect replica of the almost infinitely complex current produced at the sending end by the scanning equipment.

**2,000,000 Cycle Repeaters To Be Tried Next**

"These are results never before obtained. As soon as the present experiments are completed the experimental 1,000,000 cycle repeaters on a portion of the cable are to be replaced by experimental 2,000,000 cycle repeaters, as the next orderly step in the development of equipment which will give a coaxial cable system capable of accommodating the maximum number of telephone channels which it is economical to handle on such a cable or the widest band of frequencies which the best television scanning and reproducing apparatus may require.

"As stated above, a 1,000,000 cycle band will accommodate television currents corresponding to about 240-line pictures. It will also afford channels for about 240 simultaneous high grade telephone channels. A 2,000,000 cycle system will provide about 480 telephone channels or accommodate television currents corresponding to about 350-line pictures."

**NEW!** **INDISPENSABLE TO MODERN RADIO WORK**

**IRC**

4 3/4" diameter by 3 1/4" high

**RESISTANCE ANALYZER and INDICATOR**

A Calibrated Variable Resistor Instrument for General Use In All Types of Resistance Measurements

- Valuable to Servicemen
- Amateurs
- Radio & Electrical Engineers
- Manufacturers
- Experimenters
- Laboratories
- Colleges & Schools
- Broadcast Stations

... And to Everyone Who Has Anything to do with Resistance Measurements

The utility value of the new IRC Resistance Analyzer and Indicator is quickly evident. It has a multiplicity of uses, some of the most important being for determining by the substitution method proper values for resistors and standard Volume Controls; estimating required Volume Control tapers; volt-meter multipliers; wire wound rheostat or potentiometer; calibrated gain control or attenuator; voltage divider, etc. Complete instructions included in 16-page folder.

The Analyzer is direct reading. It has only the one adjustment knob to vary the resistance continuously from 0 to 1.0 megohm. Circuit consists of heavy duty wire wound rheostat type element from 0 to 30,000 ohms and special Metallized type resistance element from 30,000 ohms to 1.0 megohm. Case of molded Bakelite. Three fuse sizes included.

**Net Price \$4.95**

**INTERNATIONAL RESISTANCE COMPANY**  
401 NORTH BROAD STREET, PHILADELPHIA, PA.

**More Distance Per Watt - WITH TRIPLET**

MODULATION MONITOR

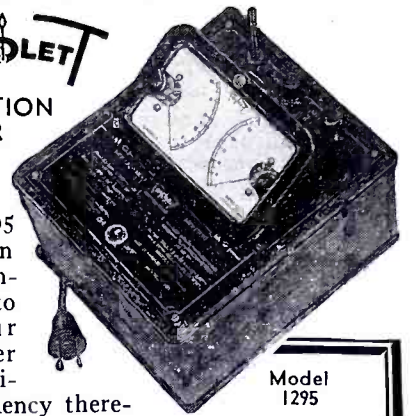

Model 1295 Modulation Monitor enables you to tune your transmitter to maximum efficiency there-

Model 1295

by saving the power loss of under-modulation. Result—clearer signal to distant stations. For all voice transmitting stations. Modulation from 40 to 120 per cent shown on direct reading scale.

**DEALER PRICE \$24.83**

Case is metal with Black Wrinkle Finish. Etched panel is silver and red on black.

**SEE YOUR JOBBER WRITE FOR CATALOG**

The Triplett Electrical Instrument Co.  
282 Harmon Dr., Bluffton, Ohio

Please send me more information on Model 1295.

Name .....

Address .....

City ..... State .....

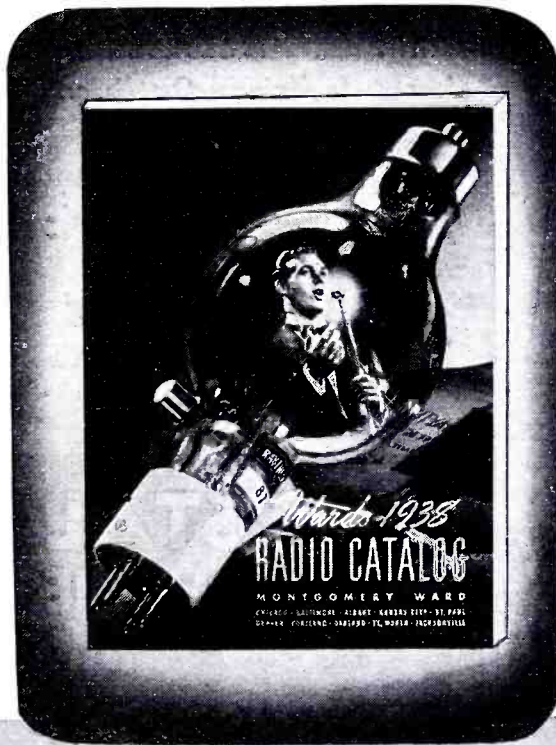

**SAVE**

Get the latest and finest radio equipment at rock-bottom prices! Use it while you're paying for it on convenient monthly terms. Send for Wards 1938 Radio Catalog—the finest ever printed. See how much you save and how easily you can buy all the equipment you need. Mail the coupon NOW for your FREE copy!

**Montgomery Ward**

*Everything Sold on Time Payments*

**MONTGOMERY WARD, DEPT. SW-3 CHICAGO, ILLINOIS**

Send me my FREE copy of Wards new 1938 Radio Catalog. I am particularly interested in the equipment checked at left.

- Sound Systems and Equipment
- "Ham" Receivers and Supplies
- Inter-Communication Systems
- Testing Instruments and Books
- "Ham" Transmitters and Parts
- Replacement Supplies and Parts

Name .....

Address .....

City .....



## Television Sweep Coil Data

(Continued from page 551)

tion, should be avoided because they tend to weaken the bulb, which is under considerable pressure due to its high vacuum. The bulb should not be subjected to extreme or rapid temperature changes. When an 1801 is removed from its associated apparatus, it is recommended that the tube be stored in its original carton, with the viewing screen up.

The base pins of the 1801 fit a standard, five-contact socket, which can be installed for the operation of the tube in any position. The socket mounting should preferably be adjustable. The socket should be made of good insulating material; insulating baffles between contacts provide an additional factor of safety.

The heater is designed to operate at 2.5 volts. The transformer winding supplying the heater power should be designed to operate the heater at the rated voltage under average line-voltage conditions.

The fluorescent screen in the 1801 employs phosphor No. 3 material, and is of the medium persistence type having high luminous efficiency. It is recommended that, in equipment using the 1801, the screen of the tube be covered with a plate of clear, shatter-proof glass. This glass plate provides protection against the possibility of the bulb collapsing due to some abnormal condition.

A deflecting yoke for use in television equipment is shown in Fig. 4. This yoke has the advantages that it is simple and is easy to construct. It has the disadvantage that it produces a certain amount of pincushion distortion and defocusing of the spot at the edges of the picture. This distortion and defocusing are due to non-uniformity of the fields of the two sets of coils, and to coupling between the two sets of coils. A more complicated yoke can be designed<sup>1</sup> so that the distortion and defocusing are very small. However, the distortion and defocusing produced by the simple yoke shown in Fig. 4 are sufficiently small so that this yoke is entirely satisfactory for many applications of the Kinescope. A yoke of advanced design which has been developed by RCA engineers is shown in Figs. 5 and 6.

A shielding case for the Kinescope may be desirable if the tube is operated near electrical apparatus whose fields may cause distortion of the spot. If an iron or steel case is employed, care should be taken in its construction to insure that the case is completely demagnetized. In television equipment, or in other applications of the 1801 where the anode No. 2 is at high potential above ground, a shielding case protects the operator against accidental contact with the high voltage on the anode No. 2 terminal cap.

The d-c supply voltages for the electrodes may be obtained conveniently from a high-voltage, vacuum-tube rectifier. Because the 1801 requires very little current, the rectifier system can be of either the half-wave or the voltage-doubler type. For the same reason, the filter requirements are simple. A 0.5- to 2.0-mf. condenser will ordinarily provide sufficient filtering. If this is inadequate for a particular application, a two-section filter is recommended. A circuit of a suitable power supply is shown in Fig. 1.

The optimum value of anode No. 2 voltage for television applications is dependent on the desired picture quality and the allowable cost of voltage-supply equipment. For high definition and high brightness of the picture, it is desirable that anode No. 2 voltage be high in order to obtain a spot which not only is small but which also has high intensity. If

<sup>1</sup>"The Cathode-Ray Tube in Television Reception," I. G. Maloff, Proc. Radio Club of America, October, 1935.

(Continued on page 579)

# My Creed

**TO GIVE** you SPECIALIZED PERSONAL SERVICE of genuine value that is not available from other jobbers.

**TO SELL** receivers, transmitters, and parts on TERMS arranged to suit you with less interest than heretofore charged.

**TO TAKE** your equipment in TRADE at a fair value.

**TO CARRY** in stock the most COMPLETE line of amateur equipment and give you quicker SERVICE, better TECHNICAL HELP, and more complete INFORMATION about equipment.

**TO ALLOW** you to TRY all receivers for TEN DAYS without obligation and to COOPERATE with you in every way I can to see that you are entirely satisfied.

You can reach me by letter, telegram, phone, or visit nearly 24 hours a day, 365 days a year. Write for any information. Your inquiries are invited.

**HENRY RADIO SHOP**  
211 North Main St., Butler, Missouri

## COMPARE BOB HENRY'S TERMS WITH OTHERS

Model of Receiver	Cash Price	Down Payment	12-month Payments
RME-69	\$151.20	\$30.24	\$10.81
Sky Buddy	29.50	5.90	2.20
Sky Challenger	69.50	13.90	4.15
Super Skyrider	99.00	19.80	7.11
Breting 14AX	99.00	19.80	7.11
NC80X & NC81X	88.00	17.60	6.33
NC100	120.00	24.00	8.59
HRO	179.70	35.94	12.82
ACR-111	189.50	37.90	13.51
Super Pro	243.00	48.60	17.30

Similar terms on all Harvey, RCA, RME transmitters and Stancor, Progressive, All Star kits.

*Robert Henry*  
W9ARA

**SHORT WAVE COIL DATA BOOK**  
COMPLETE COIL DATA AND CIRCUITS FOR ALL TYPES OF RECEIVERS AND TRANSMITTERS  
Price 25 Cents  
RADIO PUBLICATIONS  
59 HUDSON STREET  
NEW YORK

FOR RECEIVERS AND TRANSMITTERS

# The 1 and ONLY

## SHORT WAVE COIL DATA BOOK

Every experimenter knows that the difference between a good and a poor radio set is usually found in the construction of short-wave coils. Coil winding information is vitally important and in the new coil book all "dope" appears. There's illustrations which give instructions on how to wind coils, dimensions, sizes of wire, curves and how to plot them. Every experimenter needs this book—it also contains complete data on all types of receiving coils, together with many suitable circuits using these coils. Also complete data on various types of transmitting coils with many transmitting circuits such as exciters and amplifiers using the various coils described.

### Contents Briefly Outlined

S-W Tuning Inductance Charts • Coil Data for T. R. F. Receivers • One Tube Oscillodyne • Two Tube Bandspreaders • The Mono-Coil • 2-Tube Old Reliable • 2-Tube Globe Trotter • 2 Winding Coils—10-500 Meters • Doerle 3-Tube "Signal Gripper" Electrified 3-Tube Bandspreaders for the Ham • General Coverage Coils on Ribbed Forms • Coil Data for Superhet or S-W Converter • Ultra S-W Coils • Switch Coils for S-W Superhets • Experimental Coils • S-W Antenna Tuner • Most Popular S-W Tuning Circuits • Self-Supporting Transmitting Circuits Employing Coils Described • All Band Antenna Tuner for Transmitting • Plug-in Coils for Exciters • Frequency-Wavelength Conversion Chart.

**PRICE 25c PREPAID**

For a copy of this handy book, send 25c in U.S. Coin or stamps to

**RADIO PUBLICATIONS**

97 HUDSON STREET NEW YORK, N. Y.

**Bud's the best!**  
PROVED BY test!

**BUD**  
Bud Products are exceptionally well built—designed for the rigid requirements of amateur radio. The complete BUD line affords the amateur and experimenter a wide choice of components—relay racks, panels, coils and many other constructional necessities. Best of all, BUD SELLS FOR LESS at all BUD authorized distributors.

**BUD RADIO, INC.**  
CLEVELAND, OHIO., U. S. A.

**CRYSTAL HEAD PHONES**

**"TRANSFILTER"**  
Information on request

**THE BRUSH DEVELOPMENT CO.**  
3326 PERKINS AVE., CLEVELAND, OHIO

**RADIOS..SAVE UP TO 50%**

DEAL DIRECT...FACTORY PRICES! Many models to select from: AC-DC; All-Wave; armchair models; automatic tuning; car radios; Farmsets that operate like city radios! Send postcard for NEW Bargain Catalog FREE. 30-DAY TRIAL plan and agent-user proposition!

**GOLDTONE RADIO CO.**  
DEPT. C2, DEARBORN, MICHIGAN

30 DAY TRIAL \$6.98 UP Free Catalog



# Trans-Atlantic Television?

(Continued from page 536)

transmission line from the antenna, or to a calibrated ultra-high frequency signal-generator contained in the rack in the foreground. The bottom panel of this rack is a peak voltmeter useful in comparing peak signal values and determining signal-to-noise ratios. The upper panels of the two racks contain the necessary power supplies and regulators. In order to have the receiver remain perfectly stable and the signal generator hold its frequency setting, it was found desirable to regulate the a-c power supply and also the d-c plate supplies from the rectifiers.

### Special Double IF Superhet Used

Fig. 2 shows a block diagram of the receiver. The 955 acorn first detector, which may be tuned from 30 to 200 megacycles, is fed the signal and also the output of the 955 acorn high frequency or first oscillator, and produces the first intermediate frequency of 25 megacycles, which is fed to the broadly tuned first intermediate frequency amplifier. The second detector receives this 25 megacycle signal and also the output of the second oscillator which is set at 27.1 megacycles. This detector produces the second intermediate frequency of 2.1 megacycles, which is amplified by the second intermediate frequency amplifier. This amplifier has a flat band width of 100 kilocycles. The third detector is fed the 2.1 megacycle signal and provision is also made to supply it with a 2.1 megacycle voltage from the third oscillator. This third oscillator is used for cw reception and as an aid in tuning the desired signal to the center of the 2.1 mc intermediate frequency amplifier. The third detector drives a single-stage audio amplifier, the output of which terminates in a pair of jacks at the lower right-hand corner of the receiver. Provision is also made to get at the diode output directly. The receiver input may be switched to either the aerial or a signal generator. A vacuum-tube voltmeter is used to hold this generator's output constant.

To receive the ultra-short wave signals, a horizontal rhombic antenna was constructed. This antenna was 134 feet long, 69 feet wide, 45 feet high, and had an effective height of about 8 meters. The direction of London from New York is approximately N 50° E.

From January 1 to April 4, the voice channel from London was heard 45 times, whilst the video (image) channel was heard 15 times. Usually the signals were rather weak, but at times both the audio (voice) and video (picture) channels became quite strong. The maximum field strength observed was about 70 microvolts per meter on both channels. As the rhombic antenna used had an effective height of about 8 meters, the signal strength at the terminals of the receiver was about 500 microvolts.

### Signal Strong Enough to Produce Image

Unfortunately, during the period of maximum signal strength, there was no television receiver available on which to observe the video signal optically. When such a receiver was procured the period of strong signals had passed and there was not sufficient signal voltage to permit proper Kinescope synchronization. However, judging from the fact that at times the received video signal reached a value of well over 400 microvolts, it would be reasonable to assume that a useful picture could have been obtained.

The audio (voice) signal frequently was of sufficient strength to give excellent loud-

speaker reproduction! Its fading was prone to be deep and rather fast, but rarely was it of a selective (distortion producing) nature. In fact, when passed through a high fidelity amplifier and loud-speaker system, it produced exceptionally fine results as the transmitter's audio system, from microphone to antenna, is reputed to have a flat audio response curve from 40 to 10,000 cycles, something rarely to be found in the American broadcast band, due to the close spacing of transmitters and telephone line limitations. Only once was interference noted and that came from the fifth harmonic of a code transmitter on 8.3 megacycles, located on a ship off the coast of Scotland.

The audible response from the video channel consisted of a sharp 50 cycle buzz. This made it difficult to determine whether or not selective fading was present. The fading on this channel was quite slow and usually not deep.

### German and French Vision Signals Heard

It should be mentioned that the German and French television transmitters were heard on several occasions, but in general these signals were not as strong as the English transmissions and were heard less consistently. There was also reason to believe that the Italian television voice channel was received, although positive identification was not established.

Probably the reader now wonders if this is the start of regular trans-oceanic television broadcasting. In the opinion of the author this phase of television is still distant. The trans-oceanic reception of 40 to 45 megacycles may be explained as being due to exceptionally high ionization of the F<sub>2</sub> region of the Kennelly-Heaviside layer. This is in phase with the great increase in sunspot activity as the maximum of the eleven-year sunspot cycle is approached. With this in mind, it is reasonable to assume that for the next few years there will be sporadic reception of ultra-high frequencies over great distances. This phenomenon should reach its peak the winter of 1938-1939.

### How to Listen for BBC Television Signals

Anyone possessing a receiver that is fairly sensitive in the region of 40-45 megacycles could probably hear these English emissions occasionally during the coming winter. A properly designed antenna is almost essential, as the usual broadcast antenna is usually quite poor on these ultra-high frequencies. One of the simplest to construct is the common half-wave doublet. It should be 40 to 45 feet above ground (higher or lower will give inferior results), face England and have a length of 11¼ feet. The two-wire transmission line should be as short as possible.

It should be remembered that winter is the time of year most favorable for long distance reception of these signals. Probably from the middle of December to the last of February is the time during which the strongest signals will be heard. At present the London television equipment is in operation daily except Sunday from 10:00 to 11:00 a.m. and 4:00 to 5:00 p.m. Eastern Standard Time. So far we have heard only the morning program.

More on TELEVISION in next issue—  
Data for building a receiver and other practical information.

# RAYTHEON

## MEETS EXACTING STANDARDS

OF  
*More Set Engineers*  
THAN ANY OTHER TUBE!



RAYTHEON makes tubes for the majority of licensed set manufacturers in the United States! For that reason, RAYTHEON tubes not only meet the exacting standards of more Chief Engineers than any other—but they must perform in more diversified circuits than any other tube!

Your RAYTHEON jobber, too, has the RAYTHEON "RK" tubes, the finest quality "ham" tubes made! The name "RK" is your guarantee of precision-engineered "top" quality RAYTHEON amateur tubes—always!

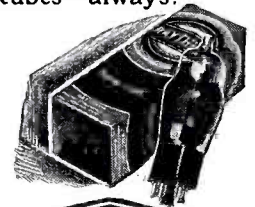

# RAYTHEON

## RADIO TUBES

445 Lake Shore Drive, Chicago, Ill.  
420 Lexington Ave., New York, N. Y.  
55 Chapel Street, Newton, Mass.  
555 Howard Street, San Francisco, Cal.  
415 Peachtree St., N. E., Atlanta, Ga.

"WORLD'S LARGEST EXCLUSIVE RADIO TUBE MANUFACTURERS"



H. G. CISIN'S AIR WAVE Air Scout Jr. Radios  
**THREE-TUBE ALL ELECTRIC AIR WAVE SET MODEL 3A-E** **\$3.20**  
 WITH PHONE Tubes Unwired

A well-designed sensitive set. Holds wonderful records for distance reception. Owners with practice able to bring in police calls, amateur, code, Transatlantic phone and broadcast entertainment. Works from any A.C. or D.C. house current. Easiest set to build. Employs newest metal ballast tube as one of the tubes. Speaker mounts on attractive panel. Range 9 1/2 to 610 meters or to 1500 meters with special long wave coil. Complete Kit includes: Ear-Phone, broadcast coil, 70 to 200 meter coil. Panel, Chassis, High Grade Variable Condenser, Potentiometer, Antenna Trim-mer, Dial, Sockets, Knobs, Wire, Resistors, Condensers, and all other required parts including instructions and diagram.

**FOUR-TUBE ALL-ELECTRIC**

**MODEL 4A-E.** Similar to 3A-E but with powerful additional audio stage. Four tubes, one a ballast. Speaker \$1 extra. Phones extra (see auxiliaries). **\$4.20**  
 ONE-TUBE BATTERY SET—Model 1B. Satisfied owners report MARVELOUS FOREIGN RECEPTION. Also other S.W. and broadcast reception same as Model 3A-E. Ear-Phone reception. Complete kit includes parts listed above plus tube and filament rheostat. **\$2.45** With Tube and Uses inexpensive batteries. Phone (unwired)

**TWO-TUBE BATTERY SET—Model 2B.** Complete kit including all parts in the 1-tube model plus parts for extra audio stage including power tube. **\$2.95** With Two Tubes & Phone (unwired)

**THREE-TUBE DE LUXE BATTERY SET—Model 3B.** Complete kit including all parts in the 1-tube model plus parts for two extra audio stages in- **\$3.45** With Three Tubes cluding all three tubes. Phone (unwired)

Following Auxiliary Parts are available: 9 1/2 to 20 meter coil (foreign) 25c; 15 to 45 meter coil (foreign) 25c; 40 to 80 meter coil (foreign) 25c; 22 1/2 volt "B" battery 75c; Two flashlight "A" batteries 10c each; 5" Find-All Loud Speaker \$1; Complete Antenna Kit 50c; Wood Screw Kit 10c. Tubes for Model 3A-E, \$1.35. Tubes for Model 4A-E, \$2.10. Long Wave Unit and coil for any model \$1. Double Earphones \$1.30. Bandspread Attachment 75c. Any model wired extra \$1.

NOTE: If you already have earphones, two extra foreign coils may be substituted in any model except 4A-E.

**WORLD FAMOUS AIR WAVE 1-TUBE AIR SCOUT**

Thrilling Short Waves, Police Calls, Broadcast Programs. Amazing Results. Kit is complete except phones and battery. Uses single dry cell tube (50c) or storage bat. tube (25c). Three foreign coils 25c ea. Single Phone 25c. **\$1.00**  
 Less Tube Unwired

H. G. CISIN, CHIEF ENGINEER  
 Allied Engineering Institute, Dept. S-44  
 98 Park Place, New York, N. Y.

**YOU NEED THIS NEW 1938 CATALOG**

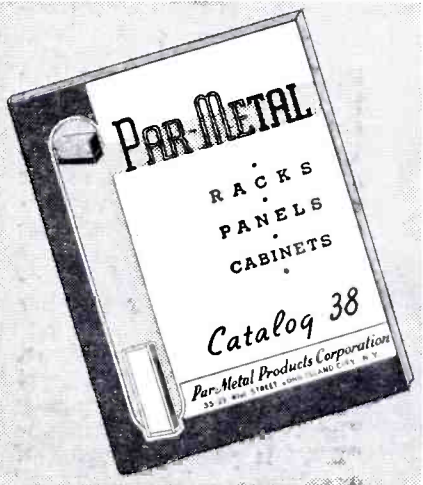

The most complete line of Racks, Panels, Cabinets, Etc. You can build up almost anything from a Short-Wave Receiver to a Professional Transmitter. Standardization of the units facilitates easy assembly of a real job of modern design and commercial appearance.

Write for your FREE copy today!

**PAR-METAL PRODUCTS CORP.**  
 3529 41st ST., LONG ISLAND CITY, N. Y.

**RADIO IN ITS ENTIRETY!**

"B-A" serves the trade with every need in radio—complete 160-page catalog of nationally known radio receivers, public address, parts, supplies and equipment. Orders shipped same day received.

COMPLETE CATALOG AVAILABLE

**BURSTEIN-APPLEBEE CO.**

1012-14 McGEE ST. KANSAS CITY, MO.

**9 People Can Talk 2-Way on One U.S.W. Circuit**

(Continued from page 535)

sinusoidal tone of frequency f1 kc. per second. This input modulates a channel-frequency oscillator having a frequency in the range 150 to 300 kc. per second, say, 155 kc. per second, resulting in a carrier frequency of 155 kc. per second together with upper and lower sidebands of (155 + f1) and (155 - f1) kc. per second. If channel No. 2 be supplied with a tone input of frequency f2, this will modulate an oscillator having a frequency of, say, 165 kc. per second, resulting in a carrier frequency of 165 kc. per second and upper and lower sidebands of (165 + f2) and (165 - f2) kc. per second. Similarly, channel 3 may have a carrier frequency of 180 kc. per second, and so on to the ninth channel of which the carrier frequency might be 280 kc. per second.

The bands of frequencies derived from the 9 channels are now added together, producing in total a single frequency band extending from (155 - f1) kc. to (280 + f9) kc. per second. This total frequency band is now used to modulate the output of the ultra short wave transmitter having a carrier frequency in the neighborhood of 76,000 kc. and to produce by this means a lower side-band extending from 76,000 - (280 + f9) kc. to 76,000 - (155 - f1) kc., and an upper side band extending from 76,000 + (155 - f1) kc. to 76,000 + (280 + f9) kc. per second. This is the band of frequencies which is radiated by the aerial system.

**Superheterodyne Receiver and Filters Employed**

The band of frequencies radiated by the transmitting system, as described above, is delivered by the distant receiving aerial system to a superheterodyne type of receiver. The second detector of this receiver produces from the above input the original side band extending from (155 - f1) kc. to (280 + f9) kc. This band of frequencies is then applied to a bank of 9 selecting circuits which operate as band-pass filters. The currents of frequency (155 - f1), 155 and (155 + f1) kc., will be passed by the first filter to a detector circuit which delivers the original frequency of f1 kc. to the first channel. Similarly, the frequencies (165 - f2) 165 and (165 + f2) kc. will be passed by the second filter to a detecting circuit which delivers the original frequency f2 to the second channel. In this manner the whole of the band of frequencies delivered by the second detector of the superheterodyne receiver will be split up, detected and delivered to the appropriate channel.

The carrier frequency of the ultra short wave transmitter is held constant within very close limits by a crystal-controlled master-oscillator, while the beating oscillator of the superheterodyne receiver is similarly crystal-controlled.

The foregoing explanation covers the transmission of 9 channels in one direction on a carrier wave of 76 megacycles (3.94 meters) approximately. For the reverse direction the circuits of the same 9 channels are transmitted on a carrier wave of 83 megacycles (3.612 meters) approximately.

Aerials: in order to minimize interfer-

ence between the transmitting and receiving waves, the plane of polarization of the waves emitted by the transmitting aerial is at right-angles to that of the waves received by the receiving aerial. At one terminal, therefore, the transmitter is equipped with an aerial system designed for vertical polarization, whereas the receiver is fitted with an aerial designed for horizontal polarization. At the other terminal the receiving aerial is vertically and the transmitting aerial horizontally polarized.

Receiver: The receiver is a superheterodyne in the output of the second detector of which the 9 auxiliary carrier frequencies of the distant transmitter are present. Each auxiliary carrier, together with its side bands, is separated out by means of filters, amplified and rectified to reproduce the original speech frequencies corresponding to the channel in question. After amplification these frequencies are passed out to the line at the required level.

It is easy to mix together 9 channels, but to separate them out again without noticeable crosstalk is a problem all its own. It is on the special design of the channel selecting circuits, by means of which this end is achieved that the successful operation of the whole system primarily depends.

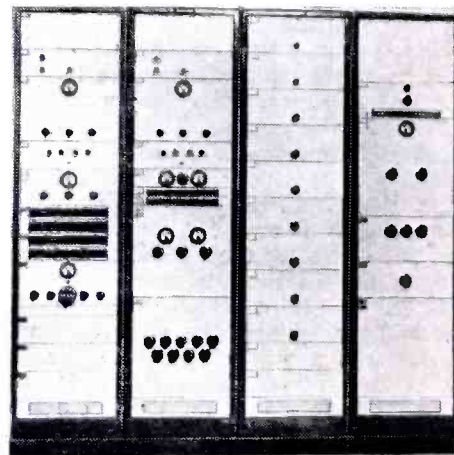

The receiver as installed at Belfast, Ireland, and Stranraer, Scotland.

General: It is quite evident that a fault in any part of the equipment common to all channels would be a catastrophe; a fault in one channel is serious, but the failure for any appreciable time of 9 channels is disastrous. The ultra short wave transmitter unit, being common to all 9 channels, is therefore, provided in duplicate. The reserve unit is normally not under tension, but if a fault such as the failure of a tube occurs, the power supplies and the aerial are automatically switched from the service to the reserve unit and a fault signal is given to the distant remote control point. That portion of the receiving equipment, which is common to all 9 channels, is similarly duplicated. In addition, the power supply is duplicated by an emergency plant which is switched in on failure of the public supply.

**An Automatic Sender for CW.**

(Continued from page 550)

with a hand key. The basis of the unit is a hand emery wheel which is obtainable from the "5 and 10." The emery wheel is removed and replaced with a small pulley and the handle is likewise taken off and replaced by a pulley to connect it to a small electric motor. The gears of the emery wheel provide the desired speed reduction from the motor speed.

The actual signal is recorded on a strip of

celluloid or movie film which has slots cut in it for the dots and dashes of the message. This strip is cemented to form an endless belt which runs over a pair of contacts which close at the points where the slots are cut in the celluloid strip. Messages are changed by changing the strips and cutting new ones with the desired calls, test signals, etc.

Television & Short Wave World (London).



# Television Sweep Coil Data

(Continued from page 576)

anode No. 2 voltage is not high, some decrease in picture brightness or definition, or both, is to be expected. However, operation at a low voltage permits of substantial saving in the cost of circuit parts, especially in the cost of the filter condenser in the rectifier circuit supplying the anode No. 2 voltage. A saving can also be made in the cost of the parts in the d-c power supply for the deflecting circuits, the reason being that the deflecting current required for full deflection of the spot is less for a low value of anode No. 2 voltage than for a high value.

The high voltages at which the 1801 is operated are very dangerous. Great care should be taken in the design of apparatus to prevent the operator from coming in contact with these high voltages. Precautions include the enclosing of high-potential terminals and the use of "interlock" switches to break the primary circuit of the high-voltage power supply when access to the apparatus is required. It is recommended that, when feasible, the 1801 be operated with the anode No. 2 at ground potential and the cathode at high negative potential with respect to ground. With this arrangement, the dangerous voltages can be made inaccessible more easily than when the tube is operated with the anode No. 2 terminal-cap at high potential above ground. The recommended arrangement generally can not be used in television equipment but is suitable for most oscillograph applications. When the recommended arrangement is used, the cathode should be connected di-

cathode circuit of the 1801.

It is important to note that the input power to the fluorescent screen should not exceed 10 mw. per sq. cm. A screen-input power in excess of this rating may cause temporary loss of sensitivity or permanent destruction of the screen material. To prevent this possibility, it is recommended that the spot always be kept in motion over a large area of the screen by the application of current to both sets of deflecting coils. When it is desired to make observations on a stationary spot, or when the spot is to scan only a small area of the screen, the brightness of the spot should be reduced to a low value by adjustment of the grid bias. In oscillograph applications where the spot traverses slowly any portion of a pattern, the brightness of the spot should be limited. When the spot moves so slowly that it is seen as a spot rather than as a line, the screen-input power should be limited as in the case of a stationary spot.

The currents to be supplied to the deflecting coils depend on the application of the 1801. In use of the tube as an oscillograph, a time-axis current is supplied to the horizontal-deflecting coils and the current under observation is amplified if necessary and supplied to the vertical-deflecting coils. In television reception, the currents supplied to the horizontal- and vertical-deflecting coils should have a sawtooth waveform, and a frequency controlled by the synchronizing components of the incoming television signal. Suitable circuits for supplying these currents are shown in Figs. 2 and 3.

A typical vertical-deflecting circuit is shown in Fig. 2. The vertical-synchronizing signal, which consists of a series of positive voltage pulses, is applied to the grid of the left-hand triode unit of the 6N7. When one of these pulses arrives at the grid, the left-hand triode unit starts to oscillate because of the feedback provided by the transformer T. The flow of grid current which accompanies this oscillation builds up a negative bias voltage on the grid leak and condenser,  $R_1-R_2$  and  $C_1$ . In a very short time this grid-leak bias reaches a value sufficient to cut off plate current. The left-hand triode unit, therefore, goes through only one half-cycle of oscillation, and then ceases to conduct. Each pulse of synchronizing voltage causes repetition of this self-blocking oscillation. In terms of grid voltage, this means that, with each pulse of synchronizing voltage, the grid goes positive for a very short time and then goes negative and stays negative until the next synchronizing pulse arrives.

The grid of the right-hand triode unit of the 6N7 is connected to the grid of the other triode unit. Therefore, with each synchronizing pulse, the plate current of the right-hand triode unit rises suddenly to a large value for a short time and then falls to zero and stays at zero until the arrival of the next synchronizing pulse. With the sudden rise in plate current, there is a sharp decrease in plate voltage because of the IR drop across  $R_4-R_5$ . During the time that plate current is cut off, there is a comparatively slow increase in plate voltage, the rate of increase being limited principally by the rate at which  $C_3$  can charge up through  $R_4-R_5$ . Since plate voltage goes periodically through a sharp decrease followed by a comparatively slow increase, the variation in plate voltage has a sawtooth waveform. This sawtooth voltage is applied to the grid of the 6C5, through  $C_4$  and  $R_7$ , and produces a sawtooth current in the plate circuit of the 6C5. Because the impedance of the deflecting coils  $L_2$  is low compared with that of the coupling choke  $L_1$ , a large part of the sawtooth current flows through the deflecting coils. *Courtesy RCA Mfg. Co. (To be concluded.)*

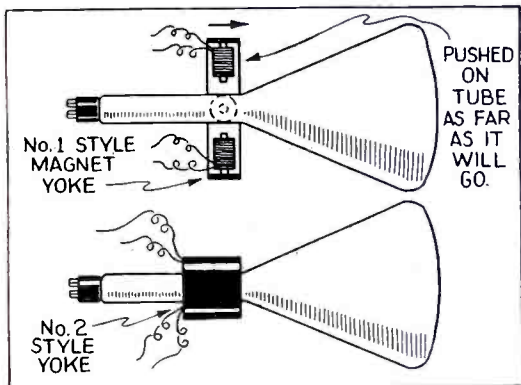

How Sweep Coils are placed on Cathode Ray Television Tubes.

rectly to one side or to the mid-tap of the heater winding. The heater winding should be adequately insulated to withstand the high voltage on the cathode.

In the use of a Kinescope, it should always be remembered that high voltages may appear at normally low-potential points in the circuit, due to condenser breakdown or to incorrect circuit connections. Therefore, before any part of a Kinescope circuit or its associated circuit is touched, the power-supply switch should be turned off and both terminals of any charged condenser grounded.

### Application

An operating circuit for the 1801, with voltage supply, is shown in Fig. 1. The electrode voltages are obtained from a bleeder circuit connected across a high-voltage supply. A bleeder current of two to five milliamperes is usually satisfactory; considerably larger values may require the use of more filtering than that provided by a single condenser shunted across the d-c supply. With small bleeder currents, a single condenser filter is usually adequate. A variable d-c voltage for the control electrode and for anode No. 1 can be obtained from potentiometers in the bleeder circuit. In a television receiver, the video signal and background-control bias supplied by the receiver are introduced in the grid-

**FOR THE BUILDER**

TOOLS AND ACCESSORIES

**FOR THE AMATEUR**

EVERY NATIONALLY ADVERTISED LINE

**FOR THE SERVICER**

REPLACEMENT PARTS HARD TO GET ITEMS

**FOR ALL RADIO MEN**

*Wholesale's*

**GREAT CATALOG!**

CONTAINS everything in radio . . . brings the World's Largest Radio Supply House right into your workshop. Now you can get all the latest equipment at tremendous savings. "Ham" equipment, test instruments, tools, parts, P.A. What you want, when you want it, at the right price. Here's your chance to buy direct at Wholesale. Get the Wholesale Catalog today!

MAIL THE COUPON FOR FREE COPY

**WHOLESALE RADIO SERVICE CO. INC.**  
 NEW YORK, N. Y. • CHICAGO, ILL. • ATLANTA, GA.  
 100 SIXTH AVENUE • 901 W. JACKSON BLVD. • 430 W. PEACHTREE ST., N. W.  
 BOSTON, MASS. • BRONX, N. Y. • NEWARK, N. J. • JAMAICA, L. I.

**WHOLESALE RADIO SERVICE CO., INC.**  
 100 SIXTH AVENUE, NEW YORK, N. Y.

Rush FREE 1938 Catalog No. 69-488

Name.....

Address.....

City.....State.....

PASTE COUPON ON PENNY POST CARD



5  
M  
E  
T  
E  
R



5  
M  
E  
T  
E  
R

### CRYSTAL CONTROL

The new HF2 10-meter crystal unit now makes possible high stability 5-meter transmitters of greatly simplified construction. Price, at all Bliley Dealers, \$5.75.

Write for Engineering Bulletin E-5.

**BLILEY ELECTRIC COMPANY**

201 UNION STATION BLDG., ERIE, PA.

### 1,000 MILES RECEPTION!!!

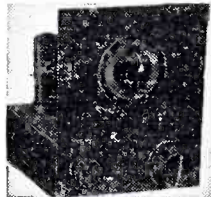

**2-TUBE KIT**  
Just what you have been looking for. A dandy all metal tube, rugged, portable radio. No "B" batteries required. Kit, including all necessary parts except ear-phones, battery, and tubes, un-wired **\$3.98**  
Wired, extra .75c  
**OFFER GOOD UNTIL APRIL 1st.** C.O.D.'s accepted.  
**ROLFE F. SCHELL, 515 Grand St. TROY, N. Y.**

### LOW PRICES ON RADIO PARTS

RCA-Victor Chokes—30 Hys.—150 Mils.	\$ .25
Franklin Fla. Trans.—5 V.—3 A.	.69
Franklin Fla. Trans.—7 1/2 V.—3 A.	.69
Power Trans.—Flush Mtg.—5 Tube Type—2 1/2 V. and 5 V.	.79
Franklin Fla. Trans.—5 V.—3 A. and 7 1/2 V.—3 A. C.T.	.95
Franklin Fla. Trans.—2 1/2 V.—12 A. C.T. and 5 V.—3 A. C.T.	.89
Pilot Double Choke—30 Hy. each—60 M.A.	.95
Franklin Plate Trans.—5000 V.C.T.—3000 V.C.T. @ 850 V.A.	9.95
Franklin Plate Trans.—4000 V.C.T.—3000 V.C.T. @ 850 V.A.	8.95
DeForest Type 250 Tubes.	.75
Sterling 866's—made by Hytron.	.89
Hytron 866's.	.99
Hytron Type 250.	.99
Hytron H.D. Type 210.	.99
Universal Condenser Microphone—new—List \$60.00	24.45
Universal Carbon Micro.—List \$25.00	7.95
Universal Type "LL" Carbon Micro.—List \$75.00	24.95
RCA-Victor R-32 Power Trans. for 2 1/2 and 1 1/2 Volt Tubes. Also 5 volt Rectifier.	.79
S.W. Coil Kits (4 coils to kit) 4 Prong 65c and 8 Prong.	.75
Pilot S.W. Coil Kits (kit of 4 coils)	.98

Send for Free Bargain Bulletin. Full of real values!  
25% with order—balance C.O.D.  
**SUPREME RADIO SUPPLY CO.**  
710-712 Broadway Schenectady, N. Y.

### AT LAST!

Our new catalog is completed.

If you are looking for VALUES, this is the book in which to find them.

Don't fail to send for

**YOUR COPY**

**TRY-MO RADIO CO., INC.**  
85 Cortlandt St., Dept. 2-8, New York City

### Let's Listen In

(Continued from page 553)

Both good signals, this at 7:20 a.m.

#### MANCHUKUO

TDD, 5.83 mc., Shinkyo, is heard from 6-9 a.m., phoning JUV, 5.79 mc., Nazaki, almost daily, good signals, this from Ashley Walcott, W6. W. S. Wade, W7, reports TDE, on 10.065 mc., as do we, with a steady signal near 6-7 a.m., daily; rarely on voice, however.

#### CHINA

XGOX, 9.77 mc., Nanking, still is on the air, but who knows for how long? A fairly readable signal, we do regret the hopelessness of sending them a report.

We were certainly surprised last week to receive two letters from Shanghai, verifying XTB, XTS, XTR, XGW. The letters must have just made the last mail!

#### JAVA

PMH, 6.72 mc., Bandoeng, is coming in very well lately, best around 6:30-7 a.m. Also YDC, 15.15 mc., at Bandoeng, with a fine signal near 7 a.m. PMN, 10.26 mc., heard this morning with an unusually FB signal for PMN, and PLP, 11.00 mc., are all easy to log. Latter two also at Bandoeng. All these stations will verify with the handsome QSL pictured in this month's column. Address reports to QRA printed on this card.

#### PHILIPPINE ISLANDS

KZIL, 14.06 mc., Phil. Gov't. station at Iloilo, on Panay Island was heard by Harry Honda, W6, calling KA1YL, the yacht "Latitude," at 9:30 a.m.

#### EUROPE

YUA, 6.10 mc., Belgrade, Yugoslavia, was again logged on a Sun. morning at 1:30 a.m., fair signal. This is a hard-to-get country that can be logged this winter.

RIR, 10.08 mc., Tiflis, U.S.S.R., was heard phoning RNE, 12.00 mc., Moscow, at 2:25 a.m.

Jim Lanyon, VES, reports three Russians, on 11.90, 14.71, and 14.93 mc., all heard re-laying RNE's program, with fine signal strength, from 11:30 a.m.-12:30 p.m.

#### HAM STARDUST

During November, as we predicted, the South African "deluge" did materialize, and we hope all of you DX fans did "clean up" at least a few of the choice South African signals on the 20 meter band. However, So. African ham DX will be coming through, though not every night, up to as late as the end of February, and if one tries nightly, 2 or 3 times a week, some of the South Africans may be heard, from 11 p.m.-12:30 a.m.

Below follows a list of our DX on 20 meters, from So. Africa:

ZS2N, 14010; ZS6AJ, 14030; ZT6AL, 14050; ZT6Y, 14050; ZS6T, 14050; ZE1JR, 14065; ZU6P, 14070; ZU6N, 14110; ZU5L, 14140; ZT6J, 14140; ZS6AJ, 14140; ZS6S, 14140; ZE1JN, 14145; ZT6AM, 14280; ZS3F, 14310; ZS5M, 14314; ZU6T, 14325; ZS5J, 14370; ZU6AF, 14380; ZT6AL, 14390; ZT5S, 14410.

Two of these, ZE1JR and ZE1JN, are in Southern Rhodesia. ZS3F also heard at 2:50 p.m., and ZU6N was heard at 3:22 p.m.

Roger Legge, W2, reports ZS3F, ZS2N, ZE1JR, ZS5M, ZT5S, ZT6AM, ZS6AU, 14300, ZU6AF, ZS6AJ, ZT6Y, ZU5G, 14350. "FB," Roger!

Ashley Wolcott reports ZS5M, ZT5S, ZU6P, ZU6AF. Murray Buitekant, W2, reports ZS5AB, 14060, ZS1B, 14065, ZS5M, FB, OB!

Harry Kentzel, W2, reports ZS3F, ZS5J, ZS5M, ZT6AL, ZT6AM, also FA3LY, L. F. end., Algeria. "Randy" Carpenter, W3, reports ZT5S, ZU6AF, and ZT6X. Come again, OM!

### A GOLD MINE OF INFORMATION



Here is an indispensable magazine which is a gold mine of information, revolutionary in scope. NEW IDEAS is a revelation in magazines in that it gives you from 300 to 400 brand new ideas every month, all of which are less than 60 days old by the time the magazine reaches you. The scouts of NEW IDEAS search the entire world for every worthwhile, practical new idea as soon as it appears anywhere in print. Some 800 different magazines, newspapers, Patent Gazettes and other sources are consulted, and the result is NEW IDEAS, by which anyone can benefit and profit.

There is no other magazine in the world today that gives you such a wealth of practical ideas. Remember that if you get only one worthwhile idea from the hundreds of ideas printed in the magazine, your money will have been well spent. In addition, the magazine makes most interesting reading in that it keeps you posted on every worthwhile new endeavor throughout the world.

**AND \$5000**  
**IN PRIZES FOR**  
**YOUR IDEAS...**

**NEW IDEAS, 99-A Hudson Street, New York, N. Y.**

NEW IDEAS has many departments, featuring,

- NEW IDEAS for Girls
- NEW IDEAS for Men
- NEW IDEAS for Boys
- NEW IDEAS for Women
- NEW IDEAS on Safety
- NEW IDEAS for Careers
- NEW IDEAS of all Sorts
- NEW IDEAS of Yesterday
- NEW IDEAS for Your Home
- NEW IDEAS for Camera Fans
- NEW IDEAS for Your Business
- NEW IDEAS for Making Money
- NEW IDEAS for Love and Marriage

The magazine is on sale the 25th of the month, and as the magazine is widely advertised, we suggest that you place your order with your news-dealer now. If the news-dealers cannot supply you, send 25c to

### ELECTRO BROILER—Every Home Needs It!

• LATEST COOKING INNOVATION MAKES TASTIER MEALS •

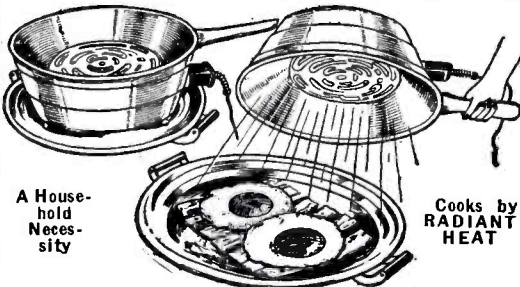

A Household Necessity

Cooks by RADIANT HEAT

A REAL cooking necessity—ELECTRO BROILER broils meat, fowl or fish—quickly and conveniently—without cooking odors. Makes food tastier by retaining all the juices and flavor—cooks by radiant heat. Simple and inexpensive to operate—use standard A.C. or D.C. current. Convertible for toasting or broiling—can be used as electric stove. Constructed of steel with attractive bakelite fittings—wood enameled handle permits easy handling. Complete unit—serving tray, cover with heating unit and electric cord . . . postpaid any-where in U.S.A. **\$6.95**

Send check or money order (register letter if you send cash or stamps) to

**HUDSON SPECIALTY COMPANY, 40-T West Broadway, New York, N. Y.**



# World Short-Wave Stations

(Continued from page 564)

6.018	ZHI	SINGAPORE, MALAYA, 49.18 m., Addr: Radio Service Co., 2 Orchard Rd. Mon., Wed. and Thu 5.40-8.0 am. Sat. 10.40 pm.-1.10 am.	5.853	WOB	LAWRENCEVILLE, N. J., 51.28 m., Addr. A. T. & T. Co. Works Bermuda nights.
6.015	HISU	SANTIAGO DE LOS CABALLEROS D. R., 49.88 m. 7.30-9 am., 12m.-2 pm., 5-7 pm., 8-9.30pm; Sun. 12.30-2, 5-6 pm.	5.850	YV1RB	MARACAIBO, VEN., 51.28 m., Addr. Apartado 214. 8.45-9.45 am., 11.15 am.-12.15 pm., 4.45-9.45 pm.; Sun. 11.45 am.-12.45 pm.
6.010	COCO	HAVANA, CUBA, 49.92 m., Addr. P. O. Box 98. Daily 7.55 am.-12m., Sun. till 11 pm.	5.830	TDD	SHINKYO, MANCHUKUO, 51.46 m. Works Tokio 6-9 am.
6.010	PRA8	PERNAMBUCO, BRAZIL, 49.92 m., Radio Club of Pernambuco, 6-9 pm.	5.830	TIGPH	SAN JOSE, COSTA RICA, 51.5 m., Addr. Alma Tica, Apartado 800. 11 am.-1 pm., 6-10 pm. Relays TIX 9-10 pm.
6.010	9MI	S. S. KANIMBLA, 49.92 m. (Travels between Australia and New Zealand). Sun. around 7 am.	5.813	TI2H	SAN JOSE, COSTA RICA, 51.59 m., Addr. Senor Gonzalo Pinto, H.
6.010	CJCX	SYDNEY, NOVA SCOTIA, 49.92 m. Relays CJCB 7 am.-1 pm., 4-8 pm.	5.800	YV5RC	CARACAS, VEN., 51.72 m., Addr. Radio Caracas. Sun. 8.30 am.-10.30 pm. Daily 7-8 am., 10.30 am.-1.45 pm., 3.45-9.30 pm.
6.005	HP5K	COLON, PAN., 49.96 m., Addr. Box 33. 7-9 am., 11.30 am.-1 pm., 6-11 pm.	5.790	JVU	NAZAKI, JAPAN, 51.81 m. Irregular.
6.005	CFCX	MONTREAL, CAN., 49.96 m., Can. Marconi Co. Relays CFCF 7.45 am.-1 am.; Sun. 10 am.-12.15 am.	5.780	OAX4D	LIMA, PERU, 51.9 m., Addr. P. O. Box 853. Mon., Wed. and Sat. 9-11.30 pm.
6.005	VE9DN	ORUMMONDVILLE, QUE., CAN., 49.96 m., Addr. Canadian Marconi Co. Sat. 11.30 pm.-2 am.	5.770	YV2RA	SAN CRISTOBAL, VENEZUELA, 51.96 m., Addr. La Voz de Tachira. 11.30 am.-12 n., 5.30-9 pm., Sun. till 10 pm.
6.000	CXA2	MONTEVIDEO, URUGUAY, 50 m. Addr. Rio Negro 1631. Relays LS2, Radio Prieto, Buenos Aires. 10.30 am.-10.30 pm.	5.758	YNOP	MANAGUA, NICARAGUA, 52.11 m. 8-9.30 pm.
6.000	ZEA	SALISBURY, RHODESIA, S. AFRICA, 50 m. (See 6.147 mc., ZEB.) Also Sun. 3.30-5 am.	5.740	TGS	GUATEMALA CITY, GUAT., 52.26 m. Wed., Thur. and Sun. 6-9 pm.
6.000	RV59	MOSCOW, U.S.S.R., 50 m. Irregular. 3-6 pm.	5.730	HC1PM	QUITO, ECUADOR, 52.36 m. Irregular 10 pm.-12 m.
5.990	XEBT	MEXICO CITY, MEX., 50.08 m., Addr. P. O. Box 79-44. 8 am.-1 am.	5.720	YV2RB	SAN CRISTOBAL, VEN., 52.45 m., Addr. La Voz de Tachira. 6-11.30 pm.
5.977	CS2WD	LISBON, PORTUGAL, 50.15 m., Addr. Rua Capelo 5. 3:30-6 pm.	5.500	TI5HH	SAN RAMON, COSTA RICA, 54.55 m. Irregular 3.30-4, 8-11.30 pm.
5.970	HJ4ABD	MEDELLIN, COL., 50.26 m., Addr. La Voz Catia. 8-11.30 pm.	5.145	PMY	BANDOENG, JAVA, 58.31 m. 5.30-11 am.
5.968	HVJ	VATICAN CITY, 50.27 m. 2-2.15 pm. daily; Sun. 5-5.30 am.	5.077	WCN	LAWRENCEVILLE, N. J., 59.7 m. Addr. A. T. & T. Co. Works England late at night irregularly.
5.950	HJN	BOGOTA, COL., Radiodifusora Nacional, 50.42 m. 6-11 pm.	5.025	ZFA	HAMILTON, BERMUDA, 59.7 m. Works N. Y. C. irregularly at night.
5.840	TG2X	GUATEMALA CITY, GUAT., 50.5 m. 4-6, 9-11 pm.; Sun. 2-5 am.	5.000	TFL	REYKJAVIK, ICELAND, 60 m. Works Europe nighttime irregularly.
5.930	YV1RL	MARACAIBO, VEN., 50.59 m., Addr. Radio Popular, Jose A. Higuera M, P. O. Box 247. Daily 11.43 am.-1.43 pm., 5.13-10.13 pm.; Sun. 9.13 am.-3.13 pm.	4.975	GBC	RUGBY, ENG., 60.3 m. Works ships irregularly.
5.825	HH2S	PORT-AU-PRINCE, HAYTI, 50.63 m., Addr. P. O. Box A103. 7-9.45 pm.	4.900	HJ3ABH	BOGOTA, COL., 61.19 m., Addr. Apartado 565. 12 n.-2 pm., 6-11 pm.; Sun. 12m.-2 pm., 4-11 pm.
5.917	YV4RP	VALENCIA, VEN., 50.71 m. Irregular.	4.836	HJ3ABD	BOGOTA, COL., 62 m., Addr. La Nueva Granada, Box 509. 12 m.-2 pm., 7-11 pm., Sun. 5-9 pm.
5.900	ZNB	MAFEKING, BRI. BECHUANALAND S. AFRICA, 50.84 m. Addr. The Govt. Engineer, P. O. Box 106. Gives news Sun. at 1.30 pm.	4.820	GDW	RUGBY, ENG., 62.24 m. Works N.Y.C. nighttime irregularly.
5.900	TIMS	PUNTARENAS, COSTA RICA, 50.85 m. 6-10 pm.	4.810	HJ2ABC	CUCUTA, COL., 62.34 m. La Voz de Cucuta, 8 pm. to 12 m.
5.898	YV3RA	BARQUISIMETO, VEN., 50.86 m., Addr. La Voz de Lara, 12 m.-1 pm., 6-10 pm.	4.807	HJ1ABB	BARRANQUILLA, COL., 62.39 m., La Voz de Barranquilla, Addr. P. O. Box 715. 11.30 am. to 1 pm., 4.30-6 pm.
5.890	JIC	TAIHOKU, FORMOSA, 50.93 m. Works Tokio 6-9 am.	4.790	VE9BK	VANCOUVER, B. C., CAN., 62.63 m. Addr. Radio Sales Service, Ltd., 780 Beatty St. Except Sun. 11.30-11.45 am., 3-3.15, 8-8.15 pm.
5.886	HCK	QUITO, ECUADOR, 50.98 m. 8-11 pm.	4.752	WOO	OCEAN GATE, N. J., 63.1 m., Addr. A. T. & T. Co. Works ships irregularly.
5.875	HRN	TEGUCIGALPA, HONDURAS, 51.06 m. 1.15-2.16, 8.30-10 pm.; Sun 3.30-5.30, 8.30-9.30 pm.	4.600	HC2ET	GUAYAQUIL, ECUADOR, 65.22 m. Addr. Apartado 249. Wed. and Sat 9.15-11 pm.
5.865	HI1J	SAN PEDRO DE MACORIS, D. R., 51.25 m., Addr. Box 204. 12 m.-2 pm., 6.30-9 pm.	4.272	WOO	OCEAN GATE, N. J., 70.22 m., Addr. A. T. & T. Co. Works ships irregularly.
			4.250	RV15	KHABAROVSK SIBERIA, U. S. S. R., 70.42 m. 1-10 am.

## 2 men, 7 miles apart, shown on Television Screen

In a recent dispatch to the New York Times it was reported that television history was made when persons in London saw and heard in their homes an animated conversation between two men standing more than seven miles apart, who could both see and hear each other.

Gerald Cook, television director of the

British Broadcasting Corporation, talked before a screen at the corporation's television station in Alexandra Palace, and Walter Mycroft, film director, was before a television receiver at the Elstree studios. The success of the experiment is held to be a remarkable foretaste of television's possibilities.

Please mention SHORT WAVE & TELEVISION when writing advertisers



No. 467-451—Transformer for Class B Driver

**"For Best Results—use Jefferson Transformers"**

Those who have had widest radio experience with receivers, transmitters, amplifiers—know that the transformers used make a big difference—as Ted Govern confirms.

Jefferson Transformers have become the recognized standard for those demanding the highest efficiency and the most reliable service. . . . You can get Jefferson Transformers from your Parts Jobber—and if you want our complete catalog and manual of Amplifier Circuit Diagrams, just clip and mail the coupon below.

**JEFFERSON ELECTRIC COMPANY**  
BELLWOOD, ILLINOIS

Canadian Factory:  
535 College St., Toronto, Ont.

Get Complete Catalog and New Amplifier Circuit Diagrams—Free.

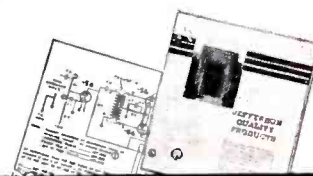

**JEFFERSON RADIO TRANSFORMERS**

JEFFERSON ELECTRIC COMPANY, BELLWOOD, ILL. 5  
Mail latest Catalog 372-R and your free manual of New Amplifier Circuit Diagrams:  
Name .....  
Address .....  
City and State.....



# RADIO INSTRUCTION

972 PAGES  
 ONLY \$4-  
 200 PHOTOS  
 USED IN 82 COUNTRIES  
 EQUAL TO 36 BOOKS  
 WEIGHS 4 POUNDS  
 508 ILLUSTR.

**THE MOST FOR YOUR MONEY**  
 in Ghirardi's 1 Volume  
**RADIO PHYSICS COURSE**

Would you be satisfied with 10 times your money's worth? Here's a bargain better than that! You can get the famous Ghirardi radio course, complete in one huge volume that will explain and make the whole fascinating field of RADIO, ELECTRICITY, and SOUND clear and easy to you no matter how slight your previous training. The world's BEST, EASIEST and MOST INTERESTING book to learn radio from. That's why it is used by radio schools, by students, by everybody in "the radio game" the world over. Take a tip from those who know—get Ghirardi and teach yourself. You can't beat it no matter how much you pay! And you get it all at the amazing low price of only \$4. MAIL COUPON TODAY!

**WHAT THIS BOOK TEACHES YOU:**

- Sound, Speech and Music
- Electric Current
- Resistance
- Ohm's Law
- Batteries
- Magnetism
- Electromagnetism
- Transformers
- Inductance
- Condensers
- Alternating Current Circuits
- Filters
- Electrical Measuring Instruments
- Radio waves and radiations
- Broadcast Stations
- Receiving Equipment
- Vacuum Tubes
- Radio and Audio Frequency Amplification
- Loud Speakers
- Battery Operated Receivers
- Power Supply Units
- Electric Receivers
- Automobile and Aircraft Receivers
- Phonograph Pickups
- P.A. Systems
- Short-Wave Receivers
- Photoelectric Cells
- Television
- Antennas and Grounds
- Testing and Servicing Receivers
- Sound Motion Pictures
- Appendices
- 856 Review Questions for Self-Study—and LOTS MORE!

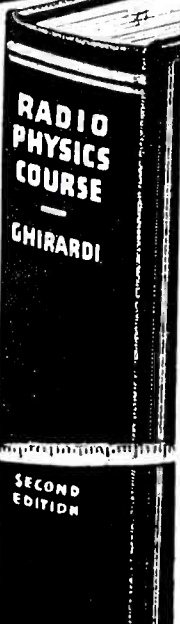

To RADIO & TECHNICAL PUBLISHING CO.  
 45 ASTOR PLACE • NEW YORK

Enc. find \$4. Send my RADIO PHYSICS COURSE at once, postpaid. (Foreign \$1.50)  
 Send me a free circular describing this book.

Name.....  
 St. & City.....  
 State..... (SWT-28)

**MONEY-BACK GUARANTEE!**

## READ AND SEND CODE

Learn Easily at Home This Quicker Way

No experience needed. Beginners read code quickly, copy accurately. If already an op, speed up your wpm with this approved amazing Master Telex Code Teacher. Only instrument ever produced which records your sending in visible dots and dashes on specially prepared paper tape—then sends back your own key work at any speed you wish. Fascinating, fool-proof—gets results because you learn by HEARING as well as SEEING. That is why thousands agree this method is surest and quickest. We furnish Complete Course, lend you the New All Electric Master Telex, and personal instruction with a MONEY-BACK GUARANTEED. Low cost, easy terms. Write today for folder S2, no obligation.



**TELEPLEX CO., 72-76 Cortlandt St., New York**

## Radio—A Wide-Open Door to Opportunity

(Continued from page 573)

ever, in spite of the fact that their training and every-day experience makes them so eminently fitted for this kind of work, in spite of the fact that this field offers such unlimited possibilities, most radio technicians seem to have overlooked completely this market for their labors. Most photo-electric installations employ vacuum tube amplifiers, with the same radio tubes and basic circuits that radio technicians are used to handling every day in radio receivers, yet most of them are completely unaware of this fact.

Because of their technical background and their first-hand knowledge of some of the most important parts of photo-electric installations; because of their experience and skill in dealing with delicate electrical equipment, radio men are the logical ones to build up this new industry whose potentialities are so vast and whose possibilities have barely been exploited. Yet, undoubtedly because it is not strictly radio work, most of them have disregarded it entirely, despite the fact that it offers even greater opportunities than radio. However, those technicians today who possess the same mettle as the pioneers in radio, who are alert enough to study the photo-electric field now and learn everything there is to know about it, are opening up a new and very promising field for their work.

A third market for the radio man's skill lies in the field of public address equipment. The public address man must have the basic knowledge that every radio serviceman has, which means that any radio serviceman interested enough and progressive enough to want to find new fields for his talents can devote himself to the study of this new branch of radio with every assurance of success. It is only recently, within the past few years, as a matter of fact, that this vast field has really been thrown open to the individual radio man, for up to that time public address equipment was not practicable for wide-scale consumption, being outside of a reasonable price range and not altogether as dependable as it is today.

The field of office and factory intercommunicating systems, long a very minor part of the public address field, has also finally come into its own since the recent development of more compact and more inexpensive units. Its potentialities are so vast that it will undoubtedly grow to be a separate and distinct field of radio, employing thousands of men for production, sales, and service work.

The branch of automobile radio also offers great possibilities to the progressive radio technician. Automobile radio today is far from perfect; there is very much room for improvement. And to the man who applies himself to its problems will accrue great rewards.

The same thing is true of short-wave and all-wave receivers. They, too, require the touch of perfection. In addition, their more widespread use in the home has opened still other fields for radio work. It has raised the problems of more complex sale and servicing

## INSURE YOUR FUTURE! Start Training Now in PRACTICAL RADIO ENGINEERING

Do you ever sit down and "look your job in the face"? Are you satisfied with your present position, or anxious to get ahead? Today, you can't be satisfied, because rapid new developments mean Radio wants only men who are **TECHNICALLY TRAINED**.

### Home Study or Residence Course

The CREI Residence School in Washington, D.C. offers thorough training in both engineering theory and practice. Completely equipped modern "labs" and shops. Outstanding faculty. Course starts in Sept. Early enrollees receive special home-study preparatory material at no extra cost. Write for complete details how you can start training today.



Read this FREE Book

### "A TESTED PLAN FOR A FUTURE IN RADIO"

Just off the press! 48 pages of interesting facts and illustrations. Describes CREI home-study and residence courses and your future in Radio. WRITE FOR YOUR COPY TODAY!

## CAPITOL RADIO ENGINEERING INSTITUTE

Dept. SW-2  
 14th and Park Rd., N. W. Washington, D. C.

Send for your copy TODAY



## Do You Like RADIO

TELEVISION, SOUND & ELECTRICITY

You men who want to know the true facts about employment opportunities and requirements in radio and related industries should have National's new book—40 pages of information and illustrations.

### NATIONAL SCHOOLS

**NATIONAL SCHOOLS**  
 Dept. SWC-2, 4000 So. Figueroa St., Los Angeles, Calif.  
 Please Send Free Book

NAME..... AGE.....  
 ADDRESS.....  
 CITY..... STATE.....

## Announcing THE FOURTH EDITION OF EXPERIMENTAL RADIO

(196 p. 6x9 cloth. 136 experiments, 167 figures). By Professor R. R. Ramsey, Ind. Univ. A revision of the original book for experimenters and students. Diagrams drawn for power packs and batteries. Many new and original ideas. The earlier editions were the first books to contain new features which are accepted now. Of this edition again it can be said, "Ramsey manages to supply that missing fact which seems to be hidden in other books."



### FUNDAMENTALS of RADIO

Second, 1935 Edition. By the same author. A modern text book with a minimum of mathematics giving fundamental theory of radio. Practice may change; Basic principles remain the same. Price: Experimental \$2.75. Fundamentals \$3.50 postpaid.

Ramsey Publishing Co.,  
 Bloomington, Indiana

## EXPERT RADIO SERVICE COURSE

Speed tough service jobs. Make more profit. The C-B Visual Service Course gives you "know how." Designed for service men by famous Midland Television School and C-B engineers. For details, see your C-B jobber or write us. Make your time pay more. Don't delay. Write TODAY.

The CLOUGH-BREngle CO.  
 2813-E W. 19th St. Chicago, Ill.

## RADIO ENGINEERING,

broadcasting, aviation and police radio, servicing, marine radio telegraphy and telephony, Morse telegraphy and railway accounting taught thoroughly. Engineering course of nine months' duration equivalent to three years of college radio work. All expenses low. Catalog free. School established 1874.

Dodge's Institute, Turner St., Valparaiso Ind.



# RADIO INSTRUCTION

## LEARN CODE RIGHT

It's easy and practical to learn or improve your radio or Morse Code, any speed. Senior model with 10 tapes and Book of Instructions—\$20.25. (Rented at low cost.) Junior model with 5 tapes and Book of Instructions—\$12.00 (Not rented). Complete oscillator equipment, less battery, \$6.50. Send for details today to—

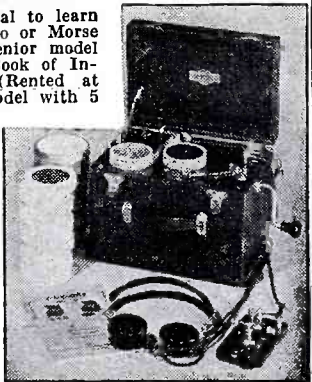

**INSTRUCTOGRAPH CO.,** Dept. SW-2  
912 Lakeside Place  
Chicago.

Canadian Representative: Radio College of Canada, 863 Bay St., Toronto

BUY ON CASH OR TERMS: HALLICRAFTER and R.M.E. SHORT-WAVE RECEIVERS, SPEED-X and VIBROPLEXES

## RADIO ENGINEERING

RCA Institutes offer an intensive course of high standard embracing all phases of Radio. Practical training with modern equipment at New York and Chicago schools. Also specialized courses and Home Study Courses under "No obligation" plan. Catalog Dept. SW-38.



### RCA INSTITUTES, Inc.

A Radio Corporation of America Service  
75 Varick St., New York. 1154 Merchandise Mart, Chicago

## BE A RADIO SERVICE EXPERT



Modern receivers require men with modern training for service work  
**LEARN AT HOME**  
Our home instruction method and service equipment offer starts you earning money almost at once. Up to \$3 an hour easy in a short time. Write for free book.

Radio Training Ass'n of America  
Dept. SW-82  
4525 Ravenswood Ave., Chicago

requirements and has kindled a new interest in more efficient antenna and noise-reducing systems.

Even a field so closely allied to radio as radio receiver design provides the right kind of radio men with plenty of opportunity to display their skill and benefit thereby. There is still much that is short of perfection in the radio receivers that are manufactured today. This is well borne out by the fact that weak spots in receivers are constantly noted and improved as each company brings out a new model. The same can be said of the construction, operation, and performance of our radio sets, although they do maintain a very high standard.

Push-button tuning in home radio receivers has opened up new fields for both designers and service men. Unquestionably more simple, rugged, and inexpensive control mechanisms are needed and will be developed within the next few years. On the other hand, servicemen will benefit by the additional servicing which the mechanisms and special circuits these receivers employ will require.

**Television:** Finally, the field of television suggests tremendous opportunities. Though the possibility of television has been imminent for so long that it has almost lost its effect, there is no doubt that the time is not very far off when television will become a reality. Considering the obstacles that have blocked the way of practical television, much progress has been made in this work and the feeling is prevalent that something will happen almost any time now that will make television in the home an actuality.

In view of this evidence of ever-widening, new fields for skilled radio work, the opinion that the radio industry has reached its peak of development is utterly unsound. The radio industry can offer nothing to those who are

content with outmoded methods. It is overcrowded only for those who resent progress because it means learning new things all the time, and whose sluggishness has caused them to be left behind by their more alert fellow craftsmen.

Radio is a great field for men with ideas, for men who are not afraid of change; it provides opportunity for newcomers who are willing to apply themselves to the study of new techniques, who are eager to learn and to improve themselves as technicians, and who are not afraid of work—real hard work—but the most fascinating and intriguing work that any red-blooded man can possibly wish for!

(Author of *Radio Physics Course*; *Radio Servicing Course*; *Modern Radio Servicing*; *Radio Field Service Data*)

## World-Wide Short-Wave Review

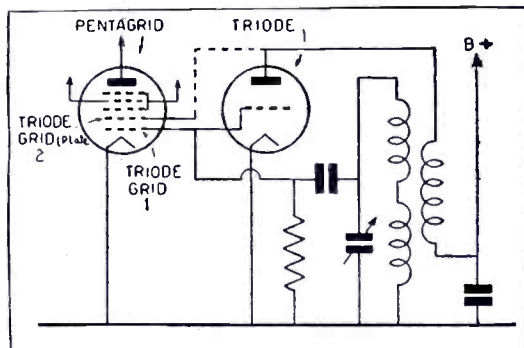

This circuit shows how to improve short-wave reception on the higher frequency end of the band.

### Improving Short-Wave Reception

● IN all-wave and short-wave superheterodyne receivers of the type using a pentagrid converter for first detector and oscillator, difficulty is sometimes encountered in obtaining strong oscillations on the high-frequency end of the band covered.

One means of overcoming this trouble, for those who are most interested in this end of the band, is to insert a triode tube for the oscillator, either in parallel with the triode portion of the pentagrid converter or to replace it, as shown in the circuit here reproduced from *Le Journal des "8"* (Paris).

In connecting the triode in parallel with the oscillator section of the pentagrid tube, the dotted wire of the circuit is connected. In some cases the inter-element capacity may be sufficient to throw the tuning off on the S.W. bands or even to prevent oscillation. In this case, the triode plate-grid of the converter tube can be omitted, using the triode grid of the converter as an injection grid for the oscillator voltage. In this case, the dotted wire is omitted.

## BOOK REVIEW

**ELECTRICAL OCCUPATIONS FOR BOYS**, by Lee M. Klinefelter. Stiff cloth covers, size 5½"x7¾"; 228 pages, illustrated. Published by E. P. Dutton Co., New York.

This is a dandy book for boys and one of the best that has come to the reviewer's attention, in many years. This treatise is fresh and sprightly and will give the young boy some practical idea of what the work of electrical and mechanical tradesmen are like. The various chapters are nicely illustrated with photographs of men at work on the various jobs described. Among the trades described are those of power station operators and engineers, electricians, electrical draftsmen, battery men, motion picture



## MAKE MORE MONEY IN RADIO

I SET YOU UP

## Ready For Business And Profits

Here at last is a distinctly new type of home training that not only teaches you all phases of Radio Service Engineering work—but which also equips you fully for an actual start in your own Radio business. Sprayberry Training has been conscientiously designed to fit you for a truly worthwhile place in Radio—a position well above the average in a fascinating industry with vast opportunities for development.

### NO EXPERIENCE NEEDED

Sprayberry Training starts right at the beginning in Radio and thoroughly covers all branches and phases in a concise, easily understood manner. Fits you for a career in any one of Radio's specialized fields, such as sound work, broadcasting, aviation Radio, etc.

### BIG PROFESSIONAL OUTFIT GIVEN

YOU GET A THREE-IN-ONE TESTER, RIDER MANUALS, (7076 pages) TOOL KIT, ELECTRIC EYE OUTFIT AND EXPERIMENTAL APPARATUS.

### "CLEARED" \$150 IN SPARE TIME

A. H. Lanoie, Northbridge, Mass., writes: "Since enrolling I have cleared a net profit of more than \$150, in spare time alone and I am not one-half through the course yet. Honestly, I cannot understand how you can give so much 'dope' for so little money."

### SPECIAL SERVICEMAN'S COURSE

An advanced Training Course for those already in Radio. Saves you time—money—teaches the easiest way to do the hardest jobs. Complete details of this advanced course and fundamental course, features, etc., fully described in my 48 page free hook. Send for your copy today.



Mail Coupon Now

SPRAYBERRY ACADEMY OF RADIO  
F. L. Sprayberry, Pres.  
145-B University Place, N.W.  
Washington, D.C.

Please send me free copy of "More Money in Radio."

Name ..... Age.....  
Address .....  
City ..... State.....  
(Mail in envelope or paste coupon on postcard.)

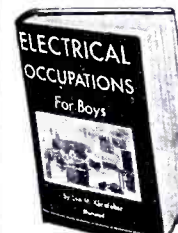

## ELECTRICAL OCCUPATIONS FOR BOYS

By Lee N. Klinefelter, B. S., M. A.

● Covering the entire field of electrical occupations available to boys when they grow up. Electrical Engineers, Power Station Operators, Army & Navy Specialists, etc.—each fully describes his own type of work and answers typical questions. Recommended by electrical magazines, engineers, instructors, and Government officials. 64 full-page illustrations. For YOUR COPY, send coupon below:

E. P. DUTTON & CO., Inc.  
Dept. S.—300 Fourth Ave., N.Y.C.  
Gentlemen: \$2 enclosed, for which please send me postpaid my copy of ELECTRICAL OCCUPATIONS FOR BOYS.

Name .....  
Address .....  
City ..... State.....

## RADIO COURSES

**RADIO OPERATING:** Prepare for Gov't License Exam. ● **RADIO SERVICING:** Including Short Wave ● **AMATEUR CODE** ● **ELECTRONICS** ● **TELEVISION:** Day and Evening Classes. Booklet Upon Request.

**New York YMCA Schools**  
6 W. 64th Street, New York City



## OMNIGRAPH CODE

Expert Training with the Automatic Omnigraph sends Code without stop. Dials changed free. Models \$2 to \$25. Folder B. The Omnigraph Co., 810 East 39 St., Brooklyn, N.Y.











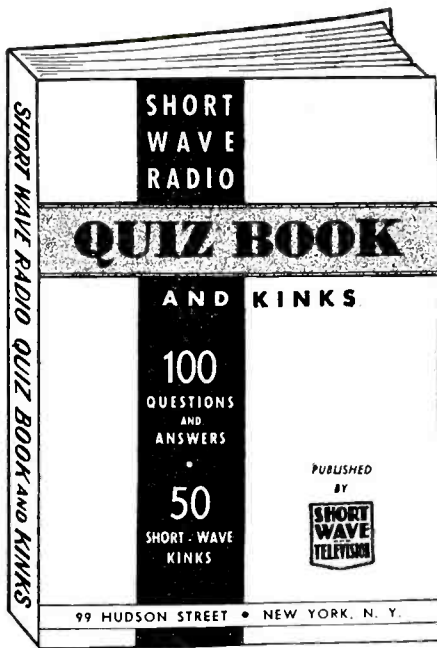

**WE HAVE NEVER MADE SUCH AN OUTSTANDING OFFER TO OUR READERS!**

HERE is a brand new book—with an unusually interesting content. The text—prepared by the Editorial Staff of SHORT WAVE AND TELEVISION, contains a variety of material which only experts could select and incorporate in such an excellent volume. "SHORT WAVE RADIO QUIZ BOOK AND KINKS" cannot be bought—it is sent to you absolutely FREE with your subscription to SHORT WAVE AND TELEVISION at the Special Rate of Seven Months for One Dollar. (Old subscribers may get this book by extending their subscription.)

The book contains 64 pages with a heavy flexible colored cover. It measures 5½x8½ inches, and includes hundreds of photographs and diagrams. The contents are outlined below.

Questions and Answers Covering S-W Transmitters.

Questions and Answers Covering S-W Receivers.

Ultra-Short-Wave Transmitters and Receivers. S-W "Kinks"—Short-cuts and Practical Wrinkles, Coil Winding Data.

How to Add an Audio Amplifier to a Small

S-W Receiver.

How to Connect an R.F. Stage Ahead of Your Present Receiver.

Dozens of Novel New Hook-Ups for the S-W Experimenter.

Clear diagrams showing how to connect the latest type tubes in place of your old tubes, so as to obtain greater DX.

**HOW TO "HOOK UP"—**

S-W Converters  
Noise Silencers

Power Supplies  
Modulators

Beat Oscillators  
Antennas

Pre-selectors  
5-meter receivers

**SHORT WAVE AND TELEVISION • 99 Hudson Street • NEW YORK, N. Y.**

SHORT WAVE AND TELEVISION, 99 Hudson Street, New York, N. Y.

Gentlemen: Enclosed you will find my remittance of \$....., for which enter my subscription to SHORT WAVE AND TELEVISION for

- 7 months—\$1.00—choice of any one of three (3) books. (Canadian and foreign—\$1.30)
- 14 months—\$2.00—choice of any two (2) of the three (3) books. (Canadian and foreign—\$2.60)
- 21 months—\$3.00—all three books (Canadian and foreign—\$3.90)

If you are a subscriber now, we will extend your present subscription. Books are to be mailed POSTPAID.

- New subscriber
- Old subscriber

Name ..... Address .....

City ..... State .....

Send your remittance by check or money order. If you send cash or unused U.S. postage stamps, please be sure to register your letter for your own protection.

Dept. SWT-238

**2 Other FREE Books  
ABC OF TELEVISION**

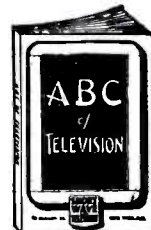

Contains latest material on Television developments. It covers theory of scanning; simple television receiver; how the eye sees; the photo-electric cell; neon lamps; need for broad channel width in transmission of high-fidelity television signals; cathode ray tube and television receivers; Farnsworth system of television transmission, and other important features.

**SHORT WAVE GUIDE**

Covers hundreds of Short-Wave questions and answers; illustrates popular Short-Wave kinks; gives instructions for building simple Short-Wave receivers; instruction on the best type of antenna to use; diagram and construction details for building a simple "ham" transmitter; practical hints on Short-Wave tuning.

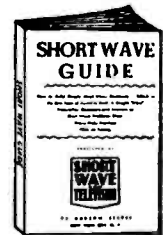

the two capacities; with the high C oscillator in our set-up there is considerable *band-spread* over the oscillator dial with limited spread on the signal dial—actually facilitating tuning.

**Oscillator and Power-Supply**

The oscillator circuit is conventional. L4 consists of three turns of No. 24 or smaller D.S.C. wire, wound between the L3 turns; it provides for feed-back sufficient to bring the stage into oscillation with more or less constant output throughout the tuning range. RFC 3 and 4 are UHF chokes in the filament feed line and are connected, by the way, right at the V3 tube terminals.

Getting back to the mixer stage—note that the signal circuit is made regenerative through *feed-back* from the cathode to L2 (through C12). The regeneration is just enough to make the L2-C1 circuit tune about as sharply as the oscillator circuit—to noticeable selectivity and signal-to-noise ratio improvement. L5 tunes by means of C16 (which is an APC trimmer installed within the L5-L6 coil form) to the desired output frequency; L6 is the output low-impedance winding proper for a good "link-coupled" match into the receiver with which the converter is to be used. The L5-L6 combination is simply a factory-built plug-in coil, designed for installation of C16 within the form, and it is replaceable by coils wound for other ranges which, with a C16 capacity of 140 mmf.

maximum, will tune from 17 to 41 meters (for wide acceptance amplification by a plug-in coil SW receiver of the TRF type), 33 to 75 meters, and 135 to 270 meters (where the receiver is a broadcast band job, TRF or superhet, requiring a converter output I.F. of approximately 1500 kc.).

The power-supply circuit is conventional and suggests the familiar arrangement of power transformer and two-section filter. C 19, 20, and 21 are all 8 mf. electrolytics, which may be of the inexpensive etched foil type. Ch1 and Ch2 are both 30 henry chokes, with a collective resistance of 1,100 ohms. R 10—an adjustable 2,000 ohm 20 watt wire wound resistor—is in circuit simply so that the power-pack output at full converter drain may be fixed at 250 volts. C 22 and C 23 are optional and advisable mica RF by-pass capacitors, with C 24 the usual line filter.

**Construction**

1. Shield the lead from the V2 plate to the output coil socket, using low capacity shield tubing. Also shield the low impedance winding leads from the latter socket to the output binding post assembly.
2. Keep all leads short and direct. Bring all returns for each stage to one chassis point—preferably the grounded No. 1 terminal of the stage socket.
3. Do not attempt to substitute the conventional .1 mf. tubular by-pass capacities for the mica postage-stamp type indicated.

4. Connect the 18 turn, quarter-inch diameter L1 coil between the V1 grid cap and a close-by chassis point, making sure that the body of the coil hangs well away from chassis to minimize capacity-to-ground effects.

5. Mount the filament chokes RFC 3 and 4 between the oscillator socket filament terminals and a two-point tie assembly. Connect .00005 mf. mica by-pass capacities at each tube socket, between one filament leg and the cathode terminal.

6. Install the APC trimmer in the output coil form, connecting it across the plate winding so that the V2 plate circuit may be tuned to desired output frequency.

**Adjustments**

Connect power pack to tuner, after checking over the wiring carefully and making the usual continuity test for opens and shorts which should precede any power turn-on. Close the A.C. line switch (which should have been mounted on the rear cover of the cabinet), measure voltages at screen, cathode, and plate points, then adjust R10 until the B plus at tube plates is 250. Screens should now measure 100 for the R.F. and H.F.O., and from 0 to 100 for the *mixer* as determined by the adjustment of R12.

If your receiver is an all-wave affair, dial it to approximately 4,000 kc.; if it is a broadcast band job only, dial it to about 1500 kc. Connect up the two units—running the two wire lead line (which should be as short as



# DATAPRINT SERVICE

New low price—  
Any 3 Prints.....\$1.00

## TESLA COIL DATA:

- Dataprint—drawings and data for building 36 inch spark Tesla.....50c
- Exciter—1 K.W. 20,000 Vt. Transf.....50c
- 3" Sp'k. Tesla Coil. Works on Ford Coil.....50c
- 3" Sp'k. Oudin Coil. Works on 110 A.C.....50c
- 20 "Tricks" with Teslas & Oudins.....50c
- 8" Sp'k. Tesla Coil.....50c
- Exciter—1/2 K.W. 15,000 Volt Transf.....50c
- Violetta—1" Sp'k. Oudin. Vibrator type.....50c
- How to Operate Oudins from V. T. Osc.....50c

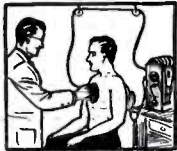
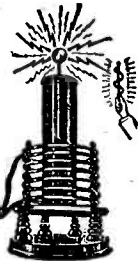

## S-W DIATHERMY (Artificial Fever)

Dataprint giving Constructional data for Small, Medium and Large size App. (All 3).....50c

## RECORD PROGRAMS on Steel Wire!

Telegraphone Data, for Voice or Code.....50c

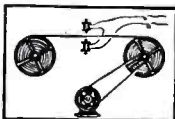

## Induction PIPE & ORE LOCATOR

Construction Data.....50c

## 20 ELECTRIC LODGE & PARTY TRICKS. Fun Galore!

"How to Do 'Em" Data 50c



## RADIO CONTROL for MODEL BOATS, etc.

Circuit data.....50c  
More DATAPRINTS You Need!

50c each..... 3 for \$1.00

- Electric Pipe Thawer..... any clock
- 100 Mechanical Movements..... "Rewinding" Armatures
- Water Turbines..... Induction Balance
- Water Wheels..... Telautograph
- Motor Circuits (20)..... Einthoven String Galvanometer
- Telephone Hookups (20)..... Magnets and Solenoids—Get our list
- Polarized Relay, Ultra-sensitive..... Wheatstone Bridge
- Ring 4 bells on 2 wires..... Induction Coils—1 to 12
- 20 Simple Bell Hook-ups..... inch Sp'k data
- Electric Chime Ringer fits.....
- Welding Trf. 2 K.W. 110 V. Prim. 18 V. Sec.....50c
- 4" metal SLIDE RULE \$2.00; 8" (20" Scale) \$5.00

## The DATAPRINT Co.

Lock Box 322

RAMSEY, N. J.

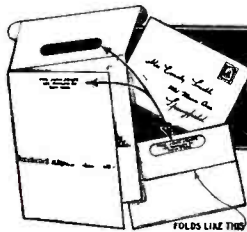

## NEW!!! Envo-letter

PERSONAL STATIONERY

\$1

A PRACTICAL LETTERHEAD AND ENVELOPE COMBINED!

THIS remarkable newly patented stationery is sweeping the country. No sheets or envelopes to waste—it's a letterhead and envelope combined. Write on three large pages—then fold into a securely sealed envelope with your name and address printed on the sheet and visible through novel cut-out feature on envelope flap. This also serves as return address for postman.

### ORDER TODAY

Saves you time and money—order a supply of personal stationery NOW.

50 ENVO-LETTERS FOR \$1.00

SPECIAL OFFER—150 ENVO-LETTERS \$1.50

Shipment made within five days.

The paper is of exceptional quality—supplied in White, Ivory and Grey Granite. Printing colors—black, blue, red or brown. Guaranteed satisfaction or money refunded.

Be sure to print your name, address, city and state to insure accuracy.

Send check or money order for full amount—register letter if you send cash or stamps.

Mailed POSTPAID in U.S.A.

## PRIVATE STATIONERY COMPANY

246 Fifth Avenue

Dept. L. SWT-238

New York, N. Y.

conveniently possible) through low capacity shield tubing and grounding the shield at both instruments. Using an L5-L6 coil which will tune to the adjusted receiver input frequency (the "lab." model specification coil for 4,000 kc. or a substituted coil whose range extends into the broadcast band for 1500 kc.), temporarily and loosely couple any available antenna to it at its V2 plate end; with both units turned on, adjust C 16 for maximum noise level, place the shield can over the output inductance, and retune on the receiver dial slightly to compensate for can capacity effects. The output coil and the input circuit of the receiver are now in proper alignment.

Tap the 6J7 HF oscillator grid cap. A clicking sound will indicate oscillation. Now loosely couple any antenna to L2—or wrap one end of a short length of insulated wire for a few turns around the L2 lead to the C1 stator lug. Turn the gain control up to about the half way mark and tune with both dials for noise pickup indicating that the converter is working. Generally, with the regeneration much less than maximum but with a screen potential on V2 sufficient to make the mixer circuit operative, L2-C1 tuning will be broad enough to permit some acceptance even if oscillator and signal circuits are slightly out of line.

Set the oscillator dial reading at about 50, then adjust C3 until a signal in the amateur 56 mc. band is tuned in, tracking with the other dial if that is possible. Note if this signal can be tuned in at two points (using C3), and select the adjustment indicating higher frequency (lowest C3 value). Remove the antenna, and connect the 5 meter half-wave affair to converter input by means of a single wire feed line (any length up to 100 feet) tied between aerial (fourteen inches from center) and the trimmer C. Now expand or contract the L1 coil, at the same time varying the setting of C, until maximum signal strength is indicated. Antenna input circuit is now in proper resonance at 56 mc.

Tune with the signal circuit dial for increased signal level, keeping R12 at a fairly low setting. If the detector circuit does not seem to "track," increase or decrease the spacing between L2 turns (with power off temporarily, as the L2 coil is "hot" remember) by extending or contracting the length of the winding until proper resonance obtains.

These adjustments might seem somewhat complex—but are not at all difficult. Proper alignment may be effected almost as quickly as these directional lines may be read.

### 10 Meter Reception

For 10 meter reception, L1 should have a size to be experimentally determined, L2 should have 11 turns tapped one turn up for regeneration and 2 turns down for V1 plate connection, and L3-4 may be the same item as required for 5 meter tuning, but loaded up to proper frequency by means of an additional fixed or variable trimmer bridged across C3. 1500 kc. makes a good I.F. or converter output frequency here, but any value within the range of the "lab." model L5-L6 coil will be satisfactory, with image suppression being of a very high order.

### List of Parts for UHF Converter

#### MEISSNER

- 1—type 7684 osc. coil (L3-L4)
- 2—type 3656 UHF filament chokes (RFC3 and RFC4)

#### HAMMARLUND

- 2—CHX RF chokes (RFC1 and RFC2)
- 2—HF-15 micro-condensers (C1 and C2)
- 2—MEX trimmers (C and C3)
- 2—FC couplings
- 1—APC-140 micro condenser (C16)
- 1—CS coil shield
- 1—No. 43 wound plug-in coil (66-150 meter range) (L5, 6)

# "NOW Anyone CAN OWN

# A SCOTT"

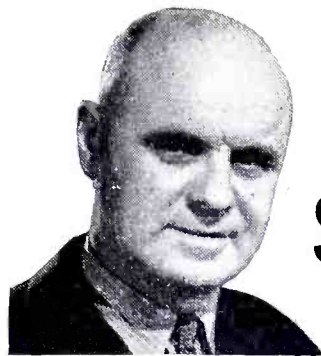

## New 16-Tube Model Only \$59.50 Down

Contrary to general opinion, Scott Custom receivers are not high priced. There are models available for the man of average means, as well as those who can afford the most costly radio built. All Scott receivers, regardless of price, are HAND MADE in Laboratories (not in production line factories). The quality of parts used in EVERY Scott is identical. Guaranteed for FIVE years.

### A Few of 93 Amazing Features

... 3 to 10 times as sensitive as many of the better mass-produced radios. Scott receivers hold 6 official World's Records on foreign reception... 50% Higher Fidelity than average high-priced radio—finer tone than costliest motion-picture sound system... Improves poorly transmitted broadcasts... Four Static-Reducing Systems (electrical and atmospheric)... Two controls for separate amplification of bass and treble tones... NOT SOLD THRU STORES—30 day Home Trial with Money-Back guarantee. Easy budget plan.

### SEND COUPON FOR SPECIAL OFFER

E. H. SCOTT RADIO LABORATORIES, INC.  
4470 RAVENSWOOD AVE., DEPT. 2888, CHICAGO

Please rush all facts, order blank, and Special Offer, on new Scott Sixteen. No obligation to me.

Name .....

Address .....

City and State.....

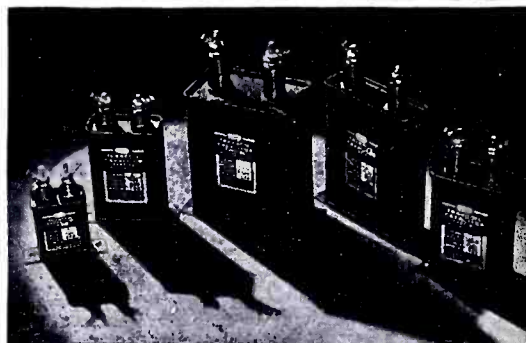

# TRANSOIL

for transmitting

## HIGHEST QUALITY OIL CAPACITORS

Ask for new complete Transmitting Catalog describing

TRANSOIL—SOLAREX—TRANSMICA

SOLAR MFG. CORP.  599 BROADWAY NEW YORK CITY

## STOPPANI COMPASS

A Precision Instrument made in Belgium. Purchased by the U. S. Government at more than \$30.00 each. Ideal for Radio Experimenters Laboratory, also may be used as a Galvanometer for detecting electric currents in radio circuits. Ruby, jeweled, solid bronze, 4 inches square, fitted in a hardwood case. Also used by hunters and surveyors.

Our price prepaid \$4.50 each

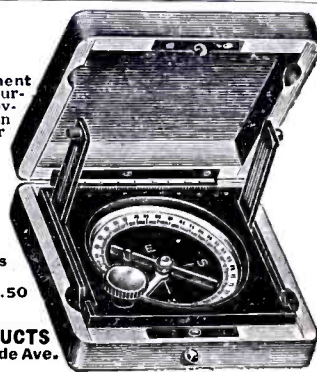

GOLD SHIELD PRODUCTS Dept. S-2, 98 Morningside Ave. New York City



# AMERICA'S MOST POPULAR RADIO BOOKS

We herewith present a selected collection of recent important radio books. We have selected these volumes because they represent the foremost radio books of their kind in print today. We publish no catalog. Order direct from this page. Prompt shipments will be made to you. Remit by money order or certified check. Register all letters containing cash.

- RADIO ENGINEERING HAND BOOK**, 850 pages, latest..... **\$4.90**
- PRACTICAL TELEVISION**, 223 pages, 127 illus..... **\$3.69**
- ELEMENTS OF RADIO COMMUNICATION** 286 pages, 241 illus..... **\$2.98**
- RADIO PHYSICS COURSE**, 992 pages, 510 illus..... **\$4.00**
- THE RADIO AMATEUR'S HANDBOOK**, 448 pages, 126 illus..... **\$1.97**
- MODERN RADIO ESSENTIALS**, over 200 pages, and over 100 illus..... **\$1.95**
- FOUNDATIONS OF RADIO**, 246 pages, 145 illus..... **\$2.47**
- PHOTOCELLS AND THEIR APPLICATION**, 332 pages, 180 illus..... **\$2.88**
- ELECTRONICS**, 134 pages, 45 illus..... **\$1.95**
- SHORT WAVE RADIO HAND BOOK**, 128 pages, 150 illus..... **\$1.00**
- PRINCIPLES OF RADIO**, 478 pages, 306 illus..... **\$3.46**
- EXPERIMENTAL RADIO**, 256 pages, 168 illus. Prepaid..... **\$2.69**
- MODERN RADIO SERVICING** 1300 pages, over 700 illus..... **\$4.00**
- FIELD SERVICE DATA AND ANSWER BOOK** 436 pages..... **\$2.50**
- Both Books..... **\$6.00**
- DRAKE'S CYCLOPEDIA OF RADIO AND ELECTRONICS**, 1050 pages, 1178 illus..... **\$4.88**

- FUNDAMENTALS OF RADIO** 426 pages, 141 illus. Prepaid..... **\$3.46**
- ELECTRICITY AT HIGH PRESSURES AND FREQUENCIES**, 248 pages, 141 illus. Prepaid..... **\$1.89**
- RADIO CONSTRUCTION AND REPAIRING**, 444 pages, illustrated..... **\$2.50**
- THEORY OF VACUUM TUBE CIRCUITS**, 226 pages, 226 illus..... **\$3.00**
- PRINCIPLES OF RADIO COMMUNICATION**, 988 pages, profusely illus..... **\$7.35**
- RADIO ENGINEERING**, 813 pages, 475 illus..... **\$5.50**
- EXPERIMENTAL RADIO ENGINEERING**, 346 pages, 250 illus..... **\$3.46**
- RADIO OPERATING QUESTIONS AND ANSWERS**, 427 pages, 106 illus..... **\$2.50**
- OFFICIAL RADIO SERVICE HANDBOOK**, over 1,000 pages, over 1,000 illus. Prepaid..... **\$3.92**
- OFFICIAL SHORT-WAVE RADIO MANUAL**, 240 pages, many illustrations. Vol. 1 (1934) Prepaid..... **\$2.00**
- Vol. 2 (1935) Prepaid..... **\$2.50**
- OFFICIAL RADIO SERVICE MANUAL**, Volume 4, 2,000 illus., over 400 pages. Prepaid..... **\$3.43**
- OFFICIAL RADIO SERVICE MANUAL**, Volume 5, over 3,000 illus., over 1,000 pages. Prepaid..... **\$6.86**
- OFFICIAL RADIO SERVICE MANUAL**, Volume 6, over 1,200 pages, over 2,500 illus. Prepaid..... **\$6.86**

## 15 HANDY—POCKET-SIZE RADIO BOOKS

Here are 15 up-to-date books on radio and air conditioning. Modern in every sense. ALL BOOKS UNIFORM—they contain 64 pages; 50 to 120 illustrations. All books written by well-known authors. Order by Number.

2. MODERN VACUUM TUBES
3. THE SUPERHETERODYNE BOOK
5. HOW TO BECOME A SERVICE MAN
6. BRINGING ELECTRIC SETS UP TO DATE
8. RADIO QUESTIONS AND ANSWERS
9. AUTOMOBILE RADIO AND SERVICING
10. HOME RECORDING AND ALL ABOUT IT
12. PUBLIC ADDRESS INSTALLATION AND SERVICE
13. ABC OF AIR CONDITIONING
14. POCKET RADIO GUIDE
15. ABC OF REFRIGERATION
16. PRACTICAL RADIO CIRCUITS
17. SERVICING WITH SET ANALYZERS
18. POINT-TO-POINT RESISTANCE ANALYSIS
19. PRACTICAL RADIO KINKS AND SHORT CUTS

PRICE PREPAID EACH BOOK..... **50c**

### HOW TO ORDER

No. C.O.D. orders. Our prices are net, as shown. Some of the books sent prepaid (in U.S. only). Those that are not thus listed are shipped collect if sufficient postage is not sent. Add 7% of price for postage.

## RADIO PUBLICATIONS, 97 HUDSON ST., NEW YORK, N. Y.



**HEY FELLOWS! 6 BACK NUMBERS OF SHORT WAVE AND TELEVISION SENT ANYWHERE IN U.S. FOR 70¢**

For a limited time only, and as long as they last, we will send you six back numbers of **SHORT WAVE & TELEVISION** assorted, your choice, for 70 cents.

The usual price for six copies would be \$1.50, and most publishers charge a higher price for back numbers over one year old.

We can supply only the following back numbers: Dec. 1930; Feb., April, June, Oct. 1931; Oct., Dec. 1933; Jan., Feb., Mar., Apr., May, June, July, Aug., Sept., Oct., 1934; 1935—All issues except January; 1936—All issues; 1937—All issues to date.

If you do not specify copies, we will send assorted numbers to fill your order. Note we cannot exchange the copies for ones that have been sent to you.

Every copy of **SHORT WAVE & TELEVISION** contains information which you should have. Here is a chance to get those copies.

As only a small supply of back numbers on hand, this offer will be withdrawn as soon as they have been sold.

We accept U.S. stamps, U.S. coin, or money order. Rush your order today.

**SHORT WAVE & TELEVISION**, 2-38  
99-101 Hudson Street, New York, N. Y.

Gentlemen: I enclose herewith 70c, for which you are to send me six back number copies of **SHORT**

**WAVE & TELEVISION** as follows:

Name .....

Address .....

City ..... State .....

### Vest Pocket Adding Machine

Sturdy Steel Construction. Lifetime Pocket Companion. Adds, Subtracts, Aids in Multiplication. Capacity, 999,999.99. A real machine—guaranteed 5 years. Send name and address. We ship immediately. On delivery, pay postman \$2.50 (plus few cents postage). (Foreign countries send cash.) Your money back after 10 days trial if not satisfied. Thousands of satisfied users.

Free Trial **\$2.50** Total Cost  
Send no money

### Mascot Slide Rule

It fits the pocket and your pocket book. Will quickly solve any problem in multiplication, division, proportion. Gives the square, the square root, logarithm and reciprocals of all numbers. Trig scale give sines and tangents of numbers. Fine black graduations on white celluloid. Price in fabricoid case \$1.00, in leather case \$1.25. Money back if not satisfied. Special offer to agents on both items.

R. Tavella Sales Co., 25 West Broadway, New York, N. Y.

### SOCKETS\*

- 1—S-8 moulded socket
- 1—S-4 moulded socket
- 3—steatite sockets
- 2—aluminum socket shells

### STANDARD TRANSFORMER (Stancor)

- 1—type P-3007 power transformer (TR)
- 2—type RC-1003 550 ohm filter chokes (CH1 and CH2)

### I.R.C.

- Half-watt resistors: R1—400 ohms; R2—10,000 ohms; R3—2 megohms; R4—50,000 ohms; R5—10,000 ohms; R6—50,000 ohms; R7—10,000 ohms; R11—600 ohms.
- Two or three-watt resistors: one 15,000 ohms (R9) and one 10,000 ohms (R8)
- 1—20 watt, 2,000 ohm, adjustable resistor (R10)
- 1—50,000 ohm potentiometer (R12)

### AEROVOX

- 6—type 1467—.006 mf. mica—C10, 11, 8, 5, 25, 26
- 2—type 1467—.001 mf.—C22, 23 (optional)
- 4—type 1468—.0001 mica—C4, 12, 13, 17
- 1—type 1468—.00025 mica—C7
- 3—type 1468—.00005 mica—C6, 9, 14
- 1—type 284 tubular—.1 mf.—C15
- 1—type 484 tubular—.1 mf.—C18
- 1—type 684 tubular—.05 mf.—C24
- 1—PBS-5 dual electrolytic (8-8 mf.)—C19, C20
- 1—PR5 single cardboard tube electrolytic (8 mf.)—C21

### RCA

(Tubes)

- 1—type 6K7
- 1—type 6L7
- 1—type 6J7
- 1—type 5Z4

### DIALS AND KNOBS\*

- 2—dials (or two better type where increased costs are permitted)
- 2—knobs
- 1—pointer knob
- 1—dial plate

### OUTPUT TERMINAL\*

- 1—three post A-G assembly for output connections

### MISCELLANEOUS\*

- 2—6 x 9 steel panels (base and back partition)
- 1—approx. 4 x 9 metal or wood base for power units
- 1—8 x 12 front panel—or one cabinet, 12 inches wide, 8 inches high, 11 inches deep, with front and back covers removable (a la "lab." model)
- 2—angle supports for mounting chassis-base to front panel
- 2—smaller angle supports for mounting back partition to chassis-base
- 2—angles, if desired, for mounting power-supply base to rear partition
- 3—stand-off insulators, 1½ inches high, 1¼ inches between mounting hole centers (for L2 and L3 mount and for antenna post)
- 25—foot roll special electric low-loss RF wire for all connections except power
- 1—8 foot length of No. 12 wire or of quarter-inch tubing tapped for single wire feed to converter 14 inches from center. This as half-wave antenna for 56 mc.
- 1—spacer 1½ inches long, for mounting inverted RF tube (or two or three, for firm support)
- 1, 2, or 3—two-inch machine screws for R.F. tube mounting
- 3—small grid caps
- No. 6 and No. 8 machine screws—assorted lengths—with nuts
- 2—quarter inch rubber grommets
- 3—¾ inch rubber grommets
- 2—1½ inch lengths of quarter inch extension rods

### SPECIAL

- L1 inductance: for 56 mc. to consist of approximately 18 turns of No. 24 D.S.C. wire (or 22) close-wound on quarter inch form, then removed, extended or contracted for proper resonance at 56 mc. and self-supported between V1 grid cap and nearby chassis-ground point.

\*Most radio mail order houses can supply this item if properly identified as to title of article, issue (month) of **SHORT WAVE & TELEVISION** and year.

## DON'T BUY!!

### Radio Tubes, Parts or Equipment

until you have sent for our new confidential Wholesale Catalog. Lowest prices. To prove that, send for our latest fall bulletin and compare prices.

### FREE PREMIUMS

given with every purchase of \$3.00 or over to American and Canadian buyers during January, or to Foreign buyers in February. Special wholesale discounts allowed on Nationally advertised Radios.

**UNITED RADIO CO.**, 58 Market St., Dept. S-2, Newark, N.J.



# Westinghouse Power Generator

Manufactured for U. S. Signal Corps

200 Watt. 110 V. AC

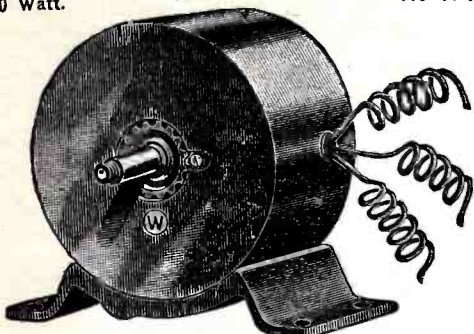

## A. C. ELECTRICAL POWER

from a Windmill, from available Waterpower, from your Automobile, from your Motorcycle, from your Bicycle, Foot-pedals or Handcrank (for transportable Radio Transmitters, Strong Floodlights, Advertising Signs); do you want to operate AC Radio sets from 32 V. DC farm light systems; operate two generators in series to get 200 V. AC; obtain two phase and three phase AC, etc., etc.

### There Are Over 25 Applications Some of which are:

A.C. Dynamo lighting from eight to ten 20 Watt 110 Volt lamps. Short Wave Transmitter supplying 110 Volts AC for operating "Ham" transmitter. Operating 110 V. AC 60 Cycle Radio Receiver in DC districts. Motor Generator. Public Address Systems. Electric Sirens on motor boats, yachts, etc. Camp Lighting. Short Wave artificial "fever" apparatus. Television. Pelton Waterwheel for lighting or other purposes. Airplane: for lighting strong search lights or electric signs. Laboratory work, etc., etc.

1/2 to 1/2 H.P. needed to run generator.  
 BLUE-PRINT 22 x 28 in. and Four-Page  
 8 1/2 x 12 in. INSTRUCTION SHEETS  
 FREE with Generator.

Generator, as described, including four replacement carbon brushes. Blue-print and instructions **\$7.90**

Send \$2.00 deposit balance C.O.D. Shipping weight 18 lbs.

(Replacement carbon brushes bought separate \$1.50 per set of four. Set of instructions bought separate \$1.00.)  
 MONEY-BACK GUARANTEE

**WELLWORTH TRADING COMPANY**

560 West Washington Blvd., SWT-2-38 Chicago, Illinois

# ELEMENTARY MATHEMATICS

For the Technician and Craftsman

## CONTENTS OF BOOK

I. ARITHMETIC: Addition, Multiplication, Division. II. Factoring and Cancellation, Fractions, Decimals, Percentages, Ratio, and Proportions. III. The Metric System. IV. How to Measure Surfaces and Capacity (Geometry). V. POWERS: Involution—ROOTS: Evolution. VI. Mathematics for the Manual and Technical Craftsman. Thermometer Conversions, Graphs or Curve-Plotting, Logarithms, Use of the Slide-Rule. VII. Special Mathematics for the Radio Technician. VIII. Commercial Calculations. Short-cut Arithmetic, Interest, Discounts. IX. Weights and Measures, Useful Tables.

PRICE **50c** POSTPAID

## TECHNIFAX

Division SWT-2-38

558 W. Washington Blvd.

Chicago, Illinois

## KEEP your home ORDERLY

Don't leave magazines scattered all over the house. Gold Shield Holder will keep them CLEAN.



12 3/4" x 9 1/2" 3/4" x 9 1/16"  
 Made of heavy cardboard, covered with Genuine DuPont fabricoid—holds 24 magazines.

Holder, 50c each, 10 for \$2.50 prepaid. Nickel silver Autogram initial, illustrated above, 10c each. Two or three initials look swell on the bottom right hand corner of the holder.

## GOLD SHIELD PRODUCTS

Dept. S-2, 98 Morningside Ave., New York City

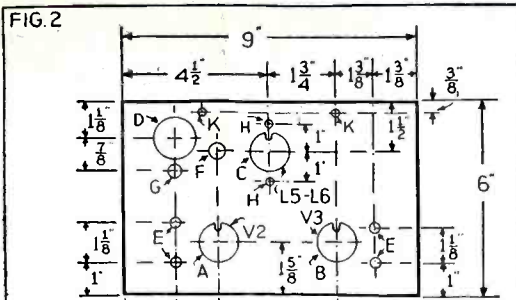

HOLES: A, B, C = 1 3/16 IN DIA. E = 3/16 IN DIA. G = 1/4 IN DIA.  
 D = 1 1/2 IN DIA. F = 3/8 IN DIA. H & K = 1/8 IN DIA.

CHASSIS OR BASE LAYOUT-CONVERTER  
 BACK PARTITION SAME SIZE AS BASE PIECE (9" X 6")

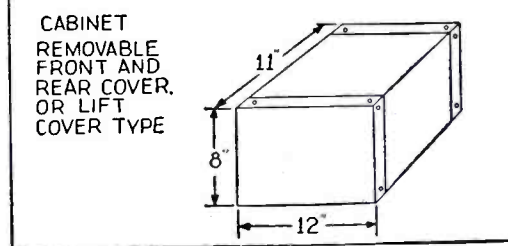
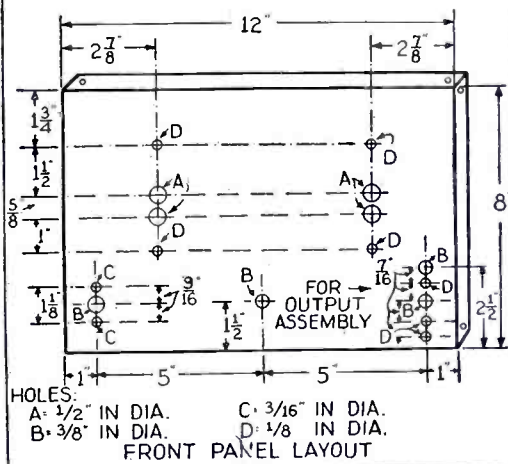
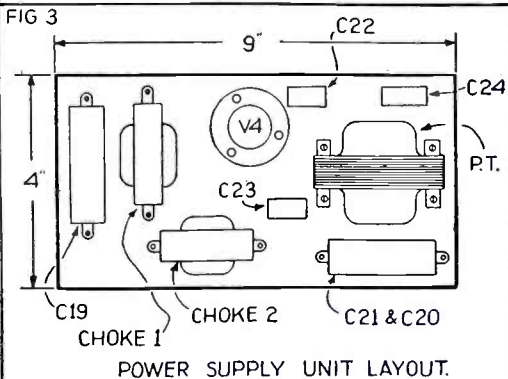

The drawings above show details of the chassis for the ultra-high frequency converter, as well as the power-supply unit layout. The lower diagrams show front panel layout and dimensions of the cabinet.

## Here's Your Button

The illustration here-with shows the beautiful design of the "Official" Short Wave League button, which is available to everyone who becomes a member of the Short Wave League. The requirements for joining the League are explained in a booklet, copies of which will be mailed upon request. The button measures 3/4 inch in diameter and is inlaid in enamel—3 colors—red, white, and blue.



Please note that you can order your button AT ONCE—SHORT WAVE LEAGUE supplies it at cost, the price, including the mailing, being 35 cents. A solid gold button is furnished for \$2.00 prepaid. Address all communications to SHORT WAVE LEAGUE, 99-101 Hudson St., New York.

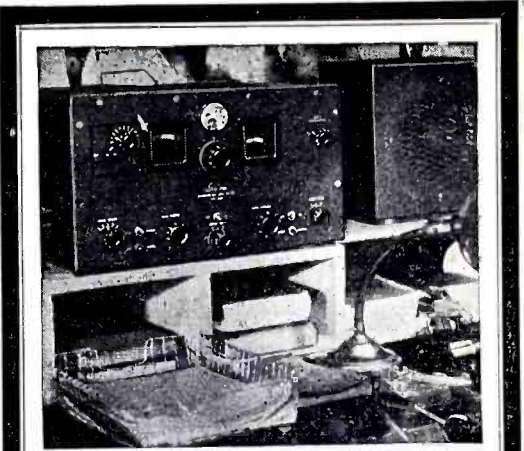

## "PERFORMANCE IS TIP-TOP!"

"WITH our "Super-Pro" receivers, we are able to constantly maintain unusually difficult schedules running 16 hours a day," says Stanley Wolff, chief operator, New York Herald Tribune wireless station. Mr. Wolff continues, "Day or night, rain or shine, these receivers are 'on their toes' offering tip-top performance." "Super-Pro" receivers feature 2 R.F. on all bands; electrical band spread; calibrated panel controls, etc. Mail coupon for further details!

HAMMARLUND MFG. CO., INC. SWT-2-38  
 424-438 W. 33rd St., N. Y. City

( ) Please send me "38" catalog.

Name .....  
 Address .....  
 City ..... State .....



CANADIAN OFFICE: 41 WEST AVE. NO., HAMILTON, ONTARIO.

## "YOU'VE GOT SOMETHING THERE" Say Amateurs

From all sides comes enthusiastic endorsement of the flexibility and performance of Astatic's new Model T-3 Microphone. Exclusive tilting mount permits convenient positioning and prevents cable breakage. Chrome finish.



LIST PRICE \$25.00  
 Write for Literature



ASTATIC MICROPHONE LABORATORY, INC.  
 Dept. J-4 YOUNGSTOWN, OHIO  
 Licensed Under Brush Development Co. Patents

Your 1938 Radio Catalog

2 STORES

## OUR 1938 RADIO PARTS CATALOG

CONTAINS ITEMS OF INTEREST TO RADIO AMATEURS AND BEGINNERS

Write for your free copy now

# CAMERADIO

963 LIBERTY AVE. PITTSBURGH, PA. 30 TWELFTH ST. WHEELING, W. VA. Establish 1919





# BRINGS YOU ANY ONE OF THESE 4 FAMOUS RADIO BOOKS

RADIO FANS! Help yourselves to a radio education for the price of 10c per book. These books give you a good foundation towards the study of radio. You'll be amazed at the wealth of information contained in them. They are especially written for beginners but are useful review and reference books for all.

Each book contains 32 pages, profusely illustrated with clear, self-explanatory diagrams. They contain over 15,000 words of clear legible type. They are an education in themselves and lay the groundwork for a complete study of radio and electricity.

### HOW TO BUILD FOUR DOERLE SHORT WAVE SETS

Due to a special arrangement with the publishers of SHORT WAVE CRAFT, we present in this book complete details for building the Doerle sets, also an excellent power pack if you plan to electrify any of the sets. Contains EVERYTHING that has ever been printed on these famous receivers. These are the famous sets that appeared in SHORT WAVE CRAFT: "A 2-Tube Receiver that Reaches the 12,500 Mile Mark," by Walter C. Doerle, "A 3-Tube 'Signal Gripper,'" by Walter C. Doerle, "The Doerle

### HOW TO MAKE THE MOST POPULAR ALL-WAVE 1-AND 2-TUBE RECEIVERS

This book contains a number of excellent 1- and 2-tube sets, some of which have appeared in past issues of RADIO-CRAFT. These sets are not toys, but have been carefully engineered. They are not experiments. To mention only a few of the sets the following will give you an idea. The Megadyne 1-Tube Pentode Loudspeaker Set, by Hugo Gernsback—How to Make a 1-Tube Loudspeaker set, by W. P. Chesney—How to Make a Simple 1-Tube All-Wave Electric Set, by F. W. Harris—How to Build a Four-in-Two All-Wave Electric Set, by J. T. Borsley and others. Each set is fully described in simple language so that anyone can build with limited means and with practically no experience a worthwhile all-wave radio set. Has 30 illustrations. 10c postpaid

### ALTERNATING CURRENT FOR BEGINNERS

This book gives the beginner a foothold in electricity and radio. Electric circuits are explained. This includes Ohm's Law, alternating current, sine waves, volts, amperes, watts, condensers, transformers, motors and generators, A.C. instruments, house wiring systems, electrical appliances and electric lamps. Here are some of the practical experiments which you can perform. Simple tests for differentiating between A.C. and D.C.; how to light a lamp by induction; making a simple electric horn; demagnetizing a watch; testing motor armatures; charging storage batteries from A.C. outlet; testing condenser with A.C.; making A.C. electromagnets; frying eggs on a cake of ice; making simple A.C. motors and many others. Has 42 illustrations. 10c postpaid

### ALL ABOUT AERIALS

In simple, understandable language this book explains the theory underlying the various types of aerials, the inverted "L," the Doublet, the Double Doublet, etc. It explains how noise-free reception can be obtained, how low-impedance transmission lines work; why transposed lead-ins are used. It gives in detail the construction of aerials suitable for long-wave broadcast receivers, for

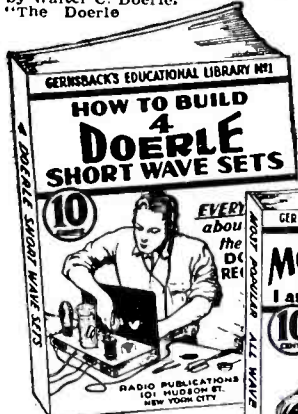

"2-Tuber" Adapted to A. C. Operation. "The Doerle 3-Tube 'Signal Gripper' Electrified," and "The Doerle C o e s 'B a n d Spread.'" Has 30 illustrations. 10c postpaid

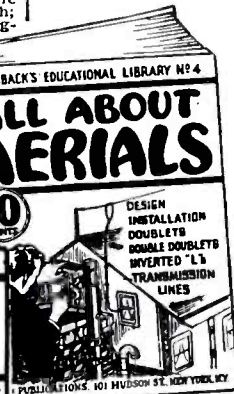
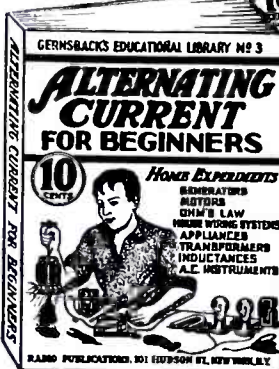
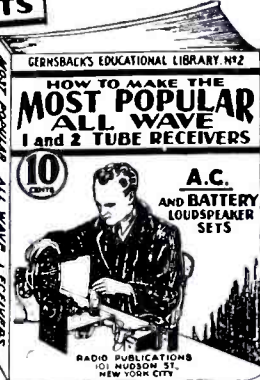

short-wave receivers, and for all-wave receivers. The book is written in simple style. Various types of aerials for the amateur transmitting station are explained so you can understand them. Has 66 illustrations. 10c postpaid

RADIO PUBLICATIONS SWT-2-38  
101 Hudson Street, New York, N. Y.  
Please send immediately POSTPAID the books checked:

No. 1—How to Build 4 Doerle Short Wave Sets.....10c  
 No. 2—How to Make the Most Popular All-Wave 1- and 2-Tube Receivers.....10c  
 No. 3—Alternating Current for Beginners.....10c  
 No. 4—All About Aerials.....10c

I am enclosing.....c; the price of each book is 10c

Send me FREE circular listing 48 new 10c publications

Name .....

Address .....

City .....

State .....

(U. S. Coin or U. S. Stamps acceptable.) Books are sent postpaid.

Remember that each book has 32 pages and contains over 15,000 words. Each book has from 30 to 66 fine illustrations. POSITIVELY THE GREATEST VALUE IN RADIO BOOKS EVER OFFERED TO THE PUBLIC.

If you do not think that these books are worth the money asked for them, return them within 24 hours and your money will be instantly refunded.

Send for our FREE circular listing 48 new 10c Publications

**RADIO PUBLICATIONS**  
101 Hudson St., New York, N. Y.

## When To Listen In

(Continued from page 559)

station ready to go on the air, and we, being believing souls, published the information; but nothing ever happened. This time, however, we have actually heard the new station so that there can be no doubt about the new transmitter being in operation. At present tests are conducted on 9.55 mc. (same frequency as OLR3A). The station generally broadcasts simultaneously with TPA4 from 6:15 p.m. on. It is putting over a very good signal with excellent quality. Apparently arrangements have been made with the Czechoslovakian broadcasting authorities as this station goes off the air when OLR3A comes on.

Undoubtedly the station will make use of frequencies in the other short-wave broadcast bands shortly.

RIO DE JANEIRO . . . Coincidental with the proclamation of the new constitution in Brazil short-wave broadcasting activities have taken on new life. PSH, the experimental phone station at Rio on 10.22 mc., is now broadcasting every evening from 7-9 pm. relaying the programs of broadcast station PRF4. Announcements are frequently made in English to the effect that all reports will be verified and if the reception of the programs abroad is satisfactory, the service will be considerably enlarged.

HOT AND COLD . . . Two widely separated scientific expeditions are providing very interesting broadcasts for short-wave listeners this winter. The first is the Holden expedition which is at present in an equatorial jungle near the head of the Amazon River in South America. A phone transmitter is part of the equipment and can be heard calling the National Broadcasting Company in New York frequently. Call letters are VP3THE. The station generally operates on 13.78 mc. The best time to pick up the station is from 7-9 pm. All reports should be addressed to the National Broadcasting Company in New York.

The other station is located at Reindeer Point, Greenland, approximately 600 miles from the North Pole. It is OX2QY, operated by the MacGregor Arctic Expedition and is heard nightly on about 14.36 mc., generally between 8 and 11 pm. Reports are to be sent to station W2QY, Cornwall-on-Hudson, New York. Reports will be verified when the expedition returns to New York.

# CLASSIFIED 15¢ A WORD

Under this heading only advertisements of a commercial nature are accepted. Remittance of 15c per word should accompany all orders. Copy should reach us not later than the 5th of the month for the second following month's issue.

**AGENTS WANTED**  
500% PROFIT SELLING GOLD Leaf Letters for Store Windows. Free Samples. Metallic Co., 446 North Clark, Chicago.

**CORRESPONDENCE COURSES**  
500,000 USED CORRESPONDENCE Courses and Educational Books. Sold. Rented. Exchanged. All subjects. Satisfaction guaranteed. Cash paid for used courses. Complete details and bargain catalog free. Send name. Nelson Company, 3275 Manhattan Building, Chicago.

**INSTRUCTION**  
RADIO ENGINEERING, BROADCASTING, aviation and police radio, servicing, marine and Morse telegraphy taught thoroughly. All expenses low. Catalog free. Dodge's Institute, Colt St., Valparaiso, Ind.

**COMPLETE TRAINING FOR ALL** Amateur and Professional Radio Licenses. New York Wireless School, 14 East 44th St., New York.

**MISCELLANEOUS**  
WE ORIGINALLY HAD FIVE thousand Stoppani Compasses for which the U.S. Government paid over \$30.00 each. We sold all but a very few. We cannot obtain more to sell at three times our present price. Send in your order before they are all sold at \$4.50 each, postage paid. Gold Shield Products, 98 Morningside Avenue, New York City.

**COIL INDUCTANCE CHARTS** complete set for any size coil; accurate; \$2.15 prepaid. Slide Rules—1 inch circular metal type \$2.00; 8" dia., 20" scale, \$5.00 prepaid. Dataprint Co., Box 322, Ramsey, N.J.

**PATENT ATTORNEYS**  
INVENTORS, ALL PATENT AND trademark cases submitted given personal attention by members of the firm. Form "Evidence of Conception" and instructions free. Laneaster, Allwine & Rommel, 436 Bowen Building, Washington, D.C.

**QSL—CARDS—SWL**  
100 NEAT SWL CARDS PRINTED with your name and address sent postpaid for \$1. Bunch of samples and RST chart for five cent stamp. WIBEF, 16 Stockbridge, Lowell, Mass.

**QSL SWL CARDS, NEAT, ATTRACTIVE,** reasonably priced, samples free. Miller, Printer, Ambler, Pa.

**SHORT WAVE RECEIVERS**  
PLANS 18 DISTANCE CRYSTAL Sets—SW record 4250 miles, with "Radiobuilder" year—25c. Laboratories, 151-A Liberty, San Francisco.



## Short Wave League

At a Directors Meeting held in New York City, New York, in the United States of America, the Short Wave League has elected

**John F. Müller**

a member of this League.

In Witness whereof, this certificate has been officially signed and presented to the above.

*H. Winfield Secor*  
Club Secretary

This is the handsome certificate that is presented FREE to all members of the SHORT WAVE LEAGUE. The full size is 7/4"x9 1/2". (See page 584.)



# Machine Makes Learning Code Easy

(Continued from page 549)

have passed a similar test and with whom he can exchange tapes. That is an advantage all around; it gives practice in *sending*, and practice in *receiving* a great variety of senders.

Some operators use the machine as an automatic transmitter for "CQ'ing" tests, etc. It can also be used for automatically transmitting messages up to four or five hundred words.

With the proper circuit to operate a relay the device may be used to record signals from the air. If the circuit to operate a relay can be constructed, it will be easy to record the signals.

A complete course of instruction in the code is furnished. There are recorded tapes that will send to you at your speed, and blank tapes so that you can *record* your own sending. The instrument is extremely quiet in operation and the speed of the sending may be instantly set and it will send hour after hour at your speed.

## Ultra-Hi Freq. Oscillator

value. The grid-blocking condenser made of a brass plate, separated from the brass disc by a thin mica sheet, is the support for the grid rod.

*Our information bureau will gladly supply manufacturers' names and addresses of any items mentioned in Short Wave & Television.*

## New Beam Xmitter Tube

and efficient suppressor action is supplied by space-charge effects produced between the screen and the plate. The 814 may be operated at maximum rating in all classes of service at frequencies as high as 30 mc., (10 meters). At higher frequencies the voltage and power output are somewhat reduced as the frequency is raised. For class B telephony with 1250 volts on the plate, the screen voltage is 300 and the D.C. grid voltage —28, and the peak R.F. grid voltage is 50. (No. 680)

*This article has been prepared from data supplied by courtesy of RCA Manufacturing Co.*

## 40 Watt Band-Switching Exciter or Transmitter

(Continued from page 563)

- 1—10,000 ohm 10 watt resistor
- 2—2,000 ohm 10 watt resistor
- 1—5,000 ohm 10 watt resistor
- 1—20,000 ohm 50 watt voltage divider

### KENYON

- (Transformer and choke)
- 1—plate-fil. trans. (see diag.) T-246
- 1—10 H. 250 ma. choke, (T-151)

### MEISSNER

- (Switch)
- 2—2-gang rotary inductance switches

### PARMETAL

- (Metal frame)
- 1—8 1/4 x 19 in. panel
- 1—17 x 3 x 11 in. chassis

### RCA

- 1—6V6-G tube
- 1—6L6 tube
- 1—807 tube

### TRIPLETT

- 1—0-150 ma. meter, square case

### BLILEY

- 1—80 meter crystal—LD-2

# BARTER AND EXCHANGE FREE ADS

NO ADVERTISEMENT TO EXCEED 35 WORDS, INCLUDING NAME AND ADDRESS

Space in this department is not sold. It is intended solely for the benefit of our readers, who wish to buy, sell or exchange radios, parts, phonographs, cameras, bicycles, sporting goods, books, magazines, etc. without profit. As we receive no money for these announcements, we cannot accept responsibility for any statements made by the readers. Use these columns freely. Only one advertisement can be

accepted from any reader in any issue. All transactions MUST be above board. Remember you are using the U. S. mail in all these transactions and therefore you are bound by the U. S. Postal Laws. Describe anything you offer accurately and without exaggeration. Treat your fellow men the way you wish to be treated. We welcome suggestions that will help to make this department interesting and profitable to both buyer and seller.

**HAMS! FANS! HERE IS A GREAT opportunity to get many S.W. radio parts to build that Xmtr or Revr. Any part you wish is at your disposal. Write me c/o W8PGY, Oswego, N.Y. Don't delay! Write today! Parts cheap for cash. Must sell at once! Write to M. E. Wetz, c/o W8PGY, 80 Lawrence St., Oswego, New York.**

**TO TRADE OR SELL 1,800 GENERAL world-wide stamps for a short wave receiver. Both the U.S. and Canadian collection are good. Paul L. West, 503 Hooge St., Martinsburg, W. Va.**

**WANTED—DIRECT CURRENT Generator from 600 to 1000 volt, 300 to 500 watt capacity. Also 110 volt generator 60 cycle A.C. of 700 watts or more. Must be suitable for gasoline engine drive. Will buy, or give choice from large stock of radio parts. E. Antoine, Rose Valley, Sask., Canada.**

**TRADE PRACTICALLY NEW INSTRUMENT code machine with tapes together with Candler course for a real good camera in good shape. Rowley Noyes, Box 1, Lloydminster, Alberta, Canada.**

**WILL TRADE OR SELL OLD ISSUES of QST in good condition 23 copies from June 1922 to June 1924 also some copies in 1922 for HI Frequency xmitting tubes or HI Voltage filter condensers or what have you. Also have 6 volt D.C. to 180 volt 40 mil. Genemotor. Elmer W. Parker, W9UJL, 324 Brandriff St., Fort Wayne, Ind.**

**WANTED TO BUY: KODAK DUO-620 or other camera with f.3.5. Anastigmat lens and Compur Rapid Shutter 1-500 sec. with a picture about 2x2. Send details. Also have to sell, 1 Official Doerle A.C.-5 No. 5000 power pack in cabinet. Coils from 10 to 550 meters included. Set in good condition. Bud Brubaker, 617 First St., Lancaster, Pa.**

**WANTED A LOW PRICE CODE practice machine and any other outfit to help to learn the radio code. Expect to have correspondence with other licensed amateur that wants to help the beginner. Address: Jose E. Mesorana, 62 de Diego St., Aguadilla, P. R. (U. S. A. possession.)**

**CANADIAN RADIO CLUBS. THE Loyalist City Amateur Radio Club Saint John N. B. is anxious to communicate with all similar radio clubs in Canada. Write President Arthur Ruthen, 56, Lansdowne Ave., Saint John, N.B.**

**WILL SWAP FIVE-METER Transmitter parts and Freq-Meter for anything I can use. Will trade fine printing for what have you? Am interested in radio and photography. Promise to answer all letters. Correspondents welcomed. M. Feigenbaum, 42 Jefferson Street, Yonkers, N.Y.**

**WANTED—EXPOSURE METER (electric) for photo. uses, for 16 mm Keystone movie camera, magazines, books, etc. or? Send swap list. Herman Williams, 94 Riverdale Ave., Yonkers, N.Y.**

**SELL OR SWAP—CRYSTAL SET radio, including new crystal, 2 sets of phones can be used at the same time. This set has made a good record. What am I offered? William Blecha, Pawnee City, Nebr.**

**EILEN BS-5 GOOD CONDITION. \$11.00. Buddy II with magnetic speaker, earphones, cabinet \$6.00. Want "Sky-Buddy" or "Sky-Chief. Erwin S. Kofsky, 202 S. 2nd St., Brooklyn, N.Y.**

**FOR SALE OR TRADE NATIONAL SW-4 Battery Receiver. All coils. Good condition. Wm. E. Sampson, Jr., 2208 Floyd Avenue, Richmond, Virginia.**

**WANTED: "HAM RECEIVER" Hallcrafters, R.C.A. or similar type. What have you? Arthur Ruthen, 56 Lansdowne Ave., St. John, N.B., Canada.**

**WANTED: PHONO-MOTOR (SINGLE speed—78 R.P.M.) and Pick-Up. Or can use combination. Will swap for stamps, covers or will buy for cash. Please send description and make. Harry Gursh, 37 Amboy St., Brooklyn, N.Y.**

**I HAVE FOR SALE OR EXCHANGE one complete 1937 edition of Radio and Television Institute's radio course valued at \$112.50. Would trade for typewriter, all wave oscillator or what have you. For information write Lyle C. Newell, Ace Radio Service, 11 Pearl St., Claremont, N. H.**

**SELL: 15 WATT 160 METER C.W. rig, complete with power, tubes, crystal and detailed instructions for beginners. Price \$12. Write to W. Zalyer, 8 Judson Avenue, Binghamton, N.Y.**

**SACRIFICE: SELLING OUT AT A loss—complete Ham station transmitter—6L6 xtal osc-multiplier, all band, crystal switching, pair of 6L6's buffer-driver pair of 203A's final amp—500 watts. Fone—CW—with 3965—3564—1960.5 kc xtals—pwr supplies—rack-panel, mike—meters—and rack and panel McMurdo Silver communications type revr—complete with speaker and 12 earphone outlets—complete to go at \$250. W8UQV, Wellsville, N.Y.**

**WILL TRADE 1935. 7 TUBE SUPER Skyrider, 5 bands—complete—for coupe car. Willing to make allowances. Marcus Felt, 530 East 145 St., Bronx, N.Y.**

**HAVE A CARTER HEAVY DUTY Genemotor 6 v. input 2.2 amp drain. 180 V. output at 30 M.A. Almost new. used 3 mo. Intermittent on radio. In original carton. Has self contained filter system. Cost \$13.50 new. Will sell or trade. State your best deal. R. Lewis, Griffithville, Ark.**

**BEST CASH OFFER TAKES NEW National SW3 for A.C. operation; perfect condition; complete with tubes and four sets of coils. E. Raymond, 6 Wing Street, New Bedford, Mass.**

**SELL OR SWAP—DEVRY. Model U 35MM silent movie projector. 110 volt 60 cycles A.C. like new. Complete with rewinds film, etc. Will swap for good radio test equipment amplifier, radio parts, or what have you? Joe Richards, 332 E. Helm St. Brookfield, Mo.**

**I AM BUILDING A "BROWNING 35." I will sacrifice my 5 tube tuned RF electron coupled receiver, complete with Rola 5" speaker and pwr. supply on same chassis. Built only 3 months ago from best of parts costing \$30.00. No reasonable offer refused. Warren Leone, 6868 Middlepointe, Dearborn, Mich.**

**BARGAIN 100 WATT 160 PHONE transmitter. Denton receiver complete \$70. W9UJP, Churubusco, Indiana.**

**A GOOD SHORT WAVE RECEIVER in good condition. It has four tubes and four coils used only a little since bought. Will sell or exchange for other short wave receiver. Write to Louis Oberdoester, 402 Ridge Ave., Allentown, Pa.**

**WANTED: A FAIRLY GOOD PRE-selector and Booster. Write Vincent Salerno, 2009 Woodlyne Ave., Camden, N.J.**

**SELL: "BAND SPREAD PORTABLE," a combined S.W. receiver and Monitor. Uses two type 30 tubes. Complete with tubes, batteries and coils for 160, 40 and broadcast bands. Additional coils can be obtained for other bands. Entire outfit is self-contained in a steel case with a handle on top. Will take best cash offer. Ted Supplee, W3GGM, RFD No. 3, West Chester, Pa.**

**ALL-STAR, JR. 5-TUBE SUPER-heterodyne kit, complete with tubes, instructions and 10 inch Wright-De-Coster electro-dynamic speaker. Invite reasonable cash offer. Joseph A. Donohue, 357 S. Queen St., Lancaster, Pa.**

**WANTED: BAND SPREAD COILS for National receiver, SW-3. Will pay cash or trade for same. George Oberlunder, 215 East Ridge St., Ironwood, Mich.**

**I WILL PAY \$1. PER DOZEN FOR old license plates. What years have you got? Anthony Shuppienus, Newport, N.J.**

**WANTED—USED INSTRUMENT complete with oscillator or telegraph sounder, 10 rolls of tape, key, instruction book, and headphone. American Morse code tapes preferred. Let me know the price and condition of equipment. Russell Nance, 6001 E. 10th Street, Kansas City, Missouri.**

**FOR SALE. BRAND NEW Haynes Clipper receiver. Fine for amateurs. \$22.00. E. W. Howatt, 139 Marine St., St. Augustine, Fla.**

**FOR SALE: HAIGIS TRANS-ciever, Peak Preselector, Tube Checker, Battery Pre-amplifier using two 19 tubes. D. B. Mikes, Noise Silencer, A. H. Ross 7 tube—with signal meter—5 meter Johnson Q Ant, Pilot S. W. Converter, W2ETD—Edwin Dunn, 2115 Washington Ave., Bronx, N.Y.C.**

**WANTED: USED CANDLER Course. James N. Glass, R. R. 1, Box 17, Eddyville, Kentucky.**

**WANT TO BUY GOOD SHORT wave receiver, slightly used. John Szlucha, R. D. One, Owego, N. Y.**

**STAMPS WANTED. WILL GIVE radio parts, etc. in exchange. Advise what you have—and want. Laboratories, 151-A Liberty, San Francisco, Calif.**

**HAVE A GAMMATRON HK354 tube with 24 hours use for \$15 and have RCA 803 with 3 hours use for sale at \$19.00. RCA 838 tube with about 400 hours use for sale at \$8.00. Complete code and phone transmitter using 46 final tube, Class B, modulator, xtal controlled. This is for sale at \$40. with mike, bug key and crystal. Jack Nelson, W8FU, 75 Minaville St., Amsterdam, N.Y.**

**HAVE STAMP COLLECTION about 230 stamps. Most are in sets and in excellent condition. Just an example of some sets: Complete U. S. Pilgrim issue mint, about 6 sets of coronations mint, and others. Above stamps alone cost me about \$5.00. Will sell collection for not less than \$10.00. Stamps are all in cellophane envelopes. Have also a fine mandolin—\$4.50, and a fine pair of ice skates size eight—\$2.50. Write for details. Charles Sneykal, 1607 First Ave., New York, N.Y.**

**SWAP FOR OR BUY AN INEXPENSIVE Barometer, what have you? Chiusholm, 616—4th, Jackson, Michigan.**

**FOR SALE: OUDIN COIL. Complete secondary with primary form, \$3.00. Pie form primary, heavy strap copper nickel plated, \$2.00. Also 1/2 KW Transformer, Navy type, built for U.S. Gov't by Emil J. Simon, \$6.00 cash. Also high voltage Fan Switch Variable Condenser with parallel sections, regular laboratory type, \$3.00 High Speed G.E. Universal AC-DC motor, 10,000 R.P.M. excellent for jewelers lathe, or window display set, \$3.50. Also heavy brass telegraph keys with switches, platinum points, W.U. type, only five available, \$1.00 each, good for a lifetime. Must be sold for cash at once. B. Sunshine, 4408—10th Ave., Brooklyn, N.Y.**

**I WANT TO TRADE AN 110 VOLT 700 to 1000 watt 60 cycle ac generator for a good short wave set, Natl. SW3 SW58 or 45 or the like. Generator absolutely trouble free used but a few hours. N. R. Thornton, Somerville, Ohio.**

**EXCHANGE COMPLETE COIL and condenser set for seven tube super. Aeroplane dial, 550 Kc.—17 Mc. Want good mike or meters. Clarence Karmark, Casselton, N. Dak.**

**RANGER .22 CALIBRE RIFLE with sling and 250 cartridges worth \$15.00. \$32.50 Doerle, D-38 7 tube T.R.F. receiver 9-600 meters, using 2-6K7's, 3-6C5's, 6L6G, 5Y3G—noise suppressor and all controls, bandspread, etc. Best T.R.F. on market. Will accept reasonable cash offer for one or both items or will trade for good superhet, 10-500 meters, 7 or more tube. L. Cavalier, 220 Russell Court, Long Branch, N.J.**

**I WANT CONSTRUCTIONAL INFORMATION and wiring diagrams on Ace Do-All DeLuxe, Eilen ER-20, etc., also used kits of these and other popular receivers if reasonably priced. Also want back issues of radio magazines, and a used Master Teleplex. If you have anything interesting to trade, write, Fenton Butler, Box 13, Hertford, N.C.**

**STAMPS—ABOUT 150 IN GOOD album, duplicates, many good, trade off others, 50c postpaid, worth much more. Envelopes with stamps intact addressed to President Roosevelt from France, Hungary, Italy, Cuba, England, Argentina; make offer. Adding Machine—adds up to one million, good as new, \$1. prepaid. Gits-Nife, 50c prepaid. Hunting Knife with stag handle and in new leather sheath, 60c postpaid. To the first person buying one of the above articles I will give free gift. Address: J. S. Jackson, Jr., 1306 Adams Street, Bowling Green, Kentucky.**

**FOR SALE—AIRMAIL STAMP collection. 1938 Scott catalog value \$14.05; 131 stamps; 27 countries. Would make excellent start for a large airmail collection. \$10.00 cash. Will send complete list, giving country, catalog value, whether used or unused, general condition of stamp, etc. If these stamps were bought in a store they would cost at least \$12.00. I also have a miscellaneous accumulation of stamps excellent for beginners in general collecting. Will give further details to interested persons. Martin D. Lewis, 439 East 89th Street, New York, N.Y.**

**TRADE: NRI ADVANCED course in Aircraft Radio for used Candler course, or what have you? Max Welton, 31 E. 24th St., Holland, Mich.**



## Simple Induction Phone

(Continued from page 541)

loop, and in this case the loops could be separated up to 7 or 8 ft. and the music heard clearly. There may be cases where this form of short-range telephone would be quite handy. For example where it might be desired to relay radio programs to someone in another building, with possibly a brick wall separating the two parties.

Another way by which the range of this induction phone may be increased is to use an amplifier tube in the transmitter, as is described in the present article. With a more powerful transmitting tube or amplifier than that described, of course, the magnetic field extending from the loop will be just that much stronger, and the stronger the magnetic field produced, the greater the distance the receiving loop can be separated from the transmitter, or at a given distance the received signal will be just that much stronger. Any of the modern type microphones may be used, care being taken to use an impedance-matching transformer. If a crystal microphone is used this is particularly important, as it has a very high impedance and with the transmitting loop of the dimensions specified in the present article, only mediocre results or none at all will be obtained unless a proper matching transformer is used.

This type of short range radio-telephone constituted one of the very first wireless systems developed, and it is, of course, of the audio frequency type and no radio frequency waves are radiated from the transmitter. This means that unless the transmitter loop happened to be located near some telephone line or other wire system, or possibly a neighbor's radio set, no interference will be created by the magnetic field of the loop.

Out in the open country or where the transmitter loop is placed at least 50 ft., or more from any open telephone lines or neighbor's radio set, there is slight, if any, chance that any interference can be picked up from the magnetic field extending from the loop. The magnetic field branching out from the transmitting loop aerial extends, of course, on either side and it is strong only for a distance of 8 to 10 ft., as the operator may soon determine after a few tests with the receiving loop.

### List of Parts

- 1—Transformer—Single-button mike to grid (T2)
- 1—Transformer—pentode to 10 ohm voice coil (T1)
- 1—Transformer—50 ohms to grid (T3)
- 3—1 mf., 100 volt condenser
- 2—.25 mf. condensers
- 1—.002 mf. condenser
- 2—500,000 ohm resistors
- 1—1 megohm resistor
- 1—50,000 ohm resistor
- 1—3,500 ohm resistor
- 1—2,000 ohm resistor
- 1—500 ohm, 2 watt resistors
- 4—Binding post strips
- 2—6-prong tube sockets
- 1—5-prong tube sockets
- Wire required:—
- ½ lb. No. 22 D.S.C.
- ¾ lb. No. 32 D.S.C.

## How To Build A Peak Voltmeter

(Continued from page 548)

### BUD RADIO, INC.

- One box type shield, No. 1244.
- Six tip-jacks, color-coded, (insulated).
- One S.P.S.T. toggle Switch.
- One No. 1200 metal panel (To be cut down to 5" x 8")
- Three name plates, INPUT, OUTPUT, ON-OFF

### Tube and Lamp

- One type "84" tube.
- One 60 Watt Electric Lamp.

### Miscellaneous

- One 5-prong socket.
- One Edison base lamp receptacle.
- One rubber cord and plug.
- Three ¾" rubber grommets.
- One pilot light jewel.
- Two angle-braces, hook-up wire and bolts.

## Index to Advertisers

<b>A</b>	
ABC Radio Laboratories.....	572
Allied Engineering Institute.....	578
Allied Radio Corporation.....	565
Amperite Co.....	592
Astatic Microphone Laboratory, Inc.....	589
<b>B</b>	
Barter & Exchange Free Ads.....	591
Biley Electric Co.....	580
Brush Development Co., The.....	576
Bud Radio, Inc.....	576
Burstein-Applebee Co.....	578
<b>C</b>	
Cameradio Co.....	589
Candler System Co.....	573
Capitol Radio Engineering Institute.....	582
Classified Advertisements.....	590
Clough-Brengle Co., The.....	572, 582
Cornell-Dubilier Corp.....	572
Coyne Electrical School.....	531, 585
Crosley Radio Corporation, The.....	566
<b>D</b>	
Dataprint Company.....	585, 587
Dodge's Institute.....	582
Dutton, E. P., & Co., Inc.....	583
<b>E</b>	
Ever Ready Label Corporation.....	585
<b>G</b>	
Goldentone Radio Co.....	576
Gold Shield Products.....	587, 589
<b>H</b>	
Hallcrafters, Inc., The.....	Back Cover
Hammarlund Manufacturing Co., Inc.....	589
Henry Radio Shop.....	576
Hudson Specialty Company.....	580
<b>I</b>	
Instructograph Company.....	588
International Correspondence Schools.....	592
International Resistance Company.....	575
<b>J</b>	
Jefferson Electric Company.....	581
<b>K</b>	
Kelsey Co., The.....	585
Kenyon Transformer Co., Inc.....	570
Korrol Radio Products Co.....	592
Kusterman, Oscar B.....	568
<b>M</b>	
Meissner Mfg. Co.....	574
Midland Television, Inc.....	567
Modell's.....	572
Montgomery Ward & Co.....	575
<b>N</b>	
National Company, Inc.....	Inside Back Cover
National Radio Institute.....	529
National Schools.....	582
New Ideas.....	580
New York Y.M.C.A. Schools.....	583
<b>O</b>	
Omnigraph Co., The.....	583
<b>P</b>	
Par-Metal Products Corporation.....	578
Private Stationery Company.....	587
<b>R</b>	
Radio Amateur Course.....	Inside Front Cover
Radio & Technical Publ. Co.....	582
Radio Constructors Laboratories.....	569
Radio Craft.....	585
Radio Publications.....	588, 590
Radio Training Assn. of America.....	583
Ramsey Publishing Co.....	582
Raytheon Production Corporation.....	577
RCA Institutes, Inc.....	583
<b>S</b>	
Schell, Rolfe F.....	580
Scott, E. H., Radio Laboratories, Inc.....	587
Short Wave Coil Book.....	576
Short Wave League.....	584
Solar Mfg. Corp.....	587
Sprayberry Academy of Radio.....	583
Standard Transformer Corporation.....	574
Superior Instruments Company.....	570
Supreme Radio Supply Co.....	580
<b>T</b>	
Tavella Sales Co.....	588
Technifax.....	589
Telex Co.....	582
Trimmo Radio Manufacturing Company.....	572
Triplet Electrical Instrument Co.....	575
Try-Mo Radio Co., Inc.....	580
<b>U</b>	
Ultra High Frequency Products Co.....	571
Ultra Precision Instruments Co., Inc.....	572
United Radio Co.....	588
Universal Microphone Co., Ltd.....	570
<b>W</b>	
Wellworth Trading Company.....	585, 589
Wholesale Radio Service Co., Inc.....	579

(While every precaution is taken to insure accuracy, we cannot guarantee against the possibility of an occasional change or omission in the preparation of this index.)

# AMPERITE

presents  
**THE ACOUSTIC COMPENSATOR**



## 3 IMPORTANT USES

PUSH UP TO INCREASE HIGHS  
PUSH DOWN TO INCREASE LOWS



- (1) The Acoustic Compensator enables you, to lower or raise the response of the microphone by the mere flip of the finger!
- (2) Makes the Velocity immediately adjustable to close talking or distant pickup.
- (3) Immediately adjustable to any type of job or occasion.

MODELS RBHk, RBMk, with acoustic compensator. Frequency range 40 to 11,000 CPS. Output, -65 db. Switch, cable connector, 25' of cable.

\$42.00 LIST

MODELS RBHn, RBMn, without acoustic compensator.....

\$42.00 LIST

MODELS RAH-RAL, excellent for speech and music. Reduces feedback. Output, -68 db.

\$22.00 LIST

**NEW!** AMPERITE CONTACT MICROPHONE for use on all string instruments... \$22.00 LIST  
AMPERITE "HAND-I-MIKE," smallest velocity made; used as hand, desk, or stand mike. \$22.00 LIST

Write for new Illustrated Bulletins.

FREE: Window Decal & Window Display; also new sales helps.

**AMPERITE Co.** 561 BROADWAY, N. Y.

**AMPERITE Velocity MICROPHONE**

## CHASSIS—CABINETS PANELS & CANS

STANDARD SIZES ON HAND  
SPECIAL SIZES MADE TO ORDER  
**KORROL RADIO PRODUCTS CO.**

232 Greenwich St., Dept. S-2 New York City

# RADIO

holds great rewards for trained men



The big opportunities in Radio will be enjoyed by trained men. The International Correspondence Schools Radio Course, prepared by leading authorities and constantly revised, will help make you a trained man! A fascinating book - FREE.

**AVIATION ENGINEERS** are leaders in modern progress



Aviation depends upon engines, and knowledge of aviation engines is a long step toward success in this rapidly growing industry. Many leading aviation engineers today took their first step by mailing a coupon to the I. C. S. at Scranton. Why don't you follow their example?

### INTERNATIONAL CORRESPONDENCE SCHOOLS

Box 2877-E, Scranton, Penna.

Explain fully about your course in the subject marked X:

- |   |   |
|---|---|
| <input type="checkbox"/> RADIO            | <input type="checkbox"/> AVIATION               |
| <input type="checkbox"/> Chemistry        | <input type="checkbox"/> Accountancy            |
| <input type="checkbox"/> Invention        | <input type="checkbox"/> Advertising            |
| <input type="checkbox"/> Refrigeration    | <input type="checkbox"/> Electrical Engineering |
| <input type="checkbox"/> Air Conditioning | <input type="checkbox"/> Drafting               |
| <input type="checkbox"/> Architecture     | <input type="checkbox"/> Show Card Lettering    |
| <input type="checkbox"/> Good English     |   |

Name.....Age.....

Address.....





In these few short months the NC-80X has become part of the National tradition. Their advanced circuit details, including the wide-range crystal filter and high IF frequency for image rejection, have brought a new standard of performance to the low priced field. Their thorobred construction keeps that performance consistently high. And their convenience makes operation swift, accurate, and tireless.

# NATIONAL NC-80X

**NATIONAL COMPANY, INC.**  
**Malden, Mass.**

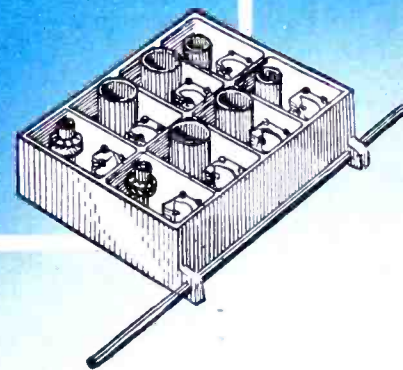



# A page from the hallicrafters Scrapbook



**THE CONTROL BOARD OF WFBR, NBC station, of Baltimore, Md., showing panel installation of 1938 Super Skyrider.**



**HENRY HOFFMAN, operator for Rev. Father Paul Schulte, "Flying Priest of the Arctic," writes from his post in the Arctic waste— "With the Sky Challenger, low-power**

**transmitters were received over a surprisingly long distance, where all other receivers I used this summer in the Hudson Bay failed. Hallicrafters receivers are also used in the Mac Gregor Expedition now in the Arctic regions.**



**ENRIQUE HIDALGO — CIE-FUEGOS, CUBA — Winner of second prize in the All-Wave B. C. DX contest with his new Super Skyrider. He says: "The receiver has created a sensation here where it has astonished every new listener."**

**T**hrough the Hallicrafters' Scrap Book, one cannot help being impressed by the widespread acceptance of Hallicrafters Communications Receivers. We are proud to show on this page a very few of the outstanding personalities who operate Hallicrafters receivers and their rigs. . . . The very fact that Hallicrafters receivers figure so prominently in leading amateur, commercial and scientific stations is in itself a testimonial to the merits of these outstanding receivers.



**W1KTC — BEATRICE HOLMAN, Belmont, Mass.: "The more I operate the Super Skyrider, the better I like it and I am only too glad to add my word of praise. Am on 10 meters at present and have heard plenty of DX this morning that I never copied before."**



**TED ROGERS—famous short wave radio columnist of the N. Y. World Telegram spins the dial of his Super Skyrider.**



**W2AMJ — FRANK LESTER, Bergenfield, N. J., at the controls of his 1938 Super Skyrider.**

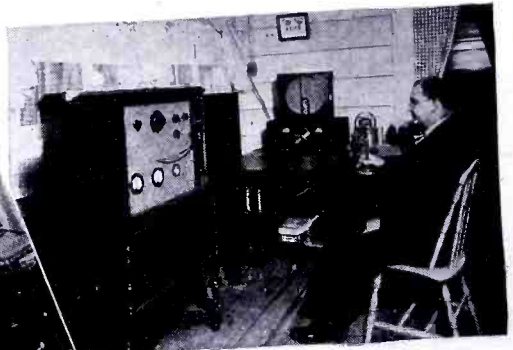

**W3DTX — W. W. KELLUM, Washington, D. C., says: "I selected the Super Skyrider because it is one of the best receivers on the market today including price and performance. In a little over a month, I have worked more DX than ever before and have had good receivers in the shack."**

**All Hallicrafters' Receivers available on liberal time-payments**

## the hallicrafters inc.

2601 Indiana Avenue, Chicago, U. S. A. • Cable Address "Hallicraft" Chicago

**WORLD'S LARGEST BUILDERS OF AMATEUR COMMUNICATIONS RECEIVERS**