

HUGO GERNSBACK
Editor

SHORT WAVE CRAFT

September

WORLD'S
LARGEST
SHORT WAVE
CIRCULATION



5 Meter ACORN

Super-Regenerator

See Page 264

25¢

IN U.S. AND
CANADA

THE RADIO EXPERIMENTER'S MAGAZINE



Exclusive New MIDWEST ELECTRIK-SAVER

Slashes Radio Current Bills IN HALF!

NEW
1937
AIR
TESTED

16-TUBE MIDWEST

5 WAVE BANDS

9 to 2,200 METERS

The Elektrik-Saver is today's most sensational radio feature. It cuts radio wattage consumption as much as 50% and results in Midwest 16 and 18-tube radios consuming no more current than an ordinary 7 or 8-tube set. This feature enables the "Air Tested" Midwest to operate on low line voltages—as low as 80 volts! In addition, the Elektrik-Saver increases tube life, reduces strain on the set, eliminates repair bills and makes for more consistent and gloriously realistic reception.

SAVE UP TO 50%
DIRECT FROM MIDWEST FACTORY

NO middlemen's profits to pay! Buying direct from the Midwest factory makes your radio dollar go twice as far. See for yourself that Midwest offers you greater radio values—enables you to buy the more economical factory-to-you way that scores of thousands of radio purchasers have preferred since 1920. Never before so much radio for so little money! Why pay more? The broad Midwest Foreign Reception and Money-Back Guarantees insure your satisfaction. You get 30 days FREE trial in your own home!

Once again, Midwest demonstrates its leadership by offering the world's most powerful and most beautiful ALL-WAVE 16-tube, 5-Band Radio. A startling achievement, it makes the whole world your playground. Powerful Triple-Twin tubes (two tubes in one!) give 18-tube results. This advanced radio is a master achievement, a highly perfected, precisely built, radio-musical instrument that will thrill you with its marvelous super performance... glorious crystal-clear "concert" realism... and magnificent foreign reception. The Dual Audio Program Expander gives a living, vital realistic quality to voice and musical reproduction. Before

85 ADVANCED 1937 FEATURES

This Super DeLuxe Midwest is so powerful, so amazingly selective, so delicately sensitive that it brings in distant foreign stations with full loud speaker volume on channels adjacent to powerful locals. Scores of marvelous Midwest features, many of them exclusive, make it easy to parade the nations of the world before you. You can switch instantly from American programs... to Canadian, police, amateur, commercial, airplane and ship broadcasts... to the finest and most fascinating foreign programs. The new Midwest Tuning System, for example, shows you exactly where to tune for foreign stations... while Automatic Aerial Adaption triples the number of foreign stations that can be secured and doubles the excitement and joy of short wave tuning.



you buy, write for the FREE 40-page four color 1937 MIDWEST USES LESS CURRENT THAN AN ORDINARY LIGHT BULB

With a Midwest, the finest entertainment the world has to offer is at your command. It is preferred by famous orchestra leaders, musicians, movie stars and discriminating radio purchasers everywhere. It enjoys an increasing world-wide sale because it outperforms ordinary receivers costing twice as much. You can order your Midwest "Air-Tested" radio from the new 40-page catalog with as much certainty of satisfaction as if you were to come yourself to our great factory. (It pictures the beautiful 1937 radios... in their actual colors!) You pay as little as 10c a day. Three iron-clad guarantees protect you: (1) A Foreign Reception Guarantee—(2) Absolute Guarantee of Satisfaction—(3) One-Year Warranty. Fill in and mail the coupon NOW!



CINCINNATI, OHIO, U.S.A.
Cable Address MIRACO... All Codes

MIDWEST RADIO CORP.

DEPT. C-14
Established 1920

Cable Address MIRACO... All Codes

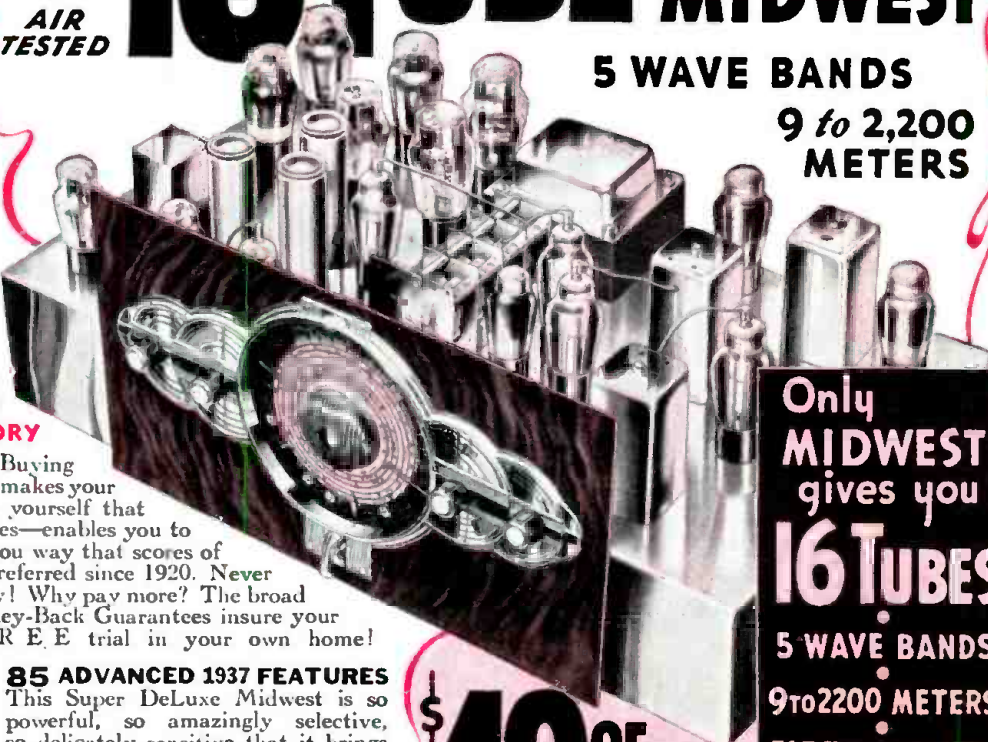

\$49.95 COMPLETE WITH GIANT THEATRE-SONIC SPEAKER

TERMS AS LOW AS 10¢ A DAY

MY MIDWEST HAS UNEQUALLED BEAUTY OF TONE AND SHARPNESS OF SELECTIVITY.
Glen Gray



CONGRATULATIONS FOR CREATING THE MIDWEST. IT BRINGS IN WONDERFUL FOREIGN RECEPTION.
Rubinoff



Only MIDWEST gives you 16 TUBES 5 WAVE BANDS 9 to 2200 METERS ELECTRIK-SAVER PUSH BUTTON TUNING AUTOMATIC AERIAL ADAPTION DUAL AUDIO PROGRAM EXPANDER 30 DAYS FREE TRIAL

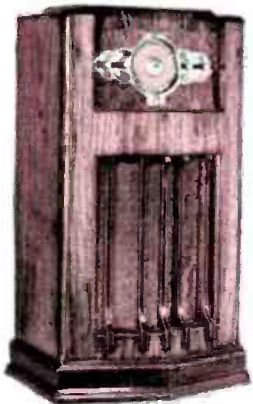

MAIL COUPON TODAY for

Free 30-DAY TRIAL OFFER
and 40-PAGE FOUR-COLOR Free CATALOG

MIDWEST RADIO CORPORATION
Dept. C-14, Cincinnati, Ohio

Without obligation on my part, send me your new FREE catalog and complete details of your liberal 30-day FREE trial offer. This is NOT an order.

Name _____
Address _____
Town _____ State _____

Special offer and prices prevail only when dealing direct with factory by mail.

OPPORTUNITIES are many for the Radio Trained Man

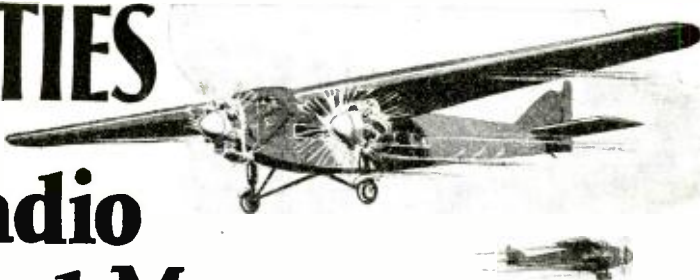

Don't be an untrained man. Let me show you how to get your start in Radio—a fast growing, live money-making industry.

Prepare for jobs as Assembler, Inspector and Tester—Radio Sales or Service and Installation Work—Broadcasting Station Operator—Wireless Operator on a Ship or Airplane, Talking Picture or Sound Work—HUNDREDS OF OPPORTUNITIES for a real future in Radio!

12 Weeks of Shop Training Pay Your Tuition After Graduation

We don't teach by book study. We train you on a great outlay of Radio, Television and Sound equipment—on scores of modern Radio Receivers, actual Broadcasting equipment, Television apparatus, Talking Picture and Sound Reproduction equipment, Code and Telegraph equipment, etc. You don't need advanced education or previous experience. We give you—RIGHT HERE IN THE COYNE SHOPS—the actual practice and experience you'll need for your start in this great field. And because we cut out all useless theory and only give that which is necessary you get a practical training in 12 weeks.



TELEVISION *and* TALKING PICTURES

Television is coming. Soon there may be a demand for THOUSANDS of TELEVISION EXPERTS! The man who learns Television now can have a real future in this great new field. Get in on the ground-floor of this amazing new Radio development! Come to COYNE and learn Television as it should be learned on Television equipment. Talking Picture and Public Address Systems offer opportunities to the Trained Radio Man. Here is a great new Radio field which is rapidly expanding. Prepare NOW for these wonderful opportunities! Learn Radio Sound Work at COYNE on actual Talking Picture and Sound Reproduction equipment.

ARRANGE TO FINANCE YOUR TUITION

I am making an offer that is the most unusual ever made by a school. I'll take you here in my shops and give you this training and you pay your tuition in small monthly payments extending over an 18-month period, the first payment to be made 5 months after you start school. I know a lot of honest fellows haven't much money these days, but still want to prepare themselves for a real job, steady work and better pay.

Mail coupon for all details of this "Pay Tuition after Graduation Plan."

ELECTRIC REFRIGERATION AIR CONDITIONING

To assure your thorough preparation for a prosperous future, I include—at no extra cost additional instruction in Electric Refrigeration, Air Conditioning and Diesel Engines, taught by personal instruction and actual work on real equipment.

ALL PRACTICAL WORK At COYNE in Chicago

ALL ACTUAL, PRACTICAL WORK. You build and service radio sets. You get training on real Broadcasting equipment. You construct Television Receiving Sets and actually transmit your own Television images over our Television equipment. You work on real Talking Picture and Sound equipment. You learn Wireless Oper-

ating on Actual Code Practice apparatus. We don't waste time on useless theory. We give you the practical training you'll need for your start in Radio—in 12 short, pleasant weeks.

MANY EARN WHILE LEARNING

You get Free Employment Service for Life. And don't let lack of money stop you—my plan makes it possible to get Coyne training with very little money. Many of our students earn part of their living expenses while going to school and if you should need this help just write to me. Coyne is 37 years old. Coyne Training is tested—proved beyond all doubt. You can find out everything absolutely free. Just mail coupon for my big free book!

H. C. Lewis, Pres. RADIO DIVISION Founded 1899
Coyne Electrical School
500 S. Paulina St., Dept. 66-2K, Chicago, Ill.

Mail Coupon Today for All the Facts

H. C. LEWIS, President

Radio Division, Coyne Electrical School
500 S. Paulina St., Dept. 66-2K, Chicago, Ill.

Dear Mr. Lewis:—Send me your Big Free Radio Book, and all details of your Special Offer, including Electric Refrigeration, Air Conditioning and Diesel Training and your "Pay After Graduation" offer.

Name

Address

City State

Please mention SHORT WAVE CRAFT when writing advertisers

IN THIS ISSUE: PROMINENT SHORT-WAVE AUTHORS

Shuart • Hooton • Johnson • Plant • Cisin • Lester • Palmer

HUGO GERNSBACK
Editor



H. WINFIELD SECOR
Managing Editor

GEORGE W. SHUART,
W2AMN
Associate Editor

Combined With
Official SHORT WAVE LISTENER

Contents for September, 1936

| | |
|---|-----|
| Editorial—"Radio Amateur Problems," by Hugo Gernsback..... | 259 |
| Short-Wave Snapshots..... | 260 |
| "Photo-Mike" Snaps Photo While You Speak..... | 261 |
| 20 Kw. Mobile Television Transmitter..... | 261 |
| RCA Demonstrates Facsimile 100 Miles on 3 Meters..... | 262 |
| S-W's in Aviation..... | 263 |
| Coast Guard Uses S-W's on Planes..... | 263 |
| The "U.H.F." Wizard Six..... | 264 |
| The "W2AMN 5-Meter MOPA," by George W. Shuart, W2AMN..... | 266 |
| Short Waves and Long Raves, Our Readers Forum..... | 268 |
| The "M.T." Xtal Transmitter, by Harry D. Hooton..... | 269 |
| Receiver-Adapter Unit for Ultra Short Waves, by Stanley Johnson, W9LBV..... | 270 |
| How to Build a "Bug" Key, by Christos M. Manitsas, W1IJJ..... | 270 |
| 5-Meter Transmitter-Receiver—Uses New Metal Tubes, by Henry B. Plant, W6DKZ..... | 271 |
| Metal-Tube Pre-Selector, by H. G. Cisin, M.E..... | 272 |
| The Beginner's Breadboard ECONOMY—2, by Frank Lester, W2AMJ..... | 273 |
| World-Wide Short-Wave Review, Edited by C. W. Palmer..... | 274 |
| New Set Has 2-Color Tuning Dial..... | 275 |
| The Zottu Multitube Oscillator..... | 275 |
| \$5.00 for Best Short-Wave Kink..... | 276 |
| Diagrams of S-W Commercial Receivers—RCA Communications Type Receiver, Model ACR-175; Crosley "Auto-Expressionator" Receiver..... | 277 |
| What's New in Short-Wave Apparatus—The New National NC-100 Receiver..... | 278 |
| Hammarlund Super-Pro Receiver..... | 279 |
| 2-Tuber with 9½ to 2000 Meter Range..... | 280 |
| An "F.B." Duplex Portable..... | 280 |
| High Quality MOPA for 5 and 10 Meters..... | 280 |
| New 5-Meter Receiver Uses 3 Tubes, by Frank Lester, W2AMJ..... | 281 |
| New Apparatus for the "Ham"..... | 281 |
| "Radio Amateur" Course, Conducted by Geo. W. Shuart, W2AMN..... | 282 |
| Does 60-Cycle A.C. Create a 60-Cycle Note?..... | 283 |
| Short Wave League and Scout News..... | 284 |
| World S-W Station List, by M. Harvey Gernsback..... | 285 |
| Alphabetical List of S-W Stations..... | 289 |
| Short-Wave Question Box..... | 290 |
| Short Wave Scouts—Thirtieth "Trophy Cup" Award..... | 292 |

Features in the Oct. "Fan" Issue

Big "Hook-up" Feature Section—Dozens of Receiver, Transmitter, and other Circuits for "Fan" and "Ham."
 "Chicken Coop" Special—the "Fan's Own" Receiver—Made from old Parts, by Nils Rohde.
 The "Twin-Tube" All-Wave Portable, by H. G. Cisin.
 The U.S.W. "Obstacle Detector" Used on S.S. *Normandie*.
 New All-Wave Superhet with "Double" I.F. Modulator Using 6L6's, by G. W. Shuart, W2AMN.
 "Ham" and "Television" Converter for 5-Meters, by W2AMN.



Certified Circuits

● **SHORT WAVE CRAFT** goes to a large expense in verifying new circuits. When you see this seal it is your guarantee that such sets have been tested in our laboratories, as well as privately, in different parts of

the country. Only "Constructional-Experimental" circuits are certified by us.

When you see our certified seal on any set described, you need not hesitate to spend money for parts, because you are assured in advance that the set and circuit are bona fide and that this magazine stands behind them.

SHORT WAVE CRAFT is the only magazine that certifies circuits and sets.

OUR COVER

● The set illustrated on our cover this month is a 5-meter super-regenerator, using Acorn tubes and incorporating the very latest technical developments in a circuit especially designed for this band. The constructional details of this receiver are given in full, with illustrations, on Page 264.

COPYRIGHT, 1936, BY H. GERNSBACK

Published by POPULAR BOOK CORPORATION

HUGO GERNSBACK, President - - - - H. W. SECOR, Vice-President
 EMIL GROSSMAN - - - - - Director of Advertising
 Chicago Ad. Office - - - - - L. F. McCLURE, 919 No. Michigan Ave.
 Publication Office - - - - - 404 N. Wesley Avenue, Mount Morris, Ill.
 Editorial and General Offices - - - - 99-101 Hudson St., New York, N. Y.
 European Agent: Gorringer's American News Agency, 9A Green St.,
 Leicester Square, London W. C. 2
 Australian Agents: McGILL'S AGENCY, 179 Elizabeth St., Melbourne

SHORT WAVE CRAFT—Monthly. Entered as second class matter May 7, 1930, at the post office at Mount Morris, Illinois, under the act of March 3, 1879. Trademarks and copyrights by permission of H. Gernsback, 99-101 Hudson St., N. Y. C. Text and illustrations of this magazine are copyrighted and must not be reproduced without permission. **SHORT WAVE CRAFT** is published on the 1st of every month. Twelve numbers per year. Subscription price is \$2.50 a year in the United States and possessions and Canada. Foreign countries, \$3.00 a year. Single copies 25c. Address all contributions for publication to Editor, **SHORT WAVE CRAFT**, 99-101 Hudson St., New York, N. Y. Publishers are not responsible for lost manuscripts. Contributions cannot be returned unless authors remit full postage. **SHORT WAVE CRAFT** is for sale at all principal newsstands in the United States and Canada. European agents: Brentano's, London and Paris. Printed in U. S. A. Make all subscription checks payable to Popular Book Corporation.



Radio Amateur Problems

An Editorial by Hugo Gernsback

● IN AN art which changes as rapidly as radio, it is not surprising that the radio amateur must frequently change his ideas, indeed, his entire mode of work, if he is to keep up to date.

Changes have come along so rapidly ever since the beginning of the art that it is often difficult to realize how great these changes are, and only by looking backwards for a few years can we appreciate what is really taking place.

On the other hand, the amateur started out in the 200 meter band and has rapidly progressed up into the higher frequencies, from 75 meters down to the present $2\frac{1}{2}$ meter wave length. All this has taken place in a rather orderly fashion, and, while the changes have been rapid, the radio amateurs have always been able to cope with the situation. Indeed, it may be said that the amateurs as a body have always been vastly more up to date than the commercial interests, because having no capital and financial structures to bother with, they have been able to make lightning-like changes, as soon as something better and newer came along.

In only one respect have the amateurs been slow to move, but this also is not their own fault. I refer to the old argument of *phone versus code*. More and more radio amateurs are taking to phone transmission, and the best estimate today is that of the total amateurs in the country, between twenty and thirty per cent of them, operate their own radio phone as a means of communication with each other. The rest are still using code. The reason for this, of course, is that the phone takes up more space in the wave band and gives, therefore, rise to more interference. If amateurs had more "elbow room" in the wave spectrum, conditions might be different. For this reason, the phone has not been growing as fast as it might have. Today, radio amateurs are using phone on the 75 meter band, on the 25 meter band, on the 10 meter band, and on the 5 meter band. By far the largest percentage are on the 75 meter band, while the smallest is on the 5 meter band. It is of interest, however, to note, that on the 5 meter band, phone operation is almost **ONE HUNDRED PER CENT OF THE TOTAL**. In other words, on the 5 meter band, practically no code is used.

This in itself is a significant fact. The only trouble at the present time in the 5-meter band is with the equipment used. More stable transmitters and receivers, such as the MOPA and the superheterodyne, should be used. The apparatus used in the average 5-meter station is seriously in need of renovation, not only to produce more intelligible signals, but so that a greater number of stations can operate within the *limits of the band* and still cause no interference with one another. The 2-tube MOPA described in this issue is the answer in so far as cleaning up the 5-meter band is concerned.

Indeed, if you go down to the open region below $2\frac{1}{2}$ meters, you immediately pop into a sort of radio amateurs' paradise, because here we have a tremendous amount of room, and we can easily accommodate a thousand-fold as many transmitters as in the 5 meter band. And that is something to think about, not only once but a number of times. But that is not all. The Federal Communications Commission

has given the amateur everything below $2\frac{1}{2}$ meters, but what have we done with this band so far? Practically nothing! It lies unused, unworked, (except for a handful of amateur stations) and our constant fear is that it will be taken away from us and given to "commercials" exclusively unless we wake up and do something about it.

Television is becoming "hotter" every day, and the big radio interests are out for wave allotments. *It is almost certain that unless something is done about it rather quickly, the amateur will be crowded out of one of the choicest bands we ever had.* Which would be a pity.

Which brings us to television, and it is here that we must report a curious apathy manifested by the entire amateur fraternity. For some reason or other, the most up-to-date and aggressive body of radio technicians, namely, the radio amateurs, sniff with disdain every time the word "television" is mentioned. Why this should be is another one of those unsolved conundrums. Amateurs have been in the advance guard of radio ever since it started, but when it comes to television the entire body, as a man, wants none of it!

But last month The Radio Corporation of America started to transmit television and announced that it would spend a million dollars in perfecting transmission from its 10 kilowatt station on top of the Empire State Building in New York. This transmission is done at about 6 meters, and as far as is known, the average coverage is about fifty miles. This however is just an orthodox technical statement and should not be taken too seriously, because eight hundred miles has already been covered in this wave band.

It is no great secret that many amateurs are operating outside of the 56 to 60 mc. band. Now with television stations being assigned frequencies immediately adjacent to both ends of the 5-meter band, amateurs must confine themselves to the *limits* of the band or *suffer serious consequences*. This is another reason why the equipment should be improved and replaced by more stable apparatus, because it is safe to say that over one-half of the stations are now out of the band and when these get back into the *legal* band crowding will be much worse than it is at the present time.

In the meanwhile, amateurs have for the first time a powerful up-to-date television transmitter that surely will go places. And it seems to me, that it is up to the amateurs to do something about it—not just talk about it. In my opinion neither the mechanical disc scanner nor the cathode ray tube is the final answer to television, and here is where the radio amateur comes in. It is conceivable that one of them might perfect an entirely different plan of reception that would wake up the entire industry and make something out of television. It is almost certain that the mechanical scanner is not the solution. It seems also that the cathode ray tube, due to its great expense, is not the solution either.

Radio broadcasting got its tremendous momentum when in 1920-21 everybody could get hold of a fifty cent detector and a two-dollar pair of phones and could readily listen in. **IT IS THIS THAT MADE RADIO**—never forget it! Television will not amount to anything unless the masses will be enabled to get a "look in" for a few dollars the same as they had a "listen in" when radio broadcasting first started.

SHORT WAVE CRAFT IS PUBLISHED ON THE 1st OF EVERY MONTH

This is the September, 1936 Issue—Vol. VII, No. 5. The Next Issue Comes Out September 1

Editorial and Advertising Offices, 99-101 Hudson Street, New York City

Short-Wave Snapshots

Short waves used by Trains, Scotland Yard and for Television.

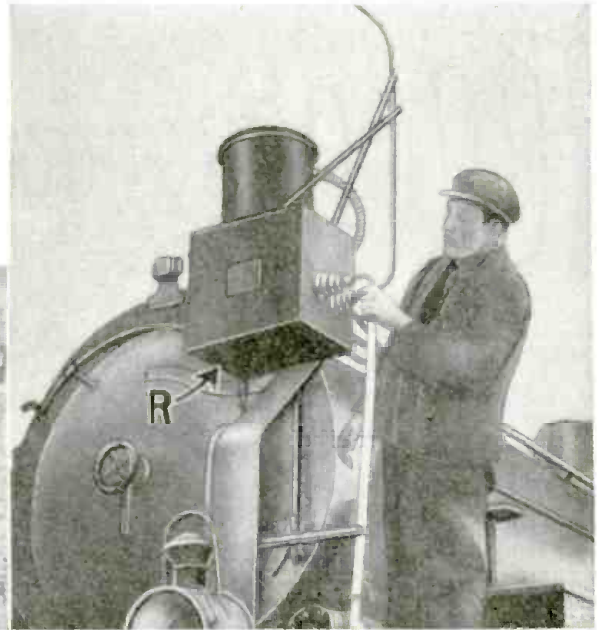

One of the difficulties of the railroad industry has been the means of communication between the signal stations and the engineers on trains. In case of a change in orders, it has always been found rather difficult to do anything but signal the train to stop at the nearest signal tower. French railroads have gotten around this by recently installing a sending and receiving station on all of the locomotives and also in the railroad yards. It was first tried out on the road between Rouen and Paris where it was found to be extremely successful. Photo at left—general view of sending station at Rouen; above—radio set "R" installed on locomotive.

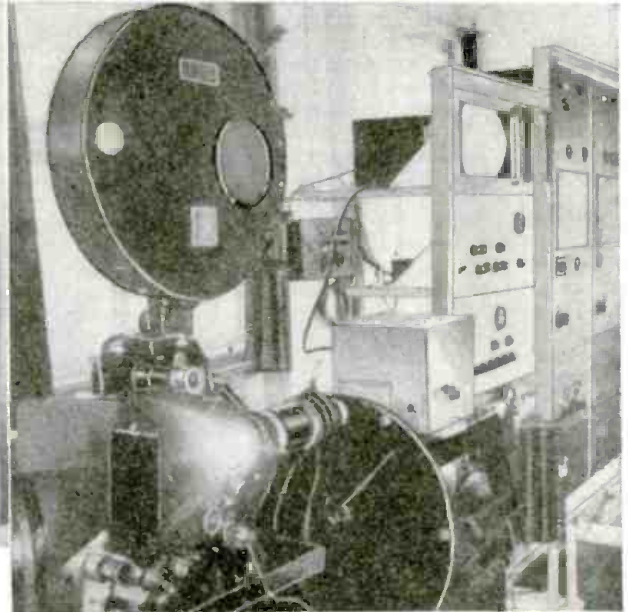

Photo above shows the famous Scotland Yard's new short-wave station (Marconi), in London. Two photos at right show Berlin television transmitter and station monitor. The loudspeaker grill appears below the cathode ray tube window. This is the Berlin television station which is in daily operation, transmitting on ultra short waves. Photo below shows short-wave transmitter and receiver in Little America as used by the recent Byrd Expedition. (Clay Bailey, chief radio operator at the main control)—(C) Byrd Antarctic Expedition II.



PHOTO-MIKE Snaps Photo While

Miniature Transmitters Broadcast Interviews and Simultaneously Snap Speakers' Pictures

● THE *photo-mike*, latest development in portable radio transmitters, which resembles and can be carried about like a news photographer's camera, was first introduced by the Columbia Broadcasting System at the Republican National Convention in Cleveland.

The new device not only is a miniature "radio station" in itself, but will take your picture as you speak! Curious observers thought they saw in it a forerunner to television. But its purpose in life is to provide complete freedom of movement during "interviews" in convention corridors and lobbies and, at the same time, obtain candid action photos of speakers for the press, with complimentary copies for "the folks back home."

The photo-mike will also automatically "mugg" and identify any uninvited but

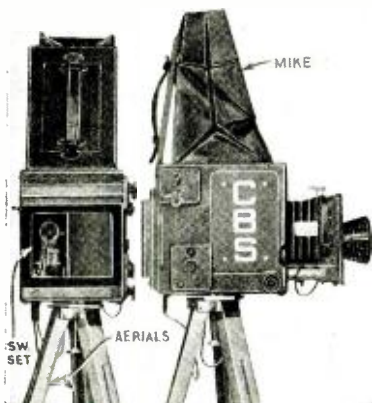

Left—the "Photo-Mike" is a clever combination of camera and ultra-short wave transmitter, with the microphone hidden in the focusing hood.

The diagram at the right shows the hook-up of the ultra-short wave portable transmitter built into one side of the camera, as shown in the accompanying photo. It operates in the 40 mc. region.

You Speak

ebullient onlooker who might step from the crowds to shout "Hello, Ma!" in the midst of a statesman's speech over the nationwide network.

"Its primary purpose, however, is to serve as a quick, mobile auxiliary for 'broadcasts' by delegates, party leaders, press commentators and other notables during possible lulls in actual proceedings on the convention floor and speakers' rostrum," explained Paul M. White, CBS director of public events, who directed the convention broadcasts.

"These ultra high frequency transmitters supplemented the battery of 68 stationary micro- (Continued on page 293)



Above—Pretty Wynette Kronz at the Cleveland convention, demonstrating to Thomas L. Sabin the method of using the CBS "Photo-Mike," which snaps your picture while you broadcast.

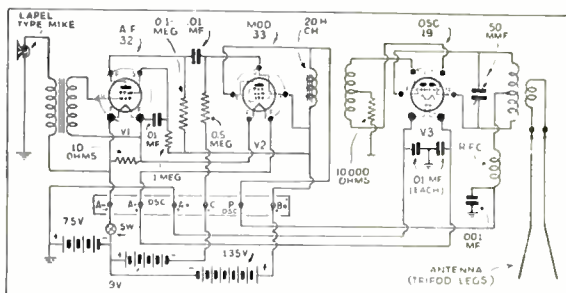

20 Kw. Mobile Television Transmitter

● BECAUSE of its great value for political propaganda, Germany at present is making great effort to accelerate television progress. Eighty cents collected each month from every German radio listener, with the idea of producing entertaining radio programs, is partly used for these experiments. Since there are 6.5 million "paying" radio listeners in Herr Hitler's Reich, relatively large sums of money are available to boost television progress at any cost.

What Germany does for example, to help make television popular is indicated by the fact that at Berlin, the Reich's capital, two of the world's largest *ultra-short wave* transmitters have been set up. Each of them has an output of 16 kilowatts, and is daily on the air for about 10 hours.

The collapsible mast which supports a small dipole antenna at the top.

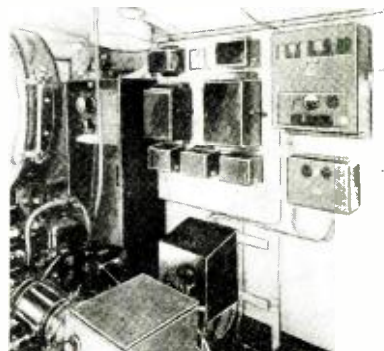

This photo shows the interior of one of the trucks which carries the television transmitter proper.

20 motor trucks transport the 20 Kw. ultra short-wave Television station.

Another attempt to force German television progress is the design and construction of an elaborate "mobile" television station on wheels. Nine hundred thousand dollars taken from the monthly listener fees have recently been spent for the construction of two ultra short-wave transmitters, each of 10 kilowatts output, and (Continued on page 319)

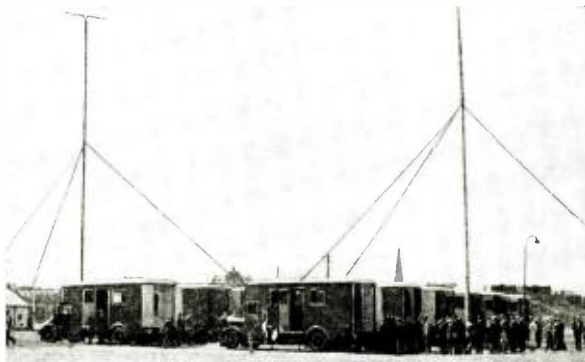
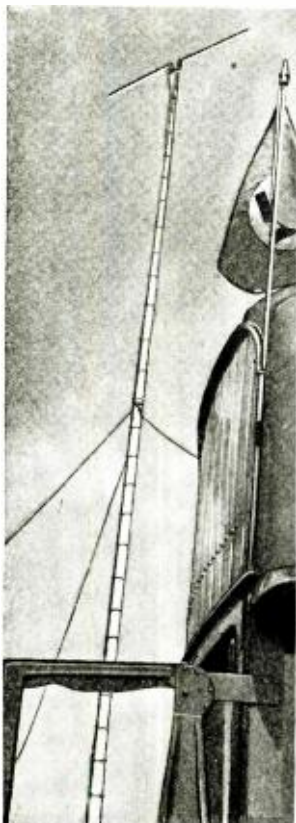

RCA Demonstrates Facsimile 100 Miles on 3 Meters

An important milestone in the advance of radio technique was reached a short time ago, when a demonstration was given simultaneously in New York and Philadelphia of a high-speed facsimile circuit operating on 3 meters. Intermediate relay stations are used to bridge the 90-mile distance between the two cities, the relay stations being controlled from the stations in either city by means of special tone signals.

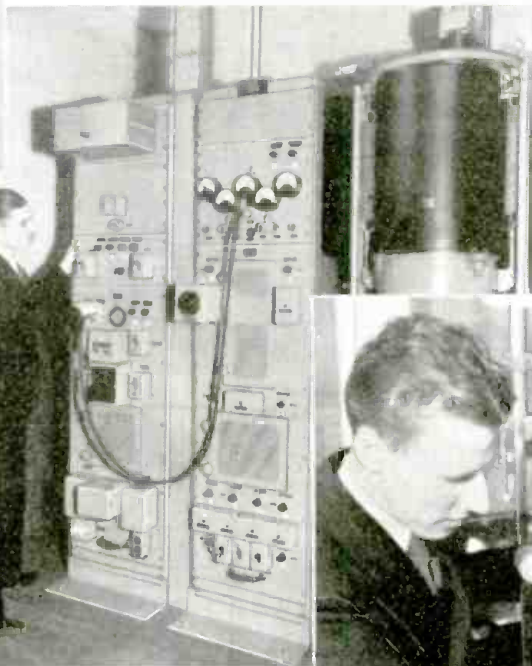
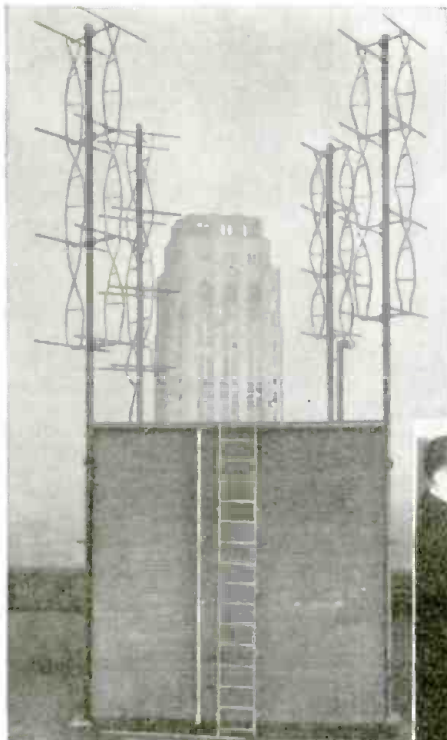

● **RADIO-COMMUNICATION** hails the approach of new services by which business men will send one another *entire letters* by telegraph instead of terse "ten-word" telegrams and in which social notes will speed through space to be received and delivered in the *exact handwriting of the senders!* The occasion was the recent demonstration of RCA's new ultra-short wave radio circuit connecting New York and Philadelphia. The circuit is unique in that it employs *ultra-short waves* with *automatic* relay stations and enables the transmission of drawings, type matter, handwriting and other visual material in facsimile, along with the simultaneous operation of automatic typewriter and telegraph channels. It is a completely *secret* system.

The two institutions which were first to recognize the importance of the electric telegraph of Samuel F. B. Morse a century ago celebrated this new era in communications by exchanging greetings. In 1836 Professor Morse gave the first demonstration of his new instrument to his colleagues at New York University. He gave the

next demonstration outside New York City before the membership of Franklin Institute, in Philadelphia. On June 11 Chancellor Harry Woodburn Chase of New York University and Vice-President W. Chatin Wetherill of The Franklin Institute, Philadelphia, exchanged pictures and greetings by *radio facsimile*. Models of the first Morse ap- (Continued on page 296)

Extreme left—The novel "pine tree" type of transmitting antenna used at the New York end of the RCA ultra short-wave circuit to Philadelphia. The aerials are placed on high buildings so as to obtain the greatest range with these very short waves.

Center photo—The ultra short-wave transmitter in New York, the "resonant lines" being incased in the cylinder at the right.

Below—Close-up of facsimile transmitter at New York; a photocell and lens system scanning the revolving "copy."



The four photos below show, from left to right, the "facsimile" receivers; the special 3-meter receiver with Acorn tubes, etc.; next, a rear view of the receiver panel, and finally a view of the receiving antenna.

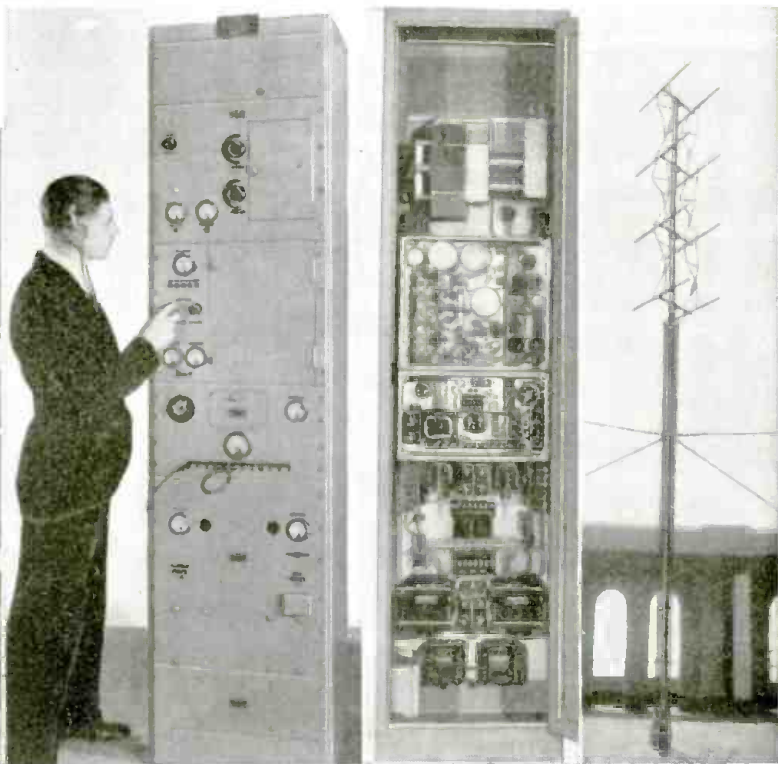

S-W's in Aviation

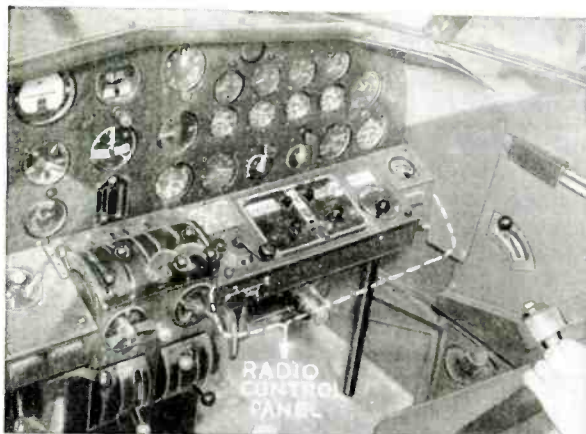

Remote Control Panel for Plane Radio

● ALL the remote control equipment used in this airlines' radio installation is grouped in one spot just in front of the co-pilot's place and so located as to be accessible to both the pilot and the co-pilot. In the photograph this equipment is shown located on a shelf just below the instrument panel proper. In the upper left-hand corner is a small chart which shows the location, frequency, and dial settings for all of the U.S. De-

(Continued on page 294)

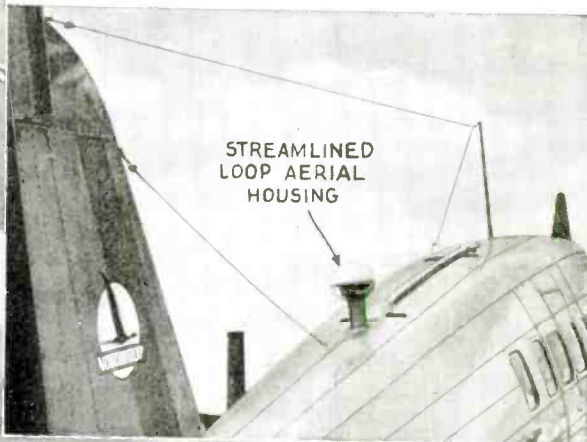

STREAMLINED LOOP AERIAL HOUSING

Stream-Lined Loop Aerial

● THE U.S. Coast Guard has developed and is now placing in use on its high-speed planes a streamlined housing for direction finding loop antennas, which reduces the wind resistance of the loop almost to the vanishing point, without any appreciable loss in efficiency of the direction-finding value; and in some ways the direction-finding value is even increased. Use of this housing, reducing the wind resistance from 57 lbs. to less than a lb. results therefore in the plane's speed increasing by 5 miles per hour. The newly developed streamline housing is a hollow "tear drop" of bakelite which is made in 2 sections, both sections being riveted together, of about 10 inches in diameter and 18 inches long. The whole object is secured to the fuselage, and the direction finding loop rotates freely inside of the housing completely protected from the force and the drag of the wind-stream.



Coast Guard Uses S-W's on Planes



Left—Position of radio equipment on U.S. Coast Guard plane is indicated at "X," and also the connection (dotted line) between it and the double loop aerial observed at the right of the photo.

● THE work of the U.S. Coast Guard aircraft division is exacting and exhaustive. Although it does "peacetime" duties, these are no less important than the duties of any other branch of government or military air arms; the Coast Guard's business is to

save lives, and to help prevent loss of life, injury, etc.

It is therefore necessary for these aircraft to be equipped with the latest and best, and most comprehensive radio apparatus. Standard equipment as now featured in Coast Guard Douglas amphibians now includes:

1. Main transmitter, for code. 75 watt power. Frequency range 275-600 kilocycles, and from 2600 to 8100 kilocycles. MCW and CW operation are provided for on Intermediate and High Frequency bands. A Master Oscillator Power-Amplifier circuit forms the basis for the radio-frequency elements of the transmitter, a Colpitts type oscillator being used on both frequency bands. The power amplifier operates at same frequency as the master-oscillator, and is neutralized by a balanced bridge network composed of capacitors in the master oscillator tank circuit. Equal but opposite radio frequency voltages are built up across the pair of capacitors in use, one voltage applied to the grid of the power amplifier for amplification, and the other being fed through a neutralizing capacitor for balancing regenerative voltage across the grid plate capacitance of the power amplifier tube. One set of controls governs both circuits, resulting in a good deal of sim-

(Continued on page 295)

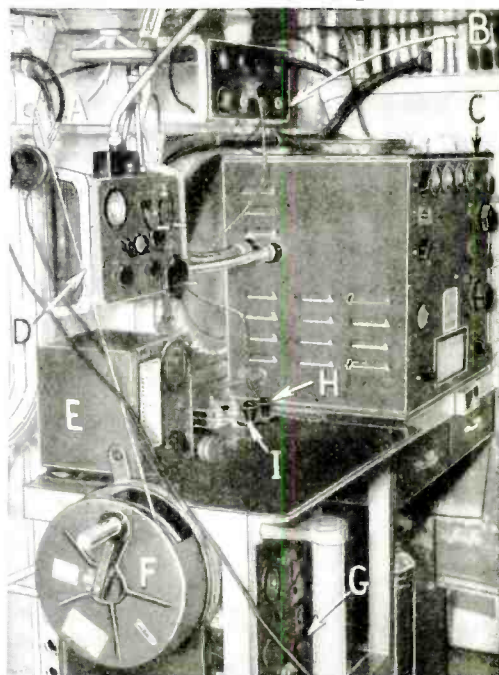

Radio cabin on U.S. Coast Guard plane: A, loop control; B, antenna control box; C, 75 watt transmitter; D, direction finder control panel; E, frequency indicator; F, antenna reel; G, aux. transmitter and receiver; h, aux. set key; and I, main trans. key.

• The "U·H·F" Wizard

This *super-regenerative* 5-meter receiver, which is featured on our front cover, should find high favor among the 5-Meter Amateurs who are interested in this class of receivers. Two Acorn tubes are used—one as an R.F. amplifier, and one as a super-regenerative detector. The other tubes are of the metal variety, functioning as audio amplifiers and separate quenching oscillator. The receiver covers the entire 5-meter amateur band.

• AMATEURS interested in a good ultra high frequency super-regenerative receiver will find this one the answer to their desires. In reality it is a modification of the "hissless" super described in the November 1935 issue of *Short Wave Craft*. The original tuned R.F. receiver used the conventional glass tubes, while this one uses the Acorn variety in the *ultra high frequency* position and metal tubes in the *low-frequency* section. A 954 pentode is employed in the high gain tuned R.F. stage, inductively coupled to a 955 triode detector, which, in turn, feeds two stages of resistance-coupled audio-frequency amplification. Two stages are necessary with the Acorn tubes because of their very small power output, compared to the larger glass tubes.

Separate Quenching Oscillator Used

We have also employed a *separate quenching oscillator* which is a 6C5 metal tube. The quenching oscillator is coupled to the detector plate through a .001 mf. condenser. This method was employed so that accurate adjustment of the low-frequency oscillator plate voltage could be obtained. This coupling method provides smoother operation than the usual parallel-plate method, because of the low voltage used on the 955 detector. The voltage applied to the *interruption frequency oscillator* governs the R.F. output of that particular

circuit, and this output or modulation frequency is quite critical. 75 volts applied to the plate of the interruption frequency oscillator allows smoothest performance in the detector circuit. With this circuit it is possible to reduce the regeneration in the detector to a point where the hiss is practically inaudible in the speaker, and still when a station is tuned in full speaker volume is obtained.

The detector is usually set just below the oscillating point, or when searching for weaker signals, so that there is just an indication of a rushing sound in the speaker. Then as the stations are tuned in, we hear a rushing carrier sound the same as you would on a superheterodyne receiver. If the regeneration control of the detector circuit is advanced so that the tube is oscillating, then the stations cause a dead-spot in the rushing sound, the same as the regular super-regenerator which is maintained in the oscillating state at all times.

Advantage of "Separated Quencher"

The main advantages of

operating a super-regenerator in this fashion with a *separate quencher* tube is that the rush in the speaker can be controlled, and the sensitivity of the receiver is practically unimpaired as changes are made in the rush (sound) level.

The R.F. and detector stages are built on two separate 4½ inch square aluminum plates, as can be seen in the photograph, and the necessary by-pass condensers are soldered directly to the socket terminals and bolted to the aluminum shield; this is very important. *The by-pass condensers of ultra high frequency apparatus should always be as near to the point to be by-passed as possible!*

The heater by-pass condensers are very important, inasmuch as if they are not employed, the heater circuit is liable to be resonant somewhere in the band and cause dead-spots. Those experiencing trouble in obtaining *smooth regeneration* control over the

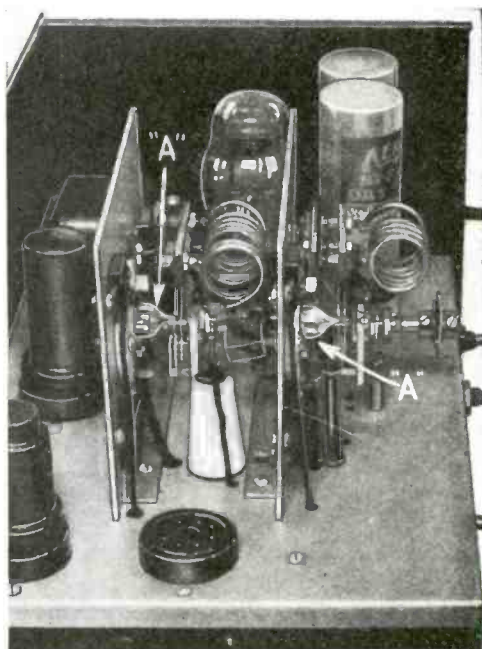
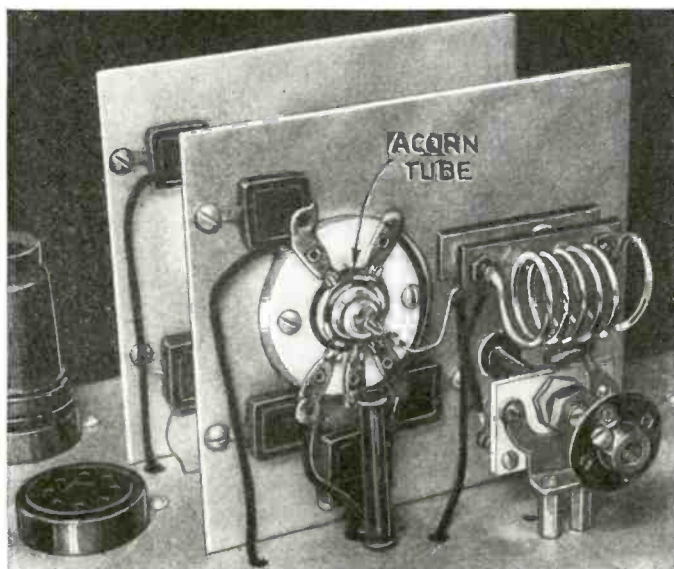

Photo above shows close-up of one of the Acorn tubes and associated tuning circuit, comprising special plug-in coil and midget condenser, with one of the metal tubes removed from the socket at the left. Photo at left shows close-up end view of the chassis. Note the two Acorn tubes "A" mounted in openings in the vertical shield plates.

entire band, will do well to investigate the heater circuits. The receiver as shown in the diagram is contained in a 12 x 8 x 7 inch black crackled finish cabinet and the only necessary accessory is the loudspeaker.

In the photograph we see that the coils for the detector and R.F. stages have one of the end-turns spaced greater than the other turns. This is the tracking adjustment and adjusting this end turn will bring the two stages into resonance with the R.F. padding condenser about mid-scale. This

SIX



condenser only tunes across three turns of the R.F. coil and at the low potential end, otherwise the leads to it would "load up" the circuit and destroy the tracking. Originally this was a 15 mmf. condenser—plates were removed so that only three remain. The main tuning condensers are 15 mmf. single bearing Trim-Airs and no alteration is required.

5-Meter Band Well Spread Out On Dial

The 5-meter amateur band covers approximately 50 degrees on the dial; for greater spread, of course, the coils may be increased slightly in size and one plate removed from the tuning condensers. The R.F. coils plug into small micalex bases. This method was employed so that changes might be made to either the 2½-meter band or to the 7 and 8-meter police bands. The coupling coil between the plate of the R.F. tube and the detector grid circuit consists of 3 turns, and is fixed. This coil is not very critical and changes in the other coils will not warrant changes in this plate coupling coil. Best results were obtained by coupling to the grid side of the grid coil. If one desires to operate the receiver as a *self-quenching* affair in the usual hissing condition it is only necessary to remove the 6C5 interruption frequency oscillator tube from its socket and advance the regeneration control slightly.

A careful test showed no apparent change in the sensitivity of the receiver with and without the *interruption frequency* oscillator tube, but, as mentioned above, the *hiss level* is considerably lower, inasmuch as regeneration can be more accurately controlled when a separate tube is used. In the audio amplifier we have incorporated volume control which is really necessary, because the stronger stations will provide entirely too much volume for the average size operating room, and it becomes necessary to turn them down. One desirable feature of the receiver employing a separate quenching tube and adjusted to the low hiss level, is that a station with serious frequency modulation can be tuned in with much better quality. For instance, on the

Tuning in the 5-meter stations is indeed a pleasure, with this perfected Acorn tube circuit devised by Mr. Shuart.

self-quenching detector, it will be found that the average station provides very little modulation in the center of the carrier, unless the transmitter is of the stabilized variety, most of the modulation being toward the high frequency side and well into the *hiss* region.

With this receiver it is possible to tune to the high frequency side and obtain good quality without the usual rushing sound. So far as super-regenerators go we believe this is the most flexible and efficient of all that we have had the opportunity of using. Stations can be brought in on this set with fair speaker volume, which you would not even be able to hear on the older style *self-quenching* receivers.

Each of the two grid coils consist of six turns of No. 12 tinned copper wire; space between turns equal to the diameter of the wire, except in the last turn which is spaced to adjust the range of the circuit. (Continued on page 308)

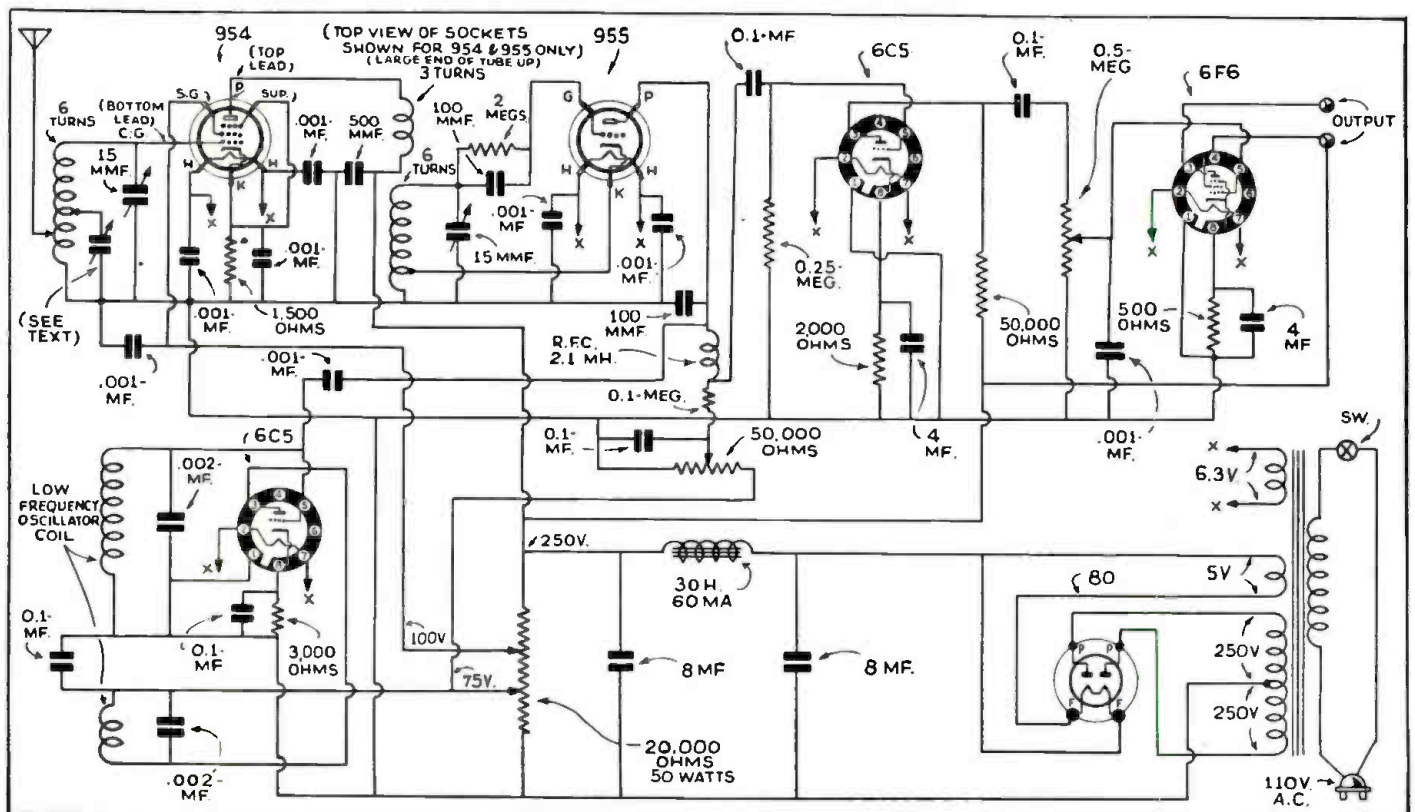

Wiring Diagram of the 5-Meter Super-Regenerator.

5-METER MOPA"



By George W. Shuart,
W2AMN

the crystal filter was in the circuit, the thousand-cycle beat note did not vary during complete modulation. With from 400 to 425 volts on the plates of the tubes, the following voltage and current readings are recommended, when the amplifier is delivering power to an antenna: oscillator plate current, approximately 50 ma.; oscillator screen, 250-275 volts; oscillator screen current, 12 ma.; amplifier plate current, 70-80 ma.; screen voltage, 150; amplifier grid current, maximum 10 ma.—minimum 6 ma. It is important that the grid current be held between 6 and 8 milliamperes for maximum efficiency and proper modulation capabilities of the amplifier. The amplifier plate current, when not delivering power to the antenna, will drop to approximately 20 ma. As the grid current is driven higher than 6 or 8 ma. the plate current will swing lower than 20 ma., but the power output will decrease.

Detuning the amplifier circuit will show a rise in plate current up to approximately 125 ma. The amplifier is still capable of supplying more R.F. to the antenna when loaded to over 100 ma. plate current. However, for efficient operation it is recommended that the plate current be kept between 70 and 80 milliamperes. In the diagram we notice that the *final amplifier* is

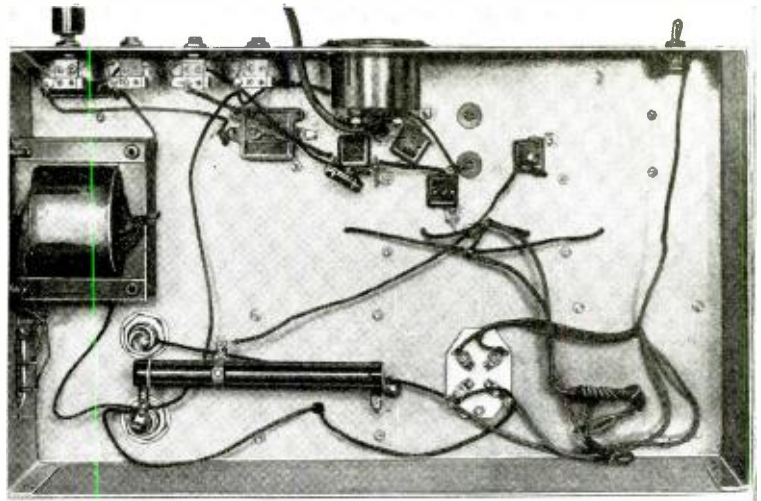
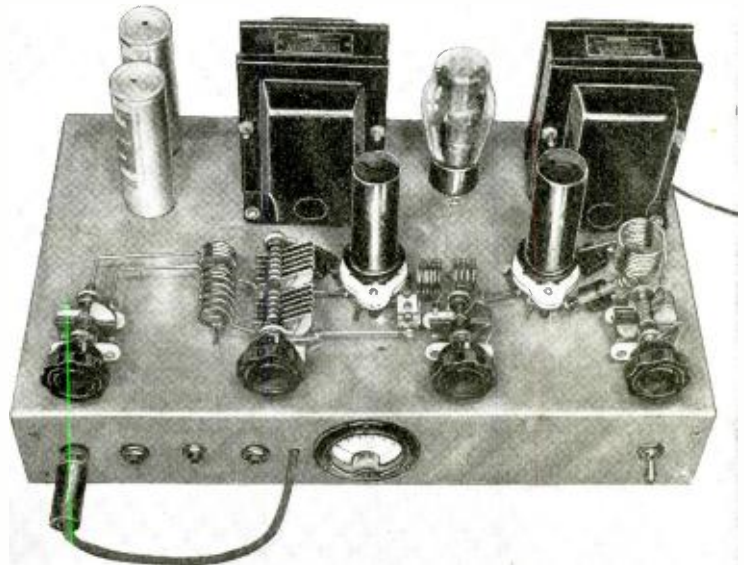

Two photos above show respectively top and bottom views of the 5-meter MOPA, utilizing two of the new 6L6 Beam tubes. Very remarkable reception reports have been received by W2AMN, especially with regard to the stability of the signal which was comparable with crystal control.

A Few Words Regarding 5 Meters

● THE tremendous growth and popularity of the 5-meter amateur band came about due solely to the simplicity of the apparatus needed. In keeping with this thought, the transmitter in this article was designed. It is comparable in operation efficiency to the most advanced amateur transmitters used in any band.

The Frequency stability is as good as "crystal." This was proven during reception of the signals of this transmitter on a 465 Kc. superheterodyne with a crystal filter. During complete modulation the carrier did not shift as indicated by a thousand cycle beat note. Only two tubes are used and they are the new 6L6 beam tubes. The power output is slightly greater than 20 watts, and the efficiency is comparable with transmitters operating on lower frequencies.

The advantages of this transmitter over a crystal-controlled transmitter is that the frequency may be readily changed and it is much more simple and less expensive to build. Needless to say, the quality of the signal is perfect. Complete construction details are given in the article, and we hope that every amateur interested in improving conditions on the 5-meter band will adopt a similar transmitter. With a transmitter of this type, no one need ever worry as to whether or not the apparatus used on the receiving end is too selective to permit good quality. Superheterodynes having a 10 Kc. selectivity have been used with this transmitter.

It only remains now for some one to develop a simple, selective 5-meter receiver as a "companion" to this transmitter. We have been working on this for some time and expect to describe such a receiver in one of the coming issues. The 5-meter band in most densely populated localities is very much overcrowded at the present time—not due to the great number of stations in operation, but due to the poor stability of the transmitters and receivers. It is high time that something be done about it.

(Continued on page 305)

neutralized by tapping off one turn of the plate coil and using a 35 mmf. condenser.

The Question of Neutralization

Experiments have proven that neutralizing is unnecessary when the tube is being excited properly, and particularly with the untuned, loosely-coupled grid circuit. Neutralizing is employed merely as a matter of precaution against possible changes in tube design. In each case, the cathodes, the metal shell of the tubes, and one side of the heater circuit are connected together and grounded to the "B" negative. The other side of the heater circuit is bypassed with a .001 mf. condenser. It is

very important that the screen, plate, and heater by-pass condensers be connected close to the circuit to be bypassed and with very short leads. Also, in the diagram we show that the plate and screen are modulated simultaneously. It has been found that the plate could be modulated alone and the screen tied down to approximately 150 volts. Grid-leak bias is used in the amplifier stage and it is the only method which will give satisfactory performance; fixed bias is not recommended in this case. No automatic biasing is incorporated in the cathode circuit because the oscillator and amplifier are switched on and off at the same time. And since

(Continued on page 305)

SHORT WAVES and LONG WAVES Our Readers Forum.

BOY! WHAT A TRANSMITTING STATION W2IOR BUILT!



Hats off to King J. Fothergill, W2IOR, Brooklyn, N. Y. A beautiful "home built" transmitter if ever there was one!

This Month's Prize Winner

The line up of the "rig" is as follows. 47 Xtal oscillator, 801 buffer, 203-A in the final running at 200 watts input. Speech, 2A6 resistance-coupled to a 56, transformer-coupled to a pair of 46 drivers, class A driving 4-46's in class B modulation. A crystal "mike" has replaced the carbon type shown in the picture.

The antenna is a voltage feed zepp, 264 feet long, with 66 ft. feeders. For the receiver I am using the same old Patterson PR-10 and it works F.B. both on fone and CW. There are four power supplies for the complete rig. At present we operate on 160 meters and mostly after 11 P.M. due to the BCL (Broadcast Listeners). I also have a 5-meter rig for local work.

**One Year's Subscription to
SHORT WAVE CRAFT
FREE**

for the "Best" Station Photo

Closing date for each contest—75 days preceding date of issue: Aug. 15 for Nov. issue, etc. The editors will act as judges and their opinions will be final. In the event of a tie a subscription will be given to each contestant so tying.

If any of the boys care to swap photos we'll be very glad to do so. Before I sign off with you and the "gang," I want to extend my heartiest thanks to you for the splendid articles that you have been running in *Short Wave Craft*, some of the ideas from which have been used in my own rig here. The knowledge gained through your publication would pay for a life's subscription, if I was to go out and buy it. I am extremely interested in your *radio course* and the five and ten meter articles. Thanks a lot for them—keep up the good work. W2IOR working and signing with the Editor of *Short Wave Craft* and the GANG after a most enjoyable 100% one-way QSO. 73 OM and I'll be seeing you later with a kilowatt job. Hi, Hi.

King J. Fothergill, Opr.
Amateur Station W2IOR
297 Baltic Street.
Brooklyn, New York.

(Continued on page 312)

Editor, SHORT WAVE CRAFT:

Due to the fact I have been very busily engaged in answering QSL cards from all around the country, I have neglected most everything else. Hi, Hi. First of all I want to thank you for the splendid way you handled the picture of the Short Wave Listening post I sent you some time ago. It was published in the Jan. 1935 issue of your splendid magazine, *Short Wave Craft*. I would also like to thank the many hundreds of "fans" that I received greetings from at that time.

It was shortly after that date I secured my "Ham" license and the call letters W2IOR. Was I proud of that call—well one look at the picture will convince most any one. Hi, Hi. The rig is all "home-built" and works out very nicely. Any one who might care to refer back to the Jan. 1935, issue, of *Short Wave Craft* can get a much better idea of the "shack" over here; this last picture was taken in the living room, and does not do justice to the "real" amateur shack which I have.

A1 Ham Station of Charles Hrdlicka

Editor, SHORT WAVE CRAFT:

Noting that the majority of station photos were of big "rigs," I wondered whether my low-power station would prove of interest. In order to find out, I am sending a photo and brief resume of my "rig."

At the left is a Doerle A.C. receiver, and the small white box beside it is the moni-

Right—The efficient "Ham" station of Charles Hrdlicka. W9SGI, Kimball, So. Dak.

tor. My transmitter is a Xtal 47 oscillator and a pair of 46's in parallel. A 550-volt power-supply is used, and the output of the "rig" is 38 watts. The transmitter is used on the 80-meter band, and I have made provisions to put it on 40 meters. Alongside of the key is my key-click filter. The station illustrated is the work of approximately one and one-half years in amateur radio.

(Continued on page 312)



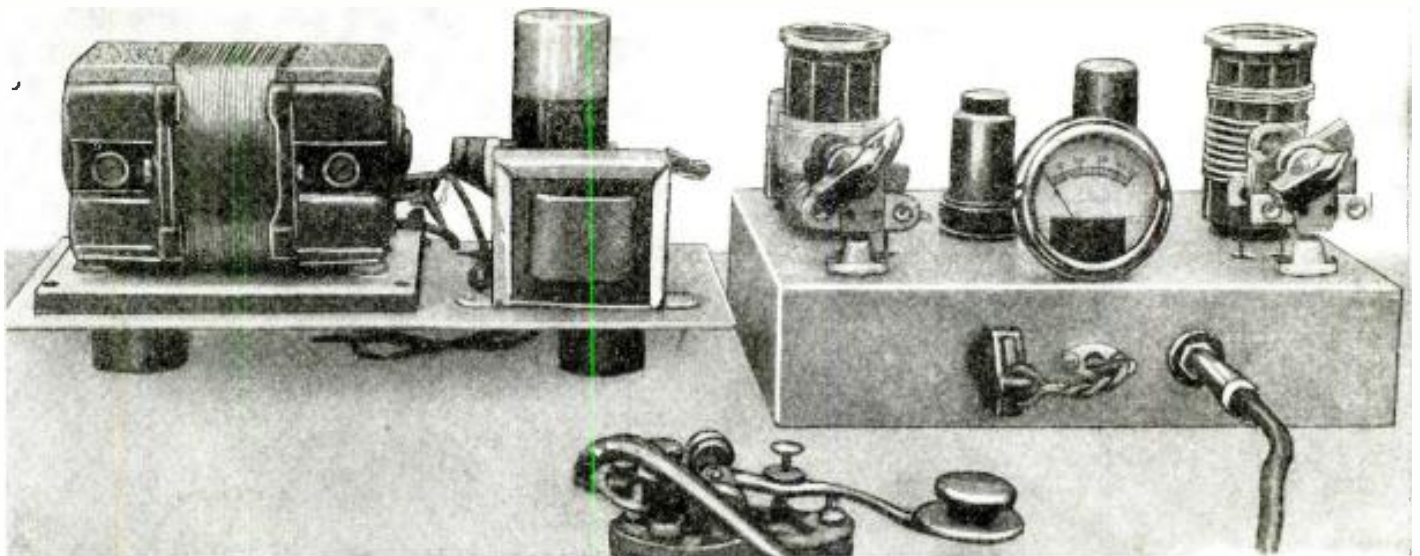

Appearance of the portable C.W. transmitter using two metal tubes, a 6C5 and a 6F6, together with 12-500 volt D. C. dynamotor.

The "M.T." Xtal Transmitter

By Harry D. Hooton

● A FEW years ago the amateur who lived in a remote rural district was truly up against it when it came to operating a transmitter. Usually no 110 volt line was available and, rather than invest in the expensive and relatively inefficient dynamotors of that period, many turned to ordinary "B" batteries for a transmitter power supply. Today, however, the situation is entirely different. A variety of power sources are now on the market, ranging from portable 110 volt A.C. plants to the more recent 6 and 12 volt D.C. outfits. It is possible to build a modern amateur transmitter, capable of a 25

A portable C.W. transmitter for rural districts, using two metal tubes and operating from a 6 or 12 volt dynamotor supplying 500 volts "B." Well suited for use in car or boat.

to 50 watt output, around either of the two power units mentioned and operate it for approximately 1½ cents an hour. This is actually as low as the cost of operating a similar transmitting set from the 110 volt A.C. lines.

The small metal-tube crystal-con-

trolled transmitter illustrated and described here is designed to be operated from either a 6 or 12 volt D.C. source and, as Fig. 1 shows it is modern and up-to-date in every detail. The circuit consists of a 6C5 metal triode as a crystal-harmonic oscillator, using the famous "Les-Tet" arrangement originated by Frank Lester, W2AMJ, and a 6F6 pentode as R.F. amplifier. This particular hook-up is very easy on the crystal and the total absence of grid chokes and link-circuits make the entire transmitter extremely simple to adjust and operate. No neutralization is required except (Continued on page 309)

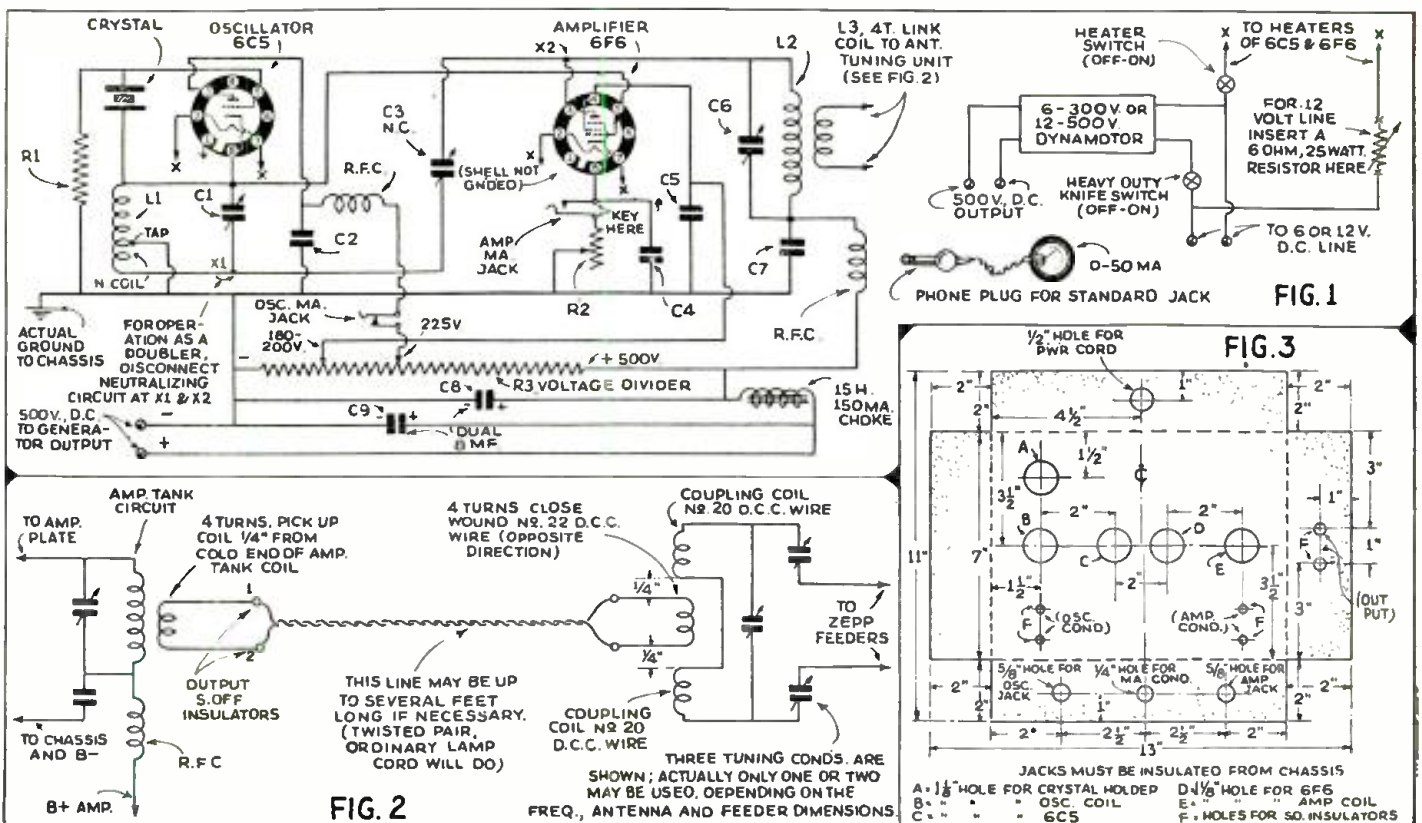

Wiring diagram of the "M.T." Xtal transmitter, especially designed for use as a portable to be operated from your car; a dynamotor operating from the car or a separate storage battery, develops the 500 volt plate current.

Receiver-Adapter Unit For Ultra Short Waves

By Stanley Johnson, W9LBY

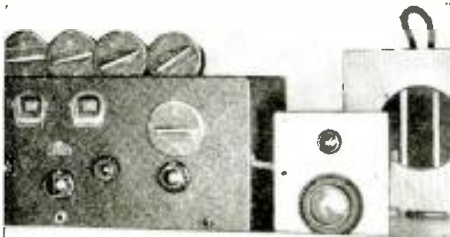

The ultra short-wave adapter in use with an all-band short-wave receiver; the adapter is at the right.

● **ALTHOUGH** the number of amateur, police, and commercial stations operating on the ultra high frequencies is increasing daily, most short-wave receivers are not equipped to tune to these frequencies. This receiver-adapter unit was designed to meet this situation and to make it possible for you to hear the fascinating traffic which is being carried on in the extremely high frequency bands. If you have a short-wave receiver, the unit may be used as an adapter to transform your receiver into an ultra short-wave set; if you do not have a receiver, the unit—with only slight modification—may be used as a “complete” one-tube super-regenerative receiver.

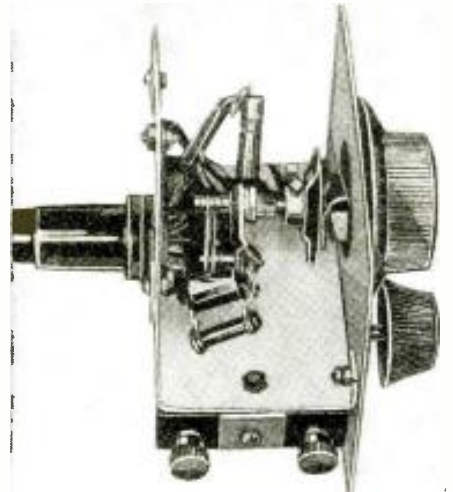

A close-up of the adapter, showing the single metal tube at the right, as well as the tuning condenser and dials.

Construction is much the same, regardless of whether the unit is to be used as a receiver or as an adapter. Most of the parts are mounted underneath the “U” shaped chassis, which was made from a scrap of car body aluminum. (Continued on page 298)

May Be Used As 1-Tube Receiver

The unit uses a single type 6C5 metal tube in the popular “minute man” super-regenerative circuit—so-called because it was popularized by Boston high-frequency enthusiasts—which is generally recognized as the best of the many self-quenching super-regenerative hook-ups. When acting as an adapter with a receiver, the unit simply replaces the tube which precedes the first audio tube of the receiver, thus utilizing the receiver to furnish the power and the audio amplification for the super-regenerative detector.

As a receiver, the unit is a one tube super-regenerative detector with headphones connected in the plate circuit. The unit illustrated is an adapter; the receiver model is identical except for the addition of a pair of binding posts for headphones and a slight change in the circuit.

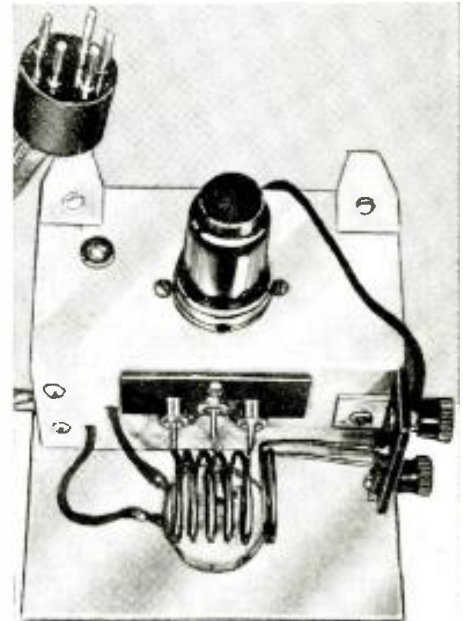

Another view of the U.S.W. adapter, showing the high-frequency coils and the metal tube, also the adapter plug.

How to Build a “Bug” Key

By Christos M. Manitsas, W1IJJ

● **THE** accompanying drawing greatly facilitates the construction of an ideal “bug” key. This arrangement enables the constructor to make such deviations as he might deem advisable without fear of disrupting the entire mechanism.

The base of the “bug” is nothing more than a lead casting, which does not necessarily have to be of superior quality—a piece of discarded lead pipe will do. The mould is made by shaping a piece of wood to the correct proportions in order to produce the indenta-

tions on the top of the lead casting, with the result that the bakelite base of the “bug” proper can recede into the lead casting.

In building this “bug,” I found that wood-working tools which had seen “better days” could be used to finish the lead casting. An old plane may be employed to finish the sides of the casting, and a wood chisel may be the means of digging out the lead in the

center of the casting, in preference to using the aforementioned method of using a piece of wood for a moulding form. When finished, a coating of black paint will greatly enhance the appearance of the base, so that it will harmonize with the bakelite sheet.

The supports for the contacts and spring adjustments, etc., may be made from the pieces of metal which hold the stator plates together on old “BC” variable condensers. The “Ham” junk-box usually lays claim to many such parts. (Continued on page 317)

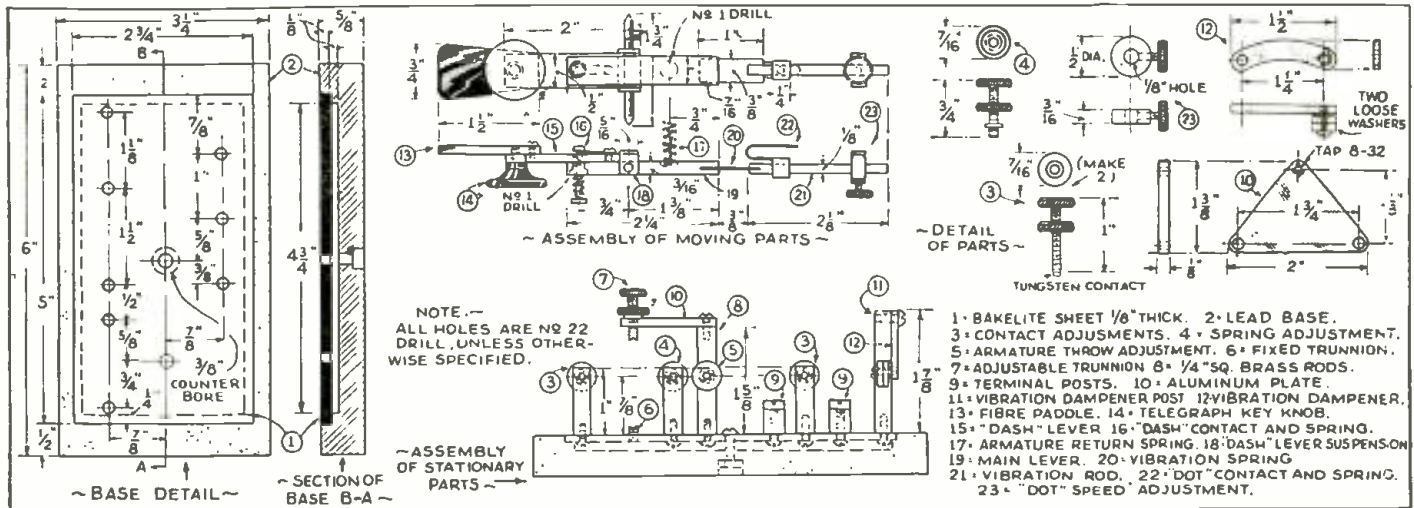

The drawing above shows all of the essential and easily-made parts necessary to construct the “bug” key.

5-Meter Transmitter-Receiver—Uses New Metal Tubes

By Henry B. Plant, W6DKZ

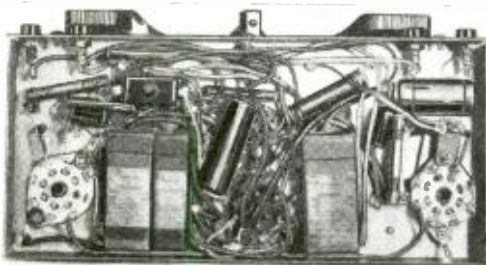
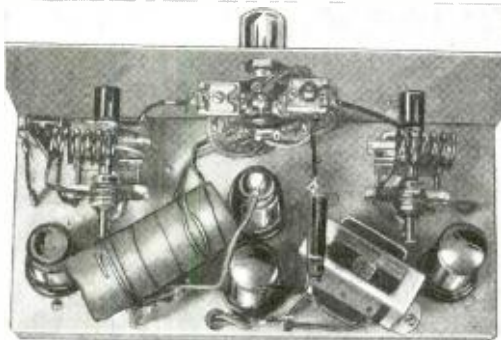
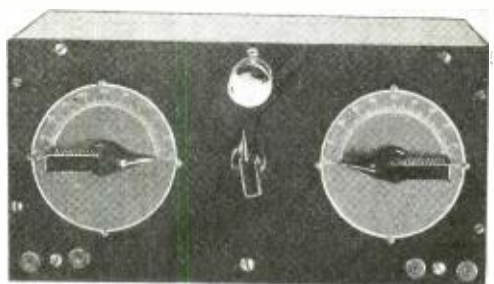

Here's a handy, low-priced portable transmitter-receiver for the 5-meter band. On tests it worked very successfully; the author had it mounted on the handle-bars of a motorcycle during some of the tests. The author has talked 60 miles with this set.

When the audio circuit was operating satisfactorily and the detector received signals with no dead spots, the 6C5 was added in place of the 76 detector. This change resulted in greater smoothness of super-regeneration and an increase in audio output. The oscillator was then replaced by a 6F6 with the screen tied to the plate, making the oscillator a tetrode. As a further experiment the 6C5 in the first audio

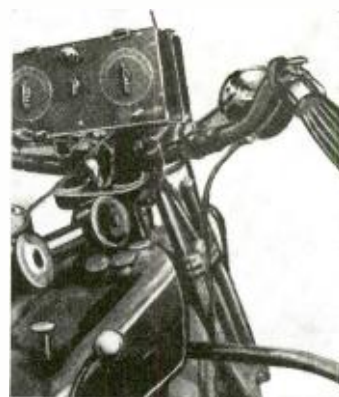

The 5-meter "rig" mounted on the handle-bars of a motorcycle.

The three photos at the left show respectively front, top, and bottom views of the 5-meter Transmitter-receiver

Set Mounted in Metal Can

The set is constructed in a metal can, formed from number 22 gauge black sheet iron. The subpanel is the same except that it is cadmium plated so that connections may be soldered directly to it. The dimensions are shown in Fig. 1. The subpanel (Continued on page 307)

● THE writer has spent some six months in an effort to find a radio transmitter-receiver for five meters that would stand exceptionally hard service. The set in mind would have to operate under the most adverse conditions, namely that it must be rigidly attached to the frame of a motorcycle. In mobile operation the set would share the vibrations of the frame. Measurements show this vibration is enough to shake the glass tubes out of any type of socket used. In the metal tube model none of the tubes have ever shaken out, but small spring-steel hold-downs have been added for safety.

First Experiments

A number of tube combinations have been tried out and discarded. First a 76 oscillator, and a 41 modulator were used as a transceiver, mounted on sponge rubber on the rear carrier of the motorcycle. This set had the disadvantages of receiving all the jars and vibrations of an unsprung rear wheel, and the operator had to turn around to see the dials. The next set was a 76 oscillator, 76 first audio, and 42 modulator-amplifier. This set drew too much current from the high-voltage supply so was never tried mobile.

The present set was first built using an audio system of metal tubes and the radio-frequency stages of glass tubes.

The audio system consisted of a 6C5 first audio amplifier, resistance coupled to a 6F6 pentode output tube. The detector was a 76, and the oscillator a 41.

stage was replaced by a 6F5, high mu triode, which is designed for resistance-coupled audio work. The lineup on the present model is therefore: Detector 6C5, first audio 6F5, second audio (modulator) 6F6, oscillator 6F6.

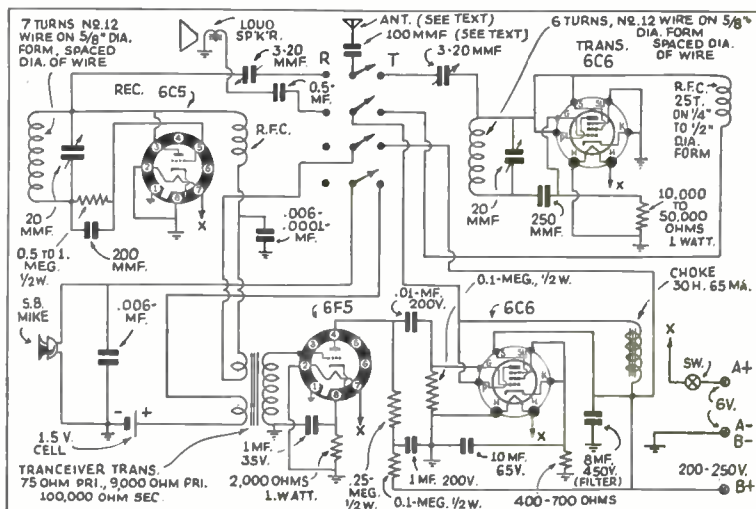

Wiring diagram of the 5-meter Transmitter-Receiver which uses metal tubes.



The three photos above show front, rear, and bottom views of the pre-selector here described by Mr. Cisin.

Metal-Tube PRE-SELECTOR

By H. G. Cisin, M. E.

● PERHAPS a majority of short-wave fans have started with a small receiver employing the familiar *regenerative detector* without any R.F. amplification. Many of these beginners' sets are of the one tube (not counting rectifier) variety, suitable for earphone operation, while others have one or two additional audio stages where sets are designed to operate a loud-speaker. All sets which come under this classification can be greatly improved by the addition of a *Pre-Selector* such as the one described in this article. In fact, this *pre-selector* will also increase the capabilities of a set having one or more R.F. stages already incorporated in it.

For the benefit of the uninitiated, the purpose of the pre-selector or pre-amplifier is to add R.F. gain to an existing receiver, so that it can pick up very weak incoming signals and pass these on to the detector and the audio amplifier. In addition, the pre-selector acts, to a certain extent, as a band-pass filter, permitting separation of stations impossible where sufficient R.F. stages are not present. Moreover, where a pre-selector is used with the conventional

This pre-amplifier or pre-selector helps to boost those weak "DX" signals, so that you can hear them with an ordinary receiver. The device is self-powered and may be used with battery sets, as well as 110-volt A.C. or D.C. receivers.

beginners' set employing a regenerative detector and an antenna trimmer, the pre-selector obviates the necessity of constantly adjusting the antenna trimmer as coils are changed to cover various wave-bands.

A number of pre-selectors have been designed, but most of these failed to meet with popular approval due to the fact that they were highly complicated, called for the use of a multiplicity of plug-in coils and switches, required multi-wire cables to obtain their power from the existing receiver and especially due to the fact that they introduced losses which offset most of the

advantages gained by using them.

The "Metal-Tube Pre-Selector" was designed by the writer, however, so that all of these faults would be eliminated. To avoid complication and to gain maximum simplicity, one R.F. stage is untuned. Thus, there is only one tuned R.F. stage, requiring only one set of plug-in coils and only one tuning condenser. To eliminate bulky and complicated cables between the pre-selector and the set, the pre-selector is "self-powered." That is to say, it is provided with its own rectifier tube and filter system, so that it can be plugged into any A.C. or D.C. source, regardless of the type of power used to energize the short-wave receiver. It will work just as well with a battery set as with an A.C. or a D.C. or a universal set.

Uses Metal Tubes

Another important feature of this pre-selector is the fact that it employs the new *metal* tubes. These are desirable for short-wave reception because of their close shielding, which prevents unwanted interaction between R.F. stages and they (Continued on page 311)

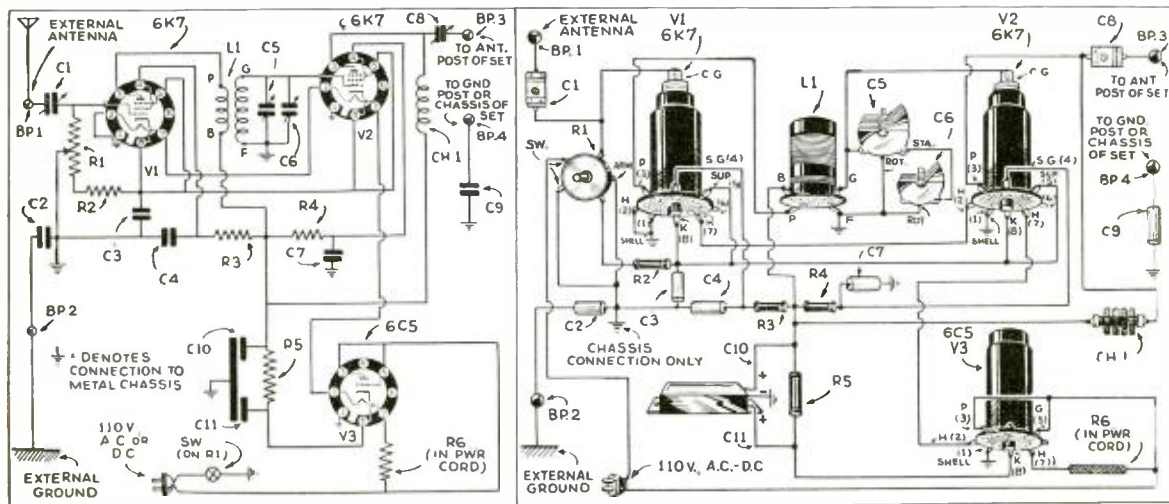

You will find it a simple matter to build this Metal-Tube Pre-Amplifier by following the drawings here presented.

The Beginner's Breadboard ECONOMY-2

By Frank Lester, W2AMJ

This greatly simplified 1-tube receiver will prove ideal for the short-wave Beginner—it actually yields 2-tube results, as a type 19 dual purpose tube is used. The "A" battery may be two No. 6 dry cells, and the plate supply a single 45-volt "B" battery.

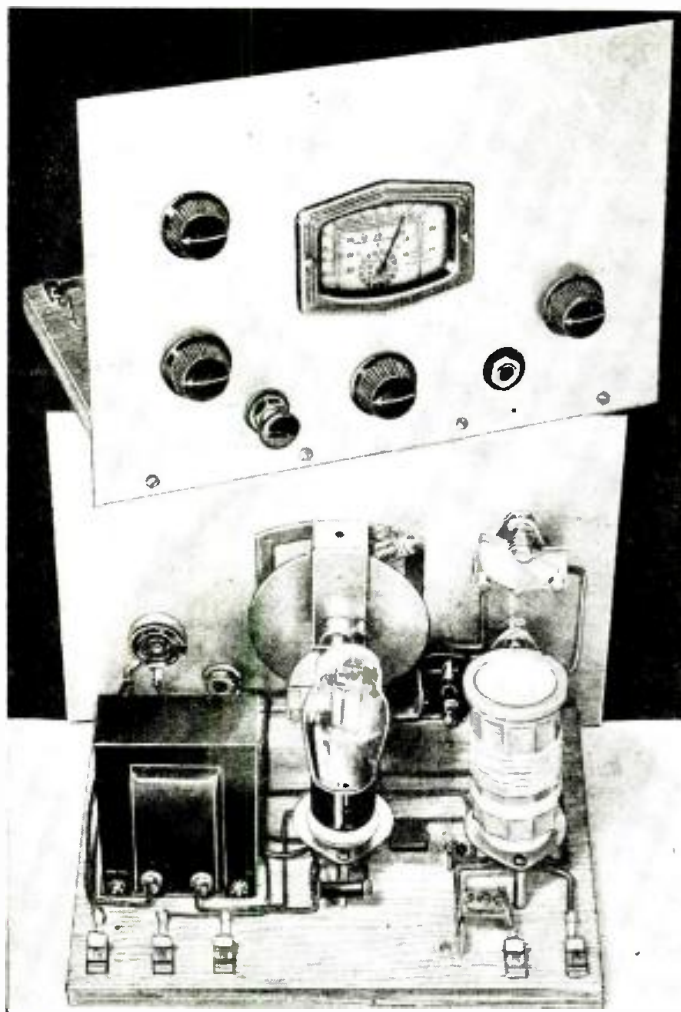

European stations can be heard easily with a pair of headphones on this "one lugger." A single 19-tube gives 2-tube performance—acting as the detector and also as one stage of A.F. amplification.

● THE "one lugger" is still the recommended starting point for the "embryonic" ham and short-wave listener. But the "one lugger" of today is a far cry from that which we ol' timers used to fool around with in the good ol' days. What, with all the new multi-function tubes and improved design of radio parts, a 1-tuber of today would run rings around 2- and even 3-tube sets of a few years ago.

1-Tube Does 2 Things

Take this receiver for example; its *single* tube (type 19) performs the function of both detection and a stage of A.F. amplification. Hence the excellent overall performance of this "1-tube" set, especially its distance-getting ability, will immensely stimulate the enthusiasm of the beginner and encourage him to greater accomplishments in the radio field.

Outwardly, the 19 tube looks no different than any other commonly-used tube; yet it has two complete sets of triode elements, with a filament common to both. It is therefore equivalent to two separate tubes such as '01A's or '12A's. Furthermore, it has a 2-volt filament which consumes but 0.26 of an ampere, so that two ordinary No. 6 dry cells, connected in series, would last quite a long time with average use. Its plate drain is also very economical; a single 45-volt B battery will give many months of satisfactory service.

Because of these and other excellent features, the "Economy-2" lends itself very nicely to the elementary requirements of the modern beginner in radio, be he listener or "ham."

Detector and 1 Audio Stage

Reference to the schematic and pictorial diagrams will reveal that the circuit of the "Economy-2" is of the conventional regenerative detector type, followed by a stage of A.F. amplification. It is a fallacy to believe that only expensive receivers—those using highly intricate circuits, can make possible successful short-wave reception. This little set, in a good location, is capable of surprising DX and consistent reception of foreign stations, the world over. The whole "secret" of good short-wave reception lies, not so much in the circuit arrangement, as in the extent of "R.F.

losses" present. These "losses" represent excessive leakage of radio frequency currents due to poor quality parts, careless construction and poor insulation.

Set Has "Band-Spread"

If the constructor uses the parts specified at the end of this article, follows the layout and circuit carefully and does a clean job of wiring and soldering—then the set will work "right off the bat." The accompanying photographs clearly indicate the relative positions of all the component parts. The main tuning condenser is the one in the center of the aluminum panel, attached to the high-ratio tuning dial. It is a 15 mmf. 3-plate midget variable *band-spread* condenser. The upper left-hand control (front view) is the 50 mmf. "tank" tuning condenser which roughly tunes the set to any one of 20, 40, 80, or 160 meter short-wave bands; depending upon which plug-in coil is being used.

The lower left-hand control is a 140 mmf. unit used as a regeneration control. The three remaining controls are from left to right, filament on-off switch, phone output jack and 6-ohm filament rheostat respectively.

Short Leads Essential

All the parts are so laid out as to make for *shortest possible leads*. This is an important (Continued on page 306)

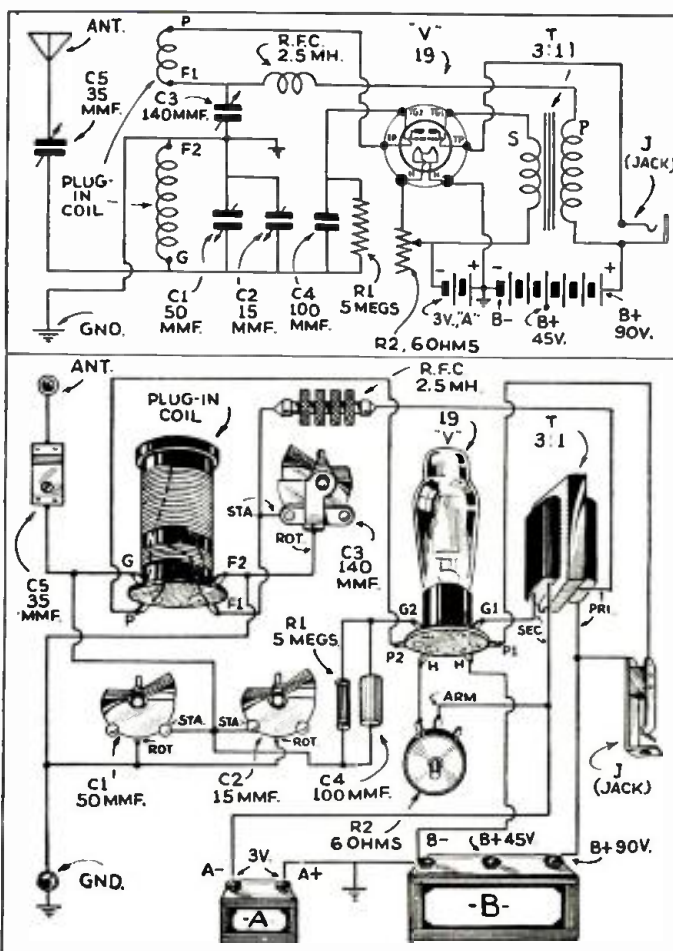

The schematic and picture wiring diagrams reproduced above will enable the beginner to easily construct this 1-tube receiver which actually gives "2-tube" results.

WORLD-WIDE SHORT-WAVE REVIEW

-Edited By C. W. PALMER

A 2.5-Meter Transceiver

● IN A recent issue of *Television and Short-Wave World* (London) a new transceiver for the 5 meter and 2.5 meter amateur bands was described.

The circuit of this unit is reproduced here for those who are interested in what the amateurs across the "big pond" are doing. The unit contains two tubes, one of which is the oscillator and the other the

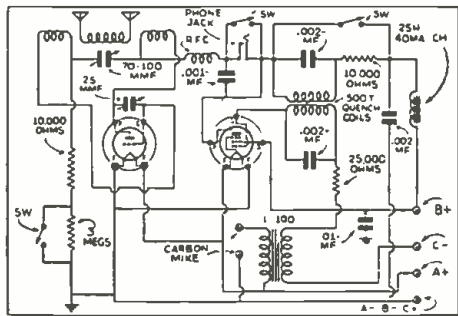
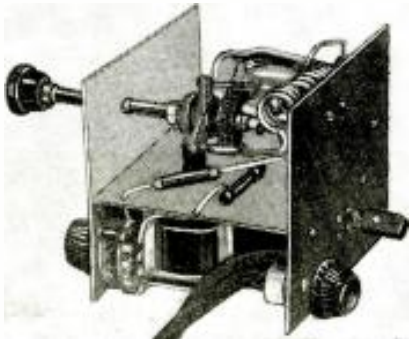

A European 2.5-meter transceiver.

modulator for transmitting, while with the switch in the receiving position, the first becomes the detector and the second is the "quenching tube" of a super-regenerative type unit.

The appearance of the set is shown in the photo which also shows the three coils of the oscillator-detector unit. These coils are identical in size and turns, being wound with No. 14 bare copper wire, to a diameter of 3/4-inch. The turns are spaced slightly more than the diameter of the wire.

The values of the other parts in the transceiver are shown in the circuit.

An Interesting Heterodyne Circuit

● IN A recent issue of *L'Antenne* (Paris) a versatile short-wave detector scheme was shown. It is an adaptation of the old heterodyne circuit in which a separate tube was used to produce audible beats for C.W. reception.

● The Editors have endeavored to review the more important foreign magazines covering short-wave developments, for the benefit of the thousands of readers of this magazine who do not have the opportunity of seeing these magazines firsthand. The circuits shown are for the most part self-explanatory to the radio student, and wherever possible the constants or values of various condensers, coils, etc., are given. Please do not write to us asking for further data, picture-diagrams or lists of parts for these foreign circuits, as we do not have any further specific information other than that given. If the reader will remember that wherever a tuned circuit is shown, for instance, he may use any short-wave coil and the appropriate corresponding tuning condenser, data for which are given dozens of times in each issue of this magazine, he will have no difficulty in reconstructing these foreign circuits to try them out.

In this case, however, it is not used only for this purpose. The tube V1 is a regenerative detector of the pentode type, using cathode regeneration (electron coupling). This tube feeds into tube V3, which is an A.F. stage of the triode variety.

Tube V2 is an oscillator, similar in construction to the detector. This is coupled to the suppressor grid of the detector. This tube accomplishes two things. First, if it is tuned to a frequency adjacent to the frequency of V1, an audible beat will be heard in the phones, which is useful in locating phone stations, and which supplies a steady beat for C.W. reception.

Second, if V2 is tuned to a frequency removed from V1 by a wide range of frequencies, super-regeneration action can be attained. This greatly increases the sensitivity of the set for high frequency reception.

Third, if V2 is tuned to a point near the second or third harmonic of the signal frequency, tube V1 is modulated at a super-audible frequency and this beat frequency (intermediate frequency) which is present in the suppressor circuit of tube V1 causes an action very similar to superheterodyne action, in which V1 acts as both first and second detectors, rectifying both the high frequency and beat frequency.

Thus it can be seen that some very interesting results can be obtained from this circuit. The coils used for V1 and V2 are of the plug-in variety and for most purposes, one set of coils would be sufficient for both tubes since a larger size coil is needed for V2 in most cases.

An Ultra-Short-Wave Detector

● IN the description of a new high-fidelity receiver which is being sold in Germany, *Funktechnische Monatshefte* (Berlin) included the circuit of the detector used to

pick up transmissions on high frequencies in the neighborhood of 7 meters. The reason for including this high frequency detector in the set is because the television transmissions which are being sent out in several German cities are using these frequencies.

The circuit of this regenerative detector is interesting in several respects. First, the type of oscillating circuit used is not the usual tuned-grid type—but is the split Colpitts circuit, in which both the grid and plate inductances are included in the tuned circuit. Regeneration is controlled by a

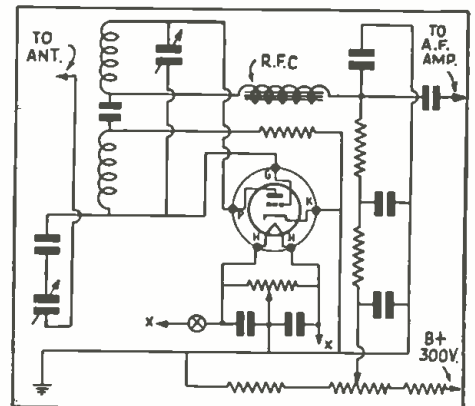

An interesting ultra-high frequency detector.

potentiometer in the plate supply circuit. The movable arm is fed through a resistance-capacity network to prevent a loss of signal energy through the power-supply circuits. The R.F. choke, surprising enough, is an iron-dust core unit. This is an unusual deviation from standard practice, since it is generally understood that iron-dust cores are not effective on high frequencies. However, it is shown experimentally in the descriptive article in the German magazine that this type of choke is superior to air-core units.

The coils used in this high-frequency tuner are silver-plated to have the lowest possible skin resistance.

It is claimed that the use of regeneration in this tuner and detector is not any cause for alarm (as far as high-fidelity reception is concerned) as the tuning is comparatively broad on these frequencies and there is no fear of cutting side-bands.

A New Tuning Indicator Tube

● THE cathode-ray tuning indicator tube has at last reached Europe, according to a recent report in *La T.S.F. Pour Tous* (Paris).

(Continued on page 317)

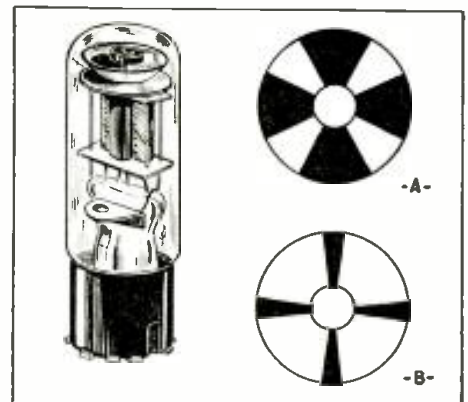

An improved tuning indicator.

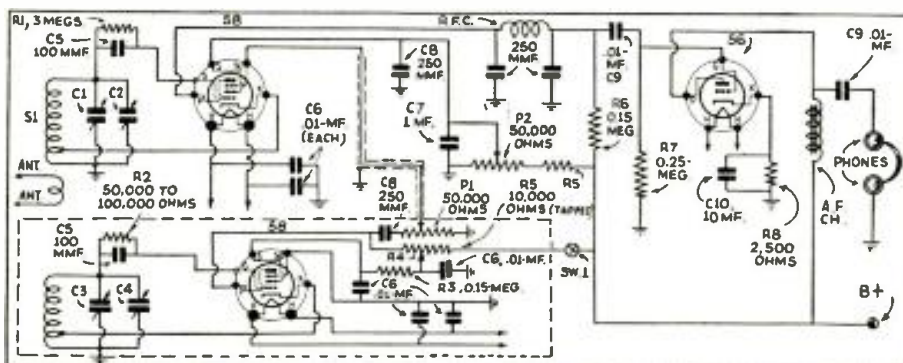

Applying a separate heterodyne oscillator for the autodyne receiver.

New Set Has 2-Color Tuning Dial

Silent tuning—automatic frequency control—two-color resonance indicating dial—and other brand-new features.



The new set here described with 2-Color Tuning dial and station indicator.

● ONE of the newest all-wave receivers, at least the larger models of this receiver, features some brand-new and very useful ideas. To begin with, the dial is illuminated in two colors, and this illumination changes automatically from red to green as the station is tuned in to resonance. Before the station is tuned in, the dial is illuminated red, and this changes to green as the station is tuned in to resonance.

The average person, especially if he happens to feel a little tired or lazy, does not always tune the station in to perfect resonance on the dial and, in consequence, the quality of musical reproduction suffers somewhat. In this new receiver such a condition cannot happen when tuning in any one of the regular broadcast stations on this set, as an automatic frequency control is provided. When the tuning indicator is moved into the approximate region of the station's resonance point on the dial, the receiver's tuned circuit *automatically and instantly* snaps into its sharp focussed tone position. This feature also cuts down the tuning time and insures that the station will always be tuned in perfectly, with a maximum qual-

ity of reproduction.

This set has another feature which will be greatly appreciated by each listener—the call letters of the stations tuned in at the moment are individually illuminated. In other words, if you have tuned in WGY, a moment's glance at the tuning dial will indicate this fact, as the letters WGY stand out in green. This part of the dial is known as the local station "Personalizer."

If there is any one thing which jars on tired nerves, it is to hear a bunch of sharp chirps as one tunes across the dial, passing perhaps half a dozen strong stations on the way to the one you are interested in at the moment. The pulling out of the tuning knob silences the loudspeaker and you can tune in perfect silence; when the exact station is reached you simply

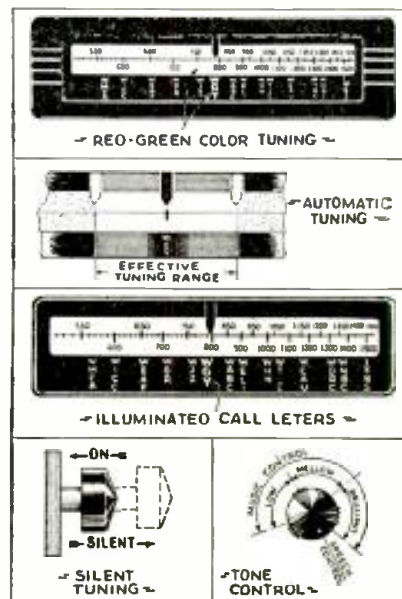

Color Tuning, "Station Indicator" and Silent Station Hunting—Features of new Receiver. (No. 559)

The ZOTTU Multi-tube Oscillator

Solves Perplexing High Frequency Problem.

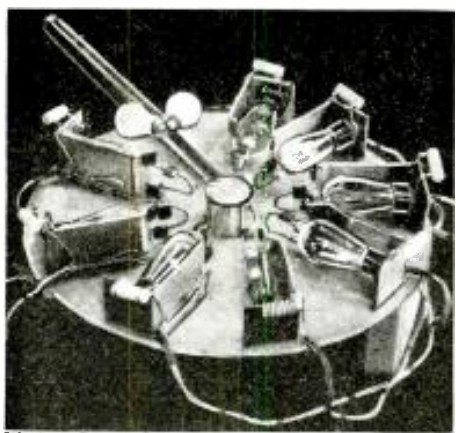

Photo above shows complete multi-tube oscillator as designed by Mr. Zottu. In the center of the group of tubes there is a specially designed low-loss tank circuit. The tubes are coupled to the tank through by-pass condensers.

it are coupled a number of individual oscillator tubes and their associated circuits, operating on approximately the frequency to which the master tank is tuned. In this manner, the power taken from the master tank circuit is proportional to the number of oscillators driving it. For instance, 10 watts from one oscillator would mean that we would obtain approximately 80 watts were eight of them employed. In this arrangement we find that all of the oscillators immediately *pull into step* at the frequency of the master tank circuit, and improved frequency stability is thus brought about.

This is an improvement over the old system wherein tubes were connected in either push-pull or parallel. The push-pull arrangement permitted the use of only two tubes, and the parallel arrangement did not work out, because the capacities of the tubes were additive and thus decreased the size of the tuned circuit, which at ultra high frequencies was already of very small proportions.

We have shown schematically in the diagram how two tubes are coupled to a master tank circuit, and we have also shown a photograph of the entire set-up employing 8 (Continued on page 312)

● IN order to satisfy the present demands for a more or less powerful oscillator in the ultra high frequency regions (around 300 megacycles), P. D. Zottu, of the RCA Laboratories,* has developed an exceptionally interesting system. So that it may be more easily understood, our readers should reflect back to the dual oscillator systems which have appeared in all of the leading magazines, wherein two oscillators are tuned together, better known as the *lock* system.

The fact that two oscillators will lock into step with each other, was the basis of the development by Dr. Zottu. In this instance a small *concentric line* is used as a master tank circuit, and to

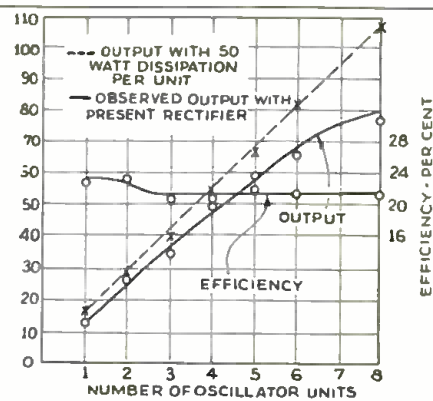
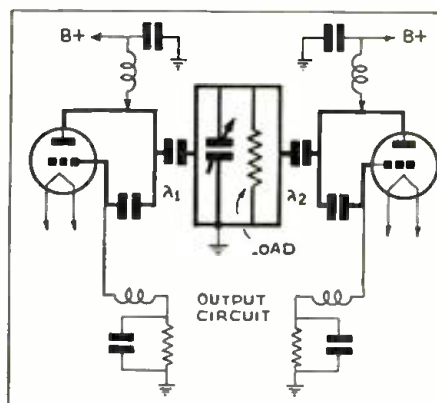
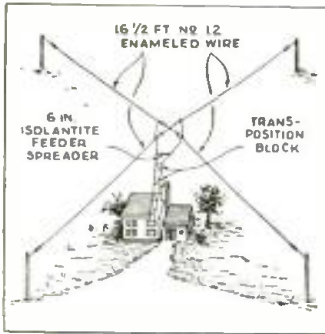

Diagram at left, above, shows how two tubes, for example, are capacity-coupled to a master tank circuit by the Zottu system. Graphic chart at right shows proportionate increase in watts output as different numbers of oscillator tubes are connected in parallel by the new system.

\$5.00 Prize



4-SIDED DOUBLET

Here is an "all-direction" doublet antenna which any "ham" or short-wave listener will find a real boon to reception. It is a combination of an "all-direction" antenna with the addition of a doublet. This eliminates the necessity of switching from one antenna to another to receive stations from certain directions. Stations from all over the world can be tuned in with this system, and the amount of QRM will be appreciably decreased.—Wah Hew Lee.

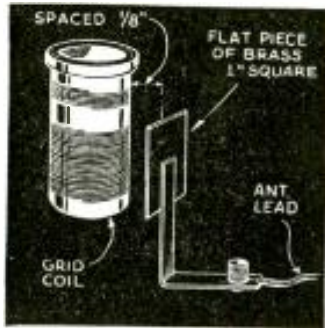

ANTENNA COUPLING

Here is a method of obtaining automatic antenna coupling. The vane should be of brass, one inch square, and should be placed approximately one-eighth inch from the coil. Once adjusted, it is automatic, due to the fact that the grid coil decreases with the wavelength and so varies the capacity of the condenser as each coil is used.—H. Hoffman.

PHONE MONITOR

I would like to submit this idea for a "ham" phone monitor. To operate, merely place the base of the tube in the vicinity of the modulated amplifier of the transmitter or the antenna. In most cases sufficient pickup will be obtained at considerable distances from the antenna or transmitter. A small antenna, two or three feet

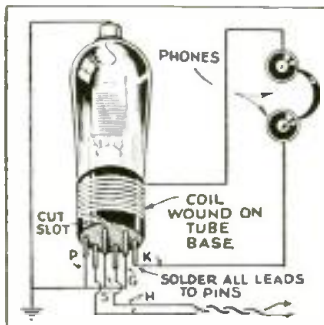

In length attached to one side of the coil, will aid considerably in picking up weak signals from the transmitter. Any type tube with a cathode may be used, and the filament of the tube is all that needs to be fed. Every phone man should have a monitor of this type in his shack.—W. T. Edelstein.

MAST ANCHOR

The following "Kink" will save considerable time when fastening aerial masts to buildings with slanting roofs. The base of the mast is cut on the proper angle to fit the roof. To this a galvanized plate sufficiently large is cut and fastened to the bottom of the mast with long screws. When the mast is erected the base may be fastened to the roof with screws or nails. Naturally, the screws or nails should also be galvanized. This mounting is by far the best I have found, and it provides a permanent structure.—Richard B. Butler.

\$5.00 FOR BEST SHORT-WAVE KINK

The Editor will award a five dollar prize each month for the best short-wave kink submitted by our readers. All other kinks accepted and published will be awarded eight months' subscription to **SHORT WAVE CRAFT**. Look over these "kinks" and they will give you some idea of what the editors are looking for. Send a typewritten or ink description, with sketch, of your favorite short-wave kink to the "Kink" Editor, **SHORT WAVE CRAFT**.

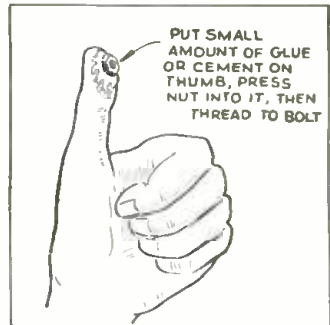

THE NUT—IT STICKS

Here is a solution to the problem of putting a nut on a bolt in a tight place. Place a small amount of glue or cement on your thumb or finger and press the nut into it. You will then be able to put the nut on the bolt very easily. (Don't forget chewing gum also!—Ed.)—Arthur Guy.

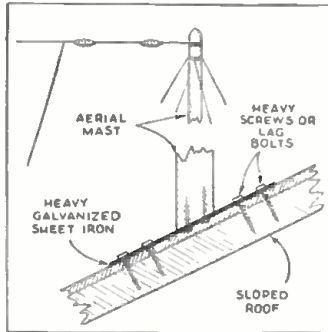

32 VOLT RECEIVER

Many rural radio fans still depend on battery power for their small home-made receivers, even though they may have access to 32-volt D.C. electricity. By using one 250-ohm 5-watt resistor, the 2-tube set using two type 30 tubes can be electrified. With a set such as this and an old pair of headphones, I have heard several foreign stations excellently, including two of the Daventry stations, EAJ—Madrid; PRO—Rome; COCH—Holland, and three in South America.—Clayton Harper.

VERNIER KINK

I found this to be a handy "Kink" and a simple one to make. The brass strip can be cut from an old condenser plate. This is connected by means of a wire to the grid side of the main tuning condenser. The screw used for the movable plate is an 8-32 flat-head and is made variable by threading it through a nut which is soldered to the panel. This plate is connected to "ground" through the panel. The brass strip should be insulated from the panel to avoid a "short-circuit."—Donald Greely.

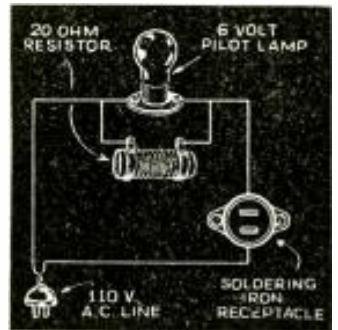
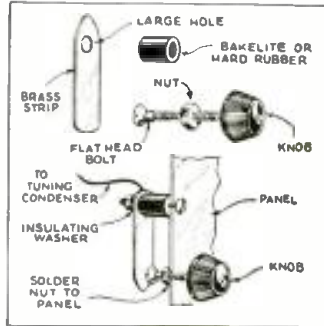

SOLDERING IRON "PILOT"

I have originated a simple reminder for turning off my soldering iron. All that is necessary is to connect a 6-volt pilot lamp to your iron. A 20-ohm rheostat is connected between one side of the line and one side of the iron receptacle. A 6-volt pilot lamp is shunted across the resistor.—Robert F. Shugart, Jr.

A.C. OSCILLATOR

The diagram depicts the hook-up for an A.C. oscillator, thus providing another use for old 201A's. The 201A can be used to "log" stations by employing a vernier dial with condenser C. It is also possible to use it for tuning various stages. The 25-watt bulb lights the 201A nicely and plug-in coils are used.—Alan Harris.

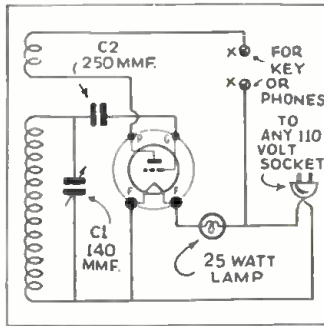
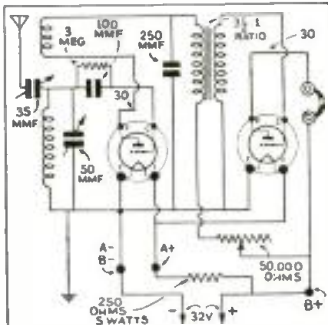

A GOOD DETECTOR

Although the use of a separate tube as the regeneration tube is not new, I believe the use of the 6F7 to take the place of the detector and regeneration tubes provides a very satisfactory arrangement. The pentode section of the 6F7 is used as the usual screen-grid detector, while the triode section is used as a separate regeneration tube.—Bob Thorburn.

WAVE TRAP

Every wave trap I have used for the purpose of eliminating interference caused by a neighboring "ham's" transmitter, also reduced the volume of reception of certain stations as much. Here is a "Kink" which solves this problem. Somewhere in the vicinity of receiving antennas put up another

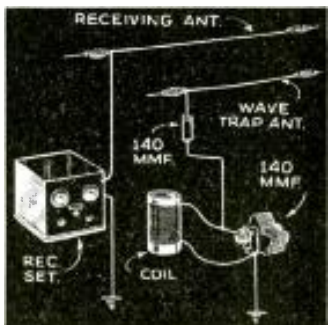

antenna similar to the others. With a coil and condenser you can tune this antenna to the frequency of the interference, thus reducing it almost completely without an additional reduction in the desired signals, even though they be on the same frequency. The diagram will give the reader a clearer insight into just how this is accomplished.—Wm. F. Dickson.

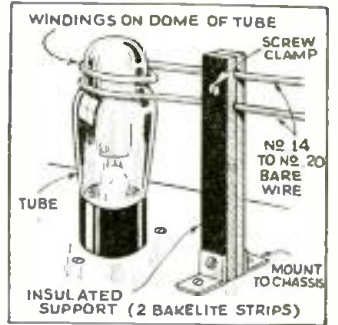

5 METER KINK

Antenna coupling to the super-regenerative receiver must be properly made in order to realize the greatest volume in signal strength. Experiments along this line led me to try to couple the antenna to the receiver by wrapping turns around the dome of the tube. The number of turns may be one or more, depending upon the amount of coupling desired. The sketch should be self-explanatory.—Harold J. Clark.

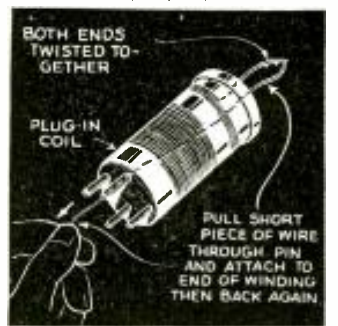

COIL HINT

After much difficulty in constructing plug-in coils, I found that it is far easier to use a separate piece of wire to thread the coil lead through the prong. In most cases it is almost impossible to get the fingers into a coil form.—Robert C. Skar.

Diagrams of S-W Commercial Receivers RCA Communications Type Receiver, Model ACR-175

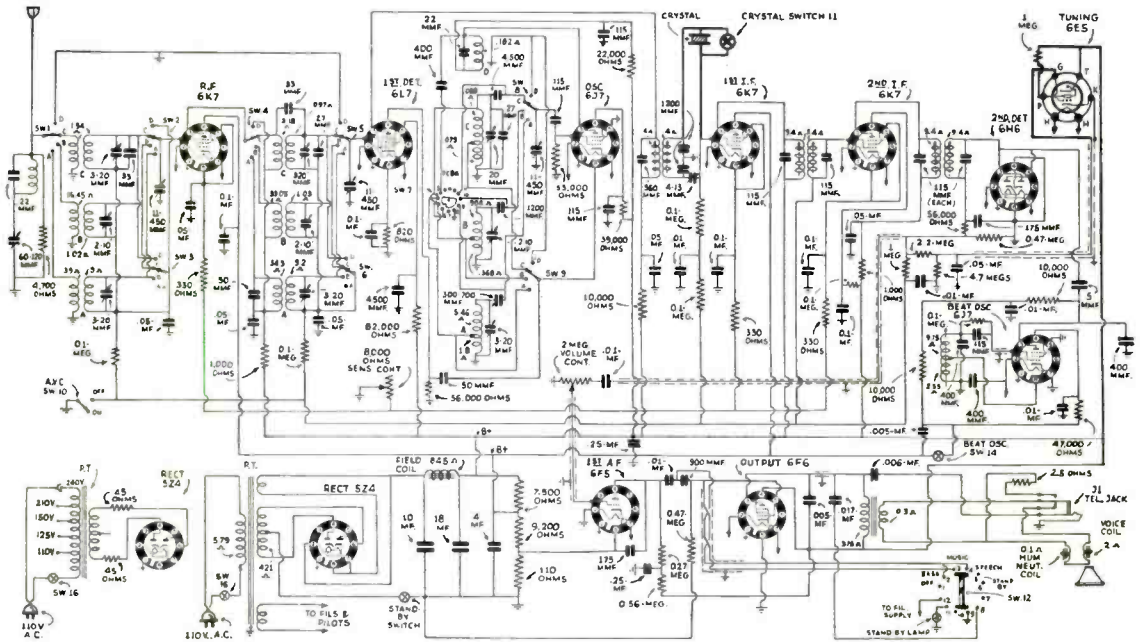

The ACR-175 receiver designed by the RCA engineers for communications type work, but suitable for "Fan" or "Ham," has the following outstanding features: Pre-selection, 11 metal tubes, Crystal filter for "single-signal" reception, Band-spread, Beat Oscillator, Sensitivity control calibrated in micro-volts, Improved A.V.C., Band-switch, Single control Tuning, Accurate Logging, Headphone jack, Separate 8-inch dynamic speaker, built-in power-supply. I.F. frequency 460 kc., works Phones or Speaker. Range 500 to 60,000 kc. or 5 to 600 meters, continuous.

Crosley "Auto-Expressionator" All-Wave Receiver

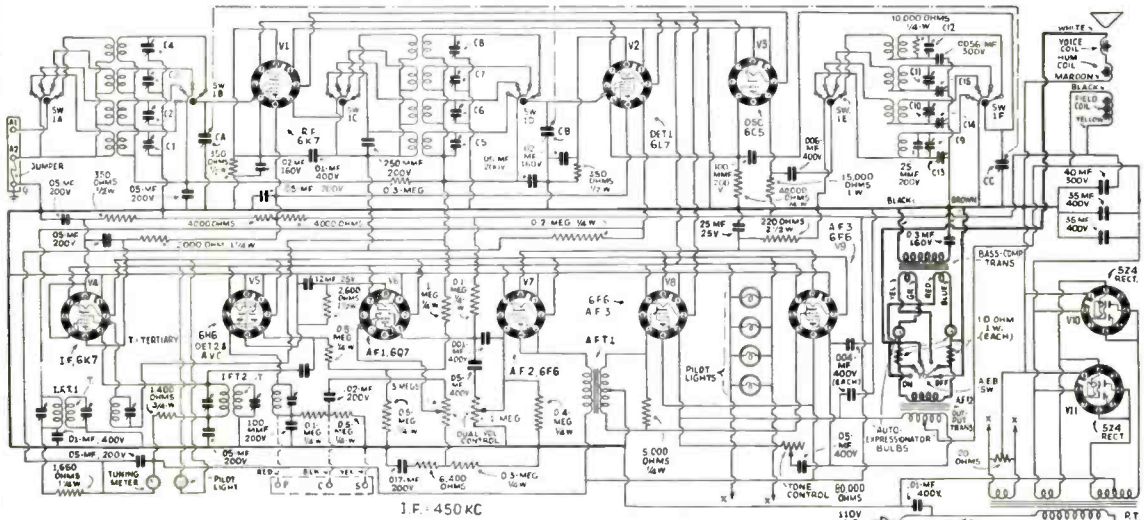

The Crosley "Auto-Expressionator" circuit—involving the use of a multi-band superhet circuit and featuring a new HIGH-FIDELITY audio circuit, arranged in the form of a Wheatstone-bridge; in two of the arms there are placed two lamp bulbs which, because of their thermal characteristics, cause an increase in current through the resistor legs of the bridge as the volume increases, thereby effecting a much greater increase in the speaker output. When the "Auto-Expressionator" is switched on, the "Expressionator" bulbs operate continuously but will not become illuminated, except at high volume levels; their "Expressionating" effect is entirely automatic. The set may be operated with or without the "Auto-Expressionator" by means of a control knob placed on the front panel of the receiver. This set uses 11 tubes and works on a 110-volt, 60-cycle A.C. circuit. Its four bands cover the following frequencies: 150-400, 540-1,900, 1,900-6,000, 6,000-19,000 kc.

WHAT'S NEW In Short-Wave Apparatus

The short-wave apparatus here shown has been carefully selected for description by the editors after a rigid investigation of its merits

The New NATIONAL NC-100 Receiver

By James Millen and Dana Bacon

This remarkable receiver covers a broad band of frequencies or from 30 mc. to 540 kc., which includes the "Broadcast" band—and all with a band-switch! 12 tubes—10 watts Output—Beat Oscillator—Super Band-Spread.



Front view of the new National NC-100 receiver which uses 12 tubes. It has band-switch and indicator, tuning lamp, and a dial which gives extraordinary band-spread.

General Description

● The NC-100 receiver is a twelve tube superheterodyne covering all frequencies from 540 to 30,000 kc., in five ranges. The circuit employed on all ranges consists of one stage of R.F., separate first detector and high frequency oscillator, two I.F. stages, a bias type power detector and a transformer coupled push-pull pentode output stage. Maximum undistorted audio output is 10 watts. A separate tube is employed to provide amplified and delayed AVC action and a separate beat frequency oscillator is coupled to the second detector for c.w. reception. A built-in power supply provides all voltages required, including

excitation for a dynamic speaker field having a resistance of 500 ohms.

Aside from the unusually high sensitivity and selectivity of this receiver, the outstanding feature is the unique system of automatic coil changing. The simplicity and efficiency of the arrangement combines all the desirable features of plug-in coils and coil switching.

Tubes: The NC-100 is supplied complete with tubes which are listed at the time of alignment.

The tubes employed are as follows: R.F. Preselector 6K7, First Detector 6J7, High Frequency Oscillator 6K7, First I.F. 6K7, Second I.F. 6K7, Second Detector 6C5, AVC 6J7, Beat Frequency Oscillator 6J7, Push Pull Output (2) 6F6, Tuning Indicator 6E5, Rectifier 80.

Antenna: The input circuit of the NC-100 is arranged for operation with either the doublet type or the single-wire type of antenna. There are two input binding posts, marked "ANT" and "GND". When using a single-wire antenna, the lead-in should be connected to the antenna post and the short flexible lead, which is connected to the chassis near the ground post, should be clamped under the "GND" termi-

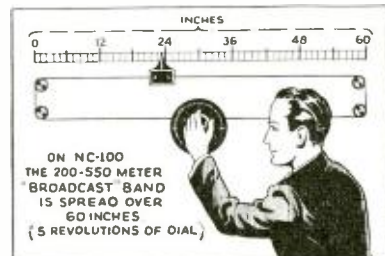

HOW S-W "FAN" BANDS ARE SPREAD OVER THE DIAL

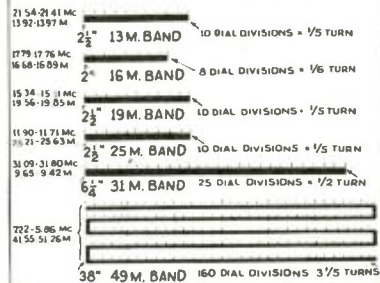

The charts above give some idea of the remarkable band spread provided by the new N.C.-100 receiver. The "broadcast" band occupies 60 inches or 5 feet alone; and the S-W "Fan" bands are spread out in fine fashion, so as to make the tuning in of foreign S-W "broadcast" stations a real pleasure.

nal. An external ground connection may or may not be necessary, depending upon the installation. The ground is usually desirable when receiving wavelengths above 100 meters, but for wavelengths below 50 meters, the use of a ground may actually weaken signals. Doublet antenna feeders should be connected directly to the input terminals and the flexible ground connection, mentioned (Continued on page 302)

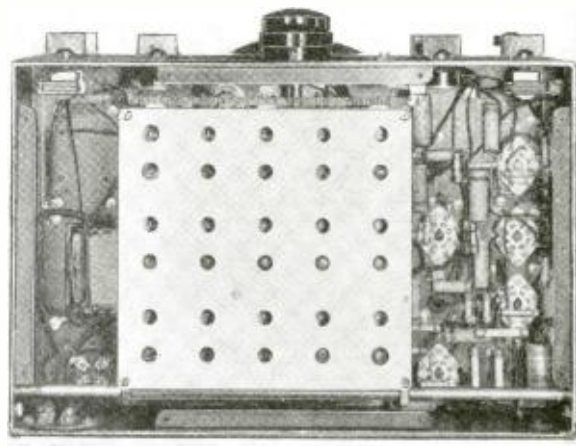
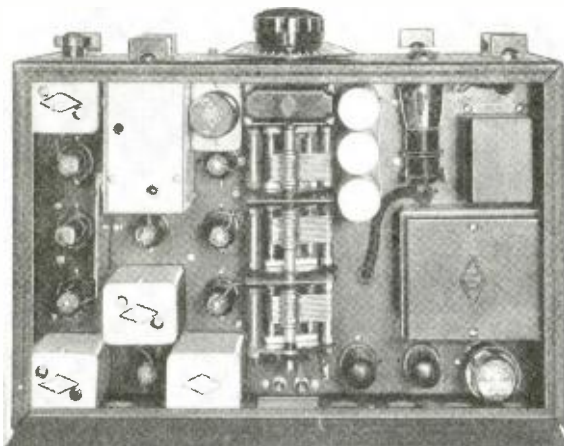

Top and bottom views of the N.C.-100 receiver. The various band coils are thoroughly shielded in the heavy metal case observed in the center, which moves along so as to make contact with the switch springs as the bands are changed, by means of the rack and pinion gear shown. (No. 563)

Names and addresses of manufacturers of apparatus described on this and following pages furnished upon receipt of 3-cent stamp; mention No. of article.

Features of the New Hammarlund SUPER PRO (Part III) By Donald Lewis



Lewis Winner caught in the act of "logging" a distant station on the new Super-Pro receiver.

● IN the previous two "Super Pro" discussions, we outlined the unique tuning system and the combination variable and laboratory-fixed I.F. channel.

Let us now study the audio system. The audio component of the 6B7 second detector diode circuit is capacitively coupled to the audio frequency gain control, which is a 250,000 ohm tapered potentiometer in the grid circuit of the 76 audio tube. This first audio stage is resistance-capacity coupled to the grid of the driver stage which is a 42 pentode operated as a Class "A" triode. The output stage is transformer coupled to the 42 driver and consists of a pair of 42 pentodes connected as triodes and operated as Class "AB". The output transformer matches the plate circuit of these output tubes to a voice coil having a resistance of 8 ohms.

The AVC System

And now a word or two about the AVC system. This is the amplified and delayed type using a 6B7 as both amplifier and rectifier. A single tuned circuit which is link-coupled to the primary circuit of the fourth I.F. transformer feeds into the control grid. A double or twin-tuned out-

put transformer feeds the amplified signal voltage from its plate circuit back to its diode plates. The AVC output transformer is an exact duplicate of the second detector output transformer with its coupling similarly adjustable, that is, the coupling between the primary and secondary can be controlled by means of a knurled nut on the top of the shield. The delayed action is accomplished by normally maintaining a no-signal bias on the diode plates of the 6B7 of approximately minus 40 volts.

Beat Oscillator

Another unusual feature of this receiver is the beat oscillator system. A 6C6 is used and electron-coupled to the input of the second detector through the coupling coil on the primary of the fourth I.F. transformer. The tuned circuit of the beat oscillator is housed in a shield, similar to those housing the intermediate transformers. In addition to the main tuning condenser which is adjustable by means of a screwdriver there is a three-plate vernier condenser connected in parallel and mounted in the upper part of the shield.



This photo shows one of the rigid tests through which the Super-Pro chassis is put in its manufacture.

The setting of this vernier condenser is continuously variable from the front panel by means of a special extension shaft and knob. In this way the pitch of a continuous wave code signal can be varied without de-tuning the signal.

The crystal filter is the next topic of discussion. The crystal filter provides not only needle point selectivity for C.W. code reception but when properly adjusted also affords added selectivity for voice and other modulated signals.

The crystal holder itself is an isolantite



Close-up view of the elaborate cam switch system used in changing from one band to another. (No. 565)

block, ground on both sides to insure an accurate and uniform air-gap above the upper surface of the crystal. It is connected in a balanced link circuit coupling the plate circuit of the first detector to the grid circuit of the first I.F. tube. This link circuit has a relatively low-impedance to match the series resistance, at resonance, of the crystal. In the other leg of the balanced link circuit a variable condenser serves to neutralize the capacitance of the crystal and its holder. The insulated shaft of this variable condenser extends through the front panel where a knob and pointer together with an engraved scale permit accurate adjustment to suit various operating requirements.

Maximum selectivity suitable for single side band C.W. (code) reception occurs at or very near the point of exact neutralization. Directly on either side of the point of exact neutralization, occur points of maximum attenuation for interfering frequencies differing by an audio amount from the desired signal. Turning the knob toward ten on the scale continuously widens the band passed by the filter, to such an extent that successful voice communication can frequently be had under conditions of interference that render reception impossible without this filter.

The crystal filter unit is very accessible: By simply removing two screws which hold the top plate of the holder the crystal can be removed for inspection. The clearance between the crystal and the top plate of the holder is .003". The wiping motion switch is trouble-free and noiseless.

While any antenna can be used, the input circuit of this receiver has been designed to connect directly to a balanced transmission line having an impedance of 115 ohms. The ordinary twisted pair lead-in wire generally available for this work has such an impedance. Where only a narrow band of frequencies is of primary importance, a very suitable antenna consists of a half-wave doublet connected di-

(Continued on page 319)



Appearance of the "direct-reading" audio frequency meter, which has a range of 0 to 5,000 cycles. (No. 550)

● RADIO engineers have been rather backward, if we may venture the thought, in providing the practical radio men in the field with direct-reading meters, such as audio frequency meters, for example. So here at last is the answer to one of the radio men's prayers—a meter on which a needle moves over a calibrated scale and reads directly in cycles per second over a range extending from zero to 5,000 cycles. The fundamental circuit design of this long-awaited instrument was devised by Dr. F. V. Hunt of the

Direct-Reading Audio-Freq. Meter

famous Cruft Laboratory of Harvard University.

The schematic circuit of this new frequency meter is shown herewith. For convenience batteries are shown supplying the grid and meter biases. T1 is an amplifier, T2 and T3 are gas-discharge tubes; T4 is a double diode and T5 is a voltage regulator. The circuits R and C control the voltage on the grids of the gas-discharge tubes; the circuits Rm, Cm, control the action of the double diode.

This meter consists essentially of an amplifier, a gas-discharge tube, counter, and an indicator. The principle of operation is as follows:

On the application of an alternating voltage to the grids of the gas-discharge tubes, the tubes become alternately conducting and non-conducting. At each transition of the current from one tube to the other, a single, short current pulse is sent through the indicator circuit. As the successive current pulses are identical, the meter reading will depend only on the number of pulses per sec-

ond, or the frequency.

The instrument includes a one-stage amplifier, the gas-discharge-tube counter circuit, diode switching tube, frequency-

(Continued on page 319)

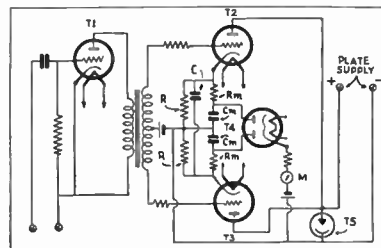
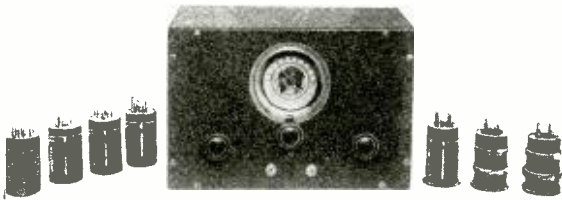

Diagram showing connection of tubes and other components of the direct-reading frequency meter.

Names and addresses of manufacturers of apparatus described on this and following pages furnished upon receipt of 3-cent stamp; mention No. of article.



2-tube all-wave receiver—an excellent "headphone" job—and it has a range of $9\frac{1}{2}$ to 2,000 meters.

● THE regenerative 2-tube receiver here shown utilizes a 6J7 metal tube as a regenerative detector and a 12A7 glass tube as an amplifier. This set is available at a nominal price in kit form and is very simple to assemble.

The seven coils are already wound and they cover the usual four short-wave bands below 200 meters; one coil covers the broadcast band, and three additional coils with bank-wound inductances enable the listener to tune in on different bands as high as 2,000 meters.

This set with a pair of good headphones, will give transoceanic reception on the short-wave broadcast and other stations, and owing to its small size it lends itself very nicely to portable requirements. Instructions and a clear wiring diagram are furnished with the kit of parts, and the kit is available with or without the black crystal finished cabinet.

This set is designed to operate from a 110-volt A.C. or D.C. lamp socket. Greater range is obtained by using a ground

2-Tuber with $9\frac{1}{2}$ to 2000 Meter Range

connection, which has a .1 mf. condenser connected in series between it and the chassis of the set. An antenna trimming condenser is supplied, and it is fitted with a large insulated adjustment knob. Regeneration is controlled by adjusting a variable 50,000-ohm resistance connected across the tickler winding. The plate circuit detector is resistance-capacity coupled to the 12A7 audio amplifier. The diode element of this 12A7 is used as a rectifier to supply the plate current. The usual filter network is supplied as shown in the diagram.

This set may be used with practically any type of antenna, and a 50 or 75 foot piece of wire and a ground connection will serve very well for the purpose. This article has been prepared from data supplied by courtesy of Trymo Radio Co. (Cont'd on p. 301)



A peek at the chassis of the 2-tube $9\frac{1}{2}$ to 2,000 meter receiver. (No. 560.)

An "F. B." Duplex Portable

● ANTICIPATING the summer needs of the amateur, the "Ultra Duplex" was designed, embodying all the latest innovations of the ultra high frequency sphere. This really compact and separate transmitting and receiving unit successfully fulfills the innermost desire of the real amateur for duplex operation. None of the familiar undesirable features of transceiver operation present themselves,

A swell portable is the one shown at the left, with its beautifully finished metal case. The metal case contains the transmitter, receiver, batteries, and loud-speaker. (No. 561.)

the designers claim, yet this is possible with a lower upkeep expense than with even the most modest transceiver. The battery drain has been shaved down mil by mil, until—by direct comparison—to say nothing of the vastly improved results, the above mentioned fact was made a reality. Operation of this unit closely resembles ordinary telephone communica-

tion. Absolutely no changeover switches of any kind are required to carry on a "two-way" conversation. Three or four units may be operated within a small radius and practically on the same frequency, due to the excellent stability characteristics of the transmitter and absolute non-radiation of the receiver. Both units are so constructed as to be entirely isolated from each other. Frequency-setting and volume-control on either the transmitter or receiver in no way effect one another. A common battery supply is possible, however, because of completely filtered battery leads. The transmitter may be monitored by the receiver, by tuning both to the same frequency. This is possible only when antennas are connected to both units, so completely isolated is the transmitter from the receiver.

Circuit analysis: The receiver portion consists of a super-regenerative detector (1C6) working on an entirely new principle, and an audio amplifier (1F4). The regeneration may be tapered down to a point where a station may be received with absolutely no back-ground hiss whatsoever. At this (Continued on page 313)

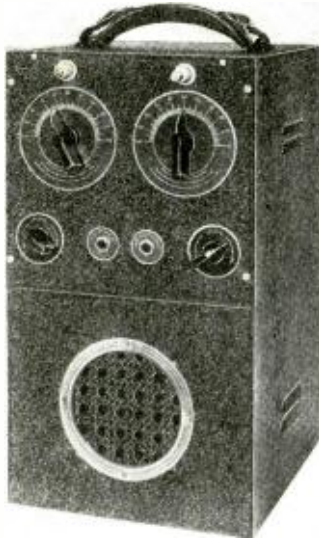

High Quality MOPA for 5 and 10 Meters

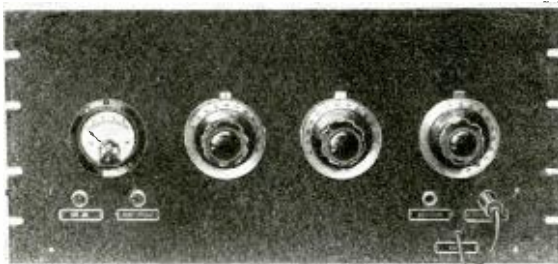

A high-quality MOPA transmitter for 5 and 10-meter work.

● EVERY one will agree that a great majority of the amateurs operating on the 5-meter band are in need of a stable and efficient transmitter. In the photographs we see a new item which is commercially available, employing three type 89 tubes in a set-up nearly identical to the 89 5-meter MOPA described in the Feb., 1936, issue of *Short Wave Craft*. In this transmitter, provision has been made for crystal operation on the 10-meter band, by employing a 20-meter crystal and 5-meter operation merely by employing electron-coupling in the oscillator

stage, doubling in its plate circuit to 5 meters and tuning the two amplifier tubes to that band. Everything except the modulator is contained in this unit; it has its own power supply. Between 18 and 20 watts of audio power are needed to modulate it 100 per cent.

The manufacturers claim excellent stability is obtained and reception is possible on the most selective of superheterodyne receivers—that is when operating on 5 meters with the electron coupled arrangement. With crystal control on 10 meters, of course, it should be absolutely stable. Four hundred volts are applied to the oscillator plate and 500 volts to the amplifier plates. The makers of this transmitter use a special 89 tube, fitted with a isolantite base, and claim that the tubes show no signs of strains when operating at 500 volts.

An antenna coupling arrangement is em- (Continued on page 313)

Rear view of the 5 and 10-meter MOPA. (No. 562)

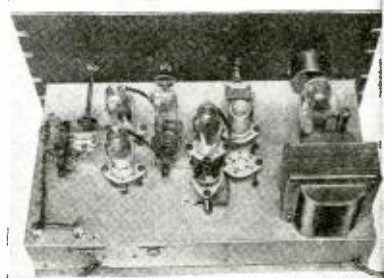

Names and addresses of manufacturers of apparatus on this and following pages furnished upon receipt of 3-cent stamp; mention No. of article.

New 5-Meter Receiver Uses 3 Tubes

By Frank Lester, W2AMJ



● ALTHOUGH the superheterodyne has practically replaced other receivers for use on the short-wave bands above 20 meters, the super-regenerative circuit still remains a favorite for 5-meter use. The reasons for this continued popularity are easy to understand. This type of circuit is simple, surefire in action, and inexpensive to construct. It possesses the remarkable ability to reject ignition interference, a feature of extreme importance in portable-mobile service and also in fixed locations in heavily travelled areas. However, the current forms of super-regenerative receivers suffer from one disadvantage which must be overcome in the general interest of 5-meter reception; that is, its strong tendency to radiate a signal of its own.

A new 5-meter receiver that overcomes these objec-

tions is shown in the accompanying illustration. It is the Lafayette "79," designed by the writer. It is the answer to the demands of 5-meter amateurs for a reliable, medium priced, 5-meter "rig" suitable for fixed station use on A.C. with a regular power-pack and also for mobile use in a car on 6 volts D.C. furnished by the storage battery.

4 Tube Results from 3 Tubes

Three tubes are used in a circuit that gives the results normally obtained from four. As may be seen from the accompanying diagram, the "79" uses a type 78 tube as an R.F. amplifier, with a complete antenna-grid tuning circuit consisting of a 10-mmf. variable capacitor (condenser) and a small plug-in coil. This stage not only eliminates detector radiation, but also increases the overall gain and selectivity. This works into one triode section of a type 79 tube, connected as a self-quenching ultra audion-super-regenerative detector. Parallel plate-feed is used to the 78 R.F. amplifier, this arrangement being altogether practicable because of the narrow frequency tuning range of the receiver.

The second section of the 79 operates as a resistance-capacitance coupled audio amplifier. This is followed by a second resistance coupled stage using a 42 power output tube. A choke-and-condenser combination is used in the plate circuit of the 42 to keep D.C. out of the earphones or loud-speaker. A 50,000-ohm potentiometer acts as regeneration control in the detector circuit, while a 500,000-ohm potentiometer in the grid circuit of the 42 acts as an audio volume control. These adjustments are independent of each other, giving the operator complete control over the R.F. and A.F. actions of the receiver. A separate stand-by switch is provided in the "B" circuit, to "kill" the receiver



This new 5-meter receiver employs a super-regenerative circuit of the latest improved type. (No. 564.)

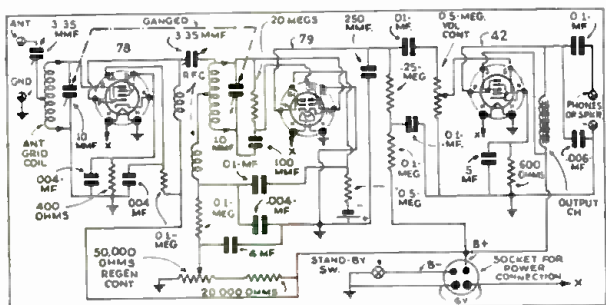

The very neat and well-designed chassis of the new 5-meter super-regenerator receiver designed by Mr. Lester.

(Continued on page 313)

NEW APPARATUS FOR THE "HAM"

FIXED TUNING EXCITER TANK, H59

● FOR the amateur who is interested in building a transmitter with fixed tuned stages, or any other type of apparatus that requires shielded tuned circuit, this new National unit should be ideal. It is provided with a 1 1/2 in. x 1 in. diameter R-39 coil form and has two 25 mmf. air dielectric condensers rated at 2,000 volts. The entire assembly is enclosed in an aluminum can 4 x 2 3/4 x 2 in.



Exciter Tank, H59. This is ideal for exciter stages or receiver circuits.

LOW-LOSS COIL-FORM AND SOCKET, H60

● IN the photograph we see a new ceramic coil form which is fitted with a plug base and has a required jack base. The form itself is isolantite 1 1/4 in. in diameter and 3 1/2 in. long, with a 1/4 in. wall. The plug-base and jack-base are constructed of R-39 material, well-known for its insulating qualities at high frequencies. A combination plug base and socket is available separately as is also the coil form. Five terminals are available in the base, making this an extremely versatile unit which will find favor among amateurs who construct solidly-built high efficiency transmitters.



Midget Trimmer, H62. How it works is clearly shown in the above drawing.

NEW VOLUME CONTROLS, H61

● THE volume control shown in the photograph is a new I.R.C. unit and a member of the complete family of potentiometers. The outstanding features are: metalized type filament permanently bounded

to a moisture-proof bakelite base, and a multi-fingered silver plated contactor and a friction clutch.

These are available with or without the switches. In this unit provision has been made for two taps which may be brought out anywhere on the element by a special method which eliminates obstructions in the path of the multi-finger sliding contact.

NEW MIDGET TRIMMER, H62

● IN the accompanying drawing—we use the drawing because it shows more detail than a photograph would—we find a new compact and excellently designed trimmer. This is of the air dielectric type, permanently sealed in a bakelite case, and varies from 1 to 12 mmf. The condenser unit consists of two cups—one smaller than the other. The degree of overlap, which is adjusted by the screw, determines the capacity. These are also said to be available in various other capacities. These variable trimmer condensers should work very nicely in conjunction with short wave and multi-tuned circuits.

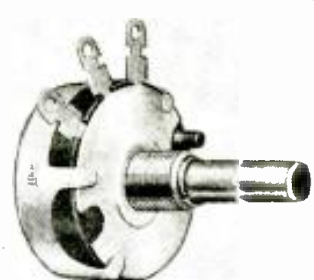

A New Volume Control, H61

TUNED DIODE TRANSFORMER, H63

● WITH the great popularity of the noise reducing circuits, the National Company has made available a special transformer designed to couple into a push pull diode. The input circuit is tuned and the tapped diode circuit is untuned and closely coupled to the primary. The photo clearly shows the constructional details.



New Plug-in Coil, H60.



Diode Coupling Transformer, H63.

Names and addresses of manufacturers of apparatus described on this and following pages furnished upon receipt of 3-cent stamp; mention No. of article.

THE RADIO AMATEUR

Conducted by Geo. W. Stuart

Radio Amateur Course

THIRTEENTH LESSON

• THERE is probably nothing so fascinating in the radio field as experimenting on the *ultra high frequencies*. In this field lies the future of radio and a great opportunity for all ambitious experimenters. In this lesson we will deal with the more or less standard super-regenerative receivers, which have become the most important part of ultra high frequency reception. The super-regenerator is capable of excellent *sensitivity* and is probably, without doubt, the most sensitive *simple* receiver which ever was or will be devised. This does not mean, though, that time will not change the method of reception of ultra high frequency signals, but for the time being the most interesting and most popular receiver is the *super-regenerator*.

Reviewing what we have already learned about *regenerative detectors* and bearing this in mind, we may easily understand the simple functions of the super-regenerator. A regenerative detector is one wherein a signal is built up by regeneration to a point, where, if we employ further regeneration—the tube will break into sustained operation oscillation.

In this unstable condition a fairly weak signal will cause the detector to commence oscillating, and these will continue to build up to an amplitude permitted by the tube constants. However, the receiver cannot reproduce the signal because after the oscillations once start they would not cease. Therefore, the *interruption frequency oscillator* is employed to stop the detector from oscillating at intervals, which depend upon the frequency of this interrupting oscillator. It is assumed that on the upward swing a signal is built up along with oscillations, but this

procedure is halted before the self-oscillations reach a value comparable with the signal.

This same action can also be obtained without the use of the low frequency oscillator. The single tube can be made to oscillate at two frequencies; one the signal frequency, and the other of super-audible frequency in the neighborhood of 15 to 50 kc. The best all-around frequency for the quenching oscillation has been found to be from 15 to 25 kc.

The selectivity of the super-regenerator is also governed by the interruption frequency. As the interruption frequency

~~~~~

The thirteenth lesson of our "Amateur Course" deals with ultra high frequency receivers, especially those intended for the 5-meter amateur band.

~~~~~

frequency becomes higher, the receiver becomes broader or more unselective. Therefore, the lowest possible frequency commensurate with good quality reproduction is desirable.

In Fig. 1 we have either a tetrode or pentode detector. In the case of the pentode the suppressor is connected to the screen-grid; either will give the same results. However, the 954 Acorn tube, especially designed for ultra high frequencies, is preferable when operating the receiver at frequencies higher than 60 meg. At 5 meters or 56 megs. it is difficult to notice the difference between the signal sensitivity of the 954

and the usual tetrode or pentode. It will be noticed, though, that the conventional receiving tubes such as the 6C6 or the 57 will give greater volume, and in this respect, it may be somewhat superior inasmuch as less audio frequency amplification is needed. Of course, this is only true in cases of a super-regenerator detector. In an R.F. amplifier circuit the 954 would be far superior to the other tubes. In the circuit in Fig. 1, the screen is modulated by connecting it in parallel with the plate circuit of the interruption frequency oscillator. The voltage to the screen is variable through the use of a variable resistor, independent of the oscillator plate voltage. It is advisable to also adjust the voltage applied to the oscillator plate for maximum sensitivity and best super-regeneration action of the detector.

It will be found that the voltage fed to the I.F. oscillator is quite critical inasmuch as with high voltage on the oscillator we will have tremendous distortion in the signal and with very low voltage on the oscillator we are liable to have *repeat spots*, that is, the station may appear at several points on the dial very close together. As we said before, there is just one value of plate voltage which gives the cleanest regenerative action in the detector circuit. We should also make sure that the detector is not *super-regenerating* by itself, that is, that it is not *self-quenching* along with the applied voltage of the I.F. oscillator. This can be determined by noting the smoothness of the regeneration control in the detector screen circuit. This should be very smooth in operation and the hiss of the detector should appear gradually as the resistance in the control is decreased. It should not *pop* into oscillation.

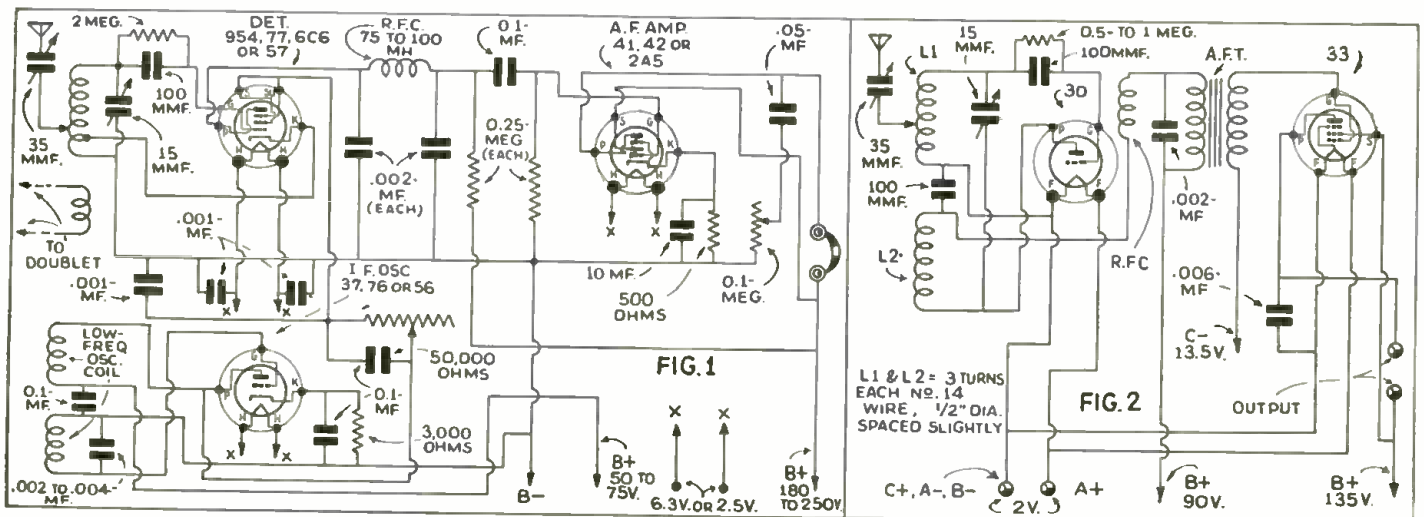

Super-regenerator using a separate quenching oscillator, together with diagram of a battery operated 5-meter receiver.

One cause of poor operation in a super-regenerator circuit of the type shown in Fig. 1 may be found in the I.F. oscillator circuit. Usually the detector, if the tube is o.k., will function properly. There are two types of I.F. or low frequency oscillator coils available on the market; one is the shielded and the other is the unshielded type. It has been found that some of the shielded type introduces a loss in the oscillator circuit, sufficient to cause the necessity of high plate voltage in order to make the oscillator function. In turn, this raises the voltage to the screen above the point where there is not enough resistance in the 50,000-ohm control to bring the detector out of oscillation. The unshielded low frequency coils, however, work perfectly. Regardless of the type of oscillator coil used, make sure that it is possible to bring the detector out of oscillation smoothly with the regeneration control "R."

Low-Frequency Oscillator Coils

There seems to be no set standard for

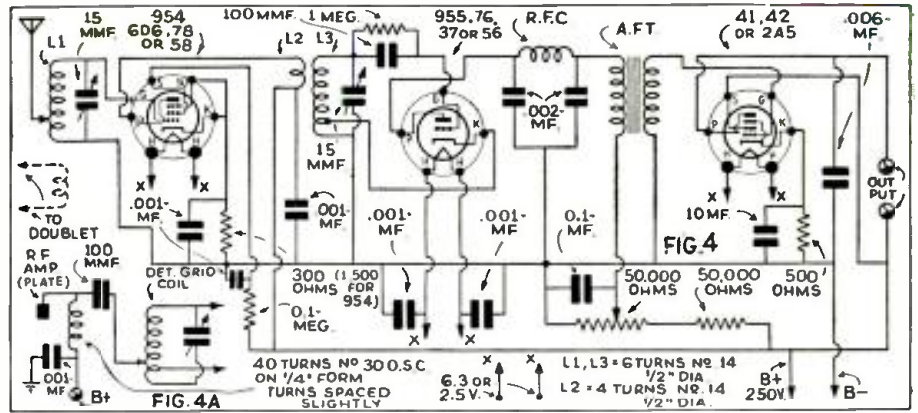
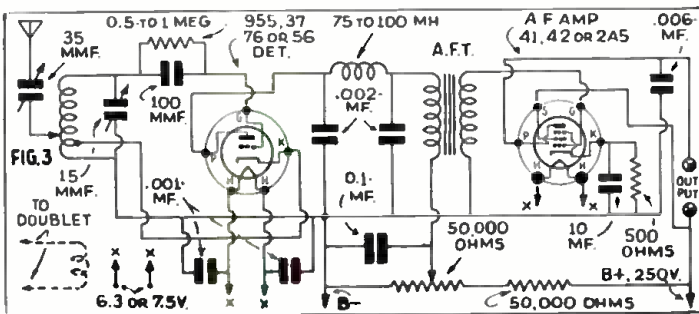

A tuned R.F. stage added to the popular 5-meter receiver, thus increasing sensitivity and eliminating radiation.

the value of inductance used in the low-frequency oscillator coils. Therefore, we have shown a capacity of .002 to .004 mf. in the grid circuit across the grid coil. This condenser is used to lower the frequency of the I.F. oscillator and its capacity will depend upon the design of the coil. In any

event, place sufficient capacity across this to bring the I.F. oscillations down to around 20 kc. A good method to follow is to connect a number of .001 mf. condensers across this secondary, bringing the oscillator into the audible range, so that a very high pitched whistle is heard; then remove one condenser at a time, until this whistle becomes inaudible to the ear. Adjusting the low frequency oscillator and its plate voltage is quite important, contrary to popular belief. With excessive voltage on the plate of the oscillator, it may take an "R8" signal to make a "sizeable" dent in the rush of the super-regenerator, where with the proper value, that is a voltage just in excess of the amount that causes repeat spots to appear, will permit even a very weak signal to cause an appreciable (Continued on page 300)

The most popular of all 5-meter receivers — a self-quenched triode, with a pentode audio amplifier.

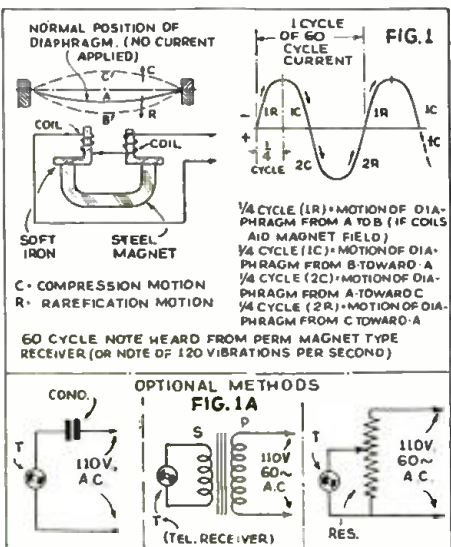

Diagram showing action through one cycle of A.C. when applied to a polarized telephone receiver.

THE physics of what happens in an ordinary telephone receiver when it is connected across a resistance or other part of a circuit supplied with 110-volt, 60-cycle alternating current, such as commonly used for lighting our houses, is quite interesting. All the more so as we frequently hear the argument raised as to whether we really hear a 60-cycle or a 120-cycle note in a telephone receiver connected to such a circuit.

Some rather unusual conditions occur in this case which are probably rarely considered by the average student. He probably has heard the note given by a

Does 60-Cycle A. C. Create a 60-Cycle Note?

telephone receiver connected to some part of a circuit excited by the ordinary 110-volt 60-cycle A.C. and decided that it was, of course, the natural 60-cycle note, and that was that. Well, let's see what happens.

In Fig. 1, we have shown several positions of the iron diaphragm in an ordinary telephone receiver of the permanent magnet type, and when no current is applied to the receiver windings (which are mounted on soft iron cores, welded or clamped to the permanent steel magnet), the diaphragm is under a magnetic stress and assumes some position such as "A," in a direction toward the pole-pieces, due to the magnetic flux passing from one pole, through the diaphragm and returning to the pole of opposite polarity adjacent to it.

Now consider that a 60-cycle A.C. is applied to the coil windings by means of a potentiometer, or a coil (See Fig. 1-A), placing the receiver across a small section of the coil, sufficient to give a suitable difference of potential. The resistor may be excited from the low-voltage secondary of a step-down transformer, such as a bell-ringing transformer, or again, in series with a condenser as shown.

Let us follow the action of the receiver diaphragm through one cycle: Downward motions of the diaphragm "R" are considered as rarefaction, and "C" representing the upward stroke of the diaphragm; let us call this the compression motion, the air being rare-

fied or compressed, as the case may be. On the first quarter cycle, and providing the direction of the current at the moment is such as to cause the magnet coils to aid the magnet field set up by the steel magnet, the diaphragm will move closer to the pole-pieces or from "A" to "B," the motions in the diagram being shown greatly exaggerated for the sake of clarity.

In the sec- (Continued on page 315)

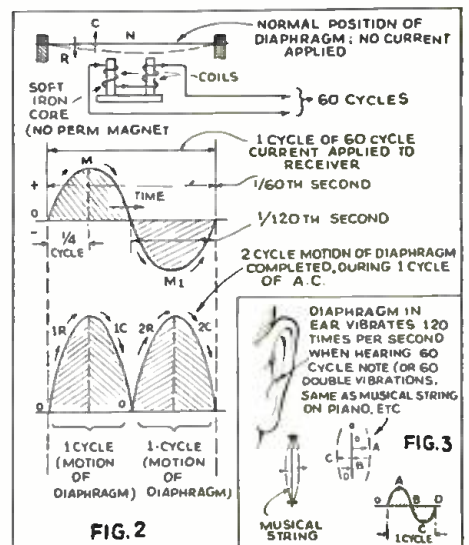

Diagram illustrating action during one cycle of A.C. when applied to a non-polarized telephone receiver.

SHORT WAVE LEAGUE

Here's Your Button

The illustration herewith shows the beautiful design of the "Official" Short Wave League button, which is available to everyone who becomes a member of the Short Wave League.

The requirements for joining the League are explained in a booklet, copies of which will be mailed upon request. The button measures $\frac{3}{4}$ inch in diameter and is inlaid in enamel—3 colors—red, white, and blue.



Please note that you can order your button AT ONCE—SHORT WAVE LEAGUE supplies it at cost, the price, including the mailing, being 35 cents. A solid gold button is furnished for \$2.00 prepaid. Address all communications to SHORT WAVE LEAGUE, 99-101 Hudson St., New York.

HONORARY MEMBERS

Dr. Lee de Forest
John L. Reinartz
D. E. Replogle
Hollis Baird
E. T. Somerset
Baron Manfred von Ardenne
Hugo Gernsback
Executive Secretary



O. L. P. Report from Brecksville, Ohio

● RECEPTION has been very erratic. The 25 meter band has been the most consistent, in so far as strong signals are concerned. Stations could be heard on the 19 meter band, but they were rather weak most of the time. A few stations on the 31 meter band came in rather strong, but the band is becoming just as congested as the 49 meter band.

The following stations were heard during this period:

GSI on 15,260 kc.—Exceptionally loud and clear.

GBS on 12,150 kc.—Very, very loud. Working N.Y.

DJD on 11,770 kc.—Very, very loud.

DZB on 10,042 kc.—Loud, but interference.

DJA on 9,560 kc.—Very loud, some noise.

COCH on 9,428 kc.—Loud but noisy.

GSI on 15,260 kc.—Very loud and steady.

GSP on 15,310 kc.—Very loud.

DJQ on 15,280 kc.—Very loud and clear.

DJD on 11,770 kc.—Very loud.

DZB on 10,042 kc.—Very choppy.

SHORT WAVE SCOUT News

GSI on 15,260 kc.—Very loud and clear.

DJD on 11,770 kc.—Very loud and clear.

ZRO on 9,635 kc.—Very loud.

GSC on 9,580 kc.—Very, very loud and clear.

EAQ on 9,860 kc.—Loud but choppy.

TPA4 on 11,715 kc.—Clear and steady.

PHI on 17,775 kc.—Very loud and clear.

DJE on 17,760 kc.—Fair, faded some.

WNC on 15,055 kc.—Fair, faded.

GAU on 18,620 kc.—Very, very loud.

CEC on 10,670 kc.—Fair, noisy.

DZB on 10,042 kc.—Choppy and noisy.

DJA on 9,560 kc.—Loud, but noisy.

HJU on 9,510 kc.—Very loud.

The stations are listed in the sequence in which they were heard.

E. M. HEISER,
Route 2, Box 124,
Brecksville, Ohio.

Report from Stamford, Conn.

● KINDLY accept my sincerest thanks for the beautiful trophy which you have awarded to me. I consider myself very fortunate to have been judged a winner of your contest and can assure your readers that the "trophy cup" is more than worth the time and energy expended. It occupies a place of honor on the top of my radio and is greatly admired by all.

The following is a report of a few stations which I have received recently:

VPD—13.07 mc., Suva, Fiji Islands. This station is heard very consistently with R-6 volume from 12:30-1:30 a.m., E.S.T.

TFJ—12.23 mc., Reykjavik, Iceland. Heard Sunday 1:40-2 p.m., E.S.T., with program in English. Signal is quite weak.

PRF5—9.50 mc., Rio de Janeiro, Brazil. Station has apparently increased power and is being received with R-8 volume daily at 5:45 p.m., E.S.T.

PLP—11.0 mc., Bandoeng, Java. Received around 7

a.m., E.S.T., daily, but signal is very weak.

VP3MR—7.08 mc., Georgetown, British Guiana. Heard daily at 6:45 p.m., E.S.T., with R-7 volume, but code QRM is very heavy in this part of the band.

PCJ—9.59 mc., Eindhoven, Holland. Coming through better than ever on this new frequency. Volume is R-8. Heard Sun. and Wed. at 7 p.m., E.S.T.

CEC—10.67 mc., Santiago, Chile. Received daily, 7-7:15 p.m., E.S.T., with R-6 to R-7 volume.

The Australian stations are coming through fairly well, as usual, while J.V.M. (Continued on page 315)



Ralph Baldwin Likes His Trophy

I am working for my Ph.D. here at the University of Michigan in the department of Astronomy. Herewith a picture of my radio receiver and myself. The radio set is an *All-Star Senior*. I built it from a kit, and consequently the set has no serial number. This is a 6 tube superheterodyne. I have changed the set a little, having replaced a "57" by a "2A6" and added an automatic volume control. This, of course, necessitated a new manual volume control. This A.V.C. aids greatly in receiving short-wave stations. I have also added an ear-phone jack. Just below the set itself is a Peak pre-selector. This helps tremendously with weak signals. I wouldn't be without it. The cabinet is a walnut one which I built in spare moments.

As for the trophy itself, it is a beautiful piece of work. I am very much pleased with it.

Sincerely,
RALPH B. BALDWIN,
918 Packard,
Ann Arbor, Michigan.



Short Wave League

At a Directors Meeting held in New York City, New York, in the United States of America, the Short Wave League has elected

John F. Müller

a member of this League

In Witness whereof, this certificate has been officially signed and presented to the above.

H. Winfield Secor
Genl. Secretary

This is the handsome certificate that is presented FREE to all members of the SHORT WAVE LEAGUE. The full size is $7\frac{1}{4}$ " x $9\frac{1}{2}$ ".



World S-W Station List

Complete List of Broadcast, and Telephone Stations

All the stations in this list use telephone transmission of some kind. Note: Stations marked with a star ★ are the most active and easily heard stations and transmit at fairly regular times. Please write to us about any new sta-

tions or other important data that you learn through announcements over the air or correspondence with the stations. Stations are classified as follows: C—Commercial phone. B—Broadcast service. X—Experimental transmissions.

Around-the-Clock Listening Guide

It is a good idea to follow a general schedule as far as wavelength in relation to the time of the day is concerned. The observance of these simple rules will save time.

From daybreak till 9 p.m. and particularly

during bright daylight, listen between 13 and 19 meters (21540 to 15800 kc.)

To the east of the listener, from about 4 p.m.-5 a.m., the 19-35 meter will be found very productive. To the west of the listener this same

band is generally found best from about 12 m. until 7 a.m. (After dark, results above 35 meters are usually much better than during daylight.) These general rules hold for any location in the Northern Hemisphere.

Short-Wave Broadcasting, Experimental and Commercial Radiophone Stations

NOTE: To convert kc. to megacycles (mc.) shift decimal point 3 places to left: Thus, read 21540 kc. as 21.540 mc.

| | | | | |
|--|---|--|--|--|
| 31600 kc. W2XDU -BX- 9.494 meters ATLANTIC BROADCASTING CO. 485 MADISON AVE., N.Y.C. Relays WABC daily 5-10 p.m., Sat., Sun. 12:30-5, 6-9 p.m. | 20040 kc. OPL -C- 14.97 meters LEOPOLDVILLE, BELGIAN CONGO Works with ORG in morning | 18680 kc. OCI -C- 16.06 meters LIMA, PERU Works various S.A. stations daytime | 17760 kc. DJE -B- 16.89 meters BROADCASTING HOUSE BERLIN, GERMANY 8:05-11 a.m. | 15660 kc. JVE -C- 19.16 meters NAZAKI, JAPAN Phones Java 3-5 a.m. |
| 31600 kc. W4XCA -BX- 9.494 meters MEMPHIS, TENN. Relays WMC daily | 20020 kc. DHO -C- 14.99 meters NAUEN, GERMANY Works S. America, mornings | 18620 kc. GAU -C- 16.11 meters RUGBY, ENGLAND Calls N. Y., daytime | 17760 kc. IAC -C- 16.89 meters PISA, ITALY Calls ships, 6:30-7:30 a.m. | 15620 kc. JVF -C- 19.2 meters NAZAKI, JAPAN Phones U.S. 3 a.m. & 4 p.m. |
| 31600 kc. W8XAI -BX- 9.494 meters STROMBERG CARLSON CO. ROCHESTER, N.Y. Relays WHAM daily 7:30 a.m.- 12:05 a.m. | 19900 kc. LSG -C- 15.06 meters MONTE GRANDE, ARGENTINA Tests irregularly, daytime | 18345 kc. FZS -C- 16.35 meters SAIGON, INDO-CHINA Phones Paris, early morning | 17741 kc. HSP -C- 16.91 meters BANGKOK, SIAM Works Germany 4-7 a.m. | 15460 kc. KKR -C- 19.4 meters RCA COMMUNICATIONS. BOLINAS, CAL. Tests irregularly |
| 31600 kc. W8XWJ -BX- 9.494 meters PENOBSCOT TOWER DETROIT, MICH. Daily 6 a.m.-12:30 a.m., Sun. 8 a.m.-12 M. | 19820 kc. WKN -C- 15.14 meters LAWRENCEVILLE, N. J. Calls England, daytime | 18340 kc. WLA -C- 16.36 meters LAWRENCEVILLE, N. J. Calls England, daytime | 17650 kc. XGM -C- 17 meters SHANGHAI, CHINA Works London 7-9 a.m. | 15415 kc. KWO -C- 19.46 meters DIXON, CAL. Phones Hawaii 2-7 p.m. |
| 21540 kc. W8XK -B- 13.93 meters WESTINGHOUSE ELECTRIC PITTSBURGH, PA. 6-9 a.m.; relays KDKA | 19680 kc. CEC -C- 15.24 meters SANTIAGO, CHILE Works Buenos Aires and Colombia daytime | 18310 kc. GAS -C- 16.38 meters RUGBY, ENGLAND Calls N. Y., daytime | 17520 kc. DFB -C- 17.12 meters NAUEN, GERMANY Works S. America near 9:15 a.m. | 15370 kc. ★HAS3 -B- 19.52 meters BUDAPEST, HUNGARY Broadcasts Sundays, 9-10 a.m. |
| 21530 kc. GSJ -B- 13.93 meters DAVENTRY B.B.C., BROADCASTING HOUSE, LONDON, ENGLAND | 19650 kc. LSN5 -C- 15.27 meters HURLINGHAM, ARGENTINA Calls Europe, daytime | 18299 kc. YVR -C- 16.39 meters MARACAY, VENEZUELA Works Germany, mornings | 17510 kc. VVY2 -C- 17.13 meters KIRKEE, INDIA Works Rugby 2-7 a.m. | 15360 kc. DZG -X-C- 19.53 meters REICHSPOSTZENSTRALAMT, ZESEN, GERMANY Works with Africa and tests ir- regularly |
| 21520 kc. W2XE -B- 13.94 meters ATLANTIC BROADCASTING CORP. 485 Madison Ave., N.Y.C. Relays WABC 6:30 a.m.-12 n. | 19600 kc. LSF -C- 15.31 meters MONTE GRANDE, ARGENTINA Tests irregularly, daytime | 18250 kc. FTO -C- 16.43 meters ST. ASSISE, FRANCE Calls S. America, daytime | 17310 kc. W3XL -X- 17.33 meters NATIONAL BROAD. CO. BOUND BROOK, N. J. Tests irregularly | 15355 kc. KWU -C- 19.53 meters DIXON, CAL. Phones Pacific Isles and Japan |
| 21470 kc. ★GSH 13.97 meters DAVENTRY B.B.C., BROADCASTING HOUSE, LONDON, ENGLAND 6-8:45, 9-10:30 a.m. | 19480 kc. GAD -C- 15.4 meters RUGBY, ENGLAND Works with Kenya, Africa, early morning | 18200 kc. GAW -C- 16.48 meters RUGBY, ENGLAND Calls N. Y., daytime | 17120 kc. WOO -C- 17.52 meters A. T. & T. CO., OCEAN GATE, N. J. Calls ships | 15340 kc. DJR -B-X- 19.56 meters BROADCASTING HOUSE, BERLIN, GERMANY 1:30-3:30 a.m. |
| 21420 kc. WKK -C- 14.01 meters AMER. TEL. & TEL. CO., LAWRENCEVILLE, N. J. Calls S. America 8 a.m.-4 p.m. | 19355 kc. FTM -C- 15.50 meters ST. ASSISE, FRANCE Calls Argentina, mornings | 18135 kc. PMC -C- 16.54 meters BANDONG, JAVA Phones Holland, early a.m. | 17080 kc. GBC -C- 17.56 meters RUGBY, ENGLAND Calls Ships | 15330kc. ★W2XAD -B- 19.56 meters GENERAL ELECTRIC CO. SCHENECTADY, N. Y. Relays WGY 10 a.m.-2 p.m. |
| 21080 kc. PSA -C- 14.23 meters RIO DE JANEIRO, BRAZIL Works WKK Daytime | 19345 kc. PMA -B-C- 15.51 meters BANDONG, JAVA Calls Holland early a.m. Broadcasts Tues., Thur., Sat., 10:00-10:30 a.m. Irregular | 18115 kc. LSY3 -C- 16.56 meters MONTE GRANDE, ARGENTINA Tests irregularly | 16270 kc. WLK -C- 18.44 meters LAWRENCEVILLE, N. J. Arg., Braz., Peru, daytime | 15310 kc. ★GSP -B- 19.6 meters DAVENTRY B.B.C., BROADCASTING HOUSE, LONDON, ENGLAND 6-8 p.m. |
| 21060 kc. WKA -C- 14.25 meters LAWRENCEVILLE, N. J. Calls England noon | 19260 kc. PPU -C- 15.58 meters RIO DE JANEIRO, BRAZIL Works with France mornings | 18040 kc. GAB -C- 16.63 meters RUGBY, ENGLAND Calls Canada, morn. and early aftn. | 16270 kc. WOG -C- 18.44 meters OCEAN GATE, N. J. Calls England, morning and early afternoon | 15290 kc. LRU -B- 19.62 meters "EL MUNDO" BUENOS AIRES, ARGEN- TINA, S. A. Broadcasts 7:30, 11-11:30 a.m. and around 4 p.m. |
| 21020 kc. LSN6 -C- 14.27 meters HURLINGHAM, ARG. Calls N. Y. C. 8 a.m.-5 p.m. | 19220 kc. WKF -C- 15.60 meters LAWRENCEVILLE, N. J. Calls England, daytime | 17810 kc. PCV -C- 16.84 meters KOOTWIK, HOLLAND Calls Java, 6-9 a.m. | 16240 kc. KTO -C- 18.47 meters MANILA, P. I. Calls Cal., Tokio and ships 8-11:30 a.m. | 15280 kc. DJQ -B- 19.63 meters BROADCASTING HOUSE BERLIN, GERMANY 12:30-7 a.m. |
| 20860 kc. EHY-EDM -C- 14.38 meters MADRID, SPAIN Works S. America, mornings. | 19200 kc. ORG -C- 15.62 meters RUYSELEDE, BELGIUM Works with OPL mornings | 17790 kc. ★GSG -B- 16.86 meters DAVENTRY, B.B.C., BROADCASTING HOUSE, LONDON, ENGLAND 6:8:45 a.m., 9 a.m.-12 n., 3:40-5:45 p.m. | 16233 kc. FZR3 -C- 18.48 meters SAIGON, INDO-CHINA Calls Paris and Pacific Isles | 15270 kc. ★W2XE -B- 19.65 meters ATLANTIC BROADCASTING CORP. 485 Madison Ave., N.Y.C. Relays WABC daily, 12 n.-4 p.m. |
| 20700 kc. LSY -C- 14.49 meters MONTE GRANDE ARGENTINA Tests irregularly | 19160 kc. GAP -C- 15.66 meters RUGBY, ENGLAND Calls Australia, early a.m. | 17780 kc. ★W3XAL -B- 16.87 meters NATIONAL BROAD. CO. BOUND BROOK, N. J. Relays WJ2, Daily exc. Sun. 8 a.m.-4 p.m. | 15880 kc. FTK -C- 18.90 meters ST. ASSISE, FRANCE Phones Saigon, morning | 15260 kc. GSI -B- 19.66 meters DAVENTRY, B.B.C., BROADCASTING HOUSE, LONDON, ENGLAND 12:15-3:30 p.m. |
| 20380 kc. GAA -C- 14.72 meters RUGBY, ENGLAND Calls Argentina, Brazil, mornings | 18970 kc. GAQ -C- 15.81 meters RUGBY, ENGLAND Calls S. Africa, mornings | 17775 kc. ★PHI -B- 16.88 meters HUIZEN, HOLLAND 7:30-9:30 a.m., daily except Tue. and Wed., 1-2 p.m. Sun. | 15865 kc. CEC -C- 18.91 meters SANTIAGO, CHILE Works other S.A. stations afternoons | 15252 kc. RIM -C- 19.67 meters TACKENT, U.S.S.R. Phones RK1 Near 7 a.m. |
| | 18890 kc. ZSS -C- 15.88 meters KLIPHEUVEL, S. AFRICA Works Rugby 6:30 a.m.-12 n | 17760 kc. ★W2XE -B- 16.89 meters ATLANTIC BROADCASTING CORP. 485 Madison Ave., N.Y.C. | 15810 kc. LSL -C- 18.98 meters HURLINGHAM, ARGENTINA Calls Brazil and Europe, daytime | 15250 kc. W1XAL -B- 19.67 meters BOSTON, MASS. Irregular, in morning |

(All Schedules Eastern Standard Time)

| | | | | |
|--|--|---|---|--|
| <p>15245 kc. ★TPA2 -B- 19.88 meters "RADIO COLONIAL" PARIS, FRANCE Service de la Radiodiffusion 98, bis, Blvd. Haussmann 4.55-10 a.m.</p> | <p>14640 kc. TYF -C- 20.49 meters PARIS, FRANCE Works Saigon and Cairo 3-7 a.m., 12 n.-2:30 p.m.</p> | <p>13390 kc. WMA -C- 22.40 meters LAWRENCEVILLE, N. J. Phones England morning and afternoon</p> | <p>11870 kc. ★W8XK -B- 25.26 meters WESTINGHOUSE ELECTRIC & MFG. CO. PITTSBURGH, PA. 5-10:30 p.m. Fri. till 12 m Relays KDKA</p> | <p>11413 kc. CJA4 -C- 26.28 meters DRUMMONDVILLE, QUE., CAN. Tests with Australia irregularly in evening</p> |
| <p>15220 kc. ★PCJ -B- 19.71 meters N.V. PHILIPS' RADIO EINDHOVEN, HOLLAND Tues. 4-6 a.m. Wed. 7-11 a.m. Sun. 6:30-7:30 a.m.</p> | <p>14600 kc. JVH -B-C- 20.55 meters. NAZAKI, JAPAN Phones Europe 4-8 a.m. Broadcasts 12 m-1 a.m. Tues. and Fri. 2-3 p.m. Mon. and Thurs. 4-5 p.m.</p> | <p>13380 kc. IDU -C- 22.42 meters ASMARA, ERITREA, AFRICA Works with Rome daytime</p> | <p>11860 kc. YDB -B- 25.29 meters N.I.R.O.M., SOERABAJA, JAVA Sat. 7 p.m.-1:30 a.m. (Sun.) Daily 10:30 p.m.-1:30 a.m.</p> | <p>11200 kc. XBJQ -X- 26.79 meters BOX 2825, MEXICO CITY, MEX. Irregular</p> |
| <p>15210 kc. ★W8XK -B- 19.72 meters WESTINGHOUSE ELECTRIC & MFG. CO. PITTSBURGH, PA. 9 a.m.-7 p.m. Relays KDKA</p> | <p>14590 kc. WMN -C- 20.58 meters LAWRENCEVILLE, N. J. Phones England morning and afternoon</p> | <p>13345 kc. YVQ -C- 22.48 meters MARACAY, VENEZUELA Calle Hialeah daytime</p> | <p>11860 kc. GSE -B- 25.29 meters DAVENTRY B.B.C., BROADCASTING HOUSE, LONDON, ENGLAND</p> | <p>11050 kc. ZLT4 -C- 27.15 meters WELLINGTON, N. ZEALAND Phones Australia and England early a.m.</p> |
| <p>15200 kc. ★DJB -B- 19.74 meters BROADCASTING HOUSE BERLIN, GERMANY 3:50-11 a.m., 4:50-10:55 p.m. Sun also 11 a.m.-12 n.</p> | <p>14535 kc. HBJ -B- 20.64 meters RADIO NATIONS, GENEVA, SWITZERLAND Broadcasts irregularly</p> | <p>13285 kc. CGA3 -C- 22.58 meters DRUMMONDVILLE, QUE., CAN. Works London and Ships afternoons</p> | <p>11855 kc. DJP -B-X- 25-31 meters BROADCASTING HOUSE, BERLIN, GERMANY 12 n.-2 p.m.</p> | <p>11000 kc. PLP -B-C- 27.27 meters BANDENG, JAVA Broadcasts Sat. 7 p.m.-1:30 a.m., Sun. 5:30-10 a.m., Also 2-7 a.m. daily</p> |
| <p>15180 kc. ★GSO -B- 19.76 meters DAVENTRY B.B.C., BROADCASTING HOUSE, LONDON, ENGLAND 3:40-5:45 p.m.</p> | <p>14500 kc. LSM2 -C- 20.89 meters HURLINGHAM, ARGENTINA Calls Rio and Europe daytime</p> | <p>13075 kc. VPD -X- 22.94 meters SUVA, FIJI ISLANDS Daily exc. Sun. 12:30-1:30 a.m.</p> | <p>11830 kc. W9XAA -B- 25.36 meters CHICAGO FEDERATION OF LABOR CHICAGO, ILL. Relays WCFL 6:30 a.m.-4 p.m., 9 p.m.-12 m.</p> | <p>10970 kc. OCI -C- 27.35 meters LIMA, PERU Works with Bogota, Col., evenings</p> |
| <p>15180 kc. RW96 -B- 19.76 meters MOSCOW, U.S.S.R. Sun. 1-2 p.m.</p> | <p>14450 kc. LSN -C- 20.85 meters HURLINGHAM, ARGENTINA Calle N.Y.C. afternoon</p> | <p>12840 kc. WOO -C- 23.36 meters OCEAN GATE, N. J. Calls ships</p> | <p>11830 kc. ★W2XE -B- 25.36 meters ATLANTIC BROADCASTING CORP. 485 MADISON AVE., N. Y. C. Relays WABC 4-9 p.m.</p> | <p>10955 kc. HS8PJ -B-X- 27.38 meters BANGKOK, SIAM Broadcasts 8-10:15 a.m. Mondays</p> |
| <p>15140 kc. ★GSF -B- 19.82 meters DAVENTRY B.B.C., BROADCASTING HOUSE, LONDON, ENGLAND 9 a.m.-12 n., 3:40-5:45, 6-8, 9-11 p.m.</p> | <p>14485 kc. TIR -C- 20.71 meters CARTAGO, COSTA RICA Phones Cen. Amer. & U.S.A. Daytime</p> | <p>12825 kc. CNR -B-C- 23.59 meters DIRECTOR GENERAL Telegraph and Telephone Stations, Rabat, Morocco Broadcasts, Sunday, 7:30-9 a. m.</p> | <p>11820 kc. GSN -B- 25.38 meters DAVENTRY B.B.C., BROADCASTING HOUSE, LONDON, ENGLAND 12:15-2:15 a.m., irregular</p> | <p>10840 kc. KWV -C- 27.68 meters DIXON, CAL. Works with Hawaii evenings.</p> |
| <p>15120 kc. HVJ -B- 19.83 meters VATICAN CITY 10:30 to 10:45 a.m., except Sunday Sat. 10-10:45 a.m.</p> | <p>14485 kc. HPF -C- 20.71 meters PANAMA CITY, PAN. Phones WNC daytime</p> | <p>12800 kc. IAC -C- 23.45 meters PISA, ITALY Calls Italian ships, mornings</p> | <p>11820 kc. GSN -B- 25.38 meters DAVENTRY B.B.C., BROADCASTING HOUSE, LONDON, ENGLAND 12:15-2:15 a.m., irregular</p> | <p>10770 kc. GBP -C- 27.85 meters RUGBY, ENGLAND Calls Sydney, Austral. early a. m.</p> |
| <p>15110 kc. DJL -B-X- 19.85 meters BROADCASTING HOUSE, BERLIN, GERMANY 5:45-7:30 a.m.</p> | <p>14485 kc. TGF -C- 20.71 meters GUATEMALA CITY, GUAT. Phones WNC daytime</p> | <p>12780 kc. GBC -C- 23.47 meters RUGBY, ENGLAND Calls ships</p> | <p>11810 kc. ★HJ4BA -B- 25.4 meters P. O. BOX 50, MEDELLIN, COLOMBIA 11:30 a.m.-1 p.m., 6:30-10:30 p.m.</p> | <p>10740 kc. ★JVM -B-C- 27.93 meters NAZAKI, JAPAN Broadcasts Tues. and Fri. 2-3 p.m., Phones U.S. 2-7 a.m.</p> |
| <p>15090 kc. RKI -B, C- 19.88 meters MOSCOW, U.S.S.R. Phones Tashkent near 7 a.m. and relays RNE on Sundays 10-11 a.m.</p> | <p>14485 kc. HRF -C- 20.71 meters TEGUCIGALPA, HONDURAS Works WNC daytime</p> | <p>12780 kc. GBC -C- 23.47 meters RUGBY, ENGLAND Calls ships</p> | <p>11810 kc. ★2RO -B- 25.4 meters E. I. A. R. Via Montello 5 ROME, ITALY 6:15-9 a.m., 9:15-11 a.m., 11:30 a.m.-12:15 p.m., 1:30-5 p.m.</p> | <p>10675 kc. WNB -C- 28.1 meters LAWRENCEVILLE, N. J. Calls Bermuda, daytime</p> |
| <p>15070 kc. PSD -C- 19.91 meters RIO DE JANEIRO, BRAZIL Calls N.Y., Buenos Aires and Europe, daytime</p> | <p>14485 kc. HRL5 -C- 20.71 meters NACAOME, HONDURAS Works WNC daytime</p> | <p>12290 kc. GBU -C- 24.41 meters RUGBY, ENGLAND Calls N.Y.C., afternoon</p> | <p>11795 kc. DJO -B-X- 25.43 meters BROADCASTING HOUSE, BERLIN, GERMANY 3-4:55 p.m.</p> | <p>10660 kc. ★JVN -B-C- 28.14 meters NAZAKI, JAPAN Phones Europe 3-8 a.m. Broadcasts daily 12 m-1 a.m., 2-8 a.m. Mon. and Thurs. 4-5 p.m.</p> |
| <p>15055 kc. WNC -C- 19.92 meters HIALEAH, FLORIDA Calls Central America, daytime</p> | <p>14485 kc. HRF -C- 20.71 meters TEGUCIGALPA, HONDURAS Works WNC daytime</p> | <p>12250 kc. TYB -C- 24.49 meters PARIS, FRANCE Irregular</p> | <p>11790 kc. W1XAL -B- 25.45 meters BOSTON, MASS. Daily 5:15-6:15 p.m. Sun. 5-7 p.m.</p> | <p>10550 kc. WOK -C- 28.44 meters LAWRENCEVILLE, N. J. Phones Argo., Braz., Peru, nights</p> |
| <p>14980 kc. KAY -C- 20.03 meters MANILA, P. I. Phones Pasife Isles</p> | <p>14470 kc. WMF -C- 20.73 meters LAWRENCEVILLE, N. J. Phones England morning and afternoon</p> | <p>12235 kc. TFJ -B-C- 24.52 meters REYKJAVIK, ICELAND Phones England mornings, Broadcasts Sun. 1:40-2:30 p.m.</p> | <p>11770 kc. ★DJD -B- 25.49 meters BROADCASTING HOUSE, BERLIN, GERMANY 11:35 a.m.-4:20 p.m.; 4:50- 10:55 p.m.</p> | <p>10520 kc. VLK -C- 28.51 meters SYDNEY, AUSTRALIA Calls Rugby, early a.m.</p> |
| <p>14970 kc. LZA -B-C- 20.04 meters SOFIA, BULGARIA Broadcasts irregularly 3:30-11:30 a.m., 2-4:30 p.m. on Sundays</p> | <p>14440 kc. GBW -C- 20.78 meters RUGBY, ENGLAND Calls U.S.A., afternoon</p> | <p>12215 kc. TYA -C- 24.56 meters PARIS, FRANCE Works French Ships in morning and afternoon</p> | <p>11750 kc. ★GSD -B- 25.53 meters DAVENTRY B.B.C., BROADCASTING HOUSE, LONDON, ENGLAND 12:15-3:25 p.m., 9-11 p.m., 12:15-2:15 a.m.</p> | <p>10430 kc. YBG -C- 28.76 meters MEDAN, SUMATRA 5:30-6:30 a. m., 7:30-8:30 p. m.</p> |
| <p>14960 kc. PSF -C- 20.43 meters RIO DE JANEIRO, BRAZIL Works with Buenos Aires daytime</p> | <p>14440 kc. GBW -C- 20.78 meters RUGBY, ENGLAND Calls U.S.A., afternoon</p> | <p>12150 kc. GBS -C- 24.89 meters RUGBY, ENGLAND Calls N.Y.C., afternoon</p> | <p>11730 kc. PHI -B- 25.57 meters HUIZEN, HOLLAND Irregular</p> | <p>10420 kc. XGW -C- 28.79 meters SHANGHAI, CHINA Calls Manila and England, 9-9 a. m. and California late evening</p> |
| <p>14950 kc. HJB -C- 20.07 meters BOGOTA, COL. Calls WNC, daytime</p> | <p>14440 kc. GBW -C- 20.78 meters RUGBY, ENGLAND Calls U.S.A., afternoon</p> | <p>12130 kc. DZE -C-X- 24.73 meters REICHSPOSTZENSTRALAMT, ZEESEN, GERMANY Works phone and tests irregularly</p> | <p>11720 kc. ★CJRJ -B- 25.6 meters WINNIPEG, CANADA Daily, 8 p. m.-12 m.</p> | <p>10410 kc. PDK -C- 28.80 meters KOOTWIJK, HOLLAND Calls Java 7:30-9:40 a. m.</p> |
| <p>14940 kc. HII -C- 20.08 meters CIUDAD TRUJILLO, D.R. Phones WNC daytime</p> | <p>14440 kc. GBW -C- 20.78 meters RUGBY, ENGLAND Calls U.S.A., afternoon</p> | <p>12100 kc. RNE -B- 25 meters MOSCOW, U. S. S. R. Sun. 6-9, 10-11 a. m., 12:30- 6 p.m. Wed. 6-7 a.m. Daily 12:30-6 p.m.</p> | <p>11715 kc. ★TPA4 -B- 25.61 meters "RADIO COLONIAL" PARIS, FRANCE 5:15-9:15 p.m. 9:45 p.m.-12 m.</p> | <p>10410 kc. KES -X- 28.80 meters BOLINAS, CALIF. Tests evenings</p> |
| <p>14940 kc. HJA3 -C- 20.08 meters BARRANQUILLA, COL. Works WNC daytime</p> | <p>14440 kc. GBW -C- 20.78 meters RUGBY, ENGLAND Calls U.S.A., afternoon</p> | <p>12060 kc. PDV -C- 24.88 meters KOOTWIJK, HOLLAND Tests irregular</p> | <p>11700 kc. KIO -X- 25.68 meters KAHUKU, HAWAII Tests in the evening</p> | <p>10350 kc. LSX -C- 28.98 meters MONTE GRANDE, ARGENTINA Tests irregularly 8 p.m.-12 mid- night.</p> |
| <p>14845 kc. OCJ2 -C- 20.21 meters LIMA, PERU Works other S.A. stations daytime</p> | <p>14440 kc. GBW -C- 20.78 meters RUGBY, ENGLAND Calls U.S.A., afternoon</p> | <p>12000 kc. RNE -B- 25 meters MOSCOW, U. S. S. R. Sun. 6-9, 10-11 a. m., 12:30- 6 p.m. Wed. 6-7 a.m. Daily 12:30-6 p.m.</p> | <p>11680 kc. KIO -X- 25.68 meters KAHUKU, HAWAII Tests in the evening</p> | <p>10330 kc. ORK -B-C- 29.04 meters RUYSELEDE, BELGIUM Broadcasts 1:30-3 p.m.</p> |
| <p>14653 kc. GBL -C- 20.47 meters RUGBY, ENGLAND Works JVH 1-7 a.m.</p> | <p>14440 kc. GBW -C- 20.78 meters RUGBY, ENGLAND Calls U.S.A., afternoon</p> | <p>11990 kc. FZS2 -C- 25.02 meters SAIGON, INDO-CHINA Phones Paris, morning</p> | <p>11595 kc. VRR4 -C- 25.87 meters STONY HILL, JAMAICA, B.W.I. Works WNC daytime.</p> | <p>10300 kc. LSL2 -C- 29.13 meters HURLINGHAM, ARGENTINA Calls Europe, evenings</p> |
| | <p>14440 kc. GBW -C- 20.78 meters RUGBY, ENGLAND Calls U.S.A., afternoon</p> | <p>11950 kc. KKQ -X- 25.10 meters BOLINAS, CALIF. Tests, irregularly, evenings</p> | <p>11560 kc. VIZ3 -X- 25.95 meters AMALGAMATED WIRELESS OF AUSTRALASIA FISKVILLE, AUSTRALIA Calls Canada evening and early a.m.</p> | <p>10290 kc. DZC -X- 29.18 meters REICHSPOSTZENSTRALA ZEESEN, GERMANY Broadcasts irregularly</p> |

(All Schedules Eastern Standard Time)

| | | | | |
|--|--|---|---|--|
| <p>10260 kc. PMN -B-C- 28.74 meters BANDOENG, JAVA Calls Australia 5 a.m. Broadcasts Sat. 7 p.m.-1:30 a.m., Sun. 5:30-10 a.m.</p> <p>10250 kc. LSK3 -C- 28.27 meters HURLINGHAM, ARGENTINA Calls Europe and U. S., afternoon and evening</p> <p>10220 kc. PSH -C- 29.35 meters RIO DE JANEIRO, BRAZIL</p> <p>10170 kc. RIO -C- 29.5 meters BAKOU, U.S.S.R. Works with Moscow 10 p.m.-5 a.m.</p> <p>10169 kc. HSJ -CX- 29.5 meters BANGKOK, SIAM Tests 9-10 a.m., Mon., Wed., Thur.</p> <p>10140 kc. OPM -C- 29.59 meters LEOPOLDVILLE, BELGIAN CONGO Phones around 3 a.m. and 1-4 p.m.</p> <p>10080 kc. RIR -C- 29.76 meters TIFLIS, U.S.S.R. Works with Moscow early morning.</p> <p>10070 kc. EDM-EHY -C- 29.79 meters MADRID, SPAIN Works with S. America evenings</p> <p>10055 kc. ZFB -C- 29.84 meters HAMILTON, BERMUDA Phones N. Y. C. daytime</p> <p>10055 kc. SUV -C- 29.84 meters ABOU ZABAL, EGYPT Works with Europe 1-6 p.m.</p> <p>10042 kc. DZB -X- 29.87 meters ZEESEN, GERMANY Works with Central America and tests 7-9 p.m.</p> <p>9990 kc. KAZ -C- 30.03 meters MANILLA, P.I. Works with Java, Cal. and ships early morning</p> <p>9950 kc. GCU -C- 30.15 meters RUGBY, ENGLAND Calls N.Y.C. evening</p> <p>9930 kc. HKB -C- 30.21 meters BOGOTA, COL. Phones Rio de Janeiro evenings</p> <p>9890 kc. LSN -C- 30.33 meters HURLINGHAM, ARGENTINA Calls New York, evenings</p> <p>9870 kc. WON -C- 30.4 meters LAWRENCEVILLE, N. J. Phones England, evening</p> <p>9860 kc. ★EAQ -B- 30.43 meters P. O. Box 951 MADRID, SPAIN Daily 5:15-9:30 p.m.; Saturday also 12 n.-2 p.m.</p> <p>9840 kc. JYS -X- 30.49 meters KEMIKAWA-CHO, CHIBAKEN, JAPAN Irregular, 11:30 p.m.-3 a.m.</p> <p>9800 kc. LSI -O- 30.81 meters MONTE GRANDE, ARGENTINA Tests Irregularly</p> <p>9790 kc. GCW -C- 30.64 meters RUGBY, ENGLAND Calls N.Y.C., evening</p> <p>9760 kc. VLJ-VLZ2 -C- 30.74 meters AMALGAMATED WIRELESS OF AUSTRALIA SYDNEY, AUSTRALIA Phones Java and N. Zealand early a.m.</p> <p>9750 kc. WOF -C- 30.77 meters LAWRENCEVILLE, N. J. Phones England, evening</p> <p>9710 kc. GCA -C- 30.89 meters RUGBY, ENGLAND Calls Arge. & Brazil, evenings</p> | <p>9675 kc. DZA -C- 31.01 meters ZEESEN, GERMANY Works with Africa and broadcasts 5-7 p.m.</p> <p>9660 kc. CQN -B- 31.07 meters MACAO, PORTUGUESE CHINA Mon. and Fri. 7-8:30 a.m.</p> <p>9650 kc. YDB -B- 31.09 meters N.I.R.O.M. SOERABAJA, JAVA 4:30-10 a.m.</p> <p>9650 kc. ★CT1AA -B- 31.09 meters "RADIO COLONIAL" LISBON, PORTUGAL Tues., Thurs., Sat. 3-6 p.m.</p> <p>9650 kc. DGU -C- 31.09 meters NAUEN, GERMANY Works with Egypt in afternoon</p> <p>9645 kc. YNLF -B- 31.1 meters MANAGUA, NICARAGUA 8-9 a.m., 12:30-2:30, 6:30-10 p.m.</p> <p>9640 kc. LRX -B- 31.12 meters "EL MUNDO" BUENOS AIRES, ARGENTINA Testing</p> <p>9635 kc. ★2RO -B- 31.13 meters E.I.A.R., ROME, ITALY M., W., F., 6-7:30 p.m. Tues., Thurs., Sat. 6-7:45 p.m.</p> <p>9615 kc. HJ1ABP -B- 31.2 meters P.O. BOX 37, CARTAGENA, COL. 11 a.m.-1 p.m. 5-11 p.m. Sun. 10 a.m.-1 p.m., 3-6 p.m.</p> <p>9605 kc. HP5J -B- 31.24 meters APARTADO 867, PANAMA CITY, PANAMA 11:45 a.m.-1 p.m., 7:30-10 p.m.</p> <p>9600 kc. CB960 -B- 31.25 meters SANTIAGO, CHILE 9:30 p.m. on</p> <p>9595 kc. ★HBL -B- 31.27 meters LEAGUE OF NATIONS GENEVA, SWITZERLAND Saturdays, 5:30-6:15 p. m. Mon. at 1:45 a.m.</p> <p>9595 kc. HH3W -B- 31.27 meters P.O. BOX A117, PORT-AU-PRINCE, HAITI 1-2, 7-8:30 p.m.</p> <p>9590 kc. ★PCJ -B- 31.28 meters N. V. PHILIPS RADIO EINDHOVEN, HOLLAND Sun. 7-8 p.m. Wed 7-10 p.m.</p> <p>9590 kc. ★VK2ME -B- 31.28 meters AMALGAMATED WIRELESS, LTD., 47 YORK ST. SYDNEY, AUSTRALIA Sun. 12 m.-2 a.m., 4:30-8:30 a.m. 10:30 a.m.-12:30 p.m.</p> <p>9590 kc. ★W3XAU -B- 31.28 meters PHILADELPHIA, PA. Relays WCAU Daily 11 a.m.-7 p.m.</p> <p>9580 kc. ★GSC -B- 31.32 meters DAVENTRY, B.B.C., BROADCASTING HOUSE, LONDON, ENGLAND 6-8, 9-11 p.m.</p> <p>9580 kc. ★VK3LR -B- 31.32 meters Research Section, Postmaster Gen'l's Dept., 81 Little Collins St., MELBOURNE, AUSTRALIA 3:15-7:30 a.m., except Sun. also Fr. 10 p.m.-2 a.m.</p> <p>9570 kc. ★W1XK -B- 31.35 meters WESTINGHOUSE ELECTRIC & MFG. CO. SPRINGFIELD, MASS. Relays WBZ, 6 a.m.-12 m. Sun 7 a.m.-12 m.</p> <p>9565 kc. VUB -B- 31.36 meters BOMBAY, INDIA 11 a.m.-12:30 p.m., Wed., Thurs., Sat.</p> | <p>9560 kc. ★DJA -B- 31.36 meters BROADCASTING HOUSE, BERLIN 12:30-3, 8:05-11 a.m., 4:50-10:45 p.m.</p> <p>9550 kc. HJ1ABE -B- 31.41 meters P.O. BOX 31, CARTAGENA, COLOMBIA Daily 7:30-9 p.m., Mon. also 10 p.m.-12 m.</p> <p>9540 kc. ★DJN -B- 31.45 meters BROADCASTING HOUSE BERLIN, GERMANY 12:30-3:50, 8:05-11 a.m., 4:50-10:45 p.m.</p> <p>9530 kc. ★W2XAF -B- 31.48 meters GENERAL ELECTRIC CO. SCHENECTADY, N. Y. Relays WGY 4 p.m.-12 m. Sat. 12 n.-12 m.</p> <p>9525 kc. LKJ1 -B- 31.49 meters JELOY, NORWAY 5-8 a.m., 11 a.m.-8 p.m.</p> <p>9520 kc. RW96 -B- 31.51 meters MOSCOW, U.S.S.R. Daily 7:30 p.m. Sun., Wed. and Fri. 6-8 p.m.</p> <p>9510 kc. ★VK3ME -B- 31.55 meters AMALGAMATED WIRELESS, 167 Queen St., MELBOURNE, AUSTRALIA Daily exs. Sun. 4-7 a.m.</p> <p>9510 kc. ★GSB -B- 31.55 meters DAVENTRY, B.B.C., BROADCASTING HOUSE, LONDON, ENGLAND 12:15-2:15 a.m., 12:15-5:45 p.m.</p> <p>9500 kc. HJU -B- 31.58 meters NATIONAL RAILWAYS BUENAVENTURA, COLOMBIA Mon., Wed., Fri. 8-11 p.m.</p> <p>9500 kc. PRF5 -B- 31.58 meters RIO DE JANEIRO, BRAZIL Irregularly 4:45-5:45 p.m.</p> <p>9490 kc. XGOX -B- 31.61 meters NANKING, CHINA 6:30-8:40 a.m., Sun. 7:30-9:30 a.m.</p> <p>9450 kc. TGW -B- 31.75 meters MINISTRE DE FOMENTO GUATEMALA CITY, GUATEMALA Daily 11 a.m.-1 p.m., 7-8, 9-11 p.m., Sat. 9 p.m.-5 a.m. (Sun.)</p> <p>9428 kc. ★COCH -B- 31.8 meters 2 B ST., VEDADO, HAVANA, CUBA Daily 8 a.m.-7 p.m., Sun 11 a.m.-12 n., 8:30-9:30 p.m.</p> <p>9415 kc. PLV -C- 31.87 meters BANDOENG, JAVA Phones Holland around 9:45 a.m.</p> <p>9330 kc. CGA4 -C- 32.15 meters DRUMMONDVILLE, CANADA Phones England Irregularly</p> <p>9280 kc. GCB -C- 32.33 meters RUGBY, ENGLAND Calls Can. & Egypt, evenings</p> <p>9170 kc. WNA -C- 32.72 meters LAWRENCEVILLE, N. J. Phones England, evening</p> <p>9150 kc. YVR -C- 32.79 meters MARACAY, VENEZUELA Works with Europe afternoons.</p> <p>9125 kc. ★HAT4 -B- 32.88 meters "RADIOLABOR," GYALI-UT, 22, BUDAPEST, HUNGARY Sunday 6-7 p.m.</p> <p>9060 kc. TFK -C- 33.11 meters REYKJAVIK, ICELAND Phones London afternoons. Broadcasts Irregularly.</p> | <p>9020 kc. GCS -C- 33.28 meters RUGBY, ENGLAND Calls N.Y.C., evenings</p> <p>9010 kc. KEJ -C- 33.3 meters BOLINAS, CAL. Relays NBC & CBS Programs in evening Irregularly</p> <p>8975 kc. VWY -C- 33.43 meters KIRKEE, INDIA Works with England in morning</p> <p>8795 kc. HKV -B- 34.09 meters BOGOTA, COLOMBIA Irregular; 6:30 p.m.-12 m.</p> <p>8775 kc. PNI -C- 34.19 meters MAKASSER, CELEBES, N.I. Phones Java around 4 a. m.</p> <p>8765 kc. DAF -C- 34.23 meters NORDEICH, GERMANY Works German Ships Irregularly</p> <p>8760 kc. GCQ -C- 34.25 meters RUGBY, ENGLAND Calls S. Africa, afternoon</p> <p>8750 kc. ZCK -B- 34.29 meters HONGKONG, CHINA Relays ZBW Daily 11:30 p.m.-1:15 a.m. Mon. and Thurs. 3-7 a.m. Tues., Wed., Fri. 6-10 a.m. Sat. 6-11 a.m.</p> <p>8730 kc. GCI -C- 34.36 meters RUGBY, ENGLAND Calls India, 8 a. m.</p> <p>8680 kc. GBC -C- 34.56 meters RUGBY, ENGLAND Calls ships</p> <p>8665 kc. CO9JQ -X- 34.62 meters 4 GENERAL GOMEZ CAMAGUEY, CUBA 5:30-6:30, 8-9 p.m. daily except Sat. and Sun.</p> <p>8590 kc. YNVA -B- 34.92 meters MANAGUA, NICARAGUA 7:30-9:30 p. m.</p> <p>8560 kc. WOO -C- 35.05 meters OCEAN GATE, N. J. Calls ships Irregular</p> <p>8400 kc. HC2AT -B- 35.71 meters CASSILLA 877 GUAYAQUIL, ECUADOR 8-11 p.m.</p> <p>8380 kc. IAC -C- 35.9 meters Pisa, Italy</p> <p>8214 kc. HCJB -B- 36.5 meters QUITO, ECUADOR 7-11 p.m., except Monday Sun. 11 a.m.-12 n.; 4-10 p.m.</p> <p>8190 kc. XEME -B- 36.63 meters CALLE 59, No. 517 MERIDA, YUCATAN "LA VOZ de YUCATAN desde MERIDA" 10 a.m.-12 n., 6 p.m.-12 m.</p> <p>8185 kc. PSK -C- 36.85 meters RIO DE JANEIRO, BRAZIL Irregularly</p> <p>8036 kc. CNR -B- 37.33 meters RABAT, MOROCCO Sunday, 2:30-5 p. m.</p> <p>7975 kc. HC2TC -B- 37.62 meters QUITO, ECUADOR Thurs., Sun. at 8 p.m.</p> <p>7901 kc. LSL -C- 37.97 meters HURLINGHAM, ARGENTINA Calls Brazil, night</p> <p>7880 kc. JYR -B- 38.07 meters KEMIKAWA-CHO, CHIBAKEN, JAPAN 4-7:40 a. m.</p> <p>7860 kc. SUX -C- 38.17 meters ABOU ZABAL, EGYPT Works with Europe 4-6 p.m.</p> <p>7854 kc. HC2JSB -B- 38.2 meters GUAYAQUIL, ECUADOR 8:15-11:15 p.m.</p> | <p>7799 kc. ★HBP -B- 38.47 meters LEAGUE OF NATIONS, GENEVA, SWITZERLAND 5:30-6:15 p. m., Saturday</p> <p>7715 kc. KEE -C- 38.89 meters BOLINAS, CAL. Relays NBC & CBS Programs in evening Irregularly</p> <p>7630 kc. ZHJ -B- 39.32 meters PENANG, MALAYA Daily 7-9 a.m. also Sat. 11 p.m.-1 A.M. (Sun.)</p> <p>7626 kc. RIM -C- 39.34 meters TACHENT, U.S.S.R. Works with Moscow early morning</p> <p>7610 kc. KWX -C- 39.42 meters DIXON, CAL. Works with Hawaii, Philip- pines, Java and Japan nights.</p> <p>7550 kc. T18WS -B- 39.74 meters "ECOS DEL PACIFICO" P. O. BOX 75 PUNTA ARENAS, COSTA RICA 6 p.m.-12 m.</p> <p>7520 kc. KKH -C- 39.89 meters KAHUKU, HAWAII Works with Dixon and broad- casts Irregularly nights</p> <p>7510 kc. JVP -B.C- 39.95 meters NAZAKI, JAPAN</p> <p>7500 kc. RKI -C- 40 meters MOSCOW, U.S.S.R. Works RIM early a.m.</p> <p>7390 kc. ZLT2 -C- 40.6 meters WELLINGTON, N.Z. Works with Sydney 3-7 a.m.</p> <p>7380 kc. XECR -B- 40.65 meters FOREIGN OFFICE, MEXICO CITY, MEX. Sun. 6-7 p.m.</p> <p>7281 kc. HJ1ABD -B- 41.04 meters CARTAGENA, COLO. Irregularly, evenings</p> <p>7100 kc. HKE -B- 42.25 meters BOGOTA, COL., S. A. Tue. and Sat. 8-9 p. m.; Mon. & Thurs. 6:30-7 p. m.</p> <p>7080 kc. VP3MR -B- 42.68 meters GEORGETOWN, BRI. GUI- ANA, S.A. Sun. 7:45-10:15 a.m. Daily 4:45-8:45 p.m.</p> <p>7074 kc. HJ1ABK -B- 42.89 meters CALLE BOLIVIA, PROGRESO-IGUALDAD BARRANQUILLA, COLOMBIA Sun. 3-6 p.m.</p> <p>7030 kc. HRP1 -B- 42.67 meters SAN PEDRO SULA, HONDURAS Reported on this and other waves Irregularly in evening</p> <p>6996 kc. PZH -B- 42.88 meters P. O. BOX 18, PARAMIRABO, DUTCH GUIANA Sun. 9:36-11:36 a.m. Mon. and Fri. 5:36-9:36 p.m., Tues. and Thur. 8:36-10:36 a.m., Wed. 2:36-4:36 p.m., Sat. 2:36-4:36 p.m.</p> <p>6976 kc. HCETC -B- 43 meters TEATRO BOLIVAR QUITO, ECUADOR Thurs. till 9:30 p.m.</p> <p>6905 kc. GDS -C- 43.45 meters RUGBY, ENGLAND Calls N.Y.C. evening</p> <p>6860 kc. KEL -X- 43.70 meters BOLINAS, CALIF. Tests Irregularly 11 a. m.-12 n.; 6-9 p. m.</p> <p>6850 kc. T16OW -B- 43.8 meters ONDA DEL CARIBE PUERTO LIMON, COSTA RICA Irregularly 8-9:30 p.m.</p> |
|--|--|---|---|--|

(All Schedules Eastern Standard Time)

| | | | | |
|--|---|---|---|--|
| <p>6800 kc. HI7P -B- 44.12 meters EMISORIA DIARIA de COMERCIO. CIUDAD TRUJILLO. DOM. REP. Daily exc. Sat. and Sun. 12:40-1:40. 6:40-8:40 p.m.; Sat. 12:40-1:40 p.m.; Sun. 10:40 a.m.-11:40 a.m.</p> | <p>6420 kc. HI1S -B- 46.73 meters PUERTO PLATA. DOM. REP. 11:40 a.m.-1:40 p.m., 5:40-7:40. 9:40-11:40 p.m.</p> | <p>6135 kc. HI5N -B- 48.9 meters SANTIAO, D.R. 6:40-9:10 p.m.</p> | <p>6090 kc. ★CRXC -B- 49.26 meters TORONTO. CANADA Daily 5:30-11:30 p.m. Sun. 11:45 a.m.-11:45 p.m.</p> | <p>6040 kc. ★W1XAL -B- 49.67 meters BOSTON. MASS. Tues., Thurs. 7:15-9:15 p.m. Sun 5-7 p.m.</p> |
| <p>6780 kc. HIH -B- 44.25 meters SAN PEDRO de MACORIS DOMINICAN REP. 12:10-1:40 p.m., 7:30-9 p.m., Sun. 3-4 a.m., 4:15-6 p.m.</p> | <p>6410 kc. TIPG -B- 46.8 meters APARTADO 225. SAN JOSE. COSTA RICA "LA VOZ DE LA VICTOR" 12 n.-2 p.m., 6-11:30 p.m.</p> | <p>6135 kc. HJ4ABP -B- 48.9 meters MEDELLIN. COL. Releys HJ4ABQ 8-11 p.m.</p> | <p>6090 kc. VE9BJ -B- 49.26 meters SAINT JOHN. N. B., CAN. 7-8:30 p.m.</p> | <p>6040 kc. YDA -B- 49.67 meters N.I.R.O.M. TANDJONGPRIK. JAVA 5:45-6:45 p.m., 10:30 p.m.-1:30 a.m.</p> |
| <p>6755 kc. WOA -C- 44.41 meters LAWRENCEVILLE. N. J. Phones England, evening</p> | <p>6400 kc. YV9RC -B- 46.88 meters CARACAS. VENEZUELA 7-11 p.m.</p> | <p>6132 kc. HIX -B- 48.93 meters CIUDAD TRUJILLO. DOMINICAN REP. Sun. 7:40-10:10; Daily 12:40-1:10 p.m., 4:40-5:40 p.m.; Tues. and Fri. 8:10-10:10 p.m.</p> | <p>6085 kc. HJ5ABD -B- 49.3 meters "LA VOZ DE VALLE" CALI. COLOMBIA 12 n.-1:30 p.m., 5:10-9:40 p.m.</p> | <p>6030 kc. ★HP5B -B- 49.75 meters P. O. BOX 910 PANAMA CITY, PAN. 12 n.-1 p.m., 7-10:30 p.m.</p> |
| <p>6750 kc. JVT -B.C- 44.44 meters NAZAKI. JAPAN KOKUSAI-DENWA KAISHA. LTD., TOKIO</p> | <p>6380 kc. YV4RC -B- 47.02 meters CARACAS. VENEZUELA 5:30-9:30 p.m.</p> | <p>6130 kc. TGXA -B- 48.94 meters GIORNAL LIBERAL PRD-GRESSISTA. GAUTEMALA CITY. GUAT. Heard in the evening.</p> | <p>6083 kc. VQ7LO -B- 49.31 meters NAIROBI. KENYA. AFRICA Mon.-Fri. 5:45-6:15 a.m., 11:30 a.m.-2:30 p.m. Also 8:30-9:30 a.m. on Tues. and Thurs.; Sat. 11:30 a.m.-3:30 p.m.; Sun. 11 a.m.-2 p.m.</p> | <p>6030 kc. VE9CA -B- 49.75 meters CALGARY. ALBERTA. CAN. Thurs. 9 a.m.-2 a.m. (Fri.); Sun. 12 n.-12 m. Irregularly on other days from 9 a.m.-12 m.</p> |
| <p>6672 kc. YVQ -C- 44.85 meters MARACAY. VENEZUELA Broadcasts Sat. 8-9 p.m.</p> | <p>6316 kc. HIZ -B- 47.5 meters CIUDAD TRUJILLO DOMINICAN REPUBLIC Daily except Sat. and Sun. 11:10 a.m.-2:25 p.m., 5:10-8:40 p.m.; Sat. 5:10-11:10 p.m.; Sun., 11:40 a.m.-1:40 p.m.</p> | <p>6130 kc. COCD -B- 48.94 meters "LA VOZ DEL AIRE" CALLE G Y 25. VEDADO. HAVANA. CUBA Releys CMCD 11 a.m.-12 n., 7-10 p.m., Sun. 12 n.-4 p.m.</p> | <p>6080 kc. CP5 -B- 49.34 meters LAPAZ. BOLIVIA 7-10:30 p.m.</p> | <p>6025 kc. HJ1ABJ -B- 49.79 meters SANTA MARTA. COLO. 6:30-10:30 p.m. except Wed.</p> |
| <p>6710 kc. ★TIEP -B- 44.71 meters LA VOZ DEL TROPICO SAN JOSE. COSTA RICA APARTADO 257. Daily 7-10 p.m.</p> | <p>6300 kc. YV12RM -B- 47.62 meters MARACAY. VENEZUELA 8-10:30 p.m.</p> | <p>6130 kc. ZGE -B- 48.94 meters KUALA LUMPUR. FED. MALAY STATES Sun., Tues. and Fri., 6:40-8:40 a.m.</p> | <p>6080 kc. HP5F -B- 49.34 meters CARLTON HOTEL COLON, PANAMA 11:45 a.m.-1:15 p.m., 7:45-10 p.m.</p> | <p>6020 kc. DJC -B- 49.83 meters BROADCASTING HOUSE. BERLIN 11:35 a.m.-4:20 p.m.</p> |
| <p>6650 kc. IAC -C- 45.11 meters PISA. ITALY Calls ships, evenings</p> | <p>6282 kc. CO9WR -B- 47.76 meters P. O. BOX 85. SANCTI SPIRITUS. CUBA 4-6. 9-11 p.m.</p> | <p>6130 kc. ★VE9HX -B- 48.94 meters P. O. BOX 988 HALIFAX. N.S., CANADA Daily 9 a.m.-12:30 p.m., 4-10 p.m. Releys CMNS</p> | <p>6080 kc. W9XAA -B- 49.34 meters CHICAGO FEDERATION OF LABOR CHICAGO, ILL. Releys WCFL Sunday 11:30 a.m.-9 p.m. and Tues., Thurs., Sat., 4 p.m.-12 m.</p> | <p>6020 kc. XEUV -B- 49.82 meters AV. INDEPENDENCIA 98. VERA CRUZ. MEX. 8 a.m.-12:30 a.m.</p> |
| <p>6635 kc. ★HC2RL -B- 45.21 meters P. O. BOX 759. GUAYAQUIL. ECUADOR, S. A. Sunday. 5:45-7:45 p.m. Tues., 9:15-11:15 p.m.</p> | <p>6280 kc. HIG -B- 47.77 meters CIUDAD TRUJILLO. D.R. 7:10-8:40 a.m. 12:40-2:10, 8:10-9:40 p.m.</p> | <p>6122 kc. HJ3ABX -B- 49 meters LA VOZ DE COLOMBIA CALI 14. No. 736. BOGOTA. COLOMBIA 5:45-11:30 p.m.</p> | <p>6079 kc. DJM -B.X- 49.34 meters BROADCASTING HOUSE. BERLIN. GERMANY 7:30-9:30 p.m.</p> | <p>6018 kc. ZHI -B- 49.85 meters RADIO SERVICE CO., 20 ORCHARD RD. SINGAPORE. MALAYA Mon., Wed. and Thurs 5:40-8:10 a.m. Sat. 10:40 p.m.-1:10 a.m. (Sun.) Every other Sunday 5:10-6:40 a.m.</p> |
| <p>6630 kc. HIT -B- 45.25 meters "LA VOZ DE LA RCA VICTOR." APARTADO 1105. CIUDAD TRUJILLO. D.R. Daily exc. Sun. 12:10-1:40 p.m., 5:40-8:40 p.m., also Sat. 10:40 p.m.-12:40 a.m. (Sun.)</p> | <p>6235 kc. HRD -B- 48.12 meters LA VOZ DE ATLANTIDA LA CEIBA. HONDURAS 8-11 p.m., Sat. 8 p.m.-1 a.m. (Sun.); Sun. 4-6 p.m.</p> | <p>6120 kc. ★W2XE -B- 48.02 meters ATLANTIC BROADCASTING CORP. 485 MADISON AVE. N. Y. C. Releys WABC. 9-10 p.m.</p> | <p>6072 kc. OER2 -B- 49.41 meters VIENNA. AUSTRIA 9 a.m.-5 p.m., Sat. to 6 p.m.</p> | <p>6015 kc. HI3U -B- 49.88 meters SANTIAGO de los CABALLEROS. DOM. REP. 10:40 a.m.-1:40 p.m., 4:40-9:40 p.m.</p> |
| <p>6625 kc. ★PRADO -B- 45.28 meters RIOBAMBA. ECUADOR Thurs. 9-11:45 p.m.</p> | <p>6230 kc. OAX4G -B- 48.15 meters Apartado 1242 LIMA. PERU Daily 7-10:30 p.m. Wed. 6-10:30 p.m.</p> | <p>6120 kc. XEFT -B- 49.02 meters AV. INDEPENDENCIA 28. VERA CRUZ. MEX. 11 a.m.-4 p.m., 7:30 p.m.-12 m. Sat. also 6:30-7:30 p.m. Sun. 11 a.m.-4 p.m., 9 p.m.-12 m. Releys XETF</p> | <p>6070 kc. YV7RMO -B- 49.42 meters MARACAIBO. VENEZUELA 6 p.m.-12 m.</p> | <p>6012 kc. HJ3ABH -B- 49.91 meters BOGOTA. COLO. APARTADO 565 6-11 p.m. Sun. 12 n.-2 p.m., 4-11 p.m.</p> |
| <p>6600 kc. HI8A -B- 45.45 meters CIUDAD TRUJILLO. DOM. REP. Irregular</p> | <p>6185 kc. HI1A -B- 48.5 meters P. O. BOX 423. SANTIAGO. DOMINICAN REP. 11:40 a.m.-1:40 p.m., 7:40-9:40 p.m.</p> | <p>6110 kc. VUC -B- 49.1 meters CALCUTTA. INDIA Daily except Sat., 3-5:30 a.m., 9:30 a.m.-noon; Sat., 11:45 a.m.-3 p.m.</p> | <p>6070 kc. HJ4ABC -B- 49.42 meters PERIARA. COL. 9-11 a.m., 7-8 or 9 p.m.</p> | <p>6010 kc. ★COCO -B- 49.82 meters P. O. BOX 68 HAVANA. CUBA Daily 9:30 a.m.-1 p.m., 4-7 p.m., 8-10 p.m. Sat. also 11:30 p.m.-2 a.m.</p> |
| <p>6558 kc. HI4D -B- 45.74 meters CIUDAD TRUJILLO. DOMINICAN REPUBLIC Except Sun. 11:55 a.m.-1:40 p.m.; 4:40-7:40 p.m.</p> | <p>6171 kc. XEXA -B- 48.61 meters DEPT. OF EDUCATION MEXICO CITY. MEX. 7-11 p.m.</p> | <p>6100 kc. ★W3XAL -B- 49.18 meters NATIONAL BROADCASTING CO. BOUND BROOK. N. J. Releys WJZ Monday, Wednesday, Saturday, 4-5 p.m., Sat. 11 p.m.-12 m.</p> | <p>6070 kc. VE9CS -B- 49.42 meters VANCOUVER. B. C., CANADA Sun. 1:45-8 p.m., 10:30 p.m.-1 a.m.; Tues. 6-7:30 p.m., 11:30 p.m.-1:30 a.m. Daily 6-7:30 p.m.</p> | <p>6005 kc. HP5K -B- 49.86 meters BOX 33. COLON. PANAMA 7:30-9 a.m., 12 n.-1 p.m., 6-9 p.m.</p> |
| <p>6550 kc. TIRCC -B- 45.8 meters RADIOEMISORA CATOLICA CDSTARRICENSE SAN JOSE. COSTA RICA Sun. 11 a.m.-2 p.m., 6-7. 8-9 p.m., Daily 12 n.-2 p.m., 6-7 p.m., Thurs. 6-11 p.m.</p> | <p>6170 kc. HJ3ABF -B- 48.62 meters BOGOTA. COLOMBIA 7-11:15 p.m.</p> | <p>6100 kc. ★W9XF -B- 49.18 meters NATL. BROAD. CO. CHICAGO, ILL. Sun., Tues., Thurs., Fri. 12 m.-1 a.m., 8 p.m.-11:59 p.m. M., W., Sat., 12 m.-1 a.m. Releys WENR</p> | <p>6060 kc. ★W8XAL -B- 49.50 meters CROSLY RADIO CORP. CINCINNATI, OHIO 5:30 a.m.-7 p.m.; 10 p.m.-1 a.m. Releys WLW</p> | <p>6000 kc. HJ1ABC -B- 50 meters QUIBDO. COLOMBIA 5-6 p.m., Sun. 9-11 p.m.</p> |
| <p>6545 kc. YV11RB -B- 45.84 meters "ECOS de ORINOCO", BOLIVAR. VENEZUELA 6-10:30 p.m.</p> | <p>6160 kc. ★YV3RC -B- 48.7 meters CARACAS. VENEZUELA 11 a.m.-2 p.m., 4-10:30 p.m.</p> | <p>6097 kc. HI3C -B- 49.2 meters "LA VOZ DE RIO DULCE" LA RAMONA. DOM. REP. 11:55 a.m.-1:25 p.m., 6:10 p.m.-12 M.</p> | <p>6060 kc. W3XAU -B- 49.50 meters PHILADELPHIA, PA. Releys WCAU 7 p.m.-10 p.m.</p> | <p>6005 kc. ★VE9DR -B- 49.86 meters CANADIAN MARCONI CO. MONTREAL. QUE., CAN. Releys CFCF 7 a.m.-11 p.m., Sun. 8 a.m.-10:15 p.m.</p> |
| <p>6520 kc. ★YV6RV -B- 46.01 meters VALENCIA. VENEZUELA 11 a.m.-2 p.m., 5-10 p.m.</p> | <p>6150 kc. ★CJRO -B- 48.78 meters WINNIPEG. MAN. CANADA 8 p.m.-12 m. Sun. 3-10:30 p.m.</p> | <p>6097 kc. ZTJ -B- 49.2 meters AFRICAN BROADCASTING CO. JOHANNESBURG. SOUTH AFRICA. Sun.-Fri. 11:45 p.m.-12:30 a.m. (next day) Mon.-Sat. 5:30-7 a.m., 9 a.m.-4 p.m. Sun. 8-10:15 a.m.; 12:30-3 p.m.</p> | <p>6060 kc. OXY -B- 49.50 meters SKAMLEBOEK. DENMARK 1-6:30 p.m.</p> | <p>6000 kc. HJ1ABC -B- 50 meters MEXICO CITY. MEX. P. O. Box 79-44 8 a.m.-1 a.m.</p> |
| <p>6500 kc. HIL -B- 46.15 meters APARTADO 623 CIUDAD TRUJILLO. D.R. 12:10-1:40 p.m., 5:40-7:40 p.m.</p> | <p>6150 kc. HJ5ABC -B- 48.78 meters CALI. COLOMBIA Daily 11 a.m.-12 n., Sun. 12 n.-2 p.m., Daily except Sat. and Sun. 7-10 p.m.</p> | <p>6097 kc. HI9B -B- 49.63 meters SANTIAO DOM. REP. Irregular 6 p.m.-11 p.m.</p> | <p>6050 kc. HJ3ABD -B- 49.59 meters COLOMBIA BROADCASTING, BOX 509. BOGOTA. COL. 12 n.-2 p.m., 7-11 p.m., Sun. 5-9 p.m.</p> | <p>5990 kc. ★XEBT -B- 50.08 meters MEXICO CITY. MEX. P. O. Box 79-44 8 a.m.-1 a.m.</p> |
| <p>6477 kc. HI4V -B- 46.32 meters CIUDAD TRUJILLO. D.R. LA VOZ DE LA MARINA 11:40 a.m.-1:40 p.m., 5:10-9:40 p.m.</p> | <p>6147 kc. COKG -B- 48.8 meters BOX 137. SANTIAGO. CUBA 9-10 a.m., 11:30 a.m.-1:30 p.m., 3-4:30 p.m., 10-11 p.m., 12 m.-2 a.m.</p> | <p>6045 kc. HJ1ABG -B- 49.65 meters EMISORA ATLANTICO BARRANQUILLA. COLO. 11 a.m.-11 p.m. Sun. 11 a.m.-8 p.m.</p> | <p>6040 kc. W4XB -B- 49.67 meters MIAMI BEACH. FLA. Releys WIOD 12 n.-2 p.m., 5:30 p.m.-12 m.</p> | <p>5988 kc. HJ2ABD -B- 50.10 meters BUCARAMANGA. COLO. 11:30 a.m.-12:30 p.m., 5:30-8:30, 7:30-10:30 p.m.</p> |
| <p>6450 kc. HJ4ABC -B- 46.51 meters APARTADO 39 IBAQUE. COLOMBIA 11 a.m.-12 n., 8-11 p.m.</p> | <p>6140 kc. ★W8XK -B- 48.88 meters WESTINGHOUSE ELECTRIC & MFG. CO. PITTSBURGH, PA. Releys KDKA 9 p.m.-12 m.</p> | <p>6040 kc. PRA8 -B- 49.67 meters RADIO CLUB OF PERNAMBUCO PERNAMBUCO. BRAZIL 1-3 p.m., 4-7:30 p.m. daily</p> | <p>6040 kc. W4XB -B- 49.67 meters MIAMI BEACH. FLA. Releys WIOD 12 n.-2 p.m., 5:30 p.m.-12 m.</p> | <p>5988 kc. XEWI -B- 50.17 meters MEXICO CITY. MEX. Mon., Wed., Fri., 3-4 p.m. Tues., Fri. 7:30-8:45, 10 p.m.-12 m.; Sat. 9-10 p.m.; Sun. 1-2:15 p.m.</p> |
| <p>6425 kc. W9XBS -X- 46.7 meters NATL. BROAD. CO. CHICAGO, ILL. Releys WMAQ. Irregular</p> | <p>6135 kc. HJ1ABB -B- 48.9 meters BARRANQUILLA. COL., S. A. P. O. BOX 715. 11:30 a.m.-1 p.m.; 4:30-10 p.m.</p> | <p>6040 kc. HJ1ABC -B- 49.65 meters EMISORA ATLANTICO BARRANQUILLA. COLO. 11 a.m.-11 p.m. Sun. 11 a.m.-8 p.m.</p> | <p>6040 kc. W4XB -B- 49.67 meters MIAMI BEACH. FLA. Releys WIOD 12 n.-2 p.m., 5:30 p.m.-12 m.</p> | <p>5988 kc. HJ2ABC -B- 50.2 meters CUCUTA. COLOMBIA 6-9:30 p.m.</p> |

(All Schedules Eastern Standard Time)

| | | | | |
|--|---|--|---|--|
| 5940 kc. TG2X -B- 50.5 meters GUATEMALA CITY, GUAT. 4-6, 9-11 p.m., Sun. 2-5 a.m. | 5850 kc. ★YV5RMO -B- 51.28 meters CALLE REGISTRO, LAS DE- LICIAS APARTADO de COR- RES 214 MARACAIBO, VENEZUELA 11 a.m.-12:30 p.m., 5-9:30 p.m. | 5770 kc. HJ4ABD -B- 51.99 meters LA VOZ CATIA, MEDELLIN, COLOMBIA 8-11:30 p.m. | 5000 kc. TFL -C- 60 meters REYKJAVIK, ICELAND Calls London at night. Also broadcasts irregularly | 4320 kc. GDB -C- 69.44 meters RUGBY, ENGLAND Tests. 8-11 p. m. |
| 5915 kc. HH2S -B- 50.72 meters PORT-au-PRINCE, HAITI BOX A103. 7:30-10:30 p.m. | 5830 kc. ★TIGPH -B- 51.5 meters ALMA TICA, APARTADO 800, SAN JOSE, COSTA RICA 11 a.m.-1 p.m., 6-10 p.m., Relays TIX 9-10 p.m. | 5720 kc. YV10RSC -B- 52.45 meters "LA VOZ de TACHIRA," SAN CRISTOBAL, VENEZUELA 6-11:30 p.m. | 4975 kc. GBC -C- 60.30 meters RUGBY, ENGLAND Calls Ships, late at night | 4273 kc. RV15 -B- 70.28 meters KHABAROVSK, SIBERIA, U. S. S. R. Daily, 3-9 a.m. |
| 5898 kc. YV8RB -B- 50.86 meters "LA VOZ de LARA" BARQUISIMETO, VENEZUELA 12 n.-1 p.m., 6-10 p.m. | 5885 kc. HCK -B- 50.98 meters QUITO, ECUADOR, S. A. 8-11 p.m. | 5713 kc. TGS -B- 52.51 meters GUATEMALA CITY, GUAT. Wed., Thurs. and Sun. 6-9 p.m. | 4820 kc. GDW -C- 62.24 meters RUGBY, ENGLAND Calls N.Y.C., late at night | 4272 kc. WOO -C- 70.22 meters OCEAN GATE, N. J. Calls ships irregularly |
| 5875 kc. HRN -B- 51.06 meters TEGUCIGALPA, HONDURAS 1:15-2:15, 8:30-10 p.m., Sun. 3:30-5:30, 8:30-9:30 p.m. | 5870 kc. ★YV2RC -B- 51.72 meters RADIO CARACAS CARACAS, VENEZUELA Sun. 8:30 a.m.-10:30 p.m. Daily 11 a.m.-1:30 p.m., 4-9:30 p.m. | 5500 kc. T15HH -B- 54.55 meters SAN RAMON, COSTA RICA Irregularly 3:30-4, 8-11:30 p.m. | 4790 kc. VE9BK -B-X- 62.63 meters RADIO SALES SERVICE, LTD., 780 BEATTY ST. VAN. COUVER, B.C., CAN. Daily exc. Sun. 11:30-11:45 a. m., 3-3:15, 8-8:15 p.m. | 4098 kc. WND -C- 73.21 meters HIALEAH, FLORIDA Calls Bahama Isles |
| 5865 kc. HI1J -B- 51.15 meters BOX 204, SAN PEDRO de MACORIS, DOM. REP. 12 n.-2, 6:30-9 p.m. | 5790 kc. JUV -C- 51.81 meters NAZAKI, JAPAN | 5145 kc. PMY -B- 58.31 meters BANDENG, JAVA 5:30-11 a.m. | 4752 kc. WOO -C- 63.1 meters OCEAN GATE, N. J. Calls ships irregularly | 4002 kc. CT2AJ -B- 74.95 meters PONTA DELGADA, SAO MIGUEL, AZORES Wed. and Sat. 5-7 p. m. |
| 5853 kc. WOB -C- 51.26 meters LAWRENCEVILLE, N. J. Calls Bermuda, nights | 5780 kc. OAX4D -B- 51.9 meters P.O. Box 853 LIMA, PERU Mon., Wed. & Sat. 9-11:30 p.m. | 5077 kc. WCN -C- 58.08 meters LAWRENCEVILLE, N. J. Phones England Irregularly | 4600 kc. HC2ET -B- 65.22 meters Apartado 249 GUAYAQUIL, ECUADOR Wed., Sat., 9:15-11 p.m. | 3040 kc. YDA -B- 98.68 meters N.I.R.O.M. TANDJONGPURIK, JAVA 5:30-11 a.m. |

Alphabetical List of S-W Stations

By Call-Letter and Frequency

(Frequency in Megacycles)

| CALL | FREQ. | CALL | FREQ. | CALL | FREQ. | CALL | FREQ. | CALL | FREQ. | CALL | FREQ. | | |
|-------|----------|--------|-----------|--------|----------|--------|-----------|-------|-----------|-------|-----------|---------|-----------|
| CB950 | 9.06 mc. | GAD | 19.48 mc. | HIX | 6.13 mc. | IAC | 17.76 mc. | ORG | 19.20 mc. | TYA | 12.22 mc. | W3XAL | 17.78 mc. |
| CEC | 19.68 | GAP | 19.16 | HIZ | 6.32 | IAC | 12.80 | ORK | 10.33 | TYB | 12.25 | W3XAL | 6.10 |
| CEC | 15.87 | GAQ | 18.97 | H11A | 6.19 | IAC | 8.38 | OXY | 6.06 | TYF | 14.64 | W3XAU | 9.59 |
| CEG | 10.67 | GAS | 18.31 | H11J | 5.86 | IAC | 6.65 | PCJ | 15.22 | VE9BJ | 6.09 | W3XAU | 6.06 |
| CGA3 | 13.29 | GAU | 18.42 | H11S | 6.42 | IDU | 13.39 | PCV | 9.59 | VE9BK | 4.79 | W3XL | 17.31 |
| CGA4 | 9.33 | GAW | 18.20 | H13C | 6.10 | (1)ZRO | 11.81 | PDK | 17.81 | VE9CA | 6.03 | W4XB | 6.04 |
| CJA3 | 11.41 | GBA | 13.99 | H13U | 6.02 | ZRO | 9.64 | PDV | 10.41 | VE9CS | 6.07 | W4XCA | 31.60 |
| CJRO | 6.15 | GBB | 13.59 | H14D | 6.56 | JVE | 15.66 | PHI | 12.06 | VE9DR | 6.01 | W8XAL | 6.06 |
| CJRX | 11.72 | GBC | 17.08 | H14V | 6.48 | JVF | 15.62 | PHI | 17.78 | VE9HX | 6.13 | W8XK | 21.54 |
| CNR | 12.83 | GBC | 12.78 | H15N | 6.14 | JVH | 14.60 | PHI | 11.73 | VIZ3 | 11.56 | W8XK | 15.21 |
| CNR | 8.04 | GBC | 8.68 | H17P | 6.80 | JVM | 10.74 | PLP | 18.83 | VK2ME | 9.59 | W8XK | 11.87 |
| COCD | 6.13 | GBC | 4.98 | H18A | 6.60 | JVN | 10.66 | PLP | 9.42 | VK3LR | 9.58 | W8XK | 6.14 |
| COCH | 9.43 | GBL | 14.65 | H19B | 6.05 | JVP | 7.51 | PLV | 11.00 | VK3ME | 9.51 | W8XWJ | 31.60 |
| COCO | 6.01 | GBP | 10.77 | HJA3 | 14.94 | JVT | 6.75 | PMA | 19.35 | VK3ME | 9.76 | W9XAA | 11.83 |
| COJK | 6.15 | GBS | 12.15 | HJB | 14.95 | JVU | 5.79 | PMC | 18.14 | VK3ME | 9.76 | W9XAA | 6.08 |
| COK9Q | 8.67 | GBU | 12.29 | HJN | 5.95 | JYK | 13.61 | PMN | 10.26 | VLD2 | 9.76 | W9XBS | 6.43 |
| CO9WR | 6.28 | GBW | 14.44 | HJU | 9.50 | JYR | 7.88 | PMY | 5.15 | VPD | 13.08 | W9XWJ | 6.10 |
| CP5 | 6.08 | GCA | 9.71 | HJ1ABB | 6.14 | JYS | 9.84 | PNI | 8.78 | VPD | 7.08 | XBQJ | 11.20 |
| CQN | 9.66 | GCB | 9.28 | HJ1ABC | 6.0 | JYT | 15.76 | PNI | 8.78 | VQ7LO | 6.08 | XEBT | 5.99 |
| CRXC | 6.09 | GCI | 8.73 | HJ1ABD | 7.28 | KAY | 14.98 | PRADO | 6.63 | VRR4 | 11.60 | XECR | 7.38 |
| CSL | 6.15 | GCI | 13.42 | HJ1ABE | 9.55 | KAZ | 9.99 | PRAS | 6.04 | VUB | 9.57 | XEFT | 6.12 |
| CT1AA | 9.65 | GCG | 8.76 | HJ1ABG | 6.04 | KEE | 7.72 | PRF5 | 9.50 | VUC | 6.11 | XEME | 8.19 |
| CT1GO | 12.40 | GCS | 9.02 | HJ1ABJ | 6.03 | KEJ | 9.01 | PSA | 21.08 | VWY | 8.98 | XEUW | 6.02 |
| CT2AJ | 4.00 | GCU | 9.95 | HJ1ABK | 7.07 | KEL | 6.86 | PSD | 15.07 | VWY2 | 17.51 | XEVI | 5.98 |
| DAF | 12.33 | GCW | 9.79 | HJ1ABP | 9.62 | KES | 10.41 | PSF | 14.96 | WCN | 5.08 | XEXA | 6.17 |
| DAF | 8.77 | GDB | 4.32 | HJ2ABA | 6.18 | KIO | 11.68 | PSH | 10.22 | WKA | 21.06 | XGM | 17.65 |
| DFB | 17.52 | GDS | 6.91 | HJ2ABC | 5.98 | KKH | 7.52 | PSK | 8.19 | WKF | 19.22 | XGOX | 9.49 |
| DGU | 9.650 | GDS | 4.82 | HJ2ABD | 5.98 | KKR | 15.46 | RIM | 15.25 | WKK | 21.42 | XGW | 10.42 |
| DJA | 9.560 | GSB | 9.51 | HJ3ABD | 6.05 | KKZ | 13.69 | RIM | 7.63 | WKN | 19.82 | YBA | 10.43 |
| DJB | 15.20 | GSC | 9.58 | HJ3ABF | 6.17 | KTO | 16.24 | RIO | 10.17 | WLA | 18.34 | YDA | 6.04 |
| DJC | 6.02 | GSD | 11.75 | HJ3ABH | 6.01 | KWO | 15.42 | RIR | 10.08 | WLK | 16.27 | YDA | 3.04 |
| DJD | 11.77 | GSE | 11.86 | HJ3ABX | 6.12 | KWU | 15.36 | RKI | 15.09 | WMA | 13.39 | YDB | 9.65 |
| DJE | 17.76 | GSF | 15.14 | HJ4ABA | 11.81 | KWV | 10.84 | RKI | 7.50 | WMF | 14.47 | YDB | 11.86 |
| DJL | 15.11 | GSG | 17.79 | HJ4ABB | 6.11 | KWX | 7.61 | RNE | 12.0 | WMN | 14.59 | YNA | 14.49 |
| DJM | 6.08 | GSH | 21.47 | HJ4ABC | 6.45 | KKJ1 | 9.53 | RV15 | 4.27 | WNA | 9.17 | YNL | 9.65 |
| DJN | 9.54 | GSJ | 15.26 | HJ4ABD | 6.07 | LRU | 15.29 | RV96 | 9.52 | WNB | 10.68 | YVNC | 13.35 |
| DJO | 11.8 | GSJ | 21.53 | HJ4ABE | 5.77 | LRX | 9.64 | RV96 | 15.18 | WNC | 15.06 | YVQ | 6.67 |
| DJP | 11.86 | GSN | 11.82 | HJ4ABL | 6.09 | LSF | 19.60 | SPW | 13.64 | WND | 4.10 | YVR | 18.30 |
| DJQ | 15.28 | GSO | 15.18 | HJ4ABP | 6.06 | LSG | 19.90 | SUV | 10.06 | WOA | 6.76 | YVR | 9.15 |
| DJR | 15.34 | GSP | 15.31 | HJ5ABC | 6.15 | LSI | 9.80 | SUX | 7.86 | WOB | 5.85 | YV2RC | 5.80 |
| DZA | 9.68 | HAS3 | 15.37 | HJ5ABD | 6.09 | LSK3 | 10.25 | SUZ | 13.82 | WOF | 14.47 | YV3RC | 6.16 |
| DZB | 10.04 | HAT4 | 9.13 | HKE | 9.93 | LSL | 15.81 | TFJ | 12.24 | WOG | 16.27 | YV4RC | 6.38 |
| DZC | 10.29 | HBJ | 14.54 | HKE | 7.10 | LSL2 | 10.30 | TFK | 9.06 | WOK | 10.55 | YV5RMO | 5.85 |
| DZE | 12.13 | HBL | 9.60 | HKV | 8.80 | LSM2 | 14.50 | TFL | 5.0 | WON | 9.87 | YV6RM | 6.52 |
| DZG | 15.36 | HBP | 7.80 | HPF | 8.80 | LSN | 9.89 | TGF | 14.49 | WOO | 17.62 | YV7RMO | 6.07 |
| DZH | 14.46 | HCETC | 6.98 | HPF | 14.49 | LSN | 14.53 | TGS | 5.71 | WOO | 12.84 | YV8RB | 5.90 |
| EAQ | 9.86 | HCJB | 8.21 | HP5B | 6.03 | LSN5 | 19.65 | TGW | 9.45 | WOO | 8.56 | YV9RC | 6.40 |
| EDM | 20.86 | HCK | 5.89 | HP5F | 6.08 | LSN6 | 21.02 | TGXA | 6.13 | WOO | 4.75 | YV10RSC | 5.72 |
| EDM | 10.07 | HC2AT | 8.40 | HP5J | 9.61 | LSX | 10.35 | TG2X | 5.94 | WOO | 4.27 | YV11RB | 6.55 |
| EHY | 20.86 | HC2ET | 4.60 | HP5K | 6.01 | LSY | 20.70 | TIEP | 6.71 | W1XAL | 15.25 | YV12RM | 6.30 |
| EHY | 10.07 | HC2JSB | 7.85 | HRD | 6.24 | LSY3 | 18.12 | TIGPH | 5.83 | W1XAL | 11.79 | ZBW | 8.75 |
| FTA | 11.94 | HC2RL | 6.64 | HRF | 14.49 | LZA | 14.97 | TIPG | 6.41 | W1XAL | 6.04 | ZFA | 5.03 |
| FTK | 15.88 | HC2TC | 7.98 | HRL5 | 14.49 | OAX4D | 5.78 | TIR | 14.49 | W1XK | 9.57 | ZFB | 10.06 |
| FTM | 19.36 | HH2S | 5.92 | HRN | 5.88 | OAX4G | 6.23 | TIRCC | 6.55 | W2XAD | 15.33 | ZGE | 6.13 |
| FTO | 18.25 | HH3W | 9.60 | HRP1 | 7.03 | OCI | 18.68 | T15HH | 5.50 | W2XAF | 9.53 | ZHI | 6.02 |
| FZR3 | 16.23 | HIG | 6.28 | HS8PJ | 10.96 | OCI | 10.97 | T16OW | 6.85 | W2XE | 21.52 | ZHT | 7.63 |
| FZS | 18.35 | HII | 6.78 | HSJ | 10.17 | OCJ2 | 14.85 | T18WS | 7.55 | W2XE | 17.76 | ZLT2 | 7.39 |
| FZS2 | 11.99 | HIL | 14.94 | HSP | 17.74 | OER2 | 6.07 | TPA2 | 15.25 | W2XE | 15.27 | ZLT4 | 11.05 |
| GAA | 20.38 | HIT | 6.50 | HVJ | 15.12 | OPL | 20.04 | TPA3 | 11.88 | W2XE | 11.83 | ZSS | 18.89 |
| GAB | 18.04 | | | HVJ | 5.97 | OPM | 10.14 | TPA4 | 11.72 | W2XE | 6.12 | ZTJ | 6.10 |

Short Wave

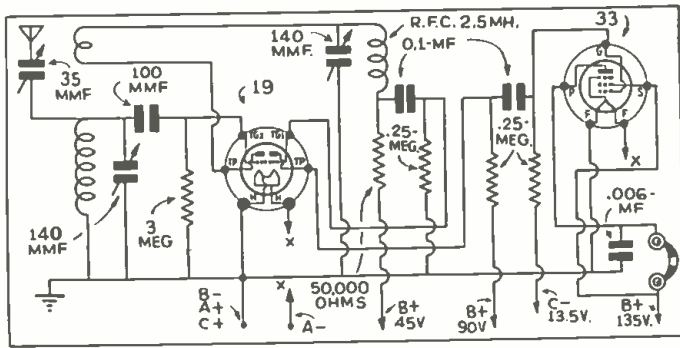

2-Tubes do the work of three in this receiver

2-TUBE BATTERY SET

Agustin Ramirez, Habana, Cuba.
 (Q) I am a constant reader of *Short Wave Craft*, and would appreciate it if you would publish a diagram of a 2-tube receiver using a 19 and a 33. This should be resistance-coupled in the entire audio portion with a regenerative detector using standard two winding coils.

(A) The diagram you request using a 19 and a 33 has been shown, and it should make an excellent battery type receiver. The 19 serves

5-volt filament winding. If it has, this winding may be used for some other purpose.

WHAT VOLTAGE CONDENSERS?

Joe Bononi, Greensburg, Pa.
 (Q) I have three 8 mf. electrolytic condensers rated at 450 volts each. I would like to know if I could use a 700-volt center-tapped transformer with these condensers. Also, should the filter chokes be mounted at

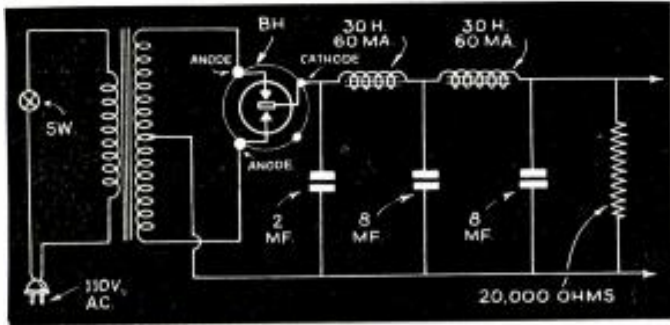

Power-supply diagram using B.H. rectifier.

as a regenerative detector and first stage of audio amplification. The second audio stage uses a 33 pentode and sufficient volume should be obtained for a sensitive speaker.

POWER SUPPLY WITH BH RECTIFIER

Carl Charles, Merriam, Kans.
 (Q) I have a type BH rectifier tube and would appreciate it if you could publish a diagram for it when used in a power-supply.

(A) A diagram for the BH rectifier is shown. The BH tube is one of the gaseous type, not requiring a filament. Therefore, the transformer need not have the usual

right-angles to each other?
 (A) With a 15,000 ohm bleeder resistor on the output of your power supply, the 450-volt condensers should work satisfactorily. It might be advisable to use *choke input* to the filter rather than condenser input. It is not necessary to mount the chokes at right angles to each other.

1-TUBE POCKET SET

Herbert Schmitt, Port Townsend, Wn.
 (Q) I have read much about the 1-tube pocket set which was described in the December, 1934, issue of *Short Wave Craft* and would appreciate it if you would print the diagram in your *Question Box*, together with the coil data.

(A) The 1-tube pocket set sure was popular with our readers, and we are pleased to reprint the diagram. The coil data is as follows: 40-meter band: grid, 18 turns, tickler 18 turns, 25 31-meter band: grid, 10 turns, tickler 10. 19 meter band: grid coil, 5, tickler 5. The above coils are close-wound on a 1 inch form with No. 26 D.S.C. wire, and a spacing of 1/8 in. between the two windings. We have also had many requests for coil data for the broadcast band, but this set is not suitable for operation in the regular "broadcast" band, inasmuch as it is entirely too unselective.

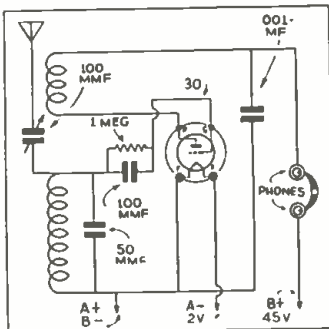
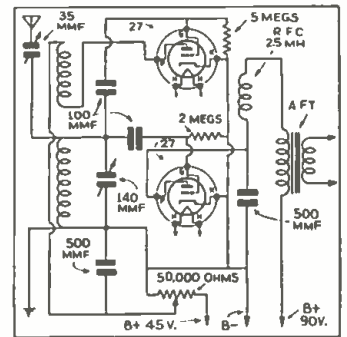

Diagram of the famous "pocket set."

SEPARATE REGENERATION DETECTOR

Charles Braun, Rochester, N.Y.
 (Q) I have become interested in the idea of using a separate regeneration stage and would appreciate it very much if you would show a diagram in your *Question Box* employing two type 27 tubes—one as a detector and the other for regeneration.

(A) The diagram shows a 27 detector and another 27 used as a "feed-back" tube. Smooth control of regeneration is obtained with this circuit. The transformer marked A.F.T. is connected to the usual audio amplifier.



Connections for Separate Regeneration tube.

much to have you print the diagram.
 (A) We are printing a diagram of a 27 regenerative detector, a 26 first audio amplifier, and a 71A second audio amplifier. Excellent results should be expected from this receiver.

38 AMPLIFIER FOR 2-TUBE SET

Reg. Pearson, Wellans, Ont.
 (Q) I am using at present a receiver employing a 6D6 in the T.R.F. circuit, a 6C6 as detector, and a 37 as the audio amplifier. I would like to add a 38 pentode to obtain speaker volume. Would you be kind enough to print the diagram in the *Question Box*?

(A) The diagram has been shown, using resistance coupling. The 50,000 ohm resistor having its terminals marked "X," should be connected to the phone terminals of the 37 audio amplifier already in the receiver.

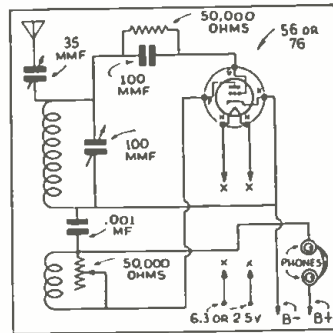

1-Tube Oscillodyne.

1-TUBE OSCILLODYNE

Selden James, Frisco, Texas.
 (Q) Please publish a diagram in the *Question Box* of the "1-tube Oscillodyne" which appeared in the April, 1933 issue of *Short Wave Craft*.

(A) We are again printing the diagram of the "Oscillodyne" and trust that our readers will save this hook-up because it is requested a great many times. The coil data for this receiver is as follows:

| Coil | Secondary | Tickler |
|------|-----------|---------|
| 1 | 4 | 6 |
| 2 | 7 | 9 |
| 3 | 14 | 12 |
| 4 | 23 | 23 |
| 5 | 36 | 36 |

These coils are close wound on tube bases with No. 36 D.S.C. wire and the spaces between the two coils is 1/8 in. (Range covered 14 to 200 meters.)

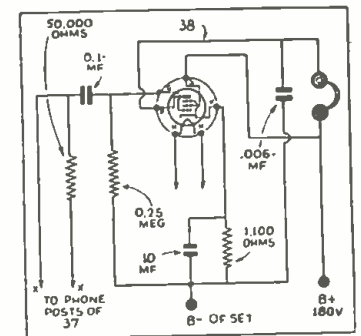

1-tube Amplifier for S-W receiver.

SHORT WAVE SET USING OLD-STYLE TUBES

D. S. Miller, Jr., Altoona, Pa.
 (Q) I would like to use the type 27, 26, and 71A tubes in a short-wave receiver. I have the necessary power-pack and would like very

building a code-practice oscillator
 John Sulimowicz, Philadelphia, Pa.
 (Q) Recently I had plans for

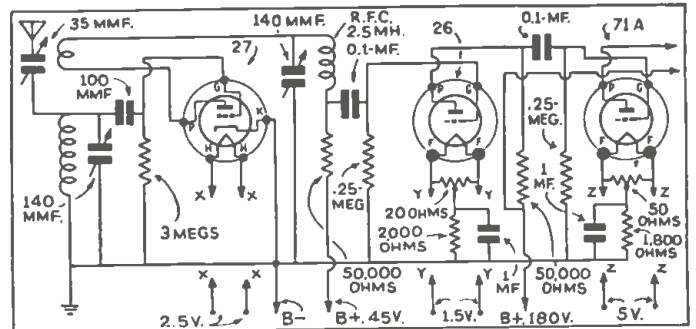

S-W receiver using "tubes of yesterday."

EDITED BY GEORGE W. SHUART, W2AMN

● Because the amount of work involved in the drawing of diagrams and the compilation of data, we are forced to charge 25c each for letters that are answered directly through the mail. This fee includes only hand-drawn schematic drawings. We cannot furnish "picture-layouts" or "full-sized" working drawings. Letters not accompanied by 25c will be answered in turn on this page. The 25c remittance may be made in

the form of stamps, coin or money order. Special problems involving considerable research will be quoted upon request. We cannot offer opinions as to the relative merits of commercial instruments. Correspondents are requested to write or print their names and addresses clearly. Hundreds of letters remain unanswered because of incomplete or illegible addresses.

QUESTION BOX

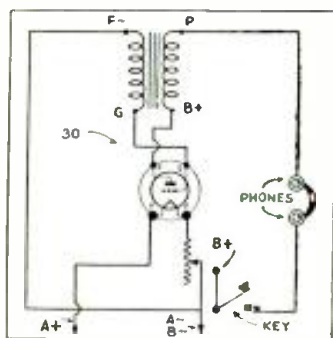

Code-practice oscillator.

using a type 30 tube. After obtaining the necessary parts, I find that I have misplaced the diagram. Would you please publish one in your *Question Box*?

(A) We have had a number of requests for a code practice oscillator diagram and the one shown

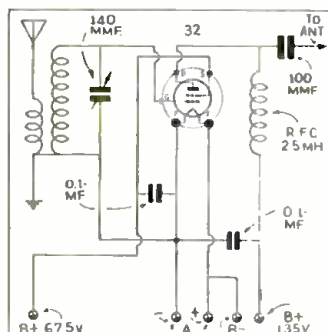

R.F. Amplifier

is the old standby. It consists of a type 30 tube and an audio transformer. Any type tube may be used merely by applying the proper voltages. The key is connected in series with the headphones.

R.F. AMPLIFIER

B. Hillin, Ontario, Canada

(Q) I have just finished constructional work on the "12,500 mile" receiver and I would like to add a stage of tuned R.F. to it. Will you please print the diagram in the *Question Box*. This, of course, should use a 2-volt tube.

(A) The 1-stage of tuned R.F.

added to the usual 2-tube battery receiver will improve results considerably. Not only will it provide a smoother control of regeneration, due to isolation of the antenna, but the R.F. gain will be greater, and especially beneficial on the weaker stations.

SHORT-WAVE CONVERTER

George Meyer, Whitefish, Wis.

(Q) I have a broadcast receiver to which I would like to attach a short-wave converter using two

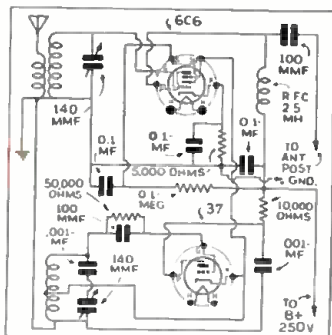

Converter diagram.

tubes. These should be a 6C6 and a 37. Would you please print the necessary diagram?

(A) This converter may be attached to any broadcast receiver having a fairly good sensitivity. A 6C6 is used as the first detector or mixer tube and a 37 as the high frequency oscillator. The output of the converter should be connected to the antenna and ground posts of the broadcast set.

6.3-VOLT SHORT-WAVE RECEIVER

Edward Daniels, Rochester, N.Y.

(Q) I would like to have you publish a diagram of a 2-tube 6.3-volt receiver using a 6C6 and a 37. Regeneration should be controlled by a potentiometer in the detector stage.

(A) We have shown the diagram you request and the 50,000-ohm potentiometer controls regeneration by varying the screen-grid voltage. This set can be used with

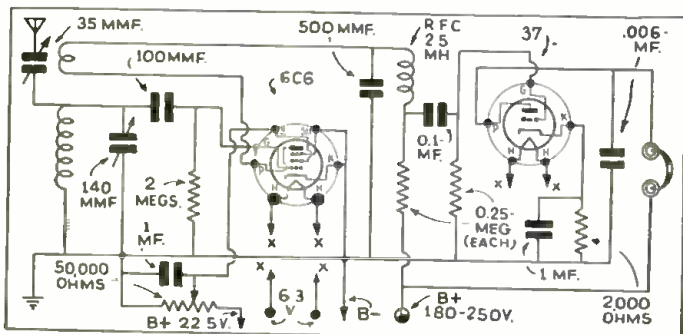

2-tube receiver using 6C6 and 37 tubes.

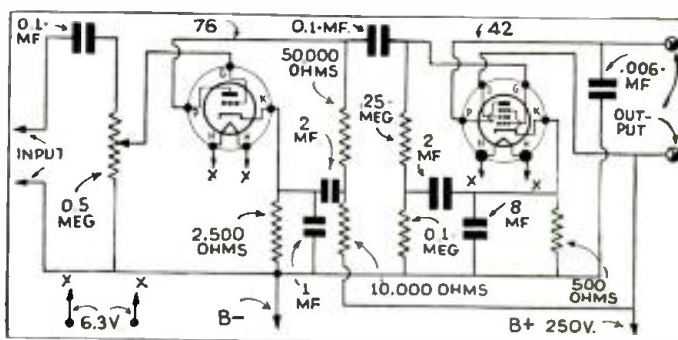

Experimental 2-tube A.F. Amplifier

a 6-volt storage battery and "B" batteries for the plate supply.

POWER-SUPPLY

R. W. Douriey, Richmond, Va.

(Q) I would like to build a power-supply delivering 250 volts for the plates of my receiver and

(A) The 2-stage amplifier shown should make an excellent accessory for the short-wave experimenter's shop, inasmuch as it can be used as an amplifier for a receiver or other experiments such as phonograph reproductions and public-address experiments.

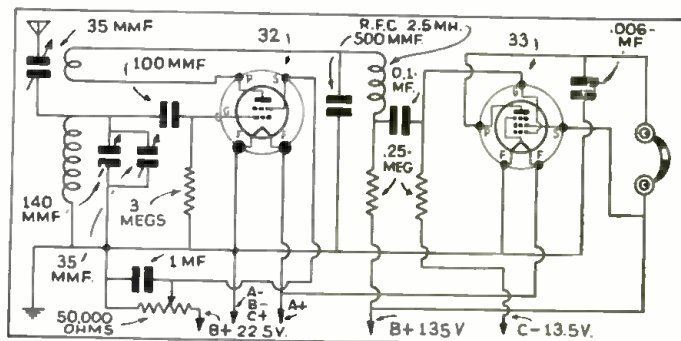

2-tube Battery Receiver diagram.

6.3 volts for the heater. Would you please print the diagram?

(A) The power-supply diagram shown can be used with any type of receiver. We recommend that any one purchasing a transformer for this power-supply obtain one with a 2.5-volt winding as well.

2-STAGE AUDIO AMPLIFIER

Robert Skar, Cedar Falls, Iowa.

(Q) Kindly publish a diagram in the *Question Box* of a 2-stage audio amplifier using a 76 and a 42. This should be resistance-coupled in both stages.

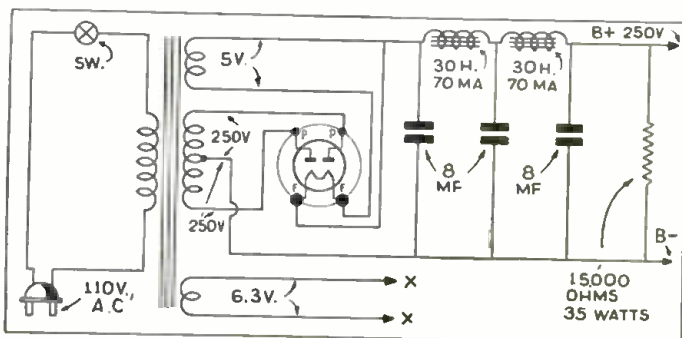

A good Power-Supply for your short-wave set.

SHORT WAVE . SCOUTS

THIRTIETH "TROPHY CUP"

Presented to

SHORT WAVE SCOUT
JOSEPH H. MILLER
2559 East 28th St.
Brooklyn, N. Y.

For his contribution toward the
advancement of the art of Radio
by



Magazine



Honorable Mention Awards

Floyd E. Reese, 2241 Pierce Ave.,
Niagara Falls, N. Y.
Bruce Hart, Woman Lake,
Pine River, Minn.

30th TROPHY WINNER

96 Stations—81 Foreign

● THE 30th trophy contest proved quite exciting, inasmuch as a number of the contestants claimed over 90 verifications, and one over 100. It was an excellent example of how easy it is to obtain verification cards, provided

● ON this page is illustrated the handsome trophy which was designed by one of New York's leading silversmiths. It is made of metal throughout, except the base, which is made of handsome black Bakelite. The metal itself is quadruple silver-plated, in the usual manner of all trophies today.

It is a most imposing piece of work, and stands from tip to base 22 1/2". The diameter of the base is 7 3/4". The diameter of the globe is 5 1/4". The work throughout is first-class, and no money has been spared in its execution. It will enhance any home, and will be admired by everyone who sees it.

The trophy will be awarded every month, and the winner will be announced in the following issue of SHORT WAVE CRAFT. The winner's name will be hand engraved on the trophy.

The purpose of this contest is to advance the art of radio by "logging" as many short-wave phone stations, amateurs excluded, in a period not exceeding 30 days, as possible by any one contestant. The trophy will be awarded to that SHORT WAVE SCOUT who has logged the greatest number of short-wave stations during any 30-day period.

you go about it in the right manner.

Our winner this month had an allowed total of 96 stations, only 15 of which were located in the United States. Mr. Joseph H. Miller, who receives the 30th trophy, neglected to give us information as to the type of receiver and antenna he was using. He merely states in his letter that he received these stations on his own receiver—presumably one that he constructed himself. All of the stations were received in a 30-day period of 1935, so that the wavelengths given are probably nothing like the present ones.

We also wish to congratulate Floyd E. Reese, of 2241 Pierce Avenue, Niagara Falls, N. Y., for his excellent total of 95 stations. It was a very close run and an excellent showing.

Verified List of Short Wave Stations Heard

U. S. A. Stations

W8XK—19.71 m. (meters)—Pittsburgh, Penna.
W8XK—25.26 m.—Pittsburgh, Penna.
W8XK—48.83 m.—Pittsburgh, Penna.
W2XAD—19.56 m.—Schenectady, N.Y.
W2XAF—31.48 m.—Schenectady, N.Y.
W1XK—31.33 m.—Boston, Mass.
W3XAU—49.5 m.—Philadelphia, Pa.
W3XAL—16.87 m.—Bound Brook, N.J.
W3XAL—49.18 m.—Bound Brook, N.J.
W2XE—19.64 m.—Wayne, N.J.
W9XAA—49.34 m.—Chicago, Ill.
W8XAL—49.5 m.—Cincinnati, Ohio.
KWU—19.54 m.—Dixon, Calif.
KWO—19.47 m.—Dixon, Calif.
VKI—47 m.—Selfridge Field, Mich.

Europe

DFR—19.24 m.—Nauen, Germany.
DFC—23.10 m.—Nauen, Germany.
DFB—17.12 m.—Nauen, Germany.
DIQ—29.15 m.—Nauen, Germany.
DCU—31.08 m.—Nauen, Germany.

(Continued on page 314)

Trophy Contest Entry Rules

● THE rules for entries in the SHORT WAVE SCOUT Trophy Contest have been amended and 50 per cent of your list of stations submitted must be "foreign." The trophy will be awarded to the SHORT WAVE SCOUT who has logged the greatest number of short-wave stations during any 30 day period; (he must have at least 50 per cent "foreign" stations). This period need not be for the immediate month preceding the closing date. The complete list of rules appeared in the September issue of this magazine.

In the event of a tie between two or more contestants, each logging the same number of stations (each accompanied by the required minimum of 50 per cent "foreigns") the judges will award a similar trophy to each contestant so tying. Each list of stations heard and submitted in the contest must be sworn to before a Notary Public and testify to the fact that the list of stations heard were "logged" over a given 30 day period, that reception was verified and that the contestant personally listened to the station announcements as given in the list.

Only commercial "phone" stations should be entered in your list, no "amateur transmitters" or "commercial code" stations. This contest will close every month on the 25th day of the

month, by which time all entries must be in the editors' hands in New York City. Entries received after this date will be held over for the next month's contest. The next contest will close in New York City August 25th; any entries received after that date will be held over till the next month.

The winner each month will be the person sending in the greatest number of verifications. Unverified stations should not be sent in, as they will not count in the selection of the winner. At least 50 per cent of the verifications sent in by each listener must be for stations located outside of the country in which he resides! In other words, if the contestant lives in the United States at least 50 per cent of his "veries" must be from stations outside of the United States. Letters or cards which do not specifically verify reception, such as those sent by the Daventry stations and, also by commercial telephone stations, will not be accepted as verifications. Only letters or cards which "specifically" verify reception of a "given station," on a given wave length and on a given day, will be accepted! In other words it is useless to send in cards from commercial telephone stations or the Daventry stations, which state that specific verifications will not be given. Therefore do not put such

stations on your list for entry in the trophy contest!

SHORT WAVE SCOUTS are allowed the use of any receiving set, from a one-tube up to one of sixteen tubes or upwards, if they so desire.

When sending in entries, note the following few simple instructions: Type your list, or write in ink, pencilled matter is not allowed. Send verification cards, letters and the list all in one package, either by mail or by express prepaid; do not split up the package. Verification cards and letters will be returned, at the end of the contest, to their owners; the expense to be borne by SHORT WAVE CRAFT magazine.

In order to have uniformity of the entries, when writing or typing your list, observe the following routine: USE A SINGLE LINE FOR EACH STATION; type or write the entries IN THE FOLLOWING ORDER: Station call letters; frequency station transmits at; schedule of transmission, if known (all time should be reduced to Eastern Standard which is five hours behind Greenwich Meridian Time); name of station, city, country; identification signal if any. Sign your name at the bottom of the list and furthermore state the type of set used by you to receive these stations. State total No. stations.



Eilen RX-14

6-tube Band-Spread Receiver
8 1/2 to 600 meters

See Editorial Article P. 151 July Issue S.W.C.
OUR LARGEST, FINEST, AND MOST SENSITIVE SHORT WAVE RECEIVER which WILL satisfy even the most discriminating SW fan. Uses two 6D6, two 76, one 42, and one 5Y3 hi-gain tubes as TUNED RF amplifier, TUNED electron coupled screen grid regenerative detector, POWERFUL 3 stage audio amplifier, HUM-FREE full wave rectifier and built-in power supply. Operates from your AC house current. POWERFUL hi-quality audio system delivering 3 watts of power to the built-in hi-fidelity dynamic loudspeaker—automatic headphone jack—smooth regeneration and volume controls—connections for doublet or single wire antenna—black shrivel finished metal chassis and cabinet of extreme beauty—selectivity, sensitivity, and volume that will amaze you. PRICE, complete with 6 tubes, 8 coils, \$21.95 cabinet, speaker, wired, less B.C. coils, ready to use.

and one 5Y3 hi-gain tubes as TUNED RF amplifier, TUNED electron coupled screen grid regenerative detector, POWERFUL 3 stage audio amplifier, HUM-FREE full wave rectifier and built-in power supply. Operates from your AC house current. POWERFUL hi-quality audio system delivering 3 watts of power to the built-in hi-fidelity dynamic loudspeaker—automatic headphone jack—smooth regeneration and volume controls—connections for doublet or single wire antenna—black shrivel finished metal chassis and cabinet of extreme beauty—selectivity, sensitivity, and volume that will amaze you. PRICE, complete with 6 tubes, 8 coils, \$21.95 cabinet, speaker, wired, less B.C. coils, ready to use.

RX-14 KIT \$14.95
of necessary parts including 8 low-loss coils for 8 1/2 to 200 meters, and simple instructions, (less cabinet, tubes, and B.C. coils, unwired). Beautiful, heavy steel cabinet, extra \$2.50
6 MATCHED ARCTURUS tubes \$2.95

SPECIAL
Complete kit, cabinet, tubes, speaker, and detailed instructions, less B.C. coils, un \$19.95
wired.....
Labor for wiring and testing, extra 2.00
Broadcast band coils (2), extra 1.45

IF METAL TUBES are preferred over the glass type, add \$1 to price.

AMATEURS:
Model RX-14-AB COMMUNICATIONS RECEIVER has same specifications as RX-14 except that it is equipped with special coils for the 20-40-80-160 M bands which spread these bands over a generous portion of the tuning dial. Also equipped with plate voltage cut-off switch for use during transmitting periods. An ideal receiver for amateur communications work. Add \$1 to price of RX-14.

RX-14B:
Battery model of RX-14. Subtract \$1 from above price (less batteries).

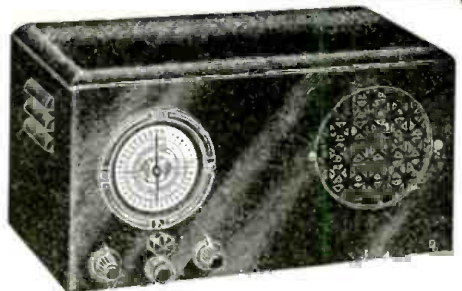

Eilen BS-5

5-Tube Band switch Receiver

9 1/2 to 600 meters
A powerful, sensitive, and selective SW receiver covering the entire wavelength span of 9 1/2 to 600 meters in 5 steps. NO PLUG-IN COILS are used. Simply turn the waveband selector switch and enjoy reception on any wavelength within this range.

Uses two 6D6, one 76, one 43, and one 25Z5 tubes as RF amplifier, electron coupled screen grid regenerative detector, powerful 2 stage audio amplifier with pentode output stage, rectifier, and complete built-in power supply.

HUM-FREE—Hi-fidelity dynamic loudspeaker—illuminated, airplane type vernier dial—band spread tuning control—automatic headphone jack—extremely smooth acting controls—operates from your AC or DC house current—beautiful, heavy, black shrivel finish chassis and cabinet.

DELIVERS GREAT LOUDSPEAKER VOLUME ON THE GREAT MAJORITY OF SHORT WAVE FOREIGN STATIONS UNDER FAIR CONDITIONS.

PRICE, complete with 5 tubes, cabinet, speaker, wired, ready to use \$16.95

BS-5 KIT, of necessary parts, including speaker and detailed instructions, less tubes, cabinet, unwired. Beautiful, black shrivel finish metal cabinet, extra \$2.00
Set of 5 MATCHED Arcturus tubes, extra, 2.50

SPECIAL: Complete kit, cabinet, tubes and instructions, unwired \$14.95
Labor for wiring and testing, extra \$2.00 (If metal tubes are preferred to glass type, add \$1)

AMATEURS:
Model BS-5-AB has same specifications as BS-5 except that it has special bandspread circuit for 20-40-80-160 M bands and is equipped with plate voltage cut-off switch. Add \$1.00 to above price.

Eilen 6C Short Wave 4-Tube Receiver

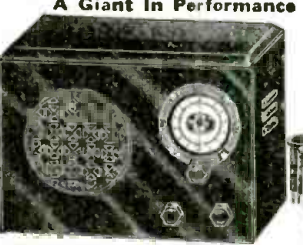

6C Kit (unwired), of all necessary parts, 4 coils for 9 1/2 to 200 meters and instructions (less cabinet, tubes, speaker, and B.C. coils), \$7.45
Beautiful cabinet, \$1.25
4 matched Arcturus tubes, 3.15
Special loudspeaker, 3.15
Broadcast band coils (2), 1.45
Special: Complete kit, cabinet, 4 tubes, loudspeaker, and one B.C. coil, unwired, \$12.45
Labor for wiring and testing, extra 1.50

FULL 6 TUBE PERFORMANCE—POWERFUL 3 STAGE AUDIO AMPLIFIER which takes the guesswork out of so-called "loudspeaker reception."
Uses 6D6-6P7 (twin 2 in 1)-76-12A (twin 2 in 1) triode tubes as RF amplifier, screen grid regenerative detector, POWERFUL 3 stage audio amplifier with pentode output stage, rectifier and built-in hum-free power supply. Completely self-contained entirely from 105 to 150 volt AC or DC light socket.

BAND SPREAD TUNING—smooth regeneration control—built-in high quality loudspeaker—automatic headphone jack—large illuminated airplane type vernier dial—large 3 winding (low-loss inductances—selectivity, sensitivity, and volume that will amaze you. Heavy black shrivel finish metal chassis and cabinet. Must be seen to be appreciated. Satisfied owners report dozens of foreign stations on loudspeaker. You may do the same under the proper conditions. ORDER YOURS TODAY! YOU'LL NEVER REGRET IT!

EILEN 6B or 6B-AB battery model of 6C using 34-19-30-33 tubes. Subtract \$1 from price of 6C or 6C-AB.

Eilen Two-Tube SHORT WAVE Radio Only \$3.00

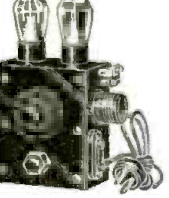

less tubes, phones, unwired

A REAL, powerful 2 tube short wave set that readily brings in amateur, police, call, broadcast stations, experimental and foreign stations under fair conditions. **THE WORLD AT YOUR DOOR!**

A **DEPENDABLE RECEIVER** which is guaranteed to give RESULTS. Operates entirely from the AC or DC house current. Simple to build and easy to operate. Beautiful, black shrivel finished cabinet and instructions furnished. Wavelength range 10 to 600 meters.

TWO TUBE BATTERY SET, less tubes, phones, batteries, unwired \$2.00
Kits wired, extra \$0.75. Tubes, each \$0.75
Cannonball double headphones \$1.35

FREE
Large, illustrated 20 page catalogue of short wave receiver kits, transmitters, and accessories. Send stamp to cover postage and handling charges.

24 hour service, 20% deposit on C.O.D. orders

Eilen HF-35 3-Tube SW Transmitter

A powerful and well engineered amateur band transmitter of great beauty and efficiency—AT A PRICE WITHIN THE AMATEUR'S REACH. Uses 59-46-46 tubes as TRITET CRYSTAL CONTROLLED OSCILLATOR—CLASS C RF POWER AMPLIFIER—built-in antenna tuning system—beautiful, black shrivel metal case and shelving—Triplet meters—Eilen transmitting dials—highest quality construction—35 watts of power output on 20-40-80-160 M bands. A transmitter that you can be proud to own. An excellent exciter unit for high power stages to be added later. 3 coils for any 1 band and instructions included.

HF-35, assembled, and ready to wire (less tubes, power supply, crystal, holder, and additional coils) \$21.95
Matched Arcturus Tubes (3) \$2.15
Eilen quartz crystal (80 or 160) \$1.95
Eilen crystal holder 1.00
Coils for additional bands, per set 1.45

HV-475 1-Tube power supply for use with HF-35, less tube (ready to wire) \$12.95
Labor for wiring extra \$1.00
#3 tube for HV-475, extra 65 cents



M-15 3-Tube Modulator for use with HF-35 and capable of modulating its entire output at 100%, priced at \$14.95 (less tubes). Three Arcturus tubes, 56-53-53, extra. \$1.95

NEW! A startling new 5 meter MOPA short wave transmitter, designed by George Shuart, W2AMN of Short Wave Craft, using two of the 6L6 tubes, and delivering a high quality signal at a full 20 watts output to the antenna. Extremely simple to build and operate. Constructed of only the finest material—Thordarson-Triplette-Dubilier-Eilen—and other well known parts are used.

Encased in beautiful, well shielded metal cabinet finished in black shrivel lacquer. A transmitter which will produce the RESULTS! Complete KIT of all parts, including cabinet, meter, and tubes, unwired, with detailed instructions and diagrams, only \$22.95
Wired and tested, extra \$7.50

SPECIAL: Genuine RCA 845 transmitting tubes (75 watt), each \$4.45
Eilen 2 section, 65 mmf per section, transmitting condensers, each \$1.25
Cannonball double phones, each \$1.35
56 tubes, RCA licensed, 12c each, 5 for 50c.
Eilen soldering irons, 75 watts, postpaid @ 95c each.

EILEN RADIO LABORATORIES, Dept. SC 9, 136 LIBERTY STREET, NEW YORK, N. Y.

phones installed among the state delegation sections throughout the auditorium and in Columbia's studios at the hall, in the Cleveland Hotel and elsewhere."

The newly designed miniature transmitters provided even swifter and smoother broadcasting operations than those which were made possible when the now familiar coat-lapel microphone were first introduced by CBS on the floors of the 1932 conventions. An even more intimate and dramatic word-picture of the political drama is expected by the technical innovations arranged this year. The new camera transmitter, unlike the lapel microphone, employs no wire lines and yet is capable of transmitting over distances up to four or five miles.

The photo-mike was conceived and developed by E. K. Cohan, director of engineering of the Columbia Broadcasting System.

Photo-Mike Snaps Photo While You Speak

(Continued from page 261)

Three of them were specially built by Mr. Cohan's assistants for convention use. Their design is simple and ingenious, as constructed by John Dyer and J. Middlebrooks of Mr. Cohan's staff. Dyer, by the way, was the engineer who operated Columbia's phenomenal phone transmitter at Little America with the Second Byrd Antarctic Expedition.

Inside the photo-mike's camera box is a three-tube transmitter and batteries for power sufficient to operate throughout the day and evening convention sessions. The power output is rated at one watt and the three photo-mikes operate respectively on 34.6, 37.6 and 40.6 megacycles with an estimated practical transmitting range of four to five miles.

Actually, of course, the miniature transmitters were employed to carry the spoken word from impromptu interviews at convention gathering spots to Columbia's master booth in the hall. There, of course, the programs were fed to Columbia's nationwide network of approximately 125 stations carrying "convention" events.

While the candidate is talking to the photo-mike, a special automatic "flashlight gun" attachment permits some thirteen candid camera pictures to be taken of the speaker as his speech goes out on the air. Meanwhile, CBS announcers and commentators are making sure not to stumble on the line: "Look pleasant please and speak right into the lens—er—the microphone." This device was also used at the Democratic convention in Philadelphia.

Please mention SHORT WAVE CRAFT when writing advertisers

IT'S FB!!

SAY THOUSANDS OF DELIGHTED
FULTONE "V"
3-TUBE RECEIVER OWNERS—

Here's the set that pulls 'em in! It's small—it's inexpensive—but how those distant stations do roll in on the speaker!! Even the most hard-belled old-timer sits up and takes notice at the great volume and clarity with which GSC and GSD, England—DJJ and DJT, Germany—2RO, Italy—T'AZ, France and many others are received! And even those hard-to-get stations—RNE, Russia; VK3MF; JVN, Japan, and T'PJ—leeland came in with surprising ease! AMPLIFIED? From all over the world!! That will give you and your friends a NEW thrill at every turn of the dial! Plugs into any AC or DC outlet. Complete range 93 to 625 meters gets everything. REAL CONTINUOUS BANDSPREAD. Large illuminated airplane dial. Built-in speaker, with provision for headphones or external speaker. Large, ribbed triple winding inductors insure maximum transference of signal energy. Correct design enables FULL FIVE TUBE PERFORMANCE from only three tubes! Entirely self-contained. Its light weight and compactness make it an ideal portable!

This is a receiver that is easy to build—easy to operate—and which will outperform higher priced receivers!!
ORDER YOUR FULTONE V—TODAY! We know that you, too, will say—EXCELLENT!! Remember! Your money refunded in full if you are not entirely pleased.



FULTONE "V"
"FIVE-IN-THREE"
6D6 6F7 12A7
S.C.F. DET. HIGH- PENTODE VOLTAGE
R.F. GAIN A.F. RECTIFIER

COMPLETE KIT
Containing every necessary part, attractive metal chassis and panel, 93 to 200 meter coils, and complete, easy to follow wiring and operating instructions. (Not wired, less tubes, cabinet, speaker and 200-625 M. coils) Three matched guaranteed tubes \$2.20 Metal Cabinet \$1.25 Loudspeaker to fit in receiver \$1.45. 200-625 Meter coils (2) \$1.25

BATTERY MODEL
Uses 6D6-6F7-38 tubes. Ideal for vacation. Inexpensively converted into AC-DC model when desired.
Complete Kit \$6.95 (less batteries, tubes, cabinet, speaker, 200-625 M. coils, not wired.)

SPECIAL COMBINATION OFFER

COMPLETE Fultone V Kit, with 3 tubes, all coils 93 to 600 meters, loudspeaker, and cabinet. (Not wired.) Laboratory wired and tested—\$1.50 extra. **\$12.45**

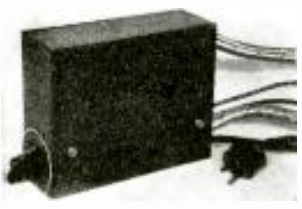

"NOISE SILENCER"
See page 78 of June Short Wave Craft for complete description of this amazing device that really eliminates motor noises, auto ignition, and many other forms of "Man-Made Static."

Complete kit of every necessary part, crystal finished chassis and cabinet (drill) and complete wiring and operating instructions not wired, less tubes. **\$3.85**
Three matched SYLVANIA all-metal tubes \$2.50 COMPLETELY WIRED, WITH TUBES, READY TO ATTACH AND OPERATE **\$8.55**
Literature on request.

HAMS!! FANS!!

VISIT OUR NEW LARGE STORE!

"Everything you need—in stock!"

SEND FOR NEW RECEIVER CATALOG

HARRISON 12 WEST BROADWAY
RADIO COMPANY NEW YORK Dept. C-9 N. Y.

POWERED BY THORDARSON



Again
THORDARSON
is chosen

New 5 meter transmitter designed by George W. Smart and powered by Thordarson. This remarkable transmitter has startled the short wave world and uses
1—T-7062 Power Transformer..... List \$5.50
1—T-7551 Filter Choke..... List \$6.00

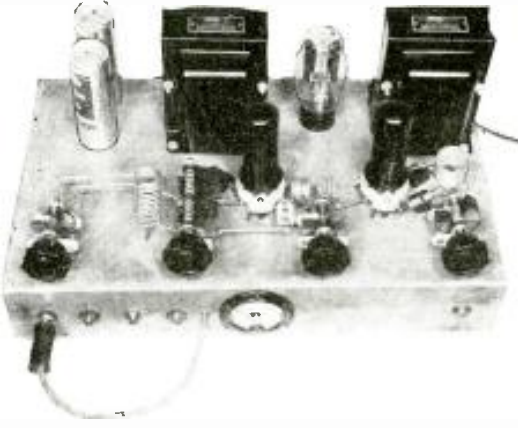

Just off the Press! 1936 Thordarson Complete Transformer Catalog. Write Factory today for your copy.

THORDARSON ELECTRIC MFG. CO.

TRANSFORMER SPECIALISTS SINCE 1895
500 West Huron St. Chicago, Ill., U.S.A.

S-W's in Aviation

(Continued from page 263)

partment of Commerce radio beacon and weather stations located on the entire route covered by Eastern Airlines from Chicago to Miami and from New York to New Orleans. Directly below this chart is shown a control unit which remotely tunes the beacon receiver. The pilot simply looks on the chart and determines what station he wishes to listen to, together with its dial number, and then turns his control unit to correspond to this dial number, thus tuning in the weather or beacon station.

In the center is shown a large panel with a number of switches. For the convenience of the pilot this is divided into two sections, two-way and beacon. The large knob in the two-way section regulates the gain of the short-wave communications receiver. The three switches immediately above the two-way gain control are not used in Eastern Airlines' installation, inasmuch as these particular switches are for use when continuous wave telegraphy and telephony are used. Eastern Airlines use only radio telephone for their plane-to-ground communication. The large switch in the two-way section is to turn the transmitter filaments off and on. The small switch in the center portion is for use with the emergency beacon receiver, transferring the filaments of this receiver from the plane's storage battery to an emergency battery and is used only in case of an emergency. Directly below this switch is a small indicating lamp which is used in conjunction with the 9-A control unit (shown as the circular control at the extreme right of the photograph). The use of this light will be described later.

In the beacon section the knob is used to regulate the gain of the beacon receiver while the large switch immediately above this turns the radio receiver off or on. The three switches to the right of this large switch are not used inasmuch as the radio beacons used on the route covered by Eastern Airlines are all of the aural type and this control unit was designed to permit reception of either visual or aural signals.

To the right of this large control unit will be found the 9-A control unit which is used to shift the radio transmitter from day to night frequency and at the same time shift the short-wave communication receiver to the appropriate day or night frequency. In order to assure the pilot that the frequency shift has been properly made, a small signal lamp lights as soon as the frequency shift is started and upon the correct completion of it, this lamp goes out, thus assuring the pilot that the shift has been made properly.

At the extreme right of the panel is a small ammeter which indicates antenna current by means of a remote thermocouple located in the 13A radio transmitter.

All of the above equipment controls the 50 watt radio telephone transmitter which is capable of transmitting radio telephone signals on one or two crystal controlled frequencies, though the transmitter itself has three channels and Eastern Airlines use only two of these. The 12-A radio receiver is used in conjunction with the 13-A radio transmitter and is tied to it by means of the remote control frequency shift. The 12-A radio receiver is of the superheterodyne type and is pretuned to the day and night frequencies used by Eastern Airlines. No tuning on the part of the pilot is necessary because the oscillator is stabilized by means of low temperature co-efficient quartz crystal oscillators.

In the Electra the output of the radio transmitter is fed through a concentric transmission line to a tuning unit located in the tail of the airplane and attached to this tuning unit is a fixed trailing wire antenna which extends out horizontally in flight directly behind the plane. There is no weight attached to this trailing wire as it extends horizontally due to the speed of the airplane through the air. Such an antenna is relatively free from drag and, therefore, does not slow the airplane down as would a fixed antenna supported by a mast on the plane.

Please mention SHORT WAVE CRAFT when writing advertisers

Coast Guard Uses S-W's on Planes

(Continued from page 263)

plification in operation. Tapped variometers supply tuning facilities for all intermediate frequencies, and variable condensers and tapped coils perform these functions for high frequencies. High voltage current is supplied by a pair of mercury vapor tubes, designed especially for 800 cycle operation. Suitable filtering is provided for CW operation, MCW operation is obtained by removing the filter circuit with a panel control. Provision has been made for the connection of fixed type and trailer antenna to a selector switch located on top of the transmitter, enabling rapid change-over from one to the other. The trailing wire antenna is used on the 275-600 kilocycle band, and either antenna for the high frequency band. The alternators used for power supply have D.C. winding and commutator, supplying their own field excitation, and for charging batteries, in conjunction with transmitter controls. There are 5 shielded compartments in the transmitter, M.O. tuning, P.A. tuning, Antenna tuning, M.O. and rectifier tubes, and Power and Relay section. Terminals are located on top of the transmitter for two antennas, ground, and connection to receiver antenna post, the latter for purpose of obtaining "break-in" operation. The trailing antenna is paid out by means of a reel, containing 30 ft. of wire. The reel is completely covered and is always at ground potential, preventing burns, and reducing fire hazard.

2. Transmitter-receiver, mounted in common cabinet, battery operated, with battery box with flexible cable for interconnecting all 3 units. 5 watt power. For transmission and reception of C.W. and voice signals. Operates from a single antenna with either a counterpoise or ground. Transmitter covers nominal frequency ranges of: 2580-3336 kc., 3144-4067 kc., and 3825-5000 kc. Desired range selected by means of a range switch. Adjustment for operation is made by setting the M.O. tuning, P.A. tuning, and three antenna coupling controls which are placed on the front panel. Transmitter delivers in excess of 5 watts into any antenna between 25-300 ft. long, when actual plate current totals for C.W. operation is 55 milliamperes at 270 volts. A high "C" Colpitts master oscillator is employed. C.W. code or telephone transmission can be used. Transmitter-receiver operates from a single six-volt 40 ampere-hour storage battery, with separate B batteries for the receiver. The receiver covers nominal frequency range of 2660-8100 kilocycles, accomplished in 6 frequency ranges: 2660-3205 kc., 3205-3860 kc., 3860-4650 kc., 4650-5605 kc., 5605-6750 kc., and 6750-8150 kc. Desired range selected by means of a switch panel, and adjustment of a single tuning control is enough to select exact frequency. This transmitter-receiver has worked distances of 1500 miles constantly.

3. Frequency Indicator. Comprises a master oscillator operating in a limited frequency range of 1000-2053 kilocycles, which by harmonic combinations, is capable of checking transmitters in 250-8100 kilocycle range.

4. RADIO DIRECTION FINDER—Homing Device; covers a frequency range of 200-750 kilocycles, and from 2000-5000 kilocycles. Receiver itself with battery box is mounted in the tail section of the plane, with remote control cables running up to operator's position forward. A remote control panel, located over the operator's head, enables him to turn the receiver on or off, and to regulate filament voltage, balance, etc., and to turn the loop antenna. The usual process in which this apparatus is used is for a vessel in distress, etc., to transmit signals, which are picked up by the plane, bearings are then taken. The pilot supplied with the bearings, and the plane then heads for the stricken vessel.

Used as a "homing device" consecutive bearings are taken on the home station or on whatever station is desired, and the pilot follows the "null" until the destination is reached.

The New Doerle

6-Tube BANDSPREAD RECEIVER
Marvelous Sensitivity and Selectivity
Only Found in the Higher Priced Models



Licensed under RCA and Hazeltine patents

- ★ Continuous bandspread tuning from 9½ to 625 meters.
- ★ An ideal DX receiver for the long distance SW fan or communications receiver for the transmitting amateur.
- ★ Beautiful large, illuminated, dual pointer, multi-colored, airplane type dial of great beauty.
- ★ Operates from either single wire type aerial or noise-free doublet.
- ★ Volume control—stage aligning trimmer—and tone controls.
- ★ Unusually smooth acting regeneration control.
- ★ Headphone jack with speaker cut-off switch.
- ★ Highly efficient, low loss ribbed plug-in coils, are a large factor in the amazing sensitivity and selectivity of this receiver. Coils are of the large 3 winding variety and are color coded for easy identification.

The famous Doerle line of receivers are now equipped with the new Octal sockets in which glass and metal tubes are interchangeable. For the first time this quality receiver is available in KIT form for the short wave experimenter who prefers to "build his own."

Uses 6 of the latest hi-gain tubes (6K7G, 6K7G, 6C5G, 6C5G, 6F6G and 5Y3) in a highly efficient and selective circuit, using two tuned stages—electron coupled regenerative detector—POWERFUL 3 stage resistance capacity coupled audio frequency amplifier with power pentode output stage—full wave high voltage rectifier and self contained hum-free power supply. Built-in High Fidelity dynamic speaker capable of handling the entire 3 watts of audio frequency power output of the receiver.

Continuous bandspread over the entire range of 9½ to 625 meters is obtainable due to the use of a special type, multi-colored, airplane dial having 125 to 1 ratio and two pointers. Two knobs are provided and make possible either fast or slow motion tuning. ALL of the AMATEUR and FOREIGN SW BANDS are spread over a generous portion of the tuning dial, thereby simplifying tuning so that even a beginner can operate it to the utmost satisfaction. Entirely free from all traces of backlash.

The entire unit is contained in a large, black crackle finished metal chassis and cabinet of extreme beauty. All controls are mounted on the front panel and all parts are readily accessible. No adjustments whatever are necessary. Nothing to get out of order. Simply plug into your electric light socket and enjoy an evening of short wave thrills and entertainment such as you have never before experienced.

Mechanical specifications: Dimensions are 17½"x8"x8¾". Net weight 23 lbs. Shipping weight 33 lbs. Designed to operate entirely from 100-130 volts. 50 to 60 cycles AC house current. Shipment made same day as order is received. Complete satisfaction guaranteed.

DOERLE 6-tube AC BANDSPREAD RECEIVER, completely wired and tested, with set of 6 matched Arcturus tubes, 8 coils for 9½ to 200 meters, cabinet, instructions, and READY TO OPERATE. Licensed under RCA and Hazeltine patents.....

(Specify whether metal or glass tubes desired.)

DOERLE 6-tube AC SW KIT, containing all necessary parts, including 8 low loss ribbed coils for 9½ to 200 meters, full size hi-fidelity dynamic speaker, beautiful cabinet, and 4 page instruction booklet (less tubes, Broadcast coils, and unwired).....

6 Arcturus matched tubes.....\$3.12
Broadcast band coils (2).....1.45

LIST PRICE \$34.95
Discount to Hams.
Fans & Experimenters 20%.

YOUR NET COST

\$27.96

less 2 Broadcast band coils, extending the range up to 625 meters, extra \$1.45.

\$17.96

INVEST in a GENUINE DOERLE 2-TUBE BATTERY RECEIVER

15 to 200 Meters

One of the most popular members of the Doerle Set family. Employs but two tubes, yet gives the performance of a set having three tubes. Uses a type 30 as regenerative detector and a type 19 twin triode (actually 2 tubes in one) as two stages of resistance-coupled audio. The world-famous reputation of the entire Doerle line, is behind this remarkable set. Requires two No. 6 dry cells and two 45 volt "B" batteries for operation. All parts and workmanship fully guaranteed. Employs a set of four 5-prong ribbed plug-in coils. These coils are interchangeable with the new 5-prong bandspread coils. Ship. wt., 10 lbs. List Price \$15.75.

\$7.25
KIT
Less Tubes, Cabinet, and Batteries

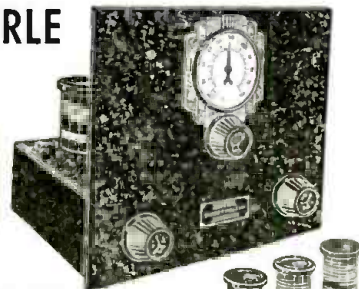

No. 5009-K Doerle 2-tube Battery Receiver Kit, not wired but with 8 Coils and Metal Cabinet, less Tubes, Batteries and cabinet, YOUR PRICE **\$7.25**
Set of 2 Matched Tubes.....\$0.98
Metal Cabinet for above.....1.25
Set of 4 Bandspread Coils.....2.95
No. 5006-K Doerle 3-tube Battery Receiver Kit, not wired but with 8 Coils and Metal Cabinet, less Tubes and Batteries, Ship. wt., 10 lbs. List Price—\$23.75. YOUR PRICE **\$12.48**
Set of 3 Matched Tubes.....\$1.80

We will wire and test any of these kits at an additional charge of \$1.50
FREE CATALOG OF DOERLE RECEIVERS. Send stamp to cover mailing costs.

GUY STOKELY RADIO CORPORATION, 126 Liberty St., Dept. S-9, New York City
SOLE MANUFACTURERS AND DISTRIBUTORS OF DOERLE SETS

Please mention SHORT WAVE CRAFT when writing advertisers

RCA Demonstrates Facsimile 100 Miles on 3 Meters

(Continued from page 262)



THAT'S WHAT THE WHOLE RADIO FIELD WANTS TO KNOW!

WHAT IS THE "BLUE-RIBBON"?

FIND OUT ALL ABOUT THE "BLUE RIBBON"

It's new! It's different! Something the entire radio field has been waiting for. Be sure to look for complete details in next month's issue of this magazine.

If you want advance dope of radio's latest sensation, write at once for important news! Address Dept. J4. BE ON THE LOOKOUT FOR THE "BLUE RIBBON."

WHOLESALE RADIO SERVICE CO.
 NEW YORK, N.Y. 100 SIXTH AVE.
 CHICAGO, ILL. 901 W JACKSON BLVD. ATLANTA, GA. 430 W PEACHTREE ST NW
 BRONX, N.Y. 541 E FORDHAM RD. NEWARK, N.J. 213 CENTRAL AVE.

BUD AMPLIFIER FOUNDATION KIT

Give that amplifier a factory built professional appearance by building it on one of these units.

Undrilled chassis—2 1/4" high. Cane design perforated metal shield cover. Finished in black wrinkle enamel.

| | | | | | |
|----------|----|-----|--------|------|-------------|
| No. 699 | 2" | 5" | 8 1/2" | high | List \$2.35 |
| No. 1125 | 2" | 5" | 8 1/2" | high | List \$2.75 |
| No. 1126 | 2" | 5" | 8 1/2" | high | List \$3.50 |
| No. 1127 | 2" | 10" | 8 1/2" | high | List \$4.25 |
| No. 1128 | 2" | 10" | 8 1/2" | high | List \$3.50 |

BUD RADIO INC.
 1937 E. 55th St. Cleveland, Ohio

The SKY BUDDY

A PRECISION ENGINEERED 5-TUBE COMMUNICATION RECEIVER FOR ONLY \$29.50 (Complete, with Tubes)

The greatest value ever offered the short wave fan. A genuine Hallcrafters' engineered junior model communication receiver at this sensationally low price! Tuning from 18 to 555 meters on three bands. 5 Tubes that function as 8. Superheterodyne circuit that compares favorably in sensitivity and selectivity with much higher priced communication receivers. Expert short wave operators are amazed at its performance.

Write today for complete details.

the hallicrafters
 MARION, INDIANA

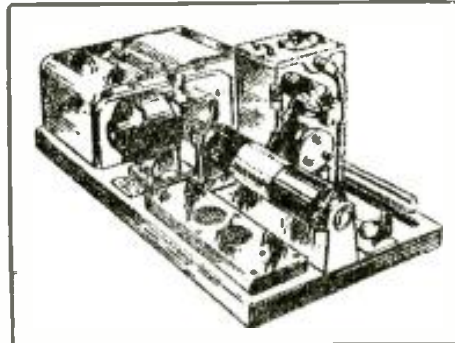

Sample of the excellent "facsimile" sent over the U.S.W. circuit.

paratus were connected to the circuit and operated simultaneously with the newest facsimile equipment.

Mr. Sarnoff Tells Advantages

In a statement to guests present at the New York end of the radio circuit for the occasion, David Sarnoff, President of the Radio Corporation of America, said: "Radio-communication is today placing in useful public service, a region of the radio spectrum which only yesterday was virtually unexplored and scientifically unconquered territory. Having developed a technique of operation for the three-meter band of radio wavelengths, we find in that region, a medium of transmission unlike anything that we have ever known."

"The most significant feature of the new communications development is that it marks the attainment of a radio circuit so efficient that we are challenged to take full advantage of it. This is very important, for radio-communication has, from its beginning, struggled to provide even better connecting radio channels between transmitter and receiver. Now we find that the ultra-short wave portion of the radio spectrum gives us a medium of almost unbelievable possibilities. We cannot only send messages in facsimile as fast as present equipment will allow, but we can send two pictures simultaneously, and on the same radio wave we can also add two automatic typewriter channels and a telegraph channel. Of course, this means that we do all

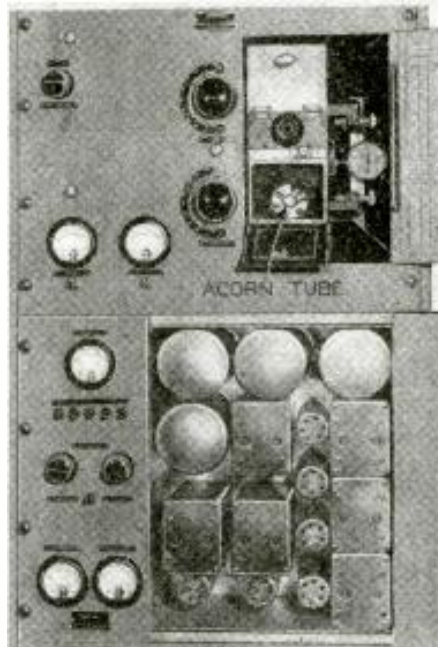

Close-up of the receiver, showing one of the Acorn tubes.

these things in both directions at the same time.

"The possibilities of multiple transmission are still not exhausted. Perhaps this single illustration will give some idea of the traffic-handling possibilities of the circuit. If we were concerned only with communication on a word basis, we could, with increased power and filter systems, operate enough automatic typewriters to carry a total of twelve thousand words per minute in both directions between New York and Philadelphia.

"Such flexibility, in being able to accommodate so many separate services simultaneously offers important commercial advantages. But we intend to continue this development further with the object of creating new devices for higher speeds of transmission on the individual channel. There would be little point in our using the new system merely to add another hundred or two automatic typewriter channels

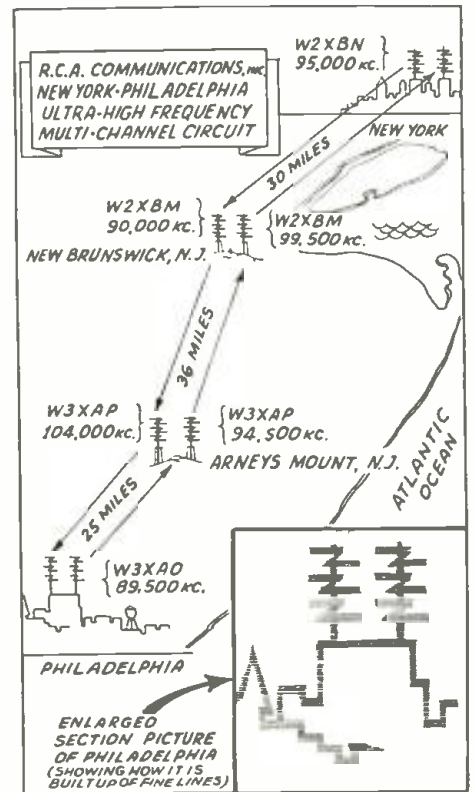

Diagram of the U.S.W. "facsimile" set-up between New York and Philadelphia.

between these two cities, when adequate wire facilities for such services already exist. We cannot be content merely to duplicate present practice at this stage of radio's development. Now that we have the circuit, we shall turn again to the laboratory to find out how best to make use of it. Of course radio wants its share of telegraphic traffic, but it looks also at the much bulkier mail-bags."

The equipment developed for the new circuit is regarded in engineering circles as a modern marvel. The automatic repeater stations, which catch the micro waves flying in both directions and fling them on to their destinations at New York and Philadelphia, are located at New Brunswick, New Jersey, and Arney's Mount, near Trenton, New Jersey. Since the range of three meter radio waves is virtually limited to line-of-sight, the points of reception and transmission for each of the stations were selected to provide the most distant optical horizon. In New York and Philadelphia, therefore, the antennas are located atop tall office buildings, whereas the intermediate

Please mention SHORT WAVE CRAFT when writing advertisers

points of New Brunswick and Arney's Mount were chosen for their favorable terrain.

Each of the repeater stations employs two different transmitting wavelengths, or one for each direction. The two terminal stations each use one sending wave, making a total of six wavelengths, or frequencies, for the complete circuit. It was explained that, if it should be desired to extend the circuit beyond either terminal point, those six micro waves could be used over and over again in the same sequence. Thus, two waves of the same length would be generated at points about one hundred miles apart, and would not interfere with each other, because of the line-of-sight limitation to their range.

Musical Note Controls Relay Stations

One of the most interesting engineering features of the new circuit is the method by which the unattended relay stations may be turned on or off from either one of the terminal stations by radio. The receivers at each of the four stations are always "alive" and ready to catch impulses from their assigned transmitters. When it is desired to make the circuit ready for traffic, New York or Philadelphia starts up its transmitter and sends a certain musical note which the receiving circuits are preset to "recognize." At the unattended receiver at New Brunswick, the tone passes through electrical filters—somewhat like a key passed through the tumblers of a lock. Electrical circuits "accept" the tone and relays are actuated, turning on the power for the "south" transmitter, which, when in operation, passes the tone on by radio to the Arney's Mount station. There the operation is repeated.

When the tone signal reaches the Philadelphia station, the transmitter at that city is also automatically turned on, and the tone starts on its return journey, back to New York. Operators in New York know that when the tone comes back to them from the "north" transmitter at New Brunswick, the entire circuit is in full operation and ready for traffic. The constant presence of the tone keeps the relays closed, and the circuit in an operating condition. When the tone is withdrawn from the circuit, relays click in the same succession over the round trip to Philadelphia, and one by one the transmitters are automatically turned off. Philadelphia has the same control over the circuit as New York.

Acorn Tubes, "Turnstile" Antennas and "Resonant Lines" Used

The new circuit is described by officials as an outstanding example of the value of RCA coordinated research and engineering in many special phases of the radio art. There being no precedent for building commercial apparatus for commercial operation on three meters, the equipment developed is unlike anything ever seen. Antennas, because of their curious form, are characterized as "Christmas trees" and "turnstiles." Certain parts of the receivers look like small steam engines and the transmitters might be taken for hot water boilers. Engineers explained that these odd shapes result from the application of the principle of "resonant lines" to both transmitters and receivers. That principle, developed for this use eliminates crystal control and provides economical and efficient means of maintaining radio equipment in steady tune at extremely short wave-lengths.

The heart of the receiver is the "shoe button" or "Acorn" tube, so dubbed because of its minute dimensions, and in the transmitters there are new power tubes specially designed for microwave service. These special tubes, along with the antenna, transmitter, receiver, facsimile and terminal control apparatus were all developed in a group of laboratories, each specializing in a separate phase of the work.

It was revealed today that, even before the completing of the new circuit, the development of improvements which promise measurably to simplify design of future installations was already under way. These improvements also contemplate increasing both the speed and the number of communication channels which can be handled simultaneously on a single radio wave.

5-METER DUPLEX TRANSMITTER RECEIVER

USING 4 TUBES

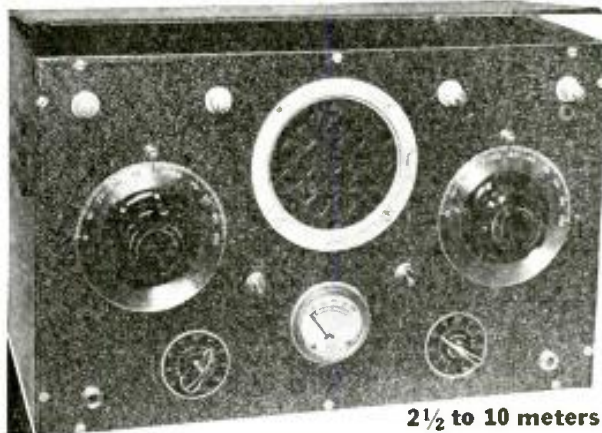

2 1/2 to 10 meters

PORTABLE BATTERIES Self Contained

Not a transceiver but a complete separate transmitter and receiver which may be used simultaneously for duplex work. (Send and receive at the same time.) Uses latest battery tubes providing an unusual combination of power and long battery life.

Ultra-Audion transmitting circuit and A.R.R.L. Minute Man type of super-regenerative receiver with powerful 2 stage amplifier operating speaker. Meter guarantees most efficient adjustment and long tube life.

Complete kit including drilled panel and chassis, meter, etc. (Less cabinet and tubes, unwired) **\$1260**
Hinged top cabinet 10"x16"x7 1/2"..... **2.10**
Assembly & Wiring..... **3.00**
Tubes: 2—30's; 1—1F4; 1—33..... **2.50**

R-S-R Jr. 3-TUBE COMMUNICATION RECEIVER 5-555 Meters



A new development of the famous Haynes R-S-R at a remarkable price for this class of receiver. A regenerative receiver with amazing selectivity. It actually will snap in and out even the powerful local broadcast stations. Super-regeneration can be used as high as 25 meters if desired or straight regeneration as low as 5 meters.
*Perfect control for reither phone, C.W. or broadcast reception. Using two 76 Super-Triodes and an 80 rectifier it will operate a speaker on good signals.

FEATURES

*Separate tank and bandsread condensers.
*Super-regeneration up to 25 meters if desired.
*High voltage A.C. transformers and 80 rectifier power supply built-in.
*Straight antenna or doublet connections with front panel variable antenna coupling.
*Standby switch for communication cover.
All coils are included, giving full coverage from 15 to 555 meters; also 5 & 10 meter bands.
Complete kit, including coils from 5 to 555 meters; drilled panel, chassis, power supply, etc., less tubes, cabinet, unwired **\$760**
Crystallized metal cabinet..... **\$1.00**
Kit of three matched tubes..... **\$1.25**
Assembled, wired and tested..... **\$2.35**

Send for complete literature on either of these

RADIO CONSTRUCTORS LABORATORIES

Dept. SW 9
136 Liberty St., New York, N.Y.

Export Dept.
105 Hudson St., N. Y. C.

GOOD RESULTS Demand GOOD INSTRUMENTS



Model 324

Triplett Electrical Instrument Co.
289 Harmon Drive
Bluffton, Ohio



TRIPLETT manufactures a complete line of electrical instruments for radio, electrical and general industrial purposes, both standard and custom built—For better short wave work, write for catalogue.

GET ON THE LIST FOR THESE CATALOGS



Here are the four big catalogs sent to every Burstein-Applebee customer this year. Each catalog is brim full of latest information and lowest wholesale prices on Radio, Electrical and Refrigeration Equipment. Write today—get on the list.

BURSTEIN-APPLEBEE CO.
1012-14 McGee St., Kansas City, Mo.

Please mention SHORT WAVE CRAFT when writing advertisers

Preview of 1937 Short-Wave Equipment



COSMAN 5-Band 15-550 Meter 4 Tube A.C.-D.C. Receiver
 Features Continuous Band spread Tuning—New Low loss 5-Band Coil Assembly—4" Airplane Dial—Dynamic speaker—Use of new metal tubes and many other important new developments to make it

one of the year's outstanding short-wave receivers. Automatic Jack permits headphone reception and cuts out built in dynamic speaker. Uses 2-6K7's, 1-25Z5, and 1-43.

- Complete kit of parts, including pictorial and schematic diagrams, unwired, less tubes and cabinet \$10.50
- Wiring and Testing, extra 2.50
- 4 Matched Sylvania Tubes 2.25
- All Metal Crystal Cabinet 2.25

"Buddy-2" 2-Tube A.C.-D.C. Receiver
 (operates on either A.C. or D.C.) Makes use of 1-6J7 metal tube and 1-12A7 as a combined rectifier and pentode output tube. Furnished with four plug-in coils which tune from 15 to 200 meters. Additional coils to extend the range down to 9½ and up to 2000 meters are available.



- Complete kit of parts including pictorial and schematic wiring diagrams, unwired, less tubes, cabinet and additional coils \$ 4.50
- Wiring and testing, extra 1.25
- 2 Matched Sylvania tubes 1.50
- Crystallized metal cabinet95
- 9½-15, and 200 to 2000 meter coils 1.75



Improved "Scout" One and Two Tube Battery Receivers
 These two popular models have been completely revised and brought up-to-date. The one tube model now makes use of a '19 type dual triode tube to provide two tube performance.

The two tube model now makes use of 1-1A3 screen grid, high gain tube and one type 35 pentode output tube, which in some cases will permit loud speaker volume. The kits are both furnished with pictorial and schematic diagrams to permit quick assembly and wiring.

- | | |
|---|---|
| One Tube Model | Two Tube Model |
| Complete kit, unwired, less tube, phones and batteries \$2.95 | Complete kit of parts, unwired, less tubes, phones and batteries \$4.25 |
| One Type 19 Sylvania Tube55 | Set of 2 Matched Sylvania Tubes 1.39 |
| Wiring and testing, 1.00 | Wiring and Testing, 1.25 |
| Set of Matched Light-weight phones, .89 | Matched set of lightweight phones, .89 |
| 1-45 V. and 2-1½ Volt batteries 1.39 | 2-45 and 2-1½ Volt batteries 2.28 |

Powertone 5 Meter Portable 3-Tube Transceiver

With proper conditions and localities this popular model permits a workable range up to 200 miles. It is a powerful low current consuming model featuring a unity coupled circuit. Once you have established contact there is no trouble in maintaining contact when switching to sending and receiving positions. Makes use of 1-30 and 2 type 19 tubes.



- Complete kit of parts including pictorial and wiring diagrams, unwired, less tubes, cabinet and microphone \$ 9.50
- Set of 3 matched Sylvania Tubes 1.48
- Portable All Metal Cabinet 1.95
- Wiring and Testing 2.50
- R.C.A.-Victor Hand Microphone 1.75

TRY-MO RADIO CO., INC.
POWERTONE ELEC. CO.

855 Cortlandt St. N.Y. C.
179 Greenwich St. N.Y. C.

Receiver-Adapter Unit for Ultra Short Waves

(Continued from page 270)

power cable furnishes filament and plate current.

Tuning in Stations

The tuning adjustment of the unit is the same regardless of whether it is used as a receiver or as an adapter. First, the regeneration control is turned up until a soft hiss, denoting super-regeneration is heard. Then stations are tuned in by slowly turning the variable condenser. When the set is tuned to a station the hiss is "knocked out" by the carrier wave of the station and only the signal is heard. *The set is most sensitive at the point where super-regeneration begins.* Adjustment of the coupling between the antenna coil and the tuning coil may be necessary to eliminate "dead-spots."

When used as a receiver the unit requires a 6.3 volt filament supply—storage battery, four dry cells, filament transformer, etc.—and a single 45 volt "B" battery. However, too long leads and other careless construction may necessitate higher plate voltage in order to obtain super-regeneration.

Since receivers differ so widely, successful use of the unit as an adapter must depend somewhat upon the ingenuity of the builder. It is easiest to use an adapter with a simple regenerative or tuned R.F. receiver,

Parts for Shuart's
W2AMN 5-meter MOPA
in stock

The Chi Rad complete kit for the 6L6 5-meter MOPA enables you to build this excellent transmitter at an extremely low cost.

We are also prepared to quote prices on the modulator equipment for the above transmitter. Write for details.

CHICAGO RADIO APPARATUS
W9RA—COMPANY, Inc.—W9PST
 415 S. Dearborn St. Chicago, Ill.

...Class B Modulator **\$2.79**
 Kit for 53, 79, 46, 59, 49, with Transformers LESS TUBES

Specify Tubes to be used

Write for full Information on

The Little Giant S. W. Receiver

Summer specials on Ultra-High Frequency Parts Transceivers and Tubes.

M. & H. Sporting Goods Co.
 512 Market St., Phila.

custombuilders
 5 & 10 Meter MOPA



- 100% Modulation Capability
- No Frequency Modulation
- Crystal Control on 10 Meters
- Built-In Power Supply
- 35 Watts Input • \$57.00 less Tubes
- With Modulator and Cabinet, less tubes \$94.00

We invite your inquiries.
custombuilders 56 West 45th St., New York

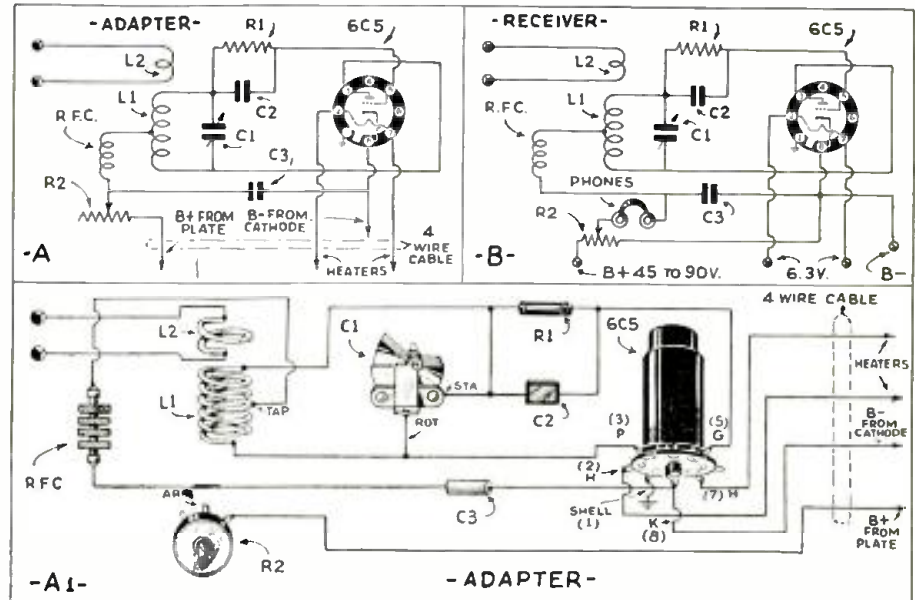

Diagrams above show "adapter" circuit connections, and also the hookup when the one tube unit is wired for use as a "receiver."

Note that there should be just enough space between the stator of the tuning condenser and the grid prong of the tube to mount the midjet grid condenser and grid resistor. The lead between the rotor of the condenser and the plate of the tube should be less than one-half inch long. The .006 mf. mica condenser is soldered directly between the end of the ultra high frequency choke and the cathode prong of the tube socket. The leads between the variable condenser and the pin-tip jacks used for coil mounting should likewise be very short. These jacks are mounted on a strip of hard rubber, or preferably vitron, or other high grade insulating material. A similar strip of insulating material holds the binding posts used for making connection with the antenna. If a single wire antenna is used, one binding post is "grounded" to the cathode prong of the tube. The stiffness of the wire is sufficient to support the antenna coil which is closely coupled to the grid coil.

The variable resistor is mounted on the panel. An insulated coupling is used between the variable condenser and the dial to eliminate hand capacity. A four-wire

although the experienced builder who understands the circuits may successfully apply it to even a complex broadcast-band super-heterodyne. Regardless of the type of receiver, the first step is to determine which tube precedes the first audio stage. The tube is then removed and the number of prongs noted. Then a plug with the same number of prongs—it may be an old tube base—is obtained and the power cable from the adapter-unit is soldered to this plug. The two wires in the cable which connect with the "heater" terminals on the 6C5 socket are wired to the heater prongs on the plug; the B minus wire in the cable goes to the cathode prong, and the B plus cable wire is wired to the plate prong. Other prongs which the plug may have are not used.

Example of Use As An "Adapter"

Perhaps a specific example will make this clearer. The adapter shown in the photographs was built up for a friend who uses it with an I.C.A. Universal Mascot receiver which has the following tube line-up: '78 tuned R.F. stage, '37 detector, '77 first audio, and '42 pentode power output tube.

Since the '37 detector precedes the first audio stage, the super-regenerative adapter replaces this tube and the plug on the power cable has five prongs to fit in the type 37 tube socket. Four of the prongs on the plug are used; the two heater prongs to furnish heater current and the plate and cathode prongs to furnish "B" current. The fifth, or grid prong, is disregarded.

In using the adapter, the adapter plug is placed in the type 37 tube socket. Whichever plug-in coil happens to be in the receiver is left there so that the power supply may feed through the tickler coil to the plate prong of the adapter plug. The antenna is, of course, connected to the adapter unit and all tuning is done with the adapter. Thus we have in effect a type 6C5 super-regenerative detector, followed by a type 77 first audio and a type 42 second audio. This combination works very well and allows loudspeaker volume on all stations. One of the most frequently heard ten-meter stations is K6MVV, an amateur phone station in Hawaii, which is often R8-9 during the afternoon (in Grand Island, Nebraska). As most listeners know, the five and the two and one-half meter bands are useful chiefly for "local" communication.

Of course, it is assumed that this unit will be used as an adapter with sets using 6.3 volt tubes. To use it with 2.5 volt receivers it would be necessary to have a separate filament supply for the adapter, although plate voltage might be obtained from the receiver.

Parts List

- L1. ten meters:
 - 8 turns No. 14 enameled wire; 1 1/8 inch outside dia. form. 5 meters.
 - 4 turns No. 14 enameled wire; 1 1/8 inch outside dia. form. 2 1/2 meters.
 - 4 turns No. 14 enameled wire; 5/8 inch outside dia. form.
- L2. 2 turns No. 14 enameled wire; 1 1/8 inch outside dia. form.
- C1. .000015 mf. midget variable condenser.
- C2. .00005 mf. midget fixed condenser.
- C3. .006 mf. midget fixed condenser.
- R1. 10 meg. midget resistor (1/4 or 1/2 watt).
- R2. 0-200,000 ohm potentiometer (variable resistor).
- RFC. high frequency radio frequency choke.
- Misc. socket, binding posts, chassis, phone tip jacks, couplings, etc.

More Frequencies for Amateurs Demanded

More space on the air is needed by amateur radio operators in the future if they are to be able to most effectively perform such public service functions as the emergency flood communications work which elicited such high praise from press and public alike last March, it was stated recently by witnesses testifying on behalf of the amateur service at an engineering conference of the Federal Communications Commission.

K. B. Warner, secretary, and F. E. Handy, communications manager of the American Radio Relay League, national amateur organization, presented detailed arguments asserting the value of the radio amateur both from a technological and emergency communications standpoint, and showed the congestion in the major amateur bands to be so great as to hamper effective operation.

Ross A. Hull, a recognized authority on ultra-high-frequency work, presented detailed testimony on engineering considerations associated with allocations in this region, and outlined the amateur's work and future needs.

Although representing 92% of the stations in the United States, amateurs have but 7% of the frequencies below 60,000 kilocycles, Handy pointed out. Their congestion is so great that in the 7,000-7,300 kilocycle region, used internationally, there are over 400 stations jammed in every channel. In the 3,500-4,000-kilocycle band, where a great part of amateur emergency communications work is performed, there are 189 U.S. stations per channel on an average. Additional frequencies were requested by the League in both of these bands, as well as in the ultra-high-frequency region.

It's Ready!

YOUR NEW 1937

ALLIED RADIO CATALOG

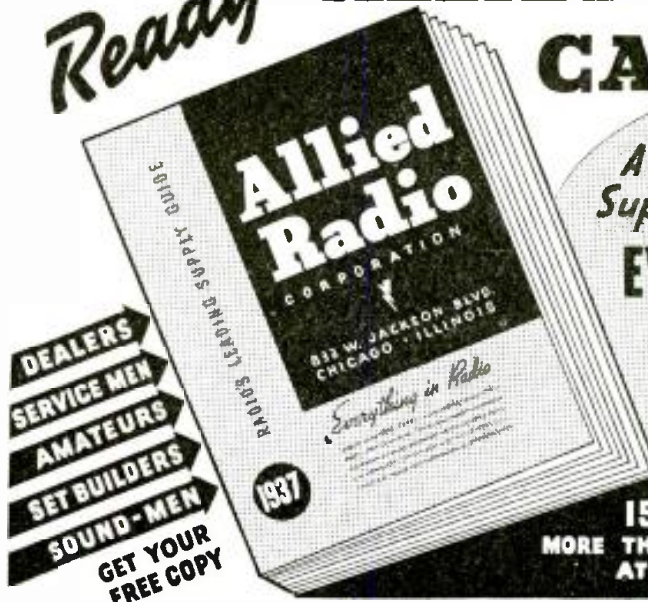

A Complete Supply Guide to **EVERYTHING IN RADIO FREE!**

152 BIG PAGES MORE THAN 10,000 ITEMS AT LOWEST PRICES

DEALERS SERVICE MEN AMATEURS SET BUILDERS SOUND-MEN GET YOUR FREE COPY

YOU NEED THIS BOOK

Here it is—the new 1937 ALLIED Radio Catalog—152 pages packed with Everything in Radio. 10,000 duplicate and replacement parts; latest types of amateur transmitting and receiving gear; newest test instruments; 1937's finest metal-tube, all-wave radio receivers; new kits for set builders; complete lines of advanced public address equipment; tools; books; etc. Everything for everyone in Radio at the lowest prices!

SERVICEMEN! Page after page of test equipment—newest tube-checkers, set-testers, analyzers, oscillographs, meters—as well as thousands of replacement parts, tools, books.

AMATEURS—Experimenters! A tremendous assortment of transmitters and receivers to meet every Ham requirement. Also dozens of build-your-own kits.

SOUND-MEN! An elaborate display of high quality Public Address equipment for every sound need. 8 to 60 watts; permanent, mobile, portable. In 110 volts AC, 6 volt, and universal models.

RADIOS! Newest 1937 models. All-Wave, Dual-Wave, and Short-Wave sets from 4 to 17 tubes. New metal-tube AC, AC-DC, 6 volt. 32 volt, battery and auto sets. Also Farmpower units and Windchargers.

No matter what your radio needs may be, you'll find them completely covered in the new 1937 ALLIED Radio Catalog. WRITE NOW FOR YOUR FREE COPY!



"I FIND EVERYTHING I NEED IN THE NEW 1937 ALLIED CATALOG. IT'S THE FINEST MOST COMPLETE RADIO SUPPLY GUIDE I HAVE EVER SEEN!"

ALLIED RADIO CORPORATION
833 W. JACKSON BLVD. CHICAGO, ILL.

Allied Radio Corp., Dept. 3-J,
833 W. Jackson Blvd., Chicago
 Send me your Free 1937 Radio Catalog. I am especially interested in _____

Name _____
Address _____

STOPPANI COMPASS

Thousands have been sold in all parts of the world. Cost the U. S. gov't. over \$30.00 each.



STOCK IS LIMITED

Rush your order before they are all sold.

Our price prepaid \$4.50 each
Gold Shield Products Co.
17 West 60th St. New York City

CORNELL-DUBILIER

TYPE TD DYKANOL
Transmitting Condensers

THE smallest . . . most dependable oil filled condenser available today!

Check these features and convince yourself

- Hermetically sealed in welded non-corrosive containers
- Equipped with glazed porcelain insulators.
- Will operate at 10% above rating without injury to unit.
- Fully fifty per cent smaller than previous types.
- Extremely inexpensive. check a few of the units listed below.

- 1 mfd. 1000 V.D.C. 2 1/2" x 1 3/16" x 1 1/16" \$2.50 list
 - 2 mfd. 1000 V.D.C. 4" x 1 3/16" x 1 1/16" 4.50 list
 - 1 mfd. 2000 V.D.C. 4 1/2" x 1 3/16" x 1 1/16" 5.25 list
 - 2 mfd. 2000 V.D.C. 4 1/2" x 2 1/2" x 1 1/2" 8.00 list
- Available in a complete capacity range from 600 to 100,000 volts D.C. Write for complete details today! Catalog No. 128 free on request.

CORNELL-DUBILIER CORPORATION
4376 BRONX BOULEVARD
NEW YORK

Please mention SHORT WAVE CRAFT when writing advertisers

RADIO INSTRUCTION

You Can Become a Fast, Capable RADIO OPERATOR at Home

With the Famous CANDLER Scientific Sound System



That trained Champion McElroy Whose Speed is 69wpm



FREE—1936 BOOK OF FACTS for Beginners, Radio ops and Amateurs. Contains McElroy's own story, how he learned code and became champion, also story of Jean Hudson, W3BAK, 9 year old World's, Champion in Class "E."

Fastest Amateurs and Com'l ops were CANDLER trained. You can learn Code RIGHT with the SYSTEM that taught the Champions. A card will bring this valuable BOOK to you. No obligation.



CANDLER SYSTEM CO. ASHEVILLE, N. C. Dept. S-9

MAC KEY AT \$7.95 finest speed key built

MAC OSC at \$3.95 ac/dc oscillator. Tone control. MAC CORD \$1.00 navy speed key cord. MAC MARINE receiver 550-850 meters. r u Int'l? Few deluxe MAC KEYS at \$15.00 fm mc dl. Wri me.

T. R. McELROY, 23 Bayside St., Boston, Mass. If u hv Mac Key wll me for any ipt & dsrb infn.

WATCH FOR THE NEXT "FAN" NUMBER, THE OCTOBER ISSUE, OUT SEPTEMBER 1ST

Be a TELEVISION EXPERT

LEARN TELEVISION with RADIO—NOW! Great opportunity for experts in this amazing new industry. Recent developments in radio make television a certainty NOW. We teach you by our "on the job" method Radio and Television from beginning to end in our previously equipped labs and studios. You actually operate thousands of dollars worth of expensive equipment. You get expert instruction and skilful guidance by radio-television specialists.

Demand for Television Experts Television now perfected and ready for the market ON THE NEXT BIG BUYING WAVE. Business leaders predict new system television will require thousands of relay and broadcasting stations. Ultra short waves will permit eighty thousand television stations in America alone.

GET IN NOW and build up with the world's next billion-dollar industry. 6 MONTHS THOROUGH PRACTICAL TRAINING. Quality instruction from home (1st Class). Complete up-to-date minute training materials with all able television equipment including the new cathode-ray. Practical experience in studio control room. Transmission operation of Television Station W3BAL. Employment and wage information upon graduation. Write for free book "Features On the Air NOW!"

S. Q. NOEL, Pres. First National Television, Inc. Dept. B-9, Power & Light Bldg., Kansas City, Mo. Without obligation, send me postpaid FREE Illustrated Book—"Features On the Air", telling of new opportunities in television. I am 17 years or older. Name Address

Radio Amateur Course

(Continued from page 283)

"dent" in the characteristic rushing sound of the super-regenerator.

In the output circuit of the super-regenerative detector, we find indicated a 75 to 100 mh. R.F. choke by-passed with two .002 mf. condensers. Theoretically, this choke should be relatively large. However, actual practice has proven that the usual 2½ mh. R.F. choke is entirely satisfactory. The idea of this filter is to keep the low frequency oscillations out of the A.F. amplifier grid circuit.

Battery-type Receiver

In Fig. 2, we find a self-quenching battery-type, 5-meter receiver, which is generally accepted as a good design for portable equipment. This uses a split-coil circuit and sufficient feed-back is employed to cause self-quenching in the detector circuit. The frequency of this "quench" is governed largely by the amount of feed-back, the size of the grid-leak, and the size of the grid condenser. The values given in the diagram are generally found satisfactory.

In Fig. 3 we have what is probably the most "popular" of all super-regenerative receivers. This is a self-quenching triode-detector with the pentode audio amplifier. This was originally introduced in the November, 1934, issue of *Short Wave Craft* and from it sprung a great number of receivers of the self-quenching variety. When first introduced, this receiver caused many unfavorable comments. The "old guard" experts frowned unfavorably upon this method, but gradually conceded that it is the best simple arrangements after all. It possesses many desirable qualities inasmuch as it is entirely self-regulating and when adjusted for the proper amount of feed-back, it is an extremely sensitive affair; undoubtedly more sensitive than the usual run of the older type separately quenched detectors. We here have used the cathode as an active R.F. element by connecting it two or three turns from the low potential end of the grid coil. In adjusting this type of detector, starting off with no plate voltage and raising it gradually, we find that at one point the detector will click into oscillation. And as the regeneration control is advanced further, raising the plate voltage, the detector will click again—this time into super-regeneration. It is just at the point beyond the second state of oscillation, where the detector is the most sensitive. Here too the 955 ultra high frequency tube may be used, but on 5 meters the conventional type, such as the 37, 76, or 56 will provide a much stronger audio signal. With the 955 two stages of audio frequency amplification would be necessary.

Tuned R.F. Stage Ahead of Detector

In Fig. 4 we have a more advanced receiver, employing a tuned R.F. stage ahead of the super-regenerative detector. The main advantage in this case is in the elimination of undesirable radiation of the detector. Super-regenerative detectors emit a strong squealing or modulated signal, which will interfere with other receivers located nearby, and for that reason it is advisable that where only a detector is used without R.F. ahead of it, the antenna coupling should be loose; and also the tubes should be operated with as low plate voltage as possible in order to limit this interference. Aside from overcoming this evil, the tuned R.F. stage provides an appreciable gain in sensitivity and makes the super-regenerative detector more easy to handle

YOUR CODE—IS IT FAST? COMPLETE?

INSTRUCTOGRAPH not only is the easiest, most practical method for beginners to learn code, but it gives the advanced operator the training needed to receive accurately, completely. When you own an Instructograph Code Teacher you can practice any time, at any speed desired. Comes in two models—Senior or Junior Economy, with complete Book of Instructions. You may buy or rent, at low cost. Send post-card for complete details now to:



INSTRUCTOGRAPH Company, Dept. SW-9, 912 Lakeside Place, Chicago, Ill. Canadian Representatives: Radio College of Canada, Ltd., 863 Bay St., Toronto

Short Wave League Members



IDENTIFY THEMSELVES WITH THE ORGANIZATION

In order that fellow members of the LEAGUE may be able to recognize each other when they meet, we have designed this button, which is sold only to members and which will give you a professional appearance.

If you are a member of the LEAGUE, you cannot afford to be without this insignia of your membership. It is sold only to those belonging to the LEAGUE and when you see it on another, you can be certain that he is a member.

Lapel Button, made in bronze, gold 35c filled, not plated, prepaid. Lapel Button, like one described above, \$2.00 but in solid gold, prepaid. Short Wave League, 99 Hudson St., N.Y.C.



Earn While Learning at Home! TELEVISION, PHOTO ELECTRIC CELLS, PUBLIC ADDRESS. Many R-T-Trained Men make up to \$75 a week and more in full-time radio job—\$5-\$15 in spare time alone. More trained men needed. Learn at home by quick, easy, R-T-I-WAY. Endorsed by 50 big concerns. Write for big Opportunity Book FREE. RADIO AND TELEVISION INSTITUTE, Inc. 2150 Lawrence Ave., Dept. 216, CHICAGO, ILL.

PHILCO CROSBLEY ZENITH GRUNOW and 46 other mfgs. endorse R-T-I

RADIO ENGINEERING

RCA Institutes offers an intensive course of high standard embracing all phases of Radio. Practical training with modern equipment at New York and Chicago schools. Also specialized courses and Home Study Courses under "No obligation" plan. Catalog, Dept. SW-36.

RCA INSTITUTES, Inc. 75 Varick St., New York. 1154 Merchandise Mart, Chicago. Recognized Standard in Radio Instruction Since 1909

QUICK WAY to make money in RADIO

Modern receivers are demanding men with modern training for service work. New training method and service equipment offer starts you earning almost at once. Up to \$3 an hour easy in a short time. Write today for FREE book of details. Radio Training Association of America Dept. S.W.C.-65 Chicago 4525 Ravenswood Ave.

RADIO COURSES

RADIO OPERATING: Prepare for Gov't License Exam. RADIO SERVICING: Including Short Wave. AMATEUR CODE. New Course in ELECTRONICS: Day and Evening Classes. Booklet Upon Request. New York YMCA Schools 6 W. 64th Street, New York City

RADIO ENGINEERING

broadcasting, aviation and police radio, servicing, marine radio telegraphy and telephony, Morse telegraphy and railway accounting taught thoroughly. Engineering course of nine months' duration equivalent to three years of college radio work. All expenses low. Catalog free. School established 1874. Dodge's Institute, Turner St., Valparaiso, Ind.

Please mention SHORT WAVE CRAFT when writing advertisers

and smoother in operation. In the diagram in Fig. 4 we show a pentode in the R.F. stage which may be of the conventional glass type, or of the newer metal type tubes, or the Acorn 954 pentode. The 954 in this case is decidedly better than the others, in so far as gain is concerned. The detector and A.F. portions of this receiver are identical to the one shown in Fig. 3. Inductive coupling is preferable between the R.F. and detector stages. However, in Fig. 4A, we show a method of coupling through a capacity with shunt voltage feed to the plate of the R.F. amplifier. In this case the most effective coupling is brought about by tapping on to the detector coil at about the mid-point.

In each of the circuits we have shown the antenna either tapped on to the grid coil of the input stage, or through a coupling coil. However, if a doublet antenna is used the coupling coil of course, is recommended. However, for a single-wire antenna or one having a single-lead, tapping the antenna on to the grid coil, near the low potential end, is preferable to the older method of tapping it directly on to the grid side of the coil. The method shown in the diagrams permits a greater variation in the degree of coupling, without appreciably affecting the calibration of the grid tuning condenser. Tuning of the R.F. stage is similar to all other receivers, as the R.F. stage comes into resonance with the detector stage, there will be a slight dip or decrease in the rushing sound and it will be necessary to advance the regeneration control for proper results.

Type of Antenna

Nearly any type of antenna will work with the 5-meter receiver. Aside from the doublet, the most effective antenna has been found to be a single eight foot wire with the lead-in tapped directly on the top as shown in Fig. 4B. The lead-in should come directly from the top of the antenna, at an angle of approximately 45 degrees, and should be no closer than this to the antenna proper. The length of lead-in does not seem to be important and tests have proven that stations which could not be heard on many other antennas came in at an R5 or 6 strength with the one shown.

In the tuned circuits of each receiver we have shown a 15 mmf. condenser and have given the sizes of the inductances. This does not provide an appreciable amount of band-spread and to increase this, remove one or two plates from the 15 mmf. condenser and add turns to the coil. The Acorn tubes will require a greater number of turns in the coil than the large glass or metal tubes. In each case the coil may be adjusted by spreading or collapsing the turns, in order to place the band well within the range of the dial. This same method is used for tracking the R.F. and detector stages.

In our next lesson we will discuss various types of superheterodyne receivers for ultra high frequencies.

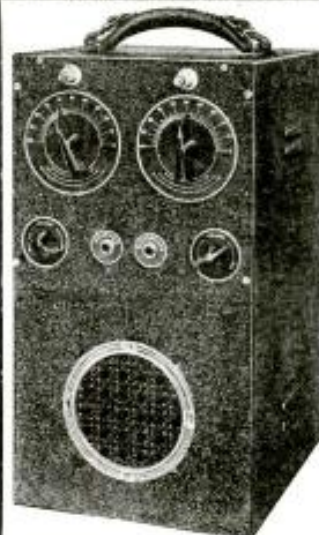

"ULTRA DUPLEX" 5-TUBE BATTERY PORTABLE

2 1/2 TO 5 METERS (56 TO 120 MC)

Embodying all the latest innovations of the ultra high frequency field, this really compact and separate receiver and transmitter successfully fulfills the innermost desire of the Amateur for trouble free duplex operation. The receiver consists of a 1C6 detector operating on an entirely new and heretofore unharnessed principle, and a 1F4 amplifier. The new 1E7G Class A modulator together with a 1B4 speech amplifier and 19 oscillator comprise the transmitter. Separate antennas are used to insure peak performance of both units at any frequency settings. A workable range of 200 miles may be expected in ideal localities.

Supplied complete with all coils, including coil for 10 meter reception.

- ★ 1C6-1F4-19-1B4-1E7G
- ★ Positively duplex
- ★ Built-in loudspeaker
- ★ New type detector circuit
- ★ 100% Class A modulation
- ★ Extremely low current drain
- ★ Absolutely non-radiating
- ★ Increased effective sensitivity

Complete with built-in speaker, and cabinet with battery compartment, wired and tested, less tubes, batteries, microphone and antenna. \$19.95

Set of 5 Sylvania tubes...\$4.62
Hand microphone.....\$1.95
Adjustable 8 ft. Antenna \$1.60



3-Tube Portable Transceiver (2 1/2 TO 5 METERS)

(Built-in Loud Speaker)

A compact powerful 2 1/2 & 5 meter portable transceiver designed for loud speaker operation, is now available in the Ultra 3 B. This remarkable unit will be found capable of maintaining positive contact when communication is once established. Class A 100% modulation is employed. This has been made possible by the new 2 Volt tubes; 1F4 Class A modulator—1B4 high gain speech amplifier. These together with a 19 tube, Oscillator-Super regenerative detector result in an ideal transceiver. When used as a receiver loud speaker volume is assured. In ideal localities a workable range up to 200 miles may be expected.

Supplied complete with all coils, including coil for 10 meter reception.

| | |
|---|---------------|
| Complete kit of parts (including all coils, less batteries, tubes, speaker, microphone and cabinet, unwired)..... | \$9.95 |
| Wired and tested..... | \$2.50 |
| Sylvania, 19 1F4, 1B4 set of 3 matched tubes..... | 2.50 |
| Cabinet with built-in speaker and battery compartment..... | 2.25 |
| Cabinet less built-in speaker with battery compartment..... | 1.95 |
| Cabinet less built-in speaker, less battery compartment..... | 1.10 |
| Hand microphone..... | 1.95 |
| Matched speaker..... | 1.25 |



Ultra 4A- 4-Tube A.C. Operated Transceiver

(2 1/2 to 5 Meters)

In the design of the Ultra 4A, A.C. operated transceiver, every tradition of radio value has been incorporated. Built-in dynamic speaker, self contained power supply, Class A 100% modulation are only a few of the outstanding features of this "Ultra High Frequency" product. The new all metal tubes are used as follows: 6F6, Class A modulator—Power amplifier, 6J7, high gain speech amplifier—1st A.F. amplifier, 5Z1, rectifier, 6A6, Oscillator-detector. The Ultra 4A is completely filtered at both R.F. and A.F. Levels. Automatic phone jack silences speaker. Tuning range 2 1/2 to 5 meters with 5 watts output.

Supplied complete with all coils, including coil for 10 meter reception.

| | |
|--|----------------|
| Complete kit of parts (including all coils, less cabinet, tubes, microphone, unwired)..... | \$15.95 |
| Wired and tested..... | \$3.00 |
| Black wrinkle finished cabinet..... | 2.50 |
| Sylvania 6A6, 6J7, 6F6, 5Z1 matched set of 4 tubes..... | 3.40 |
| Hand microphone..... | 1.95 |

Pictorial diagram furnished with kit.

WRITE IN FOR FREE DESCRIPTIVE ULTRA HIGH FREQUENCY LITERATURE
ULTRA HIGH FREQUENCY PRODUCTS COMPANY 140 LIBERTY STREET
 NEW YORK, N. Y.

Good News from COCO!
 Editor, SHORT WAVE CRAFT:
 Station COCO of Havana, Cuba, broadcasts a special English program of the Corporacion Nacional Del Turismo every Sunday night from 8-10 p.m., E.S.T. They invite listeners to write in and the best letter submitted each month is awarded as a prize, a case of 12 bottles of "Bacardi Carta Oro," that famous Cuban drink. I won the award for April. But winner or not, every "writer-in" receives free a large illustrated booklet on Cuba.—Ernest J. Orishek, 118 White St., Westfield, Mass.



BLILEY LD2 CRYSTAL UNIT

A powerful, highly active, low drift crystal unit for the 40, 80 and 160 meter bands.
 At all Bliley Dealers \$4.80
BLILEY ELECTRIC CO., ERIE, PA.

2-Tube with 9 1/2 to 2000 Meter Range

(Continued from page 280)

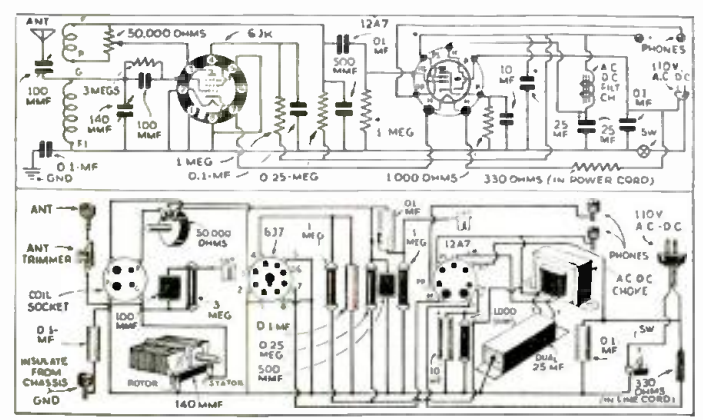

The 2-tube "head-phone" receiver illustrated on the previous page containing the general description of the set, with a range of 9 1/2-2000 meters, is illustrated in diagrammatic form in the picture at the left. Plug-in coils enable the operator to immediately convert the set for the different bands.

American Microphone Co., Inc.
CRYSTAL, ELECTROSTATIC CARBON, AND CONDENSER
 Microphones, Stands, and Accessories
New catalogue available upon request.
 1915 South Western Ave., Los Angeles, Calif.

Please mention SHORT WAVE CRAFT when writing advertisers

YOUR VOICE HUMAN ?



Give the pleasing, individualizing elements in your voice a chance.

HiLevel

start and 8' cable

List \$25.00

On your fone rig HiLevel gives you a full HUMAN voice.

Specifications: output level minus 54 D. B. Frequency response flat from 300 to 6000 cycles.

Learn of "clipped voice" in micro-phones. Send us this ad and your return address.

The TURNER COMPANY

Cedar Rapids, Ia.

Licensed under patents of Brush Development Co.

H. G. CISIN'S METAL TUBE PRE-SELECTOR

3-Tube Kit

\$6.95

Complete Kit with all coils, high-quality Find-All parts and including drilled chassis, less tubes, unwired. Set of 3-Matched Metal Tubes \$2.95 Above Kit wired and laboratory-tested—\$2 extra

H. G. CISIN, CHIEF ENG. ALLIED ENGINEERING INSTITUTE

98 Park Place Dept. S-28, New York, N. Y.

A REAL POWER PACK

at an unusually Low PRICE Only a Few Model X left 325 Volts PURE DC at 50 Milli-ampers and 2 1/2 Volts AC CT 5 Amperes. Completely wired and tested. Built on heavy steel chassis, finished in brown crackle. A rare bargain. Uses type 80 tube. Hurry, before they are all sold. SPECIAL PRICE, only **\$3.48** less tube

MODULATORS

8 Watts

Model X-6. Uses two 2A5 tubes, comes completely wired and tested. Has single button mike transformer and choke coupling to transmitter. Complete less power or tubes. Special **\$3.98**

12 Watts

Model X-7. Uses a 7S and two 42 tubes, completely wired and tested. Has double button mike transformer and choke coupling to transmitter. Complete less power or tubes. The best bargain in radio. Special **\$4.98**

The General Engineering Corp. Dept. S-9 Charlotte, Michigan

Manufacturers of
VITREOUS TRANSMITTING GRID LEAKS
VOLUME CONTROLS • POWER RHEOSTATS
Write for Complete Free Catalog
ELECTRAD, Inc.
175 Varick Street, New York

Build Your Own
Wind Charger from old auto generator. We show you how. Make money building for others. Light your buildings and play radio. Dime brings complete plans and catalog. 20 other generator changes, motors, welders, electric fans, electric lighthouse motor, etc. Satisfaction guaranteed.
LeJay Mfg. Co., 1417 Lake, Minneapolis, Minn.

The New National NC-100 Receiver

(Continued from page 278)

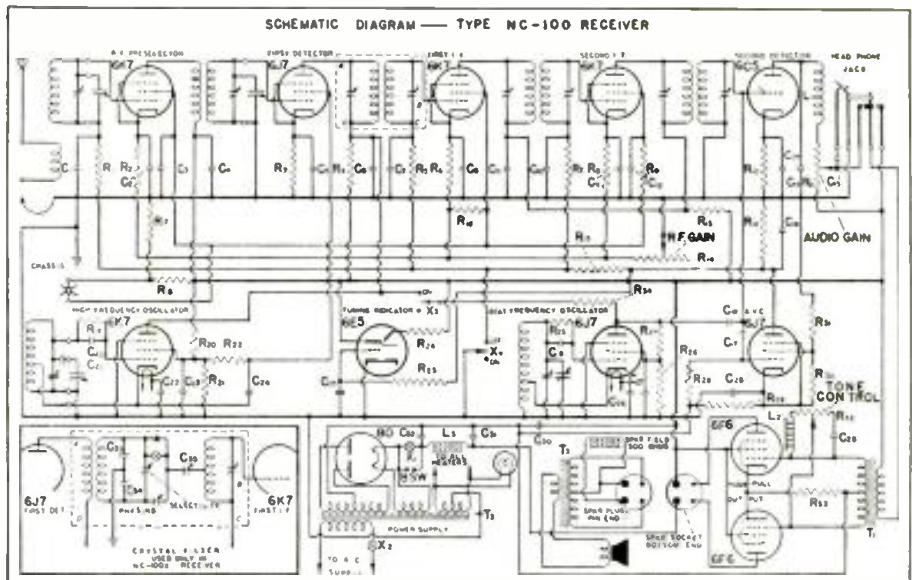

Diagram of NC-100 Receiver.



Detail of coil shield box.

mended, since vibration from the speaker is apt to be transferred to the tubes, producing microphonic noises.

Tuning Controls: The main tuning dial is located near the center of the front panel and operates the 3-gang tuning condenser. This dial is of the multi-revolution type operating through a spring-loaded gear train having a step-down ratio of 20 to 1. In tuning across any one coil range, the dial makes ten complete revolutions and since its diameter is four inches, the equivalent scale length is approximately twelve feet. There are fifty divisions about 1/4" apart around the circumference of the dial and the index numbers are changed automatically as the dial is rotated by means of an epicyclic gearing, so that the calibration is numbered consecutively from 0 to 500. The index numbers are actually changing continuously, the shift occurring at the bottom of the dial where it is not ordinarily visible.

Through this mechanism it is thus possible to obtain a continuous dial reading from 0 to 500, with the result that all signals are well spread out on the scale, making tuning and logging both convenient and precise.

above, is not used at all. The input impedance of the receiver varies over the total frequency range but averages about 500 ohms.

Output Circuit: As shown in the schematic diagram herewith the output leads of the receiver are brought to a 4-prong socket, which is mounted at the rear of the chassis. The speaker furnished with the receiver is supplied with a cable and plug, which is simply plugged into this socket.

A **headphone jack** is mounted on the front panel and is wired in such a manner that the speaker is quiet when the phones are in use. The impedance of the headphones should be approximately 20,000 ohms, this being the usual impedance of phones having a total DC resistance of between 2000 and 3000 ohms. The receiver cannot be operated unless the speaker plug is inserted in its socket, even though the speaker itself is not being used.

Speaker Mounting: The speaker is supplied either in chassis form, unmounted, or mounted in a small cabinet finished to match the receiver. To obtain best tone quality the speaker should be mounted on a large baffle isolated mechanically from the receiver. The baffle should be of non-resonant material, so that it will not vibrate. A baffle three or four feet square will generally prove satisfactory. More uniform bass response will be obtained by increasing the baffle size up to about 9 feet square.

Mounting the speaker and receiver in the same cabinet, or console, is not recom-

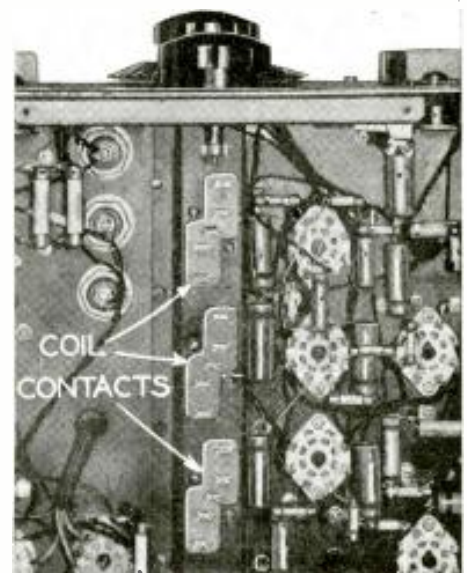

The coil pin-contact springs are clearly shown in this photo.

Please mention SHORT WAVE CRAFT when writing advertisers

The tuning system is so arranged that the dial reading increases with frequency, as shown by the calibration curves.

Range Selector: Immediately below the dial is the range selector knob which actuates the coil changing mechanism. This knob must be rotated approximately one turn to change from one range to another. The arrangement is unique in that each individual coil is completely shielded from all others and that only the coils actually in use are in any way connected in the circuit. This automatic "plug-in coil" system is extremely efficient. Dead spots, often occurring when using unshielded coils in conjunction with a switch are, of course, completely absent and the particular coils in use are in the best position both mechanically and electrically. The relatively large movement of the coils, when changing from one range to another, makes possible the use of rugged contactors of such construction that trouble-free performance is assured.

Band Indicator: The five coil ranges are marked on the front panel in a horizontal line directly over the range selector knob. Each of the range markings has a small "window" in back of which an indicator appears when that particular coil assembly is plugged into the circuit.

Starting at the lefthand side of the front panel the uppermost knob is a *tone control* for varying the frequency characteristic of the audio amplifier. When the control is rotated to the extreme counter-clockwise position, high frequency cut-off occurs at about 1500 cycles. In the mid-position (zero) the characteristic is flat from 50 to 10,000 cycles. At the extreme clockwise position, low frequency cut-off starts at 300 cycles, and the characteristic rises (about 6 db.) between 1000 and 5000 cycles. When receiving strong signals free from interference, best audio quality will be obtained with the tone control set at 0. When receiving fairly weak signals through considerable interference, it is often helpful to retard the tone control so that the noise will be reduced in relation to the signal.

Below the tone control is a *combination switch*. In the extreme counterclockwise position the receiver is turned off; in the mid-position all heater circuits and the rectifier are turned on but no B-voltage is applied; in the clockwise position the B+ is turned on to place the receiver in operating condition. In other words, the righthand switch position is used for temporarily rendering the receiver inoperative as required during periods of transmission.

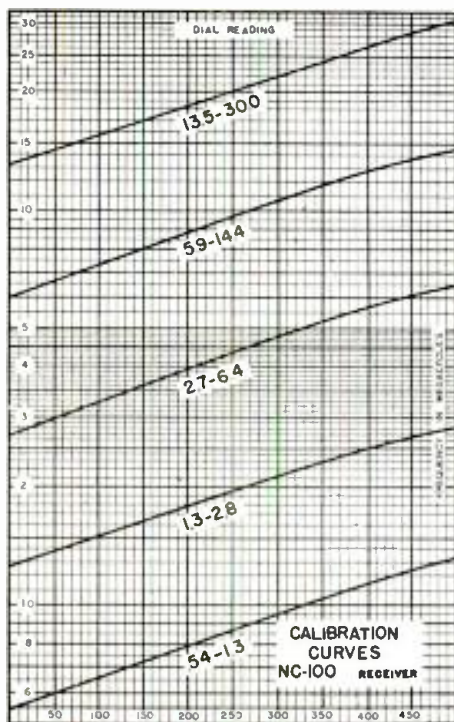

The various bands are covered in the manner graphically shown above.

SARGENT MODEL 11 UNIVERSAL—9.5 to 20,000 Meters

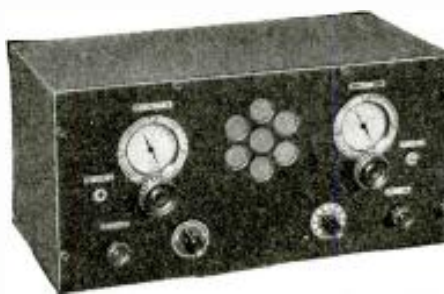

RADIO OPS!! Here's the receiver you've been waiting to hear about. Continuous tuning, without a break, from 9.5 to 20,000 meters. Dial calibrated all the way. Antenna trimmer, hand spreader on all waves, break-in switch, phone jack—everything a real operator's receiver should have, and housed in our new attractive all-metal tray-type cabinet. A.C. models use 5 tubes, D.C. and battery models, 4, (one single r.f., regenerative detector, 2 audio. Tuned r.f. circuit. Built to highest standards of engineering design. Full efficiency at short waves. Extension of tuning range introduces no additional losses, couldn't be better if designed for short waves only. Available in 3 tuning ranges.

Net prices on A.C. models follows:
Model 11-1A, UNIVERSAL TUNING RANGE,
 9.5 to 20,000 meters.....\$75.00
Model 11-1A, MARINE TUNING RANGE,
 9.5 to 3,750 meters.....\$54.00
Model 11-1A, AMATEUR TUNING RANGE,
 9.5 to 550 meters.....\$46.00
 Prices include power supply, speaker, R.C.A. tubes. Available for D.C. and battery operation, also A.C. D.C. with separate power pack. Write for details. **IMMEDIATE DELIVERY.**

Model 10—One tuning range only, 9.5 to 550 meters. Basic circuit similar to Model 11. A complete amateur receiver with hand strand, built-in speaker and power supply, complete with R.C.A. tubes. \$37.50 net for A.C. model. Available also for D.C. and battery. Write for details.

FROM the ultra highs to the audio frequencies! That is the tuning range of Model 11 Universal. Not only has this tremendously wide frequency range been covered efficiently throughout, but short wave performance has been improved over anything previously offered in a tuned r.f. receiver. Model 11 is an engineering achievement of the first order, and it sets a new standard of tuned r.f. performance. We believe it to be the finest receiver of its type ever manufactured. The extreme sensitivity, quietness and flexibility for which I.F. receivers are noted, have been retained in full and selectivity has been improved to such a point that it is matched only by the most expensive, multi-tube receivers.

AMATEURS—A COMPANION RECEIVER FOR THAT BIG SUPERHET

Owners of well equipped amateur stations pride themselves upon being ready for all emergencies. No one knows when emergency conditions might require reception of signals on 600 meters, or from the airplane beacons or long wave navy station. When the emergency arrives there is no time to buy-wire a long wave receiver.—the amateur that is the hero and saves the day is the one who has the right equipment on hand to start with. Besides its emergency use, Model 11 is an excellent stand-by receiver.—so good in fact that the larger sets begin collecting dust about the time Model 11 goes in the shack! It has every feature that appeals to the experienced wireless operator, and will be a friend to either the C.W. or the phone man.

IMMEDIATE DELIVERY

We specialize in receivers for long wave coverage, and for D.C. and battery operation as well as for A.C. (but D.C. and battery receivers are engineered as separate units, not re-hashed from A.C. designs). Our long wave receivers are not simply short wave sets with some additional coils hooked into the circuit. These receivers are planned, laid out, designed for high efficiency on the long waves as well as short. For almost any type of service they will give satisfaction on the wavelengths covered.

E. M. SARGENT CO.
 212 9th St., Oakland, Calif.

There are two insulated terminals mounted at the back of the receiver chassis, which are connected in parallel with the B+ switch. They are intended to serve as a convenient means for connecting a relay for automatically turning the receiver on and off.

To the right of this switch is the *manual R.F. gain control*. This control is ordinarily used only for receiving c.w. signals but may, of course, be used as a conventional volume control if the operator does not wish to use the AVC system. With the automatic volume control circuits in operation, as explained later, the R.F. gain control is limited in its action and is useful principally in adjusting the maximum sensitivity of the receiver. For instance, if local noise and static level is high, the R.F. gain control need only be advanced to the point where the disturbance is just plainly audible. Signals may then be tuned in with the AVC on but interchannel noise will not be objectionably high. It will be found that after a signal is tuned in, further advancing the control has no effect on output, inasmuch as the AVC characteristic is practically flat.

To the right of the *range selector knob* is the *audio gain control*, the primary purpose of which is to control volume (on either head phones or speaker) when using AVC. When using the manual R.F. control, the audio gain should not be retarded too far. If, for instance, it is set below three or four on the scale, audio output will be limited to the point where I.F. overload may occur before maximum output is reached.

The knob at the lower righthand corner of the front panel is a combination switch having three positions. In the counterclockwise position the AVC circuits are in operation; in mid-position the AVC is turned off; in the clockwise position the c.w. oscillator is turned on, the AVC still being off.

Above this switch is the c.w. oscillator vernier tuning control which varies the frequency of the oscillator over about 10 kc.

Electron Ray Tuning Indicator

Near the tuning dial is mounted a pilot light, or bullseye, and an electron ray tuning indicator. The pilot is lighted at all times when the AC switch is turned on, but the tuning indicator is lighted only when the B+ switch is on. The purpose of the tuning indicator is to provide a visual means of accurately tuning phone signals. The shaded portion of the tuning indicator

THE LITTLE RIGCHECKER

ANOTHER USEFUL GADGET

By A. J. HAYNES

If you MUST economize or don't think field strength measurements are necessary the LITTLE Haynes Rig Checker will still do most everything else around the shack but call C.Q.

Operates direct from your A.C. line—No batteries.

FEATURES: 1. Monitor: Voice quality, hum, key clicks, etc. 2. Over modulation indicator. 3. V.T. Voltmeter, A.F. or R.F., linear scale. 4. D.C. Voltmeter. 5. Receiver Tuning and Signal Strength Indicator. 6. 0-1 Milliammeter—may be used separately with or without variable shunt or fixed series resistors.

Operates direct from your power line—no batteries.

The LITTLE Haynes Rig Checker, complete with tube.....\$9.85

The BIG Haynes Rig Checker, complete with self contained batteries and tube and 7 plug-in coils.....\$17.90

Write for literature

RADIO CONSTRUCTORS LABORATORIES
 Dept. SW9, 136 Liberty St., New York, N. Y.
 Export Dept., 105 Hudson St., N. Y. C.

MODERNIZE YOUR TRANSMITTER WITH THE LATEST NATIONALLY ADVERTISED RADIO PARTS WE STOCK EVERYTHING IN AMATEUR EQUIPMENT
 Write for free catalog

CAMERADIO
 601-3 GRANT ST., PITTSBURGH, PA. • 30 TWELFTH ST. WHEELING, W.VA.
 Established 1919

OXFORD NEW SPEAKERS
 with "Changeable Fields" and Universal Transformer, bring you new convenience, performance and economy in Speaker Replacements. Ask your Jobber or Write today for Bulletin 3615.
OXFORD-TARTAK RADIO CORP.
 917 W. VAN BUREN ST., CHICAGO, U.S.A.

Please mention SHORT WAVE CRAFT when writing advertisers

WORLD WIDE ALL WAVE RADIO



ONE TUBE KIT ONLY \$1.25

Haven't you always wanted a Real Powerful Radio Receiver. all your own? A Short and Long Wave set that will actually bring in many foreign stations from all parts of the World, police calls, airplanes, amateurs, etc., as well as your local stations. ACE Radios give GUARANTEED RESULTS! Thousands now in use. Amazing Performance!

Now, the world famous ACE Construction Kits are priced so low that anyone can afford one! For only \$1.25 we send you, postpaid, every part needed to build a powerful one tube receiver with heavy, attractive metal chassis-panel. Not a feeble crystal set! Works on two inexpensive dry batteries. Later, you can change your set into the Two Tube Battery or All-Electric set at special low cost! You get a valuable radio education by wiring it yourself from our clear diagrams. It's easy for even a child! Just a few simple connections. Wave-lengths range 15 to 160 meters.

FOR MORE POWER AND VOLUME \$2.00 BUY THE TWO TUBE KIT

ALL ELECTRIC TWO TUBE RECEIVER \$3.00

Order now! NOT A TOY OR AN ATTACHMENT!! ACE RADIO LABORATORIES

1619 Broadway Dept. C-9 New York City

SPORTS BINOCULAR

A real high-power field glass that enables you to enjoy such sporting events as Baseball, Boat Races, Horse Races, etc. Most useful on Auto Trips, Hunting, Outings, Beaches, etc. It's a real buy at a fraction of its worth.



PARCEL POST PREPAID \$1.50

Money back guarantee. You can't lose!

GOLD SHIELD PRODUCTS CORP.
17 West 60th St. Dept. S. New York City

RADIO'S LIVEST MAGAZINE



8 Months for \$1.00

RADIO-CRAFT
99C Hudson Street New York, N. Y.

WANTED BRANCH MANUFACTURERS

by old established firm, to cast Christmas goods, 3 and 10c Novelties, Toy Autos, Ashtrays, etc. Can be handled in any spare room, basement or garage. No experience necessary as we furnish full instructions with moulds. A rare opportunity for these times, so if over 21 and you want to devote your spare or full time to profitable work write AT ONCE for full details as we are now closing arrangements for supply of our goods.

METAL CAST PRODUCTS CO.
1696 Boston Road, Dept. 27, New York, N. Y.

We Make to Your Specifications

Metal Cabinets, Chassis, Shield Cans to fit Chassis, Panels—Aluminum or steel.

Send us your drawing for estimates.

KORROL MFG. CO. Inc., Dept. S-9
232 Greenwich St., New York City

normally covers a sector of about 90 degrees. When tuning in a signal, the shaded area will become smaller, correct tuning being indicated by the smallest angle. Certain individual electron ray tubes may be of such construction that the shaded area disappears entirely when receiving a strong signal and the bright green edges of the pattern may actually overlap. In this case, tuning is correct when the overlap is the greatest. As a general rule, the R.F. gain control should be retarded to a point where the edges of the pattern are still separated, the angle being about 15 degrees. Turning on the C.W. oscillator will make the tuning indicator inoperative, the pattern being the same as that resulting from an extremely strong signal.

On models of the NC-100 having the crystal filter (NC-100X) two additional controls are provided, and these are mounted at the righthand side of the tuning dial. The uppermost knob is the selectivity control of the crystal filter. With the filter in use, minimum selectivity will be found with the pointer nearly vertical. Rotating the knob in either direction from this position will increase selectivity. When the filter is not in use, the knob should be set at the point giving maximum volume and sensitivity.

Immediately below the selectivity control is the phasing control and crystal filter switch. Turning this control to zero disconnects the filter; at any other setting between 1 and 10, it acts as a phasing condenser for balancing the crystal bridge circuit, eliminating heterodynes, etc.

Phone or Broadcast Reception: In receiving phone signals, the AVC may or may not be used, as desired. If it is not used, we suggest operating the audio gain control about halfway on and controlling the sensitivity with the R.F. gain control. If the operator prefers a "quiet" receiver, the audio control may be operated at 1 or 2. If AVC is used, the R.F. gain control should be well advanced and output is adjusted by the audio gain control only. The setting of the two gain controls is largely a matter to be determined by the preference of the operator and by receiving conditions. If, for instance, local noise or atmospheric static is high, it will be desirable to retard the R.F. gain control so that the sensitivity of the receiver will be held to a definite maximum. The c.w. oscillator may be used for locating carriers, in which case it is advisable to retard the audio gain control in order to avoid excessive volume when switching over to AVC. When tuning over any band, or when hunting for signals, the background noise between stations when using AVC may be objectionable. In this case, again, the audio control should be retarded and may even be turned to the off position, signals being shown by the tuning indicator.

C.W. Reception: When receiving c.w. signals, the c.w. oscillator must be turned on. Best signal-to-noise ratio will usually be obtained by retarding the audio gain and tone controls considerably and adjusting sensitivity with the R.F. gain control. Turning on the c.w. oscillator switch will, of course, result in a considerable increase in circuit noise, due to the increased sensitivity. As the oscillator vernier tuning control is turned back and forth, the characteristic pitch of this noise will change. When the characteristic pitch is fairly high, the "semi-single signal" properties of the receiver are very pronounced, one side of the audio beat note being several times louder than the other.

Phone Reception Using the Crystal Filter: The use of the crystal filter in phone reception is recommended particularly when the operator must contend with heavy interference, static, heterodynes, etc. Since such conditions prevail at most times in the amateur phone bands, the filter will be found particularly useful to amateur phone operators. To receive a phone signal when using the crystal filter, the filter is switched in by means of the phasing control and the phasing dial set at approximately mid-scale. The selectivity control is then adjusted for minimum selectivity, as indicated by maximum noise as the control is rotated back and forth. All phone signals will be great-

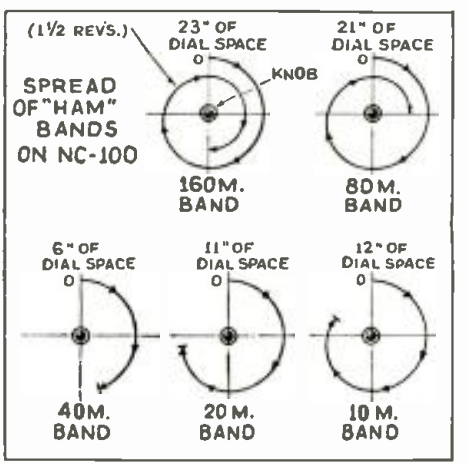

The "Ham" bands are well spread out, as shown.

ly reduced in volume, making it necessary to advance both audio and R.F. gain controls. On the majority of signals, the maximum audio output of 10 watts will not be available when using AVC with the filter, since the carrier level is held constant at the second detector and side band power is reduced by the filter. The signals may then be tuned in the usual manner, but it will be found that the selectivity is very high, with the result that all audio frequency side bands above a few hundred cycles are comparatively weak. Normally, this would result in low intelligibility of the received signal, but since the background noise, static, etc., have been correspondingly reduced, the net result is usually an improvement. The tone control should always be fully advanced.

The principal advantage of the crystal filter, however, is its ability to eliminate heterodynes. Suppose, for instance, a signal has been carefully tuned in with reasonably good intelligibility and during the transmission an interfering station comes on, causing a bad heterodyne, inverted speech, etc. Ordinarily the desired signal would be "smeared," but careful adjustment of the phasing condenser will eliminate the heterodyne and the interfering station, in most cases, completely. Intelligibility will remain practically as good as before the interfering station came on.

From a practical standpoint, it is important that the crystal filter be used most of the time where such interference is apt to be encountered, as it is almost impossible to switch on the crystal filter and re-tune the desired signal through the heterodyne. The phasing adjustment will remove one signal only. If another interfering station comes on, however, only one heterodyne will be present, instead of the several resulting from three station carriers beating together.

C.W. Reception with the Crystal Filter: To use the crystal filter for c.w. reception, the filter is switched in by means of the phasing control and the phasing condenser set about midscale. The c.w. oscillator must be turned on. Advancing the R.F. and audio gain controls will result in a hollow, ringing sound, the pitch of which will depend upon the setting of the c.w. oscillator control. The actual pitch is not important as long as it is near the middle of the audio range, where the loudspeaker or phones have good sensitivity.

When a signal is picked up, it will be found that as the receiver is tuned slowly across the carrier the beat note will be very sharply peaked at the same pitch as that of the ringing noise, previously mentioned. All other parts of the beat note will be extremely weak and, furthermore, this peak will be found to occur on only one side of the audio beat note. The sharpness of the peak is determined by the selectivity control. At maximum selectivity, the peak is so sharp that it may be hard to find, whereas at minimum selectivity the peak will be

very broad. If a signal is being received, after having been properly tuned in, and an interfering station comes on, the resulting heterodyne and interference may be eliminated by adjustment of the phasing condenser. This phasing adjustment is effective in eliminating interference regardless of the setting of the selectivity control.

Measurement of Signal Strength: The combination of the R.F. gain control and tuning indicator make possible the accurate measurement of signal strength. With AVC either on or off, the R.F. gain control is advanced to the point where the electron ray tuning indicator just begins to show some change in pattern. The accompanying calibration curve shows the relation between signal input and this setting of the R.F. gain control.

The size of the shaded area will vary

with the modulation of the signal when the AVC is off. This variation does not indicate over-modulation, or carrier shift, but is the normal result to be expected when using an amplified-delayed system of AVC.

For the amateur station operator who prefers to give reports in R or S units, rather than microvolts input, we suggest the use of the righthand scale of the chart. Adjacent points are 6 db. apart, this spacing giving a total range, between the weakest signal and an S-9 signal, of 48 db. Most operators seem to agree that the S-steps should be separated by a 4 to 1 power ratio (6 db.), and since the characteristics of the receiver determine the level of the weakest signals which may be received intelligibly, an "extremely strong" signal (R-9) is, on the NC-100, defined as one resulting in an input of 51 microvolts.

The "W2AMN 5-Meter Mopa"

(Continued from page 267)

it is almost impossible for the electron-coupled circuit to drop out of oscillation, as may happen with a crystal, there is no need for automatic bias. However, it may be incorporated should any one desire it. The value of the biasing resistor should be somewhere around 100 ohms and be bypassed with a .001 mf. condenser.

Adjustment of Transmitter Not Critical

The cathode tap on the oscillator grid coil is somewhat critical and if the dimensions given in the drawing are carefully followed, this tap should be exactly 1 1/2 turns from the "B" minus side of the coil. Outside of this there is no critical adjustment in the entire transmitter, and no one should have any trouble in obtaining excellent results. Measured power output of the final amplifier stage was just slightly over 20 watts, with approximately 35 watts input to the plate circuit.

In the power supply position, which is built on the same chassis as the R.F. unit, we have used an ordinary receiving type transformer. This transformer was rated at 365 volts each side of center-tap at 145 ma. With 8 mf. condenser input and low-resistance choke, this power supply delivered slightly over 400 volts to the transmitter. If a 450-volt transformer were used, it would be necessary to employ choke input in order to reduce the voltage. We do not recommend that over 425 volts be applied to the plates of the tubes. Almost any antenna may be used in conjunction with this transmitter. If the transmission line to the antenna is untuned, then one or two turns should be used as a coupling coil. The arrangement shown is for tuned feeders.

During the tests a vertical 8 foot rod, with a single-wire "feeder" tapped approximately 13 inches off center was used. This was clipped directly to the plate coil about three turns from the plate side. With this arrangement no coupling coil is necessary. The audio requirement for this transmitter is exceptionally modest. 15 to 18 watts should do very nicely and this is obtainable from a pair of 6F6's or a pair of 2A5's in class A-B.

This transmitter has been in operation for about 2 1/2 months, and every one hearing it, without exception, has expressed the most flattering compliments regarding the high quality and stability of the signal. Several of these amateurs were using receivers with a selectivity which permitted only the most stable signals to come through. It is now possible to construct a low-cost stabilized 5-meter transmitter that can be compared in quality with any other transmitter of amateur design operating on any band. This may seem like a "broad statement," but it is absolutely true, and we know that if the 5-meter "gang" take heed and construct something of this type, the results will be a much happier 5-meter family, and we will then command the respect of amateurs on the other bands as well as broadcast listeners who are also listening in on the 5-meter band.

Don't forget that the newer broadcast receivers take in the 5-meter band. We can imagine how horrible some of the modu-

lated oscillators sound on these very selective receivers. And we can also imagine what very poor impressions we "Hams" make on the owners.

Parts List

- 1—100 mmf. tuning condenser, Hammarlund.
- 1—20 mmf. tuning condenser, Hammarlund.
- 1—split-stator condenser, 35 mmf. per section, Hammarlund.
- 1—35 mmf. tuning condenser, Hammarlund.
- 1—plate and filament transformer (see text), Thordarson.
- 1—250 ma., 19 henry filter choke, Thordarson.
- 1—0-100 ma. meter, Triplett.
- 1—20,000 ohm wire wound resistor, 15 watts, Aerovox.
- 1—20,000 ohm voltage divider, 75 watts, Aerovox.
- 1—75,000 ohm resistor, 2-watt carbon type.
- 6—.001 mf. mica condensers, receiving type, Aerovox.
- 1—.001 mf. mica condenser, 1,000-volt, Aerovox.
- 1—.00025 mf. mica condenser, receiving type, Aerovox.
- 2—8 prong isolantite sockets, I.C.A.
- 1—10 x 17 x 3 inches electrical chassis, I.C.A.
- 2—8 mf. 500-volt wet electrolytic condensers, Cornell-Dubilier.
- 2—6L6 tubes, RCA Radiotron.

A Few Words Regarding 5 Meters

(Continued from page 267)

before "commercials" get busy. It is a well-known fact that the "commercial interests" are experimenting with apparatus for use in the ultra-high frequency region, and unless we amateurs can develop good apparatus which will prove that we can cope with the requirements, the amateur is liable to find himself in the same position in the ultra-high frequency spectrum, as he did when the commercials took over the lower frequency bands and the amateur was restricted to narrower positions of the wavelength spectrum. We might also include a word that playing music and general "clowning" over the air is not looked upon with favor, and it is also not typical of the usual amateur dignity. For instance, we have frequently heard some one trying to play a harmonica, saxophone or "what have you," and generally cluttering up that position of the band for periods of an hour or two. Such practices should be avoided—and we should also try to modernize our equipment as fast as possible.

Incidentally, the transmitter described in this article is no more expensive to build than a good oscillator arrangement of similar power, and nearly every 5-meter "Ham" has the necessary 15 to 18 watts of audio power for modulation, and some 75 watts of power for the high-voltage circuits, so that the general expense in changing over would probably be nothing more than the tube and socket costs; which would be in the neighborhood of five or six dollars. Therefore, we see no reason why the 5-meter band from now on, should not be distinguished by high quality signals the same as required in other amateur bands.—W2AMN.

WAKE UP! FELLOWS!

\$20.00 Prize Monthly for Best Set
 ● THE editors are looking for "new" receiving circuits—from 1 to 5 tubes preferably. A \$20.00 monthly prize will be awarded to the best short-wave receiver submitted. The closing date for each contest is 75 days preceding date of issue (Aug. 15 for the Nov. issue, etc.) In the event of a tie, an equal prize will be given to each contestant so tying. Address all entries to: Editor, SHORT WAVE CRAFT, 99 Hudson St., New York City.

TO-MORROW'S RECEIVER

TO-DAY!

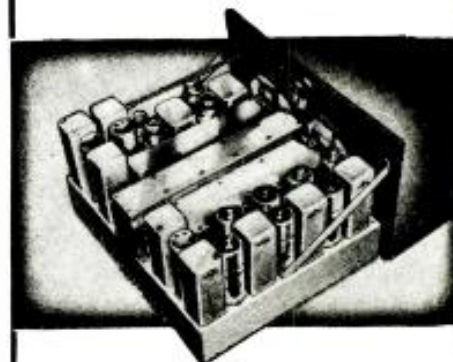

HAMMARLUND "SUPER-PRO"

YOU always wanted a receiver like the "Super-Pro." You knew that some day somebody would build your ideal receiver with revolutionary features which mean PERFORMANCE in capital letters. Features, not merely to talk about, but features that DO THINGS!

Don't wait longer. Tomorrow's receiver is here TODAY!

The nation's leading research laboratories, airways, commercial broadcasters, government departments, ships and "Hams" have put their stamp of approval on the "Super-Pro" by buying it, and coming back for more—hundreds of them.

That endorsement speaks more eloquently than any advertisement ever could.

Not room enough here for details, but you ought to have them. You can't afford to let an advanced receiver like the "Super-Pro" pass you by without getting the real low-down.

Mail the Coupon NOW!

Hammarlund Manufacturing Co., Inc.
 424-438 W. 33rd St., New York SW-9

- Check here for complete data on the new Hammarlund "Super-Pro."
- Check here for 1936 Hammarlund Catalog.

Name

Address



Low-Cost

ELECTROLYTICS

Handy cardboard-case electrolytics. Extreme compactness. Mounting flanges. Color-coded pigtails. * In 250 and 525 v. peak ratings. All popular capacities. Single, dual and triple section units. Ideal for maximum filtering in minimum space and at lowest cost.

● Write for catalog.



AEROVOX CORPORATION

72 Washington St., Brooklyn, N. Y.

Westinghouse Power Generator

Manufactured for U. S. Signal Corps
200 Watt 110 V. AC



A. C. ELECTRICAL POWER

from a Windmill, from available Waterpower, from your Automobile, from your Motorcycle, from your Bicycle, Foot-pedals or Handcrank; operates A.C. Radio Sets in D.C. districts, also A.C. Radio sets from 22 V. D.C. farm light systems; use two generators in series to get 200 V. A.C. Used as an A.C. Dynamo, lights ten 20 Watt 110 Volt lamps; Short Wave Transmitter supplying 110 Volts A.C. for operating "Ham" Sets; Motor Generator; Public Address Systems; Camp lighting; etc., etc.

There Are Over 25 Applications

SPECIFICATIONS:
HOUSING—Aluminum (Diameter 6 1/2 in., Length—5 1/4 in.). SHAFT—2 3/16 in. (driving end), Diameter—9/16 in. (the end is threaded for a distance of 1/4 in.). BASE—Cast iron (Length—7 1/2 in., Height 1 9/16 in., Width 4 3/4 in.). OUTPUT—200 watt 110 volts AC (speed 3500 R.P.M.). STATORS—Two pairs (two North and two South). ROTOR—12 tooth inductor. Built-in commutator. Rotor turns in ball-bearings.

1/2 to 1 1/2 H.P. needed to run Generator.

BLUE-PRINT 22 x 28 in. and Four-Page 8 1/2 x 12 in. Applications and INSTRUCTION SHEETS FREE with Generator.

Generator, as described, including four replacement carbon brushes. Blue-print and Instructions **\$7.90**

Send \$2.00 deposit balance C.O.D. Shipping weight 18 lbs.

(Replacement carbon brushes bought separate \$1.50 per set of four. Set of instructions bought separate \$1.00.) MONEY-BACK GUARANTEE

WELLWORTH TRADING COMPANY

560 West Washington Blvd., Dept. SWC-936, Chicago, Illinois

Modernize your 5-meter station with the W2AMN-6L6, 5-meter MOPA

We can supply the complete foundation unit for this transmitter, including the chassis and all other ICA parts used in the original transmitter, or the complete ICA version of the original at the lowest possible price. We are prepared to make immediate shipment.

QUALITY PARTS FOR HAMS SERVICEMEN RADIO INDUSTRY

Complete facilities to meet every requirement in drilling and engraving of parts, and on all insulating materials and metals. Write today for complete descriptive catalog on parts of standard manufacture. Send 10c in stamps or coins to cover cost of handling and mailing.

INSULINE CORP. OF AMERICA
25 PARK PLACE NEW YORK, N. Y.

GENERAL CEMENT

CRYSTALLIZING LACQUER
This crystal lacquer is especially adapted to provide a professional and finished appearance to all radio apparatus, such as: radio panels, chassis, test panels, analyzers, etc. Easily applied, is fast drying, air drying, and requires no baking. It can be used on all surfaces.
List Prices—2 oz. black 35c—2 oz. red, green, blue, brown, yellow 45c. Pint of black \$2.00. Pint of colors \$2.25
See your radio jobber—if he cannot supply you, write us. Send for free circular of other radio needs.
GENERAL CEMENT MFG. CO., Rockford, Illinois

RADIOS..SAVE UP TO 50%

DEAL DIRECT: Factory Price
Many models to select from AC-DC, All-wave, Farm, Car and new metal Tube Models. Your name and address on postcard brings you NEW 24 page 1936 Barson Catalog in color FREE. Get details on 30-DAY TRIAL Plan and Agent-User proposition.
Goldstone Radio Co., Dept. 306 6780 Grand River, Detroit, Mich.

HI-POWER For Sound Equipment

The Carter Genemotor supplies the most Reliable, Constant and Economical "B" Power for Class A or B Amplifiers from 6 or 12 volt battery. Output up to 500 Volts. Sturdy—Compact—Quiet. Write today for Catalog.

CARTER MOTOR CO.
367 W. Superior St., Chicago, Ill.

The Beginner's Bread-board Economy-2

(Continued from page 273)

point to keep in mind when wiring the receiver; for long leads, especially those of the grids and plates, will cause stray coupling and uncontrollable feedback, resulting in unstable and unsatisfactory operation. The tube and coil sockets, although made of isolantite, should be raised off the base-board about 1/4 of an inch by means of metal or fibre bushings. The antenna condenser, which is of the semi-variable, mica-dielectric type, should be mounted as close as possible to the antenna terminal clip and the detector grid prong of the tube socket. This condenser is adjusted for maximum set sensitivity each time a different coil is plugged into the receiver. The result is complete absence of so-called "dead-spots" on all the short-wave bands.

Care should be taken, when connecting the audio transformer, to follow the terminal markings correctly. "P" connects to one end of the R.F. choke in the plate circuit of the first triode section of the 19; "B+" goes to the B+ battery terminal; "G" connects to the grid of the second triode section of the 19; and "F—" goes to B— or ground.

"Hand-Capacity" Effects Eliminated

The use of a grounded aluminum front panel eliminates all traces of annoying "hand capacity," rendering the operation of tuning in distant stations a distinct pleasure. Although it is possible to work this receiver with a single 45-volt "B" battery, it is recommended that two be used, connected in series; 90 volts are then applied to the detector plate through the primary winding of the audio transformer, R.F. choke and tickler winding on the plug-in coil and 90 volts to the plate of the audio triode section, through the earphones.

Coil-Winding Data

The coils are wound with No. 22 DSC or SCC copper wire. Both grid and tickler windings are wound in the same direction. The tickler winding is at the bottom of the coil spaced 1/8 of an inch from the grid coil. The accompanying illustration shows the proper connections of the plug-in coils.

20-METER COIL Grid winding, 7 turns, spaced to cover one inch. Tickler, 5 turns, close wound.

40-METER COIL Grid winding, 14 turns, spaced to cover one inch. Tickler, seven turns close wound.

80-METER COIL Grid winding, 27 turns, close wound. Tickler, 11 turns close wound.

160-METER COIL Grid winding, 60 turns, close wound, Tickler, 17 turns close wound.

NOTE: The turns specifications for the tickler winding will vary a little with different constructors. Where the set does not tend to oscillate on any of the bands add a turn or two to the lower end of the tickler winding. On the other hand, where the set oscillates so strongly that it cannot easily be controlled by the regeneration condenser, remove a turn or two from the lower end of the tickler winding. The grid winding will not vary from the above specifications.

List of Parts

- C1—Lafayette 50 mmf. variable condenser.
- C2—Lafayette 15 mmf. variable condenser.
- C3—Lafayette 140 mmf. variable condenser.
- C4—Lafayette 100 mmf. grid-blocking condenser.
- C5—Lafayette 35 mmf. variable condenser.
- R1—Lafayette 5 megohm gridleak.
- R2—Lafayette 6-ohm filament rheostat.
- RFC—Lafayette 2.5 mh. R.F. choke.
- T—Lafayette 3 to 1 ratio audio transformer.
- V1—Lafayette type 19 tube.
- J—Lafayette single open-circuit phone jack.
- 1—high-ratio airplane dial.
- 2—4-prong isolantite sockets.
- 4—large "low-loss" ribbed coil forms.
- 1—filament "on-off" switch.
- 5—medium size Fahnestock clips.
- 1—aluminum front panel, 7x9 inches.
- 1—wooden baseboard, 9x9x3/4 in. thick.
- 1—19 tube. RCA Radiotron.
- Miscellaneous hardware, wire, solder, etc., etc.

*Chief engineer, amateur division, Wholesale Radio Service Co., Inc.

Every Radio "Fan" Needs These SHORT-WAVE RADIO MANUALS

There has been tremendous progress made in short-waves during the past few years, and only in the OFFICIAL SHORT-WAVE RADIO MANUALS will you find a true picture of the important developments. Whether the advancement has been in set design and construction, servicing all-wave receivers or tube changes, or new scientific discoveries in the short-wave field, all are published chronologically in these SHORT-WAVE MANUALS. The Manuals are edited by Hugo Gernsback and H. W. Secor.

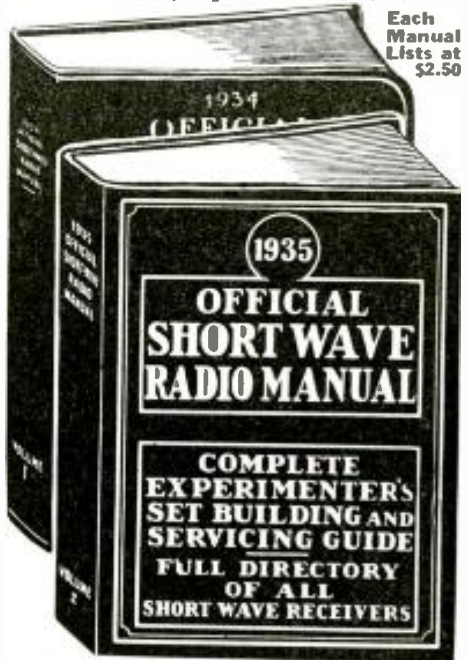

Each Manual Lists at \$2.50

Contents of the 1935 SHORT-WAVE MANUAL
Short-Wave Beginners' Section—Short-Wave Receivers—Battery Short-Wave Receivers—"5-Meter" Department—Short-Wave "Artificial Ferrer" Apparatus—Short-Wave Experimenters' Section—Ultra Short-Waves—Commercial Short-Waves—How to Build "Power Supply" Units—Latest Short-Wave Converters—The Short-Wave Antenna—Superheterodynes—Phone Transmitters for Amateur Stations—"Skip distance"—Heaviside layer—Super-Regenerative Short-Wave Receivers—Recording Short-Wave Programs—High Fidelity—Short-Wave Questions and Answers—Short-Wave Kinks—Foreign Short-Wave Receivers—Tubes for Short-Wave Purposes—Short-Wave Transmitters—Multi-purpose Tubes—Audio Amplifiers—"Band-Spread"—Plug-less "Mono-coil" Receivers—Boosters, Pre-amplifiers and Beat Oscillators—Portable Receivers and Transmitters—Short-Wave Service Data for Radio Service Men.

Contents of the 1934 SHORT-WAVE MANUAL
Important Short-Wave Receivers and how to construct them—Short-Wave Transmitters—Building one to seven tube receivers—Coil winding data—Commercial Short-Wave Receivers and Servicing Data—Kinks—Converters and their construction—Antenna and Noise Eliminators—Superheterodynes—Phone Transmitters—Short-Wave Physics—Theoretical short-wave data—Super-Regeneration in Short-Wave Sets.

Each Manual Contains Over 240 Pages—1,000 Illustrations Flexible, Looseleaf Leatherette Binder 9 x 12 Inches

Special Combination Offer
To give every short-wave enthusiast the opportunity to add both SHORT-WAVE MANUALS to his library (Volume 1 and 2) both books, if bought together, can be purchased at a saving. Each Manual sells regularly for \$2.50. If both are bought together, the price is \$4.50. You save fifty cents.

SHORT WAVE CRAFT
99-101 Hudson Street New York, N. Y.

SHORT WAVE CRAFT SWC-936
99-101 Hudson Street, New York, N. Y.

Gentlemen: I enclose herewith my remittance for which send me, postage prepaid, my copy of the OFFICIAL SHORT WAVE RADIO MANUAL as indicated below.

- () 1934 Official Short Wave Radio Manual—\$2.50
- () 1935 Official Short Wave Radio Manual—\$2.50
- () Both Manuals—\$4.50.

Name _____
Address _____

City _____ State _____

Send Remittance by check, cash, stamps or money order—register letter if cash or stamps are sent.

Please mention SHORT WAVE CRAFT when writing advertisers

5-Meter Transmitter-Receiver—Uses New Metal Tubes

(Continued from page 271)

fits inside the box and inside the bottom cover. It is fastened by three 6-32 screws to the panel. These screws do not hold the bottom cover in place. The bottom cover is held in place as are the sides and back of the subpanel, by short 6-32 screws through the metal can. The subpanel being innermost is tapped for the screws and the can and bottom cover are drilled to clear. The input and output tip jacks, are insulated from the panel and serve to hold the subpanel to the panel.

All Leads Must Be "Short!"

In wiring the set, care was exercised to see that all radio-frequency leads are kept very short. In the model here described no lead is over one and one-half inches in length. It is to be noticed that the tank tuning condensers are hot with respect to both direct current and radio-frequency, on

writer that this method gives maximum signal strength with a minimum of adjustments. The transmitting coupling using the same type of condenser can be set to deliver maximum signal to the antenna without approaching the point of instability. Modulation peaks will flash over the small isolantite base-variable condenser used so a .0001 MF. microfarad condenser was used in series with the antenna to provide the necessary insulation.

Antenna Collapsible

The antenna used on this set for portable "mobile" work is a 4 foot collapsible rod, made of brass tubing, which is designed to slip fit inside of the next larger size. These pieces are each 14 inches long with the exception of the largest piece which is mounted top and bottom on insulators. Each piece has a piece of copper wire soldered to its top, so that it will not completely telescope into its larger neighbor when the rod is collapsed. The 4 foot rod takes three extensions with the bottom, and the eight foot rod (used for distant portable work) uses all sections.

Adjusting the frequency and the coupling of the transmitter is an easy job. First with the aid of a wave meter or another amateur five meter receiver, set the transmitter to the center of the band. Then tighten the antenna coupling until a neon lamp held on the plate side of the tuning circuit just lights up. Now listen to the modulation. The signal should be loud, clear and steady in frequency. The receiver is coupled just tight enough so that the super-regenerative hiss is reduced a little. If about 250 volts is used on the plate of the oscillator the antenna will have enough radio-frequency at its top end, to cause a neon bulb to glow. This is a sign that the antenna is taking current from the oscillator.

Either of two methods of obtaining microphone current may be used. If the set is to be used on storage "A" battery and dry "B's" the microphone may obtain its current from the heater current. If either vibrator or generator supply is used the microphone must obtain its current through a filter as shown in Fig. 3 or from a separate battery as this set does.

In the plate lead of the first audio amplifier it will be noticed, there is a audio filter. The set will feed back and howl if some type of filter is not used. In this case a 1. mfd condenser and a .1 megohm resistor serve.

In the antenna circuit there is a small .0001 mf. fixed mica condenser, in series with the small 3-20 mmfd. screwdriver variable isolantite-base midget condensers. These small condensers will flash-over on modulation peaks when a grounded quarter-wave antenna is used due to the D.C. and audio voltages building up a peak across them. To stop this the series condenser is used. Coupling between the transmitter and antenna will be rather tight making it necessary to reduce the capacity in the LC circuit of the 6D6 oscillator. If the dial readings are desired to be approximately equal at equal frequencies, it will be necessary to deduct one or two turns from the transmitter coil.

Preliminary Tests

If the set does not operate on first trial, it may be that the filament circuit of some tube is not complete. To test simply hold the tube in the hand after it has operated some five minutes with the filament on. If the tube is warm, it is a sign that the filament is operating. The Oscillator and Modulator will run very hot and cannot be held in the hand immediately after use. One test for operation in the transmit position is to shunt the choke with a pair of phones or the loudspeaker, and speak into

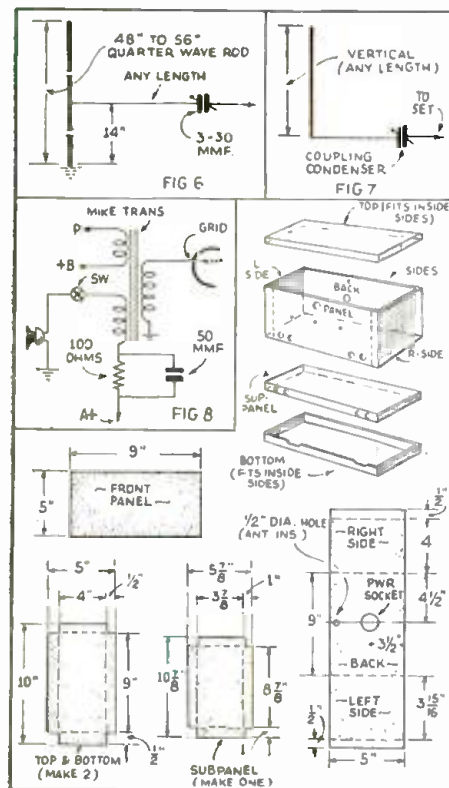

Details of antenna, shield box, etc.

both rotor and stator. They are therefore mounted on small standoff insulators and rigid-insulating couplings are used. These couplings are made from one inch pieces of 1/4 inch inside diameter bakelite tubing. In order to insure a tight fit between the shaft and the coupling, small pieces of paper are first slipped into the coupling and then the shaft is pushed into place. Bar knobs are put on the extensions of the shafts after the out-side can is in place. The insulating couplings may be drilled and tapped.

Tone Control Comes In Handy

In the detector circuit, it will be noticed that a condenser of from .006 mf. to .01 mf. microfarads is used to bypass the positive-high-voltage to ground. This condenser is used as a *tone control* to reduce the high-pitched hiss that comes from the super-regenerative detector. The higher capacity may cut down the amplification of the high pitched notes, but since the receiver is used for voice, this is no loss and helps in reading weak signals.

The antenna is connected to the grid side of the detector by capacitive coupling. Tests over some time have convinced the

BRUSH Spherical Microphone



For remote pickup, "P. A." commercial interstation and amateur use. Low in price... but built to Brush's traditionally high mechanical and electrical standards. Wide frequency response. Non-directional. No diaphragms. No distortion from close speaking. Trouble-free operation. No button current and no input transformer to cause hum. Beautifully finished in dull chromium. Size only 2 1/2 inches in diameter. Weight 5 oz. Output level minus 66 D.B. Locking type plug and socket connector for either suspension or stand mounting at no extra cost. Full details, Data Sheet No. 13. Free. Send for one.

BRUSH Lapel Microphone



For after dinner and convention speakers, lecturers, etc. Gives great mobility. The smallest, lightest microphone on the market. Size 1 1/2 x 1 1/4 x 3/8. Weight with coat attachment less than 1 oz. Special internal construction and rubber jacketed outer case insure quiet operation. No interference from breathing noises, etc. Typical Brush sound cell response and trouble-free operation. Details on request.



MAILING LISTS



GET OUR FREE REFERENCE BOOK and MAILING LIST CATALOG FREE

Gives counts and prices on accurate guaranteed mailing lists of all classes of business enterprises in the U. S. Wholesalers—Retailers—Manufacturers by classification and state. Also hundreds of selections of individuals such as professional men, auto owners, income lists, etc.

Write today for your copy

R. L. POLK & CO.
 Polk Bldg.—Detroit, Mich.
 Branches in Principal Cities
 World's Largest City Directory Publishers
 Mailing List Compilers, Business Statistics, Producers of Direct Mail Advertising.

INVENTORS
 TIME COUNTS—don't risk delay in patenting your ideas. Write for new FREE book, "Patent Guide for the Inventor" and "Record of Invention" form. No charge for preliminary information.
 CLARENCE A. O'BRIEN & HYMAN BERMAN
 Registered Patent Attorneys
 23-D Adams Building, Washington, D.C.

Please mention SHORT WAVE CRAFT when writing advertisers

**U. S. NAVY
AIRPLANE-TYPE
Microphone and Receiver**

ONLY \$4.96

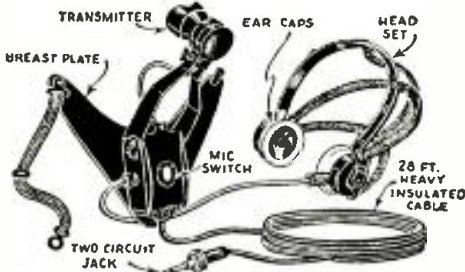

THIS Microphone and telephone headset outfit was built especially for the U. S. Navy Aviation Corps for Plane-to-Plane and Plane-to-ground communication. The Holtzer-Cabot Electric Company constructed the outfit to Government specifications and under rigid Navy Department supervision. The outfit consists of a low-impedance carbon microphone (transmitter), securely fastened to a metal breast-plate, and a set of heavy-duty, low impedance earphones. A specially constructed switch on the back of the breast-plate controls the microphone circuit. The earphones are U.S.N. Utah type, attached to adjustable headband. Twenty-eight feet of very heavy weather and waterproof conductor cable, terminating in a special brass plug, is furnished with this complete outfit. Current of not more than 10 volts should be used. A storage battery is the most satisfactory current supply. Talk in a natural tone of voice, when using the outfit, with the lips close to the mouthpiece. Shouting and loud talking should be avoided. We understand that the U.S. Government paid more than \$10.00 for each of these outfits. We have bought the whole lot at a low price and are offering them, as long as the supply lasts, at \$4.96 each, complete as shown in illustration. The shipping weight is 9 lbs.

Strict Money-Back Guarantee

All Shipments will be forwarded by Express Collect if not sufficient postage included with your order.

WELLWORTH TRADING CO.

560 W. Washington Blvd., Dept. SW-936, Chicago, Ill.

Internationally popular for its many scientific and technical articles . . .



EVERYDAY SCIENCE AND MECHANICS is the finest scientific — technical — mechanical — construction magazine in the field. Up-to-the-minute with news flashes of scientific events. Dozens of constructional articles and many popular experiments. Ideas from which you can make things to sell.

Edited by HUGO GERNS-BACK
A Host of Interesting Subjects Covered

Woodworking — Photography — Magic — Patents and Inventions — Book Reviews — Metal-Working — Chemistry — Engineering — Microscopy — Electrical Experiments — Household Helps — Astronomy — Prize Contests — and other subjects.

10c the copy (on all newsstands)

EVERYDAY SCIENCE AND MECHANICS
99-C Hudson St.
New York, N. Y.

MONUMENT \$9 up
WORLD'S BEST MARBLE AND GRANITE

Freight paid anywhere. Lettered Free. Erected if desired. Nation's best known, most beautiful and durable. Memorials, Tombstones and Grave Markers. 30% savings guaranteed. Why pay more? We sell over 1,000 every year. Write today for Big Free Catalog.
U. S. MARBLE & GRANITE COMPANY
Dept. A-92 — Oneco, Florida

PATENTS — TRADE MARKS
All inventions submitted held confidential and gives personal attention by members of the firm.
Form "Evidence of Conception" and instructions
"How to Establish Your Rights" — Free
LANCASTER, ALLWINE & ROMMEL
PATENT LAW OFFICES
475 Bowen Bldg. Washington, D. C.

the mike. A loud talk-back will be the result if the set is modulating. However this does not test the oscillator, a neon bulb on the plate side of the tank will light up brilliantly when the mike is spoken into.

Surprising results have been obtained with this little rig. Operating portable from Grizzley Peak, Berkeley, it put an R-7 signal into Saratoga one evening, and the operator gave the station in Saratoga, some fifty-five miles away, an R-6 to 7, while others in the immediate vicinity had difficulty in hearing the station at all. Another time an R-8 report was given this "rig" from Mt. Hamilton while operating portable on Eagle Rock (Santa Cruz County) some sixty miles airline away. Both times super-regenerative receivers were used at the other station. On Mt. Hamilton a fifth watt transmitter was used, and at Saratoga a 41 tube as an oscillator was used. Local reports give this set fine quality with considerable carrier strength. This is due in part to the fact that the quarter-wave antenna was but 16 inches away and had a direct lead. The quarter-wave antenna works equally well whether grounded or ungrounded.

The U.H.F. Wizard Six

(Continued from page 265)

Parts List for 5 Meter Super-Regenerator

- 7—.001 mf. mica condensers, Aerovox.
- 2—.0005 mf. mica condensers, Aerovox.
- 1—.0001 mf. mica condenser, Aerovox.
- 2—.002 mf. mica condensers, Aerovox.
- 5—.1 mf. paper by-pass condensers, Aerovox.
- 2—5 mf. low-voltage (50 vt.) electrolytics, Aerovox.
- 2—8 mf. high-voltage (450 v.v.) electrolytics, Aerovox.
- 3—15 mmf. variable condensers, Trim-Air.
- 1—1,500-ohm half-watt resistor, Aerovox.
- 2—meg. half-watt resistor, Aerovox.
- 1—100,000-ohm half-watt resistor, Aerovox.
- 1—2,000-ohm half-watt resistor, Aerovox.
- 1—500-ohm 1 watt resistor, Aerovox.
- 1—50,000-ohm half-watt resistor, Aerovox.
- 1—¼ meg. ½-watt resistor, Aerovox.
- 1—3,000-ohm ½ watt resistor, Aerovox.
- 1—50,000-ohm potentiometer, Electrad.
- 1—500,000-ohm potentiometer, Electrad.
- 1—2,000-ohm, 5-watt voltage divider with 2 sliders, Aerovox.
- 1—2.1 mh. R.F. choke, Hammarlund.
- 1—30 h., 60 ma. filter choke, Thordarson.
- 1—power transformer (see diagram). Thordarson.
- 2—Acorn tube sockets, Hammarlund.
- 3—wafer octal sockets, I.C.A.
- 1—4-prong wafer socket, I.C.A.
- 1—7 x 8 x 12 in. crackle finish cabinet and chassis, I.C.A.
- 1—954 Acorn tube, RCA Radiotron.
- 1—955 Acorn tube, RCA Radiotron.
- 2—6C5 metal tubes, RCA Radiotron.
- 1—6F6 metal tube, RCA Radiotron.
- 1—80 tube, RCA Radiotron.

Nation-Wide Amateur Radio Show at Chicago

● A National-Wide Amateur Radio Show is to be held at the Hotel Sherman, Chicago, September 5th, 6th and 7th, in conjunction with the 1936 Central Division Convention of the American Radio Relay League.

Features of the event: Technical lectures by such men as John Reinartz, Boyd Phelps and many others. Mr. Thorne Donnelley and the Lakeside Radio Club, W9PZ, staging a "PZ Party," with entertainment provided by NBC, CBS, and MBS, with probable broadcasts direct from the Convention Hall. Banquet, with introductions of the many notables present (such as President Woodruff of the A.R.R.L. and Vice-Pres. Bailey), and then another evening of fine entertainment. Code-speed contest. The usual AARS, NCR, Phone and CW group meetings; contests; YL events, trips, demonstrations; and, of course, the prizes!

The sponsor, the Chicago Area Radio Club Council, which is an affiliation of amateur radio clubs in and around Chicago, extends to amateurs throughout the nation a cordial invitation to attend. Tickets for the three-day show are \$2 in advance, (\$2.25 at the door). Mail reservations and inquiries to John Huntoon, W9KJY, Room 328, Hotel Sherman, Chicago.

VEST POCKET SOLDERING IRON



Smallest good iron now on the market. Will do the work of irons twice its size. Only 11 inches long. ½ inch in diameter. By using the highest grade elements, it heats up in half the time of ordinary irons. Guaranteed to give satisfaction or money back.
Sent Prepaid for.....\$1.00
Gold Shield Products Co., 17 West 60th St., N. Y. City

INVALUABLE

SHORT WAVE COIL BOOK

Short Wave Coil Data for Every Conceivable Short Wave Receiver
Price 25¢
RADIO PUBLICATIONS
97 Hudson Street
NEW YORK

SHORT WAVE SET BUILDERS MUST HAVE THIS BOOK

● IT is now possible for the experimenter and short wave enthusiast to obtain the most exhaustive data on short wave coil winding information that has ever appeared in print. ●
● As every experimenter who has ever tried to build a short wave set knows only too well by experience, the difference between a good and a poor receiver is usually found in the short wave coils. ●
● Very often you have to hunt through copies of magazines, books, etc., to find the information you require. ●
● Between the two covers of this book you now find every possible bit of information on coil winding that has appeared in print during the past two years. ●
● Only the most modern "dope" has been published here. ●
● No duplication. Illustrations galore, giving not only full instructions how to wind coils, but dimensions, sizes of wire, curves, how to plot them, by means of which any coil for any particular short wave set can be figured in advance, as to number of turns, size of wire, spacing, etc. ●
● There has never been such data published in such easy accessible form as this. ●

FRIENDS PESTER HIM

Dear Sirs:
I received your Short Wave Coil Book and am very well pleased. I showed it to my radio friends and now they are always pestering me for coil data. hi hi!
BERNARD A. DECKELMANN,
11348 So. State St., Chicago, Ill.

RADIO PUBLICATIONS
97 Hudson Street, New York, N. Y.

Radio Publications, 97 Hudson Street, New York, N. Y. 9-36

Please send immediately, your Short Wave Coil Book, for which I enclose 25c herewith (coin, U. S. stamps or money order acceptable). Book is to be sent prepaid to me.

Name _____
Address _____
City and State _____

The "M. T." Xtal Transmitter

(Continued from page 269)

when operating on the crystal frequency. Using a 3575 kc. crystal, the author has obtained an output of close to 10 watts on the crystal frequency and around 5 to 6 and 3 to 4 watts when doubling and quadrupling on 7150 and 14300 kc. respectively. When using the 300 volt dynamotor, the output is reduced somewhat, as might be expected, but it is still high enough to enable this transmitter to hold its own on the crowded 40 and 20 meter bands.

Set is Small and Compact

As shown in the photographs, the set is extremely small, being built up on a 7x9x2 inch electrical chassis. The crystal and its associated tuned circuit are placed at the left of the chassis; the amplifier portion is at the right. The two metal tubes are at the center where the leads to each circuit will be short and direct. Both the oscillator and amplifier coils are of the plug-in type, wound on standard 1½ inch receiving forms, for rapid band-changing.

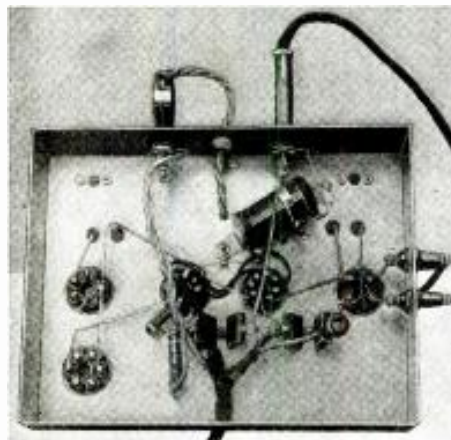
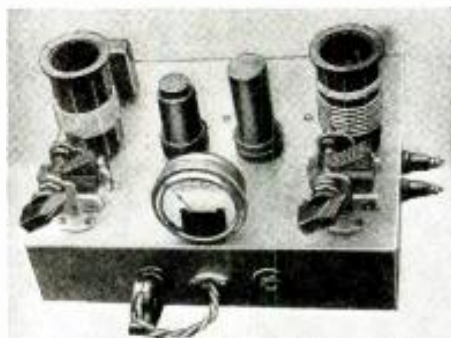

Top and bottom views of "M.T." Xtal Transmitter.

All of the sockets used in this transmitter are of the spring-mounting type which not only improve the appearance of the set but save valuable space. Both the coil and tube sockets and the coil forms should be of isolantite or similar construction in order to keep the insulation losses down to the minimum.

The plate power for this transmitter is supplied by either a 6/300 or a 12/500 volt Genemotor. The choice will depend upon the primary power available. Many farms already have the 6 volt plants in use. If a D.C. power plant (gasoline or wind-driven generator) is to be purchased especially for operating the transmitter, it is advisable to choose the 12 volt type so that the higher voltage dynamotor may be used. The operating procedure is the same in either case, i. e., the charger is first placed in operation and the charging rate is adjusted to a point slightly higher than the current drawn by the transmitter (11 amperes in our 12 volt circuit) and the 6 or 12 volt battery is then connected across the line in exactly the same

manner as when it is to be charged. The transmitter is now connected to the D.C. circuit as shown in Fig. 1, and is ready for operation. If operated in this way no trouble will arise in either the tubes or the generating unit, as the "floating" battery will act as a voltage-regulator to keep the voltage very close to the desired 6 or 12 volts. Very little or no current will be taken from the battery unless the charging rate falls below the transmitter drain. If desired, the set may be operated directly from the battery without the generator in the charging position. A fully-charged battery of the 150 ampere-hour size will operate this transmitter 10 hours before recharging is necessary.

The dynamotors may be obtained with or without the filter system. The one shown in the photo is of the unfiltered type, an external filter consisting of a 15 henry 150 milliamperes choke and a two-section 8 mfd. 600 working volts electrolytic condenser being used to smooth out the commutator ripple. When buying electrolytic condensers for transmitting purposes always choose the very best quality and look for the D.C. working voltage; the voltage rating should be at least ¼ higher than the actual voltage to be applied across the condenser. (The 450 volt condensers will serve with a 300 volt generator and two in series will take care of the 500 volt condition. *Editor.*)

Easy to Build as 2-Tube Receiver

This transmitter is no more difficult to assemble and wire than the average two-tube regenerative receiver. All leads, and especially those in the crystal oscillator circuit, must be as short and direct as possible. The usual No. 14 tinned copper bus wire is used for all leads in the R.F. circuit; the heater and power leads are of stranded rubber covered hook-up wire. The various joints are soldered with a clean, hot and well-tinned iron and rosin core solder. The construction work should be done slowly and carefully; a little extra time spent on this part of the job is well worth while.

Adjustment of Transmitter Very Simple

The adjustment of the transmitter is extremely simple and easy and will take only a few minutes to tune up for maximum output. First, place the oscillator and the amplifier coils in their respective sockets, as explained at the bottom of the coil table, and open the cathode circuit of the 6F6 stage by releasing the key. The plate voltage is now turned on and the sliding clip on the voltage-divider resistor is adjusted until approximately 225 volts is applied to the plate of the 6C5 tube. Plug the milliammeter into the oscillator jack and rotate the oscillator tuning condenser until the usual dip in plate current occurs. Adjust the condenser for minimum plate current which will be around 10 or 12 milliamperes at the oscillator plate voltage specified.

Now connect a small flash-light or pilot-light bulb across the output stand-off insulators and adjust the 5,000 ohm semi-variable resistor until all of its resistance is in the circuit. Close the 6F6 cathode circuit, rotate the amplifier tuning condenser and carefully watch the plate current of the oscillator tube. Very little or no change should take place if the oscillator has been correctly tuned. The bulb will light up at a certain setting of the amplifier condenser and the condenser should be left at this point. Place the meter in the amplifier jack and carefully adjust the amplifier condenser for the lowest plate current, which indicates resonance.

When Neutralizing is Necessary

The above directions are for operating the 6F6 as a doubler; for operation as a straight amplifier on the crystal frequency, this stage must be neutralized.



HRO JUNIOR SUPERHETERODYNE

The HRO Junior is a superheterodyne receiver, outstanding for its excellence and low price. It is designed expressly for those who are interested in world-wide short wave reception, and who demand the performance of a commercial-type receiver, but do not require the highly specialized features that necessarily increase the cost of a receiver designed expressly for two-way commercial service.

A nine tube circuit (including two stages of preselection and two stages of I.F. with air dielectric tuning condensers), a precision built tuning condenser, separate shielded coils, and strict adherence to National's high standard of quality permits the attainment of unsurpassed selectivity and sensitivity. Laboratory calibration of each coil range, plus the unique easy-reading tuning dial (two perplexing intermingled tuning scales) provides an accurate means for logging and locating stations. Fast or slow tuning is accomplished by the clever arrangement of the tuning drive mechanism. Only one knob is used—no unhandy double or two position knobs.

For those desiring the specialized features of a crystal filter, 8 meter and amateur band spread, we recommend the standard HRO!

Write for an illustrated description of both receivers.

NATIONAL CO., INC.
MALDEN, MASS.

Have You Seen the New Magazine

Jobs & Careers
THE VOCATIONAL DIGEST

Telling you how to go about:

- When You are Tackling the Job of Finding a Job;
- When You are Planning a Career;
- When You Want to Better Your Position.

Outstanding Articles In the July Issue:

Employment Counsel
Jobs Behind The News
The Choosing Of A Career
College Graduate's Prospect
Duties of Management Executives
Applying For A Position
Windows To Opportunity
Job-Getting Assistance
The Perfect Job

On all newsstands 25c

If your dealer cannot supply you, send a quarter and we will forward a copy at once.

JOBS & CAREERS

520 N. Michigan Avenue, SW9, Chicago, Illinois

Please mention SHORT WAVE CRAFT when writing advertisers

The procedure is quite simple and even a beginner should encounter no difficulty in making the necessary adjustment. Tune the oscillator as outlined above and place in the amplifier socket a coil which will cover the same frequency as that of the crystal. Adjust the small neutralizing condenser for its minimum capacity. Now plug the milliammeter into the oscillator jack, open the cathode circuit of the 6F6 and rotate the amplifier tuning condenser slowly through its 180 degrees. When this condenser passes through the point of resonance, the oscillator plate current will undergo a violent change and the oscillator may stop working altogether. The neutralizing condenser is now adjusted with an insulated screw driver until no change in oscillator plate current takes place at any setting of the amplifier plate tuning condenser. The meter is again placed in the amplifier jack and this stage is retuned for the minimum plate current reading as before. The 5,000 ohm resistor will probably have to be readjusted in order to obtain maximum output and the operator will soon learn just where to place the sliding clip after he has had a little experience with the circuit.

How to Use Tuned Feeder and Doublet

No provision has been made for antenna tuning and if a tuned transmission line is used, the coupling arrangement shown in Fig. 2 can be used. When using a doublet with the usual 70 ohm twisted feeders, the transmission line is connected directly to the output terminals. The link coil at the cold end of the amplifier coil consists of 4 turns and when transferring power to the antenna or the next amplifier stage, the coupling must be made through another 4 turn coil as shown in Fig. 2. The twisted line between the two coils may be up to several feet in length

if desired, without any loss of R.F. energy. It is desirable to keep the power leads from the storage battery-charger circuit to the transmitter and dynamotor short and to use large wire. The sizes recommended are as follows: At a distance of 75 feet, use No. 6; at 50 feet use No. 8; at 25 feet use No. 10 and at 15 feet use No. 12 wire. A resistance must be used in series with the 6.3 volt heaters of the 6C5 and 6F6 tubes when operating on the 12 volt line. For the tubes indicated, a 6 ohm resistor of at least 25 watts rating will be required. Both this resistor and the voltage-divider must be mounted out in the open air where good ventilation will be secured. The author is interested in hearing from those who build this transmitter and to learn of the results obtained with it. Any additional information will be supplied gladly if a stamped self-addressed envelope is enclosed for reply.

- R3 Voltage divider resistor with sliding clips, 20,000 ohms, 50 watts. Electrad.
- L1, L2, L3 (See coil table and text).
- RFC R.F. chokes, 2½ mh. each.
- CH Filter choke, 15 henrys, 150 ma. Thordarson.
- XTAL Quartz crystal (Bliley Type PC3 or LD2 recommended).
- One 12 to 500 volts dynamotor. (Carter No. 515. See text)
- Two closed-circuit jacks for milliammeter.
- One phone plug.
- One plug-in crystal holder. (Bud or Bliley).
- Two sockets for metal tubes. Isolantite.
- One 0-50 d.c. milliammeter, (Triplett recommended.)
- Two 5-prong sockets for coils. Isolantite.
- One 5 or 6-prong socket for crystal holder.
- One electrical chassis. 7x9x2 inches. I. C. A.
- One heavy-duty (15 amperes) switch.
- One off-on switch for heater circuit.
- Necessary hardware, solder, wire, RCA 6C5 and 6F6 tubes, etc.
- (Fixed Resistors—IRC.)
- 1—6C5 metal tube—RCA Radiotron.
- 1—6F6 metal tube—RCA Radiotron.

List of Parts for Metal Tube Transmitter

- C1 Hammarlund tuning condenser, 140 mmf. (.00014 mf.).
- C2 Mica fixed condenser, 3000 mmf. (.003 mfd.) 1000 volts. Aerovox.
- C3 Trimmer condenser. Isolantite base, 10 to 30 mmf. Hammarlund.
- C4 Mica fixed condenser, 6000 mmf. (.006 mf.) 300 volts.
- C5 Mica fixed condenser, 6000 mmf. (.006 mf.) 1000 volts.
- C6 Hammarlund tuning condenser, 140 mmf. (.00014 mf.).
- C7 Mica fixed condenser, 300 mmf. (.003 mf.) 1000 volts.
- C8-C9 Electrolytic condenser, 8 mf. each. 600 working voltage. Aerovox.
- R1 Metalized fixed resistor, 75,000 ohms, 2 watts.
- R2 Semi-variable resistor, 5,000 ohms, 50 watts or higher. Electrad.

Coil Table

| Band | Turns on L1 22. No. 18 d.c.c. close wound | Turns on L2 22. No. 18 d.c.c. close wound | Neutralizing Tap 8 turns up from the cold end | Antenna Coil 4 turns No. 22 d.c.c. close wound on cold end of L2 |
|-------|--|--|---|---|
| 80 m. | | | | |
| 40 m. | 12. No. 18 d.c.c. 1/16" space | 12. No. 18 d.c.c. 1/16" space | 4 turns up from the cold end | Same as above |
| 20 m. | 12. No. 18 d.c.c. 1/16" space | 6. No. 18 d.c.c. 1/4" space | No tap needed | Same as above |

Explanation: L1 is the oscillator coil; L2 is the amplifier plate coil. When operating on 40 or 20 meters with an 80 meter crystal, plug in an oscillator coil covering the same frequency as that of the crystal and use the 40 or 20 meter coil in the amplifier socket. No neutralizing tap is required unless the amplifier is operated on the same frequency as that of the crystal stage. The details of adjustment will be found in the text.

because it is our
Sixth Anniversary

FREE GIFT to YOU!

This year, SHORT WAVE CRAFT celebrates its Sixth Anniversary. Annual increases in circulation, plus authentic, exclusively short-wave editorial material, makes SHORT WAVE CRAFT unquestionably the leading magazine in its field. To commemorate this notable occasion, the Editors have written this outstanding book.

Partial Contents of Short Wave Guide

- Short-Wave Questions and Answers**
It is impossible to publish each month in SHORT WAVE CRAFT all the questions (and their answers) sent to us. We have printed with full illustrations, in SHORT WAVE GUIDE hundreds of important questions which have been recently received.
- Short-Wave Kinks, Illustrated**
Every short-wave fan is interested in new kinks and shortcuts. Dozens of kinks reach us every week—and in SHORT WAVE GUIDE you will find a variety of them, carefully illustrated. They will prove very valuable to you.
- Simple, Efficient Short-Wave Receivers Which Anyone Can Build**
Complete constructional plans for building many 1, 2 and 3-tube receivers will also be found. Schematic diagrams, lists of parts—everything you need to know to build these sets and make them function properly is included.
- Best Aerials for Short-Wave Reception**
The many elaborate antennas suitable for short-wave receivers often present problems for set owners. SHORT WAVE GUIDE will help you decide which aerial is best for your receiver. Many types of antenna are illustrated.
- Practical Hints on Short-Wave Tuning**
Hundreds of short-wave stations are heard by fans—and hundreds more could be heard distinctly if only you knew more about tuning them in. Expert advice on proper tuning is included in SHORT WAVE GUIDE.
- "Police Call" Receiver and How to Build It**
The most stirring signals on the air are police calls and every fan wants to hear these exciting alarms. Complete details for building and operating a "police call" receiver will be found.
- A Simple "Ham" Transmitter**
There are thousands of fans who want to build a simple transmitter. Here is the ideal transmitter for beginners. It is practical, yet inexpensive to construct. List of necessary parts, wiring diagrams, and construction details are included.

99 HUDSON STREET NEW YORK, N. Y.

Gentlemen: Enclosed you will find my remittance of ONE DOLLAR (\$1.00) (Canada and Foreign \$1.30) for which enter my subscription for Seven Months to SHORT WAVE CRAFT. You are also to send me absolutely FREE, and postpaid, a copy of the Special Anniversary Gift Book—SHORT WAVE GUIDE.

Name

Address

City..... State.....

New Subscriber Old Subscriber

Send remittance in form of check, money order or unused U. S. Postage Stamps. (Foreign: International Postal Money Order.) Register letter if it contains cash or stamps.

Please mention SHORT WAVE CRAFT when writing advertisers

Metal-Tube Pre-Selector

(Continued from page 272)

are especially desirable as an addition to a set using the old-style glass tubes, since the net effect is to modernize the old receiver.

First R.F. Stage Untuned

An inspection of the schematic diagram reveals the fact that the 6K7 metal tube is employed in the first R.F. stage. It will be noted that this is *untuned*. Antenna control is provided in the grid circuit by a small trimmer condenser which permits the pre-selector to operate efficiently on any length aerial. Coupling between the untuned stage and the tuned R.F. stage is provided by means of a set of Hammarlund four prong short wave plug-in coils. Only one coil is used at a time. The longer winding serves as a secondary and is tuned in the usual manner, while the shorter winding is used as a primary. For finer tuning, a small .00005 mf. condenser is shunted around the main tuning condenser, permitting additional spread of stations, which ordinarily would be too close together on the dial for satisfactory tuning.

Second R.F. Stage Tuned

The second, or tuned R.F. stage also employs a 6K7 tube. Coupling between the plate of this stage and the grid of the first tube in the receiver, is simplified through the use of a 2.1 mh. R.F. choke, and a small adjustable condenser in the plate circuit as shown. The power supply is of the conventional A.C.-D.C. type, employing a 6C5 metal tube as a *rectifier*, with a filter consisting of a 10,000 ohm resistor, *by-passed* at either end by eight mf. electrolytic condensers in a single card-board container. The filament voltage-reducing resistor is contained within the line cord. The input grid resistor, R1, is a 75,000 ohm potentiometer. Variation of this resistance increases or decreases incoming signal strength, thus giving smooth volume control. Where the pre-selector is used with a set having a manual volume control, the set control should be turned to nearly maximum volume. The switch, SW1, is mounted on the same shaft with the potentiometer, R1.

Constructional Details

The panel of the pre-selector measures 8 5/8" by 7 1/4" high. The chassis dimensions are 7 7/8" by 6" deep by 2 1/2" high. Panel and chassis should be firmly bolted or riveted together. Four socket holes are required, one for the plug-in coil, and three for the metal tubes.

A desirable refinement in constructing this pre-selector is the addition of a high-ratio vernier dial on the main tuning condenser.

Tuning Hints

In using the Metal Tube Pre-selector, it

should be plugged into the power supply source and connected to antenna and ground and to receiver as explained above, and the receiver should be put into operation and then the switch on the pre-selector should be turned "on." The plug-in coil used in the pre-selector should be of the same approximate wavelength coverage as that used in the receiver. In other words, if the receiver is arranged for tuning from 33 to 75 meters, the 33 to 75 meter Hammarlund coil should be plugged into the pre-selector. This does not mean that identical make coils must be used in both the receiver and the pre-selector, but merely that their wavelengths must correspond. The Hammarlund coil is recommended for use with this pre-selector.

In using the pre-selector, the set is first tuned to the desired wavelength, or to some point fairly close to it. The main tuning condenser of the pre-selector is then tuned very carefully, until the desired station is brought in and finer tuning is possible thereafter by adjusting the *band-spread* condenser.

List of Parts for Self-Powered Metal-Tube Pre-Selector

- C1—Hammarlund Equalizer Antenna Trimmer, 3 to 30 mmf., type MEX
- C2—Cornell-Dubilier .1 mf. 400 volt "Cub" Tubular Condenser, type BA-4P1
- C3—Cornell-Dubilier .1 mf. 400 volt "Cub" Tubular Condenser, type BA-4P1
- C4—Cornell-Dubilier .1 mf. 400 volt "Cub" Tubular Condenser, type BA-4P1
- C7—Cornell-Dubilier .1 mf. 400 volt "Cub" Tubular Condenser, type BA-4P1
- C5—Hammarlund Midget Condenser, 140 mmf., type MC-140-M
- C6—Hammarlund "Star" Midget Condenser, 50 mmf., type SM-50
- C8—Hammarlund Isolantite Trimmer Condenser, 10 to 70 mmf., type MICS-70
- C9—Cornell-Dubilier .1 mf. 400 volt "Cub" Tubular Condenser, type BA-4P1
- C10, C11—Cornell-Dubilier Dual Section Dry Electrolytic Condenser, 8 mfds. ea. section, 150-200 volts, type MA-1102S
- R1—Electrad Potentiometer with Switch (Sw1), 75,000 ohms, type 202-S
- R2—500 ohm Electrad Truvolt Flexible Resistor
- R3—25,000 ohm Metallized Resistor, 1/2 watt
- R4—25,000 ohm, 1/2 watt Metallized Resistor
- R5—10,000 ohm, 10 watt Electrad Vitreous Enameled Resistor
- R6—350 ohm, 50 watt Resistor in Line Cord
- L1—One Set of 4-Prong Short-Wave Coils, 17 to 270 meters, Hammarlund Type SWK-4
- CH1—2.1 mh. Hammarlund Midget R.F. Choke, type CH-X
- BP1, BP2—Twin Antenna-Ground Terminal Strip
- BP3, BP4—Eby Binding Posts, Sw1 Switch on R1
- V1, V2—6K7 Tubes, RCA Radiotron
- V3—6C5 Tube, RCA Radiotron
- Metal Panel and Metal Chassis
- 2—Screen-Grid Clips for Metal Tubes
- 3—Knobs
- 1—Calibrated Dial
- 1—4-Prong Socket for Plug-in Coils
- 3—Octal Sockets for Metal Tubes
- 1—Roll Push-Back Hook-up Wire

New Condenser Simplifies "Duplicate" Replacement Problems

FROM experience, most servicemen have found that a great deal of time and effort is wasted in getting many hard-to-find exact duplicate condenser replacements. Now, however, standard Sprague 450

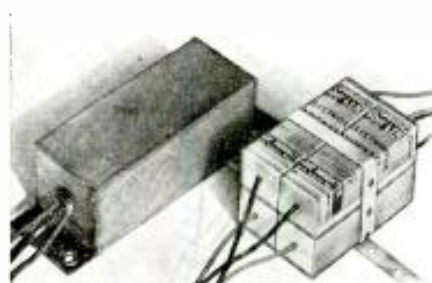

Volt and "600" Line Condensers have been designed in convenient square size and 2 1/2 inch uniform length so that they may easily be strapped together with the new ST Mounting Strap to form any replacement combination. Where mounting is a problem, the new Universal Mounting Flange can also be employed, thus enabling the serviceman to make a quick, easy replacement to match the original holes in any set chassis.

Three or four of these new small-size, square units may be combined and still be smaller than the original old unit which they are used to replace. In some cases, the cost of individual units used in this manner is even less than that of exact duplicate replacements. In others, the cost is only a few cents more—and the use of standard individual units insures better results, both mechanically and electrically.

This article has been prepared from data supplied by courtesy of Sprague Products Company.

RADIO for the HARD-OF-HEARING via Sonotone



To enable the large army of the hard-of-hearing to hear radio programs with utterly amazing new clarity and beauty, RCA has designed

a new Sonotone Radio Adapter, which is connected directly across the radio loudspeaker voice coil.

Complete with either Bone or Air Conduction Unit, and Lorgnette handle, \$28.50. Does not interfere with radio performance. Loudspeaker may be either on or off. Dealers: see your RCA Parts Distributor. To the hard-of-hearing: see any RCA Victor dealer.

BETTER ALL-WAVE RECEPTION. RCA Spider-Web Antenna, erected in a jiffy, combines tuned doublets for each band. Provides tremendous increase in signals. Now being used by amateurs as well as s-w listeners. Write for folder.



Products

RCA Manufacturing Co., Inc.

Camden, New Jersey

A Service of Radio Corporation of America

New!

1936 EDITION

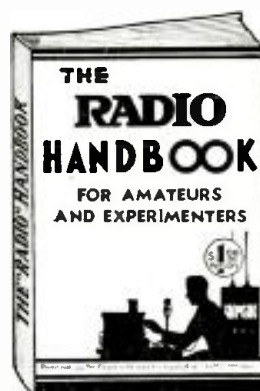

360 PAGES
OVER 400

ILLUSTRATIONS
AND
DIAGRAMS

Complete
Radio Course
AND
Valuable
Reference
Guide

- ★ Amateurs and experimenters "swear" by the facts in this new Handbook. No space has been wasted on matter which is not of practical use. Nothing of value has been omitted. The book is concise, to the point and profusely illustrated. PARTIAL LIST OF CONTENTS: Learning the Code, Fundamental Theory of Electricity, Theory of Vacuum Tubes, both receiving and transmitting, Receiver Design, Crystal Filters, A.V.C., Audio Circuits, Construction and Operation of transmitters, Famous Jones Exciter, Numerous Coil Winding Charts, Radio Telephony, Controlled Carrier Modulation, Complete 53 page chapter of 10 Meter and Ultra-High Frequency Equipment, Complete 25 page chapter on All Types of Antennas, Power Supplies, Test Instruments, Cathode Ray Oscilloscope and Its Application to Short-Wave Receivers and Transmitters, Regulations of the Federal Communication Commission and Board of Fire Underwriters, Complete List of "Q" Signals, etc., etc. Size 6"x9". Flexible card-board covers.
- ★ ORDER TODAY. Send \$1.00 plus postage (weight, 2 lbs.). Check or money order accepted. Resister letter if you send cash or unused U. S. postage stamps.

RADIO PUBLICATIONS

101 Hudson Street

New York

Please mention SHORT WAVE CRAFT when writing advertisers

DATAPRINTS

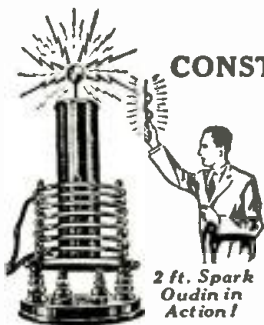

Just the
CONSTRUCTION
Information
You Need
To Build
Electrical
Apparatus

TESLA OR OUDIN COILS

Dataprint containing data for constructing this 3 ft. spark Oudin-Tesla coil. Requires 1 K.W. 20,000 volt transformer as "exciter"; see list below. Includes condenser data. . . . **\$.75**

- 8 inch spark, data for building, including condenser data; requires 1/4 K.W. 15,000 volt transformer; see list below. . . . **0.80**
- Violet type, high frequency coil data; 110 volt A.C. or D.C. type; 1" spark; used for "violet ray" treatments and "Experiments" . . . **0.80**
- How to operate Oudin coil from a vacuum tube oscillator . . . **0.50**
- 3 inch spark Tesla coil; operates on Ford ignition coil . . . **0.50**
- 3 inch spark Oudin coil; 110 volt A.C. "Kick-Coil" (Vibrator type) . . . **0.50**
- 20 Tricks with Tesla and Oudin Coils . . . **0.80**

TRANSFORMER DATA

- 1 k.w. 20,000-volt transformer data, 110-volt, 60-cycle primary. Suitable for operating 3 ft. Oudin coil . . . **0.80**
 - 1/2 k.w. 15,000-volt transformer data, 110-volt, 60-cycle primary. Suitable for operating 8-inch Oudin coil . . . **0.80**
 - Electric Welding Transf. (2 K.W. 110 Vt. Prim. 18 Vt. Sec. Other Sec. Vt. data given) . . . **0.50**
 - Induction Coils—1 to 12 inch spark data . . . **0.50**
 - ARTIFICIAL FEVER Apparatus . . . **0.75**
- (Low, Medium & High Power Data Given)



SLIDE RULE MIDGET

Metal 4" Dia.
Price \$2.00 Net.

With ease and instructions

This rule solves any problem in multiplication, division, addition, subtraction, and proportion; it also gives roots and powers of numbers, sines, cosines, tangents and cotangents of all angles; also logs of numbers. Adds and subtracts fractions. Approved by colleges.

6" Dia. 25" Scale "Special" Rule, \$5.00 Net.

TELEGRAPHONE — Records Voice or "Code" signals on steel wire by magnetism. Code can be recorded "fast" and translated "slow." Construction data (special) . . . **\$0.80**

MAGNET COIL DATA

- Powerful battery electro-magnet; lifts 40 lbs. . . **\$0.80**
- 110 Volt D.C. magnet to lift 25 lbs. . . . **0.80**
- 110 Volt D.C. 300 lb. Lift electromagnet . . . **0.80**
- 110 Volt D.C. solenoid; lifts 2 lb. through 1 in. . . **0.50**
- 110 Volt D.C. solenoid; lifts 6 lb. through 1 in. . . **0.50**
- 12 Volt D.C. solenoid; lifts 2 lb. through 1 in. . . **0.50**
- A. C. Solenoid, powerful, 110-volt, 60-cycle . . . **0.50**
- MOTOR—1/16 H.P., 110 volt A.C., 60 cycle (suitable for driving 12" fan, etc.)—Data . . . **0.50**

MISCELLANEOUS DATAPRINTS

50c each Prepaid

- | | |
|--------------------------------------|----------------------------------|
| Radio Control for Model Boats | 60 or 1200 cycle Synch. Motor |
| Electric Refrigerator Data | Induction Balance |
| Treasure or Ore Locator | Telsutograph |
| Water Turbines | Einhorn String Galvanometer |
| Water Wheels | Electric Fan Motor |
| Motor Circuits (20) | Watch Demagnetizer |
| Telephone Hook-ups (20) | Electric Furnace Draft Regulator |
| 100 Mechanical Movements | Building a Simple Telephone |
| Polarized Relay, Ultra-sensitive | Ignition Coil Data |
| Shocking coil | Battery Motor (small) |
| Ring 4 bells on 1 circuit | Wheatstone Bridge |
| 20 Simple Bell Hook-ups | Rotary Converter |
| Public Address System | |
| Electric Chime Ringer fits any clock | |

20 "Electrical Tricks" for LODGES and PARTIES . . . **\$0.50**

How to Fry Eggs on Cake of Ice Electrically. . . **\$0.80**
"Rewinding" Small Motor Armatures. . . **0.50**

"ENGINEERING SERVICE BY MAIL"

(20% off on orders for \$3.00 or more. No C.O.D.)

The DATAPRINT COMPANY

Look Box 322 RAMSEY, N. J.

The Zottu Multi-tube Oscillator

(Continued from page 275)

tubes. As Mr. Zottu says—"It is too early to predict the usefulness of the scheme presented, but if it is desired at the present time to obtain an output at the shortest possible wavelength, greater than that obtainable with a push-pull circuit, this method is one way of accomplishing it."

*Excerpt of paper presented before Institute of Radio Engineers by P. D. Zottu. Title of paper, "A Multitube Ultra-High Frequency Oscillator."

New Set Has 2-Color Tuning Dial

(Continued from page 275)

push in the knob to switch in the speaker. This new line of sets is furnished with metal tubes of course, and other features include a highly improved music-speech control, providing a wide range over the low—mellow—brilliant music region. The dynamic speaker is of new design, known as a *stabilized* dynamic speaker. A special custom-made "Personalizer" scale is provided for each locality, as, of course, a different group of stations would be "local" for a person residing in the eastern, central, and western parts of the country, for example.

Favorite stations can be tuned in by this new dial instantly, without checking the kc. positions on the dial. The tuning scale is of the sliding-rule type and lists all stations in a straight line; when changing to another band, such as a *short-wave* band, a new scale is turned into position by the band-change switch. An automatic vernier reduction-drive permits either rapid tuning or slow-speed tuning, without manual shifting of the tuning knob.

Our Information Bureau will gladly supply manufacturers' names and addresses of any items mentioned in *Short Wave Craft*. Please enclose stamped return envelope.

Short Waves and Long Raves

Boy! What a Transmitting Station W2IOR Built!

(Continued from page 268)

(A mighty fine job, King, and it is very nice to know that many of the ideas incorporated in your transmitter and station layout were gleaned through the columns of *SHORT WAVE CRAFT*. This is one of the finest looking "home-built" transmitters we have seen so far, and it should certainly serve as a fine inspiration to every red-blooded "Ham." It takes plenty of time, thought and labor in order to turn out such a neat job.—Editor)

Chas. Hrdlicka's Station

(Continued from page 268)

The rack is constructed of steel fence-posts or angle-iron welded together. I read *Short Wave Craft* regularly and find it a "dandy" magazine. One of my first transmitters was built from *Short Wave Craft* data. I have always found articles on short-wave transmission or reception, as well as different types of "rigs," of particular interest. So, fellows, if you wish a large following, stay with the short-wave amateur.

Charles Hrdlicka, W9SGI, Kimball, So. Dak.

(A very business-like looking "Ham" station, Charles, and don't forget that we are always in the market for some good short-wave "constructional" articles on both transmitting and receiving apparatus. If you have devised any new or novel control system for the station, we are also interested in articles on such subjects. Your idea of making the rack out of angle-iron is a very good one, and undoubtedly will serve as a practical hint for many of the "Hams" who are thinking of building a new rack.—Editor.)

TWO GREAT S-W BOOKS

10^C BOOKS

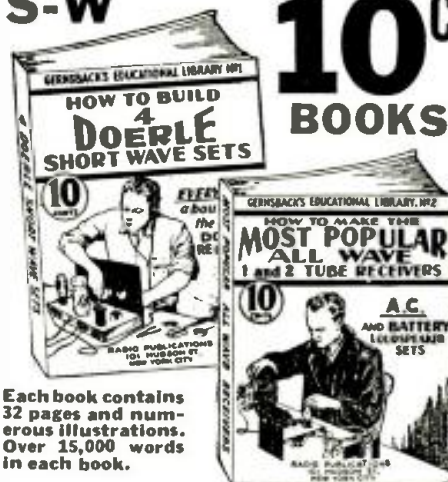

Each book contains 32 pages and numerous illustrations. Over 15,000 words in each book.

HOW TO MAKE FOUR DOERLE SHORT WAVE SETS

- ★ LITERALLY thousands of radio fans have built the famous DOERLE Short Wave Radio Receivers. So insistent has been the demand for these receivers, as well as construction details, that this book has been specially published.
- ★ Contains EVERYTHING that has ever been printed on these famous receivers. These are the famous sets that appeared in the following issues of *SHORT WAVE CRAFT*: "A 2-Tube Receiver that Reaches the 12,500 Mile Mark," by Walter C. Doerle (Dec., 1931-Jan., 1932). "A 3-Tube 'Signal Gripper,'" by Walter C. Doerle (November 1932). "Doerle '2-Tube' Adapted to A. C. Operation" (July 1933). "The Doerle 3-Tube 'Signal-Gripper' Electrified," (August 1933) and "The Doerle Goes 'Hand-Spread'" (May, 1934).
- ★ Due to a special arrangement with *SHORT WAVE CRAFT*, we present a complete 32-page book with stiff covers, printed on an extra heavy grade of paper with numerous illustrations. Nothing has been left out. Not only are all the DOERLE sets in this book, but an excellent power pack if you wish to electrify any of the DOERLE sets, is also described.

HOW TO MAKE THE MOST POPULAR ALL-WAVE 1- and 2-TUBE RECEIVERS

- ★ THERE has been a continuous demand right along for a low-priced book for the radio experimenter, radio fan, radio Service Man, etc., who wishes to build 1- and 2-tube all-wave sets powerful enough to operate a loudspeaker.
- ★ This book contains a number of excellent sets, some of which have appeared in past issues of *SHORT WAVE CRAFT*. These sets are not toys but have been carefully engineered. They are not experiments. To mention only a few of the sets the following will give you an idea.
 - The Megadyne 1-Tube Pentode Loudspeaker Set, by Hugo Gernsback.
 - Electrifying The Megadyne.
 - How To Make a 1-Tube Loud-speaker Set, by W. P. Chesney.
 - How To Make a Simple 1-Tube All-Wave Electric Set, by F. W. Harris
 - How To Build A Four-In-Two All-Wave Electric Set, by J. T. Bernsley, and others.
- ★ Not only are all of these sets described in this book, but it contains all of the illustrations, hookups, etc.—
- ★ And believe it or not, each book contains over 1000 words of new legible type. Each book is thoroughly modern and up-to-date. All the latest improvements have been incorporated into the sets.
- ★ Remember, these books sell at the extraordinary low price of ten cents; you can not possibly go wrong in buying them. Despite its low cost, our usual guarantee goes with this book as well!
- ★ IF YOU DO NOT THINK THAT THESE BOOKS ARE WORTH THE MONEY ASKED FOR THEM RETURN THEM WITHIN TWENTY-FOUR HOURS AND YOUR MONEY WILL BE INSTANTLY REFUNDED.



There has never been such a wealth of data published in low-priced radio books of this type in the history of the radio publishing business. Take advantage of the special offer we are making and use the coupon below.

RADIO PUBLICATIONS
101 Hudson Street
New York, N. Y.

RADIO PUBLICATIONS SW-9-36
101 Hudson Street
New York, N. Y.

Please send immediately books checked:
 How to Build Four Doerle Short-Wave Sets.....10c
 How to Make the Most Popular All-Wave 1- and 2-Tube Receivers.....10c
 I am enclosing.....c; the price of each book is 10c. (Coin or U.S. Stamps acceptable.) Books are sent post-paid.

Name

Address

City..... State.....

New! - GREATEST

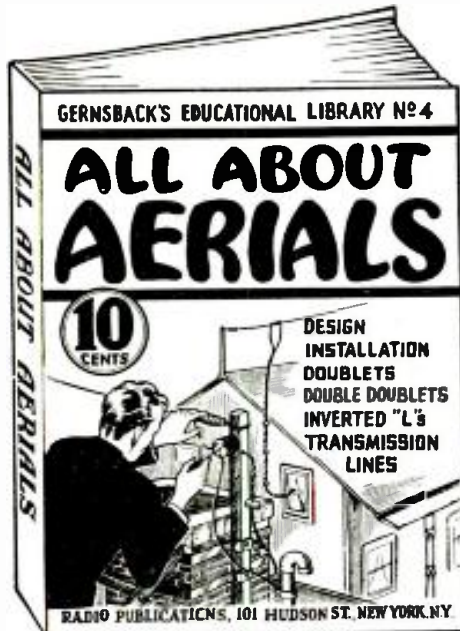

IN recent months the radio public has been made aerial-conscious by virtue of the many articles and advertisements on Aerial Equipment which have appeared in many radio magazines and literature. These articles have been so diversified, and in many cases so conflicting, that the radio experimenter, fan and Service Man are beginning to scratch their heads and ask: "What's it all about?" As a consequence, the demand for a low-priced book explaining in a clear, lucid manner the principles underlying the design and installation of efficient aerials has become a crying need. Furthermore, the steadily increasing nuisance of man-made static, resulting in noisy radio reception—particularly in connection with short-wave receivers—has made the importance of a good antenna a paramount issue. For the thousands of radio fans, both short-wave and broadcast, who wish to know just what type of antenna they should use and why, this book has been especially published.

ALL ABOUT AERIALS

In simple, understandable language this book explains the theory underlying the various types of aerials; the inverted "L," the Doublet, the Double Doublet, etc. It explains how noise-free reception can be obtained, how low-impedance transmission lines work; why transposed leads are used. It goes into detail on the construction of aerials suitable for long-wave broadcast receivers, for short-wave receivers, and for all-wave receivers. The book is profusely illustrated in a manner which will appeal to the most inexperienced in radio; clear, self-explanatory; it is written in so simple a style that it will clear up the aerial situation in your mind, once and for all. Such a wealth of information is presented in this book that you will wonder how it can be done at this low price.

Believe it or not, the book contains over 15,000 words of clear, legible type. It is thoroughly modern and up-to-date.

Remember that this book sells at the extraordinary low price of 10c; you cannot possibly go wrong in buying it. Despite its low cost, our usual guarantee goes with this book.

IF YOU DO NOT THINK THAT THIS BOOK IS WORTH THE MONEY ASKED FOR IT, RETURN IT WITHIN 24 HOURS AND YOUR MONEY WILL BE INSTANTLY REFUNDED.

There has never been such a wealth of data published in a low-priced radio book at this price in the history of radio business. Take advantage of this special offer we are making and use the coupon below.

RADIO PUBLICATIONS
101 Hudson Street
New York, N. Y.



RADIO PUBLICATIONS (No. 4) SW-9-36
101 Hudson Street
New York, N. Y.

Please send immediately your book "ALL ABOUT AERIALS," for which I enclose 10c (coin or U. S. stamps acceptable). Book is to be sent prepaid to me.

Name _____
Address _____
City _____ State _____

New 5-Meter Receiver Uses 3 Tubes

(Continued from page 281)

during transmission periods. The coils for the R.F. and detector tuning positions are of the space-wound, plug-in type, fitted with small plugs. While only coils for the 5-meter band (approximately 50-62 megacycles) are supplied with the set, the plug-in feature permits easy experimenting with still smaller or larger coils for higher or lower frequency bands.

Battery or A.C. Operation

For battery operation the Lafayette "79" has its filaments working directly off a 6-volt storage battery; up to 250 volts of "B" battery can be used for plate supply. For A.C. operation the filaments are heated by a 6.3-volt secondary on a power transformer. Any small A.C. power-pack of suitable output may be used.

Because of this convertible feature, amateurs contemplating summer automobile trips will find this the ideal set to mount on the steering column or under the dashboard. After the trip is over, the set goes back to the operating table at home, and without a single change, becomes an A.C. outfit that draws in plenty of signals.

This article has been prepared from data supplied by courtesy of Wholesale Radio Service Co., Inc.

An "F.B." Duplex Portable

(Continued from page 280)

point the tube is most sensitive to receive signals. Actual control of the regeneration is accomplished by varying the voltage on grids 3 and 5. On reaching the non-oscillating point the circuit merely stops oscillating. No fringe-howl, backlash or "bump" is encountered. This is one reason for the remarkable efficiency of the receiver.

The type 1F4 is a new output pentode designed for use in battery-operated equipment. This tube has a high degree of power sensitivity and will deliver considerable power output at the ridiculously low plate current of only 8ma. and filament current .12 ampere. The undistorted gain factor in this stage alone is 100. The plate current of the detector is almost negligible, so it can be readily seen that the total plate current of the receiver is not of "headache" proportions. The sensitivity, gain and power output is sufficient to drive to a maximum the built-in loudspeaker, even on signals ordinarily considered weak.

The transmitter is composed of 3 tubes: An oscillator (19), a speech amplifier (1B4) and a modulator (1E7G). The oscillator is designed to oscillate so stably, yet at high carrier output, that very little frequency modulation takes place, even at modulation peaks. The audio portion consists of the (1B4) pentode speech amplifier and the new (1E7G) double pentode Class A modulator. The undistorted power output of this tube is sufficient to 100% modulate the oscillator.

All batteries are self contained, 3-45 volt "B" batteries, 2-1½ volt dry cells and a 4½ volt "C" battery are used.

The entire unit including batteries and loud-speaker is housed in an attractively finished metal cabinet, 15½ inches high, 8½ inches wide and 9½ inches deep.

This article has been prepared from data supplied by courtesy of Ultra High Frequency Products Co.

High Quality MOPA for 5 and 10 Meters

(Continued from page 280)

ployed, which permits the use of tuned or untuned feeders. The front panel has a beautiful crackle finish and high-grade precision dials and meter are used.

This article has been prepared from data supplied by courtesy of Custom Set Builders.

New! - 10c BOOKS

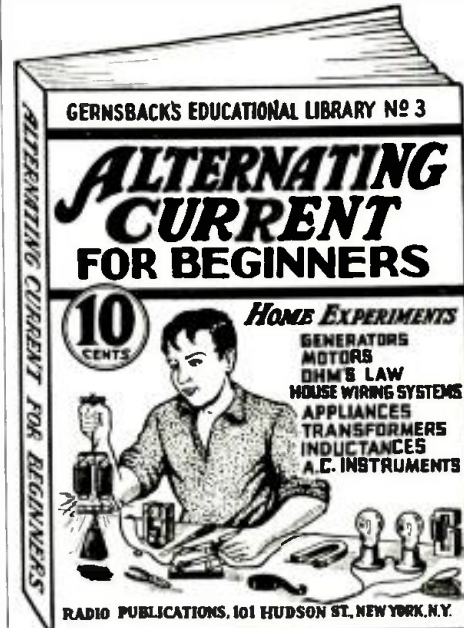

LITERALLY thousands of beginners each year ask the question "HOW CAN I GET STARTED IN RADIO?" In order to understand the theory of radio, it is necessary, first of all, to have a fundamental knowledge of electricity and, particularly of alternating currents. We stress this point because radio is a study of alternating currents of a very high frequency nature.

In this book, which is prepared especially for new beginners, we explain in a simple, lucid manner: How Alternating Current is Generated; What Its Properties Are; What The Laws Governing It Are, and How It is Applied To Everyday Household Use. Furthermore, we give in simple language detailed instructions on how to perform practical experiments with alternating current in the home.

ALTERNATING CURRENT FOR BEGINNERS
This book contains everything necessary to give the beginner his first foothold in the study of electricity and Radio. Electric circuits are explained with simple analogies to hydraulic systems. Ohm's Law, one of the fundamental laws of radio, is thoroughly explained; the generation of alternating current; sine waves; the units—volts, amperes, and watts are explained. Condensers, transformers, A.C. instruments, motors and generators—all these are thoroughly discussed. House-wiring systems, electrical appliances and electric lamps—nothing has been left out.

Here are some of the practical experiments which you can perform at home. Simple tests for differentiating between alternating and direct current; how to light a lamp by induction; how to make a simple electric horn; how to demagnetize a watch; how to test motor armatures; how to charge storage batteries from A.C. outlet; how to test condensers with A.C.; how to make A.C. electro magnets; how to fry eggs on a cake of ice; how to make simple A.C. motors and many others.

The book contains 32 pages. Profusely illustrated with clear, self-explanatory diagrams. It contains over 15,000 words of clear, legible type. It is an education in itself and lays the groundwork for a complete study of radio and electricity.

At the extraordinary price of 10c, you cannot possibly go wrong. Despite its low cost, however, our usual guarantee goes with this book.

IF YOU DO NOT THINK THAT THIS BOOK IS WORTH THE MONEY ASKED FOR IT, RETURN IT WITHIN 24 HOURS AND YOUR MONEY WILL BE INSTANTLY REFUNDED.

There never has been such a wealth of data published in a low-priced radio book of this type in the history of the radio publication business. Take advantage of this special offer we are making and use the coupon below.

RADIO PUBLICATIONS
101 Hudson Street
New York, N. Y.

RADIO PUBLICATIONS (No. 3) SW-9-36
101 Hudson Street
New York, N. Y.

Please send immediately your book "ALTERNATING CURRENT FOR THE BEGINNER," for which I enclose 10c (coin or U. S. stamps acceptable). Book is to be sent prepaid to me.

Name _____
Address _____
City _____ State _____

Cut Prices on Many Popular Radio Books

IMPORTANT—The 25 books listed are ALL different ones from those listed in last month's ad.

We herewith present a selected collection of recent important radio books. We have, after an exhaustive study, selected these volumes because they represent the foremost radio books of their kind in print today. There is such a great variety that we are sure it will satisfy any taste as well as any requirement that the student of radio might have.

We publish no catalog and ask you to be kind enough to order direct from this page. Prompt shipments will be made to you direct from the publishers. We merely act as a clearing house for a number of radio publishers and **OUR PRICES ARE AS LOW OR LOWER THAN WILL BE FOUND ANYWHERE.** Remit by money order or certified check. Register all letters containing cash.

SHORT WAVES, by C. B. Louts and H. B. Gable. Stiff covers. Size 6x9", 284 pages, 258 illustrations. Price was formerly \$2.98. **NEW PRICE NOW, \$1.00** Prepaid.

The biggest and most complete book on short waves. Covers every imaginable phase, including S. W. Superheterodynes, Television, Aircraft Radio, Ultra Short Waves, Directional Antennae, etc. The authors are famous short-wave authorities. This is the best book on Short-waves in print today.

PRACTICAL TELEVISION, by E. T. Larnar. Cloth covers, size 5 1/2 x 8 1/2", 223 pages, 127 illustrations. Price **\$3.69**

This book explains television in full, including elementary principles, photo-electric cells, and all important types of television sets as well as basic principles of optics, images, mirrors, lenses, etc.

ELEMENTS OF RADIO COMMUNICATION (Second Edition), by John H. Morecroft. Cloth covers, size 6 x 9 1/2", 286 pages, 241 illustrations. Price **\$2.98**

An introductory volume, written in easily understandable style, to the more comprehensive "Principles of Radio Communication."

OFFICIAL SHORT-WAVE RADIO MANUAL, Volume 1, by Hugo Gernsback and H. W. Secor, with 352 pages, illustrations, Flexible, Looseleaf Leatherette Binder. Size 9x12". Price **\$2.00** Prepaid.

The one and only short-wave manual published. Contains constructional information on the most important Short-Wave Receivers, sections on S.W. Transmitters, Ultra Short Waves, S.W. Beginner's section, coil winding, A.C.-S.W. Power Packs, kinks, etc., for S.W. Experimenters, sections on S.W. Converters, Antennae, Superheterodynes, Amateur Phone Transmitters, Super Regeneration in S.W. Receivers, S.W. Therapy, S.W. Physics, etc.

RADIO PHYSICS COURSE (2nd enlarged edition), by Alfred A. Chubbard. Cloth covers, size 7 1/4 x 9 1/2", 992 pages, 510 illustrations, numerous tables. Price **\$3.89**

The finest and most popular book on electricity and radio. Each subject is clearly discussed, with the aid of dozens of excellent drawings. Chapters on talkies, television, electronics and service work, etc. Biggest buy in radio.

THE RADIO AMATEUR'S HANDBOOK, (New Revised Edition), by A. Frederick Collins. Cloth covers, size 5 1/2 x 7 1/2", 394 pages, 118 illustrations. Price **\$1.97**

If you wish to become a radio amateur (radio ham) this book tells you how. Everything in receiving and transmitter sets and how to build them.

RADIO THEORY AND OPERATING, by M. T. Loomis. 5th revised Edition. Cloth-bound; size 5 1/2 x 8 1/2", thick, 1,000 pages; over 800 illus.; 450 review questions and answers. Price **\$4.38**

Written in textbook style, a tremendous amount of useful information has been crammed into this thin-paper, compact reference work. Radio transmission and reception have been covered. "From soup to nuts." A truly great book.

MODERN RADIO ESSENTIALS, by Kenneth A. Hathaway. Cloth covers, size 8 1/2 x 5 1/2", over 200 pages, and over 100 illustrations. Price **\$1.95**

NEW! Unlike most books dealing with radio fundamentals, Hathaway's new book is arranged for quick use by the practical technician. In addition, it brings the reader right up-to-date on essential radio theory.

FOUNDATIONS OF RADIO, by Rudolph L. Duncan. Cloth covers, size 5 1/2 x 8", 246 pages, 145 illustrations. Numerous tables. Price **\$2.47**

This textbook gives you the fundamentals of electricity as applied to radio. It equips you for further study in the field of radio.

PHOTOCELLS AND THEIR APPLICATION, (Second Edition), by V. K. Zworykin and E. D. Wilson. Cloth covers, size 5 1/2 x 8", 332 pages, 180 illustrations. Price **\$2.88**

Does this book tell you why and how to use light-sensitive cells? The answer is that the first edition was a "sell out," and the second edition, brought right up to date, is even a better volume. Enough said.

ELECTRONICS, by R. C. Hudson. Cloth covers, size 6 1/2", 134 pages, 45 illustrations. Price **\$1.95**

"This book is written for the reader who may wish to know something about what is going on and who has not heretofore, given the matter much attention," says the author. Read it and learn how dry rectifiers, vacuum tubes, batteries, television tubes, and other apparatus, work; get the "low down" on electrons and atoms

SHORT WAVE RADIO HANDBOOK, by Clifford E. Denton. Paper covers, size 6 1/2 x 8 1/2", 128 pages, 150 illustrations. Price **\$1.00**

Coil data, circuit data, testing data, R.F. and A.F. amplifier data—in fact, let us say, "data of every imaginable sort—in connection with short-wave radio reception."

PRINCIPLES OF RADIO, by Keith Henney, M. A. Cloth covers, size 8 1/2 x 5 1/2", 478 pages, 806 illustrations. Price **\$3.46**

A marvelously written textbook with the latest radio principles, including screen grid and pentode, amplifiers, etc.

HOW TO ORDER

We cannot ship C.O.D. Our prices are net, as shown. Some of the books sent prepaid (in U. S. only). Those that are not thus listed will be shipped by express collect if sufficient postage is not included by you.

NEW LOW PRICED RADIO BOOKS

Here are 12 new, up-to-date books on every conceivable radio subject, just published. Modern in every sense. ALL BOOKS UNIFORM from 64 to 72 pages; 50 to 120 illustrations. All books written by well-known radio authors. Order by Number:

- No. 1 RADIO SET ANALYZERS
- No. 2 MODERN RADIO VACUUM TUBES
- No. 3 THE SUPERHETERODYNE BOOK
- No. 4 MODERN RADIO HOOK-UPS, by R. D. Washburne
- No. 5 HOW TO BECOME A RADIO SERVICE MAN
- No. 6 BRINGING ELECTRIC (RADIO) SETS UP TO DATE, by C. E. Denton
- No. 7 RADIO KINKS & WRINKLES (for Experimenters)
- No. 8 RADIO QUESTIONS & ANSWERS, by R. D. Washburne
- No. 9 AUTOMOBILE RADIO & SERVICING
- No. 10 HOME RECORDING AND ALL ABOUT IT, by Geo. J. Saliba
- No. 11 POINT-TO-POINT RESISTANCE MEASUREMENTS by C. E. Denton
- No. 12 PUBLICATION ADDRESS INSTALLATION AND SERVICE

PRICE PREPAID EACH BOOK **.45**

RADIO PUBLICATIONS, 97 HUDSON ST., NEW YORK, N. Y.

Short Wave Scouts

(Continued from page 292)

- DGZ—20.54 m.—Nauen, Germany.
- DJN—31.45 m.—Zeeseu, Germany.
- DJB—19.74 m.—Zeeseu, Germany.
- DJA—31.38 m.—Zeeseu, Germany.
- DJC—49.83 m.—Zeeseu, Germany.
- DJD—25.49 m.—Zeeseu, Germany.
- DJE—16.89 m.—Zeeseu, Germany.
- DJQ—19.63 m.—Zeeseu, Germany.
- PARIS—19.68 m.—Paris, France.
- PARIS—25.23 m.—Paris, France.
- PARIS—25.6 m.—Paris, France.
- TYA—24.56 m.—Paris, France.
- TYA2—33.19 m.—Paris, France.
- TYB—24.49 m.—Paris, France.
- FTM—15.50 m.—St. Assise, France.
- FTK—18.90 m.—St. Assise, France.
- HRJ—20.64 m.—Geneva, Switz.
- HBP—38.47 m.—Geneva, Switz.
- HBL—31.27 m.—Geneva, Switz.
- RNE—25 m.—Moscow, U. S. S. R.
- EAQ—30.43 m.—Madrid, Spain.
- HAT4—32.88 m.—Budapest, Hungary.
- HAS3—19.62 m.—Budapest, Hungary.
- EHY—29.79 m.—Madrid, Spain.
- PHI—16.88 m.—Eindhoven, Holland.
- PCJ—19.71 m.—Eindhoven, Holland.
- 2RO—25.4 m.—Rome, Italy.
- 2RO—21.13 m.—Rome, Italy.
- IRW—15.37 m.—Rome, Italy.
- IRJ—22.89 m.—Rome, Italy.
- ORK—29.04 m.—Rome, Italy.

South America

- HJ1ABE—49.05 m.—Cartagena, Colom.
- HJ1ABD—41.2 m.—Cartagena, Colom.
- HJ1ARG—49.65 m.—Barranquilla, Colom.
- HJ3ABH—49.85 m.—Bogota, Colom.
- HJ4ABA—25.6 m.—Medellin, Colom.
- HJ5ABE—21.26 m.—Cali, Colombia.
- YV2RC—51.72 m.—Caracas, Venezuela.
- YV3RC—48.7 m.—Caracas, Venezuela.
- YV5RMO—51.28 m.—Maracaibo, Venezuela.
- YV6RV—46.01 m.—Valencia, Venezuela.
- PSF—20.7 m.—Rio De Janeiro, Brazil.
- PRF5—31.56 m.—Rio De Janeiro, Brazil.
- HCJB—36.5 m.—Quito, Ecuador.
- HC2R—45 m.—Quayaquil, Ecuador.
- PRADO—45.3 m.—Riobamba, Ecuador.

- North Central America**
- VE9GW—49.22 m.—Bowmanville, Canada.
 - CJRO—48.8 m.—Manitoba, Canada.
 - CGA—22.49 m.—Drummondville, Canada.
 - CGA—16.50 m.—Drummondville, Canada.
 - CZA—23.7 m.—Drummondville, Canada.
 - CGA3—22.58 m.—Drummondville, Canada.
 - CGA2—21.83 m.—Drummondville, Canada.
 - HP5J—31.28 m.—Panama, Panama.
 - HP5B—49.75 m.—Panama, Panama.
 - XECR—40.65 m.—Mexico City, Mex.
 - XEBT—50 m.—Mexico City, Mex.
 - HRF—21.7 m.—Tegucigalpa, Honduras.
 - COC—49.9 m.—Havana, Cuba.
 - HIH—44.31 m.—San Pedro De Macoris, D. R.
 - HI1J—51.15 m.—San Pedro De Macoris, D. R.
 - HI1D—46.25 m.—Santo Domingo, D. R.
- Asia**
- ZBW—34.29 m.—Hong Kong, China.
 - PMA—15.5 m.—Bandoeng, Java.
 - PLV—31.9 m.—Bandoeng, Java.
 - PLP—27.27 m.—Bandoeng, Java.
 - PLF—15.93 m.—Bandoeng, Java.
 - YDA—49.02 m.—Bandoeng, Java.
- Australia**
- VIZ-3—26.09 m.—Fiskville.
 - VK2ME—31.28 m.—Sydney.
 - VK3ME—31.55 m.—Melbourne.
 - VK3LR—31.3 m.—Lyndhurst.
- Africa**
- OPM—29.58 m.—Leopoldville, Belgian Congo.
 - SUV—29.83 m.—Cairo, Egypt.
 - SUZ—21.7 m.—Cairo, Egypt.
- Miscellaneous**
- FNSK—Normandie—22.73 m.—1500 miles east of New York.

speaker. If excessive harmonics are being developed in the amplifier, the Model 990 speaker will show up this distortion by producing a fuzzy, rattley tone, when a speaker with an ordinary conical cone, which has a more limited frequency range, will not. This naturally means when used with an amplifier which is distortion free, (that is, with total harmonics of less than 3 per cent) the speaker will give surprising reproduction, impossible with speakers using ordinary types of diaphragms, the makers claim.

The model shown is the large 12-inch loud speaker, with universal transformer to match all output tubes. It is supplied with a universal field coil to match practically any resistance. They are as follows: 2500, 2200, 1800, 1500, 1000, 700, 300, and 1800 tapped at 300 ohms.

This article has been prepared from data supplied by courtesy of Wright-DeCoster, Inc.



New "Wide-Frequency" Response Loud-Speaker

New 12" Speaker Has Wide Frequency Range

● This speaker has the new *Para-Curve* diaphragm which gives it a very wide frequency range. Due to this wide frequency response, it can be used successfully for testing an amplifier, to ascertain whether it is furnishing undistorted power to the

Please mention SHORT WAVE CRAFT when writing advertisers

Does 60-Cycle A. C. Create a 60-Cycle Note?

(Continued from page 283)

ond quarter cycle of the applied A.C. the diaphragm will move back from "B" to "A". Let us call this motion "1C" (compression). On the third quarter cycle of the applied A.C. the diaphragm will move from "A" toward "C", and let us call this "2-C" (still compression). Now let us consider the fourth quarter cycle of the A.C.—here the diaphragm will move back from the approximate position of "C" toward "A", the normal neutral position of the diaphragm.

The diaphragm has now completed one cycle, and so has the applied A.C. so that the sound heard from the vibrating diaphragm must be of course, 60 cycles. Some students become confused with this sequence of movements of the diaphragm and as they consider that the diaphragm has moved in two directions, up and down, during one cycle of the applied A.C. they frequently believe that the note heard is a 120-cycle one. Actually, the note may be specified as a 60-cycle one, or a note equivalent to 120 sound vibrations per second.

120-cycle note heard from 60-cycle A.C. on non-polarized receiver. A very interesting and different cycle of events occur, when 60 cycle A.C. is applied to a telephone receiver with a non-polarized diaphragm. Very few, if any, receivers of this type are in use today, but at one time there were a great many of these electromagnetic receivers, having no permanent steel magnet, in use. The radio experimenter may, of course, use the counterpart of the non-polarized magnet receiver, in the form, for instance, of a tin can with an ordinary electromagnet set up adjacent to the end of the can or some similar noise-creating device of the non-polarized type.

Let us follow the sequence of events when one cycle of a 60-cycle per second A.C. is applied to the coil windings of such a non-polarized receiver.

On the first quarter cycle of the applied A.C. the current through the coils rises to a maximum "M", and the diaphragm is attracted toward the iron pole-pieces of the electro-magnet and reaches a maximum downward movement; let us call this "1-R" (rarefaction). On the second quarter cycle of the A.C. the current through the coils decreases to zero, and the diaphragm returns to its normal position "N". On the third quarter cycle of the A.C., the magnetism in the iron core rises to a maximum again (M-1), and the diaphragm is again attracted toward the pole-pieces; let us call this movement "2-R" (rarefaction). On the fourth quarter of the A.C. the diaphragm moves upward as the current decreases in the magnet coils and let us call this movement "2-C" (compression). The diaphragm has thus completed two cycles of motion to the one cycle of applied A.C. and thus for 60 cycles per second we obtain 120 cycles of sound. Or the note can be said to represent 240 vibrations per second.

(Note: if a battery is included in the circuit, the magnet will be polarized, and then a 60 cycle note will be heard.)

The aural action in the ear is interesting, and when a 60-cycle sound, for example, from a receiver or loudspeaker impinges on the ear, the auditory system of the ear and brain interpret the sound to the person hearing it as a 60-cycle sound, although the diaphragm in the ear is vibrating 120 times per second! Just a bit confusing for the moment, and a situation which gives rise to many arguments. But if we remember how a musical string has to give a double vibration, as shown in Fig. 3, in order to sound a note, the process will become quite clear. In other words, when we pluck or strike a string on a musical instrument, the string starts from rest or zero, swings out, let us say to "A", then back through "B", its neutral axis on to "C", and back to "D" (or "B"). This sequence of two vibrations per cycle, one in each direction, is shown in one of the diagrams of Fig. 3, and represented by the curve O-A-B-C-D.

A very peculiar phenomenon is that even though the 60-cycle note was cut off by a filter, so that the ear did not hear it, but the source contained harmonics the human ear and sound interpreting system, comprising the brain and auditory nerve, etc., would be liberal and interpret the sound as a 60-cycle note to the listener. This is because of the fact that the ear heard the second, third, and other higher frequency harmonics. For example, suppose a person did not hear the 60-cycle fundamental note, due to filtering or for other reasons, but that he only heard the 120-cycle second harmonic, also the third and other harmonics. Then due to the fact that these harmonics are part and parcel of the fundamental note, which is built up from the harmonics (or is the accumulated effect of the harmonics), the listener would still hear a 60-cycle note (the difference frequency between the adjacent harmonics), as the brain and auditory nerve system would interpret the sound to him.

The curve representing the sensitivity of the ear is a very peculiar one, and in this particular instance it happens that the ear is more sensitive to a 120-cycle note than it is to a 60-cycle one. Also, it is possible in many cases that the second harmonic or 120-cycle note would be so strong when the sound is reproduced by connecting an ordinary receiver to a 60-cycle circuit, that the ear might procrastinate sufficiently to interpret to the individual a 120-cycle note, and higher frequency harmonics, but due to the fact that the difference frequency between adjacent harmonics is always 60 cycles, it would be interpreted as 60 cycles, a peculiar acoustic and physiological phenomena well worth keeping in mind if you should do some experimenting along this line.

Short Wave Scout News

(Continued from page 284)

10.74 mc., Tokio, Japan, has been very weak.

Moscow is now reported to be putting out a good signal on its new frequency of 9.52 mc. The call is RAN and the time is 7-8 p.m., E.S.T.

The 20 meter amateur band, although quite crowded, is very good around 6 p.m., E.S.T. In a very short time I "logged" stations in England, Spain, Ecuador, Argentina, and many other countries.

HAROLD E. BISSELL, JR.,
(Twenty-eighth Trophy Winner)
Toms Road, Stamford, Conn.

Report from South Amboy, N.J.

Among the 93 stations heard the past month were (all time in E.S.T.):
CFCX—6,005 kc.—Canadian Marconi

Company, P.O. Box 1690, Montreal, Que., Canada. CFCX relays CFCF daily from 8 a.m. to 1 a.m. and Sundays 9 a.m. to 11:15 p.m.

HIT—6,630 kc.—Ciudad Trujillo, D. R.—is heard regularly, with good strength.

VE9HX—Halifax, Nova Scotia, Canada, has changed its frequency slightly; it is heard quite regularly.

VP3MR—7,080 kc.—Georgetown, British Guiana, is heard regularly, but it is often bothered with code; it has fair strength.

HH2S—5,900 kc.—Port au Prince, Haiti, is heard often.

XBO—11,200 kc.—Mexico City.

PRF5—9,500 kc.—Rio de Janeiro, Brazil—heard several times with fair strength.

(Continued on page 317)

CUT THRU SUMMER STATIC

WITH THE D-104 ASTATIC CRYSTAL MICROPHONE



For clear, powerful "speech range" dependability under all conditions the D-104 is the choice of veteran amateurs the world over. Ruggedly constructed—economical in price—fully guaranteed. A precision built Crystal Microphone licensed under Brush Development Company Patents.

ASTATIC MICROPHONE LABORATORY, Inc.
Dept. SW, Youngstown, Ohio

ASTATIC

SEE YOUR JOBBER

I WANT MEN

FORDS GIVEN
TEA AND COFFEE ROUTES
PAYING UP TO \$60.00 A WEEK
National company needs more men at once to make regular calls on local routes. No experience needed. Advance our capital. I send everything: give you brand new Ford car as bonus. Rush name on postcard for full facts. . . ALBERT MILLS 8808 Monmouth, Cincinnati, Ohio

6 BACK NUMBERS SHORT WAVE CRAFT MAILED PREPAID 70c

For a limited time only, and as long as they last, we will send you six back numbers of SHORT WAVE CRAFT assorted, your choice, for 70 cents.

The usual price for six copies would be \$1.50 and most publishers charge a higher price for back numbers over one year old.

We can supply only the following back numbers: Dec. 1930; Feb., April, June, Oct. 1931; Sept. 1932; Oct., Nov., Dec. 1933; Jan., Feb., Mar., April, May, June, July, Aug., Sept., Oct., 1934; 1935—All issues; 1936—All issues to date.

If you do not specify copies we will use our own judgment in sending assorted numbers to fill your order. Note we cannot exchange the copies for ones that have been sent to you.

Practically every copy of SHORT WAVE CRAFT contains important information that you should have. Here is a chance to get those copies.

As we have only a small supply of back numbers on hand, this offer will be withdrawn as soon as they have been sold.

We accept U.S. stamps, U.S. coin, or money order. Rush your order today.

SHORT WAVE CRAFT
99-101 Hudson Street New York, N. Y.

SHORT WAVE CRAFT 9-36
99-101 Hudson Street, New York, N. Y.

Gentlemen: I enclose herewith 70c, for which you are to send me six back number copies of SHORT

WAVE CRAFT as follows:.....

Name

Address

City..... State.....

Please mention SHORT WAVE CRAFT when writing advertisers

Here are the six BEST SHORT-WAVE RADIO BOOKS!

Without doubt you will have to go a long way to buy better books on short waves than you find on this page. Each book is written by a well-known authority on short waves . . . each book has been carefully illustrated with photographs and diagrams to

make the study of this field of radio much simpler. The volumes on this page are the finest hooks on short-waves which are published anywhere today. Order one or more copies today . . . find out for yourself how fine they are. Prices are postpaid.



How to Get Best Short-Wave Reception

By M. HARVEY GERNSBACK

This book tells you everything you ever wanted to know about short-wave reception. The author, a professional radio listener and radio fan for many years, gives you his long experience in radio reception and all that goes with it. Why is one radio listener enabled to pull in stations from all over the globe, even small 100 watters, 10,000 miles away, and why is it that the next fellow, with a much better and more expensive equipment, can only pull in the powerful stations that any child can get without much ado? The reason is intimate knowledge of short waves and how they behave. Here are the chapters of this new book:

1. What are Short Waves and what can the listener hear on a short-wave receiver or converter?
2. How to tune and when to listen in on the short waves.
3. How to identify short-wave stations.
4. Seasonal changes in short-wave reception.
5. Types of receivers for short-wave reception.
6. Aerial systems for short-wave receivers.
7. Verifications from short-wave stations.

The book makes excellent reading matter. There are many tricks in short-wave reception that even some of the "old-timers" do not know. Be sure to get it.

40 Illustrations, 72 Pages. Stiff, flexible covers 50c

HOW TO BUILD AND OPERATE SHORT-WAVE RECEIVERS

THIS is the best and most up-to-date book on the subject. It is edited and prepared by the editors of SHORT WAVE CRAFT, and contains a wealth of material on the building and operation, not only of typical short-wave receivers, but short-wave converters as well. Dozens of short-wave sets are found in this book, which contains hundreds of illustrations, actual photographs of sets built, hookups and diagrams galore.

This book is sold only at a ridiculously low price because it is our aim to put this valuable work into the hands of every short-wave enthusiast.

We know that if you are at all interested in short waves you will not wish to do without this book. It is a most important and timely radio publication.

150 Illustrations, 72 Pages. Stiff, flexible covers 50c



THE SHORT-WAVE BEGINNER'S BOOK

HERE is a book that solves your short wave problems—leading you to easy steps from the simplest fundamentals to the present stage of the art as it is known today. It is the only low-priced reference book on short waves for the beginner. The book is profusely illustrated—it is not "technical." It has no mathematics and no technical jargon.

It also gives you a tremendous amount of important information, such as time conversion tables, all about aerials, noise elimination, all about radio tubes, data on coil windings and other subjects.

Partial List of Contents

Getting Started in Short Waves—the fundamentals of electricity. Symbols, the Short Hand of Radio—how to read schematic diagrams. Short Wave Coils—various types and kinds in making them.

Short Wave Aerials—the points that determine a good aerial from an inefficient one.

The Transposed Lead-in for reducing Static.

The Beginner's Short-Wave Receiver—a simple one tube set that anyone can build.

How to Tune the Short-Wave Set—telling the important points to get good results.

Audio Amplifiers for S-W Receivers.

Learning the Code—for greater enjoyment with the S-W set.

Wave length to Kilocycle Chart.

Wire Chart—to assist in the construction of coils.

75 Illustrations, 40 Pages. Stiff, flexible covers 25c



101 SHORT-WAVE HOOKUPS

Compiled by the Editors of SHORT WAVE CRAFT

EACH and every hook-up and diagram illustrated is also accompanied by thorough explanation of what this particular hook-up accomplishes, what parts are required, coil-winding information, values of resistors, etc., in fact, everything you want to know in order to build the set or to look up the data required.

To be sure, all of the important sets which have appeared in print during the past five years are in this valuable book. Sets such as the Doerle, Himmels, the "19" Triplex, "Heliodyne, Denton "Stand-by," Megadyne Triplex 2, "Globe-Trotter," 3-Tube Superhet, "Mindyne," "Lion" Receiver, "Doerle," 2-tube Battery, "Doerle," 3-tube Battery, "Doerle," 2-tube A.C., "Doerle," 3-tube A.C., "Doerle "Signal Gripper," Duo R.F. 4-tube Receiver, The Barrett 9-33 Tapped Coil Receiver, "Globe-Circlipper 7, The 2 Tube "Champ"—2 Tube Equal 3. Ham-Band "2-Tube Pee-Wee" Wyeth All-Way 6, Denton Economy 3, 2-Tube "Regenerative-Catillidyne" will be found here, with full descriptions. In many cases, we have also included a picture hook-up for those who do not wish to follow the regular symbolic hook-up, but wish to have a regular wiring diagram. This is a very handy volume, especially for those "fans" who wish to study the best sets in the short-wave art, from one tube up to ten tubes.

100 Illustrations, 72 Pages, 50c Stiff, flexible covers

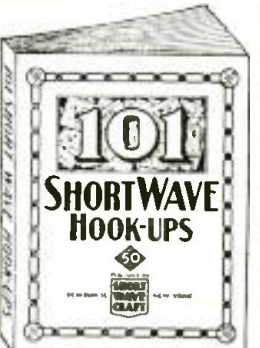

HOW TO BECOME AN AMATEUR RADIO OPERATOR

WE chose Lieut. Myron F. Eddy to write this book because his experience in the amateur field has made him pre-eminent in this line. For many years he was instructor of radio telegraphy at the R.C.A. Institute. He is a member of the I.R.E. Institute of Radio Engineers, also the Veteran Wireless Operators' Association.

If you intend to become a licensed code operator, if you wish to take up phone work eventually—this is the book you must get.

Partial List of Contents

Ways of learning the code. A system of sending and receiving with necessary drill words is supplied so that you may work with approved methods. Concise authoritative definitions of radio terms, units and laws, brief descriptions of commonly used pieces of radio equipment. This chapter gives the working terminology of the radio operator. Graphic symbols are used to indicate the various parts of radio circuits. General radio theory particularly as it applies to the beginner. The electron theory is briefly given, then waves—their creation, propagation and reception. Fundamental laws of electric circuits, particularly those used in radio are explained neat and typical basic circuits are analyzed. Descriptions of modern receivers that are being used with success by amateurs. You are told how to build and operate these sets. Amateur transmitters. Diagrams with specifications are furnished so construction is made easy. Power equipment that may be used with transmitters and receivers, rectifiers, filters, batteries etc. Regulations that apply to amateur operators. Appendix which contains the International "Q" signals, conversion tables for reference DUTD988, etc.

50c 150 Illustrations, 72 Pages, Stiff, flexible covers

TEN MOST POPULAR SHORT-WAVE RECEIVERS

—HOW TO MAKE AND WORK THEM

THE editors of SHORT WAVE CRAFT have selected ten outstanding short-wave receivers and these are described in the new volume. Each receiver is fully illustrated with a complete layout, pictorial representation, photographs of the set complete, hook-up and all worthwhile specifications. Everything from the simplest one-tube set to a 5-tube T. H. F. receiver is presented. Complete lists of parts are given to make each set complete. You are shown how to operate the receiver to its maximum efficiency.

CONTENTS

The Doerle 2-Tube Receiver That Reaches the 12,500 Mile Mark, by Walter C. Doerle.

2-R.F. Pentode S-W Receiver having two stages of Tuned Radio Frequency, by Clifford E. Denton and H. W. Secor.

My de Luxe S-W Receiver, by Edward G. Ingram.

The Binneweg 2-Tube 12,000 Mile DX Receiver, by A. Binneweg, Jr.

Build a Short-Wave Receiver in Your "Brief-Case," by Hugo Gernsback and Clifford E. Denton.

The Denton 2-Tube All-Wave Receiver, by Clifford E. Denton.

The Denton "Stand-By," by Clifford E. Denton.

The "Stand-By" Electrified.

A COAT-POCKET Short-Wave Receiver, by Hugo Gernsback and Clifford E. Denton.

The S-W PENTODE 4, by H. G. Cline, M. E. Louis Martin's Idea of A GOOD S-W RECEIVER, by Louis Martin.

75 Illustrations, 40 Pages, 25c stiff, flexible covers

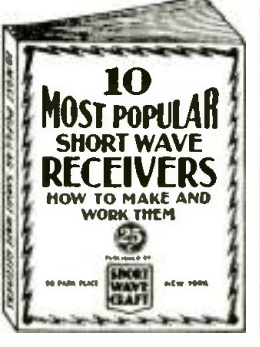

All the books shown on this page are published exclusively by

SHORT WAVE CRAFT

99-101 Hudson Street, New York, N. Y.

CLIP-MAIL

SHORT WAVE CRAFT, 99-101 Hudson Street, New York, N. Y. SW-9-36

Gentlemen: I enclose herewith my remittance for the amount of \$..... for which you are to send me, postpaid, the books checked below.

| | |
|--|--|
| () How to Get Best Short-Wave Reception..... 50c each | () How to Become an Amateur Radio Operator..... 50c each |
| () 101 Short-Wave Hook-ups..... 50c each | () Ten Most Popular Short-Wave Receivers. How to Make and Work Them..... 25c each |
| () How to Build and Operate Short-Wave Receiver..... 50c each | () The Short Wave Beginner's Book..... 25c each |

Name.....

Address.....

City..... State.....

(Send remittance in form of check or money order. If letter contains cash or unused U. S. Postage Stamps, register it.)

OVERSEAS READERS!

These books can be obtained from the following houses:

GREAT BRITAIN
Gorrings's
9a, Green Street, Leicester Square
London, England

FRANCE
Editions Radio
42 Rue Jacob
Paris

AUSTRALIA
McGill's
183-195, 218 Elizabeth St.
Melbourne, C. I

Please mention SHORT WAVE CRAFT when writing advertisers

S-W Scout News

(Continued from page 315)

HRD—6,235 kc.—La Voz De Atlantida, La Ceiba, Honduras—broadcasts daily from 8 to 11 p.m. and Sundays from 4 to 6 p.m.
LSN—21,020 kc.—Buenos Aires, Argentina, heard on May 29 working with New York; good strength.

H19B—6,050 kc.—Santiago, D.R., has been heard 5 or 6 times, fair to good.

PCJ—9,595 kc.—Eindhoven, Holland—heard on Wednesdays, several times.

LRU—15,290 kc.—Buenos Aires, Argentina, heard on June 5; fair strength.

CMA5—About 26 meters or 11,250 kc.—Havana, Cuba, heard testing with New York.

H18Q—6,240 kc.—Emisora Carta Real, Avenida Espana No. 12, Ciudad Trujillo, D.R.; Broadcasts daily from 10:40 a.m. to 1:40 p.m. and from 4:40 to 7:40 p.m.

LSX—10,350 kc.—Argentina—heard on June 19 testing with New York at 8:25 p.m.

Veris received—CFCX, DJI, DJM, H18Q, HRD, and HBL.

FLETCHER W. HARTMAN,
365 John Street,
South Amboy, New Jersey.

Report from Freeport, Pa.

YV11RB, Ciudad, Bolivar, South America, on 6.54 meg. is a new station. They broadcast 6-10:30 p.m.

The Dominican Republic pops up with another new station—H18Q, in Trujillo, on 6.24 meg.

Germany and England are using the lower frequencies for the evening broadcasts. Germany is using DJB, 15.20 meg.; London is using GSF, 15.14 meg.

(From the Mail.)—We learn from the mail that 2RO, 9.64 meg., comes in well every place. They did not change to 11.81 meg. for the afternoon programs after their test on that wavelength.

JVN, 10.66 meg., is being heard by many with not too great signal strength, but being heard all the same.

PCJ, Holland, on 9.59 meg. seems to have picked a good "spot" for their Wednesday "Happy programs." They are coming in very strong.

ANGELO CENTANINO,
Freeport, Pa.

A New Tuning Indicator Tube

(Continued from page 274)

The Philips tube manufacturing company has just introduced a tube, known as the type 4678, which is a variation of the well-known 6E5 American tube. It has certain variations from the earlier American tube, though.

Instead of the usual varying triangle of shadow in the circle of green fluorescent glow, the Philips tube has four shadows, which become narrow or wide according to the strength of the signal.

How to Build a "Bug" Key

(Continued from page 270)

The four contact points can be obtained from spark or ignition coils. Two sets of vibrators from two such coils will supply the four contact points.

All of the metal parts for this "bug" key may be made for the most part of brass or steel—whichever you happen to have handy. If you are not particularly efficient in making small mechanical parts accurately, or if you have no facility for drilling the holes properly, you can have this done at slight cost by your local machine shop. In operating this key, the dashes are formed by pressing the thumb knob 14, to the right. After gaining some experience with the "bug," pressing the lever to the left will enable the operator to send out any desired number of dots in rapid fashion. The weighted arm suspended by spring 20, vibrates several times back and forth so as to send out the dot signals, and with a little experience you will be able, with a single flip of the lever, to rattle off 5 or 6 dots like "nobody's business."

CLASSIFIED

Advertisements are inserted at 5c per word to strictly amateurs, or 10c a word to manufacturers or dealers. Each word in a name and address is counted. Cash should accompany all orders. Copy for the October issue should reach us not later than August 5.

GENERATORS

TURN SCRAP INTO MONEY. Autopower shows you how easily and economically auto generators can be converted into A.C. or D.C. generators and D.C. motors, 2 to 1000 volts; for sound, radio, power, light, or welding. No previous experience necessary—complete information all in new book, with simple instructions and illustrations. Endorsed by thousands. Only \$1.00 postpaid. Autopower, Inc., 414-D So. Hoyne Ave., Chicago.

"HAM" OFFERS AND WANTS

SWAP—CARBON, CONDENSER. crystal and velocity microphones—amplifiers, trumpets, baffles and all kinds of sound equipment. Can use Audio Beat Frequency Oscillator—Oscilloscope—factory tools and equipment—office equipment—radios—refrigerators—or what have you. Lifetime Corporation, 1010 Madison Ave., Toledo, Ohio.

SELL FIVE TUBE SKYRIDER. Three tube Gross Eagle, Perlman all wave station finder oscillator. Want larger receiver Scott, Silver or similar. Glenn Wett, Chanute, Kans.

SKYRIDER BARGAINS. ALL Models, Sell or Trade. Also RME. Cameras wanted in Trade. Also Binoculars. Wells-Smith Radio Corp., 26 N. Wells Street, Chicago, Ill.

COMPLETE 40 WATT XTAL Transmitter \$30. John Henninger, 2143 N. Howard St., Philadelphia, Pa.

SELL—DORLE AC-5 CHEAP. W2JAL, Tarrytown, N.Y.

INSTRUCTION

AMATEUR RADIO LICENSES. complete training. Resident and correspondence courses. Every graduate a licensed operator. N. Y. Wireless School, 1123 Broadway, New York.

MISCELLANEOUS

OHM'S LAW CALCULATOR—Lightning Slide Rule; solves all problems of Voltage, Current and Resistance. Power, Wire Sizes, etc. Range: 1 micro-amp. to 1000 amps.; 1 micro-volt to 10,000 volts; 1 micro-ohm to 10 meg-ohms; 1 micro-watt to 10 megawatts; wire sizes 0 to 36 B. & S. gauge. Introductory price \$1.00 prepaid. The Dataprint Co., Box 322, Ramsey, N.J.

BARGAINS; NO. 227 TUBES. Nationally known make, guaranteed 10 for \$1.00. Other numbers at low prices. Write numbers you are interested in and how many. Gold Shield Products Co., 17 West 60th St., New York.

QSL—CARDS—SWL

QSL's! SWL's! SNAPPY! BRIGHT! Different! New Equipment. Different Ideas. These bring results. 200 two colors \$1.00. Made to order. Free Samples. Prompt Service. W3AUB, Tupelo, Miss.

ATTRACTIVE SHORT WAVE LISTENERS' DX CARDS. Amateur's QSL's, Samples (Stamps). W8ESN, 1827 Cono, Toledo, Ohio.

QSL, SWL CARDS, NEAT, ATTRACTIVE, reasonably priced, samples free. Miller, Printer, Ambler, Pa.

SWL's, 200 CARDS \$1.00. W8IAM, 942 Lincoln Avenue, Columbus, Ohio.

SHORT WAVE COMPONENTS

PLUG-IN COILS, 1.7-210 METERS. Space wound on standard four prong forms, 35 set postpaid, Noel, 728 Birch, Scranton, Pa.

SHORT WAVE RECEIVERS

BUY YOUR RECEIVER ON HINDS' "Easy Payment" Plan. Write Hinds & Edgerton, 19 S. Wells St., Chicago, Illinois.

KEEP YOUR MAGAZINES CLEAN

With one year's subscription at \$2.50 or with 12 back numbers for \$1.50, we will furnish absolutely FREE a 10x12 1/2" stiff leatherette HOLDER. (For list of back numbers available, see page 315).

This will permit you to keep your room or shack tidy and be able to find any magazine you are looking for without loss of time. This holder is large enough to keep all your magazines together.

Our supply is limited, therefore we would suggest prompt action.
SHORT WAVE CRAFT, 99 Hudson St., NEW YORK, N. Y.

THE ONE AND ONLY

Encyclopedia on Short Waves

By C. R. Leutz and R. B. Gable

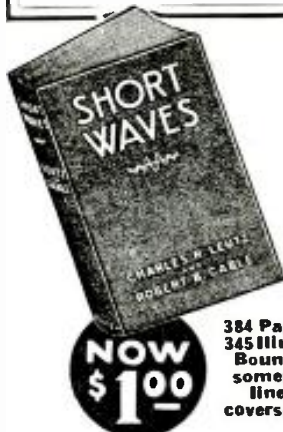

NOW \$1.00

384 Pages—Over 345 Illustrations Bound handsomely in red linen, stiff covers. Size 6x9"

"SHORT WAVES" is written by Leutz and Gable, two foremost radio authorities. You will remember Charles R. Leutz as one of the pioneers in radio, also designer and manufacturer of the famous LEUTZ Transoceanic Receivers. Mr. Robert Gable owned and operated one of the finest low power broadcasting stations in the country. He is well known as an experimenter and research worker in scientific fields. Considering the value of this book for data alone, its cost should really be more than originally asked. But when you see the illustrations in the book you will marvel at how this book could be sold for ONE DOLLAR. It originally sold for \$2.98. The book is printed on a very expensive super-calendered paper. It contains 384 pages with over 345 photographic illustrations and diagrams. The supply of these books is not expected to last long. Once they are gone no additional copies will be available. ORDER NOW—be sure to tell your friends about this remarkable book value. Send the coupon today for your copy of "SHORT WAVES" by Leutz and Gable.

YOU SAVE \$1.98 JUST AS LONG AS THE SUPPLY OF THIS BOOK LASTS! THIS BOOK ORIGINALLY SOLD FOR \$2.98

"SHORT WAVES" is the most important and comprehensive volume of short-waves ever published. This book has EVERYTHING on short-waves—it literally contains a complete education on short-waves.

• Partial Contents of "Short Waves" •

- HISTORICAL REVIEW
- SHORT WAVE PROPAGATION
- COMMERCIAL RADIO TELEPHONY
- COMM. TELEGRAPHY
- SHIP TO SHORE RADIO TELEPHONY
- DIRECTIONAL ANTENNAE
- TELEVISION
- AIRCRAFT RADIO EQUIPMENT
- SHORT WAVE BROADCAST RECEIVERS
- ULTRA SHORT WAVES (Medical and Surgical Applications)
- AMATEUR SHORT-WAVE EQUIPMENT

Don't forget that this comprehensive volume is sold on a MONEY-BACK GUARANTEE. If you are not satisfied with it, return it within three days for refund. Use the coupon at the left for ordering your copy of "SHORT WAVES" by Leutz and Gable.

RADIO PUBLICATIONS
103 Hudson St. New York, N. Y.

MAIL COUPON TODAY!

RADIO PUBLICATIONS, Dept. SWC-9-36
103 Hudson Street, New York, N. Y.

Gentlemen: Enclosed you will find my remittance of One Dollar (\$1) (cash, money order or new U. S. stamps) for which send me One copy of "SHORT WAVES" by Leutz and Gable. I understand this book may be returned to you within three days if I am not completely satisfied and my money refunded.

NAME _____

ADDRESS _____

CITY _____ STATE _____

include 15c extra to cover mailing charges) (25c foreign countries)

Please mention SHORT WAVE CRAFT when writing advertisers

SCOOP—THE BUY OF A LIFETIME

Genuine R. C. A.-Victor Dynamic Speakers

These are the same high quality speakers that are used in the late Model RCA—Victor Radios.

BRAND NEW 6 1/2 INCH SPEAKER

1500 ohms. Output transformer to match 38, 12A7, 71A, 43, 45, 2A5, 47, 59, 53 tubes, etc. Shipping weight 6 lbs. AD 600. Speaker complete.

Genuine RCA 6" Automobile radio, 6 ohm speakers, 6" for M 31 or General Electric radios. **\$1.95**

10 INCH SPEAKERS

1000, 1200, 1500, 2000 ohm field coils. Brand new, less output transformers. **\$1.95**

10" SPEAKER less transformer. **\$1.95**

OUTPUT TRANSFORMERS, extra **25c**

PP 15-2A3 extra **39c**

OUTPUT TRANSFORMERS, single pentode, extra **39c**

AD-1601 Shipping weight, 10 lbs.

GENUINE KOLSTER 12-inch DYNAMIC SPEAKER

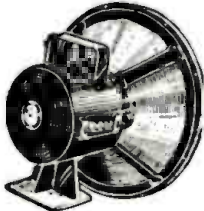

A husky 12-inch heavy-duty dynamic speaker, excellently suited for large P.A. systems. Has free-edge cone with voice coil flexibly mounted on chamois leather. Field coil resistance 6,000 ohms. Quantity **Your Price**

Limited. Measures 12 in. in diameter by 7 in. deep. Net wt., 20 1/2 lbs. Ship wt., 23 1/2 lbs. **\$250**

No. AD-502 Kolster 12 in. Dynamic Speaker.

CCA Wet Electrolytic Filter Condenser

| | |
|-----------|-----|
| 500 Volts | |
| 4 MFD | 15c |
| 6 MFD | 20c |
| 8 MFD | 23c |
| 10 MFD | 30c |
| 12 MFD | 35c |
| 14 MFD | 40c |
| 16 MFD | 45c |

Complete parts in stock for all diagrams appearing in Short Wave Craft, Radio Craft, QST, Popular Mechanics, etc.

2 1/2 MH. SHORT WAVE R. F. CHOKE



These low loss Chokes are wound on Isolantite forms and are used in every S. W. Set. Special 1 1/2 Wound Chokes All—301. **15c**

AC-DC Line Cord Resistors

In the following sizes 13, 150, 160, 180, 190, 280, 300, 350—500 ohm. Line Cord Resistors AD 303. **25c**

FREE 64-page catalog and treatise. Send stamp for our FREE treatise and catalog which contains much valuable data and radio information. There is no obligation involved. Absolutely free. Book sent by return mail.

89¢

As Illustrated

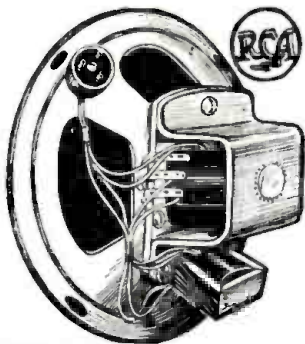

SPECIAL OFFER

DILCO R. C. A. Licensed 100% Triple Tested TUBES

YOUR CHOICE ANY GROUP **\$1.00**

| Quan. | Type | Quan. | Type | Quan. | Type |
|-------|--------|-------|---------|-------|-------|
| 3 | — 50 | 5 | — 21A | 3 | — 485 |
| 2 | — 12A7 | 4 | — 35-51 | 3 | — 6F7 |
| 3 | — 2A3 | 4 | — 36 | 3 | — 2A7 |
| 12 | — 27 | 4 | — 47 | 3 | — 32 |
| 6 | — 26 | 4 | — 82 | 3 | — 59 |
| 6 | — 01A | 4 | — 6D6 | | |
| 6 | — 12A | 4 | — 5Z3 | | |
| 1 | — 30 | 6 | — 20 | | |
| 4 | — 31 | 4 | — 33 | | |
| 6 | — 71A | 4 | — 46 | | |
| 4 | — 56 | 1 | — 1A6 | | |
| 2 | — 10 | 2 | — 484 | | |

866 RECTIFIERS **89c**

Three-Gang Midget Tuning Condenser



Capacity .000365 mf. Measure 3/4"x1 1/4" shaft. With compensating condenser. No. AD-113 **YOUR PRICE 49c**

Four-Gang Tuning Condenser

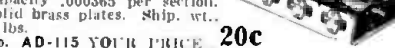

Capacity .000365 per section. Solid brass plates. Ship. wt., 5 lbs. No. AD-115 **YOUR PRICE 20c**

Midget Variable Condensers

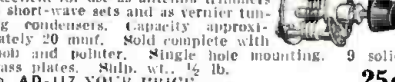

Excellent for use as antenna trimmers in short-wave sets and as vernier tuning condensers. Capacity approximately 20 mf. Sold complete with knob and pointer. Single hole mounting. 9 solid brass plates. Ship. wt., 1/4 lb. No. AD-117 **YOUR PRICE 25c**

R.C.A. Phonograph Motor

This is the same sturdy motor used in the highest quality phonographs and combinations made by R.C.A. Victor. List Price \$18.52 complete with turntable. Designed for 110-120 volts, A.C., and available for either 25 or 60 cycles (please specify which when ordering.) For 78 RPM records. Ship. wt., 10 lbs. No. AD-106 **YOUR PRICE \$3.95** Limited Quantity



Yaxley Band-Changing Switch



Designed especially for all-wave sets. Heavy silver plated contacts. Consists of six 2-gang decks—12 gangs in all. Three positions. Excellent for short-wave as well as for analyzers. List price \$4.35. Never before offered at the low price shown below. Ship. wt., 1 lb. **29c**

No. AD-111

AD-111A, 5 position switch. **49c**

BANDSPREAD VARIABLE CONDENSERS

Available with 11 plates, (approx. .00025 mf); 13 plates, (.0003 mf); 17 plates, (.000365 mf); 23 plates, (.0005 mf); 46 plates, (.001 mf). For short-wave bandspread receivers as well as for standard broadcast and long-wave receivers. Ship. wt., 2 lbs. No. AD-116 Variable Condensers—each **25c**

G. E. POWER TRANSFORMER

Manufactured by General Electric. A well designed transformer. Has 6.3 volt filament winding. Designed for 110-125 volts, 50-60 c., A.C. Specifications: 6.3 V., 2 1/2 amp.; 5 V., 2 amps. for fil. of 80 tube; 750 V., C.T., 75 mils. for plate current. Ship. wt., 5 lbs.; also available in 2 1/2 V. No. AD-101, 6 to 7 tube transformer, 75 mils. **99c**

No. AD-102, 7 to 8 tube transformer, 100 mils. **\$1.49**

No. AD-103, 8 to 10 tube transformer, 125 mils. **\$1.96**

R. M. A. Color Coded Carbon Resistors

These are all Brand New Stock. 100 Assorted sizes 50 ohm—5 meg ohm. 1/4, 1/2, 1 watt sizes guaranteed 10% accuracy resistors. Complete assortment **\$1.50**

100 resistors. **2c** each. Individual sizes. **4c** each. AD 185—shipping weight **4 lbs.**

Unshielded Power Transformers

6-8 Tube 6.3 volts. These transformers, the products of one of America's largest radio factories, are brand new. 6-tube, 6.3 filament, 280 filament, 5 volt, 750 volt, CT high. Color code diagram with each one; ideal for replacement or for new sets. AD-201 6-tube unshielded transformers. **\$0.65**

AD-202 8-tube unshielded transformers. **.85**

AD-203 10-tube unshielded transformers. **1.15**



UNITED RADIO COMPANY

Successors to Radio Trading Company
58 MARKET STREET Dept. S-7 NEWARK, N. J.



New Velocity "Mike"

● THIS is a new type of velocity microphone—radically different in design yet incorporating the latest engineering improvements in this type of microphone.

The basic principles of this new microphone eliminate many of the inherent faults of a pressure-operated unit, in that it contains no stiff diaphragm with its basic resonance peaks, but depends on the actual velocity of the sound wave actuating a lightly floating ribbon, with no resonance point of its own, for excitation.

Due to an entirely new structural feature developed and used exclusively by Lifetime, there is no accentuation of the base response, even when working very close to the microphone. The new unit will withstand severe abuse, is without

internal or background noise in operation, and is entirely unaffected by change of temperature or humidity. The directional characteristics of this microphone reduce feedback to an absolute minimum, allow radically higher gain, and decrease extraneous noises in installations where the unit must be operated near the speakers and the background level is high, its makers state.

One model is furnished in a high impedance unit for working directly into grid of tube, and also in a low impedance unit to operate into a 200 or 500 ohm line.

The grid-unit model has an output level of minus 58 DB and a frequency response of 48 to 12,000 cycles, while the line job has an output of minus 64 DB with the same frequency response.

This article has been prepared from data supplied by courtesy of The Lifetime Corp.

Girl Operators. Attention!
Listen "YL's" and "XYL's"! Why not send the Editor a good photo of your "Rig"—and don't forget yourself. A separate photo of yourself will do, with a "clear" photo of that station! \$5.00 for best "YL" photo.—Editor. See page 649 March issue for details.

Crystalizing Lacquer

● SHORT-wave set-builders have been anxiously awaiting some form of crystalizing liquid finish for their metal cabinets, and at last one has made its appearance on the market. This new *Crystalizing Lacquer* is "good news" to all short-wave "Fans" and "Hams," for it is not only available in black but also in various colors including red, green, blue, yellow, and brown.

This lacquer is a high-quality air-drying finishing lacquer, which produces a beautiful professional finish on any metal parts on which it is applied. On drying it produces a beautiful crystal effect on the surface; it is easy to apply and requires no special skill or equipment. This crystalizing lacquer can also be applied on wood or other metals.

It is available at most radio stores at a nominal price for a 2-ounce bottle; or in pint cans, where a lot of surface has to be covered. The manufacturers will be glad to mail to those interested specimen cards showing the various colors and the effects produced by the lacquer.

This article has been prepared from data supplied by courtesy of the General Cement Mfg. Co.

Please mention SHORT WAVE CRAFT when writing advertisers

• Index to Advertisers •

| | |
|--|--------------------|
| A | |
| Ace Radio Laboratories..... | 304 |
| Aerovox Corporation..... | 305 |
| Allied Engineering Institute..... | 302 |
| Allied Radio Corp..... | 299 |
| American Microphone Co..... | 301 |
| Astatic Microphone Laboratory, Inc..... | 315 |
| B | |
| Biley Electric Co..... | 301 |
| Brush Development Co., The..... | 307 |
| Bud Radio, Inc..... | 26 |
| Burstein-Applebee Co..... | 247 |
| C | |
| Cameradio Co..... | 303 |
| Candler System Co..... | 300 |
| Carter Motor Co..... | 306 |
| Chicago Radio Apparatus Co., Inc..... | 248 |
| Classified Advertisements..... | 317 |
| Cornell-Dubilier Corporation..... | 299 |
| Coyne Electrical & Radio School..... | 257 |
| Custombuilders..... | 293 |
| D | |
| Dataprint Company..... | 312 |
| Dodge's Institute..... | 300 |
| E | |
| Eilen Radio Laboratories..... | 293 |
| Electrad, Inc..... | 302 |
| Everyday Science & Mechanics..... | 303 |
| F | |
| First National Television, Inc..... | 300 |
| G | |
| General Cement Mfg. Co..... | 306 |
| General Engineering Corp..... | 302 |
| Goldentone Radio Co..... | 306 |
| Gold Shield Products Co..... | 299, 304, 303 |
| Guy Stokely Radio Corp..... | 295 |
| H | |
| Hallicrafters, Inc..... | 296 |
| Hammarlund Manufacturing Co., Inc..... | 305 |
| Harrison Radio Company..... | 294 |
| I | |
| Instructograph Company..... | 300 |
| Insuline Corp. of America..... | 306 |
| J | |
| Jobs & Careers..... | 309 |
| K | |
| Korrol Mfg. Co., Inc..... | 304 |
| L | |
| Lancaster, Allwine & Rommel..... | 303 |
| Lelay Manufacturing Co..... | 302 |
| Mc | |
| McElroy, T. R..... | 300 |
| M | |
| M. & H. Sportng Goods Co..... | 298 |
| Metal Cast Products Co..... | 304 |
| Midwest Radio Corp..... | Inside Front Cover |
| Mills, Albert..... | 315 |
| N | |
| National Company, Inc..... | 309 |
| National Radio Institute..... | Back Cover |
| New York Y.M.C.A. Schools..... | 300 |
| O | |
| O'Brien, Clarence A., & Berman, Hyman..... | 307 |
| Oxford-Tartak Radio Corp..... | 303 |
| P | |
| Pierce-Airo, Inc..... | Inside Back Cover |
| Polk, R. L., & Co..... | 307 |
| R | |
| Radio & Television Institute, Inc..... | 300 |
| Radio Constructors Laboratories..... | 297, 303 |
| Radio-Craft..... | 304 |
| Radio Handbook, The..... | 311 |
| Radio Publications..... | 312, 313, 314 |
| Radio Training Assn. of America..... | 300 |
| RCA Institutes, Inc..... | 300 |
| RCA Manufacturing Co., Inc..... | 311 |
| S | |
| Sargent, E. M., Co..... | 303 |
| Short Wave Coil Book..... | 303 |
| Short Wave League..... | 300 |
| Short Wave Manuals..... | 306 |
| Short Waves..... | 317 |
| T | |
| Teleplex Co..... | 319 |
| Thordarson Electric Mfg. Co..... | 294 |
| Triplett Electrical Instrument Co..... | 297 |
| Try-Mo Radio Co., Inc..... | 298 |
| Turner Company, The..... | 302 |
| U | |
| Ultra High Frequency Products Company..... | 301 |
| United Radio Company..... | 318 |
| U. S. Marble & Granite Company..... | 308 |
| W | |
| Wellworth Trading Company..... | 306, 308 |
| Wholesale Radio Service Co., Inc..... | 296 |
| Woman's Digest..... | 319 |

(While every precaution is taken to insure accuracy, we cannot guarantee against the possibility of an occasional change or omission in the preparation of this index.)

New Hammarlund Super-Pro

(Continued from page 279)

rectly to the receiver through a twisted pair lead-in. If all-wave reception is required it is advisable to use an accurately designed all-wave doublet with a transformer at the antenna and a twisted pair lead-in. Such antenna kits are frequently provided with a matching transformer to connect between the lead-in and the receiver, but as explained previously, due to the use of the Faraday shield input system in this set, the use of such a transformer is neither necessary nor desirable.

The receiver is equipped with all the necessary controls to insure maximum performance under a wide variety of receiving conditions. The knobs and switches are set or adjusted for the given type of service in which the operator is interested. Controlling the receiver in this manner enables the operator to use but a minimum number of adjustments to obtain the utmost in efficiency.

In the next issue laboratory curves and data will be presented, along with an "on the air" report.

This article has been prepared from data supplied by courtesy of Hammarlund Mfg. Co.

Direct-Reading Audio-Freq. Meter

(Continued from page 279)

indicating meter and power supply (with rectifier and voltage regulator).

The amplifier provides for satisfactory operation on signal inputs of three volts or less, and also provides a high impedance input circuit (one megohm). By the arrangement of the amplifier circuit, provision is made for satisfactory operation over a wide range of signal input voltages, up to 200 volts, with no change in indication of frequency.

Five ranges are provided, each starting at zero and extending to 200, 500, 1,000, and 5,000 cycles. The desired range is selected by means of a multiplier switch mounted on the panel. Individual adjustments are provided for making the indication agree with the scale of the meter on each range. These adjustments are made at the factory, but, if necessary, readjustment may be made in the field. All adjustments are accessible from the panel, which is intended for mounting in a 19-inch rack.

Our Information Bureau will gladly supply manufacturers' names and addresses of any items mentioned in *Short Wave Craft*. Please enclose a stamped return envelope.

20 Kw. Mobile Television Transmitter

(Continued from page 261)

which have been built into 12 heavy trucks. Each transmitter has its own power-plant installed into 3 trucks, consisting of Diesel-driven generators, switchboards, and facilities for use where a main supply line can be tapped. Four additional trucks are used for the transport of the 30 engineers and technicians required, and as office space for the chief engineer. Finally, there are 2 other trucks which carry a completely equipped television studio with scanning devices and all the other auxiliaries required to transmit television images.

The entire caravan consisting of 20 heavy trucks, when stretched along the road covers a length of about a mile. The total motive power used to drive this caravan exceeds 1,700 HP. All trucks are equipped with Diesel engines.

Lots of "Fan" articles in October Issue—Don't Miss It!!

THE PERFECT CODE TEACHER! NEW MASTER TELEPLEX

For beginners, experienced operators and schoolroom. The sure easy way to learn code and to speed up your speed. This amazing new instrument will record your own sending on double row perforated paper and repeat it back to you at any speed you desire. Thousands of words can be recorded on one tape.

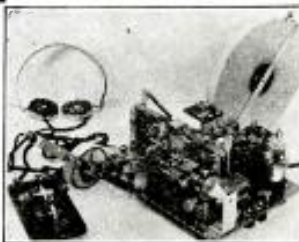

No Batteries No Winding All Electric

It is the same in principle, and in operation is equal to the Wheatstone Perforator and Transmitter, which cost over \$1,000.

BUY IT OR RENT IT

Send for Folder \$1.9 which tells you how to get the use of this instrument without buying it. No obligation. We furnish complete course and personal instruction with a money-back guarantee. Low cost, easy terms. Write today for information.

"HAM" SPECIAL Standard Teleplex A highly efficient code teacher using heavy specially prepared waxed paper tape, having two rows of perforations. Write for Free folder \$1.9.

We are the originators of this type instrument.

TELEPLEX CO.

72-76 Cortlandt St. New York City
The New Master Teleplex "The Choice of Those Who Know"

WOMAN'S DIGEST

OPENS A NEW ERA IN WOMEN'S MAGAZINES. It presents today's most urgent and serious problems for women, besides—international news, amusing articles, humor, travel stories, prize contests, unusual recipes from all over the world—loads of entertainment and information. Send 10c for sample copy or \$1.00 for the next 5 issues. Sold at better newsstands.

WOMAN'S DIGEST, 99-SW Hudson St., New York City

NO ONE READS AND THEN DISCARDS SHORT WAVE CRAFT

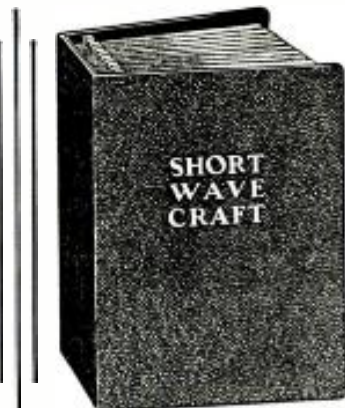

Readers keep their copies for years as a steady reference and thousands of letters attest to this.

It is now possible to save your copies and for this purpose we designed a splendid binder for you which holds twelve copies. It is made of heavy substantial material and is covered with black grain leatherette. The name of the magazine is stamped in gold on the cover.

An ingenious mechanical arrangement is provided which makes it possible to hold the copies flat when reading from the binder.

SHORT WAVE CRAFT Binder as described, prepaid in the United States \$1.25

Canada and foreign countries 25c extra. We accept money order, check, stamps or cash.

SHORT WAVE CRAFT

99-101 HUDSON ST., NEW YORK, N. Y.

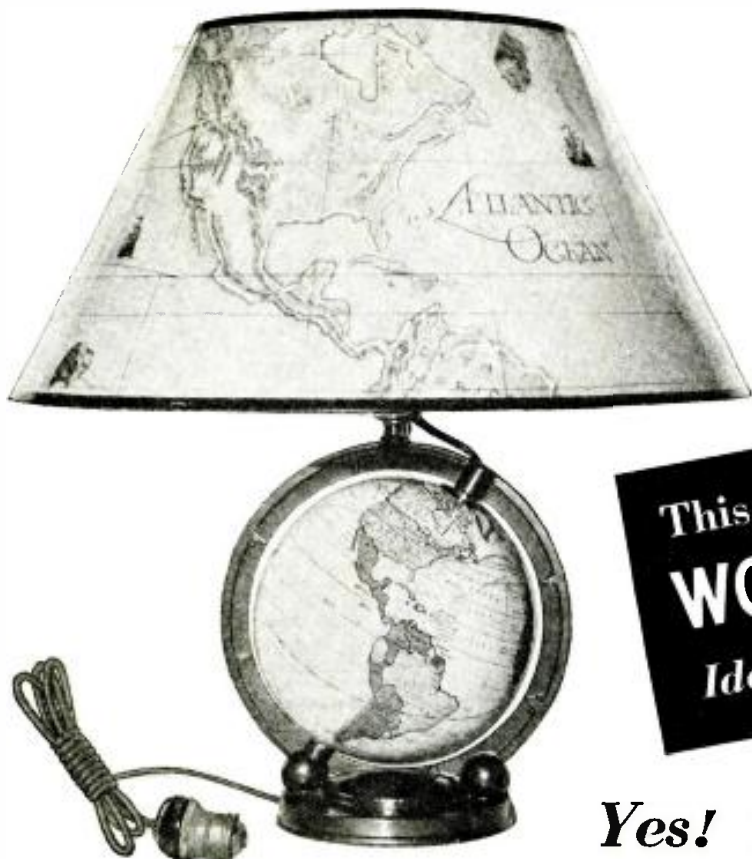

Free!

This useful and ornamental
WORLD-GLOBE LAMP
Ideal for short wave fans

Yes! The globe revolves!

NEVER in the six years that SHORT WAVE CRAFT has been published, have we found anything that is as useful and ornamental as the WORLD-GLOBE LAMP we now offer free to our readers.

This beautiful WORLD-GLOBE LAMP measures 17½" high. The attractively colored shade, with nautical and map designs, is 8" in height and 16" in diameter. It is made of fine quality parchment, highly glazed, to assure long life. A slightly damp cloth quickly removes dust from the shade. The 6¼" globe, printed in many colors, has a full meridian, and rotates. Hundreds of names—countries, cities, rivers, oceans and others are clearly printed on the globe.

Another feature on this WORLD-GLOBE LAMP is the movable hour scale found at the north pole. This permits determining the correct time in any part of the world.

The metal parts are finished in antique bronze. A piece of heavy green felt is glued under the base, therefore it may be placed anywhere, without fear of marring table, desk, etc.

The weight of the WORLD-GLOBE LAMP is nearly three pounds. When packed for shipping, six pounds.

Here is the way to get this beautiful prize. Fill in the coupon in the left hand corner—cut it out and mail it to us together with your remittance of \$2.50. You will receive a full year's subscription (12 months) to SHORT WAVE CRAFT—the greatest short-wave magazine in the world today. In addition, we will send you absolutely FREE one of these handsome WORLD-GLOBE LAMPS. Old subscribers may renew their subscription now for another year following expiration of their present one and still receive this WORLD-GLOBE LAMP.

Only a limited number of WORLD-GLOBE LAMPS are available. Take advantage of this offer without delay in order to insure receiving your free gift. RUSH THE COUPON TODAY.

Long Needed Article
Gentlemen:
Regarding your wonderful GLOBE-LAMP, please accept my sincere compliments for a long needed article and trust you'll be swamped with orders.
(Signed) W. H. Herman,
7704 Sagamore Ave.
Cleveland, Ohio.

All Admired It
Gentlemen:
I am perfectly satisfied with your GLOBE-LAMP. It is just what you have said about it in every way. All my family and friends have admired it. It arrived in perfect condition. Many thanks and the best of good luck to you and your SHORT WAVE CRAFT.
(Signed) William Owens,
30 North Fifth Street,
Bangor, Penna.

WHAT THEY SAY ABOUT THE WORLD-GLOBE LAMP!

MAIL COUPON TODAY!

Very Well Pleased
Gentlemen:
I am very well pleased with my Globe-Lamp. It presents a handsome and novel appearance and is most appropriate when located near an all-wave radio set. When lighted at night, it sheds a warm, soft glow, and the parchment shade shows up most attractively. Unquestionably, the combination of the lamp and SHORT WAVE CRAFT for \$2.50 is a real bargain.
William E. Sloan, Jr.,
67 Exchange Street,
Rochester, New York.

Unique, Beautiful and Useful
Gentlemen:
The Globe-Lamp arrived today, also the magazine. Congratulations on a premium so unique, beautiful and, above all, useful, especially to DXers on the short-wave bands. I already have a large globe, but I expect to use the small one much more frequently and with equal satisfaction. It goes fine with the new Hammerlund "Surer Pro."
T. H. Warnock,
99 Elm Street,
Meriden, Connecticut.

Wouldn't Take \$15.00 For It
Gentlemen:
I received the Globe-Lamp and I am very much pleased with it. I think it is handsome and think a good deal of it. I wouldn't take \$15.00 for it. The lamp sets on top of the radio and is handy to glance at when I hear the foreign stations.
Warren G. Ryler,
Barnstable Radio Shop,
Barnstable, Mass.
P.S.: Many thanks for the lamp!
WGR

SHORT WAVE CRAFT SWC-936
89 Hudson Street, New York, N. Y.

Gentlemen: Enclosed you will find my remittance of \$2.50 (plus.....cents shipping charges) for which enter my subscription for SHORT WAVE CRAFT for one year (12 issues). This amount entitles me to a WORLD-GLOBE LAMP free. See chart next to coupon for shipping charges on WORLD-GLOBE LAMP.

() Enclosed find my remittance of \$2.50, please send me the WORLD-GLOBE LAMP by express, collect.

Name

Address

City State

Send remittance in form of check or money order—register letter if it contains cash, stamps, or currency.

How to Order Your WORLD-GLOBE LAMP

Simply fill in the coupon at the left and mail together with check or money order. Register letter if cash or coin is sent. To cover shipping charges on WORLD-GLOBE LAMP, add to your remittance the amount indicated. If you are located: East of the Mississippi add 35 cents; Between the Mississippi and the West Coast add 70c; Foreign Countries add \$1.30. Any excess remittance will be refunded.

SHORT WAVE CRAFT

99 HUDSON STREET

NEW YORK, N. Y.

Please mention SHORT WAVE CRAFT when writing advertisers

KABLE BROS. CO., PRINTERS

WE ANNOUNCE OUR 1937 LINE

Consisting of 15 models, to fit the needs of EVERY SHORT WAVE FAN!
 Made in TWO AND THREE BANDS from 15 TO 2,000 METERS, priced from
 \$17.95 to \$95.00

EACH MODEL IS AN OUTSTANDING VALUE

DEWALD

THE INTERNATIONALLY KNOWN RECEIVER



MODEL 518

- 5 Tube Universal Hi-Gain T.R.F. Receiver.
- 2 Bands—75-550 Meters.
- Full Range Dynamic Speaker.
- Duo-colored Aeroplane Dial.
- Incorporating metal tube.
- Broadcast & American short wave. \$18.90



MODEL 520

- 5 Tube A.C. Superheterodyne Receiver.
- 2 Bands—70-190, 190-555 Meters.
- Duo-colored Aeroplane Dial.
- Full Range Dynamic Speaker.
- Broadcast & American short wave..... \$26.55



MODEL 619

- 6 Tube Universal Superheterodyne Receiver.
- 2 Bands—75-550 Meters.
- Full Range Dynamic Speaker.
- Large Duo-colored Aeroplane Dial.
- Incorporating metal tube.
- Broadcast & American short wave. \$27.50



MODEL 620

- 6 Tube A.C. Superheterodyne Receiver.
- 2 Bands—18-52, 180-555 Meter..
- Tone Control.
- Magic Eye.
- Large Duo-colored Aeroplane Dial.
- Full Range Dynamic Speaker.
- Broadcast & Foreign short wave...\$35.75



MODEL 618

- 6 Tube Universal Superheterodyne Receiver.
- 3 Bands—18-52, 16-190, 180-555 Meters.
- All Wave.
- Tone Control.
- Large Duo-colored Aeroplane Dial.
- Incorporating metal tube.
- Full Range Dynamic Speaker.
- Broadcast, American & Foreign short wave \$37.25



MODEL 621

- 6 Tube Universal Superheterodyne Receiver.
- 2 Bands—18-52, 180-555 Meters.
- Tone Control.
- Large Duo-colored Aeroplane Dial.
- Full Range Dynamic Speaker.
- Incorporating metal tube.
- Broadcast & Foreign short wave... \$35.75

Above Prices Complete, including tubes, speaker and cabinet

FREE Send for our COMPLETE CATALOG. YOU ARE SURE TO FIND A MODEL TO SUIT YOUR NEEDS. If your dealer does not have a DeWald in stock and will not order one for you, please write to us and we will have a dealer near you supply your wants.

JOBBERS We are building up a ready made business for you. THOUSANDS of DeWald sets will be sold. Get your share of our inquiries and TURN THEM INTO ORDERS.

WRITE, WIRE or TELEPHONE for our proposition—YOU WILL FIND IT PROFITABLE

Quality radios since 1921

PIERCE-AIRO INC.

Dept. 9,

510-518 Sixth Avenue

New York, N. Y.

Licensed by R. C. A. and its affiliates.



J. E. Smith, President National Radio Institute. The man who has directed the home study training of more men for the Radio Industry than any other man in America.

I WILL TRAIN YOU AT HOME IN SPARE TIME FOR A GOOD RADIO JOB!

**HERE'S
PROOF**



WORKS FOR STATE OF ILLINOIS

"If I had not taken your course, I would still be digging ditches. I just wanted to work for the State of Illinois, operating their 1,000 watt transmitter. If anyone wants to write me about your course, I shall be glad to answer." R. S. LEWIS, 126 E. Ashe St., Springfield, Ill.



PICKED UP \$1800 WHILE LEARNING

"I picked up \$1800 while studying and I call that easy money—the time I gave my Radio work did not interfere with my other business." OTIS DENTON, 14105 Lorain Avenue, Cleveland, Ohio.



MADE UP TO \$400 A MONTH

"I was working in a garage with no future in sight. My wife and I decided to put aside enough to pay for your course. We have not regretted it. I have made as high as \$400 a month in Radio." E. G. WOLKE, 1202 Eden St., Elkhart, Ind.

LESSON ON RADIO SERVICING TIPS FREE

"I'll prove that my Training gives practical, money-making information, that it is easy to understand—that it is just what you need to master Radio. My sample lesson text, "Radio Receiver Troubles—Their Cause and Remedy" covers a long list of Radio receiver troubles in A.C., D.C., battery, universal, auto, T.R.F., super-heterodyne, all-wave, and other types of sets. And a cross reference system gives you the probable cause and a quick way to locate and remedy these set troubles. A special section is devoted to receiver check-up, alignment, balancing, and testing. Get this lesson Free. No obligation.

MAIL COUPON NOW



**The Tested Way
to BETTER PAY**

FREE BOOK TELLS HOW MAIL COUPON

Do you want to make more money? Radio offers you many opportunities for well-paying spare time and full time jobs. And you don't have to give up your present job or leave home and spend a lot of money to become a Radio Expert.

Many Radio Experts Make \$30, \$50, \$75 a Week

Radio broadcasting stations employ engineers, operators, station managers and pay up to \$5,000 a year. Spare time Radio set servicing pays as much as \$200 to \$500 a year—full time jobs with Radio jobbers, manufacturers and dealers, \$30, \$50, \$75 a week. Many Radio Experts own and operate their own full time or part time Radio sales and service businesses. Radio manufacturers and jobbers employ testers, inspectors, foremen, engineers, servicemen, paying up to \$6,000 a year. Radio operators on ships get good pay and see the world besides. Automobile, police, aviation, commercial Radio, and loud speaker systems are newer fields offering good opportunities now and for the future. Television promises to open many good jobs soon. Men I have trained are holding good jobs in these branches of Radio. Read their statements. Mail the coupon.

There's a Real Future in Radio for Well Trained Men

Radio already gives jobs to more than 300,000 people. In 1935 over \$300,000,000 worth of sets, tubes and parts were sold—an increase of 20% over 1934! Over 1,100,000 auto Radios were sold in 1935, 25% more than in 1934! 22,000,000 homes are today equipped with Radios, and every year millions of these sets go out of date and are replaced with newer models. Millions more need servicing, new tubes, repairs, etc. Broadcasting stations pay their employees (exclusive of artists) more than \$23,000,000 a year! And Radio is a new industry, still growing fast! A few hundred \$30, \$50, \$75-a-week jobs have grown to many thousands in less than 20 years.

Many Make \$5, \$10, \$15 a Week Extra in Spare Time While Learning

Practically every neighborhood needs a good spare time serviceman. The day you enroll I start sending you Extra Money Job Sheets. They show you how to do Radio repair jobs that you can cash in on quickly. Throughout your training I send you plans that made good spare time money—\$200 to \$500 a year—for hundreds of fellows. My training is famous as "the Course that pays for itself."

I Give You Practical Experience

My Course is not all book training. I send you special Radio equipment and show you how to conduct experi-



ments and build circuits which illustrate important principles used in modern Radio receivers, broadcast stations and loud speaker installations. I show you how to build testing apparatus for use in spare time work from this equipment. You work out the things you read in the lesson books. Read about this 50-50 method of training—how it makes learning at home interesting, quick, fascinating, practical. Mail coupon.

Money Back Agreement Protects You

I am so sure that I can train you successfully that I agree in writing to refund every penny you pay me if you are not satisfied with my Lessons and Instruction Service when you finish. I'll send you a copy of this agreement with my Free Book.

Find Out What Radio Offers You

Act Today. Mail the coupon now for "Rich Rewards in Radio." It's free to any fellow over 16 years old. It describes Radio's spare time and full time opportunities; tells about my Training; shows you actual letters from men I have trained; telling what they are doing and earning. Find out what Radio offers YOU! MAIL THE COUPON in an envelope, or paste it on a penny post card—NOW!

J. E. SMITH, President, Dept. 6JB3
National Radio Institute, Washington, D. C.

**MAIL
COUPON
NOW!**



**This FREE BOOK has Helped Hundreds
of Men to Make More Money**

J. E. SMITH, President, Dept. 6JB3.
National Radio Institute, Washington, D. C.

Dear Mr. Smith: Without obligation, send me the Sample Lesson and your free book about spare time and full time Radio opportunities and how I can train for them at home in spare time. (Please write plainly.)

NAME..... AGE.....

ADDRESS.....

CITY..... STATE.....

14X-1

If you do not want to cut this cover—simply write us on a post card