

THE RADIO EXPERIMENTER'S MAGAZINE

HUGO GERNSBACK
Editor

SHORT WAVE CRAFT

September

WORLD'S
LARGEST
SHORT WAVE
CIRCULATION

Beginning
IN THIS
ISSUE
RADIO
AMATEUR
COURSE

Will He Win
the Trophy?



25¢
IN CANADA
30¢

Here's the new - Big

1935 OFFICIAL SHORT WAVE RADIO MANUAL



When we brought out our 1934 OFFICIAL SHORT WAVE RADIO MANUAL, of which many thousands of copies were bought by short wave enthusiasts, we promised you that a new volume would be published every year.

In keeping with this promise, we now take great pleasure in announcing the 1935 OFFICIAL SHORT WAVE RADIO MANUAL. There has been tremendous progress and a great boom in short waves in the past year, and the art has made such rapid progress that no single book, up to now, has been able to keep up with this progress. The 1935 OFFICIAL SHORT WAVE RADIO MANUAL fills this need, and it fills it completely. All the progress made in short waves, whether it is in set building, whether it is in radio servicing, whether it is in new models, whether it is in new short wave discoveries, all are faithfully reported and chronicled in this great 1935 volume.

Like its predecessor, it is a BIG book, in which you will find literally EVERYTHING in short waves—nothing has been left out. Not only is it a complete manual, but it is a great encyclopedia of short wave facts, information, hookups, photographs, tables, maps, etc., etc. The wealth of material is so great that it would take several pages to list all the valuable data that has been included in this volume.

Similar to last year's volume, the new book has been edited by Hugo Gernsback, Editor of SHORT WAVE CRAFT and H. W. Secor, Managing Editor, and if you are and have been a reader of SHORT WAVE CRAFT, and particularly if you have seen the 1934 Manual, you will know just what you can expect from this, the greatest short wave manual ever put out by Mr. Gernsback. Here are the star features of the book:

29 ★ Features:

- ★ 1—Short-Wave Beginners' Section—Dozens of new simplified circuits for 1-2 and 3 tube receivers, including famous "Doerfler" and "Oscillo-dyne", etc.
- ★ 2—Short-Wave Receivers—All types discussed with diagrams and pictures—The best types only, which have "stood the test" of actual operating service. Full details for constructing them, etc., "Band-Spreading" the Doerfler, 5-tube T.I.F. receivers, etc.
- ★ 3—Battery Short-Wave Receivers—1-2, & 3 tube sets—all the way up to special 5-tube super-heterodyne, designed especially for battery operation.
- ★ 4—"5-Meter" Department—All the latest "dope"—including newest transmitters, "Long Line" oscillators, improved "high sensitivity" receivers. How to arrange best aerial to get greatest distance, 5-meter transmitters, hook-ups, etc.
- ★ 5—Short-Wave "Artificial Ears" Apparatus—also newest therapeutic and other allied applications of ultra short waves.
- ★ 6—Short-Wave Experimenter's Section—filled with Short-Wave Kinks, Short-cuts, etc., of interest to every experimenter.
- ★ 7—Ultra Short Waves—Newest circuits, apparatus, and results obtained in this field.
- ★ 8—Commercial "Short-Wave" and "All-Wave" Receivers—Full Servicing Data for "Set-Owners", and "Service-men."
- ★ 9—How to build "Power Supply" Units for Short-Wave Receivers.
- ★ 10—Latest Short-Wave Converters—With servicing data on Commercial Models.
- ★ 11—The Short-Wave Antennas—Including latest "Voice-Inductor" type, Transposed Lead-In systems, shielded cable, Double-Doublet, etc.
- ★ 12—Short-Wave Superheterodynes—From 3 to 11 tubes—Latest descriptions and diagrams including commercial all-wave superhets.
- ★ 13—Phone Transmitters for Amateur Stations—How to build them.
- ★ 14—"Skip" Distance—Headside layer, etc.—explained; Physics of Short Waves.
- ★ 15—Super-Regenerative Short-Wave Receivers—latest circuits, etc.
- ★ 16—Recording "Foreign" and "Domestic" Short-Wave programs. All systems in use.
- ★ 17—"High Fidelity"—How to obtain it in Short-Wave Receivers.
- ★ 18—The best Short-Wave Questions and answers of the year.
- ★ 19—The best Short-Wave "Kinks" of the year.
- ★ 20—Foreign Short-Wave Review—Norel circuits, apparatus, etc.
- ★ 21—Tubes for Short-Wave purposes—including tables of latest tubes for Short-Wave transmitters and Receivers.
- ★ 22—Short-Wave Transmitters—All about the new "Long Lines". Oscillators as well as other "simplified" high-efficiency transmitters, Rack and Panel jobs, Crystal Control, etc.
- ★ 23—Multi-Purpose Tubes—How to use them on Short-Wave Sets—in which 2 tubes=4; 3 tubes=6; etc.
- ★ 24—"Audio Amplifiers" for Short-Wave Receivers, Circuits, etc.
- ★ 25—"Band-Spread"—How to spread the stations over the dial for easier tuning.
- ★ 26—"Plug-less "Mono-Coil" Receivers—How to build efficient switch-type coils to eliminate plug-in coils; "Clip-Coil" Receivers, etc.
- ★ 27—Boosters, Pre-amplifiers and Best Oscillators—How they work, with constructional data, diagrams, etc.
- ★ 28—Portable Short-Wave Receivers and Transmitters—Transmitter Power supply from Ford Coils, etc.

AND FOR SERVICE MEN

- ★ 29—Every short-wave diagram, every short-wave set, whether it is a battery set, whether it is an all-wave set, or a super-heterodyne, whether it is an experimental set, or a commercial set, will be found in this special service men's section. Hundreds of valuable diagrams, with tube layouts, resistor values, color codes of wiring cables, etc., and the purpose of each tube in each set clearly indicated on the diagram, wherever this information can possibly be obtained.

**OVER 240 BIG PAGES • OVER 1000 Illustrations
Size 9 x 12 Inches — Flexible Looseleaf Leatherette Binder**

SPECIAL PRE-PUBLICATION OFFER

As has been customary with us in the past, we give our readers the opportunity to order the book before it comes off press and save money. The price of the new 1935 OFFICIAL SHORT WAVE RADIO MANUAL will be \$2.50 as soon as it comes off the press. No reduction in price will be made later. To you, who order this book before publication, the price is \$2.00. As soon as the OFFICIAL SHORT WAVE RADIO MANUAL is published, the pre-publication price will be immediately withdrawn. It is, therefore, to your advantage to order your copy today.

CLIP AND MAIL THIS MONEY SAVING COUPON TODAY

9-35

SHORT WAVE CRAFT
89 Hudson Street,
New York, N. Y.

Gentlemen: I enclose herewith my remittance of \$2.00 for which please send me one copy of the 1935 OFFICIAL SHORT WAVE RADIO MANUAL, at the pre-publication price of \$2.00. I understand that the price of the book will be \$2.50 as soon as it is published. (Send remittance, check or money order. Register letter if it contains cash or currency.)

Name _____ State _____
Address _____
City _____



STUDENTS BUSY AT WORK IN GREAT COYNE SHOPS

Learn RADIO

SEND TODAY FOR DETAILS OF MY Pay-Tuition-after-Graduation Plan!

Train for Radio in 12 weeks, right here in the great Coyne Shops — not by correspondence — but on real Radio, Sound and Television equipment. Mail the coupon below. If you are short of money I'll send you all details of my finance plan and consider your application. If accepted, you won't have to start paying tuition back until five months from the date you start school, and then you'll have over a year to complete your payments.

Tremendous Developments Ahead in Radio and Television!

HERE is YOUR opportunity to cash in. Every day brings news of new developments in every branch of Radio and Television, with more opportunities, more jobs, and a greater future for the trained man than ever before. I consider the fellow who is ambitious enough to want to get ahead by taking my Training, worthy of my help. MAIL THE COUPON BELOW and you can prove to me that you are willing to spend just 12 weeks in the Coyne Training Shops learning Radio. Then, I'll tell you about my finance plan which has enabled many to get complete Training and pay tuition back later.

Learn By Doing In 12 Weeks

I don't care whether you are 16 or 45. It makes no difference to me if you don't know an oscillator from a spark coil. You don't need any previous experience or advanced education to master my Shop Training. Don't let lack of money hold you back from getting all details of my amazing plan.

MANY EARN While LEARNING

If you need part-time work to help pay your living expenses and will tell us your problems we may be able to help you as we have thousands of others. Then, in 12 brief weeks, in the great Training shops of Coyne, you will learn on a wide variety of modern, up-to-date A. C. Super-heterodyne sets, oscillators, analyzers and test instruments. Prepare for Amateur Broadcast, or Telegraph Radio Operator's License and to know all code and Dept. of Commerce rules for a government License Examination.

TRAINING

By Actual Work

No dull books . . . you get individual training . . . real actual work with only the theory you will need. Building real radio sets,



Auto Radio Instruction Prepare For Jobs Like These

Here are a few of hundreds of positions in the Radio field. My free employment bureau gives you life-time employment service . . .

- AIRCRAFT RADIO OPERATOR
- SHIP RADIO OPERATOR
- RADIO SERVICING
- PUBLIC ADDRESS SYSTEMS
- BROADCAST STATION OPERATOR
- TALKING PICTURE STUDIOS
- TELEVISION LABORATORY MAN

doing radio wiring and testing, trouble-shooting, repairing and servicing. That's a glimpse of how we help to make you a Radio expert, and fit you to qualify for jobs leading to the biggest pay.

Jobs - Pay - Future

"I got my present job two days after graduation, at shorter hours, and wages increased 60% over my old job," reports Arne Wiklem of Minnesota. "I have my own shop, own a real car and make fine money in the radio business," writes E. Allen of Montana, "All this is possible because I came to Coyne." And I could go on quoting from hundreds of letters of successful Coyne Trained men. What they have done, you should be able to do.

Electric Refrigeration Air Conditioning

Right now I'm including my big new Electric Refrigeration and Air Conditioning course at no extra cost.

GET THE FACTS

Coyne is your one great chance to get into Radio. This school is 36 years old—Coyne training is tested—proven beyond all doubt—endorsed by many large concerns. You can find out everything absolutely free. Simply mail the coupon and let me send you the big, free Coyne Book with photographs . . . facts . . . jobs . . . salaries . . . opportunities. Tells you how many earn expenses while training and how we assist our graduates in the field. This does not obligate you. So act at once. Just mail coupon.

Get this Free Book



Home of Coyne Shops

This is our fireproof modern Building wherein is installed thousands of dollars' worth of Radio equipment of all kinds. Every comfort and convenience has been arranged to make you happy and contented during your Training.

COYNE H. C. LEWIS, President **Founded 1899**
RADIO & ELECTRICAL SCHOOL
 500 South Paulina Street Dept. 65-2K, Chicago, Ill.

H. C. LEWIS, President
 Coyne Radio & Electrical School
 500 S. Paulina St. Dept. 65-2K, Chicago

Dear Mr. Lewis: Without obligation send me your big free catalog and all details; also tell me all about your "Pay-Tuition-After-Graduation" Plan.

Name

Address

City.....State.....

Please mention SHORT WAVE CRAFT when writing advertisers

IN THIS ISSUE: PROMINENT SHORT-WAVE AUTHORS

Warner • Doerle • Shuart • Lester • Haynes • Gregor

HUGO GERNSBACK
Editor



H. WINFIELD SECOR
Managing Editor

GEORGE W. SHUART,
W2AMN
Associate Editor

Contents for September, 1935

Editorial—"Police Short Waves," by Hugo Gernsback.....	261
Micro-Waves Span the English Channel.....	262
1-Watt Short-Wave Transmitters Used in Germany.....	263
Third Award in Our \$5.00 "YL" Contest.....	264
Vest-Pocket Set Brings in "Foreigns," by Dever K. Warner	265
The "Foreign Stations" S-W Receiver, by Walter C. Doerle	266
Electrifying the "Clipset".....	268
The "Metal Tube 2"—A Sure-Fire S-W Receiver, by Art Gregor	270
Popular 3-Tube S-W Receiver Has Constant Band-Spread, by William Weeks.....	272
Short Waves and Long Raves—Our Readers' Forum.....	274
World-Wide Short-Wave Review, Edited by C. W. Palmer	276
What's New in Short-Wave Apparatus.....	278
The Radio Amateur Department—Radio Amateur Course, Lesson No. 1, Alternating Current.....	280
New Apparatus for the Ham.....	282
The Wizard 50-Watt Transmitter, by G. W. Shuart.....	283
Short-Wave Scout Trophy Award.....	284
SHORT-WAVE STATIONS OF THE WORLD, Edited by M. Harvey Gernsback.....	285
Short-Wave Kinks.....	289
Short-Wave Question Box.....	290
Short-Wave Scout News.....	292
Short-Wave League.....	294
When to Listen In, by M. Harvey Gernsback.....	305

Features in the October Issue

- The "Police Alarm" Short-Wave Receiver, by Walter C. Doerle.
- Latest in Short-Wave Transmitters, Using the New RK31 and 23 Tubes, by George W. Shuart, W2AMN.
- A 2-Tube Beginner's S-W Receiver, by H. G. Cisin.
- The Latest in Apparatus for the Ham, Including Transmitters and Receivers.
- Second Lesson of the RADIO AMATEUR COURSE—"Vacuum Tubes."
- 5-Meter Tuned R.F. Receiver, Using Acorn Tubes. by W2AMN.



Certified Circuits

● **SHORT WAVE CRAFT** goes to a large expense in verifying new circuits. When you see this seal it is your guarantee that such sets have been tested in our laboratories, as well as privately, in different parts of

the country. Only "Constructional-Experimental" circuits are certified by us.

When you see our certified seal on any set described, you need not hesitate to spend money for parts, because you are assured in advance that the set and circuit are bona fide and that this magazine stands behind them.

SHORT WAVE CRAFT is the only magazine that certifies circuits and sets.

OUR COVER

"His Short-Wave Dream" might be another title of this month's cover. It illustrates and undoubtedly represents in a very realistic manner the actual dream of thousands of short-wave fans. Be sure to read all about this month's winner of the Short-Wave Scout "Silver Trophy" and how you may win one on page 284.

COPYRIGHT, 1935, BY H. GERNSBACK

Published by **POPULAR BOOK CORPORATION**

HUGO GERNSBACK, President - - - - **H. W. SECOR**, Vice-President
EMIL GROSSMAN - - - - - Director of Advertising
 Chicago Adv. Office - - - - - **L. F. McCLURE**, 919 No. Michigan Ave.
 Publication Office - - - - - 404 N. Wesley Avenue, Mount Morris, Ill.
 Editorial and General Offices - - - - 99-101 Hudson St., New York, N. Y.
 European Agent: Gorringer's American News Agency, 9A Green St., Leicester Square, London W. C. 2
 Australian Agents: **McGILL'S AGENCY**, 179 Elizabeth St., Melbourne

SHORT-WAVE CRAFT—Monthly. Entered as second class matter May 7, 1930, at the post office at Mount Morris, Illinois, under the act of March 3, 1879. Trademarks and copyrights by permission of H. Gernsback, 99-101 Hudson St., N. Y. C. Text and illustrations of this magazine are copyrighted and must not be reproduced without permission. **SHORT WAVE CRAFT** is published on the 1st of every month. Twelve numbers per year. Subscription price is \$2.50 a year in the United States and possessions. Canada and foreign countries, \$3.00 a year. Single copies 25c. Address all contributions for publication to Editor, **SHORT WAVE CRAFT**, 99-101 Hudson St., New York, N. Y. Publishers are not responsible for lost manuscripts. Contributions cannot be returned unless authors remit full postage. **SHORT WAVE CRAFT** is for sale at all principal newsstands in the United States and Canada. European agents: Brentano's, London and Paris. Printed in U. S. A. Make all subscription checks payable to Popular Book Corporation.

I'LL SEND MY FIRST LESSON FREE



Here's Proof

It shows how EASY it is to learn at home to fill a GOOD JOB IN RADIO

Clip the coupon and mail it. I'm so sure that I can train you at home in your spare time for a good job in Radio that I'll send you my first lesson free. Examine it, read it, see how clear and easy it is to understand. Then you will know why many men with less than a grammar school education and no technical experience have become Radio Experts and are earning two to three times their former pay as a result of my training.

Many Radio Experts Make \$40, \$60, \$75 A Week

In less than 15 years, the Radio Industry has grown from a few million to hundreds of millions of dollars. Over 300,000 jobs have been created by this growth, and thousands more will be created by its continued development. Many men and young men with the right training—the kind of training I give you in the N. R. I. Course—have stepped into Radio at two and three times their former salaries.

Get Ready Now for Jobs Like These

Broadcasting stations use engineers, operators, station managers and pay up to \$5,000 a year. Manufacturers continually employ testers, inspectors, foremen, engineers, servicemen, buyers, for jobs paying up to \$7,500 a year. Radio operators on ships enjoy life, see the world, with board and lodging free, and get good pay besides. Dealers and jobbers employ servicemen, salesmen, buyers, managers, and pay up to \$100 a week. My book tells you about these and many other interesting Radio jobs.

Many Make \$5, \$10, \$15 A Week Extra In Spare Time While Learning

The day you enroll I start sending you EXTRA Money Job Sheets, which quickly show you how to do Radio repair jobs common in most every neighborhood. Throughout your training, I send you information for servicing popular makes of sets! I give you plans and ideas that have made good spare time money—\$200 to \$1000 a year—for hundreds of fellows. My Course is famous as "the Course that pays for itself."

Television, Short Wave, Loud Speaker Systems Included

There's opportunity for you in Radio. Its future is certain. Television, short wave, loud speaker systems, police Radio, automobile Radio, aircraft Radio—in every branch, developments and improvements are taking place. Here is a real future for thousands and thousands of men who really know Radio—men with N. R. I. training. Get the training that opens the road to good pay and success.

You Get A Money-Back Agreement

I am so sure that N. R. I. can train you satisfactorily that I will agree in writing to refund every penny of your tuition if you are not satisfied with my Lesson and Instruction Service upon completion.

Free 64-Page Book of Facts

Mail the coupon now. In addition to the sample lesson, I send my book, "Rich Rewards in Radio." It tells you about the opportunities in Radio, tells you about my Course, what others who have taken it are doing and making. This offer is free to any ambitious fellow over 15 years old. Find out what Radio offers you without slightest obligation. ACT NOW! Mail coupon in an envelope, or paste on a 1c post card.

J. E. SMITH, President
National Radio Institute, Dept. 5JB3
Washington, D. C.



You Get Practical Experience with Radio Equipment I GIVE You

I'll show you how to use my special Radio Equipment for conducting experiments and building circuits which illustrate important principles used in such well-known sets as Westinghouse, General Electric, Philco, R. C. A., Victor, Majestic and others. You work out with your own hands many of the things you read in my lesson books. This 50-50 method of training makes learning at home easy, interesting, fascinating, intensely practical. You learn how sets work, why they work, how to make them work when they are out of order. Training like this shows up in your pay envelope—when you graduate you have had training and experience—you're not simply looking for a job where you can get experience.

I have doubled and tripled the salaries of many



Clears \$4,500 in 18 Months

"Before taking your Radio Course I was making \$18 a week. I came here three years ago and in 18 months I made about \$4,500 in Radio. I cannot say too much for the wonderful help I have received from N. R. I."

NOEL W. RAY,
619 Broad St.,
Gadsden, Alabama.



Spare Time Work Pays \$18 A Week

"I only do spare time Radio work and average \$18 a week. People who in good times would buy a new Radio, now have the old one fixed."

STEPHEN J. DRAPCHATY,
407 Wunderlich Ave.,
Barberton, Ohio.



Radio Engineer at WSUI

"Upon graduating I accepted a job as serviceman, and within three weeks was made Service Manager. This job paid \$40 to \$50 a week. Eight months later I obtained a position as operator with Station KWCR through your Employment Department. Now I am Radio Engineer of WSUI."

SYLVANUS J. EBERT,
University of Iowa,
Iowa City, Iowa.

The Tested Way to BETTER PAY

MAIL THIS NOW!

J. E. SMITH, President
National Radio Institute, Dept. 5JB3
Washington, D. C.

I want to take advantage of your offer. Without obligating me, send me your Free Sample Lesson and your book, "Rich Rewards in Radio."
(Please Print Plainly.)

NAME..... AGE

ADDRESS.....

CITY..... STATE..... "R"

Please mention SHORT WAVE CRAFT when writing advertisers

MAIL COUPON TODAY!

RADIO PUBLICATIONS, Dept. SWC-9
 103 Hudson Street, New York, N. Y.

Gentlemen: Enclosed you will find my remittance of One Dollar (\$1.00) (cash, money order or new U.S. stamps) for which send me One Copy of "SHORT WAVES" by Leutz and Gable. I understand this book may be returned to you within three days if I am not completely satisfied, and my money refunded.

NAME

ADDRESS

CITY STATE

(Include 15c extra to cover mailing charges)
 (25c foreign countries)

Save \$1.98

Just As Long As the Supply of this Book Lasts

The One and Only ENCYCLOPEDIA on SHORT WAVES

By C. R. Leutz and R. B. Gable

384 PAGES—Over 345 ILLUSTRATIONS

Bound handsomely in red linen. Stiff covers. Size 6x9"

Astonished at the low price we offer this book? You should be! It represents THE GREATEST RADIO BOOK YOU EVER HEARD OF or read about. You SAVE \$2.00 on a volume that regularly sells for \$3.00. The book, "SHORT WAVES" by Leutz and Gable, costs you NOW ONLY ONE DOLLAR.

The publishers of this book went out of business, and we purchased the remaining few thousand copies at a low price—WE ARE PASSING THIS LOW COST ON TO YOU.

"SHORT WAVES" is written by Leutz and Gable, two foremost radio authorities. You will remember Charles R. Leutz as one of the pioneers in radio, also designer and manufacturer of the famous LEUTZ Transoceanic Receivers. Mr. Robert Gable owned and operated one of the finest low power broadcasting stations in the country. He is well known as an experimenter and research worker in scientific fields.

Considering the value of this book for data alone, its cost should really be more than originally asked. But when you see the illustrations in the book you will marvel at how this book could be sold for ONE DOLLAR.

The book is printed on a very expensive super-calendared paper. It contains 384 pages with over 345 photographic illustrations and diagrams. Any printer will tell you that the printing of this book is a job of the craftsmen in the industry.

So confident are we that you will be satisfied with your copy of "SHORT WAVES," that it is sold on a money-back guarantee. If within three days you find that this book is not worth more than the dollar you paid, then return the book to us—your purchase price will be immediately refunded.

"SHORT WAVES" is the most important and comprehensive volume of short-waves ever published. This book has EVERYTHING on short-waves—it literally contains a complete education on short-waves.

The supply of these books is not expected to last long. Once they are gone no additional copies will be available. ORDER NOW—be sure to tell your friends about this remarkable book value. Send the coupon today for your copy of "SHORT WAVES" by Leutz and Gable.

Partial Contents of "SHORT WAVES"

HISTORICAL REVIEW

Maxwell—Hertz—Marconi—Loebs—Pickard—Vacuum Tube Invention—Early Power Tubes—First Long Distance Radio Telephony—Water Cooled Tubes—Improved Filament Construction—Pioneer Amateur Results—Loops—Multiple Tuned Antennae—Wave Antennae—Short-Wave Directional Antennae—Progress in Radio Telephony—Start of Broadcasting—Changes in Broadcast Receiver Designs—Dynamic Speakers—Remote Broadcasting—Ship-to-shore Radio Telephony—Side Band Transmission—and other important historical developments.

SHORT WAVE PROPAGATION

Long Distance Properties—Natural Shielding Effects—Observations on Broadcast Band—Initial Amateur Experiments—Simple Radiation—Light Analogy—The Ionized Region—Kennelley—Heavily Layer—Critical Wave Lengths—Ground Waves—Actual Results.

COMMERCIAL RADIO TELEPHONY AND TELEGRAPHY

International Telephone and Telegraph Systems—Area Covered—Power Requirements—Standard Transmitter—Associated Equipment—Superheterodyne Receivers—Receiving Circuits—New York to London Circuits—Wavelengths Selected—Details of other Systems.

SHIP TO SHORE RADIO TELEPHONY

Early Experiments—Point-to-Point Measurements—Deal Beach Transmitter—First Public Service—Consideration of Suitable Frequencies—Electrical Interference on Ship Board—Directive Antennae Advantages—Coastal Receiving and Transmitting Station—Automatic Volume Control—Technical Operators—Future Developments.

DIRECTIONAL ANTENNAE

Transmitting Antenna at Madrid—Methods of Super-Don't forget that this comprehensive volume is sold on a MONEY-BACK GUARANTEE. If you are not satisfied with it, return it within three days for refund. Use the coupon at the top for ordering your copy of "SHORT WAVES" by Leutz and Gable.

port—Consideration in Design—Constructional Details—Confinement to Short Wave Work—Foreign Developments.

TELEVISION

General Considerations—Transmitter Band Width—Need of Standardization—Colored Television—Early Television Inventions—Jenkins Developments—Transmitter Designs—Importance of Special Receiver Designs—Scanning Equipment—Importance of Synchronization—Television Lamps—General Electric Development—Reproduction on a Large Scale—Cathode Ray Tube Developments.

AIRCRAFT RADIO EQUIPMENT

Bureau of Standard Developments—Radio Frequency Laboratory—Aircraft Receivers—Power Supplies—Ignition Interference—Remote Tuning Controls—Aircraft Antennae—Guiding Aircraft—Radio Range Beacons—Airport Equipment—Directional Transmitters—Navigation.

SHORT-WAVE BROADCAST RECEIVERS

Early Designs—Regenerative Circuits—Advantages of Superheterodyne Circuits—Schematic Diagrams—Superheterodyne Adapters.

ULTRA SHORT WAVES (Medical and Surgical Applications)

Artificial Fevers—Relation of Heat to Disease—Short Wave Oscillators—Gall Fly Experiments—Apparatus Used—Magnetron—Theoretical Considerations—Oscillating Circuit—Frequency and Power Limitations—Electric Surgery—Electric Knife—Apparatus Used—Experiments and Research.

AMATEUR SHORT-WAVE EQUIPMENT

Amateur Communication Equipment—Radio Telegraph—Radio Telephony—Typical Apparatus—Oscillators—Frequency Doubblers—Linear Amplifiers—Modulator Unit—Miscellaneous Subjects.

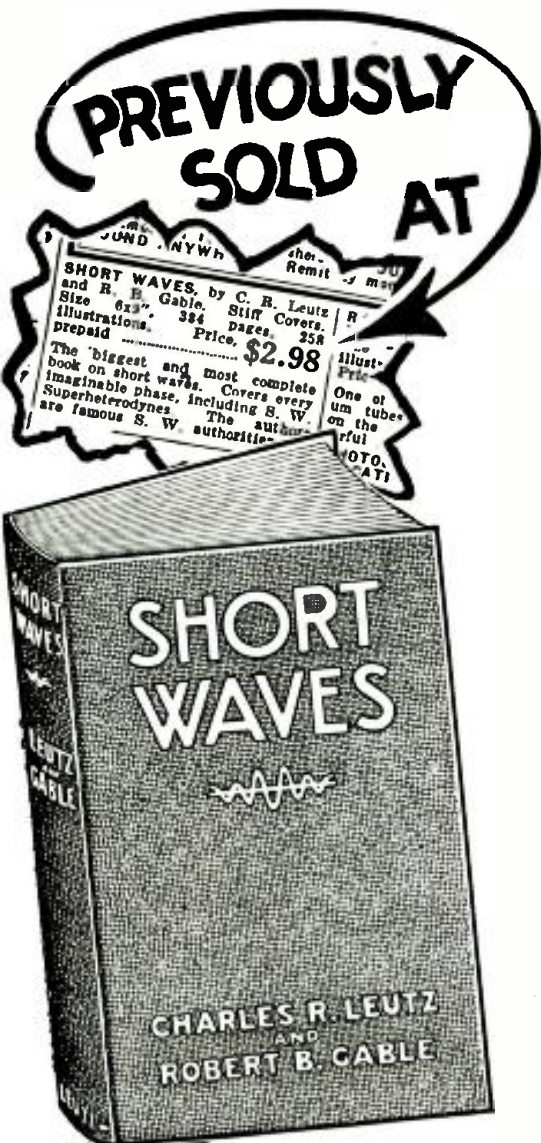

NOW \$1.00

SOLD ON A MONEY-BACK GUARANTEE IF NOT SATISFIED

RADIO PUBLICATIONS
103 Hudson Street
New York, N. Y.

Please mention SHORT WAVE CRAFT when writing advertisers



POLICE SHORT WAVES

An Editorial By HUGO GERNSBACK

● During the past three years, the instrumentality of short waves has come into use by practically all police departments of the civilized globe. There are few countries today where the police do not avail themselves of short waves in the more efficient furtherance of their business.

Police short-wave radio has become a tremendously powerful arm to the law, and nowhere is this more in evidence than in the United States. Practically all of the larger municipalities own police radio transmitters as well as police radio cars equipped with receivers; and, in some instances, these cars have a transmitter as well, so that the officers can talk back to headquarters directly from their automobiles whenever this may be required.

At the present time, there are in this country approximately 300 police radio stations, which operate at the following wavelengths or frequencies: 120- and 180-meter bands; also on the 7- and 9-meter bands.

It should not be thought that police radio is only for the detection of crime, although perhaps this commands most of the time on the transmitter. There are such items, first, as checking up on individuals, policemen on the beat, getting quick information on various subjects from policemen on the beat, etc.

When police radio first started, the voice transmissions were made in plain English. It was soon found out, however, that many criminals availed themselves of short-wave receivers and thus listened in themselves to police transmissions, and in this manner nullified, in many cases, the effort of police to apprehend criminals in the act of committing a crime. For this reason, at the present time, anything along this nature is no longer transmitted in plain English but certain code words are used. These code words are meaningless to the uninitiated, and as they are changed frequently, the listener-in does not know what the code words or numbers refer to. In this manner the police maintain the necessary secrecy, particularly in those cases where this is of the utmost necessity.

Police radio in our crowded centers is particularly useful in the disentanglement of traffic due to automobile crashes or other mishaps, by dispatching policemen to the scene in short order. But, for the average short-wave listener, the detection of crime and all that goes with it is of a most romantic nature and gives him thrills galore. The listener, however, should first understand that due to the peculiar action of short waves, the effects of the various transmitters reach far beyond the points for which they were intended. If you have a good receiver, and if you are tuned in to the police wave band, you will be apt to receive police calls from stations practically all over the entire country and full loudspeaker strength. Indeed, it is impossible to tell where the call originates, unless the

police department itself announces the call.

Many police station announcers do not bother with this formality, although they are required to do so. If no station announcement is given, of course the listener-in does not know from what part of the country the call originates. On the other hand, sets installed in police cars are usually of such a nature that they receive only emissions from their own stations, and these receivers very seldom get calls from other cities. Incidentally, practically every police department has a gong which sounds before and after the announcement, and every policeman quickly identifies his own station gong to the exclusion of others that might come over the receiving set.

As far as the short-wave listener is concerned, we might say that he has a great duty to perform, particularly in helping to detect crime. Many citizens are now helping their police departments to apprehend criminals, so that the police can grab them in the very performance of the crime. Thus, it has frequently happened that a man or woman witnessing a holdup, perhaps across the street, instantly called up the police department and gave the information, which was immediately broadcast. The listening police car near the scene of the crime can thus be on the actual scene of the crime within seconds. In this manner many holdups and other crimes have not only been prevented but criminals are often arrested on the spot.

To the short-wave listener there is perhaps nothing more thrilling today than listening, particularly in the evening, to the police transmissions. With the usual receiver there is apt to be a good deal of crowding on the dial due to the fact that so many police stations operate on approximately the same wavelength (frequency). Much of this can be eliminated by using a set which has band-spread attachments, which makes tuning much easier in such narrow bands.

Thus, in our next issue there will be described a special receiver designed *only* for police call reception and equipped with band-spread in order to separate the stations.

By listening in to various police announcements, short-wave listeners are frequently able to cooperate with the police department in locating stolen cars and when the police department broadcast the calls to help in locating missing persons. In other cases, listeners who had heard broadcasts about certain cars, suspected to hold criminals, spotted such cars and instantly transmitted the information to their police department over the telephone, in which case the fleeing cars were intercepted and the criminals apprehended quickly.

Intelligent listening and quick thinking by short-wave listeners will help their respective police departments in ridding the country of a good deal of crime.

SHORT WAVE CRAFT IS PUBLISHED ON THE 1st OF EVERY MONTH

This is the September 1935 Issue—Vol. VI, No. 5. The next Issue Comes Out September 1.

Editorial and Advertising Offices, 99-101 Hudson Street, New York City

MICRO-WAVES SPAN the English Channel

More and more uses for micro-waves are being discovered every day. This particular installation shows how short sections of telephone line or other communication transmission lines can be eliminated by micro-wave transmitters and receivers, so long as there are no large intervening objects which might block the transmission and reception. Because micro-waves are quasi-optical in character, the transmitters and receivers must be mounted on high towers.

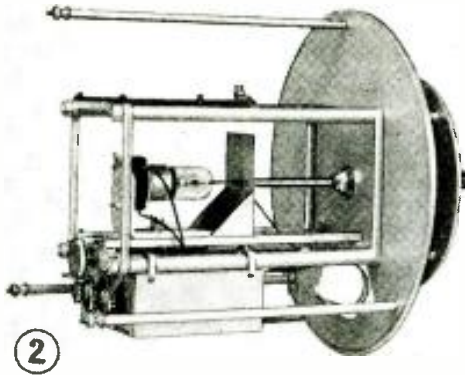
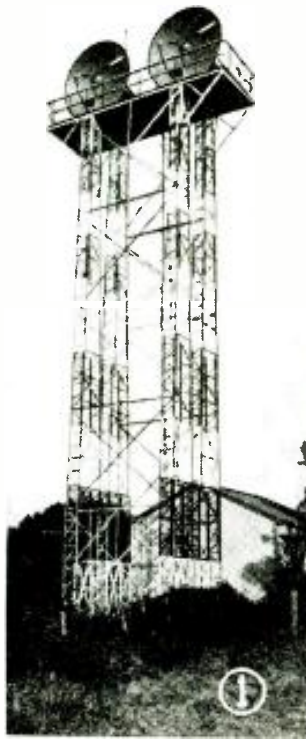

system is automatic, insofar as the power supply is concerned. Voltage regulators and other control devices are used to maintain perfect uninterrupted communication. The transmitting system uses a regular modulator together with the necessary amplifier stages in order to bring the voice or code up to a sufficient level for complete modulation.

The code and printing machines use an audio frequency tone-generator to supply the necessary modulation for receiving.

Fig. 1 shows the towers on top of which are mounted the transmitter and receiver parabolic reflectors. Fig. 2—the micro-wave generator, which is located behind the parabolic reflector shown in Fig. 3. Fig. 4—the master control room through which the different types of service are routed.



● RADIO engineers have at last found that the ultra-short waves or micro-waves as they are sometimes called, can be used to take the place of telephone or telegraph circuits to particular advantage in some cases. For instance, if we have two points between which we desire to hold communication or transmit messages of some type and they are fairly close together (in the neighborhood of between 10 and 30 miles) and the type of territory between these two locations does not permit the erection of poles to carry a telephone or telegraph line and provide communication needed, micro-waves become a very important and useful adjunct.

We can install very low-powered transmitting and receiving stations, the cost of which will be much lower than the average radio station, because of its low power and simplicity. Secrecy can be maintained because these waves can be focused in a very narrow beam, which excludes reception from all directions other than that in which the beam is focused.

In the accompanying photographs we have some very interesting views of the micro-wave equipment which is used to cope with just such a condition as mentioned above. This system is used to communicate across the

English Channel; one station is located in Lympne and the other in St. Inglevert. The distance between the two stations is some 56 kilometers (about 35 miles).

In Fig. 1 we see the two enormous steel structures which support the transmitting and receiving station forming one side of the circuit. The two parabolas which serve to focus the waves for transmission and reception are mounted on the top of this steel structure. The parabolas are approximately 9 3/4 ft. in diameter.

Behind these parabolic mirrors is located the micro-wave generator tube and its associated controlling circuits, these are shown in Fig. 2. Fig. 3 is the front view and in the center of the large parabola is a small cup-shaped instrument which further aids in concentrating the focus of the transmitted wave and this cup is supported by three large brackets as can be seen in the photograph.

In Fig. 4 we have a view of the control room through which can be routed the various types of traffic which the system handles.

This circuit is one of the most versatile of any radio hook-up. Arrangements have been made for high speed printing, regular Morse and radiotelephone communication. The entire

An elaborate receiver is used wherein the incoming waves are changed to a frequency of approximately 300 kc. and then amplified through the intermediate frequency amplifier, finally detected and amplified similar to the conventional superheterodyne.

The output of a receiver can be connected to either a teleprinting device which will print the incoming signals or to an outside line for telephone communication. In other words, the entire installation takes the place of telephone or telegraph cables which otherwise would be used to bridge the gap between the two shores of the English Channel.

While we do not know of any truly micro-wave system such as this being installed in the United States, we do have a very interesting installation and one which is very much similar in operation. This American system was developed by the Bell Telephone Laboratories and it bridges Cape Cod Bay from Provincetown, R.I., to Green Harbor, Mass.

Here too, due to the large expanse of water between, it was deemed more advisable to use a radio communicating system rather than build a 25-mile telephone line. These transmitters and receivers operate on a wavelength of 4.7 meters (Continued on page 310)

1-Watt Short-Wave TRANSMITTERS Used in Germany

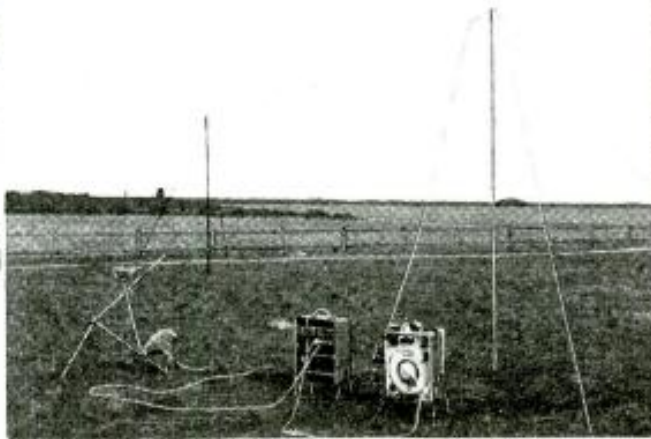

and battery container at the right. 4. Short-wave portable transmitter for use on small airships. 5. 10-watt portable transmitter and receiver.



1. Portable short-wave transmitter carried on the back with a special harness. 2. Above, 15-watt short-wave station, transmitter and receiver with pedal-driven dynamo for exciting the transmitter. 3. Left: 1-watt short-wave set

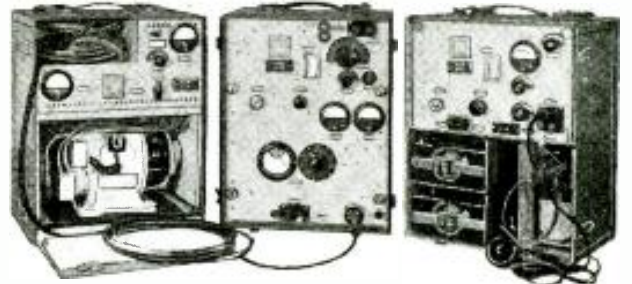

● Among the European nations Germany is at present the most *air-conscious* one. German boys of today desire to fly as eagerly as they wanted to be a treasure-hunter, or a cowboy and trapper 20 years ago. Since motor-driven planes are not cheaper in Germany than elsewhere the boys construct their planes. These planes are, of course, only motorless ones—so-called *gliders*—which are built in the school machine-shop with the help of an air-minded teacher.

Each of the boys contributes as much money as his parents can afford. This money is used by the teacher to buy the raw material for the glider-plane to be constructed, and if the plane is ready the students have a chance to enjoy the thrill of flying by taking a so-called "Gleitflug-Kursts" (Lessons on how to pilot a glider-plane).

Since such a glider-plane is not able to carry two persons, the instructor—often an army pilot—is able to communicate with the student-pilot, high up in the air, only by means of yelling and gestures, an instruction method which is of course not sufficient to prevent bad crashes, sometimes ending with the destruction of the glider.

To avoid these unwanted accidents the instructors are now using small *portable telephone transmitters* to communicate with the student-pilot. Despite the fact that the output of these transmitters does not exceed more than 1 (one) watt, and only a small telescopic antenna is used, these transmitters operating on a wavelength between 60 and 100 meters often bridge remark-

ably long distances.

The student-pilot receives the telephone signals by means of a small 4-tube receiver, which is battery-operated. These receivers are not only of very small size but also extremely light. The entire weight, including batteries, is about 7 to 8 pounds. Headphones installed in the pilot's cap, serve as the sound reproducers. A horizontal hanging wire about 18 feet long is used as the antenna. Sometimes the guy wires of the plane do the trick as antenna.

While these transmitters of 1-watt output are used by small glider-schools only, the larger training camps have transmitters of about 15-watt output. The instructor then has the opportunity of contacting the student under all circumstances. Each of the glider-planes has for that reason a certain number, and interested short-wave listeners often have a chance to hear the instructor calling for example a certain plane: "Glider No. 567, do so and so," or if the weather conditions are not favorable: "Calling all gliders, calling all gliders, to go down!"

These 15-watt transmitters are divided into three handy boxes, which are carried by the students like knapsacks on the back. One box contains the transmitter. The second one the aerial supports and the antenna wires, and the third one the power source, the pedal-operated generator, used like a bicycle. The pedal generator is so designed that it may be folded up in a few minutes. Each of the boxes has a weight of about 50 pounds. As experience shows such a station may be put

in operation in a time not exceeding two minutes after arriving at a certain place, this time includes the erection of the aerial supports and the antenna wires.

Similar transportable transmitters completed by a fitting transportable receiver are often used for communication purposes in case of sport events and political demonstrations. Telephony and code traffic is used in all such cases. Such a station is very often installed in a small dirigible to supervise traffic regulations, etc., from above.

The German Broadcasting Co. is using portable 10-watt transmitters for reports about interesting events direct from the spot. Often a special communication car, furnished with several short-wave transmitters is in use. However, in all cases where such a large car cannot be used, a small 10-watt transmitter, divided into three or four boxes, is employed for the transmission. These transmitters are of a relatively light weight and easily bridge distances of 10 to 15 miles.

Another very interesting type of portable short-wave station, also operating on a wavelength of 60 to 100 meters, but often furnished with a continuously variable wave range from 40 to 2,000 meters, is used by the German army. These very small stations, having an output only of *one watt*, may be used alternately for telephony and code transmission. If the code-key is touched, a small buzzer operating as a tone generator, modulates the trans-

(Continued on page 303)

Third Award In Our \$5.00 "YL" Contest

Come On, Girls, Here's Your Chance to Win \$5.00 for Best Photo of Your Station

PRIZE WINNER—

Dorothy Hagerty, W6JMH

● A DESCRIPTION of the apparatus shown in the photograph follows: On the table to the right is the receiver using a 58 regenerative T.R.F., 58 buffer, 57 electron-coupled detector and 56 impedance-audio, with separate power supply. Both a "bug" and standard key may be seen on the table.

The rack and panel is the transmitter used mostly on 20 meters. The two lower shelves contain separate power supplies. Middle panel consists of a 59 crystal tritet, link-coupled to a pair of 46's in push-pull. This in turn is link-coupled to final stage in panel above, an 830 is used as a final amplifier, run normally at 100 watts input.

In the upper left corner of the photograph is the transmitter used mostly on 80 meters: it consists of a 47 crystal, 46 buffer and a 510 final with 50 watts input.

At the lower left is a 2-tube receiver that is also used as a monitor. Two separate Fuch type antennas are used: one, 130 feet running east and west and one, 99 feet long running north and south.

Mrs. Dorothy Hagerty (W6JMH)

(Editor's note: Mrs. Hagerty is a real ham and she has made a careful study of short-wave radio and knows all the names and the function of each piece of apparatus. She wrote a very fine article entitled, "Why I Could Not Do without Short Waves," in the Feb.-March issue of the Short-Wave Listener.



Above — The likeness of Dorothy Hagerty, W6JMH, a California lady amateur who is expert in operating a transmitter, as well as a receiver on all the ham bands. She is also a short-wave fan and enjoys hearing short-wave broadcasts from foreign countries.



Left — This photo shows the ham or amateur radio station operated by Dorothy Hagerty, W6JMH, of California. A complete description of this interesting and finely built transmitter and receiver is given in the accompanying story.

Miss Veronica Carew's Station

● THE "rig" was built with the help of a local ham. It is 5 ft. high, 14 inches wide and 14 inches deep. It is a 7-shelf affair; the bottom shelf holds all the power and filament transformers



Here we have a view of the ambitious-looking transmitter operated by Miss Carew, together with a short-wave ham receiver at the right.



Miss Veronica (Ronnie) Carew, who has been on the air for 1½ years. She has worked all U.S. districts on 40 and 80 meters. A complete description of her station appears herewith.

and rectifier tubes. The second shelf has all the filtering equipment;

the third shelf contains a 59 tritet oscillator. The fourth shelf contains an 841 buffer-doubler.

The first shelf has been left empty for future expansion. The sixth shelf holds the final amplifier, consisting of 210's in push-pull, and the top shelf holds a Collins "Antenna Network."

This rig is used exclusively on 40-meter C.W. I also have a self-excited rig, consisting of 45's in push-pull, which I use quite frequently on 80-meter C.W. An 80-meter Zepp antenna is used on all bands. The receiver is a National SW-3.

I have been on the air for 1½ years and I have worked all U.S. districts on 40 and 80 meters.

Miss Veronica (Ronnie) Carew, W1H1H, 17 Manning St., Medford, Mass.

Alice E. Johnson, W9IJD

● I HOPE you like the accompanying photo of myself and station.

W9FOX was my portable call. As there are no more portable calls, that call does not belong to me any more. I operate W9IJD, which is listed under my husband's name.

Am using a 4-stage Xtal-controlled transmitter with a 100-watt tube in the final stage. Input on 40 meters about 450 watts, on 20 meters about 230. My receiver is a National FB7.

This station has worked five continents and has been heard in all continents; 36 countries have been worked. (Continued on page 298)



Alice E. Johnson, W9IJD, of Minneapolis, Minn., and the station she operates.

Vest-Pocket Set Brings in "Foreigns"

By Dever K. Warner*



The Vest-Pocket short-wave receiver in operation; a sensitive pair of headphones such as the Trimm 4,800-ohm "featherweights," or the new Brush "crystal" phones will provide a very sensitive receiver.

Thanks to the use of one of the new No. 955 Acorn tubes, this real vest-pocket short-wave receiver has become a reality. It provides headphone reception of "foreign" stations as well as local ones.

● FROM time to time one hears about so-called vest-pocket radios but an actual investigation usually reveals that a vest would have to have pockets the size of a "mail-man's bag" to really accommodate these sets. However, the introduction of the RCA tube number 955 Acorn tube opened up a vast field of possibilities for designing a radio set powerful enough to "get" Europe, yet small enough to actually be carried in a

tainable were used throughout, with the result that the completed radio is not much larger than a deck of cards. The tube used, commonly known as an "Acorn" tube, is almost identical in performance to the well-known 37-tube, although, as its name implies, it is (Continued on page 297)

vest pocket. Such a radio receiver is the one described in this article, which when mounted in a wooden box measures only 4" by 2½" by 1½", and were the radio mounted in a box made from sheet metal, the over-all dimensions would be even smaller.

As the main object in mind in building such a set as this is compactness, it was decided to forego the advantages of using plug-in coils to cover the various bands and make this set a single-band receiver; the data given in this article describes how to make a coil to tune in the 49-meter band, on which programs of both the National and the Columbia broadcasting networks and a majority of the "Foreign" broadcasts may be heard. If it is desired to build this set to cover any other band, the proper number of coil turns can easily be determined by consulting any good set of inductance tables.

Circuit Is Standard

A brief glance at the circuit diagram will reveal that there is nothing peculiar or tricky to the circuit at all. It is basically the same circuit that has been used for years in making one-tube radios. However, the smallest parts ob-

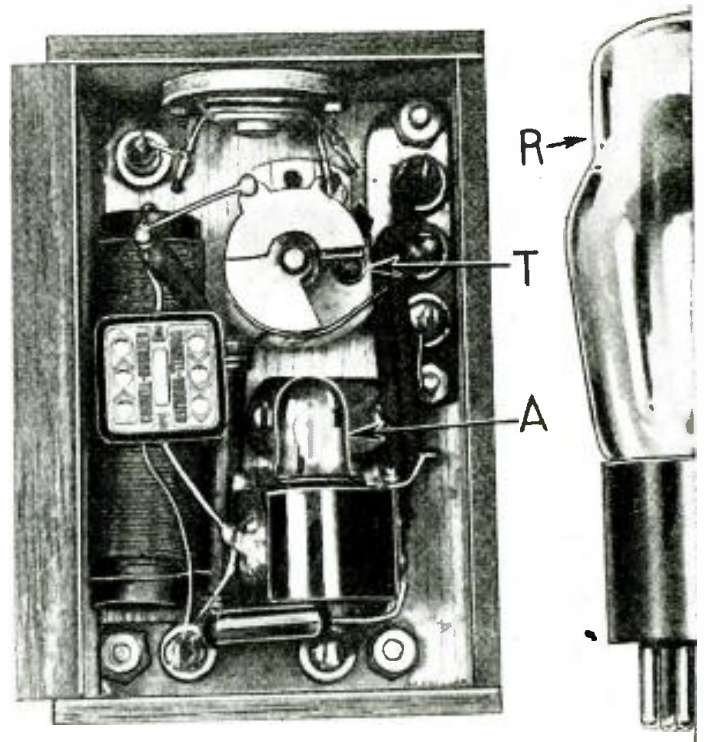

Close-up view of the Vest-Pocket receiver, showing the Acorn tube at "A," the tuning condenser at "T," and a standard tube at "R" to show comparative size.

*The Warner Radio Service, Bridgeport, Conn.

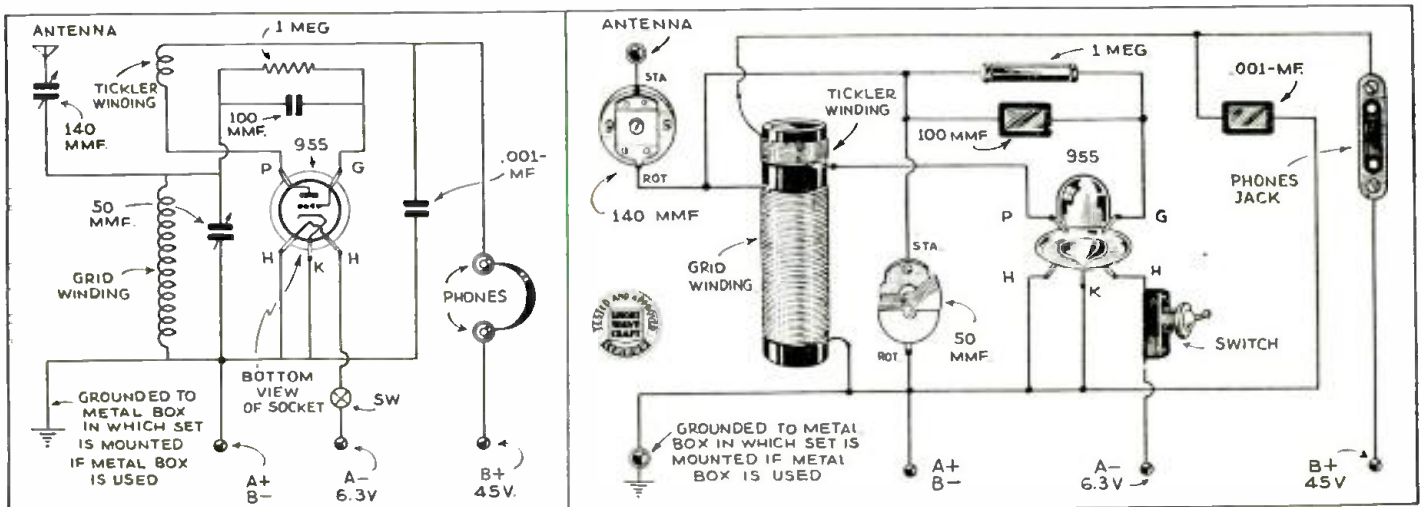

Wiring diagrams, both schematic and physical, for the Vest-Pocket 1-tube receiver which works on batteries carried in the pocket. A small aerial will yield surprising results.

The "FOREIGN

By Walter C. Doerle

Designer of the Famous Original "Doerle" Receiver

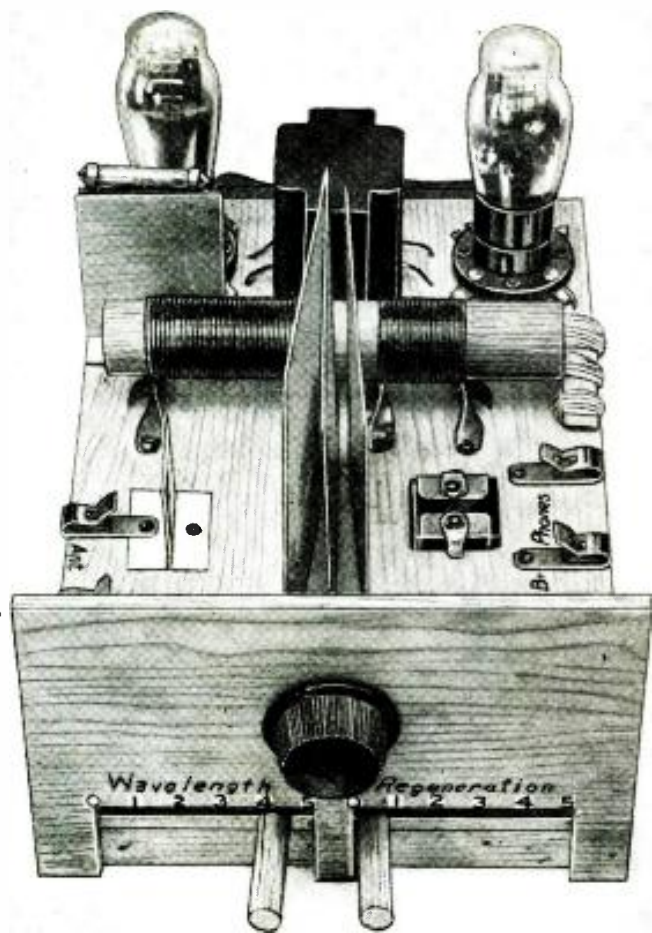

This view of the "Foreign Stations" S-W receiver shows very clearly the arrangement of the tuning and regenerative control handles, which project through slots cut in the front panel.

these "strings," without connection to electric power and do not these homes deserve to have the thrill of short-wave reception comparable to those in more moderate circumstances?

Because short waves on high-priced receivers, comparable to present financial stringencies, are beyond the reach of many, this set was made so that the individual on the lowest rung of the economic ladder not only has heard of short waves, but is now able to listen-in on them.

idea in mind, some reasons are presented which should get you interested in traveling along the short-wave channels of radio reception.

Witness the great devastation brought by the dust storms and the quiet but austere atmosphere of those regions with regards to what might next happen.

Such a short-wave receiver here described does not compel the constructor to be too finicky. For the 49-meter band being of short waves but not of ultra short waves, allows him much leeway (constructor or "poetic license"). Hence superficial criticalness as regards construction, wiring, placing of parts, etc., has been eliminated. However, be careful, and if you can hook up a doorbell outfit, you can get this set working in fine shape.

The 49-meter band was chosen because the majority of foreign short-wave stations are around this region of wavelengths (47-51 meters) and who is it that does not want to get in on other continents' transmissions? Furthermore, this 49-meter band has the most stations which broadcast voice and at regular schedules.

Since this set uses the most versatile materials known to man—wood panel, subpanel and a couple of "2½ size" clean tin cans cut to shape as described later for the condensers—this puts the purchasing cost of other parts at a minimum, and allows the constructor to

● WHEN one contemplates the economic conditions of his fellow men and surveys in his mind's eye what passes through the ether on the medium of short waves, it is very simple to understand how others make supreme sacrifices with thought and talent in order that entertainment may come to all instead of a select few. Thus with this

Would not such a simple short wave set herein described have proved a means of entertainment through those torturous hours?

From even a glance, the distribution of population of the United States is strung along the Pacific Slope, Mississippi Valley, and the Atlantic Coast with many isolated homes in between

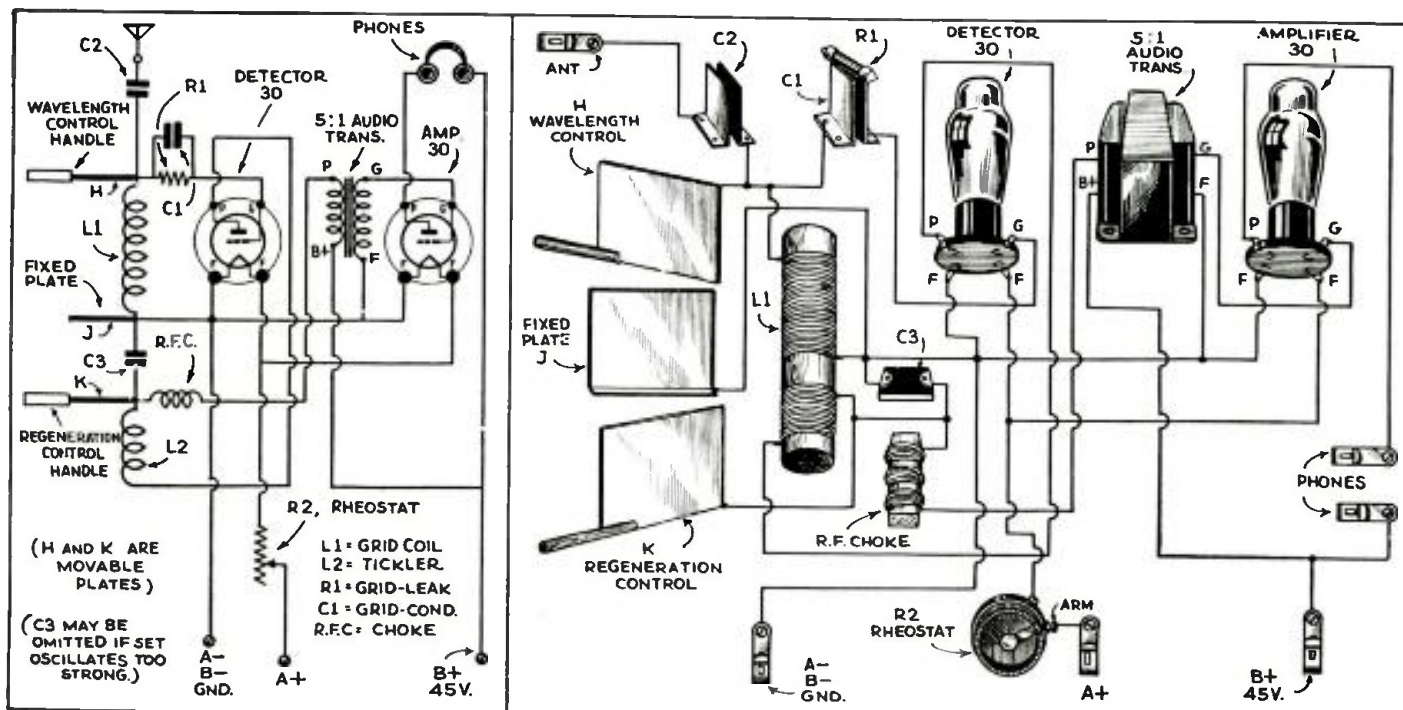

You will find it a very easy matter to construct this low-priced short-wave receiver here described by Mr. Doerle in detail. The beauty of this design lies in the fact that most of the parts can be built from tin, wood and other materials found about the average workshop.

• FIRST of New Series by Mr. Doerle

STATIONS" S-W Receiver

make the most unique short-wave set and incorporate his own handwork features.

It is still the cry of many "we want efficiency" and of course on short waves this is one of the paramount items of consideration. It has been taken into account by designing the set to work the 49-meter band only. You may have a 10-tube set to get radio stations from ultra-short waves to ultra-long waves, but somewhere in between, the set will have only one high value of performance—maybe none at all. In other words, radio efficiency is analogous to the resonance curve of a tuned circuit—one high value and on both sides of this peak, decreasing performance value.

Photographs Show You How

Fig. 1 shows how the set appears to the eye for a plan view of the receiver. It portrays the simple but efficient arrangement of the component parts. The two Fahnestock clips serve for the headphones with one of the clips serving for B+ connection. The four clips in line near the middle of the subpanel are twisted a 90-degree turn, so that the "terminals" on the plug-in coil shown to the right in the photo, make slip but positive grip connections with them. The three clips toward the panel and on the right-hand side of the photo are for connections of "antenna," "A—, B—, ground" and "A+" respectively.

The detector tube is on the right-hand side, the 5:1 ratio audio transformer in the middle, with its accompanying audio tube at the left. Both of these tubes are of the 2-volt filament (type '30) variety and of course with total current drain of .12 amperes from two No. 6 dry cells connected in series, it is easy to see that the batteries for this set will last an exceptionally long time. Plate voltage for the tubes is supplied from a 45-volt "B" battery.

On the panel is mounted a 10-ohm rheostat which, when turned so that the movable arm makes contact on the

At last we have prevailed on Mr. Doerle—designer of the original 2-tube "Doerle" receiver—to prepare a series of articles for the readers of "Short Wave Craft." This receiver is different from any that we have described heretofore, in that all of the parts except the tubes and the headphones can be built by the constructor himself. Even the rheostat can be built from a small coil of resistance wire fitted with a clip. This set works on two ordinary dry cells and a single 45-volt "B" battery. The cost of the set need not exceed \$1.50, tubes included.

resistance wire, the voltage on the tube filaments will be very nearly two volts. Remember these facts—as the dry cells age, the movable arm on the rheostat must be advanced and these filaments glow a very low dull red color. Any color above this, may cause the filaments to burn out. Thus starting with fresh batteries and using the rheostat properly, experience will dictate proper caution. Holding the hand over the tube glass (envelop) when the rheostat arm just makes contact, will give you a better idea as to the very low brilliance of the tube filaments.

Photo No. 2 gives you the picture from the operator's angle and some features not previously described. Thus the plug-in coil is in place, showing how it is mounted on the four Fahnestock clips. The filament rheostat R2 is centrally located on the panel which measures 7" by 5". The "Wavelength" control handle is on the left-hand side and the "Regeneration" control handle on the right. The slots through which

the control handles pass are cut 1½" by 2½", thus allowing for ¼"-square sub-panel cleats, the thickness of subpanel and ⅜" diameter of handles.

To make the numeral figures appear like those made by an expert draftsman, a "month sheet" was taken from a calendar, the numerals from it cut to the fitting size and then glued on the panel as shown. Of course for your convenience, you may put the numerals on freehand style, use O-100 (10-unit intervals) or place them according to increasing or decreasing capacities of the condensers.

And speaking of condensers, the center plate "J" and movable plate "K" constitute the *regeneration* condenser of the receiver, while the center plate "J" and the movable plate "H" constitute the *wavelength* (tuning) condenser. This may be readily checked by thinking of these three plates as sections of the wiring of the receiver, which go to grid, filament, and radio-

(Continued on page 299)

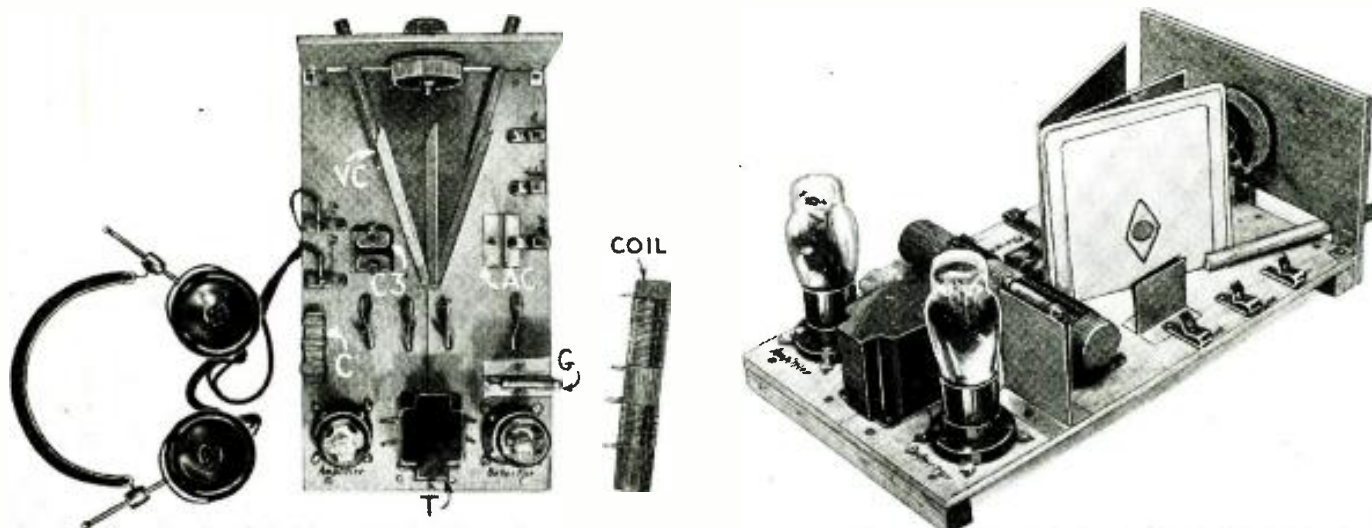

Believe it or not—the set as shown above is all wired! Secret? The wiring is all underneath! C is the R.F. choke; VC is the variable condenser; T is the audio transformer; G the grid-leak; AC is the antenna condenser; C3 .00015 mf. condenser.

Electrifying the CLIP-

How to Electrify the Universal Hook-Up Board

● CONTINUING with last month's feature article on the *Universal Hook-Up Board*, we describe herewith a *Universal Power-Pack* which will en-

prong breadboard-type socket; one type 25Z5 rectifier tube; one triple 8-mf. (24-mf. in all) electrolytic condenser; one 100-ohm filter choke; one zero to 300 D.C. voltmeter; two compression type 20-watt rheostats; 12 double-

inch wood screws, well soaped for easy driving. The socket will require ½-inch screws. Both rheostats are mounted on brackets, which in turn are fastened to the board. The condenser unit is held securely by means of a metal strap. Two or three layers of good friction tape make a very good strap for this purpose. The voltmeter is raised above the board by means of two S-shaped angle brackets. Slip a Fahnestock clip under each of the screws holding these brackets.

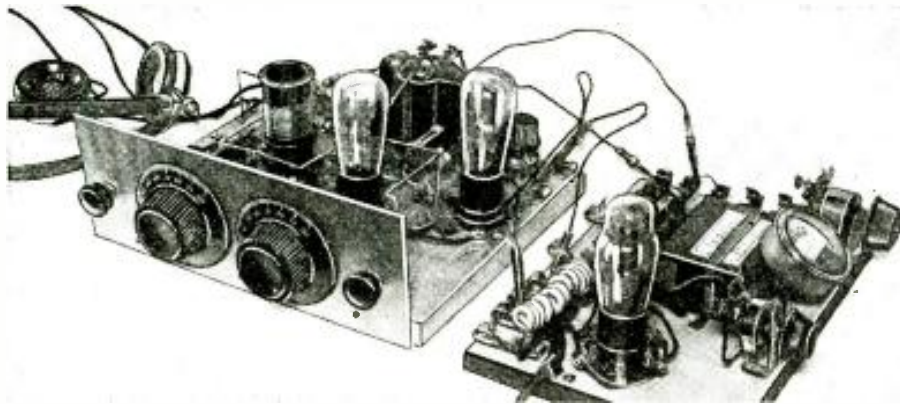

Here we see the Clipset receiver, described in complete detail last month, at the left of the picture, while the new 110 volt "power-supply" unit appears at the right.

Calculating the "A" Supply Resistors

As we all know, practically all A.C.-D.C. receivers operate with their tube filaments hooked up in series. The reason, of course, is economy. If we connect seventeen of the 6.3-volt tubes in series across the 110-volt line, we can light their filaments without danger of burning them out. That is because each tube "consumes" 6.3 volts or "drops" the line voltage by 6.3 volts. Therefore, collectively, the seventeen tubes "consume" slightly more than 107 volts of the line voltage of 110 volts; which is close enough for safe operation. The entire arrangement would draw only 0.3 ampere (representing the current of a single tube) and would require no line voltage-reducing resistor. If these same seventeen tubes were hooked up in parallel, the entire arrangement would consume but 6.3 volts and would therefore require a line-reducing resistor to lower the line voltage from 110 to 6.3 volts. Furthermore, the tubes would draw, collectively, 5.1 amperes, which current, flowing through the reducing resistor, would cause close to 529 watts of power to be dissipated uselessly in the form of heat.

This pack has been designed to supply "A" power for a maximum of four tubes arranged in series. The 25Z5 has a 25-volt filament. The three other

able you to electrify circuits on the hook-up board. This power-pack is indeed "universal" in the strictest sense of the word. To begin with, it may be operated on any 110-volt electric line, either A.C. or D.C., regardless of frequency. Then too, it is capable of furnishing not only "B" voltages but "A" as well! It is designed to energize the filaments of anywhere from one to four tubes including the rectifier—all connected in series. Besides, with a few deft changes—without the use of a soldering iron—the circuit can easily be changed from one of half-wave rectification to one which affords full-wave rectification and voltage-doubling. This latter circuit can only be used where A.C. is available. And finally, this extremely versatile unit will supply enough current to energize the field of a dynamic speaker.

To our knowledge, this is the first time that an A.C.-D.C. power-pack has been designed to furnish both "A" and "B" power; and don't forget that the tube filaments in an A.C.-D.C. receiver are generally arranged in series, which makes the provision of "A" power more interesting. Heretofore, A.C.-D.C. packs were made to supply "B" voltages only.

This pack is indeed one of the simplest and most economical to construct, being laid out in "breadboard" fashion and containing but a minimum of parts. Yet, withal, it is an extremely versatile unit, with good efficiency and very low hum-level. The breadboard was obtained in a "five-and-dime" store and cut down to 10" x 6¾" so as not to be too unwieldy. The soldering iron, of course, was "outlawed" from the very start. But wait, not entirely, it was used to solder two Fahnestock clips to the terminals of the filter choke. From then on, however, it was conspicuous by its absence.

Before proceeding with the actual construction, gather before you the following parts: one line cord and plug with built-in 350-ohm resistor; one 6-

type Fahnestock clips; and about a dozen medium-sized single-type Fahnestock clips. Attach the latter-sized clips to each of the binding posts on the sockets and the potentiometers. If these parts are other than those specified at the end of this article, they may not have binding posts and hence the clips may have to be soldered on. Attach two clips to the terminal lugs of the filter choke as well as to the wood screws which hold this unit to the board. Everything is now ready to be laid out, fastened to the board and wired.

For shortest leads and maximum convenience in wiring, it is recommended that the constructor follow the layout shown in the illustrations. All components are fastened down with ¼-

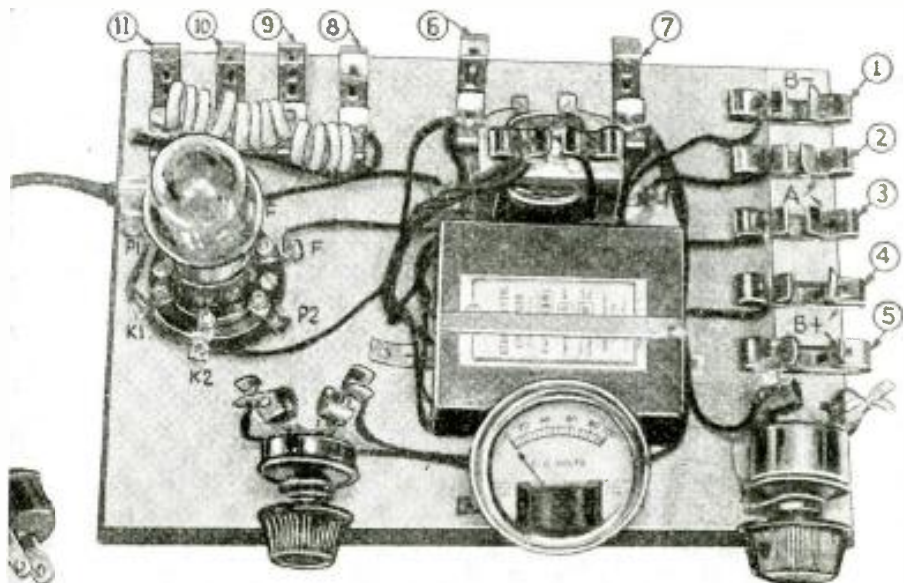

A close-up view of the 110 volt A.C.-D.C. universal power-pack, which supplies not only the "B" voltages but the "A" as well.

SET



external tubes are assumed to be each of the 6.3-volt type. Now, adding the filament voltages of the four tubes, we have a total of 43.9 volts as compared to 110 volts of the line. The difference between these two voltages must be "dropped" or "consumed" by a line voltage-reducing resistor. By applying Ohm's Law, we find that this resistor must be 227 ohms. (A 225-ohm unit will do.)

So far, so good! But suppose we wanted to operate only two external tubes or even one. Well, that's easy. By following the same procedure as above and Ohm's Law, we find that every time we remove one of the external tubes from the circuit, we must add 20 ohms to the line voltage-reducing resistor, until we finally get to the point where only the 25Z5 rectifier tube is in the circuit, at which time the value of the resistor figures up to approximately 285 ohms. We must therefore have a resistor that can be varied by some means from a minimum of 225 ohms to a maximum of 285 ohms. In practice, this was done by using a 225-ohm line cord and three separate 20-ohm resistors, each or all of which could be shorted out of the circuit at will.

For the sake of economy, we obtained a 350-ohm line cord and proceeded to cut out of it the three 20-ohm resistors as well as the required 225-ohm line cord. The procedure for doing this was quite simple.

In the August number the first article describing how to build the "Clipset" receiver was published. As many readers would probably rather use the electric light socket as a source of current-supply, for both the heater and plate circuits, the editors have had the power-supply unit here shown designed and tested. This power unit may be operated on either 110 volts A.C. or D.C. and it will not only furnish the "B" voltages but also the "A" as well, with a very low hum level.

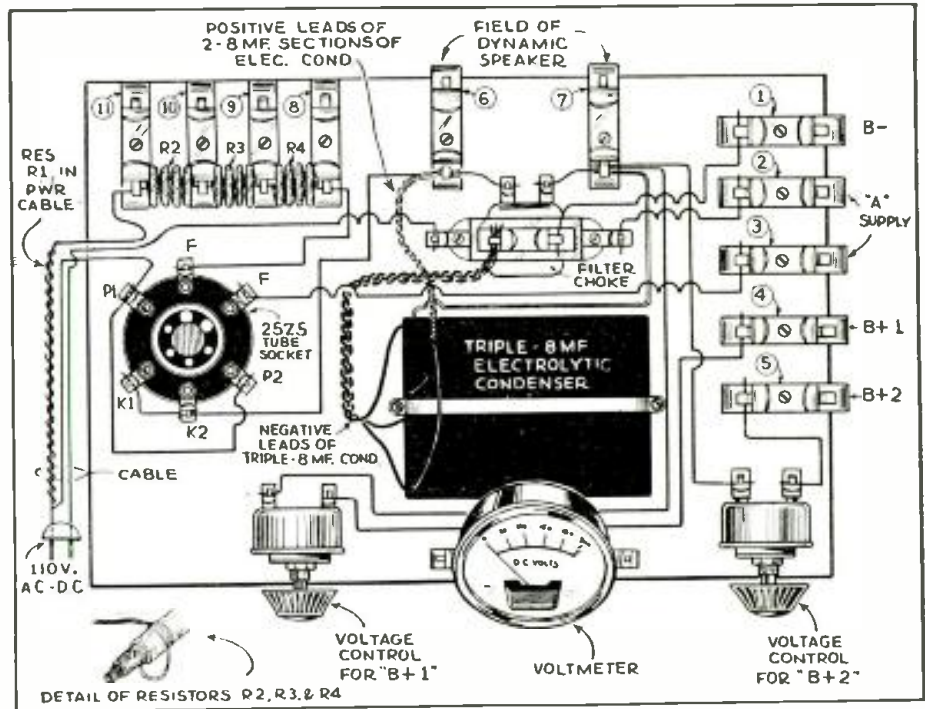

Physical drawing showing top view of the 110-volt A.C.-D.C. "universal" power-pack.

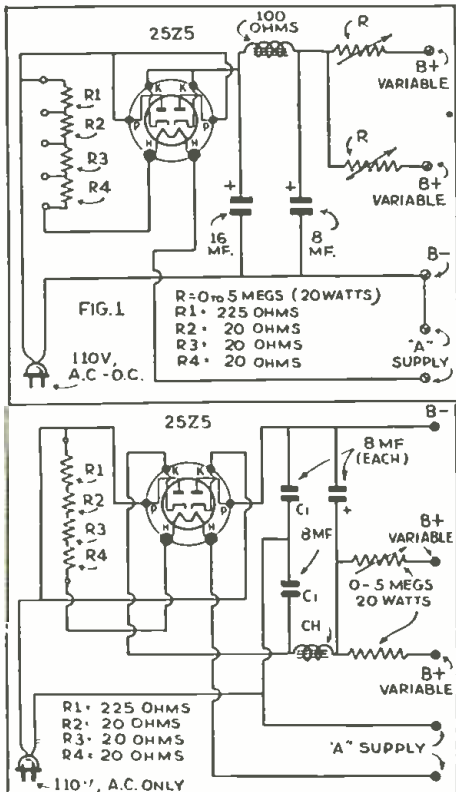

Above—schematic wiring diagrams for a "half-wave" rectifier hook-up and in the lower diagram, connections for a "full-wave" rectifier.

Our 350-ohm line cord was exactly 100 inches long. Therefore, 350 divided by 100 gave us 3.5 ohms per inch. Now, the line cord for our power-pack, as figured out above, is 225 ohms. Therefore, 225 divided by 3.5 tells us that our line cord measured from the plug up would have to measure approximately 65 inches to give us the required 225 ohms. We therefore measured 65 inches from the plug-in cord and cut off the balance. From the scrap cord, we cut out the three 20-ohm resistors. If this scrap cord comprises 3 1/2 ohms of resistance per inch, then 20 ohms represents approximately 5 1/2 inches. However, instead of cutting off three 5 1/2-inch sections from the scrap cord, we cut three 6 1/2-inch sections so that we would have a half inch at the end of each "manufactured" resistor to which to make connections properly. Inasmuch as these resistors were cut from the main line cord, we do not have to worry about their power rating.

The line cord which you will purchase, or which you may have, does not necessarily have to be 350 ohms. It can be anywhere from 290 ohms up, but be sure that you follow the same procedure in "manufacturing" your three strip resistors and line cord. Always remember that the end products must be one 225-ohm line cord and three 20-ohm resistors.

Cut the sections accurately and you are sure to have the proper voltages on the heaters.

The "B" Supply

Figure 1 shows schematically the hook-up of this Universal A.C.-D.C. Power-pack. You will note that the elements of the 25Z5 tube are arranged for half-wave rectification. This circuit may be used on either A.C. or D.C. However, where the constructor intends to use the power-pack on A.C., it is advisable that he take advantage of the circuit shown below Figure 1. This is a full-wave rectification, voltage-doubling circuit, capable of giving you a maximum voltage output of at least 220 volts. Referring again to Figure 1, notice that 16 microfarads of condenser capacity is used in the input to the filter choke. The high amount of capacity here results in a greater voltage output. The higher the capacity at this point, the better will be the results. The filter choke is a standard A.C.-D.C. type having a maximum D.C. resistance of only 100 ohms. The electrolytic condenser following this choke is 8 mf. The rheostats R-5 and R-6 are each 0 to 5 megohms placed in the circuit to give you two variable "B" voltage controls. The voltmeter mounted on the breadboard is very handy for determining just what voltage you are obtaining after adjusting resistors R-5 and R-6.

Operation of "Power-Pack"

If you desire to obtain only "B" voltages from this unit, then it is necessary to connect (Continued on page 303)

The "METAL TUBE 2"—A

● **UNDOUBTEDLY** the greatest single change in radio within the last five years is the introduction of the new *all-metal* tubes. A good many of these tubes are of the same type as the former glass bulb tubes and seem to ex-

hibit the same characteristics. The advantages and disadvantages of these tubes will be disclosed later when they have been given the "acid" test. At the present time all that we can say is that they work just as well as the glass tubes and can be used in the same circuits, although of course, they require an entirely different socket mounting because of the 8-prong bases which these tubes have. You must be particularly careful when using these new tubes too, because it is a simple matter to place one in the wrong socket and consequently do a lot of damage. *Mark the tube number alongside of the sockets*

so that there will be no mistakes made! Tests conducted with the tubes made available to the writer showed that they will operate on all frequencies up to

the most popular with the average short-wave fan. The circuit is a standard regenerative one of proved performance. If the reader wishes to build the receiver using standard glass-type tubes he may and he can be sure of obtaining excellent results. The set was not designed especially for the new metal tubes for that particular reason. The only change necessary when using the glass tubes instead of the metal ones is in the sockets and the addition of a tube shield for the detector.

The Metal "Detector" Tube

The detector tube is known as the 6J7, triple grid detector-amplifier and can be used in place of the type 57 or 6D6 glass bulb tubes. The 6J7 needs no tube shield because of the metal shell which replaces the usual glass envelope and which is grounded to the "B" negative side of the circuit, entirely shielding the elements of the tube. However, we believe that later it may be found necessary to employ a small cap to fit over the top of the metal envelope to shield the grid terminal. Although it is not necessary in this type of receiver it may be beneficial in the high-gain I.F. amplifiers of a superheterodyne. This small cap would only need to be about one inch long and three quarters of an inch in diameter.

The Metal "A.F." Tube

The audio frequency amplifier of the receiver uses a triode which is known as the 6C5 and replaces the 56, 27, 37, and 76 glass-type tubes. These new metal tubes have a separate pin in the base which is connected to the metal shell, and to effect shielding this pin must be connected to that part of the circuit which is *grounded*. In this receiver the shells are connected directly to the metal chassis which is *grounded* and to which all "B" negative connections are made.

Speaking of the bases of the tubes care must be taken in wiring, because

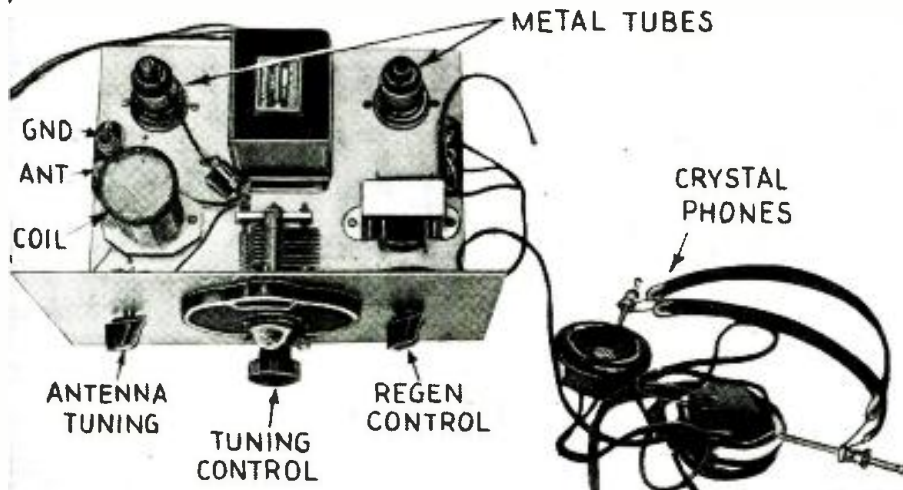

General view of the 2-tube set using the new "metal" tubes.

100 mc. (three meters) and they should be ideal for all-wave and regular short-

wave sets. The receiver shown in the photographs was selected for the new metal tubes because it is unquestionably

FIRST TIME!
This is the *first* ALL-METAL
Tube Receiver!

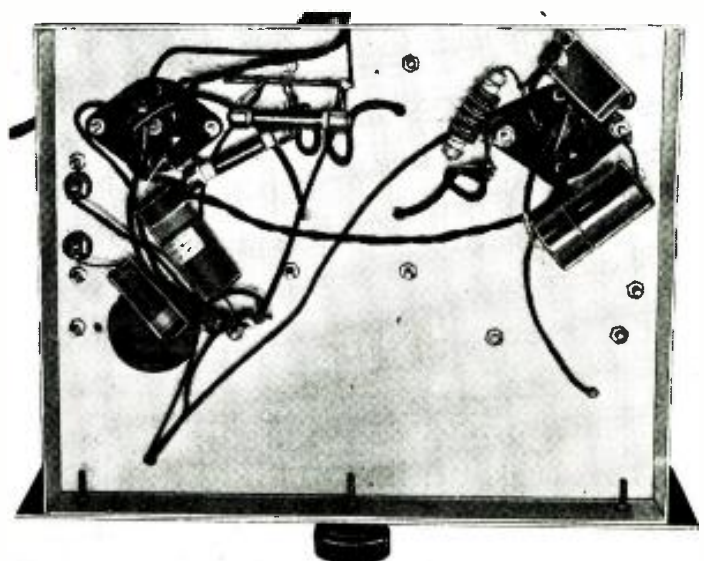
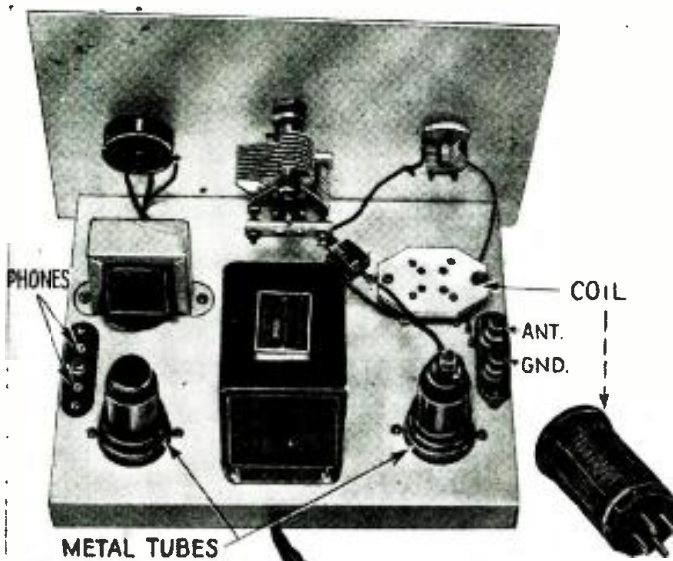

These views clearly show the layout of parts in 2-tube set employing the new "metal" tubes. Note simplified construction under the subpanel.

Sure-fire S-W Receiver



By Art Gregor

Here is a "sure-fire" 2-tube short-wave receiver using the new metal tubes. It uses a screen-grid regenerative detector known as the 6J7 and a 6C5 triode audio amplifier. Tests have proved that these new tubes are well adapted to short-wave reception and we had no difficulty in pulling in all of the foreign short-wave broadcast stations with this 2-tube receiver. A special output circuit is incorporated in this set, allowing the use of the new high-impedance crystal earphones.

inch aluminum chassis, with a 7x10 inch aluminum panel. Looking at the back of the set we have the antenna tuning condenser in front of the plug-in coil, and the 6J7 detector tube right behind the coil, all on the right-hand side. The tuning condenser is located in the center of the panel and the National impedance coupling unit is directly behind it. On the left-hand side of the panel and chassis is the regeneration control potentiometer. Behind this is the output choke for the amplifier and the 6C5 amplifier tube. The phone terminal strip is on this side of the chassis and the antenna-ground strip is on the extreme right of the chassis.

tional coupling unit, which consists of a choke, a resistor and a condenser. This impedance plate load gives slightly more audio gain and is very useful in a small set of this kind. However, the plate impedance can be replaced with a 250,000-ohm resistor with very fine
(Continued on page 311)

the sockets all have eight prongs and the tubes only have the required number; the unused pins are left out of the tube base and are left in the sockets, making it rather confusing at first when wiring up the set. The bottom of the tubes have a central aligning plug, allowing the tube to be inserted in the socket in only one position and on the plug is a key with a corresponding slot in the socket. This slot is very important because it is used as a reference point when determining the position of the different connections. The drawing shows the bottom view of the socket; don't forget this, or the whole set will be wired improperly!

Chassis and Panel Details
The receiver is built on a 7x9x1/2

Tickler Connected in Cathode Circuit

In the detector circuit we find that the tickler is connected in the cathode circuit rather than the plate circuit. This was done for convenience in wiring and also to keep the R.F. currents out of the audio circuit as much as possible. This method of connection is very useful in small sets because of the added stability obtained. The plate circuit of the detector is fed into a Na-

Parts List—Metal Tube Set

- 1—35 to 50 mmf. trimmer, National.
- 1—140-150 mmf. tuning condenser, National.
- 1—.0001 mf. mica condenser, Aerovox.
- 1—.0005 mf. mica condenser, Aerovox.
- 2—.1 mf. by-pass condensers, Sprague.
- 1—National "impedformer coupler."
- 1—.1 mf. by-pass condenser, Sprague.
- 1—2000-ohm resistor I.R.C.—1 watt.
- 1—3 meg. resistor I.R.C. 1/2 watt.
- 1—.5 meg. resistor I.R.C. 1 watt.
- 1—50,000-ohm Potentiometer, Electrad.
- 1—Output choke, or A.F. Trans. primary.
- 1—2.5 mh. R.F. choke, National.
- 2—8-prong tube sockets.
- 1—4-prong Isolantite socket, National.
- 2—Twin terminal strips.
- 1—National dial.
- 1—7x9x1 inch Aluminum chassis, Blan.
- 1—7x10 inch Aluminum panel, Blan.
- 1—Set plug-in coils. See Data.
- 1—6C5 tube (metal) RCA Radiotron.
- 1—6J7 tube (metal) RCA Radiotron.

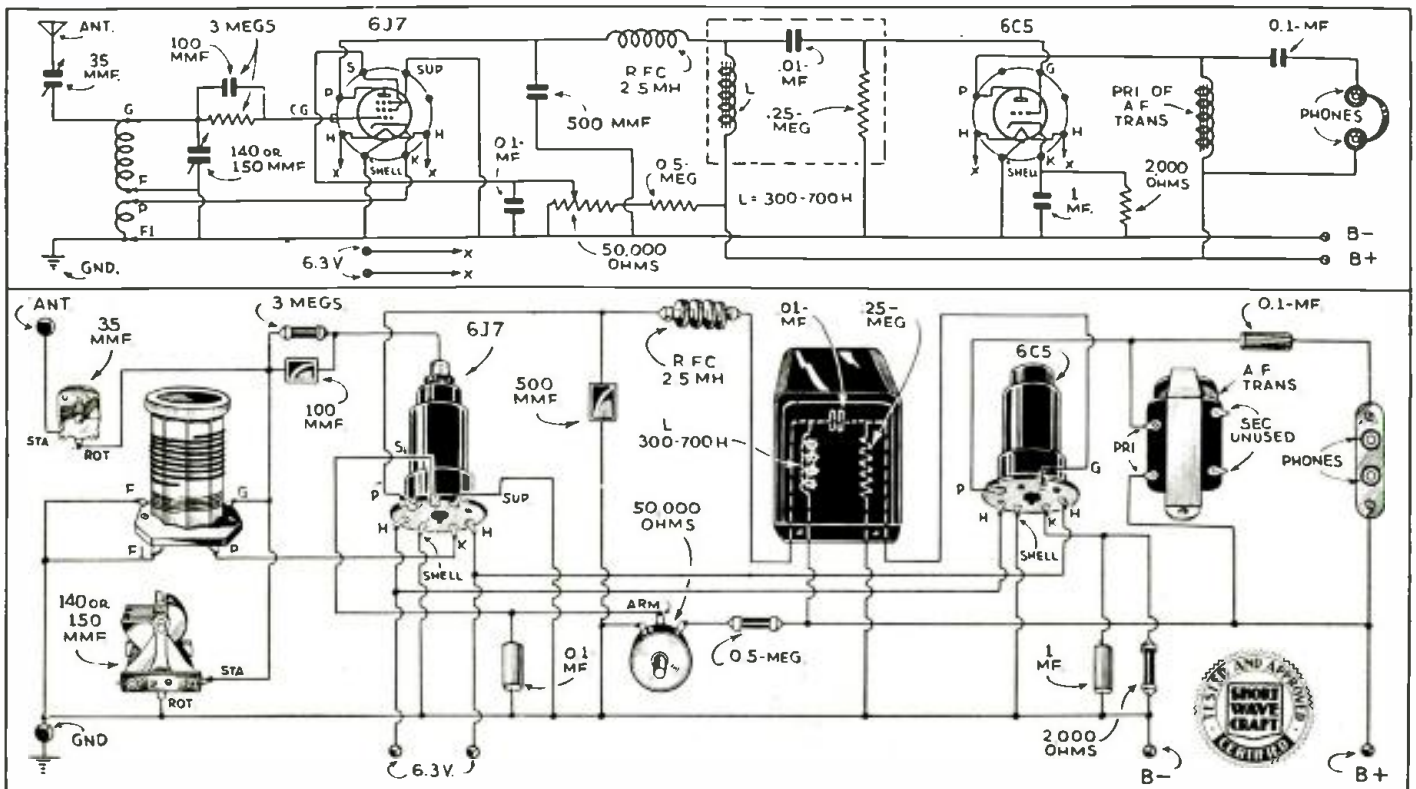

Above—Simple wiring diagrams which practically anyone can follow in building this attractive 2-tube receiver, which employs the very latest "all-metal" tubes.

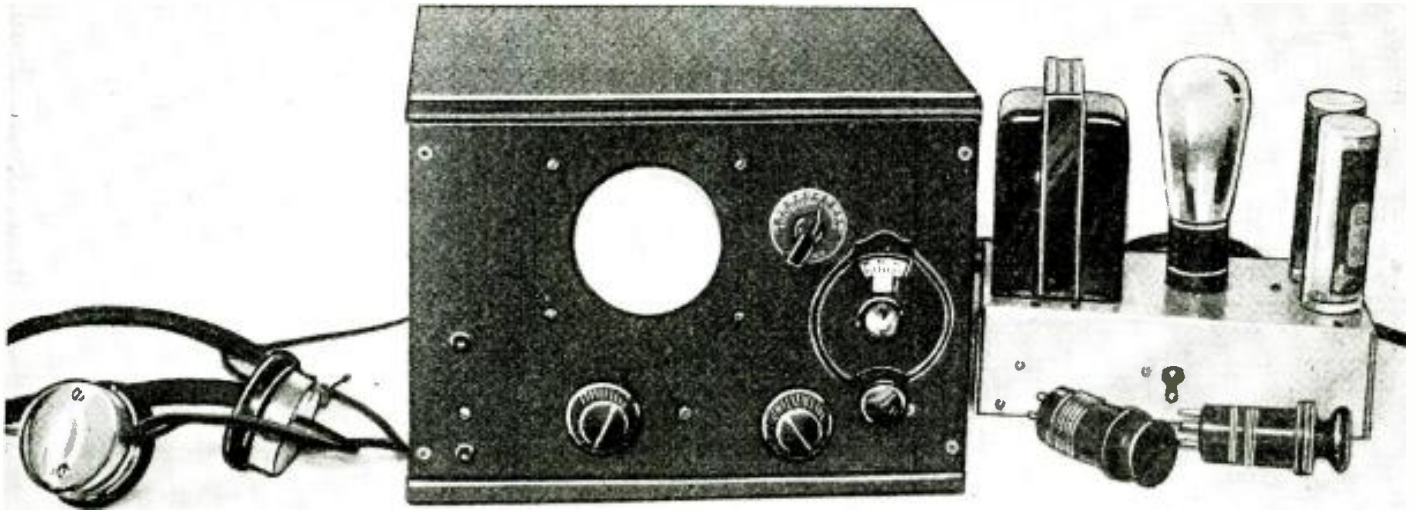

Note that the plug-in coils are replaced from the front of this set—an excellent feature. Constant band-spread is employed and it works surprisingly smooth. All the popular European S-W musical and other programs have been heard on this dandy headphone set.

Popular 3-Tube S-W Receiver Has Constant Band-Spread

By William Weeks



This S-W Receiver proved to be a very smooth-working one in actual tests. It features continuous band-spread and employs the two condenser method, which has been widely used. The highly efficient 6.3 volt tubes are used, the plate supply current being furnished by batteries or power unit.

difficulty inasmuch as the writer is located very near some powerful broadcast stations and due to the grid circuit not being tuned, these stations built up sufficient voltage across the usual R.F. choke to be heard all over the tuning range in the receiver. Experiments showed that with two chokes, one broadcast choke and one short-wave choke, most of this difficulty could be eliminated, better than with the use of the .0001 mf. variable antenna coupling con-

● THE receiver shown in the accompanying photographs was designed to incorporate some very important features which would aid in obtaining maximum stability. The first of course, was simplicity. This meant that we did not want to incorporate a tuned R.F. stage but still wanted to maintain the isolation provided by the R.F. stage and eliminate the detuning effects which the usual antenna coupling methods bring about. This meant that the R.F. stage would be untuned and capacitively coupled to the detector stage.

In order to maintain an efficient and stable detector, electron coupling was adopted, together with the use of a potentiometer to vary the screen-grid voltage for regeneration control.

Only one stage of audio amplification was used as this set was intended for headphone operation, and the one stage provided plenty of volume, in fact on most stations more volume than could be conveniently used, it was for this reason that the 500,000-ohm potentiometer was incorporated in the grid circuit of the audio stage, in order to give volume control independent of the untuned R.F. and detector stages.

In order to accommodate the power supply which was on hand, 6.3 volt tubes were used. A 6D6 screen-grid pentode is used as the untuned R.F. stage; a 6C6 is used as the electron-coupled regenerative detector and a 76 resist-

ance-coupled audio amplifier.

The R.F. stage provided the most

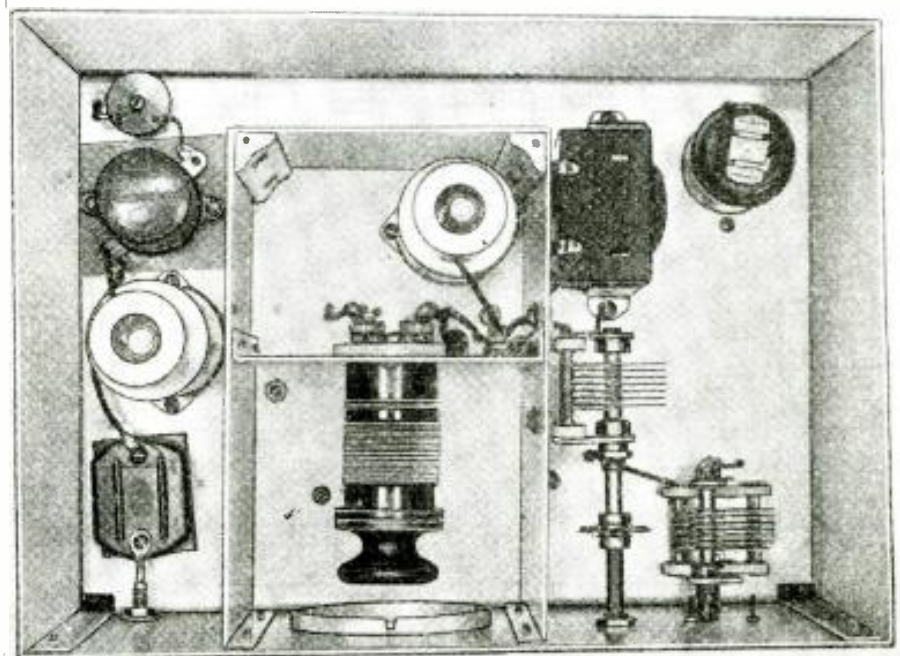

Top view of the 3-tube Constant Band-spread receiver, showing shielding and position of plug-in coil. The R.F. stage is untuned, thus simplifying the construction of this receiver.

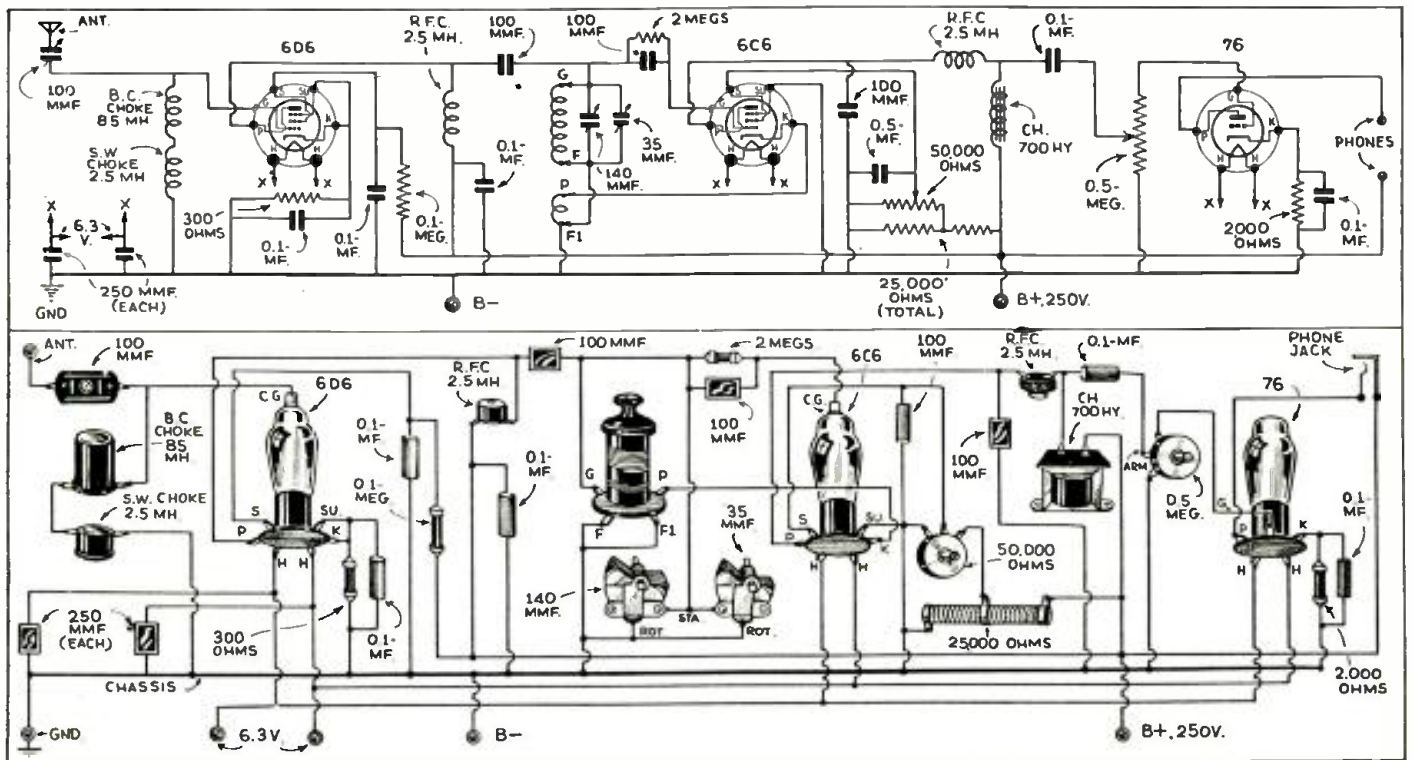

A study of the diagrams above will reveal at once that it is dead easy to build this 3-tube S-W receiver. By setting the main band condenser and then tuning for the station with the smaller parallel variable condenser, the tuning operation is rendered very smooth—and it is continuous or operative on all bands.

denser (even the strongest stations could be tuned out). The broadcast choke is an 85mh. unit and the short-wave choke has an inductance of approximately 2.5 millihenries. The plate circuit of the 6D6 is coupled through a .0001 mf. mica condenser to the grid of the 6C6 detector.

Continuous Band-spread

The B+ is shunted to the plate of the 6D6 through a 2.5 m.h. R.F. choke. The .1 mf. by-pass condenser on the B+ side of this choke aided considerably in obtaining stable operation of the R.F. stage. If overloading of the detector is encountered, we suggest that a 20,000-ohm potentiometer be connected in series with the cathode of the 6D6. This will serve as an R.F. volume control. Another feature which was designed in this receiver was *continuous band-spread*. This was accomplished by connecting a 35 mmf. condenser in parallel with the 140 mmf. tuning condenser.

The main tuning dial controls the 35 mmf. condenser and the 140 mmf. condenser is used for band-spreading and is just to the left of the dial and is equipped with a small metal scale and a pointer so that stations can be logged easily.

Regular two-winding Alden coils can be used in the detector circuit, providing a tickler connection is made correctly. The lead of the tickler which is nearest to the grid coil is connected to the cathode, while the other side of the tickler coil goes directly to the B- or ground side of the circuit.

In order to get the most out of the screen-grid detector, a 700 henry A.F. choke was used in the plate circuit. This gives a considerable gain over the usual 250,000-ohm resistor. The entire detector circuit is enclosed in a shielded compartment, which can be easily seen from the photograph showing the inside view of the receiver.

For convenience, the plug-in coil sys-

tem is arranged so that it can be inserted by removing an aluminum cap which fits securely into the opening. A 25,000-ohm voltage divider is incorporated in the receiver and tapped at a point which gives 30 volts. Across this 30-volt section is shunted the 50,000-ohm potentiometer, which is by-passed with a .5 mf. condenser.

Very smooth regeneration control is obtained with a minimum of detuning. In order to eliminate any tunable hums, two .00025 mf. mica condensers were used to by-pass the heater circuit. The dimensions of the metal cabinet in which this receiver is mounted are 8 x 8 x 11 inches.

Power Supply

The power supply, for the benefit of those who do not already have one, is designed to deliver 250 volts for the plates of the tubes and 6.3 volts for the heaters of the tubes. The filter of the power supply consists of two 30-henry, 75 ma. chokes and three 8 mf. electrolytic condensers; it is conventional in every respect.

Glancing at the photograph which shows the inside view of the receiver, we note that there is ample room for the parts and no unnecessary crowding. The untuned R.F. stage, that is the 6D6 and the two R.F. choke coils which are connected in the grid circuit of the 6D6, are located on the left-hand side of the chassis. (With the front of the set facing it).

Directly in the center of the chassis is mounted the small aluminum shield compartment in which is housed the plug-in coil and its socket together with the 6C6 detector tube. The A.F. choke, which forms the plate load for the detector tube and the 76 resistance coupled audio amplifier, are both mounted on the right-hand side of the small shield compartment.

The base, which supports these parts, is made to fit securely into the metal cabinet and is fastened in the sides with small self-threading screws. All wiring other than that associated with the detector tube is done below the chassis. Either an aluminum or steel chassis can be used; however, aluminum is easier to work with. As the cabinet is constructed with heavy sheet steel, it is necessary that you have a circle-cutter (fly-cutter) in order to cut the large hole for the plug-in coil to pass through. The entire cabinet is finished in black crackle enamel and can be procured from almost any radio mail-order house.

This receiver during tests pulled in all of the *foreign* broadcast stations with full earphone volume.

Parts List

- 1—140 mmf. tuning condenser, Hammarlund
 - 1—35 mmf. tuning condenser, Hammarlund
 - 1—.0001 mf. antenna trimmer, Hammarlund
 - 3—.0001 mf. mica condensers, Aerovox
 - 3—.1 mf. by-pass condensers, Sprague
 - 1—.5 mf. by-pass condenser, Aerovox
 - 2—2.1 mh. R.F. chokes, Hammarlund
 - 1—85 mh. broadcast choke, Hammarlund
 - 1—700-henry plate impedance, Kenyon
 - 1—300-ohm 1/2-watt resistor, I.R.C.
 - 1—100,000-ohm 1/2-watt resistor, I.R.C.
 - 1—2 meg. 1/2-watt resistor, I.R.C.
 - 1—50,000-ohm potentiometer, Electrad
 - 1—25,000-ohm voltage divider, with sliders, Electrad
 - 1—500,000-ohm potentiometer, Electrad
 - 1—2000-ohm 1-watt resistor, I.R.C.
 - 2—.00025 mf. mica condensers, Aerovox
 - 2—6-prong wafer sockets, Na-Ald.
 - 1—5-prong wafer socket, Na-Ald.
 - 1—Set of plug-in coils, 15 to 200 meters; Hammarlund
 - 1—Crackle-finished cabinet, Federated Purchaser
 - 1—3-inch vernier dial
 - 1—6D6 RCA Radiotron
 - 1—6C6 RCA Radiotron
 - 1—76 RCA Radiotron
 - 2—Tube shields
- Coil Data—See page 311.

SHORT WAVES and

Charles Pecci Has Dandy Ham Station

Prize of one year's subscription to Short Wave Craft awarded



Prize winning amateur station W8NKV

Editor, Short Wave Craft:

My transmitter is a M.O.P.A. and uses a type 10-crystal oscillator followed by a type 10 buffer, with two additional type 50 tubes used as buffers, driving a pair of 10's in push-pull.

The modulator system consists of two

(We take pleasure in awarding one year's subscription to Short Wave Craft to Mr. Charles A. Pecci, owner and operator of W8NKV. That's a fine station you have, Charles, and we wish you all the luck in the world in your amateur activities.—Editor)

type 27 speech amplifiers and a 46 modulator. There are four power-supplies in this transmitter, one for the oscillator, one for the phone end, and one for the final R.F. amplifier stage and bias. Approximately 1,000 volts at 200 mils (M.A.) is the input to the final stage. However, the full input is very seldom used, and in most cases 135 watts input is not exceeded.

The transmitter is operated on 7,200 kc. and I use a separate antenna. The receiver is a National SW3 and is shown on the table. There is also a push-pull amplifier using 45 tubes available for speaker operation.

The panel of the transmitter is constructed of Masonite, which is very neat in appearance and can be obtained at a very nominal cost. The panel is given two coats of varnish to further enhance its appearance. — Chas. A. Pecci, W8NKV (Trustee for W8-NOX), Pittsburgh. Radio Club, 1527 Monterey St., N.S., Pittsburgh, Pa.

some of the W's. They appear to be a great gang. Wish we were able to carry out communication on same line, as they do.

Now, about this "No-code Test on 5-meter" biz: Believe there was some move afoot in England some years ago to do away with the code test altogether, but it suffered much the same fate as that which the Federal Radio Commission sees fit to give the movement in the U.S. Of course there is something to say for the no-code test, in some cases. Those are the cases where the popular transceivers are to be used on construction work, on bridges, railways, or such like where communication over short distances is needed. I do, however, absolutely bar the issuing of licenses to people who are out to play "telephones" with neighbors, etc., and block up the ether (if that's possible!). There are few places where a block doesn't exist. The 5-meter band is in much the same condition as the waves under 100 meters were ten years ago. There was plenty of room then, and plenty of room for everybody to get on the air, but look at it now. Even with stiff "regs." it's still a "helluva mess," so think what it would be like if licenses were issued to every budding announcer. Another thing, if these guys are so darn clever, let'm sit down and learn Morse; it's the easiest thing out, once you've passed the five-word-a-minute stage, and I guess everyone'll agree with me that that isn't so very difficult to attain with a little study. A half hour every evening and you'll have it in 30 days!

I wish some of these "no-coders" could see the fellows who come to the R.N.W.A.R. training centers twice a week. Young chaps of 20 and not-so-young 40's and 50's learn Morse right from the "know-nothing" stage, to a good twelve within a couple of months. Besides, what happens when the modulator suddenly breaks down? How are they going to answer the other man when he calls on C.W., and what'll they say when conditions are bad, as they are right at this minute, when the other man says, "Going over to C.W. O.M.?" Be great to say, "Sorry O.M. Don't know Morse, it's out of date, etc., etc.!!!"

Sure, Morse is out of date, as far as teleprinters are concerned. As a matter of fact it has entirely disappeared from the London Central Telegraph Office. But what about 600 meters? If you want to hear a nice drop of interference, just come over here on a foggy day (they're not common here, by the way), and listen to the traffic (!) on the North Sea. A fat lot would get through if it was all phone. No, phone is quite O.K. while the air's clear and conditions are dandy, but let everyone come on, and X's get bad, and then see how much of that QSO you'll get.

And just as a parting shot. What about these continual breakdowns of communications in the States. Amateurs have done

We're the "Tops" He Thinks!

Editor, Short Wave Craft:

After reading the letter from another English reader in the May "S.W.C." I thought it would be a great idea to let you have another letter from just one more Englishman.

First let me shoot off some of those praises for the "mag" that I've been holding back for some time. It's a real magazine, and by that I mean plenty. The English radio papers get on my nerves. If they describe the simplest of sets they sit up and yell about it for weeks. You know—"Greatest set of the century, etc., etc.," "Revolutionary Radio"—blah, blah, blah. I don't doubt they're not all right sometimes, but it does get a bit heart-sickening. Think you could compare it to American radio ads. There is only one paper really worth buying, you may know it, *Wireless World*, a pioneer of radio papers. Still, there's no paper that deals with transmission. There is an article about once every blue moon, but that sure doesn't satisfy me. Along with a contemporary paper of yours, namely *Radio News*, which does not altogether cover the same ground as you do, and the A.R.R.L. "Q.S.T." I manage to satisfy my craving, if you can call it such for articles on transmission.

The most interesting part of your paper I think is *Reader's Forum*. On that account you may be interested to hear a few details of my, at the moment, modest rig. Crystal-

controlled on 3740 kc. with PT4, directly heated pentode, as C.O., and W.F.4211E as P.A. C.O. is fed from separate power-pack, giving 350 volts, while P.A. gets 750 volts at 60 m/as from U14 rect. Bias on C.O. is auto, and battery on P.A. Input is around 40 watts, and aerial is 64 feet long, end-fed Hertz. No ground used. No amateur license is held, and station is principally for *Royal Naval Wireless Auxiliary Reserve* work. Have had R9 plus reports from extreme north of Scotland, and average of six or seven from Malta. I have hopes of taking out an amateur license and adding modulator for phone work, but at the moment the only thing acting as the proverbial "fly in the ointment" is the dough! The receiver, by the way is a simple O.V-1. Battery fed. On 20 and 40 bands brings in the stations like nobody's business. I'm not at all interested in DX-ing, and sitting up nights trying to locate ZXF or XZY holds not the slightest fascination for me. Like to carry out long-distance QSO's, though.

My interest in radio is not altogether amateurish. I hold both First and Second P.M.G. certificates, or as you know them—*Commercial Tickets*. At the moment am anxiously awaiting a seagoing job. Been waiting for four months, and getting rather tiresome, but I guess it'll come along. Hope I'll manage some day to visit the States (U.S.A.), because then I'll be able to visit

One Year's Subscription to SHORT WAVE CRAFT FREE

for the "Best" Station Photo

Closing date for each contest—60 days preceding date of issue: Aug. 1 for October issue, etc. The editors will act as Judges and their opinions will be final. In the event of a tie a subscription will be given to each contestant so tying.

a lot of yeomen work there in that respect. You'd get a lot of traffic through on a phone, wouldn't you? But I'll bet you'd get a darn sight more through by punching a key!

I know these phone hounds have the excuse that Morse is no good where experimental work on phone only is to be done, but they could leave quite a lot of air unpolluted if they did preliminary contacting on C.W., and went over to phone for the actual test only.

(Continued on page 313)

LONG RAVES • • • OUR READERS' FORUM

OUR 1-TUBE POCKET-SET WORKS WONDERS

Editor, Short Wave Craft:

Three years ago I read Mr. Hugo Gernsback's book "Radio for All" and a friend here in town who has built 85 radios (mostly B.C. sets) gave me a trunkful of old parts. With this help, my first set, a Reinartz, was built and is still in operation but is not as crude. It is a 3-tube "loud-speaker" set, which has picked up at least 250 B.C. stations and many amateurs.

I have read *Short Wave Craft* since January 1934 and am a member of the *Short Wave League*.

Last winter I built the "1-Tube Pocket Set" described in the December, 1934, issue, in a cigar box with an added audio stage. On a 125-foot aerial W8XK and W8XAL and VE9GW gave loud-speaker volume. At least 22 stations on 49 meters were logged "clear," from South America to U.S.S.R.

On Feb. 12 I took this set to a near-by hill and tried it. Code came in on no aerial at all and with a piece of wire 55 feet long wrapped around trees I picked up GSA, DJC,, and last but not least, YV2-RC as well as many locals. Code was loud enough to give me a headache! The set never has been bothered with man-made interference and static is very faint. This is the best reception anyone in this town has ever had. The actual set cost less than the batteries and is very economical.

I am now building a switch-coil set and if it is half as good as this pocket set, I'll be satisfied.

So-o-o-o here's to Mr. Gernsback and *Short Wave Craft* magazine for the best magazine in radio and the best circuits!

DONALD R. YOCOM,
P. O. Box 25,
Sugar Grove, Ohio.

(We agree with you, Donald, that the 1-tube Pocket Set is a "Wow." We have had hundreds of letters similar to yours, telling of the wonderful results obtained from this little set. We are glad you like the 1-tube Pocket Set and find *Short Wave Craft* magazine to meet with your approval. Thanks very much.—Editor)

His Station Built from Our Plans

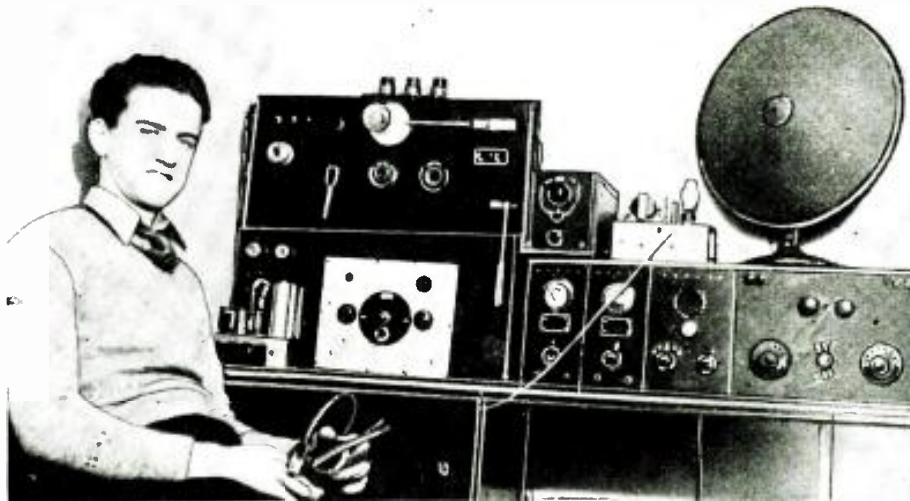

Mr. Jack E. Lacey at his favorite pastime.

Editor, Short Wave Craft:

I am sending you a picture of my "rig" which I have constructed, entirely from various articles appearing in *Short Wave Craft*. On the left is the power-pack, followed by a receiver, with which I have had excellent results, the "Triplex 2" by Mr. Shuart. Next comes a "general utility panel," housing testing apparatus and the antenna tuner on the right end. On top of the panel is the 1-tube Oscillodyne, which has given wonderful reception, combined with the one stage of audio amplification pictured beside it.

The antenna is 40 feet high and 78 feet long, with 39 feet on each side of a transposed lead-in. It runs from east to west. Since using a tuned antenna, my reception has improved measurably.

I have received the following stations

and have "veris" from the majority of them: DJA, 2RO, VK2ME, VK3ME, OXY, TI4NRH, CT1AA, GSG, GSD, GSC, GSB, GSA, EAQ, COG, HCJB, LSN, PSK, IRM, FZR, HAT, and numerous North American stations.

JACK E. LACEY,
42 Windsor St.,
Kearny, N.J.

(Quite a list of DX stations you have received, Jack, and a very nice layout of apparatus shown in your photo. The Triplex 2 and Oscillodyne receivers were very popular with our readers and your letter adds to the grand total of hams who have already written us, regarding the excellent results they have obtained with these receivers. Thanks very much and we hope to hear from you again.—Editor.)

A Snappy Amateur Station

Editor, Short Wave Craft:

Herewith a photo of my amateur station for your magazine. The transmitter is a rack-and-panel type, and uses a 59 tri-tet,

a 46 buffer and a pair of 510 tubes in push-pull for the final amplifier, with about 63 watts input. I am using the Collins system of antenna coupling. I use a separate

power supply for the oscillator and buffer and another for the final, also have a spare one to use for a class "B" modulator when I get it done.

On the table is a receiver using a 58 untuned R.F. a 58 Det and a 56 Audio; next in line is a homemade bug and a couple of straight keys. Then a monitor using a 30 tube and on top of that is an absorption type wavemeter using a Neon tube for a resonance indicator.

I have a portable 5-meter receiver and transmitter.

My transmitter is mostly on 3530 and 3582 kcs. I use a zepp ant. for transmitting.

I formerly operated W9JZZ at Valparaiso, Ind., while going to Dodges Radio School there. I have also held W8ZZCH portable license.

I am the holder of a commercial second-class license endorsed for radio-telephone first. Also my amateur license is a Class A.

I am now an operator at WIBX, but formerly was a "brass-pounder" on the S.S. Clemens A. Reiss (WADE) on the Great Lakes.

Oh yes, I am also a U.S.N.R. station.

LAWRENCE W. BRIGGS,
503 Plant St.,
Utica, N.Y.

(Mr. Lawrence W. Briggs (W8HWR), deserves a great deal of credit for his excellent workmanship in designing that businesslike-appearing rack and panel transmitter. "Congrats" OM!—Editor)

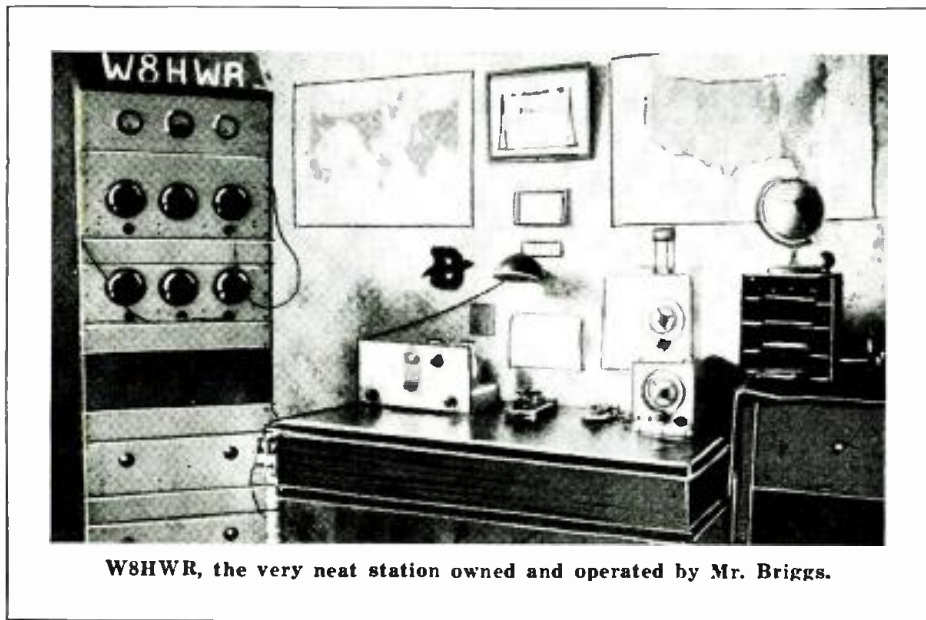

W8HWR, the very neat station owned and operated by Mr. Briggs.

WORLD-WIDE SHORT-

Novel S-W Receivers

● EVERY year at about this time, *Wireless World* magazine, cooperating with several amateur radio clubs in England has what they call their Field Day, in which numerous S.W. transmitter "hunts" and other activities take place.

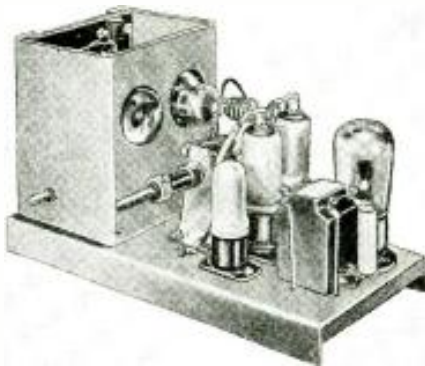

The 5-meter Superhet.

In a description of the coming events for this year, a recent issue of the above magazine printed several interesting short-wave receiver circuits.

The first of these is a 2-tube short-wave super-regenerative set designed for the 5-meter band. In this circuit, condenser C1 is a 50 mmf. variable; C2 has a maximum capacity of 35 mmf.; C3 is a 100 mmf. fixed condenser; C4 is .01 mf.; C5 .001 mf.; R1 is 2 megohms; R2 is 50,000 ohms, variable.

The coils, L1 and L2 each contain three turns of No. 14 wire at 3/4-in. diameter and coil L has one turn at the same diameter.

The second circuit is a loop-operated ultra-short wave receiver (also a super-regenerator) but having a separate interruption-frequency tube instead of a single tube for detector and "quenching."

In this set, C1 is 30 mmf. for each section; C2 is 15 mmf.; C3 is 100 mmf.; C4 and C5 are .006 mf. units; C6 is .005 mf.; C7 is .01 mf.; R1 is 1 meg.; R2 is 30,000 ohms; R3 is 50,000 ohms; R4 is 5,000 ohms; R5 is a 50,000-ohm variable resistor; R6 is 50,000 ohms; R7 is 1,000 ohms variable and R8 is 500 ohms.

The third receiver is a superhet circuit designed for operation on the 5-meter band. It comprises a first detector, oscillator, 2 I.F. stages, a second detector and an output stage. The I.F. amplifier is tuned to 4,000 kc. and the I.F. transformers are

● The Editors have endeavored to review the more important foreign magazines covering short-wave developments, for the benefit of the thousands of readers of this magazine who do not have the opportunity of seeing these magazines first-hand. The circuits shown are for the most part self-explanatory to the radio student, and wherever possible the constants or values of various condensers, coils, etc., are given. Please do not write to us asking for further data, picture-diagrams or lists of parts for these foreign circuits, as we do not have any further specific information other than that given. If the reader will remember that wherever a tuned circuit is shown, for instance, he may use any short-wave coil and the appropriate corresponding tuning condenser, data for which are given dozens of times in each issue of this magazine, he will have no difficulty in reconstructing these foreign circuits to try them out.



Short-Wave Wavemeter.

Unlike most of the calibrated oscillators and wavemeters used in this country, this unit employs a small buzzer to generate the high frequency signal.

As shown in the photo, the complete wavemeter is enclosed in a small die-cast aluminum case with the condenser dial on top and a coil socket on the side. The instrument is calibrated by bands—a set of curves is supplied to correspond to each

wound with a primary of 25 turns and a secondary of 50 turns of 32 D.S.C. wire on a slotted form 3/4-inch in diameter. The windings are in slots 1/64-in. wide, one slot for the primary and two for the secondary. The details for the aerial and oscillator coils are not given, but can be worked out from other 5-meter superhet circuits.

These three circuits are interesting as a comparison to the 5-meter equipment used in the U.S. and described in many past issues of *Short Wave Craft*.

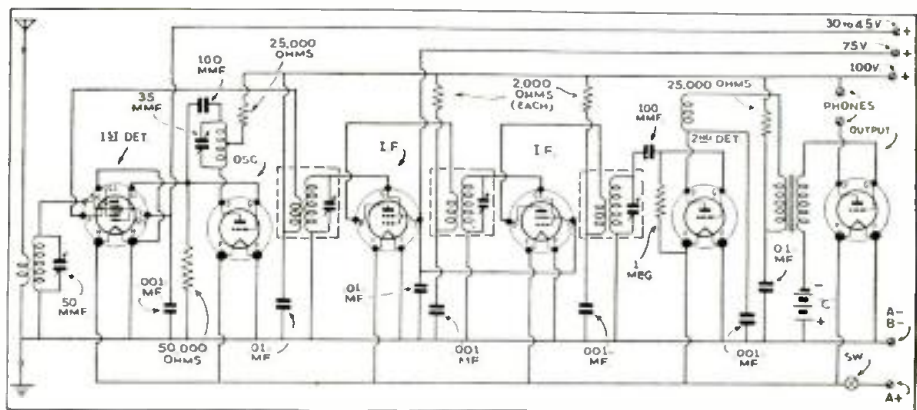

Hook-up of 5-meter Superhet.

A S-W Wavemeter

● ACCORDING to a recent issue of *Wireless World Magazine*, a new wavemeter has just been introduced to aid short-wave fans to tune and calibrate their receivers, and also for use in tuning and adjusting amateur transmitters.

coil. The coils cover 10 to 29.6, 29 to 88.6 and 80 to 225 meters.

The use of the high frequency buzzer gives a sharply tuned note. The signal is not strong though it is adequate for use with most short-wave receivers. However, it can easily be used as an absorption

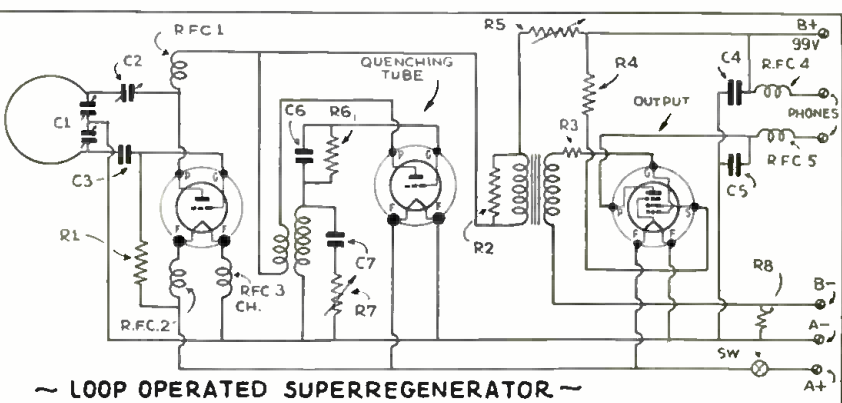
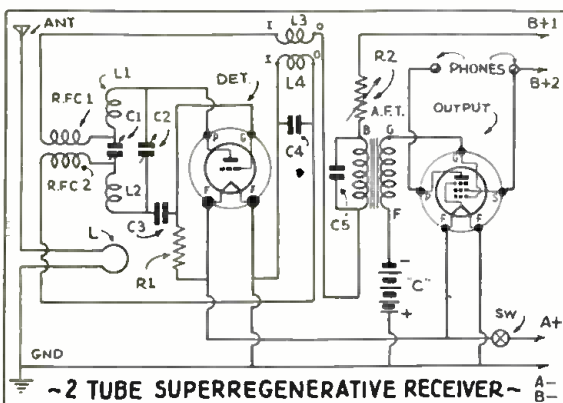

Hook-ups for 2-tube Super-regenerative receiver; also for loop-operated set.

WAVE REVIEW.

Edited by
C. W. PALMER

type wavemeter if the signals are not strong enough to break through strong QRM in the receiver. For transmitter adjustment, of course, a visual indicator is needed to tell when the frequency of the meter corresponds to that of the transmitter. A small flashlight bulb serves this purpose—a socket is provided for it in the unit.

A Sensitive Short-Wave Converter

● ANOTHER magazine which we have not quoted from for some time is *Radio Revista*, the Latin-American magazine published in Buenos Aires, S.A.

It is a well-known fact that in parts of South America, reception is impossible on any but the shortwaves during certain seasons of the year. For that reason, short-wave receivers and converters have made quite a hit there.

An ambitious designer writing in a recent issue of the above-mentioned publication described a very unusual short-wave converter. The usual type of converter consists of a frequency converter and if it is fortunate it contains an I.F. coil to increase the selectivity somewhat.

The converter in question, though, contains not one, but two stages of tuned R.F. before the converter tube. This is commendable practice, for it eliminates the annoying image frequencies as well as supplying sufficient selectivity to separate stations in the crowded amateur and broadcast bands.

The alignment of such a converter, however, is not easy, especially if a wide range is to be covered by plug-in coils or switching.

The circuit of the converter and a photo of the chassis, looking down on the top of the tubes are shown here. Unfortunately, the coil details were not included, as commercial coils were utilized. The values of the other parts, though, are given on the circuit diagrams.

An Unusual Short-Wave Converter

● A RECENT issue of *Wireless World* contained the constructional details for making a rather unique converter for use in connection with a broadcast receiver.

We pointed out several months ago on this page that pentagrid converter tubes (*heptodes* as they are called in England) will not oscillate on frequencies above a certain critical point, and for other reasons their operation on the high frequency end of the spectrum is not at all reliable.

Several methods have been devised to overcome this defect, including the use of a separate triode for the oscillator section of the frequency converter. A recent issue of *Wireless World* contained another scheme which retains the advantages of electron-coupling between the oscillator and first detector, yet permits operation on higher frequencies.

This consists of the use of two *heptodes* connected in push-pull as shown in the accompanying circuit. Both the input and oscillator circuits are connected in this

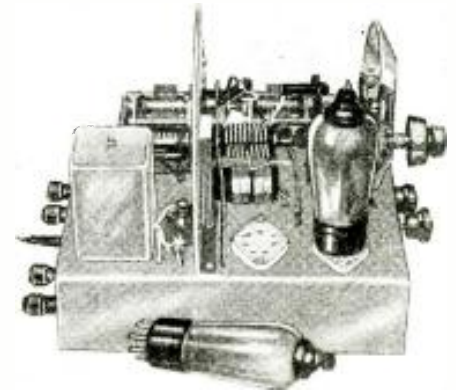

Another S-W converter is shown above, with hook-up below.

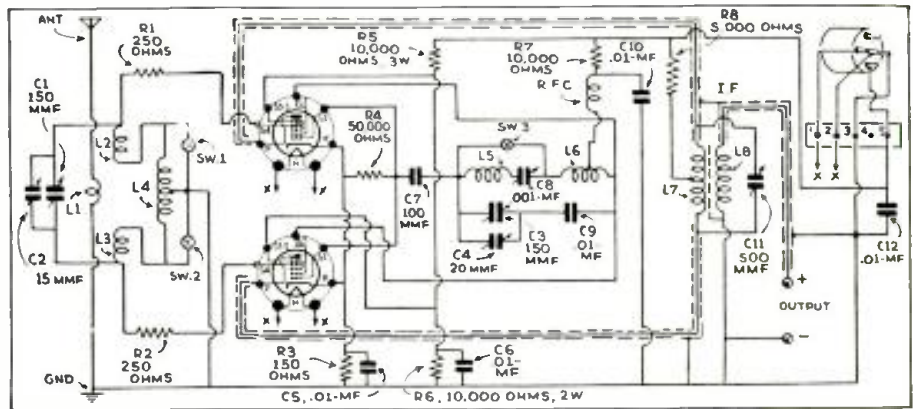

manner, which makes the circuit a fine one for the advanced experimenter to try, either as a superheterodyne input or a converter arrangement. The values of the condensers and resistors are shown on the

circuit, though they will have to be varied to suit American tubes and parts. Coil details will have to be worked out by the individual.

A photo of the converter is also shown.

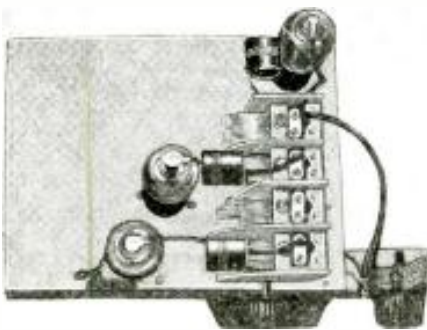

Above: Appearance of S-W converter; below: connections of converter.

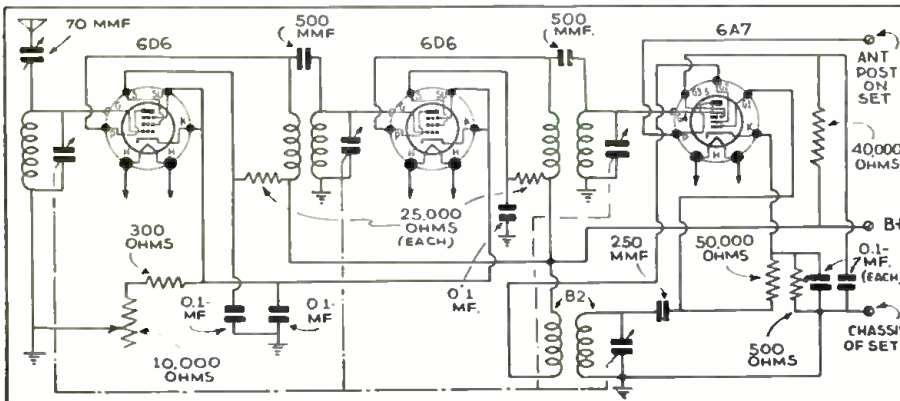

An Australian Tuner Unit

● TO facilitate the construction of short-wave receivers, an Australian company has just introduced a new tuner unit which is adjusted at the factory for alignment over two short-wave bands and the broadcast band.

This eliminates the difficult job of alignment which is the stumbling block for most amateur constructors of short-wave superheterodyne sets.

The coil kit is in the form of a small chassis and includes an aerial coil, an intermediate coil and an oscillator coil for each band, with a band-switch wired ready for connection to an I.F. amplifier, second detector and A.F. amplifier.



An Australian short-wave tuner unit; below—as built in set.

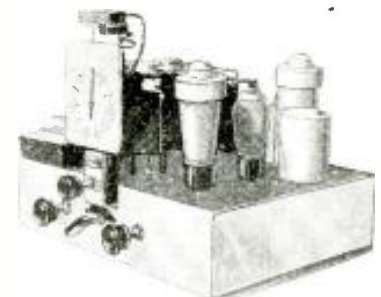

Pretuned I.F. coils are also made with alignment adjusted to the optimum value for the tuner unit. From a recent copy of *Radio Review of Australia*.

WHAT'S NEW In Short-Wave Apparatus

The short-wave apparatus here shown has been carefully selected for description by the editors after a rigid investigation of its merits

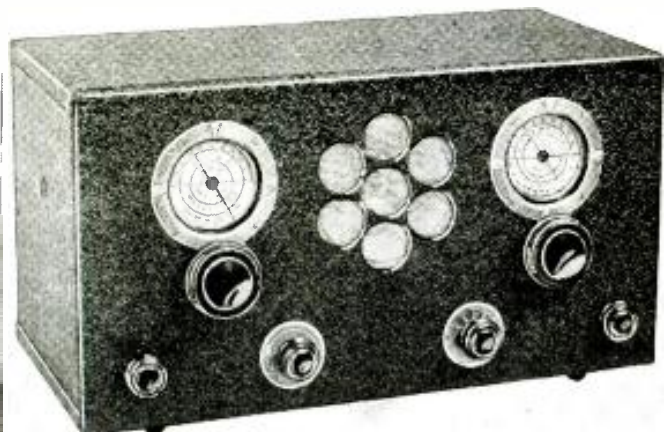

Note the neat appearance of the Sargent Model 10 receiver, which is available in two different hands; 15 to 550 meters, and 15 to 1,500 meters. No. 300.

New Sargent Model 10 Receiver

This set is useful for the fan as well as the ham, and comprises a sharply tuned R.F. stage, a Regenerative Detector, and two stages of Audio.

Coil Changing Switch and Antenna Trimmer. Phone Jack is on the side of the receiver.

The band-spreader is a new development, and is adjustable so as to give wide spread on amateur bands. The band-spreader is a mechanical one, having three adjustments for varying degrees of spread. The dial is calibrated in M.C. (megacycles) for the 20-, 40-, and 75-meter phone bands. The wide bands, 80 and 160 meters, are split in half, and either half may be covered with the band-spreader. Calibration of the band-spread dial makes extremely accurate frequency readings possible in the narrow amateur bands, within considerably less than 10 kc. Although the Sargent Model 10 Receiver is regularly listed in three tuning ranges, it can be supplied for practically any tuning range upon special order. The circuit lends itself ideally to extension to the higher wavelengths, and a tuning range from 15 to 15,000 meters could be supplied in this receiver without interaction between coils, or without any loss whatever at the high frequency end of the range.

THE receiver shown in the accompanying diagram and photo is one of the well-known Sargent line—the Model 10—and employs four tubes besides the rectifier. This receiver has more than fifteen outstanding features, and among them we find the following: The set covers the broadcast band (it is supplied in two different ranges; the first 15 to 550 meters, and the second optional range 15 to 1500 meters); tuning dial calibrated in megacycles; calibrated adjustable band-spreader; coil switch for making changes in the bands—no plug-in coils; built-in power supply; headphone jack; designed for use of doublet or regular antenna; set available for any operating voltage, making it ideal for shipboard or yacht installations; it also makes a very good amateur "stand-by" receiver.

The Model 10 is not a superheterodyne. The circuit employs a 6D6 stage of sharply tuned R.F. amplification with trimmer, a 6C6 regenerative detector with screen regeneration control, a 75 audio driver and a 42 audio output tube. An 80 rectifier is used, making a total of 5 tubes. Power output with good tone is obtainable up to the limit of the audio tube.

The receiver is ruggedly built, with high safety factor on all parts, so as to stand up indefinitely under the continuous service demands of communication work.

All circuits to the R.F. amplifier stage and the detector are carefully isolated and by-passed with individual condensers so as to keep selectivity at a maximum, eliminate hum, and keep noise level low. Tuning is done with the single dial at the right. The left-hand dial is the band-spreader which can be used either as a band-spreader or as a vernier. Along the bottom, left to right, controls are Regeneration, R.F. Gain Control (Volume),

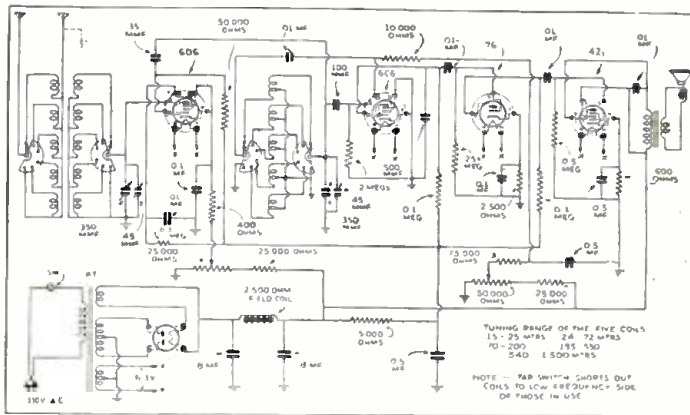

Wiring diagram of the Sargent Model 10 receiver.

Interference Analyzer Makes it Easy to Locate Radio Noise

THE Interference Analyzer just introduced by the Sprague Products Company, fills a long-felt need of radio servicemen, public utility trouble-shooters, electricians, and laboratory experimenters. Not only does it make possible the prompt location and elimination of all types of radio interference, but it affords an easy and inexpensive means of demonstrating to radio set owners just where and how annoying interference originates.

The analyzer is a compact, professional-type instrument, 4½" wide, 7" high and 3" deep, contained in a sturdy bakelite case. With it you can tell exactly what condensers or chokes are needed to eliminate noise from small appliance motors, oil burners, electric motors, beer parlor equipment, flashing traffic lights, dentists' and physicians' appliances and a host of others. By connecting the analyzer into the circuit, the serviceman can show his customer how interference may be eliminated by use of the proper filtering equipment.

It is only necessary to connect the analyzer into the circuit of the electrical appliance suspected of causing interference. Then with the customer's radio (or the



New Interference Analyzer which will make many friends among radio men—it enables the radio service man to ascertain what type of interference eliminator is required in any specific case. No. 301.

serviceman's own portable set) turned on, different filter banks are automatically connected into the circuit by means of the analyzer switching device, until the one is found that eliminates the noise most effectively. By noting the position of the analyzer switch, the serviceman can refer to his instruction card and learn the part numbers of the condensers or chokes needed to get exactly the same filter combination. Upon installing these parts, he is then assured of getting the same results obtained when using the analyzer. There is no guesswork—no necessity of buying more parts than will actually be used.

The Analyzer will also prove helpful to those who install appliances, oil burners, and other electrical equipment. By testing with the analyzer when installations are made they can also install the necessary filter material then and there and be sure they are right.

A Massachusetts serviceman who obtained one of the first analyzers to leave the Sprague factory used it to land the job of filtering a large number of traffic lights in his city.

Names and addresses of manufacturers of sets described on this and following pages furnished upon receipt of stamped envelope: mention No. of article.

New S-W AIRCRAFT SETS



Appearance of the new Aircraft transmitter. No. 302

duction of the most complete and advanced assortment of aircraft radio apparatus. Each unit is a product of that specialized type of engineering which modern aviation's special requirements make necessary. Outstanding among the new instruments is an extremely compact, light-weight and low-cost receiver which should prove especially attractive to sportsman pilots. It is available in a choice of two wave-band reception combinations, either to receive the beacon and entertainment bands or the beacon and communications bands. Each is a highly efficient superheterodyne receiver, equipped with four multi-function tubes giving the equivalent of six-tube performance, with a resultant lower primary power drain. The receiver case, with built-in "B" and "C" power supply unit measures only 8 3/4" by 6 3/4" by 9 1/2", and weighs but 16-lbs, 10 oz. It is remotely controlled by mechanical cable from a unit which fits



Latest type Aircraft short-wave receiver.

● SPACIOUS hangar accommodations, radio installation and servicing facilities, office and resting spaces, as well as a working demonstration of all the newest types of aviation radio apparatus are placed at the disposal of itinerant pilots by the RCA Manufacturing Company, at its newly established aviation radio headquarters, located at Camden's Central Airport. The company has also announced the intro-

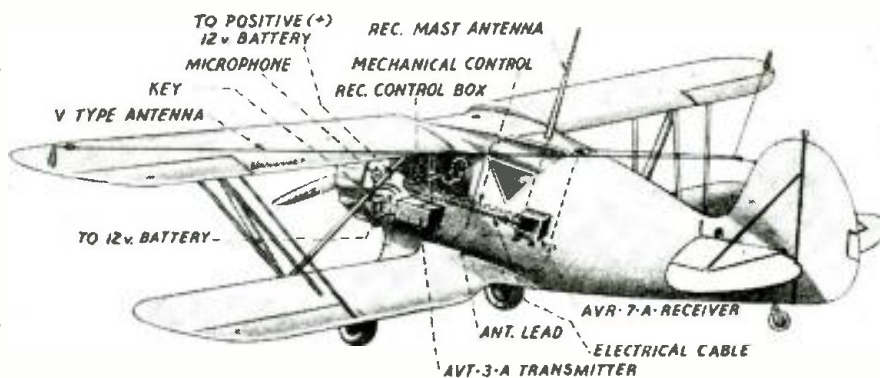

This diagram shows the complete installation of a transmitter and receiver aboard the airplane. Tuning Range 46-149 meters

easily into the small, unused spaces on the instrument panel. It requires only standard aircraft dry cells or storage batteries for its low, economical current drain. Ease of operation, ruggedness of construction and simplicity of installation are some of the many features to recommend the new receiver.

Then there is a new aircraft transmitter of 20 watts power output and (Continued on page 296)

A 5-Meter Superheterodyne Kit

By Frank Lester, W2AMJ*

● A SUPERHETERODYNE for five-meter operation can be made almost as simple as a straight super-regenerator, and will give definitely superior results insofar as sensitivity, selectivity and noise level are concerned. The absence of "mush," that noise characteristic of all super-regenerators, will appeal to amateurs accustomed to and annoyed by sets of the latter type.

A properly designed five-meter superhet has another important feature, and that is

stability, both internal and external. By this the writer means it does not radiate strong signals back into the receiving antenna. Some super-regenerators are better transmitters than receivers; in crowded districts the QRM created by these sets is getting to be pretty serious.

A five-meter superhet that any ham can put together in a couple of evenings is the new Lafayette kit, a completed sample of which is shown in the accompanying illustrations. Six tubes are used exclusive

of the power rectifier, which is not included. As the 6.3-volt series of tubes is employed, the same receiver unit can be operated without change with either a small A.C. power pack or a battery combination consisting of a six-volt storage battery and a block of "B" batteries. This arrangement makes the set adaptable to experimental use in an automobile and to fixed use in the "shack."

The circuit comprises a stage of tuned (Continued on page 307)



Inside view of the Lafayette 5-Meter Superheterodyne, showing the arrangement of the shielding. The plug-in coil of the first-detector stage (right) has been removed to show the mycalex receptacle. The chassis is of heavy copper-plated steel. No. 303.

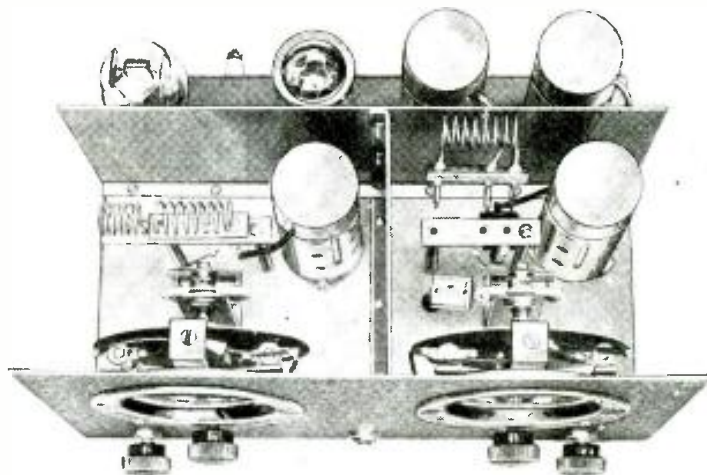

The Lafayette 5-Meter Superheterodyne as it looks in its steel cabinet with hinged top. Left dial, R.F. stage tuning; right dial, first-detector stage tuning. Lower left knob, R.F. volume control; lower right knob, audio volume control. Speaker jack in center.

THE RADIO AMATEUR

Conducted by Geo. W. Shuart

Radio Amateur Course

Lesson No. 1—Alternating Current

● IN order to understand the workings and phenomena of various radio circuits, it is essential that the student have a thorough knowledge and understanding of *alternating current* (A.C.) electricity. There is nothing so difficult about A.C. if the student forms a clear mental picture of just what happens in the production of this type of electricity. Most of us are familiar with the operation of direct current which is a *steady uniform flow of electricity in one direction*. A.C., on the other hand, is unlike D.C. inasmuch as the direction of flow is not uniform or constant. In Fig. 1 we have a straight line which is known as the *time line*. The waving line drawn along the straight line represents alternating current. Starting at the left of the line we find that the current is zero; as we proceed to the right along this time line the current builds up gradually until it reaches a maximum and then decreases gradually to zero; it then builds up in

the opposite direction to another maximum and finally decreases to zero again. This represents one complete cycle in which the current has gone through two alternations.

In Fig. 1 two complete cycles are shown. If this were to take place in the period of one second it would be said to have a frequency of two cycles. Hence, the term 60-cycle A.C. which is commonly used for designating the type of electricity used in home service, which means 60 complete cycles or 120 alternations per second. The frequency of alternating current is the number of times a complete cycle takes place in a period of one second.

To obtain a clear picture of the operation previously described let us refer to Fig. 1-B, which shows the hydraulic analogy. We have a cylinder pump with a complete loop through which a liquid can be pushed. The piston of this pump is driven by a motor or else by hand. If the drive wheel "A" is turned to the

left the piston moves to the left, forcing the liquid through the tube "L," in one direction and causing the indicator at the top of the loop to indicate that pressure is being exerted upon it. When the piston is to the extreme left and the motor-driven disc has rotated through 180 degrees, the flow stops, allowing the indicator hand to return to zero, due to the two centering springs which are attached to it. This indicates half of a cycle.

Then, as the motor is rotated through the remaining 180 degrees, the opposite of the previously mentioned action takes place, causing the vane or indicator to register a maximum in the opposite direction, and then return to zero after that half of the cycle is completed.

Associated with alternating current we also have voltage or pressure, termed E.M.F. or electromotive force. This voltage is alternating in the same manner as the current and at the same frequency.

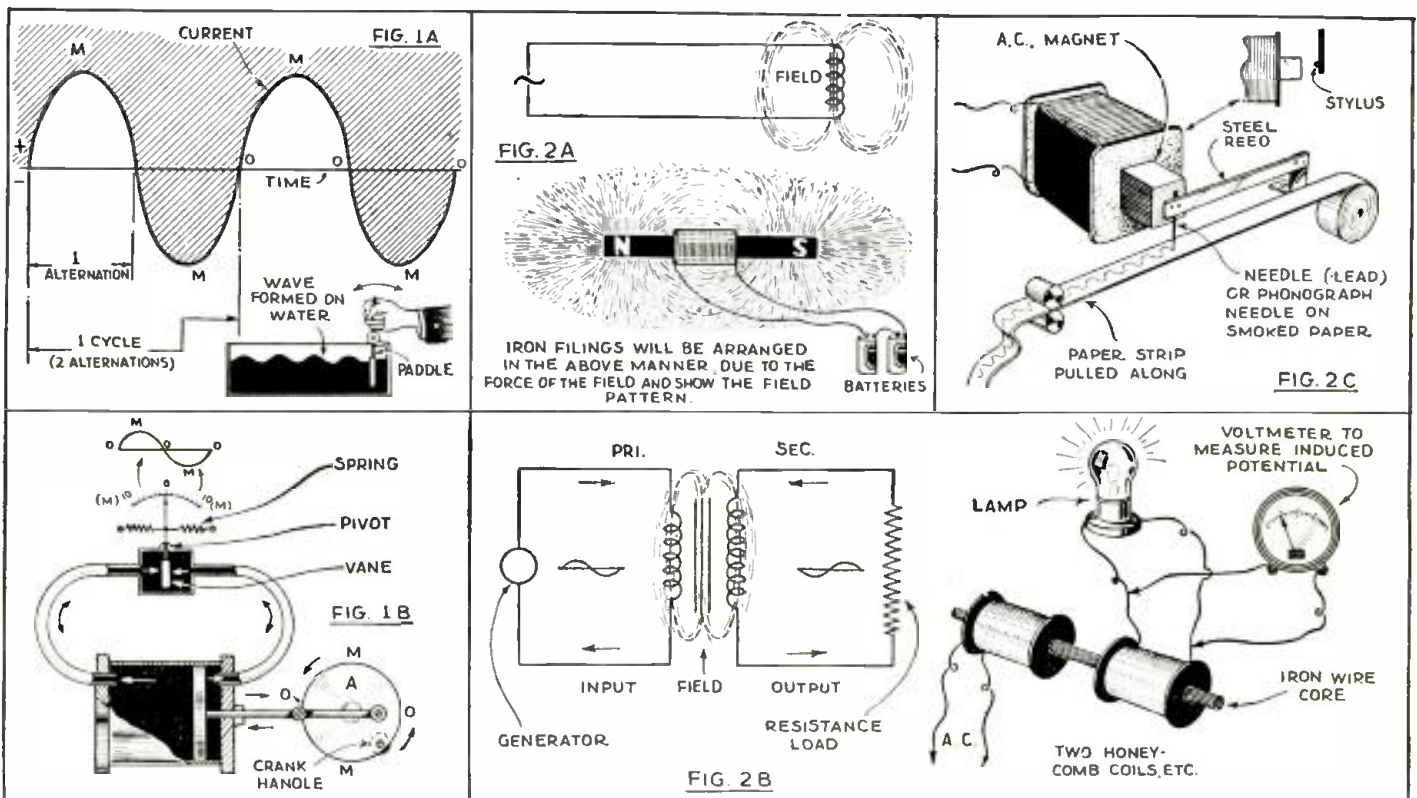

The drawings above show respectively—An analogy for wave motion and how alternating current reverses from positive to negative many times a second; an hydraulic analogy for A.C.; the production of a magnetic field about a simple A.C. electro-magnet, as well as the interlocking magnetic field produced in the A.C. transformer, and which links the secondary with the primary. Fig. 2C shows a simple method for recording the fluctuations or periodical changes occurring in an alternating current by drawing a slip of paper along under the recording needle, which is attached to the vibrating armature or reed.

After reading several thousand letters received from short-wave amateurs, including both licensed hams as well as prospective hams, the editors concluded to follow the suggestion made in many of these letters to the effect that a course in

short waves, from the ham angle, would be very welcome and useful. It will be especially prepared so as to gradually carry the student along through the elements of oscillatory circuits and the *how* and *why* of the vacuum tube.

The chief value of alternating current lies in the fact that it can be transmitted over long distances at high voltages and low currents, permitting the use of small wire and greater saving in cost, and at intervals stepped down to lower voltages with high currents through the medium of the transformer. The action of the transformer, briefly explained, is to step the imposed voltage up or down depending upon what the case may require.

If we connect a coil of wire such as shown in Fig. 2A, preferably one that has an iron core, to a 110-volt 60-cycle A.C. source, or any A.C. generator for that matter, we find that the continuously alternating current flow through the coil induces a magnetic field (radiated lines of force) about the coil, see Fig. 2A. This field builds up and collapses twice for every cycle of the imposed alternating current.

Now, if we were to place another coil in close proximity to this coil and one of similar design, we would find that the fluctuating magnetic field in the one coil would induce an E.M.F. or voltage in the added coil; this is known as induction. The entire theory of a transformer is based upon this fact and operates on a plan or principle of mutual induction.

If the two coils shown in Fig. 2B have the same number of turns and we impose a potential of 110 volts upon the primary, then theoretically we will have 110 volts across the two terminals of the secondary. No current will flow in this secondary until it is either short-circuited wholly or in part, either by connecting the two terminals together or by inserting between the two terminals a resistor. The current which will

then flow depends upon the resistance of the short circuit.

This resistor is known as the load circuit. If the load circuit is purely resistive, that is noninductive and non-capacitive, Ohm's Law can be applied in the same manner as when solving direct current problems. If no load is connected across the secondary terminals of the transformer, the only current which will be flowing in the primary will be that amount which is necessary to energize the primary circuit and is usually termed the magnetization current. But, just as soon as we impose a load upon the secondary and cause a current to flow in this circuit, which incidentally flows in a direction opposite to the current flow in the primary, we have an increase in the primary current.

In order to obtain a clearer picture of just what happens in the primary and secondary of a transformer we offer the mechanical analogy shown in Fig. 3. The two outer scales marked from 0 to 10 in steps of two units, represent the amount of current in either primary or secondary that would be shown on an ammeter.

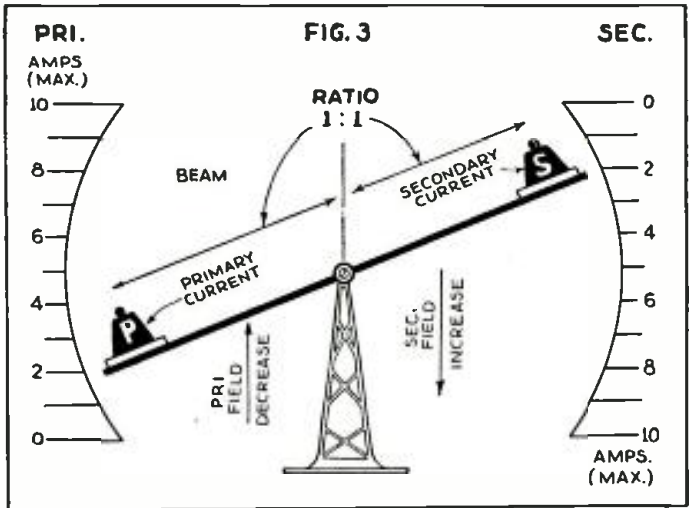

Fig. 3. Mechanical analogy of the action taking place in an A.C. transformer. As the secondary current represented by the weight "S" increases, the primary current also increases.

are in opposition to the field already in the core and tend to decrease it, thus raising weight "P," which is the primary current, upward until the platform becomes horizontal, indicating the same amount of primary current as secondary current.

When the weight "S" is opposite one zero mark, weight "P" in this analogy, will also be opposite the other zero mark. However, as previously mentioned, there is always a slight amount of current flowing in the primary circuit in order that it may be energized.

Always remember that the current in the primary and secondary of the transformer are opposite and that the fields are also opposite.

In all cases, though, it is important to remember that the frequency of the alternating current in the secondary is absolutely the same as the frequency in the primary circuit.

So far as we have considered the two coils, the primary and secondary windings are identical and therefore the voltage in the secondary circuit will be the same as the voltage impressed upon the primary. However, if the number of turns in the secondary coil is one half the number of turns in the primary coil, the voltage will also be one half of the primary voltage. As an example: in transformer design, if we have a primary consisting of 550 turns and we impose a potential of 110 volts upon it, we find by dividing the number of turns by the imposed voltage we have five turns per volt.

In designing the secondary then all we have to remember is that for every volt required in the secondary circuit we should have five turns. Space and time do not permit the complete technical discussion of transformer design and

(Continued on page 293)

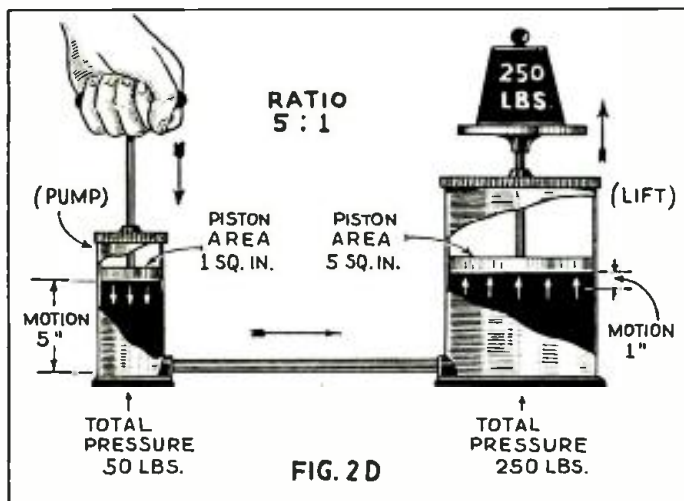

Fig. 2D above shows a very interesting analogy for the A.C. transformer, in which the voltage applied to the primary may be changed to a higher or lower voltage in the secondary. In the hydraulic press shown above, a pressure of 50 pounds exerted by the small downward moving piston at the left, is eventually transformed into an increased pressure of 250 pounds in the large cylinder at the right.

The TOBE "Communications" Receiver

By A. J. Haynes

● EARLY in May Mr. Browning sent the writer one of the first of the Tobe Communications Receivers for test. This new receiver has so many unique features that a brief description should be of interest to all amateur operators. This set was designed by Glenn H. Browning for the sole purpose of communication work on the amateur channels.

In the first place it is unusual in that it is *not* a compromise all-wave job but is designed specifically for communication work on the 160, 80, 40 and 20 meter amateur channels. This permits the use of electrical band-spread throughout, resulting in maximum efficiency plus stability and positive logging to 1 K.C. even on the 20 and 40 meter bands. This not only provides perfect tuning control but allows the receiver to be used as an accurate frequency meter.

The circuit is a seven-tube superheterodyne incorporating a special amateur model of the Tobe Super-Tuner. R.F. amplification and preselection is used on all four bands ahead of the first detector. This booster stage has been well designed as it shows good signal gain even on the 20 meter band and in spite of the single tuning control the tracking seems to be accurate over the entire frequency range. The tuned circuits all have a high inductance to capacity ratio with small maximum condenser capacities.

Besides the tuning and band selector controls on the panel there are five additional controls as follows: Audio volume; audio beat oscillator and A.V.C. (combined in one rotary switch); I.F. sensitivity control; on and off switch and tone control (combined); standby switch (cuts off oscillator but leaves I.F., final detector and audio functioning, so that receiver

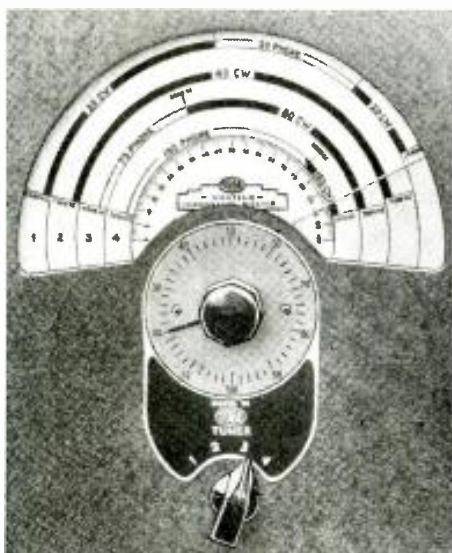

The "Ham" bands are exceptionally well spread out over the dial of the new Tobe "Communications" receiver, as the above photo clearly shows. This set is a superhet and is available in kit form, an idea which will appeal to every "Ham." No. 305.

may be used for monitoring while transmitting). A phone jack which cuts in on the first audio stage and includes the tone control is also provided.

The audio beat oscillator is coupled to one of the diode plates in the final detector. This is an excellent idea as it gives velvety smooth C.W. signals and is unusually free from drift.

Selectivity is obtained by a sharply tuned antenna circuit plus the R.F. preselection and triple tuned, double band-pass, I.F. amplification. This gives a total of eight tuned circuits (not counting the two oscillators).

The writer was a bit skeptical about the one stage of I.F. amplification providing sufficient gain. On actual test, however, the receiver went well below the normal atmospheric noise level even at 20 meters and had a very even sensitivity curve which was better than 1 microvolt absolute over the entire range. This single stage of I.F., together with the well designed stage of preamplification ahead of the first detector, undoubtedly is responsible for the low noise level of the set itself, making it possible to copy weak C.W. signals even on the loud speaker.

The tuning dial is quite unusual and one of the most practical we have seen for communication work. The phone and C.W. channels are clearly marked and spare dials are furnished which may be calibrated in frequencies or directly logged in any manner desired. They are quickly interchangeable.

This receiver undoubtedly owes much of its excellent performance to the fact that it was obviously designed for just one purpose, a communication receiver for the four amateur bands and nothing else.

NEW APPARATUS FOR THE "HAM"

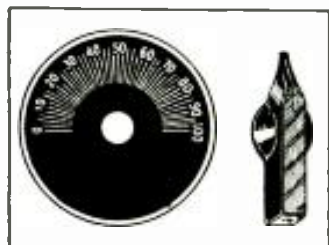

Latest metal dial plate and knob which will help immensely in "dressing up" your transmitter or receiver. (H1)

Metal Dial Plates and Knobs. (H1)

The Ham who wishes to dress-up his transmitter, receiver, or any other apparatus which he may be using, will find these black-etched dials and bakelite pointers particularly useful.

The dials are available in two sizes: one is 3 inches in diameter and the other is 1 1/2 inches in diameter. Pointer knobs to match these dials are obtainable in lengths of 1 1/4 inches and 2 1/2 inches. The knobs are bakelite, of course.

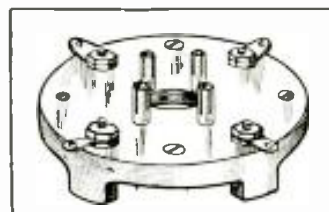

New 50 watt Bud socket of extra heavy construction, especially useful in "Ham" transmitter construction. (H2)

New 50-Watt Socket. (H2)

Here is a very neatly designed 50-watt transmitting tube socket. It is made of a ceramic material and does not have the usual shell. The four terminals are slotted tubular affairs into which the vacuum tube prongs are pushed making very rigid mounting and eliminating the losses which occur in the metal shell type socket.

It is designed for flush base mounting and has heavy terminals and connection strips which are nickel-plated. The screw-plug pins are all nickel plated. The base is glazed, reducing all possibilities of moisture absorption and creating a really low-loss socket.

New Class B Power Tube. (H3)

The RK31 shown in the photo is one of the latest additions to the fast-growing tube family. It is designed to work with zero grid bias, simi-

lar to the type 46 and has a tentative rating of 125 watts. It resembles the RK18 in appearance and can be used as a radio frequency or audio frequency amplifier. Two of these tubes in a class B amplifier would deliver 140 watts. It has a 7 1/2 volt filament and operates with a maximum of 1250 volts on the plate.

Hammarlund "Acorn" Tube Socket. (H4)

The Hammarlund Mfg. Co., has just announced production of a new socket for the 955 and the 954 "Acorn" tubes.

The photo clearly shows its construction. It is mounted on an extruded isolantite base. The five spring terminals are made of tinned bronze and have a special locking lug which prevents them from turning. The underneath part of the socket is perfectly plain.

Tobe Ham Band Tuner. (H5)

The new Tobe ham-band tuner is designed similar to the all-wave unit used in the Browning '35 receivers. However, this only covers the four amateur bands and is so adjusted that electrical band-spread is accomplished on all of these bands, to the extent of covering the entire dial scale. It is ideally suited for Ham receivers and comes already adjusted.

Burgess Ribbon Battery. (H6)

The new "Ribbon" type Burgess B battery shown in one (Continued on page 308)

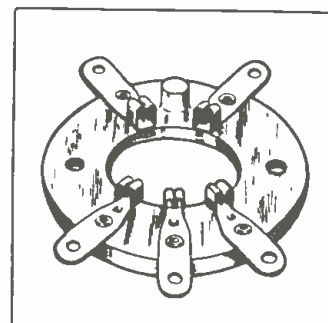

Hammarlund Acorn Tube Socket. (H4)

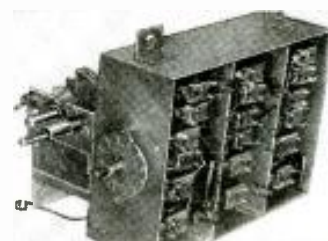

Tobe Ham-Band Superhet Tuner. (H5)



Ribbon Battery. (H6)

RK-31 "zero bias" power tube, to be used as audio or radio frequency. Two of these tubes in a class B amplifier will deliver 140 watts. (H3)

THE WIZARD 50-Watt Transmitter

By George W. Shuart, W2AMN

In Tests It Has Compared Favorably with 250-Watter

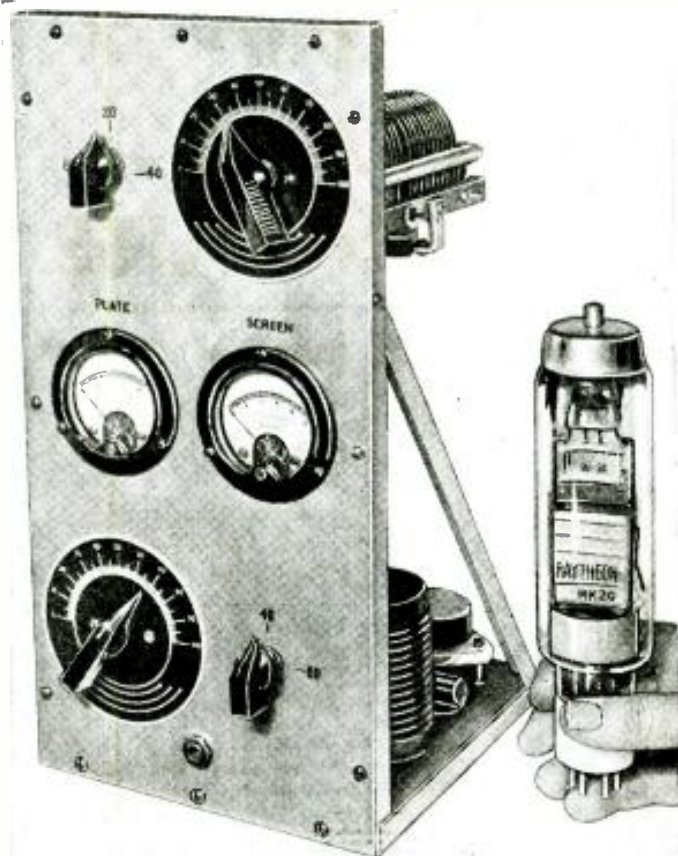

This transmitter is the acme of simplicity and economy. It has everything the up-to-date ham could desire. It is crystal-controlled, has between 50 and 60 watts output, and can be operated on any of the amateur bands by merely flipping a switch. It uses the new RK20 screen-grid pentode. Tests "on the air" have shown remarkable results.

Front view of this excellent 1-tube ham transmitter.

panel and base for further rigidity. A review of the above dimensions will convince any one that this is really a compact transmitter. The circuit is very simple and an easy one to get working and more than simple to adjust and operate.

● The requirements for a good all-round amateur station have long been considered and they stack up thus: All-band operation, 50 watts output, crystal control, combined with simplicity and low cost. A good many ham stations have achieved almost this status for a long time; however, there have always been one or two drawbacks regardless of how good the ham was at designing his apparatus or what kind of equipment he used.

Uses But 1 Tube

With the latest developments in tube design and the lower prices of ham equipment, it is now possible to build a transmitter which will have all the above requirements. The transmitter here described is *crystal-controlled*, giving all the advantages well known to this type of transmitter. It is simplicity itself, extremely simple and economical to operate, will work on

any three amateur bands with two crystals, and has from 20 to 60 watts output. And probably best of all its features, it uses but one tube!

To further its simplicity and economy it uses a band switching arrangement by which you can change from one band to another without changing coils and above all, the change can be made in about one half minute. Sounds almost unreasonable, all these features in a single transmitter, does it not? Still they are a fact, and besides, it has been operated at the writer's station, W2AMN, for the past several months and proved to be so doggone good that the regular 250-watt rig has not been operated since the one-tuber was finished and it looks as though this little outfit will be in use for a long time to come. A good many of our friends have stopped in to give it the once-over and—believe it or not—nearly all of them have decided to duplicate it!

Circuit Is a M.O.P.A.

The circuit is really a M.O.P.A. inasmuch as the crystal oscillator consists of the first three elements which form a triode. The plate circuit can be turned to either the crystal frequency or to the second harmonic, or double the crystal frequency. No instability is experienced because the tube is well constructed and so well screened that no neutralizing is necessary. There are only two coils used
(Continued on page 301)

RK 20 Is the Tube!

Before we become too enthused over the rig we had better get down to the business of this story. The tube used is an RK20, which is a screen-grid pentode with a rated output of over 50 watts! The tube operates with from 1,000 to 1,250 volts on the plate and requires 7.5 volts for the filament. The plate supply does not need to be an expensive one although it should have good regulation. If the plate supply delivers 125 milliamperes at around 1,000 volts it is entirely adequate.

The whole transmitter is built on an aluminum panel and chassis. The panel is 7 inches wide and 14 inches high, while the base is 7 inches square and ½-inch high to allow for the few wires that are run underneath it. The panel stands upright and is reinforced with ½-inch aluminum angles as can be clearly seen in the pictures. Two diagonal braces are fastened between the

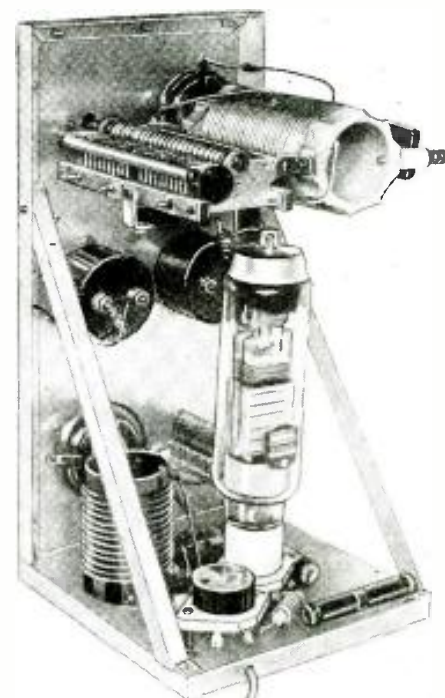

Rear view of the new 1-tube transmitter with the tube in place.

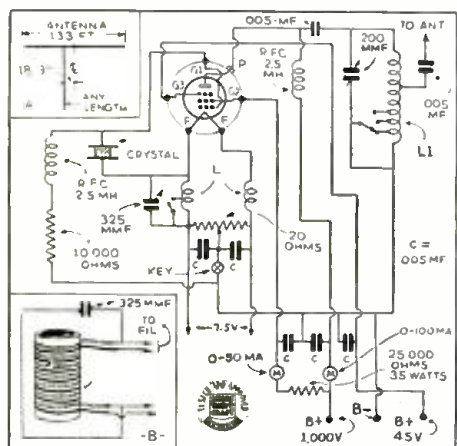

Hook-up for the Wizard 50-watt transmitter. It has crystal control. The cathode coils are shown in detail in the small drawing.

EIGHTEENTH "TROPHY CUP"

Presented to
SHORT WAVE SCOUT

JUAN C. STORER
ARECIBO, PUERTO RICO

For his contribution toward the
advancement of the art of Radio



Magazine

18TH TROPHY WINNER

Juan C. Storer,
Arecibo, Puerto Rico
66 Stations, 61 Foreigns

● WE are very pleased to award the 18th Short-Wave Scout Trophy to Mr. Juan C. Storer of Puerto Rico, who had the very excellent total of 66 stations, 61 of which were *foreign*, only 5 being located in Puerto Rico. In Mr. Storer's letter he states that a total of 98 stations were received, but he was only able to obtain 66 verification cards. That surely is very fine work, Mr. Storer, and we congratulate you upon your achievement because receiving conditions are not the best in the Central and South American countries, due to the terrific atmospheric disturbances caused by the tropical storms prevalent in those areas.

Mr. Storer used a General Electric M61 6-tube receiver. The antenna was of the conventional flat-top variety, pointing east and west, about 35 feet above the ground with the leadin coming from the eastern side. Mr. Storer further states that no earphones, pre-selector, or pre-amplifier systems were employed.

NORTH AMERICA

Station.	Frequency in kc.	Name of Sta.	City.
W3XAL-17780		National Broad. Co., Bound-	Brook, N.J.
W3XAL-6100		National Broad. Co., Bound-	Brook, N.J.
W8XK-15210		Westinghouse Station,	Pitts-
		burgh, Pa.	
W8XK-11870		Westinghouse Station,	Pitts-
		burgh, Pa.	
W8XK-6140		Westinghouse Station,	Pitts-
		burgh, Pa.	
W2XAD-15330		Int. Gen. Elec. Co., Schene-	tady, N.Y.
W2XAF-9530		Int. Gen. Elec. Co., Schene-	tady, N.Y.
W3XAU-9590		Philadelphia, Pa.	
W3XAU-6060		Philadelphia, Pa.	
W1XAZ-9570		Springfield, Mass.	
W9XAA-6080		Voice of Labor & Farmer, Chi-	cago, Ill.
W8XAL-6060		Crosley Radio Corp., Cincin-	nati, Ohio.
W1XAL-6040		University Club, Boston, Mass.	
W9XF-6100		National Broad. Co., Chicago, Ill.	
CJRO-6150		Canadian Radio Comm., Winni-	peg Canada.
W2XE-6120		Columbia Broad. System, New	York City.

WEST INDIES AND CENTRAL AMERICA

COC-6010	Havana.
COH-9428	Havana.
CO9GC-6150	Sto. de Cuba.
H11J-5865	S. Pedro, Macoris.
HIX-6000	Sto. Domingo.



● ON this page is illustrated the handsome trophy which was designed by one of New York's leading silversmiths. It is made of metal throughout, except the base, which is made of handsome black Bakelite. The metal itself is quadruple silver-plated, in the usual manner of all trophies today.

It is a most imposing piece of work, and stands from tip to base 22½". The diameter of the base is 7¾". The diameter of the globe is 5¼". The work throughout is first-class, and no money has been spared in its execution. It will enhance any home, and will be admired by everyone who sees it.

The trophy will be awarded every month, and the winner will be announced in the following issue of SHORT WAVE CRAFT. The winner's name will be hand engraved on the trophy.

The purpose of this contest is to advance the art of radio by "logging" as many short-wave phone stations, amateurs excluded, in a period not exceeding 30 days, as possible by any one contestant. The trophy will be awarded to that SHORT WAVE SCOUT who has logged the greatest number of short-wave stations during any 30-day period.

SHORT WAVE SCOUTS

Honorable Mention Awards

First Honorable Mention:

Ralph Majewski, Amsterdam, N.Y.
41 stations

Second Honorable Mention:

Albert E. Emerson, Cleveland, Ohio.
32 stations

- HI4D-6482—La Voz de Quisqueya, Sto. Domingo.
 HI1A-6185—La Voz del Yaque, Sto. de los Caballeros.
 HI5E-6900—Radiodifusora Ozama, Sto. Domingo.
 VP6YB-7072—Barbados.
 XEBT-6000—El Buen Tono, Mexico City.
 TIGPH-5823—Radio Alma Tica, San José, C.R.
 YN1GG-6450—La Voz delos Lagos, Managua, Nicaragua.
 HP5B-6030—Radio Miramar, Panama.

SOUTH AMERICA

- HJ1ARJ-6006—La Voz de Santa Marta, Santa Marta, Columbia.
 HJ4ABE-5930—Radiodifusora de Medellin, Medellin, Columbia.
 HJ4ABC-6220—La Voz de Pereira, Pereira, Columbia.
 HJ5ABD-6490—La Voz del Vallo, Cali, Columbia.
 HJ4ABB-7142—Radio Manizales, Manizales, Columbia.
 HJ1ABD-7281—Emisora de la Hereica, Cartagena, Columbia.
 HJ1ABD-6100—Emisora de la Hereica, Cartagena, Columbia.
 HJ4ABI-6065—Ecos de Occidente, Manizales, Columbia.
 HJ3ABH-6012—La Voz de la Victor, Bogota, Columbia.
 HC2RL-6666—Guayaquil, Ecuador.
 PRADO-6618—El Prado, Riobamba, Ecuador.
 YV5RMO-5850—Ecos del Caribo, Maracaibo, Venezuela.
 YV3RC-6150—Radiodifusora, Venezuela, Caracas, Venezuela.
 YV6RV-6030—La Voz de Carabobo, Valencia, Venezuela.
 YV6RV-6520—La Voz de Carabobo, Valencia, Venezuela.
 YV2RC-6112—Broadcasting Caracas, Caracas, Venezuela.

EUROPE

- HVJ-15121—Radio Vaticano, Vatican City.
 FYA-11720—Radio Coloniale, Paris.
 FYA-11875—Radio Coloniale, Paris.
 PHI-11730—Hilversum, Holland.
 PCJ-15220—Eindhoven, Holland.
 HBI-9595—Radio Nations, Geneva.
 HBP-7799—Radio Nations, Geneva.
 CT1AA-50.12 met.—Radio Colonial, Lisbon.
 ORK-10330 kc.—Radio Ruysselede, Belgium.
 EAQ-9860—Transradio Espanola, Madrid.
 RW59-6000—U.S.S.R.
 DJE-17760—Berlin.
 DJD-11770—Berlin.
 DIQ-10290—Berlin.
 DJA-9560—Berlin.
 DIN-9540—Berlin.
 DJC-6020—Berlin.
 ZRO-9780—Radio EIAR, Rome, Italy.

AUSTRALIA

- VK3LR-9580—National Broad. Ser., Victoria.
 VK2ME-9590—The Voice of Australia, Sidney.
 VK3ME-9510—Melbourne.

(Continued on page 308)

Short-Wave Stations of the World

Corrected and Revised Monthly

Complete List of Broadcast, Police and Television Stations

We present herewith a revised list of the short-wave broadcasting, experimental and commercial radiophone stations of the world. This is arranged by frequency, but the wavelength figures are also given for the benefit of readers who are more accustomed to working with "meters." All the stations in this list use telephone transmission of one kind or another

and can therefore be identified by the average listener.

Herewith is also presented a very fine list of police as well as television stations. Note: Stations marked with a star ★ are the most active and easily heard stations and transmit at fairly regular times.

Please write to us about any new stations or other important data that you

learn through announcements over the air or correspondence with the stations themselves. A post card will be sufficient. We will safely return to you any verifications that you send in to us. Communications of this kind are a big help.

Stations are classified as follows: C—Commercial phone, B—Broadcast service, X—Experimental transmissions.

Around-the-Clock Listening Guide

Although short-wave reception is notorious for its irregularity and seeming inconsistency (wherein lies its greatest appeal to the sporting listener), it is a good idea to follow a general schedule as far as wavelength in relation to the time of the day is concerned. The observ-

ance of these simple rules will save time. From daybreak till 8 p.m. and particularly during bright daylight, listen between 13 and 19 meters (21540 to 15800 kc.).

To the east of the listener, from about 4 p.m.-4 a.m., the 25-35 meter will be found very pro-

ductive. To the west of the listener this same band is best from about 10 p.m. until shortly after daybreak. (After dark, results above 35 meters are usually much better than during daylight.) These general rules hold for any location in the Northern Hemisphere.

Short-Wave Broadcasting, Experimental and Commercial Radiophone Stations

NOTE: To convert kc. to megacycles (mc.) shift decimal point 3 places to left: Thus, read 21540 kc. as 21.540 mc.

21540 kc. W8XK -B- 13.93 meters WESTINGHOUSE ELECTRIC PITTSBURGH, PA. 7-9 a.m.; relays KDKA	19355 kc. FTM -C- 15.50 meters ST. ASSISE, FRANCE Calls Argentine, mornings	17810 kc. PCV -C- 16.84 meters KOOTWIJK, HOLLAND Calls Java, 6-9 a. m.	16233 kc. FZR3 -C- 15.48 meters SAIGON, INDO-CHINA Calls Paris and Pacific Isles	15270 kc. ★W2XE -B- 19.65 meters ATLANTIC BROADCASTING CORP. 485 Madison Av., N.Y.C. Relays WABC daily, 10 a.m.-5 p.m.
21470 kc. GSH -B- 13.97 meters DAVENTRY, ENGLAND B.B.C., BROADCASTING HOUSE, LONDON, ENGLAND See "When to Listen In" column	19220 kc. WKF -C- 15.60 meters LAWRENCEVILLE, N. J. Calls England, daytime	17790 kc. ★GSG -B- 18.86 meters BRITISH BROAD. CORP. DAVENTRY, ENGLAND See "When to Listen In" Column	15880 kc. FTK -C- 18.90 meters ST. ASSISE, FRANCE Phones Saigon, morning	15260 kc. GSI -B- 19.66 meters DAVENTRY, ENGLAND B.B.C., BROADCASTING HOUSE, LONDON, ENGLAND See "When to Listen In" column
21420 kc. WKK -C- 14.01 meters A. T. & T. CO. LAWRENCEVILLE, N. J. Calls Argentina, Brazil and Peru, daytime	19160 kc. GAP -C- 15.66 meters RUGBY, ENGLAND Calls Australia, early a.m.	17780 kc. ★W3XAL -B- 18.87 meters NATIONAL BROAD. CO. BOUND BROOK, N. J. Relays WJZ, Daily exc. Sun. 8-9 a.m.; Tues., Thurs., Fri., 2-3 p.m.	15810 kc. LSL -C- 18.98 meters HURLINGHAM, ARGENTINA Calls Brazil and Europe, daytime	15250 kc. W1XAL -B- 19.67 meters BOSTON, MASS. Irregular, in morning
21060 kc. WKA -C- 14.25 meters LAWRENCEVILLE, N. J. Calls England noon	18970 kc. GAQ -C- 15.81 meters RUGBY, ENGLAND Calls S. Africa, mornings	17775 kc. ★PHI -B- 16.88 meters HUIZEN, HOLLAND Daily exc. Tues. and Wed. 7:30- 9:30, Sat. and Sun. till 10:30	15760 kc. JYT -X- 19.04 meters KEMIKWA-CHO, CHIBA- KEN, JAPAN Irregular in late afternoon and early morning	15245 kc. ★ -B- 19.68 meters "RADIO COLONIAL" PARIS, FRANCE Service de la Radiodiffusion 103 Rue de Grenelle, Paris 6-10 a.m.
21020 kc. LSN6 -C- 14.27 meters HURLINGHAM, ARG. Calls N. Y. C. 8 a. m.-5 p. m.	18830 kc. PLE -C- 15.93 meters BANDONG, JAVA Calls Holland, early a. m.	17760 kc. ★DJE -B- 16.89 meters BROADCASTING HOUSE BERLIN, GERMANY Irregular 8-11:30 a.m.	15660 kc. JVE -C- 19.16 meters NAZAKI, JAPAN Phones Java 3-5 a.m.	15220 kc. ★PCJ -B- 19.71 meters N.Y. PHILIPS' RADIO EINDHOVEN, HOLLAND Broadcasts relaying PHI Sat. and Sun. 7:30-10:30 a.m. Also tests Tues. 3-6 a.m., Wed. 7-11 a.m.
20700 kc. LSY -C- 14.49 meters MONTE GRANDE ARGENTINA Tests irregularly	18620 kc. GAU -C- 16.11 meters RUGBY, ENGLAND Calls N. Y., daytime	17760 kc. IAC -C- 16.89 meters PISA, ITALY Calls ships, 6:30-7:30 a. m.	15620 kc. JVF -C- 19.2 meters NAZAKI, JAPAN Phones U.S., 5 a.m. & 4 p.m.	15210 kc. ★W8XK -B- 19.72 meters WESTINGHOUSE ELECTRIC & MFG CO. PITTSBURGH, PA. 9 a.m.-7 p.m. Relays KDKA
20380 kc. GAA -C- 14.72 meters RUGBY, ENGLAND Calls Argentina, Brazil, mornings	18345 kc. FZS -C- 16.35 meters SAIGON, INDO-CHINA Phones Paris, early morning	17310 kc. W3XL -X- 17.33 meters NATIONAL BROAD. CO. BOUND BROOK, N. J. Tests irregularly	15415 kc. KWO -C- 19.46 meters DIXON, CAL. Phones Hawaii 2-7 p.m.	15200 kc. ★DJB -B- 19.73 meters BROADCASTING HOUSE BERLIN, GERMANY 12:30-2. 3:45-7:15 a.m., 8-11:30 a.m. and 12 N-4:30 p.m.
19900 kc. LSG -C- 15.08 meters MONTE GRANDE, ARGENTINA Tests irregularly, daytime	18340 kc. WLA -C- 16.36 meters LAWRENCEVILLE, N. J. Calls England, daytime	17120 kc. WOO -C- 17.52 meters A. T. & T. CO., OCEAN GATE, N. J. Calls ships	15410 kc. PRADO -B- 19.47 meters RIOBAMBA, ECUADOR Irregularly on Sun. 4:30-6 p.m.	15370 kc. ★HAS3 -B- 19.52 meters BUDAPEST, HUNGARY Broadcasts Sundays, 9-10 a.m.
19820 kc. WKN -C- 15.14 meters LAWRENCEVILLE, N. J. Calls England, daytime	18310 kc. GAS -C- 16.38 meters RUGBY, ENGLAND Calls N. Y., daytime	17080 kc. GBC -C- 17.56 meters RUGBY, ENGLAND Calls Ships	15355 kc. KWU -C- 19.53 meters DIXON, CAL. Phones Pacific Isles and Japan	15140 kc. ★GSF -B- 19.82 meters BRITISH BROAD. CORP. DAVENTRY, ENGLAND See "When to Listen In" Column
19650 kc. LSN5 -C- 15.27 meters HURLINGHAM, ARGENTINA Calls Europe, daytime	18200 kc. GAW -C- 16.48 meters RUGBY, ENGLAND Calls N. Y., daytime	16270 kc. WLK -C- 18.44 meters LAWRENCEVILLE, N. J. Phones Arg., Braz., Peru, daytime	15330kc.★W2XAD -B- 19.56 meters GENERAL ELECTRIC CO. SCHENECTADY, N. Y. Relays WGY daily, 2-3 p.m. Sun. 10:30 a.m.-4 p.m.	15120 kc. ★HVJ -B- 19.83 meters VATICAN CITY ROME, ITALY 10:30 to 10:45 a.m., except Sunday
19600 kc. LSF -C- 15.31 meters MONTE GRANDE, ARGENTINA Tests irregularly, daytime	18135 kc. PMC -C- 16.54 meters BANDONG, JAVA Phones Holland, early a. m.	16270 kc. WOG -C- 18.44 meters OCEAN GATE, N. J. Calls England, morning and early afternoon	15280 kc. DJQ -B- 19.63 meters BROADCASTING HOUSE BERLIN, GERMANY 12:30-2 a.m., 8-11:30 a.m.	15090 kc. RKI -C- 19.88 meters MOSCOW, U.S.S.R. Phones Tashkent near 7 a.m. and relays RNE on Sundays irregularly
19380 kc. WOP -C- 15.48 meters OCEAN GATE, N. J. Calls Peru, daytime	18040 kc. GAB -C- 16.63 meters RUGBY, ENGLAND Calls Canada, morn. and early aftn.	16240 kc. KTO -C- 18.47 meters MANILLA, P. I. Calls Cal., Tokio and ships		

(All Schedules Eastern Standard Time)

<p>15055 kc. WNC -C- 19.92 meters HIALEAH, FLORIDA Calls Central America, daytime</p>	<p>12800 kc. IAC -C- 23.45 meters PISA, ITALY Calls Italian ships, mornings</p>	<p>11715 kc. ★ -B- 25.61 meters "RADIO COLONIAL" PARIS, FRANCE 6-9 p.m. 10 p.m.-12 m.</p>	<p>10055 kc. ZFB -C- 29.84 meters HAMILTON, BERMUDA Phones N. Y. C. daytime</p>	<p>9572 kc. LKJ1 -B- 31.34 meters JELOY, NORWAY 5-8 a.m., 11 a.m.-6 p.m.</p>
<p>14980 kc. KAY -C- 20.03 meters MANILA, P. I. Phones Pacific Isles</p>	<p>12780 kc. GBC -C- 23.47 meters RUGBY, ENGLAND Calls ships</p>	<p>11710 kc. ★HJ4BA -B- 25.62 meters P. O. BOX 50 MEDELLIN, COLOMBIA 11:30 a.m.-1 p.m., 6:30-10:30 p.m.</p>	<p>9950 kc. GCU -C- 30.15 meters RUGBY, ENGLAND Calls N.Y.C. evening</p>	<p>9570 kc. ★W1XK -B- 31.35 meters WESTINGHOUSE ELECTRIC & MFG. CO. SPRINGFIELD, MASS. Relays WBZ, 6 a.m.-12 m.</p>
<p>14950 kc. HJB -C- 20.07 meters BOGOTA, COL. Calls WNC, daytime</p>	<p>12396 kc. CT1G0 -B- 24.2 meters PAREDE, PORTUGAL Sun. 10-11:30 a.m., Tues., Thur., Fri. 1:00-2:15 p.m.</p>	<p>11680 kc. KIO -X- 25.68 meters KAHUKU, HAWAII Tests in the evening</p>	<p>9890 kc. LSN -C- 30.33 meters HURLINGHAM, ARGENTINA Calls New York, evenings</p>	<p>9565 kc. VUB -B- 31.36 meters BOMBAY, INDIA 11 a.m.-12:30 p.m., Wed., Thurs., Sat. Sun. 7:30-8:30 a.m.</p>
<p>14600 kc. JVH -B.C- 20.55 meters NAZAKI, JAPAN Broadcasts daily 4-5 p.m. and 12 m.-1 a.m.</p>	<p>12290 kc. GBU -C- 24.41 meters RUGBY, ENGLAND Calls N.Y.C., afternoon</p>	<p>11413 kc. CJA4 -C- 26.28 meters DRUMMONDVILLE, QUE., CAN. Tests with Australia irregularly in evening</p>	<p>9870 kc. WON -C- 30.4 meters LAWRENCEVILLE, N. J. Phones England, evening</p>	<p>9560 kc. ★DJA -B- 31.38 meters BROADCASTING HOUSE, BERLIN 5:05-9:15 p.m.</p>
<p>14590 kc. WMN -C- 20.56 meters LAWRENCEVILLE, N. J. Phones England morning and afternoon</p>	<p>12150 kc. GBS -C- 24.69 meters RUGBY, ENGLAND Calls N.Y.C., afternoon</p>	<p>10770 kc. GBP -C- 27.85 meters RUGBY, ENGLAND Calls Sydney, Austral. early a. m.</p>	<p>9860 kc. ★EAQ -B- 30.43 meters P. O. Box 951 MADRID, SPAIN Daily 5:15-7:30 p.m.; Saturday also 12 n.-2 p.m.</p>	<p>9540 kc. ★DJN -B- 31.45 meters BROADCASTING HOUSE BERLIN, GERMANY 3:45-7:15 a.m. 5:05-10:45 p.m.</p>
<p>14535 kc. HBJ -B- 20.64 meters RADIO NATIONS, GENEVA, SWITZERLAND Broadcasts irregularly</p>	<p>12000 kc. ★RNE -B- 25 meters MOSCOW, U. S. S. R. Sun. 6-9, 10-11 a.m., 3-6 p.m. Daily 3-6 p.m., Wed. also 5-6 a.m.</p>	<p>10740 kc. ★JVM -C- 27.93 meters NAZAKI, JAPAN Phones California evenings</p>	<p>9840 kc. JYS -X- 30.49 meters KEMIKAWA-CHO, CHIBA- KEN, JAPAN Irregular, 4-7 a. m.</p>	<p>9530 kc. ★W2XAF -B- 31.48 meters GENERAL ELECTRIC CO. SCHENECTADY, N. Y. Relays WGY 5:25-11 p.m. Sun. 4:15 p.m.-12 m.</p>
<p>14500 kc. LSM2 -C- 20.69 meters HURLINGHAM, ARGENTINA Calls U. S., evening</p>	<p>11991 kc. FZS2 -C- 25.02 meters SAIGON, INDO-CHINA Phones Paris, morning</p>	<p>10675 kc. WNB -C- 28.1 meters LAWRENCEVILLE, N. J. Calls Bermuda, daytime</p>	<p>9800 kc. LSE -C- 30.61 meters MONTE GRANDE, ARGENTINA Tests irregularly</p>	<p>9518 kc. ★VK3ME -B- 31.54 meters AMALGAMATED WIRELESS, Ltd. G. P. O. Box 1272L MELBOURNE, AUSTRALIA Wed., Thurs., Fri., Sat. 5:00-7:00 a. m.</p>
<p>14485 kc. TIR -C- 20.71 meters CARTAGO, COSTA RICA Phones Cen. Amer. & U.S.A. Daytime</p>	<p>11950 kc. KKQ -X- 25.10 meters BOLINAS, CALIF. Tests, irregularly, evenings</p>	<p>10660 kc. ★JVN -C- 28.14 meters NAZAKI, JAPAN Broadcasts irregularly 2-7:45 a.m.</p>	<p>9790 kc. GCW -C- 30.64 meters RUGBY, ENGLAND Calls N.Y.C., evening</p>	<p>9510 kc. ★GSB -B- 31.55 meters BRITISH BROAD. CORP. DAVENTRY, ENGLAND See "When to Listen in" Column</p>
<p>14485 kc. HPF -C- 20.71 meters PANAMA CITY, PAN. Phones WNC daytime</p>	<p>11940 kc. FTA -C- 25.13 meters STE. ASSISE, FRANCE Phones CNR morning, Hurlingham, Arge., nights</p>	<p>10550 kc. WOK -C- 28.44 meters LAWRENCEVILLE, N. J. Phones Arge., Braz., Peru, nights</p>	<p>9760 kc. VLJ-VLZ2 -C- 30.74 meters AMALGAMATED WIRELESS OF AUSTRALIA SYDNEY, AUSTRALIA Phones Java and N. Zealand early a.m.</p>	<p>9500 kc. ★PRF5 -B- 31.58 meters RIO DE JANEIRO, BRAZIL Daily except Sun. 5:30-6:15 p. m.</p>
<p>14485 kc. TGF -C- 20.71 meters GUATEMALA CITY, GUAT. Phones WNC daytime</p>	<p>11890 kc. ★ -B- 25.23 meters "RADIO COLONIAL" PARIS, FRANCE 11 a.m.-5 p.m.</p>	<p>10520 kc. VLK -C- 28.51 meters SYDNEY, AUSTRALIA Calls Rugby, early a.m.</p>	<p>9750 kc. WOF -C- 30.77 meters LAWRENCEVILLE, N. J. Phones England, evening</p>	<p>9428 kc. ★COH -B- 31.8 meters 2 B ST., VEDADO, HAVANA, CUBA 10 a.m.-12 n., 4-6:30, 8-10 p.m. also 11 a.m.-12 N. Thurs.</p>
<p>14485 kc. YNA -C- 20.71 meters MANAGUA, NICARAGUA Phones WNC daytime</p>	<p>11870 kc. ★W8XK -B- 25.26 meters WESTINGHOUSE ELECTRIC & MFG. CO. PITTSBURGH, PA. 5-9 p.m. Fri. till 12 m Relays KDKA</p>	<p>10430 kc. YBG -C- 28.76 meters MEDAN, SUMATRA 5:30-8:30 a. m., 7:30-8:30 p. m.</p>	<p>9710 kc. GCA -C- 30.89 meters RUGBY, ENGLAND Calls Arge. & Brazil, evenings</p>	<p>9415 kc. PLV -C- 31.87 meters BANDOENG, JAVA Phones Holland around 9:45 a.m.</p>
<p>14470 kc. WMF -C- 20.73 meters LAWRENCEVILLE, N. J. Phones England morning and afternoon</p>	<p>11860 kc. GSE -B- 25.29 meters BRITISH BROAD. CORP. DAVENTRY, ENGLAND See "When to Listen in" Column</p>	<p>10420 kc. XGW -C- 28.79 meters SHANGHAI, CHINA Calls Manila and England, 8-9 a. m. and California late evening</p>	<p>9635 kc. ★2RO -B- 31.13 meters E.I.A.R. ROME, ITALY M., W., F. 6-7:30, 7:45-9:15 p.m.</p>	<p>9330 kc. CJA2 -C- 32.15 meters DRUMMONDVILLE, CANADA Phones England irregularly</p>
<p>14440 kc. GBW -C- 20.78 meters RUGBY, ENGLAND Calls U.S.A., afternoon</p>	<p>11830 kc. W2XE -B- 25.36 meters ATLANTIC BROADCASTING CORP. 485 MADISON AVE., N. Y. C.</p>	<p>10410 kc. PDK -C- 28.80 meters KOOTWIK, HOLLAND Calls Java 7:30-9:40 a. m.</p>	<p>9600 kc. ★CT1AA -B- 31.25 meters LISBON, PORTUGAL Tues., Thurs., Sat. 3:30-6 p.m.</p>	<p>9280 kc. GCB -C- 32.33 meters RUGBY, ENGLAND Calls Can. & Egypt, evenings</p>
<p>13990 kc. GBA -C- 21.44 meters RUGBY, ENGLAND Calls Buenos Aires, late afternoon</p>	<p>11811 kc. ★2RO -B- 25.4 meters E.I.A.R. Via Montello 5 ROME, ITALY 8:15-9 a.m., 9:15-10:15 a.m., 2:30-5 p.m.</p>	<p>10410 kc. KES -X- 28.80 meters BOLINAS, CALIF. Tests evenings</p>	<p>9595 kc. ★HBL -B- 31.27 meters LEAGUE OF NATIONS GENEVA, SWITZERLAND Saturdays, 5:30-6:15 p. m. Mon. at 1:45 a.m.</p>	<p>9170 kc. WNA -C- 32.72 meters LAWRENCEVILLE, N. J. Phones England, evening</p>
<p>13610 kc. JYK -C- 22.04 meters KEMIKAWA-CHO, CHIBA- KEN, JAPAN Phones California till 11 p. m.</p>	<p>11800 kc. CO9WR -X- 25.42 meters P. O. Box 85 SANCTI SPIRITUS, CUBA Testing in early evening</p>	<p>10350 kc. LSX -C- 28.98 meters MONTE GRANDE, ARGENTINA Tests irregularly 8 p.m.-12 mid- night.</p>	<p>9590 kc. ★VK2ME -B- 31.28 meters AMALGAMATED WIRELESS, LTD., 47 YORK ST. SYDNEY, AUSTRALIA Sunday 12M.-2 a.m., 4:30-8:30 a.m., 10:30 a.m.-12:30 p.m.</p>	<p>9125 kc. HAT4 -B- 32.88 meters "RADIOLABOR," GYALI-UT, 22 BUDAPEST, HUNGARY Sunday 6-7 p.m.</p>
<p>13585 kc. GBB -C- 22.08 meters RUGBY, ENGLAND Calls Egypt & Canada, afternoons</p>	<p>11790 kc. W1XAL -B- 25.45 meters BOSTON, MASS. Tues., Thurs. 7:30-9 p.m., Sun. 5-7 p.m.</p>	<p>10330 kc. ORK -B.C- 29.04 meters RUYSELEDE, BELGIUM Broadcasts 1:30-3 p.m.</p>	<p>9590 kc. HPSJ -B- 31.28 meters J Street, PANAMA CITY, PANAMA 7:30-10 p.m.</p>	<p>9020 kc. GCS -C- 33.26 meters RUGBY, ENGLAND Calls N.Y.C., evenings</p>
<p>13415 kc. GCJ -C- 22.36 meters RUGBY, ENGLAND Calls Japan & China early morning</p>	<p>11770 kc. ★DJD -B- 25.49 meters BROADCASTING HOUSE, BERLIN, GERMANY 12-4:30, 5:05-10:45 p.m.</p>	<p>10300 kc. LSL2 -C- 29.13 meters HURLINGHAM, ARGENTINA Calls Europe, evenings</p>	<p>9590 kc. W3XAU -B- 31.28 meters NEWTOWN SQUARE, PA. Relays WCAU 11 a.m.-6:50 p.m.</p>	<p>9010 kc. KEJ -C- 33.3 meters BOLINAS, CAL. Relays NBC & CBS Programs in evening irregularly</p>
<p>13390 kc. WMA -C- 22.40 meters LAWRENCEVILLE, N. J. Phones England morning and afternoon</p>	<p>11750 kc. ★GSD -B- 25.53 meters BRITISH BROAD. CORP. DAVENTRY, ENGLAND See "When to Listen in" Column</p>	<p>10290 kc. DIQ -X- 29.18 meters KONIGSWUSTERHAUSEN, GERMANY Broadcasts irregularly</p>	<p>9580 kc. ★GSC -B- 31.32 meters BRITISH BROAD. CORP. DAVENTRY, ENGLAND See "When to Listen in" Column</p>	<p>8795 kc. HKV -B- 34.09 meters BOGOTA, COLOMBIA Irregular; 6:30 p.m.-12 m.</p>
<p>13075 kc. VPD -X- 22.94 meters SUVA, FIJI ISLANDS Daily exc. Sun. 12:30-1:30 a.m.</p>	<p>11720 kc. ★CJRX -B- 25.6 meters WINNIPEG, CANADA Daily, 8 p. m.-12 m.</p>	<p>10260 kc. PMN -C- 29.24 meters BANDOENG, JAVA Calls Australia 5 a.m.</p>	<p>9580 kc. ★VK3LR -B- 31.32 meters Research Section, Postmaster Gen'l's. Dept., 61 Little Collins St., MELBOURNE, AUSTRALIA 3:15-7:30 a.m. except Sun. also Fri. 10:30 p.m.-2 a.m.</p>	
<p>12840 kc. WOO -C- 23.36 meters OCEAN GATE, N. J. Calls ships</p>	<p>11250 kv. LSK3 -C- 29.27 meters HURLINGHAM, ARGENTINA Calls Europe and U. S., after- noon and evening</p>	<p>10250 kv. LSK3 -C- 29.27 meters HURLINGHAM, ARGENTINA Calls Europe and U. S., after- noon and evening</p>		
<p>12825 kc. CNR -B. C. 23.39 meters DIRECTOR GENERAL Telegraph and Telephone Stations, Rabat, Morocco Broadcasts, Sunday, 7:30-9 a. m.</p>	<p>10220 kc. PSH -C- 29.35 meters RIO DE JANEIRO, BRAZIL</p>			

(All Schedules Eastern Standard Time)

<p>8775 kc. PNI -C- 34.19 meters MAKASSER, CELEBES, N.I. Phones Java around 4 a. m.</p>	<p>7000 kc. HJ5ABE -B- 42.86 meters CALI, COLUMBIA Irregular in evening</p>	<p>6425 kc. VE9AS -X- 46.7 meters FREDERICTON, N.B., CANADA Operates irregularly</p>	<p>6112 kc. YV2RC -B- 49.08 meters CARACAS, VENEZUELA Sun. 9:30 a.m.-10:30 p.m. Daily except Sun. 11 a.m.-1:30 p.m., 4-9:30 p.m., Tues., till 10 p.m.</p>	<p>6060 kc. VQ7LO -B- 49.50 meters NAIROBI, KENYA, AFRICA Mon.-Fri. 5:45-6:15 a.m., 11:30 a.m.-2:30 p.m. Also 8:30-9:30 a.m. on Tues. and Thurs. Sat. 11:30 a.m.-3:30 p.m. Sun. 11 a.m.-2 p.m.</p>
<p>8760 kc. GCQ -C- 34.25 meters RUGBY, ENGLAND Calls S. Africa, afternoon</p>	<p>6905 kc. GDS -C- 43.45 meters RUGBY, ENGLAND Calls N.Y.C. evening</p>	<p>6375 kc. YV4RC -B- 47.06 meters CARACAS, VENEZUELA 4:30-10:30 p.m.</p>	<p>6110 kc. GSL -B- 49.10 meters British Broadcasting Corp. Davenport, England See "When To Listen In"</p>	<p>6060 kc. W3XAU -B- 49.50 meters NEWTOWN SQUARE, PA. Relays WCAU, Philadelphia 7 p.m.-10 p.m.</p>
<p>8750 kc. ZEK -B- 34.29 meters HONGKONG, CHINA Relays ZBW Daily 11:30 p.m.-1:15 a.m. Mon. and Thurs. 3-7 a.m. Tues., Wed., Fri. 6-10 a.m. Sat. 6-11 a.m.</p>	<p>6860 kc. KEL -X- 43.70 meters BOLINAS, CALIF. Tests irregularly 11 a. m.-12 n.; 6-9 p. m.</p>	<p>6316 kc. HIZ -B- 47.5 meters SANTO DOMINGO DOMINICAN REPUBLIC Daily except Sat. and Sun. 4:40-5:40 p. m.; Sat., 9:40-11:40 p. m.; Sun., 11:40 a. m.-1:40 p. m.</p>	<p>6110 kc. VUC -B- 49.1 meters CALCUTTA, INDIA Daily except Sat., 3-5:30 a. m., 9:30 a. m.-noon; Sat., 11:45 a. m.-3 p. m.</p>	<p>6045 kc. HJ3ABI -B- 49.63 meters BOGOTA, COLO. Irregular in evening</p>
<p>8730 kc. GCI -C- 34.36 meters RUGBY, ENGLAND Calls India, 8 a. m.</p>	<p>6800 kc. HIH -B- 44.12 meters SAN PEDRO DE MACORIS DOMINICAN REP. 12:10-1:40 p.m., 6:40-7:40 p.m., Sun. 3-4 a.m., 12:10-1:40 p.m., 2:20-4:40 p.m.</p>	<p>6250 kc. HJ4ABC -B- 48 meters PERIERA, COL. 9:30-11:30 a.m., 7-8 or 9 p.m.</p>	<p>6110 kc. HJ4ABB -B- 49.1 meters MANIZALES, COL., S. A. P. O. Box 175 Mon. to Fri. 12:15-1 p. m.; Tues. & Fri. 7:30-10 p. m.; Sun. 2:30-5 p. m.</p>	<p>6042 kc. HJ1ABG -B- 49.65 meters BARRANQUILLA, COLO. 12 n.-1 p.m., 6-10 p.m. Sun. 1-6 p.m.</p>
<p>8680 kc. GBC -C- 34.56 meters RUGBY, ENGLAND Calls ships</p>	<p>6755 kc. WOA -C- 44.41 meters LAWRENCEVILLE, N. J. Phones England, evening</p>	<p>6230 kc. OAX4B -B- 48 meters Apartado 1242 LIMA, PERU Wed. & Sun. 7-10 p.m.</p>	<p>6100 kc. W3XAL -B- 49.18 meters NATIONAL BROADCASTING CO. BOUND BROOK, N. J. Relays WJZ Monday, Wednesday, Saturday, 4-5 p.m. Sat. also 11 p.m.-12 m.</p>	<p>6040 kc. YDA -B- 49.67 meters TANDJONGPRIOK, JAVA 10:30 p.m.-1:30 a.m., 5:30-11 a.m.</p>
<p>8560 kc. WOO -C- 35.05 meters OCEAN GATE, N. J. Calls ships irregular</p>	<p>6750 kc. JVT -X- 44.44 meters NAZAKI, JAPAN KOKUSAI-DENWA KAISHA, LTD., TOKIO Broadcasts 2-7:45 a.m.</p>	<p>6198 kc. CT1GO -B- 48.4 meters Portuguese Radio Club PAREDE, PORTUGAL Sun. 11:30 a.m.-1 p.m. Daily exc. Tues. 7:20-8:30 p.m.</p>	<p>6100 kc. W9XF -B- 49.18 meters DOWNERS GROVE, ILL. Relays WENR, Chicago Daily except Mon. Wed. & Sat. 2:30 p.m.-1 a.m. Mon., Wed., 2:30-4:5 p.m.-2 a.m. Sat 2:30-4:5 p.m.-11 p.m.</p>	<p>6040 kc. PRA8 -B- 49.67 meters RADIO CLUB OF PERAMBUCO PERAMBUCO, BRAZIL 3:00-3:30 p.m. and from about 4-7 p.m. daily</p>
<p>8380 kc. IAC -C- 35.8 meters Pisa, Italy</p>	<p>6660 kc. TIEP -B- 45.05 meters LA-VOZ DEL TROPICO SAN JOSE, COSTA RICA APARTADO 257, Daily 7-10 p.m.</p>	<p>6185 kc. HI1A -B- 48.5 meters P. O. BOX 423, SANTIAGO, DOMINICAN REP. 11:40 a. m.-1:40 p. m. 7:40-9:40 p. m.</p>	<p>6097 kc. JB -B- 49.2 meters AFRICAN BROADCASTING CO. JOHANNESBURG, SOUTH AFRICA Sun.-Fri. 11:45 p.m. 12:30 a.m. (next day) Mon.-Sat. 3:30-7 a.m. 9 a.m.-4 p.m. Sun. 8-10:15 a.m.; 12:30-3 p.m.</p>	<p>6030 kc. W1XAL -B- 49.87 meters BOSTON, MASS.</p>
<p>8214 kc. HCJB -B- 36.5 meters QUITO, ECUADOR 7:14-11:14 p.m., except Monday Sun. 4:14-10:44 p.m.</p>	<p>6650 kc. HC2RL -B- 45.06 meters P. O. BOX 759, GUAYAQUIL, ECUADOR, S. A. Sunday, 5:45-7:45 p. m. Tues., 9:15-11:15 p. m.</p>	<p>6175 kc. HJ2ABA -B- 49.58 meters TUNJA, COLOMBIA 1-2: 7:30-9:30 p.m.</p>	<p>6090 kc. VE9GW -B- 49.28 meters BOWMANVILLE, ONTARIO, CANADA</p>	<p>6030 kc. VE9CA -B- 49.75 meters CALGARY, ALBERTA, CAN. 9 a.m.-3 p.m., 7 p.m.-12 m.</p>
<p>8185 kc. PSK -C- 36.65 meters RIO DE JANEIRO, BRAZIL Irregularly</p>	<p>6650 kc. IAC -C- 45.1 meters PISA, ITALY Calls ships, evenings</p>	<p>6170 kc. HJ3ABF -B- 48.62 meters BOGOTA, COLOMBIA 6-11 p.m.</p>	<p>6090 kc. VE9BJ -B- 49.28 meters SAINT JOHN, N. B., CAN. 7-8:30 p. m.</p>	<p>6020 kc. CQN -B- 49.83 meters MACAO, CHINA Mon. and Fri. 3-5 a.m.</p>
<p>8036 kc. CNR -B- 37.33 meters RABAT, MOROCCO Sunday, 2:30-5 p. m.</p>	<p>6620 kc. PRADO -B- 45.30 meters RIOBAMBA, ECUADOR Thurs. 9-11:45 p.m.</p>	<p>6160 kc. YV3RC -B- 48.7 meters CARACAS, VENEZUELA Generally 4:00-10:00 p. m.</p>	<p>6080 kc. CP5 -B- 49.34 meters LAPAZ, BOLIVIA 7-10:30 p. m.</p>	<p>6020 kc. DJC -B- 49.83 meters BROADCASTING HOUSE, BERLIN 12 n.-4:30 p.m., 9:30-10:45 p. m.</p>
<p>7901 kc. LSL -C- 37.97 meters HURLINGHAM, ARGENTINA Calls Brazil, night</p>	<p>6611 kc. RV72 -B- 45.38 meters MOSCOW, U. S. S. R. 1-8 p. m.</p>	<p>6155 kc. CO9GC -B- 48.74 meters GRAU & CAMENOS LABS., BOX 137, SANTIAGO, CUBA 9-10 a.m., 11:30 a.m.-1:30 p.m., 3-4:30 p.m., 10-11 p.m., 12 m.-2 a.m.</p>	<p>6080 kc. W9XAA -B- 49.34 meters CHICAGO FEDERATION OF LABOR CHICAGO, ILL. Relays WCFL Sunday 11:30 a. m.-9 p. m. and Tues., Thurs., Sat., 4 p. m.-12 m.</p>	<p>6018 kc. ZHI -B- 49.9 meters RADIO SERVICE CO., 20 ORCHARD RD., SINGAPORE, MALAYA Mon., Wed. and Thurs 5:40-8:10 a.m. Sat. 10:40 p.m.-1:10 a.m. (Sun.) Every other Sunday 5:10-6:40 a.m.</p>
<p>7880 kc. JYR -B- 38.07 meters KEMIKAWA-CHO, CHIBAKEN, JAPAN 4:7:40 a. m.</p>	<p>6610 kc. HI4D -B- 45.39 meters SANTO DOMINGO, DOMINICAN REPUBLIC Except Sun. 11:55 a.m.-1:40 p.m.; 4:40-7:40 p.m.</p>	<p>6150 kc. CSL -B- 48.78 meters LISBON, PORTUGAL 7-8:30 a.m., 2-7 p.m.</p>	<p>6080 kc. W9XAA -B- 49.34 meters CHICAGO FEDERATION OF LABOR CHICAGO, ILL. Relays WCFL Sunday 11:30 a. m.-9 p. m. and Tues., Thurs., Sat., 4 p. m.-12 m.</p>	<p>6010 kc. COC -B- 49.92 meters P. O. BOX 98 HAVANA, CUBA Daily 9:30-11 a.m., 4-7 p.m. and 8-10 p.m. Sat. also 11:30 p.m.-1:30 a.m.</p>
<p>7860 kc. HC2JSB -B- 38.17 meters GUAYAQUIL, ECUADOR 8:15-11:15 p.m.</p>	<p>6550 kc. TIRCC -B- 45.77 meters RADIOEMISORA CATOLICA COSTARRICENSE SAN JOSE, COSTA RICA Irregularly 12n-2 p.m. and 5-7 p.m.</p>	<p>6150 kc. CJRO -B- 48.78 meters WINNIPEG, MAN., CANADA Sun. 3-10:30 p. m.</p>	<p>6072 kc. ZHJ -B- 49.41 meters PENANG, MALAYA Daily 7-9 a.m. also Sat. 11 p.m.-1 A.M. (Sun.)</p>	<p>6000 kc. RV59 -B- 50 meters MOSCOW, U. S. S. R.</p>
<p>7799 kc. HBP -B- 38.47 meters LEAGUE OF NATIONS, GENEVA, SWITZERLAND 5:30-6:15 p. m., Saturday</p>	<p>6550 kc. TI2PG -B- 45.77 meters APARTADO 225, SAN JOSE, COSTA RICA "Costa Rica Broadcasting" 9-10 p.m.</p>	<p>6140 kc. W8XK -B- 48.86 meters WESTINGHOUSE ELECTRIC & MFG. CO., PITTSBURGH, PA. Relays KDKA 9 p.m.-1 a.m.</p>	<p>6072 kc. OER2 -B- 49.41 meters VIENNA, AUSTRIA 9 a.m.-3, 7-10 p.m.</p>	<p>5990 kc. XEBT -B- 50.08 meters MEXICO CITY, MEX. P. O. Box 79, 44 8 a.m.-1 a.m.</p>
<p>7715 kc. KEE -C- 38.89 meters BOLINAS, CAL. Relays NBC & CBS Programs in evening irregularly</p>	<p>6528 kc. HIL -B- 45.95 meters SANTO DOMINGO, D.R. Sat., 8-10 p.m.</p>	<p>6130 kc. ZGE -B- 48.92 meters KUALA LUMPUR, FED. MALAY STATES Sun., Tues. and Fri., 6:40-8:40 a. m.</p>	<p>6070 kc. VE9CS -B- 49.42 meters VANCOUVER, B. C., CANADA Sun. 1:45-9 p. m., 10:30 p. m.-1 a. m.; Tues. 6:30 p. m., 11:30 p. m.-1:30 a. m. Daily 6:30-7:30 p. m.</p>	<p>5980 kc. XECW -B- 50.17 meters CALLE del BAJIO 120 MEXICO CITY, MEX. 4-4:30 p.m., 10:30 p.m., 12 m.</p>
<p>7715 kc. KEE -C- 38.89 meters BOLINAS, CAL. Relays NBC & CBS Programs in evening irregularly</p>	<p>6520 kc. YV6RV -B- 46.01 meters VALENCIA, VENEZUELA 5-7, 9-11 p.m., Irregular</p>	<p>6120 kc. YDA -B- 49.02 meters N.J.R.O.M. BANJOENG, JAVA 10:40 p.m.-1:40 a.m., 5:45-6:45 p.m., 5:30-11 a.m.</p>	<p>6065 kc. HJ4ABL -B- 49.46 meters MANIZALES, COL. Daily 11 a.m.-12 n., 5:30-7:30 p.m. Sat. 10:30-11:30 p.m.</p>	<p>5980 kc. HIX -B- 50.17 meters SANTO DOMINGO, DOMINICAN REP. Tues. and Fri. at 8:10 p.m. Sun. at 7:40 a.m., irreg. Tues. and Thurs.</p>
<p>7510 kc. JVP -C- 39.95 meters NAZAKI, JAPAN Heard irregularly</p>	<p>6500 kc. HJ5ABD -B- 46.15 meters MANIZALES, COL. 12-1:30 p. m., 7-10 p. m.</p>	<p>6120 kc. W2XE -B- 49.02 meters ATLANTIC BROADCASTING CORP. 485 MADISON AVE., N. Y. C. Relays WABC, 5-10 p.m.</p>	<p>6060 kc. OXY -B- 49.50 meters SKAMLEBOAEK, DENMARK 1-6:30 p. m.; also 11 a. m.-12 n. Sunday</p>	<p>5970 kc. HJ3ABH -B- 50.25 meters BOGOTA, COLO. APARTADO 565 7-11 p.m.</p>
<p>7400 kc. HJ3ABD -B- 40.54 meters P. O. Box 509 BOGOTA, COLOMBIA Daily 12-2 p. m.; 7-11 p. m. Sunday, 5-9 p. m.</p>	<p>6447 kc. HJ1ABB -B- 46.53 meters BARRANQUILLA, COL., S. A. P. O. BOX 715, 11:30 a. m.-1 p. m.; 5-10 p. m.</p>	<p>6115 kc. HJ1ABE -B- 49.05 meters CARTAGENA, COL. P. O. Box 31 Daily 11:15 a. m.-1 p. m.; Sun. 9-11 a.m.; Mon. 10 p.m.-12 m. Wed. 8-11 p.m.</p>	<p>6060 kc. W8XAL -B- 49.50 meters CROSLY RADIO CORP. CINCINNATI, OHIO 6:30 a.m.-7 p.m., 10 p.m.-1 a.m. Relays WLW</p>	<p>5968 kc. HVJ -B- 50.27 meters VATICAN CITY (ROME) 2-2:15 p. m., daily, Sun., 5-5:30 a. m.</p>
<p>7380 kc. XECR -B- 40.65 meters FOREIGN OFFICE, MEXICO CITY, MEX. Sun. 6-7 p.m.</p>	<p>6425 kc. W3XL -X- 46.70 meters NATIONAL BROADCASTING CO. BOUND BROOK, N. J. Tests irregularly</p>	<p>7310 kc. HJ1ABD -B- 41.04 meters CARTAGENA, COLO. Irregularly, evenings</p>	<p>7310 kc. HJ1ABD -B- 41.04 meters CARTAGENA, COLO. Irregularly, evenings</p>	<p>5950 kc. HJ1ABJ -B- 50.42 meters SANTA MARTA, COLO. 11 a.m.-1 p.m., 7-9 p.m.</p>
<p>7100 kc. HKE -B- 42.25 meters BOGOTA, COL., S. A. Tue. and Sat. 8-9 p. m.; Mon. & Thurs. 6:30-7 p. m.</p>	<p>7030 kc. HRP1 -B- 42.67 meters SAN PEDRO SULA, HONDURAS Reported on this and other waves irregularly in evening</p>	<p>7100 kc. HKE -B- 42.25 meters BOGOTA, COL., S. A. Tue. and Sat. 8-9 p. m.; Mon. & Thurs. 6:30-7 p. m.</p>	<p>7100 kc. HKE -B- 42.25 meters BOGOTA, COL., S. A. Tue. and Sat. 8-9 p. m.; Mon. & Thurs. 6:30-7 p. m.</p>	<p>7100 kc. HKE -B- 42.25 meters BOGOTA, COL., S. A. Tue. and Sat. 8-9 p. m.; Mon. & Thurs. 6:30-7 p. m.</p>

(All Schedules Eastern Standard Time)

<p>5950 kc. HJ4ABE -B- 50.42 meters MEDELLIN, COLO. Mon. 7-11 p.m., Tues., Thurs., Sat. 6:30-8 p.m., Wed. and Fri. 7:30-11 p.m.</p>	<p>5825 kc. TIGPH -B- 51.5 meters SAN JOSE, COSTA RICA 6:15-11 p.m.</p>	<p>5660 kc. HJ5ABC -B- 53 meters CALI, COLOMBIA 11 a. m.-12 N. Tues. and Thurs. 8-10 p. m. Sun. 12 N.-1 p. m.</p>	<p>4600 kc. HC2ET -B- 65.22 meters Apartado 249 GUAYAQUIL, ECUADOR Reported Wed., Sat. 9-11:30 p.m.</p>	<p>4098 kc. WND -C- 73.21 meters HIALEAH, FLORIDA Calls Bahama Isles</p>
<p>5940 kc. TGX -B- 50.5 meters SR. M. NOVALES, GUATEMALA CITY, GUAT. Daily except Sun., 8-10 a.m., 1-2:30 p.m., 8 p.m.-12m.</p>	<p>5790 kc. JUV -C- 51.81 meters NAZAKI, JAPAN Broadcasts 2-7:45 a.m.</p>	<p>5077 kc. WCN -C- 59.08 meters LAWRENCEVILLE, N. J. Phones England Irregularly</p>	<p>4470 kc. YDB -B- 67.11 meters NIROM SOERABAJA, JAVA 10:30 p.m.-1:30 a.m., 5:30- 11 a.m., 5:45-6:45 p.m.</p>	<p>4002 kc. CT2AJ -B- 74.95 meters PONTA DELGADA, SAO MIGUEL, AZORES Wed. and Sat. 5-7 p. m.</p>
<p>5890 kc. HJ2ABC -B- 50.97 meters CUCUTA, COL.</p>	<p>5780 kc. HI1J -B- 51.9 meters SAN PEDRO de MACORIS, DOM. REP. 7-9:30 p.m.</p>	<p>5025 kc. ZFA -C- 59.7 meters HAMILTON, BERMUDA Calls U.S.A., nights</p>	<p>4320 kc. GDB -C- 69.44 meters RUGBY, ENGLAND Tests, 8-11 p. m.</p>	<p>3543 kc. CR7AA -B- 84.67 meters P. O. BOX 594 LOURENCO MARQUES, MO- ZAMBIQUE, E. AFRICA 1:30-3:30 p.m., Mon., Thurs., and Sat.</p>
<p>5853 kc. WOB -C- 51.26 meters LAWRENCEVILLE, N. J. Calls Bermuda, nights</p>	<p>5780 kc. OAX4D -B- 51.9 meters P. O. Box 853 LIMA, PERU Mon., Wed. & Sat. 9-11:30 p.m.</p>	<p>4975 kc. GBC -C- 60.30 meters RUGBY, ENGLAND Calls Ships, late at night</p>	<p>4273 kc. RV15 -B- 70.20 meters KHABAROVSK, SIBERIA. U. S. S. R. Daily, 3-9 a. m.</p>	<p>3490 kc. YDH3 -B- 85.96 meters BANDONG, JAVA Daily except Fri., 4:30-5:30 a. m.</p>
<p>5850 kc. YV5RMO -B- 51.28 meters MARACAIBO, VENEZUELA 5:15-9 p. m.</p>	<p>5714 kc. HCK -B- 52.5 meters QUITO, ECUADOR, S. A.</p>	<p>4820 kc. GDW -C- 62.24 meters RUGBY, ENGLAND Calls N.Y.C., late at night</p>	<p>4272 kc. WOO -C- 70.22 meters OCEAN GATE, N. J. Calls ships Irregularly</p>	<p>3040 kc. YDA -B- 98.68 meters NIROM TANDJONGPURIK, JAVA 10:30 p.m.-1:30 a.m., 5:30-11 a.m.</p>

All Schedules Eastern Standard Time

Police Radio Alarm Stations

<p>CGZ Vancouver, B.C. 2342 kc. CJW St. Johns, N.B. 2390 kc. CJZ Verdoon, Que. 2390 kc.</p>	<p>KNFA Clovis, N.Mex. 2414 kc. KNFB Idaho Falls, Idaho 2414 kc. KNFC SS Gov. Stevens, (Wash.) 2490 kc. KNFD SS Gov. J. Rogers, (Wash.) 2490 kc. KNFE Duluth, Minn. 2382 kc. KNFF Leavenworth, Kans. 2422 kc. KNFG Olympia, Wash. 2490 kc. KNFH Garden City, Kans. 2474 kc. KNFI Mt. Vernon, Wash. 2414 kc. KNFJ Pionera, Cal. 1712 kc. KNFK Bellingham, Wash. 2490 kc. KNFL Shuksan, Wash. 2490 kc. KNFM Compton, Cal. 2490 kc. KNFN Waterloo, Iowa 1682 kc. KNFO Storm Lake, Iowa 1682 kc. KNFP Everett, Wash. 2414 kc. KNFQ Skykomish, Wash. 2490 kc. KNGE Cleburne, Tex. 1712 kc. KNGF Sacramento, Cal. 2422 kc. KNGG Phoenix, Ariz. 1698 kc. KNGH Dodge City, Kans. 2474 kc. KNGI El Centro, Cal. 2490 kc. KNGJ Duncan, Okla. 2450 kc. KNGL Galveston, Tex. 1712 kc. KSNE Duluth, Minn. 2382 kc. KSW Berkeley, Cal. 1658 kc. KVP Dallas, Tex. 1712 kc. VDM Halifax, N.S. 1690 kc. VYR Montreal, Can. 1706 kc. VYW Winnipeg, Man. 2396 kc. WCK Belle Island, Mich. 2414 kc. WEY Boston, Mass. 1630 kc. WKDT Detroit, Mich. 1630 kc. WKDU Cincinnati, Ohio 1706 kc. WMJZ Indianapolis, Ind. 2442 kc. WMD Buffalo, N.Y. 2422 kc. WMO Highland Park, Mich. 2414 kc. WMP Framingham, Mass. 1666 kc. WNFP Niagara Falls, N.Y. 2422 kc. WPDA Tulare, Cal. 2414 kc. WPDB Chicago, Ill. 1712 kc. WPDC Chicago, Ill. 1712 kc. WPDD Chicago, Ill. 1712 kc. WPDE Louisville, Ky. 2442 kc. WPDF Flint, Mich. 2466 kc. WPDG Youngstown, Ohio 2458 kc. WPDH Richmond, Ind. 2442 kc. WPDI Columbus, Ohio 2430 kc. WPDK Milwaukee, Wis. 2450 kc. WPDL Lansing, Mich. 2442 kc. WPDN Dayton, Ohio 2430 kc. WPDQ Auburn, N.Y. 2382 kc. WPDO Akron, Ohio 2458 kc. WPDP Philadelphia, Pa. 2474 kc. WPDR Rochester, N.Y. 2422 kc. WPDS St. Paul, Minn. 2430 kc. WPDT Kokomo, Ind. 2490 kc. WPDU Pittsburgh, Pa. 1712 kc. WPDV Charlotte, N.C. 2458 kc. WPDW Washington, D.C. 2422 kc. WPDY Detroit, Mich. 2414 kc. WPDZ Atlanta, Ga. 2414 kc. WPEA Fort Wayne, Ind. 2490 kc. WPEB Syracuse, N.Y. 2382 kc. WPEC Grand Rapids, Mich. 2442 kc. WPED Memphis, Tenn. 2466 kc. WPEE Arlington, Mass. 1712 kc. WPEF New York, N.Y. 2450 kc. WPEG New York, N.Y. 2450 kc. WPEH New York, N.Y. 2450 kc. WPEI Somerville, Mass. 1712 kc. WPEJ E. Providence, R.I. 1712 kc. WPEK New Orleans, La. 2430 kc. WPEL W. Bridgewater, Mass. 1666 kc. WPEM Woonsocket, R.I. 2466 kc.</p>	<p>WPEP Kenosha, Wis. 2450 kc. WPES Saginaw, Mich. 2442 kc. WPET Lexington, Ky. 1706 kc. WPEV Portable (in Mass.) 1666 kc. WPEW Northampton, Mass. 1666 kc. WPFA Newton, Mass. 1712 kc. WPFC Muskegon, Mich. 2442 kc. WPFE Reading, Pa. 2442 kc. WPFH Jacksonville, Fla. 2442 kc. WPFJ Baltimore, Md. 2414 kc. WPFK Columbus, Ga. 2414 kc. WPL Hammond, Ind. 1712 kc. WPLM Hackensack, N.J. 2430 kc. WPLN Gary, Ind. 2470 kc. WPLP Birmingham, Ala. 2382 kc. WPLQ Fairhaven, Mass. 1712 kc. WPLR Knoxville, Tenn. 2474 kc. WPLS Clarksburg, W.Va. 2490 kc. WPLT Swathmore, Pa. 2474 kc. WPLU Johnson City, Tenn. 2470 kc. WPLV Asheville, N.C. 2474 kc. WPLW Lakeland, Fla. 2442 kc. WPLX Portland, Me. 2422 kc. WPLY Pawtucket, R.I. 2466 kc. WPM Bridgeport, Conn. 2466 kc. WPMH Palm Beach, Fla. 2442 kc. WPMI Yonkers, N.Y. 2442 kc. WPMJ Miami, Fla. 2442 kc. WPMK Bay City, Mich. 2466 kc. WPMN Port Huron, Mich. 2466 kc. WPMO S. Shenectady, N.Y. 1658 kc. WPMR Rockford, Ill. 2458 kc. WPMQ Providence, R.I. 1712 kc. WPMG Findlay, Ohio 1596 kc. WPMH Albany, N.Y. 2414 kc. WPMI Portsmouth, Ohio 2430 kc. WPMJ Utica, N.Y. 2414 kc. WPMK Cranston, R.I. 2466 kc. WPMN Binghamton, N.Y. 2442 kc. WPMO South Bend, Ind. 2490 kc. WPMR Huntington, N.Y. 2490 kc. WPMQ Muncie, Ind. 2442 kc. WPMG Columbus, Ohio 1596 kc. WPMH Mineola, N.Y. 2490 kc. WPMI New Castle, Pa. 2482 kc. WPMJ Cohasset, Mass. 1712 kc. WPMK Boston, Mass. 2382 kc. WPMN Mobile, Ala. 2466 kc. WPMO Worcester, Mass. 2474 kc. WPMR Johnson City, Tenn. 2466 kc. WPMH Fitchburg, Mass. 2422 kc. WPMI Nashua, N.H. 1682 kc. WPMJ Massillon, Ohio 2458 kc. WPMK Steubenville, Ohio 1634 kc. WPMN Marion Co., Ind. 2450 kc. WPMO Richmond, Va. 1712 kc. WPMR Medford, Mass. 2490 kc. WPMQ Charleston, W.Va. 2490 kc. WPMG Fairmont, W.Va. 1596 kc. WPMH Wilmington, Ohio 1682 kc. WPMI Portable in Ohio 2442 kc. WPMJ Orlando, Fla. 2466 kc. WPMK Tampa, Fla. 2466 kc. WPMN Zanesville, Ohio 2466 kc. WPMO Jackson, Mich. 2490 kc. WPMR Parkersburg, W.Va. 1634 kc. WPMQ Culver, Ind. 1682 kc. WPMH Cambridge, Ohio 2450 kc. WPMI Bristol, Va. 2474 kc. WPMJ Elizabethton, Tenn. 1674 kc. WPMK Harrisburg, Pa. 2458 kc. WPMN Cleveland, Ohio 2474 kc. WPMO Toledo, Ohio 2414 kc. WPMR Groves Pt. Village, Mich. 1666 kc. WPMQ E. Lansing, Mich. 1666 kc.</p>
--	---	--

"WHEN TO LISTEN IN"
Appears on Page 305

(Television Stations See Page 302)

ANTENNA CONDENSER SWITCH
\$5.00 Prize

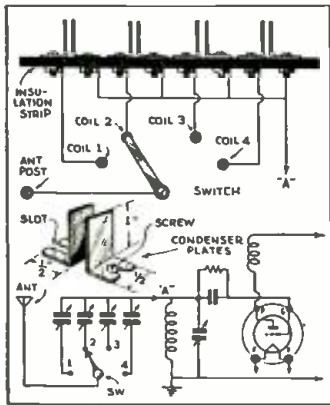

The short-wave experimenters who build simple receivers which require the use of an antenna-coupling condenser will find this kink especially valuable. It consists of a small strip of bakelite or other insulating material on which is mounted four antenna-coupling condensers. The drawing clearly shows how these plates should be made in order to be adjustable. There is a separate condenser for each short-wave band and when putting it into operation each condenser should be adjusted for that particular band. Then when you change from one band to another it is only necessary to rotate the switch and bring the antenna condenser for that band into use.—Charles Dopita.

\$5.00 FOR BEST SHORT-WAVE KINK

The Editor will award a five dollar prize each month for the best short-wave kink submitted by our readers. All other kinks accepted and published will be awarded eight months' subscription to **SHORT WAVE CRAFT**. Look over these "kinks" and they will give you some idea of what the editors are looking for. Send a typewritten or ink description, with sketch, of your favorite short-wave kink to the "Kink" Editor, **SHORT WAVE CRAFT**.

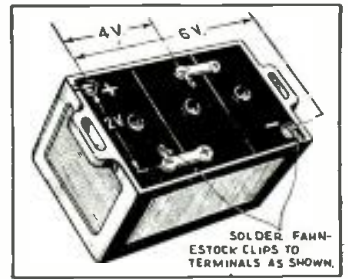

HANDY TEST-PROD

A very serviceable test-prod can be made from ice-picks by covering part of the pick with rubber tubing (see drawing) and by fitting rubber stop-plug caps on each end of the wooden handle. The wire goes in through the top.—Harry Hassink.

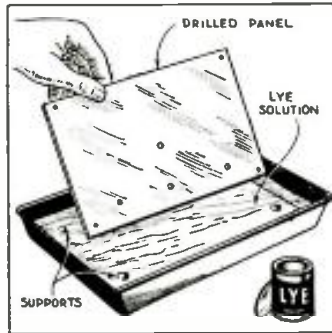

PUSH-PULL INPUT TRANSFORMER

Set builders desiring to use push-pull in the output stage can save the cost of an "input" push-pull transformer by wiring it in accordance with the accompanying diagram. Any standard audio transformer can be used, and gives tone quality equal to that obtained by using a regular push-pull input transformer.—David Eastman.

INDUCTANCE SWITCH

In order to make an inductance switch from an old rheostat, remove the element part and unwind the resistance wire. At even intervals wind a thin piece of copper strip around the form that the wire was wound on. Insert as many strips as you want contacts and reassemble rheostat. This switch can be used with tapped S-W coils.—Joe Naemara.

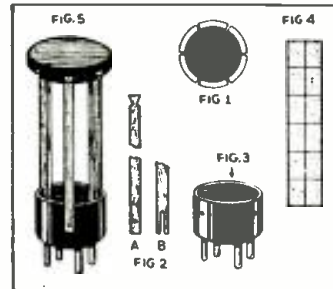
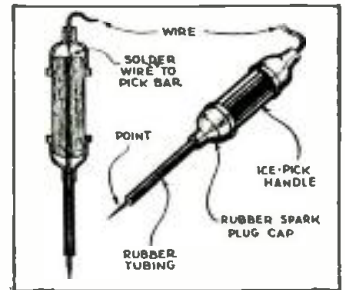

PLUG-IN COIL FORM

Good plug-in coil forms can be made using old tube bases. Cut a strip of paper the circumference of the tube base and use a compass or dividers to divide it into six equal parts (Fig. 4). Wrap this around the base and drill shallow holes in the base, on the division lines, with a knife point. Finish drilling the holes with a 1/16-inch drill. (Fig. 3.)

The top of the coil form is made of wood. A circle is cut from a three-eighths or one-half-inch board. Make the top one-half inch larger in diameter than the tube base. Draw a circle on the underneath side of the top one quarter of an inch smaller than its diameter. This is the guide line for adjusting the upper ends of the upright pieces. Divide the top into six equal parts and cut the notches for the upper ends of the upright pieces, on the dividing lines. The shape of the notches can be seen by looking at the finished coil form. (Fig. 5.) The upright pieces may be made of wood, hard rubber or bakelite. Cigar-box wood is easy to work and makes good coil forms. The lower end is slotted to fit over the tube base. (Fig. 215.)—Earl Ewens.

FINISHING ALUMINUM PANELS

It is now possible for the amateur set builder to put a professional-like finish on his aluminum panels. Simply make a solution consisting of one can of household lye to one gallon of water. Put this into a cheap tin baking pan. It should be large enough to hold the panel when it is resting on four supports, which are used to keep it from touching the sides of the pan. These supports can be small stones, or anything of like nature. The panel should first be thoroughly washed and then placed "face up" in the pan, being sure that it is covered with the solution. The usual time required is from ten to thirty minutes, the larger the panel, the longer the time required to finish it.—Jim Bokluk.

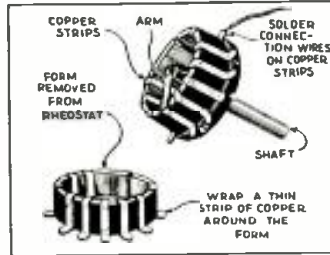

VERNIER REGENERATION CONTROL

For smooth regeneration control on very weak signals the following kink is very effective: Connect a three-plate midsize condenser across the main regeneration control condenser. With the plates of this vernier condenser uncharged, tune in a signal and stop the set from oscillating with the main control. Now, gradually increase the capacity of the vernier condenser and you will find that the signal can be built up to a much greater extent than with the ordinary control.—W. Zelezng.

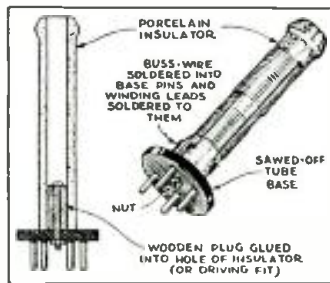

INSULATING TUBE COIL FORM

I have found a convenient method of using old lead-in insulators and old tube bases for a very compact and efficient coil form. A bolt is cemented in the small end of the insulator with porcelain cement or regular household cement. Then a 1/4" hole is drilled through the center of the tube base for the bolt to pass through, and the tube base is bolted on with this arrangement. This coil works fairly well and is very compact. Also, the knob on the insulator acts as a good handle.—Bud Noratta.

FOR YOUR DX-ER TIPS

For the DX-er who receives tips and notices of special broadcasts and new stations from various sources and wants a compact way of recording them, this little idea might help. Get a diary (at least 6x8 inches, with ruled pages for each day in the year) and as you receive your tips enter them in the diary. Then when doing your DX-ing you have all the information in front of you, by simply turning up the required day. As an example you get a tip that a certain station is on Monday, Wednesday, and Saturday, and you wish to send them a report and you have not heard the same. Enter the station and frequency as well as time on the first M, W, and S, to come and then when DX-ing on that day, this information will be before you in compact form. This can also be used when you receive an advance notice of a special DX broadcast that you wish to hear.—James F. Maguire.

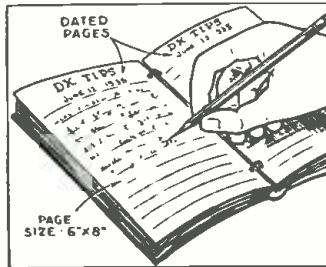

TAPPING STORAGE BATTERY

In obtaining different filament on heater voltage for tubes from storage batteries, I solder Fahnestock clips on each section of the battery, then I have 2 volts, 4 volts, and 6 volts. When reducing to a fraction of the next voltage, I use a variable resistor and a voltmeter to obtain the correct voltage.—Walter Kinkowski.

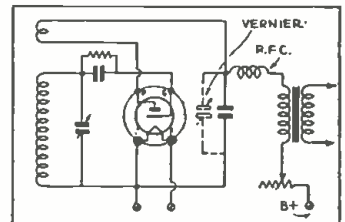

REAL VERNIER TUNING

For the radio operators who are having trouble tuning in stations on their vernier dial, I present the following kink: Take an ordinary vernier dial and remove the knob. Mount your tuning condenser on a second metal panel about three inches from the front panel, next mount a vernier dial with a knob removed on your second panel with a fiber insulating rod connecting the front vernier dial with the second one. Place the first knob on the front of your panel and place the second one in back on a supported metal panel and your "super-vernier" tuner is complete.—Otis R. Hill, Jr.

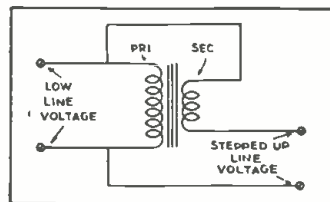
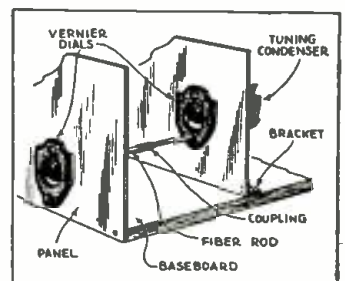

VOLTAGE BOOSTER

The A.C. line voltage, particularly in rural communities, sometimes drops to a low value during the evening hours. An easy and simple way to boost it to its proper value is to use a small transformer, with a secondary rating of between 5 and 15 volts, connected as shown. It may be necessary to reverse the leads to the secondary to get the proper relation between primary and secondary windings.—George Jelinek.

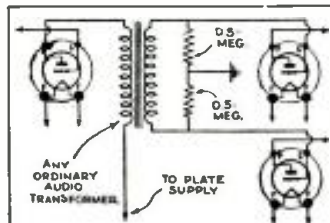

Short Wave

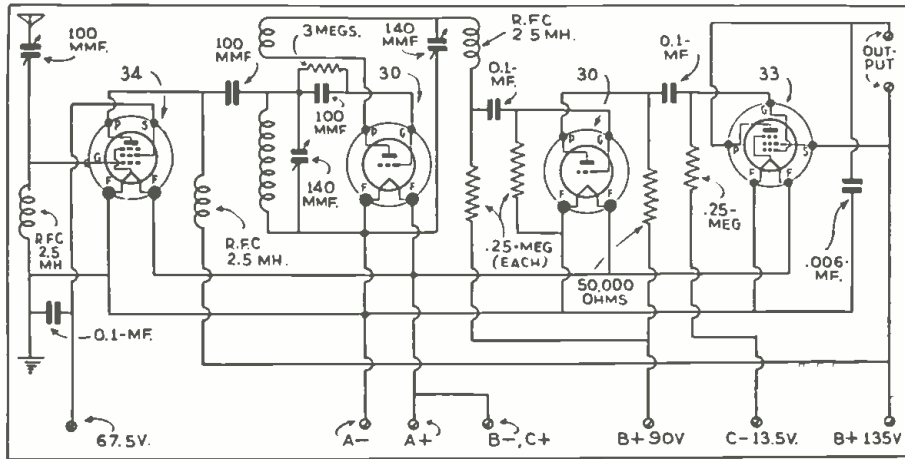

4-tube battery-operated short-wave receiver.

FOUR-TUBE BATTERY SET

John Lemko, Auburn, N.Y.

(Q) I would like to build a short-wave receiver having 4 battery tubes using a 32 or 34 in the untuned R.F. stage, followed by two 230's and a 33 in a resistance-coupled circuit.

(A) We are pleased to print the diagram you requested and you should obtain excellent results with it. It should operate a speaker on most of the stronger stations, that is, a sensitive magnetic speaker.

WHY NOT 57 A.F. AMPLIFIERS?

W. Q. Jones, New York City

(Q) I have been a reader of *Short Wave Craft* for a number of years and in your *Question Box* I seldom see high-gain pentodes used in audio amplifiers.

Why don't you use tubes such as the 57 or 6C6 as they give greater amplification than the other tubes? Wouldn't two 57's and a 2A5, transformer coupled, give a great deal of amplification without much feedback?

(A) Since the 2A5 does not require a tremendous amount of excitation or input voltage, it would not be advisable to use two 57's as drivers. A single 56 is entirely satisfactory, especially when you are using the amplifiers on a short-wave receiver.

A 56, properly driven, will result in the maximum output obtainable with a 2A5 connected as a pentode. Therefore, additional amplification before the 2A5 would only result in greater gain and no greater volume.

HAM SYMBOLS

Claude M. Willson, Newark, Ohio.

(Q) I would like to have some information regarding the various groups of letters used by amateurs. I have heard the various expressions and was, of course, unable to understand the conversation because I did not know what these meant. They are: OM, YL, HI, 73, QSL, FB, QST, CQ, QSO, VE4, W6, W2.

(A) They are respectively: old man, young lady, indicates laugh, best regards, verify reception, fine business, general broadcast by A.R.R.L., general inquiry call, establish contact, 4th Canadian District, 6th American District, 2nd American District.

ECONOMICAL A.C. RECEIVER

Short-wave Fan, Schenectady, N.Y.

(Q) I would like to have you print a diagram of a 4-tube A.C. receiver using a 6C6 and a 37 and two other similar tubes.

(A) The diagram you requested is shown on this page. In the R.F. stage a 6D6 pentode is used inductively coupled to a 6C6 regenerative detector. In the audio amplifier we have two stages of resistance-coupling using a 37 driver and a 41 pentode output tube. This should make an excellent short-wave receiver.

If you should wish to add band-spread to this receiver it is only necessary to connect two small tuning condensers in parallel with the large ones. These small condensers should have a capacity of from 20 to 35 mmf. The small ones will be used for band-spread and the large ones for band-setting.

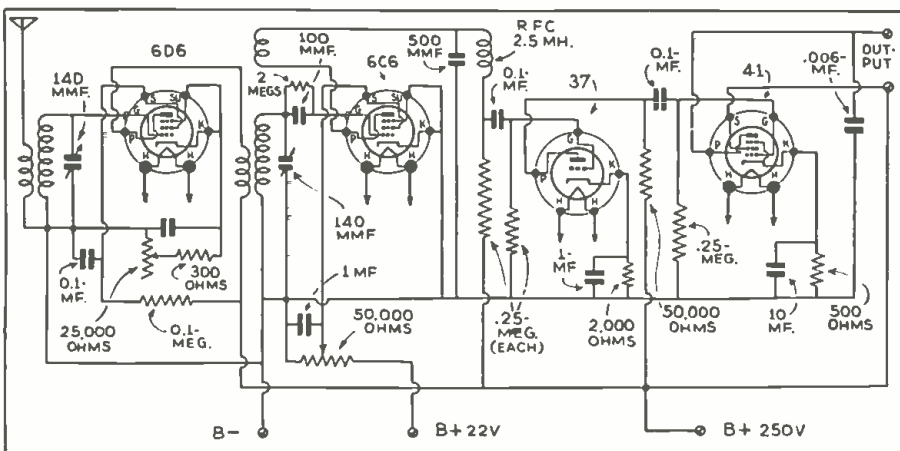

Economical T.R.F. receiver with 6.3 volts tubes.

EDITED BY GEORGE

Because the amount of work involved in the drawing of diagrams and the compilation of data, we are forced to charge 25c each for letters that are answered directly through the mail. This fee includes only hand-drawn schematic drawings. We cannot furnish "picture-layouts" or "full-sized" working drawings. Letters not accompanied by 25c will be answered in turn on this page. The 25c remit-

OHM'S LAW

Donald Johnson, Salina, Kansas.

(Q) What values of resistors should be connected in series with a 250-volt power supply to reduce it to 135 volts at 40 ma. (milliamperes).

(A) To find the value of a resistor proceed as follows: subtract 180 volts from 250 volts; this leaves 70 volts. Ohm's Law states that ohms equal voltage divided by the current. The voltage across the resistor would be 70 volts, and the current flowing through it being .040 amperes, the answer is 1750 ohms. The other values can be found by following the same rule.

TWO-STAGE AUDIO AMPLIFIER

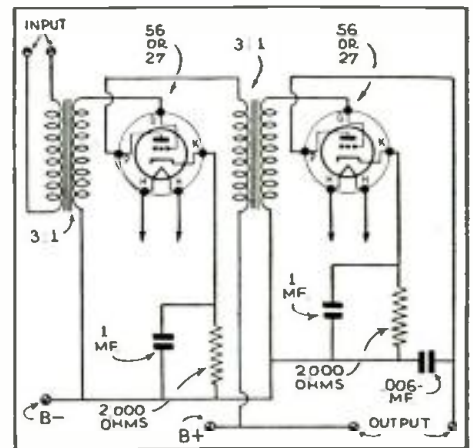

Diagram of 2-stage A.F. amplifier

Sal Ferle, Hartford, Conn.

(Q) Will you kindly print a diagram of a 2-stage amplifier which can be used with a short-wave receiver already having a 27 tube. This amplifier should use the type 27 in both stages.

(A) The 2-stage amplifier shown in the diagram will work very satisfactorily with your 1-tube receiver. Two stages of audio amplification are obtained with the two type 27 tubes, which are interchangeable with 56's. The 56's are slightly more economical, because they require less heater current.

NOISY CONDENSER

Kurt Sporre, Plainfield, N.J.

(Q) When the main tuning condenser of my 3-tube short-wave receiver is turned rapidly, loud clicks are heard in the headphones. Would you please tell me what the cause of this is?

(A) Undoubtedly your trouble is due to dirty bearing in the condenser or possibly the rotary plates have become slightly bent and are shorting condenser.

We suggest that you give it a thorough cleaning and examine the plates to make sure they are not bent.

A pipe-cleaner can be used to clean out the dust and dirt which may accum-

QUESTION BOX

W. SHUART, W2AMN

tance may be made in the form of stamps or coin.

Special problems involving considerable research will be quoted upon request. We cannot offer opinions as to the relative merits of commercial instruments.

Correspondents are requested to write or print their names and addresses clearly. Hundreds of letters remain unanswered because of incomplete or illegible addresses.

ulate between the plates. For greasy substances it may be necessary to dip the pipe-cleaner in alcohol or some other liquid which will dry rapidly and leave the condenser clean.

POWER SUPPLY FOR SIMPLEST TRANSMITTER

Walter Nagy, Carteret, N.J.

(Q) Will you please publish a diagram of a power supply which can be used in conjunction with the "Simplest Ham Transmitter" which was described in the June issue of *Short Wave Craft*?

(A) The transmitter using the single 802 tube has been found to be very effective, and we are pleased to print this power supply diagram which should be very satisfactory.

Make sure the power supply transformer has the 6.3-volt filament winding, otherwise it will be necessary to use a separate

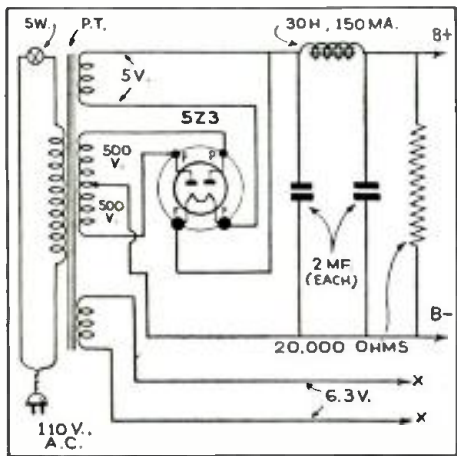

Simple 500-volt power supply.

transformer for the heater. The transformer should be capable of supplying at least 500 volts at 150 milliamperes.

A 3-TUBE A.C. RECEIVER

Carman Keim, Hollsopple, Pa.

(Q) I have a 2-tube short-wave set using a 6C6 regenerative detector and a 37 audio amplifier. I pick up all the U. S. and Canadian stations and several South Americans. Do you think it is possible for me to receive European stations with this set?

(A) There is no reason in the world why you should not pick up European stations if you are receiving the South American and Canadian stations.

(Q) Please put in a diagram for a 3-tube A.C. set using a 6C6, one 37, and a power tube such as 42 or any other similar tube.

(A) We take pleasure in presenting the diagram on this page which uses a 6C6 regenerative detector, a 37, and a 41 as audio amplifiers all resistance-coupled. You should obtain excellent results with this set.

FINDING HIGH VOLTAGE LEADS IN RECEIVERS

Walter Lee, Wahiawa, Oahu, T.H.

(Q) I am a beginner and interested in building a 2-tube receiver. I would greatly appreciate it if you would answer the following question: Which is the "B" negative and the "B" positive of an A.C. all-electric receiver?

(A) In the majority of cases B negative is the chassis. In other words, a connection going to the metal chassis will form the "B" negative side of the circuit. The "B" plus will be found by tracing the leads from the filament of the rectifier tube through a filter choke or speaker field and then to the voltage divider (resistance). At this point on the voltage divider the maximum "B" plus usually exists.

A.F. AMPLIFIER

Lewis Wiederhold, Philadelphia, Pa.

(Q) Please publish in your *Question Box* a diagram of a 2A5 in an audio amplifier circuit to be used in conjunction with the National SW3. I think either resistor- or impedance-coupling would be best since the radio is used in the SW3 receiver.

(A) You will find such a diagram on this page using resistance-coupling. This will work with any short-wave receiver having a triode output tube.

AMPLIFIER FOR HAM-BAND PEE-WEE

Matthew Dawidowicz, Chicago, Ill.

(Q) Would you be good enough to illustrate a 1-tube amplifier, which could be added to the "Pee-Wee" receiver, using either a 47 or 2A5 tube, whichever would be best?

(A) We believe a 2A5 would be much more suitable than a 47, inasmuch as it has an indirectly heated cathode and allows a simpler method for obtaining bias. You will find a diagram printed herewith.

UNTUNED R.F. AMPLIFIER

M. Krochak, Rahway, N.J.

(Q) I am one of your lucky readers who built the "2-Tube Band-Spread Doerle" described in the May 1935 issue of *Short Wave Craft*. The set has been even better than you claimed it would be. However, I would like to add an untuned R.F. stage to it, using a 58 tube. Would you be kind enough to print the necessary diagram?

(A) The diagram of the 58 R.F. amplifier is shown herewith. You will notice that in the grid circuit we have shown both a coil and a resistor. These are not used

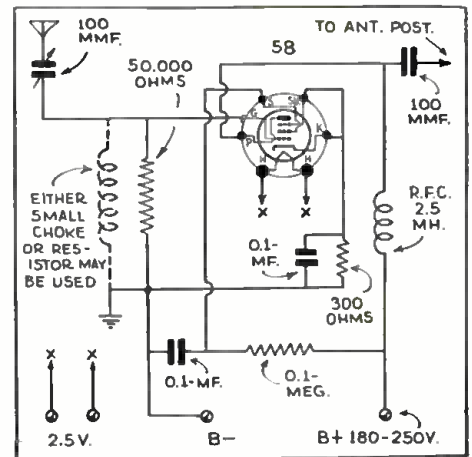

Untuned R.F. amplifier for Doerle set.

together. The choke coil, if one is used, should be 2.5 mh., and the resistor used should have a value of approximately 50,000 ohms.

If the receiver with an untuned R.F. stage is to be operated in locations close to powerful broadcast stations, there is liable to be interference, moreso with the choke than with the resistor. The solution of the problem is to tune the R.F. stage. This is readily accomplished by replacing the choke with a plug-in coil and tuning this coil with a regular tuning condenser.

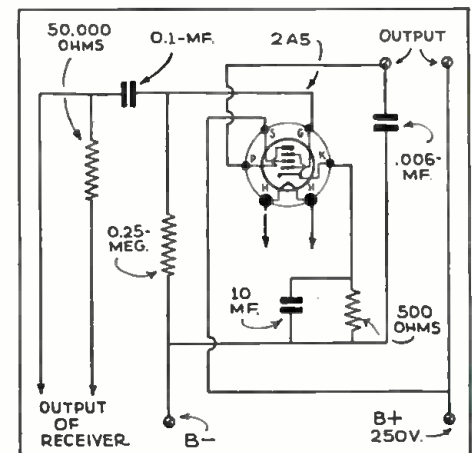

One-stage resistance-coupled amplifier using 2A5.

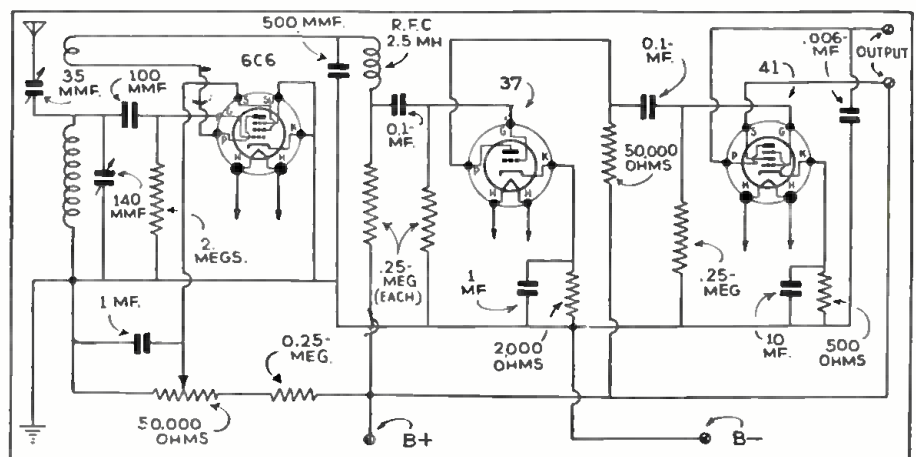

Three-tube diagram with two resistance-coupled audio stages

Short Wave SCOUT NEWS

Listening Post Report from Cleveland, Ohio

● THE 25-meter band seems to be the best, because of less atmospheric disturbances. The 49-meter band is not so good at the present time. Amateur reception has been good this month and I shall appreciate their cards. I have already sent them mine. Received on 19 to 20 meters—EA4AO; H17B; LU1AP; UP5IS; ON4RX; K4SA; B2AK and B2AH, and many others from Hawaii, Mexico, Cuba, South American countries, Canada, and the United States. Here is an opportunity to pick up another "veri" for that collection of yours. EAQ Station Magazine, \$1.00 for a one year's subscription. The book is written in both English and Spanish, and a special prize verification is given with each subscription. So log them and send for it; address P. O. Box 951, Madrid. HJ5ABC, Cali, Colombia, listed as 53.00 meters is now 42.70 meters. Mon., Tues., Wed., and Fri., 7 to 9:30 p.m.

PK1WK is now changed to YDH3 DeKORT-Bandoeng, Java, 85.96 met. daily, except Fri., 4:30 to 5:30 a.m.

Watch for these stations, they will be on the air soon.

DURBAN, Africa, (no call so far) 48.00 meters, 4:00 a.m. to 3:30 p.m. Address is: African Broadcasting Co., Town Hall, Durban, Africa.

HP5H, The Voice of Colon, on 49.40 meters, 300 watts power. (Colon, Panama, or Canal Zone.)

There are three stations owned and operated by the SOCIETE-HAITIENNE-DE-AUTOMOBILE, P. O. Box 103, Port Au Prince, Haiti. They are: HH2R, Port Au Prince, 31.40 mtrs. No time sch'd. HH2S, Port Au Prince, 49.40 mtrs. No time sch'd. HH2T, Port Au Prince, 25.90 mtrs. No time sch'd.

I heard HH2R announcing this information on June 12.—Wm. C. Palmer, R 2, Brooklyn, Stn., Cleveland, Ohio.

Huntington Beach, Calif., Report

● THE 31- and 49-meter bands have been very noisy; although there has been very much noise we have been able to pull through all the G-stations and all of the DJ's.

For the last three weeks we have been receiving PLV, Bandoeng, Java, with a R9 volume. They have been coming through on Tuesday mornings at 7:00 a.m., P.S.T., with a musical program of Javanese music, but they announce in English.

TIRCC, San Jose de Costa Rica has been "banging in" here with R9 volume.

This Post has enjoyed listening to the NBC experimental station W10XFN located in Rapid City, S. Dak., testing with W3XL, Bound Brook, N.J., every Monday and Friday evening, about 6:00 p.m., P.S.T.

HKV has been coming in quite regularly with R8-9 volume.

HCJB, Quito, Ecuador, comes in very good every evening; their schedule is daily, 7:00 p.m. to 11:00 p.m., E.S.T., except Sunday. Sunday they are on from 4:00 p.m., E.S.T. till 10:00 p.m.

Radio "COLONIAL" on 25 meters comes in very good. CJRO and CJRX have been pounding in here QSA-5-R9 PLUS, all this month.

I would like to say that the reception of these stations is all received on loud-speaker; we don't use headphones at all. Verifications received this last week were 3ME, Aust., HCJB, Quito, on 36.5 meters; TIRCC 45.8 and 22.30 meters, and also CO9GC, Cuba. CO9GC is not owned by Grau and Caminero any more, but Mr. Grau is the sole owner of this station now.

Hank G. Wedel,
305 Sixth St.,
Huntington Beach, Calif.

O.L.P. Report from Freeport, Pa. Report for June

This is a report on how I tune for short-wave stations.

On Sundays at 6:00 p.m., E.S.T. on 31.28 meters. VK2ME is very fine business; we can hold them till 8:00 p.m., E.S.T.

At 8:00 p.m. we can either tune in on PCJ, 19.71 meters, PHH, 16.88 meters, CS6,

Robert Graham Proud of His "Trophy"

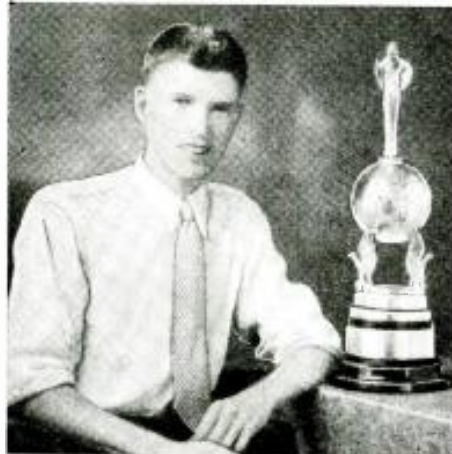

Your trophy has been admired by a great many people who have visited my house, and they all think that your contest is a very fine idea. I will be very glad to answer any letters from other readers of your fine magazine who enjoy dialing for foreign stations.

Thanking you again for the many courtesies extended, and hoping this photograph is satisfactory.

ROBERT GRAHAM,
Flint, Mich.

16.86 meters, DJE, 16.89 meters. Irregular times and Radio Coloniale which does not come in very good at this time of the year.

We listen to them for about an hour and a half, then go fishing for Rk1 on 19.94 meters or RNE on 25 meters.

In the afternoon at 2:00 o'clock Radio Coloniale is very "fine business" on 25.23 meters up until the "sign-off."

2RO on 31.13 meters is heard also. They have now changed to 25.4 meters IRM on 30.52 meters can be heard calling Cairo from 4:00 to 6:00 p.m., playing records. They have a bad hum—something like W1XK's. DJD (at 5 p.m., E.S.T.) on 25.49 meters comes in and they are always heard good.

"Radio Coloniale" (at 6:00 p.m.) is on 25.60 meters; HJ4ABA on 25.60 meters and GSD on 25.53 meters.

The 49-meter band (although there is a lot of static) YV3RC, HJ1AB, XEBT, YV6RV and HC2RL are heard fine.

Latest "Hot" Tips for Short-Wave Listeners from our "OFFICIAL LISTENING POSTS"

W8XK now uses the National anthem as their "sign-off" signature.

Angelo Centanino,
Box 516, Freeport, Pa.

Report from Oliver Amlie, Phila., Pa.

● RECEPTION at this post has been very good for all of 1935 so far; reception on 16 to 40 meters has been best from March up till now, June. These bands will be good till late in October. Best hours to listen in, 16 to 35 meters, from 6:00 E.S.T. to 10 a.m.; 6:00 p.m. to 1:00 a.m., 2:00-3:00 a.m. The short-wave band of 25 meters is crowded with stations from 6 p.m. to 1 a.m. each evening. Such stations as FYA, W8XK, KKQ, GSE, DJD, GSD, HJ4ABA, CJRX, KIO, and many other stations, new ones, but have not had time to find out what call letters they are; just chuckful of stations on this 25-meter band, also on the 28-31 meter band, at the same hours.

Here are a few "real" DX stations for the would be DYED-IN-THE-WOOL DX-er. The hours are early, but they are there for you to "grab."

(All Time "Eastern Standard Time.")
OPM 10100 kc. Belgian Congo. Fri. 2-3:15 a.m. often 1:45-2:15 a.m.

PPQ 10760 Rio de Janeiro. Fri. 7:00 p.m. till 8:30 p.m.

PSF 14590 Rio de Janeiro. Sat. 7:30-9:00 p.m.

PLV 9630 Bandoeng, Java, calling Tokio, Fri. 7-8:00 a.m.

TIBA 14485 Guatemala City. Sun. 5:30-7:00 p.m.

LTZ 9750 Sydney, Australia. 2:30-4:00 a.m. daily.

HRF 14950 Tegucigalpa, Honduras. Sat. Sun. 9:50-11:30 a.m.

YV4AC 7310 Caracas, Venezuela. Sun. 2:00-3:00 a.m.

VK2ME 9590 Sydney, Australia, Sun-Mon. 12 mid. to 2:00 a.m. 5:00-9:00 a.m. only.

VK3ME-VK3LR are still on the same hours as listed in *Short Wave Craft*.

VPD 13075 Suva, Fiji Island, is not always on the air from 1:30-2:30 a.m.

My Australian reception reports now stand up till June 18, at 185 complete, or 185 verifications; 300 is my mark by Oct. 25, 1935.

International 6,000 to 12,500 Mile Short-Wave Club

● OLIVER AMLIE, the very active short-wave listener of Philadelphia, Pa., has recently become president of the *International 6,000 to 12,500 Mile Short-Wave Club* and Joseph H. Millen of Brooklyn, N.Y., is vice-president.

To become a member of this club one must first pick out a station, one at least 6,000 miles or more distant and send the station from one to five reports of reception each month for three months. When sending in the first report he is to write the engineer of that particular station that he wishes to report to him for three months straight on reception of that station at his location; at the end of the three months period he will ask the station for a three-months' verification.

When receiving this three-months' "veri" you are to send this to the president of the club, Oliver Amlie, 56th City Line Ave., Overbrook, Philadelphia, Pa., and he will send you a Membership Card and return your "veri" with it. If you wish to try for more "veris" you will be awarded one "merit stamp" for each 6,000 mile or more distant station; after receiving 10 Merit Stamps you will receive one *Official Gold DX Ace Stamp*.

(Continued on page 312)

The Radio Amateur

(Continued from page 281)

we suggest that the readers refer to some of the excellent books which have been published covering this subject.*

If one would like to obtain a visual picture of the field and action of alternating current when applied to a solenoid a simple experiment can be made by constructing the apparatus shown in Fig. 2C. This consists of a coil having an iron core and beside this core a thin piece of steel is mounted. By fastening a piece of pencil lead to this piece of steel and placing under it a piece of paper, so that the lead comes in contact with the paper as it is moved along, the electrical action can be transferred to the paper by applying 110-volts 60-cycle A.C. to the coil, when the thin strip of steel will vibrate back and forth rapidly.

Now as we pull the paper forward at the rate of 1 foot per second we will have approximately 60 complete cycles drawn on the paper, very much similar to those shown in Fig. 1A.

A hydraulic analogy of the action of a transformer is illustrated in Fig. 2D, in the form of a hydraulic jack. We have a small pump to the left, which pumps liquid into a large cylinder, forcing the piston of this cylinder upward.

The principle is as follows: in the small pump we have high pressure and small quantity which, translated into electrical terms would mean, "high voltage and low current." In the large chamber of the hoist or jack, we have a large quantity and a low pressure. If the ratio between the areas of the two cylinders is 5 to 1 (1 square inch for the pump and 5 square inches for the hoist), then for every 5 inches of movement of the small pump, we have a movement of 1 inch in the large one. The reason one man can lift hundreds of pounds with this hoist is because if we exert a pressure of 50 pounds per square inch upon the small pump, we will have a lifting force equal to the ratio between the two, or 250 pounds, which will be lifted 1 inch for every 5 inches we move the pump at a pressure of 50 pounds.

Of course, this would only be true if there were no losses in the action of the pump; however as there is some loss, the pump is less than 100 percent efficient and we find the ratio of power transfer to be slightly less than 5 to 1. This also holds true in the operation of an electrical transformer which usually runs anywhere from 70 percent to 85 percent efficient.

The foregoing explanations of alternating current electricity and action of transformers was given in the briefest possible manner in order to acquaint the student with some of the principles involved, so that he may clearly understand some of the actions which will take place in radio circuits to be described later on in this series of lessons. For those seriously interested in the technical side of alternating current electricity we suggest that they read some of the excellent works on this subject.

OHM'S LAW
 $E = I \times R$
 $I = E \div R$
 $R = E \div I$

Where E is the voltage, I is the current and R is the resistance of D.C. circuits or A.C. circuits, where the circuit measured is purely resistive, noninductive, and non-capacitive, and the power factor is unity.

*Alternating Current Electricity, by Timble and Higbie.

New "Magnetic" Loud Speaker

Wright-DeCoster, Inc. are bringing out a magnetic type speaker which has many new features. The fact that it has fewer parts, no solder used in the mechanical linkages, and extremely rugged construction, should make it operate with no attention whatever almost indefinitely. The new "Hyflux" speaker has an exceptional frequency range for a magnetic type unit, with a tone quality very similar to a dynamic type speaker.

SEE FOR YOURSELF! FREE!!

Try a laboratory wired Fulltone V in your own home, under your actual operating conditions, without charge! Get your fingers on the controls and do some REAL DX-ing. Convince yourself that this is really the most sensational receiver today! After five days, if you can hear to part with it we don't want you to keep it! Send it back and we'll return your money without any deductions whatsoever. Your only expense is transportation.

But don't worry, we know you'll want to keep your Fulltone V! 8,611 satisfied owners can't be wrong!

THE NEW FULTONE V

is the set that pulls 'em in! It's small—it's inexpensive—But how those distant stations do roll in on the speaker! Even the most hard-boiled old-timer sits up and takes notice at the volume and clearness of speech with which DFB and DFB, Germany; GSB and GSC, England; EAM, Spain; PVA, France; and many others, are received! And even those hard-to-get stations—JVN, Japan; NK3ME and VK3LH, Australia; and ICNE, Russia came in with surprising ease! Amateurs? From all over the world!

Here's the set that we know you will be proud to own! That will give you and your friends a thrill at every turn of the dial!

Plugs into any 110 volt AC or DC house current outlet. Coils supplied tune from 15 to 200 METERS. Provision for built-in speaker—external speaker—or headphones. Correct design insures full five tube performance—screen grid RF—regenerative detector—1st AF—Power pentode output and rectifier. All from three dual purpose tubes! Entirely self-contained. Its light weight and compactness makes it an ideal portable set. Professional type "Sector Vision" dial. This is a receiver that is easy to operate—and which will outperform higher priced sets!

Correct design and the use of highest grade parts insures consistent and ever-remarkable performance for many years!
 Order Your Fulltone V today! We know that you, too, will say—Excellent!!

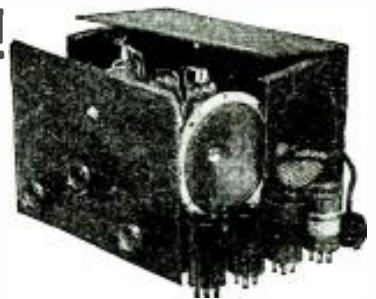

FIVE-IN-THREE 6F7-76-12A7

Complete kit, including all necessary parts (except hook-up wire), crystal finished metal chassis with all holes, and complete, easily followed instructions. **\$7.45**

Set of matched Sylvania Tubes.....\$2.20
 Metal cabinet as illustrated.....\$1.25
 Special loudspeaker.....\$1.45
 Two broadcast band coils.....\$1.25

\$12.75 SPECIAL COMBINATION OFFER **\$12.75**
 Complete Kit, Tubes, Speaker, Cabinet and Broadcast band coils.....

ANY KIT IN THIS AD **\$1.50**
 WIRED and TESTED **extra**

The Harrison "MULTI-KIT"

The greatest innovation in Short Wave history! 17 different receivers—battery, AC, and All Electric A.C.D.C. Each one carefully designed for world beating performance! A model for every taste and purpose! The "MULTI-KIT" FOUNDATION contains all of the parts common to each of these remarkable sets such as the heavy metal chassis with all holes drilled, the low-loss tuning condenser and 10-200 meter coils, condensers, resistors, etc. Add to this Foundation Kit any of the "Build-up Units" and you have all the parts to construct that set. Later, you can add more power to your set or change to any other model at small expense because you still use the same Foundation Parts.

Yet, despite this flexibility which enables you to keep your set up-to-date, each model actually brings you higher value at lower cost than ever before. For example, The Foundation Kit (\$3.45) plus the "Build-up Unit" No. 9 (\$1.80) gives you a modern, dry cell operated, "Three-in-one" receiver. It uses a type 19 twin triode and a 33 Power Pentode. The complete kit costs you only \$5.25. And look at this! Build-up Unit No. 13 added to the Foundation Kit (Total—\$5.90) makes an all-electric kit with its own built in power supply "Four-in-Two" with its twin 6F7 tube (Screen-grid pentode and high gain triode) and its twin 12A7 (power amplifier pentode and rectifier) Plugs into any light socket. Unbeatable Value!

Order Your Multi-Kit Today for Many Years of Real Fun!!

FOUNDATION KIT \$3.45

Built-Up Unit	Uses Tubes	Powered by	Price
No. 1	30	Batteries	40c
No. 2	30-30	Batteries	90c
No. 3	30-30-33	Batteries	\$1.45
No. 4	18	Batteries	\$1.10
No. 5	19-33	Batteries	\$1.80
No. 6	56	AC Power Pack	40c
No. 7	56	AC Power Pack	90c
No. 8	2A5	AC Power Pack	\$1.15
No. 9	50-50-2A5	AC Power Pack	\$1.65
No. 10	12Z3	All Electric	\$1.85
No. 11	12A7	All Electric	\$2.35
No. 12	36-70-12Z3	All Electric	\$2.40
No. 13	36-12A7	All Electric	\$2.40
No. 14	6F7-76-12A7	All Electric	\$2.40
No. 15	6F7-76-12Z3	All Electric	\$2.45
No. 16	6F7-12A7	All Electric	\$2.45

FREE SHORT WAVE CATALOG—SEND FOR IT!

HEY HAMS!! FIFTY WATTERS at the lowest price ever guaranteed Western Electric 211 D standard 50 watt transmitting tubes. Regular price is above \$15.00. **\$4.90**
 Our Special Price
 SEND FOR HAM LITERATURE

HARRISON RADIO CO. Dept. C-9 New York City
 142 Liberty Street
 ★★ THE HOME OF FOUR STAR SERVICE ★★

HANDY Electric PAINT SPRAYER

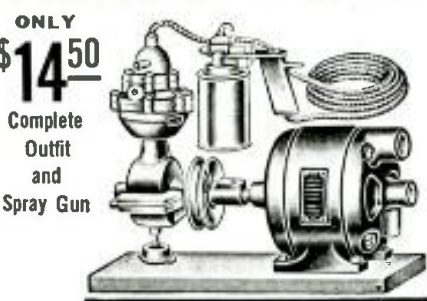

ONLY \$14.50
 Complete Outfit and Spray Gun

Startling offer! Famous spraying outfit includes pressure internal mix spray gun, adjustable, non-clogging, fan and round spray nozzles. Ideal for spraying paint, varnish, enamel, lacquer, shoe dyes, aluminum paint, insecticides, etc. The power was never time and labor and does better work. Outfit complete with spray gun, National Compressor with sealed piston (ensures pump will heavy duty Westinghouse motor 110 volt, 60 cycle, A.C. plug and cord safety valve, 15 ft. air hose. Just plug into light socket and it is ready for operation. \$14.50 complete. Send \$5.00 deposit, balance C. O. D. Shipping weight, 30 lbs. Sold on money-back guarantee basis.

Do not write for Catalog.

WELLWORTH TRADING COMPANY
 560 W. Washington Blvd. Chicago, Ill.

WELLWORTH TRADING COMPANY SW-935
 560 W. Washington Blvd., Chicago, Ill.

Enclosed you will find my remittance of \$14.50, for which please send me

Electric Paint Sprayer, by Express collect.
 Or \$5.00 deposit, with balance C. O. D.

Name.....
 Address.....
 City..... State.....

Triple-Sealed TUBULARS

See those wax filled ends? Something new—and important—in tubular condensers. It means triple-sealing: (1) Wax-coated non-inductive sections; (2) Wax impregnated tubing with embedded aluminum foil; (3) Wax-sealed ends. RESISTANCE to humidity; 4½ times longer life. And these AEROVOX quality units cost no more!

DATA Send for new 1935 catalog. Also sample copy of Research Worker.



72 Washington St. Brooklyn, N.Y.

Become a Radio Expert GOOD JOBS Learn RADIO-TELEVISION

Electricity—Talking Pictures—in Los Angeles
 Learn profitable trades by practical shop methods. Enroll with National—oldest, largest trade school in the West. 30,000 graduates. Quality as a radio repair man; television expert; sound expert; broadcast; station technician; electrician and for many other jobs. Earn room and board while learning. Biggest opportunity for you. For limited time we will allow coach railroad fare to Los Angeles. Send for free book which gives full details about different jobs you can qualify for. Complete course of instruction and photographs of school operations. Sign and mail coupon.

NATIONAL SCHOOLS,
 Dept. 9-SWC, 4000 So. Figueroa St., Los Angeles, Calif.
 Please send me your Big Free Book on Television, Talking Pictures Radio and Electricity. Also details of R. R. fare offer.

Name.....
 Address.....
 City..... State.....

SHORT WAVE LEAGUE



HONORARY MEMBERS

Dr. Lee de Forest
 John L. Reinartz
 D. E. Replugle
 Hollis Baird
 E. T. Somerset
 Baron Manfred von Ardenne
 Hugo Gernsback
Executive Secretary

Hot Arguments Against "No-Code" License

Learn Code, Says Ex-Navy Operator *Editor, Short Wave Craft:*

● GET into the game, o.m. (old man) and get into it right. This is a great fraternity and an organization of a bunch of wonderful fellows. The greatest bunch of fellows, as a whole you will meet, because they have nothing to gain or lose by being so. Once a Ham, always a Ham and no matter where you are, whether in the U.S.A. or away from it, if you see a funny-looking antenna, with wires leading down from it that looks like a ladder, you go right up to the front door and introduce yourself and you will be surprised at the reception you will receive.

Speaking of "long-lost" brothers you will

about the hardest thing to get but after you get it you sure can enjoy it. I always figured that if 50,000 others can do a thing, I will either do it or die in the attempt. Uncle Sam will never make a "no-code" test on any frequency, so get busy and join the greatest fraternity there is.

Thanking *Short Wave Craft* for the chance to give a practical version, I am

Very truly yours,
 HERBERT A. STEARNS,
 P. O. Box 133,
 Willimantic, Conn.

Don't Be Selfish—Learn Code, He Says *Editor, Short Wave Craft:*

● I HAVE been reading your magazine now for over four years and I truly believe it is the most interesting of them all for the average young operator or short-wave listener. Of course I read other magazines such as QST, R/9, RADIO, etc., but they are somewhat advanced for the most of us.

I do not have a transmitter of any sort yet, but I do expect to be "on the air" soon. The transmitter is now under construction. The one drawback seems to be the CODE. That brings up the CODE question.

I have been following the "NO-CODE" argument in your magazine each month and I, although I am only a "listener" now, am in favor of the code test for all bands. This code has had me stumped for the biggest part of two years now, but some day I will be able to pass it and, until then, I must stay in my place, which is nothing more than right.

I agree with A. F. Fraure on this code proposition. Just where would radio communication be today if it were not for the ability of transmission of the c.w. signals (code). Just look at the numerous rescues and public emergency aids that have the amateur to thank for being able to use this much-abused code. Now picture what would have happened had these operators been using phone for emergency work. We all know that c.w. will penetrate QRM where phone would not have succeeded.

Of course the question is for NO-CODE tests below five meters. It's true that these high frequencies are not being used for c.w. but—what will it be if we leave it in the hands of the modern amateur? It will be developed the same as all the

other bands have been in the past. If there be any doubt in your mind as to the truth of this statement, write to the A.R. R.L. headquarters and find out just what the real amateurs are doing in this band.

These hams in the East are not using their equipment for just a gossip QSO. They are using it for a purpose and that is to bring 5-meter rigs to as near perfection as it is possible. Just how much success would they have in doing this if the band was cluttered up by uninterested men, women and children passing their line of chatter on the gossip of their neighbors, men passing business hints, etc. Any human being with a head on his shoulders can see and understand just what this sort of a condition would lead to.

Even though the present-day, average 5-meter rig only pushes signals a few miles amateurs are working with equipment that will send and receive signals over a distance of a hundred miles or more.

Let us all think this thing over like hu-

(Continued on page 317)

Here's Your Button

The illustration here shows the beautiful design of the "Official" Short Wave League button, which is available to everyone who becomes a member of the Short Wave League.

The requirements for joining the League are explained in a booklet, copies of which will be mailed upon request. The button measures ¾ inch in diameter and is inlaid in enamel—3 colors—red, white, and blue.



Please note that you can order your button AT ONCE—SHORT WAVE LEAGUE supplies it at cost, the price, including the mailing, being 35 cents. A solid gold button is furnished for \$2.00 prepaid. Address all communications to SHORT WAVE LEAGUE, 99-101 Hudson St., New York.

be treated as a long-lost arm or leg. I have traveled over most of the U.S. and England and have visited with thousands of amateurs and I can truthfully say that I have never been made to feel unwelcome. I have learned a lot of radio from these visits also, picked up "dope" that I have found very useful, and I am not what one would call a "chicken" in this radio either.

I have fooled with radio since 1912, with the old spark coils for a transmitter, with the frequency taking up the entire dial and thought it great stuff when the Navy Yard in Boston told me to "pipe down," as I was causing interference there, twenty miles away! I served six years in the Navy and seven in the Marine Corps as an operator, besides giving the "commercial ticket" a whirl for eleven months! So I am not a "chicken" in this game, but I can still pick up information and "dope" and find it very useful. Learn the code, o.m., it might come hard to you, but at the same time all good things come hard. A million dollars is



Short Wave League

At a Directors Meeting held in New York City, New York, in the United States of America, the Short Wave League has elected

John F. Müller

a member of this League.

In Witness whereof, this certificate has been officially signed and presented to the above

H. W. Hill Secor
 Chief Secretary

This is the handsome certificate that is presented FREE to all members of the SHORT WAVE LEAGUE. The full size is 7¼" x 9½".

See page 318 how to obtain certificate.

This Crystal DX Business

● FROM time to time reports of extraordinary distances achieved by humble crystal sets give rise to heated contentions in the press and other circles where these matters are discussed. Thus it will continue until both contending parties realize that each is right. This, however, can only be possible if both the limitations and peculiarities of the humble (but not too humble) crystal sets are appreciated.

Many years ago crystal ranges at night often extended to several hundreds of miles; and transmitter powers then were but a fraction of those in use today. High-power transmitters extended the normal range of the crystal set very considerably, and it is by no means uncommon on a winter's night to find the field strength of a foreigner actually greater than that of the old local station. Since the crystal set used to receive the old locals fairly well, it follows that there must occasionally be foreigners who are now better received than those old-timers. But, in general, these are not really consistent, as fading and interference have to be taken into consideration.

How, then, shall we reconcile this with the claims of many people who have actually heard American broadcasts on simple crystal receivers? First, we must consider the relays from America—and it is surprising how many people still believe a relay to be a direct contact with the point of origin! Many claimants may fall under this heading. Second, we must put the effects of re-radiation, fortunately less serious today than formerly, since there are less sets reacting directly upon an aerial. The effects of re-radiation are interesting and perplexing, as may be seen from the following.

In the early days of broadcasting the writer's set was a detector with regeneration directly coupled to the aerial. A lady living a few doors away had a standard type of crystal set. Normally, only Cardiff was audible on this set, when the writer's set was not working. But, happily or unhappily for the lady, when the writer's set was in operation the only station audible on the crystal set was the one tuned in on the writer's set—Cardiff, Manchester, London, Brussels, Rome, or Madrid—and at considerably more volume than one would expect from a crystal set. Nor was this all, for one night, via radio, the writer heard himself being discussed in connection with a foreign program and was much perplexed, because he recognized the lady's voice. This was verified and it was found that if anyone spoke near the headphones attached to the crystal set, the speech was audible in the writer's phones, and vice versa. Thereafter, if the lady did not care for the program thrust upon her by the writer, in the first lull of the program she would say, "Can you please put me on to Rome?" and the writer would reply, "Stand by . . . over!" America was frequently received on the lady's crystal set through this phenomenon of re-radiation. The re-radiation did not appear excessive, but the aerials were fairly near.—J. C. E. in "World Radio," May 31 issue.

How to Test Small Fixed Condensers

● THE condition of fixed condensers of the mica or paper dielectric type can be determined easily by experimenters and the only equipment needed is a 45-volt B battery and a pair of phones. The simple procedure is described by W. M. Bailey, chief engineer of the Cornell-Dubilier Corporation, according to the New York Sun.

Connect the capacitor director across the battery for a second or two. Remove it and then carefully place the phone tips across the terminals of the capacitor. A single loud click, which is produced by the discharge through the phones, will indicate that the condenser is in good condition. If only a slight noise, or none at all, is heard, the capacitor is leaky, shorted, or open.

THE EILEN 5A RECEIVER



6D6-6D6-76-12A7 Tubes—A Masterpiece in Design

- Uses 4 of the latest hi-gain tubes, 6D6-6D6-76-12A7 (dual purpose tube) in special circuit as RF amplifier, screen-grid regenerative detector, triode audio amplifier, power pentode amplifier, rectifier & built-in power supply.
- ★ 5 old type tube performance
- ★ Illuminated airplane vernier dial
- ★ BAND-SPREAD tuning
- ★ Great VOLUME-Power plus
- ★ An excellent "DX" receiver for the long-distance fan.
- ★ Large 3 winding coils
- ★ Built to the famous EILEN standard of quality.
- ★ Operates on 110 V ac or dc house lighting circuit
- ★ Makes a powerful amateur station receiver
- ★ Operates a speaker on many stations
- ★ Covers approximately 10-600 meters.
- ★ **SOLD ON A MONEY BACK GUARANTEE—YOU MUST BE SATISFIED.**

Beautiful, heavy black shined finish metal chassis & cabinet. Must be seen to be appreciated. Kits for 10-200 meters & instructions included. **ORDER YOURS TODAY.**

KIT, assembled and ready to wire
Matched Arcturus tube..... \$2.75
Beautiful metal cabinet, hinged lid..... 1.25
Broadcast band coils (2)..... 1.25

SPECIAL COMPLETE KIT, tubes, cabinet, \$11.45 & IC coils.
Labor for wiring, extra..... \$1.50

THE EILEN B-1 BATTERY MODEL of the 5A described above. Uses 54 42-30-55 tubes operating from 2 V. It A battery. Four tube performance. Otherwise has same specifications as the 5A. Subtract \$1 from price of the 5A.



EILEN HG-35 RECEIVER

A CUSTOM-BUILT high quality receiver designed so as to give regular broadcast receiver volume on LONG DISTANCE under fair conditions. Uses 5 "high-gain" tubes 6D6-6D6-76-12A7 in circuit producing REAL RESULTS.

Mr. J. H. of Upper Montclair, N. J., writes: "I got more than my money's worth. The set had only 3 days when I had it but I received 210, 111, 68-D, 4-SC, GSB-EAQ besides 75 amateurs in 1 S and Canada."

★ Read editorial description on page 152 July issue of Short Wave Craft.

- ★ Covers 10-600 meters.
- ★ Illuminated high-ratio airplane dial
- ★ Headphone Jack.
- ★ Operates on AC house lighting current.
- ★ Tremendous speaker volume.
- ★ Large 3 winding coils.
- ★ Built-in dynamic speaker.
- ★ Band-spread tuning.
- ★ Built-in power supply.
- ★ Volume control.
- ★ Unusually neat appearance.
- ★ **YOU MUST BE SATISFIED.**

RECEIVER, with coils for 10-200 meters & instructions, ready to wire..... \$12.95
Matched Arcturus tubes..... \$2.95
Broadcast coils (2)..... 1.25
Beautiful cabinet..... 1.00

SPECIAL COMPLETE KIT, cabinet, tubes, & IC coils..... \$16.95
Labor for wiring & testing, extra..... \$2.00

The All-Electric Jr.
An electric set for the beginner. Uses a 12A7 (dual purpose tube) as regenerative receiver and built-in power supply. Simple and efficient. Instructions and SW coils furnished.

KIT..... \$3.45
Arcturus tube..... .95
Broadcast coils..... .95

SPECIAL KIT, tube and IC coils 4.95
Labor for wiring..... .75

The DC Receiver
A powerful, battery receiver. Uses 19 (dual purpose tube) and 33 tubes as regenerative detector and 2 stage amp. Operates speaker on many stations. Some owners report foreign stations on speaker. SW coils and instructions included. KIT ready to wire..... \$5.75
Arcturus tube..... 1.90
Broadcast coils (2)..... 1.25
Metal cabinet..... 1.00

Special KIT, cabinet, tubes, and IC coils..... \$9.45
Labor for wiring and testing, extra..... 1.35

Magnetic speaker, unmounted, \$1.35—Mounted \$2.75—Cannonball phones \$1.25
\$1.00 deposit on COD orders. 36 hour service. Stamp for receiver catalogue

EILEN RADIO LABORATORIES, Dept. SC9, 136 Liberty St., New York, N. Y.
(The Standard of quality)

Short Wave League Members IDENTIFY THEMSELVES WITH THE ORGANIZATION



In order that fellow members of the LEAGUE may be able to recognize each other when they meet, we have designed this button, which is sold only to members and which will give you a professional appearance.

If you are a member of the LEAGUE, you cannot afford to be without this insignia of your membership. It is sold only to those belonging to the LEAGUE and when you see it on another, you can be certain that he is a member.

See page 318
Lapel Button, made in bronze, gold filled, not plated, prepaid..... 35c
Lapel Button, like one described above, \$2.00 but in solid gold, prepaid.....

PATENTS — TRADE MARKS

All inventions submitted held confidential and given personal attention by members of the firm.
Form "Evidence of Conception" and instructions
"How to Establish Your Rights"—Free
L. ANCASTER, ALLWINE & ROMMEL
PATENT LAW OFFICES
475 Bowen Bldg. Washington, D. C.

RADIO ENGINEERING

broadcasting, aviation and police radio, servicing, marine radio telegraphy and telephony, Morse telegraphy and railway accounting taught thoroughly. Engineering course of nine months' duration equivalent to three years of college radio work. All expenses low. Catalog free. School established 1874.
Dodge's Institute, Turner St., Valparaiso, Ind.

READ AND SEND CODE

Learn Easily At Home This Quicker Way

No experience needed. Beginners read code quickly, copy accurately. If already an op., speed up your wpm with this amazing improved Master Teleplex. Only instrument ever produced which records your sending in visible dots and dashes on embossed copper tapes then sends back your own key work. Fascinating, fool-proof, gets results because you learn by HEARING as well as seeing. Teleplex has taught the code to more students in past few years than all other methods combined. Used by U. S. Army and Navy, I. C. A., A. T. & T., and others. We furnish Complete Course, text and personal instruction with a MONEY-BACK GUARANTEE. Low cost, easy terms. Write today for folder S-33, no obligation.



TELEPLEX COMPANY
76 Cortlandt St.
New York, N. Y.

MASTER TELEPLEX. "The Choice of Those Who Know"

You can tune in hard-to-get Foreign Programs if you use



CANNONBALL HEADSETS

Our phones are built with heavy bar magnets which

The "popular" set with the "hams." greatly increase their efficiency.

Write for illustrated circular S-9
C. F. CANNON COMPANY
SPRINGWATER, N. Y.



FREE!

IMPORTANT BUYING GUIDE

For Radio Servicemen, Dealers, Experimenters and Short-Wave Fans. Supplement Catalog No. 29, 1935, Spring-Summer Edition

Lowest Prices—This Book Will Save You Money 32 Pages — Two Colors — Profusely Illustrated

Packed between the covers of this new book is a huge array of modern radio equipment and other electrical and scientific merchandise—perhaps the very material for which you have been looking—and at prices which cannot possibly be any lower. A truly important buying guide for radio servicemen, experimenters, dealers, short-wave fans, biological and optical students, and other men following scientific professions.

Contains all-wave radio receivers, automobile sets, low-priced microscopes, field glasses, complete public address systems, Official Doerle and other short-wave receivers, crystal radios, radio replacement parts and accessories, latest testing instruments, etc., etc. You can increase the value of your dollar by buying at the low prices contained in this buying guide. This amazing book will show you how to save money by buying economically. Why not start saving now? Don't delay. Write today for your free copy. You are not obligated in any way.

WRITE TODAY—send postcard or letter. Buying guide sent by return mail. IT'S ABSOLUTELY FREE.

RADIO TRADING CO.

101A Hudson St.

New York, N. Y.

See pages 308 and 316 for our other "Ads"

Another S-W Converter

● SHORT-WAVE converters, as we have pointed out before, are much more popular in Europe than they are in this country. All-wave sets with switches for changing from one band to another are not nearly so common as in the U.S. and there is a real demand for devices which will permit a regular broadcast (or intermediate frequency as they call it) receiver to cover the popular S-W phone bands.

Amateur Wireless recently printed a short description of a new Kolster-Brandes S-W converter designed for use with the receivers made by this company.

The converter has a neat appearance as a glance at the photo shows. The tuning covers the wavelengths from 15 to 80 meters in two steps. Very good reception was claimed for this unit, by the above magazine.



This short-wave converter, described recently in an English radio magazine, will be of interest to all S-W "Fans."

New S-W Aircraft Sets

(Continued from page 279)

weighing only thirty-eight pounds, a "single package" equipment of exceptional capabilities. It is a small, single-unit transmitter especially designed and constructed to meet the severe requirements of aircraft communications. During flight, it offers the pilot a choice of three types of high-quality emission including telephone, continuous-wave-telegraph (CW), and tone modulated continuous-wave-telegraph (MCW)—assuring reliable and efficient communication with ground stations in all kinds of weather and under all operating conditions. The entire equipment, including dynamotor supply, is housed in a single, durable, metal case measuring only 10½" by 10" by 16½". Reception is provided in the frequency range of from 2000 to 6500 kilocycles and a simple switching arrangement permits rapid selection while in flight of any of three pre-determined frequency channels within this range. Power is supplied by a standard 12-volt storage battery or other direct-current source. Accessibility to the chassis is provided by an ingenious mechanical arrangement by which the entire chassis slides out for inspection.

Included in this newly developed aviation radio apparatus are a complete and impressive variety of airport communication instruments. Provision against rapid obsolescence is one of the many ingenious engineering features of the equipment. For instance, an airport starting with one of the lower-powered communication transmitters can add additional power, and provide for speech amplification systems and radio-beacon service, by adding other apparatus especially engineered for adaptation, and using the original transmitter as a foundation. In addition to the ruggedness, ease of operation and adaptability which the airport manager should expect from present-day advanced aircraft radio design and construction, the new apparatus represent a marked improvement in appearance. Trim, smart lines and two-toned finish serve a decorative as well as utilitarian purpose.

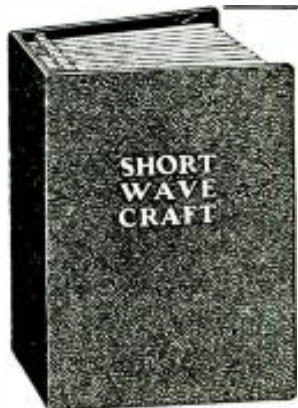

NO ONE READS AND THEN DISCARDS SHORT WAVE CRAFT

Readers keep their copies for years as a steady reference and thousands of letters attest to this.

It is now possible to save your copies and for this purpose we designed a splendid binder for you which holds twelve copies. It is made of heavy substantial material and is covered with black grain leatherette. The name of the magazine is stamped in gold on the cover.

An ingenious mechanical arrangement is provided which makes it possible to hold the copies flat when reading from the binder.

SHORT WAVE CRAFT Binder as described, \$1.25 prepaid in the United States.

Canada and foreign countries 25c extra. We accept money order, check, stamps or cash.

SHORT WAVE CRAFT

99-101 HUDSON STREET NEW YORK, N. Y.

Most Amazing Typewriter Bargain EVER OFFERED

NEW REMINGTON PORTABLE ONLY 10c A DAY



FIRST TIME! Remington's new purchase plan now lets you buy a genuine latest model Remington Portable No. 5 direct from the factory for only 10c a day. Not used or rebuilt. Not incomplete. A beautiful brand new regulation Remington Portable. Standard 4-row keyboard, standard width carriage, margin release on keyboard, back spacer, automatic ribbon reverse; every essential feature found in standard typewriters.

FREE With your machine we send you free a 19-page course in typewriting. Teaches touch system quickly, easily. Soon you dash off letters quicker than with pen and ink. You also get a handsome, sturdy carrying case, free.

BIG PRICE REDUCTION

The amazing low price and easy terms now make it possible for you to buy this genuine, complete Remington Portable for only 10c a day. But we cannot guarantee present prices long. Higher wage scales, rising cost of materials, everything points to higher prices. So we say, "Act now... while our liberal offer still holds good!"

YOU DON'T RISK ONE CENT Try this typewriter in your home or office on our 10-day FREE TRIAL OFFER. Then if you do not agree that it is the

finest portable at any price, return it at our expense. You don't even risk shipping charges. It's the best chance you've ever had to own so complete a machine for so little money. So don't delay. Mail the coupon NOW!

CLIP COUPON

Remington Rand Inc., Dept. 214-D, 205 E. 42nd Street, New York City

Please tell me how I can buy a new Remington Portable typewriter for 10c a day. Also send your new catalog.

Name _____

Address _____

City _____ State _____

10 DAY FREE TRIAL OFFER

Please mention SHORT WAVE CRAFT when writing advertisers

Vest-Pocket Set

(Continued from page 265)

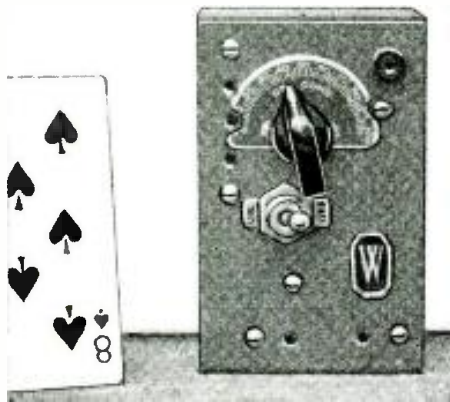

the size of an acorn. The tuning condenser is an extra-small model made by Hammarlund for tuning intermediate frequency transformers, and this is about the size of a ping-pong ball. The coil is wound on a piece of bakelite tubing $\frac{5}{8}$ " in diameter and $2\frac{1}{4}$ " long. The remainder of the parts are ordinary small-size parts available at any radio supply house and are conveniently fitted into the odd spaces around the other parts, as shown in the accompanying picture.

As the sockets available for the Acorn tube at the present time are somewhat cumbersome, the writer found that a very satisfactory socket could easily be made by bending the small copper clips that are furnished with each tube at a point as close to the contact ends of the clips as possible so as to form a right-angle and mounting these on a piece of bakelite tubing 1" in diameter and $\frac{5}{8}$ " long by means of small brass screws. The completed socket can then be screwed securely to the inside of the box which holds the radio.

The tuning condenser, not being designed to take a knob, must be modified so that a control knob may be attached to it. As it is, the condenser has a shaft whose diameter is slightly greater than $\frac{1}{4}$ " which extends from the condenser about $\frac{1}{4}$ ". It is therefore necessary to solder a short length of quarter-inch shafting to this, over which the control knob may be slipped. It will be found that the easiest way to make a strong soldered joint is to apply a liberal quantity of solder to each half of the joint; then, holding the short length of shaft, which is to be added, in place with a pair of pliers, apply heat to the shaft so as to cause the solder previously applied to flow throughout the entire area of contact. This joint will have much greater strength than one made in the usual manner.

Coil—How Made

The coil is wound on a piece of $\frac{5}{8}$ " diameter bakelite tubing. The grid coil consists of 43 turns of No. 24 double silk-covered wire and the tickler coil consists of 37 turns of the same size wire. There is a space of $\frac{1}{8}$ " between the grid coil and the tickler coil. The completed coil assembly may be secured to the inside of the mounting box by drilling a hole in the tubing at an end where it extends slightly beyond the winding of the coil itself. For purposes of keeping the set as compact as possible, no variable regeneration control was embodied in the circuit. With 40 turns of No. 24 wire on the tickler coil, the set should give good *super-regeneration*, as evidenced by a loud hissing sound which disappears when any fairly strong signal is tuned in. If difficulty is had in obtaining this *super-regeneration*, a little experimenting with the number of tickler turns will no doubt bring about the desired results. The antenna trimmer condenser also affects the *super-regeneration* to a certain extent, and this should be ad-

New HIGH-FREQUENCY SOCKETS by HAMMARLUND

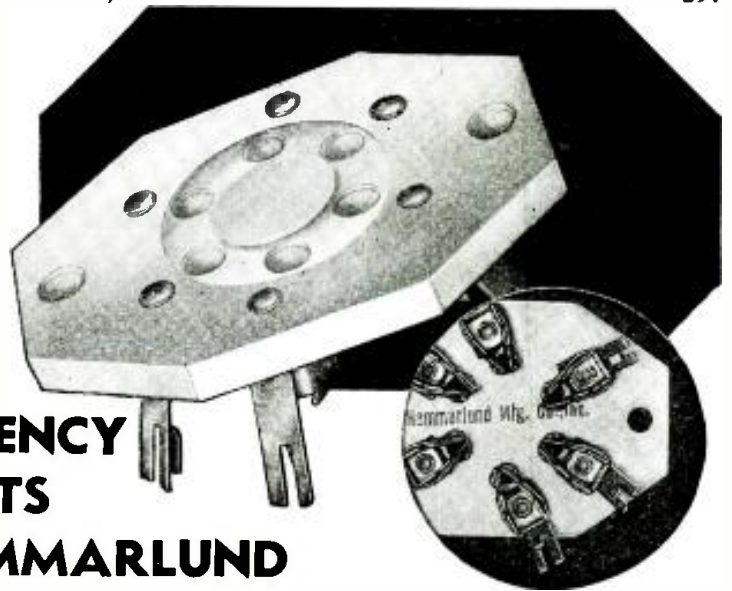

HAMMARLUND originated low-loss, wafer-type Isolantite sockets, and they have never been excelled for high-frequency work.

Only Grade "B-100," the lowest-loss, strongest Isolantite material is used—glazed on top and sides, and "Ceresin"-treated underneath to prevent moisture absorption.

Long leakage paths between new-type, positive side-gripping spring contacts.

Due to a unique square-inset anchorage, Hammarlund Socket contacts *cannot* twist, loosen or shift position, with changes in temperature and humidity. The new circular Guide-Groove makes insertion easier. For 4, 5, 6 or 7 prongs, 60c each list.

The new Hammarlund "ACORN" Socket, for .5 to 5-meter work, is a real low-loss achievement. Extruded Isolantite base with alignment plug. Top, sides and plug, highly glazed. Silver-plated, double-grip spring clips, eyeletted and lipped to base to prevent shifting. $1\frac{7}{8}$ " diameter. \$1.50 each list.

Write Dept. SW-9 for Data

Hammarlund Manufacturing Co.
424-438 W. 33rd St., New York



Short Wave League Letter-heads

Designed for Members



This is the official letterhead

It is invaluable when it becomes necessary to deal with the radio industry, mail order houses, radio manufacturers. It can be used in many ways and gives you a professional standing. No member of the LEAGUE can afford to be without this letterhead.

This can only be used by members of the LEAGUE. No one else can purchase it.

See page 318 of this issue for order blank. Take advantage of this opportunity to handle your LEAGUE correspondence in a business-like manner.

SHORT WAVE LEAGUE
99-101 Hudson St., New York, N. Y.

Here is a real sensation! A large and good looking SPORTS BINOCULAR

A powerful field glass that enables you to enjoy such sporting events as—Horse racing, Baseball, Prize Fights, Football games; can be used on Auto Trips, Beaches, Outings, etc.



PARCEL POST PREPAID **\$1.50**

$5\frac{1}{4}$ " long, extended to $6\frac{1}{2}$ ". Lenses nearly two inches in diameter. Black crackle finish. Carrying strap.

Supply limited—ORDER NOW!
Money back guarantee. *You can't lose!*
GOLD SHIELD PRODUCTS CORP.
17 West 60th St. Dept. S. New York City

RESISTOR SPECIALISTS

Featuring:

- NEW QUIET CARBON VOLUME CONTROLS
- VITREOUS RESISTORS
- TRUVOLT RESISTORS
- POWER RHEOSTATS

Write Dept. SW-9 for Catalog

175 Varick St., New York, N.Y.

ELECTRAD

4,600 Short-Wave Stations are listed in this magazine!

NEW

WE ARE happy to present to the thousands of short wave fans this new magazine which enthusiastic readers of Short Wave Craft have urged us to publish. Here is a book that you will feel proud to possess because it reflects your patience and perseverance in logging distant stations. It is a record you will be proud of in days to come. It is the finest and most complete book of its kind ever published. There is nothing like it on the market now, nor was there ever a book published like it before.

4600 SHORT WAVE STATIONS

It contains the largest listing of short wave stations in the world, a much larger list in fact than the list published in SHORT WAVE CRAFT,

or any other magazine. Due to space limitations, no regular magazine can publish all the world stations. There are so many short wave stations, which normally cannot be included in any monthly magazine list, but frequently you hear these calls and then you wish to know from where they originate. The OFFICIAL SHORT WAVE LISTENER gives you this information, besides a lot of other information which you must have.

This is an entirely new magazine for the short wave listener, such as has not existed before. It is totally different in get-up and contents from any other short wave magazine, and nothing like it has ever been published before.

To begin with, the new magazine comes with a four-color cover, and it is beautifully printed throughout. It contains a great variety of material, all of which is essential today to the short wave listener.

IT IS NOT A TECHNICAL MAGAZINE. It is designed for the short wave-listener only. The July issue, which is now on all newsstands, contains the material you find listed below.

ASK YOUR NEWS DEALER FOR A COPY OF THIS NEW SHORT-WAVE MAGAZINE

25c the Copy

justed until maximum signal strength is obtained.

Antenna

It might be well to emphasize at this point that this adjustment will probably have to be altered slightly if the set is connected to a different antenna than the one used when making the initial adjustment. The length of the antenna is not a critical factor in the operation of this set. Results were equally good using a long outdoor antenna, as with a few feet of wire slung over the back of a chair. As a matter of fact, for real portable use, the writer ran a wire to the spring belt he was wearing and this gave perfectly satisfactory results on local reception, although a more efficient antenna is recommended when trying to bring in a "foreign" station. In keeping with the idea of compactness, the writer replaced the usual earphones with a high impedance ear unit from a discarded electric hearing aid, enabling the radio to be worn quite inconspicuously.

Batteries—Type Used

The power for this small radio comes from flashlight batteries. Heater current is furnished by four small cells connected in series. The "B" voltage is supplied by 40 cells of the type used in "fountain-pen" type flashlights, connected in series. Connections between cells are made by soldering short lengths of wire to them. The assembled battery of cells may be grouped in any convenient form. Some may prefer mounting them on a strip of leather to be worn as a belt, while others may bunch the batteries together and place them in a small box. The writer found it very convenient to bunch the batteries in two separate groups of about equal size and carry one group in each coat pocket. Wires from the batteries are connected to the radio set through a three-gang phone-tip jack of the flush type. The earphones are connected to the set by a two-gang jack of the same type. The antenna is connected to the set by means of a single insulated phone-tip jack. The power switch is placed in the small space just large enough for it under the bulb of the tube, between the tube and the tuning condenser. It is of the single-pole single-throw toggle type, and cuts off the heater current.

Parts List for Vest Pocket Set

- 1—RCA number 955 Radiotron ("Acorn" tube).
- 1—Hammarlund 50 mmf. midget tuning condenser No. APC-50.
- 1—140 mmf. mica-dielectric trimmer condenser.
- 1—.001 mf. mica midget condenser.
- 1—.0001 mf. mica midget condenser.
- 1—1 megohm, ½-watt, IRC resistor.
- 1—midget single-pole, single-throw toggle switch.
- 1—3-gang phone-tip jack.
- 1—2-gang phone-tip jack.
- 1—Single insulated phone-tip jack.
- 1—Crowe-etched indicator plate, numbered 0 to 100.
- 1—Small knob for ¼" shaft.
- 1—Bakelite tube, ⅝" diameter, 2¼" long.
- 1—Bakelite tube, 1" diameter, ⅝" long.
- Batteries—see text—Burgess.

Alice E. Johnson's Station

(Continued from page 264)

I go in for "DX" mostly; however, nothing prevents or stops a good "rag-chew." My prize "rag-chew" lasted 2 hours, 5 minutes, then, the only reason I signed off was because the "OM" was hungry.

Thanks for using Western Union for the telegram you sent me. I'm an Automatic Operator for that company during my spare time and had the message 19 minutes after you filed it.

Mrs. Alice E. Johnson, W9IJD,
3815 Thomas Ave., N.,
Minneapolis, Minn.



Well Illustrated

Features in the September Issue:

- Where to find the Short-Wave Stations on "YOUR" dial.
- Scrambled Speech—What Is It?
- Photos of Short-Wave Artists From Australia.
- Short-Wave Kinks—Monthly Prize for Best Kink.
- Handsome Silver Trophy For Best Short-Wave Listening Post Photo.
- Grand List of Short-Wave Stations of the World—Including Call Letters and Frequencies.
- Call Letters and Frequencies of Police and Television Stations.
- "Best" Short-Wave Station List.
- Hungarian Short-Wave Artists' Photos.
- Latest News of the Russian Short-Wave Vocalists and Instrumentalists.
- Kilocycle and Meter Converter Chart.
- Standard Time Zones of the World.
- Short-Wave Artists from India.
- Short-Wave Fiction—A Gripping Story for the Short-Wave Listener.

From this you will see that the magazine has been designated as a companion magazine to SHORT WAVE CRAFT.

If you are now a reader of SHORT WAVE CRAFT magazine, you will not wish to be without THE OFFICIAL SHORT WAVE LISTENER MAGAZINE. The new magazine will help you tremendously in your short wave reception at all times, and will give you priceless and invaluable information, such as you cannot get anywhere else. Nothing like it appears in print anywhere today. THE OFFICIAL SHORT WAVE LISTENER MAGAZINE, in other words, is a necessity.

OFFICIAL SHORT WAVE LISTENER MAGAZINE
99 Hudson Street, New York, N.Y.

P. S.—If you cannot get the magazine at your newsstand due to sell-out, send 25c in cash, stamps, or money order, and we will send the magazine to you direct, prepaid.

Please mention SHORT WAVE CRAFT when writing advertisers

The "Foreign Stations" S-W Receiver

(Continued from page 267)

frequency choke (RFC) connections.

Guidance for Minimizing Expenses

Since the customary arrangement of radio parts has been to stretch them out in "abreast" fashion, necessity here invented the idea that they must go "city-lot" fashion—depth with a small frontage—in order that good appearance be also incorporated into the construction of this set. This then permits of the set being installed in a reasonable-sized cabinet and allows plenty of space for the variable condensers.

To make these variable condensers, two "2½ size" tin cans (a gallon-size oil container is suitable) had the ends removed, the cylindrical part straightened out and all three plates H, J, and K cut to the following size of 4½ by 4½ inches. But it was found necessary to bend back on themselves about ¼", all four edges of each plate of this thin metal so that rigidity would be given to the plates. This prevented the plates from flexing and consequently the received signals would not "wobble."

Since the subpanel was made of two pieces of ¼" box wood (3½" by 12") nailed close together on ¾" by ¾" by 7" cleats, this left a crack in the middle thereby permitting the center plate J to be inserted and pushed through so that wiring connections could be made to it.

For the two movable plates H and K, a small round-head brass machine or wood screw was soldered at one corner of them (with these plates resting in the slot heads of the screws) which provided for allowing these plates to turn on a pivot. The shank side of the screw-head acts as a small bearing surface. Then where these three plates appear to intersect (as shown by the angles between them) two small holes were drilled ⅛" each side of the crack, through which the screw length passed. Care should be taken here, so that the screw-heads do not touch the middle plate J. This would result in "shorting out" the tuning coil L1 or short-circuiting the "B" battery terminals.

Because the regeneration condenser has an extremely low minimum capacity, it was necessary to add in parallel with it a .00015 mf. fixed condenser. This condenser C3 is shown in the photographs mounted with two small wood screws by the "Phones" clips.

Just for experiment's sake, very large plates for H, J, and K were tried (6"x10") and these really eliminated the use of condenser C3, but these plates being so tall made the set appear like the Flat-iron Building.

One will find that these 2½-size tin cans provide enough material for the other condensers—antenna-coupling condenser C2 and grid condenser C1. Thus for the "making" of condenser C2, two plates are cut 1½"x1½" with ½" edge of each bent at right angles, giving an effective condenser area of 1½"x1". Then holes are punched through the centers of the folded edges and the two plates mounted with small screws on the sub-panel with ⅛" spacing between them. (Since all wiring is done under the sub-panel, make sure that all screws go completely through it, so that electrical connections may be made to the various parts). On one plate is also fastened a clip to which connection is made to the antenna; the other plate being connected as shown in the receiver-circuit diagram.

The grid condenser C1 is made in like manner, but the two plates are cut 2"x3" with the 3" dimension standing vertical. The gridleak R1 of 5 megohms "bridges" the gap between these plates of this grid condenser, one end of the grid leak being soldered to each plate. Thus this combination of R1 and C1 enables the detec-

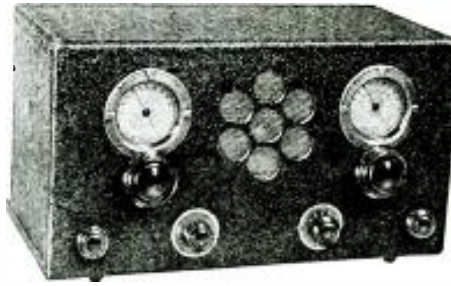

Announcing—
Sargent Model 10
A Complete, Self-Contained
COMMUNICATION TYPE
All-Wave Receiver

Look at These Features—

- Covers Broadcast Band
- Illuminated Airplane Dials
- Tuning Dial Calibrated in M. C.
- Adjustable, Calibrated Band Spreader
- Built-in 5-inch Jensen Speaker
- Coil Switch for Wave Changing—No Plug-in Coils
- Choice of Three Tuning Ranges
- Built-in Hum-free Power Supply
- Large Tuning Knobs
- Headphone Jack
- Attractive All-Metal Cabinet
- Doublet or Regular Antenna
- An A-1 Amateur Receiver
- Ideal for Shipboard Installations
- Write for D.C. and Battery Prices

Amateur Net Prices

Standard Model, 15-550 Meters, complete\$34.50
Marine Model, 15-1500 Meters complete\$39.50

IMMEDIATE DELIVERY

E. M. SARGENT CO.

212-S Ninth St. Oakland, Calif.

Sargent-10 Communications Receiver

Described and Illustrated Above

Model 10SA (15-550 meters) complete with tubes, Jensen dynamic speaker, power supply—entirely self contained in metal cabinet—Nothing else to buy. **\$34.50**

Model 10MA—same as 10SA except for tuning range—(15-1500 meters) \$39.50
Ranges from 15 to 15,000 meters on special order.

SARGENT 8-34 Super-Het (15-550) Complete \$54.50. MARINE Model 8-34 (15-1500) Complete \$62.50
SARGENT PRE-SELECTOR, Complete with Tube \$14.75

MARINE RADIO COMPANY has a complete line of all standard radio receivers including the new Patterson PR- receiver, RME9-D, RCA-ACR 136, McMurdo-Silver 5C, Super-Skyriter, etc.

MARINE RADIO COMPANY

MANUFACTURERS OF "MARINE" TRANSMITTERS
124-07 101st Avenue, Richmond Hill, N. Y.

Telephone Cleveland 3-2400

Cable Address "Elecmarine"

It's NOW

EVERYDAY SCIENCE AND MECHANICS is the finest scientific—technical—mechanical—constructional magazine in the field. Up-to-the-minute with news flashes of scientific events. Dozens of constructional articles and many popular experiments. Ideas from which you can make things to sell.

10¢

EVERYDAY Science and Mechanics

Get your copy today! On all newsstands

10c the copy Over 150 Illustrations

Everyday Science and Mechanics 95 C Hudson St., New York, N. Y.

A MOST OF INTERESTING SUBJECTS COVERED

Woodworking—Photography—Magic—Patents and Inventions—Book Reviews—Metalworking—Chemistry—Engineering—Microscopy—Electrical Experiments—Household Hints—Astronomy—Prize Contests—and other subjects.



RADIO CODE The Practical Way

to acquire the code—to increase speed is to practice at home, using your own Instructograph Code Teacher. It sends perfect code—at the speed you want, fast or slow. You practice when and where you please.

With each Instructograph, sold or rented, comes Book of Instructions showing how to practice to the best advantage. Any expert operator can tell you that practice with proper equipment is 90% of what is needed to acquire the code; Instructograph supplies that equipment. The other 10% well directed instruction, is furnished by our Book of Instructions, written by an expert operator. If you want to acquire the code—and at lower cost than by any other satisfactory method we know of—write TODAY for our descriptive folder and attractive new terms. You will be surprised when you hear how little it costs to buy or rent complete Instructograph equipment. So don't delay; write TODAY for full details. No obligation.

INSTRUCTOGRAPH COMPANY Dept. SW-9
912 Lakeside Place Chicago, Ill.
Representatives for Canada: Radio College of Canada, Ltd., 863 Bay St., Toronto

Send in your name for new catalog to be issued shortly.

"CHI-RAD"
SPECIALIZING SHORT WAVE SUPPLIES
CHICAGO RADIO APPARATUS COMPANY, Inc.
Amateur Sta. W9RA-W9PST
415 South Dearborn Street (Near Van Buren Street)
Est. 1921 **CHICAGO**

Please mention SHORT WAVE CRAFT when writing advertisers

**H. G. Cisin's ALL ELECTRIC
Only Set
of its kind
in
the world**



Powerful—Operates directly from any home lighting circuit, either A.C. or D.C. Self-Contained Power Supply. Wonderful short wave reception. Broadcast reception on indoor aerial. Many Air Scout owners report reception from England, Germany, Spain, Rome and other foreign stations—also police calls, code, airline and Trans Atlantic phone conversations. Uses four plug-in coils to cover band from 10 to 200 meters. Extra coils for broadcast reception. Special Long Wave Coil Unit up to 2000 meters also available. Operates several headsets simultaneously. Speaker operation possible on strong stations. Complete Assembled Kit, with instructions and picture diagram, and all four short wave coils, ready to \$395 wire.

- Aerovac Tubes.....\$1.55
 - Broadcast Coils......95
 - Special Long Wave Coil and Long Wave Condenser Unit.....1.45
 - Lightweight Earphone (single)......50
 - Total.....\$3.40
- Special Combination Offer**—Assembled Kit, tubes, all coils including long wave unit, earphone.....\$7.35
- Above Cost on Built, Wired and Laboratory Tested ready to use \$1.00 extra send stamp for circuit on 5-Tube All Wave Space Explorer, Professional "S"; Police Call 1-Tube Battery-Operated Air Scout, etc. Kits supplied for any set described in Short Wave Craft and other radio publications.
- H. G. CISIN, Chief Engineer**
Allied Engineering Institute
88 Park Place Dept. S-12 New York, N. Y.

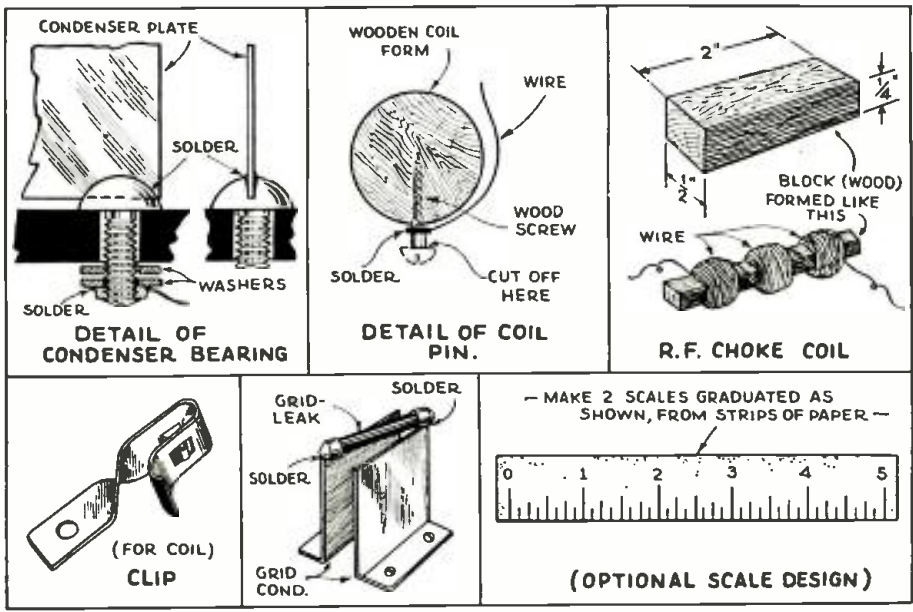

Hints which will help the constructor building this set.

Health Ray Carbon Lamp
SAVES DOCTOR'S BILLS

Everyone in the family needs the health giving Violet Rays. This is a large CHROMIUM plated lamp using standard carbons emitting rays of ultra violet and infra red. If Sun Tan is desired, order accordingly. Cures colds, rheumatism, and other ailments. Size 11 1/2" high, 10" wide, 5 1/2" deep. Weight 8 1/2 pounds. Interesting literature sent free. \$3.38 (List price with Screen and Goggles—\$10.00). YOUR COST—F.O.B., N.Y.....

WONDERFUL VALUE!
Gold Shield Products Co., 17 West 60th St., N. Y. City

WE STOCK
A COMPLETE LINE OF
NATIONALLY ADVERTISED
RADIO EQUIPMENT
FOR
SERVICEMEN—AMATEURS
DEALERS—EXPERIMENTERS
Write for Free Catalog
CAMERADIO
601-3 GRANT ST., PITTSBURGH, PA. 30 TWELFTH ST. WHEELING, W.VA.
Established 1919

SPECIAL FOR THIS MONTH
Send \$1.00 (\$1.25 Canada and foreign) and we will send you **SHORT WAVE CRAFT** for Eight months. "DO IT NOW!"
SHORT WAVE CRAFT
99-101 Hudson Street New York

FREE CIRCUIT DIAGRAMS FREE
RCH 5—All Wave Regenerative A.C. 5 Tube
JR. 2—All Wave A.C.-D.C. 2 Tube
RCH Super 5—A 5 tube A.C. All Wave

THOR RADIO CORP.
167 Greenwich St. New York City

tor tube to automatically bias itself and permits the tube to have good sensitivity.

The control handles are made of 3/8" dowel wood cut 5" in length. One end is "saw-cut" slotted for about 3/4" and inserted through the panel opening. The slotted end of each dowel is wedged on the movable plate H and K as shown in the photographs. Thus you have accomplished vernier tuning, elimination of more expensive variable condensers, elimination of dials and maintenance of anti-battery capacity effects.

The plug-in coil, constituting L1 as secondary and L2 as tickler was made in the following manner: a 6" section of a broomstick, which had a diameter very near 1" was used. Then 1" long brass wood-screws were mounted in a straight line to the depth of the thread in this wood coil-form. This left the smooth shank of the screws (with screw heads filed off) far enough out so that the ends of coils L1 and L2 could be soldered to them and also make grip connections with the spring tongues of the clips. Thus these four screws are spaced for the coil L1 of 37 turns a distance apart of 2", for the coil L2 of 23 turns a distance of 1 1/4" and between L1 and L2 a distance of 1". Then the turns of No. 16 enameled copper wire were close-wound between these screws and the coil ends soldered to them.

The choke coil (seen at the right-hand end of the plug-in coil of photo No. 2) labeled RFC in the receiver diagram hook-up, is wound with No. 36 S.C.C. copper wire with a three-section winding with sections having 60-80-150 turns. The 60-turn section is connected nearest the tickler coil L2. The form for winding this choke coil was 1/4" box wood cut 1/2" wide by 2" long. Thus theory and practice make this radio-frequency choke a necessity, for if such radio currents are not choked to their proper paths, the headphones set will be "alive" and squeals will be heard in the phones with ever so small a movement of the arms near the connecting cords.

Photograph No. 3 was purposely taken to give the reader an elevation view of this receiver and it shows in a more relative aspect, the sizes of the parts. It greatly elaborates to the mind's eye what many words would fail to even give an inkling of portrayal.

Some Refinements in the Adventure
For those more generously situated, the large variable condenser plates could be made of radio-chassis material, the antenna-coupling condenser could be a small variable midget, the grid-leak condenser a .0001 mf. fixed condenser, the subpanel

of bakelite, the panel of metal for those who are "shield-minded" and a host of other innumerable features.

However, the effort has been to make and offer you in this article, the most unique and simplest short-wave set of many a day.

Send in some testimonials. Be fair. Don't exaggerate for this will kill personality quicker than a radio flash.

Build the set and listen for your short-wave programs. (To tune in the 25- to 35-meter bands use 15 turns on L1, and 11 turns on L2.—Editor.)

- List of Parts**
- Wood Cleats 3/4"x3/4"x7".
 - Wood Panel 7x5.
 - Wood Subpanel 2 pcs. 3 1/2"x12".
 - 10-ohm rheostat, R2.
 - 10" length of 3/4" dowel.
 - 6" length of 1" dowel.
 - 9 Fahnestock clips.
 - 3 plates 4 1/2"x4 1/2".
 - 2 plates 1 1/2"x1 1/2".
 - 2 plates 2"x3".
 - 5 megohm grid-leak, R 1.
 - 2 UX sockets.
 - 5:1 audio transformer.
 - 20 feet of No. 16 enameled copper wire.
 - 24 1"-long brass wood screws.
 - 6 feet of hook-up wire.
 - .00015 mf. fixed condenser (disconnect C3 if set oscillates too strongly.—Ed.)

- Operative Equipment**
- 2 '30 type tubes. RCA Radiotron.
 - 2 No. 6 dry cells (1 1/2 vts. each).
 - 45-volt "B" battery. Burgess.
 - Headphones (2000 ohms or higher) Trimm (Cannonball: Acme).

Walter C. Doerle
originator of the now world-famous "Doerle Circuit"—has prepared 6 articles for **SHORT-WAVE CRAFT**.
The Second will appear in the **NEXT ISSUE!**
It will describe:—
"Police Call" S-W Receiver—
A 2-Tuber—and involves a "brand-new" principle of simplified construction, the cost of the set being very low.

The Wizard 50-Watt Transmitter

(Continued from page 283)

in the transmitter, one in the filament circuit and another in the plate circuit.

The filament or cathode coil is a two winding affair, consisting of twelve turns in each winding. Two No. 14 D.C.C. wires are wound side by side in a single layer on a 2"x3" bakelite tube. One of the windings is tapped at the sixth turn for operation with a 40-meter crystal. The crystal is connected between the filament side of the coil, which is tuned with a 325 mmf. condenser, and the first grid of the tube. Grid bias is obtained with a 10,000-ohm resistor connected in series with a 2.5 mh. R.F. choke, and between the grid and the "B" negative. The screen grid receives its voltage directly from the plate supply through a 25,000-ohm, voltage-dropping resistor, which should have a rating of around 35 watts.

Next in line in the tube we have the suppressor grid. This can be connected directly to the "B" negative, but a considerable increase in output will be obtained if a positive potential of about 45 volts is impressed up on it.

Best results were obtained with a 45-volt "B" battery connected to the suppressor. It can also receive its voltage from the plate supply, but the current drawn by it is so slight that a small battery can be used and will give a more constant voltage.

The high voltage is applied directly to the plate of the RK20 through a 2.5 mh. R.F. choke in order that the plate-tuning condenser would not have to be insulated from the metal chassis. The plate *band-changing* switch is not insulated either, but both the cathode tuning condenser and the cathode switch are insulated to prevent a short circuit. The plate coil is wound on a ceramic 2½" dia. coil form and has 26 turns of No. 12 tinned copper wire. This coil has three taps, one for each band 20, 40, and 80 meters. The 40-meter tap is at the fourteenth turn from the B minus end and the 20-meter tap is at the twenty-first turn. The leads to the taps on the plate coil are carefully soldered and made of copper braid. Heavy copper strip or wire can also be used. The plate coil is 2½ inches in diameter and 3¾ inches long and the turns are spaced the diameter of the wire. All fixed by-pass condensers are 1,500-volt high-frequency type condensers and should be of the best quality because a condenser failure can cause serious damage to the power supply and to the meters.

Speaking of meters there are two, one 0-50 M.A. scale for the screen grid current and another 0-100 M.A. scale for the plate current. Looking at the front of the panel we have the two meters in the center and on the lower half are the cathode tuning condenser on the left and the switch on the right. On the top of the panel is the plate-tuning condenser on the right and the switch on the left. The antenna used was a single wire Hertz shown in the diagram.

Tuning Procedure

Tuning in either of the amateur bands is an easy matter if the following suggestions are followed. With the key open set the oscillator condenser at full capacity, then close the key; *immediately*, adjust the oscillator condenser until the *screen* meter shows 25 mills (M.A.). Don't hold the key down any longer than necessary to make this adjustment. Now with the 80-meter crystal in the circuit, close the key again and tune the plate condenser to a point which gives minimum plate current; this will be around 20 mills (M.A.), possibly as low as 10 mills. The whole plate coil and oscillator coils are always used for this operation of

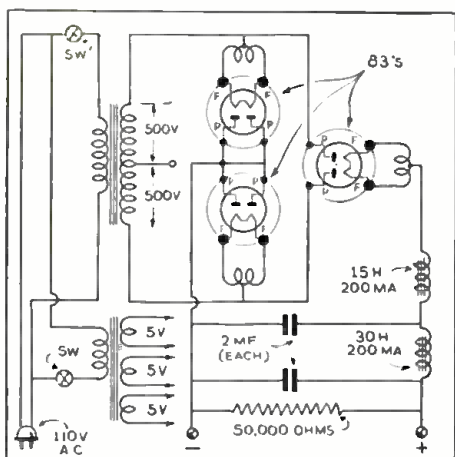
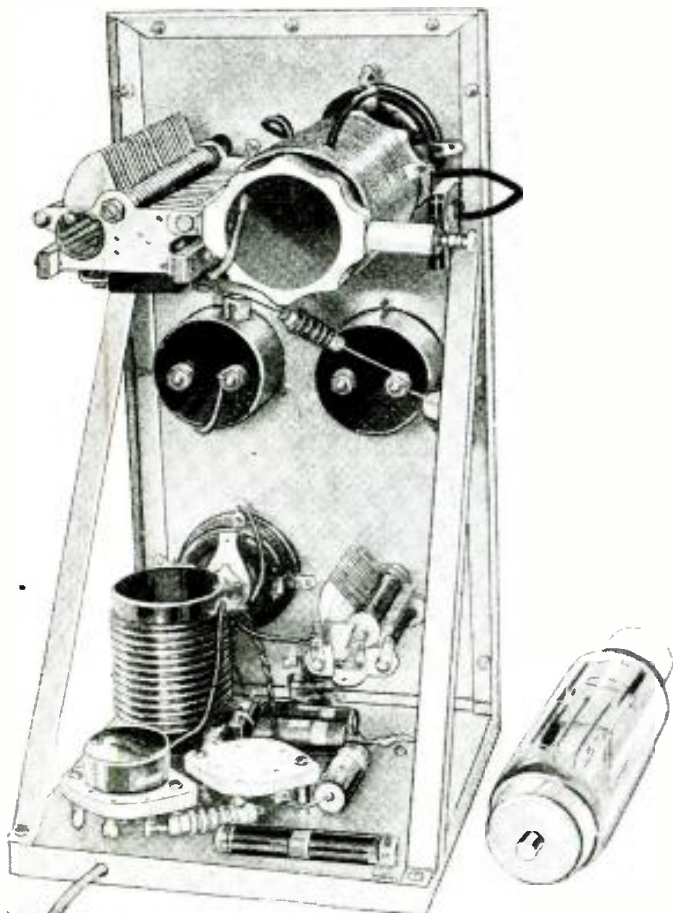

Diagram of plate supply unit.



Rear view of Transmitter.

Please mention SHORT WAVE CRAFT when writing advertisers

GIVE

YOUR SET A CHANCE



TO WIN THE SWST AND A YEAR'S SUPPLY OF BB'S

When you go out after that SWST (Short Wave Scout Trophy), give your set a real chance to win—wire in a new set of BB's (Burgess Batteries). Get back the old surge of power, the hair-line selectivity, the delicate sensitivity you almost forgot you had built into your set! Step right out and win a shiny new SWST—and a whole year's supply of BB's. We will give a year's supply of BB's to every amateur who wins the SWST with a BB-powered set. BURGESS BATTERY CO., Freeport, Illinois.



BURGESS

BATTERIES AND FLASHLIGHTS

Here They- BRAND NEW-

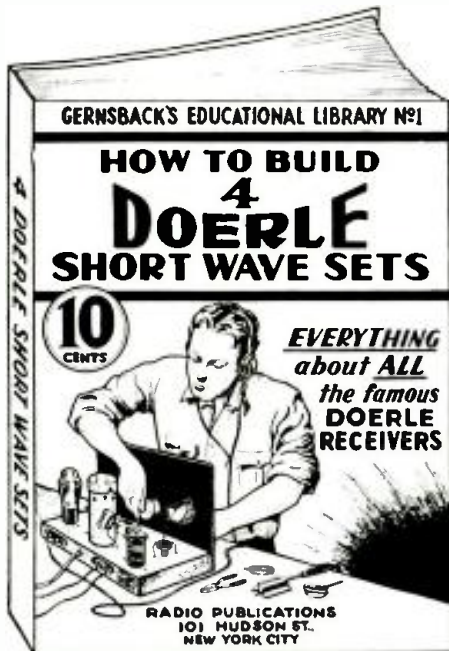

★ **L**ITERALLY thousands of readers have built the new famous DOERLE Short Wave Radio Receivers. So insistent has been the demand for these receivers that all available literature, including back numbers of SHORT WAVE CRAFT, have long been exhausted.

★ For the thousands of readers who wish to build any, or all of the many approved DOERLE Short Wave sets, this book has been specially created.

HOW TO MAKE FOUR DOERLE SHORT WAVE SETS

★ Contains EVERYTHING that has ever been printed on these famous receivers. Four of the most popular sets are described herein. These are the famous sets that appeared in the following issues of SHORT WAVE CRAFT: "A 2-Tube Receiver that Reaches the 12,500 Mile Mark," by Walter C. Doerle (Dec., 1931-Jan., 1932). "A 3-Tube Signal Gripper," by Walter C. Doerle (November 1932). "Doerle 2-Tube" Adapted to A. C. Operation," (July 1933). "The Doerle 3-Tube Signal-Gripper Electrified," (August, 1933) and "The Doerle Goes 'Band-Spread,'" (May, 1934).

★ Due to a special arrangement with SHORT WAVE CRAFT, we now present a complete as well as compact 32-page book with stiff covers, printed on an extra heavy grade of paper, with numerous illustrations. Nothing has been left out. Not only are all the DOERLE sets in this book, but an excellent power pack if you wish to electrify any of the DOERLE sets, is also described. A wealth of detail is presented in this book despite its ridiculously low price—and, believe it or not, it contains over 15,000 words of legible new type. Everything has been brought up to date; it isn't merely a reprint of what was printed originally, but any improvements on the original sets that were made by readers and various laboratories have been incorporated in this most up-to-date book.

★ And at the extraordinary price of 10c you cannot possibly go wrong. Despite its low cost, our usual guarantee goes with this book as well.

★ **IF YOU DO NOT THINK THAT THIS BOOK IS WORTH THE MONEY ASKED FOR IT, RETURN IT WITHIN TWENTY-FOUR HOURS AND YOUR MONEY WILL BE INSTANTLY REFUNDED.**

★ There has never been such a wealth of data published in a low-priced radio book of this type in the history of the radio publishing business.

★ Take advantage of the special offer we are making and use the coupon below.

RADIO PUBLICATIONS
101 Hudson Street
New York, N. Y.

RADIO PUBLICATIONS (No. 1) SW-9-35
101 Hudson Street
New York, N. Y.

Please send immediately your book HOW TO MAKE FOUR DOERLE SHORT WAVE SETS, for which I enclose 10c (coin or U. S. stamps acceptable). Book is to be sent prepaid to me.

Name
Address
City State

course. Next attach the antenna and again tune the plate condenser for minimum plate current.

A final adjustment of the oscillator condenser will probably increase the output, but don't let the screen current exceed 30 mills (M.A.) for doubling to 40 meters the plate switch is set to that band and the plate condenser tuned as before. If you duplicate this job you will have one swell transmitter and I don't mean maybe. If you want to hear it, give W2AMN a buzz on 3511 kc. any evening.

Parts List—RK20 Transmitter

- 1—200 mmf. (approx.) transmitting condenser.
- 1—325 mmf. midget condenser, Hammarlund.
- 7—1,500-volt .005 mf. by-pass condensers, Sprague.
- 1—Transmitting coil form. See text.
- 1—10,000 grid-leak, 10 watts or over, Aerovox.
- 1—75-ohm C.T. resistor, Electrad.
- 1—25,000-ohm, 35-watt resistor, Aerovox.
- 2—Ohmite inductance switches.
- 2—Dials and knobs, ICA.
- 1—0-50 ma. meter, Triplett.
- 1—0-100 ma. meter, Triplett.
- 2—2.5 mh. R.F. chokes, Hammarlund.
- 2—5-prong Isolantite sockets, Hammarlund.
- 1—80 or 40 meter. crystal or both, Biley.
- 1—Single circuit jack, I.C.A.
- 1—RK20 tube.
- 1—7x14x $\frac{1}{2}$ " aluminum panel, Blan.
- 1—7x7x $\frac{1}{2}$ " aluminum base, Blan.
- 6 feet of $\frac{1}{2}$ " aluminum angle, Blan.

Television Stations

(Continued from page 288)

2000-2100 kc.

- VE9AU—London, Ont., Can.
- VE9DS—Montreal, Que.
- W2XDR—Long Island City, N.Y.
- W8XAN—Jackson, Mich.
- W9XK—Iowa City, Ia.
- W9XAK—Manhattan, Kans.
- W9XAO—Chicago, Ill.
- W6XAH—Bakersfield, Calif.

2750-2850 kc.

- W3XAK—Portable
- W9XAP—Chicago, Ill.
- W2XBS—Bellmore, N.Y.
- W9XAL—Kansas City, Mo.
- W9XG—W. Lafayette, Ind.
- W2XAB—New York, N.Y.
- VE9AR—Saskatoon, Sask., Can.
- VE9ED—Mt. Joli, Que., Can.

42000-56000, 60000-86000 kc.

- W2XAX—New York, N.Y.
- W6XAO—Los Angeles, Calif.
- W9XD—Milwaukee, Wis.
- W2XBT—Portable
- W2XF—New York, N.Y.
- W3XE—Philadelphia, Pa.
- W3XAD—Camden, N.J.
- W10XX—Portable & Mobile (Vicinity of Camden)
- W2XDR—Long Island City, N.Y.
- W8XAN—Jackson, Mich.
- W9XAT—Portable
- W2XD—New York, N.Y.
- W2XAG—Portable
- W1XG—Boston, Mass.
- W9XK—Iowa City, Ia.
- VE9BZ—Vancouver, B.C., Can.
- VE9DS—Montreal, Que., Can.
- VE9AU—London, Ont., Can.
- VE9RC—Quebec, Que., Can.
- VE9AG—Walkerville, Ont., Can.

"Voice of Electricity" Programs Impress American Consular Service and Moscow Embassy

● Letters of congratulation for the quality of programs and reception of W2XAD and W2XAF, G.E. short-wave stations at Schenectady, N.Y., have been received from the American consulates in Zurich, Switzerland, Santiago, Chile, Beirut, Syria, and the American embassy at Moscow.

Reception of W2XAD at the Beirut, Syria, consulate is generally superior to that of all other American short-wave stations. Hugo Richter, at the Zurich consulate, states that programs from the G.E. station make him homesick at times.

Are!! 10c BOOKS.

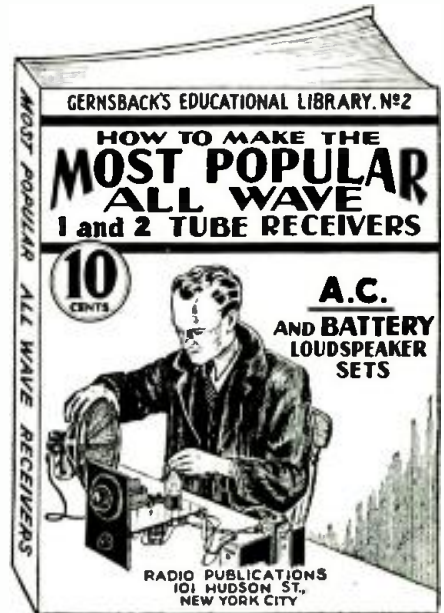

★ **T**HERE has been a continuous demand right along for a low-priced book for the radio experimenter, radio fan, radio Service Man, etc., who wishes to build 1- and 2-tube all-wave sets powerful enough to operate a loud-speaker. Sets of this type are always intensely popular with all classes of people who not only wish to amuse themselves to see how good a set they can build with a single or two tubes, but frequently such sets are important for special purposes, particularly where a good little set is required and where space is at a premium. For the thousands of readers who wish to build such sets, this book has been especially published.

HOW TO MAKE THE MOST POPULAR ALL-WAVE 1 and 2-TUBE RECEIVERS

★ This book contains a number of excellent sets some of which have appeared in past issues of RADIO-CRAFT, and have been highly successful. These sets are not toys but have been carefully engineered. They are not experiments. To mention only a few of the sets the following will give you an idea.

★ The Megadyne 1-Tube Pentode Loud-speaker Set, by Hugo Gernsbach. ● Electrifying The Megadyne. ● How To Make a 1-Tube Loud-speaker Set, by W. P. Chesney. ● How To Make a Simple 1-Tube All-Wave Electric Set, by W. Green. ● How To Build A Four-In-Two All-Wave Electric Set, by J. T. Bernstein, and others. Not only are all of these sets described in this book, but it contains all of the illustrations, hookups, etc.—the book, in fact, contains everything. Nothing at all has been left out. A wealth of important detail is presented in this book that will make you wonder how we can do it at the price.

★ And believe it or not, the book contains over 15,000 words of new legible type. The book is thoroughly modern and up-to-date. It isn't just a reprint of what was printed before. All the latest improvements have been incorporated into the sets.

★ Remember that this book sells at the extraordinary low price of ten cents; you can not possibly go wrong in buying it. Despite its low cost, our usual guarantee goes with this book as well.

★ **IF YOU DO NOT THINK THAT THIS BOOK IS WORTH THE MONEY ASKED FOR IT, RETURN IT WITHIN TWENTY-FOUR HOURS AND YOUR MONEY WILL BE INSTANTLY REFUNDED.**

★ There has never been such a wealth of data published in a low-priced radio book of this type in the history of the radio publishing business.

★ Take advantage of the special offer we are making and use the coupon below.

RADIO PUBLICATIONS
101 Hudson Street
New York, N. Y.

RADIO PUBLICATIONS (No. 2) SW-9-35
101 Hudson Street
New York, N. Y.

Please send immediately your book "HOW TO MAKE THE MOST POPULAR ALL-WAVE 1- AND 2-TUBE RECEIVERS," for which I enclose 10c (coin or U. S. stamps acceptable). Book is to be sent prepaid to me.

Name
Address
City State

Please mention SHORT WAVE CRAFT when writing advertisers

Electrifying the Clipset

(Continued from page 269)

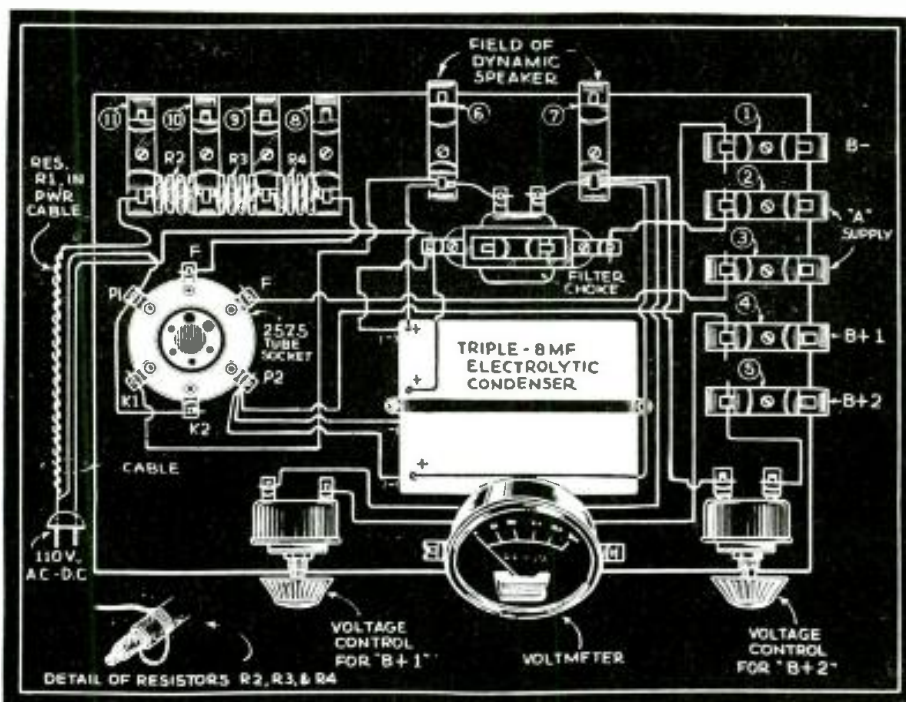

Circuit diagram of the Clip-Board full-wave voltage doubling power supply. In this circuit the electrolytic condenser should be non-polarized for best results.

clips 2 and 3 altogether with a "jumper" wire. Your "B" voltages are then obtained from clips 4 and 5 with clip 1 being "B" minus. If you are supplying these "B" voltages to a receiver of more than four tubes, then there will be sufficient "B" current flowing through the circuit to energize the field of a dynamic speaker. This field is used in lieu of the filter choke which, by means of the Fahnestock clips, can be disconnected from the circuit.

If you desire to use this power-pack merely to energize a dynamic speaker, it will be necessary to connect clips 1 and 7 together by means of a "jumper" wire and disconnect the filter choke from the circuit. The field coil of the dynamic speaker is then connected to clips 6 and 7.

If the power-pack is to supply "A" voltages as well as "B" voltages, the procedure is as follows: Shorting out resistor 4 by "jumping" clips 8 and 9 permits the pack to supply "A" power for one 6-3-volt tube. Shorting out resistors 4 and 3 by "jumping" clips 8, 9, and 10 provides filament power for two tubes, and finally, shorting out resistors 4, 3, and 2 by "jumping" clips 8, 9, 10, and 11 (that is, by connecting all these clips to-

gether), provides filament current for three external tubes, all in series with the filament of the 25Z5 rectifier. The "A" current is obtained from clips 2 and 3. The "B" voltages, of course, are obtained, as before, from clips 5 and 4 with clip 1 being "B" minus.

This "clip shorting" business all sounds very complicated, but only because it is more difficult to explain than it is actually to perform in practice. This power supply is one of the most practical units ever designed, and will be of inestimable value to its owner.

List of Parts—"Clipset"

- 1—Line cord and plug with built-in 350-ohm resistor; R1, R2, R3, R4. Ohmite.
 - 1—Six-prong socket, breadboard type; Alden.
 - 1—Type 25Z5 tube. R.C.A. Radiotron.
 - 1—Triple 8-mf. (24 mf. in all) electrolytic condenser unit; Tobe type 538. (Aerovox; Sprague.)
 - 1—100-ohm filter choke.
 - 1—Zero to 300 D.C. voltmeter; Readrite.
 - 2—Compression-type carbon rheostats; (Manufacturers' name on request.)
 - 12—Fahnestock clips, double type.
 - 12—Fahnestock clips, single type, medium size.
 - 1—Breadboard, 10" x 6 1/4", 1/2" thick.
- For the voltage-doubling circuit use non-polarized condensers.

Transmitters Used in Germany

(Continued from page 263)

mitter. A very sensitive 5-tube superhet, with seven tuned circuits, gives a selectivity so high that many stations operating in near-by channels may be used at the same time without any danger of mutual disturbances.

These small army stations are, despite their small output of one watt, very efficient. Despite the fact that a very simple "L" antenna is used, 20 miles are easily bridged where code is transmitted. Telephony is transmitted over distances of 10 to 12 miles easily. The operator has a normal French-type telephone for telephone transmission. Since these stations are working in two-way traffic, a very interesting trick has been used to cut-off the receiver when the transmitter is used to radiate the telephone signals. The micro-

phone currents are fed into a rectifier, which operates as a kind of combination between a squelch-circuit and an A.V.C. system. If the microphone is in operation, the bias voltage of the receiver is automatically changed and the entire receiver is cut off. Since the time-constant of this cut-off system is very short, a regular two-way conversation can be carried on.

The entire station is divided into three small portable boxes of about 25-pound weight for each part, and a small hand-driven generator is used as power source.

More 5-Meter DX—590 Miles

● JUST before this issue went to press we received an interesting letter from Mr. H. J. Gruber, (W8MGP) of Cincinnati, Ohio, stating he heard W2AMN, George Shuart's 5-meter station, on July 12 at 7:18 P.M., QSA 5 R7 to 8. On that same evening W2AMN heard W8CYE of Dayton, Ohio, at 8:15 P.M. E.S.T.

5 METER Super Het



- ★ NO SUPER-REGENERATIVE RUSH
- ★ INCREASED SENSITIVITY
- ★ IMPROVED SELECTIVITY

Here is a Super-het for 5 M. reception that is almost as simple as a straight super-regenerative receiver, but it will prove far superior as regards sensitivity, selectivity and noise level. The absence of super-regenerative "rush" is an outstanding characteristic. Any ham can build this 6-tube super-het without much difficulty.

- SWXR-22098—Complete Kit of Parts for 5 M. Super-het including cabinet, panel and special copper plated chassis, but less power supply, tubes and speaker \$16.75
- If wanted completely wired add \$3.25
- SWXY-21942—Power Supply Kit for the above \$8.25
- Add \$1.25 if desired completely wired.

FREE Ham Catalog

Exclusively for the Amateur! 48 pages in all including 16 pages of diagrams, general operating hints, questions and answers on Ham Xmitting and receiving trouble. There are pages on 25 and 5 M. Xmitters and Receivers, latest S. W. sets, and Kits, C.W. and phone Xmitting equipment with outputs from 2 to 100 watts; PLT's tubes, parts, etc. Get your FREE copy NOW!



WHOLESALE RADIO SERVICE CO.
100 SIXTH AVENUE - NEW YORK, N.Y.
BRONX, N.Y. ATLANTA, GA. NEWARK, N.J.
542 E. Fordham Rd. 430 W. Peachtree St. N.W. 219 Central Ave.

WHOLESALE RADIO SERVICE CO.,
100 Sixth Ave., Dept. SW-95, New York, N. Y.
 Send me additional data on 5 M. super-het Kit.
 Send me FREE Ham Catalog No. 54-A.

Name _____
Address _____
City _____ State _____

WHEN CHOOSING A RADIO SCHOOL

RCA Institutes, with its reputation established by 26 years service, is an institution recognized as an important factor in the radio industry. Whether elementary radio principles or advanced subjects, sound applications or practical radio engineering, RCA Institutes is prepared to give you the instruction you need.

RESIDENT SCHOOLS NEW YORK AND CHICAGO with modern standard equipment
EXTENSION COURSES FOR HOME STUDY under convenient "no obligation" plan
Illustrated Catalog on Request.

R. C. A. INSTITUTES, Inc. Dept. SW-35
75 Varick St., New York—1154 Merchandise Mart, Chicago

DRASTIC CUT
in Radio Noise on ALL Waves
Unconditionally Guaranteed with the new LYNCH HI-FI Antenna
Arthur H. Lynch, Inc., 227 Fulton St., N. Y. PIONEER OF NOISE-REDUCING AERIALS

A. C. ELECTRICAL POWER

From a Windmill, from available Waterpower, from your Automobile, from your Motorcycle, from your Bicycle, Foot-pedals or Handcrank (for transportable Radio Transmitters, Strong Floodlights, Advertising Signs); do you want to operate AC Radio sets from 32 V. DC farm light systems; operate two generators in series to get 200 V. AC; obtain two phase and three phase AC, etc., etc.

Get Our

Westinghouse

200 Watt, 110 V. AC

Power Generator

Manufactured for U. S. Signal Corps

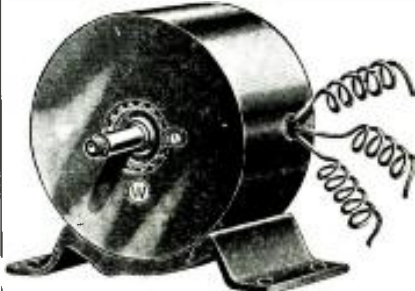

SPECIFICATIONS

HOUSING—Aluminum (Diameter 6 1/4 in., Length—5 1/4 in.). SHAFT—2 3/16 in. (driving end). Diameter 9/16 in., the end is threaded for a distance of 3/4 in.). BASE—Cast Iron (Length—7 1/4 in., Height 1 9/16 in., Width 4 1/4 in.). OUTPUT—200 Watt 110 Volt AC (speed 4200 R.P.M.). STATORS—Two pairs (two North and two South). ROTOR—12 tooth inductor. Built-in commutator. Rotor turns in ball bearings. 3/4 to 1/2 H.P. needed to run generator.

FREE With each generator, we supply a set of diagram-blue prints and instructions showing twenty-five different uses, technical information, electrical hook-ups and installing explanations. We also include a set of four replacement carbon brushes.

There Are Over 25 Applications Some of which are:

A.C. Dynamo lighting from eight to ten 20 Watt 110 Volt lamps. Short Wave Transmitter supplying 110 Volts AC for operating "Ham" transmitter. Operating 110 V. AC 60 Cycle Radio Receiver in DC districts. Motor Generator. Public Address Systems. Electric Signs on motor boats, yachts, etc. Camp Lighting. Short Wave artificial "fever" apparatus. Television. Pelton Waterwheel for lighting or other purposes. Airplane: for lighting strong search lights or electric signs. Laboratory work, etc. etc. Generator, as described, including four replacement carbon brushes. Blue-print and instructions **\$7.90**

Send \$2.00 deposit balance C.O.D.
Shipping weight 18 lbs.

(Replacement carbon brushes bought separate \$1.50 per set of four. Set of instructions bought separate \$1.00.)

MONEY-BACK GUARANTEE.
DO NOT WRITE FOR CATALOG

WELLWORTH TRADING COMPANY SW-9-35
560 W. Washington Blvd., Chicago, Ill.

Enclosed you will find my remittance of for which please send me
 Westinghouse Power Generator by Express collect
 or balance C.O.D.

Name

Address

City..... State.....

STOPPANI COMPASS

A Precision Instrument made in Belgium. Purchased by the U. S. Government at more than \$30.00 each. Ideal for Radio Experimenters Laboratory, also may be used as a Galvanometer for detecting electric currents in radio circuits. Ruby, jeweled, solid bronze, 4 inches square, fitted in a hardwood case.



Also used by hunters and surveyors

Our price prepaid \$4.50 each

Gold Shield Products Co., 17 West 60th St., N. Y. City

LATEST DEVELOPMENTS ON TUBES

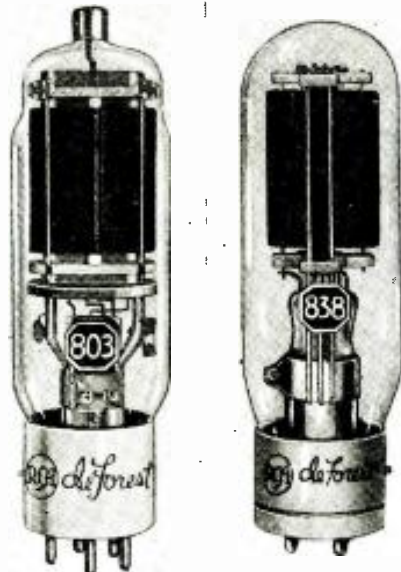

Tube at left—the new RCA 803; at right, the new RCA 838

D.C. Screen voltage, 600 Max.
D.C. Suppressor voltage, +40.
D.C. Grid voltage, -40.
D.C. Plate current, 80 milliamperes.
D.C. Screen current, 15 milliamperes.
D.C. Grid, 3 milliamperes.
Driving power, 1.5 watts.
Carrier power, 53 watts.

Operated under these conditions, this tube will have a peak power output, under complete modulation, of over 200 watts with a driving power of only 1 1/2 watts; this is really a remarkable tube. It is undoubtedly possible to use this tube in the "tritet" circuit, thus providing a 1-tube, crystal-controlled transmitter with over 200 watts output. We will have further information in the next issue. No. 307.

The RK100

● THE RK100 will undoubtedly appeal to those living in D.C. districts. This tube is designed to operate with 110 volts D.C. on the plate. It differs from the usual vacuum tube inasmuch as it contains mercury vapor and an auxiliary grid which acts as the anode for the ionizing discharge. This grid also serves as a cathode for the amplifier or oscillator section of the tube. As a Class "C" amplifier the following specifications are given by the manufacturer:

D.C. Plate voltage, 110 volts.
D.C. Plate current, 250 M.A.
Ionizing discharge current, 250 M.A.
Power output, 12 watts.
R.F. Power input, 3 watts.

Twelve watts from a 110-volt tube is surely a large amount of power, and many of our readers who wish to build low-voltage transmitters should find this tube ideal. No. 308.

The RK28

● THE RK28 is a filament type pentode designed along lines similar to the 803. Typical Class "C" operating conditions are as follows:

Filament voltage, 10.
Filament current, 5 amperes.
Plate voltage, 2000 volts.
Screen voltage, 400 volts.
Control grid, -100 volts.
Suppressor, +45 volts.
Screen grid current 60 M.A.
Control grid current, 10 M.A.
R.F. Power input, 1.8 watts.
Carrier output, 200 watts.
Plate current, 140 M.A.

No. 309

Glancing over this list of transmitting tubes we venture to say that the future amateur transmitters will change considerably in design and performance, especially when one considers the capabilities of these new R.F. pentodes, which have a rated output of some 200 watts with only 2 or 3 watts of excitation.

New Tube Identical to All-Metal Tubes

● AN enterprising company has developed and marketed a new line of tubes, designated as the "G" series, which are identical in electric characteristics and pin connections to the all-metal tubes. It is stated that several of the larger set manufacturers and many smaller ones have already developed circuits employing these new "G" tubes. Early announcement of some of these radio receivers is expected.

Carrying the same type numbers as do the all-metal tubes, the letter "G" is suf-

The RCA 838

● THE recent announcement of several new types of transmitting tubes should be of particular interest to the radio amateur, inasmuch as they are all designed to improve his transmitting conditions and in most cases lower his operating cost. The first of these is the new RCA 838, which is shown in one of the accompanying photographs. This is a 3-electrode tube designed for zero bias Class B audio frequency use; however, it will give satisfactory results as an R.F. amplifier with frequencies as high as 30 m.c. and has a maximum plate dissipation of 100 watts.

As an R.F. amplifier and oscillator the "key-down" conditions without modulation are as follows:

D.C. Plate voltage, 1250 volts Max.
D.C. Plate current, 175 milliamperes Max.
D.C. Grid current, 70 milliamperes Max.
R.F. Grid current, 7 1/2 amperes Max.
Plate input, 220 watts Max.
Plate dissipation, 100 watts Max.

TYPICAL OPERATION

D.C. Grid voltage, -90 volts.
D.C. Plate current, 150 milliamperes.
D.C. Grid current, 30 milliamperes.
Driving power, 6 watts.
Power output, 130 watts.

Of course, for Class "B" operation no additional external bias is necessary. This tube is said to work very well as a 5-meter R.F. amplifier with slightly reduced input. (Filament 10 volts at 3.25 amperes.) No. 306.

RCA 803—New R.F. Pentode

● ANOTHER new tube recently announced is the RCA 803. This is an R.F. pentode of the filament type and designed for suppressor or control grid-modulated use and has a rated plate dissipation of 125 watts. Typical operation of this tube as an R.F. amplifier Class "B" telephony are as follows:

Filament voltage, 10 volts.
Filament current, 3.25 amperes.
D.C. Plate voltage, 2000 Max.

Please mention SHORT WAVE CRAFT when writing advertisers

fixed to denote the glass envelope type. The "G" line follows conventional tube manufacturing processes which have been perfected and overcomes the difficulties invariably associated with not only new designs, but also with a totally new development.

As announced to date, "G" line comprises the following types: Pentagrid Converter; Detector-Amplifier Triode; Power Output Triode; High-Mu Triode; Power Output Pentode; Double Diode; Detector-Amplifier Triple Grid; Super Control-Amplifier Triple Grid; Pentagrid-Mixer-Amplifier; Full-Wave Rectifier (Interchangeable with 5Z4).

These tubes are directly interchangeable with corresponding type numbers of all-metal tubes. The photograph illustrates a type 6K7G tube and shows the general appearance of the "G" line with the all-metal tube base connections and guide pin (No. 305).

New "G" series tube at right.



When to Listen In

By M. Harvey Gernsback

(All Schedules in Eastern Standard Time)

DAVENTRY

● DAVENTRY is at present operating as follows: Trans. 1, 12:15 to 2:15 a.m. on GSB and GSD. Trans. 2, 6 to 8:45 a.m. on GSF and either GSG or GSH. Trans. 3, 9 to 10:45 a.m. on GSF and GSG; at 10:45 a.m. to 12 noon on GSF and GSE. Trans. 4, 12:15 p.m. to 4 p.m. on GSB and GSD. A third transmitter will be used as follows: from 12:15 to 2:15 p.m. on GSI and from 2:15 to 4 p.m. on GSL. From 4:15 to 5:45 p.m. (Sundays from 3 to 4:45 p.m.) on GSB and either GSF or GSD.

Trans. 5, 6 to 8 p.m. on GSD and GSC. Trans. 6, 10 to 11 p.m. on GSC and either GSL or GSD.

JAPAN

The special program for the United States broadcast by the Japanese station now takes place daily from 12 midnight until 1 a. m. Normally it is broadcast through JVH on 14600 kc. Another program is broadcast by the same station from 4 to 5 p.m. daily in English. This program is apparently intended for European listeners. From 4 to 8 a.m. daily JVN relays the programs of one of the Tokyo broadcasting stations. All reports should be sent to the Overseas Section of the Broadcasting Corp. of Japan, at Tokyo.

ICELAND

There is now under construction at Reykjavik in Iceland a short-wave telephone station. This station will mainly be used for radio telephone communication between Iceland and Europe. However, it is expected that broadcast programs will occasionally be sent out by this station. Three different wave-lengths have been assigned to the transmitter and three different sets of call letters. They are as follows: TFJ, on 12235 kc., TFK, on 9060 kc.; and TFL, on 5000 kc. The power of this station will be 8.5 kw.

HAITI

The station at Port au Prince in Haiti in the West Indies, mentioned in this column last month, operates on the following frequencies: on 6070 kc., HH2S; on 9545 kc., HH2R; on 11570 kc., HH2T. This station is testing irregularly from 7 to 9 p.m. on any one of these three wave-lengths. These stations are owned and operated by the Societe-Haitienne-D'Automobile, Box 103, Port au Prince, Haiti.

SWITZERLAND

The Monday broadcasts from the League of Nations' station at Geneva now takes place on 9595 kc. on Mondays at 1:45 a.m. instead of on 16 meters as announced last month.

AUSTRALIA

The schedule of VK2ME at Sydney for the month of August is as follows: Sundays only, 12 midnight to 2 a.m., 4:30 to 8:30 a.m., and 10:30 a.m. to 12:30 p.m. For the month of September it will be 12:30 a.m. to 2:30 a.m., 4:30 to 8:30 a.m. and 9:30 to 11:30 p.m. VK3LR, at Melbourne is now reported operating daily from 12 midnight to 3 a.m. in addition to its old schedule. VK3ME also at Melbourne is planning to begin operating daily except Sundays in a short time, and to extend its broadcasting activities so that it will be on the air from about 4 to 7 a.m. each day instead of from 5 to 7 a.m. as at present.

NEW YORK

W2XE, in New York City is now operating on a new schedule daily from 10 a.m. to 5 p.m. on 15270 kc. and from 5 p.m. to 10 p.m. on 6120 kc. The 25 meter wave-length is not being used at present.

PITTSBURGH

W8XK has also made some changes in its schedule: the 13 meter transmitter operates from 7 to 9 a.m., the 19 meter transmitter operates daily from 9 a.m. to 7 p.m., and the 25 meter transmitter operates from 5 p.m. until 9 p.m. The 49 meter transmitter operates from 9 p.m. until 1 a.m. On Fridays the 25 meter transmitter also operates until midnight.

PARIS

Several letters received from the operators of Radio Coloniale indicate that the call letters FYA do not belong to this station. Actually they have no call letter at all, so, henceforth, address them as only "Radio Coloniale". The revised operating schedule for this station is as follows: 15245 kc., from 6 to 10 a.m.; on 11890, from 11 a.m. until 5 p.m.; and on 11715 kc., from 6 to 9 p.m. and 10 p.m. to 12 midnight. They also have been testing from 3 to 5 a.m. We have no further information concerning their new high-power transmitter.

BERLIN

The schedule of the German short-wave stations remains the same as it has been in the past two months with two exceptions. The North American program is now broadcast from 5:05 until 10:45 p.m. instead of until 10:30 p.m. as formerly. DJB, on 15200 kc. operates irregularly, using a directional antenna to North America, from 12 noon to 4:30 p.m. sending the same program as the African beam transmitter.

EXPERIENCED MEN Get the Big Radio Jobs

S. Q. NOEL

PRES. FIRST NATIONAL TELEVISION, INC.

"Every qualified man I train puts in actual hours at my 1,000 Watt Commercial Radio Station! When you have completed my training course, you are a tested radio and television expert—ready to step into the BIG PAY class! You have had actual experience behind you in genuine radio broadcasting work which gives you preference in any radio job. The hours you spend in my ultra-modern, "Hi-Fidelity" commercial station W9XBY and my licensed television experiment station W9XAL mean dollars to you. Never before have you been offered so great an opportunity! Tune in on "Hi-Fidelity" Station W9XBY—1530 kilocycles.

Get your license while learning

A government operator's license is a passport to a real job with a future! My students qualify for their licenses and get certified service records while learning. FREE employment service for life on graduation. No previous experience needed. Write today and let me point the way to the highest-pay radio jobs!"

S. Q. Noel, Pres. First National Television, Inc. (Training Division)

Dept. BB-9, Power and Light Bldg., Kansas City, Mo.

Without obligation, send me postpaid FREE Illustrated Folder telling about new opportunities in radio and television. I am 17 years or older.

Name _____ Age _____

Address _____

FOR CONSISTENT FOREIGN SPEAKER RECEPTION!

Order Your
World
Trotter
"SW4"

Sensational
advanced
design! using
one 76, one
6D6 and one
type 12A7
DUAL
TUBE.

7.25

With band-
spread \$1.00
additional.

... brings you all the parts needed to build this remarkable AC-DC, all electric receiver: with four coils to cover from 14 to 210 meters, and easy-to-follow instructions. Cracked finish black metal cabinet size 12 x 7 x 7 \$1.50. Special loud-speaker \$1.35. Broadcast coil to cover from 200 to 550 meters makes the set all-wave! Your price \$1.10.

SPECIAL COMBINATION OFFER!!
Complete kit; speaker, cabinet, \$10.95
broadcast coils, easy-to-follow in-
structions for only.....

Wired and tested add \$1.50. Set of matched 6 months guaranteed Arcturus tubes \$2.15.

WORLD TROTTER RADIO LABS.
168 Washington Street, Division C12, New York City

A.C. Electric Generating Plants

ONAN ALTERNATING CURRENT ELECTRIC PLANTS furnish the same current as city service—110 volt, 60 cycle, A.C. Operates Radios, Water Systems, Refrigerators, all household appliances.



Sizes 350 to 50,000
watts

Operate on Gasoline, Gas or Distillate. No battery and no need to start engine. Ideal for places remote from electric service. For Public Address, Sound Amplification, Portable Lighting and Standby Equipment.

Some Dealer's Territory Available.

D. W. ONAN & SONS
470 Royalston Ave.,
Minneapolis, Minn.

Please mention SHORT WAVE CRAFT when writing advertisers

THE Only 100% RADIO CATALOG
 IT'S **Free** 1935
 THOUSANDS OF PARTS
 SET-BUILDING KITS
 TEST INSTRUMENTS
 PUBLIC ADDRESS
 SHORT WAVE GEAR
 ALL-WAVE AUTO
 BATTERY RADIOS

ALLIED RADIO CORPORATION

833 W. Jackson Blvd., Chicago, Ill. Dept. E
 Send me your FREE Spring & Summer Catalog.

Name

Address

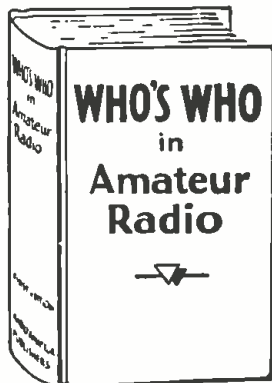

HAMS NEED THIS BOOK!

50c

144 Pages
 6 3/4 x 9 1/2" in size

An Excellent Radio Book

which every short-wave "ham" will want to have on his shelf or desk. Plenty of photos of the prominent "hams" with neat descriptions of their careers and activities are given. The "ham" pedigrees are listed in numerical order by station calls, beginning with W1 and ending with W9. The book is printed on a fine stock of paper. Sent postpaid to readers of SHORT WAVE CRAFT for only fifty cents. Send stamps or coin.

RADIO PUBLICATIONS

97 Hudson St. New York, N. Y.

RADIO COURSES

Radio Operating
 Prepare for Gov't license exam.

Radio Amateur Code

Radio Servicing
 Including short wave

New Course Radio Electronics
 All day 1 year course starts Sept. 23.

Resident Courses
 Write for Booklet

New York YMCA Schools
 6 West 64th Street New York City

"Stations in France, Germany, S. America

etc. received on your One Tube Receiver. Excellent performance... ACE Construction Kits include all necessary parts and clear simple instructions. One Tube dry cell Receiver \$1.95 Two Tube (More Volume) \$2.85 ALL ELECTRIC Two Tube Set. Plug into any house line. No batteries needed! \$3.65 Kits shipped 75c extra. Tubes 25c each. Double phones \$1.25. ORDER NOW! Send \$1 or if full remittance we pay postage. Send for FREE Literature.

ACE RADIO LABORATORIES 1619 B'way N.Y.C. Dept. C-9

See Page 302 for Details on Two Brand New Radio Books at 10c!

720 Miles on 5 Meters!

By W2AMN.

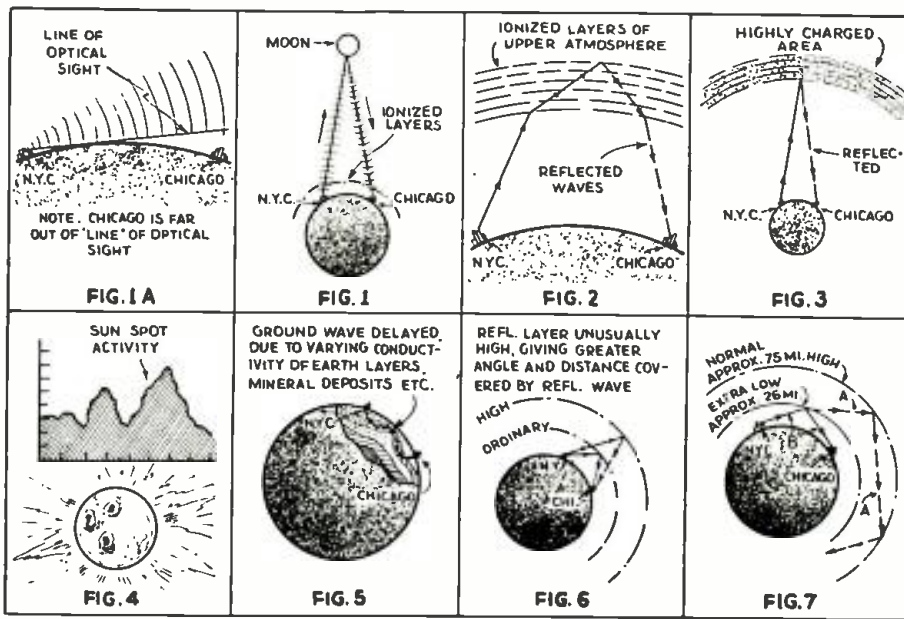

The above diagrams show some of the theories which have been proposed from time to time to account for some of the extra long distance transmission obtained with ultra short waves. Fig. 1A shows the transmission of ultra short waves of 5 meters or less in length and how they would miss a point 700 miles distant by following the line of "optical sight." Fig. 1 shows theory that 5-meter waves may pierce the Heaviside and other ionized atmospheric layers, and be reflected from the moon or other heavenly body.

Fig. 2 shows how the wave may have been refracted and reflected from ionized layers so as to reach Chicago. Fig. 3.—Some scientists have advocated the theory that ultra short waves may project into space far beyond the earth, strike a highly ionized layer or "cloud" of electrons and be reflected back to the earth. Or, another theory which accounts for many freak "long-distance" short-wave transmissions is sun-spot activity, as shown in Fig. 4, although in this case the degree of sun-spot activity did not seem to check with the phenomenal range of 700 miles obtained on 5 meters.

Fig. 5 indicates a ground wave theory, layers of varying conducting mediums accounting for the phenomenal transmission. Fig. 6 shows an extra great height of the Heaviside layer, which might account for the greater range of transmission. Fig. 7 shows W2AMN's theory in which a subnormal height of the reflecting layer might have accounted for the 700-mile transmission on 5 meters, the line AA showing normal reflection of the wave which reflects at such an angle as to miss the earth, but when reflected from the lower layer altitude it would follow the line B and reach Chicago.

● IN years past the possible distance that could be covered with ultra short-wave transmitters was within the optical range, however, each year this range seems to have stretched considerably and, at the present moment the distance covered with the conventional 5-meter amateur transmitter is some 720 miles!

Just a few minutes before this story was written we received a telephone call from our good friend, Frank Lester, W2AMJ, and at the opening of the conversation we detected a slight tremor in his voice as he proceeded to read the following telegram which he had received via Mackay Radio Service:

"Listened in on my 5-meter receiver last night and the air was flooded with 56 (5 meter) megacycle stations, talking about the freaky conditions of the evening before when the east coast 5-meter stations were coming through to QSA5. W2AMJ, Frank Lester's station, was heard here with a wallop. Signed, E. J. Necker."

Reception in this case was on June 24. Then Frank read a letter which he had received from the Illinois Ham Club, Inc., which ran as follows:

"Dear OM: On Sunday, the 23rd, 1935, at 11:30 a.m., E.S.T., your 5-meter signals were heard in Chicago by W9KQW and by an SWL. I also heard a W1 but was unable to verify the complete call."

The letter also went on to state that the conditions lasted for several hours and the signals were fading very badly.

This is quite a remarkable occurrence and "things have been happening" on the ultra high-frequency bands in the last few

weeks. We were also informed that the Harrisburg, Pa., Police Radio operating on 7 meters was heard in Kansas City, Mo., and during a prearranged schedule, the Kansas City Police and the Harrisburg Police held a two-way car-to-car conversation on the 7-meter sets!

It has also been reported that 7-meter signals from Europe have been heard in South America; however, complete details are not available at this time.

Further checking of this Chicago situation revealed that a good many of the amateurs operating on the 5-meter band were heard in the Chicago area, W2AMJ's signals having been reported the strongest of all. For those who are interested, the transmitter used at W2AMJ is a "long-lines" oscillator very much like the one described by W2AMN in the October 1934 issue of Short Wave Craft.

We pass this information along to our many amateur readers in hopes that they will be on the lookout for DX signals in the 5-meter band, and we hope to have more information on the subject, inasmuch as test schedules have been arranged, and we will probably have a good story before long.

'Tis said that "fools rush in where angels fear to tread" and undoubtedly many extraordinary theories attempting to account for this remarkable 700-mile jump of the 56 mc. signals will be offered in short order. Don't be bashful—if you think you have a good theory send it to the Editor, and if accepted and published, the article will be paid for at regular rates.

Please mention SHORT WAVE CRAFT when writing advertisers

A 5-Meter Superhet Kit

(Continued from page 279)

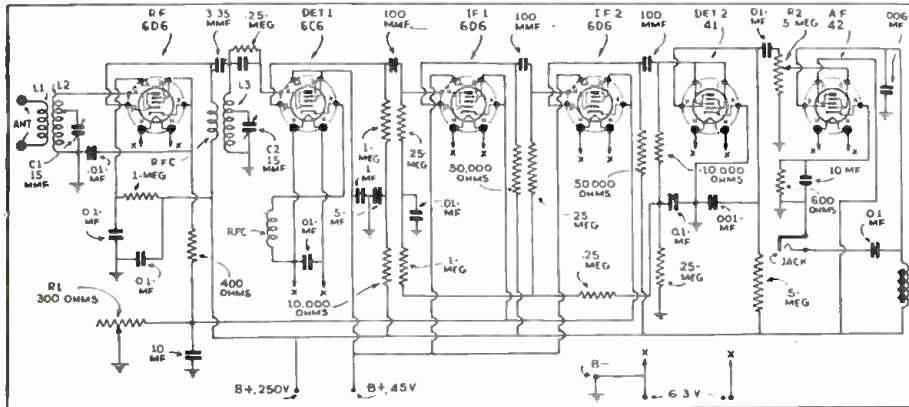

Here is the circuit diagram of the new 5-meter superheterodyne designed by Frank Lester, W2AMJ. The main features of this type of 5-meter receiver are, of course, the absence of hiss, and its extreme sensitivity. The tuned R.F. stage increases the sensitivity and also reduces back-ground noise.

R.F. amplification, tuned autodyne first detector, two stages of resistance-capacitance, coupled I.F., second detector and semi-A.V.C. tube, and a power pentode output stage capable of working a dynamic speaker to full volume.

To simplify the arrangement of the parts and to eliminate trimming and aligning troubles, separate controls are provided for the R.F., and detector tuning condensers, C1 and C2, respectively. The R.F. stage actually provides some appreciable gain (remember, it is not working into a super-regenerative detector), it improves the signal-noise ratio, and it eliminates dead-spots in the detector tuning, due to that "old devil"—antenna absorption!

The first detector works on the autodyne principle, the grid circuit being detuned a trifle from the signal frequency so that a comparatively low frequency beat develops. This simple method of obtaining heterodyne action is quite practicable on the ultra-high frequencies.

Feed-back between the grid and plate of the first detector is obtained by the use of a small R.F. choke in the cathode circuit—a form of electron coupling. The choke is common to both the grid and plate circuits and therefore oscillation is maintained at a steady rate. The grid condenser-leak combination, and also the screen and plate voltages, are adjusted to give smooth regeneration, but not super-regeneration.

The use of resistance-capacitance coupled I.F. greatly simplifies the construction of the receiver. There are no magnetic fields or interaction effects, and extensive shielding therefore is not required. A type 41 tube, with the screen and grid hooked together to form a high- μ triode, is used as the second detector. Part of the rectified grid current is taken off the grid leak and returned to the grids of the I.F. tubes, to give automatic volume control.

Two volume adjustments are provided: a cathode resistor R1, regulating the bias on the R.F. and I.F. amplifier tubes; and a grid potentiometer R2, regulating the audio output.

Various methods of coupling the antenna to the receiver can be tried. If a two-wire transmission line is used it can be connected directly to the antenna coupling coil, or one feeder can be grounded and the other run up a turn or two on the grid coil L2. Single wire lines should be connected to the grid of the R.F. tube through a 10 to 30 mmf. trimmer condenser.

The hay-wire appearance and construction so common today among five-meter receivers have been carefully avoided in the Lafayette set. A heavy, copper-plated steel chassis, all formed and drilled, gives the finished set a truly professional appearance. A heavy T shaped shield keeps the R.F., detector, and I.F.-A.F. stages well

isolated. The coils are of the plug-in type, with tiny banana plugs and mycalex bases. The antenna coil L1 is fixed, but L2 and L3 are removable. Coils for 2½ and 10 meters will be available shortly after this article appears. For five meters, L1 consists of six turns, L2 and L3 eight turns, of No. 12 tinned wire, wound around a ½-inch diameter form. The taps on L2 and L3, two turns from the grid ends, give enough band-spread to make the tuning dials turn about three-quarters of the scale for the five-meter band.

The front panel is finished in black crackle. The chassis slides into a similarly finished cabinet, which has a hinged cover to permit changing of the coils. The whole set measures 12 inches long, 7¾ inches high and 8 inches deep.

When this new receiver was shown to some local Hams, the first question they asked was,

"Does the R.F. stage really tune?"

The answer is "Yes." A movement of three to five dial degrees off resonance will cause the signal to "drop out." The detector dial is, of course, much sharper one degree here being the average tuning "sharpness."

The set has been tested very thoroughly and has proven to be satisfactory in every respect. For instance at the writer's station W2AMJ, located in Bergenfield, N.J., signals from a five-meter transmitter at Walden, N.Y., about 50 miles away, were R2-R3 with a super-regenerative receiver, and easily R7-R8 with the new Lafayette job, and with none of the QRM experienced with the first set. Several stations that were never heard before at all came in quite well with the superhet.

The set was also tried at W2DLG, located on top of the Hotel New Yorker, in New York City, one of the best known five-meter stations in the East. Here also it brought in new stations and in general out-performed several other receivers.

WTMJ to Improve Facsimile Equipment

● WTMJ, the Milwaukee Journal Station, which for more than a year has been broadcasting a regular daily schedule of facsimile transmission over one of its short-wave experimental stations, will soon make radical changes in its equipment for this work. These improvements will make it possible to reproduce picture material on a tape seven inches wide instead of only four inches as heretofore. Much finer definition of the drawing will be obtained by scanning the subject material at the rate of 100 lines per minute, and by the use of a chemically treated paper in the recording device.

Please mention SHORT WAVE CRAFT when writing advertisers

Just What You've Wanted!

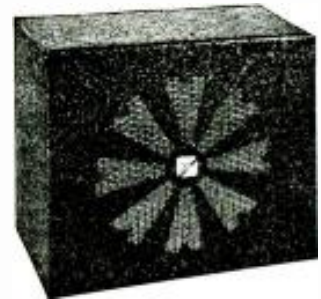

WRIGHT-DECOSTER METAL CABINET SPEAKERS

for the Amateur who demands results

Model 880 Equipped with 6" Dynamic Speaker with Universal Transformer to match all output tubes, 2500 ohm field.
List Price..... **\$880**

Model 980 Equipped with 8" Dynamic Speaker with Universal Transformer to match all output tubes, 2500 ohm field.
List Price..... **\$980**

Cabinets finished in black crystalline. Size, 9" high, 10" wide.

Model 470 A.C. Field Supply

Furnishes necessary field excitation for A.C. operation of the above models. So designed as to fit into the housing perfectly.
List Price..... **\$470**

Write for dealer's discount, catalog and name of nearest distributor. Wright-DeCoster distributors are always anxious to cooperate with you.

WRIGHT-DECOSTER, Inc.

2257 University Ave. St. Paul, Minn.

UNCLE DAVE'S

UNCONDITIONAL GUARANTEE ON ALL OUR RADIO SUPPLIES

3-10 TUBE RADIO SHACK

135 BROADWAY, ALBANY, N. Y., U.S.A.

SPECIAL! 1-tube DC short wave receiver enclosed in metal cabinet... bandspread on all bands... complete with tube, coils for both short wave and broadcast... b and s wired and tested.....\$2.35

ONLY A FEW LEFT AT THIS GREAT SALE PRICE!

Peerless breadboard power supply with voltage divider, 350 volt at 75 ma; 2½ volt at 6 a; completely filtered... complete wired & tested, less tube.....\$2.95

Send for our free ham catalog—Just out!

SHORT OF CASH?

You can buy all standard short wave receivers on our famous

"Painless Payment Plan"

Lowest down payments and long-term terms. Write for technical bulletins and terms on sets.

Amateur Stations
W9APY-W9CRT-W9DDE-W9WR

WILCOX RADIO SALES CO.
182 W. Adams St. Chicago, Ill.

QUICK WAY to make money in

TRAIN WITH R.T.A. NOW

RADIO Modern receivers are demanding men with modern training for service work. New training method and service equipment offer starts you earning almost at once. Up to \$3 an hour easy in a short time. Write today for FREE book of details.

Radio Training Association of America
Dept. S.W.C. 59
4513 Ravenswood Ave., Chicago

Why gamble?—

INVEST in a genuine DOERLE



2-TUBE BATTERY RECEIVER 15 to 200 Meters

One of the most popular members of the Doerle Set family. Employs but two tubes, yet gives the performance of a set having three tubes. Uses a type 30 as regenerative detector and a type 19 twin triode (actually 2 tubes in one) as two stages of resistance-coupled audio. The world-famous reputation of the entire Doerle line, is behind this remarkable set. Requires two No. 6 dry cells and two 45 volt "B" batteries for operation. All parts and workmanship fully guaranteed. Employs a set of four 5-prong ribbed plug-in coils. These coils are interchangeable with the new 5-prong bandsread coils. Ship. wt., 10 lbs. List Price \$15.75.

\$7.64
KIT
Less Tubes and Batteries

No. 5009-K Doerle 2-tube Battery Receiver Kit, including Coils but less Tubes and Batteries. YOUR PRICE **\$7.64**
Set of Matched Tubes \$1.00
Metal Cabinet for above90
Set of Bandsread Coils 2.34
No. 5008-K Doerle 3-tube Battery Receiver Kit with 8 Coils and Metal Cabinet, but less Tubes and Batteries. Ship. wt., 10 lbs. List Price—\$23.75
YOUR PRICE **\$12.41**
Set of Matched Tubes \$1.80
We will wire and test any of these kits at an additional charge of \$1.50.
125 to 1 Bandsread Dial for the 3-tube set \$1.75 extra

RADIO TRADING CO.

101-A Hudson St. N. Y. C.

VEST POCKET SOLDERING IRON



Smallest good iron now on the market. Will do the work of irons twice its size. Only 10 inches long. 1/2 inch in diameter. By using the highest grade elements, it heats up in half the time of ordinary irons. Guaranteed to give satisfaction or money back. We issue no catalog on this item. Enclose \$1.20 and iron will be sent postpaid in U.S. 10c extra in Canada.

GOLD SHIELD PRODUCTS CO.,
17 West 60th St., N. Y. City

Special Subscription Offer

You can now save 25 cents on a year's subscription to the OFFICIAL SHORT WAVE LISTENER MAGAZINE. Send us \$1.25—\$1.50 in Canada and Foreign Countries—and we will send the next six issues—right to your home.

Official Short Wave Listener Magazine
99-101 Hudson St. New York, N.Y.

Short Wave Scout Trophy Award

(Continued from page 284)

Read These Rules Carefully

IMPORTANT: Do not fail to remember that all the entries must now be entered according to the new rules which are herewith reprinted for the benefit of those who intend submitting lists of stations. Read the new rules carefully!

Briefly they are: The Trophy will go to the person submitting the "greatest number of verifications!" No unverified stations are required! Also, at least 50 per cent of the verifications submitted must be for stations located OUTSIDE of the country in which the entrant resides. Only letters or cards specifically verifying reception of a given station will be considered.

Trophy Contest Entry Rules

● NOTE that we have amended our rules and you will find that the rules now read:

In order to protect everyone, the rules have been amended that a sworn statement before a Notary Public which only costs a few cents to get, must be sent in at the same time.

For the complete article of the Purpose of the SHORT WAVE SCOUTS, we refer to page 393 of the November, 1933, issue.

Here are the rules amended:

You wish to know how you can win this valuable trophy, and here are the simple rules. Be sure to read them carefully. Do not jump at conclusions.

1.—A monthly trophy will be awarded to one SHORT WAVE SCOUT only.

2.—The purpose of this contest is to advance the art of radio by "logging" as many short-wave commercial phone stations, in a period not exceeding 30 days, as possible by any one contestant.

3.—The trophy will be awarded to that SHORT WAVE SCOUT who has logged the greatest number of short-wave stations during one month.

4.—In the event of a tie between two or more contestants each logging the same number of stations, the judges will award a similar trophy to each contestant so tying.

5. Verifications are necessary; these must be sent in with each entry. All cards or verification letters must be sent in at the same time with a statement by the SHORT WAVE SCOUTS, giving the list of stations in typed or written form, with the station calls, wave-lengths, and other able information. (See below.) The verification letters and cards will be returned to the SHORT WAVE SCOUT at the end of each monthly contest. (See Jan., 1933, editorial how to obtain verification.)

Note! All Stations Sent In Must Now Be Verified!

6.—The winner each month will be the person sending in the greatest number of verifications. Unverified stations should not be sent in, as they will not count in the selection of the winner. At least 50 per cent of the verifications sent in by each listener must be for stations located outside of the country in which he resides! In other words, if the contestant lives in the United States at least 50 per cent of his "veries" must be from stations outside of the United States. Letters or cards which do not specifically verify reception, such as those sent by the Daventry stations and, also by commercial telephone stations, will not be accepted as verifications. Only letters or cards which "specifically" verify reception of a "given station," on a given wave length and on a given day, will be accepted! In other words it is useless to send in cards from commercial telephone stations or the Daventry stations, which state that specific verifications will not be given. Therefore do not put such stations on your list for entry in the trophy contest!

7.—This is an international contest in which any reader, no matter where located, can join. It is allowable for SHORT WAVE SCOUTS to list stations in their own countries, if they desire to do so.

8.—SHORT WAVE SCOUTS are allowed the use of any receiving set, from a one-tube up to one of sixteen tubes or upwards, if they so desire.

9.—When sending in entries, note the following few simple instructions: Type your list, or write in ink, pencilled matter is not allowed. Send verification cards, letters and the list all in one package, either by mail or by express prepaid; do not split up the package. Verification cards and letters will be returned, at the end of the contest, to their owners; the expense to be borne by SHORT WAVE CRAFT magazine.

10.—In order to have uniformity of the entries, when writing or typing your list, observe the following routine: USE A SINGLE LINE FOR EACH STATION; type or write the entries IN THE FOLLOWING ORDER: Station call letters; frequency station transmits at; schedule of transmission, if known (all time should be reduced to Eastern Standard which is five hours behind Greenwich Meridian Time); name of station, city, country; identification signal if any. Sign your name at the bottom of the list and furthermore state the type of set used by you to receive these stations.

11.—Don't list amateur transmitters or code stations in this contest.

12.—This contest will close every month for the next twelve months on the first day of the month, by which time all entries must have been received in New York. Entries received after this date will be held over for the next month's contest.

13.—The next contest will close in New York, August 1.

14.—The judges of the contest will be the editors of SHORT WAVE CRAFT, and their findings will be final.

15.—Trophy awards will be made every month, at which time the trophy will be sent to the winner. Names of the contesting SCOUTS not winning a trophy will be listed in Honorable Mention each month.

16.—From this contest are excluded all employes and their families of SHORT WAVE CRAFT magazine.

17.—Address all entries to SHORT WAVE SCOUT AWARD, 99-101 Hudson St., New York City.

FREE BATTERIES TO TROPHY WINNER!

● The manufacturers of the well-known Burgess batteries have offered to furnish FREE one year's supply of batteries—all the batteries that the "trophy" winning set will need for a year—and providing it happens to be a Burgess Battery-powered set. A very fine offer indeed, and the editors are glad to pass on the good word to all of their embryo trophy contestants.

Burgess Ribbon Battery (H6)

(Continued from page 282)

of the photographs on page 282 is something rather unusual in battery design. Because the cells are fastened side by side, this battery becomes very flexible. It can be hung flat against a wall, laid flat on any horizontal surface or folded up in any one of many convenient shapes made possible by its design. This battery will meet with just about any condition which may exist. It is made of 22.5, 45, 90 and 135 volt units with convenient taps and contains the same high grade cells found in all Burgess products.

Please mention SHORT WAVE CRAFT when writing advertisers

Notes from "Down-Under"— Short Waves in Australia

(From Duncan Clarke, Melbourne)

● BECAUSE there are huge empty spaces in Australia, short-wave radio wireless is being employed in many ways to maintain communications. In area, Australia is as big as the United States, but we have only six million people here. Right in the heart of the desert there are veritable oases on which are located cattle stations and, in the wilder parts, there are mission stations. All are provided with short-wave equipment. At Hermansberg Mission, between Alice Springs and Darwin, the German Monks operate a short-wave transmitter, energizing current being supplied from a dynamo spun by a foot-treadle machine of "one-man" power.

Recently the *Melbourne Herald* sent a man through Central Australia. His first big story was dispatched by short waves from the Hermansberg Mission station, picked up at Cloncurry, North Queensland, and transmitted by land line to Melbourne 1500 miles to the south. These crude short-wave stations in the wilds of Australia are also employed to summon medical aid in case of sickness. There is always a man on duty at Cloncurry listening for signals from 'way back. The aerial (flying) doctors stationed in central and north Australia have their planes equipped with short-wave receivers so that they also may pick up messages while flying over the empty regions.

Having read this little tid-bit of news, short-wave fans now turn up a map of Australia! You will be able to appreciate what radio means to the lonely people of Australia's "Never-Never"!

Radio laws in Australia are harsh on the experimenter and probably because of the restrictions the urge to defeat the law is pretty persistent. There are many hams in this country. They do a lot of "tick-tacking" with each other and get much enjoyment out of the experiments. Pirating on the air, however, is looked upon as good sport, and because of our wide spaces and small population it is difficult, almost impossible, for the Government inspector to detect culprits. Horse-racing is a religion down here and wireless has helped the "evangelists" to spread good and bad news from the racecourses to the betting shops outside. At the Sydney Cup meeting held on Apr. 22, a man was arrested for being in possession of a short-wave transmitter stowed way in an inside pocket. Government agents said, in court, that he was transmitting messages from the racecourse. The case fairly bamboozled the state court so now the High Court of Australia has to determine whether the man with the pocket transmitter really infringed the wireless telegraph laws of the Commonwealth.

Short-wave radio communication in lonely Central and Northern Australia has been developed by Australian Inland Mission, an organization of the Presbyterian Church. The mission has hospitals and outposts in these wild territories and all are equipped with radio. The transmitters, many of which are operated by these brave mission nurses, are of standard design. The generator which supplies the power, is foot-operated, similar to a bicycle, and can generate a power of about 20 watts, at a pressure of 300 to 400 volts. The gears are enclosed in an oil-tight casing. The transmitter is crystal-controlled, the crystal maintaining the wavelength at a definite value and keeping the note signal steady, thus making the signals easy to read, even if the generator is driven unevenly. The receiver is a 2-tube regenerative circuit, usually known as the P.I., and Tetrode valves (tubes) are used. A set of batteries gives from four to six months' service. The sets can be set up and operated within a few minutes. Recently a sick man was brought into an

outback mission hospital. His case baffled the nurses so one of them called up the aerial doctor by Morse code, giving the symptoms. The doctor at Cloncurry replied by phone, advising the nurses of the treatment required. The man lived.

"Hot" American Drama Burns Englishman's Tie

● SO realistic was the drama from the United States that the Englishman pictured himself at the scene of the huge forest fire. Actually, he was some 3,000 miles away. The fire crackled; he even smelt smoke! It stifled him. What's this? By jove, it was his bally old tie on fire!

That testimonial of the quality of a recent American Radio Relay League drama broadcast from W2XAF, G.E. short-wave station, speaks for itself. The Englishman told the story in a letter to the Schenectady station, thrilling to the real-life dramas presented by the American transmitter.

Variable Impedance Modulation Transformer

● HERE is a new transformer for use in radio transmitters, which permits coupling the 500-ohm output of any audio amplifier to any R.F. plate circuit carrying not over 215 milliamperes of direct current. It will handle up to 80 watts of audio power.

The primary of this transformer is wound to match the impedance of a 500-ohm line. The secondary is tapped to match a 5,000-, 6,000-, 7,000-, 8,000-, 9,000-, or 10,000-ohm plate circuit impedance.

This transformer may be permanently connected to the plate circuit of the R.F. amplifier tube in a transmitter and any standard public address amplifier system may be coupled to the 500-ohm primary whenever it is desired to modulate the signal from an audio circuit.

This is the first time the universal system of coupling, popularized in small radio output transformers, has been applied to a large unit employed in transmitter circuits.

The manufacturer recognizes the desire of amateurs to make one piece of equipment serve at times in several different positions. Furthermore, this design simplifies the distributors' stock, as this one unit is adaptable to circuits which previously required six individual transformers.

The size of this new transformer is 6 1/2" x 5 3/4" x 8". The weight is 16 1/2 lbs. Its audio characteristic is essentially flat up to 7,000 cycles.

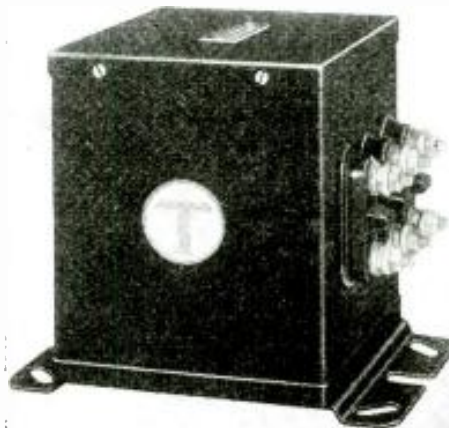

New Variable Impedance Transformer of many uses. No. 304.

Please mention SHORT WAVE CRAFT when writing advertisers

Record Breaking PERFORMANCE

**GREATER DISTANCE
LESS NOISE . . . with this
Superlative All-Wave Receiver!**

More words of praise have been written editorially about the BROWNING 35 than any radio receiver in the past 10 years. That's because it actually lives up to or exceeds all the claims made for it. Listening Post observers who insist upon low noise level and high sensitivity have been amazed at its performance. You, too, will be astonished at its quiet operation plus its ability to bring in hard-to-get stations!

The Browning 35 with the Tobe Tuner when built into an expensive cabinet (made obsolete because of the out-dated receiver) will modernize that cabinet and bring you superlative performance which cannot be exceeded by any present day All-Wave receiver. Get the facts from your lobbyist at once or write us direct.

FREE Illustrated tabloid telling how to modernize obsolete receivers, with the BROWNING 35, plus diagrams, parts list, prices, etc. Write—

TOBE DEUTSCHMANN CORP.
Dept. I-13, Canton, Massachusetts

Export Dept.
105 Hudson St., New York



WITH
This Newest
**ALL-WAVE
RECEIVER**

BROWNING 35
With the **TOBE Super Tuner**

TRIPOLET
**GOOD MEASURING AND
RADIO INSTRUMENTS AT
PRICES YOU CAN AFFORD
TO PAY.**

THE TRIPOLET ELECTRICAL INSTRUMENT CO.
174 Main Street Bluffton, Ohio, U.S.A.

Absolutely NEW

● **RACO Multi (7) BAND 1-Tube
AC-DC Receiver. 12-2000 Meters**

- The only All Wave Receiver at such
- LOW PRICE. Cost
- endorsed by the RACO
- trademark. True the
- new multi-purpose
- 12A7 tube. A custom
- built job. Foreign
- reception guaranteed
- Dimension 5" x 4 1/2" x 3"
- Kit with 4 coils 12-
- 200 meters \$3.95
- Cabinet \$1.00
- No. 5 coil (200-550)
- meters .39
- No. 6 coil (550-1150)
- meters .59
- No. 7 coil (1100-2100) meters .69 RCA licensed tube \$1.00
- Wiring and testing \$1.00

RADIO CONSTRUCTORS LABS.

136 LIBERTY
STREET



Dept. SW-207
New York, N. Y.

WE MAKE TO ORDER

Metal Cabinets—Chassis
Shield Cans to fit Chassis
Panels—Aluminum or Steel
We do Painting and Plating

Send us your inquiries

KORROL MFG. CO., Inc., Dept. S-9
232 Greenwich St. New York City

DATAPRINTS

Just the
CONSTRUCTION



Information
You Need
To Build
Electrical
Apparatus

TESLA OR OUDIN COILS

Dataprint containing data for constructing this 3 ft. spark Oudin-Tesla coil. Requires 1 K.W. 20,000 volt transformer as "exciter". See list below. Includes condenser data. . . **\$.75**

- 8 inch spark, data for building, including condenser data; requires 1/4 K. W. 15,000 volt transformer; see list below..... **0.50**
- Violetta type, high frequency coil data; 110 volt A.C. or D.C. type; 1" spark; used for "violet ray" treatments and "Experiments"..... **0.50**
- How to operate Oudin coil from a vacuum tube oscillator..... **0.50**
- 3 inch spark Tesla coil; operates on Ford ignition coil..... **0.50**
- 3 inch spark Oudin coil; 110 volt A.C. "Kick-Coil"..... **0.50**
- 20 Tricks with Tesla and Oudin Coils..... **0.50**

TRANSFORMER DATA

- 1 k.w. 20,000-volt transformer data, 110-volt, 60-cycle primary. Suitable for operating 3 ft. Oudin coil..... **0.50**
- 1/4 k.w. 15,000-volt transformer data, 110-volt, 60-cycle primary. Suitable for operating 8-inch Oudin coil..... **0.50**
- Electric Welding Transf. (2 K.W., 110 Vt. Prim., 18 Vt. Sec. (other Sec. Vt. data given)..... **0.50**
- Induction Coils—1 to 12 inch spark data..... **0.50**
- ARTIFICIAL FEVER APPARATUS..... 0.75**

(Low, Medium & High Power Data Given)



**SLIDE
RULE
MIDGET**

Metal 4" Dia.
Price \$1.50.

Case 50c extra

This rule solves any problem in multiplication, division, addition, subtraction, and proportion; it also gives roots and powers of numbers, sines, cosines, tangents and cotangents of all angles; also logs of numbers. Adds and subtracts fractions. Approved by colleges.

10" Dia. 27" Scale "Special" Rule. \$2.75.

Multiplies and Divides, but has no "Trig" Scales.

TELEGRAPHONE — Records Voice or "Code" signals on steel wire by magnetism. Code can be recorded "fast" and translated "slow." Construction data (special)..... **\$0.60**

MAGNET COIL DATA

- Powerful battery electro-magnet: lifts 40 lbs. **\$0.50**
- 110 Volt D.C. magnet to lift 25 lbs. **0.50**
- 110 Volt D.C. 300 lb. Lift electromagnet..... **0.50**
- 110 Volt D.C. solenoid: lifts 2 lb. through 1 in. **0.50**
- 110 Volt D.C. solenoid, lifts 6 lb. through 1 in. **0.50**
- 12 Volt D.C. solenoid, lifts 2 lb. through 1 in. **0.50**
- A. C. Solenoid, powerful, 110-volt, 60-cycle..... **0.50**
- MOTOR**—1/16 H.P., 110 volt A.C., 60 cycle (suitable for driving 12" fan, etc.)—Data..... **0.50**
- 60 or 1,200 cycle Synchronous motor Data..... **0.50**

MISCELLANEOUS DATAPRINTS

- Treasure Locator..... **\$0.50**
- Electric Refrigerator data..... **0.50**
- 20 motor circuits—hook-ups..... **0.35**
- 20 practical telephone hook-ups..... **0.35**
- 100 mechanical movements for inventors..... **0.50**
- Polarized Relay—Ultra Sensitive..... **0.50**
- Electro-medical coil (shocking coil)..... **0.50**
- Water-Wheels—How to Build and Light your house..... **0.50**
- 20 Electric Bell circuits..... **0.50**
- Public Address System..... **0.50**
- Electric chime ringer; fits any clock..... **0.50**

20 "Electrical Tricks" for LODGES and PARTIES..... **\$0.50**

How to Fry Eggs on Cake of Ice Electrically..... **\$0.50**
"Rewinding" Small Motor Armatures..... **0.50**

"ENGINEERING SERVICE BY MAIL"

Send Sketch of Your Problem for Estimate. (20% off on orders for \$3.00 or more. No C.O.D.)

The DATAPRINT COMPANY

Look Box 322 RAMSEY, N. J.

Second Link In 5-Meter Radio Chain Established

● THE low-powered 5-meter radio transmitter which has been in operation at the Hotel New Yorker for the past eight or nine months has been moved to a new location, 40 Wall St., New York City, which is almost at the tip of Manhattan Island.

The apparatus has been installed on the sixty-fourth floor of the Manhattan Company's building, at that address, and even though the station has been in operation but a few days, some remarkable results have been obtained. The night the station was put in operation, a two-way direct conversation was held with amateur station W3DAR at Stratford, Pa., where the signals from the New York station were reported as being R7, which means good strong signals.

Communicates through Lightning Storm

During the conversation with the station at Stratford, Pa., a very severe lightning storm was in progress in New York. At one time a streak of lightning was observed which appeared to extend from Bay Ridge to the Bronx about 15 miles. Many other extremely long bolts were observed and many of them apparently in the immediate vicinity of the tower in which the New York station is located.

None of this display caused any interruption in the conversation. However, such a lightning storm would have caused great difficulty with communication on any of the ordinary communication frequencies.

From this high vantage point, a storm reported by a station at Elizabeth, N.J., was observed to approach New York and its electrical effect was watched as it approached. When the storm did break, the electrical discharges were accompanied by a terrific wind and the radio antenna, which was mounted on the end of a long pole, extending out of a window on the 64th floor, was whipped around very badly. Neither the whipping of the antenna, nor the electrical discharges had any apparent effect upon reception or transmission. The same antenna was used for both transmitting and receiving.

Proves Effectiveness of Suitable Antennas

Communication on the ultra high-frequencies, such as the 5-meter wavelength at which this new station is operating, is such a new field that a great many statements have been made concerning its limitations which are now coming to be considered incorrect. At first, it was thought that communication on these frequencies would be confined to line of sight.

The first definite proof of the incorrectness of this theory was found in the series of tests conducted between the experimental station owned by James Millen, of Malden, Mass., and the headquarters of the American Radio Relay League, located at Hartford, Conn. This is a distance of approximately 120 miles and there are two ranges of high hills between these points, over which it was necessary for the signals to pass.

The success of the tests between Malden and Hartford were found to be largely dependent upon the use of suitable antennas, rather than the use of extremely high power.

The results obtained at the new location of the Garden City Radio Club, verify these findings and the difference in performance reported by stations in the Philadelphia area is considered important.

Signals first heard in Philadelphia from the New York area, were picked up by Mr. Robert Hatch at station W3AZG, located at Riverton, N.J., and they were received from the Garden City Radio Club, located at the Hotel New Yorker. In this instance, an antenna of the type known as a vertical half-wave radiator, and with a matched impedance transmission line, was

employed. Later a beam-array incorporating two half-wave radiators and two half-wave reflectors was installed at the New Yorker and the signal in the Philadelphia area was reported to have increased approximately 35 percent. At the club's new headquarters, a single half-wave radiator with a matched impedance transmission line was employed and, while the signal in Philadelphia was reported as being better than the first signal received from New York, it was not as loud as the signal received when the beam was employed.

This is especially interesting, according to Mr. Arthur H. Lynch, who is in charge of the club's New York experimental work, for the reasons that it proves very conclusively that transmission, over comparatively long distances, does not depend as much on height or high power, as has been believed up to now. He says the club's new transmitting location is approximately 300 ft. higher than the former location and that in spite of this fact, it was possible to put a better signal into the Philadelphia area with a special antenna from an altitude of 600 ft. than is now being done with an antenna of regular type. The power employed in both of these tests was the same and was approximately 45 watts.

Plans New Links

As a result of the successful tying up of New York and Philadelphia with communication systems which, at best, may be considered temporary, the Garden City Radio Club is now more enthusiastic than ever concerning the feasibility of the 5-meter chain connecting Malden and Washington. The link between Malden and Hartford is now a fact. The New York to Philadelphia link is assured and Mr. Lynch says that, in spite of the failure of last year's attempt to link Hartford with New York, suitable antenna arrangements will be employed at the club's new location, which will assure this contact. Linking Philadelphia and Washington, through Baltimore and Wilmington, will, he says, be a comparatively simple matter, and application of the experience gained as a result of the experiments conducted during the past few months should find the chain in operation within a very short time.

Micro-Waves Span the English Channel

(Continued from page 262)

and are modern in every respect, inasmuch as a crystal-controlled master oscillator amplifier circuit is employed. The receivers are modern superheterodynes, with the main oscillator of the super-het receiver also crystal-controlled. This system is in use entirely for telephone work and just replaces the ordinary phone circuit. Incoming telephone calls are routed through the radio hook-up in the same manner as they would be if a land wire system were used.

The transmitters are mounted on the 100 ft. poles which were provided for this purpose. The antennas are also mounted atop these poles and long transmission lines from the transmitters to the antenna serve as the connecting link. This system is rather complex, in that they have a special tone generator which operates at a frequency of 1000 cycles, interrupted at 20 cycles, for ringing the operator at either end of the circuit. For instance, so modern is this equipment that the operator at the central station at either end of the circuit can make checks upon the operating conditions of the transmitters themselves. Twenty-four-hour-a-day service is provided and to date, faultless performance has been maintained.

Please mention SHORT WAVE CRAFT when writing advertisers

The "Metal Tube 2"—A Sure-fire S-W Receiver

(Continued from page 271)

results and slightly less amplification. The audio amplifier is conventional and uses a choke coil in the plate circuit in order to keep the plate current of the tube out of the earphones. This also allows the use of the new crystal earphones which are very much more sensitive and allow much better reception where weak signals are concerned. The .1 mf. coupling condenser should be a good one, preferably a 600-volt affair, because if this should fail and if crystal phones are used they are liable to be damaged, due to the heavy current which would be passing through them. The plate choke consists of the primary of an audio transformer; the secondary, of course, being unused. Any other similar choke having the proper inductance would also be satisfactory.

During tests this set performed very nicely and all the distant foreign stations were brought in with more than sufficient earphone volume! The antenna used was about 75 feet long and 30 feet high. The ground consisted of the usual water-pipe connection. Tuning is very simple and the regeneration control is unusually smooth. The tubes require 6.3 volts for the heaters and approximately 250 volts for the "B" or plate supply. This can be obtained in any convenient manner and if the reader wishes to build a power-pack, a very good one is described in the July issue on page 140.

If band-spread is desired it can be accomplished by using a 20 or 35 mmf. condenser to tune with and the large condenser for band-setting. The two condensers will, of course, be connected in parallel.

Coil Data

Meters	Turns	Length of Winding	Wire Size	Tickler
17-41	9	1 1/4"	No. 16*	4
33-75	18	1 1/2"	No. 18*	6
66-150	38	1 3/4"	No. 24*	11
135-270	81	1 7/8"	No. 26†	18
250-560	140	2 3/4"	No. 29†	30

Coil diameter 1 1/2", 2 1/2" winding space.

*Tinned Bare. †Enameled.

Webster City Radio League

● I AM very much interested in the pages you devote to what one might term an "open forum." Some of the arguments there add a little spice to the verbal side of the short-wave situation.

However, I do think there is an advantage in you gentlemen opening a column for the purpose of letting the other fellow know what the rest of us are doing. At times I notice a letter from some local organization in some of the cities and towns of this country and know that their article is read by thousands of interested amateurs, both licensed and unlicensed. Letters from the DX (distance) listeners are interesting as well as those from the transmitting amateurs. There is a soft spot in my heart for those lads who have not as yet acquired their ticket (license) because I well remember the days and nights I yearned for the right to possess my own transmitter and be able to chat with the rest of the boys. I never fail to send a card of acknowledgment to these "silent amateurs" for I know that when they do become licensed amateurs they usually turn out to be real buddies.

The particular reason for writing this letter to you is for passing on the information that we have organized a club in Webster City called the *Webster City Radio League*. Some of us have built many of the receivers described in your magazine and found them to be just what they were said to be. Some of the boys in our organization, (46 verified members), are short-wave listeners and have had considerable success with their receivers (and if the truth of it were known, they have heard more countries than have I, a licensed amateur).

Our club has been organized since last October, and has made good progress since its origin. Several of the members have receivers and the transmitter is located in the back room of my home and works under my call with myself at the controls. Of course, none of the boys are allowed to operate the CW transmitter unless they are licensed, and five of them besides myself have their tickets and six more of them are going down for the "exam" this fall.

So far, we have worked every district and all states on 40 meter CW (except Iowa, our own state) and on 80 we have had equal success with the exception of two states, Idaho and Maine. The success of this station on 160 phone has been somewhat limited due to lack of equipment with which to build. We have worked stations in Mexico and Cuba on 40 meters as well as three districts in Canada.

We plan to be on the air with a good 160-meter outfit sometime this fall and will be glad to hear from any of you DX listeners who happen to hear us.

Also, always glad to QSO any of the hams in the country and always looking for new friends.

I hope your magazine continues to give us the information and hook-ups you have in the past and know that your publication is gaining in favor every day.

And so, until the next time we may write again, may success and good DX crown your every effort.

L. L. KNOWLES, W9NWF,
616 First St.,
Webster City, Iowa.

Milwaukee Amateurs Present Own S-W Program

● AN unusual program, probably the only one of its kind in existence, is presented every Saturday night over W9XAZ, the experimental transmitter of WTMJ, the Milwaukee Journal Station. The Kilocycle Club, one of Milwaukee's leading amateur organizations, is the sponsor. The programs originated in the operating room of W9XAZ located on top of the Schroeder Hotel, and are entirely written and presented by the amateur operators themselves.

The amateur program is the latest development in the close cooperation which has existed between the local amateurs and WTMJ experimental engineers. Early last December W9XAZ, which operates on 31.6 megacycles with a power of 500 watts, was used for experiments in high-fidelity transmission. To give local amateurs something worth listening to, regular WTMJ programs were sent to the experimental transmitter between the hours of 3:00 and 7:30 p.m. This daily program schedule soon developed a wide following among the amateurs and experimenters, and their reports of checks on the short-wave transmission become increasingly helpful to the engineers. Reports were received from points as far as 35 miles from the transmitter.

It has also been found that the local amateurs rely upon W9XAZ as a means of calibrating their own equipment. As this transmitter is the only one with any appreciable power in the vicinity which has a wavemeter, amateurs working on a band which ends at 30.0 megacycles find it convenient to go up to the 31.6 megacycle frequency of W9XAZ to check on their sets.

The hams' Saturday night program is both interesting and educational and should do much to develop further interest in short-wave experimental stations in and about Milwaukee. It consists of notes on the activities of local amateurs, announcements of activities of amateur clubs in Milwaukee and vicinity, the exchange of ideas for experimenters, and talks by leading amateurs.

Plans are under way for a second weekly program to be sponsored, prepared, and broadcast by another local amateur organization.

SPRAGUE INTERFERENCE ANALYZER

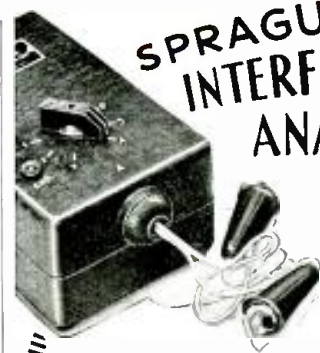

\$9.75

NET
(with adapters)

★ SHOW CUSTOMERS JUST WHERE INTERFERENCE ORIGINATES . . . Then Eliminate It!

At last—a quick, practical way for eliminating radio interference from ANY electrical device. No more guessing. No lost time. First you actually *eliminate* the noise with the Analyzer. You *show* customers just what proper filtering of appliances will do. Then, from the instruction sheet, you learn what Sprague filter condensers or chokes to install to insure *exactly* the same results as those obtained with the Analyzer. Inexpensive—will quickly pay for itself in new business it helps you build. See it at Sprague jobbers or write for catalog. SPRAGUE PRODUCTS CO., North Adams, Mass.

BY THE MAKERS OF

SPRAGUE CONDENSERS

Every Radio Service Man should be a member of the Institute of Radio Service Men

SPRAGUE 600 LINE

Short Wave Signals

—you never heard before will come in strong and clear over a Brush piezo electric headphone. Brush 'phones are highly sensitive—rugged—and extremely durable. High impedance permits their operation from any normal source. Response, 60 to 10,000 cycles. Brush phones are not magnetic . . . they require a minimum of power . . . can be used in airplanes, or close to other sensitive instruments. Price, complete with head band, leads, and full instructions for use, only \$12.00. Data sheet No. 10 gives full headphone information, including circuit diagrams, etc., free on application. Write for yours.

THE BRUSH DEVELOPMENT CO.
1887 East 40th St., Cleveland, Ohio

Regent 5 Band 15-550 Meter

Switch Receiver

This new improved "Regent" completely eliminates the use of plug-in coils. Independent tuning of the five separate bands is accomplished by means of a five-band switch. No more groping around for the proper coils. A great distance getter that will fulfill the requirements of every radio experimenter or amateur. Uses 2-5A's, 1-56, 1-80 and 1-2A's.

Complete kit of parts including speaker, airplane dial, blueprints, and all accessories and cabinet. . . . \$12.50
Wired and Tested (Extra) 2.00
Set of Matched R.C.A. Licensed Tubes 2.05

TRY-MO RADIO CO., INC.
85 Cortlandt St. 179 Greenwich St.
N.Y.C. Send for New Catalog N.Y.C.

WORLD FAMOUS International Dx AC-DC or battery 3-tube kit

6.75 with all parts for set and power supply speaker, 4 coils 15-220 meters and diagram. Extra: wiring \$1.75, 3 tubes \$2.25, broadcast coil 75c, metal cabinet \$1.50

Experimental Radio Labs. 168 Washington St., New York, N. Y.

Please mention SHORT WAVE CRAFT when writing advertisers

FREE!

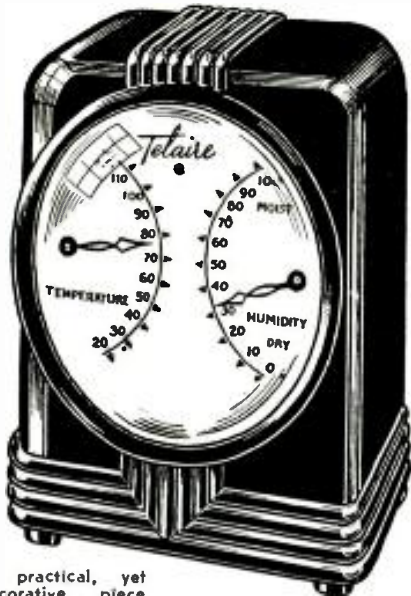

A practical, yet decorative, piece for home or office

We have obtained a quantity of the famous "Telair" Air-Meter instruments which not only tell the temperature, but relative humidity of the air as well. This is a beautiful instrument, accurately made, and is housed in a genuine Bakelite case of modern and most pleasing design. The size of the instrument is 4 inches high by 3 inches wide by 1 1/2 inches deep.

For a limited time only, we are offering a few of these instruments with subscriptions to SHORT WAVE CRAFT. After the supply of "Telaires" has been exhausted, no more can be had, in which case your money will be refunded. You must act immediately.

USE THE COUPON BELOW.

The instruments are guaranteed to be accurate; they can be used in home or office as a practical, yet decorative piece.

CLIP—MAIL COUPON NOW!

SHORT WAVE CRAFT SW-935
101 Hudson Street, New York, N. Y.

Gentlemen: As per your advertisement, I enclose herewith \$2.00 for a full year's subscription (12 issues) to SHORT WAVE CRAFT (\$2.50 for Canada and foreign countries). In consideration of this subscription, you are to send me immediately, free of charge and prepaid, one of the "Telair" Air-Meter instruments, as described above.

Name
 Address
 City State



RADIO'S LIVEST MAGAZINE
 Edited by HUGO GERNSBACK

RADIO-CRAFT is devoted to general Radio in all its phases, to Radio Servicing and to the advanced set builder and Radio Technician. Kinks show simple ways out of difficult problems. The latest radio equipment is illustrated and described.

RADIO-CRAFT is fully illustrated with photographs, diagrams and sketches. Each issue contains over 150 illustrations. 15c for Sample Copy.

8 Months for \$1.00

RADIO-CRAFT
 99C Hudson Street New York, N. Y.

SPECIAL FOR THIS MONTH

Send \$1.00 (\$1.25 Canada and foreign) and we will send you SHORT WAVE CRAFT for Eight months. **DO IT NOW!**

SHORT WAVE CRAFT
 99-101 Hudson Street New York

Short Wave Scout News

(Continued from page 292)

E. M. Heiser, Brecksville, Ohio

● DUE, I believe to the variable weather we have had for the past few weeks, short-wave reception has been very changeable.

There were a few very cool evenings, during which reception on 6,000 kc. was comparable to winter reception on this frequency.

The 9,600 kc. band is steadily improving, as is also the 11,000 kc. band. 2RO on 11,811 is being heard very well, in fact, louder than they have been heard during the last two years.

DJD on 11,770 kc. and FYA on 11,720 kc. are also coming in with tremendous volume.

EAQ on 9,860 kc. has been coming in very weak and unsteady. GSF on 15,140 kc. has been heard at 4:30 p.m., E.S.T. and coming in with good volume and clarity. No stations have been heard on 18,000 kc.; although a few "carriers" have been heard, none were understandable.

Have been trying to hear one of the Japanese stations which are working evenings, but have not had any success as yet. Although the amateurs working on 15,000 kc. can be heard most any time and with plenty of "wallop," the regular broadcast stations on this frequency, have been almost entirely missing. Reception in this locality has been best from 3:00 p.m. on, with the "peak" at 7:00 p.m.

In general, reception for this period has been just medium.

Edward M. Heiser,
 Rt. 2, Box 124,
 Brecksville, Ohio.

S-W Notes From Tulsa, Okla.

● THIS post has heard quite a number of stations this month, most of them from 16.6 mc. to 9.02 mc. The first of course, are the ones known as the "foreign locals," such as: GSF, GSE, GSD, GSC, GSB, FYA, DJD, DJB, 2RO, EAQ. These stations are heard daily in good shape.

GSD on 11.75 mc. and GSB on 9.51 mc. can be heard up to and past 1:00 a.m., E.S.T. PHI, Huizen, Holland, also heard on 17.77 mc. and VK2ME on 9.59 mc. heard on the schedule time as listed in *Short Wave Craft*, also VK3LR. The same "veris" received from 3LR say 600 watts, (now 1000 watts, edit.), but I believe that most listeners will agree with me when I say they sound like a 20 kw. transmitter!

VPD, Suva, Fiji Islands, is heard on 13.07 mc. from 12:30 a.m., E.S.T. to 1:30 a.m., E.S.T. (heard once with an R9 volume.) KTO, Manila, on about 16.23 mc. can be heard irregularly around 6:00 p.m., E.S.T., and as late as 2:00 or 3:00 a.m. with a good signal. KTO calls KWU-JVE as a rule. JVE is on a frequency of 15.66 mc., and JVF on 16.62 cycles is also heard good.

One night at 2:30 a.m., E.S.T., JVE was heard working a station during a terrific downpour of rain, thunder, and lightning. The signal remained steady and fairly understandable; JVM on 10.74 mc. heard also. VLK, Sydney, Australia, on 10.52 mc. is heard nightly around 1:00 a.m., E.S.T., for several hours after this time also. PLE on 18.83 mc. is heard mostly any evening (noise level permitting) excepting Saturday and Sunday. VIZ-3, a station near Melbourne, Australia, is heard irregularly anywhere from 6:00 p.m. on up, testing with CGA-4. These two stations are heard near 11.56 mc. or a little less.

ZLT, Wellington, New Zealand, has not been heard lately. Stations heard in South American regions are El Prado, Thursday nights, HKV, OJC-2, Lima, Peru; CEC, Santiago, Chile; LSN, Buenos Aires, Argentina; IJY-HJB, Bogota, Colombia; HCIFG, an amateur on the low-frequency side of the 20-meter band and one in San Jose, Costa Rica; call is TI2RC, both come in QSA5-R9.

HRF, Tegucigalpa, Honduras, heard near 14.48 megs. with loud signal at 7:08 p.m., E.S.T. I almost forgot to mention hearing HAS on 13.671 mc., using phone. "Veris"

received this month were PPH, ZLT, VKSLR, CJRX, CEC, PHI, KTO.
 Wade Chambers,
 Tulsa, Okla.

REPORT FROM FLINT, MICH.

● THE Australians VK2ME and VK3ME on 9.59 m.c. and 9.51 m.c. respectively have been coming through very well here. Generally QSA4-5 R6-7. VK3ME was heard exceptionally well June 18—6:30 a.m., QSA5 R7 with very little static.

The 49-meter band was very noisy because of summer static. HJ4ABE, at Medellin, Colombia, on 5.95 m.c. has been heard several times QSA5 R7. HJ4ABL, "Voice of the WEST" at Manizales, Colombia, 6:10 m.c. heard QSA4-5 R6-7.

Saturday evenings around 11:00 p.m. E.S.T. YV6RV at Valencia "La Voz de Carobobo" 6.52 m.c. heard QSA5 R6-7 after 7 p.m., E.S.T.

GSD, 11.75 m.c.; DJD, 11.77 m.c.; Radio-Colonial, 11.70 m.c. have been heard exceptionally well after 7 p.m., E.S.T., GSD being the outstanding station, generally QSA5 R8-9 with DJD a close second.

In the 14 m.c. phone band, foreign section, HJ5ABE, at Cali, Colombia, has been heard nearly every evening after 7 p.m., E.S.T. Heard QSA5 R7-8 several times. I do not know whether this is a harmonic or not, as I have also heard YV5RMO on 25-meter band and I understand this was a harmonic.

PRA8 located at Pernambuco, Brazil, 6.04 m.c. can be heard from 2:30 to 3:30 p.m. irregularly. I have, however, had much trouble receiving it clearly because of static and interference. Anyone interested in 20-meter or 14 m.c. signals from hams can certainly pull them in now as several countries have been heard here in early evening hours.

HJ1ABB, 6.44 m.c. is increasing its power to 1500 watts, which should pep up this signal considerably. Such stations as 2RO at Rome on 9.6 m.c. and EAQ on 9.86 m.c. have been heard well at times, but not so very consistently. COH at Havana, always yields a very good signal.

Hope to have a better report next month and will try to hook some new ones.

ROBERT GRAHAM,
 314 W. Eldridge Ave.,
 Flint, Mich.

NEWS FROM GREENFIELD, MASS.

● DURING the past week the short-wave reception was very good on all wavelengths; following are the outstanding stations and their wavelengths which were heard regularly:

2RO—9.64 m.c. Rome, Italy—reception was R9.

EAQ—9.87 m.c. Madrid, Spain—reception was R9+.

HLR—9.59 m.c. Geneva, Switzerland—reception was R7.

GSC—9.58 m.c. London, England.*

GSB—9.51 m.c.*

GSL—6.11 m.c.*

GSD—11.75 m.c.*

GSE—11.86 m.c.*

GSF—15.14 m.c.*

*All received day after day with R7-9 signal strength.

CT1AA—9.59 m.c., very good R8.

PHI—17.77 m.c. Holland, was heard also on 11.73 m.c. R7—once.

HVJ—15.11 m.c. Vacation City, R7.

FYA—11.87 m.c. Paris, France, R8.

DJN—9.54 m.c. Zeesen, Germany.†

DJA—9.57 m.c. Zeesen, Germany.†

DJD—11.77 m.c. Zeesen, Germany.†

†All received daily R9+.

COH—9.43 m.c. Havana, Cuba, R8.

LSX—10.35 m.c. Buenos Aires, heard daily R9.

The North American stations W1XAL—11.79 m.c.; W3XAU—9.54; W8XK; CJRX; CJRO; VE9GW; all received daily.

The following stations were heard, but not so regularly and sometimes hard to identify:

VK3LR—9.58 m.c. Melbourne, Australia, R4

Please mention SHORT WAVE CRAFT when writing advertisers

VK3ME—9.51 m.c. Melbourne, Australia, R3-1.
 VK2ME—9.59 m.c. Sydney, Australia, R6.
 DIQ—1029 m.c. Germany, irregularly, R7.
 RNE—12:00 m.c. Moscow, U.S.S.R., R4.
 HP5J—9.59 m.c. Panama City, R6.
 XECR—7.38 m.c. Mexico City—heard on Sunday, R5.
 YV5RMO—5.85, Maracaibo, Venezuela, R7.
 PRF5—9.50 m.c. Rio de Janeiro, R8.
 YV4RC—6.37 m.c. Caracas, Venezuela, R7.
 This concludes my report for June.

HERMAN BORCHERS,
 240 Federal St.,
 Greenfield, Mass.

JOHN SORENSEN REPORTS FROM NEW YORK

● STATIONS heard and logged are: GSB, GSC, GSD, GSE, GSF, GSG, also GSI, DJA, DJB, DJC, DJD, DJE, DJN, DIQ, DFB, FYA, (Radio Coloniale) on 19.25 meters.

FAQ, ORK, LKJ1, on 31.42 meters; JB on 49.2 meters; JVM, 2RO, on 25.4 meters; HBP, HBL, HBJ, on 20.5 meters; HAS3, HAT4, PHI on 16.8 meters; PCJ, on 19 meters; LSX, on 29 meters; LSN on 29 meters; RNE on 25 meters; CT1AA on 31.32 meters; OER2 on 49.4 meters; HBQ, OAX4D, TIGPH, TIEP, PRF5, PRAS, PRADO, on 45.3 meters; COC, COH, CO9C, HP5B, HP5J, HI2S, 49.4 meters; HCJB, HJ4ABA, HJ4ABC, HC2RL, HJ5ABD, HJ1ABB, HJ4ABB, HJ4ABL, HJ3ABD, HJ1ABD, HJ1ABE, HJ1ABJ, at Santa Marta on 49.85 meters; HJ2ABC on 51 meters; HJ3ABH, HKV on 34 meters; HIZ, HIX, HIH, ZFBB, on 29.8 meters; HI1A; S.S. Normandie; VK2ME, VK3ME, VK3RL, YV3RC, YV2RC, YV4RC, YV6RV, XECR, VPD on 22.9 meters; YV5RMO, W3XAL 16 meters; W3XAL on 49 meters; W9XF, W9XAA, W8XK on 19, 25, 49 meters; W2XE, both 19 and 25 meters; W3XAU on 31 and 49 meters; W8XAL on 49 meters; W2XAF, W2XAD, W1XK, W1XAL on 49 and 25 meters; CJRX, CJRO, VE9GW, and many unidentified stations have been heard.

Veries received this month: HAS3, HAT4, CT1GO, HJ4ABA, HCJB, on 36.5 meters; PRA8 on 49.67 meters; HJ3ABH, HJ1ABD, HJ1ABE, on 49.05 meters; HIZ, PHI, on 16.88 meters; 2RO on 31.13 meters; LKJ1 on 31.42 meters; OAX4D, 51.9 meters—I sent them four reports and four international reply coupons—I received one reply—no wonder it is owned by All-American Cables,

LISTENING POST REPORT FROM GEORGE D. SALLADE, SINKING SPRING, PA.

● PMA, one of the many Netherland East Indies disseminators, has been heard quite consistently at this post. If conditions are favorable this transmitter can be heard almost any day at 10:00 a.m., E.S.T. The frequency is approximately 19,468 kc. Try tuning for this station several days in succession and most likely it will be heard.

Each day from 10:00 to 10:30 a.m. they have been sending out a fine musical program. I wonder how many listeners heard "Ramona" played in Javanese rhythm on one of these programs?

The station address is: Gouvernements Radio-Dienst, Bandoeng, Java, Netherland, East Indies.

On Sunday June 23, listeners had a fine opportunity to log Radio-Nations stations HBJ and HBH. The frequency of HBJ is 14,550 kc. and HBH, 18,450 kc. Letters should be addressed to: M. G. Gallarti, Information Section, League of Nations, Geneva, Switzerland.

At present the 20-meter amateur band is offering plenty of foreign DX. Listed below are a few that were heard very recently:

VP3BG, Georgetown, British Guiana; ON4AC, Antwerp, Belgium; G5NI and G5ML, Kennelworth, England; TI2RC, San Jose, Costa Rica; HP1A, Panama City, Panama; HC1FG, Riobamba, Ecuador.

The best time for tuning this band is from 6:00 to 7:00 p.m., E.S.T.

GEO. D. SALLADE,
 Sinking Spring, Pa.

Short Waves and Long Raves

(Continued from page 274)

Well, I've said a lot of stuff, but allow me to end up with the best of the best to S.W.C., and here's to its immortality. But do let's have a lot more of those articles on transmission, etc. and what about an article or two on b.c. short-wave station technique with accompanying diagrams.

Many thanks for many fine amateur station photos.

JEFFREY B. PIZER,
 R.N.W.A.R. Station M.D. 3,
 361, Camden Road,
 N. 7. London, England.

(Thanks very much, Jeffrey, and we are glad that you find Short Wave Craft so interesting. We hope that the ship which you are waiting for arrives soon, and if it should visit New York, we trust that you will stop in and give us the once-over. Fine business, your having commercial operator's tickets, and we hope that you obtain your amateur license in the near future so that we may hear that fine station which you mentioned in your letter. About this "no-code" argument, well, we won't go into that, because there is not enough space here for such a tremendous subject. Being a ham at heart you will probably be interested in our new Amateur Section.—Editor)

HE GETS FINE "TELEVISION" RESULTS!

Editor, SHORT WAVE CRAFT:

I must tell you about the fine "television" program I received from W9XG Thursday, Oct. 18, which was the finest ever. I saw an airplane taking off and in flight, too, and it was so clear I could even tell it was a tri-motor plane. I could even see the propellers turn! They also showed horse races and close-ups of movie stars, and on these close-ups they have numbers on the

left side of the pictures, which I could see very plain. I got numbers 15 and 35 very, very plain. I have noticed in the last few weeks that television reception has improved a great deal. W9XG operates on 2800 kc., a 60-line disc with a speed of 1200 R.P.M., on Tuesday from 7:30 to 8:30, Thursday from 8:00 to 9:00 p.m. (C.S.T.)

W. H. SINGLETON,
 Box 54,
 Keota, Iowa.

(Television is very close to our heart, "WHS," and we shall be very glad to receive more details on the apparatus you use, an how many stations you are able to pick up.—Editor)

1,500 STATIONS ON A "DOERLE"

Editor, SHORT WAVE CRAFT:

I have been a reader of your magazine for quite some time and I think it's great. I'm using a 3-tube Doerle Signal Gripper as a receiver, built from plans given in your magazine and—Boy, what a set! To date I have logged over 1500 stations, both phone and CW. The only thing that holds me back on a transmitter is that I have no "B" supply. I live in a district where there is no "juice"; I have a 32-volt Delco plant. Rotary converters are too expensive and batteries don't last.

GEORGE HALES,
 Brown's Mills, N.J.

(The Doerle "Signal-Gripper" has had a long and glorious career, thanks to the enthusiasm of our many readers who have become interested in building and testing it. You certainly have rolled up a mighty fine log, "G.H."—1500 stations strong! Possibly you could make use of one of the new vibrator "B" supplies, similar to those used on automobile receivers and which work on the 6-volt storage battery.—Editor)

(Continued on page 315)

Please mention SHORT WAVE CRAFT when writing advertisers

The QUICKEST WAY to LEARN CODE
THE FAMOUS CANDLER SCIENTIFIC METHOD

Candler Students

All the champions use the Candler Method. T. R. McElroy, official speed 77 WPM; Jean Hudson, 9 year old World's Champion Class "E"; Watson, W1BGL, Byrd Expedition.

CANDLER GUARANTEES that you can learn to pass the examination for either your Amateur or Commercial License quickly and easily at HOME. Learn to read CODE by SOUND just like you read a newspaper by sight.

THOUSANDS of BEST and FASTEST Amateurs and Commercial Operators have been trained by Original CANDLER SOUND Method in past 24 years. IT MUST BE RIGHT. Ask any Skilled Operator! Ask the CHAMPIONS!

FREE—New 1935 BOOK OF FACTS

for Amateurs and Com'l Ops. just off the press. Send for it today. Explains everything. Whether you want to learn CODE or develop Championship Speed, it will be valuable to you.

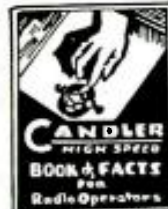

CANDLER SYSTEM Co.,
 Dept. S-9 6343 S. Kedzie Ave.,
 Chicago

G. E. MOTORS

These motors were manufactured by the General Electric Company and originally intended for use by a large manufacturing company.



Here are the specifications: 1/30 h.p. 4800 R.P.M. Universal A.C. and D.C. 110 volts instant reverse. Size: Diameter 3 inch, length 5 inch.

Add 25c for special packing and mailing anywhere in U.S.A. Ship. Wght. 3 lbs.

\$2.45 Each DO NOT WRITE FOR CATALOG

WELLWORTH TRADING CO. SW-9-35
 560 W. Washington Blvd., CHICAGO, ILL.
 Enclosed find \$..... for which ship:
 G. E. Motors @ \$2.70 each (Prepaid In U.S.A.)

Name.....
 Address.....
 City.....State.....

ASTATIC

THE QUALITY CRYSTAL MICROPHONE



Noted for quality, dependability, ruggedness and performance. A professional microphone at an amateur price and fully guaranteed. Modernize your transmitter. See your jobber today!

Licensed under Brush Development Co. patents.

ASTATIC MICROPHONE LAB., Inc.
 YOUNGSTOWN, OHIO
 "Pioneer Manufacturers of Quality Crystal Devices"



The Famous "19" Duplex 2 in 1 World wide short-wave receiver. Capable of foreign speaker reception!

Complete kit with one coil
 Arcurus 19 DUAL tube.....55c
 Set of 3 extra coils.....45c
 Wired and tested add.....45c

Send \$ for circuit. 25c for diagram.
 RADCO NEW YORK, 77 Cortlandt St., N. Y. C. Dept. S2

WORLD GLOBES

FOR SHORT WAVE ENTHUSIASTS

NOW AT LOW PRICES

THESE remarkable globes, executed in fourteen colors, are absolutely indispensable for short wave fans. Notable among the numerous features of these world globes, is that a damp cloth quickly removes all dust and water does not harm the surface.

Short Wave fans are enabled to determine correct time in various centers of the world with the aid of these maps; distances from city to city can be accurately established.

There is a graduated "Meridian" scale of black enameled metal with the 9" and 12" globes. An additional feature is the movable hour scale found at the north pole—this facilitates determining the hour in any part of the world.

Only on a globe of this size is it possible to get an accurate picture of countries and their relative positions to each other. You will actually be amazed when you compare distances—from New York to Moscow; from Cape Town to Tokio; from Los Angeles to Rio de Janeiro, etc. A flat map is deceptive for measuring, but take a small string and stretch it across the globe, from city to city, and you have the correct distances.

Here are globes that add dignity to home, office, studio or laboratory—a globe that everyone would be proud to possess.

Each world globe contains a listing of over 7,500 cities in nations the world over—spellings conform to international geographic standards—all globes are of 1934 production. **GET ONE OF THESE FINE WORLD GLOBES TODAY!**

SPECIAL THIS MONTH

World Globe No. 147

12" Globe. New model—equipped with wooden floor stand finished in wainut. Height overall 35". Globe constructed with half meridian. New World Globe Handbook included FREE. A marvelous buy. Never has a floor model Globe been sold at such a low price. Shipping weight 9 lbs.

PRICE \$3.95

F.O.B. Chicago.

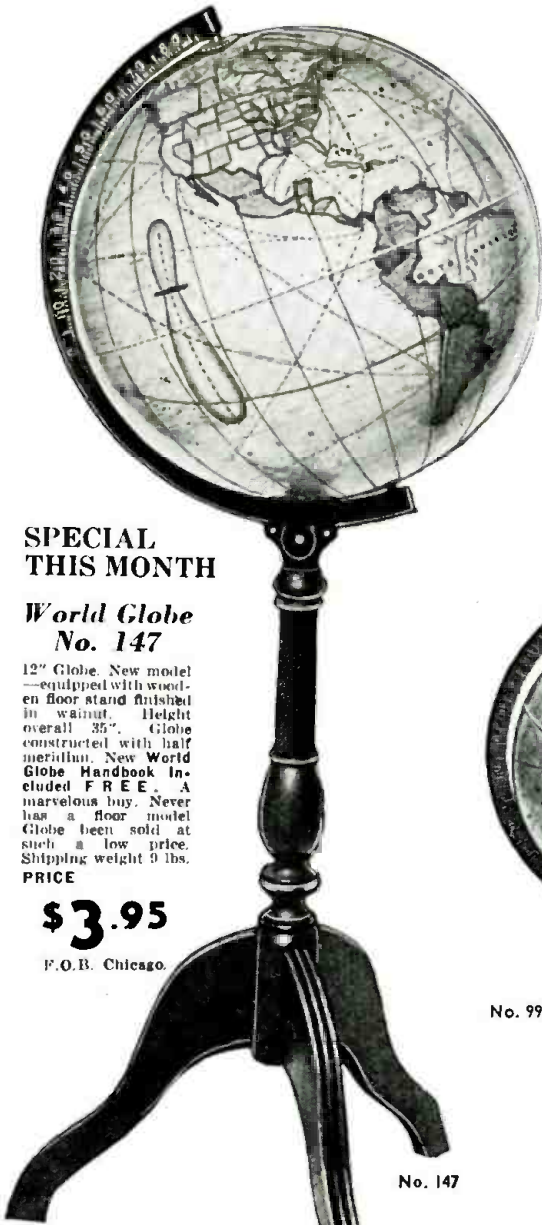

No. 147

Gentlemen:
I received the World Globe and am certainly well pleased with its completeness, appearance and its usefulness. Short wave listening has become a hobby with me, and this World Globe is a necessary accessory to any short wave listener or, for that matter, to any home.
P. C. ELLIS, Supt.
Laboratory—19th and Campbell Streets, Kansas City, Mo.

ORDER YOUR GLOBE TODAY!

SHORT WAVE CRAFT SWC-9-35
99 Hudson Street, New York, N. Y.

Gentlemen: Enclosed you will find my remittance of \$..... for which please ship me the following World Globe.

() World Globe No. 99 @ \$2.05
() World Globe No. 147 @ \$3.95
() World Globe No. 47 @ \$0.90
() World Globe No. 139 @ \$2.95

Name

Address

City State

Send remittance in check or money order—register letter if it contains cash, stamps or currency. GLOBES ARE SHIPPED FROM OUR WAREHOUSE IN CHICAGO—F. O. B. FROM THAT CITY.

World Globe No. 99

9" Globe, equipped with sturdy, black metal base and full meridian. Same ball as our No. 139 but reduced 1/4 in size and scale. Included with globe is newly printed World Globe Handbook FREE. Shipping weight 6 lbs.

PRICE \$2.05

F.O.B. Chicago.



No. 99

World Globe No. 47

7" Globe, equipped with sturdy metal base and half meridian. Index to countries of the world by latitude and longitude shown on base. Shipping weight 2 lbs.

PRICE \$0.90

F.O.B. Chicago.



No. 47



No. 139

SPECIAL THIS MONTH

World Globe No. 139

12" Globe, equipped with sturdy, black metal base and half meridian. Contains over 7,500 names and cities. Spellings conform to authoritative world standards. Hundreds sold to many short wave fans during the last year. Copy of World Globe Handbook included FREE. Shipping weight 8 lbs. **PRICE**

\$2.95

F.O.B. Chicago.

All globes are carefully packed in original cartons assuring safe delivery. **ORDER BY NUMBER.** Send check or money order, plus sufficient postage for delivery by parcel post. Globes are shipped from our Chicago warehouse. Register letter if it contains cash, or currency or stamps. If preferred, specify that shipment be sent express collect. **ALL ORDERS ARE FILLED PROMPTLY.**

ALL GLOBES SHIPPED IMMEDIATELY

SHORT WAVE CRAFT 99 HUDSON STREET, NEW YORK, N. Y.

Please mention SHORT WAVE CRAFT when writing advertisers

Short Waves and Long Waves

(Continued from page 313)

THAT "INTERFERENCE" PROBLEM

Editor, SHORT WAVE CRAFT:

In a recent editorial in SHORT WAVE CRAFT comment was invited from interested observers relative to instances of interferences due to the overlapping of frequencies or of broadcasting schedules.

In response to the editorial mentioned I submit some instances of this evil in the hope that a sufficiently representative array of DX listeners will also volunteer their protests, and so provide you with the necessary facts to enable you to proceed in your very laudable attempt to correct a condition which a number of us find quite discouraging.

The condition at its worst in the experience of the writer is found in the overcrowded 49-meter band, the frequencies included roughly between 40 and 60 meters. In California, this band is at its best from 5 to 7 p.m., P.S.T., and the recent reappearance of W1XAL on 49.67 meters or 6.04 meg. has caused interference with the transmissions of stations HJ1ABG on the same frequency and of HJ3ABI on 49.6 meters, 6.05 meg.

The transmission of DJC, 49.83 meters, 6.02 meg., is interfered with by VE9DN on 49.96, 6.00 meg., COC on 50 meters, and the new station HC5B of Panama on 49.8 meters, 6.02 meg.

Another instance is found at 49.34 to 49.45, 6.07 or 6.08 meg. Here we have the transmissions of CP5 and HJN interfering with each other and TIRA supposed to be on the same frequency adding to the already scrambled mix-up. W9XAA interferes here on Sunday nights.

Another case occurs on 47.8 meters, 6.23 meg., supposed to be the frequency of H11A, now being taken over by OA4B of Lima.

The particular cases mentioned above are of stations which are all supposed to be on the air at the same time—between 5 and 7 p.m. Obviously when we try to work them we get all the heterodyne whistles, squeals, and other types of noise which I have not the correct name for, but we get no reception from any of them, except when one or more of the interfering stations sign off.

The writer does not recall any specific instances of interference on the 19-, 25-, or 30-meter bands at this time, but expresses as his personal point of view that the 10 kc. separation between the stations as shown in the list is hardly enough for good clean results, where one station is W1XAZ in this country and the other a foreign station like GSC of England. How the DX-er can hear VUY of Bombay, while W1XAZ is on the air on the same frequency, is a mystery to me.

I express a purely personal point of view again in my belief that present-day receivers with 10 kc. separation will not tune sharp enough to cut off a powerful U.S. station from a relatively weaker foreign station within 10 kc. and I have not found that they will separate two foreign stations which transmit within 5 kc. of each other as some of them do.

The 49-meter band is not only overcrowded for our equipment but also too crowded to permit the accomplishment of whatever may be aim of the station which is transmitting the program. I can conceive of no possible benefit from a transmission that the listener can not hear or is so hopelessly mixed up with the broadcast of another station that it is painful to listen to.

With the present vogue of all the production type radio manufacturers turning out "All-Wave" jobs, as well as the increasing output of the builders of custom-built equipment, the time seems to be opportune for the various commissions who supervise the allotment of transmitting frequencies to accord some recognition to the claims of an increasingly large class of investors in short-wave equipment, that as

a measure of fairness to them, the bands allotted to purely entertainment purposes be increased and not only increased but also more carefully distributed and supervised.

From a total of 60,000 kc. of radio channels, it would seem that the 950 kc. allotted to the broadcast band and entertainment channels amounting to about 1000 more, or a total of 1950 kc. between "B.C." and short-wave and all the rest of the spectrum allotted to commercial purposes, the proportion is such that one would think that some of this overcrowding is unnecessary. These remarks are of course made without a full knowledge of all the factors involved, and the writer's generalizations may be incorrect.

So much for the crowded bands. There are some other forms of interference not alluded to in your editorial which are just as serious to the DX listener and just as far-reaching in their effect. These are: the harmonics from transmitters on the amateur phone bands which in cases known to the writer fall on the 19-, 25-, 30-, and 49-meter bands where the foreign broadcasts are heard and also the code signals from powerful local sources which ride in over large areas of the dial and spoil many a foreign broadcast for us.

The best equipment available with all the preselectors and crystals there are seems unable to cope with either form of interference; the writer has tried out various forms of wave traps and similar units and has found that anything that will reduce the interference will also reduce the desired signal.

The only relief for the broadcast short-wave listener that I can see is to move all the amateurs up to 5- or 10-meter phone, where they will not interfere with other listeners. How the amateurs will react to this proposition, I have no idea.

G. C. GALLAGHER,
18 Delano Ave., San Francisco, Calif.

(Thanks very much for your letter on the troublesome interference experienced on a number of short-wave channels, and we have written to several of these stations repeatedly in response to letters received from our readers, asking the interfering stations to please try and change their frequency or rearrange their time schedule, so as not to interfere with important key stations such as Berlin and other stations. Let us hope that at the next International Radio Conference that most of the short-wave interference problems will be cleared up.—Editor)

THE "DOERLE" GREAT

Editor, Short Wave Craft:

I have been a constant reader of Short Wave Craft for the past six years and intend to be in the future. I have bought and read every radio magazine on the market, but have never found one to equal Short Wave Craft.

I constructed the "Doerle" using a 58 detector, 56 first audio, and 47 power pentode, driving a dynamic speaker. All of the following stations were heard on the loud-speaker. W1XK, WNA, GCS, WOA, PRADO, YV6RC, HJ1ABB, HJ3ABF, W8-XK, W2XE, W3XAL, W9XF, VE9GW, W9-XAA, W8XAL, W3XAU, W1XAL, and XEBT. Also 75 police stations, 20 airport stations, and over 1,000 phone and C.W. amateur stations from the U.S., Canada, Mexico, and South America.

A few commercial code and ship-to-shore stations were also logged. I would appreciate letters from amateurs and SWL's. I promise to answer every one.

I am a member of the Short-Wave League. Short Wave Craft has my best wishes for the future success.

ROBERT A. HESS,
Box 229, Salem Pike,
Mt. Washington,
Cincinnati, Ohio.

(Thanks very much, Robert, and we are glad you have had such excellent results with your "Doerle" receiver and venture to say that you will receive plenty of correspondence from the readers of this department and you will be kept busy if you answer all of it.—Editor)

Please mention SHORT WAVE CRAFT when writing advertisers

BRUNO The SYMBOL OF QUALITY

GUARANTEED

BRUNO, with their Model "M" microphone offers the short wave fan and experimenter a guaranteed, truly high fidelity quality microphone at prices within the reach of all.

Frequency response from flat 50 to 12,000 CPS.

Write for complete and detailed descriptive information to Department "S" on these microphones.

BRUNO Laboratories
20-22 WEST 22nd ST.
New York, N. Y.

WHAT YOU NEED TO SUCCEED IN RADIO



Courtesy of the National Broadcasting Company

RADIO is a highly specialized business. As it develops it is becoming more exacting in its demands. But radio is the modern field of opportunity for those who keep step with its progress!

There is a great need for trained men in the radio industry. There is no place for untrained men. Experience must be accompanied by technical knowledge.

A pioneer in home study, the International Correspondence Schools have kept pace with the times and offer courses which give practical instruction in fundamentals and latest developments alike. The courses were prepared and are constantly revised by the Who's Who of Radio!

Up to date in every respect, the Complete Radio Course covers the whole field of radio. The I. C. S. Radio Servicing Course was prepared specially for men who wish to become service experts, and win over competition. The I. C. S. Radio Operating Course is vital to mastery of operating and transmitting.

We will be pleased to send you details of any or all of these subjects. Just mark and mail the coupon—the information will be forwarded at once. Do it today—now!

INTERNATIONAL CORRESPONDENCE SCHOOLS

Box 2882-B, Scranton, Pa.

Without cost or obligation, please tell me all about the NEW RADIO COURSE

Name _____ Age _____

Street Address _____

City _____ State _____

If you reside in Canada, send this coupon to the International Correspondence Schools Canadian, Ltd., Montreal, Canada



at last!
CONTINUOUS
BANDSPREAD

on all bands

THE OFFICIAL
DOERLE
BANDSPREAD

5-TUBE DE-LUXE A. C.
SHORT-WAVE RECEIVER

NATION-WIDE
TESTIMONIALS
PRAISE THIS SET

Gentlemen:

I received your "Official Doerle A. C. 5" today, after being adjusted by your engineers. I have had the receiver turned on less than 10 minutes and at the present time I am listening to the American Hour coming from IRA Rome, Italy. It is a wonderful relief to listen in without hearing a lot of noise. I would like to at this time thank you ever so much for making this adjustment. You cannot tell how much I appreciate this favor. You can certainly count on me as one of your boosters and I shall spread your name and products to all of my friends.
GEORGE LESLIE ALLEN,
Morris Plains, N.J.

Dear Sir:

Just a letter of recommendation concerning the Doerle A. C. 5. What a set, oh boy, for bringing in the DX night after night. I receive about 10 stations a week, that are new programs, besides 50 I already received. Besides I logged 700 hams. Stations that aren't even listed in call books give me a thrill. I only use a 20 ft. antenna wrapped around a chimney.
FRANCIS KMEC, Allentown, Pa.

Gentlemen:

This will acknowledge receipt of my Doerle short-wave receiver. This 1935 model is the smoothest and best operating set I have ever operated, both on amateur and foreign reception. I have heard practically all of the South American stations, Russia, Spain, and of course, France, Germany, Japan, and lots of others. This little receiver is just as you say it is—the best for the money and I have seen sets selling for lots more, which do not come within a mile of this Doerle.

If anybody wants to know if people will treat them white, just let me know and I will tell absolutely yes.

S. L. SMITH, Colorado, Texas.

Gentlemen:

I am very well satisfied with the set and here are some of DX stations which I have received on it:

On 20 meter coil: EAQ—Madrid, Spain; PRF5—Rio Grande, Brazil, S.A.; LSX—Monte Grande, Argentina, S.A.; DIQ—Germany (Koenig Wusterhausen); GSB—England (Daventry); COH—Havana, Cuba.

On 49 Meters: DJD—Berlin, Germany; H2-CRI—Guayaquil, So. America; 2RO—Rome, Italy; DKC and DKF—Germany; XEBT—Mexico City, Mexico.

Also many other South American Stations and Central American stations. Amateurs in more than 36 different states and including Canadian amateurs.

AUGUSTE THEBERGE, River Edge, N.J.
Original letters plus others may be seen at our office.

Complete Price
\$27.54
WITH TUBES
Nothing Else to Buy

- ▶ Doublet Antenna Input or
- ▶ Standard Antenna input
- ▶ 8-Low Loss Bakelite Plug-in Coils
- ▶ 15-200 Meters
- ▶ Fully Shielded
- ▶ Bandsread Dial
- ▶ Dynamic Speaker
- ▶ Headset Jack
- ▶ Beautiful Cabinet

BEFORE you buy any other Short-Wave Receiver, be sure to take advantage of our FREE five day trial offer explained below. Satisfy yourself, in your own home and at your leisure that this IS one of the greatest values in radio, and that it DOES have features which are found in more expensive receivers.

A powerful 5-tube "rig" complete with its self-contained hum-free power pack and dynamic speaker; all mounted on a single chassis and contained in a large handsomely finished black crackle cabinet with patterned screen speaker grill.

Two tuned stages—regenerative detector, 3AF stages with powerful 4I pentode output and perfectly matched dynamic speaker; all these features contribute to the great power and fine performance of this Doerle short-wave receiver.

CONTINUOUS BANDSPREAD ON ALL BANDS. A special double-pulser, double-scale, airplane dial having a tuning ratio of 125 to 1 is employed.

Many fine features that you would expect to find in more expensive receivers are incorporated in this "ACE TOP-NOTCHER" of the entire Doerle line.

Either a short-wave doublet or standard antenna may be used. A new antenna-adjusting scheme permits perfect alignment of both tuned circuits without appreciably affecting the setting of the tuning dial. Provisions are made to use headphones if desired, with a switch to cut out the dynamic speaker. All parts and workmanship fully guaranteed.

LOOK AT THIS DX-QSL LIST!

During its initial test, in New York City, this receiver pulled in on its loud speaker, at good room volume, the following enviable list: W1XAL, W1XAZ, Boston; W3XAL, Boundbrook, N.J.; W8XAL, Cincinnati; W9XAA and W9XF, Chicago; G5C, G5D, G5E, G5F, Daventry, England; DJA, DJB, DJC, DJD, Zeesien, Germany; HBL, HBP, Geneva; VE9GW Ontario; V9DN Quebec; CE9DR Montreal; VE9HX Halifax; XETE Mexico City; YU1BC, YV3BC Caracas CP5 Bolivia; LSN Buenos Aires; COC Havana; EAQ Madrid; WQO and WEF, testing with the Byrd Expedition and a whole flock of amateurs in practically every radio district of the United States. After that, we could no longer keep our eyes open so we "signed off" to bed.

The testimonials printed on this page testify that, in actual use, our customers are attaining even greater success. Uses a simple regenerative circuit so simple as to be entirely fool-proof. Tubes: 1—6D6, 1—6E7 (actually two tubes in one), 1—35, 1—4I power output tube and 1—80 full-wave rectifier. Two gang tuning condenser; single dial control; FULL-VISION ILLUMINATED BAND SPREAD AIRPLANE DIAL. Ship. wt. 35 lbs. No. 5000. "DOERLE AC-5" Short-Wave Receiver. Complete with Tubes, Speaker and 8 coils 15 to \$27.54 200 meters. Completely wired and tested. (NOT SOLD IN KIT FORM) YOUR PRICE
Set of 2 Broadcast coils \$1.75 additional

7 PAGES
of
Instructions
and
Diagrams
Included
with each
SET

USE THIS COUPON FOR
FREE 5 DAY TRIAL

RADIO TRADING CO., 101A HUDSON ST., NEW YORK

Gentlemen: 9-35
I enclose dollars cents, for your new Doerle 5-Tube De-Luxe Short-Wave receiver on a five day free trial basis. I am to prove to my own satisfaction that it will give me world-wide reception and that your guarantee means exactly what it says. If, at the end of five days after receipt of radio, I am not perfectly satisfied, I will write you accordingly, whereupon, you will send shipping instructions. Upon receipt of the radio, you will refund me the full purchase price. I agree to pay express charges one way, and you the other.

C.O.D. SHIPMENT. I enclosedollars.....cents deposit, balance ofdollars.....cents C.O.D.

PRINT Name
Address
Town State.....

FREE IMPORTANT BUYING GUIDE FOR RADIO DEALERS, SERVICE MEN, EXPERIMENTERS AND SHORT-WAVE FANS

32 Pages. Two Colors. Profusely Illustrated 1-p-to-the-minute catalog containing low prices which save you money. Contains radio sets, parts, public address equipment, short-wave receivers, etc. etc.

Name the item—it's in the catalog

Send post card or letter. Book sent by return mail. See pages 296 and 308 for our other "ads."

RADIO TRADING CO., 101A Hudson St., New York City

Please mention SHORT WAVE CRAFT when writing advertisers

Short Wave League

(Continued from page 294)

man beings and stop trying to satisfy our own selfish wants and leave this band to the men that are really interested in the development of equipment for such high frequencies. Don't fill the air with needless QRM!!!

JOE E. HESTER,
1430 South College St.,
Tulsa, Okla.

Retain Code Test, He Says

Editor, *Short Wave Craft*:

● ONLY a month ago the writer became violently intrigued and intensely interested in *short-wave radio*. Naturally I have been a listener to broadcast programs for years.

Knowing absolutely nothing about the *short waves*, or the technical side of radio, I am throwing myself into the 5-meter "no-code test" argument. People who know the least about a subject generally are very free to give advice.

At the age of 47, it is my intention, if nothing happens, to become a full-fledged ham. I have always been addicted to hobbies and having been precipitated into this one rather suddenly, I find it the most interesting of any with which I have ever come in contact. I have no earthly patience with the person who criticizes the amateur radio fraternity. Furthermore, I have no patience with anyone who is unwilling to learn, or try to learn the code, in order to become a ham. My own worry is due to the tremendous amount of technical knowledge which I think I should have, and other operators should have in order not to gum up the works.

It is a matter of history as to the services which have been rendered by the amateurs in radio, and it is a matter of record to what tremendous extent they have made possible the perfecting of wireless transmission in all its phases.

The writer wishes to go on record, and, as stated above, at present he does not know one single letter of the code, as being in favor of licensing all parties, amateur or otherwise, operating a transmitter of any rank or smell. In reading the last two issues of your magazine I have seen many sound and sensible arguments in favor of requiring an examination and very few arguments on the other side of the picture.

HAL DRAKE,
717 Ashby St., N.W.,
Atlanta, Ga.

Why Code Test Should be Retained

Editor, *Short Wave Craft*:

● HAVING read your magazine, *Short Wave Craft*, for the past three years, of late I have noticed the controversy about the code-test for Radio Operator's License, and in a recent copy of your magazine I read an article by a Mr. Wooding, in which he stated that code was an old and obsolete method of expressing oneself for great distances over the air, before the discovery of the modulated wave. I wonder if Mr. Wooding has ever held a Radio Operator's license, either amateur or commercial, and if he ever heard the SOS from a liner far out at sea, as the disabled ship floundered and tossed about. And if he did, if he realized what those dots and dashes meant to the passengers on board; also how important it was that those dots and dashes be heard for a great distance. Perhaps if he were in the operator's place he would think differently about the code, after he had undergone an experience of that nature.

A modulated wave will never, in my opinion, equal the unmodulated wave of a C.W. signal. Consider for instance our reception of foreign programs today, especially during a storm; let us suppose for example we are listening to a program from England, and suddenly the static increases to a point where the signal-to-noise ratio is equal, just at a time when we are trying to hear an important announcement as is a common occurrence—we miss the announcement. Now suppose this had been a

CLASSIFIED

Advertisements are inserted at 5c per word to strictly amateurs, or 10c a word to manufacturers or dealers. Each word in a name and address is counted. Cash should accompany all orders. Copy for the October issue should reach us not later than August 5th

<p>BOOKS</p> <p>ARMY-NAVY GIVES FREE radio operators' training for service on aircraft, ships. Salary, expenses paid. Information pamphlet, how to apply, 20c. Continental, Box 344, Dept. 1, Indianapolis, Ind.</p>	<p>follows: Australia, Fiji Island, New Zealand, Africa, England, France, Spain, Italy, Germany, South America, which can you cover? Test starts in Oct., 1935. Let's hear from you amateurs at once. Oliver Amie, 56th City Line Ave., Overbrook, Philadelphia, Penn., U.S.A.</p>	<p>QSL-CARDS-SWL</p> <p>QSL CARDS, NEAT, ATTRACTIVE, reasonably priced, samples free. Miller, Printer, Ambler, Pa.</p>
<p>ELECTRICAL SUPPLIES</p> <p>INSULATION, WIRE, VARNISHES, SUPPLIES, etc. Send 3c stamp for bulletin. Auto Power, 114 S. Hoyle Ave., Chicago.</p>	<p>FOR SALE—USED CARTER Super Generator with built-in filter, 6 to 200 volts at 50 ma. Perfect condition, \$7.00. Suitable for ham portables. H. G. McEntee, 484 Hanks Ave., Ridgewood, N.J.</p>	<p>REPLY GETTERS, SWLs, QSLs cards, Samples (stamps), W8ESN, 1827 Cone, Toledo, Ohio.</p>
<p>GENERATORS</p> <p>TWENTY PRACTICAL AND LOW cost changes converting Ford, Dodge, or Chevrolet generators into new generators and motors 100-500 watt capacity, direct or alternating current, with 6 to 400 volts for radio operation, power, light, or welding. Also instructions for rewinding armatures; 350 definitions of electrical terms, etc. All in new, revised book with simplified instructions and illustrations. Endorsed by thousands—Only \$1.00 postpaid. Auto Power—114 S. Hoyle Ave., Chicago.</p>	<p>SKYRIDER 5, 12-200 METERS, complete, perfect, \$18.00, Bill Lyons, 4451 Jackson, Chicago.</p> <p>TWO-TUBE DOERLE BAND Spread, \$7.50, John Bechtler, 111-11 126th Street, Ozone Park, N.Y.</p>	<p>RADIO EQUIPMENT</p> <p>'PUBLIC' ADDRESS, MIKES, SKY-riders, Short Wave, Many bargains, Wells-Smith, 21 North Wells, Chicago.</p>
<p>100 TO 700 WATT AC GENERATORS — guaranteed; inexpensive. W3LJAJ, Bellevue, Iowa, Route 4.</p>	<p>INSTRUCTION</p> <p>RADIO ENGINEERING, BROADCASTING, aviation and police radio, Servicing, Marlow and Morse Telegraphy taught thoroughly. All expenses in Catalog free, Dodge's Institute, Cull St., Valparaiso, Ind.</p>	<p>SHORT WAVE COMPONENTS</p> <p>4 BAKELITE PLUG-IN COILS. Wound on tube bases .30. Tall forms .10. 6 prong .60. Noel 728 Birch, Scranton, Pa.</p>
<p>"HAM" OFFERS & WANTS</p> <p>AMATEURS: WANTED AT ONCE 10 number 1 amateurs to send messages to foreign countries, if you can reach out for them, your service is needed badly, you will be well rewarded for your work, write for details at once. Countries to be covered are as</p>	<p>MISCELLANEOUS</p> <p>OHM'S LAW CALCULATOR - Lightning Slide Rule; solves all problems of Voltage, Current and Resistance, Power, Wire Sizes, etc. Range: 1 micro-amp. to 1000 amps.; 1 micro-volt to 10,000 volts; 1 micro-ohm to 10 megohms; 1 micro-watt to 10 megawatts; wire sizes 0 to 36 B. & S. gauge. Introductory price \$1.00 prepaid. The Dataprint Co., Box 322, Ramsey, N.J.</p>	<p>CRYSTALS 80 & 160 METERS \$1.35. Get yours from the QSL man, W3DGH, 1816 N. 5th Ave., Minneapolis, Minn.</p>
		<p>SHORT WAVE RECEIVERS</p> <p>IMMEDIATE SHIPMENT: PR-12 \$83.70. Prepaid; ACR-136 \$69.50; 1 retine 12 \$93.00; Super-Skyrider prepaid; Silver, National, and Hammarlund receivers. Collins transmitters. Trade-in your receiver. Code machines rented. Henry Radio Shop, Butler, Mo.</p>

distress signal from a ship at sea, and the operator had been able to give latitude and longitude but once, when the transmitter had become inoperative. The chances are that the code would have carried through above the noise-level, whereas a modulated wave would perhaps have been lost, with resultant loss of lives.

The code test may be eliminated from the license examination for the band below six meters, but code will not be done away with on other examinations. I am personally in favor of the code test in all license examinations.

Very truly yours,

COLSON SOUND STUDIOS,
Thomas F. Colson,
Chief Engineer,
Ex-operator X-W8AIL,
Amsterdam, N.Y.

Indian Radio Amateur Listens to American Horse Race

● D. R. D. WADIA, president of the Indian Radio Amateur at Santa Cruz, India, tuned to W2XAD just before a crocodile hunt recently, heard a crowd shouting, then the hoof-by-hoof description of a horse race being relayed by the General Electric station. It was 11 o'clock at night in India, and 2 p.m. in the afternoon, daylight time, at W2XAD's transmitter in Schenectady, N.Y.

Broadcast so Clear in Egypt Listener Suspects Man of Blushing

● H. F. CURTIS, of Alexandria, Egypt, in a letter to W2XAD, G. E. short-wave station at Schenectady, N.Y., explained he had listened to track and field events at Ann Arbor, Mich., via the station, and the broadcast was so clear he suspected Jesse Owens, runner, of blushing when introduced to a girl friend over the air. According to Mr. Curtis, the track star has many friends in Egypt who would like to see Owens represent the United States at the Berlin Olympic games next year.

6 Copies of SHORT WAVE CRAFT 70c PREPAID

For a limited time only, and as long as they last, we will send you six back numbers of SHORT WAVE CRAFT assorted, your choice, for 70 cents.

The usual price for six copies would be \$1.50 and most publishers charge a higher price for back numbers over one year old.

We can supply all copies except the following: June-July, Aug.-Sept., Oct.-Nov., 1930; Dec.-Jan., 1931; Dec.-Jan., May, June, Sept., Nov., 1932; Jan., Feb., March, May, June, July, 1933; Dec., 1934.

If you do not specify copies we will use our own judgment in sending assorted numbers to fill your order. Note we cannot exchange the copies for ones that have been sent to you.

Practically every copy of SHORT WAVE CRAFT contains important information that you should have. Here is a chance to get those copies.

As we have only a small supply of back numbers on hand, this offer will be withdrawn as soon as they have been sold.

We accept U.S. stamps, U.S. coin, or money order. Rush your order today.

SHORT WAVE CRAFT
99-101 Hudson Street New York, N. Y.

SHORT WAVE CRAFT 9-35
99-101 Hudson Street, New York, N. Y.
Gentlemen: I enclose herewith 70c, for which you are to send me six back number copies of SHORT WAVE CRAFT as follows:

Name

Address

City

State

Please mention SHORT WAVE CRAFT when writing advertisers

... SHORT WAVE ESSENTIALS FOR MEMBERS OF THE SHORT WAVE LEAGUE ...

A FEW WORDS AS TO THE PURPOSE OF THE LEAGUE

The SHORT WAVE LEAGUE was founded in 1930. Honorary Directors are as follows: Dr. Lee de Forest, John L. Reinartz, D. E. Replogle, Hollis Baird, E. T. Somerset, Baron Manfred von Ardenne, Hugo Gernsback, Executive Secretary.

The SHORT WAVE LEAGUE is a scientific membership organization for the promotion of the short wave art. There are no dues, no fees, no initiations, in connection with the LEAGUE. No one makes any money from it; no one derives any salary. The only income which the LEAGUE has is from its short wave essentials. A pamphlet setting forth the LEAGUE'S numerous aspirations and purposes will be sent to anyone on receipt of a 3c stamp to cover postage.

FREE MEMBERSHIP CERTIFICATE

As soon as you are enrolled as a member, a beautiful certificate with the LEAGUE'S seal will be sent to you, providing the stamps or coin is sent for mailing charges.

Members are entitled to preferential discounts when buying radio merchandise from numerous firms who have agreed to allow lower prices to all SHORT WAVE LEAGUE members.

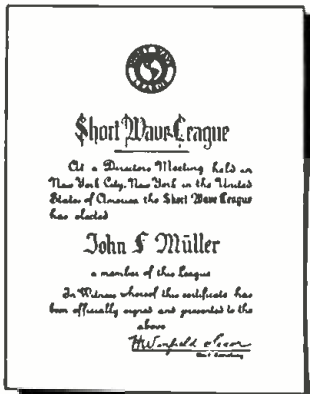

Illustration of engraved free membership certificate

SHORT WAVE ESSENTIALS LISTED HERE SOLD ONLY TO SHORT WAVE LEAGUE MEMBERS

They cannot be bought by anyone unless he has already enrolled as one of the members of the SHORT WAVE LEAGUE or signs the blank on this page (which automatically enrolls him as a member, always provided that he is a short wave experimenter, a short wave fan, radio engineer, radio student, etc.).

Inasmuch as the LEAGUE is international, it makes no difference whether you are a citizen of the United States or any other country. The LEAGUE is open to all.

Application for Membership SHORT WAVE LEAGUE

SHORT WAVE LEAGUE 99-101 Hudson Street, New York, N. Y. 9-35

I, the undersigned, herewith desire to apply for membership in the SHORT WAVE LEAGUE. In joining the LEAGUE I understand that I am not assessed for membership and that there are no dues and no fees of any kind. I pledge myself to abide by all the rules and regulations of the SHORT WAVE LEAGUE, which rules you are to send to me on receipt of this application.

I consider myself belonging to the following class (put an X in correct space): Short Wave Experimenter Short Wave Fan Radio Engineer Student I own the following radio equipment:

Transmitting

Call Letters.....

Receiving

Name

Address

City and State.....

Country

I enclose 10c for postage and handling for my Membership Certificate.

SHORT WAVE LEAGUE LETTERHEADS

A beautiful letterhead has been designed for members' correspondence. It is the official letterhead for all members. The letterhead is invaluable when it becomes necessary to deal with the radio industry, mail order houses, radio manufacturers, and the like: as many houses have offered to give members who write on the LEAGUE'S letterhead a preferential discount. The letterhead is also absolutely essential when writing for verification to radio stations either here or abroad. It automatically gives you a professional standing.

A—SHORT WAVE LEAGUE letterheads, per 100..... **50c**

OFFICIAL SHORT WAVE LISTENER MAGAZINE

The finest magazine of its kind ever published—totally different in get-up and contents from any other. Contains the largest listing of short wave stations in the world, up-to-the-minute, including "Police," "Television" and short-wave stations, as well as a special list of the star short-wave stations with their frequencies and call letters. Also contains photos and descriptions of short-wave broadcasting stations in various parts of the world with photos of short-wave studio artists—How to locate "weak" distance stations, and other hints for the "short-wave listener"—Question and Answer Department for the "listener"—Silver Cup Trophy for best photo of readers' listening "posts," etc.

B—Official Short Wave Listener Magazine..... **Prepaid 25c**

RADIO MAP OF THE WORLD AND STATION FINDER

The finest device of its kind published. The world's map on heavy board is divided into 23 sections, while the rotary disc shows you immediately the exact time in any foreign country. Invaluable in logging foreign stations. Also gives call letters assigned to all nations. Size: 11" x 22"

C—Radio Map of the World and Station Finder..... **Prepaid 25c**

GLOBE OF THE WORLD AND MAGNETIC COMPASS

This highly important essential is an ornament for every den or study. It is a globe, 6 in. in diameter, printed in fifteen colors, glazed in such a way that it can be washed. This globe helps you to intelligently log your foreign stations. Frame is of metal. Entire device substantially made, and will give an attractive appearance to every station, emphasizing the long-distance work of the operator.

D—Globe of the World..... **Prepaid \$1.25**

SHORT WAVE LEAGUE LABEL BUTTON

This beautiful button is made in hard enamel in four colors, red, white, blue and gold. It measures three quarters of an inch in diameter. By wearing this button, other members will recognize you and it will give you a professional air. Made in bronze, gold filled, not plated. Must be seen to be appreciated.

E—SHORT WAVE LEAGUE label button..... **Prepaid 35c**

EE—SHORT WAVE LEAGUE label button, like the one described above but in solid gold..... **Prepaid \$2.00**

SHORT WAVE LEAGUE SEALS

These seals or stickers are executed in three colors and measure 1 1/4 in. in diameter, and are gummed on one side. They are used by members to affix to stationery, letterheads, envelopes, postal cards and the like. The seal signifies that you are a member of the SHORT WAVE LEAGUE. Sold in 25 lots or multiples only.

G—SHORT WAVE LEAGUE seals..... per 25, **Prepaid 15c**

SHORT WAVE MAP OF THE WORLD

This beautiful map, measuring 18x26 in. and printed in 18 colors is indispensable when hung in sight or placed "under the glass" on the table or wall of the short wave enthusiast. It contains a wealth of information such as distances to all parts of the world, political nature of the country in which a broadcast station is located, etc., and from the manner in which the map is hinged off gives the time in different parts of the world at a glance.

F—SHORT WAVE Map of the World..... **Prepaid 25c**

PLEASE NOTE THAT ABOVE ESSENTIALS ARE SOLD ONLY TO MEMBERS OF THE LEAGUE—NOT TO NON-MEMBERS WITH EXCEPTION OF ITEM B.

Send all orders for short wave essentials to SHORT WAVE LEAGUE, 99-101 Hudson Street, New York City.

If you do not wish to mutilate the magazine, you may copy either or both coupons on a sheet of paper.

SHORT WAVE LEAGUE 99-101 Hudson St., New York, N. Y.



G—15c for 25



F—25c each

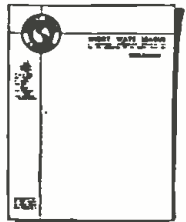

A—50c per 100



B—25c per copy

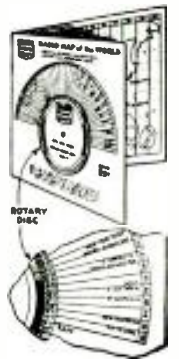

C—25c each



D—\$1.25 each



E—35c each

SHORT WAVE LEAGUE, 99-101 Hudson Street, New York, N. Y.

Gentlemen:

I am already an enrolled member in the SHORT WAVE LEAGUE

I am a new member and attach my application to this coupon

Please send me the following short wave essentials as listed in this advertisement:

for which I enclose \$ herewith
(The LEAGUE accepts money order, cash or new U. S. Stamps in any denomination. Register cash and stamps.)

Name

Address

City and State

Country

9-35

Please mention SHORT WAVE CRAFT when writing advertisers

● Index to Advertisers ●

A	
Ace Radio Laboratories.....	306
Acme Specialty Co.....	319
Aerovox Corporation.....	293
Allied Engineering Institute.....	300
Allied Radio Corp.....	306
Astatic Microphone Laboratory.....	313
B	
Bruno Laboratories.....	315
Brush Development Co., The.....	311
Burgess Battery Company.....	301
Bud Radio Inc.....	319
C	
Cameradio Co.....	300
Candler System Co.....	313
Cannon, C. F. Company.....	295
Chicago Radio Apparatus Co., Inc.....	299
Classified Advertisements.....	317
Coyne Radio & Electrical School.....	257
D	
Dataprint Company.....	310
Deutschmann, Tohe, Corp.....	309
Dodge's Institute.....	295
E	
Eilen Radio Laboratories.....	295
Electrad, Inc.....	297
Everyday Science & Mechanics.....	299
Experimental Radio Labs.....	311
F	
First National Television Inc.....	305
G	
Gold Shield Products Co.....	300, 304, 308
H	
Hammarlund Manufacturing Co.....	297
Harrison Radio Company.....	293
I	
Instructograph Company.....	299
International Correspondence Schools.....	315
K	
Korrol Mfg. Co., Inc.....	309
L	
Lancaster Allwine & Rommel.....	295
Lynch, Arthur H., Inc.....	303
M	
Marine Radio Company.....	299
Midwest Radio Corp.....	Back Cover
N	
National Company, Inc.....	Inside Back Cover
National Radio Institute.....	259
National Schools.....	293
New York Y.M.C.A. Schools.....	306
O	
Onan, D. W., & Sons.....	305
P	
Popular Homecraft.....	319
R	
Radeo, New York.....	313
Radio Constructors Labs.....	309
Radio Craft.....	312
Radio Publications.....	260, 302
Radio Trading Co.....	296, 308, 316
Radio Training Assn. of America.....	307
RCA Institutes, Inc.....	303
Remington-Rand, Inc.....	296
S	
Sargent, E. M., Co.....	299
Short Wave Coil Book.....	306
Short Wave League.....	295, 297, 318
Short Wave Listener Magazine.....	298
Short Wave Manual.....	Inside Front Cover
Sprague Products Company.....	311
T	
Teleplex Co.....	295
Thor Radio Corp.....	300
Triplet Electrical Instrument Co., The.....	309
Try-Mo Radio Co., Inc.....	311
U	
Uncle Dave's Radio Shack.....	307
W	
Wellworth Trading Company.....	293, 304, 313
Wholesale Radio Service Co., Inc.....	303
Who's Who in Amateur Radio.....	306
Wilcox Radio Sales Co.....	307
World Trotter Radio Labs.....	305
Wright-DeCoster, Inc.....	307
X	
X.L. Radio Laboratories.....	319

(While every precaution is taken to insure accuracy, we cannot guarantee against the possibility of an occasional change or omission in the preparation of this index.)

German Interval Signal

● THE German interval signal, well known to all American short-wave listeners, is produced in the German short-wave station Zeesen, near Berlin, by means of a very interesting electro-mechanical device which, in its construction resembles the old-fashioned music boxes used many years ago to entertain our grandfathers.

The diagram shows the wiring system of the interval signal apparatus, the tunes from which are radiated to the four corners of the world. As it is well known, this signal consists of a range of musical tunes which when played in the right succession produce the melody of an old German folk-song.

The interval signal apparatus consists of a certain number of steel pieces, in their design very similar to tuning forks. These "tune-forks," if hit in the right succession, by means of a cam spindle, produce the melody. This melody is not picked up, as sometimes believed, through a microphone but rather from a number of small electromagnetic pickups, which in turn are directly connected with the input transformer of the microphone pre-amplifier. Each of these "tune-forks" has its own pickup magnet. If the "tune-fork" is hit from one of the cams of the cam spindle the magnetic flux of the pickups varies, because the "tune-fork" vibrates directly in front of the electromagnet. The mechanical vibrations are therefore directly converted into current variation in the same manner as also often applied for record pickups.

An interesting part of the interval signal apparatus is a relay which ensures that the melody always goes with its first tune over the air. This relay obtains its direct current from a copper oxide rectifier, as shown in the diagram, and opens the way to the microphone pre-amplifier only in case the interval signal starts with its first tune.

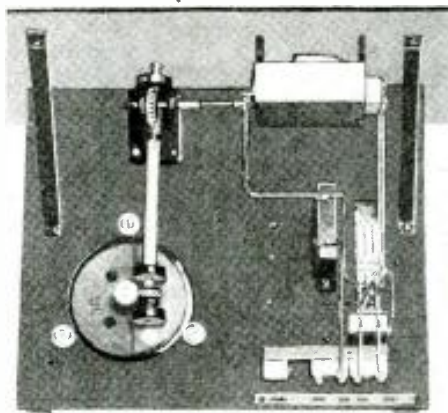

Photo, courtesy N.Y. Sun

Device used at German S-W station to produce "interval signal."

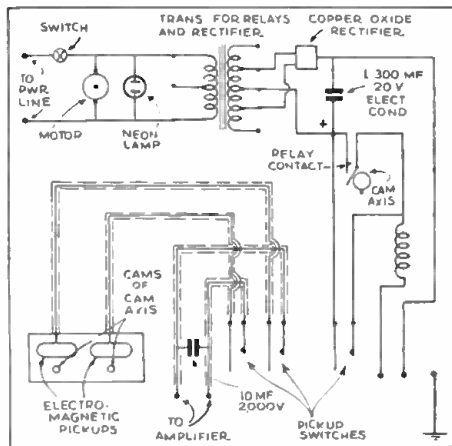

Diagram of German "Interval Signal" apparatus.



SCIENTIFICALLY PRODUCED

- | | |
|-------------------------------------|---------------------|
| Variable Condensers | Servicemen's Tools |
| Plug-In Coil Forms | Soldering Iron Tips |
| Transmitting Coil Forms | Crystal Holders |
| Wound Coil Kits | R.F. Chokes |
| Microphone Stands | Transmitting Chokes |
| Microphone Plugs | Aerial Parts |
| Microphone Connectors | Auto Aerials |
| Microphone Jacks | Auto Suppressers |
| Sockets, Receiving and Transmitting | Switches |
| Plugs and Adapters | Radio Convenience |
| Stand-Off Insulators | Outlets |
| Dials and Knobs | Chassis |
| Test Leads | Metal Cabinets |
| | Name Plates |

BUD Components are specified by amateurs, experimenters and engineers for Quality, Efficiency and Economy.

BUD RADIO INC. CLEVELAND, OHIO

Please Send Me Your Latest Catalog FREE!

Name.....

Address.....

City.....

SWC 9-35

Complete Plans

For Building Useful and Practical Things at Home



If you like to make things, here's a magazine you'll enjoy. Each issue of POPULAR HOMECRAFT is crammed with plans for making such beautiful and useful things as: Book Cases, China Closets, Bird Houses, Ship Models, Rustic Furniture, Lamps, Children's Playthings, Tea Tables, Antiques, Candle Sticks, etc. Covers wood-working, metal-working, lathe work, leather-craft, toys, copper, brass and pewter work. Explains use and care of tools. A real "How-to-do-it" magazine. Scores of large, clear drawings make every step simple. Nothing else like it.

ONE YEAR \$3.00 TWO YEARS \$5.00 (CANADA—50c A YEAR ADDITIONAL)

ORDER NOW.

POPULAR HOMECRAFT

Published ten times a year.

Dept. SWC., 737 N. Michigan Ave., Chicago, Illinois

ANNOUNCING

THE NEW

ACME DELUXE



5500 OHMS RESISTANCE
EXCEPTIONALLY HIGH IMPEDANCE

ANOTHER OF THE VERY POPULAR ACME PHONES

MAIL THIS AD FOR INFORMATION

ACME SPECIALTY CO.

2000 MENDEL ST. CHICAGO, ILL. SW-9

Mail us your order for the world's most reliable and accurate Balancing or Grid Condenser

X L VARIO DENSER in 4 ranges

Mod. N, Cap. 12 to 20 MMF

Mod. G, Cap. 20 to 100 MMF

Mod. GS, Cap. 100 to 500 MMF

Mod. G10, Cap. 500 to 1000 MMF

on the XL PUSH POST (best spring type Binding Post)

Type H (Aluminum Base, Bakelite insul. 1 1/2 To 1 5/8)

Type M (All Aluminum Body) at 10c each.

Get wherever you desire quick connections and positive contact at all times.

X. L. RADIO LABORATORIES

Dept. S.W.9, 1224 Belmont Ave., Chicago, USA.



Mod. N \$1.00 ea.
Mod. G \$1.50 ea.

Please mention SHORT WAVE CRAFT when writing advertisers

Here are the Six BEST SHORT-WAVE RADIO BOOKS!

Without doubt you will have to go along way to buy better books on short waves than you find on this page. Each book is written by a well-known authority on short waves . . . each book has been carefully illustrated with photographs and diagrams to

make the study of this field of radio much simpler. The volumes on this page are the finest books on short-waves which are published anywhere today. Order one or more copies today . . . find out for yourself how fine they are. Prices are postpaid.

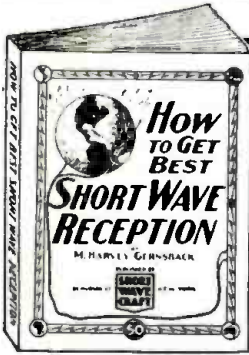

How to Get Best Short-Wave Reception

By M. HARVEY GERNSBACK

This book tells you everything you ever wanted to know about short-wave reception. The author, a professional radio listener and radio fan, for many years, gives you his long experience in radio reception and all that goes with it.

Why is one radio listener enabled to pull in stations from all over the globe, even small 100 watters, 10,000 miles away, and why is that the next fellow, with a much better and more expensive equipment, can only pull in the powerful stations that any child can get without much ado?

- The reason is intimate knowledge of short waves and how they behave. Here are the chapters of this new book:
1. What are Short Waves and what can the listener hear on a short-wave receiver or converter?
 2. How to tune and when to listen in on the short waves.
 3. How to identify short-wave stations.
 4. Seasonal changes in short-wave reception.
 5. Types of receivers for short-wave reception.
 6. Aerial systems for short-wave receivers.
 7. Verifications from short-wave stations.

The book makes excellent reading matter. There are many tricks in short-wave reception that even some of the "old-timers" do not know. Be sure to get it.

40 Illustrations, 72 Pages. Stiff, flexible covers **50c**

HOW TO BUILD AND OPERATE SHORT-WAVE RECEIVERS

THIS is the best and most up-to-date book on the subject. It is edited and prepared by the editors of SHORT WAVE CRAFT, and contains a wealth of material on the building and operation, not only of typical short-wave receivers, but short-wave converters as well. Dozens of short-wave sets are found in this book, which contains hundreds of illustrations; actual photographs of sets built, hookups and diagrams galore.

This book is sold only at a ridiculously low price because it is our aim to put this valuable work into the hands of every short-wave enthusiast.

We know that if you are at all interested in short waves you will not wish to do without this book. It is a most important and timely radio publication.

150 Illustrations, 72 Pages. Stiff, flexible covers **50c**

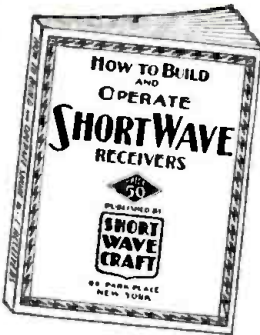

THE SHORT-WAVE BEGINNER'S BOOK

HERE is a book that solves your short wave problems—leading you in easy stages from the simplest fundamentals to the present state of the art as it is known today. It is the only well-illustrated reference book on short waves for the beginner.

The book is profusely illustrated—it is not "technical." It has no mathematics and no technical jargon.

It also gives you a tremendous amount of important information, such as true conversion tables, all about aerials, using elimination, all about radio tubes, data on coil winding and other subjects.

Partial List of Contents

Getting Started in Short Waves—the fundamentals of electricity, symbols, the Short Wave Radio—how to read schematic diagrams. Short Wave Coils—various types and kinds in making them.

Short Wave Aerials—the points that determine a good aerial from an inefficient one.

The Transposed Lead-in for reducing static.

The Beginner's Short-Wave Receiver—a simple one tube set that anyone can build.

How to Tune the Short-Wave Set—telling the important points to get good results.

Audio Amplifiers for S-W Receivers.

Learning the Code—for greater enjoyment with the S-W set. Wave length to Kilocycle Chart.

Wire Chart—to assist in the construction of coils.

75 Illustrations, 40 Pages. Stiff, flexible covers **25c**

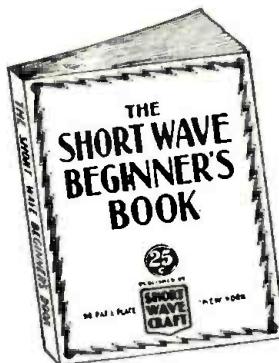

101 SHORT-WAVE HOOKUPS

Compiled by the Editors of SHORT WAVE CRAFT

EACH and every look-up and diagram illustrated is also accompanied by a thorough explanation of what this particular hook-up accomplishes, what parts are required, and so on—valuable information, value of resistors, etc. In fact, everything you want to know in order to build the set or to look up the data required.

To be sure, all of the important sets which have appeared in print during the past five years are in this valuable book. Sets such as the Doerle, Diminute, the "19" Triplex, "Signal Grippe," "Two R.F. 4-tube Superhet, "Lion," "Bugs-Tracker," "2-Tube Superhet, "Miner," "Lion" Receiver, "Doerle" 2-tube Battery, "Doerle" 3-tube Battery, "Doerle" 2-tube A.C., "Doerle" 3-tube A.C., Doerle "Signal Grippe," Two R.F. 4-tube Receiver, The Sargent 9-33 Tapped Coil Receiver, "Sub-Girdler" 7, The 2-Tube "Champ"—2 Tubes Equal 3, Ham-Band "2-Tube Power," Worth All-Way 6, Denton Economy 3, 2-Tube "Regenerative-De-Lindgren" will be found here, with full descriptions. In many cases, we have also included a picture look-up for those who do not wish to follow the regular symbolic look-up, but wish to have a regular wiring diagram.

This is a very handy volume, especially for those "fops" who wish to study the best sets in the short-wave art, from one tube up to ten tubes.

100 Illustrations, 72 Pages, Stiff, flexible covers **50c**

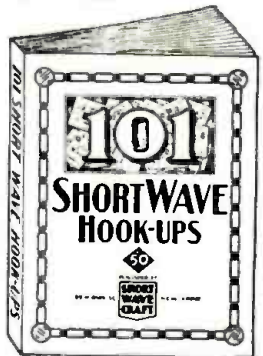

HOW TO BECOME AN AMATEUR RADIO OPERATOR

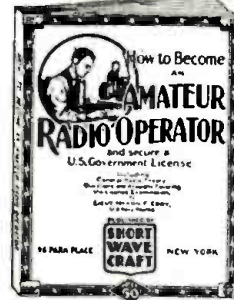

WE show you, Myron F. Eddy, to write this book because his experience in the amateur field has made him prominent in this line. For many years he was instructor of radio electronics at the R.C.A. Institute. He is a member of the I.R.E. (Institute of Radio Engineers), also the Veteran Wireless Operators' Association.

If you intend to become a licensed code operator, if you wish to take up phone work eventually—this is the book you must get.

Partial List of Contents

Ways of learning the code. A system of sending and receiving with necessary drill work is supplied so that you may work with approved methods. Concise, authoritative definitions of radio terms, units and laws, brief descriptions of commonly used pieces of radio equipment. This chapter gives the working terminology of the radio operator. Graphic symbols are used to indicate the various parts of radio circuits. General radio theory, particularly as it applies to the beginner. The electron theory is briefly given, then waves—their creation, propagation and reception. Fundamental laws of electric circuits, particularly those used in radio are explained, next and typical basic circuits are analyzed. Descriptions of modern receivers that are being used with success by amateurs. You are told how to build and operate these sets. Amateur transmitters and their construction with specifications are furnished so construction is made easy. Power equipment that may be used with transmitters and receivers, rectifiers, filters, batteries, etc. Regulations that apply to amateur operators. Appendix which contains the International "Q" signals, conversion tables for reference purposes, etc.

150 Illustrations, 72 Pages, Stiff, flexible covers **50c**

TEN MOST POPULAR SHORT-WAVE RECEIVERS

—HOW TO MAKE AND WORK THEM

THE editors of SHORT WAVE CRAFT have selected ten outstanding short-wave receivers, and these are described in the new volume. Each receiver is fully illustrated with a complete layout, pictorial representation, photographs of the set complete, hook-up and all worthwhile specifications. Everything from the simplest one-tube set to a 5-tube T. R. F. receiver is presented. Complete lists of parts are given to make each set complete. You are shown how to operate the receiver to its maximum efficiency.

CONTENTS

- The Doerle 2-Tube Receiver That Reaches the 12,500 Mile Mark, by Walter C. Doerle.
- 2-R.F. Pentode S-W Receiver having two stages of Tuned Radio Frequency, by Clifford E. Denton and H. W. Secor.
- My de Luxe S-W Receiver, by Edward G. Ingram.
- The Binneweg 2-Tube 12,000 Mile DX Receiver, by A. Binneweg, Jr.
- Build a Short-Wave Receiver in your "Brief-Case," by Hugo Gernsback and Clifford E. Denton.
- The Denton 2-Tube All-Wave Receiver, by Clifford E. Denton.
- The Denton "Stand-By," by Clifford E. Denton.
- The "Stand-By" Electrified.
- A COAT-POCKET Short-Wave Receiver, by Hugo Gernsback and Clifford E. Denton.
- The S-W PENTODE 4, by H. G. (Cris) M. E.
- Louis Martin's Idea of a GOOD S-W RECEIVER, by Louis Martin.

75 Illustrations, 40 Pages, Stiff, flexible covers **25c**

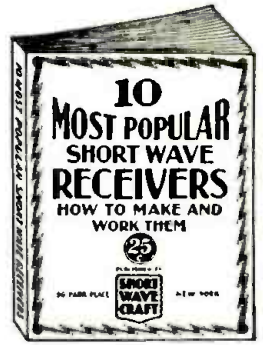

All the books shown on this page are published exclusively by

SHORT WAVE CRAFT

99-101 Hudson Street, New York, N. Y.

CLIP-MAIL

SHORT WAVE CRAFT, 99-101 Hudson Street, New York, N. Y. SW-9-35

Gentlemen: I enclose herewith my remittance for the amount of \$..... for which you are to send me, postpaid, the books checked below.

- | | |
|--|--|
| () How to Get Best Short-Wave Reception..... 50c each | () How to Become an Amateur Radio Operator..... 50c each |
| () 101 Short-Wave Hook-ups..... 50c each | () Ten Most Popular Short-Wave Receivers, How to Make and Work Them..... 25c each |
| () How to Build and Operate Short-Wave Receiver..... 50c each | () The Short Wave Beginner's Book..... 25c each |

Name..... Address..... City..... State.....

(Send remittance in form of check or money order. If letter contains cash or unused U. S. Postage stamps, register it.)

These Books are Authentic For All Short Wave Work and LOW in Price

COUPON TODAY!

Please mention SHORT WAVE CRAFT when writing advertisers

AN AMAZING NEW RECEIVER

NATIONAL

HRO

Communications Type RECEIVER

NET PRICE
\$167.70
with tubes, less
speaker and power
supply.

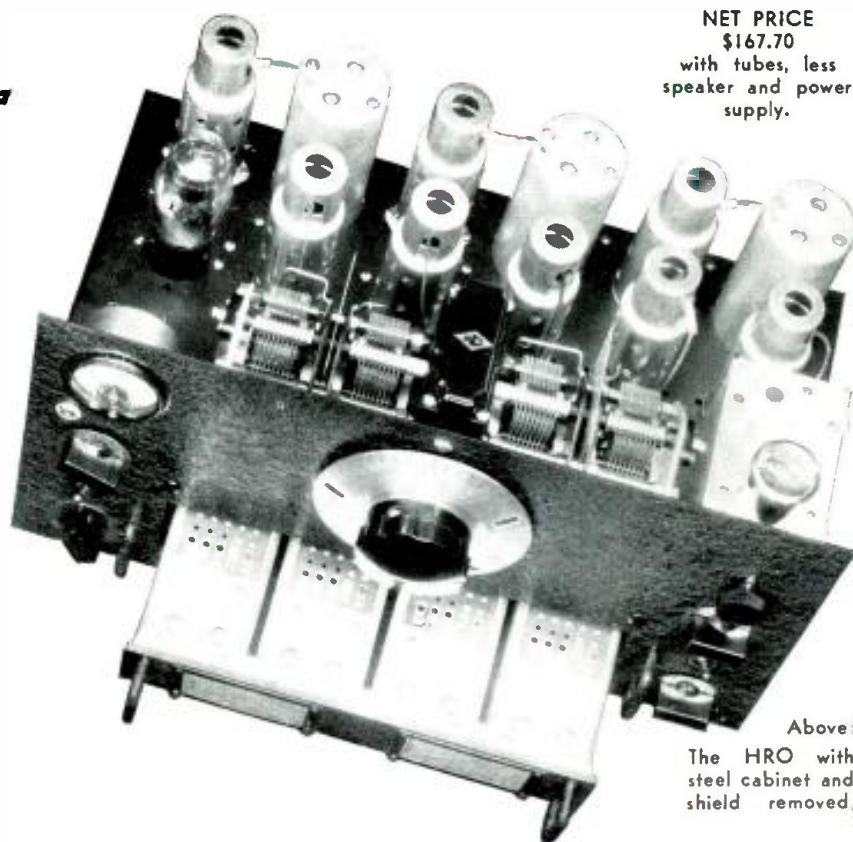

Above:
The HRO with
steel cabinet and
shield removed.

The new National HRO Receiver is a high performance professional receiver, not a broadcast receiver with short wave ranges added. Although it offers complete frequency coverage including the regular broadcast band, it is primarily a short wave receiver, designed to provide consistent communication under adverse conditions. It is backed by the experience of a concern that has for years built high performance receivers for government and professional use.



PRECISION-BUILT

The HRO is built for fine performance, not low price. The precision worm drive condenser and micrometer dial alone carry a price of \$24.50, ten times the cost of ordinary equipment. With such parts, bargain prices are impossible. It is built for the man who wants the best. Illustrated above is a cut-away view of the drive mechanism of the condenser. Note the ball-bearing thrust, the carefully machined worm and accurately-hobbed, preloaded worm gears. Only such construction can give the precise control necessary with a receiver that has a maximum selectivity of a few hundred cycles (not kilocycles!) The remarkable micrometer dial reads DIRECT to one part in five hundred, which permits permanent, accurate logging of all stations.

OUTSTANDING FEATURES:

- Nine Tubes, not including rectifier.
- Two Preselector Stages.
- Single Signal (Crystal Filter) standard equipment, providing enormous selectivity when conditions require it.
- Ganged Plug-in Coils, with each coil individually shielded.
- Strictly single-control Tuning.
- Calibration for each range mounted on coil.
- Four gang Precision Condenser, with preloaded worm-drive tuning, 20-1 ratio.
- Micrometer Dial, spreading tuning over 500 division, numbered every 10 division, direct reading.
- Automatic or Manual Volume Control.
- Vacuum Tube Voltmeter with Instrument calibrated in S scale of carrier intensity.
- Electron Coupled, air padded oscillators.
- Two I.F. stages with Litz-wound coils, air condenser tuned.
- Beat Frequency Oscillator for "Offset" C.W. Tuning.
- Phone Jack on Panel.
- 2½ Volt AC and 6 volt AC or Battery models.
- Relay Rack Mounting available.

PLUG-IN COIL FOR HIGH EFFICIENCY

The HRO employs plug-in coils rather than coil switching, for only by having individual shields, free from unused coils and trimmers can such high performance be realized. The four coils in each set—two stages of preselection, detector and oscillator—are ganged together for swift, easy handling and plug-in as a unit. A switching device on each coil permits change from general coverage ranges to band spread ranges which expand the amateur bands over the entire dial. Individually calibrated curves are mounted on the front of each coil. The illustration below shows a complete coil assembly, together with a coil assembly removed from its case. Note the air-dielectric trimming condensers that are used throughout the H.F. and I.F. stages and the insulation of genuine low-loss R-39. Coils for continuous frequency coverage from 4 to 30 megacycles, plus calibrated band spread on the 10, 20, 40 and 80 meter bands is included with the receiver. Two extra coils to extend the range down to 500 kc. are supplied at extra cost.



SEND COUPON FOR DESCRIPTIVE BOOKLET



RELAY-RACK MOUNTING

The HRO is also available for professional use with a standard relay rack, as illustrated at the left.



NATIONAL CO., MALDEN, MASS.

Gentlemen: Please send me immediately your bulletin describing the HRO Receiver, and your General Catalogue No. 240. I enclose 6c to cover mailing costs.

NAME

ADDRESS

SWC 9 35

SAVE UP TO 50% by BUYING YOUR RADIO *Direct from* MIDWEST LABORATORIES

Exciting World-Wide Entertainment... Glorious New Acousti-Tone
Guaranteed with Amazing New 1936 **MIDWEST**
SUPER Deluxe



18 Tube SIX-IN-ONE Radio

(ALL WAVE - 6 BANDS)

PUSH BUTTON TUNING!
ONLY RADIO COVERING 4½ to 2400 METERS - 12000 MILE RANGE
30 Days FREE Trial!

WORLD'S
GREATEST RADIO VALUE
\$59 50
with New
GIANT
THEATRE-
SONIC
(LARGE TUBES) SPEAKER

TERMS AS LOW AS \$5.00 DOWN

EVERYWHERE,

radio enthusiasts are saying:
"Have you seen the new 18-tube, 6-band, Acousti-Tone V-Spread Midwest?" It's an improvement over Midwest's 16-tube set, so popular last season. This amazingly beautiful, bigger, better, more powerful, super selective, 18-tube radio . . . is not obtainable in retail stores . . . but is sold direct to you from Midwest Laboratories at a positive saving of 30% to 50%. Out-

performs \$250 sets. Approved by over 120,000 customers. Before you buy any radio write for FREE 40-page catalog. Never before so much radio for so little money. Why pay more? You're triply protected with: *One-Year Guarantee, Foreign Reception Guarantee and Money-Back Guarantee.*

PUSH-BUTTON TUNING

Now, offered for first time! Simply pushing Silencer Button hushes set between stations . . . while pressing Station Finder Button automatically indicates proper dial position for bringing in extremely weak stations.

METAL TUBES

This Midwest is furnished with the new glass-metal counterpart tubes. Set sockets are designed to accept glass-metal or METAL tubes, without change. Write for FREE facts.

80 ADVANCED 1936 FEATURES

Midwest's brilliant performance made possible by scores of advanced features, many of them exclusive. Only Midwest tunes as low as 4½ meters and as high as 2400 meters...6 bands...18 tubes... push button tuning...acousti-tone V-spread design...pre-aged adjustments...Fidel-A-Stat...Triple Calibration...etc. See pages 12 to 20 in FREE catalog. Six-bands . . . offered for first time! E, A, L, M, H and U . . . make this super deluxe 18-tube set the equivalent of six different radios . . . offer wave bands not obtainable in other radios at any price! Now, thrill to new explorations in sections of radio spectrum that are strangers to you. Every type of broadcast from North and South America, Europe, Asia, Africa and Australia is now yours. Send today for money-saving facts!

FULL-SCOPE HIGH FIDELITY . . . SPLIT-HAIR SELECTIVITY

Now, get complete range of audible frequencies from 30 to 16,000 cycles as being transmitted by four new High Fidelity Broadcasting stations—W1XBS—W9XBY—W2XR—and W6XAL. Bring in distant, weak foreign stations, with full loud speaker volume, on channels adjacent to powerful locals.

Delighted With Super Performance

Davison, Mich. A radio engineer confirmed my opinion—that no other make of radio will compare with my Midwest for tone, selectivity, volume, ease of tuning and wider range. It is great entertainment. R. F. Collier.



Praises World-Wide Reception

Maysville, Ky. My friends envy my Midwest and say it beats theirs in price and performance. It is amazingly sensitive and brings in Holland, Spain, etc. Its full, rich, non-fading tone denotes super quality and advanced workmanship. W. E. Purdon, Rural Route No. 1.



Acousti-Tone V-Spread Design
(Pat. Pending)

Send for FREE 40-page catalog illustrating new 1936 Midwest models and chassis in four colors. Full Scope High Fidelity Console, at left, shows dispersing vanes and exclusive V-front that propel High Fidelity waves uniformly to the car.

DEAL DIRECT WITH LABORATORIES

No middlemen's profits to pay—you buy at wholesale price direct from laboratories . . . saving 30% to 50%. Increasing costs are sure to result in higher radio prices soon. Buy before the big advance . . . NOW . . . while you can take advantage of Midwest's sensational values. You can order your 1936 Full Scope High Fidelity Acousti-Tone radio from the 40-page catalog with as much certainty of satisfaction as if you were to come yourself to our great radio laboratories. You save 30% to 50% . . . you get 30 days FREE trial . . . as little as \$5.00 puts a Midwest radio in your home. Satisfaction guaranteed or money back. Write, today, for FREE catalog.

SAVE UP TO 50%



MAIL COUPON TODAY! FOR FREE 30-DAY TRIAL OFFER and 40-PAGE FOUR-COLOR FREE CATALOG

MIDWEST RADIO CORP., Dept. 14C, Cincinnati, Ohio.
Without obligation on my part, send me your new FREE catalog and complete details of your liberal 30-day FREE trial offer. This is NOT an order.

User-Agents Make Easy Extra Money
Check Here for Details

Name _____
Address _____
Town _____ State _____
 Check here, if interested in a Midwest Auto Radio.

MIDWEST RADIO CORP.
DEPT. 14C CINCINNATI, OHIO U.S.A.
Established 1920 Cable Address MIRACO All Codes