

HUGO GERNSBACK  
Editor

# SHORT WAVE CRAFT

January 1935

WORLD'S  
LARGEST  
SHORT WAVE  
CIRCULATION

**XMAS DREAM**  
of a  
**Short-Wave Fiend**

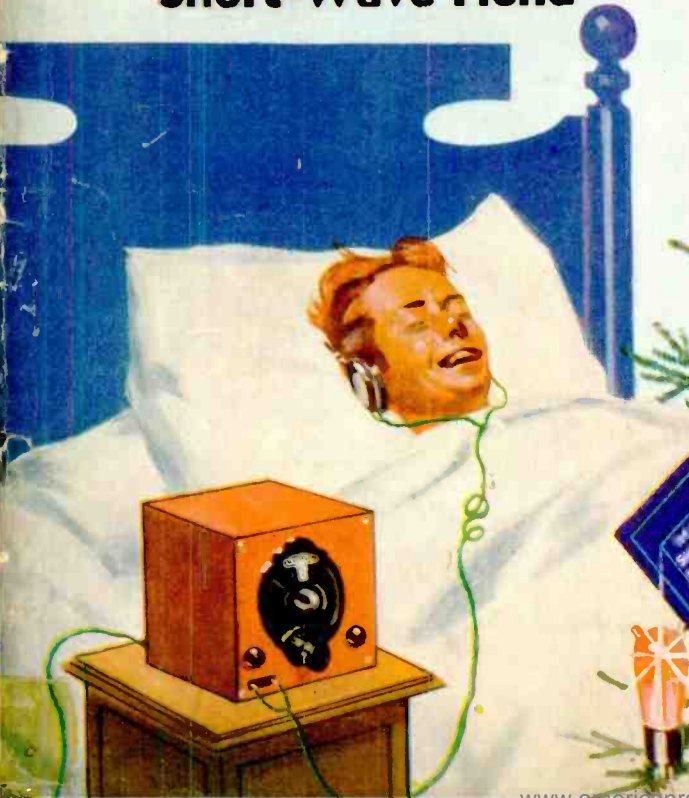

25¢  
IN CANADA  
30¢

# WORLD GLOBES

## FOR SHORT WAVE ENTHUSIASTS

### NOW AT LOW PRICES

THESE remarkable globes, executed in fourteen colors, are absolutely indispensable for short wave fans. Notable among the numerous features of these world globes, is that a damp cloth quickly removes all dust and water does not harm the surface.

Short Wave fans are enabled to determine correct time in various centers of the world with the aid of these maps; distances from city to city can be accurately established.

There is a graduated "Meridian" scale of black enameled metal with the 9" and 12" globes. An additional feature is the movable hour scale found at the north pole—this facilitates determining the hour in any part of the world.

Only on a globe of this size is it possible to get an accurate picture of countries and their relative positions to each other. You will actually be amazed when you compare distances—from New York to Moscow; from Cape Town to Tokio; from Los Angeles to Rio de Janeiro, etc. A flat map is deceptive for measuring, but take a small string and stretch it across the globe, from city to city, and you have the correct distances.

Here are globes that add dignity to home, office, studio or laboratory—a globe that everyone would be proud to possess.

Each world globe contains a listing of over 7,500 cities in nations the world over—spellings conform to International Geographic standards—all globes are of 1934 production. GET ONE OF THESE FINE WORLD GLOBES TODAY!



**World Globe No. 147**

12" Globe, New model—equipped with wooden floor stand finished in walnut. Height overall 35". Globe constructed with half meridian. New World Globe Handbook Included FREE. A marvelous buy. Never has a floor model Globe been sold at such a low price. Shipping weight 9 lbs.

PRICE

**\$4.15**

F.O.B. Chicago.



No. 99

**World Globe No. 99**

9" Globe, equipped with sturdy, black metal base and full meridian. Same ball as our No. 139 but reduced 1/4 in size and scale. Included with globe is newly printed World Globe Handbook FREE. Shipping weight 6 lbs.

PRICE

**\$2.05**

F.O.B. Chicago.



No. 47

**World Globe No. 47**

7" Globe, equipped with sturdy metal base and half meridian. Index to countries of the world by latitude and longitude shown on base. Shipping weight 2 lbs.

PRICE

**\$0.90**

F.O.B. Chicago.

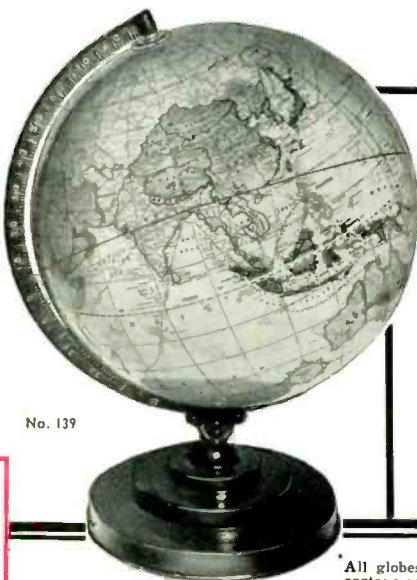

No. 139

**SPECIAL THIS MONTH ONLY**

**World Globe No. 139**

12" Globe, equipped with sturdy, black metal base and half meridian. Contains over 7,500 names and cities. Spellings conform to authoritative world standards. Hundreds sold to many short wave fans during the last year. Copy of World Globe Handbook included FREE. Shipping weight 8 lbs. PRICE

**\$2.95**

F.O.B. Chicago.

All globes are carefully packed in original cartons assuring safe delivery. ORDER BY NUMBER. Send check or money order, plus warehouse. Register letter if it contains cash, or currency or stamps. If preferred, specify that shipment be sent express collect. ALL ORDERS ARE FILLED PROMPTLY.

ALL GLOBES SHIPPED IMMEDIATELY

Gentlemen:  
I received the World Globe and am certainly well pleased with its completeness, appearance and its usefulness. Short wave listening has become a hobby with me, and this World Globe is a necessary accessory to any short wave listener or, for that matter, to any home.  
P. C. ELLIS, Supt.  
Laboratory—19th and Campbell Streets, Kansas City, Mo.

**ORDER YOUR GLOBE TODAY!**

SHORT WAVE CRAFT SWC-1-35  
99 Hudson Street, New York, N. Y.

Gentlemen: Enclosed you will find my remittance of \$..... for which please ship me the following World Globe.

- ( ) World Globe No. 99 @ \$2.05
- ( ) World Globe No. 147 @ \$4.15
- ( ) World Globe No. 47 @ \$0.90
- ( ) World Globe No. 139 @ \$2.95

Name .....  
Address .....

City ..... State .....

Send remittance in check or money order—register letter if it contains cash, stamps or currency. GLOBES ARE SHIPPED FROM OUR WAREHOUSE IN CHICAGO—F. O. B. FROM THAT CITY.

**SHORT WAVE CRAFT 99 HUDSON STREET, NEW YORK, N. Y.**



J. E. Smith,  
President  
National Radio  
Institute

# I WILL HELP YOU START A SPARE TIME OR FULL TIME RADIO SERVICE BUSINESS WITHOUT CAPITAL

**HERE ARE A FEW EXAMPLES  
OF THE KIND OF MONEY  
I TRAIN MY MEN TO MAKE**

**Clears \$4500 in 18 Months**

"Before taking your Radio Course I was making \$18 a week. I came here three years ago. In about 18 months I made about \$4500 in Radio. I cannot say too much for the wonderful help I have received from N. R. I."

Noel W. Ray,  
619 Broad St.,  
Gadsden, Alabama.



**Spare Time Work Pays  
\$18 a Week**

"I only do spare time Radio work and average \$18 a week. People who in good times would buy a new Radio, now have the old one fixed."

Stephen J. Drapchaty,  
407 Wunderlich Avenue,  
Barberton, Ohio.



**Now Owns Own Business**

"If I had not taken your Course I would be digging ditches instead of running my own business. One week I made \$75 on repairing alone, and this doesn't count sales. If a fellow wants to get into Radio, N. R. I. is the starting point."

R. S. Lewis,  
Modern Radio Service,  
Pittsfield, Ill.



**You Get PRACTICAL EXPERIENCE  
with Radio Equipment I Give You**

My Course is not all theory. I'll show you how to use my special Radio equipment for conducting experiments and building circuits which illustrate important principles used in such well-known sets as Westinghouse, General Electric, Philco, R.C.A., Victor, Majestic, and others. You work out with your own hands many of the things you read in our lesson books. This 50-50 method of training makes learning at home easy, interesting, fascinating, intensely practical. You learn how sets work, why they work, how to make them work.



**Free Book Tells How  
Mail Coupon!**

The world-wide use of Radio sets for home entertainment has made many opportunities for you to have a spare time or full time Radio business of your own. I give you instructions early in your Training for doing 28 Radio jobs common in almost every neighborhood. Many N. R. I. men make \$5, \$10, \$15 a week extra in spare time while learning. I show you how to install and service all types of receiving sets. I give you Radio equipment and instructions for conducting experiments, for building circuits and testing equipment, and for making tests that will give you broad, practical Radio experience. Clip the coupon below and get my free 64-page book, "Rich Rewards in Radio"—it gives you a full story of the success of N.R.I. students and graduates, and tells how to start a spare time or full time Radio business on money made in spare time while learning.

**Many N. R. I. Men Make \$5, \$10,  
\$15 a Week Extra in Spare  
Time While Learning**

Many of the seventeen million sets now in use are less than 50% efficient. I will show you how to cash in on this condition. I will show you the plans and ideas that have enabled many others to make \$5, \$10, \$15 a week in spare time while learning. Ford R. Leary, 1633 Davison Road, Flint, Mich., wrote: "My part-time earnings while taking the N. R. I. Course were \$651."

**Get Ready Now for  
a Radio Business of Your Own  
and for Jobs Like These**

Broadcasting stations use engineers, operators station managers, and pay up to \$5,000 a year. Radio manufacturers use testers, inspectors, foremen, engineers, servicemen and buyers, and pay up to \$6,000 a year. Radio dealers and jobbers employ hundreds of servicemen, salesmen,

managers, and pay up to \$5,000 a year. Radio operators on ships enjoy life, see the world, with board and lodging free, and get good pay besides. My book tells you of the opportunities in these fields, also in Aviation Radio, Television, Police Radio, Short Wave Radio, Automobile Radio and other new branches of this fast growing industry. Get it.

**I Train You at Home  
in Your Spare Time**

Hold your job until you're ready for another. Give me only part of your spare time. You do not need a high school or college education. Hundreds with only a common school education have won bigger pay through N. R. I. J. A. Vaughn jumped from \$35 to \$100 a week. J. E. McLaurine increased his earnings 100 per cent. The National Radio Institute is the Pioneer and World's Largest organization devoted exclusively to training men and young men by Home Study for good jobs in the Radio industry.

**You Must Be Satisfied**

I will give you an agreement to refund every penny of your money if you are not satisfied with my Lesson and Instruction Service when you complete my Training. And I'll not only give you thorough training in radio principles, practical experience in building and servicing sets, but also Advanced Specialized Training in the type of Radio work you choose.

**Get My Free Book of Facts**

Mail the coupon for "Rich Rewards in Radio." It's free to any ambitious fellow over 15 years old. It tells you about Radio's spare time and full time opportunities; about my training; what others who have taken it are doing and making. Mail coupon now in an envelope, or paste it on a 1c post card.

J. E. SMITH, Pres.  
Dept. 5AB3  
National Radio  
Institute  
Washington, D. C.



**This Coupon is Good For One  
FREE COPY OF MY NEW BOOK**

J. E. SMITH, President,  
National Radio Institute,  
Dept. 5AB3,  
Washington, D. C.



Dear Mr. Smith: Without obligation, send me the Service Manual and your free book about spare time and full time Radio opportunities, and how I can train for them at home in spare time. (Please print plainly.)

Name..... Age.....

Address .....

City..... State..... "M"

**Find out about the World Famous Course that Pays for Itself**

Please mention SHORT WAVE CRAFT when writing advertisers

**IN THIS ISSUE: PROMINENT SHORT-WAVE AUTHORS**

**Merriam • Shuart • Worcester • Palmer • Woehr • Lester**

**HUGO GERNSBACK**  
Editor



**H. WINFIELD SECOR**  
Managing Editor

**GEORGE W. SHUART,**  
**W2AMN**  
Associate Editor

**Contents for January, 1935**

Editorial—Needed Short-Wave Improvements, by Hugo Gernsback ..... 517

Ultra Short Waves Extend Land Telephone Lines, by F. F. Merriam, Bell Telephone Laboratories..... 518

They Are TELEVISIONING in Berlin!..... 519

Short Waves Reduce Poison in Aspic Viper Venom—the work of Madame Dr. Marie Phisalix and Dr. Col. François Pasteur, Paris..... 520

COLD CATHODE Tube Demonstrated!..... 521

Over the Mountains on 5 Meters..... 521

Automatic Band-Spread!..... 521

“Economy 2” Battery Receiver—Uses New Type 15 Cathode Battery Tubes, by George W. Shuart, W2AMN ..... 522

The Short-Wave Fan’s DX-er, By J. A. Worcester, Jr. 524

5-Meter Superhet Uses ACORN Tubes—A Superior 5-Tube Receiver, by George W. Shuart, W2AMN... 526

World-Wide Short-Wave Review, edited by C. W. Palmer ..... 528

SHORT-WAVE SCOUT NEWS—Report from Official “Listening Posts”..... 530

Eleventh Winner of SHORT-WAVE SCOUT “TROPHY” ..... 531

SHORT WAVES AND LONG WAVES—Our Readers’ Forum ..... 532

A Variable Wave-Length Antenna..... 534

A Direct-Reading Condenser Tester, by F. L. Sprayberry ..... 534

A Low-Power Phone Transmitter, by W. A. Woehr, W9PTZ ..... 535

What’s New in Short-Wave Apparatus—A Modern 100 Watt Transmitter..... 536

\$5.00 Monthly for Best Short-Wave Kink..... 540

SHORT WAVE STATIONS OF THE WORLD—Complete List, including “Police” and “Television” Stations, edited by M. Harvey Gernsback..... 541

When to Listen In, by M. Harvey Gernsback..... 544

SHORT WAVE LEAGUE..... 545

Short Wave QUESTION BOX..... 546



**Certified Circuits**

● **SHORT WAVE CRAFT** goes to a large expense in verifying new circuits. When you see this seal it is your guarantee that such sets have been tested in our laboratories, as well as privately, in different parts of the country. Only “Constructional-Experimental” circuits are certified by us.

When you see our certified seal on any set described, you need not hesitate to spend money for parts, because you are assured in advance that the set and circuit are bona fide and that this magazine stands behind them.

**SHORT WAVE CRAFT** is the only magazine that certifies circuits and sets.

**OUR COVER**

● “Xmas Dream of a Short-Wave Fiend,” is the subject of our cover illustration this month and undoubtedly thousands of short-wave enthusiasts, people of all ages, will go to bed on Christmas Eve wishing for a fine, new short-wave receiver or transmitter. And who can tell—maybe old Santa will fulfill their dreams.

COPYRIGHT, 1934, BY H. GERNSBACK

Published by **POPULAR BOOK CORPORATION**

HUGO GERNSBACK, President - - - H. W. SECOR, Vice-President  
EMIL GROSSMAN - - - - - Director of Advertising  
Chicago Adv. Office - - - - - L. F. McCLURE, 919 No. Michigan Ave.  
Publication Office - - - - - 404 N. Wesley Avenue, Mount Morris, Ill.  
Editorial and General Offices - - - 99-101 Hudson St., New York, N. Y.  
London Agent: HACHETTE & CIE., 16-17 King William St., Charing Cross, W.C.2  
Paris Agent: HACHETTE & CIE., 111 Rue Reaumur  
Australian Agents: MCGILL’S AGENCY, 179 Elizabeth St., Melbourne

**Features in the February Issue**

How to Get “High Fidelity” with Your Old Audio Amplifier, by Wilhelm E. Schrage.

The “Economy 3”—A New Circuit—including R.F., Detector and A.F.; has T.R.F., Band-Spread, Latest Tubes, suited to “fan” or “ham,” by George W. Shuart, W2AMN.

A 5-Meter Portable Transmitter, Using High-Voltage Dynamotor.

3 Tubes=6 in a new “High Efficiency” Superhet Circuit. It has A.V.C. ’n everything, by M. Harvey Gernsback.

**SHORT-WAVE CRAFT**—Monthly. Entered as second class matter May 7, 1930, at the post office at Mount Morris, Illinois, under the act of March 3, 1879. Trademarks and copyrights by permission of H. Gernsback, 99-101 Hudson St., N. Y. C. Text and illustrations of this magazine are copyrighted and must not be reproduced without permission. **SHORT WAVE CRAFT** is published on the 1st of every month. Twelve numbers per year. Subscription price is \$2.50 a year in the United States and possessions. Canada and foreign countries, \$3.00 a year. Single copies 25c. Address all contributions for publication to Editor, **SHORT WAVE CRAFT**, 99-101 Hudson St., New York, N. Y. Publishers are not responsible for lost manuscripts. Contributions cannot be returned unless authors remit full postage. **SHORT WAVE CRAFT** is for sale at all principal newsstands in the United States and Canada. European agents: Brentano’s, London and Paris. Printed in U. S. A. Make all subscription checks payable to Popular Book Corporation.

# OPPORTUNITIES *are many* for the Radio Trained Man



Don't spend your life slaving away in some dull, hopeless job! Don't be satisfied to work for a mere \$20 or \$30 a week. Let me show you how to get your start in Radio — the fastest-growing, biggest money-making game on earth.

## **Jobs Leading to Salaries of \$50 a Week and Up**

Prepare for jobs as Designer, Inspector and Tester—as Radio Salesman and in Service and Installation Work—as Operator or Manager of a Broadcasting Station—as Wireless Operator on a Ship or Airplane, or in Talking Picture or Sound Work—HUNDREDS OF OPPORTUNITIES for a real future in Radio!

## **Ten Weeks of Shop Training** **Pay Your Tuition After Graduation**

We don't teach by book study. We train you on a great outlay of Radio, Television and Sound equipment—on scores of modern Radio Receivers, huge Broadcasting equipment, the very latest and newest Television apparatus, Talking Picture and Sound Reproduction equipment, Code Practice equipment, etc. You don't need advanced education or previous experience. We give you — RIGHT HERE IN THE COYNE SHOPS — the actual practice and experience you'll need for your start in this great field. And because we cut out all useless theory and only give that which is necessary you get a practical training in 10 weeks.

# TELEVISION *and* TALKING PICTURES

And Television is already here! Soon there'll be a demand for THOUSANDS of TELEVISION EXPERTS! The man who learns Television now can have a great future in this great new field. Get in on the ground-floor of this amazing new Radio development! Come to COYNE and learn Television on the very latest, newest Television equipment. Talking Picture and Public Address Systems offer opportunities to the Trained Radio Man. Here is a great new Radio field just beginning to grow! Prepare NOW for these wonderful opportunities! Learn Radio Sound Work at COYNE on actual Talking Picture and Sound Reproduction equipment.

## **PAY FOR YOUR TRAINING** ***After You Graduate***

I am making an offer that no other school has dared to do. I'll take you here in my shops and give you this training and you pay your tuition after you have graduated. Two months after you complete my course you make your first payment, and then you have ten months to complete your payments. There are no strings to this offer. I know a lot of honest fellows haven't got a lot of money these days, but still want to prepare themselves for a real job so they won't have to worry about hard times or lay offs.

I've got enough confidence in these fellows and in my training to give them the training they need and pay me back after they have their training.

If you who read this advertisement are really interested in your future here is the chance of a life time. Mail the coupon today and I'll give you all the facts.

## **ALL PRACTICAL WORK** ***At COYNE in Chicago***

**ALL ACTUAL, PRACTICAL WORK.** You build radio sets, install and service them. You actually operate great Broadcasting equipment. You construct Television Receiving Sets and actually transmit your own Television programs over our mod-

ern Television equipment. You work on real Talking Picture machines and Sound equipment. You learn Wireless Operating on actual Code Practice apparatus. We don't waste time on useless theory. We give you the practical training you'll need—in 10 short, pleasant weeks.

## **MANY EARN WHILE LEARNING**

You get Free Employment Service for Life. And don't let lack of money stop you. Many of our students make all or a good part of their living expenses while going to school and if you should need this help just write to me. Coyne is 33 years old. Coyne Training is tested—proven beyond all doubt. You can find out everything absolutely free. Just mail coupon for my big free book!

**H. C. Lewis, Pres. RADIO DIVISION Founded 1899**  
**COYNE ELECTRICAL SCHOOL**

**500 S. Paulina St., Dept. 15-2K, Chicago, Ill.**

### ***Mail Coupon Today for All the Facts***

**H. C. LEWIS, President**  
**Radio Division, Coyne Electrical School**  
**500 S. Paulina St., Dept. 15 2K, Chicago, Ill.**

Dear Mr. Lewis:—Send me your Big Free Radio Book, and all details of your Special Offer, including your "Pay After Graduate" offer.

Name .....

Address .....

City..... State.....

Please mention SHORT WAVE CRAFT when writing advertisers



## PRESENTS A COMMUNICATIONS RECEIVER

With features you have always wanted and at  
a price you can afford to pay—\$69.50 complete.

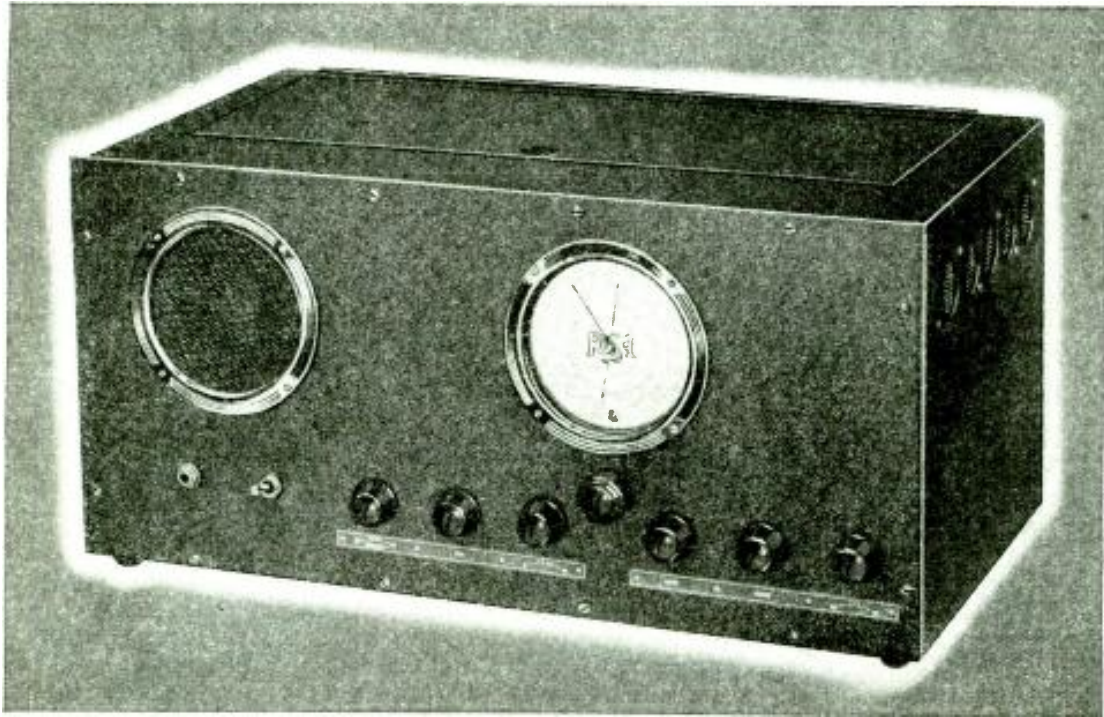

### THE ACR-136

The ACR-136 is a seven-tube superheterodyne receiver covering from 540 to 18,000 kilocycles. Pre-selection, A.V.C., front-panel band-switching, and a mechanical band-spread system with calibrated dial and vernier pointer which permit positive logging of any station, are outstanding features of this new amateur receiver. Both r-f and a-f gain controls are provided to permit unusual flexibility in controlling background noise. The tone

quality is exceptional for this type of receiver. These features plus excellent sensitivity and selectivity make the ACR-136 an outstanding value. ★ ★ The ACR-136 is supplied complete with tubes, speaker and power-supply (self-contained). There is nothing else to buy, yet the net price to the amateur is only \$69.50, f. o. b. factory. ★ ★ For more complete information and the name of your nearest amateur sales outlet handling the ACR-136, write to:

AMATEUR RADIO SECTION  
**RCA VICTOR COMPANY, INC.**  
CAMDEN, NEW JERSEY



## Needed Short-Wave Improvements

An Editorial By HUGO GERNSBACK

● SHORT WAVES, as all of us know, are still in their infancy, and much remains to be done, particularly when it comes to 100 percent perfect short-wave reception.

When broadcasting first started in 1920, broadcast reception was also bedeviled with many problems that made reception difficult and often impossible. Radio engineering in the succeeding years smoothed out a great many of the problems and today broadcast reception, while not as yet perfect, is rapidly becoming so.

In short waves, we have a parallel case to the early days of broadcasting, with the exception that the problems are somewhat different, because short waves have their own peculiarities which require entirely different treatment, and for that reason the solution of the problem must be different.

The most important improvement is, of course, the elimination of *man-made* static. This is the great "bug-a-boo" in short-wave reception today. Parasitic noises such as caused by electrical appliances in the building, passing cars and busses, electric motors, trolley cars, etc., all give rise to a noise level which often destroys or badly mars reception. While our new aerials, particularly of the transposition lead-in type, have done much to cure this trouble, still it is not the final word. As I have mentioned before, I still believe that the final solution lies in the vacuum tube, fitted with a special circuit to reject all of the "man-made" static.

Fading *compensation* is next on the list of improvements. While in the multi-tube sets we already have *automatic volume control*, which compensates to a great extent for the fading phenomena, still there is much that remains to be done in this field. On a poor day for reception, even a multi-tube set with automatic volume control does not solve the problem. It is thought by many radio authorities that we must have sets with far greater sensitivity than we have today and then automatic volume control will be more efficient than it is now. More sensitive tubes are coming out all the time, and in a few years it is conceivable that this phase of the problem will have been conquered too, even with sets having as low as three tubes.

This brings us to another point, also coupled with the above problem: There are days in which short-wave reception is exceedingly poor. We may have several weeks of excellent foreign reception followed by days where it is almost impossible to pick up foreign stations, even though they are on the air and going "full blast!" The reason for this is found in the upper layers of our atmosphere, the so-called Heaviside or Appleton layers, which seems to shift, due probably to "sunspot" activity. When this happens, it is as if the high frequency radio currents were "short-circuited" and very little energy, if any, reaches your receiving aerial. That means poor reception for that day and sometimes no reception at all.

Now, of course, the transmitting station engineers or operators know these things, or should know them. When a foreign government spends yearly millions of dollars to maintain their high-powered short-wave stations, they

should naturally be sufficiently interested to see to it that their emissions actually reach the ears of the far-distant listeners. If the reception falls off for certain days, the transmitting station should be informed by radiogram or cablegram immediately. The transmitter would then automatically put on higher power in order to cut through the barrier as far as this is possible. It may require the doubling of the power, always providing that the station has that much reserve power to apply. It is felt that most of them either have such reserve power or could get it in order to bridge the "poor" days when it became necessary.

Linked with the above, there is also another improvement or rather service which is badly needed. I term this, for want of a better name, "*Radio Intensity Maps*." During the past year or so, American readers have become interested in daily weather charts which most of the better newspapers print as a special service. The reader who studies these weather charts gets a pretty good idea what the weather will be during the next 24 to 48 hours.

Radio intensity maps could be printed on the same basis from information gathered by the various governments. Such "intensity" maps would be similar to the weather maps; they would show the prevailing condition of reception in our own country. Foreign countries will, of course, given similar service to their nationals. You would have then, for example, a map in the United States showing intensity lines giving in hundreds of degrees the radio reception to be expected in various parts of the country, and while there would be no high and low barometric regions on the radio intensity maps, there would be *highs* and *lows* for our "radio weather," if I may call it such. There would also be *isorads*, which would replace the *isobars* which are now used on weather maps. *Isorads* are lines running through different localities having the same reception intensity in percentages. For instance, excellent reception in New York, Chicago, and Denver would be linked by an *isorad* line 100. Poor radio reception for a section such as Washington, Atlanta, and Miami, would be marked with 10 on the *Isorads* line. It would be no trick at all for the newspapers to get up such daily radio intensity charts, and the short-wave listeners would get a service which is sorely needed today.

Another needed improvement, particularly for the sets in use by the public, is *automatic bandspread*. At the present time a number of sets are made which have such bandspread arrangements, but they require an extra manual control to switch the bandspread feature into operation. It is felt that an *automatic* control could be incorporated into every set in order to bandspread *continuously*. This is particularly important today, because the public has not as yet become accustomed to the fine tuning necessary in short waves. By continuous automatic bandspreading, the tuning will, of course, not be nearly as fine, and the public will become better educated to the thrills of short-wave reception, programs from overseas, speeches and lectures by famous old-world experts, etc.

---

**SHORT WAVE CRAFT IS PUBLISHED ON THE 1st OF EVERY MONTH**

This is the January, 1935, Issue—Vol. V, No. 9. The Next Issue Comes Out January 1

---

Editorial and Advertising Offices, 99-101 Hudson Street, New York City

# Ultra Short Waves Extend Land Telephone Lines

By F. F. MERRIAM\*

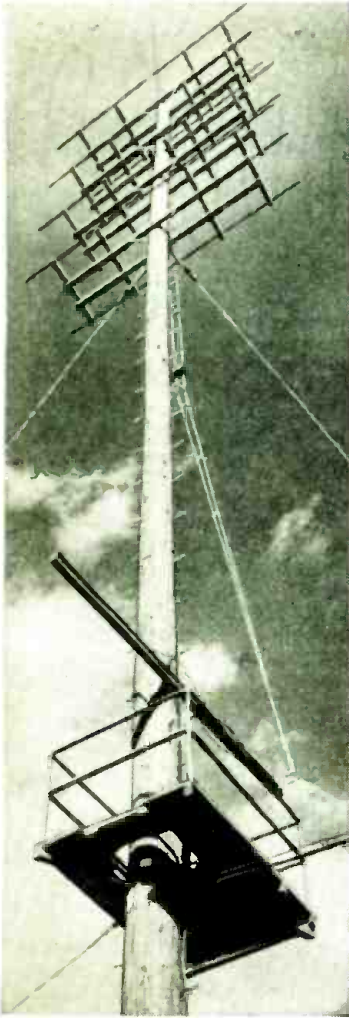

One of the 4.7 meter antenna masts at Green Harbor, Mass.

A practical test of 4.7 meter waves over a distance of 25 miles is now being carried out daily between Green Harbor and Provincetown, Mass., across Cape Cod Bay. The engineers of the Bell Labs., developed the automatic 4.7 meter apparatus here described.

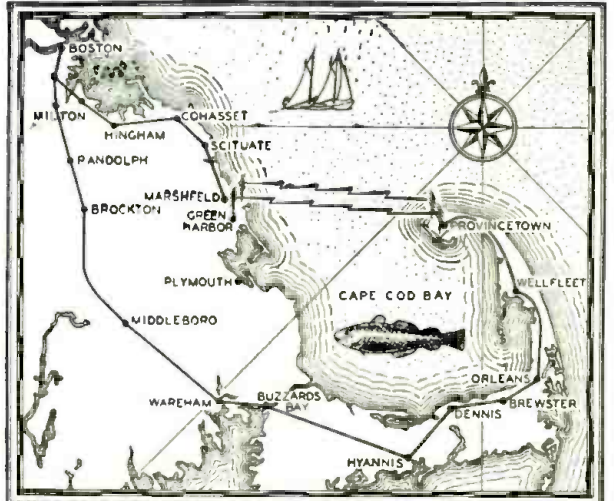

Map showing the 25 mile "over-water" gap bridged for daily telephone service by 4.7 meter waves between Green Harbor and Provincetown.

● FOLLOWING the commercial application of short waves to transoceanic telephony in 1928 and 1929, attention was directed by Bell Telephone Laboratories toward determining the properties and usefulness of ultra-short waves. The short-wave transoceanic circuits are operated at frequencies between 5 and 21 megacycles while the ultra-short waves are at frequencies above 30 megacycles, which is generally taken as the upper limit of the short wave range. It had previously been discovered that these higher frequencies were not in general reflected from the Kennelly-Heaviside layer. They were, therefore, considered primarily suitable for short-distance communication, where the waves followed essentially an optical or straight-line path from the transmitter to the receiver. In the telephone plant there are instances where natural barriers so separate points only a short distance apart that it is difficult and expensive to construct ordinary telephone lines or submarine cables to connect them. It seemed that for such conditions ultra-short wave radio extensions might be a satisfactory means of giving telephone communication. To be economically feasible, however, such radio circuits must be inexpensive both in first cost and in operation.

During the last few years, the Laboratories have been experimenting with an ultra-short wave circuit between Deal and Holmdel, N.J., with the thought of developing equipment capable of unattended operation. Some time ago this development reached the stage where it seemed desirable to carry out a trial of a two-way circuit under conditions approximating commercial use to gain experience with the problems involved in regular operation. In particular, it was desired to design and install the radio stations for operation without direct attendance, so that the apparatus could be located remotely from a central office.

After a study of possible locations, it was decided in cooperation with the New England Telephone and Telegraph Company to carry out the trial installation across Cape Cod Bay, between Green Harbor and Provincetown, Mass. The coastal station of the New England Telephone and Telegraph Company, already existing at Green Harbor, made a convenient place in which to install one end of the system. The physical conditions are also favorable for an ultra-short wave link between that point and Provincetown, 25 miles away. The sand dunes near Provincetown, rising about 100 feet in height,

(Continued on page 553)

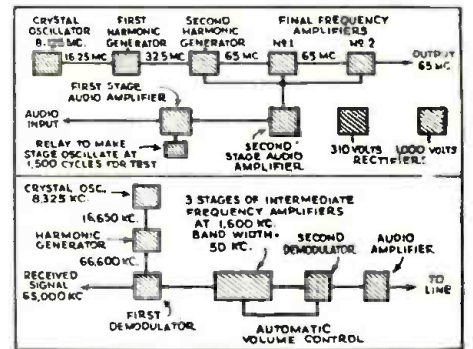

Fig. 1—block schematic of ultra short-wave transmitter; Fig. 2—schematic of ultra short-wave receiver.

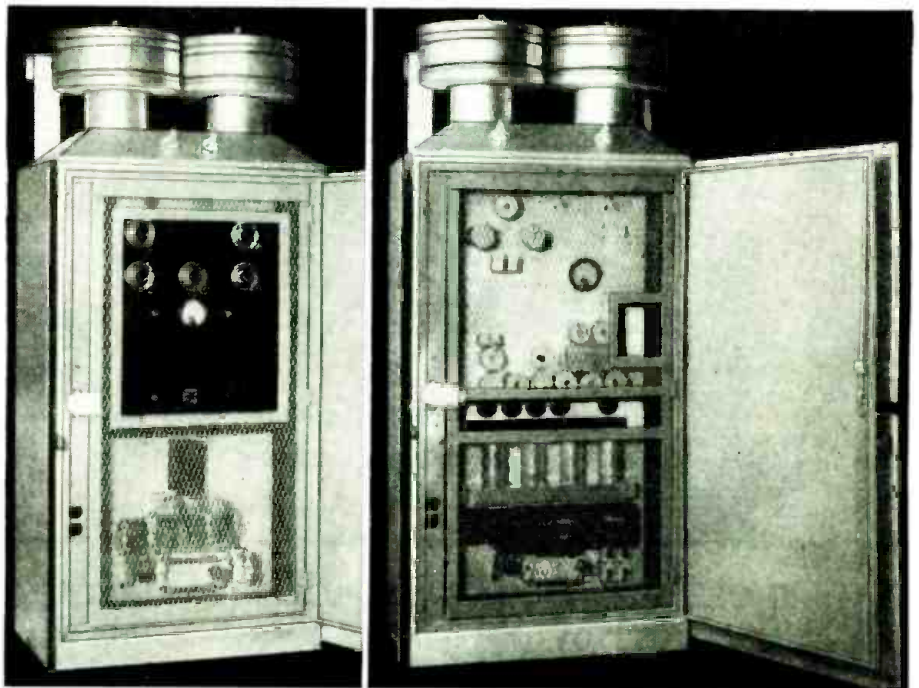

Fig. 4, left, shows 4.7 meter Receiver mounted in metal container suitable for pole mounting and fitted with safety provisions to prevent maintenance experts from getting a high voltage shock; Fig. 3 right, shows 4.7 meter Transmitter also arranged for pole mounting.

Photos courtesy Bell Tel. Lab.

\*Radio Research, Bell Telephone Laboratories.



# They Are TELEVISIONING IN Berlin!

While practical public television is fast asleep in this country, the German and other European television experimenters have been forging ahead, and the accompanying illustrations and discussion give some new light on what we "might have done"!

**By H. WINFIELD SECOR**

From data supplied by our German Correspondent

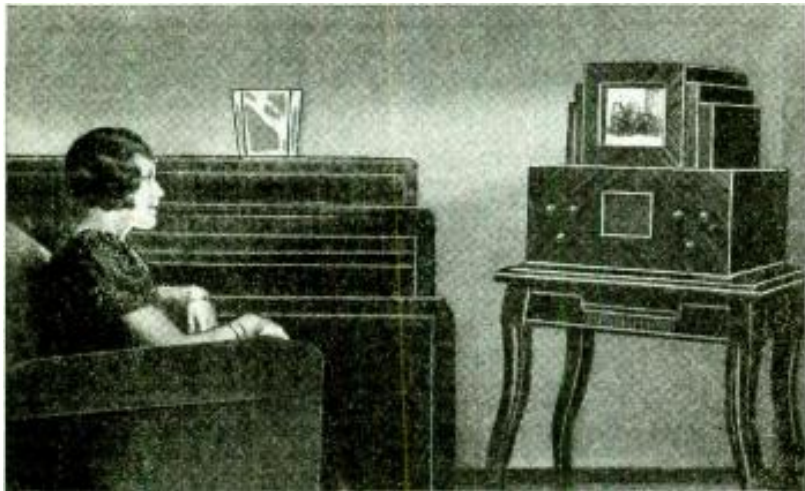

Here we see the latest manufactured model of combination voice and image television receiver in use in Germany. This is the Loewe apparatus.

● TELEVISION has been making fast strides in Germany, and several other European countries, including England and France. Practical everyday television in America has, sad to relate, almost gone backward instead of forward and it is a pity that American radio experimenters and the public at large have been for the past two years, and still are, without television except for a few stations which are bravely broadcasting a few programs here and there across the country. All we hear in this country is that the laboratory images are wonderful, but it is too bad that we could not have kept up the momentum in television broadcasting that we had a couple of years ago.

The photos on this page just go to show what can be done—this is the latest Loewe television apparatus developed and perfected in Germany. This apparatus is being manufactured in quantity and it not only reproduces the moving television image on the

screen of the receiver, but the "sound" as well! The tuner is incorporated in the lower part of the cabinet as well as the control knobs for the framing of the image and the modulation of the cathode ray or Braun tube.

This excellent television apparatus was exhibited at the last radio exposition in Germany. The images were very fine indeed, the improved detail being due to the use of as high as 180 lines per inch in the scanning. The wave length used for transmitting the television images in Berlin is 6.92 meters or a frequency of 42,900 kc. The next step will be the use of microwaves, having a length of one centimeter up to one meter possibly. The German *Reichspost* in connection with the Reichs Broadcasting Company have decided to carry out several elaborate television experiments through the coming months, and to aid in making these experiments, the television image "pick-up" car here shown was

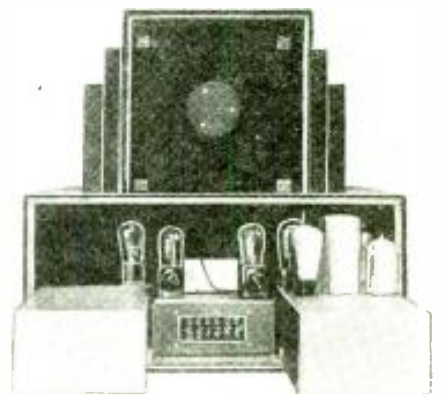
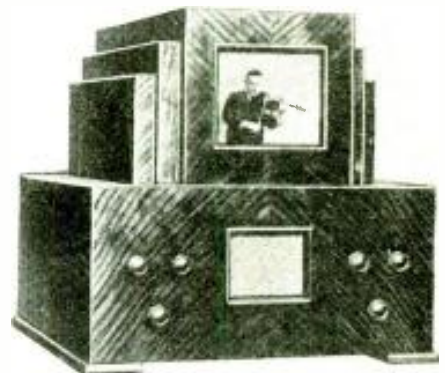

Top photo—front view of the combined "image and sound" television receiver for the Home. Center—rear view of the Loewe "home" televisor, and lower photo the cathode-ray or Braun tube used to reconstruct the image.

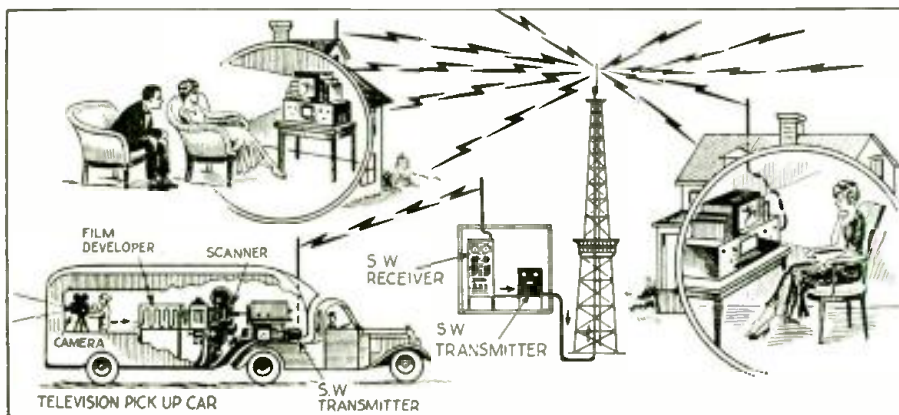

The newest German television system, whereby scenes are photographed from the "pick-up" camera truck here shown, the "talkie" movie film developed in one minute, flashed by short waves to the television broadcast station and picked up in theater or home on short waves also.

# Short Waves Reduce POISON IN ASPIC VIPER'S VENOM

By DR. MARIE PHISALIX and DR. COLONEL FRANCOIS PASTEUR\*



Dr. Delmar Nicholson of Orlando, Fla., who makes a specialty of removing the poison from rattlesnakes to be used for treatment of spinal meningitis. He is here shown removing the poison from a 6-foot specimen of the dangerous rattler—the Florida diamondback.

● The poisonous effect of the venom of the Aspic viper was greatly reduced by subjecting the venom to a high frequency oscillating field. The various experiments carried out by the two French savants are here described and undoubtedly these experiments, in the editor's opinion, will lead to a successful method of treating persons infected with snake venom with high frequency oscillations.

● IN earlier experiments we showed the action of various types of radiation on the venom of the *Aspic Viper*. The recent entry of short waves into the field of general therapeutics encouraged us to try their action also on this venom.

The technique of the researches we undertook can be understood from the following statement of our experimental conditions:

The solution of venom (10 in 1000) in saline (salt) solution, to the total quantity of 50 cubic centimeters was placed in a conical Erlenmeyer flask made of pyrex glass, having a total capacity of 100 cubic centimeters and a flat base 55 millimeters in diameter. It was suspended to avoid all propagation of the waves by direct contact, and corked to prevent evaporation and heat radiation, with an electrode of spherical base, 20 centimeters in diameter on either side. One cubic centimeter of this solution is sufficient to kill a mouse of 20 grams weight, following subcutaneous inoculation. The initial and exterior temperature of the liquid was 22 degrees; in the course of the experiments this temperature mounted to between 37.5 and 38 degrees no matter what the duration of the exposure, but the last represents an extreme figure beyond which it never rose.

Therefore the modifications in the chemical structure can be attributed solely to the electrical action of the short waves.

The power-head between the electrodes, which were sometimes 15 and sometimes 30 centimeters apart, was constant at 25 watts. The wave-length was fixed at 20 meters, thus corresponding to a frequency of the order of 15 million cycles per second.

EXPERIMENT 1—Length of exposure, 15 minutes: distance of the

Two of them weighed 23 and 19 grams; both died 1 hour 30 minutes after injection; the third, weighing 19 grams, died after 5 hours. Unirradiated solutions produce death for mice of this type after 6 hours normally. The toxicity of the venom thus seems to have grown, and the succeeding experiments show the reason.

EXPERIMENT 2—Length of exposure, 30 minutes; distance of the electrodes, 30 cm. (12 inches); dose inoculated 1.1 cc. (cc=cubic centimeter.)

Four mice were inoculated with the irradiated solution, all weighing 23 grams each. Two of them died after 3 hours, the third after 7 hours, and

electrodes, 30 cm.; dose inoculated 1 cc.

the fourth in slightly less than 12 hours.

Two control mice were inoculated with unirradiated venom. One died after a period greater than 12 hours, the other resisted the venom, and moreover was vaccinated by it, for 6 days later he resisted a dosage of 1.1 cc. of pure venom, a dose infallibly fatal to a fresh animal. Thus the irradiation had had no effect on the venom.

EXPERIMENT 3—Length of exposure, 15 minutes; distance of the electrodes, 30 cm.; then another exposure of 45 minutes; distance of the electrodes 15 cm, dose injected 1 cc.

Three male mice were used. One, weighing 20 grams died after 20 hours; the two others, which weighed 19 grams each, died after 7 and 8 hours respectively. The control mice died after 5 and 6 hours respectively.

(Continued on page 573)

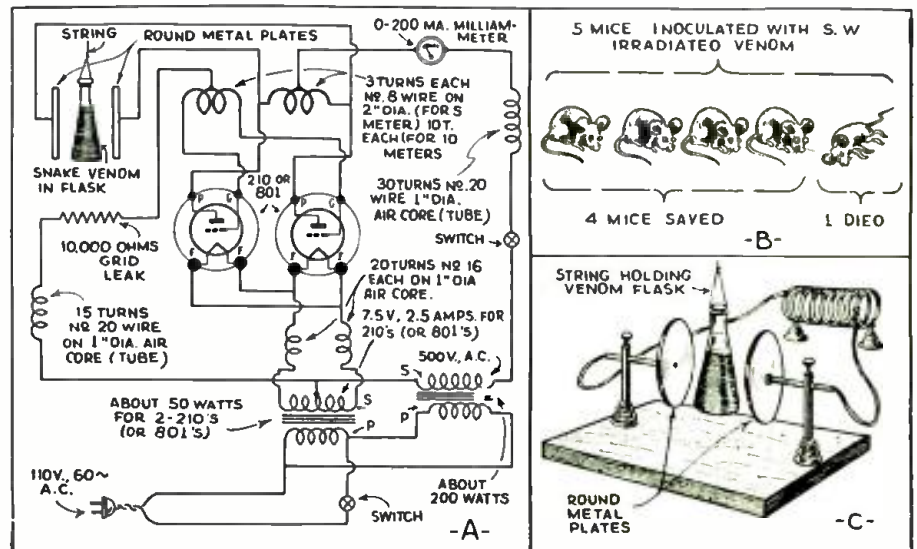

Above: Hook-up of high frequency oscillator similar to one used for such experiments as those described. Right: In one test 4 out of 5 mice were saved and only 1 died, after being inoculated with "irradiated" snake venom. Venom is treated by suspending between 2 discs connected to high frequency oscillator.

\*See also the Academy of Sciences (French), proceedings: Vol. 199, No. 3, July 18, 1931, page 235.

# COLD CATHODE Tube Demonstrated!

## Has No Filament or Grid

● MR. P. T. FARNSWORTH, of television fame, has displayed his genius by inventing a cold cathode tube. The new tube has no filament or grid and is one of the outstanding tube developments so far to take place in the radio industry. The tube consists of two cathodes and a ring-anode sealed in an evacuated glass envelope. It can be used as a detector, modulator, or oscillator, and has tremendous possibilities. It can be made to generate oscillations over a frequency range from 2000 kc. to 60 mc., the limits of which only depend on the dimensions of the tuned circuits and it has a power output of approximately 25 watts with 35 watts input. At a recent demonstration, one of these new tubes was used to maintain communication between San Francisco and Honolulu, and between New York and San Francisco, on approximately 35 meters. On this test, the cold cathode tube was used to drive a pair of 150 watt tubes in the final amplifier of a transmitter. With 1100 volts, at 30 milliamperes, on the anode, ample excitation for the two 150-watt tubes was obtained. The cathodes of these new tubes are coated with Caesium silver oxide to facilitate secondary emission. A large solenoid is placed around the tube and supplied with direct current in order to maintain an intense magnetic field which envelopes the tube. When used as an amplifier a high frequency voltage should be applied to the cathode terminals and a DC voltage should be applied to the anode, to hold it at a positive potential with respect to the cathodes. In this case, the cathodes are shunted with a coil and variable condenser in parallel. This tuned circuit, of course, should resonate at the frequency of the applied high frequency voltage. The longitudinal magnetic field prevents any flow of free electrons in the inter-electrode space from being drawn to the anode. The high frequency (Continued on page 555)



Ralph M. Heintz (center) explains the operation of the Farnsworth Cold Cathode Tube to Bernard H. Linden (left), U. S. Radio Inspector, and Donald Lippincott (right), director of Television Laboratories, Inc.

## Over Mountains on 5 Meters!

● THE old question of whether or not communication on ultra high frequencies can be held between stations located in mountainous areas seems to have taken a backward step within the last few months. Scientists have claimed that ultra high frequencies are more or less quasi-optical—that is, the transmitting and receiving stations must be in optical sight of each other. Recently Dr. Marconi in an interview with the editors, stated that he had been successful in getting through mountainous areas on the ultra high frequencies but that he was unable to state whether or not the signals went *over* or *through* the mountains until further tests had been made. In the drawings, we have endeavored to show the readers the condition which exists between three stations namely portable W3AC at High Point Park, N.J., W2HBW at Walden, New York, and W2AMN (Continued on page 558)

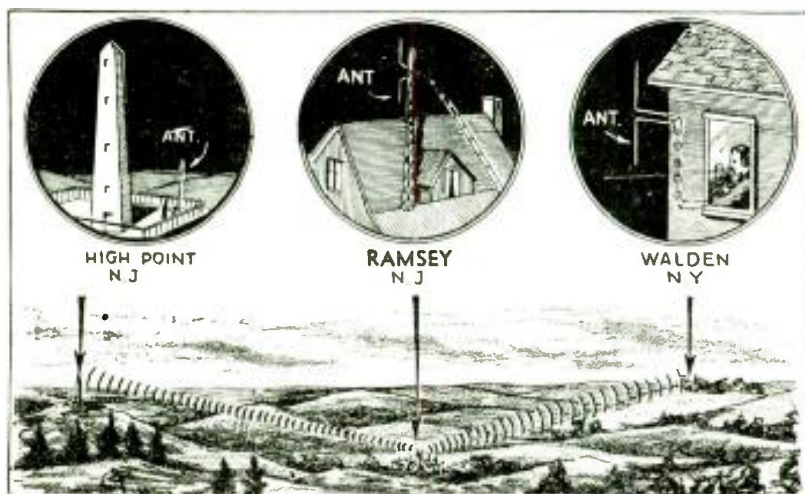

Remarkable distances, considering the intervening mountainous country, have been covered on the 5-meter band as shown in the accompanying picture.

## Automatic Band-Spread!

● WHAT practically every All-Wave receiver needs today is some form of *band-spread*, especially when trying to separate the stations in the badly crowded 49-meter band, which carries quite a number of American, as well as European short-

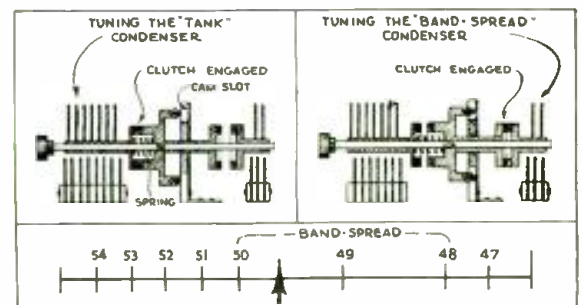

We predict that tomorrow practically every All-Wave receiver will have some form of "automatic band-spread" to simplify tuning on such crowded bands as the 49 meter

wave broadcast programs. Hugo Gernsback, the editor of this magazine, has conceived a very ingenious arrangement of *automatic band-spread*, which we dare say will be found on practically every *all-wave* set tomorrow, in some form or other. As the diagram shows it would be a very simple matter to adapt Mr. Gernsback's idea to any receiver so that when the main tuning knob is turned and the indicator is on the 49-meter band, for example a cam-operated clutch attached to the main tuning shaft disconnects the "tank" condenser and connects a *band-spread* condenser in its place. The ap- (Continued on page 558)



# "Economy 2" Battery

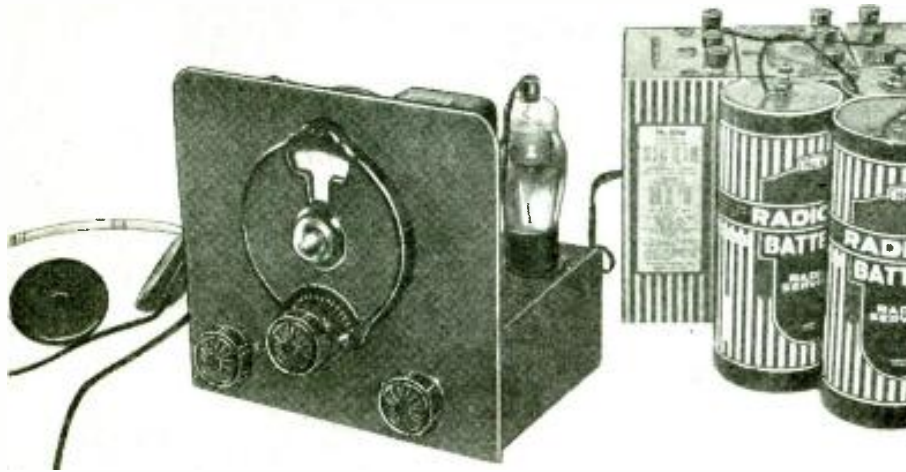

Above—is the general view showing the "Economy-2" together with the necessary batteries. Note the extremely neat appearance of this set.

● SHORT WAVE "fans," step right up! Here is the short-wave battery set you have been waiting for! It has all the "earmarks" of a set using the A.C. operated tubes, but works efficiently on dry cells! It makes use of the new type 15 tube, which has an indirectly heated cathode and allows the use, at last, of efficient electron-coupled circuits with battery tubes.

● THE fellows in the rural districts where there is no electric power supply, at last have an excellent chance to construct a receiving set with all the "earmarks" of an electrified 110 volt outfit. This is made possible by the introduction of the new Sylvania type 15 screen-grid pentode. It is a modern tube, designed to work from a two volt battery supply with moderately low current drain (.22 ampere). Its greatest feature of course is the *indirectly heated cathode*. This makes possible the construction of a set that has *no microphonic tube noises!* The tube has an amplification factor of 600 with 135 volts on the plate!

As a regenerative detector or oscillator the tube performs equally as good as most of the others which work on higher heater voltages. The input (grid to cathode) capacity is only 2.35 mmf. rendering it better suited for high and ultra high frequency work than many other types of screen-grid tubes. The set herein described uses two of these tubes, one as a *regenerative detector* and the other as a *triode audio amplifier*.

The detector is connected up in the usual manner, but the audio differs somewhat from the usual run of circuits. The 15 type tube could not be used satisfactorily in the audio stage as a pentode, because of its high plate impedance and the fact that we must connect the earphones in its plate circuit in this particular receiver. To get around this we have connected it up as a triode by connecting the screen-grid directly to the plate. The suppressor of course cannot be connected to the plate because it is already connected to the cathode inside the tube. Bias is obtained, in the usual manner, by inserting a resistor in the cathode circuit.

With this new tube we can use some of the well-known electron-coupled circuits in a much simpler manner. There is a wonderful opportunity for the "battery set" constructor and many new ideas will undoubtedly be presented in the near future.

### 3 Dry Cells Run 2 Tubes

The heater current of the 15 is .22 ampere and while this is considerably higher than the average battery-operated tube, it can be worked out very nicely by simply connecting the heaters in series. In using dry batteries we find that they will give better and more economical service when the current drain is low. When we connect these tubes in series, we have to increase the voltage; however the current requirements remain the same. (.22 ampere.) For two tubes the voltage required is 4 and for three tubes the voltage is 6. A three tube set could be run very economically with four dry cells.

The various values used in the detector circuit are nearly the same as in any regenerative set. The grid condenser is a .0001 mf. affair and best results were obtained with a three megohm resistor for the grid-leak. Plug-in coils are used for convenience and are the new Hammarlund type wound on ribbed "XP-53" forms and cover a range of from 17 to 270 meters. Only two windings are used, one for the

*tickler* and one for the *grid coil*. The tuning condenser has a capacity of 140 mmf.; for band-spread another small condenser having a capacity of 35 mmf. can be shunted in parallel with the larger condenser and serves to effect *band-spread*; the large condenser will then be used to adjust the range of the smaller one.

### Regeneration Control

The antenna is connected directly to the grid of the detector through a small Hammarlund variable padding condenser, having a capacity of 25 mmf. This condenser is mounted directly on the front panel for convenience and after once set for a given antenna needs little attention. Regeneration is controlled by a potentiometer connected in the screen-grid circuit of the 15 detector and gives very smooth control of feed-back. If the builder does not wish to use this method it can be arranged so that the plate condenser is variable instead of a fixed affair and regeneration controlled by varying the capacity. In this case the potentiometer is not necessary. The screen-grid lead is connected directly to the 22.5 volt terminal of the "B" battery.

Having a very high plate impedance the 15 tube when used as a detector requires either resistance or impedance coupling to the audio stage. In this set we use a National *impediformer*. However a 250,000 ohm resistor could be used but with considerably less volume.

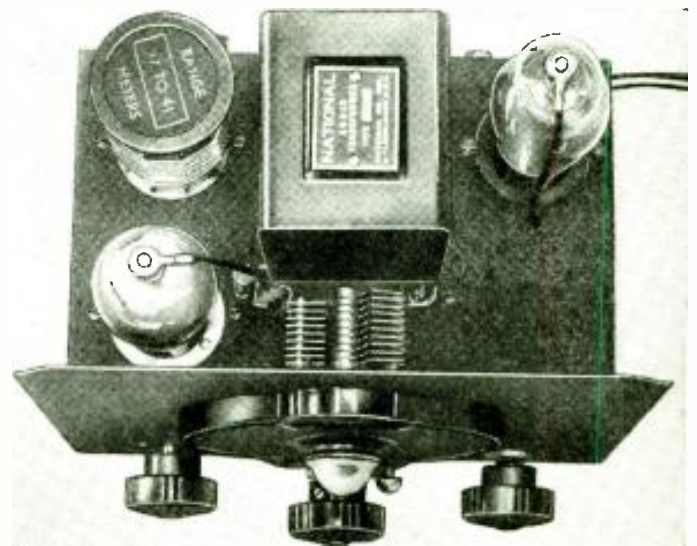

Above we have the top view, showing the arrangement of parts used in the battery operated "Economy-2."

# Receiver

In the plate circuit of the 15 detector we have a radio frequency filter consisting of two fixed condensers and an r.f. choke. Two .0005 mf. condensers and a 2.5 mh. choke are used. This eliminates considerable trouble in that the R.F. currents are kept out of the audio system and a more stable set will be the result.

The audio component in the plate of the detector is fed into the audio amplifier through the .1 mf. audio coupling condenser. The grid of the audio amplifier is returned to the "B" negative through the one-half megohm grid-leak.

This set requires 4 volts for the heater supply and is run off three dry cells. This gives 4.5 volts for the two tubes or 2.25 volts for each. This, while higher than recommended, seems to have no ill effects on the life of the

Right—We have the diagrams, both schematic and physical, of the "Economy-2," using type 15 tubes.

tube. If the reader wishes to be more exact it is recommended that he use a 6 ohm variable rheostat in order that proper voltage may be obtained.

### Placement of Controls

Looking at the front of the receiver we find that the main tuning dial is in the center of the panel and the antenna trimmer is located on the left-hand side. On the right-hand side is the regeneration-control potentiometer. In the rear view the tube nearest the coil is the detector tube. The coupling choke is located between the two tubes. If one wishes to operate the heaters of (Continued on page 567)

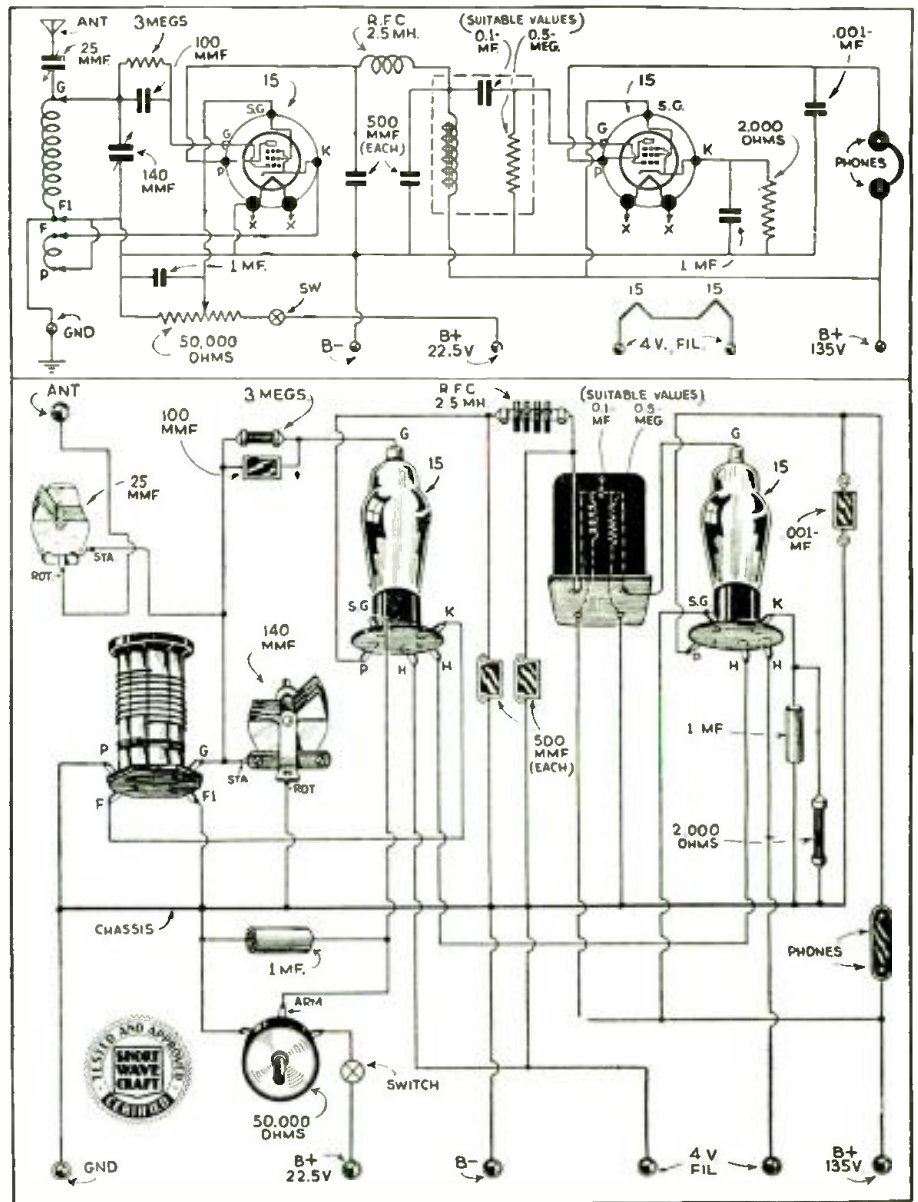

## Coupling Doublet Aerial to Untuned R.F. Set

● Here is an interesting short-wave kink. It is a device to couple a transposed antenna to an untuned R.F. set. It consists of a wooden thread spool 1 3/8" x 1 3/4", boiled in paraffin, with a 1/4" deep groove cut in the center (a wooden dowel may be substituted for the spool). In this groove 200 turns of No. 34 wire is wound in "jumble" (i.e., helter-skelter) fashion. This coil is the choke of the R.F. stage. It must be small in diameter so it will not tune the R.F. tube to a certain frequency. Over this winding a layer of insulating paper is wound. Over this 50 turns of No. 28 wire is wound, layer fashion, for a length of one inch. This coil is the antenna coil. The antenna is inductively coupled to the receiver by these two coils. Two Fahnestock spring clips are screwed to each end of the spool and the four leads of the two coils are respectively connected. A single layer of tape is then wound around the spool to give it a "commercial" appearance.

The antenna coupling resistors I used with this device were two flashlight battery carbons, pointed at each end and held in an old resistor block with the brass straps underneath re-

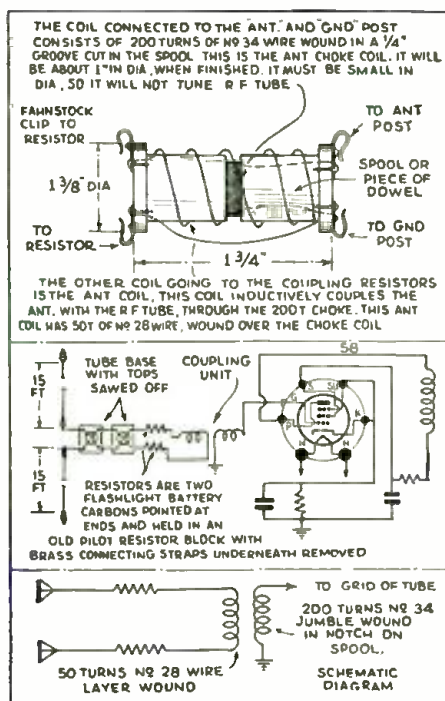

moved. The regular choke or resistor in the set is removed and the secondary of the coupler connected to the antenna and ground posts, or it can be built into the receiver.

Of course, there is little use of using a special coupler and its associated equipment if a good job is not done in constructing and erecting the antenna. In noise reducing antennas it is absolutely necessary to mount the an-

Left—complete group of drawings showing the construction and connections of the doublet antenna "coupler."

tenna as far away as possible from all sources of noise. This means that the lead-in will have to be extremely long in most cases. Two sections of the flat top in the antenna can be 15, 30, or 50 feet long each. Use enameled wire, either stranded or solid, preferably No. 12 gauge. The feeders can either be transposed with transposition blocks having one and one-half to two inch centers or can consist of any of the present day high frequency cables which (Continued on page 569)

# The SHORT-WAVE FAN'S

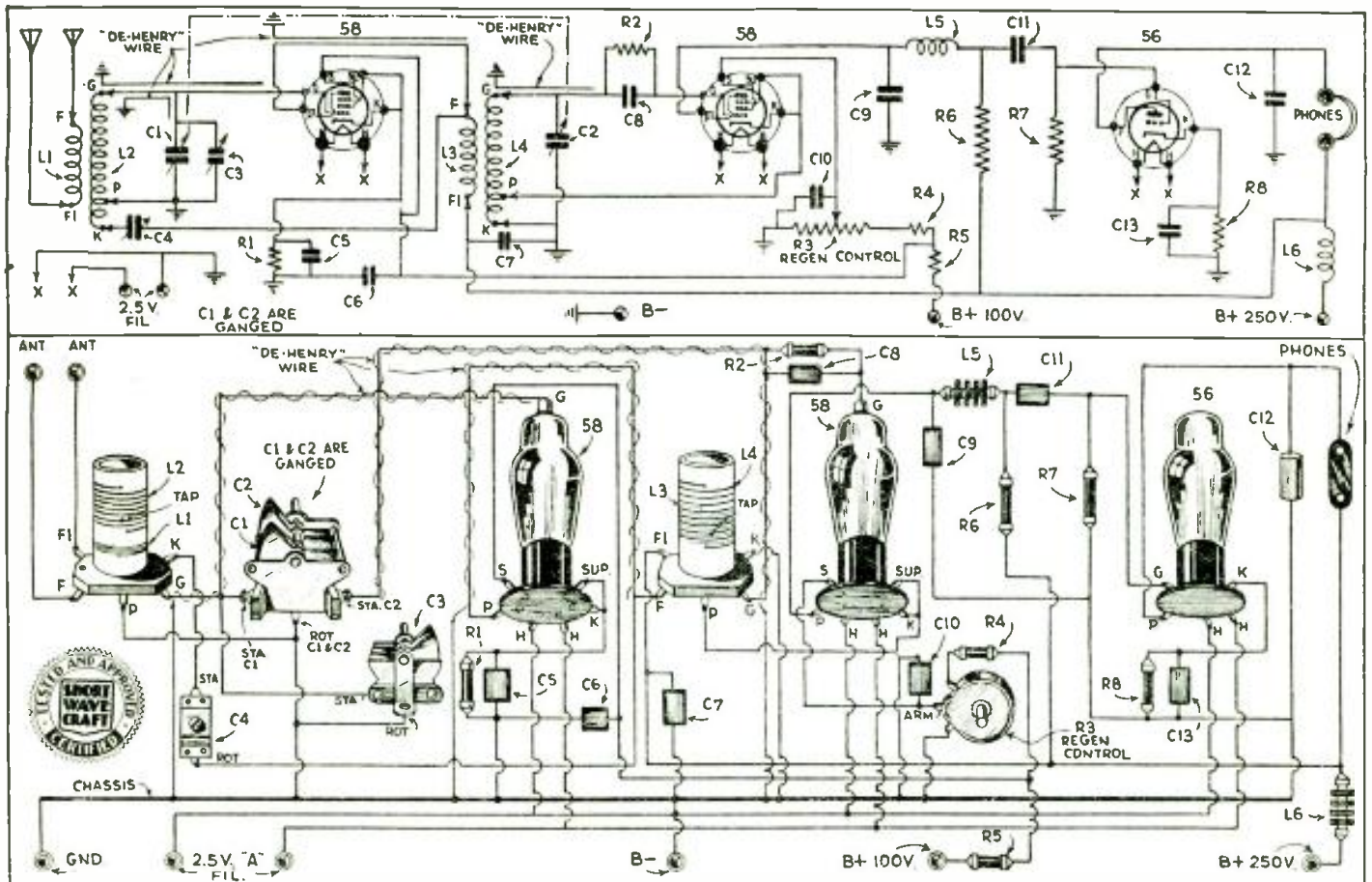

Although you may never have built a short-wave receiver, you will have no difficulty in building this smooth-working, extremely easy tuning Short-Wave Fans' "DX-ER" here described by Mr. Worcester, famous designer of the Oscillodyne, and many other sets previously described in this magazine. Both schematic and picture wiring diagrams are here presented.

● PERHAPS the most puzzling question confronting the S.W. enthusiast is that of the best type of receiver to build. The three types of receivers finding the most appeal at present are the simple regenerative receiver, the tuned R.F. regenerative receiver, and the superheterodyne. This latter circuit has the advantage over the other two as regards selectivity, but has the disadvantages of high cost and complicated construction. Aside from these disadvantages is the undesirable phenomenon of repeat points or image interference which is inherent in a superheterodyne circuit and can only be eliminated by employing a signal frequency preselection amplifier at a still further increase in the cost and involved construction. The simple regenerative receiver, on the other hand, has the advantage of extreme simplicity and low cost and is capable of receiving any signal that can be picked up on the much more complicated superheterodyne, providing that there is not too much adjacent channel interference.

The remarkable efficiency of the regenerative receiver is due to the combination of the regenerative action, which effectively reduces the losses in the tuned input circuit to zero, and the high resistance grid leak-condenser combination, which provides a type of amplification in itself, by permitting the mean grid potential to vary with the signal due to the blocking action produced. The main disadvantages of this circuit are the extremely critical regeneration control and the phenomenon of "dead-spots" produced at intervals in the tuning range by *antenna resonance*. This latter difficulty can be overcome by employing an untuned R.F. amplifier stage. The over-all efficiency of the receiver is adversely affected by this procedure, however, due to the fact that the untuned amplifier actually acts as a "losser" at the higher frequencies, such as those employed for short-wave broadcast transmission.

## Overcoming Disadvantages of Simple Regen. Set

The tuned R.F. regenerative receiver overcomes both of

the disadvantages of the simple regenerative set by impressing a stronger signal upon the grid of the detector, and further by isolating the *high-gain* detector circuit from the antenna system. The addition of a tuned R.F. stage introduces some complication in that rather extensive shielding of the two circuits is necessary if interlocking of controls and possible oscillation are to be eliminated. Obviously, an additional tuning condenser, set of plug-in coils, tube, and trimming condenser are also required. In the past, it has not generally been found possible to obtain sufficient gain in the R.F. amplifier to warrant the installation of the above additional apparatus, with the consequent increase in cost of the completed receiver and attendant constructional difficulties. While a voltage gain of 200 is possible in an R.F. amplifier stage at a frequency of 465 kc., and a gain of 50 or more easily obtained throughout the broadcast band, it is not ordinarily possible to exceed a gain of 5 or 10 at the frequencies used for S.W. broadcast transmission.

For some time the writer has been interested in the problem of increasing the "gain" in a short-wave R.F. amplifier stage and has incorporated his findings in this connection in the receiver to be described in this article. Two main reasons were found for the marked decrease in amplification at the S.W.B.C. frequencies and satisfactory methods of eliminating same were evolved. The first and most obvious difficulty experienced on the short waves was the much poorer L/C ratio existing when the conventional 100 or 140 mmf. tuning condenser were employed. The smaller the ratio of inductance to capacity in the tuned circuits the smaller is the voltage developed across the same at resonance. Of course, this voltage also depends on the series resistance of the tuned circuit and consequently this latter quantity should be reduced to as low a value as possible. In this receiver, the L/C ratio is increased by employing tuning condensers having a maximum capacity of only 25 mmf. Separate plug-in coils

# "DX-ER"

By J. A. WORCESTER, JR.

THIS MONTH'S \$20.00 PRIZE WINNER



● This set was designed especially for the 19, 25, 30 and 49 meter short-wave broadcast bands. Among the new features—this set spreads the stations over the dial for easy tuning; lead inductance loss is reduced to a minimum; detector is electron-coupled; R.F. stage is neutralized; "doublet" aerial is used; improved signal strength provided by high L-C ratio, due to using low-capacity tuning condensers.

are then provided to cover the 19, 25, 30, and 49 meter broadcast bands. Another advantage resulting from the use of a small tuning capacity is the greatly increased station separation on the dial, which reduces the congestion usually experienced on the shorter waves and obviates the necessity of providing a band-spreading arrangement. The series circuit resistance is reduced by employing isolantite coil forms and by spacing the turns. Resistance introduced by the variable condensers is minimized by employing a low-loss unit in which dielectric losses are greatly reduced by employing "mycalex" insulation.

### Precautions Necessary to Eliminate Losses

In spite of the above precautions it will be found that results still fall far below the value theoretically possible. A careful study of this situation revealed that this state of affairs was largely due to the characteristic impedance of the wiring itself. Although it may appear that the amount of wire carrying R.F. does not amount to much as far as actual length is concerned, it should be remembered that 6 inches of wire at the frequencies employed in S.W. broadcasting is equivalent to one mile of wire used to transmit voice frequencies. Hence, it will be appreciated that in an electrical sense we are dealing with *fairly long lines* and the distributed constants of the same will have to be taken into consideration. Any electrically *long line* having distributed constants has what is known as a *characteristic impedance*. This impedance depends on the value of the various constants and more particularly on the



As will be seen from this picture the various units comprising Mr. Worcester's latest receiver are well isolated by proper shielding. This set will enable you to enjoy the daily "musical" and other programs broadcast by "World-Wide" short-wave stations on the 19, 25, 30, and 49 meter bands.

*distributed inductance and capacitance.* If we assume for the sake of illustration that the *characteristic impedance* of the lead connecting the plate of the R.F. amplifier tube to the primary winding of the R.F. transformer has a characteristic impedance of 25,000 ohms, it is apparent that even if we increase the shunt impedance of the tuned output circuit to infinity, which can be approximated by the critical application of regeneration, the actual plate load *as the plate sees it*, is only slightly greater than the characteristic impedance.

If the lead in question were several wavelengths long, then the plate load would be determined entirely by the characteristic impedance of the wire and would be entirely independent of the plate load. As it is, the effect of the plate lead is to decrease the impedance of the circuit at resonance. The above discussion applies equally in the case of the grid leads and leads connecting the secondary inductances to the variable condensers.

### "De-Henried" Wiring

In this receiver the above discussed effects were eliminated by employing what for convenience's sake will be called *de-henried* wiring. The purpose of this construction is to reduce the inductance of the leads carrying R.F. current to a negligibly (Continued on page 549)

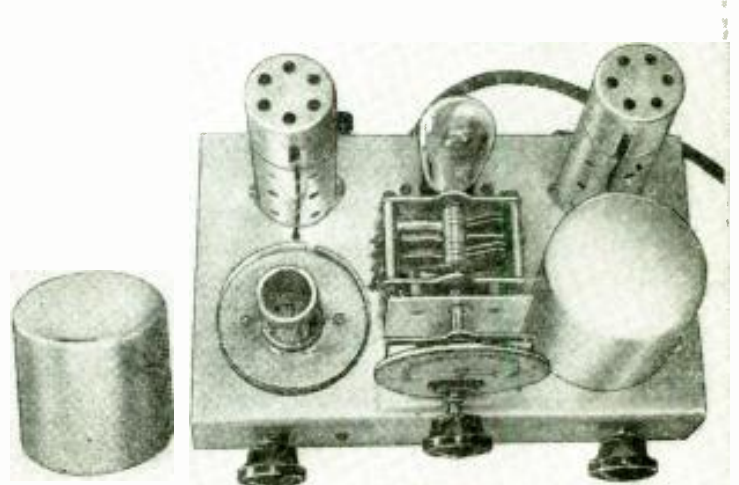
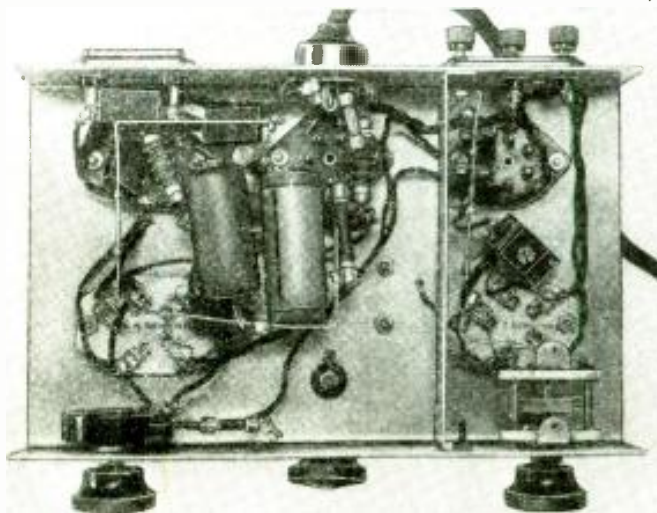

The two photos above show bottom and front views of the Short-Wave Broadcast Fan's "DX-ER." It employs but 3 tubes and operates from the 110 volt A.C. circuit. The plate supply can be from B-batteries, B-eliminator, or power-pack.

# 5-Meter SUPER-HET

By George W. Stuart, W2AMN.

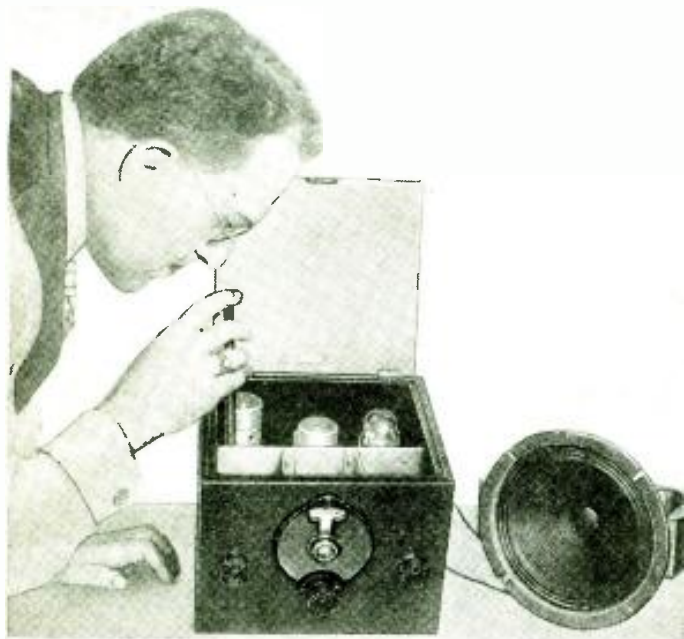

Above we have the general view of the compact, ultra-high-frequency superheterodyne.

● SUPERHETERODYNE receivers have become the "by-word" in radio reception on all wave lengths above 10 meters. It has been proved to everyone's satisfaction that a *superhet* is far superior to any other kind of receiver. That is, providing it is *well designed!* However on the ultra high frequencies the superhet has never become very popular; this is due to several well-known facts. First—most of the amateur transmitters operating on the higher frequencies are of the modulated oscillator type and are consequently very unstable because of the high degree of frequency modulation. And—frequency modulation and superhets don't agree!

Second—it has been, up to the present time, very difficult to obtain tubes for the high frequency portion of the superhet that were suitable. Third—the background noise such as power-leaks, automobile ignition and general QRM caused by hundreds of electrically operated devices are amplified to a very great extent on a receiver using double detection and more or less override the desired signal.

All but the last of the above can be overcome very successfully in the following manner: We can improve our transmitters by using M.O.P.A. circuits, and by making use of the "Long Lines" in the tuning circuits, described by the writer in recent issues of this magazine. We now have the new RCA 955 tube which is especially designed for frequencies above 56 megacycles. With the above mentioned facts in mind the decision was made to design a superhet, that was usable under ordinary conditions, and prove to ourselves just when and where a "superhet" could be used.

Some very interesting effects were noticed during the process of designing this receiver. We found that about 75 percent of the stations now operating in the 5-meter band could be received with fair intelligibility, at a far greater volume level than with an ordinary super-regenerative set which is extensively used today. Stations that were too weak to be understandable with the super-regenerator were brought in with *comfortable room* volume on the superhet, although in locations having a high level of "man-made" static the superhet proves to be far too sensitive and its full value could not be appreciated.

## The Circuit Uses 2-955 Acorn Tubes

The high-frequency converter section of this set uses two RCA 955 Acorn tubes, one as *detector* and the other as the *oscillator*. The circuits are more or less conventional and little need be said of them. The cathode in both cases is not at ground potential. In the first detector we introduce regeneration in order to increase *sensitivity*; the diagrams are self-explanatory. Coupling between the oscillator and first detector is accomplished by virtue of the tuning condenser construction. The condenser is a National type SE90 remodeled to have two sections consisting of two rotors and two stators in each section. The rotor plates are so placed that they do not come between the stators of each section. In other words the stators are responsible for

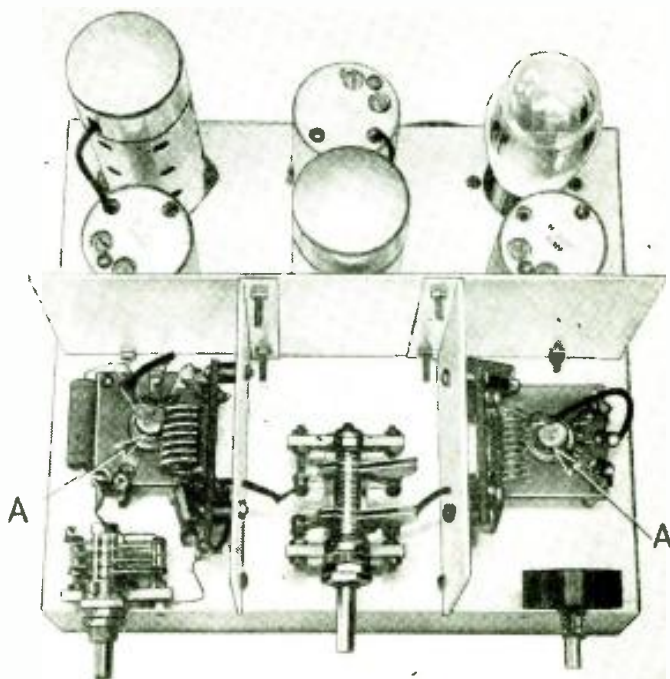
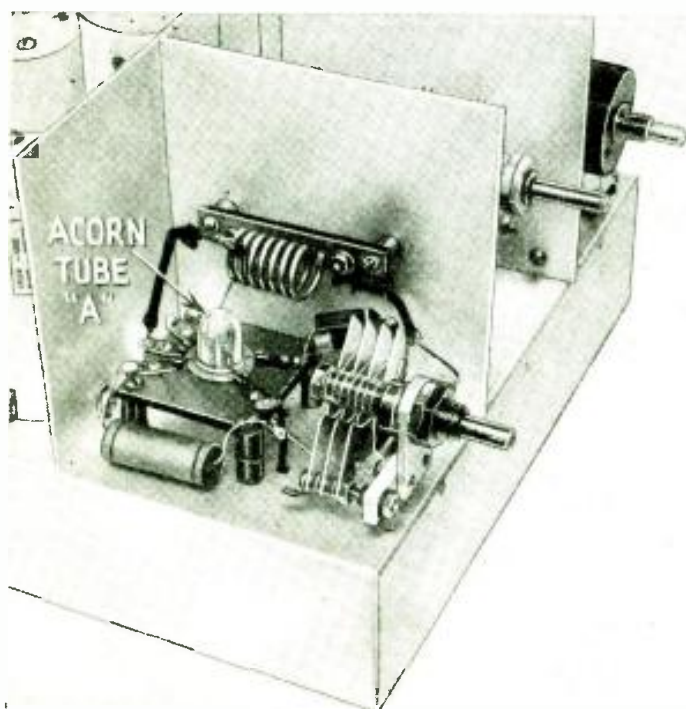

These two views clearly illustrate the general construction and layout of parts. Note the specially constructed two-gang tuning condenser.



# Uses ACORN Tubes



coupling between the oscillator and detector. The spacing between the two condensers being approximately one-half inch. If the builder wishes to spread the bands over a greater portion of the dial it is suggested that the tuning condensers have only one rotor and stator plate. With the four plate condensers the 5-meter band covers about 30 points on the dial (at the low capacity end of the scale) and it is so sharp that it is possible to receive five strong stations over the width of a single division! *Is that selectivity*, when compared to a super-regenerator?!

In the diagram it can be seen that the antenna connects to the cathode tap on the coil, this is to prevent the detector from oscillating. If trouble is encountered due to oscillation here, it is advised that a variable resistor or potentiometer be put in the "B" plus lead of the detector. Shielding is accomplished by the three upright aluminum sections formed to provide three compartments; the cabinet used is a National SW3 metal box.

### The Low Frequency Amplifier

The greatest trouble in *superhets* of this kind has always been in the "IF" amplifier. Conventional "IF" amplifier design is not practical on the higher frequencies. The "IF"

Are *superhets* practical on ultra-high frequencies? The author has endeavored to present in this article some very interesting facts regarding the construction of an up-to-date, ultra short-wave superheterodyne receiver, and has clearly brought out its advantages over other types of receivers. This set uses the new RCA "Acorn" tubes in the high frequency portion. Special information is given regarding the proper construction of the intermediate frequency transformers, which are really the "heart" of a set of this kind. Five tubes are used, which provide 6-tube performance.

amplifier must be rather broad in frequency response and have a nearly "flat-topped" *selectivity* curve. The writer has designed the IF transformers so that *double hump* selectivity is obtained. This effect is obtained when the two sections of the transformer have a high value of mutual inductance. Very close coupling between the windings causes high mutual inductance and (Continued on page 571)

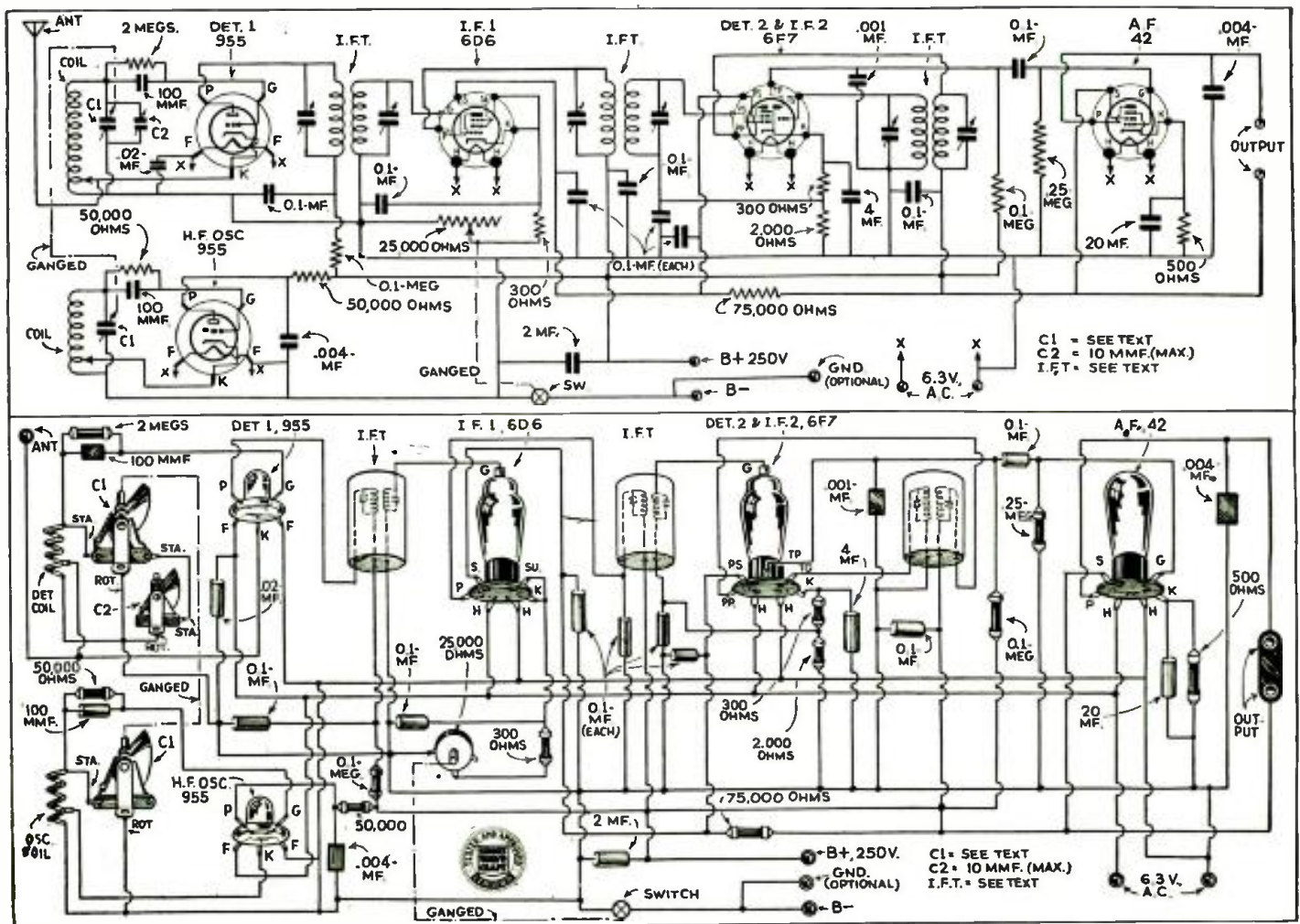

Above we have the schematic and physical drawings of this ultra-high-frequency superheterodyne, clearly showing the connections to various parts.

# WORLD-WIDE SHORT-

## Hints in Short-Wave Receiver Design

● THE circuit here, which appeared in the latest issue of *Bastelbriefe Der Drahtlosen*, a German radio magazine, while fundamentally quite common, being of the regenerative type with a stage of R.F. amplification and a pentode audio stage, has some novel tricks tucked away which are not at first evident.

The short-wave experimenter would do well to study this circuit carefully, and profit by this well-designed set, as yours truly—the Editor—did.

First, look at the power-supply section of the set. It appears to have a few extra condensers, but is otherwise commonplace. These condensers, though, are what "do the trick!" Four .1-mf. by-pass condensers shunted across the high voltage winding and the rectifier filament winding prevent

● The Editors have endeavored to review the more important foreign magazines covering short-wave developments, for the benefit of the thousands of readers of this magazine who do not have the opportunity of seeing these magazines first-hand. The circuits shown are for the most part self-explanatory to the radio student, and wherever possible the constants or values of various condensers, coils, etc., are given. Please do not write to us asking for further data, picture-diagrams or lists of parts for these foreign circuit, as we do not have any further specific information other than that given. If the reader will remember that wherever a tuned circuit is shown, for instance, he may use any short-wave coil and the appropriate corresponding tuning condenser, data for which are given dozens of times in each issue of this magazine, he will have no difficulty in reconstructing these foreign circuits to try them out.

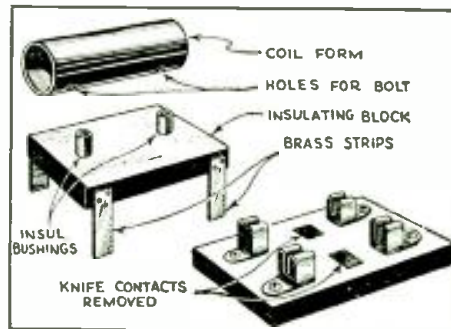

A unique method of mounting short-wave plug-in coils, using parts of an old knife-switch.

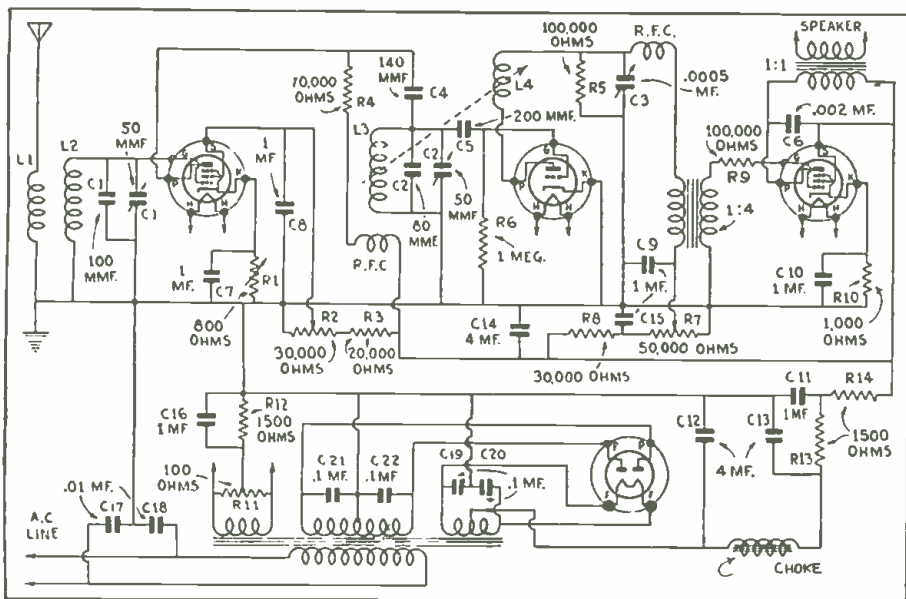

Improved German hook-up of 3-tube S.W. receiver with highly filtered power-supply. Regeneration is controlled by a variable condenser shunted by a fixed resistance.

sign and also because it utilizes some of those old parts which are cluttering up the box in which you keep unused coils, condensers and similar "gadgets."

As shown in the accompanying sketches, the scheme consists of taking double-pole, double-throw knife switches, removing the throw contacts and insulated handle and putting the remaining four contact clips to work holding coils which are made to fit.

The knife portion of the switch is cut up into sections which are secured to bakelite, wood, or similar blocks of the right size, depending on the dimensions of the switch. The coils, themselves, which may be of any desired type, are secured to the strips on the sides.

Only one switch is needed for each coil assembly, and any desired number of coils can be made to plug into the receptacle thus formed.

## An Inexpensive Transmitter

● LAST month's *Bastelbriefe Der Drahtlosen* featured an inexpensive amateur transmitter, covering the usual amateur bands of 20, 40 and 80 meters. While simple transmitters are not often advocated for amateur construction in this country, due to the interference difficulties encountered when such broadly tuned circuits are employed, this transmitter when used for C.W. work will be sufficiently selective as a beginner's unit.

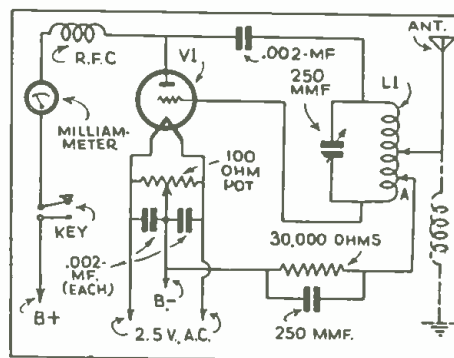

Diagram of simple triode transmitter.

The transmitter contains a single tube of the triode type using an A.C. filament supply. The coil for the 80 meter band consists of 15 turns of No. 10 or 12 wire, wound on a form 3 inches in diameter. The 40 meter coil contains 10 turns and the 20 meter coil, 6 turns. A spacing of approximately 1/8 inch is left between turns.

In the circuit here, direct coupling is used between the tuning coil and the aerial. The radio regulations in the U. S. prevents the use of such coupling and it will be necessary

any stray R.F. currents to feed into the grid or plate circuits of the R.F. or detector tubes. The use of the condensers across the rectifier filament is unusual, and quite logical, as this winding is at a high potential with respect to the core and the other windings of the transformer. In addition, it will be noticed that the usual buffer condensers have not been omitted from across the primary winding. This combination will no doubt help to remove some of that annoying background noise with which you have been troubled.

Next, a continuously variable control in the form of a variable resistor and a fixed limiting resistor is used for the screen-grid of the R.F. tube. This seems superfluous, at first, but is a very handy control to have, when the last ounce of amplification is desired to bring in that weak station. By bringing the R.F. tube to a point approaching oscillation, the output of this tuned stage can be almost doubled, according to some experiments tried by the Editor. But the adjustment is dependent on frequency—therefore the adjustable control.

Regeneration in this set is controlled by a plate condenser, shunted by a fixed resistance. This resistor has the effect of broadening the adjustment of the condenser, to facilitate adjustment, and while it may reduce the regeneration a little, this is easily compensated by a little closer

coupling of the tickler coil. The resistor also has a tendency to prevent "fringe howl" and is really a worth-while kink.

To further prevent the last named trouble, a resistor is connected in series with the secondary of the A.F. transformer which has the effect of suppressing oscillation tendencies in the pentode amplifier.

One other scheme resorted to, which is worth mentioning in this receiver, is the method of coupling the R.F. amplifier to the detector. Capacity coupling is used, but as R.F. chokes are notably full of resonance points (even when well-made and designed) a 70,000-ohm resistor is connected in series with the choke. Then, if any resonance points are encountered, the R.F. currents will be blocked at least by the high resistance. The plate voltage, though, is not seriously reduced as the resistance is not very high. The resistor acts as a sort of extra protection against "dead spots."

## S.W. Coil Mounting

● ODD methods of mounting plug-in coils for short-wave receivers have long been the secret hobby of many a short-wave enthusiast, including the Editor.

An issue of *Toute La Radio*, a French magazine, contained a method which is interesting because it is so unique in de-

# WAVE REVIEW

Edited by  
**C. W. PALMER**

to connect the aerial to a small coil consisting of 3 or 4 turns of heavy wire wound on a form about 1½ inches in diameter.

The R.F. choke in the plate supply circuit consists of 250 turns of No. 28 D.C.C. wire on a 1 inch form. The values of the remaining parts are shown in the circuit.

While the construction of a simple transmitter of this type is quite easy, the experimenter must keep several things in mind. First, it is necessary to have an amateur transmitting license to operate any radio transmitter. This applies to a unit of any power, however small, since short-wave transmitters can cover great distances with the simplest types of equipment. Second—it is necessary to keep within the regulations of the government regarding the frequency on which signals are transmitted; and third—with a transmitter of this type very low power should be used so that it does not interfere excessively with other amateurs. A small receiving tube such as the type 56 with about 200 volts on the plate will be a satisfactory compromise.

## Directional Effects on Ultra-Shorts

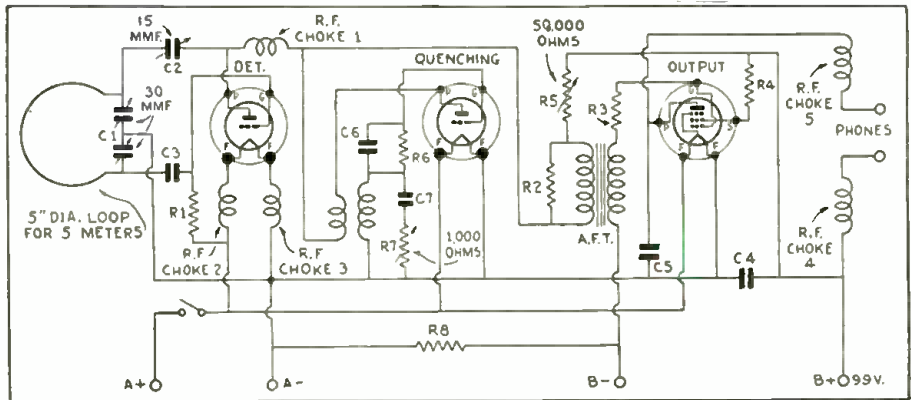

Diagram of "loop" receiver for 5 meters. It's a super-regenerator.

● EVEN so lucrative a field as ultra-short-wave amateur radio becomes prosaic if the experimenter does not have some object in view when pursuing his hobby. A well-known writer in *Wireless World* ap-

preciated this fact in presenting some practical observations on a radio field day held in England a short time ago.

The aerial systems on ultra-short waves—that is wave lengths below 10 meters, act entirely different than the same systems on longer waves. For example, the point of greatest signal strength when using a loop aerial for reception (position of the loop) is just opposite to that on longer waves, when a horizontal di-pole type of radiator is used at the transmitter. Also, using a loop, signals fall very rapidly if the loop is less than 4 feet above the ground, but do not increase to a noticeable degree if greater heights are used.

In the attached circuit, a simple 3-tube super-regenerator is shown. This circuit was used by the author of the article mentioned in the Ham's "field day" and shows how a loop aerial can be connected to an ultra-short-wave receiver. (The loop should be approximately 5" in diameter for 5 meters.—Editor.)

## A Cuprous Oxide Rectifier

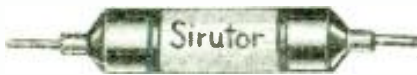

The newest German wonder—a cuprous oxide rectifier that can be used as a diode rectifier, second detector, or A.V.C. rectifier.

● ALTHOUGH this device is not especially suited to short waves, it is of interest to the short-wave fan, who builds the super-het type of set.

It is a new cuprous oxide rectifier designed with the idea of keeping the internal capacity low, so that it can operate on frequencies well up into the radio frequency spectrum.

This rectifier, which can be used as a "diode" type rectifier, as a second detector or as an A.V.C. rectifier, consists of a series of five elements housed in a small insulated tube, with metal ends.

This rectifier will carry approximately .25-ma. continuously and will operate efficiently on wave lengths as low as 200 meters. The capacity is too high for successful operation on the short waves, but since the superheterodyne circuit is so much in favor, it can be utilized very effectively.

This new rectifier is available in Germany under the trade name of *Sirutor-Rafa*.

use has speeded the practical development of this phase of communication to a marked degree.

The use of these waves for telephony across the English Channel, etc., have furthered the need for dependable circuits and devices.

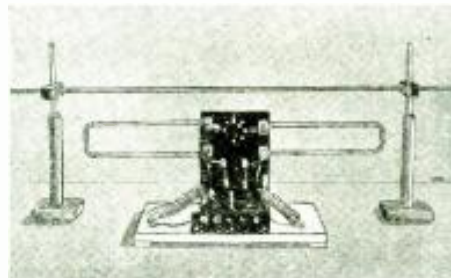

Photo of "trombone" tuner for grid and plate circuits of ultra short-wave set.

One of the difficulties that has hindered the rapid development of transmission on "ultra-shorts" is the need for flexible control of frequency, especially if dipole aerials are utilized.

A recent issue of *Funk* magazine, a German publication, outlines a new method for tuning transmitters—a development of Messrs. Kuhn and Huth—which overcomes some of the difficulties mentioned above. As shown in the accompanying illustrations, it consists of an oscillatory circuit in which the grid and plate tuning is accomplished by shifting sliding copper tubes which make up the grid and plate inductances, until the correct inductive and capacitive value is attained. A study of this circuit shows the similarity to the commonly used "tuned-grid, tuned-plate" circuit which all Hams have used on longer wave lengths at one time or another.

This easily tuned oscillator is then coupled to a half-wave radiator by simply bringing the entire oscillatory circuit near the aerial. This provides variable coupling to permit variation of output and to reduce aerial damping to a minimum. The oscillator can, of course, be coupled to any form of radiator, either inductively or through a suitable condenser, though other methods than the one shown do not offer the same flexibility or ease of adjustment.

The oscillator shown is a simple, theoretical circuit, which may be modulated, amplified, or keyed in any desired manner. It will, however, give the experimenter some "food for thought" along the lines of simplification and ease of adjustment.

## An Italian Converter

● IN this month's mail bag of foreign magazines, we have a new one—*Radio Lux* from Milan, Italy, which presents a simple short-wave converter.

The converter covers the wave lengths between 12 and 70 with a set of four tapped coils in the grid circuit. The grid coils are wound on a piece of 1½-inch-diameter tubing and consist of 4 turns for the first section, 4 for the second, 5 for the third and 6 for the fourth. Number 24 enamel wire is used and a space of ¼ inch is left between sections. The oscillator coils consist of 10 turns of No. 24 enam. wire on a tube 1½ inch in diameter with a tap at the sixth turn. The 6-turn coil thus formed is the grid section, while the 4-turn section is for the plate.

## Ultra-Short Wave Developments

● THE introduction of ultra-short-wave radio communication into commercial

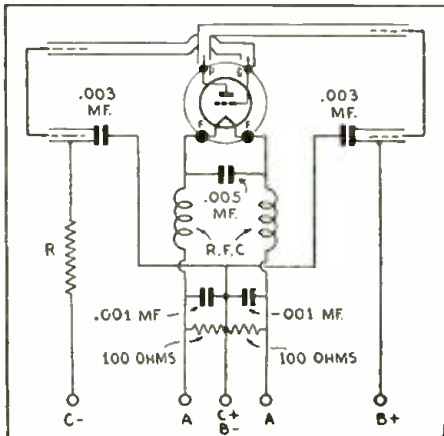
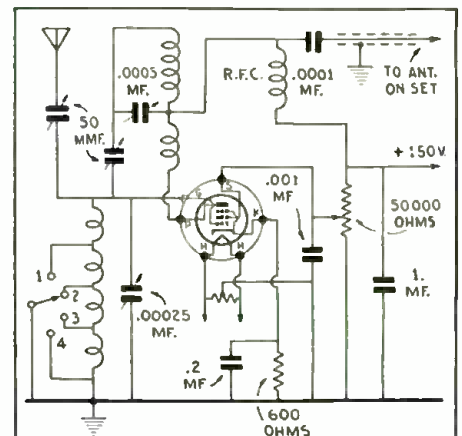

Diagram shows method of tuning grid and plate circuit by sliding copper tubes.



New "Hot" S-W Converter circuit from Italy. The tube is a R.F. pentode.

# Short Wave SCOUT NEWS

Report from Official Listening Post of Geo. D. Sallade, Sinking Spring, Pa.

● RECEPTION at this post was excellent in the last month. Several new signals were heard in great fashion.

All short wave "fans" should give a vote of thanks to the Eucharistic Congress which indirectly was responsible for many broadcasts from the South American city, Buenos Aires. Among the transmitters heard at this post were LSY, LSQ, LSX and LSN.

For several days a new Netherland station has been heard with an R9 signal. The approximate frequency is 15,220 kc. The schedule is almost identically the same as PHI. This station I believe is operated by Phillips Radio.

On October 19 a new German station was heard testing with Tokio. The call was announced as DFC and the wavelength as 20 meters.

"La Voz del Tropico" was heard transmitting a program for the I.S.W.C. on October 20th at 9:15 P.M. E.S.T. Signal strength was very good.

The Japanese transmitter on 6700 kc. continues to be heard at R6 strength. The best time in Eastern Pennsylvania is about 6:00 A.M. E.S.T.

On October 23, J1AA on 15760 kc. was heard testing with KWO. The time was 6:00 P.M. E.S.T.

Two recent verifications are printed below:

Roma (125) 21/9/34  
Via Calabria N. 46/48

Dear Sir,

We are in receipt of your letter Sept. 3, 1934 and we confirm as correct your reception of our Station IRM on the date and time given.

We are sorry not to be able to send you any schedule of transmissions because only on special occasions our short-wave stations retransmit programs from the Italian broadcasting stations.

Yours truly,  
Societa Italo Radio (signed)

## Oliver Amlie A Happy Trophy Winner

● I received my Trophy Wednesday Noon, and I will have photos made up for the next issue of SHORT WAVE CRAFT. I think the Trophy is a "honey." My Boss and Madam like it very much, and my wife is crazy about it—she dreams of it at night! As for me, I don't know what to say; it seems like a dream, and I look at it all the time. I am more than pleased with my most beautiful Trophy, and a thousand thanks to SHORT WAVE CRAFT for this cup.—Oliver Amlie, Philadelphia, Pa.

## Hot Tips from Our Listeners

Moscow, the 5th October, 1934.

Dear Sir,  
We have received your letter of the 15th ultimo, and beg to confirm your report of our test transmission on that date through our Radio Stations RKI and RNE.

Yours very truly,  
(signed)

### Official Listening Post Report from Heinie Johnson

● OCTOBER has been a treat in more ways than one to "short-wave fans." The air has cleared up, new signals have appeared and DX hounds have begun "dial twirling."

Regardless of opinion of any expert to the opposite, CQN is the call of a Chinese signal on 52 meters. Works irregular in early mornings, phonograph records and voice. Most powerful signal heard here this month, especially on morning of October 9.

Watch for "Radio DUSA" located at

"League of Nations" heard well on 38 meters.

GSB now working each night until 3:30 a.m., C.S.T.

19 meter band better than usual.

Germany has a new signal on about 16.50 meters.

This post wishes to thank the many "fans" who wrote to him during the past 60 days and assures you that he enjoys your letters. Effort has been made to answer all individually. For those interested in our receiving equipment we suggest that you write Mr. James Millen, National Company, Inc., Malden, Mass. He will send you technical details.

Shortly we will tell you how to cover all continents in 24 hours.

We will pick a day of week when needed signals are sure to work and will give exact time to best receive each signal. Will include some good catches, so watch for it.  
—Heinie Johnson.

## Florian Poeschl Pleased With Tro

### Point Man Wins Radio Trophy

Once again the Point and its citizens will be proud to know that one of its residents has obtained the unique distinction of being the only individual in the whole Dominion of Canada who has won a Cup for Radio Efficiency.

The man in question is Mr. Florian Poeschl owner of Frank's Radio Service, and the reason for his success was that, with his own built short wave set he got no less than 168 stations from practically all over the world: South America were all heard Australia, Japan, Europe and clearly and distinctly on this set. The Trophy is a marvellous piece of Silverware and anyone desirous of seeing it can see it after the Radio Show (where it is now on display) at 0702 Charlevoix St. The inscription on the Trophy reads:— AWARDED TO

FLORIAN POESCHL for his contribution towards the advancement of the Art of Radio by Shortwave Craft.

Readers will join in tendering him hearty congratulations upon his achievement.

At left we have reprinted a clipping from Mr. Poeschl's local newspaper. Below—Mr. Poeschl himself with his handsome SHORT WAVE SCOUT Trophy Cup.

are pictures and I leave it to you to choose anyone you like for publication; I am also enclosing the newspaper clipping. I am very sorry that I cannot send you a reception report this month as I have very much to do which prevents me from listening in at present time. But I will do my best to send you a "listening post" next month.

I again thank you very much for the Trophy.

Florian Poeschl,  
0702 Charlevoix St.,  
Point St. Charles, Montreal, P. Que., Can.



Editor, SHORT WAVE CRAFT:

I cannot find words to express the joy which overcame me, as I received the beautiful Trophy. I wish to thank you very, very much for the same. I am especially happy to be the only Canadian winner so far, and also that I had the largest list ever sent in to you. I had an article about the "Trophy" in the local newspaper and the Trophy was also at the local Radio Show. Everyone that sees the Trophy is highly delighted with it. Herewith

Lima, Peru. Heard evening of October 20 on 51 meters. Post Office Box announced as 853.

This new catch is an R9 signal with a fine quality program.

Every "fan" in America should be able to enjoy an evening of excellent music from COC now. This station will receive many reports. Post Office Box 98, Havana, Cuba.

YDA on 49.02 meters is heard almost daily. Strong signal but fairly high noise level. We believe our good friend who enjoys reputation of being the world's No. 1 announcer has deserted PHI to work at this station and where is PHI?—we have not heard them for a couple of weeks. Tune for YDA early in mornings.

Our Jap. friend, JYR, JYM, etc., has moved main channel operation to about 42 meters. Good signal.

### "O.L.P." Report from John Sorensen, Bronx, New York City

● ALL G, D, and F stations were heard well. Also EAQ, ORK, PCJ, 19 ms., PHI, 25.6 meters, TIEP, HJ1ABB, HJ1ABD, HJ4ABB, COC, HC2RL, LSX, LSQ, PRF5, YV2RC, CJRO, XEET, HIX, VK2ME, WOB, WCG, WCF, WEL, WEP, WCO, YV5RMO, HJY, HBL, OA4B—this besides many "locals" has been coming in here R8-9-QSA4-5. The following R4-6, QSA2-4; VK3ME, VK3RL, VLK, 28.5 meters; IRM, RNE, RW15, LKJ1, OXY, JVT, KNRA. I have increased my aerial to 370 feet long. All my reception is on loud-speaker! The 19 meter band has been good mornings till noon; 25 meters fair afternoon till 5 p.m. 31 meters—good till 9 p.m. 49 meters good after midnight.

(Continued on page 566)

# SHORT WAVE SCOUTS

## ELEVENTH "TROPHY" WINNER

Frank Hogler, 222 Wyckoff Ave., Brooklyn, N.Y.

110 Stations; 55 Verifications

● THIS month's SHORT-WAVE SCOUT Trophy goes to Mr. Frank Hogler of Brooklyn, N.Y. Mr. Hogler has submitted one of the best lists that we have received thus far. It includes a total of 110 stations, with 55 veries. There were no disqualifications in Mr. Hogler's entry and it was complete in every detail. The receiver used in building up this fine list of stations heard was a Model A, 16 tube MID-WEST All-Wave Receiver, used in conjunction with a 50-foot antenna of No. 12 enameled copper wire and a 20-foot transposed lead-in. The antenna is located 15 feet above the roof of Mr. Hogler's residence. Congratulations, Mr. Hogler, for your very fine list.

The list of stations submitted by any entrant in this "Trophy Contest" may be for any 30-day period. It is advisable to keep your list of stations until you have completed the necessary 50 percent veries, so that you can mail the entire list, including your verified and unverified stations, together. The verification cards submitted must be those received in answer to inquiries, on programs heard during the 30-day period you select! "Old veries" will be disqualified. Take an oath before your local notary public to the effect that you have personally received and listened to stations listed in your entry. Mention in your list the 30-day period which you have selected. Group the verified and unverified stations in two distinct lists, and state what 30-day listening period the list is for.

### Mr. Hogler's Verified Station List (June 6 to July 5)

- LSX-23.98 M.—Transradio International, San Martin, 329, Buenos Aires, Arg., S.A.
- PRA3-36.65 M.—Radio Club De Brazil, Rio de Janeiro, Brazil, S.A.
- OCI-16.06 M.—All-America Cables, Inc., Lima, Peru, S.A.
- HC2RL-45.00 M.—Calle Tomas Martinez No. 307, Guayaquil, Ecuador, S.A.
- YV2RC-49.08 M.—Broadcasting Caracas, Caracas, Venezuela, S.A.
- YV3RC-48.78 M.—Radiodifusora Venezuela, Caracas, Venezuela, S.A.
- HJ4-ABE-50.6 M.—Radiodifusora de Medellin, Medellin, Colombia, S.A.
- HJ1-ABB-46.46 M.—La Vos de Barranquilla, P.O. Box 715, Barranquilla, Colombia, S.A.
- PRADO-19.43 M.—Fabrica de Tejidos de "El Prado," Riobamba, Ecuador, S.A.
- XEBT-49.83 M.—El Buen Tono, S.A. Mexico, D.F.
- XETE-31.25 M.—Empresa de Telefonos Ericson, P.O. Box 1396, Mexico, D.F.
- VK2ME-31.28 M.—Amalgamated Wireless, (A/SIA) L.T.D., Sydney, Australia.
- VK3ME-31.55 M.—Amalgamated Wireless, (A/SIA) L.T.D., Melbourne, Vic., Australia.
- VK3LR-31.31 M.—National Broadcasting Service, Lyndhurst, Vic., Australia.

- CT1AA-31.25 M.—Radio Colonial, Av. Antonio Augusto de Aguiar, 144, Lisbon, Portugal.
- EAQ-30.43 M.—Radiodifusion Ibero-Americana, P.O. Box 951, Alcala 43, Madrid, Spain.
- FYA-19.68 M.—Direction de la Radiodifusion, 103 Rue de Grenelle, Paris, France.
- FYA-25.20 M.—Direction de la Radiodifusion, 103 Rue de Grenelle, Paris, France.
- FYA-25.63 M.—Direction de la Radiodifusion, 103 Rue de Grenelle, Paris, France.
- I2RO-25.4 M.—Ente Italiano Audizioni Radiofoniche, Rome, Italy.
- PHI-16.88 M.—Radio Hilversum (Philips Radio) Eindhoven, Holland.
- ORK-29.04 M.—Radio Ruyaselede, West Flanders, Belgium.
- DGU-31.09 M.—Reichspostzentralamt Schöneberger St. 11-15, Berlin, Germany.
- HBL-31.3 M.—The Secretary General, League of Nations, Geneva, Switzerland.
- HPB-38.47 M.—The Secretary General, League of Nations, Geneva, Switzerland.
- DJB-19.73 M.—German S.W. Broadcasting House, Berlin, Germany.
- DJD-25.51 M.—German S.W. Broadcasting House, Berlin, Germany.
- DJC-49.83 M.—German S.W. Broadcasting House, Berlin, Germany.
- DJA-31.38 M.—German S.W. Broadcasting House, Berlin, Germany.

## ELEVENTH "TROPHY CUP" WINNER

Presented to  
SHORT WAVE SCOUT  
FRANK HOGLER  
Brooklyn, N.Y.

For his contribution toward the advancement of the art of Radio

by



Magazine



● ON this page is illustrated the handsome trophy, which was designed by one of New York's leading silversmiths. It is made of metal throughout, except the base, which is made of handsome black Bakelite. The metal itself is quadruple silver-plated, in the usual manner of all trophies today.

It is a most imposing piece of work, and stands from tip to base 22½". The diameter of the base is 7¾". The diameter of the globe is 5¼". The work throughout is first-class, and no money has been spared in its execution. It will enhance any home, and will be admired by everyone who sees it. The trophy will be awarded every month, and the winner will be announced in the following issue of SHORT WAVE CRAFT. The winner's name will be hand engraved on the trophy.

The purpose of this contest is to advance the art of radio by "logging" as many short-wave commercial phone stations, in a period not exceeding thirty days, as possible by any one contestant. The trophy will be awarded to that SHORT WAVE SCOUT who has logged the greatest number of short-wave stations during any 30-day period; at least 50 percent must be "verified."

### HONORABLE MENTION AWARDS

William H. Martin  
Canton, Mass.

78 Stations, Total; 40 Verifications

- GBA-21.44 M.—Rugby Radio Station, Rugby, England.
- GBU-24.0 M.—Rugby Radio Station, Rugby, England.
- KWU-19.53 M.—Transpacific Communication Co., Ltd., Dixon, Calif., U.S.A.
- W9XAA-49.34 M.—Northeast Tower, Navy Pier, Chicago, Ill., U.S.A.
- W1XAZ-31.33 M.—Westinghouse Relay Station, Boston, Mass., U.S.A.
- W2XE-19.64 M.—Atlantic Broadcasting Corp., New York City, N.Y., U.S.A.
- W2XE-25.36 M.—Atlantic Broadcasting Corp., New York City, N.Y., U.S.A.
- W2XE-49.02 M.—Atlantic Broadcasting Corp., New York City, N.Y., U.S.A.
- W9XF-49.19 M.—National Broadcasting Corp., Chicago, Ill., U.S.A.
- W8XK-19.72 M.—Westinghouse Electric & Mfg. Co., Pittsburgh, Pa., U.S.A.
- W8XK-13.93 M.—Westinghouse Electric & Mfg. Co., Pittsburgh, Pa., U.S.A.
- W8XK-25.27 M.—Westinghouse Electric & Mfg. Co., Pittsburgh, Pa., U.S.A.
- W8XK-48.86 M.—Westinghouse Electric & Mfg. Co., Pittsburgh, Pa., U.S.A.
- W8XAL-49.50 M.—Crosley Radio Corp., Cincinnati, Ohio, U.S.A.
- W3XAU-31.28 M.—Broadcasting Co., Philadelphia, Pa., U.S.A.

(Continued on page 569)

# SHORT WAVES and

## Hats Off to This Crackerjack Station Operated by Wells Chapin, Jr., W9DUD

"Prize-winning" station photo awarded One year's subscription to SHORT WAVE CRAFT



Zowie! What a ham station this turned out to be! We'll bet Mr. Chapin spent a young fortune on dials and meters alone. The transmitter is rated at 600 watts output!

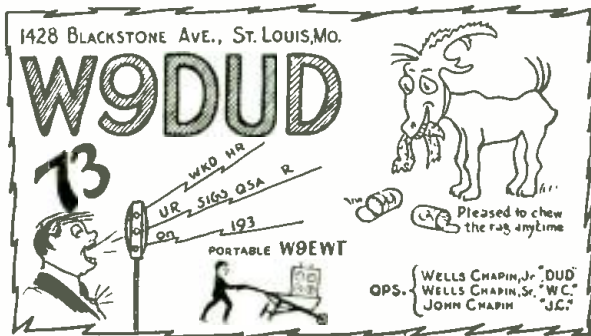

Here's the nifty QSL card W9DUD sends to those reporting reception of his station.

## A Nifty S-W "Listening Post"

Editor, SHORT WAVE CRAFT:

I am sending you a picture of my short-wave "listening post." It is not a "ham" licensed station yet so have not added the transmitter, but as I expect to go up soon for my ticket, I am living in the hopes of completing this outfit with a nice panel job.

I first became interested in amateur radio about one year ago, after having the great pleasure of reading issues of *Radio-Craft* and *SHORT WAVE CRAFT* given me by a friend.

Starting out with a little 3-tube "battery job," I soon replaced it with the 4-tube "Regent" that you see in the picture. Then last June I decided for something a bit better so got the Patterson P-R-10. I will give you a brief report on the layout here.

On the wall are two pictures of the U.S.S. *New York* that I served on back in the war days. Below them, from left to right, is a picture of the XYL, then my certificate of membership in the ARRL, another membership certificate from the *Short Wave League*, directly over the Patterson

receiver is a list of the abbreviations and their meanings used in amateur work. On the table at the left is my Patterson P-R-10 receiver used for DX-ing, below that on the shelf I keep all my issues of *SHORT WAVE CRAFT*, below them a two-stage P.A. amplifier and now on the desk I have an assortment of radio and electrical books, a Readrite Model 710 tester and my Regent 4-tube job, used merely for copying code. I also have a code-practice oscillator for practice purpose, the mill (typewriter) is concealed in the desk while it is being used as my work bench. Hi, Hi.

I have never missed an issue of your splendid magazine since I was first introduced to it, and each issue is looked forward to with great interest. All I am able to say about this magazine

is that it satisfies every reasonable requirement of a short-wave publication and may the good work continue. Regards to all those responsible for its success—73.

Very truly yours,

KING J. FOTHERGILL  
297 Baltic Street,  
Brooklyn, New York.

(Mighty fine work, King, and just shows what a real short-wave "fan" can do, when he makes up his mind to get somewhere.—Editor.)

## WE HAVEN'T "MISLED" HIM YET!

Editor, SHORT WAVE CRAFT:

Beyond any doubt for the short-wave "fan", *SHORT WAVE CRAFT* is the best twenty-five cents' worth to be had.

From your March, 1934, issue I constructed the "2-tube" receiver as shown on page 659 by Mr. Cosman. However, I employed data given by Mr. Malsberger for construction of the power-pack because I had on hand a half dozen .01 mf. capacity condensers. From your January issue of this year, from data supplied by Mr. Tipse, I built a power transformer using No. 36 enamel wire, instead of No. 34 as specified for high voltage coils. I wound the coils all by hand and while this was somewhat tedious, I enjoyed doing it this way. This transformer supplied the power to the set.

Such stations as VE9GW, W8NK, W2NE, W1XAL, W3XAL, W1XAZ, W2XAF, W9XF, will at times operate the speaker. K4SA, in Porto Rico, and some station in South America, are the only foreign stations to be brought in outside of a little ship-to-shore chatter, but I don't sit up nights to 3 or 4 a.m. I haven't gone to any trouble of installing any special type of antenna. Doubtless results may be bettered by doing so. *SHORT WAVE CRAFT* hasn't fooled me yet with any misinformation on constructional data.

GEORGE H. FIELDHOUSE,  
5300 39th Ave., S.,  
Minneapolis, Minn.

(The editors try to make the articles in *SHORT WAVE CRAFT* as accurate as possible, but now and then slight errors will occur, due to typographical or draftsmen's mistakes. We are glad that you liked the articles by Messrs. Cosman, Malsberger and Tipse.—Editor)



King J. Fothergill of Brooklyn certainly has a snappy looking short-wave "listening post," equipped with a typewriter n'everything.

# LONG WAVES • • • OUR READERS' FORUM

## THE "GLOBE-TROTTER" BRIDGES THE ATLANTIC EASILY

Editor, SHORT WAVE CRAFT:

Been reading your "mag" now for over a year and I think you publish some mighty fine articles in it. Have read what all of these "fellers" have to say about the different circuits, and after putting it off for some time, I am now going to tell you about the *Globe-Trotter* I built. I constructed it in a Crosley "Bandbox" case, substituted an inductance coil in the antenna for the 100 mmf. postage stamp condenser, and added an extra spaced variable condenser in the tuning circuit for band-spread, and Boy, Oh Boy, do I get DX! I have heard all the hams from here to the Pacific, Mexico to Canada, and plenty of foreign stations. I listened to G6RX, England on 4,320 kc. for over an hour. I am not going to take up your time with a long list of stations, but I want to tell you that the little *Globe-Trotter* sure "brings them in"!

I like your articles on simple transmitters, also; give us plenty of them. Well I'll be seeing you again, best of luck, es 73.

LESTER MACGOWAN,  
S. Paris, Maine.

(Glad to know that you "bridged the Atlantic" with the "Globe-Trotter" receiver; this set made many thousands of friends it seems, and one of the reasons for its success apparently is its extreme simplicity and lack of any "fancy frills." More power to you and the "Globe-Trotter."—Editor.)

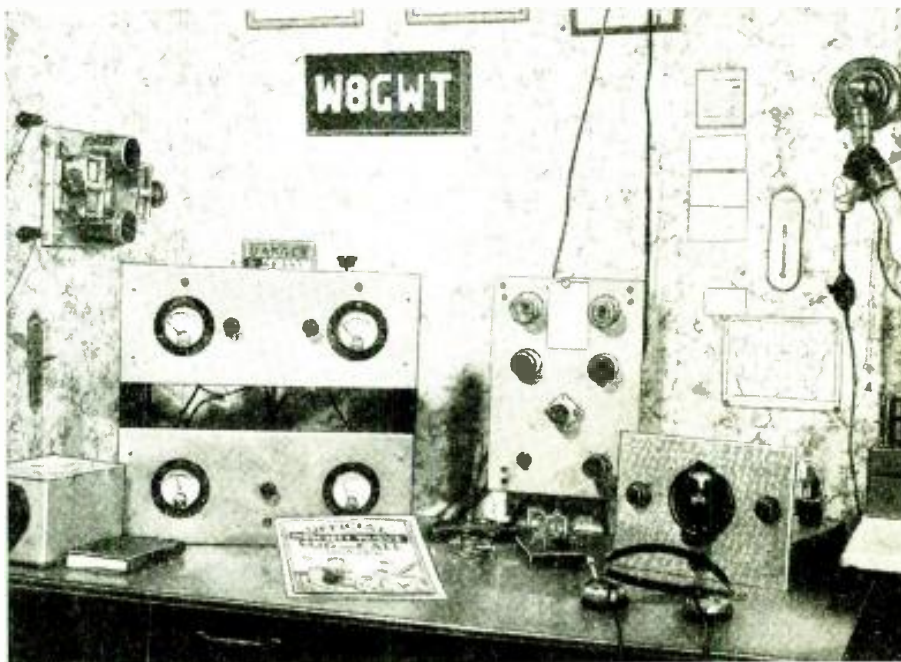

W8GWT hands out a "hot" signal when its owner, Francis Orcutt, takes hold of the key. This station is an Official Relay station and operation has been mainly on the 80, 40 and 20 meter bands.

## AMATEUR RADIO STATION W9LFF

Editor, SHORT WAVE CRAFT:

W9LFF is the station owned and operated by yours truly in Iowa City, Iowa. This station has been on the air since April 25, 1933.

The first transmitter was a 160 meter phone outfit on 1,780 kilocycles. Due to the lack of power the station was changed to a code outfit using two 45s in parallel with 200 volts on the plate. The receiver used was home-made from a description given in an old issue of SHORT WAVE CRAFT. It used a 56 detector and a 56 stage of audio. This was used for about 500 contacts on 3,535 kilocycles.

On July 2, 1933, the transmitter was changed to a single 210 in a tuned-plate, tuned-grid circuit with 500 volts of power, and a National SW-3, receiver was purchased. This layout was used until March 24, 1934, with over 1,500 contacts checked up; the station was arranged as you see it in the picture.



Max Otto, W9LFF, of Iowa City, Iowa, has built himself a nifty looking transmitter, and by the display of QSL cards his station must "click."

## Francis Orcutt Maintains a Busy Station

Editor, SHORT WAVE CRAFT,

New York, N. Y.:

W8GWT has been consistently on the air since early 1932. Operation has been mainly on 80 and 40 meters with some 20-meter operation. Five-meter operation is contemplated for "local" communication and experimenting during the coming fall and winter. W8GWT is an Official Relay Station of the A.R.R.L. and 80-meter operation is principally for activity in "traffic nets." Forty meters is used for rag-chewing, "dx," and for "traffic relays" over longer distances.

The present "rig" as shown consists of the usual 47 crystal oscillator, a 46 doubler or buffer, depending on the band operated in and a 510 amplifier. Antennas consist of an 80 meter single-wire fed Hertz and a 40 meter Zepp, with arrangements for coupling with the Collins network.

The receiver shown is used for all types of short-wave listening and consists of a 35 RF stage, a 24 detector and 27 audio. It has ample gain for loudspeaker oper-

The transmitter which is in operation now is a 47 crystal-controlled oscillator which gets its power from a 300 volt power supply mounted on bottom shelf of the rack. The next stage is two 46s which are run on 400 volts from the bottom shelf also. The final stage is a 203-A with 1,200 volts on the plate.

The antenna used is a single wire full-wave on 80 meters. It is 325 feet long and is 45 feet above the ground. The antenna is coupled to the transmitter by a Collins antenna coupling system.

The transmitting rack is made entirely of wood. It contains three sections; the bottom one contains three separate power supplies. The middle section has the oscillator and buffer stages and the top one houses the final amplifier.

The meter is a Weston 0-200 milliammeter which can be plugged into any of the stages by means of a patch-cord.

The receiver next to the rack is a 4-tube B.C. (broadcast band) receiver. The National SW-3 is still being used, as you can see; it is on the right side of the table. On top of the SW-3 can be seen a home-

made monitor which is caged in a hand-made galvanized iron can. The statue of "Micky Mouse" on top of the monitor is the mascot of the station. This station operates on all three main amateur bands and has many "skeds" and handles a lot of traffic. A good friendly QSO (contact) is welcome at all times.

Yours truly,

MAX OTTO, W9LFF,  
824 No. Gilbert St.,  
Iowa City, Iowa.

(Some "rig" Francis, and we are pleased to note the wide diversity of your short-wave activities.—Editor.)

made monitor which is caged in a hand-made galvanized iron can. The statue of "Micky Mouse" on top of the monitor is the mascot of the station.

This station operates on all three main amateur bands and has many "skeds" and handles a lot of traffic. A good friendly QSO (contact) is welcome at all times.

Yours truly,

MAX OTTO, W9LFF,  
824 No. Gilbert St.,  
Iowa City, Iowa.

(Well you've certainly been through the mill, Max, and we salute your fine "log" of 1,500 contacts.—Editor.)

One Year's Subscription to  
SHORT WAVE CRAFT  
FREE

for the "Best" Station Photo

Closing date for each contest—60 days preceding date of issue: Jan. 1 for March issue, etc. The editors will act as judges and their opinions will be final. In the event of a tie a subscription will be given to each contestant so tying.

# A Variable Wavelength Antenna

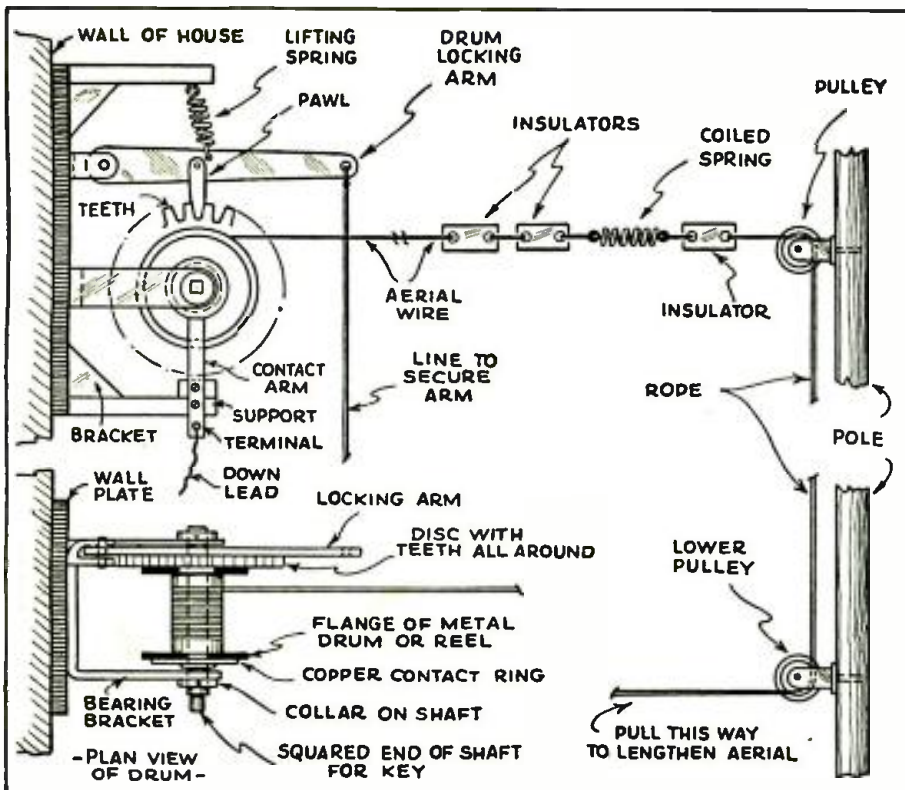

Interesting details of the construction followed in building a variable wavelength antenna are illustrated above.

short-wave reception, the idea being to have the aerial of such a length that it favors a certain wavelength or band of wavelengths.

The natural wavelength of any aerial depends primarily on its length, and the wavelength (in meters) can be found by multiplying its length in feet by 0.3 and the result by 4. For example, an aerial 50 feet long has a natural wavelength of  $50 \times 0.3 \times 4 = 60$  meters, or, if we wish to know what length of wire to use in order to obtain a given natural wavelength, we must multiply the number in meters by 3.3 and divide the result by 4. Thus, if we require an aerial with a natural wavelength of 30 meters, the length of

$$\text{wire required will be } \frac{30 \times 3.3}{4} = 24.75 \text{ feet or 24 feet 9 inches.}$$

The following table (obtained by the above method) will give a close idea as to the different aerial lengths required to cover the waveband between 10 and 80 meters, the usual range covered by most dual-range tuning coils for short-wave work:

(Continued on page 552)

- IN THE early days of short-wave reception every amateur dreamed of having efficient tuning condensers which would be smoothly and silently variable; then came the variable grid-leak, volume control, and now variable-mu valves. This desire to have various features of variable value has caused attention to be directed to the aerial used for

## A Direct-Reading Condenser Tester

By F. L. SPRAYBERRY

● PRACTICALLY every experienced serviceman has, no doubt, frequently been in a position where he has wanted to test a condenser for capacity but where he has been without the means of doing so. Recently, however, a simple circuit has been developed in the writer's laboratory to fill this increasingly important need. With this,

it is not only possible to test condensers for capacity, but also for shorts and opens. Electrolytics as well as condensers of other types can be handled quickly and conveniently. Moreover, all three tests may be made at the same

time and while the condenser is in the receiving circuit providing there is nothing connected in parallel with it. Should another part be connected in parallel to the condenser, it is only necessary to disconnect one side to apply the test.

This new circuit (shown in Figure 1) (Continued on page 560)

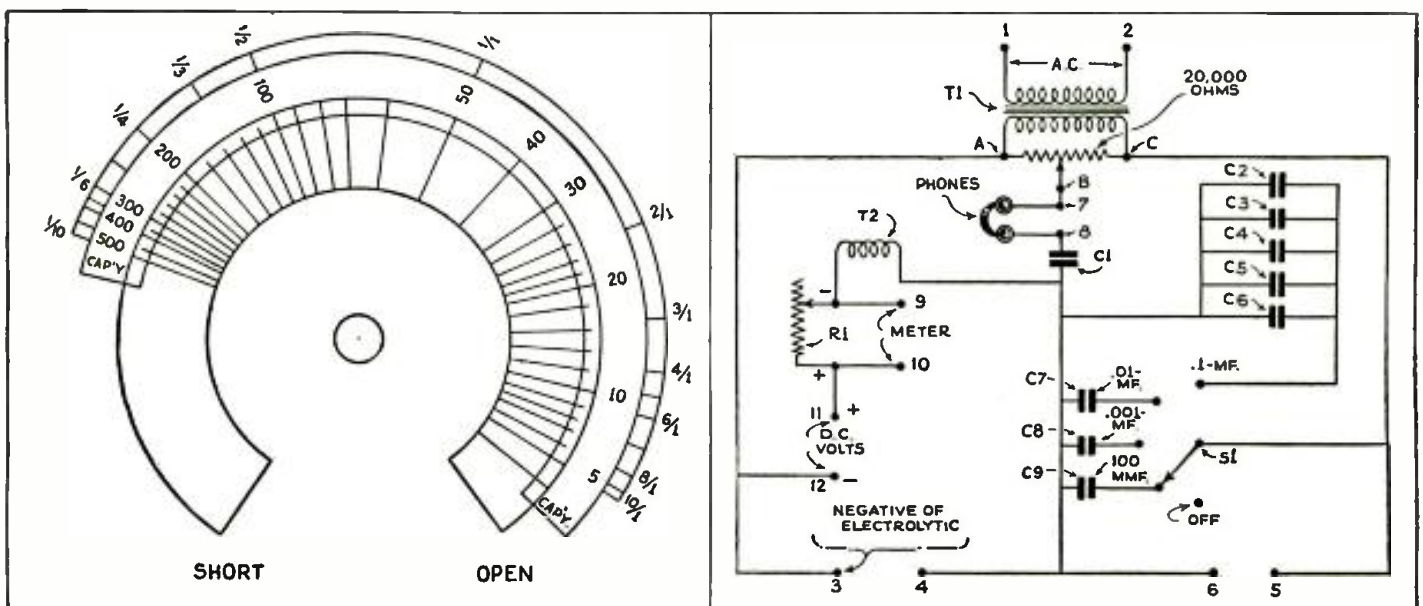

Fig. 1, at right, shows simple circuit connections of the balanced bridge for measuring condenser values; Fig. 2, at left, shows special dial which is used on the potentiometer.



# A Low-Power Phone TRANSMITTER

## With Full Constructional Details

This article describes how to build a low-priced phone and "CW" Ham Transmitter, which, thanks to carefully thought out design, sure "steps out"! It contains a single 46 tube as the final modulated R.F. amplifier.

By W. A. WOHR, W9PTZ

● AMATEUR radio being just a hobby, it seemed very practical to construct a low-power transmitter with a minimum of cash outlay and yet have something which would justify its existence. What the author has done along this line, others interested in phone transmitters should also be able to duplicate, and in most cases better "buys" may be made, depending on the size city you happen to live in. Usually the larger the city the better the bargains, but suffice it to say the station about to be described was constructed at Geneseo, Illinois, a town of 3,900 population. But now let's get on with our story.

W9PTZ first went into operation February, 1934, on the 160 meter phone band with a "bread-board" transmitter consisting of a 47 crystal oscillator and a 46 R.F. amplifier, modulated by a 250. The speech amplifier was a 27, modulated by a single-button mike. Results were very promising for such low-power, so that plans and construction of the present transmitter were put under way. As seen in the photo, it consists of a very compact yet easily accessible layout, built on the familiar "rack and shelf" style. Briefly the layout is as follows: bottom shelf is the "power-supply" unit, second shelf the audio and modulator unit, third shelf the crystal oscillator and R.F. buffer stage, and top shelf the final R.F. amplifier and antenna tuning unit. A condenser mike is used and it can be seen at lower left of picture, together with a single-button hand mike. Two dry cells, in back of the transmitter, furnish current for the mike and filaments of the 30's used in the pre-amplifier of the condenser mike. A separate "B" eliminator is used with the pre-amplifier, although plans are under way to incorporate a separate filter and tap-off of the main power supply for the pre-amplifier "B" voltage.

The receiver is the improved *Victor Superhet*, as described by the author in the Nov. '34 issue of *SHORT WAVE CRAFT*. To the right of the receiver is the loud speaker cabinet, which also contains the receiver power supply as well as the last audio tube and speaker.

### Antenna Details

A 125 foot antenna and counterpoise system is used for transmitting, while a separate antenna is used for the re-

ceiver. When transmitting only two switches are used, for the *send* and *receive* positions, one on the transmitter and one on the receiver.

For the details of the transmitter construction we will take the power supply unit and describe it first. The chassis is built of white pine covered with clear lacquer (or white shellac). A two inch strip is built around the chassis, giving it sufficient depth so that all small parts may be mounted underneath and out of sight. Also most of the wiring is run below deck in point-to-point fashion. The main power supply, 500 volts filtered D.C., consists of a 175 watt transformer having a 1,100 volt ct. (center-tapped) secondary, two 7½ volt windings, and a 3 volt winding. This unit is sold by mail-order houses for \$2.00 to \$3.00 including a small resistor to use for the filament of the 83 rectifier tube when running it from one of the 7½ volt windings. The other 7½ volt windings. The other 7½ volt winding lights the 250 modulator tubes. The 3 volt winding is not used. The filament of a 201A is connected in series with the negative high voltage and serves as a fuse in case anything should go wrong while operating the transmitter. This eliminates the possibility of burning out a filter choke or power transformer.



Here we have the photograph showing the complete transmitting and receiving station of Mr. Woehr, W9PTZ. Note the convenient "rack and panel" arrangement used in mounting the various units of the transmitter.

Use an old 201A tube as they can usually be picked up for the asking. (Continued on page 548)

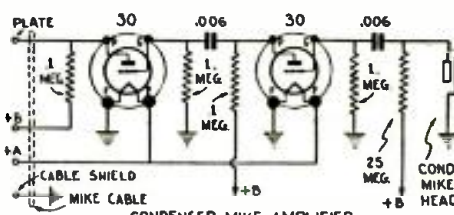

Circuit diagram of the 2 stage pre-amplifier used in conjunction with the condenser microphone.

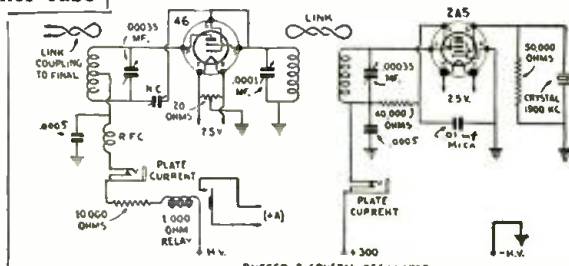

This is the "crystal-controlled" oscillator and buffer, using a 2A5 link-coupled to a 46.

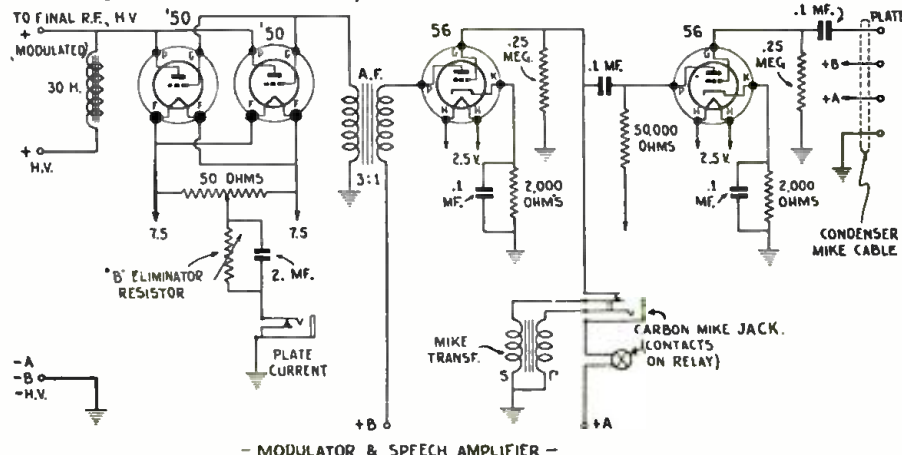

Above—we have the audio amplifier and modulator portion of Mr. Woehr's efficient transmitter.

# WHAT'S NEW

## In Short-Wave Apparatus

The short-wave apparatus here shown has been carefully selected for description by the editors after a rigid investigation of its merits.

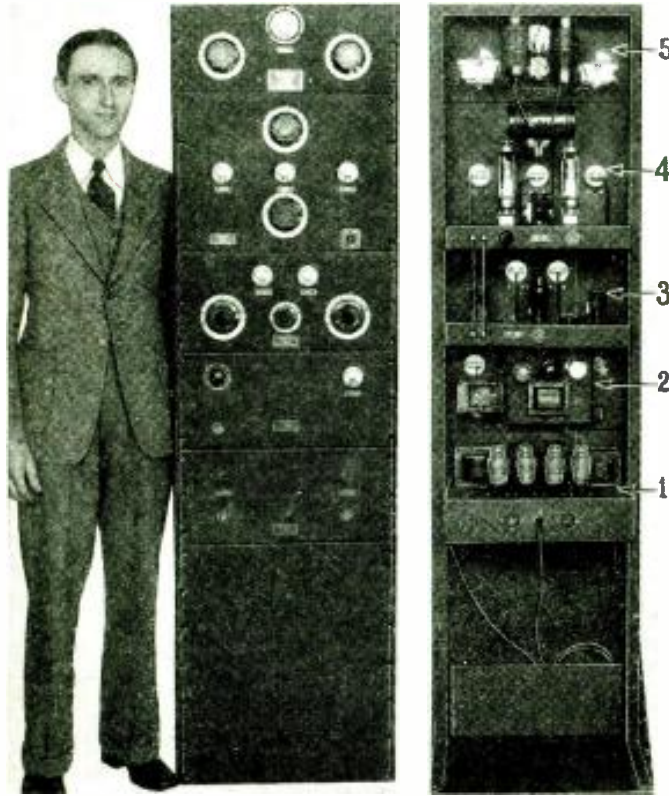

The designer poses with this beautiful modern rack and panel, 100-watt transmitter. No. 1—power supply unit. No. 2—modulator. No. 3—"Les-tet" exciter unit. No. 4—push-pull final amplifier. No. 5—antenna-matching network.

No. 236

● RACK-AND-PANEL construction, in the minds of most amateurs, has been associated with commercial stations. In the past this type of transmitter design has been something nice to think about, but few "hams" have had enough money to enjoy its obvious advantages in the way of appearance, mechanical strength, and electrical flexibility. For either permanent or experimental installations, a rack job is unquestionably ideal.

In his capacity as head of the amateur division of a large Eastern radio firm, the writer has noted the steadily increasing interest in rack transmitters and he has also observed that the biggest deterrent to their more widespread use is price. Accordingly, he decided to investigate the situation and see if something couldn't be done about it. From reading the hundreds of letters that came to him from amateurs all over the country, he judged that there was a definite demand for a transmitter of 100 watts rating, this figure representing a good level; anything smaller would not satisfy hams who already were pumping 40 or 50 watts into a single 210, and anything larger would mean excessive cost, particularly in the way of power equipment. The rack-and-panel idea, of course, was to be followed out entirely. The transmitter must also have the utmost stability, be arranged for optional modulation apparatus for phone at minimum cost, contain plenty of meters to tell what is going on in the circuits, and be adaptable to different types of antenna.

The transmitter as illustrated has been built up of a number of independent but inter-connecting units, a description of which undoubtedly will interest readers of SHORT WAVE CRAFT who are amateurs now or will be amateurs shortly.

First for a general idea of the outfit's physical size and layout. The whole job stands 6 feet high off the ground, and measures 19 3/4 inches wide and 16 3/4 inches

## Modern 100-Watt TRANSMITTER

100-Watt C.W. or 40-Watt Phone

By FRANK LESTER, W2AMJ\*

deep at the base. The rack is of sturdy one-inch structural iron, the panels of 1/8 inch steel. All surfaces are finished in black crackle, which is impervious to finger marks, moisture and all the other abuses to which a radio transmitter is subjected. There are five units of uniform width, from top to bottom as follows: universal antenna coupling unit, push-pull power amplifier, "Les-Tet" exciter unit, modulator, and power supply. A blank panel closing in the bottom is furnished for any use the owner cares to put it to.

### Les-Tet Exciter Unit

The "Les-Tet" exciter unit is shown diagrammatically in Fig. 1. This uses a single 2B6 tube in a circuit developed by the writer and found to possess highly desirable characteristics. The 2B6, which has not received the recognition it deserves, consists of two triodes in one envelope, with the cathode of the first and smaller "tube" connected internally to the grid of the larger "tube." This construction permits the use of the 2B6 as a marvelous crystal oscillator and buffer amplifier (or doubler) combination. The crystal is connected directly across grid G1 and cathode K1 of the first tube unit. The plate tank circuit, consisting of plug-in coil L1 and condenser C1, is connected above ground—between the cathode and ground, as shown. L1

(Continued on page 559)

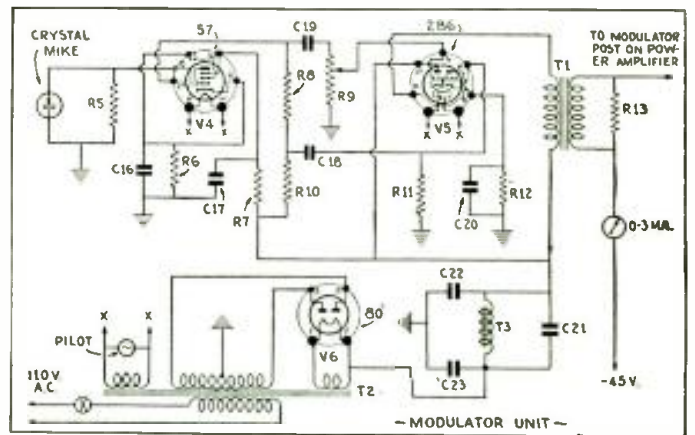

Circuit diagram of speech amplifier and modulator designed for suppressor grid modulation.

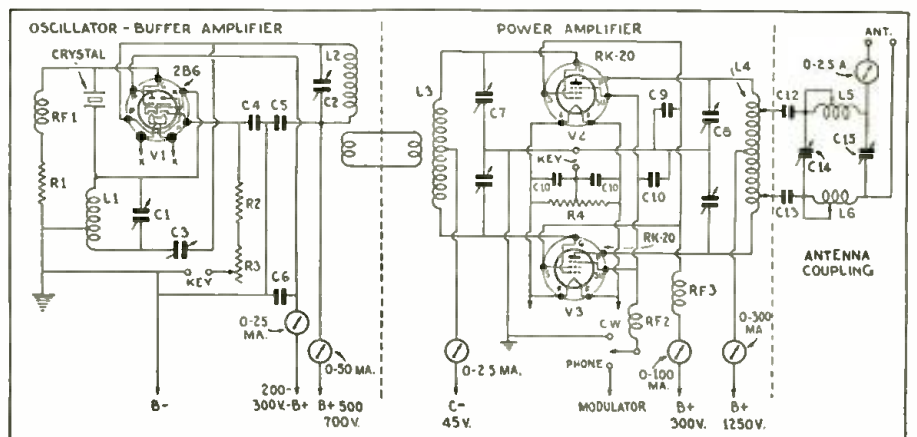

Above we have the diagram of the radio frequency portion using a 2B6 as oscillator and huffer, and a pair of RK-20's as "power amplifiers."

\*Engineer, Wholesale Radio Service Co., Inc.

Names and addresses of manufacturers of sets described on this and following pages furnished upon receipt of stamped envelope; mention No. of article.

# New Hi-Fi Aerial and Receiver Coupler Midget I.F. Transformer and New Equalizing Condenser

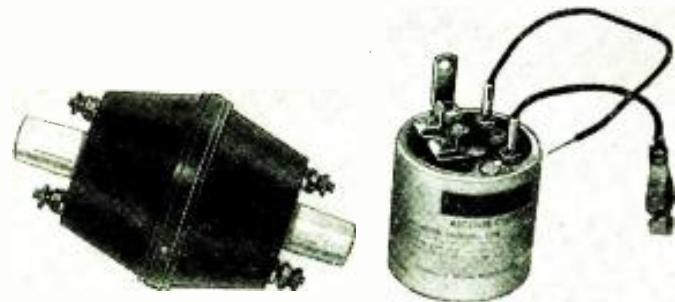

Left—New Hi-Fi Antenna and Receiver couplers, designed to increase the effectiveness of “noise-reducing” antennas. Designed by Arthur Lynch.

● IN the photograph we see the new Lynch antenna coupler and the Hi-Fi receiver coupler. The antenna coupler is housed in a weatherproof bakelite case, with the coils and condensers mounted inside on an Isolantite insulator. The two sections of the doublet antenna are fastened to this insulator and in this way there is absolutely no strain on the more delicate parts of the impedance matching transformer. This is intended primarily for doublet antennas, where a reduction in background noise is necessary. This patented coupler performs very efficiently

Refer to No. 245.

The receiver coupler is designed to match the transmission line coming from the antenna coupler and provide effective coupling to the receiver. It is adjustable for high and low impedance input windings to the receiver.

The antenna coupler consists of a special matching network which allows effective coupling on the short-wave bands and causes no loss in signal strength to stations in the regular broadcast band.

on the broadcast band, as well as the short-wave bands, and does not present the usual loss of the signal strength on the broadcast band when used with an all-wave receiver.



The new Hammarlund “midget” I.F. transformer and also latest “padding” condenser. No. 238.

● IN the above photograph we have two new Hammarlund products—one is an exceptionally small and efficient I.F. (intermediate frequency) transformer. It is designed to be used in compact receivers of the superheterodyne variety. Except for its size this transformer is mechanically and electrically the same as the popular two-inch Hammarlund transformers. It is a double-section transformer having both inductances tuned. The condensers are mounted on an isolantite base. The measurements are 3 1/2 inches high by 1 7/16 inches square.

The other interesting new item is a miniature equalizing condenser, measuring but 5/8" by 3/4" in size. This should prove very popular with the short-wave “Fans,” inasmuch as it can be tucked into an out-of-the-way place. Mica dielectric is used; also phosphor bronze spring-plates and it is mounted on isolantite.

## Two New National S-W Condensers

● THE National Company of Malden, Mass., recently announced the introduction of two very interesting items intended for short-wave use. One is the model TMS variable transmitting condenser available in two sizes, having a working voltage of 1000 and 2000 for use in oscillator, buffer, and doubler and low-power amplifiers of transmitters. It is an all-aluminum affair and it is solidly constructed with *isolantite* insulation. It should prove invaluable where space is at a premium. In the lower right-hand portion of the photograph we see a new mica dielectric midget *padding* condenser mounted on a *steatite* base. It is extremely light in weight and small in size and can be conveniently mounted directly on the leads, in much the same manner as fixed condensers, chokes, resistors, etc., are being used. It should serve excellently for padding various tuned circuits.

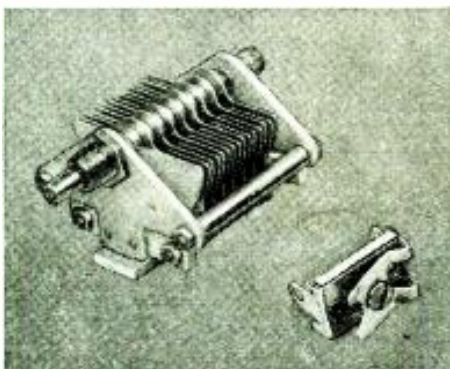

Two new National condensers of particular interest to all S.W. “Fans.” No. 239.

## The De Luxe Gothic RGH 4

● THE handsome panel niche makes for convenience in changing from one band to another as well as exceptional efficiency and short leads. The niche is made of metal and is formed to make a shield for the coil that it houses. No *hand-capacity* effects are evident on any of the bands. The circuit is of the regenerative type with three circuit coils in the tuned R.F. and the detector stages. A single 2A5 in

By Robert C. Herzog,  
B.S., E.E.\*

the output stage with a matched speaker is sufficient to bring in even the European stations on the loud-speaker.

The detector plate choke is a shielded high-impedance type, capable of carrying at least 3MA without saturation.

In wiring the set all the filament, screen,

and B plus leads are run around the edges of the chassis, so as to leave the center clear for the small parts and the more important wires. The radio frequency and detector plate and grid leads are wired from point to point with heavy bus-bar. The leads to the detector and the radio frequency grids should be as short as possible with No. 18 stranded wire.

When the set is completely wired, check  
(Continued on page 575)

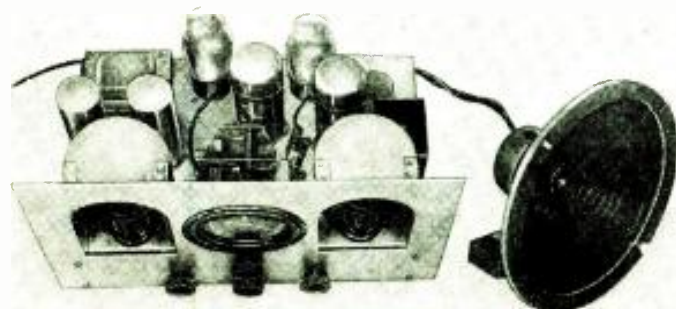

Above—the Deluxe Gothic RGH 4, a 4-tube short-wave receiver of improved design. Right—diagram showing values of parts and hook-up. No. 240.

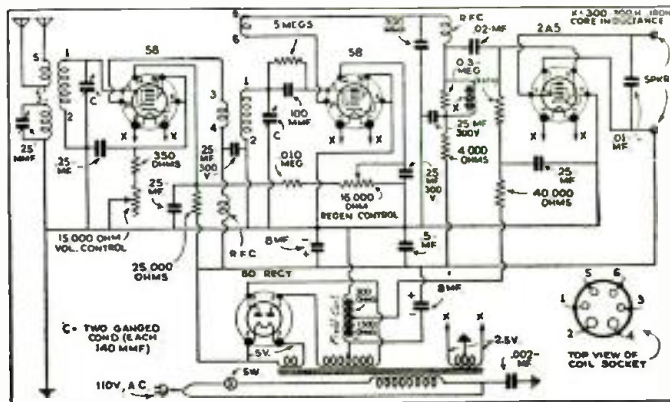

Names and addresses of manufacturers of sets described on this and following pages furnished upon receipt of stamped envelope; mention No. of article.

# Velocity MIKE Gives High Fidelity



Note the "professional" appearance of this new velocity type microphone, which is capable of excellent quality reproduction.

● THIS new Amperite *Velocity Microphone* opens up a new field for the radio experimenter who is interested in *high-quality* reproduction of voice or music. The velocity microphone being well-known as a high quality instrument has become rather popular within the last few years. This microphone has a frequency response of from 42 to 10,000 cycles per second, with a maximum difference of only 1 DB. (decibel). The instrument is made very rugged and is designed to take considerable abuse. It is not affected by temperature, pressure, or humidity, and is thoroughly shielded with a bronze and steel case. The model shown is the RA1 and is designed for public address and amateur radio work. The one necessary piece of

equipment that has to be used with a microphone of this type is an additional two stages of pre-amplification. We are showing a suitable circuit using two types 56 or 37 tubes. The output transformer which couples the microphone to the input circuit of

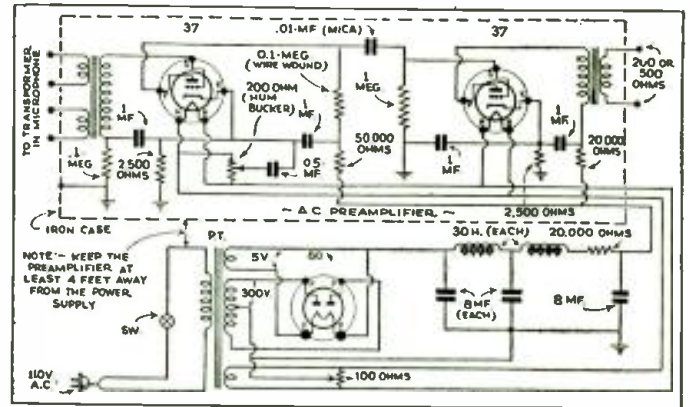

Diagram of suitable "pre-amplifier" to be used with the velocity type microphone. No. 241.

the amplifier is contained directly within the base of the microphone. It is truly professional in appearance and should appeal to the most critical radio man.

## All-Electric All-Wave Set By Guy Stokely, E. E.\*

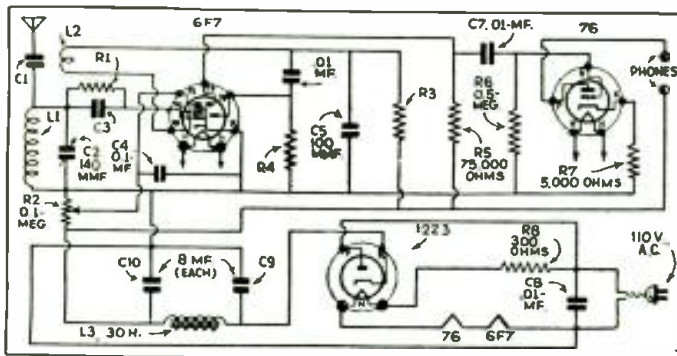

Diagram of this efficient 3-tube S.W. receiver. No. 242.

● THIS all-wave receiver has been designed to meet the present demand for a simple, inexpensive, and completely electrified short wave receiver that is capable of world-wide reception. There are many problems involved in the design of such a receiver. These problems are concerned with the attainment of sufficient oscillator stability, sensitivity, selectivity, and hum attenuation, and still employ only the absolute minimum number of parts. The present design, in the opinion of the author, represents the greatest value per unit of investment that it is possible to attain in designing such a simple receiver.

\*E. E. Ellen Radio Laboratories.

(Continued on page 556)

## 15 to 2000 Meter Receiver

● HERE is a really modern 15 to 2000 meter superheterodyne receiver. The short-wave bands from 15 to 200 meters, as well as the broadcast band and other wave lengths up to 2000 meters can be received very efficiently on this *Trans-Universal* receiver. It uses a new development in the switch and coil assemblies. In the photograph the coils can be clearly seen beside the set and are identical to those incorporated in this receiver. It has full automatic volume control with an inter-channel noise suppressing switch. By a simple flip of this switch, all noises usually encountered in between stations with receivers having automatic volume control can be eliminated. The set uses a stage of tuned R.F. ahead of the first detector and this stage is *tuned* all the way down to 15 meters practically eliminating repeat points on wave lengths as low as 15 meters.

(Continued on page 558)

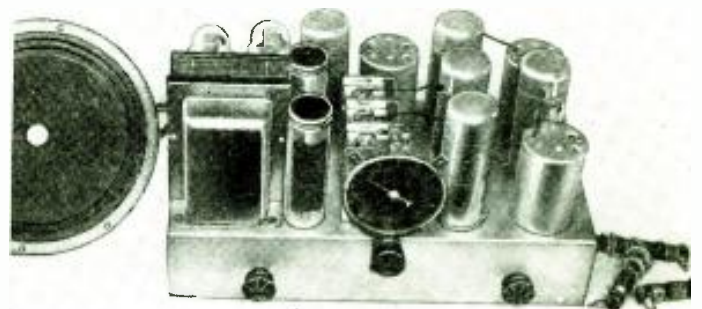

Wiring diagram of the "Trans-Universal" All-Wave Receiver No. 246.

# A TRANSCEIVER of Improved Design

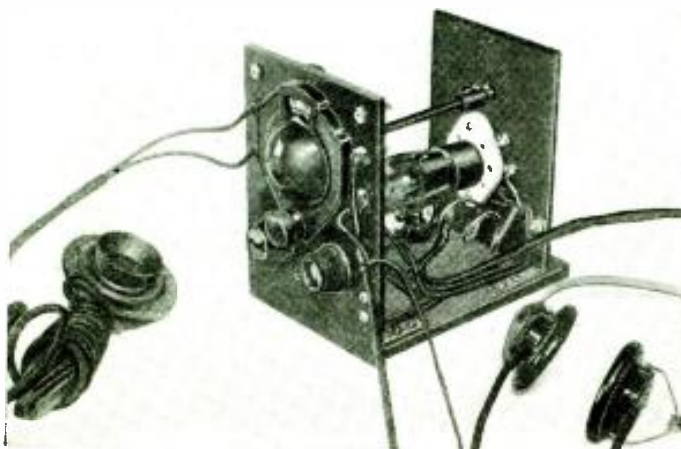

The "works" of the Knight "Transceiver." No. 243.

● THE Transceiver which is here described, illustrates the simplest and least expensive form in which the unit can be constructed.

This transceiver offers a good illustration of the use of a type 19 tube as a push-pull oscillator for transmission, and a push-pull super-regenerative detector for reception. The plate coil is made of a copper tubing. The grid coil is placed inside of the plate coil, affording unity coupling. The center tap of the grid is brought out through a hole in the tubing. The tank is tuned by means of a 15 mmf. midget variable condenser.

Grid modulation is employed, the microphone varying the grid bias at voice frequencies. It is well to note at this point, that the transmitter will not oscillate with the microphone lying flat. This may be illustrated by holding a single turn of wire through a pilot light near the tank

(Continued on page 557)

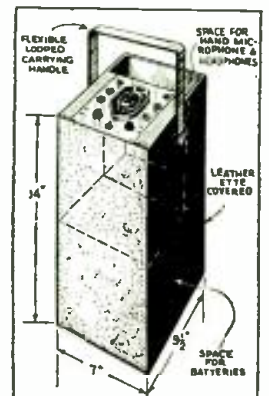

Drawing showing case which houses the "Transceiver" and battery compartment.



Extremely compact yet a very smooth-working set is the new Harrison "5 in 3" 3-tube S.W. receiver. It uses plug-in coils and has all the latest refinements. No. 247.

# Five-In-Three Makes Compact A.C.-D.C. Set

By WILLIAM GREEN\*

● This remarkable 3-tube receiver actually gives the results of five tubes! A 6F7 tube takes care of the R.F. and detector stages; a 76 is the first A.F. and a 12A7 acts as a power output pentode and rectifier.

● AFTER trying many different circuits I realized that what a fellow really needs is a set small in size, light enough to be easily carried around, with power supply, speaker, and all built right in. A set that really gets them all on the speaker with real volume. The receiver shown here is really all of this and more. Its weight with tubes, speaker, etc., in operating condition is only eight pounds, and what's more you can plug it into any 110 volt outlet, either A.C. or D.C., and you're ready to go. The set has been designed so that it is very sensitive to the weakest signals which are built up through the successive R.F., detector, high gain first audio, and power pentode output stages so that they reach the speaker with lots of clean volume.

### Secret of the Circuit

After carefully looking over the current requirements of new tubes the ones that I found to fit in exactly with the requirements were the 6F7 pentode-triode, the 76 super-triode, and the 12A7 power pentode-rectifier. Let us take them in order. The 6F7 tube contains four grids, two plates, a cathode, and a heater. By referring to the diagram you will note that a grid and a plate are used as a triode and the remaining three grids and plate constitute a separate super-control R.F. pentode. The only common element is the cathode.

We all know the real heart of a short wave receiver is in the radio frequency and detector portion and when we speak of sensitivity we think of these circuits. Therefore, several different circuits and arrangements of parts were tried in order to select the smoothest operating, most powerful, and most sensitive combination. The result is the set described here which by far exceeded my fondest hopes. An R.F. stage is used to couple the antenna to the triode. The pentode is here selected so that a high gain may be provided before the signal reaches the detector. This is essential in a receiver that is to provide maximum amplification of the very weak signals. The R.F. stage has been carefully balanced and is condenser coupled to the following tube. The triode is the regenerative detector. Although an effort was made to eliminate super-

fluous parts, and thus make not only its cost low and the set light, but also easy to build and wire; enough bypass condensers were used to insure complete absence of hums, whistles, and fuzzy tone in the signals. Regeneration, you will find, is practically constant over the entire tuning range, with the annoying "dead spots" conspicuous by their absence. When building the detector I tried every conceivable type of feed-back and regeneration control. The potentiometer type was finally selected. In every way the potentiometer proved far more suitable. A variable condenser has a decided effect on the tuning. This means that it would be practically impossible to accurately log a station. With the control I have used, a station once received will always reappear at the same dial setting. It is interesting to note at this point that in one trial of the set it was found unnecessary to touch the regeneration control after it was once set. Several stations, one after the other, were tuned in using only one control—the tuning knob.

### Two Audio Stages

For the purpose of amplifying the

signals, it was found necessary to use two stages. Here, as well as in the radio frequency end of the set, a great deal of consideration was given the choice of the most suitable tubes. Every tube was tried including the 6C6, 6D6, 37, and the 76. The latter was finally selected because it gave good voltage amplification with a minimum of distortion. The high gain of this supertriode was utilized by providing an unusually high plate load resistor—150,000 ohms!

The final circuits are in another new combination tube, the 12A7. This tube contains a pentode audio output section and a diode rectifier section all in one glass envelope. The pentode section is a full sized output tube and it swings the speaker with ease. The diode section is conventional in every way and is practically the same as a 12Z3.

### Self-Contained Power Supply

The 110 Volt current after passing through the rectifier is filtered by the choke and two 8 mfd. electrolytic condensers in an effort to eliminate every trace of hum.

(Continued on page 552)

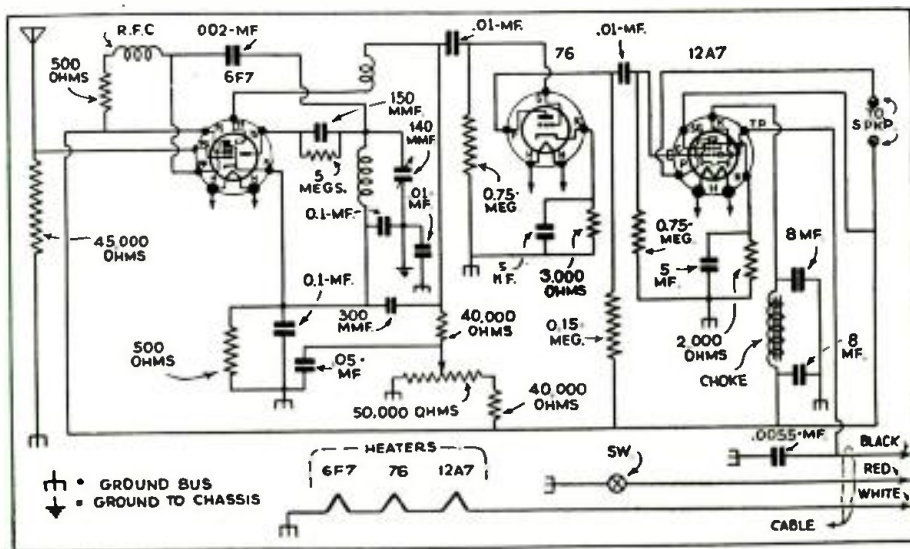

Wiring diagram for the Harrison "5 in 3" A.C.-D.C. set which operates on 110 volts alternating or direct current.

\*Design Engineer, Harrison Radio Company.

**\$5.00 Prize  
SIMPLE ANTENNA  
COUPLER**

Here is a description of a home-made antenna coupler that can be used in conjunction with any of the four prong plug-in coils. Two pieces of hard rubber were cut from an old panel and drilled as shown in the accompanying drawing. (FIG. 11. The primary coil consists of ten turns No. 21 D.S.C. copper wire, wound on a form of approximately two and one eighth inches. Paper is first wrapped several times around

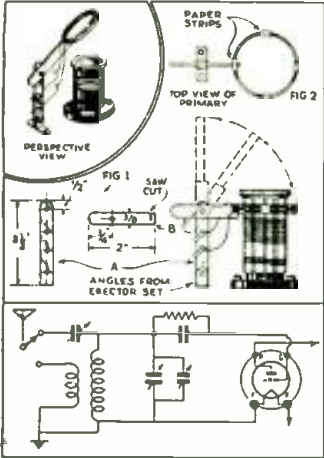

a two inch form and the end pasted. The wire is then wound over this, the turns being kept close together, and glued in several places. Small strips of paper are then glued on the outside of the coil and left to dry. The coil is then removed from the form and the strips of paper are then fastened around the turns, making a firm, self-supporting coil. The coil is fastened to the little rubber strips by inserting it into the saw cut at one end and glued. (Fig. 2)—Ernest Dummer.

**HANDY MAP**

This map will be most convenient to a Short Wave listener. I am very much satisfied with this map. It is made out of an old blind, set up the blind and glue your map to it. When not in use zip-up. This is welcome where space is limited.—John Vetter.



**GRID CLIP FROM CUR-  
TAIN SPRING**

Here is a description of an improved grid cap connector made out of spring curtain rods. A spring can be obtained at any five and ten cent store. Cut a piece of spring about one and one half inch long, put the ends together and put a drop of

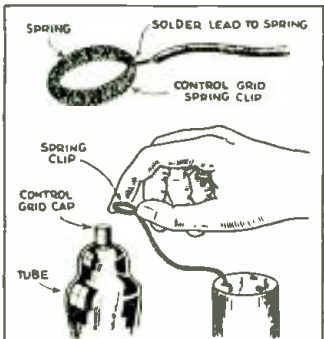

solder on to hold the ends tight together. Then solder a piece of wire on for the connection. Then place the completed cap over the grid connection of the tube as shown.—Ervin Sperath.

**\$5.00 FOR BEST  
SHORT WAVE KINK**

The Editor will award a five dollar prize each month for the best short-wave kink submitted by our readers. All other kinks accepted and published will be paid for at regular space rates. Look over these "kinks" and they will give you some idea of what the editors are looking for. Send a typewritten or ink description, with sketch, of your favorite short-wave kink to the "Kink" Editor, SHORT WAVE CRAFT.

**KEEPING PHONE CORDS  
UNTANGLED**

After having so much trouble with the wire on my set of headphones, always continually twisting, I hit upon the idea of twisting push back wire around the two wires from phone to plug in cable. It solved the situation completely as it keeps the wires in the most convenient place.—Joel Levy, Jr.

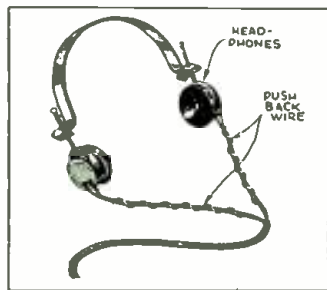

**SIMPLE P.A. SYSTEM**

Many times I have desired to make use of a public address system at parties, etc., and finally hit upon the idea of constructing a 215 oscillator which can be connected directly to the broadcast receiver. The oscillator is modulated with an ordinary microphone in series with the B negative supply. By tuning the oscillator and broadcast receiver to resonance the oscillator acts as a miniature broadcasting station and full speaker volume can be obtained. However, care should be taken to make sure that this instrument does not interfere with other receivers in the neighborhood.—Marine Schell.

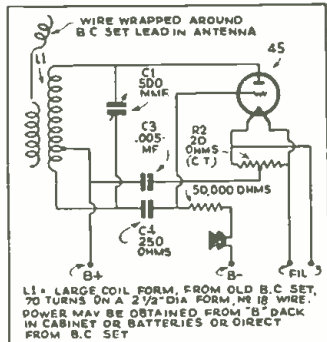

**HANDY 2-GANG CONDENSER  
KINK**

Short Wave condensers are quite expensive and having some old 00035 on hand I thought of separating the stator plates, in half and making two small condensers which would be ganged together, and varied by the same rotor. Taking the condenser in half, with the center plate removed and four plates on each side, the condensers will have a capacity of about .00015 mf. each. The old condenser is taken apart or rather the stator is removed, the sides cut through at the middle plate which is removed, and the inside ends filed smooth. A metal plate is cut out to fit in between. And when the stators are assembled back this plate is inserted between the stators with rubber insulators holding it in place tightly. It is then grounded thus shielding the two condensers. I have used this condenser in the two tube super-het in your December issue and have obtained fine results. Diagram appears above in next column.—E. M. Granville.

**HANDY SUBSTITUTE**

For the "Ham" who gets all set to test his Transmitter some evening and finds that his neon test bulb has been lost, stepped on, or the baby has swallowed it. Dig down in the junk box and salvage an old Raytheon He-tiller tube, type 3H, connect the four prongs with a piece of bare wire and you have a serviceable test bulb as you had before, giving a glow much the same as your neon bulb.—Marine Schell.

**TOOLS FOR WORKING  
METAL CHASSIS**

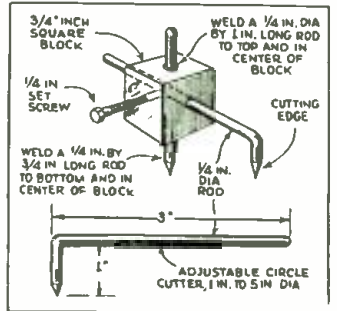

The above diagram clearly shows the construction of an instrument which can be used for cutting large holes in bakelite or metal panels. The drawing clearly indicates how simply this tool can be constructed. The cutting instrument should be made of high grade steel especially where hard materials are being worked. The 3/4 inch square block can be made of ordinary iron. The drawing below shows a very simple method

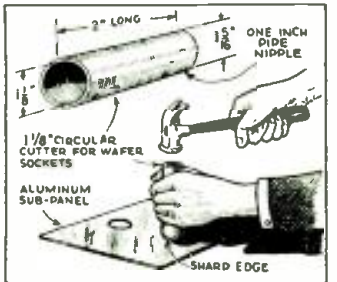

of constructing a punch for making socket holes in metal panels or chassis. Secure a piece of 1 5/16 inch outside diameter pipe, file each end as straight as possible and sharpen one end in order that a cutting edge will be effected. Simply place the panel to be punched over some hard wooden material.—S. B. Wells.

**HANDY SWITCH MOUNT**

Here is drawing of a debradable switch mount. This is made from an old discarded metal case earphone. You just have to drill a hole in the middle and mount the switch. Then lead the wires from the switch out of a hole drilled in the side.

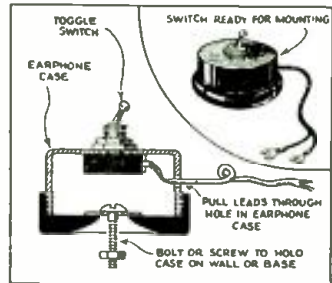

This is very handy for "bread-board" transmitters and receivers and in dark places, where it is hard to find small toggle switches. It is a good idea to have a large washer when you mount the earphone cap, so as to take the strain off the bakelite.—Joe Berkstefer.

**NOVEL STAND-OFF IN-  
SULATOR**

A very efficient stand-off insulator can be constructed from a 5 inch porcelain insulating tube. Both ends of the tube are fitted with wood dowels, in order to facilitate mounting. The drawing below clearly shows how the screw is fastened in one end and how the base is fitted to the other end.—George Shenberger.

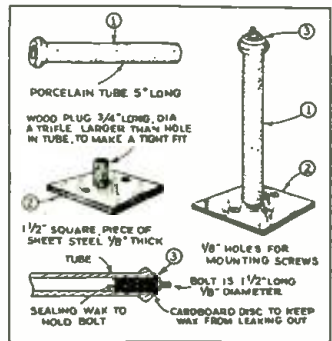

**INCREASING SIZE OF  
TUBE BASE COILS**

By using two tube bases as shown in the diagram you can increase the length of the coil in order to accommodate the larger windings. This is done by sawing off the prong end of one tube base. Then put the two coils end to end and wrapping them with glued paper. R. S. Dekker.

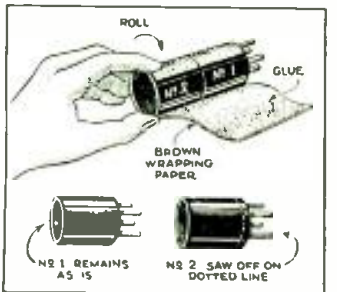

**CHEAP LEAD-IN**

I think that a pair of lead-in holes made from two coffee pot tops is the cheapest that any "Ham" can get. Drill a hole in each top and through the pane of glass, then put one on each side of the window pane with a 6"x1/4" brass bolt with a washer and nut on each end of the tops.—Harry Gaul.

# Short Wave Stations of the World

## Complete List of Broadcast, Police and Television Stations

We present herewith a revised list of the short-wave broadcasting, experimental and commercial radiophone stations of the world. This is arranged by frequency, but the wavelength figures are also given for the benefit of readers who are more accustomed to working with "meters." All the stations in this list use telephone transmission of one kind or another

and can therefore be identified by the average listener.

Herewith is also presented a very fine list of police as well as television stations. Note: Stations marked with a star ★ are the most active and easily heard stations and transmit at fairly regular times.

Please write to us about any new stations or other important data that you

learn through announcements over the air or correspondence with the stations themselves. A post card will be sufficient. We will safely return to you any verifications that you send in to us. Communications of this kind are a big help.

Stations are classified as follows: C—Commercial phone. B—Broadcast service. X—Experimental transmissions.

## Around-the-Clock Listening Guide

Although short wave reception is notorious for its irregularity and seeming inconsistency (wherein lies its greatest appeal to the sporting listener), it is a good idea to follow a general schedule as far as wavelength in relation to the time of the day is concerned. The observ-

ance of a few simple rules will save the short wave fan a lot of otherwise wasted time.

From daybreak till noon and particularly during bright daylight, listen between 13 and 19 meters (21540 to 15800 kc.).

To the east of the listener, from about 1 P.M.-6 P.M., the 25-35 meter will be found very

productive. To the west of the listener this same band is best from about 7 P.M. until shortly after daybreak. (After dark, results above 35 meters are usually much better than during daylight. These general rules hold for any location.

## Short-Wave Broadcasting, Experimental and Commercial Radiophone Stations

<b>21540 kc. W8XK</b> -B- 13.93 meters WESTINGHOUSE ELECTRIC PITTSBURGH, PA. 7 a. m.-2 p. m.; relays KDKA	<b>19220 kc. WKF</b> -C- 15.60 meters LAWRENCEVILLE, N. J. Calls England, daytime	<b>17810 kc. PCV</b> -C- 16.84 meters KOOTWIJK, HOLLAND Calls Java, 6-9 a. m.	<b>15880 kc. FTK</b> -C- 18.90 meters ST. ASSISE, FRANCE Phones Saigon, morning	<b>15270 kc. ★W2XE</b> -B- 19.65 meters ATLANTIC BROADCASTING CORP. 485 Madison Av., N.Y.C. Relays WABC daily, 11 a. m.-1 p. m.
<b>21420 kc. WKK</b> -C- 14.01 meters A. T. & T. CO. LAWRENCEVILLE, N. J. Calls Argentina, Brazil and Peru, daytime	<b>19160 kc. GAP</b> -C- 15.66 meters RUGBY, ENGLAND Calls Australia, early a. m.	<b>17790 kc. GSG</b> -B- 16.86 meters BRITISH BROAD. CORP. DAVENTRY, ENGLAND See "When to Listen In" Column	<b>15810 kc. LSL</b> -C- 18.98 meters HURLINGHAM, ARGENTINA Calls Brazil and Europe, daytime	<b>15250 kc. W1XAL</b> -B- 19.67 meters BOSTON, MASS. Irregular, in morning
<b>21060 kc. WKA</b> -C- 14.25 meters LAWRENCEVILLE, N. J. Calls England noon	<b>18970 kc. GAQ</b> -C- 15.81 meters RUGBY, ENGLAND Calls S. Africa, mornings	<b>17780 kc. ★W3XAL</b> -B- 16.87 meters NATIONAL BROAD. CO. BOUND BROOK, N. J. Relays WJZ, 10 a. m.-4 p. m. every day	<b>15760 kc. JYT</b> -X- 19.04 meters KEMIKWA-CHO, CHIBAKEN, JAPAN Irregular in late afternoon and early morning	<b>15243 kc. ★FYA</b> -B- 19.68 meters "RADIO COLONIAL" PARIS, FRANCE Service de la Radiodiffusion 103 Rue de Grenelle, Paris 7:30-11 a. m.
<b>21020 kc. LSN6</b> -C- 14.27 meters HURLINGHAM, ARG. Calls N. Y. C. 8 a. m.-5 p. m.	<b>18830 kc. PLE</b> -C- 15.93 meters BANDENG, JAVA Calls Holland, early a. m.	<b>17760 kc. DJE</b> -B- 16.89 meters REICHS-RUNDFUNK-GESELLSCHAFT BERLIN, GERMANY Irregular 8 a. m.-2 p. m.	<b>15660 kc. JVE</b> -C- 19.16 meters NAZAKI, JAPAN Phones Java 3-5 a. m.	<b>15220 kc. PCJ</b> -X- 19.71 meters S. A. PHILIPS' RADIO EINDHOVEN, HOLLAND Broadcasts irregularly in morning relaying P.H.I.
<b>20700 kc. LSY</b> -C- 14.49 meters MONTE GRANDE ARGENTINA Tests irregularly	<b>18620 kc. GAU</b> -C- 16.11 meters RUGBY, ENGLAND Calls N. Y., daytime	<b>17760 kc. IAC</b> -C- 16.89 meters PIZA, ITALY Calls ships, 6:30-7:30 a. m.	<b>15620 kc. JVF</b> -C- 19.2 meters NAZAKI, JAPAN Phones U.S., 5 a. m. & 8 p. m.	<b>15210 kc. ★W8XK</b> -B- 19.72 meters WESTINGHOUSE ELECTRIC & MFG. CO. PITTSBURGH, PA. 10 a. m.-4:15 p. m. Relays KDKA
<b>20380 kc. GAA</b> -C- 14.72 meters RUGBY, ENGLAND Calls Argentina, Brazil, mornings	<b>18345 kc. FZS</b> -C- 16.35 meters SAIGON, INDO-CHINA Phones Paris, early morning	<b>17310 kc. W3XL</b> -X- 17.33 meters NATIONAL BROAD. CO. BOUND BROOK, N. J. Relays WJZ irregularly	<b>15415 kc. KWO</b> -C- 19.46 meters DIXON, CAL. Phones Hawaii 2-7 p. m.	<b>15200 kc. ★DJB</b> -B- 19.73 meters REICHS-RUNDFUNK-GESELLSCHAFT BERLIN, GERMANY 12:15-2 a. m., 8-11:30 a. m. Also 4-5:30 a. m. on Sundays
<b>19900 kc. LSG</b> -C- 15.08 meters MONTE GRANDE, ARGENTINA Tests irregularly, daytime	<b>18340 kc. WLA</b> -C- 16.36 meters LAWRENCEVILLE, N. J. Calls England, daytime	<b>17120 kc. WOO</b> -C- 17.52 meters A. T. & T. CO., OCEAN GATE, N. J. Calls ships	<b>15410 kc. PRADO</b> -B- 19.47 meters RIOBAMBA, ECUADOR 4:30-6 p. m. Sun.	<b>15140 kc. ★GSF</b> -B- 19.82 meters BRITISH BROAD. CORP. DAVENTRY, ENGLAND See "When to Listen In" Column
<b>19820 kc. WKN</b> -C- 15.14 meters LAWRENCEVILLE, N. J. Calls England, daytime	<b>18250 kc. FTO</b> -C- 16.43 meters ST. ASSISE, FRANCE Calls S. America, daytime	<b>17120 kc. WOY</b> -C- 17.52 meters LAWRENCEVILLE, N. J.	<b>15355 kc. KWU</b> -C- 19.53 meters DIXON, CAL. Phones Hawaii	<b>15120 kc. HVJ</b> -B- 19.83 meters VATICAN CITY ROME, ITALY 5:00 to 5:15 a. m., except Sunday. Also Sat. 10-10:30 a. m.
<b>19650 kc. LSN5</b> HURLINGHAM, ARGENTINA Calls Europe, daytime -C- 15.27 meters	<b>18200 kc. GAW</b> -C- 16.48 meters RUGBY, ENGLAND Calls N. Y., daytime	<b>17080 kc. GBC</b> -C- 17.56 meters RUGBY, ENGLAND Calls Ships	<b>15340 kc. DJR</b> -Z- 19.56 meters REICHS-RUNDFUNK-GESELLSCHAFT, BERLIN, GERMANY Testing irregularly	<b>15090 kc. RKI</b> -C- 19.88 meters MOSCOW, U.S.S.R. Phones Tashkent near 7 a. m. and relays RNE on Sundays irregularly
<b>19600 kc. LSF</b> -C- 15.31 meters MONTE GRANDE, ARGENTINA Tests irregularly, daytime	<b>18135 kc. PMC</b> -C- 16.54 meters BANDENG, JAVA Phones Holland, early a. m.	<b>16270 kc. WLK</b> -C- 18.44 meters LAWRENCEVILLE, N. J. Calls England, Arg., Braz., Peru, daytime	<b>15330 kc. ★W2XAD</b> -B- 19.56 meters GENERAL ELECTRIC CO. SCHENECTADY, N. Y. Relays WGY daily, 2:30-3:30 p. m.	<b>15055 kc. WNC</b> -C- 19.92 meters HIALEAH, FLORIDA Calls Central America, daytime
<b>19380 kc. WOP</b> -C- 15.48 meters OCEAN GATE, N. J. Calls Peru, daytime	<b>18115 kc. LSY3</b> -C- 16.56 meters MONTE GRANDE, ARGENTINA Tests irregularly	<b>16270 kc. WOG</b> -C- 18.44 meters OCEAN GATE, N. J. Calls England, morning and early afternoon	<b>15300 kc. CP7</b> -B- 19.6 meters LA PAZ, BOLIVIA	
<b>19355 kc. FTM</b> -C- 15.50 meters ST. ASSISE, FRANCE Calls Argentine, mornings	<b>18040 kc. GAB</b> -C- 16.63 meters RUGBY, ENGLAND Calls Canada, morn. & early aftn.	<b>16233 kc. FZR3</b> -C- 18.48 meters SAIGON, INDO-CHINA Calls Paris and Pacific Isles	<b>15280 kc. DJQ</b> -X- 19.63 meters REICHS-RUNDFUNK-GESELLSCHAFT, BERLIN, GERMANY Tests irregularly	

(Time given is Eastern Standard Time)

<b>14980 kc. KAY</b> -C- 20.03 meters MANILA, P. I. Phones Pacific Isles	<b>12780 kc. GBC</b> -C- 23.47 meters RUGBY, ENGLAND Calls ships	<b>11720 kc. FYA</b> -B- 25.6 meters "RADIO COLONIAL" PARIS, FRANCE 6:15-9 p. m. 10 & m.-12 midnight	<b>9950 kc. GCU</b> -C- 30.15 meters RUGBY, ENGLAND Calls N.Y.C. evening	<b>9575 kc. KZRM</b> -B- 31.33 meters ERLANGER & GALINGER, INC. MANILA, PHIL. ISL. Broadcasts irregularly from 5-9 a. m.
<b>14950 kc. HJB</b> -C- 20.07 meters BOGOTA, COL. Calls WNC, daytime	<b>12290 kc. GBU</b> -C- 24.41 meters RUGBY, ENGLAND Calls N.Y.C., afternoon	<b>11680 kc. KIO</b> -X- 25.68 meters KAHUKU, HAWAII Tests in the evening	<b>9890 kc. LSN</b> -C- 30.33 meters HURLINGHAM, ARGENTINA Calls New York, evenings	<b>9570 kc. ★W1XAZ</b> -B- 31.35 meters WESTINGHOUSE ELECTRIC & MFG. CO. SPRINGFIELD, MASS. Relays WBZ, 7 a. m.-1 a. m.
<b>14590 kc. WMN</b> -C- 20.56 meters LAWRENCEVILLE, N. J. Phones England morning and afternoon	<b>12150 kc. GBS</b> -C- 24.69 meters RUGBY, ENGLAND Calls N.Y.C., afternoon	<b>10770 kc. GBP</b> -C- 27.85 meters RUGBY, ENGLAND Calls Sydney, Austral. early a. m.	<b>9870 kc. WON</b> -C- 30.4 meters LAWRENCEVILLE, N. J. Phones England, evening	<b>9565 kc. VUB</b> -B- 31.36 meters BOMBAY, INDIA 11 a. m.-12:30 p. m., Wed., Sat.
<b>14535 kc. HBJ</b> -B- 20.64 meters RADIO NATIONS, GENEVA, SWITZERLAND Broadcasts irregularly	<b>12000 kc. ★RNE</b> -B- 25 meters MOSCOW, U. S. S. R. Sat. 10-11 p. m. Sun. 6-7 a. m., 10-11 a. m.	<b>10740 kc. JVM</b> -C- 27.93 meters NAZAKI, JAPAN Phones California evenings	<b>9860 kc. ★EAQ</b> -B- 30.43 meters P. O. Box 951 MADRID, SPAIN Daily except Saturday, 5:15-7 p. m.; Saturday, 1-3 p. m., 5:15-7:30 p. m.; Tues. and Thurs. 5:15-7:30 p. m.	<b>9560 kc. DJA</b> -B- 31.38 meters BROADCASTING HOUSE, BERLIN 8-11:30 a. m., 5:15-9:15 p. m. also 4-5:30 a. m., Sundays
<b>14500 kc. LSM2</b> -C- 20.69 meters HURLINGHAM, ARGENTINA Calls U. S., evening	<b>11991 kc. FZS2</b> -C- 25.02 meters SAIGON, INDO-CHINA Phones Paris, morning	<b>10675 kc. WNB</b> -C- 28.1 meters LAWRENCEVILLE, N. J. Calls Bermuda, daytime	<b>9840 kc. JYS</b> -X- 30.49 meters KEMIKAWA-CHO, CHIBA- KEN, JAPAN Irregular, 4-7 a. m.	<b>9540 kc. DJN</b> -X- 31.45 meters REICHS-RUNDFUNK- GESELLSCHAFT, BERLIN, GERMANY Tests irregularly
<b>14485 kc. TIR</b> -C- 20.71 meters CARTAGO, COSTA RICA Phones Cen. Amer. & U.S.A. Daytime	<b>11950 kc. KKQ</b> -X- 25.10 meters BOLINAS, CALIF. Tests, irregularly, evenings	<b>10660 kc. JVN</b> -C- 28.14 meters NAZAKI, JAPAN Tests 2-7 a. m.	<b>9800 kc. LSE</b> -C- 30.61 meters MONTE GRANDE, ARGENTINA Tests irregularly	<b>9540 kc. LKJ1</b> -B- 31.45 meters JELOY, NORWAY Relays Oslo 10 a. m.-4 p. m.
<b>14485 kc. HPF</b> -C- 20.71 meters PANAMA CITY, PAN. Phones WNC daytime	<b>11940 kc. FTA</b> -C- 25.13 meters STE. ASSISE, FRANCE Phones CNR morning, Hurlingham, Arge., nights	<b>10550 kc. WOK</b> -C- 28.44 meters LAWRENCEVILLE, N. J. Phones Arge., Braz., Peru, nights	<b>9790 kc. GCW</b> -C- 30.64 meters RUGBY, ENGLAND Calls N.Y.C., evening	<b>9530 kc. ★W2XAF</b> -B- 31.48 meters GENERAL ELECTRIC CO. SCHENECTADY, N. Y. Relays WGY 7:25-11:30 a. m., Sundays, 7:25 p. m.-12:30 a. m.
<b>14485 kc. TGF</b> -C- 20.71 meters GUATEMALA CITY, GUAT. Phones WNC daytime	<b>11885 kc. ★FYA</b> -B- 25.24 meters "RADIO COLONIAL" PARIS, FRANCE 11:15 a. m.-2:15 p. m., 3-6 p. m.	<b>10520 kc. VLK</b> -C- 28.51 meters SYDNEY, AUSTRALIA Calls Rugby, early a. m.	<b>9780 kc. I2RO</b> -B- 30.67 meters E. I. A. R. ROME, ITALY Monday, Wed., Fri. 6:30-8 p. m. and irregularly at other hours.	<b>9510 kc. ★GSB</b> -B- 31.55 meters BRITISH BROAD. CORP., DAVENTRY, ENGLAND See "When to Listen In" Column
<b>14485 kc. YNA</b> -C- 20.71 meters MANAGUA, NICARAGUA Phones WNC daytime	<b>11870 kc. ★W8XK</b> -B- 25.26 meters WESTINGHOUSE ELECTRIC & MFG. CO. PITTSBURGH, PA. 4:20-10:00 p. m. Sat. till 1 a. m. Relays KDKA	<b>10430 kc. YBG</b> -C- 28.76 meters MEDAN, SUMATRA 5:30-6:30 a. m., 7:30-8:30 p. m.	<b>9760 kc. VLJ-VLZ2</b> -C- 30.74 meters AMALGAMATED WIRELESS OF AUSTRALIA SYDNEY, AUSTRALIA Phones Java and N. Zealand early a. m.	<b>9510 kc. ★VK3ME</b> -B- 31.55 meters AMALGAMATED WIRELESS, Ltd. G. P. O. Box 1272L, MELBOURNE, AUSTRALIA Wed., 5-6:30 a. m.; Saturday, 5:00-7:00 a. m.
<b>14470 kc. WMF</b> -C- 20.73 meters LAWRENCEVILLE, N. J. Phones England morning and afternoon	<b>11860 kc. ★GSE</b> -B- 25.29 meters BRITISH BROAD. CORP., DAVENTRY, ENGLAND See "When to Listen In" Column	<b>10420 kc. XGW</b> -C- 28.79 meters SHANGHAI, CHINA Calls Manila and England, 6-9 a. m. and California late evening	<b>9750 kc. WOF</b> -C- 30.77 meters LAWRENCEVILLE, N. J. Phones England, evening	<b>9505 kc. ★PRF5</b> -B- 31.58 meters RID DE JANEIRO, BRAZIL Daily except Sun. 5:30-6:15 p. m.
<b>14440 kc. GBW</b> -C- 20.78 meters RUGBY, ENGLAND Calls U.S.A., afternoon	<b>11855 kc. DJP</b> -X- 25.31 meters REICHS-RUNDFUNK- GESELLSCHAFT BERLIN, GERMANY Tests irregularly	<b>10410 kc. PDK</b> -C- 28.80 meters KOOTWIJK, HOLLAND Calls Java 7:30-9:40 a. m.	<b>9710 kc. GCA</b> -C- 30.89 meters RUGBY, ENGLAND Calls Arge. & Brazil, evenings	<b>9428 kc. COH</b> -B- 31.8 meters 2 B ST., VEDADO, HAVANA, CUBA Daily 8:30-10:30 p. m.
<b>13990 kc. GBA</b> -C- 21.44 meters RUGBY, ENGLAND Calls Buenos Aires, late afternoon	<b>11830 kc. ★W2XE</b> -B- 25.36 meters ATLANTIC BROADCASTING CORP. 485 MADISON AVE., N. Y. C. 3-5 p. m. Relays WABC	<b>10410 kc. KES</b> -X- 28.80 meters BOLINAS, CALIF. Tests evenings	<b>9600 kc. ★CT1AA</b> -B- 31.25 meters LISBON, PORTUGAL Tues. and Friday, 4:30-7 p. m.	<b>9415 kc. PLV</b> -C- 31.87 meters BANDONG, JAVA Phones Holland, 7:40-9:40 a. m.
<b>13610 kc. JYK</b> -C- 22.04 meters KEMIKAWA-CHO, CHIBA- KEN, JAPAN Phones California till 11 p. m.	<b>11811 kc. I2RO</b> -B- 25.4 meters ROME, ITALY	<b>10350 kc. ★LSX</b> -C- 28.96 meters MONTE GRANDE, ARGENTINA Tests irregularly 8 p. m.-12 mid- night. Used in Byrd Broadcasts	<b>9595 kc. ★HBL</b> -B- 31.27 meters LEAGUE OF NATIONS GENEVA, SWITZERLAND Saturdays, 5:30-6:15 p. m.	<b>9330 kc. CJA2</b> -C- 32.15 meters DRUMMONDVILLE, CANADA Phones England irregularly
<b>13585 kc. GBB</b> -C- 22.08 meters RUGBY, ENGLAND Calls Egypt & Canada, afternoons	<b>11795 kc. DJO</b> -X- 25.43 meters REICHS-RUNDFUNK- GESELLSCHAFT BERLIN, GERMANY Tests irregularly	<b>10330 kc. ★ORK</b> -C- 29.04 meters RUYSELEDE, BELGIUM Broadcasts 2:45-4:15 p. m.	<b>9590 kc. ★VK2ME</b> -B- 31.28 meters AMALGAMATED WIRELESS, LTD., 47 YORK ST. SYDNEY, AUSTRALIA See "When to Listen In" Column	<b>9280 kc. GCB</b> -C- 32.33 meters RUGBY, ENGLAND Calls Can. & Egypt, evenings
<b>13415 kc. GCJ</b> -C- 22.36 meters RUGBY, ENGLAND Calls Japan & China early morning	<b>11790 kc. W1XAL</b> -B- 25.45 meters BOSTON, MASS. Irregularly in the evening	<b>10300 kc. LSL2</b> -C- 29.13 meters HURLINGHAM, ARGENTINA Calls Europe, evenings	<b>9590 kc. PCJ</b> -X- 31.28 meters S. A. PHILIPS' RADIO EINDHOVEN, HOLLAND Broadcasts irregularly	<b>9170 kc. WNA</b> -C- 32.72 meters LAWRENCEVILLE, N. J. Phones England, evening
<b>13390 kc. WMA</b> -C- 22.40 meters LAWRENCEVILLE, N. J. Phones England morning and afternoon	<b>11760 kc. DJD</b> -B- 25.51 meters BROADCASTING HOUSE, BERLIN 12-4:30 p. m.	<b>10290 kc. DIQ</b> -X- 29.16 meters KONIGSWUSTERHAUSEN, GERMANY Broadcasts irregularly	<b>9590 kc. W3XAU</b> -B- 31.28 meters NEWTOWN SQUARE, PA. Relays WCAU 12 noon 7:50 p. m.	<b>9020 kc. GCS</b> -C- 33.26 meters RUGBY, ENGLAND Calls N.Y.C., evenings
<b>12840 kc. WOY</b> -C- 23.36 meters LAWRENCEVILLE, N. J.	<b>11750 kc. ★GSD</b> -B- 25.53 meters BRITISH BROAD. CORP., DAVENTRY, ENGLAND See "When to Listen In" Column	<b>10260 kc. PMN</b> -C- 29.24 meters BANDONG, JAVA Calls Australia 5 a. m.	<b>9580 kc. GSC</b> -B- 31.32 meters BRITISH BROAD. CORP., DAVENTRY, ENGLAND See "When to Listen In" Column	<b>8775 kc. PNI</b> -C- 34.19 meters MAKASSER, CELEBES, D. E. I. Phones Java around 4 a. m.
<b>12840 kc. WOO</b> -C- 23.36 meters OCEAN GATE, N. J. Calls ships	<b>11730 kc. ★PHI</b> -B- 25.57 meters HUIZEN, HOLLAND Daily ex. Tue. & Wed. 8:00-9:30 or 10:30 a. m.	<b>10250 kv. LSK3</b> -C- 29.27 meters HURLINGHAM, ARGENTINA Calls Europe and U. S., after- noon and evening	<b>9580 kc. ★VK3LR</b> -B- 31.32 meters Research Section, Postmaster Gen'l's Dept., 61 Little Collins St., MELBOURNE, AUSTRALIA 3-8 a. m. except Sun.	<b>8760 kc. GCQ</b> -C- 34.25 meters RUGBY, ENGLAND Calls S. Africa, afternoon
<b>12825 kc. CNR</b> -B, C- 23.39 meters DIRECTOR GENERAL Telegraph and Telephone Stations, Rabat, Morocco Broadcasts, Sunday, 7:30-9 a. m.	<b>11720 kc. ★CJRJX</b> -B- 25.6 meters WINNIPEG, CANADA Daily 8 p. m.-12 m. Sunday, 8:10:30 p. m.	<b>10220 kc. PSH</b> -C- 29.35 meters RIO DE JANEIRO, BRAZIL		<b>8730 kc. GCI</b> -C- 34.36 meters RUGBY, ENGLAND Calls India, 8 a. m.

(Time given is Eastern Standard Time)



<p><b>8680 kc. GBC</b> -C- 34.36 meters RUGBY, ENGLAND Calls ships</p>	<p><b>6660 kc. TIEP</b> -B- 45.05 meters LA-VOZ DEL TROPICO SAN JOSE, COSTA RICA Irregular in evening</p>	<p><b>6120 kc. ★W2XE</b> -B- 49.02 meters ATLANTIC BROADCASTING CORP. 485 MADISON AVE., N. Y. C. Relays WABC. 6-11 p. m.</p>	<p><b>6060 kc. OXY</b> -B- 49.50 meters SKAMLEBOAEK, DENMARK 1-6:30 p. m.; also 11 a. m.-12 n. Sunday</p>	<p><b>5940 kc. TGX</b> -B- 50.5 meters SR. M. NOVALES, GUATEMALA CITY, GUAT. Daily except Sun., 8-10 a. m., 1-2:30 p. m., 8 p. m.-12 m.</p>
<p><b>8560 kc. WOO</b> -C- 35.05 meters OCEAN GATE, N. J. Calls ships irregular</p>	<p><b>6650 kc. IAC</b> -C- 45.1 meters PIZA, ITALY Calls ships, evenings</p>	<p><b>6115 kc. HJ1ABE</b> -B- 49.05 meters CARTAGENA, COL. P. O. Box 31 Daily 11:15 a. m.-1 p. m.; Sun. 9-11 a. m.; Mon. at 10 p. m. Wed. 8-10 p. m.</p>	<p><b>6060 kc. ★W8XAL</b> -B- 49.50 meters CROSLEY RADIO CORP. CINCINNATI, OHIO 7:30 a. m.-6 p. m.; 11 p. m.-1 a. m. Relays WLW</p>	<p><b>5930 kc. HJ4ABE</b> -B- 50.6 meters MEDELLIN, COLOMBIA Mon., 7-11 p. m.; Tues., Thurs., Sat., 6:30-8:00 p. m.; Wed. and Fri., 7:30-11:00 p. m.</p>
<p><b>8560 kc. WOY</b> -C- 35.05 meters LAWRENCEVILLE, N. J.</p>	<p><b>6620 kc. PRADO</b> -B- 45.30 meters RIOBAMBA, ECUADOR Thur. 9-11:30 p. m.</p>	<p><b>6112 kc. ★YV2RC</b> -B- 49.08 meters CARACAS, VENEZUELA Sundays, 9-11:30 a. m.; 1:30- 10:30 p. m.; Weekdays, 11:30 a. m.-1 p. m., 5:30-9:30 p. m.</p>	<p><b>6060 kc. VQ7LO</b> -B- 49.50 meters NAIROBI, KENYA, AFRICA Mon., Wed., Fri., 5:45-6:15 a. m., 11 a. m.-2 p. m. Tues., 3-4 a. m., 11 a. m.-2 p. m., Thurs., 8-9 a. m., 11 a. m.- 2 p. m., Sat., 11 a. m.-3 p. m., Sun., 10:50 a. m.-2 p. m.</p>	<p><b>5880 kc. HJ2ABA</b> -B- 51.02 meters TUNJA, COL. 1-2 p. m., 7:30-10 p. m.</p>
<p><b>8380 kc. IAC</b> -C- 35.8 meters PIZA, ITALY</p>	<p><b>6611 kc. RW72</b> -B- 45.38 meters MOSCOW, U. S. S. R. 1-6 p. m.</p>	<p><b>6110 kc. ★VE9HX</b> -B- 49.10 meters HALIFAX, NOVA SCOTIA 9:30 a. m.-1 p. m.; 6-12 p. m.</p>	<p><b>6060 kc. W3XAU</b> -B- 49.50 meters NEWTOWN SQUARE, PA. Relays WCAU Philadelphia 8 p. m.-11 p. m.</p>	<p><b>5853 kc. WOB</b> -C- 51.25 meters LAWRENCEVILLE, N. J. Calls Bermuda, nights</p>
<p><b>8214 kc. HCJB</b> -B- 36.5 meters QUITO, ECUADOR 7:14-10:15 p. m. except Monday</p>	<p><b>6500 kc. HJ5ABD</b> -B- 46.14 meters MANIZALES, COL. 12-1:30 p. m., 7-10 p. m.</p>	<p><b>6110 kc. VUC</b> -B- 49.1 meters CALCUTTA, INDIA Daily except Sat., 3-5:30 a. m., 9:30 a. m.-noon; Sat., 11:45 a. m.-3 p. m.</p>	<p><b>6050 kc. ★GSA</b> -B- 49.59 meters BRITISH BROADCAST CORP. DAVENTRY, ENGLAND See "When To Listen In" Col.</p>	<p><b>5792 kc. OA4AC</b> -B- 51.8 meters RADIO DUSA LIMA, PERU Irregularly 9-11:30 p. m.</p>
<p><b>8185 kc. PSK</b> -C- 36.65 meters RIO DE JANEIRO, BRAZIL 7-7:30 p. m. irregularly Relays PRA3</p>	<p><b>6447 kc. ★HJ1ABB</b> -B- 45.53 meters BARRANQUILLA, COL., S. A. P. O. BOX 715 11:30 a. m.-1 p. m.; 5-10 p. m.</p>	<p><b>6100 kc. HJ1ABD</b> -B- 49.18 meters CARTAGENA, COL. 11:30 a. m.-12:30 p. m.; 7-9 p. m.</p>	<p><b>6040 kc. W1XAL</b> -B- 49.67 meters BOSTON, MASS. Very irregular</p>	<p><b>5614 kc. HCK</b> -B- 52.5 meters QUITO, ECUADOR, S. A.</p>
<p><b>8036 kc. ★CNR</b> -B- 37.33 meters RABAT, MOROCCO Sunday, 2:30-5 p. m.</p>	<p><b>6425 kc. ★W3XL</b> -X- 46.70 meters NATIONAL BROADCASTING CO. BOUND BROOK, N. J. Tests irregularly</p>	<p><b>6100 kc. ★W3XAL</b> -B- 49.18 meters NATIONAL BROADCASTING CO. BOUND BROOK, N. J. Relays WJZ Monday, Wednesday, Saturday, 5:30 p. m.-1 a. m.</p>	<p><b>6040 kc. YDB</b> -B- 49.67 meters N. I. R. O. M. SOERBAJA, JAVA 10:40 p. m.-1:40 a. m., 5:40-9:40 a. m.</p>	<p><b>5660 kc. HJ5ABC</b> -B- 53 meters CALI, COLOMBIA 11 a. m.-12 N. Tues. and Thurs. 8-10 p. m. Sun. 12 N.-1 p. m.</p>
<p><b>7901 kc. LSL</b> -C- 37.97 meters HURLINGHAM, ARGENTINA Calls Brazil, night</p>	<p><b>6316 kc. HIZ</b> -B- 47.5 meters SANTO DOMINGO DOMINICAN REPUBLIC Daily except Sat. and Sun. 4:40-5:40 p. m.; Sat., 9:40- 11:40 p. m.; Sun., 11:40 a. m.-1:40 p. m.</p>	<p><b>6100 kc. ★W9XF</b> -B- 49.18 meters DOWNERS GROVE, ILL. Relays WENR, Chicago Daily except Mon, Wed., &amp; Sat., 4:30 p. m.-2 a. m.</p>	<p><b>6025 kc. CQN</b> -B- 49.79 meters MACAO, CHINA Mon., Fri., 7-9 a. m.</p>	<p><b>5577 kc. WCN</b> -C- 59.08 meters LAWRENCEVILLE, N. J. Phones England irregularly</p>
<p><b>7880 kc. JYR</b> -B- 38.07 meters KEMIKAWA-CHO, CHIBA- KEN, JAPAN 4-7:40 a. m.</p>	<p><b>6275 kc. HJ3ABF</b> -B- 47.81 meters BOGOTA, COLOMBIA P. O. Box 317 12-1:30 p. m., 7-11 p. m., exe. Sunday, Wed. and Sat. 6-11 p. m., Tues. and Fri. 6:30-11 p. m.</p>	<p><b>6095 kc. ★VE9GW</b> -B- 49.22 meters BOWMANVILLE, ONTARIO, CANADA Sun. 1-9 p. m. Mon.-Wed., 3 p. m.-12 m. Thurs.-Sat., 7 a. m.-12 m.</p>	<p><b>6020 kc. ★DJC</b> -B- 49.83 meters BROADCASTING HOUSE, BERLIN 12 N.-4:30 p. m., 5:30-10:45 p. m.</p>	<p><b>5525 kc. ZFA</b> -C- 59.7 meters HAMILTON, BERMUDA Calls U.S.A., nights</p>
<p><b>7799 kc. ★HBP</b> -B- 38.47 meters LEAGUE OF NATIONS, GENEVA, SWITZERLAND 5:30-6:15 p. m., Saturday</p>	<p><b>6272 kc. HI1A</b> -B- 47.84 meters P. O. BOX 243 SANTIAGO, DOMINICAN REP. 11:40 a. m.-1:40 p. m., 7:40-9:40 p. m.</p>	<p><b>6090 kc. VE9BJ</b> -B- 49.26 meters SAINT JOHN, N. B., CAN. 7-8:30 p. m.</p>	<p><b>6012 kc. ZHI</b> -B- 49.9 meters RADIO SERVICE CO., 20 ORCHARD RO., SINGAPORE, MALAYA Mon., Wed., Thurs., 5:40-8:10 a. m.; Sat., 12:10-1:10 a. m., 10:40 p. m.-1:10 a. m. (Sunday)</p>	<p><b>5475 kc. WOO</b> -C- 63.1 meters OCEAN GATE, N. J. Calls ships irregularly</p>
<p><b>7400 kc. HJ3ABD</b> -B- 40.54 meters P. O. Box 509 BOGOTA, COLOMBIA Daily 12-2 p. m.; 7-11 p. m. Sunday, 5-9 p. m.</p>	<p><b>6160 kc. ★YV3RC</b> -B- 48.7 meters CARACAS, VENEZUELA Generally 4:00-10:00 p. m.</p>	<p><b>6080 kc. CP5</b> -B- 49.34 meters LAPAZ, BOLIVIA 7-10:30 p. m.</p>	<p><b>6010 kc. ★COC</b> -B- 49.92 meters P. O. BOX 98 HAVANA, CUBA Daily 9:30-11 a. m., 4-6 p. m., Sat. also at 11:30 p. m.</p>	<p><b>4975 kc. GBC</b> -C- 60.30 meters RUGBY, ENGLAND Calls Ships, late at night</p>
<p><b>7220 kc. HKE</b> -B- 41.55 meters BOGOTA, COL., S. A. Tue. and Sat. 8-9 p. m.; Mon. &amp; Thurs. 6:30-7 p. m.</p>	<p><b>6150 kc. ★CJRO</b> -B- 48.78 meters WINNIPEG, MAN., CANADA 8 p. m.-12 p. m. Sun. 8-10:30 p. m.</p>	<p><b>6080 kc. ★W9XAA</b> -B- 49.34 meters CHICAGO FEDERATION OF LABOR CHICAGO, ILL. Relays WCFL Sunday 11:30 a. m.-9 p. m. and Tues., Thurs., Sat., 4 p. m.-12 m.</p>	<p><b>6000 kc. ★XEBT</b> -B- 50 meters MEXICO CITY, MEX. P. O. Box 79-44 7 p. m.-1 a. m.</p>	<p><b>4820 kc. GDW</b> -C- 62.24 meters RUGBY, ENGLAND Calls N.Y.C., late at night</p>
<p><b>7140 kc. HJ4ABB</b> -B- 42.02 meters MANIZALES, COL., S. A. P. O. Box 175 Mon. to Fri. 12:15-1 p. m.; Tues. &amp; Fri. 7:30-10 p. m.; Sun. 2:30-5 p. m.</p>	<p><b>6140 kc. ★W8XK</b> -B- 48.86 meters WESTINGHOUSE ELECTRIC &amp; MFG. CO. PITTSBURGH, PA. Relays KDKA 4:30 p. m.-1 a. m.</p>	<p><b>6079 kc. DJM</b> -X- 49.35 meters REICHS-RUNDFUNK- GESELLSCHAFT BERLIN, GERMANY Tests irregularly</p>	<p><b>6000 kc. EAJ25</b> -B- 50 meters BARCELONA RADIO CLUB, BARCELONA, SPAIN 3:30-4:30 p. m., Saturday</p>	<p><b>4752 kc. WOO</b> -C- 63.1 meters LAWRENCEVILLE, N. J.</p>
<p><b>6977 kc. EAR110</b> -B- 43 meters MADRID, SPAIN Tues., Sat., 5:30 p. m.</p>	<p><b>6130 kc. ZGE</b> -B- 48.92 meters KUALA LUMPUR, FED. MALAY STATES Sun., Tue., and Fri., 8:40-8:40 a. m.</p>	<p><b>6072 kc. OER2</b> -B- 49.41 meters VIENNA, AUSTRIA 9 a. m.-5 p. m. daily</p>	<p><b>6000 kc. RW59</b> -B- 50 meters MOSCOW, U. S. S. R. 4-6 p. m., daily</p>	<p><b>4752 kc. WOY</b> -C- 63.1 meters LAWRENCEVILLE, N. J.</p>
<p><b>6905 kc. GDS</b> -C- 43.45 meters RUGBY, ENGLAND Calls N.Y.C. evening</p>	<p><b>6122 kc. JB</b> -B- 49 meters JOHANNESBURG, SOUTH AFRICA Daily except Sat. and Sun., 11:45 p. m.-12:30 a. m., 4-7 a. m., 9 a. m.-3:30 p. m., Sat., only, 4-7 a. m., 9 a. m.- 4:45 p. m. Sun., only, 11:45 p. m.-12:30 a. m., 8-10:30 a. m., and 12:30- 3 p. m.</p>	<p><b>6070 kc. ★YV5RMO</b> -B- 49.42 meters MARACAIBO, VENEZUELA 5:15-9 p. m.</p>	<p><b>5990 kc. YV4RC</b> -B- 50.25 meters CARACAS VENEZUELA 7:30-9:30 p. m.</p>	<p><b>4727 kc. WOO</b> -C- 70.22 meters OCEAN GATE, N. J. Calls ships irregularly</p>
<p><b>6860 kc. KEL</b> -X- 43.70 meters BOLINAS, CALIF. Tests irregularly</p>	<p><b>6120 kc. YDA</b> -B- 49.02 meters SANTO DOMINGO DOMINICAN REPUBLIC Tues. and Fri., 8-10 p. m.; Sun., 7:45-10:40 a. m., 3-5 p. m.; Sat., 10:40-11:40 p. m.</p>	<p><b>6070 kc. VE9CS</b> -B- 49.42 meters VANCOUVER, B. C., CANADA Fri., 12:30-1:45 a. m.; Sun., 12 noon-12 midnight</p>	<p><b>5970 kc. HJ2ABC</b> -B- 50.27 meters CUCUTA, COL. 11 a. m.-12 n.; 6-9 p. m.</p>	<p><b>4727 kc. WOY</b> -C- 70.22 meters LAWRENCEVILLE, N. J.</p>
<p><b>6755 kc. WOA</b> -C- 44.41 meters LAWRENCEVILLE, N. J. Phones England, evening</p>	<p><b>6120 kc. YDA</b> -B- 49.02 meters SANTO DOMINGO DOMINICAN REPUBLIC Tues. and Fri., 8-10 p. m.; Sun., 7:45-10:40 a. m., 3-5 p. m.; Sat., 10:40-11:40 p. m.</p>	<p><b>6065 kc. HIX</b> -B- 49.46 meters SANTO DOMINGO DOMINICAN REPUBLIC Tues. and Fri., 8-10 p. m.; Sun., 7:45-10:40 a. m., 3-5 p. m.; Sat., 10:40-11:40 p. m.</p>	<p><b>5968 kc. HVJ</b> -B- 50.27 meters VATICAN CITY (ROME) 2-2:15 p. m., daily, Sun., 5-5:30 a. m.</p>	<p><b>4727 kc. WOY</b> -C- 70.22 meters LAWRENCEVILLE, N. J.</p>
<p><b>6750 kc. JVT</b> -C- 44.44 meters NAZAKI, JAPAN Relays JOAK, Tokio 2-8:30 a. m.</p>	<p><b>6120 kc. YDA</b> -B- 49.02 meters SANTO DOMINGO DOMINICAN REPUBLIC Tues. and Fri., 8-10 p. m.; Sun., 7:45-10:40 a. m., 3-5 p. m.; Sat., 10:40-11:40 p. m.</p>	<p><b>6065 kc. HIX</b> -B- 49.46 meters SANTO DOMINGO DOMINICAN REPUBLIC Tues. and Fri., 8-10 p. m.; Sun., 7:45-10:40 a. m., 3-5 p. m.; Sat., 10:40-11:40 p. m.</p>	<p><b>5968 kc. HVJ</b> -B- 50.27 meters VATICAN CITY (ROME) 2-2:15 p. m., daily, Sun., 5-5:30 a. m.</p>	<p><b>4727 kc. WOY</b> -C- 70.22 meters LAWRENCEVILLE, N. J.</p>
<p><b>6666 kc. ★HC2RL</b> -B- 45.00 meters P. O. BOX 758, GUAYAQUIL, ECUADOR, S. A. Sunday, 5:45-7:45 p. m. Tues., 9:15-11:15 p. m.</p>	<p><b>6120 kc. YDA</b> -B- 49.02 meters SANTO DOMINGO DOMINICAN REPUBLIC Tues. and Fri., 8-10 p. m.; Sun., 7:45-10:40 a. m., 3-5 p. m.; Sat., 10:40-11:40 p. m.</p>	<p><b>6065 kc. HIX</b> -B- 49.46 meters SANTO DOMINGO DOMINICAN REPUBLIC Tues. and Fri., 8-10 p. m.; Sun., 7:45-10:40 a. m., 3-5 p. m.; Sat., 10:40-11:40 p. m.</p>	<p><b>5968 kc. HVJ</b> -B- 50.27 meters VATICAN CITY (ROME) 2-2:15 p. m., daily, Sun., 5-5:30 a. m.</p>	<p><b>4727 kc. WOY</b> -C- 70.22 meters LAWRENCEVILLE, N. J.</p>

(Time given is Eastern Standard Time)

# Television Stations

**2000-2100 kc.**  
 W2XDR—Long Island City, N.Y.  
 W8XAN—Jackson, Mich.  
 W9XK—Iowa City, Ia.  
 W9XAK—Manhattan, Kansas.  
 W9XAO—Chicago, Ill.  
 W6XAH—Bakersfield, Calif.

**2750-2850 kc.**  
 W3XAK—Portable  
 W9XAP—Chicago, Ill.

W2XBS—Bellmore, N.Y.  
 W6XS—Los Angeles, Calif.  
 W9XAL—Kansas City, Mo.  
 W9XG—W. Lafayette, Ind.  
 W2XAB—New York, N.Y.

**42000-56000, 60000-86000 kc.**  
 W2XAX—New York, N.Y.  
 W6XAO—Los Angeles, Calif.  
 W9XD—Milwaukee, Wis.  
 W2XBT—Portable  
 W2XF—New York, N.Y.

W3XE—Philadelphia, Pa.  
 W3XAD—Camden, N. J.  
 W10XX—Portable & Mobile (Vicinity of Camden)  
 W2XDR—Long Island City, N.Y.  
 W8XAN—Jackson, Mich.  
 W9XE—Chicago, Ill.  
 W9XAT—Portable  
 W2XD—New York, N.Y.  
 W2XAG—Portable  
 W1XG—Boston, Mass.

# Police Radio Alarm Stations

CGZ	Vancouver, B.C.	2452 kc.	KGZR	Salem, Ore.	2442 kc.	WPEI	E. Providence, R.I.	1712 kc.	
CJW	St. Johns, N.B.	2416 kc.	KGZS	McAlester, Okla.	2458 kc.	WPEK	New Orleans, La.	2430 kc.	
CJZ	Verdeem, Que.	2452 kc.	KGZT	Santa Cruz, Cal.	1674 kc.	WPEL	W. Bridgewater, Mass.	1666 kc.	
KGHG	Las Vegas, Nev.	2474 kc.	KGZU	Lincoln, Neb.	2490 kc.	WPEM	Woonsocket, R.I.	2466 kc.	
KGHK	Palo Alto, Cal.	1674 kc.	KGZW	Lubbock, Tex.	2458 kc.	WPEP	Arlington, Mass.	1712 kc.	
KGHM	Reno, Nev.	2474 kc.	KGZX	Albuquerque, N.Mex.	2414 kc.	WPES	Saginaw, Mich.	2442 kc.	
KGHO	Des Moines, Iowa	1682 kc.	KSW	Berkeley, Cal.	1658 kc.	WPET	Lexington, Ky.	1706 kc.	
KGHX	Santa Ana, Cal.	2430 kc.	KVP	Dallas, Tex.	1712 kc.	WPEW	Northampton, Mass.	1666 kc.	
KGHY	Whittier, Cal.	1712 kc.	VYR	Montreal, Can.	1712 kc.	WPEA	Newton, Mass.	1712 kc.	
KGHZ	Little Rock, Ark.	2406 kc.	VYW	Winnipeg, Man.	2416 kc.	WPFC	Muskegon, Mich.	2442 kc.	
KGJX	Pasadena, Cal.	1712 kc.	WCK	Belle Island, Mich.	2414 kc.	WPFE	Reading, Pa.	2442 kc.	
KGLX	Albuquerque, N.M.	2414 kc.	WEY	Boston, Mass.	1558 kc.	WPFJ	Jacksonville, Fla.	2442 kc.	
KGOZ	Cedar Rapids, Iowa	2466 kc.	WKDT	Detroit, Mich.	1558 kc.	WPFK	Baltimore, Md.	2414 kc.	
KGPA	Seattle, Wash.	2414 kc.	WKDU	Cincinnati, Ohio	1706 kc.	WPL	Columbus, Ga.	2414 kc.	
KGPC	St. Louis, Mo.	1706 kc.	WMDZ	Indianapolis, Ind.	2442 kc.	WPFJ	Hammond, Ind.	1712 kc.	
KGPD	San Francisco, Cal.	1674 kc.	WMJ	Buffalo, N.Y.	2422 kc.	WPFK	Hackensack, N.J.	2430 kc.	
KGPE	Kansas City, Mo.	2422 kc.	WMO	Highland Park, Mich.	2414 kc.	WPL	Gary, Ind.	2470 kc.	
KGPG	Vallejo, Cal.	2422 kc.	WMP	Framingham, Mass.	1666 kc.	WPFM	Birmingham, Ala.	2382 kc.	
KGPH	Oklahoma City, Okla.	2450 kc.	WPDA	Tulare, Cal.	2414 kc.	WPFN	Fairhaven, Mass.	1712 kc.	
KGPI	Omaha, Neb.	2466 kc.	WPDB	Chicago, Ill.	1712 kc.	WPFQ	Knoxville, Tenn.	2474 kc.	
KGPI	Beaumont, Tex.	1712 kc.	WPDC	Chicago, Ill.	1712 kc.	WPFQ	Clarksburg, W. Va.	2490 kc.	
KGPK	Sioux City, Iowa	2466 kc.	WPDD	Chicago, Ill.	1712 kc.	WPFQ	Swathmore, Pa.	2474 kc.	
KGPL	Los Angeles, Cal.	1712 kc.	WPDE	Louisville, Ky.	2442 kc.	WPFQ	Johnson City, Tenn.	2470 kc.	
KGPM	San Jose, Cal.	1674 kc.	WPDE	Flint, Mich.	2466 kc.	WPFQ	Asheville, N.C.	2474 kc.	
KGPN	Davenport, Iowa	2466 kc.	WPDG	Youngstown, Ohio	2458 kc.	WPFU	Portland, Me.	2422 kc.	
KGPO	Tulsa, Okla.	2450 kc.	WPDH	Richmond, Ind.	2442 kc.	WPFV	Pawtucket, R.I.	2466 kc.	
KGPP	Portland, Ore.	2442 kc.	WPGI	Columbus, Ohio	2430 kc.	WPFV	Palm Beach, Fla.	2442 kc.	
KGPP	Honolulu, T.H.	2450 kc.	WPGK	Milwaukee, Wis.	2450 kc.	WPFZ	Miami, Fla.	2442 kc.	
KGPR	Minneapolis, Minn.	2430 kc.	WPL	Lansing, Mich.	2442 kc.	WPGA	Bay City, Mich.	2466 kc.	
KGPS	Bakersfield, Cal.	2414 kc.	WPL	Dayton, Ohio	2430 kc.	WPGH	Port Huron, Mich.	2466 kc.	
KGPP	Salt Lake City, Utah	2406 kc.	WPL	Auburn, N.Y.	2382 kc.	WPGH	S. Schenectady, N.Y.	1658 kc.	
KGPP	Denver, Colo.	2442 kc.	WPL	Akron, Ohio	2458 kc.	WPGI	Rockford, Ill.	2458 kc.	
KGPP	Baton Rouge, La.	1574 kc.	WPL	Philadelphia, Pa.	2474 kc.	WPGI	Providence, R.I.	1712 kc.	
KGPP	Wichita, Kans.	2450 kc.	WPL	Rochester, N.Y.	2382 kc.	WPGI	Findlay, Ohio	1682 kc.	
KGPP	Fresno, Calif.	2414 kc.	WPL	St. Paul, Minn.	2430 kc.	WPGI	Albany, N.Y.	2414 kc.	
KGPP	Houston, Tex.	1712 kc.	WPL	Kokomo, Ind.	2490 kc.	WPGI	Portsmouth, Ohio	2430 kc.	
KGPP	Topeka, Kans.	2422 kc.	WPL	Pittsburgh, Pa.	1712 kc.	WPGI	Utica, N.Y.	2414 kc.	
KGPP	San Diego, Cal.	2490 kc.	WPL	Charlotte, N.C.	2458 kc.	WPGI	Cranston, R.I.	2466 kc.	
KGPP	San Antonio, Tex.	2482 kc.	WPL	Washington, D.C.	2422 kc.	WPGI	Binghamton, N.Y.	2442 kc.	
KGPP	Chanute, Kans.	2450 kc.	WPL	Detroit, Mich.	2414 kc.	WPGI	South Bend, Ind.	2490 kc.	
KGPP	Des Moines, Iowa	2466 kc.	WPL	Atlanta, Ga.	2414 kc.	WPGI	Huntington, N.Y.	2490 kc.	
KGPP	Klamath Falls, Ore.	2382 kc.	WPL	Fort Wayne Ind.	2490 kc.	WPGI	Mineola, N.Y.	2490 kc.	
KGPP	Wichita Falls, Tex.	2458 kc.	WPL	Syracuse, N.Y.	2382 kc.	WPGI	Boston, Mass.	1712 kc.	
KGPP	Phoenix, Ariz.	2430 kc.	WPL	Grand Rapids, Mich.	2442 kc.	WPGI	Mobile, Ala.	2382 kc.	
KGPP	Shreveport, La.	1712 kc.	WPL	Memphis, Tenn.	2466 kc.	WPGI	WRBH	Cleveland, Ohio	2458 kc.
KGPP	El Paso, Tex.	2414 kc.	WPL	Arlington, Mass.	1712 kc.	WPGI	WRDQ	Toledo, Ohio	2474 kc.
KGPP	Tacoma, Wash.	2414 kc.	WPL	New York, N.Y.	2450 kc.	WPGI	WRDR	GrossePt. Village, Mich.	2414 kc.
KGPP	Santa Barbara, Cal.	2414 kc.	WPL	New York, N.Y.	2450 kc.	WPGI	WRDS	E. Lansing, Mich.	1666 kc.
KGPP	Coffeyville, Kans.	2450 kc.	WPL	New York, N.Y.	2450 kc.				
KGPP	Waco, Tex.	1712 kc.	WPL	Somerville, Mass.	1712 kc.				

## When to Listen In

By M. Harvey Gernsback

### Daventry

• The Daventry schedule for December is as follows. Trans. 1, 3-5 a.m. on GSD and either GSB or GSF. (After Dec. 16, 3:30-5:30 a.m.) Trans. 2, 6-7:30 a.m., (except Sunday) on GSF and either GSG or GSE; 7:30-9 a.m. daily on GSB and either GSF or GSE. Trans. 3, 9:15-10:45 on GSE and GSC; 10:45 a.m.-12:15 p.m. on GSC and GSA; 12:15-12:45 p.m. on GSD and GSA. Trans. 4, 1-3 p.m. on GSD and GSB; 3-5:45 p.m., on GSB and GSA Trans 5, 6-8 p.m. on GSC and GSA.

### Rome

• I2RO, at Rome, Italy, has resumed broadcasting. Two separate transmitters will shortly be available for broad-

casting the programs. At present a program beamed toward North America is sent out on Mon., Wed., and Fri. on a wavelength of 30.67 meters. Other wave lengths available are 48.7, 42.98 and their old wave of 25.4 meters. The time of this trans. is from 6:30-8 p.m. It is likely that a shift will be made to one of the higher wave lengths since the first broadcasts were not heard at all in this country.

### Panama

• A new broadcasting station at Panama City, Panama, in Central America will shortly go on the air. It will operate on 6040 Kc. (49.67 meters). It will be located at the Miramar Club and will broadcast concerts from the club.

### Sydney

• The schedule of VK2ME at Sydney, Australia, from December, January and February is: Sundays only, 1-3 a.m. and 5-11 a.m.

December 9th the program will be dedicated to Canada; during 2:15 and 3:00 a.m. and also from 6:30 to 7:30 a.m.

### PRF5

The address of PRF5 is: Mr. Salles Filho, Director of the Brazilian Official Broadcasting Program, Rio de Janeiro, Brazil.

### Holland

Our old friend PCJ at Eindhoven, Holland, which has been silent for nearly three years is definitely back on the air again. It operates irregularly on two wave  
 (Continued on page 575)

# SHORT WAVE LEAGUE



## HONORARY MEMBERS

Dr. Lee de Forest  
John L. Reinartz  
D. E. Replogle  
Hollis Baird  
E. T. Somers  
Baron Manfred von Ardenne  
Hugo Gernsback  
*Executive Secretary*

## A Logical Argument for "No-Code" Exams. on 5 Meters

Editor, SHORT WAVE CRAFT:

● I WOULD like to voice my humble opinion, in regard to the controversy over the "no-code" test below 5 meters, through your magazine SHORT WAVE CRAFT, which has been of great value to me, whose hobby is short-wave radio.

The reason for this letter is the unsportsmanlike manner a few of those people, who wish the code test continued, have answered those of us who agree with the negative.

In one article, we who do not want a code test on this frequency, are called, "gas-bag artists." How naive! In answering him, and I could think of a lot of adjectives to call him by; everyone who uses voice transmission, whether it be the amateur or commercial station, is a "gas-bag artist," according to his adolescent point of view. I might ask him if whenever he uses the public telephone, he would rather use the organs nature provided him with for speech, or whether he would dah dit dah, dit dit dit, dah dah dah, in that fashion? Hi.

Another chap calls us "brainless" and mentions laziness in his article, and "Why don't we get down to work and learn the code?"

In answer to the lack of brain-power idea of his, I might humbly state that I am a technician in the medical field. Myself and the two physicians and surgeons I work for are very much interested in 56 mc. transmission. These doctors have no use for code, will never use it. One of these doctors is an Ear, Eye, Nose, and Throat specialist, and is interested in voice transmission in connection with his work, as well as for a hobby. Why impose upon these people, and others that have no desire for c.w., something that they do not want or

need on this frequency?

Now, if persons of a high enough order of intelligence to go through six to eight years of medical school and to pass the state medical board examinations, are not possessed with sufficient gray matter to learn twenty-six characters of the alphabet, in the approved manner and speed, then may Providence provide for our coming generations. Certainly amateur radio would profit by an addition to its ranks of this type of person. So you see, sir, the argument that we cannot learn the code is weak and unsupported. I believe as one article so aptly put it, "It is like believing in the future of the horse." It is an antiquated form of communication!

Consider for the moment, which would be the better action for the commission to adopt: (1) Abolishing the code test below 5 meters, and opening the field to persons who are interested in "voice transmission" only, who will bring new thoughts and ideas into the field, or (2) continuing to impose a code test on this frequency and thereby slamming the door of amateur radio in the faces of worthy persons? I would like to know the motivation in entering amateur radio of some of these persons of the affirmative that insist in covering their lack of knowledge of the subject by calling us names.

In regard to the "laziness" this same person speaks of: Would you sir, or anyone, call a person that labors on the average of 15 to 17 hours a day, 7 days a week, 52 weeks a year for the good of their community, lazy??

Honestly, such opinions as some have advanced, who are in favor of the code test, make me boil, if I may use that expression. But then, we should consider the source.

I do not object to a constructive criticism on this or any subject, but when someone of an opposite opinion raises such feeble arguments as have been mentioned, might I humbly suggest for them to do a little research on the other side of the fence! I highly recommend the article in SHORT WAVE CRAFT by Mr. J. A. Worcester, W2GAU. Also the article by Mr. Paul Lomaster in the August 1934 issue of SHORT WAVE CRAFT. They are very fine articles and regardless of whether you agree with

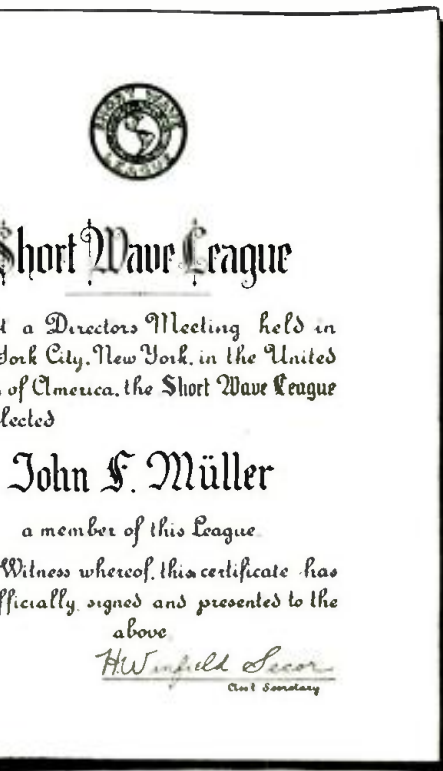

This is the handsome certificate that is presented FREE to all members of the SHORT WAVE LEAGUE. The full size is 7¼" x 9½".

See page 576 how to obtain certificate.

## Get Your Button

The illustration here-with shows the beautiful design of the "Official" Short Wave League button, which is available to everyone who becomes a member of the Short Wave League.

The requirements for joining the League are explained in a booklet, copies of which will be mailed upon request. The button measures ¾ inch in diameter and is inlaid in enamel—3 colors—red, white, and blue.

Please note that you can order your button AT ONCE—SHORT WAVE LEAGUE supplies it at cost, the price, including the mailing, being 35 cents. A solid gold button is furnished for \$2.00 prepaid. Address all communications to SHORT WAVE LEAGUE, 99-101 Hudson St., New York.



them or not, they are worth a few moments of your time.

Might I offer a small straw vote, taken by myself in this city, of a few persons who are interested in this subject. I contacted eleven men who are going to take their amateur license examination the next time it is offered in this territory. Out of these eleven men there are only two that cannot send and receive the code at the required "ten per." Ten of these men will build 5 meter transceivers, which they are particularly interested in. All of these men are in favor of a no code test below 5 meters. I also contacted eight amateurs who have their "tickets" (licenses), one of these men holds a first-class commercial license, the other, I believe, is shortly to have an N in front of his call. All were in favor of a no-code test with the exception of one amateur who just received his ticket and is not on the air as yet. I

(Continued on page 569)

# Short Wave

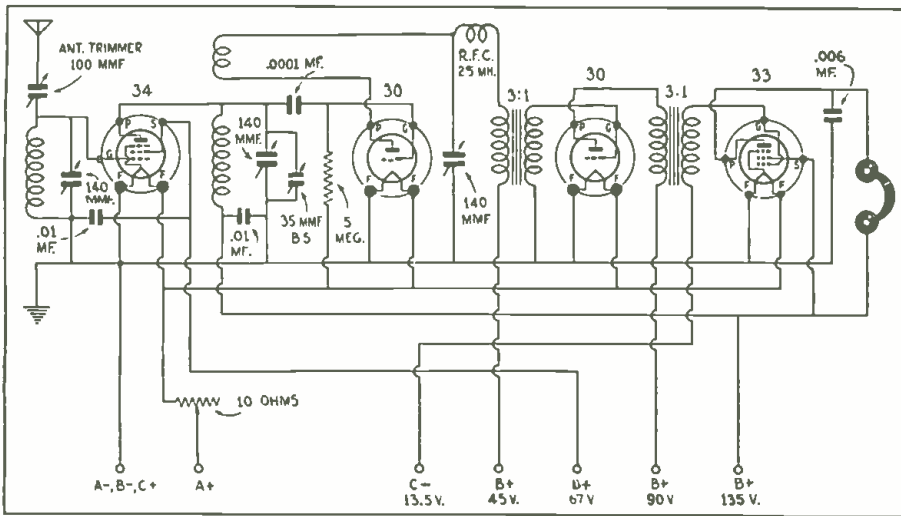

Above is diagram of 4-tube battery operated T.R.F. receiver. Note—bottom views of sockets are shown in these diagrams.

### T.R.F. BATTERY RECEIVER

C. B. Ray, Shelbyville, Tenn.

(Q) Please publish a diagram of a 4-tube battery receiver using 2-volt tubes, with variable condensers to band-spread. I had thought of using one 32, two 30's and one 33. If you think some other line-up of tubes best please print what you think the best.

(A) A receiver using a line-up similar to the one you desire should give excellent service. However, the R.F. tube for best results should be a 34. The set, consisting of a 34 T.R.F. amplifier, a 30 regenerative detector, another 30 as the first stage of audio, and a 33 operating as the power output tube, should be capable of working a speaker with fairly good volume on the various foreign stations. Band-spread is accomplished by connecting a small condenser in parallel with the detector tuning condenser, the small condenser being used for band-spread tuning and the smaller one for band setting. No band-spread condenser is necessary in the R.F. stage because it is rather broad in tuning. If the two condensers were ganged, however, it would be necessary to have band-spread condensers in each stage.

### OBTAINING OPERATOR'S LICENSE

John Smith, Norfolk, Va.

(Q) I am a boy of 14 and have taken SHORT WAVE CRAFT magazine for several months. I am especially interested in phone transmitting, and am thinking of making a transmitter. But is there any special age you have to be to have a transmitter, and where do I apply for a transmitting license? What does the examination consist of?

(A) There is no special age requirement in obtaining an operator's license. The examination consists of a code test of 10 words per minute, five letters to the word, and a technical examination covering the construction of a modern transmitter and receiver, together with various questions regarding the laws governing radio amateur operation. You should apply to the Customs House, Boston, Mass., for the examination.

### ADDING AMPLIFIER TO 2-TUBE SUPER

Harry S. Wimer, Ellwood City, Pa.

(Q) I have built the 2-tube superhet that was described in the December 1933 issue and would like to know how I could add a 42 tube to it for a little more power output—do you think it would work O.K.

with one 42 in the final? I have the 42 tube and the six prong socket.

(A) You should undoubtedly experience

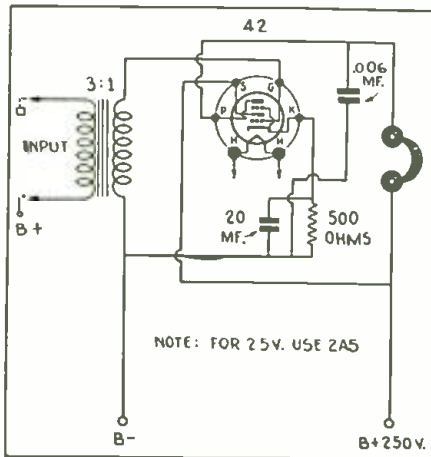
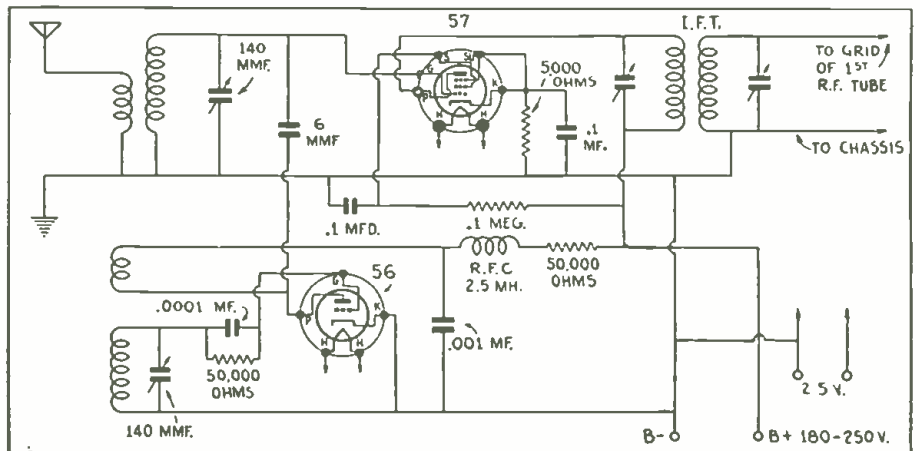

Diagram of type 42 amplifier.

excellent speaker performance with the Victor 2-tube Superhet described in the December 1933 issue, with the addition of a 42 pentode power amplifier. It is not a very difficult job to add a 42 to the above set and if you follow the accompanying diagram you should have no trouble.



2-Tube Superheterodyne Converter using type 56 and 57 tubes.

### EDITED BY GEORGE

● Because of the amount of work involved in the drawing of diagrams and the compilation of data, we are forced to charge 25c each for letters that are answered directly through the mail. This fee includes only hand-drawn schematic drawings. We cannot furnish "picture-layouts" or "full-sized" working drawings. Letters not accompanied by 25c will be answered in turn on this page. The 25c remit-

### BATTERY-OPERATED TRANSMITTER

D. C. Blake, Redwood, Miss.

(Q) At your future convenience would you please publish the diagram of such a transmitter as I will try to outline below:

First, it shall use only the 2-volt battery tubes, for oscillator and amplifier, these because of their low current consumption, or the 6.3 volt tubes. Second, it shall not require over 180 volts of "B." Third, crystal-control and ability to work on the 80, 40, and 20 meter bands. Fourth, it shall have an output of at least 8 watts from the last amplifier stage. Such a diagram, for the construction of a transmitter, would be of great benefit to many others who have no A.C. supply available.

(A) On page 596 of our February 1934 issue, there appears an article by Bernard Montgomery, (W2AJD) describing a very efficient battery-operated transmitter. The title of the article is "650 miles on 1 1/2 watts." We believe that you will find this article very interesting.

### ALL-WAVE AIR-SCOUT

Leo Stern, Jr., New York City, N.Y.

(Q) What are the values of the two electrolytic condensers used in the "All-Wave Air-Scout"?

(A) As stated in the article describing the All-Wave Air-Scout on page 117 of the August issue, you will find that the two electrolytic condensers have a capacity rating of 8 mf. each.

### 2-TUBE CONVERTER

P. Hoerner, E. McKeesport, Pa.

(Q) I am now using a short-wave converter with 2-tubes, type 24 and 27. I had European stations, with favorable weather, like locals. I would like to change to type 57 and 56 tubes. Will you please publish a diagram of a converter using these tubes?

(A) We are pleased to print a diagram of a converter using a 57 first detector, and a 56 oscillator. However, we do not believe there will be a tremendous amount of improvement over your present converter, which uses a 24 detector and a 27 oscillator.

# QUESTION BOX

## W. SHUART, W2AMN

tance may be made in the form of stamps or coin.

Special problems involving considerable research will be quoted upon request. We cannot offer opinions as to the relative merits of commercial instruments.

Correspondents are requested to write or print their names and addresses clearly. Hundreds of letters remain unanswered because of incomplete or illegible addresses.

### LOW-POWER TRANSMITTER

W. Stillwell, Albuquerque, N. Mex.

(Q) I intend to become an amateur in the near future and would like to have you print a diagram for a 2A5 crystal-controlled oscillator with 2A5 amplifier. About what would the input be with 350 volts on the plate of the oscillator tube and 500 on the plate of the amplifier tube?

(A) A transmitter using two 2A5's, one as a crystal-controlled oscillator and the other as a "high MU" R.F. neutralized amplifier, should give very fine results. You will notice in the diagram which we have printed, that the two grids have been connected together in order to make the 2A5 amplifier a high MU tube. When connected in this manner no fixed bias is necessary. The grids are returned through a fixed resistor. However it is not advisable to place more than 300 volts on the plate. The plate current of the final amplifier under load should not exceed 50 milliamperes for best results.

### BEST ANTENNA

P. Bixler, Jr., Westminster, Md.

(Q) Please send me information or put it in *Short Wave Question Box*, the best kind of antenna to use with the National S.W. 3 A.C.

(A) This is really a hard question to answer, inasmuch as various locations will require different types of antennas. In our October 1934 issue, on page 344, we gave complete information covering five or six different types of antennas. We suggest that you read this article carefully and choose the antenna which will best suit your purpose. If you have the room and facilities the inverted "V" antenna will undoubtedly give best results.

### BEST AMPLIFIER TUBE

A. H. Gustafson, Philadelphia, Pa.

(Q) In the *Question Box* of your September issue you show a 3-tube A.C. set using a 224 tube as detector, with two stages of 227 audio. Would you please let me

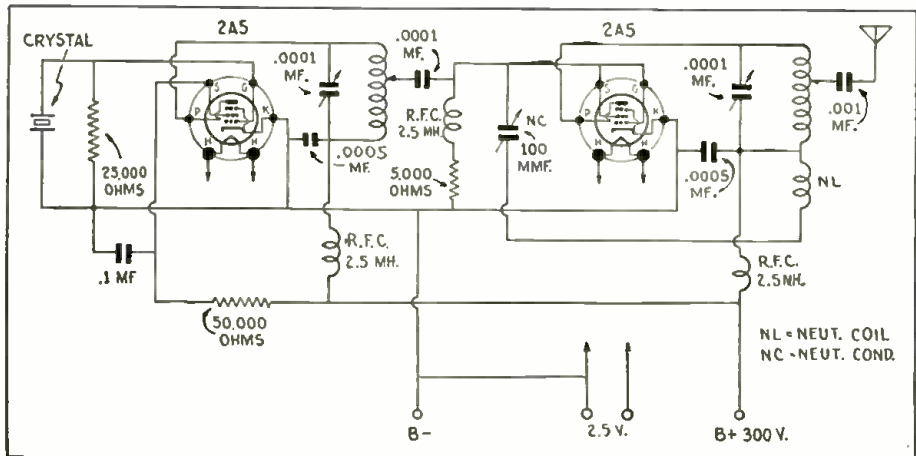

Crystal-controlled MOPA transmitter using 2A5 tubes.

know the correct B+ voltage for this receiver as same was now shown. Would 180 volts be satisfactory? Also could a stage of audio be added to the 53 *Twinplex* shown some months ago. Would it be possible to

and trouble would probably be experienced from feed-back. We believe it would be much more satisfactory if you were to use a single 27 in addition in the amplification already shown in the diagram.

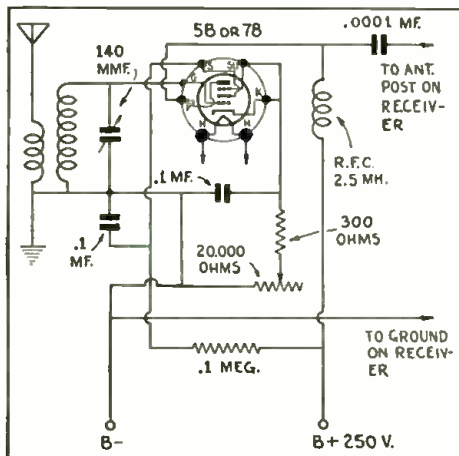

T.R.F. amplifier using 58 or 78 tubes.

use another 53 tube as two stages of audio or a one stage of 227 audio.

(A) The B voltage for the receiver described in the *Question Box* of our September issue can be from 180 to 250. The 53 could be added and form a 2-stage resistance-coupled audio amplifier. However, this would provide three stages in the set

### R. F. STAGE FOR HAM-BAND "PEE WEE"

B. M. Burch, Denver, Colo.

(Q) Will you please print in your *Question Box* a circuit for an R.F. amplifier for the "Ham-Band Pee Wee" 2-Tube Receiver described in the November 1933 issue of *SHORT WAVE CRAFT*, using a type 58 tube.

(A) With the addition of a tuned R.F. stage the "Ham-Band Pee Wee," which was described in the November 1933 issue, should give excellent performance. Bandspread will not be needed in the tuned R.F. stage as R.F. stages usually tune rather broad and no critical adjustment is necessary. We are pleased to print the diagram at left and trust you will have no trouble in getting it to work.

### MODULATED OSCILLATOR

Walter Stewart, Fanwood, N. J.

(Q) Can a modulator using two 227's as speech amplifiers and a 245 push-pull modulator be used with the R.T. Push-Pull Amateur CW Transmitter? If so, please print a 4-tube modulator that can be used. The filament supply is 2 1/4 volts and the plate supply is 790 volts.

(A) Under no condition should any of our readers attempt to use a modulated oscillator for phone transmission. The new regulations require that the signal should be free of frequency modulation and this is impossible with a modulator oscillator. The above requirements of course only apply to the 160, 80, and 20 meter phone bands. Modulated oscillators are permitted on 5 and 10 meter bands and on all frequencies higher than 110 megacycles. We believe if you intend to operate on the low-frequency bands that you should by all means use an MOPA (master-oscillator power-amplifier) with at least one buffer stage between the oscillator and the modulated amplifier.

### 2-STAGE AUDIO AMPLIFIER

Vincent Ekman, Ironwood, Mich.

(Q) Please publish in the *Question Box*, a circuit of a 56 transformer coupled to a 2A5 audio output tube.

(A) An audio amplifier consisting of a 56 transformer-coupled to a 2A5 pentode should make a very fine general purpose audio amplifier unit and can be used in conjunction with any type of short-wave receiver where speaker volume is required. We suggest that our readers save this diagram for future reference.

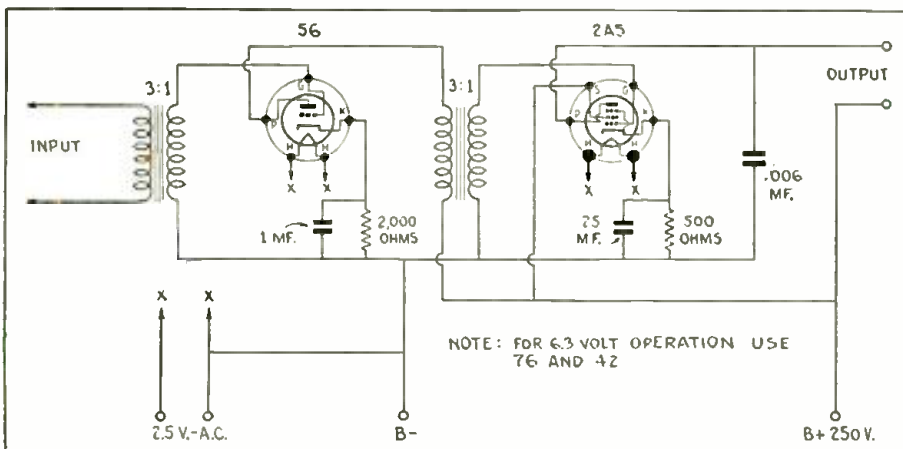

Diagram of 2-stage amplifier which can be added to any short-wave or broadcast receiver.

A trip to the local radio dealer's shop produced a couple of old battery-model broadcast receivers and two "B" eliminators for less than \$2.00. When buying the receivers pick out ones with good variable condensers as these are used in the RF end. The chokes from the "B" eliminators were of the double type in one frame and these were connected in parallel, one unit being used as the filter choke in the power supply. The eliminators also yielded enough fixed condensers to connect in series across each side of the filter choke. Use at least three condensers in series for each filter capacity and use the same size condensers for all three. This then gives us three condensers in series across each side of the filter choke. One of the "B" eliminator transformers is taken apart and three 2½ volt secondaries of number 18 wire wound on, one for the oscillator and speech amplifier filaments and one for the buffer and one for the final RF amplifier.

### Bleeder Resistance

Various resistors were series-connected as a *bleeder*, giving a total of about 40,000 ohms. Try to get a combination so that 200 to 300 volts can be tapped off for the speech amplifier and oscillator. Lacking the bleeder arrangement use several of the compression type carbon resistances from old "B" eliminators, in series and adjust for proper voltage. These will run hot so keep your fingers off of them as much as possible. Two switches are used on the power-pack, one as the main switch for the 110 volt line, which turns on the heater filaments, and one switch which turns on the main power supply. The latter is used for send and receive work. If a faster method of operating the transmitter is wanted (the 83 takes a few seconds to warm up) place the second switch in the high voltage negative lead, and have the high voltage transformer run all the time along with the heater type tubes. This method was used for awhile, but most amateurs could not come back as quick so the present method is used, thus allowing the electric light meter more time off.

A small pilot light connected to the 2½ volt filaments completes the power supply. So far the only new parts purchased are the power transformer and an 83 tube. Next we will take a look at what's on shelf number 2.

### The Meters Used

The first thing that strikes the eye is the panel with the two meters on. The right hand one is an 0-150 volt AC to measure line voltage; it was used only because it was at hand and could just as well have been omitted. The other is a very much needed piece of apparatus and is a 0-30 and 0-300 D.C. milliammeter. A range of 0-150 M.A. would be just as good if not better for this work, but use whatever you have. None of the readings will be over 100 mills (M.A.) and the lowest will be about 15 mills. A short piece of cord with a speaker plug on the end is used to plug the meter into the various circuits through the different jacks shown mounted on the front of the chassis units. If you are lucky your two battery sets will have some jacks on, which should of course be used. The jacks are wired in the circuit so that normally the circuit is closed through the jack springs but on inserting the plug the current then flows through the plug and so through the meter. Watch your jack connections so that the meter will read in the same direction for each jack. In the photo the left jack is in the modulator plate circuit, while the right-hand jack is for the single-button mike. The two 250 modulators are in parallel, using Heising system of modulation. The modulation choke is obtained from one of the "B" eliminators. If only the single-button carbon mike is to be used, then one stage of speech amplification using a 56 tube will be all the AF needed. This is transformer coupled to the modulator, using A.F. transformers from the battery receivers.

### Microphone Transformer

One transformer should be taken apart and a new primary wound on, consisting

## A Low-Power Transmitter

(Continued from page 535)

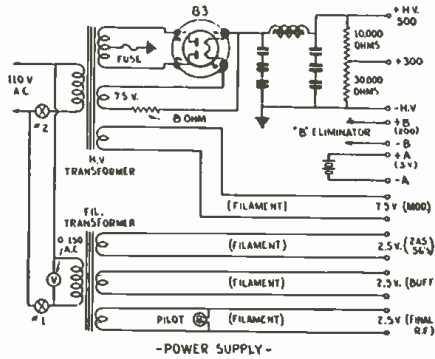

Complete power supply diagram showing the connections of the filament and plate transformers.

of 200 to 400 turns of No. 30 enameled wire. This is the *mike* transformer for the single button mike. If a condenser mike is to be used put on another stage of resistance coupled A.F. ahead of the present 56 stage, using another 56 tube. This, together with the two stage pre-amplifier in the condenser mike, will give enough "gain" for this work. The beginner is advised to start out with the carbon mike and then progress to the condenser, if the need for better quality is felt. The carbon mike used here is one from a cradle type telephone unit and has very good quality, reports more often indicating a "double-button" mike, rather than just a single button. One of the variable carbon resistances is used as the bias resistor for the modulator and the

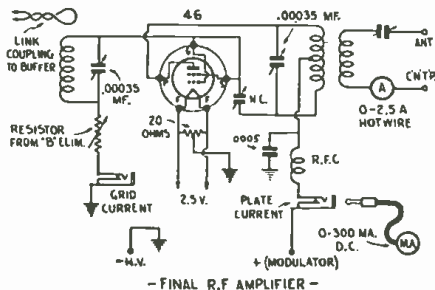

Above is the final, modulated amplifier using a 46 as a high mu triode.

by-pass condensers are taken from the "B" eliminators. For safety, use two fixed condensers in series for each by pass unit. If you are short on cash use only one modulator and when you are more "flush" slip in the other one. If one modulator is used run it at about 50 ma. idle, swinging up to about 90 ma. on the peaks. This is not according to Hoyle but gives good

## Special Short-Wave Number

The January issue of RADIO-CRAFT Magazine will be a special Short-Wave Number, and as such will be of more than passing interest to all readers of SHORT WAVE CRAFT.

This issue contains a considerable amount of new short-wave material which demands your attention.

Get a copy on the newsstands—out December 10th.

modulation and the quality is always reported as being good. When using both modulators, run the total plate current at about 80 ma., reaching 90 to 100 ma. on the peaks. This gives good modulation along with very good quality.

For this unit we have had to buy new, only the 250s, the 56 and perhaps the meter, if you do not already have one. That completes the second shelf so now let's step up to the third and see what it contains.

### Oscillator Stage

To the right of the chassis is mounted the variable condenser, inductance, 2A5 tube and crystal of the oscillator stage. The jack below the dial being for the oscillator plate current. To the left is the variable condenser, inductance and 46 tube of the buffer stage. Its plate current jack is mounted just below the condenser dial. Between the two dials may be seen the small neutralizing condenser of the buffer stage. In the rear of the chassis a small variable condenser and inductance coil are mounted to tune the grid circuit of the 46, as link coupling is used throughout the R.F. (radio frequency) portion of the transmitter. The various resistors and by-pass condensers are mounted below deck out of sight together with most of the wiring. The various tuning inductances for these two stages are wound on two inch diameter forms and were obtained from one of the battery sets. Each one is cut down to about 45 turns and all are mounted at right angles to each other. The oscillator is run with about 250 volts on the plate, while the buffer has the full 500 volts from the power supply.

If you buy your crystal from an amateur, have him test it out for you to make sure it operates properly. The 2A5 or use a 47 if you have one handy, and the 46 will be purchased new for this unit along with the crystal.

Now let's take a look at the top shelf. It contains a single 46 as the final modulated R.F. amplifier. The left-hand variable condenser tunes an inductance similar to those used on the third deck. Next comes the neutralizing condenser and then the final tank condenser. Its inductance is on a three inch tube using No. 18 enameled wire slightly space wound. On the front of the chassis is mounted a variable resistor (from the "B" eliminator) which is used as the bias resistor on the 46. Two jacks are seen, one in the grid circuit and one in the plate circuit of the 46. The right hand knob of the upper deck is the antenna variable condenser, which is series connected with the antenna inductance (25 turns close wound on a three inch form) together with the hot wire radiation ammeter. This meter is not needed unless you feel like having one, as a small flashlight bulb connected to two or three turns of wire is used mostly for tuning up the outfit. This completes the transmitter and as you have seen the cash outlay for parts was kept at a minimum.

### General Hints

The grid current of the final stage should run 15 ma. or more and the plate current should be kept below 75 ma. if you want your tube to last. The black rack frame, measuring 36x16x9, is constructed of 1x2 white pine and is given a coat of black house paint. Use only one coat and it will leave a dull finish which is a very pleasing contrast to the clear lacquered chassis bases.

Diagrams for the various hookups comprising the transmitter may be obtained from past issues of SHORT WAVE CRAFT.

The condenser "mike" is a home-made unit, the head being made out of a horn-type loud speaker unit and using a 5c Hershey bar tinfoil as the diaphragm. (.006 inch thick aluminum foil is usual.) The base is from a horn type loud speaker and is of cast metal construction with a plate on the bottom fastened to the case by screws. On this plate has been mounted the two 30 type tubes together with the necessary resistors and condensers to make up the pre-amplifier. A shielded

(Continued on page 564)

## The Short-Wave Fan's "DX-ER"

(Continued from page 525)

### "De-Henried" Wiring

small value. This procedure changes what would be normally a fairly long line electrically into one in which the distributed constants can be neglected. The actual construction merely consists of an additional insulated wire wound about the one to be de-henried with a pitch of about one turn per inch in order to insure intimate coupling, and grounded at the high potential end as indicated in the schematic diagram. Anyone doubting the effectiveness of this construction can try the following experiment with an ordinary regenerative receiver. Take the plug-in coil covering say 60 to 120 meters and starting from the ground end interwind an additional winding having about 6 turns less than the original winding. It will be noted that when both ends of this winding are left open the frequency coverage of the coil is unchanged; while when the high potential end of this auxiliary winding is grounded the frequency coverage of the coil is determined by the portion of the winding which is not interwound with the auxiliary winding. In other words the interwound turns effectively cancel out the turns of the original winding with which they are interwound.

### The Circuit

Before considering the actual constructional details of the receiver incorporating the above discussed features, it might be advisable to review briefly the details of the schematic diagram as shown in Fig. 1. It will be noted that three tubes are employed: a 58 as an R.F. amplifier, a 57 as a regenerative detector, and a 56 as a resistance coupled audio amplifier. The primary of the antenna input coil L1 has both terminals normally ungrounded so that a doublet type of antenna can be employed if desired. A triple binding post strip is provided permitting the use of an ordinary antenna by connecting one of the above terminals to the ground terminal, the remaining terminal being connected to the antenna. It will be noted that L2 is tapped to provide the neutralizing circuit in conjunction with C4. Neutralization is necessary due to the high gain circuits producing sufficient feedback through the grid-plate capacities, with their associated wiring, to cause oscillations when in resonance. The condenser, C-4, is adjusted initially to counterbalance this effect and once adjusted needs no further attention. C3 is the trimming condenser employed to maintain the two circuits in resonance. The high potential at leads joining L2 with the grid of the R.F. amplifier tube and C2 are de-henried as indicated.

### Electron-Coupled Detector

Electron coupling is employed in the detector stage due to its greater stability and simplicity. It will be noted that the plate output and grid input leads are also de-henried in the manner indicated. The usual procedure of varying the screen-grid voltage for regeneration control is incorporated in this receiver. The audio amplifier is entirely conventional and no detailed discussion of this part of the circuit is necessary. A dry electrolytic condenser of high capacity is used at C13 since it costs only slightly more than an ordinary .5 mfd paper condenser and is much more effective in preventing degenerative feedback. A 56 tube is employed as it provides adequate volume for headphone reception and its low plate current does not affect the sensitivity of the earphones.

### Chassis and Layout

The receiver is constructed on a 14 gauge aluminum chassis measuring 10"x6 1/4"x2". On top of the chassis are mounted the dual .000025 mf. tuning condenser and accompanying airplane dial, and the two tube and coil shields. The location of these components can be determined by an inspection of

# For a Merry Christmas

Directions: Make heavy mark around set desired. Leave magazine, open at this page, where it can be seen. Santa should do the rest!

A gift that will bring joy to any boy, 6 to 60—A Short Wave Receiver!

Thrilling—Entertaining—Instructive. Clear, simple instructions and picture diagrams with every set.

A model for every purse and purpose. Buy the best! It costs you no more!

## The FULTONE V

### NEW FIVE-IN-THREE SET

#### 6F7 — 76 — 12A7

Here's the set that pulls 'em in. It's small—It's inexpensive—but how those distant stations do roll in on the speaker! Even the most hard-boiled volunteer sits up and takes notice at the volume and clearness of speech with which DJD and DJB, Germany; GSB and GSC, England; EAQ, Spain; PYA, France; and many others are received! And even those hard-to-get stations—JVN, Japan; VK3ME and VK3LR, Australia; and RNE, Russia came in with surprising ease! Amateurs! From all over the world!

Here's the set that we know you will be proud to own! That will give you and your friends a thrill at every turn of the dial! Plug into any 110 volt AC or 100 house current outlet. Coils supplied tune from 15 to 200 meters. Provision for built-in speaker—external speaker or headphones. Correct design insures full five tube performance—screen grid RF—regenerative detector 1st AF—Power pentode output and rectifier. All from three dual purpose tubes! Entirely self-contained. Its light weight and compactness makes it an ideal portable set. This is a receiver that is easy to build—easy to operate—and which will outperform higher priced sets!

Correct design and the use of highest grade parts insures consistent and ever-remarkable performance for many years! Tremendous sales and quantity purchasing makes the low price possible! Order your Fultone V today! We know that you, too, will say—Excellent!



Complete kit, including all necessary parts crystal finished metal chassis with all holes, and complete, easily followed instructions. **\$7.45**

- Set of matched Tubes.....\$2.20
- Metal cabinet as illustrated.....\$1.25
- Special loudspeaker.....\$1.45
- Two broadcast band coils.....\$1.25

**SPECIAL COMBINATION OFFER**  
Complete Kit, Tubes, Speaker, Cabinet and Broadcast band coils... **\$12.75**

## A Mightily Mite! The FULTONE "DUETTE"

### All Wave—Two-In-One—All-Electric

4 x4"x5 1/2"—2 1/4 lbs. Complete!  
A powerful handful of radio that will surprise you with its volume and reception ability. European S.W. Broadcast stations are easily picked up with excellent headphone volume! Use the new two-in-one type 12A7 Tube! High gain pentode detector and power rectifier. A real, powerful two tube receiver! This set is certainly no toy!

Small enough to fit in the palm of the hand! Very, very inexpensive! Yet—the Fultone "Duette" has features found only in much higher priced receivers—Smooth acting friction drive vernier dial—Quiet regeneration control Front panel adjustment for sensitivity—Built-in power supply providing all voltages needed (Set plugs into any 115 to 130 volt AC or DC house line)—Line noise and tunable hum filter—Power switch—Attractive, durable metal chassis and cabinet—Complete coverage from 15 to 625 meters (It gets everything!)

Easy construction kit includes all necessary parts, drilled chassis and cabinet, 15 to 200 meter coils, and simple instructions. **\$4.45**  
Sylvania 12A7 tube.....\$1.95  
200 to 625 meter broadcast band coil.....\$1.25

**SPECIAL COMBINATION OFFER \$6.25**  
Complete Kit, tube, and B.C. coils.....

### FULTONE "DUETTE" BATTERY MODEL

Uses the new type 19 tube—two separate tubes in one bulb! Detector and one stage audio amplifier. Economical operation on two dry cells and one or two B batteries.

Complete easy construction kit, as above.....\$3.75  
**COMBINATION OFFER \$5.50**  
Complete Kit, tube, and BC coils.....

## The FULTONE II

### SCREENGRID POWER PENTODE

A modified version of the well known 12,500 Mile Two Tuber which uses a 32 screen grid detector and a 33 power pentode output tube. (Dry cell operation.) This combination results in even more sensitivity and volume! An excellent and time proven Short Wave Receiver.



Complete Kit, including coils (15 to 200 meters), heavy, attractive metal chassis and cabinet with hinged cover and clear instructions.. **\$5.75**  
Set of Matched Tubes.....\$1.50

**ORDER NOW! You will be satisfied!**  
Deposit required with all orders.

Any Kit on this page—Assembled—Wired and Tested—\$1.25

**HARRISON RADIO CO.** Dept. C-1 New York City  
142 Liberty Street  
★ ★ THE HOME OF FOUR STAR SERVICE ★ ★

## THE HARRISON ORIGINAL

### 12,500 MILE TWO-TUBE SETS

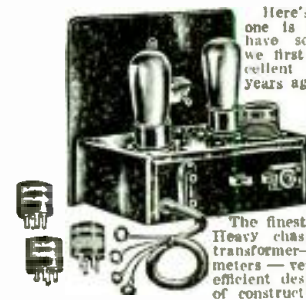

Here's the set that everyone is talking about! We have sold thousands since we first introduced this excellent receiver over two years ago. Every S.W. station in the world has been received with these sets!

The remarkable performance, neat appearance, and low cost make this the outstanding value today! Nostalgic!

The finest parts throughout! Heavy chassis—full size audio transformer—four coils 15 to 200 meters—vernier dial—modern, efficient design. The simplicity of construction and ease of operation make it the ideal beginner's set!

Battery Model uses two type 30 tubes and inexpensive long life dry batteries. **\$4.45**  
AC Model uses two 27 or 56 tubes.  
Either Model **COMPLETE KIT—\$4.45**  
Set of two Sylvania Tubes \$1.10

## AC-DC ALL-ELECTRIC MODEL

The world famous Harrison 12,500 mile set with a built-in hum free power pack supplying all necessary heater and plate voltages. Entirely self-contained! No batteries! Just plug into the 110 volt house line.



Complete kit, including drilled metal chassis, all parts, and clear picture diagrams. **\$5.95**

Set of three matched Sylvania tubes, \$1.50.  
(See Pg. 361 Oct. S.W.C.)

### ACCESSORIES

- Neat black crystal finished metal cabinet with hinged lid for the 12,500 Mile receiver. Protects tubes, coils, and wiring from damage and dust.....\$1.00
- Set of two broadcast band coils for any of the sets described above. Tune from 200 to 625 meters. Enables you to hear all the regular broadcast stations and the long wave ship and press transmissions merely by plugging in these coils. Make your set a real All-Wave Receiver.....\$1.25
- Set of two coils.....\$1.25
- AC Power Pack for AC model. Delivers 250 volts and 250 volts. Also excellent for amplifier or transmitter. Complete kit.....\$3.45
- Sensitive Lightweight Headphones 2000ohm, \$1.05; 4000 ohm, \$1.45
- Complete Antenna kit—includes antenna wire, lead in wire, insulators, ground clamp, knobs, etc.....75c

# Scientifically Produced

## Bud Superior Built Midget Condensers

The U. S. Bureau of Standards states that a variable air condenser, to be standard, must be rigid in construction, capacity must remain constant, and be definite, resistance must be kept at a minimum.

In announcing BUD SUPERIOR BUILT MIDGET CONDENSERS we have strived to live up to these specifications.

1. Riveting and soldering of all permanent connections between end plate and stator assemblies assure you of rigid, vibrationless, and precision construction. Single hole panel mounting or base mounting is provided for.
2. Heavy aluminum end plates with closely fitted bearings insure smooth operation and long life. Accurately spaced and soldered, special rolled, hard drawn brass condenser plates maintain a constant and definite capacity.
3. Soldering of all brass condenser plates to their respective brass shafts assure you of absolutely minimum resistance.

BUD SUPERIOR BUILT MIDGET CONDENSERS are of the straight line frequency type for better spread between stations.

We can highly recommend the use of BUD SUPERIOR BUILT MIDGET CONDENSERS for use with ultra high frequencies, broadcast and short wave receivers, low power transmitters, wave traps, compensating condensers as tuning and padding condensers, laboratory and experimental work and any other use in which a SUPERIOR BUILT CONDENSER is required.

All BUD SUPERIOR BUILT MIDGET CONDENSERS insulate the rotor from the stator assembly with "ISOTEX", (a ceramic composition made from the purest of raw materials and having the highest of insulating qualities, withstanding tremendous electrical strain).

### BUD SUPERIOR BUILT SINGLE GANG CONDENSERS



These Condensers have front and rear bearing. The rotor is insulated from the stator with ISOTEX.

Cat. No.	Cap. Mmfd.	Plates	Price
902	35	5	\$1.25
903	50	7	1.35
904	80	11	1.55
905	100	14	1.85
906	140	19	2.00
907	150	21	2.10
908	200	27	2.30
909	250	33	2.45
910	325	43	2.90



Constructed with only one bearing and end plate.

Cat. No.	Cap. Mmfd.	Plates	Price
323	20	3	\$.85
322	35	5	1.00
148	50	7	1.10
901	80	11	1.15
321	100	14	1.25
396	140	19	1.45
320	150	21	1.50

## Bud Polarized R. F. Chokes



A new efficient Popular Priced R. F. Choke of sectionalized winding. Thoroughly impregnated to minimize effects of moisture.

Catalogue No.	550	551	552	553	724	554	555	556
Inductance M. H.	80	60	30	10	8	5.5	3.4	2.5
Dist. Cap. MMFD.	3.15	3.2	3.1	3	3	2.25	2.2	2.1
D. C. Res. Ohms	250	120	70	40	35	55	40	30
Cur't. Rating M. A.	75	80	100	125	125	125	125	125
Price	45c	45c	45c	40c	40c	40c	40c	40c

Listed above are but a few of the items in the complete BUD line. Write for New 1935 Catalog! All list prices shown in this advertisement are subject to 40% discount when purchase is made from an authorized BUD jobber. If your jobber cannot supply BUD parts, send your order direct to us together with your jobber's name and we will make shipment direct.

## BUD RADIO INC.

1937 E. 55th STREET  
CLEVELAND, OHIO

## LEOTONE 4-TUBE WEEK-ENDERS S.W. RECEIVER



Battery Operated

Here is a modern short-wave receiver that serves the requirements of the most critical fan—a set that has been thoroughly tested and which gives results so gratifying to every set owner.

The Leotone portable (battery operated), 4-tube short-wave receiver, covers 15 to 200 meters. With plug-in coils, it uses the following tubes: 1—31 as R.F.; 1—32 as detector; 1—32 screen grid high gain resistances coupled first audio, assuring adequate volume on all signals; 1—30 as second audio.

This receiver draws less current than a single 201-A assuring exceptionally long life to batteries. Only standard, high quality parts are used, including Benjamin sockets. Set Battery requirements include 3 small type 45 volts and 2—4½ volt batteries.

Full vision dial, in brown morocco leather case with sufficient room for headphones and aerial wire. Any suitable ground or antenna system can be used. Complete kit, including Brown Morocco Leather Case and set of four coils covering 15-200 meter band, less tubes and batteries

**\$9.25**

LEOTONE RADIO COMPANY Dept. 1-35, 63 DEY STREET  
NEW YORK, N.Y.

the photographs. At the rear of the chassis are mounted the triple binding post assembly, the twin speaker jack and the power cable socket. The remaining parts are mounted underneath the chassis and their location can be determined from the photographs. The R.F. stage is isolated from the remainder of the receiver by the aluminum shield plate shown. As a further precaution against feedback the various ground connections are made to individual bus-bar circuits as indicated. The ground bus for the R.F. section runs from the ground binding post to the rotor of the trimming condenser, C3. The detector circuit bus runs from the B— terminal of the power socket, which is grounded to the chassis, to the rear of the tuning condenser. This bus forms a three-sided square as indicated in the photographs. The remainder of the wiring is self-explanatory as the various fixed condensers and resistors are connected directly to the required points by means of their pigtailed.

### Eliminating Hum

In order to provide hum-free operation, the grid condenser and leak combination, C8, R2, is mounted directly on the detector screen-grid clip and enclosed by the cap of the tube shield. This cap should be lined around the sides and top with light cardboard in order to prevent possible grounds. In the interests of a low hum-level, it is also necessary to ground one of the heater lines to the chassis as indicated in the schematic diagram. The winding data for the coils are given in table forms.

In connecting up the receiver, be sure to ground one of the doublet coil terminals if an ordinary antenna is used. The power supply should, of course, be well filtered if complete freedom from hum is to be experienced. When tuning the receiver, the trimming condenser should be set at the point where oscillations are most easily produced. If this point happens to be one of the extremes of the condenser, some readjustment of the turns on L2 will be necessary. The neutralizing condenser, C4, had best be adjusted when employing the 49 meter coils. If it is possible to produce oscillations with the potentiometer completely retarded at some settings of C4 the other two controls, the setting of C4 should be increased until this is impossible.

Results were very good. On the 19 meter band, FYA, DJB, GSF, and PRADO were received; on the 25 meter band FYA, GSD, GSE, and DJD were received; while on 30 meters DJA, GSB, GSC, and YV3RC were logged. No attempt was made to log the Australians. All of the shortwave "best-bets" were received on 49 meters. It is possible to receive 20 meter amateur phone stations with the 19 meter coil and on this band were heard H17G in San Domingo, X1G in Mexico, CM2WZ, CM6XS in Cuba, K4SA in Porto Rico, and numerous 6's and 7's in the States. A few other Spanish-speaking stations were not identified.

It should be remembered that the 19 meter band is generally best in the morning, the 25 meter band best in the early afternoon, the 30 meter band late in the afternoon till dark, and the 49 meter band after dark. In spite of the above generalities some of the best reception is had at other times than those indicated above. For instance, PRADO in Riobamba, Ecuador, was heard on 19 meters at 6:30 in the evening broadcasting a special program for the Ecuadorian colony in France; while HJ2ABC in Columbia was heard on 49 meters at 11 o'clock in the morning. DX reception on 20 meters is generally best in the early evening.

### Parts Required

L1, L2—See text for winding details. 19, 25, and 30 meter coils wound on Hammarlund CF-5-M Midget isolantite coil forms. 49 meter coils wound on Hammarlund CF-5 isolantite coil forms.

L3, L4—See text for winding details. See above for forms.

L5, L6—Hammarlund midget 2.3 mh. R.F. chokes.

C1, C2—Condenser, two gang 25 mmf. per section, equipped with Mycalex or Isolantite insulation.

Please mention SHORT WAVE CRAFT when writing advertisers



- C3—Hammarlund MC-35-S Midget isolantite condenser.
- C4—Hammarlund Equalizer, 3-35 mmf.
- C5, C6, C7—Aerovox .001 mf. mica condenser.
- C8—Aerovox .0001 mf. mica condenser.
- C9, C12—Aerovox .0005 mf. mica condenser.
- C10—Aerovox .5 mf. tubular by-pass condenser. 400 DCWV.
- C11—Aerovox .01 mf. tubular by-pass condenser. 400 DCWV.
- C13—Aerovox 25 mf., 25 volt dry electrolytic condenser.
- R1—Metallized resistor, 500 ohms, 1 watt.
- R2—Metallized resistor, 1 megohm, 1/2 watt.
- R3—Electrad 50,000 ohms potentiometer, type 205.
- R4—Metallized resistor, 50,000 ohms, 1/2 watt.
- R5—Metallized resistor, 5,000 ohms, 1/2 watt.
- R6, R7—Metallized resistor, 250,000 ohms, 1 watt.
- R8—Metallized resistor, 2,000 ohms, 1 watt.

- 1—Aluminum chassis, 10" by 6 1/4" by 2", 14 gauge. Blan. (Korrol)
- 1—Crowe Tuning Unit, type 123, airplane dial.
- 2—Hammarlund 5-prong isolantite condensers, type S-5.
- 2—ICA 5-prong wafer sockets.
- 2—ICA 6-prong wafer sockets.
- 1—Na-Ald triple binding post strip.
- 1—Na-Ald twin speaker jack.
- 1—Na-Ald 5-prong connectoralrd plug.
- 2—Hammarlund tube shields, type TS-50.
- 2—Shield cans 3" dia. by 3" height. Blan.
- Miscellaneous wire and hardware.

**COIL DATA**  
Antenna Coil

LT	L2*
19 M. 8 T. No. 26 DSC.	11 1/2 T. No. 20 En. Tap at 3 1/2.
25 M. 7 T. No. 26 DSC.	16 1/2 T. No. 20 En. Tap at 5.
30 M. 9 T. No. 30 DSC.	19 1/2 T. No. 20 En. Tap at 5.
49 M. 13 T. No. 26 DSC.	26 T. No. 20 En. Tap at 7.
Detector Coil	L4*
19 M. 6 1/2 T. No. 26 DSC.	9 1/2 T. No. 20 En. Tap at 2.
25 M. 8 1/2 T. No. 26 DSC.	12 1/2 T. No. 20 En. Tap at 2.
30 M. 10 1/2 T. No. 26 DSC.	14 1/2 T. No. 20 En. Tap at 2.
49 M. 16 T. No. 30 DSC.	21 T. No. 20 En. Tap at 2.

\*Spaced to occupy 1" on 1" dia. form except 49 meter coil, which occupies 1 1/2" on 1 1/2" dia. form.  
\*\*Interwound with L4. M—Meters.

**"5 METER NEWS"**

● MANY of our fans, who are interested in ultra high frequency transmission and reception, will undoubtedly be glad to learn that Arthur Lynch, of noise reducing antenna fame, has installed a 5 meter transmitter on the roof of the Hotel New Yorker and some very remarkable work is being done. The transmitter is a duplicate of the "long line" transmitter, described in the October, 1934 issue of SHORT WAVE CRAFT, and is laying down an R9 signal all over the Metropolitan area in New York and New Jersey. He is also using the new receiver described in the November, 1934 issue of SHORT WAVE CRAFT and reports that the performance of the receiver and transmitter leaves practically nothing to be desired. The most interesting part of this new station, is that Mr. Lynch intends to develop a 5 meter "chain," taking in Washington, Baltimore, Philadelphia, Hartford, W. Hartford, and Malden, Mass. This will be really an accomplishment and from present indications there is every possibility of it being accomplished in great style. Reports on signal strength in various locations will be appreciated and communications (post card will do) should be sent to W2AMN in care of this magazine. We hope to have more complete information and pictures next month.—W2AMN.

**WANTED!**

A young man for Chicago territory, well posted on amateur radio, able to make rough sketches and furnish advertising suggestions, to call on prospects handed to him by the Advertising Manager of a radio magazine with the largest circulation in the world. Part or full time. Give full particulars of your experience in first letter. State salary or commission expected. Address L. F. McClure, 919 N. Michigan Ave., Chicago, Ill.

## A New Inexpensive Amateur 5 METER TRANSCEIVER



**BUILD IT YOURSELF**

5 Meter Phone communication opens a thrilling new field of amateur radio activity. You can build your own effective Two-Way Phone from this popular amateur transceiver kit for 5 Meter operation designed by W. F. Marsh. Easy to build—low in cost. A tried and proved kit. Equally successful as transmitter or receiver. Compact designed for portable use. Uses a type '19 tube for excellent output. Kit of essential parts includes all necessary condensers, resistors, tubing, socket, dial, knobs, wire, hardware, drilled bakelite panels and base, easy-to-follow wiring diagram and attractive compact leatherette-covered carrying case with handle and lid. The De Luxe Kit of essential parts as described... **\$7.95**

The De Luxe Kit is also available complete with accessories including batteries, hand microphone, headphones, **\$13.70** and type '19 tube at

**"Breadboard" Style Kit**

For those who wish to build the 2 Way Phone for stationary operation, the "Breadboard" model kit is offered at an amazingly low price. The kit of essential parts is the same as that listed above, but less the portable case. The price is only **\$4.95**

Complete "Breadboard" Kit with accessories is **\$10.71**

**SEND FOR FREE PARTS LIST**



## SHORT WAVE HEADQUARTERS



Every Amateur, Set-Builder and Experimenter, will find the new 1935 ALLIED Catalog a perfect and complete guide to everything in the line of Short Wave Transmitting and Receiving equipment. We are Short Wave specialists and will be glad to quote you for complete kits covering any transmitting or receiving circuit described anywhere. There are hundreds of "scoops" in the new 1935 ALLIED Catalog—new professional S.W. sets, new Transceivers, new transmitting tubes, the new antenna gear, more than 20 new Set-Building Kits including the famous All-Star and the National Experimenter's 2 Tube S.W. set. Also the most complete line of high quality Short Wave parts in Radio at prices which are consistently lower.

**SEND FOR THIS GREAT 1935 RADIO CATALOG FREE**

Over 100 amazing pages. Packed with the latest Dual Wave, All-Wave, Short Wave and Broadcast receivers—new Set-Building Kits—an amazing P.A. listing—complete Short Wave Transmitting and Receiving Equipment—Test Instruments—thousands of Standard replacement parts and accessories. You need this wonderful book!

**Allied Radio CORPORATION**  
833 W. JACKSON BLVD., CHICAGO

833 W. JACKSON BLVD., CHICAGO, Dept. E.

Send me:

YOUR FREE 1935 RADIO CATALOG.

Enclosed you will find \$\_\_\_\_\_ for:

5 Meter De Luxe Kit of Essential Parts

De Luxe Kit Complete With Accessories

"Breadboard" Kit  "Breadboard" Kit Complete

Name \_\_\_\_\_

Address \_\_\_\_\_



## THIS IS NOT

THE SORT OF MAGAZINE THAT YOU READ AND THEN DISCARD

Readers keep their copies for years as a steady reference and thousands of letters attest to this. It is now possible to save your copies and for this purpose we designed a splendid binder for you which holds twelve copies. It is made of heavy substantial material and is covered with black grain leatherette. The name of the magazine is stamped in gold on the cover. An ingenious mechanical arrangement is provided which makes it possible to hold the copies flat when reading from the binder. SHORT WAVE CRAFT Binder as described, **\$1.25** prepaid in the United States. Canada and foreign countries 25c extra. We accept money order, check, stamps or cash.

**SHORT WAVE CRAFT**  
99-101 HUDSON STREET NEW YORK, N. Y.

## HIT OF THE SHOW!



**PERFORMANCE**

At a recent demonstration of the new POSTAL '35, before a gathering of well known amateurs and short wave fans, the POSTAL '35 Custom Built receiver outperformed the set that won all foreign DX records.

**CAPTAIN HORACE L. HALL**

the famous Short Wave Authority who writes for the New York Sun, Radio Tower, Radio News and many foreign publications, choose the New POSTAL '35 for his DX listening post. Proof of its superiority.

**OVER 50 IMPORTANT FEATURES**

Such as the Postal drawer coils, built in T.R.F. pre-selector stage, continuous bandspread, A.V.C., Audio and R.F. volume control, two 4 1/2 inch calibrated aeroplane dials, precision tuning meter, 10 tubes, etc.

**SOLD WITH A 10 DAY TRIAL MONEY BACK GUARANTEE**

WRITE IMMEDIATELY FOR FREE DESCRIPTIVE PAMPHLET NO. 140 AND SPECIAL PRICES TO SWC READERS.

**POSTAL RADIO**  
135 E. LIBERTY ST. NEW YORK, N. Y.

**NEW 1935 S. W. BOOSTER**  
The new Postal custom built two stage pre-selector is the only two stage self powered short wave booster on the market. Easily connects to any all-wave receiver and is guaranteed to improve reception over 100%.  
**WRITE IMMEDIATELY FOR FREE 16 PAGE DESCRIPTIVE BOOKLET**

Please mention SHORT WAVE CRAFT when writing advertisers

# IMPROVED 1935 SUPERBA

**FOREIGN RECEPTION GUARANTEED OR YOUR MONEY REFUNDED**

Due to the enthusiastic request of our customers, we are pleased to present the 1935 edition of the famous Superba. With such innovations as litz wound intermediates on isolantite cores, new high Q coils, A.V.C. on all frequencies. Beautiful aeroplane dial with micro tuning, in conjunction with our efficient bandspreading enables us to separate even the most closely bunched foreign stations. This Seven Tube Receiver has brought to its various owners verifications from the most distant points on the globe.

- Wired Model, complete with tubes, cabinet, coils and speaker, **\$34.00**
- Wired Chassis, complete with tubes, coils and speaker, **30.00**
- Complete Kit, with tubes, speaker, coils and blueprint **25.88**



## FIVE TUBE 1935 SUPERTONE BANDSPREAD RECEIVER



The advent of the aeroplane dial has necessitated the unified control of our Supertone Bandspread Receiver. Circuit has been revised to use a two range condenser, equalization of the two stages is attained by the use of a three plate Hammarlund condenser. Potentiometer in the screen lead has simplified the control of regeneration. Bandspreading is attained on all bands and is most appreciated on the heavily crowded ham bands. Set has been adapted for earphone reception with switch for disconnecting last audio stage mounted on the front panel. The power pack with a brute force filter using 30 mfd. with a connection for speaker field gives a hum proof power supply which can be used on any AC short wave receiver.

- Chassis, wired and tested with coils **\$10.00**
- Power Pack, wired and tested **4.98**
- Five tubes and 8" dynamic speaker **5.23**
- Complete Kit, tubes, speaker and power supply **18.00**
- Cabinet for receiver **2.50**

SEND for descriptions of our other Short Wave Receivers.

### SUPERTONE PRODUCTS CORP.

35 Hooper Street, Dept. S-1 35, Brooklyn, N. Y.

## A Variable Wavelength Antenna

(Continued from page 534)

Natural wavelength in meters	Length of wire in feet
10	8.25
20	16.50
30	24.75
40	33.0
50	41.25
60	49.50
70	57.75
80	66.0

The free end of the aerial wire is provided with two egg-type insulators, a coiled spring and another insulator, to which is attached the hauling rope or line which passes over the top pulley—fixed to the usual wireless pole at the far end of the garden—down the pole, round the lower pulley and thence back to the house where it is secured, within easy reach.

With the aerial extended to 14 feet—equivalent to a natural wavelength of 16.8 metres by the formulae given—the Empire transmitter for the African zone was picked up at fair loudspeaker strength but subject to fading. Extending the aerial another 9 feet gave a length of 23 feet, corresponding to a natural wavelength of 27.6 meters. The same transmission was tuned in again and found to be louder, with fading not so deep, the volume dropping to a comfortable loudspeaker strength, while the peak strength between fades was much greater than ever obtained before. Experiments on other parts of the waveband have shown that reception is improved by adjusting the length of the aerial.—World Radio.

(In this article the author referring to "natural wavelength" means the greatest wavelength at which a grounded antenna will function. In his meter-to-feet conversion he uses 3.3 as a factor instead of 3.28. These calculations are near enough for "receiving" purposes but will not serve for computing dimensions of transmitting antennas.—Editor)

## 100% Short Wave Book and it's

# FREE!

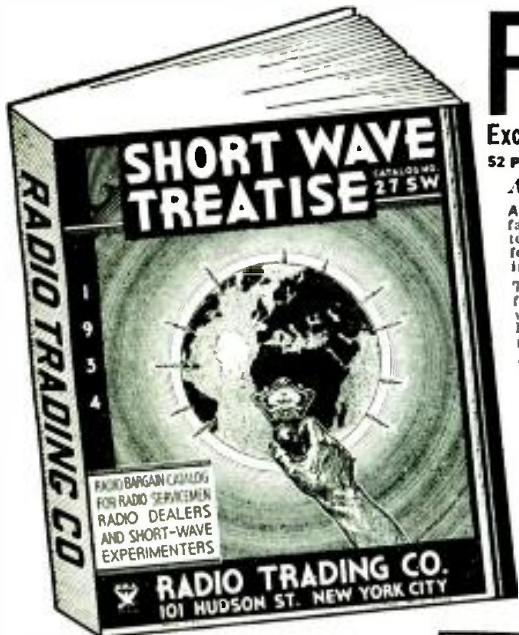

Exclusively Short-Waves From Beginning to End  
52 PAGES 50 HOOK-UPS 500 ILLUSTRATIONS

### A Real Text Book On Short-Waves

ANOTHER GREAT EVENT! This special edition of our famous Treatise is exclusively short-wave from beginning to end. Packed between its two covers is a wealth of information covering the entire short-wave field. Every word in it is new.

This Short-Wave Treatise contains 52 solid pages of useful short-wave information, diagrams, illustrations, short-wave kinks and real live short-wave radio merchandise. It contains more valuable short-wave radio information—more real live "meat"—than many text books on the subject. Special attention has been given to the short-wave beginner. Numerous articles are devoted entirely to his interest. Yet, we have not forgotten all you old-timers. There is plenty of real "dope" for you too.

#### PARTIAL LIST OF CONTENTS

Getting Started in Short-Waves—Helpful Short-Wave Kinks—Principles of Short-Wave Converter Operation—Bandspreading Explained—How to Build the "19" Unimount Twinplex For Less Than \$5.00—How to Tune For Foreign Short-Wave Stations—How to "Bandspread" the 2-Tube Electrified Doerle Set—How to Build a 5 and 10 Meter Phone and C.W. Push-Pull Transmitter—How to Build a Medium Power Transmitter Using the New 203-A Tubes—All About the New Short-Wave Transmitting and Receiving Antennas—Notes on Short-Wave Operation (Effect of Time of Day and Season of Year on Short-Wave Reception)—Complete Up-to-Date Characteristics of Transmitting Tubes, etc., etc.

## "5 in 3" A.C.-D.C. Set

(Continued from page 539)

### Coil Data

Range	No. Turns	Size Wire	Space between Windings	No. Turns	Size Wire
15 to 25 meters	3½	25 DSC	3/16 in.	7½	25 DSC
23 to 45 meters	7½	25 DSC	1/8 in.	8½	25 DSC
42 to 90 meters	16½	25 DSC	1/8 in.	9½	25 DSC
85 to 200 meters	39½	30 DSC	1/8 in.	11½	30 DSC

Knibbed coil form used; dia. = 1¼ inches.

### List of Parts

- 1—Chassis as illustrated (Fultone V).
  - 1—Cabinet with speaker grill (optional).
  - 1—140 mmf. variable condenser (Hammarlund, Fultone).
  - 1—Vernier dial (Crowe).
  - 1—Loud speaker.
  - 1—Tone Filter (or 750 ohm filter choke).
  - 2—7 prong wafer sockets.
  - 1—5 prong wafer sockets.
  - 1—4 prong coil socket (see text).
  - 1—Set of coils as described.
  - 1—350 ohm line cord.
  - 1—50,000 ohm potentiometer.
  - 1—Switch.
  - 1—R.F. choke. 2.5 M.H. (Hammarlund; National).
  - 1—Electrolytic condenser, 8—8 mf. 175 volts
  - 5—5 mf. 35 volts Aerovox)
  - 2—.1 tubular condenser.
  - 3—.01 tubular condenser.
  - 1—.5 tubular condenser.
  - 1—.0055 mica condenser.
  - 1—.002 mica condenser.
  - 1—.0003 mica condenser.
  - 1—.00015 mica condenser.
  - 1—5 meg resistor.
  - 2—750,000 ohm resistor.
  - 1—150,000 ohm resistor.
  - 1—45,000 ohm resistor.
  - 2—40,000 ohm resistor.
  - 1—3,000 ohm resistor.
  - 1—2,000 ohm resistor.
  - 2—500 ohm resistor.
  - 1—Speaker twin Jack.
  - 2—Knobs.
  - 2—Screen grid clips.
- Note: Parts made by other manufacturers than those specified may be used, provided they are of good quality and possess the same electrical characteristics.

WRITE TO-DAY

## RADIO TRADING CO.

101A Hudson St.

New York City

### ALUMINUM PANELS

16 Gauge.....7x12, 28c; 7x14, 32c  
5/64 inch or 13 Gauge.....7x10, 29c  
7x12, 34c; 7x14, 41c; 7x18, 49c; 7x21, 68c  
These panels are a special lot at the above prices. Longer and wider at correspondingly low prices. Add postage on 2 lbs. for each. We do not publish a catalogue. Estimates gladly furnished on request.

Radio parts for over 10 years.  
**BLAN THE RADIO MAN, Inc.**  
177 Greenwich St. Dept. 8 New York, N. Y.

Enclose five cents coin or U. S. stamps for postage — Treatise sent by return mail. PRINT NAME AND ADDRESS CLEARLY.

### When It's Needed in a Hurry!

Servicemen—Amateurs—Experimenters

Depend on  
**BURSTEIN-APPLEBEE CO.**  
America's Livest Radio House  
in America's Handiest Shipping Point.

1012-A McGee St.,  
Dept. 131  
Kansas City, Mo.

1935 Catalog  
148 Pages  
Write us if you haven't a copy.

Please mention SHORT WAVE CRAFT when writing advertisers

## Ultra Short Waves Extend Telephone Lines

(Continued from page 518)

make it possible to secure an optical path across the bay. Furthermore, Provincetown is fairly accessible by motor car around the Cape and is already provided with wire circuits, so that the radio link need not be completely depended upon. This location is thus a good proving ground for this new type of telephone circuit.

Accordingly, the radio link has been established across the bay, as indicated on the map, and extended at Green Harbor by wire to Boston, to form a direct Boston-Provincetown toll circuit. At Boston and at Provincetown the circuit appears at a jack in the switchboard alongside the jacks of other toll circuits. The insertion of a cord into the jack starts the radio transmitter at that end of the radio link. The receivers at both ends are kept in constant operation while the circuit is available for traffic. Ringing is accomplished by sending a 1000 cycle tone interrupted at 20 cycles over the radio circuit. Since the radio transmitter requires less than one second to start, the operator may ring immediately after inserting the cord. Privacy equipment, similar to that used on the transatlantic short wave channels, is installed.

The receiver is started and stopped by the operation of a key at the local test board. The power supply is arranged so that when the receiver is in operation, current is also applied to some of the filaments of the transmitter. Provision is also made for testing the overall operation of the transmitter and receiver at each end from the local test board. A tone is generated which modulates the transmitter, and if both transmitter and receiver are operating properly, a sidetone will be produced in the local receiver which can be heard by the test board operator.

The transmitter, developed by R. W. Friis and L. M. Klenk under the supervision of N. F. Schlaack, is crystal controlled, and is capable of delivering 15 watts of carrier power which can be completely modulated. A block schematic for the Green Harbor transmitter is shown in Figure 1. The Provincetown transmitter is the same except that the output frequency is 63 megacycles. A quartz crystal oscillator is followed by two harmonic generators, a push-pull modulating amplifier, and a push-pull power amplifier. Modulation is accomplished by supplying audio-frequency modulating power to the plate and screen of the modulating amplifier and to the screens of the second harmonic generator and the power amplifier.

Two rectifiers employing hot-cathode mercury-vapor tubes supply plate and screen potentials for all tubes. Grid bias potentials are obtained from cathode resistors and grid leaks. Grid and plate circuits of each stage are shielded from each other to prevent extraneous coupling and interstage feedback. The transmitter operates entirely on standard commercial 110-volt, 60-cycle current.

The radio receivers, developed by G. Rodwin and C. H. Swannack under the direction of F. A. Polkinghorn, also operate from a 110-volt, 60-cycle circuit, and are of the double detection type. A block schematic is shown in Figure 2. To make unattended operation possible, a crystal oscillator is used as a source of beating frequency. A single-stage harmonic generator produces sufficient voltage of the eighth harmonic of the crystal frequency for satisfactory operation of the detector. The intermediate frequency amplifier consists of three stages of amplification at 1600 kilocycles, and has a band width of approximately 50 kilocycles. A small

## NOW AT LAST!

PROVEN, DEPENDABLE WORLD-WIDE RECEPTION WITH THESE FAMOUS NEW DELUXE ALL-ELECTRIC ALL-WAVE

# WORLD TROTTER RECEIVERS

the PROFESSIONAL band spread DX5 the AMATEURS FAVORITE DX3

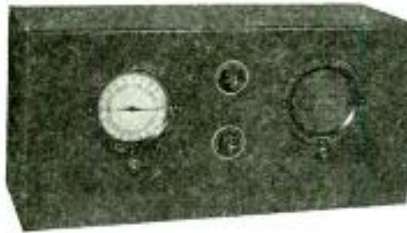

- LATEST TUBES! one type 6D6, one type 76, one type 38A and two type 12Z3's. WHAT A COMBINATION!
- NEW! color calibrated aeroplane dial!
- CONTINUOUS BAND SPREAD!
- PHONE OUTLET!
- 5 DISTINCT WAVE-BANDS! 14 to 550 Meters!
- DYNAMIC SPEAKER!! Built-in!
- VOLTAGE DOUBLER AC POWER SUPPLY! Self contained!
- VERY EASY TO BUILD!
- BUILT-IN COIL HOLDER RACK!
- ATTRACTIVE METAL CABINET!
- EXCEPTIONALLY LOW PRICE!
- FOREIGN RECEPTION GUARANTEED!!
- IT'S DEPENDABILITY IS YOUR GUARANTEE FOR UNEQUALLED THRILL IN WORLD-WIDE RECEPTION!!



- EASY TO BUILD!
- 1935 model ADVANCED ENGINEERED!
- BUILT-IN AC-DC POWER SUPPLY!
- SPEAKER built-in!
- 3 of the BEST S.W. TUBES! one type 6D6, one type 38A and one type 76 is incorporated! Its outstanding performance will marvel you and give you new thrills around the world.

-----ORDER NOW!-----ORDER BLANK-----ORDER NOW!-----

WORLD TROTTER RADIO LABS., Division C2, 168 Washington Street, New York, N. Y.

Gentlemen: Please rush to me the items checked below. Date \_\_\_\_\_

One COMPLETE "PROFESSIONAL" band spread DX5 KIT, including power supply, coils to cover from 14 to 210 meters, DYNAMIC SPEAKER, coil holder rack, and complete instructions for only \$14.95

EXTRA for black crackle finished metal cabinet, size 12x18x10" \$2.50

MATCHED ARCTURUS 6 months guaranteed tubes 3.10

IF you prefer it CUSTOM BUILT add 2.25

BROADCAST coil from 200 to 550 meters. 95c

One COMPLETE "AMATEURS FAVORITE" DX3 KIT assembled including power supply, four coils to cover from 14 to 210 meters and complete instructions. SPECIAL OFFER, FOR ONLY \$6.50

EXTRA for speaker \$1.35

EXTRA for the black crackle finished metal cabinet 1.95

Kit of 6 months GUARANTEED ARCTURUS tubes 2.20

IF you prefer it CUSTOM BUILT add 1.25

BROADCAST COIL to cover from 200 to 550 meters. 75c

Please enclose at least 80% of order to cover the above items checked. Send it PP.  EXP.

I enclose \$ \_\_\_\_\_

Name \_\_\_\_\_ Address \_\_\_\_\_ Town \_\_\_\_\_ State \_\_\_\_\_



## The Breakers

ATLANTIC CITY, NEW JERSEY

On the Boardwalk

SITUATED DIRECTLY ON THE OCEANFRONT AND CONVENIENT TO ALL PIERS AND AMUSEMENTS



\$6 WITH MEALS Daily WITHOUT MEALS \$3  
PRIVATE BATH Per Person PRIVATE BATH

Hot and Cold Sea Water in all Baths

EXCELLENT FOOD

GARAGE ATTACHED



### NOW READY

## The 1935 PROFIT GUIDE

104 Pages—Full of Marvelous buys. A complete line of public address amplifiers and equipment short wave accessories—speakers—replacement parts—servicemen's supplies, etc.

SEND FOR YOUR FREE COPY TODAY  
BALTIMORE RADIO CORPORATION  
721 Broadway Dept. S New York, N. Y.

Just Off the Press!

RADIO'S GREATEST VALUES

100 Pages. Filled with Latest Design Portable, Mobile and Rack & Panel, Public Address Amplifiers, Short-Wave and All-Wave Receivers and Converters, Inter-Office Call Systems, Test Equipment, Replacement Parts, Kits, Tubes, and Accessories—all at Unbeatable Rock Bottom Prices! Send For Your Copy To-Day!

COAST-TO-COAST RADIO CORP.  
123 S. WEST 17th STREET, NEW YORK, N. Y.



Please mention SHORT WAVE CRAFT when writing advertisers

# 2 new BOOKS on SHORT WAVES

HERE are two brand new books which you have been looking for for a long time. They contain everything that you have been asking for for many months. These new books will give you the latest information of everything you wish to know in two respective fields. Be sure to order them today. You will not regret it.

They make excellent companions to our other handbooks, which you may have.

7" x 10"

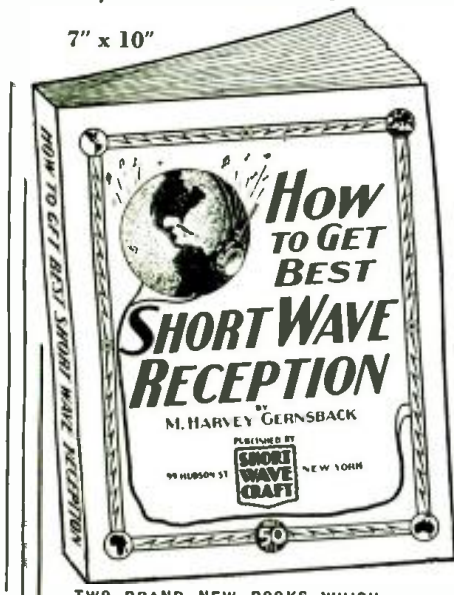

TWO BRAND NEW BOOKS WHICH EVERY ALERT SHORT-WAVE FAN SHOULD HAVE IN HIS LIBRARY

7" x 10"

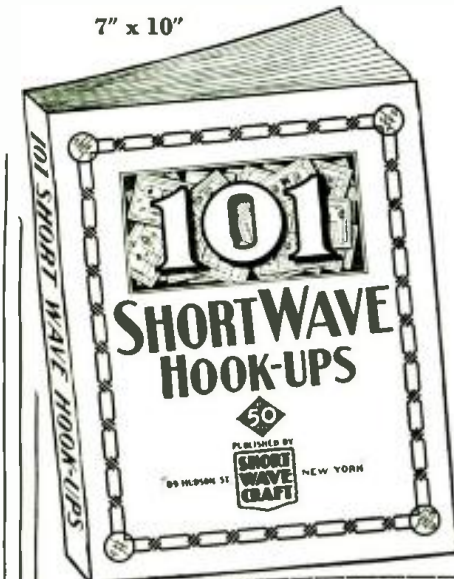

SHORT WAVE CRAFT, 99 Hudson Street, New York City.

Gentlemen: I enclose \$ for which you are to send to me, postpaid, immediately upon publication, the books checked below:  
 "How to Get Best Short Wave Reception"  
 "101 Short Wave Hookups"

Name .....

Address .....

City and State .....

(Send check or money order. If you send cash or uncancelled U. S. Postage Stamps, register it.)

SWC-1-35

## "How to Get Best Short Wave Reception"

By M. HARVEY GERNSBACK

Here is a book that gives you everything you ever wanted to know about short-wave reception.

The author, a professional radio listener and radio fan for many years, gives you his long experience in radio reception and all that goes with it.

Why is one radio listener enabled to pull in stations from all over the globe, even small 100 watters, 10,000 miles away, and why is it that the next fellow, with a much better and more expensive equipment, can only pull in the powerful stations that any child can get without much aid?

The reason is intimate knowledge of short waves and how they behave. Here are the chapters of this new book:

1. What are Short Waves and what can the listener hear on a short-wave receiver or converter?
2. How to tune and when to listen in on the short waves.
3. How to identify short-wave stations.
4. Seasonal changes in short-wave reception.
5. Types of receivers for short-wave reception.
6. Aerial systems for short-wave receivers.
7. How to get verifications from short-wave stations.
8. Short-wave hints.

The book is profusely illustrated with the best kind of illustrations that it was possible to obtain.

Please note that this is not a re-hash of anything that has appeared before. Everything in the entire book has been written to order, and there is no duplication of anything here that has appeared in print before.

The book will make excellent reading matter, whether you are a rank beginner or whether you have been at it for a long time. There are many tricks in short-wave reception that even some of the "old-timers" do not know. That is the reason for this book. Be sure to get it.

Place your order at once.

72 pages, over 40 illustrations.

Price ..... **50c**

## 101 SHORT WAVE HOOKUPS

Compiled by the Editors of SHORT WAVE CRAFT

Here is a worthwhile book that every short-wave listener, every short-wave fan, and every short-wave amateur has waited for a long time. It gives you the 101 best short-wave hook-ups which have appeared heretofore. It is a veritable encyclopedia of the best in short-waves when it comes to hook-ups.

And do not run away with the idea that we just give you a few plain hook-ups. Each and every hook-up and diagram illustrated is also accompanied by a thorough explanation of what this particular hook-up accomplishes, what parts are required, coil-winding information, values of resistors, etc. In fact, everything you want to know in order to build the set or to look up the data required.

To be sure, all of the past five years which have appeared in print during the important sets which have appeared in this valuable book. Sets such as the Doerle, Dismore, the "19" Twinplex, Oscillodyne, Duo-Aplidyne, Denton "Stand-by," Megalyne Triplex 2, "Globe-Trotter," 2-Tube Superhet, Minidyne, "Loop" Receiver, "Doerle" 2-tube Battery, "Doerle" 3-tube Battery, "Doerle" 2-tube A.C., "Doerle" 3-tube A.C., Doerle "Signal Gripper," "Control" Band-Spread 2-tube Receiver, 3/4 Meter Portable Transmitter and Receiver, Duo R.F. 4-tube Receiver, The Sargent 9-33 Tapped Coil Receiver, Globe-Girdler 7, The 2-Tube "Champ," -2 Tubes Equal 3, Ham-Band "2-tube Pee-Wee," Wynth All-Wave 6, "Rex" Portable Super-het Receiver, The "53" 1-tube Twinplex, Stuart Band-Spread S.W. Converter, The "Ace" Band-Spread 3, Denton Economy 3, 2-Tube "Regenerative-Oscillodyne" will be found here, with full descriptions. In many cases, where it was necessary, we have also included a picture hook-up for those who do not wish to follow the regular symbolic hook-up, but wish to have a regular wiring diagram.

Also note, that in many cases, we have not just reproduced old hook-ups or diagrams. In many cases they have been brought up-to-date, to give you the latest information available in such sets.

This is a very handy volume, especially for those "fans" who wish to study the best sets in the short-wave art, from one tube up to ten tubes, instead of leafing through a dozen magazines and going through back numbers.

The present volume brings you everything in a clarified manner, leaving nothing to your imagination. The book is thorough, and up to date, and will be a welcome addition to your Radio library.

72 pages, over 100 illustrations.

Price ..... **50c**

amount of automatic volume control is provided to compensate for slight variations in received voltage caused by variation in humidity and other factors.

The receiving and transmitting antennas are identical and are mounted on 100-foot poles 50 feet apart. Horizontal exciter and reflector elements are supported on standard cross-arms. Four pairs of half-wave exciter elements, each comprising two half-wavelength conductors, are spaced one-half wavelength apart in a vertical plane on one side of the pole. Reflector elements are similarly arranged on the opposite side of the pole, the spacing between exciters and reflectors being one-quarter wavelength. The transmitter and receiver are each mounted in a metal container suitable for mounting on the antenna poles at a later date. At the present time they are installed in a small building located between the transmitting and receiving antennas. The mechanical design of the transmitters and the station layout were made by M. E. Fultz and J. L. Mathison. The system was put into trial service early in July.—Bell Laboratories Record.

## 2.5 to 5 Meter Telescoping Antenna

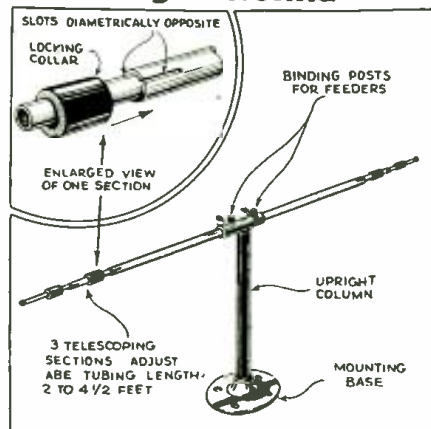

The adjustable 2.5 to 5 meter telescoping antenna can be used either vertically or horizontally. No. 237.

● HERE is an interesting antenna assembly designed for portable transmission and reception on the ultra high frequencies. It is adjustable in length from 4 to 9 feet taking in the 2 1/2 and 5 meter amateur bands. It is a dipole affair so constructed that it can be conveniently mounted either on the running board or the side of the automobile. The illustration clearly shows the method by which the two telescoping sections (there are three parts to each section) can be adjusted and locked in place, making a sure and positive contact at the joint. The mounting standard of this new American Radio Hardware Co. antenna is 13 inches over all, and has a 3/4 inch cast iron base plate, into which the one inch wooden mounting bar is screwed. Thus the base plate can be left mounted permanently and the antenna screwed into place when being used and taken down when not in use.

### FREE "Resistor" Bulletin

● YOU can obtain free a very useful Amateur Handbook which explains the use of resistors of various types and sizes for amateur radio receivers and transmitters, by simply writing to us and mentioning Number 501.

This booklet contains valuable tables and formulas, together with graphic charts, which permit rapid computation of the voltage, current and resistance relations in the filament, and plate circuits of receivers and transmitters. An A.C.-D.C. Frequency-Meter-Monitor is described; a class "B" modulator with type 800 tubes; Receiver Power Supplies, etc. To obtain a copy of this valuable book without charge, simply send a card mentioning No. 501 to:

Service Department  
 SHORT WAVE CRAFT  
 99-101 Hudson Street  
 New York City

Please mention SHORT WAVE CRAFT when writing advertisers

### Cold Cathode Tube Demonstrated!

(Continued from page 521)

electrostatic field draws them to the alternately, positively charged cathodes. The strength of these several fields can be adjusted to allow an electron to be shuttled back and forth between the cathodes any desired number of times before it is finally drawn out of circulation at the anode. The high velocity electron striking the cathode causes the emission of from 2 to 8 secondary electrons, the number of secondary units depending upon the velocity of the impact electron and thus upon the amplitude of the voltage, which is applied to the cathode. Each emitted secondary also causes the emission of more secondary electrons, the process being rapidly cumulative and gives rise to a tremendous amplification of current.

#### Condition for Maximum Output

The anode attraction which causes electrons to leave the vicinity of the cathode and which increases its velocity as it approaches the plane of the anode also decelerates its velocity as it leaves the anode plane, and approaches the second cathode which is charged positively so as to attract it. The resultant velocity may not be sufficient to cause emission from the second cathode but in order to insure this emission, additional energy must be imparted to it. This energy is obtained from that stored in the resonant circuit shown in the diagram. The high frequency supply is of the order of 50 megacycles and should be loosely coupled to the tuned circuit in order to apply from 25 to 90 volts across the cathode terminals. One hundred volts or more can be applied to the anode depending upon the desired output.



The Electron Multiplier as a high-frequency self-excited oscillator.

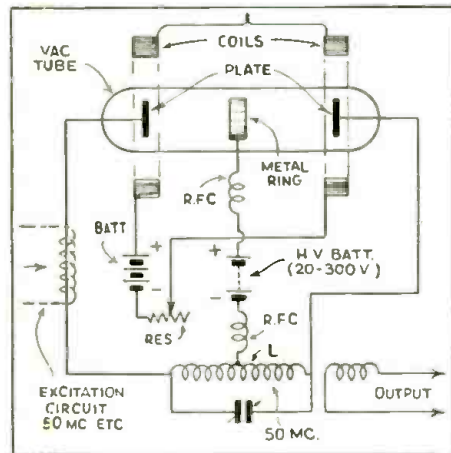

Hook-up of "Cold Cathode" Tube.

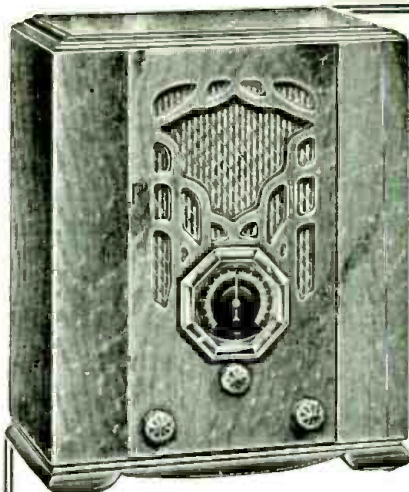

### LA SALLE TRANS-UNIVERSE ALL-WAVE RECEIVER

The Trans-Universe is the pride of the La Salle laboratory. At your finger tips are the stations of the world. Enjoy music and entertainment from foreign lands. Listen to ships at sea, airplane reports, police signals, stations in Europe, Africa, South America, Australia, roll in with excellent volume and power galore. No more hunting for these stations just snap the switch and set the dial on the desired wavelength. The Trans-Universe is a 7 tube Superhet. Plug in coils have been eliminated by the use of a new coil and ball bearing switch assembly designed in our laboratory. This new coil and switch is the acme of efficiency. The circuit uses a 3 gang condenser and consists of a tuned stage of I.F., an electron coupled oscillator, 3 litz wound high gain doubly tuned intermediate full automatic volume control and Pentode Power Output. The set uses the following tubes: 6D6, 6A7, 6D6, 6D6, 75, 42 and 83V. The 42 tube delivers 3 watts of undistorted output, same as a 2A5 tube. The Trans-Universe covers 5 bands from 12 to 55, 40 to 85, 70 to 200, 200 to 550, 550 to 2000 meters. Only highest quality of parts are used in this set. Such as: Thordarson, Hammarlund, Solar, Automatic De Jur, Micomold, Utah, Carter. The use of a 12 to 1 ratio airplane type dial calibrated in KC and MGC simplifies tuning of foreign stations.

- Model LTU: complete wired and tested chassis and speaker ready for operation with tubes. **\$41.75** less cabinet.
- Model LTK: complete kit of parts includes all parts speaker diagrams, etc., and tubes less cabinet. **\$36.75**
- Model LTUC: complete set ready for operation in a beautiful Gothic Cabinet Complete with tubes and Utah speaker. **\$44.50**

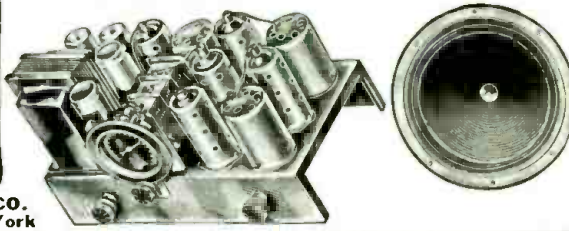

LA SALLE RADIO PRODUCTS CO.  
140 Washington St., New York

CABLE ADDRESS: "UNCLEDAVE" INCLUDE 20% DEPOSIT WITH C.O.D. ORDERS  
WRITE IN FOR OUR NEW HAM CATALOG—JUST OFF THE PRESS!

### UNCLE DAVE'S RADIO SHACK 356 BROADWAY FOREIGN TRADE SOLICITED ALBANY, N. Y. Long Distance Phone: 4-5746

PEERLESS 40-DX TRANSMITTER, crystal controlled, new tubes, new circuits. Professional in appearance and operation. 35 watts CW—10 watts phone. Write for complete details and new low price.

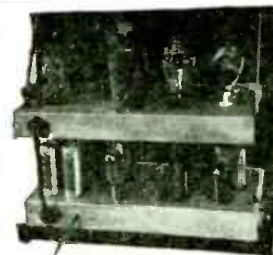

Pilot Universal Super Wasp, NEW, beautiful walnut cabinet, wave-change switch, no plug-in coils, 15-650 meters, factory wired and tested, complete with six tubes. WHILE THEY LAST **\$20.95**

2-gang condensers, .00035 each section, FB for that small transmitter, each **.89**

High frequency buzzers, FB for code learning, each **.39**

Peerless precision crystals, ground to your frequency in the 160 or 80 meter bands, complete with adjustable holder. **\$2.75**

PEERLESS TRANSMITTER  
Rear View **\$2.75**

WANTED—USED TELEPLEXES!

## Announcing Amazing Typewriter Bargain

New Remington Portable only 10c a Day  
10-DAY FREE TRIAL OFFER

Only 10c a day buys this latest model Remington Portable! Not a used typewriter. Not a rebuilt machine. It's a brand new, regulation Remington typewriter. Simple to operate, yet does the finest work. Full set of keys with large and small letters.



MAIL COUPON

for full facts about this astounding offer

Try this typewriter in your home or office on our 10-day FREE TRIAL OFFER. If at the end of 10 days you do not agree that this Remington is the finest portable at any price, you can return it at our expense. Don't delay. Don't put it off. Mail the coupon today. Or use postcard if you prefer. Write for our new catalogue showing the most complete line of portable and desk models ever offered.

REMINGTON RAND INC., Dept. 214-1  
BUFFALO, NEW YORK.

Please tell me how I can buy a new Remington Portable Typewriter for only 10c a day. Also enclose one of your new catalogues.

Name .....  
Address .....

FREE TOUCH  
TYPEWRITING COURSE

Please mention SHORT WAVE CRAFT when writing advertisers

HERE IS A

# Christmas Present For You!

Send among your friends three of any item advertised below and we will ship you four for the price of three, therefore your own will cost you nothing. Act promptly as this offer will not be repeated.

**EXTRA SPECIAL OFFER FOR DECEMBER ONLY!**  
We will ship two Stoppani Compasses for the price of one. Total \$4.50.

## STOPPANI COMPASS

A Precision Instrument made in Belgium. Purchased by the U. S. Government at more than \$30.00 each. Ideal for Radio Experimenters. Laboratory, also may be used as a Galvanometer for detecting electric currents in radio circuits. Ruby, jeweled, solid bronze, 4 inches square, fitted in a hardwood case.



Our price prepaid \$4.50 each

## Vest Pocket SOLDERING IRON



Smallest good iron now on the market. Will do the work of irons twice its size. Only 10 inches long, 1/2 inch in diameter. By using the highest grade elements, it heats up in half the time of ordinary irons. Guaranteed to give satisfaction or money back. We issue no catalog on this item. Enclose \$1.20 and iron will be sent postpaid in U.S. 10c extra in Canada.

## GOLDEN GEM PORTABLE ADDING MACHINE



Adds! Subtracts! Multiplies!

Does the Work as Accurately as Machines Selling at \$300.  
**OVER 300,000 SOLD THROUGHOUT THE WORLD**

The adding machine pictured above is today unquestionably the world's most famous pocket and desk adding machine. Since 1904 this marvelous little "Swiss Watch among Adding Machines" has been purchased by governments, institutions, and individuals the world over. There is nothing more simple to operate than the GEM adding machine. Numbers are registered on the machine as quickly as they are spoken. All carrying from column to column is done automatically without the slightest attention from the operator. It is this feature, especially, that distinguishes the GEM from all other small adding machines, all of which require the attention of the operator for the carrying process. Interesting literature and testimonial letters from users all over the country sent upon request. Nickel Plated, weatherproof pouch..... \$ 8.95  
Chrome Finish, weatherproof pouch..... 9.95  
De Luxe Model in beautiful plush lined case (1.29 Postage Paid in any part of U. S. Canada and Foreign Countries extra.

Maximum current output is obtained when the anode voltage is just sufficient to allow an electron to travel from one cathode to another during one half of the high frequency excitation cycle. The external magnetic field can be then done away with, if the cathodes are properly curved instead of being plane. This curvature can be calculated so as to focus the electrons automatically for specified anode and cathode voltages. This would eliminate the D.C. supply for the magnetic focusing.

## All-Electric All-Wave Set

(Continued from page 538)

The nucleus of this set is a special circuit built around the new high gain 6F7 tube. Originally designed for superheterodyne use, this tube is readily adapted to other services. It is in reality two tubes in one bulb, i.e., an RF pentode and a medium mu triode. Used in conjunction with types 76 and 12Z3 tubes, we have 4-tube performance from three tubes.

Inspection of the circuit diagram reveals the use of the RF pentode section of the 6F7 as a screen-grid regenerative detector, the output of which is resistance coupled to the triode section of the same tube which serves as the first audio amplifier stage. Resistance coupling is again employed to the second stage which uses a type 76 tube. A 12Z3 tube functions as a half wave rectifier, and the filaments of all tubes are connected in series as in the usual A.C.-D.C. arrangement. The result is a screen-grid regenerative detector, two stage audio amplifier, rectifier and complete built-in power supply. No external power pack or batteries are necessary.

C1 is the usual antenna series condenser having a capacity range of about 6-70 mmf. Grid leak-condenser detection is used, values of 5,000,000 ohms and 0.0001 mf, respectively being satisfactory. The large value of grid leak results in a high level of sensitivity. Feed-back occurs between the coils L1 and L2 both of which are wound upon the same form. Regeneration is controlled by means of the potentiometer R2 which varies the screen-grid voltage of the detector section of the 6F7 tube.

The plate resistance of the RF pentode section of the 6F7 is quite high, hence it is necessary to use a large value of plate resistor in order to take full advantage of the high gain possibilities of this tube. A value in the neighborhood of 200,000 ohms is quite satisfactory. The mica condenser C5 (.0001 mf.) by-passes the RF currents around the audio amplifier. The audio frequency component of the detector's output is coupled into the triode section of the 6F7 by means of the coupling condenser C6 (.01 mf.) and the grid resistor R3 (3,000,000 ohms). The audio amplifier section utilizes grid leak bias which is satisfactory in this case. A type 76 tube serves as the second audio frequency amplifier stage. This tube is superior to the older type 37, due to its somewhat greater amplification factor. The resistor R7 furnishes the bias for this stage. The headphones or magnetic speaker connect directly in the plate circuit of the 76 tube.

## Health Ray Carbon Lamp

PAYS FOR ITSELF IN A FEW TREATMENTS.



Everyone in the family needs the health giving Violet Rays.

This is a large CHROMIUM plated lamp using standard carbons emitting rays of ultra violet and infra red. If Sun Tan is desired, order accordingly. Saves doctor's bills. Cures colds, rheumatism, and other ailments. Size 11 1/2" high, 10" wide, 5 1/2" deep. Weight 8 3/4 pounds. Interesting literature sent free. List price with Screen and Goggles—\$10.00. YOUR COST—F.O.B., N.Y., \$3.38.

**WONDERFUL VALUE!**

Send M.O., Stamps or Check. All Goods Sold F.O.B. New York  
**GOLD SHIELD PRODUCTS CO., 98 Park Place, New York**  
Business Established in 1901. Reference: SHORT WAVE CRAFT

# ANKER-CRUISER

## 3-TUBE A.C.-D.C. SET

WORLD-WIDE RECEPTION

KIT \$10.45 NET



### OUTSTANDING FEATURES

Electron coupled feedback, 3 tubes, 6C6, 43, and 2E25, humfree built-in 110 V. AC-DC power supply, front panel plug-in coils, front panel phone plug, automatic speaker cutoff, hinged cover black crackled metal cabinet, 13 to 200 meters—complete kit of parts, including 4 front plug-in coils, hardware, diagram, instructions, etcetera. List, \$17.41; net \$10.45. Wiring and testing, list \$3.40; net \$2.05. Broadcast coil, list, \$3.99; net \$2.59. Kit of Arcturus Tubes, list, \$3.95; net, \$2.37. Ankerlite phone, list, \$1.75; net, \$1.05. Order from this page. Free Anker Catalog on Request. **ANKER LABS** Dept. S-1-35 New York City

# READ AND SEND CODE

Learn Easily At Home This Quicker Way

No experience needed. Beginners read code quickly, copy accurately. If already an op. speed up your rim with this approved amazing New Master Teletex. Only instrument ever produced which records your sending in visible dots and dashes—then sends back to you audibly through headphones. Fascinating, fool-proof gets results because you learn by HEARING as well as seeing. Teletex has taught the code to more students in past few years than all other systems combined. Used by U. S. Army and Navy, U. C. A., A. T. & T., and others. We furnish Complete Course, lend you the New Master Teletex, and give you personal instruction with a MONEY-BACK GUARANTEE. Low cost, easy terms. Write today for folder S. 25, no obligation.

**TELEPLEX COMPANY**  
76 Cortlandt St.  
New York, N. Y.

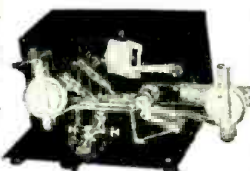

## \$20.00 PRIZE MONTHLY FOR "BEST" 1-TUBE SET

Or other short-wave set article accepted and published. Send diagram first or set if you prefer.

Sets must be sent PREPAID and should be CAREFULLY PACKED in a WOODEN box!

The closing date for each contest is sixty days preceding date of issue (Jan. 1 for the March issue, etc.). In the event of a "tie" an equal prize will be paid to each contestant so tying.

The judges will be the editors of SHORT WAVE CRAFT, and George Shuart and Clifford E. Denton, who will also serve on the examining board. Their findings will be final.

Address your entries to:  
Editor,  
SHORT WAVE CRAFT,  
99-101 Hudson St.,  
New York City.

Please mention SHORT WAVE CRAFT when writing advertisers

# Transceiver of Improved Design

(Continued from page 538)

coil. With the microphone held upright in normal operating position, the lamp will light brightly. The intensity of the light will vary when the microphone is spoken into and it will go out completely when the microphone is laid flat.

A double-pole, double-throw switch is employed to make the necessary circuit change from "transmit" to "receive." The rheostat should be set at the point where best operation occurs. If turned up too far, the life of the tube will, of course, be considerably shortened.

The 500,000 ohm variable resistor is used to adjust the grid bias for reception. Its setting will be fairly critical, but once found, will require but little change.

The midget tuning condenser should be mounted as near the tank coil as possible, with the tube socket close by. Leads should be short and direct. The tuning dial should be coupled to the tank condenser by means of an insulated rod, in order to reduce the effect of hand capacity. By-pass condensers should be connected directly to minus filament terminal of the tube socket.

Either of two types of antenna systems may be used with the Knight Transceiver. A single wire vertical antenna may be connected direct to the tank coil at a point not to exceed one half inch on either

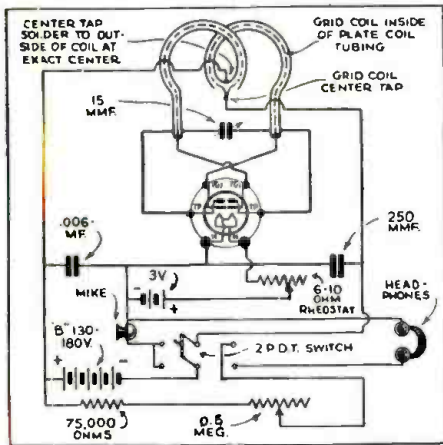

Hook-up of Transceiver

side of the center tap. This antenna may vary in length, but should always be an even multiple of a quarter wave. Roughly speaking, this means that the antenna may be 8 feet, 16 feet, 24 feet, etc.

The most successful type of antenna is the PICKARD system using two quarter wave rods center-fed and link-coupled to the tank. The tank coupling coil may consist of one or two turns of wire coupled within 2" or 3" of the tank coil. The transmission line may be cut any length. The coupling coil at the antenna should approximately match the tank coupling coil. This type of antenna is much more efficient than a single wire system in both transmitting and receiving.

To check the reception, the D.P.D.T. switch should be set on the "receive" side, and the rheostat turned up to a point where the tube seems to attain its normal filament brilliancy. The variable resistor should then be set at the point where the characteristic rushing noise of a super-regenerative receiver is loudest. The dial should then be turned slowly until a point is reached where the hissing ceases or diminishes. This quiet point indicates that a station has been tuned in. The variable resistor should then be adjusted to a point of maximum response.

### Essential Parts for "Breadboard" Transceiver

- L-5 turns—1" outside diameter of 1/8" copper tubing.
- L1—Grid coil on inside of plate coil tubing—use hook-up wire.

# ALAN

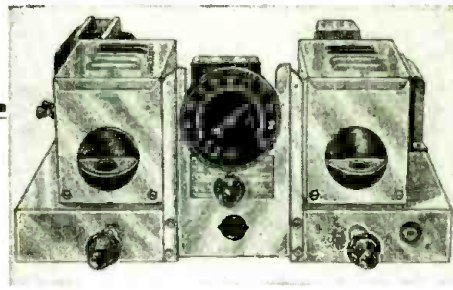

# D. R. 6

## DUAL

## REACTION

Employs six tubes. Dual Reaction circuit using 3—58's; 1—56; 1—2A5; 1—80. Built in power supply—utilize Alan silva wound, 3-circuit front plug-in coils, phone jack, dual ratio dial, field supply. Completely enclosed in beautiful crackled metal cabinet.

Complete kit of parts, including 4 sets of coils, cabinet and complete constructional data, list, less tubes and speaker \$41.60.....Net to Amateurs **\$24.95**

Wired and laboratory tested additional \$4.50 Net Kit of Sylvania tubes for same.....\$3.75 Net 8 in. Dynamic speaker to match (Utah, Rola, Magnavox).....\$3.50 Net

Order from your nearest source of supply.

## ALAN RADIO CORP.

172 Washington Street Dept. S-1-35 New York, N.Y.  
1028 South Olive Street Los Angeles, Calif.

## The New PATTERSON PR-12

12 tube super-het 2 stages pre-selection  
8 to 550 meters  
Continuous Band Spread All Bands Calibrated

	List	Net
PR-12 Complete	\$139.50	\$ 82.00
Xtal PR-12 Complete	149.50	87.90
PR-12 in Console Complete	169.50	99.65

### A Challenge to ANY Set at ANY Price

SARGENT 8-34 8 tube super-het 15 to 560 meters. Complete	\$ 49.50
SARGENT "Marine" model 15 to 1500 meters. Complete	57.50
SARGENT 3 tube amateur special Kit, Wired	15.75
McMURDO Silver SC 8 tube super-het 13 to 200 meters. Complete	74.70
With crystal. Complete	83.70
PEAK Pre-Selector	19.80
McMURDO Silver 10D 100 watt Phone-CW transmitter	119.70
10D complete with all accessories—Tubes, "mike" crystal, etc.	155.00

ALL SHIPPED PREPAID  
We also have the entire new line of Patterson receivers for the home, 6 to 10 tubes, 8 to 550 meters, console and midget styles. Priced from \$30 to \$120. (Net Wholesale Prices.) We pay transportation charges.

"Everything for the Ham and SWL"  
**L. I. MARINE & ELECTRIC CO.**  
163-18 Jamaica Avenue, Jamaica, N. Y.

## HOLIDAY SPECIAL!

Get Started Right in Amateur and Short Wave Radio

One of the largest selling beginners' books is the Short Wave Manual by Don Wallace, winner of the Hoover Cup for best short-wave communication. This 156 page Manual, 9x12, with almost 200 illustrations and diagrams, shows how to build sets of the type used by Wallace in his record-making achievement. No theory... everything from FACT. A wealth of data on IRL and amateur short-wave antennas, new SOUND system for learning the code, construction and operation data on simple 2-tube tuned antenna s.w. receivers and amateur sets. Much valuable information on building simple beginners' transmitters, phones, etc. YOU CAN HAVE A COPY OF THIS BOOK for only 50c, plus 10c for mailing... 60c in all. This offer expires Jan. 1st, or when the supply is exhausted. Better act immediately!

## GOING BIG!



Here is a book that shows how to construct, design and operate 12 types of 5 meter receivers, transceivers and antennas. Written by Jones, designer of the 5-meter equipment for the great San Francisco Bay Bridge project. Tells everything you want to know about 5 meters. Price... only 25c per copy, postpaid. Send 85c TODAY.

Get both these books... Prepaid. Stamps accepted "RADIO," Pacific Building, San Francisco, Cal. Here is 85c. Send me the SHORT WAVE MANUAL and the 5 METER BOOK, PREPAID.

NAME \_\_\_\_\_  
STREET & NO. \_\_\_\_\_  
CITY \_\_\_\_\_  
STATE \_\_\_\_\_

## Short Wave League Members

IDENTIFY THEMSELVES WITH THE ORGANIZATION



In order that fellow members of the LEAGUE may be able to recognize each other when they meet, we have designed this button, which is sold only to members and which will give you a professional appearance.

If you are a member of the LEAGUE, you cannot afford to be without this insignia of your membership. It is sold only to those belonging to the LEAGUE and when you see it on another, you can be certain that he is a member.

See Page 576

- Lapel Button, made in bronze, gold filled, not plated, prepaid..... 35c
- Lapel Button, like one described above, but in solid gold, prepaid.....\$2.00

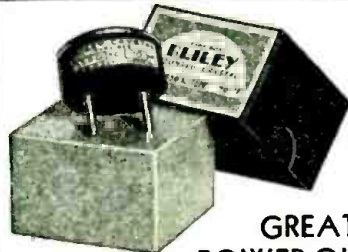

## GREATER POWER OUTPUT BLILEY BC-3 Mounted Crystals

Mc Band	Supplied to specified frequency within:				
	Precision	Exact Freq.	± 1Kc	± 5Kc	± 10Kc
7.0, 3.5	0.03%	\$7.50	\$5.90	\$4.90	\$3.95*
1.7	0.03%	8.40	6.80	5.80	4.80

\*Or your choice from distributor's stock.

Crystals manufactured between 20 Kes and 15 Mes. Prices on request.

Bliley Crystals are sold at all progressive distributors of amateur equipment and manufactured under NRA.

**BLILEY ELECTRIC COMPANY**  
Union Station Bldg. Erie, Pa.

# FREE RADIO'S LEADING CATALOG

## For 1935!

Send for the most complete and truly timely book in Radio. Over 100 amazing pages—a great Radio Profit Guide—packed with real Radio "Scoops."

● **NEW.** 1100 Wave, All-Wave, Short Wave and Broadcast Receivers—all with new Airplane Dial and Dual Purpose tubes, etc.—Electric, Battery, and 32 Volt models—at new low prices.

● **NEW.** An entirely new line of Build-Your-Own Kits. Band-spread types. Short Wave, All-Wave, Superhets and T. R. F.'s. Also the famous All-Star and the New National Experimenters' 2 tube S.W. sets. More than 20 great kits to choose from.

● **NEW.** An amazing selection of Test Equipment. New Supreme 5" Full Vision Meters; Triplet's magnificently complete offering for the Radio Serviceman at astonishingly low prices.

**1935 RADIO**

**SEND FOR THIS GREAT NEW BOOK!**

● **NEW.** A great section devoted to Amateur Radio. New professional type receivers, the complete National line, new antenna gear, new tubes, including everything for S. W. Transmitting and Receiving.

● **NEW.** The greatest P. A. array in Radio. 4 to 50 watts—portable, mobile, and permanent systems. New steel cabinet design. Latest phone and mike equipment. A wonderful offering doubling your profit opportunities.

And, of course, Radio's most complete stock of perfect Standard Line replacement and Set-building parts. Let us quote you for kits covering any circuit appearing in any magazine or handbook.

**SEND FOR YOUR COPY TODAY**

**Allied Radio**

833 W. Jackson Blvd., Chicago, Dept. E

Please send me your FREE 1935 Catalog

Please quote for Kit described in \_\_\_\_\_

NAME \_\_\_\_\_

ADDRESS \_\_\_\_\_

CITY \_\_\_\_\_ STATE \_\_\_\_\_

## IT'S A "CLEAR SIGNAL" IF IT IS ASTATIC EQUIPPED



**EQUIP** with Astatic dependable crystal devices now for a happy new year and you'll find pleasure in giving as well as receiving. The D-104 Astatic crystal microphone is professional in character and performance, yet rugged in construction and economically priced. List price \$21.00.

struction and economically priced. List price \$21.00.



The Astatic S-type pickup is an exceptionally light weight transcription unit of remarkable fidelity and superb performance. Especially recommended for studio reproduction and transcription recordings. S-8 Pickup List price \$15.00.

At your jobber

Licensed under Brush Development Co. Patents  
**ASTATIC MICROPHONE LABORATORY, INC.**  
 YOUNGSTOWN, OHIO

"Pioneers in the development of crystal devices"

- 1 ft.—3/16 copper tubing
  - 1—15 mmf. Hammarlund Star cond.
  - 1—Isolantite 6-prong socket
  - 1—.006 Knight Mica Condenser
  - 1—.0025 Knight Mica Condenser
  - 1—10-ohm rheostat
  - 1—DPDT Knife switch
  - 1—75,000-ohm 1/2 watt Knight resistor
  - 1—500,000-ohm potentiometer
  - 1—Insulated coupling
  - 1—Insulated shaft
  - 1—"3" Vernier dial
  - 2—Knobs
  - 2—"Output" Binding posts
  - 2—"Input" Binding posts
  - 1—"Input" Binding post
  - 1—"Input" Binding post
  - 1—25 ft. roll hookup wire
- Accessories
- 2—F704—Dry cells
  - 1—F4705—Single button hand mike
  - 1—F1915—Headphones
  - 1—F517—Raytheon 19 tube
  - 3—F707—"B" Batteries

## 15 to 2000 Meter Receiver

(Continued from page 538)

This also is a decided advantage inasmuch as a tremendous increase in sensitivity is gained by the use of this R.F. stage together with an increase in the signal to background noise ratio. The beautiful airplane dial is calibrated for ease of tuning in finding stations and has a 12:1 ratio. The cabinet is of walnut and includes a full-sized dynamic speaker. The tubes used are a 6D6 in the tuned R.F. stage, a 6A7 as pentagrid converter, two 6D6 tubes in the two-stage I.F. amplifier, a 75 as second detector, A.V.C., and first stage of audio feeding the 42 power output pentode. The rectifier is an 83 V. Under test all the foreign broadcast stations were brought in with full speaker volume. A close study of this set shows that this set is really efficiently designed and sound in every respect.

## Over Mountains on 5 Meters!

(Continued from page 521)

(George W. Shuart) located in Ramsey, N. J. Perfect communication can be held at any time between W2AMN and either of the other two stations. Several ranges of mountains existing between High Point Park and Ramsey have absolutely no effect on the signals W2AMN receiving an R8 report from High Point! Between W2HBW and W2AMN, there is located mountain ranges as high as 1500 feet and perfect communication can be held at any time, with an R6 report at either end. The transmitter at Walden is an M.O.P.A. using a matched-impedance antenna system for transmission and reception. The transmitter at Ramsey is the same one that was described on the October issue of SHORT WAVE CRAFT, using the "long lines." For reception a vertical 8-foot antenna is used, located some 50 feet above the ground, with the lead-in being taken from the top! The observations and test between the above three stations have proved absolutely that it is possible to "get through" mountainous areas, with ultra high frequency transmitters and with reliable communication. All work so far has been done on 5 meters, but in the near future higher frequencies will be tried to determine whether or not the same holds true.

## Automatic Band-Spread!

(Continued from page 521)

pearance of the tuning scale with this automatic band-spread is shown in the drawing. This feature could be arranged to automatically throw in the band-spread feature at any other crowded point along the dial, as the manufacturer might find desirable after a thorough test on his particular set. This feature can, of course, be easily put into service by experimenters also.

## NOW YOU WON'T HAVE TO SHOP FOR S. W. COILS

Because the popular-priced Na-Ald coils have not been increased in price yet they now have Victron "AA" insulation on the lowest wave coil. Special Na-Ald Processed Low-Loss Synthetic for the other three and all windings treated with Liquid Victron Coil Dope.

All coils listed below are boxed with diagrams and directions and use 140 mmf. size condenser. Each of the following three S.W. Coil Sets (13 to 200 meters) have 3 coils wound on the special Na-Ald Processed Synthetic Molded Forms and the fourth coil—13 to 31 meters—is wound on VICTRON "AA", the ultimate in low-loss insulation. Precision wound coils with convenient color-coded grip-rim for easy insertion and removal from socket.

- 704SWS 4-pin Coils.....List \$2.00 set
  - 705SWS 5-pin Coils.....List \$2.50 set
  - 706SWS 6-pin Coils.....List \$3.50 set
- Set of 2 Coils for 100-550 meters.
- 704BCS 4-pin Coils.....List \$1.50 set
  - 705BCS 5-pin Coils.....List \$1.75 set
  - 706BCS 6-pin Coils.....List \$2.00 set
- Band Spreading Coils with ceramic padding condenser mounted on each coil. Simplifies tuning. Spreads stations.
- 705SWB-20-40-80-160 m. Amateur Coils.
  - 705SWBC-19-25-31-49 m. S.W. B.C. Coils. List price \$4.00 per set. \$1.00 per coil.
  - Long Wave Coils for S.W. Sets using 140 mmf. and 4-prong Coils.
  - 704LW1 450-980 meters....List \$1.00
  - 704LW2 940-2000 meters....List \$1.00
  - 704LWS Set of 2 Coils...List \$2.00 set

Now you can get the Extra Value of the Na-Ald Processed Synthetic Molded Coil Forms at these new low prices. 1 1/2" dia x 2" winding space. Color-coded grip-rim—red, yellow, green and blue.

No. Prongs	List Price	No. Prongs	List Price
704 4-pin	20c	707 7-pin	30c
705 5-pin	EACH	707A 7-sm	EACH
706 6-pin		708 8-pin	

Peep up your weak signals by using coils wound on the ultimate in low-loss insulation:

**NA-ALD VICTRON "AA" COIL FORMS**

704V 4-pin.....List \$1.00	707V 7-pin.....List \$1.00
705V 5-pin.....List \$1.00	707VA 7-sm.....List \$1.00
706V 6-pin.....List \$1.00	708V 8-pin.....List \$1.00

For consistency use LIQUID VICTRON coil dope on your Victron coils and for better operation use it on the regular coil forms.

**No. LV2 LIQUID VICTRON "Coil Dope".....List price 35c can**

Here is the NEW Acorn Tube Socket insulated with genuine Na-Ald Victron "AA" standard construction. Alignment post prevents incorrect insertion.

**No. 4955V Acorn Tube Socket.....List \$1.50**

**NEW-NA-ALD VERNIER DIAL**

Here is the new Na-Ald VICTRON insulated R.F. Choke Coil, designed especially for use at the ultra high frequencies where losses are so all-important. Five tapered universal wound plates on a VICTRON form which can be rigidly mounted thus preventing wobbly signals from vibration. Small pie at "hot" plate end of choke for reduced capacitance. Use this choke in all applications and enjoy its greater efficiency. D.C. resistance 30 ohms. Inductance 2 1/2 m.h.

**No. 702R—Na-Ald VICTRON R.F. Choke. \$ .70**  
 List Price .....

Here is the Na-Ald Condenser insulated with Victron "AA" whose pi. at r.f. is only 0.0002. Note these outstanding features. Silver pressure contact on rotor. No grease or film or oxide skin as in hearing contacts. Self centering, self tightening cone bearing cannot loosen or produce noise. Minimized metal gives extremely low minimum capacity. Most practically shaped plates for station separation. Soldered brass plates precision spaced. 140 mmf. max. cap. Universal mounting. Two double solder tabs.

**No. C-140 Na-Ald VICTRON "AA" Insulated \$2.50**  
 S.W. Condenser. List price.....

Here are the Victron "AA" Sockets. Contacts are out in air, touching VICTRON only where mounted. Ultra low-loss. Mounts easily with use of hand-drill. Jack-top binding posts. Overhanging solder tabs for below chassis wiring.

**No. 494V, 495V, 496V, 497V and 497VA 4, 5, 6, \$1.00**  
 7 and small 7 contact respectively. List Price.....

New 700 COIL SELECTOR takes any four 4, 5 and 6 Prong coils for selection by turning knob. Mounts on chassis and panel. Modernizes old sets—eliminates handling and storing coils. Simple—compact—rugged—highly efficient—reliable self cleaning pressure contacts. Without coils.

**No. 700.....List price \$3.50**

**No. 700V NA-ALD VICTRON "AA" Insulated Coil Selector.....List Price \$7.50**

**No. 700CPL Complete Coupling Hardware for ganging No. 700 Coil Selectors in tandem.....List price 25c**

Be sure to send for new 16 page catalog listing new items, including S.W. VICTRON Parts. When writing, include the name and address of your parts supplier.

**ALDEN PRODUCTS CO.**  
 Dept. SW 1  
 BROCKTON, MASS.

**NA-ALD**



# Modern 100-Watt Transmitter

(Continued from page 536)

is tapped about one-third of the way up from the bottom, this section providing neutralizing voltage (through C3) for the amplifier section of the 2B6 when the latter is used as a straight amplifier on

pair on the power-amplifier, just above. It might be mentioned in passing that this oscillator-amplifier unit by itself is an excellent low-power transmitter, with an output of 7 to 10 watts. The single tube constitutes a full M.O.P.A., and the signals on the air have that steady-as-a-rock, piercing note characteristic of a well-built crystal-controlled job. Many amateurs are buying this unit as a starter, and intend to build up the whole outfit, piece by piece. Incidentally, all the units of this transmitter, including the rack it-

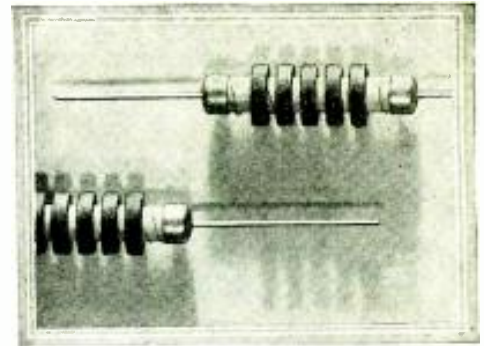

MIDGET R.F. CHOKE

## HAMMARLUND "CH-X" CHOKES

*Unequaled in Quality Features, and So Inexpensive They Can be Used Generously!*

**T**HERE are many places in a circuit where radio-frequency filtering is needed for best results—such as detector plate circuits, all B+ leads and all grid leads.

And now that Hammarlund's new "CH-X" MIDGET R.F. CHOKE is perfected and costs so little, you can afford to use it wherever desirable. The "CH-X" is the smallest and lightest R.F. Choke ever devised. Its features are *exclusive*. It is in a class by itself.

Only 1/2 in. x 1 1/2 in. in size, it is small enough to fit where space is at a premium, and so light in weight that the tinned copper leads afford ample support. The leads, extending straight from the end caps, greatly facilitate convenience and neat wiring. The end caps are small, thin and scientifically spaced so that distributed capacity to the adjacent coils is at a minimum.

Inductance is 2.1 mh. Five universal-wound, impregnated pies on Isolantite core. Price only 75¢ each, less 40% to experimenters.

MAIL COUPON FOR DETAILS

HAMMARLUND MFG. CO.,  
424-438 West 33rd St., New York.

Check here and attach 10c for 16-page Hammarlund 1935 Short-Wave Manual illustrating and describing most popular S-W circuits of past year, with schematic and picture diagrams and parts list.

Check here for FREE information on Hammarlund Chokes.

Check here for FREE General Catalog.

Name .....

Address .....

SW-1

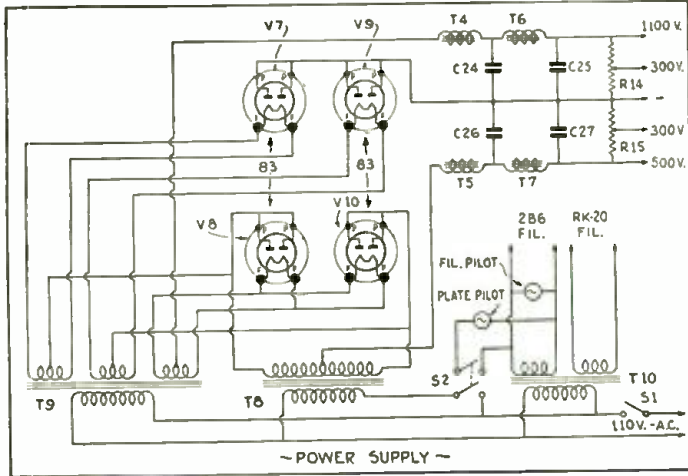

Diagram of the power supply which uses a bridge rectifier and furnishes complete power for the transmitter.

the crystal's fundamental frequency. Since neutralization is unnecessary when the second 2B6 section operates as a frequency doubler, and the neutralizing condenser C3 becomes undesirable, the coil L2 is wound on a 5-prong form, and C3 can be removed from the circuit merely by cutting the link to the fifth pin. For instance, suppose an 80-meter crystal is used. For 80-meter operation the second 2B6 section acts as a straight buffer and must be neutralized, and therefore C3 is left in the circuit with the stock coil unchanged. For 40-meter operation with the same crystal, a 40-meter coil is used for L2, with the link removed to remove C3. The correct adjustment of the latter for 80-meter neutralization is thus left undisturbed and there is none of the usual mess of returning the exciter unit when shifting from one band to another.

### How Excitation Is Varied

Variable excitation of the amplifier section of V1 is made possible by R3, which merely controls the grid bias. R2 is a fixed limiting resistor to prevent the tube from losing all its bias if R1 is accidentally turned all out. This is a simple and effective control and works beautifully.

Both L1 and L2 are wound on receiving forms and can be pushed in and pulled out of their sockets in a jiffy. The arrangement of the parts of the exciter is shown in a close-up photograph, and is simplicity itself. The 2B6 sits in the center of the chassis, with the crystal, L1 and C1 at its right, C3 directly behind it, and L2, C2 and R3 to its left. Individual milliammeters are used for the oscillator and amplifier units of the 2B6.

The two little stand-off insulators on the left bridge directly to a corresponding

self, are available separately.

### RK-20 Tubes Used

The power amplifier, link coupled to the buffer amplifier, uses two of the new Raytheon RK-20 power pentodes in push-pull. These tubes require no neutralization and lend themselves beautifully to economical, simple suppressor-grid modulation for phone. The grid coil L3 is wound on a small plug-in form, like L1 and L2, while the plate tank L4 is a heavy inductor wound on an accurately threaded bakelite form. The tuning condensers C7 and C8 are of the split stator type. The screen, suppressor and filament circuits are all adequately filtered by suitable condensers and R.F. chokes.

A two-position switch allows quick changing from C.W. to phone. For telegraph operation the suppressors are returned directly to filament, and for phone are run to the secondary of the modulating transformer in the modulator unit.

**Meters:** Meters are provided for reading grid, screen and plate current. These are permanently in the circuit and require no juggling of plugs or other loose connectors.

The tubular envelopes of the RK-20's, with the plate connections at the top, permit a perfectly balanced and symmetrical layout of parts, following the actual electrical circuit almost exactly.

The antenna coupling unit makes use of the Collins universal impedance matching idea, and allows the use of double-wire feeders with half-wave Hertz antennas. An additional coupling coil, permitting the use of single wire systems, is available as an accessory. This is truly a universal coupling device, yet is very easy to adjust. The coils L5 and L6 are fixed in place, being arranged with clips for variation of their inductance as different antenna systems require. A 0-2 1/2 ampere meter is furnished.

This coupling system has another advantage in that it suppresses harmonics very successfully, something that ordinary coupling arrangements do not do at all.

The modulator unit, mounted on the rack directly below the exciter, is a self-contained three-stage resistance-capacity coupled amplifier, with its own power-pack. The crystal microphone (which is recommended for its quality and simplicity) is connected across the grid circuit of V4, a 57, operating as a voltage amplifier. This works into V5, a 2B6, operating with the two triode sections in cascade. The grid potentiometer R9 is the gain control. The power pack is of usual construction, using

(Continued on page 565)



Above is the "Les-tet" exciter unit providing crystal oscillator and "buffer" stage with a single 2B6 tube.

Please mention SHORT WAVE CRAFT when writing advertisers



# Learn CODE The CANDLER Way PRACTICE EQUIPMENT Furnished FREE With SCIENTIFIC CODE COURSE

Complete Training in Code, Radio Fundamentals and Theory to enable you to pass the Exam.. Build your own station and operate it.

All skilled amateurs and com'l ops will tell you CANDLER Training is the best that can be had, and that our students read fast press and traffic as easily as they read a newspaper, and copy behind with "mill" or pencil.

FREE—CSCG SCHEDULE, listing all CSCG stations broadcasting daily practice programs from every district. Listen to CANDLER trained ops on your s. w. receiver.

"Work your former student, Watson, Chief Op, BEAR OF OAKLAND, WHEW, every night. One of finest ops I ever worked. We hit up to 45wpm right along. I work Candler men in all parts of world. They're fast—plenty! CANDLER COURSE best investment I ever made."  
73. L. S. HENDERSON, Op., KFS, M.R.T. Half Moon Bay, Calif.

CANDLER signed GUARANTEE (not promise) protects you. Money back if you "flunk."

Get your training where the champions and world's fastest ops got theirs. Small cost, easy payment plan. FREE BOOK OF FACTS gives details. A card will bring it.

CANDLER SYSTEM Co. Dept. S-1-35  
6843 S. Kedzie Ave., Chicago



# WORLD WIDE ALL WAVE ~ RADIO

A real powerful long and SHORT WAVE Radio Receiver that actually gets local and foreign broadcasts, police, amateur, airplane, etc., transmissions direct! Thousands now in use. Owners report reception of Foreign Stations with amazing volume. Works on two inexpensive batteries. Not a toy! RESULTS GUARANTEED!

Acc construction kits have all necessary parts mounted on attractive metal chassis and panel. All ready for wiring. Clear picture diagrams. Wire it yourself. It's easy. Range 15 to 800 meters. Complete Kits, with coil—

● ONE TUBE KIT, \$1.95 ● TWO TUBE, \$2.85

ALL ELECTRIC 105-125 Volt AC-DC two-tube house current set. No batteries needed! Complete Kit, \$3.65

Kits wired, 75c extra. Tubes, 85c ea. Double Phones, \$1.25 ORDER NOW. Send \$1. balance C.O.D., or if full remittance with order, we pay postage. Free literature.

FREE!! Large color map of the World, Valuable Short Wave data, etc.! Send 10c for handling, NOW!!

ACE RADIO LABORATORIES  
1619 Broadway Dept. C-1 New York City

# RADIO COURSES

**Radio Servicing**  
Including short wave receivers.  
**Radio Operating**  
Prepare for Gov't. license exam.  
**Radio Amateur Code**

Resident Courses  
Write for Booklet

New York YMCA Schools  
6 West 64th Street New York City

# 1935 RADIO CATALOG



# Free Book

All models: AC-DC midsets; dual and world-wide all-wave, farm, battery and car—at factory Prices! Write for 24-page Bargain Catalog and 30-DAY TRIAL plan. Prices from \$9.95 UP.

AGENTS WRITE!

GOLDENTONE RADIO CO.,  
114 Oakman Bldg. Detroit, Mich.

# Using the Direct Reading Bridge Circuit

The function of S1 is to connect known values of capacity across one arm of the bridge. While these capacities bear a definite relation to the unknown capacity, we do not use their actual values in determining the condition of an unknown unit. It is much easier and less confusing to use a simple multiplier value. This circuit has been so worked out that four multiplier values are employed. The first is .1, the second .01, the third .001 and the fourth .0001. (Note that these values do not represent capacity values—they are multiplier values only.) The position of S1 determines the multiplier value used. Therefore, it would be a good plan to mark the knob S1 so that you will always know the value of the multiplier regardless of the position of the switch.

To use this device connect terminals 1 and 2 of Fig. 1 to the 110-volt A.C. line. Connect the 'phone to terminals 7 and 8. Connect the test leads to terminals 3 and 4. Then connect a .5 mf. condenser to the leads. This will allow you to check the operation of the circuit.

Set S1 to the .1 multiple position. This will connect 5 mf. of known capacity into the circuit, thus multiplying the scale by .1 (one-tenth). Rotate the knob until no signal is heard in the 'phone. The reference mark will be at approximately 5, proving that the actual capacity is .5, since the 5 on the scale is multiplied by .1 (one-tenth).

To check the .5 mf. capacity further, set switch S1 to the .01 multiplier position. This will connect .5 mf. of known capacity into the circuit multiplying the scale by .01 (one-hundredth). Rotate the knob again until no signal is heard in the 'phone. The reference mark now will be at approximately 50, again proving that the actual capacity is .5, since the 50 on the scale is multiplied by .01.

Likewise, we can again check the .5 mf. condenser by turning S1 to the .001 multiplier position. No signal will now be heard at approximately 500. As we multiply this by .0001, we move the decimal point over three places to the left, giving us .5 mf. again for the capacity.

The "no signal" point can also be obtained at a position to the left of the 500 with S1 turned to the .0001 multiplier position. However, as this is off the scale it should be disregarded.

This same procedure is to be followed in determining the condition of practically any type of doubtful condenser. It is only necessary to connect the condenser to 3 and 4. Once the condenser is connected to 3 and 4 simply rotate the potentiometer knob for balance and read the value of the condenser on the scale of Fig. 2.

# Tests Which Prove Opens and Shorts

Condenser shorts and opens can easily be indicated with this circuit. To prove this, short-circuit terminals 3 and 4. No sound will now be heard when the knob is turned all the way to the left. To prove an open-circuit, remove both (or one) leads from terminals 3 and 4. Note that the no signal point will now occur with the knob turned all the way to the right. Both operations just described represent conditions of shorts and opens.

Leaky condensers may be detected by noting that a complete dying-out of the signal in the 'phone will not take place although there will be a minimum sound point on the dial. In order to understand what this means, try connecting a 1000-ohm resistance (or more) across terminals 3 and 4 while a good condenser under test also remains connected. The effect described above will be readily recognized.

# Electrolytic Condenser Tests

Electrolytic condensers are easily tested with this circuit. As before, the con-

Shhh! Shhh!  
**QUIET**  
Please!



Individually TESTED for NOISE

# ELECTRAD Quiet VOLUME CONTROL

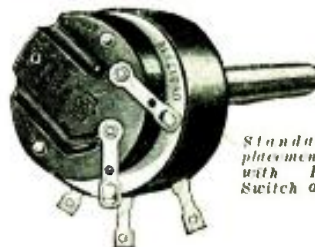

Standard Replacement Unit with Power Switch attached

REVOLUTIONARY in its operating mechanism, Electrad's new Guaranteed Quiet Volume Control fills a long-felt want. Absolute quiet, smooth, positive control of volume is accomplished for the first time in radio history.

# Built on a Radically New Engineering Principle



Resistance element baked on flat outer rim of Bakelite ring

Floating contact shoe glides over resistance element in straight path

More even distribution of current, smoother control and longer life are attained with this construction. Molded Bakelite case, when mounted, projects only one-half inch behind panel. New type power-switch (approved by underwriters) instantly attachable. Long aluminum shaft—easily cut. All standard replacement values.

Mail coupon for descriptive folder.

from  
**RESISTOR**  
Headquarters



1935 CATALOG

Electrad, Inc.  
175 Varick St., New York, N. Y.

Please send new 1935 Resistor Catalog. Check here for folder on new QUIET Volume Control.

Name \_\_\_\_\_

Address \_\_\_\_\_

MAIL COUPON FOR

SW-1

Please mention SHORT WAVE CRAFT when writing advertisers

↓ WORLD-WIDE RECEPTION ↓

# ANKER

ALL-WAVE SUPERHETERODYNE  
"DREADNAUGHT"



### QUICK FACTS

- ✓ Continuous band spread.
- ✓ Standard parts used throughout.
- ✓ Easily lined up. I.F.'s prealigned.
- ✓ 7 tube all wave super-het circuit.
- ✓ Built in Beat oscillator.
- ✓ Power supply also built in.
- ✓ 9½ to 550 meter range.
- ✓ Hi-ratio airplane dial tunings.
- ✓ Tone and static control.
- ✓ Hi signal to noise ratio.
- ✓ Front panel phone jack, automatic speaker cutout.

Foundation Kit consisting of drilled "Dreadnaught" chassis and black crackled panel, coil shield, and complete directions including schematic and pictorial diagrams. **Net Price \$1.95**  
The remaining material can be bought when needed.

Complete Kit, including all necessary parts, 4 pairs of plug in inductances 9.5 to 200 meters, hardware, diagrams, etc., etc. List **\$49.95**  
**\$29.91** NET

#### LESS TUBES AND SPEAKER.

#### ACCESSORIES

- Wiring and testing list \$11.25. Net \$6.75
  - 2 pair of broadcast coils, 200 to 550 meters. list \$2.60. Net \$1.56
  - Anker high fidelity dynamic speaker in cabinet to match receiver. list \$8.25. Net \$4.95
  - Kit of genuine Arcatrus tubes for "Dreadnaught", list \$7.15. Net \$4.20
  - Black crackled metal cabinet with hinged cover, ventilating louvres etc., list \$3.35. Net \$3.15
  - If rack Panel is desired instead of regular panel additional list \$2.00. Net \$1.20
- Order Direct from This Page—Free Catalogue of Anker Products on Request  
**ANKER LABS**  
20 W. 22nd St., Dept. S-1-35, New York City

denser to be tested is connected between terminals 3 and 4. Make certain that terminal 3 is connected to the negative lead (can) of the condenser. A high D.C. voltage source is connected between terminals 11 and 12, observing the polarity as shown in Fig. 1. If no high D.C. voltage from an A.C. power or B eliminator is available a single 45-volt battery may be used. A high-range milliammeter is now connected between 9 and 10. As a precaution, the 6 to 10-ohm rheostat should be turned all the way to the right so as to put a short circuit across 9 and 10. This is done to protect the meter in case of a complete short in the electrolytic condenser. The initial current is quite high and when operating current is developed, the rheostat can be turned to the off position, provided the condenser is not shorted. If there is a complete short, the condenser should be discarded.

A complete short will be evident after the condenser has been in the circuit a few minutes since the current will not reduce to less than 10 milliamperes. The leakage current through a normal electrolytic condenser should not be more than .25 milliamperes per microfarad of capacity, or not more than 2 ma. for an 8 mfd. condenser.

### Percentage of Accuracy

In checking the capacity of one known capacity by four positions of S1 you will probably note that all readings will not agree exactly. This is to be expected because as most servicemen realize commercial condensers as well as numerous other parts are manufactured with a plus or minus tolerance of 10 per cent from the specified value. This, of course, is more than ample for most jobs where a tolerance of twenty to fifty per cent from rated values can exist without materially decreasing efficiency. Therefore, in checking condensers, always consider all measurements as approximate.

The highest degree of accuracy is obtained when the "no sound" point on the potentiometer occurs near point 50 on the dial. Therefore, it is advisable to use the multiplier position of S1 that comes closest to making the "no sound" point occur near 50.

### Special Data Sheets Available

This condenser tester may also be used to test resistors and other small receiver parts for value, shorts and opens. It is also possible to test transformers for ratio between windings and to tell if windings are shorted or open. However, space here does not permit giving detailed directions for work of this kind. We will gladly send complete data sheets for the tester including a special scale (Fig. 2).

(Note: If you desire these Data Sheets and Special Scale, write and ask for DATA No. 502. Address your request to—SERVICE DEPT., SHORT WAVE CRAFT, 99-101 Hudson St., New York City.)

### Parts You Will Need for Making the Condenser Tester

- 1—Panel 7 x 9 inches.
  - 12—Binding posts.
  - 1—Non-shorting 1-gang 5-point switch (S1).
  - 6—1 mf. condensers (C1, C2, C3, C4, C5 and C6).
  - 1—.5 mfd. condenser (C7).
  - 1—.05 mfd. condenser (C8).
  - 1—.005 mfd. condenser (C9).
  - 1—No. RP102—20,000-ohm potentiometer with A.C. switch. Yaxley.
  - 1—6 or 10-ohm rheostat (R1).
  - 1—A.F. transformer (any ratio between 4 to 1 and 6 to 1). (T1).
  - 1—30-henry choke (T2).
  - 1—Set headphones with band.
  - 1—Set test leads with clips.
  - 1—Portable carrying case—8 x 14 inches (1 inch space for 'phones and leads).
- Courtesy "The I.R.C. Servicer."

# WESTINGHOUSE

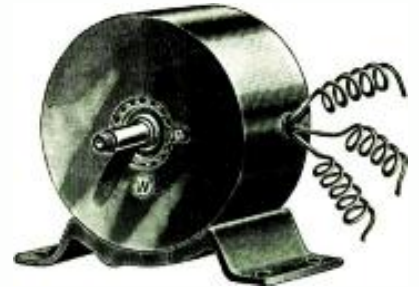

## Power Generator

MANUFACTURED FOR U. S. SIGN. CORPS  
SPECIFICATIONS

- WEIGHT—14½ lbs.
- HOUSING—Aluminum (Diameter—6¼ in. Length—5¼ in.)
- SHAFT—2 3/16 in. (driving end) (diameter 9/16 in.—the end is threaded for a distance of ¼ in.)
- BASE—Cast Iron. (Length—7¾ in. Height—1 9/16 in. Width—4¾ in.)
- OUTPUT—200 Watt 110 volts AC (speed 4500 R.P.M.)
- STATORS—Two pairs (two North and two South)
- ROTOR—12 tooth inductor. Built in commutator. Rotor turns in ballbearings.

(GENERATORS HAVE NEVER BEEN USED)

**FREE** With each Westinghouse Generator we supply free of charge a set of diagram-blue prints and instructions showing twenty-five different uses, giving technical information, electrical hookups and installing explanations. We also include free of charge a set of four replacement carbon brushes.

## THERE ARE OVER 25 APPLICATIONS

### SOME OF WHICH ARE:

- A.C. DYNAMO lighting from eight to ten 20 Watt 110 Volts lamps
  - SHORT WAVE TRANSMITTER supplying 110 Volts AC for operating "Ham" transmitter.
  - OPERATING 110 V. AC 60 CYCLE RADIO RECEIVER in DC districts.
  - MOTOR GENERATOR.
  - PUBLIC ADDRESS SYSTEMS.
  - ELECTRIC SIRENS on motor boats, yachts, etc.
  - CAMP LIGHTING.
  - SHORT WAVE artificial "fever" apparatus.
  - TELEVISION.
  - FELTON WATERWHEEL for lighting or other purposes.
  - AIRPLANE: for lighting strong search lights or electric signs.
  - LABORATORY WORK.
- Furthermore the following uses are explained: How to obtain electrical power: from a Windmill, from available Waterpower, from your Automobile, from your Motorcycle, from your Bicycle, Footpedals or Handcrank (for transportable Radio Transmitters, Strong Floodlights, Advertising Signs); how to operate AC Radio sets from 32 V.DC farm light systems; how to operate two generators in series to get 200 V.AC; how to obtain two phase and three phase AC.. etc., etc.

Generator as described above including four replacement carbon brushes and folder containing instructions and uses **\$7.90**

Shipping weight 18 lbs. (Replacement carbon brushes bought separate \$1.50 per set of four. Set of instructions bought separate \$1.00.)

Remit by check or money order. Shipped Express Collect if sufficient money is not enclosed for parcel post. Money refunded if not satisfied.

**WELLWORTH TRADING COMPANY**  
560 W. Washington Blvd. CHICAGO, ILL.

WELLWORTH TRADING COMPANY SW-1-35  
560 W. Washington Blvd., Chicago, Ill.

Enclosed you will find my remittance of \$..... for which please send me

( ) Power Generator, \$7.90 each.

Name .....

Address .....

City ..... State.....

# Baird

## OCTOCOILS



16 to 30 Meters    29 to 58 Meters    54 to 110 Meters    103 to 225 Meters

- 4 PRONG. 4 Coils to Set, 15 to 225 Meters. \$2.50 PER SET of 4 Coils; 65c Each Coil
- 6 PRONG. 4 Coils to Set, 15 to 225 Meters. \$3.50 PER SET of 4 Coils; 90c Each Coil

Can be applied with better results to any circuit using Short-wave plug-in coils. Standard since 1927—used in over 60 foreign countries.

Broadcast Coil—4 prong, \$1.00; 6 prong, \$1.50  
Made of genuine Bakelite in distinctive colors using heavy enameled wire and packed in individual boxes. BEWARE OF IMITATIONS. We are the pioneer manufacturers of popular priced Short-wave plug-in coils. SATISFACTION GUARANTEED. Up-to-date diagrams included FREE.

Shortwave & Television Corp., 70 Brookline Ave., Boston, Mass.

Gentlemen: Please send me postpaid ..... sets OCTOCOILS —4 —6 prong (check which type you want) for which I enclose \$.....

NAME.....

ADDRESS.....

## ANTENNAE FOR ALL WAVES

BUILT READY-TO-HANG-UP. LYNCH materials used exclusively. For suggestions and estimate, send sketch of location.

Illustrated: LYNCH Hi-Fi Duplex Cage, Giant Killer lead in ALL WAVE Antenna System complete \$13.75

AMPLIVOX LABORATORIES 227 Fulton St. New York City

Please mention SHORT WAVE CRAFT when writing advertisers

# Start to Send and Read RADIO CODE at Once!

Practice with Instructograph Code Teacher. More and more code students are using Instructograph for CODE PRACTICE, because in no other way can they get regular, systematic practice so necessary to a complete mastery of code. Don't be misled. Even Residents as well as Extension Schools use a machine with a perforated tape to teach their classes. Government code exams for Amateur and Commercial licenses are always given by a machine with a perforated tape. If there was a better way, the large schools and Government would have it.



## Provides Code Practice Anywhere—Any Time—Any Speed

Why waste time trying to pick up code from a short wave receiver—why wait for code schedules which can seldom be timed in when wanted—why be dependent on the convenience of some one to practice with, when the Instructograph provides everything needed to master the code and pass any code exam? No experience necessary. We furnish Complete Course of Instructions with Instructograph which make everything clear and simple. Just like an Instructor would do. Failure impossible.

### Terms as Low as \$2 Per Month

Find out for yourself—in your own home—in your own way, how quickly and easily you can learn code with Instructograph. Rent it for 2 months. If you are not convinced that it is the quickest and easiest way to learn code and become a real operator—send it back. Terms as low as \$2 per month. Rental may be applied on purchase price if desired. Start to send and read RADIO CODE at once! Write for details NOW! No obligation. A postcard will do.

**INSTRUCTOGRAPH COMPANY Dept. SW-13**  
912 Lakeside Place Chicago, Ill.

# BIG RADIO VALUES 1935

Amazing bargains in the newest and finest of 1935 models! BUY DIRECT from us and SAVE UP TO 50%. Factory prices on the complete line, every set guaranteed: AC-DC midgelets; worldwide all-wave; dual wave; consoles; car, farm and battery models. Also 2, 6 and 32 volt. Beautiful modern cabinets; illuminated airplane type dials; separate short wave switch control; foreign reception bands marked; greater power and selectivity. Get our low prices from

**\$9.65 UP**

30-DAY HOME TRIAL, you risk nothing! Satisfaction Guaranteed. Try your Fordson 30 days before deciding. Send TODAY for complete, FREE information!

**FORDSON RADIO INC., Dept. 37-1**  
Oakman Bldg., Detroit, Mich.

**OUR AGENTS MAKE MONEY!**  
Openings for several active representatives. Write now!

## HOME CHARGE Your Battery for a NICKEL with the New HI-Rate HOMCHARGER

PLUGS in any lamp socket. Charges any auto-type battery overnight. Creates no radio interference. Uses no expensive bulbs, "dry units" or messy liquids. Has only ONE moving part, replaceable for \$1.00, after thousands of hours' use. The FASTEST, most EFFICIENT and LONGEST-LIVED home charger made. Ideal for Battery Station, Garage, Trucks, etc. Money-back guarantee. Nearly one million sold since 1929 at \$19.50 list. Now only \$10.95 postpaid (or at your dealer), complete with ammeter, 10-foot cables, dash plug, etc. Write for introductory proposition and FREE booklet. (Commission Salesmen Wanted).

**THE AUTOMATIC ELECTRICAL DEVICES CO.**  
Dept. 8 324 East Third Street, Cincinnati, Ohio

## NOW A REAL 8-TUBE SHORT WAVE SUPER

- Continuous Band Spread
- With Preselector Stage
- Built in beat oscillator

Complete Kit for above including 4 sets of coils. List \$57.50, **\$34.50** Now  
Wired and laboratory tested, additional **\$6.50**

### Alan Radio Corporation

172 Washington St., Dept. S-1-35, New York, N. Y.  
Western Office: 1028 So. Olive St., Los Angeles, Cal.

## They Are Televising in Berlin!

(Continued from page 519)

line scanning, this calls for the transmission of one million points of light per second; to attain this highly desirable form of "high fidelity" television transmission, a band 500,000 cycles wide would be necessary and this will only be possible by using ultra short waves for broadcasting the television images. If such a high-grade transmission light-spot frequency should be used, we should require a band extending from 200 to 240 meters which is out of the question, as this would block out a goodly part of our present broadcasting stations. In ultra high frequencies we could obtain a 1/2-megacycle channel by using a band extending from 4.96 to 5 meter.

The way in which this particular German system works is as follows: The scene is photographed with the usual "sound-camera," either outside or from within the television pick-up car with its large windows; the film is then developed, fixed, washed, and dried in approximately 1 minute, then passed through a regular motion picture projector which has a Nipkow scanning disc and a photo-cell arranged in front of the moving film.\* As the film passes by the scanning disc with its many holes, it causes progressive spots of light, line by line, to be impressed on the photo-cell. The variations in the photo-cell current are then passed through a sensitive high-frequency amplifier of 8 to 9 stages, which are then caused to modulate a short-wave radio transmitter.

It is interesting to note that there are two different types of receiving apparatus available. The one here shown and intended for "home" use, projects the image on a screen measuring about 8" by 10". A public theater or hall receiver and projector is capable of exhibiting a television picture about 10 by 12 feet. Thanks to the very clever way in which this television system has been developed so that both sound track and image are scanned at the transmitting station simultaneously, positive synchronism is assured at all times between image and voice. The "home" type television receiver uses the so-called cathode ray or Braun tube.

All we know in this country about recent television transmission and reception is a few meager reports emerging from the secret laboratories of two or three of the large radio corporations, which state that wonderful images have been reproduced in the laboratory by means of cathode ray tubes. The unofficial story of American television is that one of the large radio corporations is about to build a series of ultra short-wave (about 3 to 7 meters) television transmitting stations in the larger cities and which, owing to the quasi-optical (line-of-sight) properties of these ultra short waves, will only have a short range of 50 miles radius. When, and if, these stations are built and put into operation sometime within the next two to five years, then we are supposed to have practical television. Too bad we could not have proceeded the way we were going a couple of years ago with our mechanical scanning systems, so that we could have had some enjoyment receiving the television images which could and should have been transmitted to us during the ensuing dead period of over two years, since the Columbia Broadcasting System and several others went "off the air" with their television transmission. We would undoubtedly have seen a great improvement in the received image by this time, if television had been kept "alive." One of the surprises that awaits some of the "cathode-ray" enthusiasts for television reception, is the fact that we undoubtedly are going to have a whole flock of mechanical scanning systems also, which experimenters are going to build

\*To transmit "talking" movies it would seem necessary to scan the image and voice sections of the film "separately" with 2 Nipkow discs and photo-cells; the outgoing wave being doubly modulated. At the receiver, two tuning circuits would then be used to pick up the respective voice and image components of the wave and send them through their respective amplifiers to loud-speaker and image projector (scanner and neon tube, etc.)—Editor.

# NEW 100 Watt TRANSMITTER

ALL LATEST FEATURES ENTIRELY SELF CONTAINED



This modern 100 watt C.W. and 30-40 watt Phone Transmitter will amaze you. Not only is its initial cost low, but for its rated output it is the most economical transmitter ever offered the amateur.

It incorporates all the latest features and is entirely self contained. Just connect a key, a crystal microphone and antenna. Plug into 110 V. 60 cycle outlet and operate! Complete control through use of meters permanently connected in circuit.

**\$175.00**

## Build Your Own

### Long or Short Wave Receiver

It's easy to build your own Broadcast or Short Wave set, Transmitter, Transceiver, etc. Not only can you save money in its construction but . . . by buying parts from us you save even more.

We can supply you with approved Quality parts for practically any radio kit described by Short Wave Craft, Radio News, Popular Mechanics, Popular Science Monthly and other leading radio and technical publications!

You can afford to be up to date with the latest developments when you build it yourself . . . and you buy your parts from us at LOWEST WHOLESALE PRICES! Ask us to quote you on your requirements!

## Big FREE Catalog

### 192 Thrilling Pages!

Yes, that's the word . . . for on every page are amazing bargains in latest developments by practically every leading manufacturer! Here is the Greatest Radio Catalog ever printed! Contains Big Specialized Sections devoted to Broadcast and All-Wave Receivers, Tubes, Short Wave Kits, Sets and Equipment, Replacement parts, Refrigerator parts, Public Address, etc.



Wholesale Radio Service Company,  
100 Sixth Ave., Dept. SW-15,  
New York, N. Y.

- ( ) Send me your FREE 192 page catalog.
- ( ) Quote me on kit described in my letter.
- ( ) Send data and prices on 100 watt X'mitter.

Name \_\_\_\_\_  
Address \_\_\_\_\_  
City \_\_\_\_\_ State \_\_\_\_\_

**WHOLESALE RADIO SERVICE CO.**  
NEW YORK ATLANTA  
100 Sixth Avenue 430 W. Peachtree St. N.W.  
Local Branch 219 Central Ave., Newark, New Jersey

Please mention SHORT WAVE CRAFT when writing advertisers

## WHEN CHOOSING A RADIO SCHOOL

RCA Institutes, with its reputation firmly established by 25 years service, is an institution recognized as an important factor in the radio industry.

Whether elementary radio principles or advanced subjects, sound applications, mathematics or practical radio engineering, RCA Institutes is prepared to give you the instruction you need.

**Resident Schools at New York and Chicago**  
Modern Apparatus and Laboratory Equipment—Conveniently Located—Day and Evening Classes—Tuition Rates \$3 to \$10 Weekly.

Extension courses for home study on convenient "no obligation" plan. Examination and technical advisory services. Free post-graduate practical training at resident school with modern equipment under instructing engineers.

Write for Catalog.

## RCA INSTITUTES, Inc.

Dept. SW-35



75 Varick Street  
NEW YORK

1154 Merchandise Mart  
CHICAGO

Recognized Standard in Radio Instruction Since 1909.

## Never Before

Foreign reception like this

You Change Your Wave Band in a Jiffy



The specially constructed chassis and black crackle panel with airplane dial and Gothic recesses make the

## DeLuxe ALL WAVE RGH-4 RECEIVER

Bob Herzog's latest Short Wave sensation a convenience as well as a joy

Marvelous World-Wide Reception—Dynamic Speaker \$2.00 extra.

Complete Kit of Highest Quality Parts, including 8 Short Wave Coils

**\$11.95**

## FREE KITS MOUNTED FREE

Kits Shipped Redi-Mounted for Easy Wiring It's a Cinch to Build It—You Can't Go Wrong

## THOR RADIO COMPANY

167 Greenwich St. Dept. T. New York  
MAIL ORDERS FILLED  
FREE TECHNICAL DATA

## WANT A TELEVISION JOB?

Radio and Television are packed with romance. Every hour interesting and immensely profitable. For free details write First Nat'l Television, Power & Light Bldg. Kansas City, Mo., Dept. BB-1



for the fun and instruction they get out of it, and just because the scanning speed is stepped up to 150 or 200 lines there is no reason at all, according to one of our leading American television and radio engineers, that mechanical scanning cannot be adapted to meet this speed. Another thought is that some form of vibrating scanner, operated by electrical tuning forks or otherwise, will undoubtedly be devised to accomplish the same purpose as the cathode tube, which requires quite elaborate auxiliary apparatus to fulfill its functions as a television scanner. Not only are the cathode tubes liable to be fairly expensive to start with, but at the present time their life is very short, and at times they are said to be quite erratic in their action. The great asset of the cathode tube for television is the fact that the cathode ray within the tube can move at almost infinite speed and it therefore lends itself ideally to high scanning speeds such as 180 lines or more. The ray is caused to move across the fluorescent screen at lightning speed and moves progressively up and down the screen, so as to "paint" the picture or moving image (not a "still" picture), thanks to specially designed oscillators. The currents from these oscillators act through magnet coils or static plates on the cathode beam, and it moves back and forth in response to the oscillating fields.

## A Low-Power Transmitter

(Continued from page 548)

cable connects this mike to the speech amplifier, using a plug and socket arrangement on the rear of the modulator unit.

### PARTS LIST FOR WOHR TRANSMITTER

- Crystal Oscillator**
- 1—50,000 ohm resistor. Aerovox.
  - 1—40,000 ohm resistor. Aerovox.
  - 1—.00035 mf. variable condenser.
  - 1—.0005 fixed mica condenser. Aerovox.
  - 1—.01 mica condenser. Aerovox.
  - 1—closed circuit jack. I.C.A.
  - 1—crystal and holder (frequency depending upon band). Bliley.
  - 1—2A5 tube, RCA Radiotron.
- Buffer Stage**
- 1—10,000 ohm fixed resistor. 50 watts.
  - 1—20 ohm center tap resistor. Aerovox.
  - 1—.0001 mf. variable condenser. Aerovox.
  - 1—.00035 mf. variable condenser.
  - 1—.0005 fixed mica condenser. Aerovox.
  - 1—50 mmf. midget condenser. National.
  - 1—R.F. choke 2.5 to 5 mh. National.
  - 1—closed circuit jack. I.C.A.
  - 1—relay optional.
  - 1—type 46 RCA Radiotron.
- Final Amplifier**
- 2—.00035 mf. variable condensers.
  - 1—50 mmf. nc. variable. National.
  - 1—.005 mf. mica condenser. Aerovox.
  - 1—R.F. choke, 2.5 to 5 mh. National.
  - 1—closed circuit jack. I.C.A.
  - 1—variable resistor. 5000 ohms at least. 30 watts.
  - 1—46 RCA Radiotron.
- Modulator Unit**
- 3—.1 mf. by-pass condenser. Aerovox.
  - 2—250,000 ohm resistors. Aerovox.
  - 2—2000 ohm fixed resistors. Aerovox.
  - 1—50,000 ohm fixed resistor. Aerovox.
  - 1—A.F. transformer, 3:1.
  - 1—30 henry modulator choke.
  - 1—50 ohm center tap resistor. Aerovox.
  - 1—5000 ohm variable resistor 75 watts.
  - 1—2 mf. condenser. Aerovox.
  - 1—closed circuit jack. I.C.A.
  - 1—microphone transformer.
  - 1—open circuit jack with filament control. I.C.A.
  - 2—56 RCA Radiotrons and 2—250's, RCA Radiotron.
- Power Supply**
- 1—high voltage transformer with two 7½ volt windings 500-0-500.
  - 1—filament transformer.
  - 3—2.5 volt windings.
  - 1—30,000 ohm resistor, 50 watts.
  - 1—10,000 ohm resistor, 50 watts.
  - 1—filter choke, 250 ma.
  - 2—1000 volt 2 mf. condensers. Aerovox.
- Pre-Amplifier for Condenser Mike**
- 2—.1 meg. fixed resistors. Aerovox.
  - 2—.1 meg. fixed resistors. Aerovox.
  - 1—25 meg. fixed resistor. Aerovox.
  - 2—.006 mf. condensers. Aerovox.
  - 2—type 30 RCA Radiotrons.
  - 1—condenser microphone. Amperite.

## DATAPRINTS

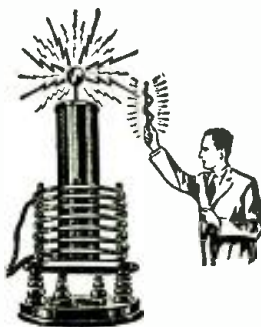

Just the Technical Information You Need To Build Electrical Apparatus

Dataprint containing data for constructing this 3 ft. spark Oudin-Tesla coil. Requires 1 K.W. 20,000 volt transformer as "exciter". See list below. Includes condenser data. **\$0.75**

- TESLA OR OUDIN COILS**
- 36 inch spark. data for building, including condenser data. **\$0.75**
  - 8 inch spark, data for building, including condenser data; requires ¼ K. W. 15,000 volt transformer; see list below. **0.75**
  - Violetta type, high frequency coil data; 110 volt A.C. or D.C. type; 1" spark; used for "violet ray" treatments and "Experiments". **0.50**
  - How to operate Oudin coil from a vacuum tube oscillator. **0.50**
  - 3 inch spark Tesla coil; operates on Ford ignition coil. **0.50**
  - 3 inch spark Oudin coil; 110 volt A.C. "Kick-Coil". **0.50**
  - 20 Tricks with Tesla and Oudin Coils. **0.50**

- TRANSFORMER DATA**
- 1 k.w. 20,000-volt transformer data. 110-volt. 60-cycle primary. Suitable for operating 3 ft. Oudin coil. **0.50**
  - ¼ k.w. 15,000-volt transformer data. 110-volt. 60-cycle primary. Suitable for operating 8-inch Oudin coil. **0.50**
  - Electric Winding Transformer (State secondary voltage). **0.50**
  - Induction Coils—1 to 12 inch spark data. **0.50**

**HOT! ARTIFICIAL "FEVER" APPARATUS—Ultra Short Wave Apparatus—Sold only to Physicians and Bacteriologists. Constructional Data for Small, Medium and Large Apparatus. **\$0.75****

- NEW! RADIO AND TELEVISION**.....\$0.50 Each (Minimum Order 2 prints!)
- The Find-All Pentagrid A.C.-D.C. "Short-Wave" Converter (3 Tubes).
  - "All-Wave" Find-All Four (A.C.; no plug-in coils). 3-Tube Battery Operated Personal Receiver. 2 V. tubes.
  - "Pat" Portable, Sr. (Universal A.C.-D.C., 38 Output, Magnetic Speaker)
  - The "Short Wave" Triple Pentode with 44 and 42 Tubes (A.C.).
  - The 2-volt Superheterodyne with Latest 2-volt Pentodes (8 tubes).
  - Nine Easy Ways to "Modernize" the Radio Set.
  - 7-Tube Television Receiver.

**TELEGRAPHONE** — Records Voice or "Code" signals on steel wire by magnetism. Code can be recorded "fast" and translated "slow." Construction data (special) **\$0.50**

- MAGNET COIL DATA**
- Powerful battery electro-magnet; lifts 40 lbs. **\$0.50**
  - 110 Volt D.C. magnet to lift 25 lbs. **0.50**
  - 110 Volt D.C. 300 lb. Lift electromagnet. **0.50**
  - 110 Volt D.C. solenoid; lifts 2 lb. through 1 in. **0.50**
  - 110 Volt D.C. solenoid; lifts 6 lb. through 1 in. **0.50**
  - 12 Volt D.C. solenoid, lifts 2 lb. through 1 in. **0.50**
  - A. C. Solenoid, powerful, 110-volt, 60-cycle. **0.50**
  - MOTOR—1/18 H.P., 110 volt A.C., 60 cycle (suitable for driving 12" fan, etc.)—Data. **0.50**
  - 60 or 1,200 cycle Synchronous motor. **0.50**

- MISCELLANEOUS DATAPRINTS**
- Treasure Locator **\$0.50**
  - 2 K. W. 110 vt. to 18 vt. transformer data. **0.50**
  - 20 motor circuits—hook-ups **0.35**
  - 20 practical telephone hook-ups **0.35**
  - 100 mechanical movements for inventors **0.50**
  - Polarized Relay—Ultra Sensitive **0.50**
  - Electro-medical coil (shocking coil) **0.50**
  - Water-Wheels—How to Build and Light your house **0.50**
  - 20 Electric Bell circuits. **0.50**
  - Public Address System **0.50**
  - Electric chime ringer; fits any clock. **0.50**

**20 "Electrical Tricks" for LODGES and PARTIES** .....\$0.50

How to Fry Eggs on Cake of Ice Electrically. **\$0.50**  
"Rewinding" Small Motor Armatures. **0.50**  
**"ENGINEERING SERVICE BY MAIL"**  
Send Sketch of Your Problem for Estimate.  
(20% off on orders for \$3.00 or more. No C.O.D.)

**The DATAPRINT COMPANY**  
Lock Box 322 RAMSEY, N. J.

**ANNOUNCING THE NEW PROFESSIONAL - "3" ALL-WAVE AIR SCOUT**  
 "Only Set of Its Kind In the World"  
 INVENTED BY H. G. CISIN

Pat. Pending  
 U.S. Serial  
 No. 592,586



**Superlative 3-Tube Performance!!**

CERTIFIED RECEPTION of Australian, Asiatic, South American and European stations reported. Hundreds of letters on file praising Air Scout. Uses CISIN circuit; two tubes in one envelope giving pentode regenerative detection, triode audio amplification. Special tube for rectification. Built-in power supply. No batteries. Operates from any 110-volt A.C. or D.C. house lighting circuit. Uses ordinary aerial. Beautiful black crystalline-finish metal panel. Newly invented coil frame. Calibrated dial. Low-loss parts used exclusively. All controls on front panel. Coils for 10 to 215 m. & instructions included. Workmanship, materials, performance guaranteed.

<b>KIT ASSEMBLED</b> .....	<b>\$5.95</b>
Wired and Laboratory Tested Extra.....	\$1.45
Zetube Tubes.....	1.25
Broadcast Coil.....	.95
Light weight single earphone.....	.50
Double Earphones.....	1.20

Free circulars available on nine amazing Air Scout models.

**ALLIED ENGINEERING INSTITUTE**  
 98 Park Place Dept. S-14 New York, N. Y.

**It's NOW**

EVERYDAY SCIENCE AND MECHANICS is the finest scientific-technical - mechanical - constructional magazine in the field. Up-to-the-minute with news flashes of scientific events. Dozens of constructional articles and many popular experiments. Ideas from which you can make things to sell.

Edited by **HUGO GERNSBACH**

A HOST OF INTERESTING SUBJECTS COVERED:—Aviation—Radio—Woodworking—Astronomy—Patents and Inventions—Home Hints—Metalworking—Chemistry—Engineering—Microscopy—Electrical Experiments—Household Helps—Shop Hints and other subjects.

Get your copy today!  
 on all newsstands  
 10c the copy

Over 150 Illustrations

**SPECIAL FOR THIS MONTH ONLY.**

Send \$1.00 (\$1.25 Canada and foreign) and we will send you SHORT WAVE CRAFT for Eight months. **DO IT NOW.**

**SHORT WAVE CRAFT**  
 99-101 Hudson Street New York

**RADIO ENGINEERING**, broadcasting, aviation and police radio, servicing, marine radio telegraphy and telephony, Morse telegraphy and railway accounting taught thoroughly. Engineering course of nine months' duration equivalent to three years of college radio work. All expenses low. Catalog free. School established 1874. Dodge's Institute, Turner St., Valparaiso, Ind.

**100-Watt Transmitter**  
 (Continued from page 559)

an 80 rectifier. To use phone instead of C.W., the operator merely shifts the switch on the power amplifier panel and snaps on the modulator power switch, after, of course, he has tuned the transmitter to one of the phone channels.

**Power Supply Is "Heavy Duty"**

The bottom-most unit is the heavy-duty "power supply," using four type 83 rectifier tubes in a bridge circuit, to give 1250 volts at 250 ma. and 550 volts at 200 ma. Two separate filament transformers are used: one for the 83 filaments and the other for the 2B6 in the exciter and the RK-20's in the power amplifier. The regulation is very good and the ripple voltage is exceptionally low. The filter condensers are of the oil impregnated type—not electrolytics.

At the bottom of the rack is a compartment for holding grid bias batteries. Power connections between the various units are made by convenient plugs and cables. One unit can be pulled out of the rack for inspection, revision, etc., without disturbing any of the others in the slightest. The flexibility of the whole arrangement will greatly appeal to the amateur accustomed to the confusion and hay-wire aspect of bread-board layouts.

As far as actual operation is concerned, this new Lafayette transmitter leaves little to be desired. With as much as 120 watts of power available for C.W., and 30 to 40 watts on phone, DX is merely a matter of the band selected, the location and the operator's skill. The transmitter itself certainly does its stuff!

**Lafayette Parts List—Oscillator and Amplifier**

- C1—100 mmf.
- C2—100 mmf.
- C3—25 mmf.
- C4—.01 mf.
- C5—.005 mf.
- C6—.005 mf.
- C7—130 mmf. each section (split sections).
- C8—70 mmf. each section (split sections).
- C9—.002 mf.
- C10—.002 mf.
- C11—.002 mf.
- C12—.001 mf.
- C13—.001 mf.
- C14—480 mmf.
- C15—220 mmf.
- L1—Oscillator inductor ("plate" coil).
- L2—Amplifier inductor (plate tank).
- L3—Power amplifier grid inductor.
- L4—Power amplifier plate tank.
- L5, L6—Antenna impedance matching inductors.
- R1—100,000 ohms.
- R2—1000 ohms.
- R3—5000 ohms.
- R4—75 ohms, center tapped.
- RF1, RF2, RF3—2.5 millihenry r.f. chokes.

**Parts List—Modulator Unit**

- C16—5 mf.
- C17—.5 mf.
- C18—.5 mf.
- C19—.1 mf.
- C20—25 mf.
- C21—.1 mf.
- C22—8 mf.
- C23—4 mf.
- R5—5 megohms.
- R6—5000 ohms.
- R7—2 megohms.
- R8—250,000 ohms.
- R9—1 megohm potentiometer.
- R10—100,000 ohms.
- R11—10,000 ohms.
- R12—750 ohms.
- R13—10,000 ohms.
- T1—Modulation transformer.
- T2—Power supply transformer.
- T3—30 henry filter choke.

**Parts List—Power Supply**

- C24—2 mf.
- C25—4 mf.
- C26—4 mf.
- C27—4 mf.
- R14—50,000 ohms.
- R15—25,000 ohms.
- T4—Swinging chokes.
- T5—
- T6—Filter chokes.
- T7—
- T8—High voltage transformer.
- T9—Rectifier filament transformer.
- T10—2B6—RK20 filament transformer.

**SHORT WAVE PRODUCTS of RELIABILITY**

Servicemen, Amateurs and Experimenters know that ICA stands for QUALITY. Insist upon ICA products for reliability and dependability. The list prices shown are subject to a discount of 40% when purchased thru your Jobber or favorite Mail Order House. or send your order direct naming Jobber and we will see that you are promptly supplied.

**Build Your Own Short Wave Receiver**



ICA Short Wave kits are the World's easiest to build! Each comes complete with point-to-point diagrams. Line consists of 1 and 2 tube battery sets and 3, 4 and 5 tube All-Electric models. List prices \$9.95 and up. Licensed under RCA and Hazeltine patents. Don't build until you get full details!

**5 Meter Tranceiver Kits**

Choice of 3 models: 2 volt, 6 volt or A.C. model. Made completely of ICA parts. Easy to build. Complete instructions, diagrams. List prices (respectively)



**\$19.50 \$19.25 \$19.75**

**S. W. COILS**

Wound on Small Bakelite Ribbed Forms  
 4 prong, 2 windings. 4 coils cover 16-217 meters. Have low-loss wire for primary and tickler. Will tune with 140 mmfd. condenser. List price \$1.90  
 6 prong, 3 windings. List price \$2.75



**S. W. COILS**

Wound on Small Bakelite Rim Type Forms  
 Fit UX sockets. 1 1/4" diam. x 2 1/2" high. Primary and secondary windings. 4 coils cover 16 to 217 meters. Will tune with 140 mmfd. condenser. List price \$2.50  
 6 prong, 3 windings. List price \$1.65



**Coils for 5 Meter Tranceivers**

(QST Specifications)  
 Interruption Frequency Oscillator with 4 lugs. List price \$1.00. 5 Meter RF Choke with two mounting feet. List price 60c. 5 Meter Dual mounting base. List price 75c. Complete as above with blue print. List price \$2.25

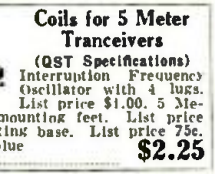

**Dial and Pointer Knobs**

Direct drive. Heavy brass, black finish, silver etched lines and numerals. 3 1/2" diam. Calibrations 100 to 0 or 0 to 100. List price 75c. 2" diam. Calibration 100 to 0 or 0 to 10. List price 50c



**Handle Type Coil Forms**

Consists ribbed form drilled and tapped for handle (supplied) and insulating tubing to protect windings. 4 or 5 prong. List price 95c; 6 or 7 prong. List price \$1.00



**Universal Midget Condensers**

Removable shaft with lock nut provides permanent condenser alignment. Insulex insulation. Spacing .026". 15, 25, 50, 100 and 140 mmfd. capacities. List prices: 85c, 95c, \$1.05, \$1.15, \$1.50



**BIG New 1935 CATALOG**

Send 10c stamps or coin to cover cost of handling and mailing big new 1935 catalog listing hundreds of parts and accessories as well as our complete line of receiver kits. Supply limited. Send now to avoid disappointment!

**INSULINE CORP. OF AMERICA**  
 23-25 Park Place, Dept. W-15, New York, N. Y.

Please mention SHORT WAVE CRAFT when writing advertisers

**NO WISE MAN WOULD BUILD A HOUSE ON QUICKSAND**

When Building an All Wave Set, Choose the Foundation with Care.

**EAGLE "7" ALL-WAVE**

Matched Superheterodyne Kit

A perfectly matched set of coils and intermediates with which you can build a Powerful 7 tube All Wave Set, or convert your present Receiver into a splendid All Wave Super.

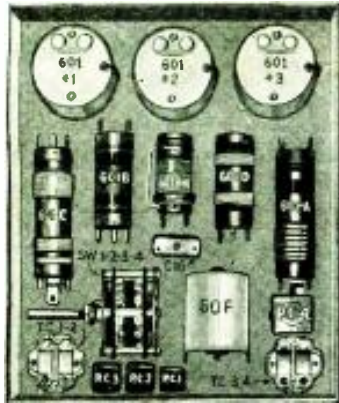

What you get for \$8.95

- 1—B.C. Ant. Coil No. 601
- 1—B.C. Translator Coil No. 601A
- 1—75-200 meter S.W. Coil No. 601B
- 1—37-75 meter S.W. Coil No. 601C
- 1—12-35 meter S.W. Coil No. 601D
- 1—Input I.F. Trans. No. 601-1
- 1—Inter-stage I.F. Trans. No. 601-2
- 1—Output Stage I.F. Trans. No. 601-3
- 2—Dual Detector Trimmers TCI-2-3-4
- 4—Accurate Pajdding Cond. PCI-2-3-4
- 1—Rectifier Plate Filter Choko No. 60F
- 1—Oscillator Comp. Condenser C16
- 1—Wave Band Selector Switch
- 1—Full size Diagram Layout

Technical data mailed FREE. No obligation.

The Matched EAGLE "7" ALL-WAVE KIT.....\$8.95  
 Drilled Foundation Chassis.....\$1.50

**EAGLE RADIO CO.**

84 Cortlandt St. New York

**S. W. Scout News**  
 (Continued from page 530)

**Short Wave Scout Report of Herman Borchers, Greenfield, Mass.**

The Australian station came in nicely; have heard VK3LR day after day, with fine volume. VK2ME is still broadcasting a special program to each state in the Union. On October 31 the program was dedicated to the District of Columbia.

LSX, 28.98 meters, Mont Grand, Argentine, was on the air October 13 from 4:15 to 4:30 p.m., E.S.T. Reception R7.

PRF5 Rio de Janeiro and GSC, London, are the outstanding stations on the 31 meter band. PRF5 is like a "local," using chimes as an identification and announcing in English, German, and three additional languages.

RNE, 25 meters, Moscow has been fair from 10 to 11 a.m.

HBL on 31.27 meters and HBP, 38.47 meters, Geneva, has been heard well Saturdays from 5:30 to 6:15 p.m. OER2 on 49.4 meters is on the air daily from 9.30 a.m. to 5 p.m.

Holland has a fine new station on 19.7 meters. The call letters are PCJ and it is on the air simultaneously with the station PHI, 25.75 meters. It is on the air daily from 7:30 to 10:30 a.m. and Saturdays and Sundays as late as 11:30 a.m. The announcements are made in five different languages, Dutch, French, English, German, and Spanish.

**Report from Oliver Amlie, Phila., Pa.**

Oct. 26, 50.06 meters HJ4ABC reception very clear and loud; clear night, cool, always good on Friday evening. Oct. 26, 49.34 meters, CP5 signals very clear, good reception. Oct. 26, 49.50 m., W3XAU signal very powerful and clear channel. Oct. 26, 48.78 m., YV3RC, signals very good. Oct. 26, 49.46 m., HIX, signals very good, clear, like locals. Oct. 26, 49.02, VE9GW, signals fair, fading at times, also CKRC, CRCP, all on same channel. Oct. 26, 49.10 m., VE9HX, signals very poor, can hardly hold. Oct. 26, 31.48 m., W2XAF, signals very poor at 7:30 p.m., fine at 10 p.m.

The above stations can be heard any Friday evening from 7 to 11 p.m. Oct. 27, reports from Australia are my best catches. The Australian Radio Commission has asked this post to give him some information on their stations: Oct. 27, VK3ME-VK3LR, 31.55 and 31.31 m. Both these stations came in fine from 6:45 a.m. till 7:45 a.m. First time I could get a line on VK3LR, letter for verification has been sent-in on this station, making 3 verifications from Australia for 1934. Signals from these stations were loud-speaker strength at this date, cool weather here, sky clear. Oct. 27 VK2ME-VK3ME, 31.28-31.55.

**Trophy Contest Entry Rules**

THE rules for entries in the SHORT WAVE SCOUT Trophy Contest have been amended and only 50 per cent of your list of stations submitted need be verified. If, for example, you send in a list of 100 stations with 50 verification cards, you will receive credit for the other 50 per cent or 100 stations total. The trophy will be awarded to the SHORT WAVE SCOUT who has logged the greatest number of short-wave stations during any 30 day period; (he must have at least 50 per cent veris) this period need not be for the immediate month preceding the closing date. The complete list of rules appeared in the August issue of this magazine.

In the event of a tie between two or more contestants, each logging the same number of stations (each accompanied by the required 50 per cent veris) the judges will award a similar trophy to each contestant so tying. Each list of stations heard and submitted in the contest must be sworn to before a Notary Public and testify to the fact that the list of stations heard were "logged" over a given 30 day period, that reception was verified and that the contestant personally listened to the station announcements as given in the list.

Only commercial "phone" stations should be entered in your list, no "amateur" transmitters or "commercial code" stations. This contest will close every month or the first day of the month, by which time all entries must be in the editors' hands in New York City. Entries received after this date will be held over for the next month's contest. The next contest will close in New York City, January 1.

The judges of the contest will be the editors of SHORT WAVE CRAFT, and their findings will be final. Trophy awards will be made every month, at which time the trophy will be sent to the winner. Names of the contesting SCOUTS not winning a trophy will be listed in Honorable Mention each month. From this contest are excluded all employees and their families of SHORT WAVE CRAFT magazine. Address all entries to SHORT WAVE SCOUT AWARD, 99-101 Hudson Street, New York City.

**HERE IT IS**

**SHORT WAVE SET BUILDERS MUST HAVE THIS BOOK**

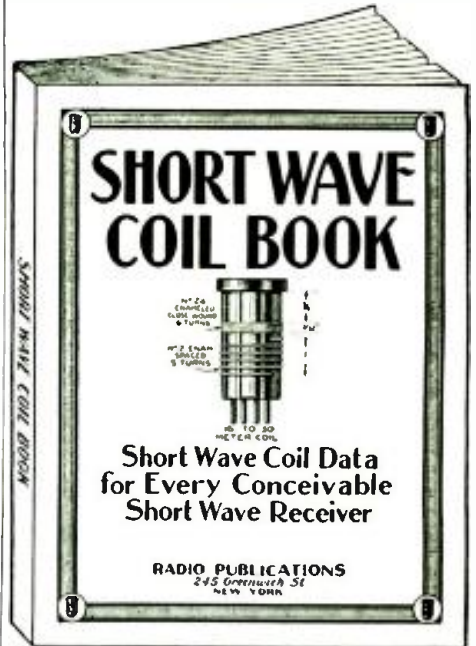

**SHORT WAVE COIL BOOK**



Short Wave Coil Data for Every Conceivable Short Wave Receiver

RADIO PUBLICATIONS  
 245 Greenwich St.  
 NEW YORK

FOR the first time, it is now possible for the experimenter and short wave enthusiast to obtain the most exhaustive data on short wave coil winding information that has ever appeared in print.

As every experimenter who has ever tried to build a short wave set knows only too well by experience, the difference between a good and a poor receiver is usually found in the short wave coils. Very often you have to hunt through copies of magazines, books, etc., to find the information you require. The present data has been gotten up to obviate all these difficulties.

Between the two covers of this book you now find every possible bit of information on coil winding that has appeared in print during the past two years. Only the most modern "dope" has been published here.

No duplication. Illustrations galore, giving not only full instructions how to wind coils, but dimensions, sizes of wire, curves, how to plot them, by means of which any coil for any particular short wave set can be figured in advance, as to number of turns, size of wire, spacing, etc.

There has never been such data published in such easy accessible form as this.

Take advantage of the special offer we are making today, as due to increasing costs, there is no question that the price will increase soon.

**RADIO PUBLICATIONS**  
 97 HUDSON STREET  
 NEW YORK, N. Y.



Radio Publications, 97 Hudson Street, New York, N. Y. 1-35

Please send immediately, your Short Wave Coil Book, for which I enclose 25c herewith (coin, U. S. stamps or money order acceptable). Book is to be sent prepaid to me.

Name.....  
 Address.....  
 City and State.....

**RADIO**

**THEORY PHYSICS**

**SHORT WAVES — BROADCAST TELEVISION**

Are you a beginner or amateur in the field of radio? Would you like to become an operator, technician or engineer at a good salary?

Prepare yourself at home for big-money jobs with a future and really understand your work!

Our easy, step-by-step PERSONAL INSTRUCTION gives you real information you can USE!

One of the finest courses ever offered at a price you can afford. Less than

**\$1.25 A WEEK**  
 for a few short weeks! Write

**RADIO TECHNOLOGICAL COLLEGE**  
 1202 Omar Avenue, Houston, Texas

**TRANS-CEIVER!**

NEW! A complete Midget Transmitter and Receiver combined in this simple one-tube set. Foreign reception. Local transmission. Tunes 4 to 200 meters. Uses two small inexpensive batteries, (3 and 45 volt) key and phones. Results Guaranteed.

\$3.95

Prepaid, ONLY

Wired, tested, with coil, and instructions; less 25c net. Extra coils 50c ea.

Remit \$1.00. C.O.D. \$2.95. ORDER NOW, write—  
**THE BURKS RADIO CO.**  
 1448 W. Decatur St. Decatur, Ill.



Please mention SHORT WAVE CRAFT when writing advertisers



# "SIGNAL HOP"

**Beyond Your Fondest Hopes With PEAK Pre-Selector and Pre-Amplifier**

The last word in Pre-Amplification! Two tuned stages of hi-gain 58 type tubes. Hundreds of tests prove that signals of R3 to R5 audibility are consistently boosted to R9 and R9+. Besides tremendous signal gain, PEAK gives increased sensitivity; absolute rejection of image or repeat spots; reduction of background noise; increased selectivity!

Operates with any S.W. or All-Wave set. Comes complete with 3 sets of built-in coils (none to plug in) covering all frequencies with overlap from 14-200 M. Other features include airplane type dial, smooth regeneration, automatic changeover over switch, SELF-CONTAINED FILAMENT SUPPLY, etc. For 110-120 V. 50-60 Cycles. A.C.



**ATTENTION!**  
Hans and S.W. Fans! Order or get all the facts TODAY! List price \$33, less 40% your price \$19.80 complete, less tubes. Order through your Jobber, M.O. House or direct from

**EASTERN RADIO SPECIALTY CO.**

Peak Products  
Dept. SC-15,

New York, N.Y.

1845 Broadway

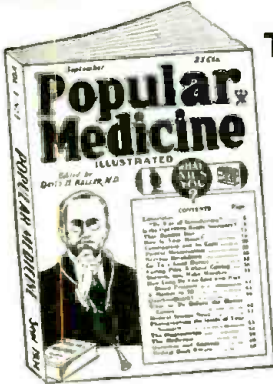

## KNOW THYSELF!

This new monthly magazine is also your medical guide. WHAT AILS YOU? POPULAR MEDICINE tells and advises you thoroughly. Written for you by doctors. Non-technical, yet authoritative for all laymen. Many anatomical illustrations. At All News Stands.

**SPECIAL OFFER!**  
8 Months for \$1

Send 15c for Sample Copy  
Popular Medicine  
97C Hudson Street  
New York, N. Y.



## RADIO'S LIVEST MAGAZINE

Edited by HUGO GERNSBACH

RADIO-CRAFT is devoted not only to the radio experimenter and technician, but also to the beginner in radio. Picture diagrams simplify construction of sets. Kinks show simple ways out of difficult problems. The latest radio equipment is illustrated and described.

8 Months for \$1.00

RADIO-CRAFT is fully illustrated with photographs, diagrams and sketches. Each issue contains over 150 illustrations. 15c for Sample Copy.

## RADIO-CRAFT

99C Hudson Street

New York, N. Y.

## AUTOMATIC FURNACE REGULATOR

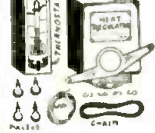

**COMPLETE KIT \$39.50**  
With "Thermostat"

Includes wire, chain, pulleys, damper control unit and Room Thermostat. Instructions. Saves 1/2 to 2/3 Coal Bill.

DATAPRINT CO.  
Box 322, Ramsey, N. J.

## CODE LEARNED AT HOME WITH AUTOMATIC OMNIGRAPH



Has helped thousands. Leads quickly to big money jobs. Everlasting metal dials exchanged free during course. Your first small cost, the last expense you'll have. OMNIGRAPHS from \$2.50 to \$25.00—the standard for over 30 years. Get started in this profession now. Catalog 4 U.

THE OMNIGRAPH MFG. CO., 810 East 39th St., Brooklyn, N. Y.

**CHEMICAL**  
Outfits 10 Scientists  
**MICRO PHOTO**  
Amateur Supplies  
Brings You this complete catalog listing hundreds of items of interest to the amateur experimenter.  
**SPECIAL 30 DAY OFFER** for those who send immediately

J. H. WINN MFG. CO., Dept. 89, 124 West 23 St., New York

## "Economy 2" Battery Receiver

(Continued from page 523)

the tubes with A.C. it can be easily done as the tubes are designed to work on either current. However make sure that the voltage is correct! For the plate supply, "B" batteries are used although the set could be well operated with a good "B" eliminator. The batteries afford absolutely quiet operation and they are recommended. Three 45 volt units furnish the 135 volts and should last a very long time as the plate current drain of the set is very low, around 4 or 5 milliamperes.

When using small receivers a good antenna system should be used in order to obtain proper performance. The antenna should be at least 75 feet long and mounted as high in the air as possible and well out in the clear, away from surrounding objects. In the October issue there appeared a very complete article on antennas and it is recommended that some of the practical important hints there set forth be put into practice.

### Operation

Tuning and operation of this two tube set is very simple and even the most inexperienced "Fan" should have no difficulty. Set the regeneration control so that the detector is oscillating—tune in a station—then "back-off" the regeneration control until the whistle disappears and the voice comes in clearly. For receiving code, of course, the detector will remain in oscillation at all times. Use a good ground connection on the set and when making connections do not use too much solder but make sure that every connection is firmly made. The values of all the parts are given together with a table showing the correct sizes of the plug-in coils; follow the diagram carefully and you will have a nifty little set.

### Parts List for "Economy 2"

- 1—140 mmf. tuning condenser, Hammarlund.
- 1—100 mmf. mica condenser, Aerovox.
- 2—.0005 mf. mica condenser, Aerovox.
- 1—.001 mf. mica condenser, Aerovox.
- 2—1 mf. by-pass condenser, Aerovox.
- 1—.1 mf. by-pass condenser, Aerovox.
- 1—2 meg. half watt grid leak.
- 1—1/2 meg. half watt grid-leak.
- 1—50,000 ohm potentiometer, Electrad.
- 1—R.F. choke 2.5 mh. (approx.) Hammarlund.
- 1—National Impedaformer (type, S-101).
- 1—4-prong Isolantite socket, Hammarlund.
- 1—5 prong Isolantite socket, Hammarlund.
- 1—5 prong wafer socket, Na-Ald.
- 1—National vernier dial.
- Knobs, binding posts, etc.
- 1—set of Hammarlund plug-in coils, 17-270 meters—see coil table for data.
- 1—midget variable antenna trimmer, Hammarlund, 25 mmf. (air dielectric) type APC.
- 2—type 15 tubes, Sylvania.
- 3—45 volt "B" batteries, Burgess.
- 3—No. 6 dry cells, Burgess.

### Coil Data "Economy 2"

Band	Turns	Wire No.	GRID COIL		TICKLER	
			Winding	Turns	Winding	Turns
17-41	9	14 tinned	1 1/4 in.	4	28 DSC	
33-75	18	18 tinned	1 1/2 in.	6	28 DSC	
66-150	38	22 tinned	1 3/4 in.	11	28 DSC	
135-270	80	28 enameled	1 7/8 in.	16	28 DSC	

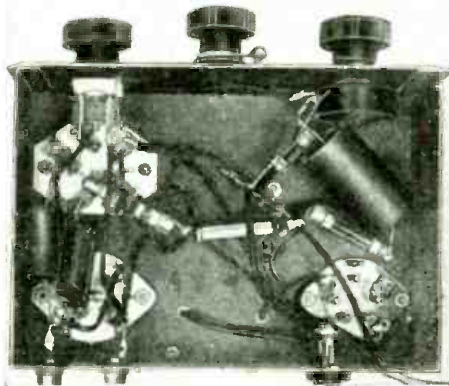

Bottom View of Receiver.

## The All-Electric All-Wave Receiver

**Greatest Value On The Market**

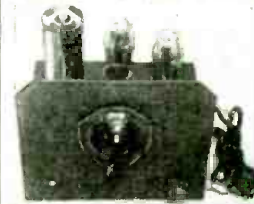

reception. Circuit has been re-designed so as to be bigger and more powerful than ever. Uses 6F7 (2 tubes in 1 bulb), 76 & 12Z3 tubes as screen-grid regenerative detector, 2 stage audio amplifier, rectifier & built-in power supply. Due to the use of the dual purpose tube, the 6F7, this circuit produces 4 tube performance from 3 tubes. No batteries. Simply plug into 110 volts house lighting circuit & operate. Sensitive & gives great volume. Works speaker on many stations. Covers 10-600 meters. Mounted on heavy, black crackle finish metal chassis and panel. Coils for 10-200 meters. Instructions included. **FOREIGN RECEPTION GUARANTEED.**

6F7  
76  
12Z3  
tubes

New 4 in 3 circuit

A completely electrified all-wave receiver capable of world-wide reception.

**KIT ASSEMBLED and ready to wire \$5.95**

Wired & tested extra.....\$1.25  
Matched Arcturus tubes.....2.25  
Broadcast coils (2).....0.95  
Beautiful black finish metal cabinet, hinged lid.....1.00



## THE DC ALL-WAVE RECEIVER

19  
33  
tubes

New 3 in 2 circuit

An extremely powerful battery operated set. Designed for loudspeaker operation. Tremendous headphone volume. Uses 19 (2 tubes in 1 bulb) & 33 tubes in special 3 tube circuit. Special filament arrangement produces low filament current drain. Requires 3 dry cells, 2 45 volt batts., & 1 C battery. Range 10-600 meters. Mounted on beautiful black crackle finish metal chassis & panel. Owners report foreign stations on speaker. Coils for 10-200 meters. Instructions included. **FOREIGN RECEPTION GUARANTEED.**

**KIT ASSEMBLED and ready to wire \$5.75**

Wired & tested extra.....\$1.25  
Matched Arcturus tubes.....1.90  
Broadcast coils (2).....0.95  
Beautiful black finish metal cabinet, hinged lid.....1.00

volume. Uses 19 (2 tubes in 1 bulb) & 33 tubes in special 3 tube circuit. Special filament arrangement produces low filament current drain. Requires 3 dry cells, 2 45 volt batts., & 1 C battery. Range 10-600 meters. Mounted on beautiful black crackle finish metal chassis & panel. Owners report foreign stations on speaker. Coils for 10-200 meters. Instructions included. **FOREIGN RECEPTION GUARANTEED.**



## The EILEN Masterpiece

Designed for those who demand the ultimate in results & appearance. Uses 6F7 (2 tubes in 1 bulb), 43, & 12Z3 tubes in special 4 tube circuit, as screen-grid RF

amplifier, detector, power pentode audio amplifier, rectifier & built-in power supply. Operates from 110 volt house lighting circuit. **Humfree.** Designed for loud-speaker operation. Phones may also be used. This receiver will amaze you by its ability to consistently pick up those weak foreign stations with excellent volume. Built into a beautiful black crackle finish metal cabinet. Illuminated airplane type vernier dial. **FOREIGN RECEPTION GUARANTEED.**

Receiver, ready to wire.....\$9.95  
Wired & tested extra.....2.00  
Matched Arcturus tubes.....2.75

Magnetic loudspeaker, 8 1/2" dia. cone, wonderful tonal quality, built into beautiful oak cabinet, for use with any of the above receivers, walnut.....\$4.85  
Cannonball headphones.....1.35

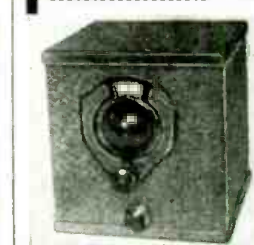

## THE EILEN 2

An inexpensive 4 amplifier receiver that is ideal for the beginner. Constructed of the highest grade parts & uses one of the new type 19 (2 tubes in 1 bulb) in a 2 tube circuit. Produces good headphone volume. Operates from 2 dry cells & 45 volt battery. Built into beautiful black crackle finish metal cabinet. Compact & makes an ideal portable.

**Kit \$3.95**

Wired & tested extra.....\$1.00  
Arcturus 19 tube......95  
Broadcast coils (2)......95

able. Coils for 10-200 meters, & instructions included. **FOREIGN RECEPTION GUARANTEED.**

**C.O.D. ORDERS FILLED. PROMPT SHIPMENT. EILEN RADIO LABORATORIES**

Dept. SC1, 463 Fourth Avenue, New York, N.Y.

Please mention SHORT WAVE CRAFT when writing advertisers

# Two Short-Wave Standbys ★★★

**Famous "19" Twinplex Kit**  
For Short-Wave Foreign Reception  
**15-550 Meters**



Economical  
**2-VOLT**  
Operation

**ONLY \$4.92**  
with

**Earphone and Two Plug-in Coils**  
Less Tube

The TWINPLEX is ACTUALLY A TWO-TUBE SET; yes, we repeat, A TWO-TUBE SET.

**FULL-FLEDGED TWO-TUBE SET AT THE PRICE OF A ONE-TUBE SET. JUST IMAGINE TWO TUBES IN ONE GLASS ENVELOPE.** That is the story of the new "19" tube. It is a 2-volt tube, which has a **DOUBLE SET OF ELEMENTS.**

The "19" TWINPLEX is available **ONLY** in kit form. Shipping weight 5 pounds.

It is now possible, with a single tube of this type, to receive short-wave stations from all over the world, loudly, clearly—**REGULARLY**—night after night, whenever they are on the air. Two coils are furnished, one for the 40-meter foreign broadcast band and the other for the regular broadcast band.

No. SW-308 Famous Twinplex Short-Wave Receiver Kit with all parts **INCLUDING SINGLE HEADPHONE AND BAND**—but no tube **YOUR PRICE \$4.92**

No. SW-309 Complete Accessories for TWINPLEX Receiver, comprising 1 Type "19" Tube, 2 No. 6 Dry Cells, 2 45-volt "B" Batteries. Shipping weight 20 pounds. **YOUR PRICE \$3.52**

**YOUR PRICE** Additional Plug-in Coils for the 20, 80 and 160 meter bands—45c each. We'll wire the set for you for \$1.50 additional.

## -DOERLE- AMATEUR BANDSPREAD GLOBE-GIRDLER

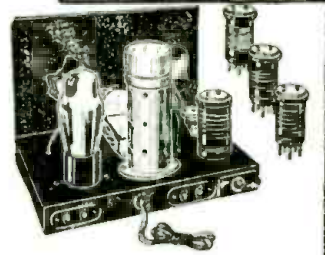
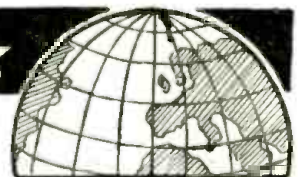

**Every Short-Wave Amateur Band Spread Over 100 Degrees on the Dial.**

No more maze of shrieking, incoherent stations one on top of the other! No more ear-splitting, nerve-wracking bedlam of noise—like half dozen menageries suddenly turned loose.

Any particular amateur band may now be spread over practically the entire tuning scale of the dial. Stations which before were closely crowded or passed by entirely, can now be spread over the entire dial and thus be easily intercepted. Not only that but through the use of the powerful 2A5 pentode in the output stage, most of these short-wave stations will now come in on the loud speaker.

The circuit incorporates the new Alden 5-prong bandspread plug-in coils. These coils are specially designed for this particular work, each having a padding condenser mounted to the top. This condenser is shunted across the entire secondary winding, whereas the main tuning condenser is across only part of this winding.

The same standard of high quality parts used in other Doerle receivers is maintained here. All component parts are mounted on a beautiful black, crackle-finished chassis with the Official Doerle nameplate bolted to the front panel. Although this receiver may be used with batteries it is recommended for A.C. operation. A good, well-filtered power supply such as the one we recommend for our other Doerle receivers should be used. The set uses 1-57 and 1-2A5. A set of 4 bandspread plug-in coils are furnished with the receiver. Shipping weight, 8 lbs.

**No. 307. Official Doerle Amateur Bandspread Receiver, Less Tubes But Including Coils.**

**YOUR PRICE . . . . . \$11.70**

**FREE** See pages 552 and 571 for our free catalogs.

**ONLY \$11.70**

# RADIO TRADING CO., 101A Hudson St., New York City

## Short Wave League Letter-heads

Designed for Members

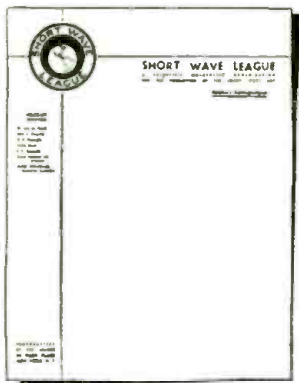

*This is the official letterhead*

It is invaluable when it becomes necessary to deal with the radio industry, mail order houses, radio manufacturers. It can be used in many ways and gives you a professional standing. No member of the LEAGUE can afford to be without this letterhead.

This can only be used by members of the LEAGUE. No one else can purchase it.

See page 576 of this issue for order blank. Take advantage of this opportunity to handle your LEAGUE correspondence in a business-like manner.

**SHORT WAVE LEAGUE**  
99-101 Hudson St., New York, N. Y.

## 5 Tube Set Works Loud Speaker

● THIS 5-tube short-wave receiver has one dial control; the two tuned stages are ganged. A 58 is used in the tuned R.F. stage, 57 as regenerative detector and a 56 first audio feeding a 2A5 pentode output amplifier, with a 280 rectifier. Resistance coupling is used in the audio stages and provides excellent quality together with sufficient volume to operate the dynamic speaker to full output. Regeneration in the detector circuit of the "Supertone 5" is obtained by the plate feed-back method and is controlled by a 20,000-ohm potentiometer. Inductive coupling is used between the R.F. amplifier and regenerative detector in order to obtain the greatest amount of gain and highest degree of selectivity. Three winding coils are used in this position. Two-winding coils are necessary for the R.F. stage, one winding is used for the antenna coupled coil, the other for the tuned grid circuit. A very simple arrangement is used to allow headphone reception if one does not wish to have the speaker going. A switch is connected in series with dynamic speaker and by opening this circuit and plugging in the headphones at the back of the chassis the operator has a 3-tube headphone job, inasmuch as the headphones are connected in the plate circuit of the first stage of audio. Extra precaution is taken in the power supply to reduce hum and other noises to a minimum. A double-section filter is used with 32 mf. of filter condenser. Two by-pass

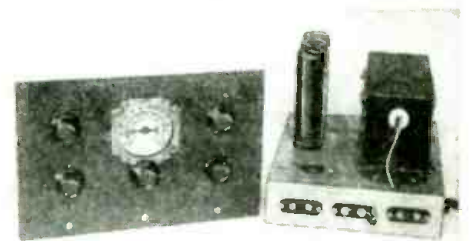

Appearance of "Supertone 5"  
No. 244 (Refer to No. when inquiring about this set.)

condensers are used in the primary of the power transformer to prevent any noise from coming in over the line. The diagram is shown and clearly indicates the connections and values of the different parts.

In the photograph shown above, the power supply is the separate unit to the right.

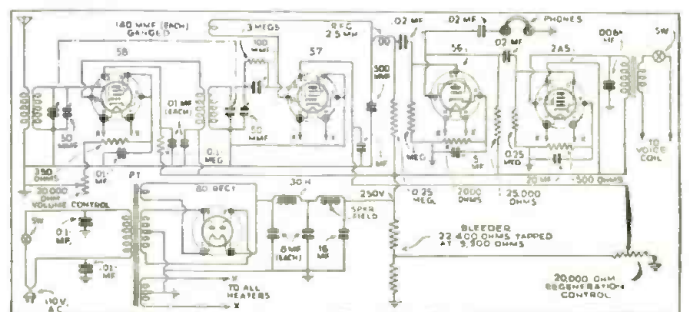

Hook-up of "Supertone 5"

Please mention SHORT WAVE CRAFT when writing advertisers

The World's Famous  
**INTERNATIONAL DX**  
SHORT WAVE RECEIVER  
ALL ELECTRIC  
ALL WAVE  
**6.75**



For Complete Kit containing standard parts, including sensitive SPEAKER. 4 coils 14-200 Meters and plain diagram.  
Extra for wiring \$1.75  
6D6, 76, 38A Areturus Tubes \$2.25  
Crackle finished Metal Cabinet, as illustrated \$1.95  
Broadcast coil 200-500 Meters, .75  
FREE: Circular about 3, 4, and 5 tube S.W. sets.

**EXPERIMENTAL RADIO LABS.**  
168 WASHINGTON STREET NEW YORK N. Y.

**THE BEST IS NONE TOO GOOD**

The Trimm Featherweight is not a common headphone. It is a scientifically developed and precision built product.

We specialize in solving unusual applications. Let our engineers know your headphone problems. We have a model to meet each need.



**TRIMM RADIO MFG. CO**  
Dept. SW-1-35  
1528 Armitage Avenue Chicago, Illinois

**SEXOLOGY**

THE MAGAZINE OF SEX SCIENCE

SEXOLOGY, foremost educational sex magazine. Is written in simple language and can be read by every member of the family. It is instructive, enlightening—not a rescue book contains no offensive matter.

Contains 25 important articles on Sex Science, 68 pages, with attractive two-color cover. Here are a few of the more important articles:

- "Sex Incompatibility"—Is Pregnancy Dangerous in women over 30? (Illustrated)—Neuragia of the Sex Organs (Illustrated)—Circumcision Among the Jews (Illustrated)—Aged Men as Fathers (Illustrated)—Sexual Life of Athletes—The "Juvenator" Fraud (Illustrated)—Man Carries Twin in Tumor (Illustrated)—Gestation in Man and Animals (Illustrated)—Extraordinary Sex Habits—Questions and Answers.

SEXOLOGY, 95 Hudson St., NEW YORK, N. Y.

**FOREIGN RECEPTION GUARANTEED**

**3 TUBE A. C. SHORT WAVE KIT A LEADER IN ITS LINE**

Uses 6F7—42 and 80. Very simple to construct from blueprint and instructions furnished. Will operate dynamic or magnetic speaker. Complete. **\$10.95** with five coils..... \$1.50  
Wiring, extra..... \$1.00  
**FREE: Write for illustrated circular showing our complete line.**

**NESTONE RADIO CO.**  
Dept. S-1, 168 Washington Street, New York City

**CHASSIS**

We manufacture all the modern types used by the leading short wave set builders, experimenters and hams in all finishes. Send drawing for estimate. We make any size.

**KORROL MFG. CO., Inc.**  
232 Greenwich St., Dept. S.W., New York

**S. W. League**  
(Continued from page 545)

also contacted twelve people, who at present are enthusiastic S.W.L.'s and are potential amateurs. Four of these are professional people, four are radio-service men, two are women and the remaining two are young chaps about 19 years of age. All but two were sufficiently well versed on the subject to offer an opinion. One of these two, after having the subject explained, thought that the no-code test below 5 meters was "quite sensible." The other party was undecided but "rather favored the idea of a no-code test." All the others agree that the adoption of a no-code test below 5 meters would be a sensible and logical thing to do.

In regard to what I have said about those who are for a code test on this frequency, I have no personal animosity against any of them, my bone of contention being that we should not be called "gas-bag artists," "lazy," etc., etc. I do not believe any constructive thought was behind these statements and I am sure that if they will only look ahead, not a week or a year, they will see some good and commendable points in the advocacy of a no-code test below 5 meters.

With television only a step in the future toward perfection the possibilities of transferring energy over the ultra short waves, and many other probabilities unthought of at this time, I think it would be to the Federal commission's credit if they abolished the code test on this frequency and opened the field to those of us who are interested in voice transmission only. Then too, as Mr. Paul Lomaster has said, the commercial interest in this band is by no means a ghost, but rather a real honest-to-goodness threat to the amateur, and if they do not occupy this band more so than in the past, the amateur is going to find himself out in the cold, as far as the 5 meter band is concerned.

In organization there is power! Might I suggest to those that are vitally interested in this subject to join the SHORT WAVE LEAGUE, which is I believe in favor of a no-code exam., and of which I soon hope to become a member.

Thanking you again, I remain  
73 to all (including the opposition). Hi.  
J. DONALD SHIRER,  
2131 Olive Ave.,  
Lakewood, Ohio.

**S. W. Scout Award**  
(Continued from page 531)

- W3XAU—49.50 M.—Broadcasting Co., Philadelphia, Pa., U.S.A.
- W2XAD—19.56 M.—National Broadcasting Co., Schenectady, N.Y., U.S.A.
- W2XAF—31.48 M.—National Broadcasting Co., Schenectady, N.Y., U.S.A.
- W3XAL—16.87 M.—National Broadcasting Co., Inc., R.C.A. Building, New York, U.S.A.
- WEF—31.0 M.—Radio Corp. of America, 66 Broad St., New York, U.S.A.
- CJRX—25.60 M.—James Richardson & Sons, Ltd., Winnipeg, Manitoba, Canada.
- CJRO—48.85 M.—James Richardson & Sons, Ltd., Winnipeg, Manitoba, Canada.
- VE9GW—49.22 M.—Bowmanville, Ontario, Canada.
- CGAR—62.0 M.—Canadian Marconi Co., Drummondville, Quebec, Canada.
- CGA4—32.15 M.—Canadian Marconi Co., Drummondville, Quebec, Canada.
- VE9HX—49.1 M.—Maritime Broadcasting Co., Ltd., Halifax, Nova Scotia.

**Coupling Doublet Aerial**  
(Continued from page 523)

are on the market. The lead-in should not be run too close to sources of noise than necessary and one should avoid very sharp bends in bringing the lead-in from the antenna. Where it is necessary to change the direction of the lead-in it is suggested that a well rounded out corner be used because of the losses effected by sharp angular bends.—Henry Mike Kiertscher.



**AEROVOX** is specified

Yes, in the majority of short-wave assemblies Aerovox components are specified. Not just advertising . . . nor paid-for publicity . . . nor favoritism. Aerovox is specified simply because Aerovox components offer quality and service at a within-reach price.

- MICA . . . Aerovox units recognized as most accurate units obtainable for precision work.
- PAPER . . . Conservative Aerovox ratings sought for longest service life . . . adequate safety margin . . . lowest losses.
- ELECTROLYTIC . . . hermetic sealing . . . all-aluminum corrosion-proof construction . . . surge-proof spacers . . . characteristically Aerovox.
- and RESISTORS . . . complete line . . . carbon, wire-wound vitreous-enamel, lavite, wire-wound strip, grid-leak . . . fit companions for Aerovox condensers.

**New Catalog** . . . just off the press . . . 1935 Edition . . . sent on request. Also sample copy of our monthly Research Worker. And meanwhile, see Aerovox products first-hand at your nearest dealer.

**AEROVOX**  
CORPORATION  
72 Washington St. Brooklyn, N.Y.

**LOW PRICES!**

8 mfd. 450 V.W. 600V. Peak cardboard dry elec. condensers (guaranteed)	\$0.30
8 mfd. 450 V.W. Alum. Can dry elec. condensers (guaranteed)	.45
Power trans. 5 tube, 2½ and 5V. windings, horizontal type	.75
Victor R.F. coils-ant. and R.F. types, each	.35
Filter chokes, 30 hys. for A1 DC sets	.35
TRIAD tubes (first) types: 210, 2x1, 250 each	1.25
Na-Aid S.W. coil kits, 4 coils to kit: 4 prong	2.05
\$1.18; 5 prong \$1.47; 6 prong	
Hammarlund coil forms: 4 and 5 prongs each	.24
2½ h. prong	.12
Coil forms, 4 and 5 prong types, bakelite, each	.12
Resistors 10 watt, coated resistances 5 to 25M ohms, each	.15
Water sockets 4 and 5 prong types, doz.	.40
Octocoll S.W. coil kits, 4 to set, 4 prong \$1.47; 6 prong	2.05
20% deposit with order, balance C.O.D. Send only \$10	

Distributors of nationally known radio parts. Write for prices on parts interested.

**M. SCHWARTZ & SON**  
710-712 Broadway Schenectady, N. Y.



# FREE!

1935 EDITION



A Veritable Text Book

**NOT JUST ANOTHER CATALOG**

This completely revised and enlarged 1934 edition contains 108 solid pages of useful radio information, diagrams, illustrations, radio kinks and real live radio merchant life. It contains more valuable radio information—more real live "meat"—than many textbooks on the subject. As usual considerable space has been devoted to the beginner in radio.

**PARTIAL LIST OF CONTENTS**

Chapter Two of "Fundamental Principles of Radio for the Beginner"—The New Tubes, Their Uses, and Their Fundamental Circuits—How to Make Money with Public Address Systems, How to Install and Maintain Them—How to Retamp Six-Volt Battery Sets to Use Two-Volt Tubes—Prize Winning Kinks and Short Cuts in Radio—How to Build the "R T" Beginner's Transmitter—How to Build the Famous Twinplex Short Wave Receiver—How to Construct an Amateur Radio Transmitter—A Most Modern and Complete Tube Chart Including Socket Connections for all Tubes—Numerous Free Offers, etc., etc.

**WRITE TODAY**

Enclose 5c coin or U. S. stamps for postage. Treatise sent by return mail.

**RADIO TRADING CO.**  
101A Hudson Street, New York City

## Superhet Uses Acorn Tubes

(Continued from page 527)

if the tuned circuits are staggered slightly, a very satisfactory selectivity curve is obtained. For comparison between this amplifier and the usual run of "IF" amplifiers, refer to the drawings. The frequency of the amplifier has to be quite high in order to reduce selectivity. In this case we used around 1500 kc. The transformers used are the midget variety made by the Miller Coil Co., and originally they were tuned to 465 kc. Sufficient turns were removed in order to make them tune to 1500 kc. Around 25 feet of wire was removed. Other types may require varying amounts. In order to get close coupling the hack-saw was brought into play. The section of wood dowel between the two coils in the transformer was sawed out and the two remaining sections glued together.

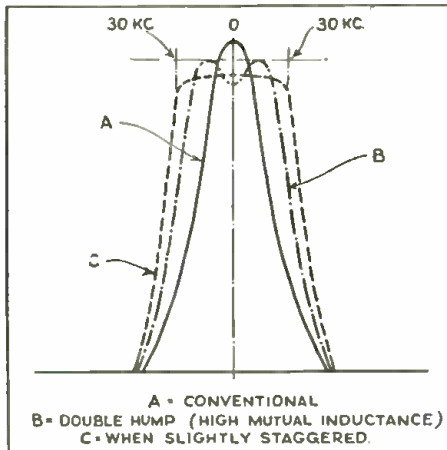

A - CONVENTIONAL  
B - DOUBLE HUMP (HIGH MUTUAL INDUCTANCE)  
C - WHEN SLIGHTLY STAGGERED.

Selectivity Curves of "IF" Amplifier.

### Tubes Used

Due to the 955 "Acorn" tubes having 6.3 volt filaments, for convenience the amplifier also uses the 6.3 volt tubes. The first amplifier is a 6D6 and the second "IF" amplifier uses a 6F7. This tube having two sets of elements comes in real handy and saves an extra tube. The screen-grid portion is used for the "IF" stage and the triode portion for the second detector. In this tube it is necessary that two resistors be connected in the cathode circuit, in order to obtain different values of bias for the two stages. Make sure that it is connected as shown in the diagram and that the same values are used. Then there will be no trouble and the results will be just as good as two separate tubes. The second detector is resistance-capacity coupled to the pentode audio stage, which uses a 42 pentode. With this line-up the full three watts of output power can be obtained on the average 5-meter signal.

Aligning the "IF" stages of this set is not at all difficult, due to their being very broad in tuning, although in order to get the best quality signal it is necessary to use care in offsetting the tuning. This can be done quite easily by listening to a station while adjusting the condensers, although an oscilloscope would be very beneficial in obtaining the optimum adjustment.

(Continued on page 573)

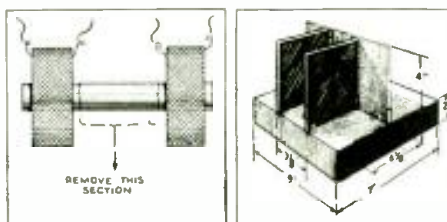

Details of chassis and how center of I.F. transformer core is sawed out.

## SLIDE RULES . . .

Midget 5 in 1 Circular Type:



Metal 4" Dia.  
Price \$1.50  
Case 50c extra

- 1.23<sup>2</sup> = ? √50.41 = ?
- 1.24<sup>2</sup> = ?
- Tan 8° 5' = ?
- Cot 79 1/2° = ?
- 4 3/4 × 1/4 = ?
- Log 56.25 = ?
- 6% of 146.9 = ?
- 5.16 - 8 1/2 + 1.78 = ?

Solve easily all these and dozens of other mathematical problems without pencil and paper—by means of the Midget Slide Rule. This rule solves any problem in multiplication, division, addition, subtraction, and proportion. It also gives roots and powers of numbers. The "Trig" scales give the sines, cosines, tangents and cotangents of all angles; also logs of numbers. Adds and subtracts fractions. Approved by colleges.

10" Dia., 27" Scale "Special" Rule, \$3.00.  
Multiplies and Divides, but has no "Trip" Scales.

**RADIO Slide Rule—Short Wave Type**  
Price \$1.00 Prepaid

Printed on white Bristol board: Size 8 1/2" x 11". Every short wave and radio student must have this inductance, capacity, and "coil-dimension" slide rule. It will answer such questions as: What is inductance of coil one inch in diameter, winding two inches long and having 30 turns per inch? What winding length of No. 24 S. C. wire must be put on a form two inches in diameter, to obtain an inductance of 100 microhenries? To what frequency and wavelength will 35 microhenry coil tune with a 50 mmf. condenser?



**NEW! "OHM'S LAW" CALCULATOR**  
Solves All Problems of Voltage, Current and Resistance. Price.....\$1.00 Prepaid  
DATA-PRINT CO., Box 322, Ramsey, N. J.

## QUALITY APPARATUS FOR Short Waves



**GEN-WIN POLICE AND SHORT WAVE ADAPTER**  
Convert your broadcast set into a short-wave set tuning from 80 to 200 meters. Get exciting police alarms from stations thousands of miles away. Airplane communications while planes are in flight. Amateur phone and international code communications. The biggest thrill and fun for so little money. Installed in a jiffy. Plugs directly into the detector tube socket. Specify the detector tube in your set, or if uncertain as to detector tube, advise make and model number of set when ordering.

No. 190—for '30, '40, '90, '12A, '200A or '201A Detector Tube	Price \$1.39
No. 191—for '32 or '34 Detector Tube	1.39
No. 200—for '27, '37 or '56 Detector Tube	1.39
No. 201—for '24, '35, '51, '36, '39 or '44 Det. Tube	1.39
No. 206—for '57, '58, '77, '78, 6C8 or 6D6 Det. Tube	1.49

**GEN-WIN SHORT WAVE COIL KIT**  
The GEN-WIN Short Wave Plug-in coils have stood the test. They have been in great demand for the past three years, and are still selling strongly to the thousands of discriminating experimenters who appreciate the remarkable results they are getting from these excellent coils. The GEN-WIN Short Wave coils can be used in any one of the many circuits published each month in Short Wave Craft magazine. The coils have plate and secondary windings so designed that they will oscillate over the entire short wave band, 15 to 225 Meter with .00014 or .00015 Mfd. Condenser.

No. 404E—4 Prong—4 coil kit (15-225 meters)	Price \$1.50
No. 404B—4 prong—Broadcast coil (200 to 550 M.)	.55
No. 406E—6 prong—4 coil kit (15-225 meters)	1.95
No. 406B—6 prong—Broadcast coil (200-550 M.)	.65

**ALL-WAVE COIL KIT—Range 25 to 550 Meters**  
Comprises a precision wound tuner and R.F. coil, both having tapped secondaries, which permits you to enjoy both SHORT WAVE and BROADCAST PROGRAMS. If you own an Ambassador or any other three circuit tuner receiver, you can easily convert the set into an all-wave receiver, by replacing the coils with these new GEN-WIN ALL-WAVE coils. Coils may be had for use with either .00035 or .0005 Mfd. condenser. Specify which when ordering. Wiring diagram included free with coils. Separately 10c.  
All Wave Tuner (as illustrated).....90c  
All Wave R. F. Coil.....75c  
Send remittance in check or money order.  
Register letter if it contains currency.

**GENERAL WINDING COMPANY**  
Incorporated  
254 W. 31st St. Dept. 1-S NEW YORK, N. Y.

## WATCH THE "LEADERS" FOLLOW LYNCH

For more than two years Arthur H. Lynch has been emphasizing the fact that  
**"No Radio Can Be Better Than Its Aerial"**



## ANTENNA SYSTEMS

are as superior to all other antenna systems as the present high-fidelity radio receivers are superior to the noisy, squealing sets of years ago. The "leaders" are just beginning to realize they have been playing a game of Rip Van Winkle.

**ASK YOUR DEALER**  
to demonstrate a LYNCH Antenna— or write us for free literature.

**Then COMPARE!**  
**ARTHUR H. LYNCH, INC.**  
227 Fulton St., New York, N. Y.  
PIONEER OF NOISE-REDUCING AERIALS

## JUST OUT! 1935 ALAN PRIZEWINNER

- FEATURING**
- Front Plug-in Coils
  - Quiet Built-in AC-DC Supply
  - Extended Frequency Range
  - New Hi-Vern Dial
  - New Improved Circuit
- Complete Kit of Parts including Cabinet hardware, instructions, etc..... \$10.55  
Wired Additional.....\$2.45

Write in For Full Information  
**ALAN RADIO CORP.**  
172 WASHINGTON ST., N. Y.  
1028 SO. OLIVE ST., LOS ANGELES

# The 4 ESSENTIAL SHORT WAVE BOOKS

'ROUND THE WORLD FANS USE THESE GREAT SHORT WAVE BOOKS

These great books contain everything on short waves that is really worth knowing—they are books which have been most enthusiastically welcomed by short-wave fans. The cost of the books is extremely low in comparison with the valuable material which they contain.

There is not a short-wave fan, experimenter or interested radio-minded reader who will not want these books. Right up-to-the-minute with new material on outstanding developments in the short wave field. The books are authoritative, completely illustrated and not too highly technical.

## Ten Most Popular Short Wave Receivers. How to Make and Work Them

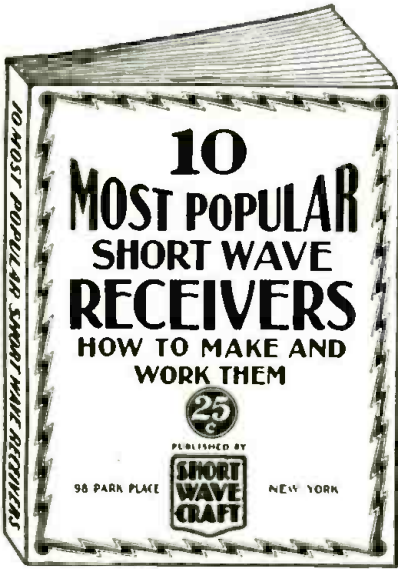

This new volume is a revelation to those who wish to build their own short wave receivers. The editors of **SHORT WAVE CRAFT** have selected ten outstanding short wave receivers and these are described in the new volume. Each receiver is fully illustrated with a complete layout, pictorial representation, photographs of the set complete, hookup and all worthwhile specifications. Everything from the simplest one tube set to a 5-tube T. R. F. receiver is presented. Complete lists of parts are given to make each set complete. You are shown how to operate the receiver to its maximum efficiency.

### CONTENTS

The Doerle 2-Tube Receiver That Reaches the 12,500 Mile Mark, by Walter C. Doerle.  
 2-H. F. Pentode S-W Receiver having two stages of Tuned Radio Frequency, by Clifford E. Denton and H. W. Spenn.  
 My de Luxe S-W Receiver, by Edward G. Ingram.  
 The Blineweg 2-Tube 12,000 Mile DX Receiver, by A. Blineweg, Jr.  
 Build a Short Wave Receiver in your "Brief-Case," by Hugo Gernsback and Clifford E. Denton.  
 The Denton 2-Tube All-Wave Receiver, by Clifford E. Denton.  
 The Denton "Stand-By," by Clifford E. Denton.  
 The "Stand-By" Electrified.  
 The Short-Wave MEGADYNE, by Hugo Gernsback.  
 A COAT-POCKET Short Wave Receiver by Hugo Gernsback and Clifford E. Denton.  
 Boy, Do They Roll In on this One Tube by C. E. Denton.  
 The S-W PENTODE-4, by H. G. Cisin M. E.  
 Louis Martin's Idea of A GOOD S-W RECEIVER, by Louis Martin.

25c

40 PAGES  
OVER 75 ILLUSTRATIONS  
IMPORTANT

THERE IS NO DUPLICATION BETWEEN THIS BOOK AND OUR OTHER VOLUME—"HOW TO BUILD AND OPERATE SHORT WAVE RECEIVERS." ALL THE MATERIAL PUBLISHED IN THE NEW BOOK HAS NEVER APPEARED IN ANY BOOK BEFORE.

## How to Build and Operate Short Wave Receivers

is the best and most up-to-date book on the subject. It is edited and prepared by the editors of **SHORT WAVE CRAFT**, and contains a wealth of material on the building and operation, not only of typical short-wave receivers, but short-wave converters as well. Dozens of short-wave sets are found in this book, which contains hundreds of illustrations; actual photographs of sets built, hookups and diagrams galore.

The book comes with a heavy colored cover, and is printed throughout on first-class paper. No expense has been spared to make this the outstanding volume of its kind. The book measures 7 1/2 x 10 inches.

This book is sold only at such a ridiculously low price because it is our aim to put this valuable work into the hands of every short-wave enthusiast.

We know that if you are at all interested in short waves you will not wish to do without this book. It is a most important and timely radio publication.

Over 150 Illustrations  
72 Pages 7x10 Inches

50c

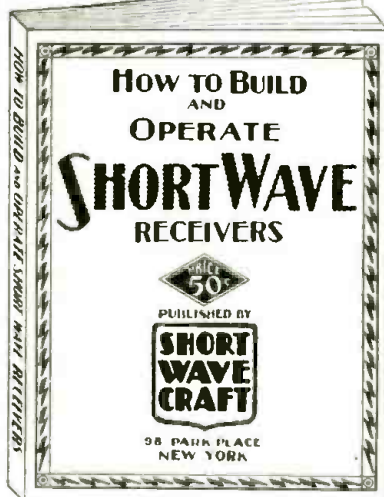

## How to Become an Amateur Radio Operator

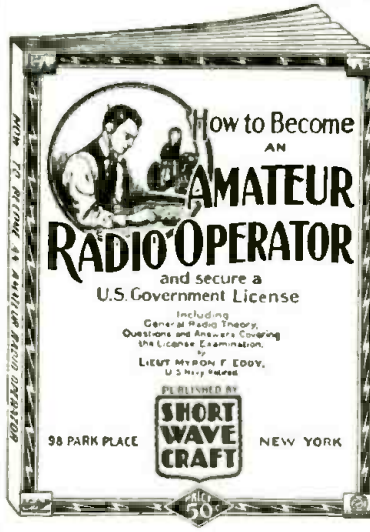

We chose Lieut. Myron F. Eddy to write this book because his long years of experience in the amateur field made him pre-eminent in this line. For many years he was instructor of radio telegraphy at the R.C.A. Institute. He is a member of the I.R.E. (Institute of Radio Engineers), also the Veteran Wireless Operators Association.

If you intend to become a licensed code operator, if you wish to take up phone work eventually, if you wish to prepare yourself for this important subject—this is the book you must get.

### Partial List of Contents

Ways of learning the code. A system of sending and receiving with necessary drill words is supplied so that you may work with approved methods. Concise, authoritative definitions of radio terms, units and laws, brief descriptions of commonly used pieces of radio equipment. This chapter gives the working terminology of the radio operator. Graphic symbols are used to indicate the various parts of radio circuits. General radio theory particularly as it applies to the beginner. The electron theory is briefly given, then waves—their creation, propagation and reception. Fundamental laws of electric circuits, particularly those used in radio are explained next and typical basic circuits are analyzed. Descriptions of modern receivers that are being used with success by amateurs. You are told how to build and operate these sets. Amateur transmitters. Diagrams with specifications are furnished so construction is made easy. Power equipment that may be used with transmitters and receivers, rectifiers, filters, batteries, etc. Regulations that apply to amateur operators. Appendix which contains the International "Q" signals, conversation tables for reference purposes, etc.

Over 150 Illustrations  
72 Pages 7x10 Inches

50c

All the books shown on this page are published exclusively by

**SHORT WAVE CRAFT**

99-101 Hudson Street, New York, N. Y.

CLIP-MAIL

### SHORT WAVE CRAFT

99-101 Hudson Street, New York, N. Y.

Gentlemen: I enclose herewith my remittance for the amount of \$..... for which you are to send me, postpaid, the books checked below.

- ( ) Ten Most Popular Short Wave Receivers. How to Make and Work Them.....25c each
- ( ) The Short Wave Beginner's Book.....25c each
- ( ) How to Build and Operate Short Wave Receivers.....50c each
- ( ) How to Become an Amateur Radio Operator.....50c each

Name.....  
 Address.....  
 City..... State.....

(Send remittance in form of check or money order. If letter contains cash or unused U. S. Postage Stamps, register it.)

SW-1-35

These Books are Authentic For All Short Wave Work and **LOW** in Price

**COUPON TODAY!**

Please mention **SHORT WAVE CRAFT** when writing advertisers

# Acorn Tube Superhet

(Continued from page 571)

## Parts List for 5-Meter Super

- 2—100 mmf. mica condensers, Aerovox.
  - 1—.001 mf. mica condenser, Aerovox.
  - 2—.004 mf. mica condenser, Aerovox.
  - 1—.02 mf. by-pass condenser, Aerovox.
  - 9—.1 mf. by-pass condensers, Aerovox.
  - 1—2 mf. by-pass condensers, Aerovox.
  - 1—4 mf. condenser, Aerovox.
  - 1—20 mf. electrolytic condenser, Aerovox.
  - 1—2 megohm half-watt grid-leak.
  - 2—50,000 ohm half-watt resistors.
  - 2—100,000 ohm half-watt resistor.
  - 2—300 ohm half-watt resistor.
  - 1—75,000 ohm one-watt resistor.
  - 1—2000 ohm half-watt resistor.
  - 1—250,000 ohm half-watt resistor.
  - 1—500 ohm, 2-watt resistor.
  - 1—25,000 ohm potentiometer with switch, Electrad.
  - 1—SE 90 National condenser (remodeled; see text).
  - 1—18 mmf. National condenser, with plates removed to make 10 mmf.
  - 3—465 kc. I.F. transformers remodeled as per description in text (Miller).
- Sufficient National Vietron insulation to construct two 955 sockets and coil mountings.
- 2—6-prong wafer sockets, Na-Ald.
  - 1—7-prong wafer socket, Na-Ald.
  - 1—National Vernier dial.
  - 1—National SW3 metal cabinet (black crystalline finish).
  - 2—955 tubes RCA Radiotron.
  - 1—6D6 tube, RCA Radiotron.
  - 1—6F7 tube, RCA Radiotron.
  - 1—42 tube, RCA Radiotron.
  - 1—special chassis with partitions to fit National Cabinet; Blan.
  - 1—special home-made coils; see coil table for data.

### Coil Data

- 5-Meter Band**
- 1st Detector coil—6 turns No. 16 tinned wire  $\frac{1}{2}$ " inside diameter, length of coil  $1\frac{1}{4}$ ".
  - Oscillator coil—7 turns No. 16 tinned wire  $\frac{1}{4}$ " inside diameter, length of coil  $1\frac{1}{4}$ ".
- 2.5-Meter Band**
- 1st Detector coil—4 turns No. 16 tinned wire  $\frac{1}{4}$ " inside diameter, length of coil  $1\frac{1}{4}$ ".
  - Oscillator coil—5 turns No. 16 tinned wire  $\frac{1}{4}$ " inside diameter length of coil  $1\frac{1}{4}$ ".

# Short Waves Reduce Viper Poison

(Continued from page 520)

tively. Thus, there is a diminution of the toxic effect when the radiation is prolonged.

**EXPERIMENT IV**—Length of exposure, 80 minutes; distance of electrodes, 20 cm.; then another exposure of 30 minutes; distance of electrodes, 15 cm. (6 inches); dose injected, 1.1 cc.

Three subjects received this injection. One, weighing 10 grams, died between 12 and 13 hours later; the two others, weighing respectively 24 and 27 grams resisted the venom and survived. The control mice died between 5 and 8 hours after injection. There was thus, as in the case of experiment 3, a manifest reduction of the toxicity of the venom, but the antigens of the venom no longer existed. And they did not reappear later, for the two subjects who recovered were unable to resist an injection of 1.1 cc. of pure venom given them 3 days later. Thus, we may ascribe the augmentation of the toxic effect observed in Experiment 1, to the complete and very early disappearance of the antigens.

**EXPERIMENT V**—Length of the exposure, 60 minutes; distance of the electrodes, 15 cm. (6 inches); dose injected 1.1 cc.

Three mice were inoculated with this solution. One, weighing 22 grams, died unexpectedly after 1 hour, 30 minutes; the other two presented the usual symptoms of venom poisoning, but resisted the attack.

In all the cases the hemorrhagic lesions (where blood breaks through wall of blood vessels) characteristic of the action of venom were present; but the short waves evidently do not modify the hemorrhagin (poisonous) content of the venom, but this constituent plays only a minor role in the mechanism of death as a result of the venom of the Aspic Viper.

From these experiments and their results we may draw the following conclusions:

1. The first action of short waves on the venom of the Aspic Viper is to destroy completely the antivenomous substances (antigenes) which cause the venom to appear more poisonous than it is (Experiment 1).
2. The neurotoxin which is the primary cause of death in poisoning cases from a viper bite, is not affected by the short waves; for venom which has been sufficiently irradiated only kills one out of every four or five mice. (Experiments 4 and 5.)
3. The hemorrhagin of the venom is not modified at all, whether the subject dies or resists, which shows its relatively unimportant effect in the mechanism of death from Viper bite.
4. The various results show that the short waves produce upon the venom of the viper much the same effect as ultra-violet radiation, and have no effect with regard to transforming the venom into a vaccine.

### Educational Programs on Short Waves

WILLIAM M. BARBER, Educational Director of Short-Wave Broadcast Station, W1XAL, owned and operated by the World-Wide Broadcasting Corporation, announces that beginning December 1 this station will devote its entire facilities to educational, non-profit programs. The programs will start Sunday, December 1, 7:30 p.m. and continue on Sundays, Tuesdays, and Thursdays of each week. If you like these programs write to William M. Barber, 11 Bond St., Newton, Mass., for if the response warrants, daily programs will be given, starting with January.

# CLASSIFIED

Advertisements are inserted at 5c per word to strictly amateurs, or 10c a word to manufacturers or dealers. Each word in a name and address is counted. Cash should accompany all orders. Copy for the February issue should reach us not later than December 5th

**ACCESSORIES**  
GENERAL ELECTRIC BATTERY operated dynamotors 24/750 volt .825. (On 12 delivers 375) 500 cycle 500 watt alternators \$7.50 List. Henry Klezle, 501 East 94th Street, New York.

**"HAM" OFFERS & WANTS**  
SALE OR SWAP, PADA AUTO "B" Eliminator 180 Volts—New—\$5.00; Westinghouse 32-350 Volts, 80 mhz motor generator new—\$7.50, Kazmeroff, 606 W. 114 St., New York.

SELL CHEAP—PUSH PULL 3-band transmitter also 500-watt A.C. generator—WJMAJ Bellevue, Iowa, Route 1.

AC RECEIVER COMPLETE, TWO Tubes, Plenty Dn., \$5.00. Ted Conrad, Mantrose, Mo.

TRADE 30-WATT TRANSMITTER for motorcycle. L. C. Odie, McKinney, Texas.

**INSTRUCTION**  
GOVERNMENT GIVES FREE Radio operators' training for service on aircraft, ships. Salary, expenses paid. Information booklet, how to qualify, apply, 20c. Continental, Box 341F, Indianapolis, Ind.

**MISCELLANEOUS**  
AN EXCELLENT HOLIDAY Present—Golden Gem Portable Adding Machine; Adds, Subtracts, Multiplies as accurately as \$300 machines. Over 300,000 sold since 1904. Works automatically. Nickel plated—\$3.95. Chrome Finish—\$9.95. DeLuxe Model in plush-lined case—\$11.29. Interesting literature sent on request. Write for discount to agents, Gold Shield Products Co., 98 Park Place, Dept. C., New York City.

GIM'S LAW CALCULATOR—Lightning Slide Rule; solves all problems of Voltage, Current and Resistance, Power, Wire Sizes, etc. Range: 1 micro-amp. to 1000 amps.; 1 micro-volt to 10,000 volts; 1 micro-ohm to 10 megohms; 1 micro-watt to 10 megawatts; wire sizes 0 to 36 B. & S. gauge. Introductory price \$1.00 prepaid. The Dataprint Co., Box 322, Ramsey, N.J.

TEN PRACTICAL AND INEXPENSIVE changes converting Dodge 12-V. Ford T.A., Chevrolet Delco 6-V generators, into 100-500 watt capacity A.C. generators, or into 32-110 volt D.C. motor or generator. Dodge is 500-W. self-excited. All in one book illustrated with complete simplified instructions and drawings for only \$1. AUTO-POWER, 414 S. Hoyne Ave., Chicago.

AGENTS WANTED FOR OUR Vest Pocket Soldering Iron. It is the smallest good iron made. 10 inches long and heats up in half the time. Does the work of irons twice its size. Will satisfy or money back. \$1.00 brings sample. Gold Shield Products Co., 98 Park Place, Dept. C., New York City.

AGENTS WANTED FOR STOP-Pan Compass—Cost U.S. Government \$30.00. Ideal for Radio Experimental Laboratory. Ruby, jeweled, solid bronze, 4 inches square, in hardwood case, sells for \$4.50. Agent's price \$2.50. Gold Shield Products Co., 98 Park Place, Dept. C., New York City.

AGENTS WANTED FOR HEALTH Ray Carbon Lamp. Pays for itself in a few treatments. List price with Screen and Goggles, \$10.00—Your Cost \$3.38. Interesting literature Free. Gold Shield Products Co., 98 Park Place, Dept. C., New York City.

AGENTS WANTED FOR HEALTH Ray Carbon Lamp. Pays for itself in a few treatments. List price with Screen and Goggles, \$10.00—Your Cost \$3.38. Interesting literature Free. Gold Shield Products Co., 98 Park Place, Dept. C., New York City.

AGENTS WANTED FOR HEALTH Ray Carbon Lamp. Pays for itself in a few treatments. List price with Screen and Goggles, \$10.00—Your Cost \$3.38. Interesting literature Free. Gold Shield Products Co., 98 Park Place, Dept. C., New York City.

AGENTS WANTED FOR HEALTH Ray Carbon Lamp. Pays for itself in a few treatments. List price with Screen and Goggles, \$10.00—Your Cost \$3.38. Interesting literature Free. Gold Shield Products Co., 98 Park Place, Dept. C., New York City.

AGENTS WANTED FOR HEALTH Ray Carbon Lamp. Pays for itself in a few treatments. List price with Screen and Goggles, \$10.00—Your Cost \$3.38. Interesting literature Free. Gold Shield Products Co., 98 Park Place, Dept. C., New York City.

**AGENTS WANTED FOR HEALTH** Ray Carbon Lamp. Pays for itself in a few treatments. List price with Screen and Goggles, \$10.00—Your Cost \$3.38. Interesting literature Free. Gold Shield Products Co., 98 Park Place, Dept. C., New York City.

**AGENTS WANTED FOR HEALTH** Ray Carbon Lamp. Pays for itself in a few treatments. List price with Screen and Goggles, \$10.00—Your Cost \$3.38. Interesting literature Free. Gold Shield Products Co., 98 Park Place, Dept. C., New York City.

**AGENTS WANTED FOR HEALTH** Ray Carbon Lamp. Pays for itself in a few treatments. List price with Screen and Goggles, \$10.00—Your Cost \$3.38. Interesting literature Free. Gold Shield Products Co., 98 Park Place, Dept. C., New York City.

**PLUG-IN COILS. 15-210 METERS.** Wound on 4-prong tube bases. .30 set. Long forms .50. Six-prong .75. Noel, 809 Alder, Scranton, Pa.

**SENSITIVE POLICE AND AMATEUR** short-wave attachments. Work better than short-wave midgets. For 4-tube midgets, etc. \$1.00 postpaid. Delft, Oakland, Calif.

**SHORT WAVE RECEIVERS**  
IN STOCK—LOWEST WHOLESALE prices: Patterson PR-12 complete \$82 prepaid; Silver 5C \$74.70 prepaid. All other receivers, shortwave apparatus. Trade-in your receiver. Code machines rented. Write Henry Radio Shop, Butler, Mo.

**SHORT WAVE RADIOS IN** Leather Camera Cases. \$8. Wm. Ballari, 14A Burnett, Sapulpa, Okla.

**NEW TUBELESS 1850 MILE** Radio. Operates Speaker. Blueprint 17 others. 25c Coin. Setbuilders List Free. Modern Radiolabs, 151-A Liberty, San Francisco.

**SHORT WAVE SUPPLIES**  
INSTALLATION WIRE, VARNISHES, supplies, etc. Send 3c stamp for bulletin. AUTOPOWER, 414 S. Hoyne Ave., Chicago.

**SHORT WAVE SUPPLIES**  
INSTALLATION WIRE, VARNISHES, supplies, etc. Send 3c stamp for bulletin. AUTOPOWER, 414 S. Hoyne Ave., Chicago.

**SHORT WAVE SUPPLIES**  
INSTALLATION WIRE, VARNISHES, supplies, etc. Send 3c stamp for bulletin. AUTOPOWER, 414 S. Hoyne Ave., Chicago.

**SHORT WAVE SUPPLIES**  
INSTALLATION WIRE, VARNISHES, supplies, etc. Send 3c stamp for bulletin. AUTOPOWER, 414 S. Hoyne Ave., Chicago.

**SHORT WAVE SUPPLIES**  
INSTALLATION WIRE, VARNISHES, supplies, etc. Send 3c stamp for bulletin. AUTOPOWER, 414 S. Hoyne Ave., Chicago.

**SHORT WAVE SUPPLIES**  
INSTALLATION WIRE, VARNISHES, supplies, etc. Send 3c stamp for bulletin. AUTOPOWER, 414 S. Hoyne Ave., Chicago.

**FREE Catalog**

180 Pages full of all types of radio and electrical apparatus including: Short-Wave Receivers; All-Wave Receivers; Public Address Systems; Replacement Parts; Tubes; Short-Wave Products and thousands of items too numerous to mention.

The greatest radio catalog for the general radio trade. **GUARANTEED LOWEST PRICES—GUARANTEED QUALITY.** Send For Your Free Copy TODAY!

**An All Around Radiobook** General Short Wave and PUBLIC ADDRESS MANUAL

A general book covering every factor in radio, including: Short-Waves, All-Waves, Public Address and Transmitting. Hundreds of illustrations and schematics. Every article is a gem. For the low price every radio man—serviceman, dealer or experimenter—can find this book an indispensable asset to his radio library. Bound in Cardinal Red Leatherette Cover. Send For Your Copy Today!

50c

**TRY-MO RADIO CO.**  
85-5 Cortland St. New York, N.Y.

**PATENTS — TRADE MARKS**  
All inventions submitted held confidential and given personal attention by members of the firm.  
Form "Evidence of Conception" and instructions  
"How to Establish Your Rights"—Free  
LANCASTER, ALLWINE & ROMMEL  
PATENT LAW OFFICES  
475 Bowen Bldg. Washington, D. C.

**YOU WILL WANT TO USE OUR NEW**

line of Vietron parts in keeping with the ultra low-loss of the new 955 Acorn Tubes. Write today for new 16-page catalog just printed showing Short Wave parts.

**ALDEN PRODUCTS CO.**  
Dept. SW 1 715 Center St. BROCKTON, MASS.

**NA-ALD**

**MARVEL OF THE AIR**



**World Short Wave Sets**

This amazing two tube battery set brings the entire world to your home. 10,000 mile reception guaranteed! This supersensitive receiver uses the latest type 2 volt tubes to insure battery economy. Highest quality material used throughout its entire construction.

Foundation Kit with complete instructions and picture diagrams ready to assemble with 4 plug-in coils 10-200 meters..... **\$349**

Set wired and tested in our laboratory. Complete with 4 plug-in coils 10-200 meters..... **\$475**

This low price for a limited time only. Get yours now.

Special coil for Broadcast Band.....\$49  
Sylvania or Raytheon '30 Tubes..... .40  
Sylvania or Raytheon '33 Tubes..... .75  
25% Deposit Required with mail orders

**National Radio Distributing Co.**  
406 Communipaw Ave., Jersey City, N.J.

# The best crop of the year! in Short Wave Receivers

## Presenting the Advanced Doerle!

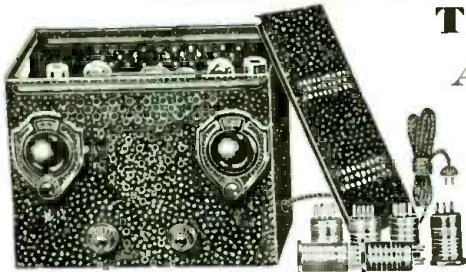

**THE NEW  
Advanced  
"DOERLE  
A.C. Five"**

15 to 200 Meters

**Built-in Power Supply and Dynamic Speaker  
COMPLETE—NOTHING ELSE TO BUY**

Well, you Doerle Enthusiasts, isn't this what you've been waiting for? A powerful 5-tube Doerle Receiver, complete with its hum-free power supply and dynamic speaker; all mounted on a single chassis and contained in a beautiful, black, crystalline-finished metal cabinet! Two tuned stages, two A.F. stages with powerful 2A5 output and perfectly matched dynamic speaker; all contribute to the enormous power and superlative performance of this "top-notch" of the Doerle line.

During its initial test, in one sitting, this receiver pulled in on its loud speaker, at good room volume, the following variable log: DJD, DJC, and DJA, Germany; J1AA, Japan; GSD and GRC, England; CJRX, CJRO and VE9GW, Canada; EAU, Spain; HJ3ABF, Bogota, Colombia; XDA, Mexico; FYA, France; WQO and WEF, testing with the Byrd Expedition and a whole flock of amateurs in practically every radio district of the United States. After that we could no longer keep our eyes open, so we "signed off" to bed.

The receiver employs a 58 as RF amplifier, a 57 as detector, a 56 as first audio amplifier, a 2A5 as power output tube and an 80 as full-wave rectifier. The antenna is coupled inductively to the first tuned circuit through the medium of the three-winding, 6-prong plug-in coils used in the first RF stage. This effectively eliminates the bothersome antenna trimming condenser. Provisions are made for plugging in earphones. The entire set measures 11 3/4" wide x 8 1/2" deep x 8 1/2" high. Ship. Wt. 19 lbs.

**\$26<sup>90</sup>**

**No. J332—The Official "Doerle A.C. Five," self powered, ready to use, complete with tubes, 2 sets of plug-in coils and dynamic speaker, as illustrated.**

**FREE!  
CATALOGS**

See our ads on pages 552 and 571

**LOWEST PRICE  
IN THE WORLD**

**ONLY \$375**

Anyone can assemble this simple, yet efficient short-wave receiver in a half-hour's time. All major component parts come to you all ready mounted on plated metal chassis. No previous experience in, or knowledge of, radio required to build it. The set was designed especially for beginners and, as such, is the simplest on the market—yet simple as it is, it pulls in **AFTER NIGHT—whenever they are on the air.** The receiver uses 2 type 30 2-volt tubes for operation and is the simplest in European short-wave stations. **REGULARLY—NIGHT** Complete diagram included. Sold with 4 plug-in coils covering the range of from 15 to 200 meters. **opportunity knocks. Get started in short-waves while your price is \$375.**

**No. J334 World-Wide Two-Tube Receiver. YOUR PRICE. \$3.75**  
**Set of 2 Matched 30 Tubes. YOUR PRICE. \$1.50**  
**Set of 2 No. 6 Dry Cells and 2 45-Volt "B" Batteries. \$2.50**

**Short-Wave  
PRE-SELECTOR  
AND BOOSTER**

Can be added to any short-wave receiver from a 1 tube battery set to a 10 tube superhet. No rewiring of your set is necessary. Just connect directly to the Aerial and Ground post of your present receiver and you are all set for greatly improved reception on all bands. This booster has its own power supply which connects with A.C. or D.C. Line. Just the pre-selector owners of two stage supers have been looking for to reduce line response to a minimum. Booster is housed in a beautiful, crinkle-finished cabinet with hinged top for easy changing of plug-in coils.

**ONLY \$8.95**

**Tubes—6D6 and 25Z.....\$1.95**

**Mono-Coil Converter**  
Featured in Oct. Short Wave Craft Magazine

Designed for one specific purpose—THE RECESSION OF FOREIGN SPEECH AND MUSIC—this new converter is, naturally, the most efficient ever designed. Heretofore, such equipment has been made to cover the tremendous range of from 10 to 200 meters, and hence could not function very efficiently on any one particular band. This Mono-Coil converter will work with any receiver, battery, A.C.-D.C. or A.C., having at least one I.F. stage.

**NO PLUG-IN COILS OF ANY KIND ARE EMPLOYED.** Set measures 9 1/2" wide x 8" deep x 7 1/2" high. Ship. wt. 12 lbs. Power pack operation. Ship. Wt. 9 lbs.

**No. J229 New Mono-Coil Converter Kit. Your Price.....\$14.95**

**Trans-Atlantic Two**  
Featured in Oct. Short Wave Craft Magazine

15 to 200 Meters

The "Trans-Atlantic Two" is so well designed that it actually gives **4-TUBE PERFORMANCE.** The set uses a 6BT as combination untuned RF stage and regenerative detector. A 79 is employed as two stages of resistance-coupled AF amplification. Regeneration is very smooth, being controlled by a variable condenser.

**New Band-Switching Arrangement**—By merely turning a knob on the front panel any one of the four bands from 10 to 200 meters may be switched into the circuit. The switch itself is of unique design, permitting the use of any type of plug-in coils. This receiver uses 3-winding, 6-prong type plug-in coils. Ship. Wt. 9 lbs.

**No. J228 "Trans-Atlantic 2" Kit. less tubes. Your Price.....\$10.95**

# DOERLE GLOBE-GIRDLING Receivers—

**Important Notice** WE ORIGINALLY brought out the now justly famous DOERLE short wave receivers in 1932. Since that time, we have always followed the policy of making these receivers just as good as it was humanly possible to do irrespective of price. In our Grade A receivers, we have steadfastly maintained the "quality first" policy. We, however, realized that many wished to get lower priced sets, and we are now offering such a popular priced line to our many friends and followers.

This new line still uses excellent materials, although we use somewhat lighter chassis, and in other respects we have effected considerable savings which are now passed on to you. Even at these low prices, however, we could not afford the risk of cheapening the main parts. We still use HAMMARLUND TUNING CONDENSERS, and other equally well-known components. The sets we offer here are not quite as rugged as our standard DOERLE sets on which we never skimp, but if you are looking for a low-priced set, a receiver that will do the work and do it well, here are the sets for you.

This new line of DOERLE receivers may be likened to low-priced automobiles as compared with the more luxurious and expensive ones. Both types will get you to the same places, yet one will outlast the other and will be easier to handle. Our usual guarantee goes with these lower-priced sets, the same as with our higher-priced ones. The electrical circuits, wiring, etc., are exactly the same as our higher-priced sets.

**\$4.45** GENUINE HAMMARLUND CONDENSER

**NEW 230 RCA LICENSED TUBES**

**4 STANDARD SIZE PLUG-IN COILS**

**AUDIO TRANSFORMER**

**BATTERY CABLE**

You will make no mistake in getting any one of these sets. These "Globe Girdling" DOERLE sets are guaranteed to bring in short-wave broadcast stations from all over the world and you will get music and every kind of entertainment from all 5 continents.

The excellent performance of these 2-Tube Doerle receivers has already become traditional. Mass production of chassis, the use of good "over-flow" parts from manufacturers and tube-base plug-in coils, make it possible for us to sell these competitive receivers at the **LOWEST PRICES ON THE MARKET.**

**NO. J349 2-VOLT BATTERY MODEL DOERLE KIT**—This receiver uses 2 of the new economical 30 tubes. Batteries required are 2 No. 6 dry cells for a 2 volt storage coil and 2 45-volt "B" batteries. Sold complete with instructions and diagram. Shipping weight 5 lbs. **YOUR PRICE, Less Tubes.....\$4.45**  
 Pair of Matched 30 Tubes.....\$1.25

**NO. J350 ALL-ELECTRIC-A.C.-D.C. DOERLE KIT**—This model requires no battery or power pack at all. It works anywhere and on any type of current at 110 volts. Has a self-contained power supply. Uses 3 type 37 tubes. Shipping weight 8 lbs. **YOUR PRICE, Less Tubes.....\$3.95**  
 Three Matched 37 Tubes.....\$1.75

**NO. J351 STRAIGHT A.C. DOERLE KIT**—This model uses either 2 56's or 2 27's. It may be used in conjunction with our own power pack, listed below. The set may also be run on a 2 1/2-volt filament transformer or a "1" eliminator or, instead of the "1" eliminator, 2 45-volt "B" batteries. Shipping weight 6 lbs. **YOUR PRICE, Less Tubes.....\$4.45**  
 Pair of Matched 56 or 27 Tubes.....\$1.30

**NO. J352 COMPETITIVE A.C. POWER PACK KIT**—A compact power unit delivering 2 1/2 volts at 5 amps for filament supply and 250 volts D.C. at 50 ma for plate supply. Requires a type 80 as rectifier. **YOUR PRICE, Less Tubes.....\$4.70**  
 Rectifier Tube.....\$ .40

WE WILL WIRE AND TEST ANY OF THESE KITS WHEN ORDERED FOR \$1.25  
 Send money order or certified check. C.O.D. only when 20% remittance accompanies order.

**RADIO TRADING CO., 101-A HUDSON ST., NEW YORK CITY**

Please mention SHORT WAVE CRAFT when writing advertisers



**Index to Advertisers**

<b>A</b>	
Ace Radio Laboratories.....	561
Aerovox Corporation.....	569
Alan Radio Corporation.....	557, 563, 571
Alden Products Co.....	558, 573
Allied Engineering Institute.....	565
Allied Radio Corporation.....	551, 558
American Radio Hardware Co., Inc.....	560
Amplivox Laboratories.....	562
Anker Labs.....	556, 562
Arco Tube Company.....	560
Astatic Microphone Laboratory, Inc.....	558
Automatic Electrical Devices Co.....	563
<b>B</b>	
Baltimore Radio Corp.....	553
Blan. the Radio Man, Inc.....	552
Bliley Electric Company.....	557
Breakers, Hotel.....	553
Rud Radio Inc.....	550
Burks Radio Company.....	566
Burstein-Applebee Co.....	552
<b>C</b>	
Candler System Co.....	561
Centrallion Engineering Co.....	560
Classified Advertisements.....	573
Coast-to-Coast Radio Corp.....	553
Co-Ra-Co Radio Company.....	560
Coyne Electrical School.....	515
<b>D</b>	
Dataprint Company.....	564, 567, 571
Dodge's Institute.....	565
<b>E</b>	
Eagle Radio Co.....	566
Eastern Radio Specialty Co.....	567
Eilen Radio Laboratories.....	567
Electrad, Inc.....	561
Everyday Science & Mechanics.....	565
Experimental Radio Labs.....	569
<b>F</b>	
Fordson Radio Incorporated.....	563
First National Television, Inc.....	564
<b>G</b>	
General Winding Company, Inc.....	571
Goldentone Radio Company.....	561
Gold Shield Products Co.....	556
<b>H</b>	
Hammarlund Manufacturing Co.....	559
Harrison Radio Company.....	549
<b>I</b>	
Instructograph Company.....	563
Insuline Corp. of America.....	565
<b>K</b>	
Korrol Mfg. Co., Inc.....	569
<b>L</b>	
Lancaster, Allwine & Rommel.....	573
La Salle Radio Products Co.....	555
Leotone Radio Co.....	550, 575
L. I. Marine & Electric Co.....	557
Lynch, Arthur H., Inc.....	571
<b>M</b>	
Midwest Radio Corp.....	Back Cover
<b>N</b>	
National Company, Inc.....	Inside Back Cover
National Radio Dist. Co., Inc.....	573
National Radio Institute.....	513
Nestone Radio Co.....	569
New York YMCA Schools.....	561
<b>O</b>	
Omnigraph Mfg. Co.....	567
<b>P</b>	
Popular Medicine.....	567
Postal Radio Corp.....	551
<b>R</b>	
"Radio".....	557
Radio Craft.....	567
Radio Publications.....	570
Radio Technological College.....	566
Radio Trading Co.....	552, 568, 571, 574
RCA Institutes, Inc.....	564
RCA Victor Co.....	516, 575
Remington-Rand, Inc.....	555
<b>S</b>	
Schwartz, M. & Son.....	569
Sexology Magazine.....	569
Shortwave & Television Corp.....	562
Short Wave Coil Book.....	566
Short Wave League.....	557, 568, 576
Supertone Products Corp.....	552
<b>T</b>	
Teleplex Co.....	556
Thor Radio Co.....	564
Trimmo Radio Mfg. Co.....	569
Try-Mo Radio Co., Inc.....	573
<b>U</b>	
Uncle Dave's Radio Shack.....	555
<b>V</b>	
Vibroplex Co., Inc.....	575
<b>W</b>	
Wellworth Trading Company.....	562
Wholesale Radio Service Co., Inc.....	563
Winn, J. H., Mfg. Co.....	567
World Trotter Radio Labs.....	553

(While every precaution is taken to insure accuracy, we cannot guarantee against the possibility of an occasional change or omission in the preparation of this index.)

**De Luxe Gothic RGH 4**

(Continued from page 537)

carefully, making sure all connections are soldered firmly.

**Antenna Connection:** Although the doublet antenna is almost a necessity for short-wave reception, good results are obtainable on an ordinary antenna. Verifications have been received already by "fans," from all parts of the world, including New Zealand and Australia, all on the loud-speaker.

**List of Parts**

**Coils**

- 2—Sets of 6-prong coils (8 coils)
- 2—Thor R.F. chokes
- 1—NS44 plate choke (300 henry)
- 1—Thor power transformer 600V-40MA
- 1—Speaker for 2A5

**Condensers**

- 1—140 mmf., 2-gang condenser
- 1—25 mmf., midjet condenser, variable
- 2—Thor 8 mf., 450V electrolytic condensers
- 4—25 mf., 200 volt by-pass condensers
- 2—25 mf., 300 volt by-pass condensers
- 1—5 mf., 500 volt by-pass condensers
- 1—02 mf., 300 volt by-pass condensers
- 1—01 mf., 300 volt by-pass condensers
- 1—002 mf., 300 300-volt by-pass cond.
- 1—0003 mf., 300-volt by-pass condenser
- 1—0001 mf., condenser (mica)

**Resistors**

- 1—15,000-ohm potentiometer with switch
- 1—15,000-ohm variable control
- 1—25,000-ohm one watt
- 1—5, megohm half watt
- 2—300,000-ohm half watt
- 1—40,000-ohm half watt
- 1—10,000-ohm half watt
- 1—350-ohm half watt
- 1—4,000-ohm half watt

**Other Requirements**

- 1—Thor RGH 5 chassis, coil shields, and panel
- 1—Crowe airplane dial, escutcheon plates and pilot light bracket
- 4—Knobs
- 2—58 tube shields
- 5—Wafer sockets
- 2—6-prong sockets
- 3—Binding posts
- Resistor racks
- Line cord and plug
- No. 18 hookup wire
- Solder and hardware

**"When to Listen In"**

(Continued from page 544)

lengths, 19.71 and 31.28 meters. The latter is the wave length which it formerly operated on. It has no regular schedule as yet, but frequently operates on 19.71 meters relaying the program of PHI.

**Shanghai**

• XGBD at Shanghai on 31.32 meters, which was mentioned several months ago in this column as being under construction has been heard testing recently during the early morning hours. Listeners who hear the station please send us reports.

**Havana**

• A new broadcasting station is reported at Havana, Cuba. The call letters are COH or COA. The station operates on approximately 31.8 meters. It is supposed to be on the air daily from 8:30-10:30 p.m. The address is 2B Street, Vedado, Havana, Cuba.

**KDKA DX Club**

May we again remind our listeners that the KDKA Short Wave Club broadcasts listening tips each Sunday morning from midnight to 12:30 a.m. on 980 Kc. This program is also radiated on W8XK, the short-wave station on 11870 kc. and 6140 kc. It is possible that this program may shift to Monday morning at the same hour.

**Vienna**

• OER2 at Vienna, Austria, on 6072 kc. is now on daily from 9 a.m.-5 p.m.

ALL SCHEDULES EASTERN STANDARD TIME.

Get Fullest Pleasure from your All-Wave set with this

**Noise Reducing ANTENNA**

Every home with an all-wave set needs this new, specially designed antenna! With it you can hear foreign stations with all the clarity and beauty of domestic reception.

Specially designed to free short-wave reception from interference from autos, motors, and other man-made static. Insures greater volume with less noise. Improves standard broadcast reception. Price \$6.00. Ask your dealer or service engineer today to make a *Certified Installation.*

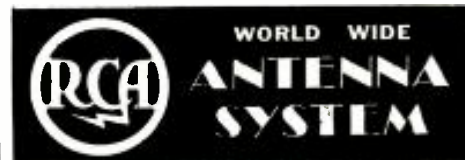

Here It Is! MARTIN JUNIOR For Limited Time ONLY \$10



All Standard Features. The only difference is in size. Heavy contact points. 2 3/4-pound black japanned base. Ideal for Radio. Easy to use. Easy to own at this low price. Order NOW before it is too late. Money order or registered mail. Write for catalog. Dept. S. THE VIBROPLEX CO., Inc 825 Broadway, New York, N. Y.

**HAVE YOU A HEADACHE**

trying to find out where you can obtain certain parts that you need for your short wave radio or your station? Stop worrying. This is the "House of a Million Parts", where you can obtain the most up-to-date or any obsolete part. Send us a list of your needs and we will quote our lowest prices. Interesting literature mailed free.

**LEOTONE RADIO CO.**  
63 DEY STREET Dept. 8-1-35 NEW YORK CITY

Please mention SHORT WAVE CRAFT when writing advertisers

# ... SHORT WAVE ESSENTIALS FOR MEMBERS OF THE SHORT WAVE LEAGUE ...

### A FEW WORDS AS TO THE PURPOSE OF THE LEAGUE

The SHORT WAVE LEAGUE was founded in 1930. Honorary Directors are as follows:

Dr. Lee de Forest, John L. Reinartz, D. E. Repligle, Hollis Baird, E. T. Somers, Baron Manfred von Ardenne, Hugo Gernsback, Executive Secretary.

The SHORT WAVE LEAGUE is a scientific membership organization for the promotion of the short wave art. There are no dues, no fees, no initiations, in connection with the LEAGUE. No one makes any money from it; no one derives any salary. The only income which the LEAGUE has is from its short wave essentials. A pamphlet setting forth the LEAGUE'S numerous aspirations and purposes will be sent to anyone on receipt of a 3c stamp to cover postage.

### FREE MEMBERSHIP CERTIFICATE

As soon as you are enrolled as a member, a beautiful certificate with the LEAGUE'S seal will be sent to you, providing 10c in stamps or coin is sent for mailing charges.

Members are entitled to preferential discounts when buying radio merchandise from numerous firms who have agreed to allow lower prices to all SHORT WAVE LEAGUE members.

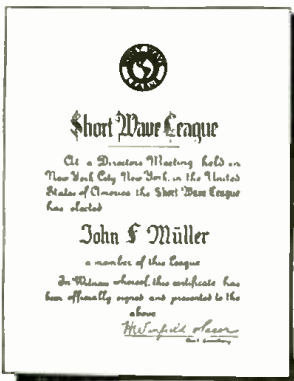

Illustration of engraved free membership certificate

### SHORT WAVE ESSENTIALS LISTED HERE SOLD ONLY TO SHORT WAVE LEAGUE MEMBERS

They cannot be bought by anyone unless he has already enrolled as one of the members of the SHORT WAVE LEAGUE or signs the blank on this page (which automatically enrolls him as a member, always provided that he is a short wave experimenter, a short wave fan, radio engineer, radio student, etc.).

Inasmuch as the LEAGUE is international, it makes no difference whether you are a citizen of the United States or any other country. The LEAGUE is open to all.

### Application for Membership SHORT WAVE LEAGUE

SHORT WAVE LEAGUE 1-35 99-101 Hudson Street, New York, N. Y.

I, the undersigned, herewith desire to apply for membership in the SHORT WAVE LEAGUE. In joining the LEAGUE I understand that I am not assessed for membership and that there are no dues and no fees of any kind. I pledge myself to abide by all the rules and regulations of the SHORT WAVE LEAGUE, which rules you are to send to me on receipt of this application.

I consider myself belonging to the following class (put an X in correct square): Short Wave Experimenter  Short Wave Fan  Radio Engineer  Student  I own the following radio equipment:

Transmitting \_\_\_\_\_  
Call Letters \_\_\_\_\_  
Receiving \_\_\_\_\_  
Name \_\_\_\_\_  
Address \_\_\_\_\_  
City and State \_\_\_\_\_  
Country \_\_\_\_\_  
I enclose 10c for postage and handling for my Membership Certificate.

### SHORT WAVE LEAGUE LETTERHEADS

A beautiful letterhead has been designed for members' correspondence. It is the official letterhead for all members. The letterhead is invaluable when it becomes necessary to deal with the radio industry, mail order houses, radio manufacturers, and the like; as many houses have offered to give members who write on the LEAGUE'S letterhead a preferential discount. The letterhead is also absolutely essential when writing for verification to radio stations either here or abroad. It automatically gives you a professional standing.

A—SHORT WAVE LEAGUE letterheads, per 100..... **50c**

### OFFICIAL SHORT WAVE LEAGUE LOG AND CALL MAGAZINE

Here is the finest book of its kind ever published. It contains the largest listing of short wave stations in the world, much larger in fact than the list published in SHORT WAVE CRAFT and other magazines. All experimental stations, no matter where located, are listed. A large section is provided where calls can be listed in a proper manner. This log section gives dial settings, time, date, call letters, location, and other information. Another section has squared-paper pages on which you can fill in your own frequency curve for your particular receiver. It helps you to find stations which otherwise you could never log. It is the only book of its kind published.

B—Official Log and Call Magazine.....Prepaid **25c**

### RADIO MAP OF THE WORLD AND STATION FINDER

The finest device of its kind published. The world's map on heavy board is divided into 23 sections, while the rotary disc shows you immediately the exact time in any foreign country. Invaluable in logging foreign stations. Also gives call letters assigned to all nations. Size 11"x22".

C—Radio Map of the World and Station Finder.....Prepaid **25c**

### GLOBE OF THE WORLD AND MAGNETIC COMPASS

This highly important essential is an ornament for every den or study. It is a globe, 6 in. in diameter, printed in fifteen colors, glazed in such a way that it can be washed. This globe helps you to intelligently log your foreign stations. Frame is of metal. Entire device substantially made, and will give an attractive appearance to every station, emphasizing the long-distance work of the operator.

D—Globe of the World.....Prepaid **\$1.25**

### SHORT WAVE LEAGUE LAPEL BUTTON

This beautiful button is made in hard enamel in four colors, red, white, blue and gold. It measures three quarters of an inch in diameter. By wearing this button, other members will recognize you and it will give you a professional air. Made in bronze, gold filled, not plated. Must be seen to be appreciated.

E—SHORT WAVE LEAGUE lapel button.....Prepaid **35c**

EE—SHORT WAVE LEAGUE lapel button, like the one described above but in solid gold.....Prepaid **\$2.00**

### SHORT WAVE LEAGUE SEALS

These seals or stickers are executed in three colors and measure 1 1/4 in. in diameter, and are gummed on one side. They are used by members to affix to stationery, letterheads, envelopes, postal cards and the like. The seal signifies that you are a member of the SHORT WAVE LEAGUE. Sold in 25 lots or multiples only.

G—SHORT WAVE LEAGUE seals.....per 25, Prepaid **15c**

### SHORT WAVE MAP OF THE WORLD

This beautiful map, measuring 18x26 in. and printed in 18 colors is indispensable when hung in sight or placed "under the glass" on the table or wall of the short wave enthusiast. It contains a wealth of information such as distances to all parts of the world, political nature of the country in which a broadcast station is located, etc., and from the manner in which the map is blocked off gives the time in different parts of the world at a glance.

F—SHORT WAVE Map of the World.....Prepaid **25c**

### PLEASE NOTE THAT ABOVE ESSENTIALS ARE SOLD ONLY TO MEMBERS OF THE LEAGUE—NOT TO NON-MEMBERS.

Send all orders for short wave essentials to SHORT WAVE LEAGUE, 99-101 Hudson Street, New York City.

If you do not wish to mutilate the magazine, you may copy either or both coupons on a sheet of paper.

SHORT WAVE LEAGUE 99-101 Hudson St., New York, N. Y.



G—15c for 25

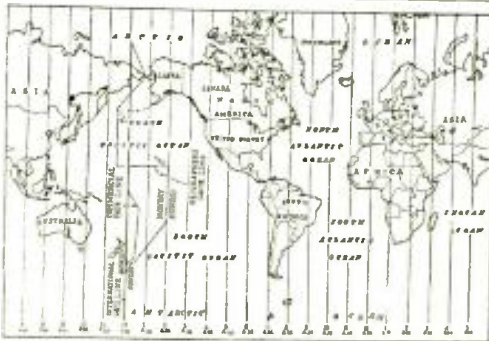

F—25c each



A—50c per 100



B—25c per copy



C—25c each



C—25c each



D—\$1.25 each



E—35c each

SHORT WAVE LEAGUE, 99-101 Hudson Street, New York, N. Y.  
Gentlemen:  
I am already an enrolled member in the SHORT WAVE LEAGUE   
I am a new member and attach my application to this coupon   
Please send me the following short wave essentials as listed in this advertisement:  
.....  
.....  
.....  
for which I enclose \$ \_\_\_\_\_ herewith.  
(The LEAGUE accepts money order, cash or new U. S. stamps in any denomination. Register cash and stamps.)  
Name \_\_\_\_\_  
Address \_\_\_\_\_  
City and State \_\_\_\_\_  
Country \_\_\_\_\_  
1-35

Please mention SHORT WAVE CRAFT when writing advertisers

# Have You Received YOUR COPY?

THE NEW NATIONAL CO. CATALOGUE

*Waiting for You!*

NEW RECEIVERS!

NEW PARTS!

Ask Your NATIONAL Dealer or Use Coupon Below



**NEW TR 56 MC TRANSCEIVER**  
 A portable combination 5 meter receiver and transmitter (special booklet available). Uses two tubes.



**New Cathode Ray Oscilloscope**  
 Provides instantaneous graphic picture of actual operating conditions in transmitter circuits. (Booklet available).



**NEW TYPE HRO AMATEUR RECEIVER**  
 Two stages of pre-selection, two air-tuned IF stages, calibrated band spread, automatic volume control, 4-gang condenser, micrometer dial, single signal filter, new ganged plug-in coils, vacuum tube voltmeter, and many other new features.

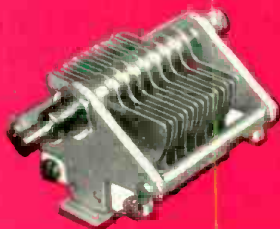

**New TMS Transmitting Condenser**  
 For low power use. Steatite-Isolanite insulation. Compact, inexpensive.

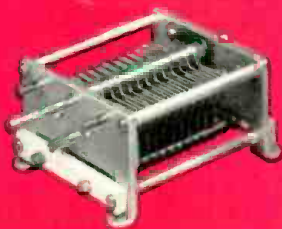

**New TMC Transmitting Condenser**  
 For power stages where peak voltages do not exceed 3000. Compact, rigid.



**New NC 800 Neutralizing Condenser**  
 For high voltage use, especially with RCA-800.



**New M30 Mica Padding Condenser**  
 Steatite mounting. Max. capacity 30 mfd.

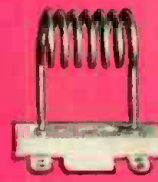

**New Type XR-9 Five-Meter Coil**  
 Copper coil, air-spaced winding on Steatite base.



**NEW PW PRECISION CONDENSER & MICROMETER DIAL UNIT**  
 A new and entirely self-contained ganged condenser unit for high frequency receivers. Worm-gear drive 20-1 ratio. Full of new and advanced features.



**New Type CH Crystal Holder**  
 Holds crystal vertically. 2 forms, for transmitting or for resonator use.



**New XT-8 Choke Coil Form**  
 Steatite form for small choke coils and resistances



**New TX-9 Shaft Coupling**  
 Steatite insulation, for isolating circuits.

Illustrated above are just a few of the many new items shown in the new National Catalogue No. 240. National Radio Products include these and many other new items, and of course the well-known National Velvet Vernier Dials, Transmitting Condensers, Receiving Condensers, IF Transformers, RF Chokes, Sockets, Coil Shields, Transformers, and HF Dielectrics. Included also are the famous NATIONAL AGS and AGSX Re-

ceivers, the FB-7A and FB-XA Amateur Receivers, the SW-3 High Frequency Receiver, the PSK Preselector, the SRR 5 Meter Super-Regenerator Receiver, the HFC 5 Meter Converter—as well as the power units for operating these receivers. Call at your National Dealer's today for a free copy of this new catalogue, or send coupon below, enclosing 6c to cover mailing costs.

**NATIONAL COMPANY, Inc., 61 Sherman Street, Malden, Mass.**

Gentlemen: Please send me your new catalogue No. 240. I enclose 6c to cover mailing costs.



Name .....

Address ..... SWC-1-35

SAVE UP TO 50% BY BUYING YOUR RADIO *Direct from* MIDWEST LABORATORIES

Thrill to *Guaranteed World-Wide* HIGH FIDELITY Performance with This Amazing New 1935 MIDWEST SUPER Deluxe 16-TUBE ALL-WAVE Radio! (ALL FIVE WAVE BANDS)

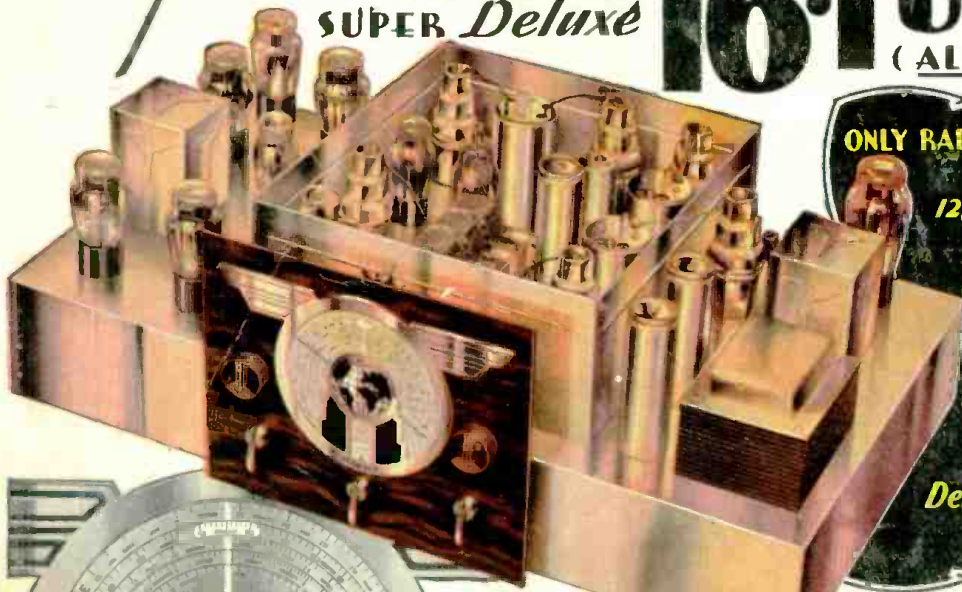

**Only Midwest Gives You Multi-Function Dial**

This dial was designed in keeping with the trend of the times, yet is not an airplane dial! It is a many-purpose dial that performs many functions. Now, Midwest guarantees that inexperienced persons can secure good foreign reception. Send for FREE miniature of actual rotating dial which clearly shows these outstanding advantages:

1. Dial calibrated in Kilocycles, Megacycles and Meters;
2. Call letters of American Broadcast Stations printed on dial and illuminated;
3. Slow-Fast, Smooth-Acting Tuning;
4. Station Group Locator;
5. Simplified Tuning Guide Lights;
6. Automatic Select-O-Band Indicator;
7. Illuminated Pointer Indicator;
8. Silent Shadow Tuning—Improvement on Meter Tuning;
9. Centralized Tuning.

**New Style Consoles**

The Midwest 36-page catalog pictures a complete line of beautiful, artistic de luxe console and chassis in four colors. Write for new FREE catalog today!

Midwest long-range radios are priced as low as **\$27.50**



ONLY RADIO COVERING 9 TO 2,400 METERS. 12,000 MILE TUNING RANGE

WORLD'S GREATEST RADIO VALUE

**\$57.50** with New

Deluxe Auditorium-Type SPEAKER.

**30 Days FREE Trial!**

TERMS as low as **\$5.00 DOWN**

**BEFORE** you buy any radio write for the new FREE 1935 Midwest "Fifteenth Anniversary" catalog and see for yourself the many reasons why 110,000 satisfied customers bought their radios direct from the Midwest Laboratories and saved from 1/3 to 1/2. Why pay more than the direct-to-you laboratory price? You, too, can make a positive saving of from 30% to 50% by buying this more economical way. Learn why Midwest outperforms sets costing up to \$200.00 and more. Never before so much radio for so little money! Midwest gives you triple protection with: One-Year Guarantee, Foreign Reception Guarantee, Money-Back Guarantee.

**50 ADVANCED 1935 FEATURES**

Many exclusive features include: Micro-Tenuator... Fidel-A-Stat... Separate Audio Generator... Ceramic Coil Forms, etc. Only Midwest covers a tuning range of 9 to 2400 meters (33 Megacycles to 125 KC)—enabling you to easily and successfully tune in even low-powered foreign stations up to 12,000 miles away with crystal-clear, loud-speaker reception.

All 5 Wave Bands enable you to enjoy today's finest High Fidelity American programs. In addition, you get Canadian, police, amateur, commercial, airplane and ship broadcasts and derive new delight and new excitement from un-

equalled world-wide broadcasts... England, France, Germany, Spain, Italy, Russia, Australia, etc. Send today for money-saving facts!

**SENSATIONAL HIGH FIDELITY RECEPTION**

This bigger, better, more powerful, clear-toned, super selective, 16-tube radio gives you absolute realism—assures you of lifelike, crystal-clear tone—unlike anything you have ever experienced before. You will hear one more octave—overtone—that cannot be brought in with ordinary radios. Now, hear every instrument, every voice, every shade and inflection of speech.



Take advantage of the amazing 30-day FREE trial offer. Send for FREE catalog.

**World-Wide Reception**

Here are some of the stations I have heard: EAQ, Madrid, Spain—DJJB, Zeelen, Germany—G8B, G8F, Daventry, England—VK8ME, Melbourne, Australia—VK2ME, Sydney, Australia—HJ2ABA, HJ4ABE, HJ3ABF, Colombia, S. A., and many more. Golden Hatfield, 2202 Grand Avenue.



**Paruvian Praises Foreign Reception**

Lima, Peru—We have heard the five continents with your Midwest. Have received Madrugar, Sydney, London, Paris, Vienna, Moscow, Madrid, New York, Shanghai, Tokio and also South American transmitters, Narciso H. Buchanan, Apartado 98, Plaza San Martin, 171.



**DEAL DIRECT WITH LABORATORIES**

Increasing costs are sure to result in higher radio prices soon. Buy before the big advance... NOW... while you can take advantage of Midwest's sensational values... no middlemen's profits to pay. You can order your 1935 High Fidelity radio from the new Midwest catalog with as much certainty of satisfaction as if you were to select it in our great radio laboratories. You save 30% to 50% when you buy this popular way... you get 30 days FREE trial, as little as \$5.00 down puts a Midwest radio in your home. Satisfaction guaranteed or money back. Write for new FREE catalog today.

**SAVE UP TO 50%**

**MAIL COUPON TODAY! FOR AMAZING 30-DAY FREE TRIAL OFFER AND NEW 1935 CATALOG**

MIDWEST RADIO CORP., Dept. 850 Cincinnati, Ohio. Without obligation on my part send me your new FREE 1935 catalog, FREE Miniature Dial, and complete details of your liberal 30-day FREE trial offer. This is NOT an order.

User-Agents Make Easy Extra Money

Check Here for Details

Name.....  
Address.....  
Town..... State.....

**MIDWEST RADIO CORP.**

DEPT. 850 — CINCINNATI, OHIO, U. S. A.

Established 1920 Cable Address Miraco... All Codes