

HUGO GERNSBACK
Editor

SHORT WAVE CRAFT

December

WORLD'S
LARGEST
SHORT WAVE
CIRCULATION

1-Tube "POCKET SET"

Gets Europe

See Page 458



25¢
IN CANADA
30¢



Radio Tube Racketeers FOILED...!

PAUL WHITEMAN TELLS HOW
TO MAKE SURE TUBES ARE
REALLY NEW

IN THE DISHONEST DEALER'S STORE

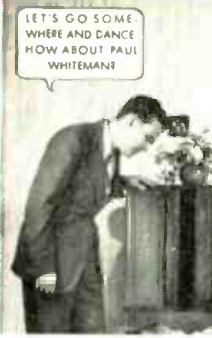

NEW RCA SEALED CARTON PROTECTS YOU AGAINST OLD RADIO TUBES SOLD AS NEW

Assures your getting genuine
Micro-Sensitive RCA Radio Tubes

A METAL-LOCKED safe for every radio tube... protection against hundreds of thousands of old radio tubes repolished and slipped into new cartons and sold to the unsuspecting public as new. To guard the marvelous new Micro-Sensitive RCA radio tube, experts have developed the new non-refillable *RCA Sealed Carton*. Strong metal sealing staples lock up the tube from factory to your set. The tube can be tested without being removed from the carton... but the carton must be *completely destroyed* before tube can be used.

To put new life in your radio, ask your Authorized RCA Radio Tube Agent to put new Micro-Sensitive radio tubes in your set... the tubes with these 5 big improvements: (1) *Quicker Start*. (2) *Quieter Operation*. (3) *Uniform Volume*. (4) *Uniform Performance*. (5) *Sealed Carton Protection*.



LOOK FOR THIS SIGN in
your neighborhood. It identifies
a dealer selected by RCA.



TUNE IN on Radio City Studio Party
9 to 9:30 E. S. T. every Saturday night
over N. B. C. Blue Network. Hear the
big stars of your favorite programs.



Lunningham
Radiotron



How a "Tip" got Tom a Good Job

Panel 1: GEE, THERE'S DJC IN BERLIN. THAT'S THE TENTH FOREIGN STATION TONIGHT. RADIO IS SURELY FUN.

Panel 2: HELLO, TOM. HOW'S EVERYTHING? OH, NOT SO GOOD BILL, BUT I'M STILL HAVING FUN PLAYING WITH RADIO. HADDJCLAST NIGHT ON A LITTLE SET I BUILT. IS RADIO STILL YOUR HOBBY TOO?

Panel 3: NO, TOM. I'VE BEEN TOO BUSY MAKING GOOD MONEY OUT OF RADIO TO SPEND TIME "PLAYING" WITH IT. GOSH, BILL, YOU'RE SURE LUCKY. I NOTICED YOUR SWELL CLOTHES AND SNAPPY CAR. I THOUGHT YOU HAD INHERITED A MILLION. TELL ME ABOUT IT.

Panel 4: I AM LUCKY, TOM, BUT YOU HAD THE SAME CHANCE. REMEMBER ABOUT A YEAR AGO I SHOWED YOU A BOOK FROM NATIONAL RADIO INSTITUTE THAT TOLD ABOUT THE OPPORTUNITIES AND BIG FUTURE IN RADIO, AND HOW OTHERS HAD SUCCEEDED THROUGH THEIR HOME TRAINING? REMEMBER, I TRIED TO GET YOU TO ENROLL FOR THEIR COURSE WHEN I DID.

Panel 5: WELL, IT WAS THE SMARTEST MOVE I EVER MADE. I'M DOING SWELL. MARY AND I ARE TO BE MARRIED NEXT MONTH. TOM, WHY DON'T YOU SNAP OUT OF IT? DON'T STAY IN THAT DREARY LOW PAY JOB ALL YOUR LIFE. RADIO IS MORE THAN A PLAYTHING. IT'S A BIG BUSINESS. IT'S YOUR OPPORTUNITY. TAKE MY TIP. IT ISN'T TOO LATE. RADIO IS STILL YOUNG AND GROWING.

Panel 6: IF BILL SUCCEEDED, I CAN TOO! THEN I CAN MAKE REAL MONEY SERVICING RADIO SETS OR GET A JOB IN A BROADCASTING STATION OR INSTALL AND SERVICE LOUD SPEAKER SYSTEMS OR MAKE GOOD MONEY IN ANY ONE OF THE MANY OTHER NEW AND GROWING BRANCHES OF RADIO. THERE'S NO END OF GOOD JOBS FOR A TRAINED RADIO MAN! YES, SIR, I'M GOING TO SEND FOR THAT FREE BOOK AND GET THE DOPE RIGHT NOW!

Panel 7: YOU CERTAINLY KNOW RADIO. MINE NEVER SOUNDED BETTER. N. R. I. TRAINING CERTAINLY PAYS. I JUST STARTED A FEW MONTHS AGO AND I'M MAKING GOOD MONEY ALREADY. THIS SPARE TIME WORK IS SWELL FUN, AND SOON I'LL BE ALL SET FOR A GOOD FULL TIME JOB. THANKS!

OH, TOM IT'S WONDERFUL TO THINK HOW FAST YOU'VE GONE AHEAD SINCE YOU WENT INTO RADIO. WE NEVER COULD HAVE GOTTEN MARRIED ON WHAT YOU WERE GETTING BEFORE.

OUR WORRIES ARE OVER. I'M MAKING GOOD MONEY NOW, AND THERE'S A BIG FUTURE AHEAD FOR US IN THIS LIVE WIRE RADIO FIELD.

I will help you start a spare time or full time **Radio service business Without Capital**



Many Radio Experts Make \$40, \$60, \$75 a Week

The world-wide use of Radio sets has made hundreds of opportunities for good spare time or full time Radio businesses. Many of the seventeen million Radio sets are only 25% to 40% efficient. I will show you how to cash in on this condition. I will show you how to install and service all types of receiving sets in spare time. I'll show you how to make enough money while learning Radio to start your own service business. Clip the coupon. Get my free book, "Rich Rewards in Radio." Read how hundreds of N. R. I. men have made good money in spare time or full time businesses.

Many Make \$5, \$10, \$15 a Week Extra in Spare Time While Learning
The day you enroll I send you directions for doing 28 Radio jobs common in almost every neighborhood for spare time money. I give you plans and ideas that have made \$200 to \$1,000 a year for many N. R. I. men in spare time. My Course is famous as "The Training that pays for itself."

Get Ready Now for a Business of Your Own and for Jobs Like These
In just about 15 years Radio's growth has created over 300,000 jobs. Thousands more jobs will be opened by new Radio developments. Broadcasting stations use engineers, operators, station managers and pay up to \$5,000 a year. Manufacturers employ testers, inspectors, foremen, engineers, servicemen, buyers, for jobs paying up to \$7,500 a year. Dealers and jobbers, employ servicemen, salesmen, buyers, managers, and pay up to \$110 a week. My Free Book tells about these and other opportunities.

Television, Short Wave, Loud Speaker Systems Included
There is opportunity for you in Radio. Its future is certain. Television, short wave, loud speaker systems, ship Radio, police Radio, automobile Radio, aviation Radio—in every branch, developments and improvements are taking place. Here is a real future for thousands of men who really know Radio—men with N. R. I. training. Get the training that opens the door to good pay and success in this growing industry.

Find Out What Radio Offers You
I am so sure N. R. I. can train you satisfactorily that I agree in writing to refund every penny of your tuition if you are not satisfied with my Lesson and Instruction Service upon completion. Get my 64-page book of facts. It's free to any ambitious fellow over 15 years of age. It tells you about Radio's opportunities; about my Course; what others are doing and making. Find out what Radio offers you. No obligation. ACT NOW! Mail coupon in an envelope, or paste it on a 1c postcard.

J. E. SMITH, President Nat'l Radio Institute, Dept. 4NB3 Washington, D. C.

HERE'S PROOF THAT N. R. I. MEN MAKE GOOD MONEY

"Made \$6,000 in 2 Years"
"Soon after the depression started, I found myself without a job, but I was well protected with N. R. I. training. I swung right to full time Radio servicing and I have made over \$6,000 in a little over two years."—Wm. Shartlyent, Sparty Radio Service, 93 Broadway, Newark, N. J.

"\$500 a Year in Spare Time"
"Although doing spare time Radio work only, I have averaged about \$500 a year extra in addition to my regular income. Full time Radio work would net me many times that amount."—Edw. H. Fawcett, Slough Rd., Ladner, B. C., Canada.



FREE: Radio Servicing Tips

Let me PROVE that my Course is clear, easy to understand, and fascinating to study. Send the coupon for a free lesson, "Trouble Shooting in D.C., A.C. and Battery Sets." This interesting lesson gives 132 ways to correct common Radio troubles. I am willing to send this book to prove that you, too, can master Radio—just as thousands of other fellows have done. Many of them, without even a grammar school education, and no Radio or technical experience, have become Radio experts, and now earn two or three times their former pay. Mail the coupon now.

MAIL THIS for FREE 64 page book

Dear Mr. Smith: Without obligation, send me the Service Manual and your free book about spare time and full time Radio opportunities, and how I can train for them at home in spare time.

J. E. SMITH, President National Radio Institute, Department 4NB3 Washington, D. C.

NAME.....
ADDRESS.....
CITY.....
STATE..... M

Please mention SHORT WAVE CRAFT when writing advertisers

IN THIS ISSUE: PROMINENT SHORT-WAVE AUTHORS

Johnson . Lovejoy . Swank . Shuart . Palmer

HUGO GERNSBACK
Editor



H. WINFIELD SECOR
Managing Editor

GEORGE W. SHUART,
W2AMN
Associate Editor

Contents for December, 1934

Editorial—Short-Wave Congestion, by Hugo Gernsback... 453

2-Way Police Calls on 5 Meters..... 454

Admiral Byrd Opens "Radio Show" Via Short Waves.... 455

Short Waves Relay "Morro Castle" Survivors' Stories.... 455

Radio Colonial—French Empire Station..... 456

Micro Waves Will Transmit Pictures..... 457

1-Tube Pocket Set "Gets" Europe! by G. W. Shuart..... 458

Latest "DOERLE" Set Uses New "Acorn" Tubes! by H. W. Secor 460

3 Tubes = 5 in This "Battery Receiver," by George W. Shuart, W2AMN..... 462

World-Wide, Short-Wave Review, edited by C. W. Palmer 464

SHORT WAVE SCOUT News..... 466

Tenth Winner of SHORT WAVE SCOUT "Trophy"..... 467

SHORT WAVES AND LONG WAVES—Our Readers' Forum.. 468

A Short Wave Receiver in "Book" Form, by Heinie Johnson 470

A Simplified Radio Control System, by Rex E. Lovejoy, W5AFC..... 472

A Low-Powered DeLuxe Transmitter, by Jerrold A. Swank, W8HXR..... 473

What's New in SHORT WAVE Apparatus..... 474

SHORT WAVE STATIONS OF THE WORLD, Complete List, including "Police" and "Television" Stations, edited by M. Harvey Gernsback..... 477

WHEN TO LISTEN IN, by M. Harvey Gernsback..... 480

SHORT WAVE LEAGUE..... 481

\$5.00 Monthly for Best Short Wave KINK..... 482

Short Wave QUESTION BOX..... 483

3.1 Meter Receiver, By Dr. W. Möller..... 499

Certified Circuits



● **SHORT WAVE CRAFT** goes to a large expense in verifying new circuits published in this magazine. Whenever you see the seal shown here in connection with any of the sets published in this and future issues of **SHORT WAVE CRAFT**, this will be your guarantee that this set has been tested in our laboratories, as well as privately, in different parts of the country to make sure that the circuit and selected parts are right. Only "Constructional-Experimental" circuits are certified by us.

When you see our certificate seal on any set described you need not hesitate in spending money for parts, because you are assured in advance that the set and circuit are bona fide and that this magazine stands behind it.

SHORT WAVE CRAFT is the only magazine that thus certifies circuits and sets.

OUR COVER

● The 1-tube pocket set shown on the front cover this month actually picked up European vocal and instrumental programs on short waves without an antenna—seems almost unbelievable, yet absolutely true! Read all about this dandy pocket receiver; just how you may build one for your own use at slight cost on page 458.

COPYRIGHT, 1934, BY H. GERNSBACK

Published by **POPULAR BOOK CORPORATION**

HUGO GERNSBACK, President - - - H. W. SECOR, Vice-President
 EMIL GROSSMAN - - - Director of Advertising
 Chicago Adv. Office - - - L. F. McCLURE, 919 No. Michigan Ave.
 Publication Office - - - 404 N. Wesley Avenue, Mount Morris, Ill.
 Editorial and General Offices - - - 99-101 Hudson St., New York, N. Y.
 London Agent: HACHETTE & CIE., 16-17 King William St., Charing
 Cross, W.C.2
 Paris Agent: HACHETTE & CIE., 111 Rue Reaumur
 Australian Agents: MCGILL'S AGENCY, 179 Elizabeth St., Melbourne

Features in the January Issue

- 3 Tubes = 5 in "Brand New" Superhet Circuit—"Band-Spread" is Optional.
- New Circuit for the 955 "Acorn" tubes, by George W. Shuart, W2AMN.
- Snake Venom Made Non-poisonous by Short Waves—the remarkable work of Madame Dr. Marie Phisalix and Dr. Colonel Francois Pasteur, Paris.
- The Farnsworth Cold Cathode Tube.
- Transmitting Antennas—Design of Feeders, etc.

LEARN RADIO IN 10 WEEKS!

BY ACTUAL SHOP WORK ON REAL EQUIPMENT

PAY FOR YOUR TRAINING
-In Small Monthly Payments-
AFTER YOU GRADUATE

Come to Coyne now! No need to wait till you have more cash or for "better times" to get your training in the World's most fascinating, highly-paid profession. I'll train you, here at Coyne, in a practical way so that you will be prepared to take a real job and cash in quickly! . . . AND I'LL FINANCE YOUR TRAINING! Not until two months after you have graduated will you have to start to pay me back . . . then you can take a whole year to do it in easy monthly amounts. Get the particulars of this sensational plan NOW—just mail the coupon below.



REAL OPPORTUNITIES

FOR THE RADIO TRAINED MAN

With Coyne training you will be qualified to accept a job as Designer, Inspector, or Tester—as Radio Salesman or in Service and Installation—as Operator or Manager of a Broadcasting Station—as Wireless Operator on a Ship or Airplane—as a Talking Picture or Sound Expert—or in any of hundreds of other fascinating, well-paid jobs.

TALKING PICTURES—TELEVISION

Yes, Coyne training is complete! It fits you to take an important place in these new fields that offer great opportunities for trained men, and which are being developed rapidly. Be ready for your chance in Television as well as in Sound Amplification and Radio. At Coyne you are trained on real Talking Pictures and Television equipment.

ELECTRIC REFRIGERATION — AIR-CONDITIONING

Included at NO EXTRA COST

So that you may have the kind of all-round training that increases your earning capacity, and enables you to grasp every opportunity. I am—for a limited time—including my big, new course in Electric Refrigeration and Air Conditioning. Here is a big chance for you to get practical training in a great new field at no additional cost.

NO ADVANCE EDUCATION OR PREVIOUS EXPERIENCE NEEDED

I don't teach you by book study! Your training at

H. C. LEWIS, President RADIO DIVISION Founded 1899
COYNE ELECTRICAL SCHOOL
500 S. Paulina St., Dept. 94-2K, Chicago, Ill.

Coyne comes through actual work, under the individual guidance of expert instructors, on a great outlay of Radio, Broadcasting, Television, Talking Picture and Wireless Code equipment. Because we cut out useless theory, you can get a practical training in only 10 weeks, if you can understand simple English and are sincere in your effort.

SPARE TIME WORK WHILE LEARNING

Employment Service After Graduation

If you need part-time work while at school to help pay expenses, I'll help you get it. And, when you enroll at Coyne, you get a lifetime scholarship and free employment service for life after graduation.

MAIL COUPON TODAY!

I'll Send You All the FACTS

Fill in the coupon below, and mail it to me today. As soon as I receive it, I'll send you My Big Free Book, that tells all about Coyne and contains hundreds of pictures of these great Shops, and I'll tell you all about my "Pay After Graduation Plan", and all the other features of my course.

.....

H. C. LEWIS, President, Coyne Electrical School
 Radio Div., 500 S. Paulina St., Dept. 94-2K Chicago

Dear Mr. Lewis: Send me your big FREE Book; details of your FREE Employment Service; and tell me all about your special offer of allowing me to pay for training on easy monthly terms after graduation.

Name.....

Address.....

City..... State.....

Please mention SHORT WAVE CRAFT when writing advertisers

Indispensable

say these Short Wave fans—

**EDITED BY
HUGO GERNSBACK
AND
H. W. SECOR**

<p>"CLASSIEST BOOK" Gentlemen— Your "Official Short Wave Manual" just received. It is the classiest book I have seen for a long time, a fine binding, very good paper, good readable printing and diagrams. Who could ask for more? It was well worth waiting for. Many thanks. (s) H. H. PEEBLES, 8512 Carnegie Avenue, Cleveland, Ohio.</p>	<p>"WOULDN'T TAKE \$10.00 FOR IT" Gentlemen— I received my copy of the OFFICIAL SHORT WAVE RADIO MANUAL (and autographed too) this morning. I have just finished looking it over, and say, I wouldn't take a ten-spot for it. Everything a ham could want between the two covers. I certainly am satisfied with my copy and know everyone else who gets one will be satisfied and proud too. I am sure that this is the finest and most up-to-date book out, and consequently would like all of it. Very truly yours, (s) LOUIS SCHMADLBECK Beaver Dam, Wis.</p>	<p>"WORTH MORE THAN YOU ASK FOR IT" Dear Mr. Gernsback: I am in receipt of the 1934 OFFICIAL SHORT WAVE RADIO MANUAL, and wish to state after looking it over I think it is one of the finest Manuals I ever saw published on Short Waves, and I certainly wish to congratulate you on your effort of compiling such a fine Manual. It is sure filled full of good Radio Material, and I am proud of my Manual. It is worth quite a bit more than what you ask for it. FERREL THOMAS, 1328 Locust Street, St. Louis, Mo.</p>	<p>"GLAD TO OWN ONE" Gentlemen— I received my "SHORT WAVE RADIO MANUAL" and it is a real joy to read and study the book. I waited long for it, but it was worth waiting for. I am introducing it around to all of my friends, and I am glad to own one of these books. Yours respectfully, (s) VINCENT KRAJNAK, 100 West 119th Street, New York City.</p>
--	---	---	--

WORLD'S GREATEST SHORT WAVE BOOK!

We are proud to present the first modern and complete book on Short Waves which has appeared in the field. There has been a big boom in short waves during the past two years in spite of the depression. Tremendous progress has been made, but up to now there has not been an adequate book depicting all the progress that has been made. The 1934 OFFICIAL SHORT WAVE RADIO MANUAL now fills this need completely. It is a big book in which you will find everything on short waves, regardless of what it might be. It is not only a complete manual, but a veritable encyclopedia of facts, information, hookups and illustrations. Lack of space does not permit a complete description of this comprehensive volume. The Manual has been edited by Hugo Gernsback, Editor of SHORT WAVE CRAFT, and H. W. Secor, Managing Editor. If you are a reader of Mr. Gernsback's other publications, you know just about what to expect from this book—his greatest effort in the short-wave field.

\$2.50 List

15 VALUABLE FEATURES

- A large section featuring the most important Short-Wave Receivers and how to construct them.
- Short-Wave Transmitters in all their phases.
- A complete Ultra Short-Wave Section featuring construction of 1, 3, 5 and 10 meter receivers.
- A complete Short-Wave Beginner's section. These vary from 1 to 7 tube receivers.
- A section devoted exclusively to coil winding with all information about it.
- A section on Commercial Short-Wave Receivers. Every important commercial receiver, including all-wave sets, is represented. Full servicing data is included which makes it invaluable for Service Men.
- A section devoted to A.C. Short-Wave Power Packs and how to build them.
- A section for the Short-Wave Experimenter and short-wave kinks—hundreds of them.
- A section on the important new art of Short-Wave Therapy (treatment of diseases by short waves).
- A section devoted to Short-Wave Converters and their construction. Full servicing data on all commercial models is included.
- A special section on Short-Wave Antennae and noise eliminating procedures.
- A section on Short-Wave Superheterodynes. This section tells how to build them, including many commercial models of receivers. The latter with complete service data.
- A section on Amateur Phone Transmitters and how to build them.
- A Short-Wave Physics section on theoretical short-wave data for the advanced experimenter and radio student.
- A most interesting section on Super-Regeneration in Short-Wave Receivers.

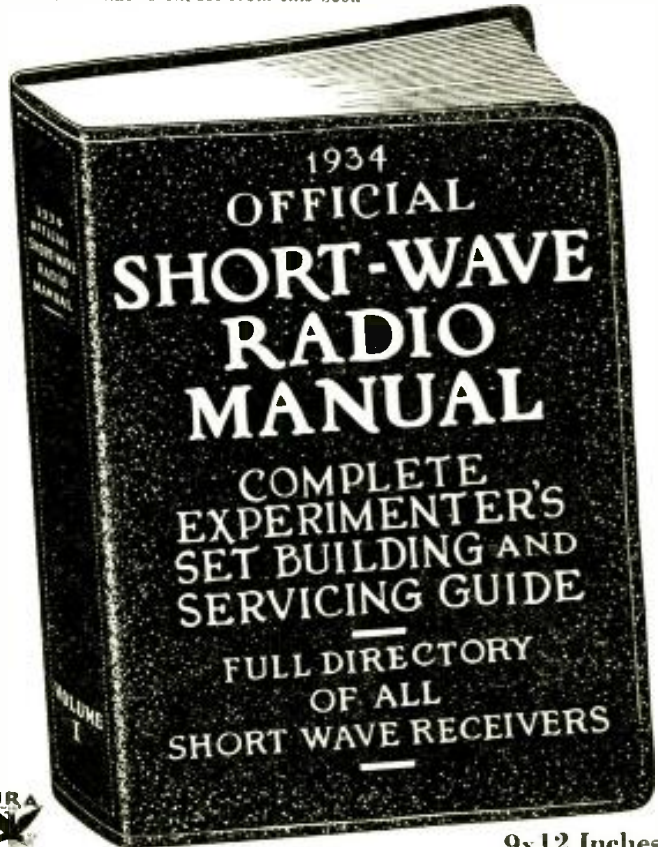

Over 210 Big Pages—Over 1,000 Illustrations
Flexible, Looseleaf Leatherette Binder

Published by
SHORT WAVE CRAFT
99-101 Hudson Street New York, N. Y.
CLIP AND MAIL COUPON!

SHORT WAVE CRAFT. 99-101 Hudson Street, New York, N. Y. Depl. SWC 12-34

Gentlemen: I enclose herewith my remittance of \$2.50 for which you are to send me, POSTAGE PREPAID, One Copy of the 1934 OFFICIAL SHORT-WAVE RADIO MANUAL. (Send remittance in check or money order. Register letter if it contains cash, stamps or currency.)

Name

Address

City..... State.....

Please mention SHORT WAVE CRAFT when writing advertisers



The Short-Wave Congestion

An Editorial By HUGO GERNSBACK

● THERE are now a total of between 8,000 and 9,000 short-wave radio-phone stations on our globe. These stations transmit modulated speech, music, and various forms of entertainment, which are received by listeners in all parts of the world. In addition to these radio-telephone stations, there are also many thousands of *code* stations. We will disregard the latter, and for the time being consider only the broadcast telephone stations; as these are the ones in which the average listener is most interested nowadays.

These 8,000-odd broadcast stations, to be sure, do not all operate simultaneously, for very good reasons; because, if they did, it would be impossible to listen to any program of any kind. The short wave spectrum in which most short-wave radiotelephone broadcasting goes on nowadays lies between the frequencies of 21,540 KC. (13.93 meters) and 3600 KC (83.5 meters). In this spectrum there are located 1,794 channels normally spaced 10 kilocycles from each other. In addition to this, we have the ultra-short wave spectrum, which comprises a band between 29,982 kilocycles and 299,820 kilocycles, (1 to 10 meters). This section can also accommodate some 26,983 channels, all 10 kilocycles apart. But, for the present, we will only consider the normal short-wave spectrum, where most of the radio entertainment comes in; and that is the range from 37,480 kilocycles to 1,499 kilocycles (8 meters to 200 meters).

In this spectrum alone, there are many thousands of short-wave stations, comprising the short-wave broadcast stations, airplane stations, police stations, amateur stations and television stations. (The latter, while they broadcast a television signal, also use voice and other entertainment; particularly when some of them broadcast simultaneous sight and sound.)

From this, it will be seen that—inasmuch as we have only a relatively few channels in this spectrum—it will be impossible to operate all the thousands of stations, let alone many thousand amateur phone stations which are springing up all the time, as well as the thousands of airplane stations.

For the purpose of this article, we will consider only the regular short-wave broadcast stations, which transmit speech and various kinds of entertainment. There are probably over a thousand of these, and it will be seen that there are not so many short-wave broadcast channels in the normal assigned spectrum, which covers, roughly, from 21,540 kilocycles (13.93 meters) to 3600 kilocycles (83.28 meters). What then happens? It is certain that not all of these short-wave broadcast stations can operate at the same time; because if they did there would be entirely too much interference. For one thing, the time difference, divided over the globe, helps the situation somewhat. When some stations are on the air, others are off, and vice versa. Thus, when you listen to Australia between the hours of 5 and 7 in the morning (if you are an American listener) the chances are that no American short-wave broadcast station is on the air at that time. Then also, while we have thousands of li-

censed short-wave broadcast stations, not all of them broadcast regularly, day in and day out. Many are licensed for purely experimental work, and for that reason use their equipment only for various short periods during the month. Others broadcast only two or three times a week.

But nevertheless, there is a considerable amount of congestion in the "ether" at the present time, and if allowed to continue, it is apt to ruin every short-wave radio broadcast that is put on the air. What is particularly aggravating, at the present time, is the *heterodyne* interference which is occasioned by some of the important short-wave stations. For instance, those in this country who listen to the English and German stations are often highly annoyed by the "peanut" whistle which is audible when tuning to these important stations. Often, this heterodyne whistle is so strong that it is impossible to listen to the powerful European stations.

Frequently, during the past few months, the English and German programs were utterly ruined by several small South American stations, which were not only operating at the same time but using practically the same channels (around 6,000 kilocycles) and thereby played havoc with the programs. Such interference was, of course, not intentional; it is usually carelessness of the interests of the broadcast listeners. But the smaller stations are not solely responsible for this situation, since the large ones themselves are sometimes to blame for that situation. Not long ago, it was found that some of the powerful European stations were off their frequency; in technical parlance, *they wandered off their frequency*. Two adjacent powerful stations, thereby, were caused to interfere in such a manner that both programs received in America were ruined. Neither of the important stations (who were written to by SHORT WAVE CRAFT) confessed to any deviation because both of the transmitters are operated by crystal control, which is not supposed to vary; though once in a while, in spite of careful watching, such "wandering" will occur. It does not happen often because, the more powerful the station, and the more expensive the equipment, the less chance there is for this to occur. The main trouble at the present time, however, is the interference caused by the small stations with the larger ones, and it is here that readers of SHORT WAVE CRAFT can be of real help.

It is suggested by the writer that listeners who hear heterodyne whistles, which mar the program of an important *foreign* station, should report such an occurrence, *providing they can identify the offending station or stations*. In other words, it will not do to say only "This or that station was interfered with." The point is to see if you can unscramble the stations, and then report to SHORT WAVE CRAFT the call letters of the *two stations*; or even *three*, if such should be the case. If there is persistent heterodyning, SHORT WAVE CRAFT wishes to know about it; and will undertake to untangle the cause of complaint by notifying the station or stations at fault.

SHORT WAVE CRAFT IS PUBLISHED ON THE 1st OF EVERY MONTH

This is the December, 1934, Issue—Vol. V, No. 8. The Next Issue Comes Out December 1

Editorial and Advertising Offices, 99-101 Hudson Street, New York City

2-Way POLICE CALLS on 5 Meters

New five-meter police car system permits two-way talking with Telephone Subscriber



Captain Walter Kirchoff of the New Rochelle, N. Y., Police Department, using the new French type radio telephone; note hook on dash.



The rear bumper of the new G.E. Police car acts as the "aerial" and is insulated from the body of the car. The power of the charged antenna is shown by the 15-watt lamp, which is here shown lighted on one wire only.

● A NEW type police radio-car system that provides two-way communication from a moving car was acclaimed by the police in a recent demonstration at New Rochelle, N.Y. Unlike other attempts at two-way communication from mobile units this new system eliminates external antennas on the roof of the car—the standard rear bumper alone serving as an aerial. In fact there is nothing about the car that would indicate it is radio-equipped as far as the outside is concerned, which is considered quite an advantage by detectives.

Photo at right shows Patrolman John H. Moon conversing with cars from Headquarters by means of microphone attached to dial telephone. The system is so designed that several transmitters located in different parts of large cities can be turned on by dialing their code numbers. On left of photo is Headquarters receiving equipment used for police car work with loudspeaker incorporated on right of panel. This is one of the first practical two-way systems devised and the quality is just like that in ordinary telephone conversations. Both the police cars and Headquarters can converse *simultaneously* just as in ordinary conversation, without anything more than lifting the phone off the hook. The car operator can also talk direct to a "telephone subscriber" through a mixer circuit located at headquarters. Another feature of the system is the (Continued on page 503)

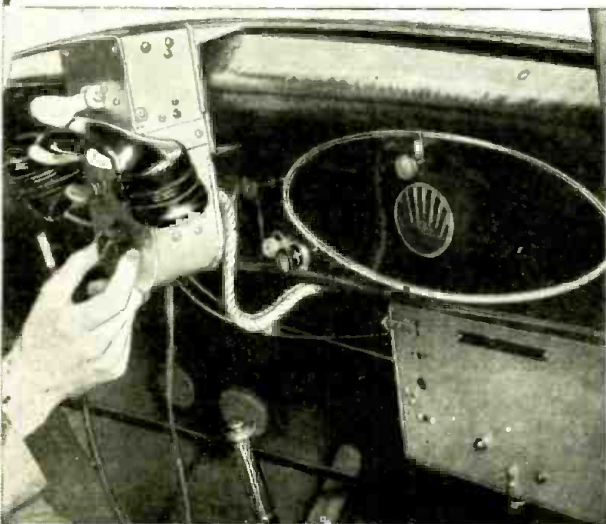

Here we see the tuning unit and also the support for the French phone which is clamped on the dash. The 5-meter receiving set is shown under the dash at lower right. Once set, the tuning dial is left alone. Note how phone is supported in cradle; lifted it closes the circuit.

The new G.E. 5-meter police car equipment is so designed that no one can distinguish the car from any other. Note rubber-mounted transmitter in rear trunk; directly below.

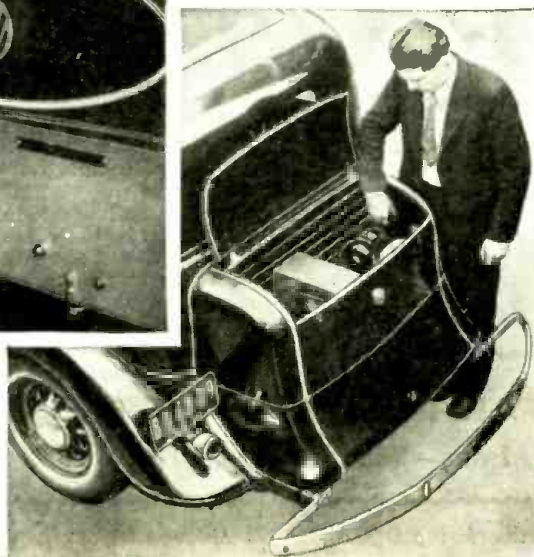

Finger points to insulated bushing supporting the rear bumper; this insulated bumper acts as the "antenna." The wire connecting the insulated bumper to the transmitter can be clearly seen and also the insulating washers.

Admiral Byrd Opens Radio Show via Short Waves

● THE National Electrical and Radio Exposition held in Madison Square Garden, New York City, was officially opened by a short-wave signal flashed from Little America by Admiral Richard E. Byrd. When Admiral Byrd at his advanced weather observation post, 123 miles south of Little America, pressed the key, the signal was relayed through the 1,000 watt broadcast transmitter in Little America, and when it arrived finally at the Radio Exposition it caused the lights in one of the studios to flash on. The accompanying drawing shows how this remarkable short-wave demonstration was carried on. When Admiral Byrd pressed the key at his advance post, it caused to be radiated a telegraph signal from the small portable radio telegraph transmitter with which the advance post is fitted, this signal being picked up by a short-wave antenna and receiver at Little America. The signal immediately passed into the 1,000 watt transmitter at Little America and started on its journey to Buenos Aires, S.A. Here the signal was instantly relayed through a powerful short-wave transmitter and leaped northward again to Riverhead, L.I., where the RCA long-distance receiving station is located. From this point the signal, after being suitably amplified, passed over a wire circuit to New York City, through the RCA control switchboard in lower New York, and thence up-town to the Columbia Broadcasting System Building at 485 Madison Ave., then to the Madison Square Garden studio control switchboard located just outside the studio at the Radio Exposition. As the dia- (Continued on page 503)

How a short-wave code signal was flashed by Admiral Byrd over 10,000 miles of space to officially open the National Electrical and Radio Exposition in New York City. The operators in New York could talk to Admiral Byrd by the return "cuing" circuit from Rocky Point direct to Little America.

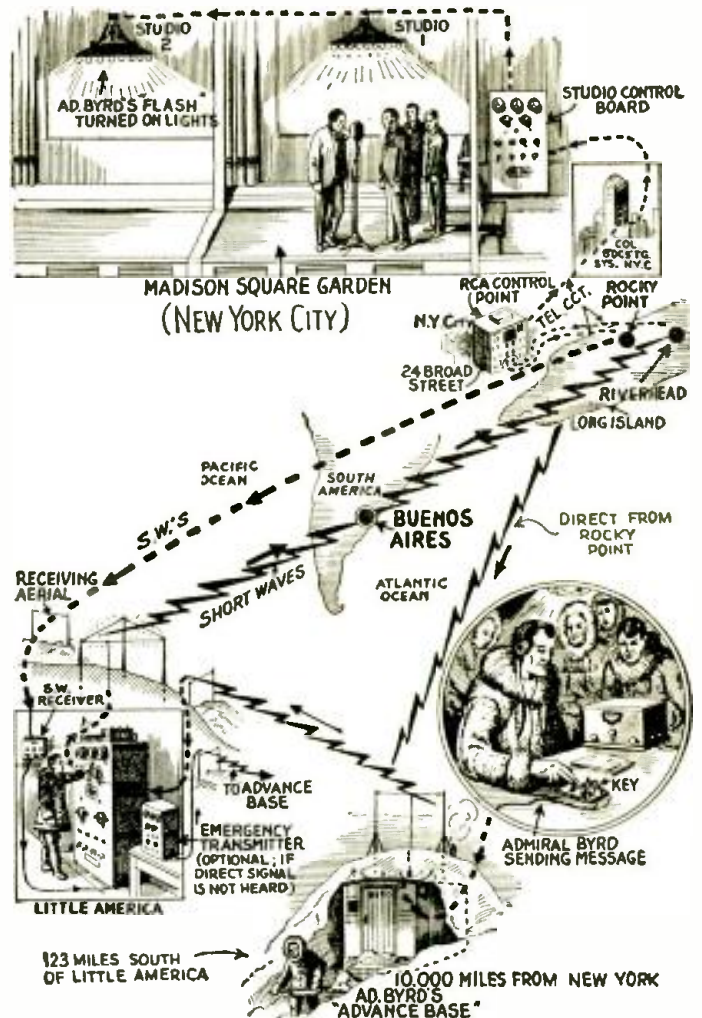

Short Waves Relay MORRO CASTLE Survivors' Stories

● THE mobile short-wave transmitter owned and operated by the National Broadcasting Company, played a star rôle in relaying "hot news" stories told by survivors of the ill-fated *Morro Castle*. The part played by the mobile transmitter is shown pictorially in the illustration on this page. The survivors who landed at Spring Lake, N.J., were asked to tell their stories briefly before the microphone of the mobile transmitter. The microphone is arranged with a long flexible cable, so that it can be placed in a building or out in the open when desired. The wavelength used by the portable transmitter to transmit the voices of the survivors to the necessary line connecting

with NBC headquarters in New York was 8.66 meters. A special short-wave receiver was erected in the Hotel Monmouth at Spring Lake to pick up the short waves from the mobile unit, which picked up the tales of the survivors and officers in charge of relief work at several different locations about Spring Lake, anywhere from ½ mile to 4½ miles from the special hotel receiving station.

The voices of the survivors were carried over special telephone circuits from the Hotel Monmouth telephone switchboard to the RCA control station in New York and then passed on to the NBC headquarters at 711 Fifth Ave., New York, where they were broadcast over the telephone and radio network across the country. The mobile short-wave transmitting unit has served in several important events in recent months and it marks a long step forward in the presentation of spot news to the radio listening public.

The power of the short-wave transmitter in the mobile unit is 150 watts. The car is fitted with receivers for different wavelengths and it is equipped to transmit on a number of different frequencies which are 34.6 mc., 34.7 mc., 1606 kc., 2102 kc., and 2020 kc., and 2760 kc., crystal control. A collapsible antenna is used. It has a range from 20 to 25 miles on ultra high frequencies—greater, of course, on the lower frequencies. A gasoline engine-driven generator is used to provide the power for this mobile unit. Crystal control is used on all frequencies and the installation is complete with the receivers to operate on all the above frequencies.

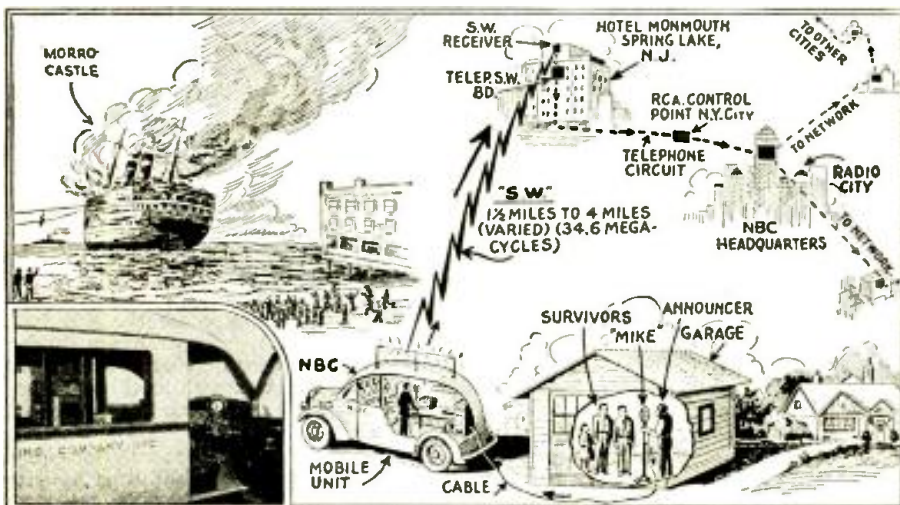

How the NBC mobile transmitter unit served to pick up the voices of survivors of the "Morro Castle" and put them on the broadcast network.

RADIO COLONIAL, the French Empire Station

One of the world's most powerful short-wave transmitting stations, heard frequently in this country.

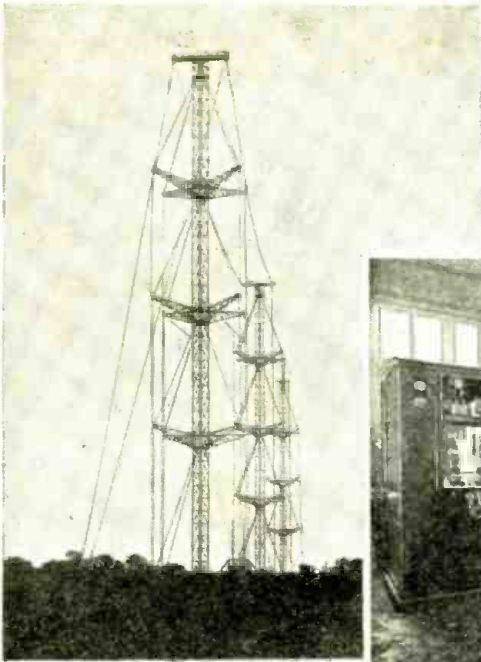

Left—beautiful layout of one of the main short-wave transmitting apparatus rooms of the Pontoise station. The corner of the power room shown is the short-wave transmitter, master oscillator, and quartz crystal regulator. Below—we see the interesting assembly or line-up of short-wave receivers for the different channels at Pontoise.

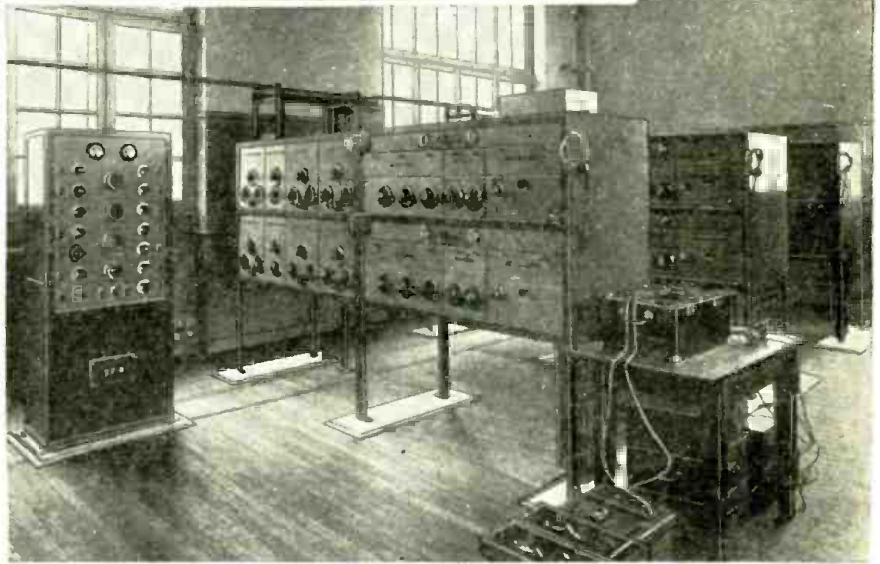

Top photo shows 300 foot antenna masts at the Pontoise station. Each transmitter is rated at 15 kw. Photo directly above—auto-oscillator used in short-wave transmitter.

Right—Building at right of photo houses the S.W. receivers; Center building contains wave control apparatus; building at left, office and power-house.

● *Radio Colonial* has been on the air for over three years and it has been heard in practically all parts of the world. There are actually two transmitters located at Pontoise, a suburb of Paris. Both of these transmitters are capable of working on any one of three different wavelengths (19.68, 25.2, and 25.6 meters). Two different directional antenna systems are available also. One of these radiates in an East-West direction for the benefit of Asia and North America, and the other in a North-South direction, used primarily for service to South Africa. The original purpose for this station was, as in the case of the British station at Daventry, to give a broadcast service to the French Colonial Empire. However, it has been found that the station serves the whole world today, and for this reason the French Government is using this station to further its good-will relations with other coun-

tries of the world. The station is on the air every day with programs for different parts of the world. The power employed by each of the transmitters is 15 kw. Generally only one transmitter is used at a time, although on occasion two may be used together. Most of the announcements are made in French although recently the directors have started an *English News Service* each evening. The programs radiated from this station are mainly excerpts from programs from the various *long wave* stations in France. Formerly a great deal of time was given to long talks, but more recently the directors have been emphasizing musical programs. This station broadcasts to North Amer-

ica every day on a wavelength of 25.6 meters from about 6:00 o'clock in the evening until 9:00 and from about 10:00 until midnight E.S.T. The programs are generally very well heard during the summer months. In addition to this, they are on the air from noon to 6:00 p.m. on a program intended for Africa, but this program is frequently heard very well in this country. In the afternoon they use a wavelength of 25.2 meters.

In addition to the transmitting equipment there is also a building housing several sensitive short-wave receiving sets. These are used for the purpose of picking up foreign short-wave stations. (Continued on page 503)

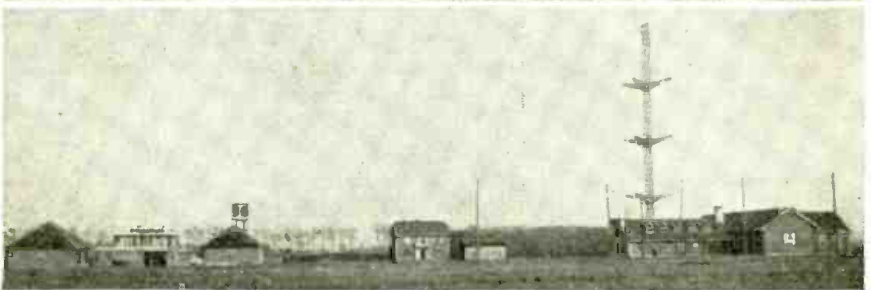

Micro Waves Will Transmit Pictures

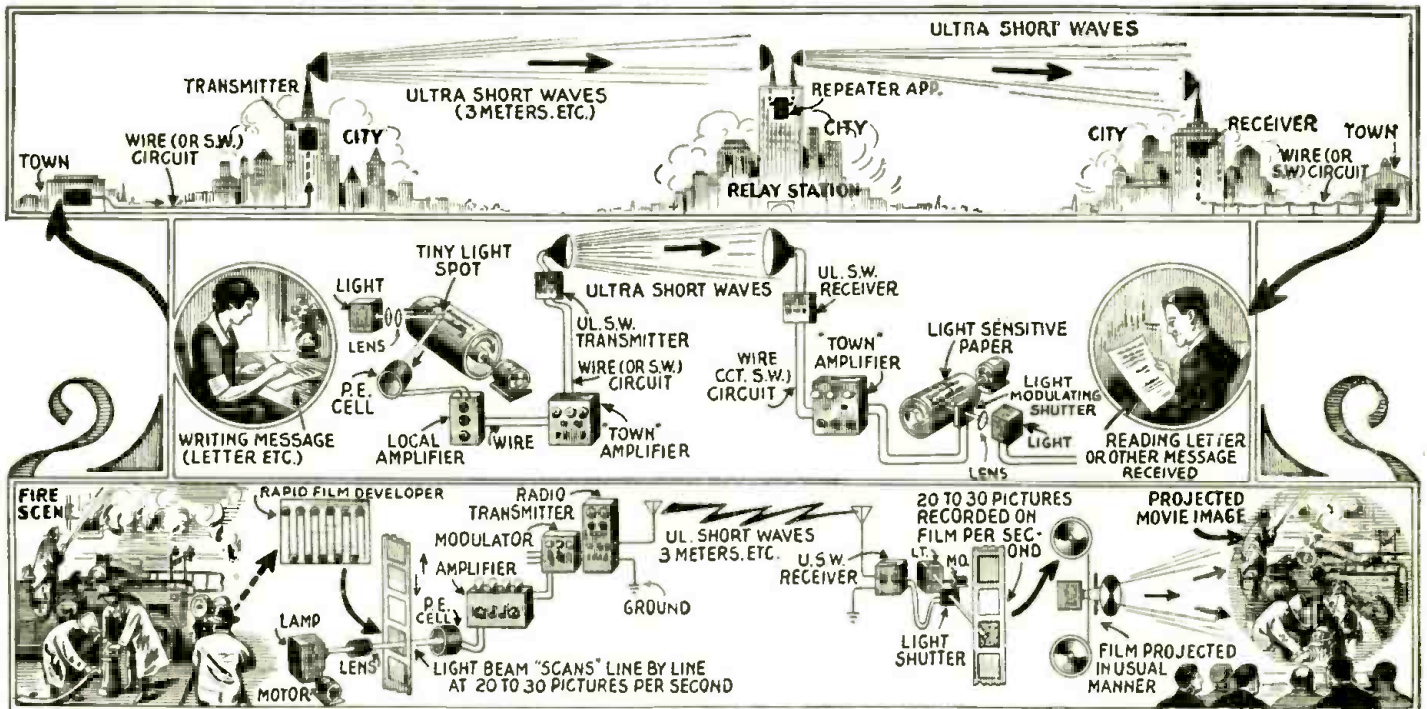

Picture above shows how letters, telegrams, and pictures will be transmitted tomorrow by means of ultra short waves or "micro waves" as they are frequently called. As the range of these waves in the region of 3 meters or less is limited, "repeater" stations are used to bridge great distances. When the speed of picture transmission is raised to that of motion picture projection, or 20 images per second, radio movies will be a fact.

● THE president of the Radio Corporation of America, David Sarnoff, recently gave the radio-minded public a glimpse of what they may expect tomorrow. Thanks to ultra short waves, 3 meters or less in length and which will be relayed where necessary by suitable *repeater* stations, erected on high buildings or other elevations, apparatus and systems are now being built and coordinated by the RCA engineers so as to provide an intercity network for the rapid transmission of photos, drawings, and hand-written letters, bank notes, checks, etc. Tomorrow, we shall be able, according to Mr. Sarnoff's predictions, to

picture is taken of a fire or other scene and the film rapidly developed in one of the new style high-speed photographic dark-rooms mounted on a truck. The images can then be passed through a high-speed scanning apparatus and the various ultra short-wave signals corresponding to the light and dark portions of the scanning bands or lines for each image transmitted and relayed as *(Continued on page 497)*

24-Inch Waves Demonstrated

● David Sarnoff, president of the Radio Corporation of America, recently stated that facsimile pictures transmitted by ultra short waves will prove to be the gateway to television. By using micro waves and suitable repeater stations, pictures can be transmitted in a fraction of a minute. A wavelength of 3 meters is being used in experimental tests at present. Eventually hand-written or typed messages and pictures will be transmitted at a speed approximating that of motion pictures or at the rate of 20 to 30 pictures per second.

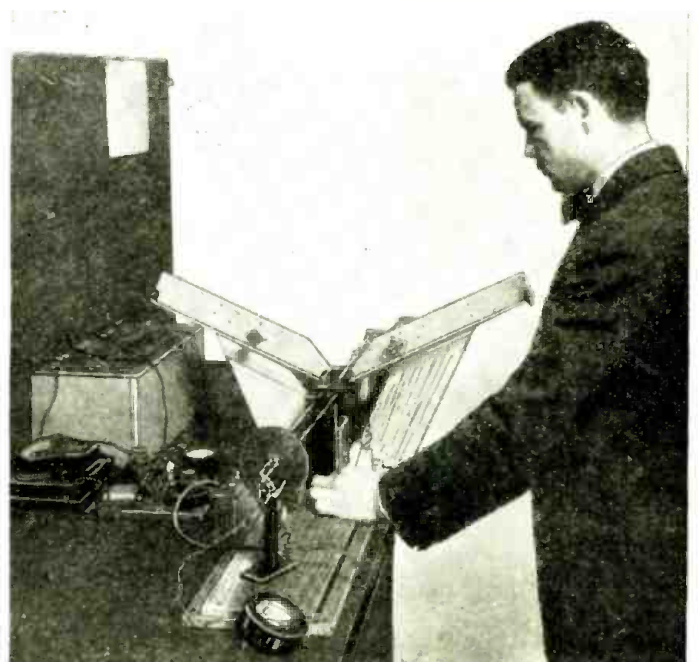

A glimpse of the Radio Research Department of the famous Bell Telephone Labs., in New York City. Mr. J. G. Chaffee is shown testing an ultra short-wave experimental apparatus designed to produce waves 60 centimeters or 24 inches long. Four tuned circuits are utilized in the detector circuit of this apparatus.

write a letter or note in code or otherwise which will be transmitted to our friend or business associate in the twinkling of an eye.

At present it is a matter of several minutes before a photo or drawing is transmitted by a rapid series of radio signals exchanged between the transmitting and receiving picture stations, but tomorrow Mr. Sarnoff promises the speed of transmission of images will be stepped up until, thanks to the micro waves, pictures will be hurled through the ether with a rapidity equaling that of the motion picture speed now used, or about 20 pictures per second.

Once we can transmit images as fast as the speed of motion pictures, 20 to 30 frames or images per second, we shall have arrived at one form of practical television, such as our picture portrays. In other words, a notion

1-Tube "Pocket"

By **GEORGE W. SHUART, W2AMN**



Music from Europe without an antenna! This pocket set did it! The batteries are carried in the pocket.

● **MANY** of our readers have sent in requests for a simple short-wave receiver that could be used for portable work and small enough to fit in one's pocket. While it is nearly impossible to construct an elaborate set for this purpose, it is quite possible to make one that will work very nicely and one on which *foreign* stations can be received with surprising ease. In fact, stations in Europe were received with this set *without an antenna of any description*. In sets of this kind it is not practical to use more than one tube because of the heavy filament current requirement which would necessitate use of an A battery of considerable weight.

The main objective is to keep the battery element as light as possible and small enough to fit in another pocket. This little set will operate very nicely with a 22.5 volt block of batteries for the plate supply and two regular flashlight cells for the filament.

Many different ways of mounting and carrying the batteries will suggest themselves to the reader undoubtedly. However we show in the photographs of the set two methods of arranging the batteries. In both cases they are of the home-assembled style. Pen-flashlight cells are used in making up the "B" block. One method shows a very neat arrangement wherein they are all mounted on a strap which forms a belt that can be worn around the waist. This is an old stunt used in stage tricks. The other is more simple and does not require so much effort in construction. The cartridges are strapped together to make a flat affair which can be carried in the pocket.

The writer happened to have available a bakelite case which once contained a shaving set. This case measures 1 3/4" x 3" x 6 1/2" and proved to be just the thing. However any other case having dimensions similar to it will serve so long as the various parts can

be conveniently mounted; a small camera case of the flat variety should serve just as well. A metal case can be used but there is no necessity for one as not the slightest sign of body capacity effects were noticeable, even though not the least bit of shielding was used.

Super-Regeneration Used

By referring to the circuit diagram we find that the circuit is straightforward in every respect. In order to obtain the tremendous amplification necessary in a set of this kind, the tube was made to *super-regenerate* by supplying its own quenching frequency. It is a well-known fact that if the number of tickler turns are increased over the usual amount necessary to obtain ordinary regeneration, the grid of the tube will "block" at intervals, the frequency of which is more or less controlled by the value of the grid-leak and grid-condenser. In this manner a very sensitive detector will result.

There is one serious drawback in super-regeneration—and that is the strong signal which is radiated from a set of this type. Therefore it is recommended that it be operated only in the less congested areas where there are few short-wave receivers and where the danger of interfering with others is nil. We have seen 5-meter super-regenerative receivers radiate a signal over a distance of 5 to 7 miles.

The tube used is a type 230 Radiotron and is the most convenient for a set of this kind, inasmuch as the filament requirements permit the economical use of very small batteries. The coils are not of the plug-in type as there was not enough room for the

socket. The set was designed to cover only the 49 meter S-W broadcast band, as most of the stations can be heard in the evening on that wave-length. However data is given for coils that will cover the other S-W broadcast bands; this will be found at the end of the article.

Due to the set covering only the S-W broadcast bands a small tuning condenser is used. This is one of the new Hammarlund ultra-midget affairs, having a total capacity of 50 mmf. It is very small in size (1" x 1 1/2") and allows more room for the other parts in the set, than would one of the regular size midgets.

These small condensers are equipped with a very short shaft, intended for screwdriver adjustment and it is necessary to extend it somewhat in order to use the dial. This was done by simply soldering to it a one half inch length of quarter inch shaft. The condenser is mounted slightly to one side of the case in order to leave room for the tube and coil. The wafer type tube socket is mounted in the case with two short angles; mount the socket so that there is space enough to insert and remove the tube easily.

There is no *regeneration control* provided, but the tickler coil is made just the right size to produce the right amount of feed-back. The size of the grid-leak should be just one megohm, no more or less. A .001 mf. plate by-pass condenser is necessary in order to keep the r.f. out of the phone cords and aid in obtaining smooth oscillation. Also be sure that the grid condenser is of the size indicated in the diagram. We had quite a bit of trouble in obtaining super-regeneration at the start until we found that this condenser was incorrectly marked; if in doubt, use one marked slightly larger than the one shown in order to be on the safe side.

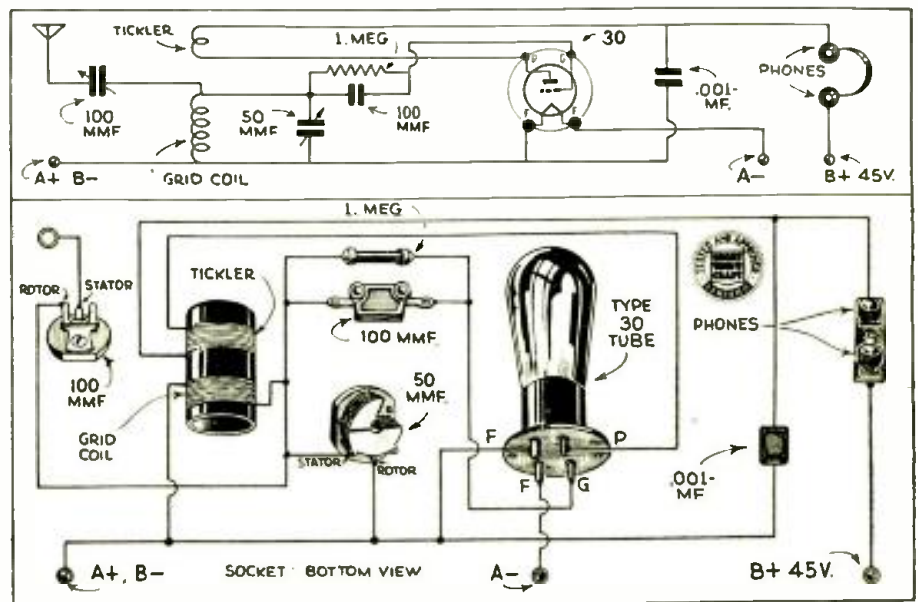

It is a cinch to build the 1-tube pocket short-wave receiver by following the simplified wiring diagrams here presented. By using coils having different numbers of turns all the S.W. bands may be covered.

Set" Gets Europe



● Astonishing indeed is the fact that this remarkably compact 1-tube short-wave pocket receiver actually picked up European stations without an aerial. The unusually high sensitivity of this set is due to careful design of the circuit. With a short aerial, this 1-tube pocket set picked up stations galore when tested by the editors inside a steel frame building in New York.

Only 1 Tuning Control

The antenna trimming condenser is mounted on the inside of the case and needs little adjustment. No external knob was found necessary. Merely adjust it for the particular antenna you are using and leave it there. This makes it a very simple set to tune, as there is only one control to adjust and that is the main tuning knob.

The adjustment of the antenna trimmer has quite an effect on smoothing up the regeneration so adjust it for best results. Best action of the detector is obtained when the antenna is adjusted to the point where tighter coupling will cause the tube to stop hissing. The usual hissing sound characteristic of super-regenerative receivers is present, although it will completely disappear when a moderately strong station is tuned in. Thus it is not the least bit annoying while listening to a station.

The antenna can be anywhere from 5 to 100 feet long. Best results were obtained with an antenna only several feet long and with the antenna condenser adjusted to maximum capacity. The filament battery has three volts and it is advisable to insert a resistor having approximately 16 ohms in series with it in order to insure long tube life. This can be either a fixed wire-wound affair or in the form of a 20-ohm variable rheostat mounted on the battery.

Coil Data

Band	Grid	Tickler
49 meter	18	18
25-31 meter	10	10
19 meter	5	5

All coils close-wound with No. 26 D.S.C. wire on a 1-inch tube, spacing between tickler and grid coils 1/8 inch.

Parts List for Pocket Set

1—100 mmf. Antenna trimmer, Na-Ald.

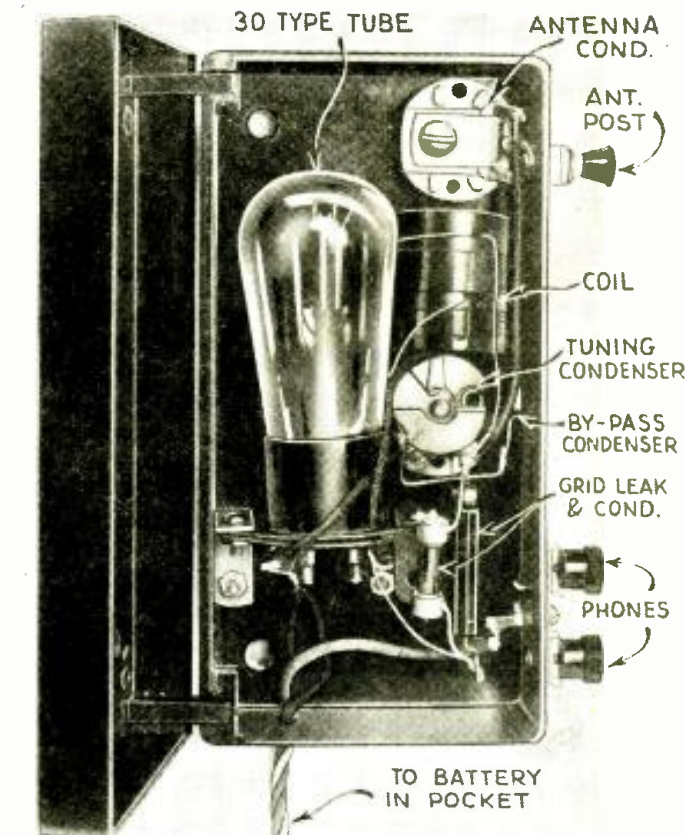

The "innards" of the remarkable 1-tube "Pocket Receiver" which proved to be astonishingly sensitive and selective. With only a short aerial, stations thousands of miles away were picked up and European programs were actually heard without any antenna at all!

- 1—50 mmf. tuning condenser (see text) Hammarlund.
- 1—100 mmf. mica condenser; Aerovox.
- 1—.001 mf. mica condenser; Aerovox.
- 1—1 meg. 1/2 watt resistor. Ohmite.
- 1—4 prong wafer socket, Na-Ald.
- 1—Phone binding post strip, Na-Ald.
- 1—Antenna binding post, Na-Ald.
- 1—Bakelite Case (see text).
- 1—RCA 30 Radiotron.

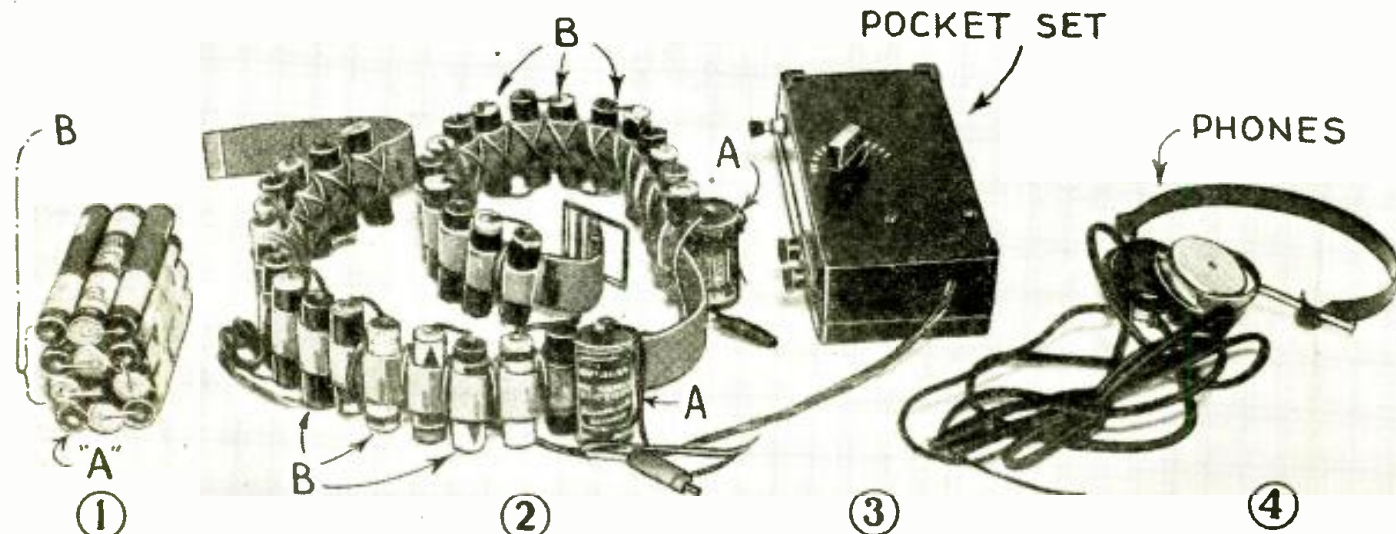

Batteries for the pocket receiver may be arranged in a number of different ways. By using pen-light flashlight batteries, which measure about .5 inch in diameter, the "A" and "B" units can be arranged in a group as at 1, or in a home-made belt (2). 3 is the pocket receiver and 4 the 2,000 ohm head-phones.

Latest "Doerle" Set

By H. W. SECOR

955 Is a Triode

These new tubes are only the size of an *acorn*, measuring $1 \times 1\frac{1}{8}$ inches, including terminals. By comparing the entire receiver with the regular screen-grid tube also shown in one of the photographs, you can easily appreciate the extremely small size of the tube. In every respect except size, this tube closely resembles the older type 37. That is, it is a *triode* having an indirectly heated cathode; the heater requires 6.3 volts, although the current requirements are much less than the 37's, being .16 amperes for the new 955. The *internal capacities* are much lower of course, as it was designed for the ultra high frequencies. The plate-to-grid capacity is 1.40 mmf.; the grid-to-cathode capacity is 1.0 mmf. and the plate-to-cathode capacity is only 0.60 mmf. This valuable little tube will oscillate in conventional "feed-back" circuits at wave-lengths as low as *one-half* meter!

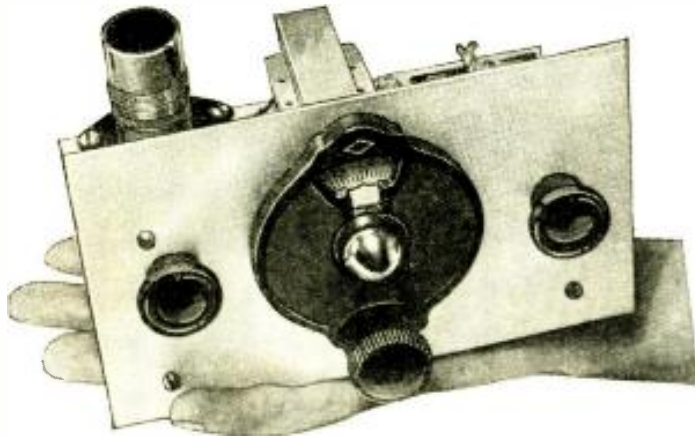

Here's the "2-Tube Midget DOERLE Receiver" held in the palm of a hand; it is made possible, thanks to the new RCA "Acorn" 955 tubes. The set, as you see, is complete with batteries ready to connect to phones and aerial. All the principal "foreign" S.W. broadcast stations, as well as "locals," were received with good head-phone volume.

• WE KNOW that our friends will certainly be tickled to learn that the RCA Radiotron experts have at last brought out a real "midget" tube. For years we, you, everybody, have been waiting for a tube of this type and we can hardly believe our eyes when we gaze upon the new RCA 955. Of course the prime purpose of this wonderful little tube is for operation on the *ultra high frequencies*—below 5 meters. But this does not mean that it will not work on the lower frequencies, that is, those that take in the short-wave "broadcast" bands or 19 to 50 meters. It does, and very efficiently at that. It is now possible to build a receiver that will operate anywhere from 1 to 200 meters. The set shown in the photographs was built for the express purpose of investigating the qualities of the new tubes. It was possible to operate this set perfectly all the way from 200 meters down to 1 meter. This little set created so much favorable comment when viewed by our friends that we decided to present it to the readers of SHORT WAVE CRAFT in its original form.

The set is complete in every detail and is operable in any location without any accessories, other than an aerial and a pair of head-phones. The batteries are built into the under side of the chassis; "A" and "B" batteries, believe it or not. The entire set measures only $6\frac{1}{2}$ by $4\frac{1}{4}$ by 5 inches and weighs but 3 pounds. Needless to say it should be housed in a protective box of some kind and it sure would make a "nifty" portable—and what a Christmas gift!

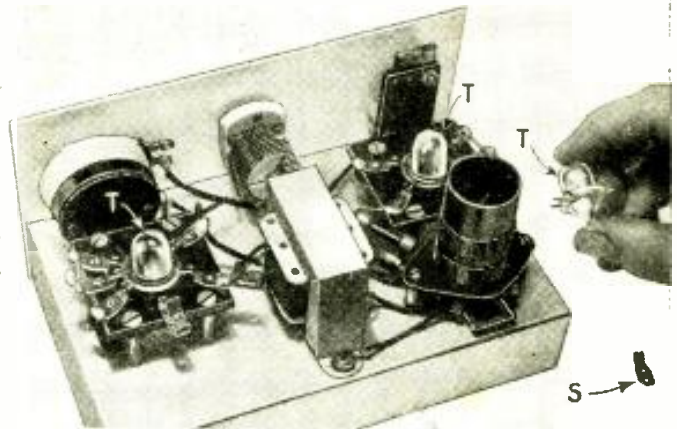

Rear view of the 2-Tube Midget DOERLE Receiver, showing the position of the two RCA Acorn tubes, the tiny new Hammarlund tuning condenser in the center of the panel, also a spare tube and one of the socket clips appearing at the right.

Socket

The construction of the tube, except for the method by which the leads from the elements are brought out, is the same as for any other tube, only that it is much smaller. At this time there is no *socket* commercially available for the 955 and it is likely that the reader will have to build his own after the style shown. Five small clips are furnished with each tube, one for each of the five leads coming out around the sides of the tube. Complete details are given in the drawings for the construction of a suitable *socket* and the reader should have little difficulty in constructing it.

Circuit for 955 Acorn Tubes

• Glancing at the diagram we find that the circuit is a conventional one. The detector has the usual tickler for feed-back and regeneration, and is transformer-coupled to the audio amplifier. Forty-two volts are used on the plates of the tubes; the actual detector plate voltage, of course, depends upon the setting of the regeneration control. A variable series resistance is used to control regeneration, in order that there will be no undue drain on the "B" batteries, which usually is the case when a potentiometer hookup is used. The "B" block consists of 14 Burgess "pen-flashlight" cartridges (3 volts each) connected in series and these very conveniently fit into the base. The heater voltage is supplied by four of the "baby" type flashlight cells. While these do not give economical service due to their short life at the current drain of .32 ampere, they very nicely serve the purpose in this set. After all in a set of this type we are willing to pay a fair price for compactness.

Plug-in coils are used and are wound on the National midget four-prong R39 4-pin forms. Data is given for various wave-bands in the coil table.

When operated on wave-lengths above 10 meters the set was used as a regular regenerative affair, similar to the *Doerle*, after which it was named. On wave-lengths below

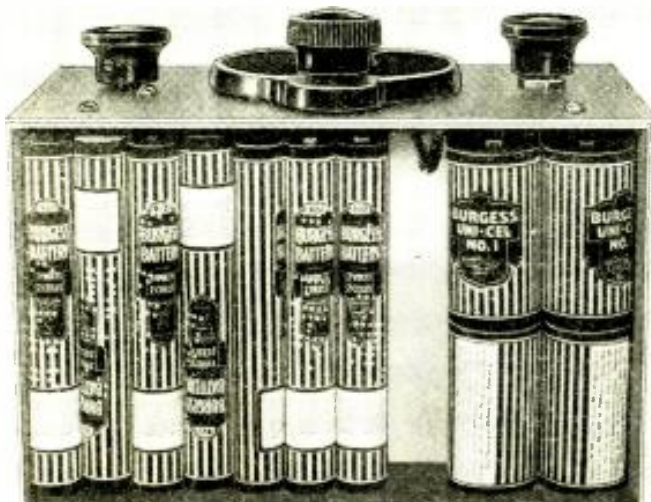

A bottom view of the Midget DOERLE 2-tube Receiver, showing the 42-volt B and 6-volt A battery. The B batteries comprise fourteen 3-volt "pen" flashlight batteries wired in series.

Uses New "Acorn" Tubes

10 meters it was made to function as a *super-regenerative* set. In this instance the tickler coil was made the same size as the grid coil and by turning the regeneration control full on, the detector breaks over into super-regeneration. No changes are needed in the circuit, the only difference being in coil construction.

In a set of this type where a very wide range of frequencies is to be covered, it must be stressed that the leads be as short as possible; otherwise the set will not work well on the higher frequencies. The tuning condenser is the new Hammarlund ultra-midget type, having a total capacity of 100 mmf. It measures but 1 x 1½ inches. This is far too great



● "Hier ist Kurzwellensender DJC Hallo Nordamerika" . . . this German greeting as well as Paris, Madrid, Rome, and other

short-wave broadcast centers in Europe were picked up easily on the new Midget 2-Tube DOERLE Receiver, built around the new RCA "Acorn" tubes. This is the very latest in short-wave receivers and it weighs but 3 pounds, complete with A and B batteries; it measures only 4¼x5x6½ inches. The editors will pay liberally for articles on "miniature receivers" using the new Acorn Tubes. So Get Busy!

a capacity for the ultra high frequencies if comfortable tuning is desired, but this can be overlooked as this set is not designed for that particular purpose. (These new tiny variable condensers are available in 25, 50, 75 and 100 mmf. capacities.)

The characteristics of the 955 tube are as follows:
Heater Voltage.....6.3 volts

It's Here! The Tiny Tube You've Wanted

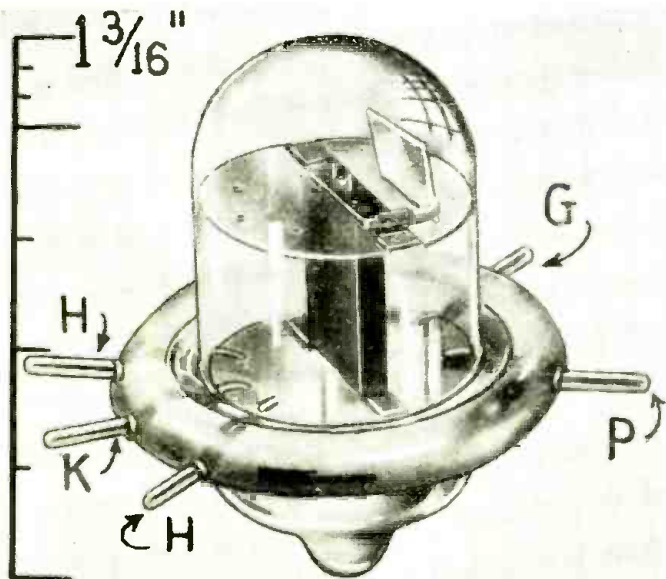

A close-up of the radio tube "the world has been waiting for"—the new RCA "Acorn" 955 tube! It is the size of an acorn and it is particularly well adapted to the ultra short waves.

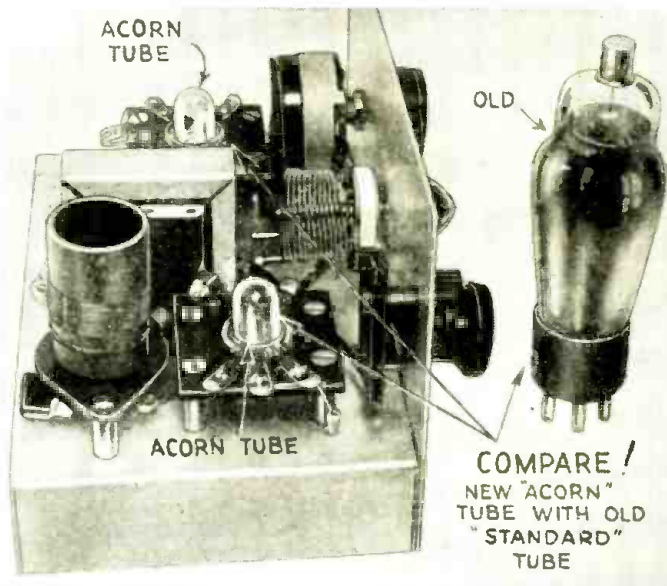

Compare the tiny new RCA "Acorn" 955 tube with the standard receiving type tube at the right. The Acorn tube snaps in and out of the socket. Note the new Hammarlund midget tuning condenser

Heater Current.....	0.16 amp.
Maximum Plate Voltage.....	180 volts
Grid Voltage.....	5 volts
Maximum Plate Current.....	4.5 milliamps
Mutual Conductance.....	2,000 micromhos

(Continued on page 501)

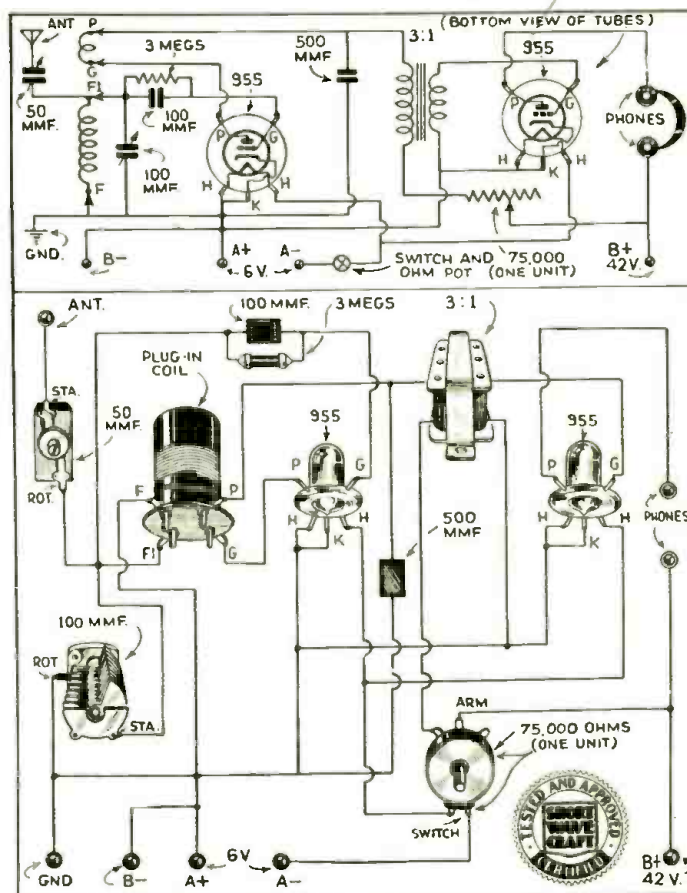

Schematic and picture diagrams of Midget "DOERLE" 2-tube set.

3 Tubes Equal 5 in This

By George W. Shuart, W2AMN

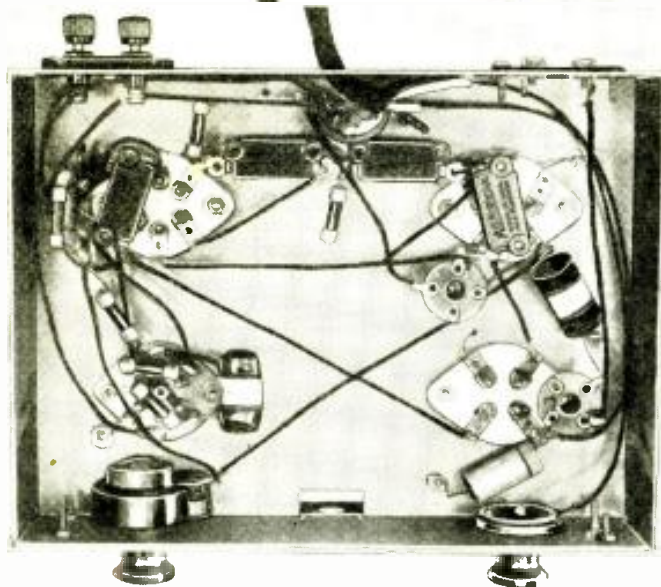
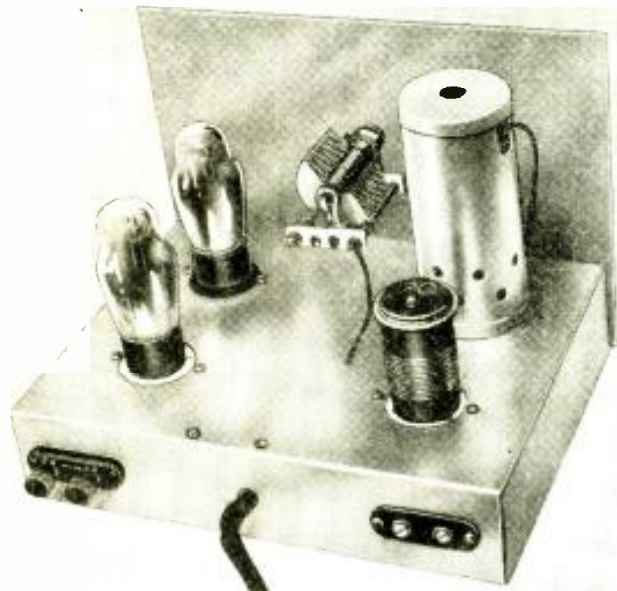

You will find it a very simple matter indeed to build up this extraordinary 3-tube receiver, rear and bottom views of which are shown above. By employing Na-Ald or other "hand-spread" coils the stations can be "spread over the dial" very nicely.

● MANY of our readers have asked for battery-operated receivers using the 2-volt type tubes. Many of these "Boys" are located in the rural districts where there is no main power source or where the lighting service is of the 32-volt type. Of course even the fellows in the cities have requested the battery sets because of the minimum amount of noise present in this type of receiver. There is no doubt of this when one considers the fact that most of the receivers used in the trans-Atlantic telephone are battery-operated. This is because of the extremely quiet operation afforded by a battery type receiver.

If care is taken in the design of battery-operated sets, it is possible to obtain results very closely approaching the sensitivity of an A.C. operated rig. In the receiver presented in this article the sensitivity is extremely high and operation is as good as any A.C. set. The set uses one type 34 tube as a stage of untuned r.f., a 19 as a detector and separate regeneration tube and, finally, a 19 as two stages of resistance-coupled audio.

Separate Tube Element Used for Regeneration

The use of the 19 in the special detector circuit is a very

worth-while improvement over the usual arrangement. In this circuit the detector tube functions only as a triode rectifier and the amount of regeneration necessary to produce oscillation is taken care of in the other section of the 19.

This is unquestionably the most efficient way in which to obtain feed-back. Heretofore it has not been very popular, because it has been necessary to utilize an extra tube. However the use of the 19 twin-triode nicely overcomes this disadvantage. The stability obtained is really marvelous and the smoothness of control makes one wonder if this is really a regenerative receiver. You can set the regeneration control at any point in either the short-wave broadcast or amateur bands and the whole band can be covered without the slightest need of readjustment; it tunes like a superhet!

In adjustment of the regeneration control it differs slightly from the single-tube autodyne detector, in that the point of maximum sensitivity is not on the very threshold of oscillation, where much distortion exists. In fact maximum sensitivity is present quite a ways from the oscillation point, and remains such up to the point where the tube oscillates, providing a rather broad regeneration control. The regeneration control has very little if any effect on the tuning. Needless to say, the quality of a

● Did you ever crave a real smooth-working regenerative receiver using 3 tubes, which would tune in the stations like a good superhet? In this brand new receiver recently developed by Mr. Shuart, smooth and absolutely positive control of the regeneration is assured by utilizing one of the triode elements of a 19 tube for the regeneration alone; the other triode of the first 19 being used as a detector. A second 19 tube provides two stages of resistance-coupled audio, while a 34 acts as an R.F. tube.

signal received on a detector of this type is far superior to the regular detector.

Untuned R.F. Stage

The untuned r.f. stage was used solely for the purpose of eliminating the effects of the antenna upon the grid circuit of the detector. There is not the slightest trace of dead-spots in this set. It is a stable and as smooth as a broadcast receiver!

The second 19 tube was used to obtain good quality rather than volume. A type 33 could have been used, but the quality would not have been near as good as the two stages of resistance-coupled audio afforded by the 19. Then again two stages of resistance-coupled audio will give very fine volume with practically no tube noises, where as the use of the 33 pentode would have resulted in more set noises.

Controls Are Simple

Looking at the front of the set we find the tuning dial in the center of the panel and the regeneration control knob in the lower left-hand side. The right-hand knob is the filament control rheostat. The 34 r.f. tube is the one shielded and directly in front of the plug-in coil. The 19 detector and regeneration control tube is located to the rear right of the base, and the one nearest to the panel represents the two stages of audio. The front panel is seven by ten inches and the base is eight by seven and two inches deep. This provides plenty of space for the parts and there is no undue crowding. A five-prong socket is

Battery Receiver



Featuring Separate Regeneration Triode

used for the plug-in coils and provides a very versatile arrangement. For the short-wave broadcast bands the new Na-Ald broadcast band-spread coils are used with a very nice band-spread tuning effect. For the Amateur bands, the amateur band-spread coils are used and the "ham" bands are spread over nearly the whole dial. If one wishes to cover the entire short-wave range of from 15 to 200 meters, the five-prong general coverage coils are used. All these arrangements are possible without the slightest change in the wiring of the set. For the battery supply of this set many combinations can be used.

It is suggested that "B" batteries be used for the plate supply. Either the portable or regular type should last a long time, because the total drain on the B's is but 15 milliamperes with 135 volts on the tubes. The set will operate very nicely with 90 volts but the increase in volume is well worth the 135 volt potential. The filaments require 2 volts at .58 ampere. While a pair of No. 6 dry cells will give excellent service it is recommended that some of the other types be used for economical operation. A 2-volt storage battery should give years of service. Heavy duty 3-volt "A" battery

(Continued on page 495)



The designer of the "3-tube equals 5" Battery Receiver, which features the use of a separate regeneration triode, is here shown giving the set its final test. "O.K." says W2AMN.

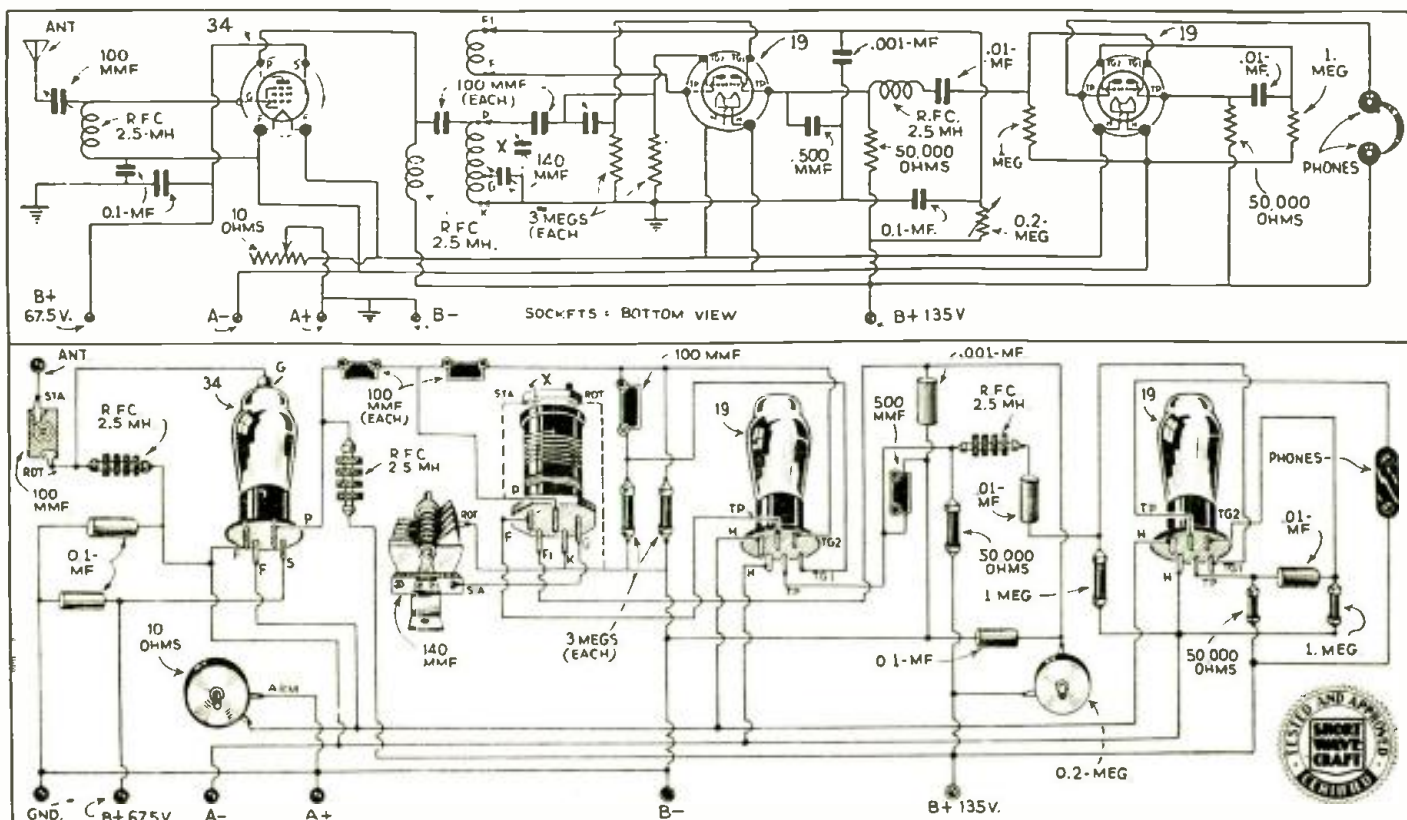

Wiring diagrams, both schematic and physical, are reproduced above so that even the inexperienced "fan" can easily build this 3-tube receiver which really gives 5-tube results.

WORLD-WIDE SHORT-

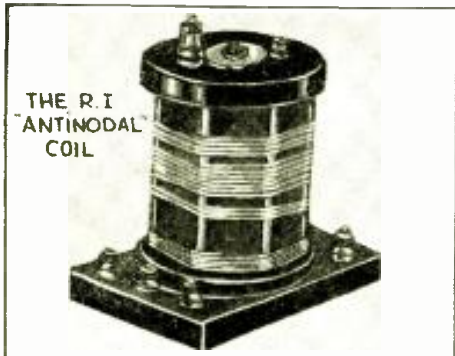

THE R. I. "ANTINODAL" COIL

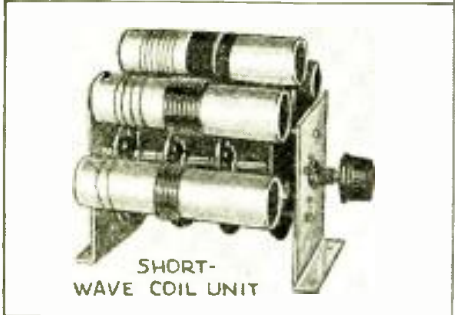

SHORT-WAVE COIL UNIT

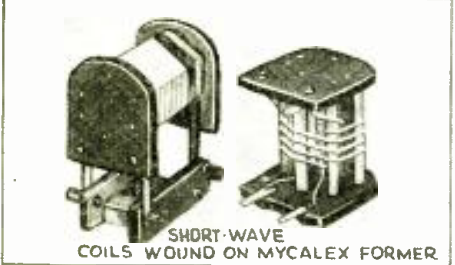

SHORT-WAVE COILS WOUND ON MYCALEX FORMER



ANODE CONVERTER (B-SUPPLY) FOR S.W. REC

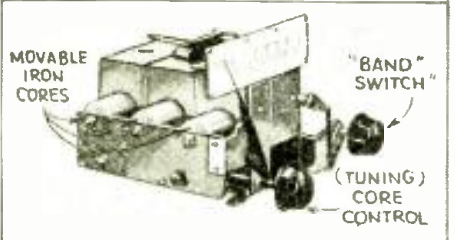

MOVABLE IRON CORES "BAND" SWITCH (TUNING) CORE CONTROL

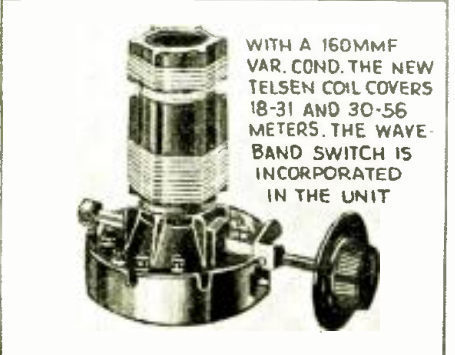

WITH A 160MMF VAR. COND. THE NEW TELSON COIL COVERS 18-31 AND 30-56 METERS. THE WAVE-BAND SWITCH IS INCORPORATED IN THE UNIT

● The Editors have endeavored to review the more important foreign magazines covering short-wave developments, for the benefit of the thousands of readers of this magazine who do not have the opportunity of seeing these magazines first-hand. The circuits shown are for the most part self-explanatory to the radio student, and wherever possible the constants or values of various condensers, coils, etc., are given. Please do not write to us asking for further data, picture-diagrams or lists of parts for these foreign circuits, as we do not have any further specific information other than that given. If the reader will remember that wherever a tuned circuit is shown, for instance, he may use any short-wave coil and the appropriate corresponding tuning condenser, data for which are given dozens of times in each issue of this magazine, he will have no difficulty in reconstructing these foreign circuits to try them out.

Short Waves at the English "Radio Show"

● England has just celebrated the annual radio show at *Olympia*—that eagerly anticipated event of the radio year. The magazines received by the Editor from that country are filled to capacity with new sets and parts or components, as our British radio cousins call them.

Among these are a number of interesting new coils for the short-wave experimenter. A few of these are shown here for the benefit of American readers who like to know what is going on abroad.

The first is a completely shielded coil assembly, covering the popular short-wave broadcast bands of 18-31 and 30-56 meters. The coil also includes a wave-change switch incorporated as an integral part of the coil. This method of construction keeps the wires short and completely shielded—and also simplifies the task of set construction, as the coils are then wired like single-band inductances.

Another interesting example of coil design is the multi-coil assembly, which resembles closely a coil unit of American manufacture. However, this coil is entirely different in electrical design, as it covers the unusually wide wave-band of 10 to 2,000 meters. Thus even for European broadcast conditions, it may be termed an "all-wave" coil unit. Five coils cover this wide range, which includes the short waves, medium waves, and long waves (according to English terminology). Several types are made covering superhet and regenerative circuits.

Still another coil shown here is especially designed to remove those annoying *dead-spots* which so many short-wave fans are bothered with. This coil bears the attractive name of "Antinodal" and although an examination of the picture fails to reveal the secret of its success, the latter is without doubt found in the careful choice of wire size and spacing for each wave-band.

The last of this interesting group of coils uses a form of insulation which is finding much favor among radio engineers for high frequency work, because of its fine insulation and ideal power factor. The insulation is called *mycalex* and is made by fusing glass and mica under terrific heat and pressure until a fine textured gray-colored material is produced. The coils shown are wound on strips of this insulating material—they are made in a variety of shapes for plug-in and solid mounting.

Along similar lines, is the permeability tuner pictured here. This is a complete tuning unit, covering both the broadcast band and the most popular of the short waves. It depends in its operation upon the use of special cores which slide in and out of the coils and which vary the inductance of the coil, depending on the position of the cores. The latter is made of extremely finely divided magnetic material which is especially designed for the purpose.

It is interesting to note that with this type of construction, the usual tuning condensers are dispensed with, since tuning is accomplished by the movement of the core. Two knobs are shown on the unit pictured. One is the tuning control and the other is the wave-change switch for changing from one band to another.

These units are made in different types having varying numbers of coils, and units are also available for superheterodyne use having oscillator coil characteristics to match a predetermined intermediate frequency. This is accomplished by a change in the core shape and size on the oscillator section, so that its frequency range is limited to the required degree.

The last of the short-wave items displayed in the popular English magazines, from which these items have been chosen (including *Wireless World*, *Popular Wireless*, *Amateur Wireless* and *Wireless Magazine*) is a "B" power unit ("Anode (plate) convertor" the British call it) designed particularly for the short-wave receiver. The unit contains such features as a neon tube voltage stabilizer, a three-section filter and a built-in line noise filter. A unit of this type should provide substantially quiet plate voltage and has the additional advantage of being adaptable to sets using class "B" amplifiers (which are very popular abroad) because of the voltage stabilizer.

A Unit for the Amateur

● This month, we have a new magazine in the list from which we extract interesting foreign items. This is a magazine published in Sydney, Australia, and devoted to radio subjects in general, with a generous section devoted to the transmitting amateur. The name of the magazine is *Radio Realm*.

In this amateur section, appears an interesting article on the ills and troubles encountered in phone transmission—such as frequency modulation, lopsided modulation, over-modulation, etc., and the way in which these can be checked and corrected by the use of a combined modulation meter and phone monitor.

This modulation monitor is simply a V.T. voltmeter using either a 37 or a 56 tube—or the triode portion of a 55 or 75. In the first circuit, L2, C1 is tuned to the frequency of the transmitter, with L1 coupled through a lead having one or two turns at the end coupled to the transmitter tank. This will draw practically no current from

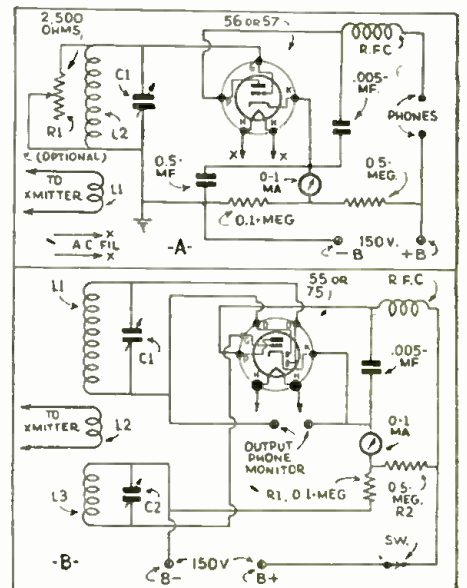

Circuit for simple and effective modulation monitor.

WAVE REVIEW

Edited by
C. W. PALMER

the tank coi., so it may be left permanently in this position.

In operation, it will be found that with R2 out of the circuit the tube may draw about 0.4 ma. R2 is used to drop the current to almost zero, so its value will vary with different tubes and different plate voltages.

With this in order, couple the loop to the transmitter. The plate current should move upwards, and the circuit L2, C1 should be tuned to resonance. Coupling to the transmitter should now be varied in order to bring the plate current to 0.4 ma. and then the transmitter modulated.

The needle should remain steady, and if it moves down there is insufficient excitation. If nothing happens, modulation may be increased until there is a movement. But if the needle moves upward, this shows the presence of lopsided modulation, which is certain to result from over-modulation.

This instrument, therefore, shows how high the transmitter can be modulated.

It is possible to hear and monitor the actual transmission, although for this purpose we would recommend the use of the circuit at B. The switch in the plate lead is to cut off the plate current when the unit is not in operation, because of R1 and R2.

A New Zealand S.W. Converter

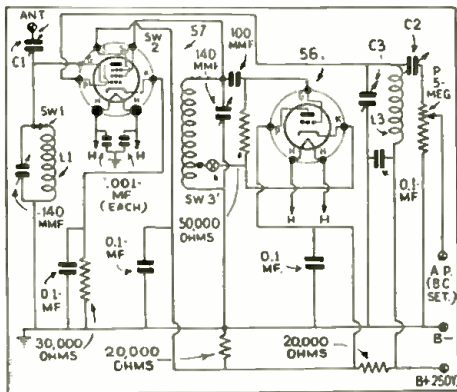

An interesting short-wave converter, comprising a detector and an oscillator, using 57 and 56 type tubes. Coil L2 is the 56 grid coil.

While converters have been on the wane in this country, due to the introduction of so many all-wave sets, this condition is not true in other countries. An example appeared recently in *New Zealand Radio News*, in which the circuit here appeared.

The unit consists of a detector and an oscillator, using a type 57 and a type 56 tube. It will be noticed that these tubes are American types which are sold extensively in Australia and New Zealand.

The converter uses two separate tuning controls, as the author points out that full sensitivity over a wide range of frequencies is difficult to obtain by the amateur constructor, if two or more condensers are ganged together.

The values of the parts used in the set are indicated on the circuit which is easily followed. Condenser C1 is a small adjustable aerial condenser which has a maximum capacity of about .00002 mf. This may be in the form of two twisted insulated wires or any of the other convenient forms of condensers which have been described in past issues of *SHORT WAVE CRAFT*.

The radio receiver to which the converter is attached should be tuned to about 1,000 kc. and coil L3 with its tuning condenser (L3 is a regular broadcast coil of any convenient construction to cover the regular broadcast band) is tuned to the same frequency as the radio receiver. This adjustment can be made by listening to the

background noise, when the converter and set are in operation.

The coils L1 and L2 are wound on two lengths of tubing 1 1/4 ins. in diameter. The four coils of L1 are wound on one tube and the four oscillator coils on the other, with a space of about 1/2-inch between windings. Number 22 enameled copper wire is used for all windings.

Turns L1	Turns L2	Tap from ground
46 1/2	23	8
17	13	5
6	5 1/4	2
3	2 1/4	1

A suitable wave-change switch having three sets of switch points, well spaced out, should be employed for shifting from one band to another.

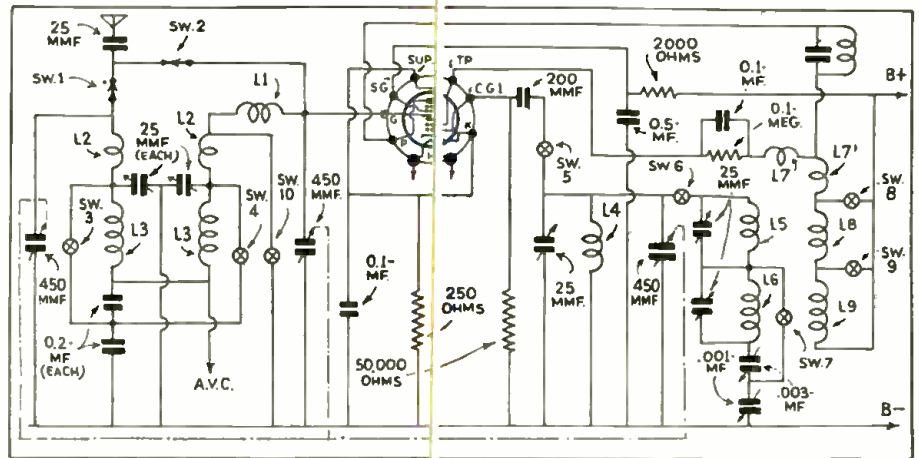

An improved circuit design for use with the "Octode" tube.

A Circuit for the Octode Tube

Several months ago, we announced the introduction of a new tube for frequency conversion or translation in super-heterodyne sets, known as the *Octode*.

It will be remembered that this new tube was similar in design to our well-known 2A7 and 6A7 tubes, except that an additional element had been added, a suppressor grid, in the screen-grid circuit, which had the effect of stabilizing the tube action as well as increasing its usefulness tremendously on the high frequencies, where the 2A7 has a tendency to stop oscillating.

In a recent copy of *Radio-Welt* magazine a circuit appeared which was specifically designed for this tube, to bring out all its hidden qualities as an all-wave tube. By a complicated switching arrangement, sections of the aerial and oscillator coils are short-circuited out of the tuned circuits for high frequency reception. The aerial is also switched from a band-pass tuning circuit to direct grid coupling on the higher frequencies, so that the greatest gain can be realized.

While this circuit has little practical value to the set constructor, since the octode tube cannot be obtained in this

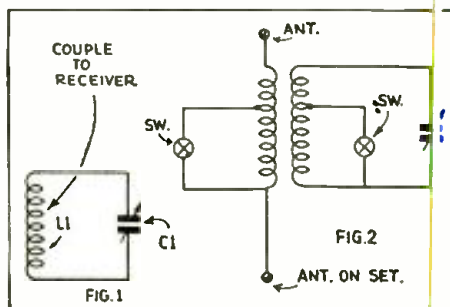

The wavemeter circuit shown will prove useful in calibrating short-wave receivers.

country, it is an interesting example of the methods employed by our cousins across the "big pond" in utilizing the full advantage of a new tube, by varying the method of aerial coupling for different wave bands.

Calibrating the S.W. Receiver

The constructors of short-wave sets who like to wind their own coils, have long been handicapped by the lack of some device which will tell them just what tuning range they can get with their latest masterpiece.

A well-known English writer, in *Amateur Wireless* magazine, recently gave some interesting pointers on how to determine these facts.

"The obvious solution is to make a wave

meter. I have made up one or two units that have come in very handy when I have been in doubt as to the coverage of a new receiver.

"Without question, the simplest wave meter is the absorption type which is merely a coil tuned by a variable condenser, as shown in the illustration here. The coil should be similar to the one you are using in the receiver. Mount it on a base and fasten the tuning condenser next to it.

In "January" Issue
The B-S 4
A "band-spread" 4-tube set that works
loud-speaker.

"Tune in a station on your receiver that you have positively identified and leave the set just gently oscillating. Bring the meter close to the tuning coil in the receiver and adjust C1 until you hear a plop in the reproducer (phones).

"Do this with all the stations that you have identified until you can draw a curve in the usual way. Four stations well spaced over the dial are all you need, and if the dial readings and frequencies are plotted on a piece of square, ruled paper, a line can be drawn through the four points so that all the stations in between can be located.

"There is only one snag to this arrangement and that is the dial reading or calibrations remain constant only as long as the wave meter is always held the same distance from the tuning coil. A variation on this circuit works quite well and overcomes the above difficulty. This consists of adding a primary coil to the previous unit and coupling the wave meter to the aerial binding post on the set, in series with the lead-in. The wave meter should be a distance from the set in this case, to minimize direct coupling between the two coils."

Report From Charles Guadagnino, Detroit, Mich.

● RECEPTION here in September has greatly improved, especially on the 49-meter band. The South Americans on 49 meters are being received here on my Patterson PR-10 from R-6 to R-9+ with good modulation.

With the winter months coming, DX should be very good for Australian stations and South American stations.

The following stations were received here this month:

HC2RL, 45 meters, Guayaquil, Ecuador. Sundays, 5:45 p.m. to 7:45 p.m. Tuesdays 9:15 p.m. to 11:15 p.m. Strong Signals.

HJ1ABB, 46 meters, Barranquilla, Colombia. Daily 7 to 10 p.m. Very good.

HJ3ABF, 48 meters, Bogota, Colombia. Daily. Little fading. 7 to 11 p.m. R-6.

YV2RC, 49 meters, Caracas, Venezuela. Daily. This is old (YV1BC) 5 p.m. to 10 p.m. R-9. Good programs.

W9XF, Chicago, Ill., 49.1 meters. 3:30 p.m. to 1 a.m. On Tuesday, Thursday, Friday, and Sundays.

HCJB, 73 meters, Quito, Ecuador, Daily. Fading. 7 p.m. to 10 p.m. Fair volume.

W10XDA, 21 meters, Schooner "Morrisey" Irregular. Near the Arctic Circle. Tests with amateur stations. Very good. R-9. DJB and DJD—R-8, 19.7 meters, 25.5 meters.

Have not heard I2RO, Rome, Italy, in quite a while. Must still be repairing.

EAQ, Madrid, Spain. Not so hot lately. Poor modulation and fading.

LSX, 28.0 meters, Buenos Aires, Argentina. Irregular. Tests with New York. Near 6 p.m.

Hope to hear from other fellows who own Patterson PR-10 or Patterson Pre-Selector.

Charles Guadagnino,
15226 Mack Ave., Detroit, Mich.

Official Listening Post Report of Geo. D. Sallade, Sinking Spring, Pa.

● THIS post has enjoyed excellent reception in the past few weeks. Every continent (excepting Antarctica) was heard with an R8 signal, at some time during the month.

The Australians have been heard almost every morning sending out excellent signals. Reception was best when VK3ME or VK2ME were broadcasting, but even VK3LR was very good at times. They were heard well on Sept. 6 with a QSA5/R9 signal. How many fans are hearing W2XAF and VK2ME testing for a coming event? VK2ME, by the way, uses a frequency of 10,520 kc. They test very frequently at 11:00 GMT.

The Japanese stations JVL, JVM, and JVN are heard very often at this post. Their respective frequencies are 6750 kc., 10,740 kc., and 10,660 kc. The best time to tune these stations in Eastern Pennsylvania is around 11:00 GMT. At present I have no definite station information, but it seems that different wave-lengths are used from day to day. On Sept. 19 JVN was heard, while on the twentieth I heard JVL.

Several South Americans were heard testing this month. Among these were LSQ on 19,400 kc. testing with "Rio." LSQ was heard QSA5/R9. HJB on 11.8 megs. frequently calls WMC in Hialeah, Fla. I heard them on Sept. 2, at 16:00 G.M.T. LSX was heard on a special transmission for NBC on Sept. 6. Their broadcasts are among the best from the distant South. LSN, and LSL were heard sending out a fine musical program on Sept. 7. The program was specially broadcast for "Rio." LSL used a frequency of 7,900 kc. and LSN, 9,900 kc.

On Sept. 9 I heard IRM testing with Buenos Aires. The frequency used was 9,823 kc. and the time was 20:00 G.M.T. Frequently the announcer would call "Pronto, pronto, pronto—pronto Buenos Aires." A bird call similar to the warbling notes of a feathered songster was used during the broadcast.

The Soviet stations RKI and RNE were

Short Wave SCOUT NEWS

heard on Saturday, Sept. 15. RKI was heard on 15,040 kc. and RNE on 12,000 kc. The time was 13:30 G.M.T. RKI was heard QSA5/R8 and RNE, QSA5/R5.

"La Voz del Tropica" located in San Jose, Costa Rica, continues to come in very strongly. Their frequency is approximately 6,700 kc. Their transmissions are usually from 8:00 to 10:00 p.m. E.S.T. KNRA was heard several times. Usually

Herman Borchers Thinks Trophy Is Beautiful



"The surprise of my life came when I opened the big brown box and beheld my beautiful silver trophy. It is a superb piece of workmanship and I think I should know whereof I speak, having been more than ten years in the silver and jewelry trade. I can honestly say, that my efforts to succeed seem small in comparison to the rich reward that I have earned. I am very very grateful, to SHORT WAVE CRAFT magazine for my beautiful reward and also for the many interesting articles, which have been the official guide to all the thousands of Short-Wave "fans," who appreciate their unlimited and everlasting aid and information."—Herman Borchers, Winner of the eighth Trophy Cup.

Latest "Hot" Tips for Short- Wave Listeners from our "OFFICIAL LISTENING POSTS"

by consulting the local newspaper their broadcasts can be determined. Their frequency is usually determined by the time of day, etc.

Station COC is back on the air and can be heard almost nightly. The best time to hear them in Eastern Pennsylvania is just before nightfall.

Report From O.L.P. of John Sorensen, New York City

● FIRST I wish to make a correction in the July report on OXY, 49.5 meters. Veri should have been 11° 25' 26" East Longitude instead of West Longitude. I repeat the report from LCL Veri as you did not list this. Why, I don't know. They confirm reception from their S.W. St. LCL on 42.92 meters the 8th of May. LCL is situated 50 miles south of Oslo on the Island of Jeloy, relaying programs on one of the following wave-lengths: 31.45 Ms. (meters), 48.94 Ms., 60.98 Ms. 73.17 Ms. antenna is a dipole, aerial power 1 kw.

Veri received from VK2ME and VK3ME, two very interesting cards.

Reception has been good one day, bad the next day—still the following stations have been heard several times during the month.

OXY on approximately 49.35 Ms. (meters).

LCL, 31.45 Ms.—VK3LR, 31.31 Ms.

JVM on 27.93 Ms.—VK3ME-VK2ME.

HJ1ABB, 46.53 Ms. and also 49.67 Ms.

XEFT, 49.5 Ms. also 49.8 Ms.

San Jose, Costa Rica on 44.7 Ms.

YV5RMO, 49.39 Ms.—HC2RL 45 Ms.

HJ4ABB, Manizales, Col. 41.6 Ms.

HJ3ABD, 40.54 Ms.—LSX, 28.98 Ms.

CT1AA, 31.25 Ms.—HBL, 31.27 Ms.

ORK, 29.04—station in Costa Rica on 50.8 meters or 51 meters and many more.

"G" stations and "D" stations have been good also. EAQ was good also.

Heard several South American stations not identified.

RW15 has been heard before 5 a.m. but not good enough for report to station. PHI, 16.88 has been good—FYA, 25.2 meters good. PRF5, Rio Janeiro, 31.58 meters. A good many unidentified stations have been heard.

Edward M. Heiser, Brecksville, Ohio, Reports

● THE month of September has been the poorest month of this year at this post for short-wave reception. The stations could be heard, but there were about three evenings, which could be called good.

There are quite a few new South American stations on the air now and they have surely made a mess of the 49-meter band. I have not been able to identify any of them as yet.

One of them is on about 58.5 meters, usually between 7 and 8 p.m. and come in pretty fair.

Another is on practically the same wave and with about the same signal strength as DJC (49.83M.) and causes a very good heterodyne whistle. This station gives three fast calls like a cuckoo bird between numbers and open their broadcast with a very fine soprano, singing "Ave Maria."

Another is on about 38 meters, between 8 and 9 p.m. and gives two cuckoo calls after each number. This station is in Colombia, S. A., and when heard, they were advertising "Johnny Walker" whiskey.

There is a new commercial phone station, HJY, in Bogota Colombia, S.A., on 16.5 meters and when heard they were testing with CEC in Santiago, Chile. Have heard them several times between 10 and 11 a.m.

I had never done any listening when the Australian stations were on, so I tried it this past month. The evening I listened (Sept. 8) was not very good and I could just hear them. Usually when a station gives their call is the proper time for them to fade or have a fine burst of static, but this time I was very surprised. Although the music could just be heard, when the call was given it came in as clear as a bell.

(Continued on page 481)

SHORT WAVE SCOUTS

TENTH "TROPHY" WINNER
 Oliver Amlie, 56th City Line Ave.,
 Overbrook, Philadelphia, Pa.

94 Stations; 47 Verifications

● OLIVER AMLIE of Philadelphia, Pa., takes the Short-Wave Scout "Trophy" this month. Mr. Amlie is well-known to the short-wave fraternity for his 3-tube DX'er receiver circuit which was described originally in the April, 1932 issue of SHORT WAVE CRAFT. It was this circuit which he employed while rolling up his log of 94 accepted stations, 47 of which were verified.

Mr. Amlie deserves a lot of credit as he has consistently gone after some of the hardest short-wave "catches" and all on 3 tubes—regenerative detector, and two audio stages.

The list of stations submitted by the entrant in this Trophy Contest may be for any 30-day period. Keep your list of stations until you have received at least 50 percent veris, so that you can mail the veris, list, letter, and oath all in one package. Bear in mind that the verification cards must be those received in answer to inquiries made regarding programs heard during your selected 30-day Official Listening Period. Arrange your station list in two groups, if possible, the first the *verified* group and the second, the *unverified*. State in your letter the total number of stations logged and also the number of verified ones. Before you mail your list and the veris, go before a local Notary Public and take an oath to the effect that the person submitting the list of stations has *personally* listened to the stations named. Also, state in your letter what 30-day "Listening Period" the list of stations is for.

Mr. Amlie's Verified Station List

- GSH—Davenport, Eng., 13.97 m., 21470 kc.—Daily 6 a.m. to 8:30 a.m.
- GSG—Davenport, Eng., 16.86 m., 17790 kc.—Sunday 6:30 a.m. to 8:30 p.m.
- W3XAL—Bound Brook, N. J., 16.872 m., 17780 kc.—Daily 10 a.m. to 4 p.m.
- W2XAD—Schenectady, N. Y., 19.56 m., 15330 kc.—Daily 2-3 p.m.
- FYA—Paris, France, 19.68 m., 15240 kc.—See letter.
- W4XK—Pittsburgh, Pa., 19.73 m., 15210 kc.—Daily 10 a.m. to 4:15 p.m.
- D1B—Berlin, Germany, 19.73 m., 15210 kc.—Daily 9:45 a.m. to 1 p.m. noon
- GSF—Davenport, Eng., 19.81 m., 15140 kc.—Daily 8:45 a.m. to 12:45 p.m. noon.
- I2RO—Rome, Italy, 25.04 m., 11810 kc.—Daily 8-10 a.m., 2-6 p.m.
- FYA—Paris, France, 25.25 m., 11865 kc.—Daily see letter.
- CJRX—Winnipeg, Canada, 25.50 m., 11720 kc.—Daily 8-11 p.m.
- FYA—Paris, France, 25.63 m., 11705 kc.—See letter.
- GSD—Davenport, Eng., 25.53 m., 11750 kc.—Daily 1 p.m. noon to 5 p.m., Sun. morning 12:15-2:15 a.m., heard since April 25, 1934.
- EAQ—Madrid, Spain, 30.43 m., 9860 kc.—Daily 5:30 to 7 p.m., Sat. 1-4 p.m.
- CT1AA—Lisbon, Portugal, 31.25 m., 9600 kc.—Tues.-Fri. 4:30-7 p.m.
- NETE—Mexico City, 31.25 m., 9600 kc.—Daily 7 p.m. to 12 midnight.



TENTH "TROPHY CUP" WINNER

Presented to
SHORT WAVE SCOUT
 OLIVER AMLIE
 Philadelphia, Pa.

For his contribution toward the advancement of the art of Radio
 by



Magazine

● ON this page is illustrated the handsome trophy, which was designed by one of New York's leading silversmiths. It is made of metal throughout, except the base, which is made of handsome black Bakelite. The metal itself is quadruple silver-plated, in the usual manner of all trophies today.

It is a most imposing piece of work, and stands from tip to base 22½". The diameter of the base is 7¾". The diameter of the globe is 5¼". The work throughout is first-class, and no money has been spared in its execution. It will enhance any home, and will be admired by everyone who sees it.

The trophy will be awarded every month, and the winner will be announced in the following issue of SHORT WAVE CRAFT. The winner's name will be hand engraved on the trophy.

The purpose of this contest is to advance the art of radio by "logging" as many short-wave commercial phone stations, in a period not exceeding thirty days, as possible by any one contestant. The trophy will be awarded to that SHORT WAVE SCOUT who has logged the greatest number of short-wave stations during any 30-day period; at least 50 percent must be "verified."

HONORABLE MENTION AWARDS

There were no Honorable Mention awards this month as the other entries besides Mr. Amlie's failed to have the qualifying 50 percent verifications.

- VK2ME—Sydney, Australia, 31.28 m., 9590 kc.—Sun. 6-8:30 a.m.
- W3XAU—Philadelphia, Pa., 31.28 m., 9590 kc.—Daily 12 noon to 8 p.m.
- VK3ME—Melbourne, Australia, 31.55 m., 9510 kc.—Wed., Sat. 6-7:30 a.m.
- GSC—Davenport, Eng., 31.29 m., 9585 kc.—Daily 6 p.m. to 9 p.m.
- W1XAZ—Boston, Mass., 31.33 m., 9570 kc.—Daily 7 a.m. to 1 a.m. next day.
- DJC—Berlin, Germany, 31.38 m., 9560 kc.—Daily 8 p.m. to 11 p.m.
- W2XAF—New York, 31.48 m., 9530 kc.—Daily 6:40 p.m. to 10 p.m.
- GSB—Davenport, Eng., 31.55 m., 9510 kc.—Sun. morning 12:15 a.m. to 2:15 a.m.
- KNRA—Seth Parker, 32.88 m., 8950 kc.—See letter.
- WEL—New York, 33.70 m., 8965 kc.—See letter.
- HC2RI—Quayaquil, Ecuador, 45.00 m., 6666 kc.—Tues. 9:15-11:15 p.m., Sun. 5:45-7:45 p.m.
- KNRA—Seth Parker, 45.00 m., 6666 kc.—See letter.
- W3XAL—Bound Brook, N. J., 46.70 m., 6425 kc.—Irregular 3-5 p.m.
- YV3RC—Caracas, Venezuela, 48.78 m., 6150 kc.—Daily 6:30 to 10:30 p.m.
- CJRO—Winnipeg, Canada, 48.78 m., 6150 kc.—Daily 8-11 p.m. and 11:30-12:30 a.m.
- W8XK—Pittsburgh, Pa., 48.86 m., 6140 kc.—Daily 4:30-10 p. m.

- VE9HX—Halifax, Nova Scotia, 49.01 m., 6110 kc.—See card.
- W2XE—New York, 49.02 m., 6120 kc.—Daily 6-11 p.m.
- YV2RC—Caracas, Venezuela, 49.02 m., 6120 kc.—Daily 8-10:30 p.m.
- W9XF—Chicago, Ill., 49.18 m., 6100 kc.—Daily 3:30 to 10 p.m. and 7-9 a.m.
- W3XAL—Bound Brook, N. J., 49.19 m., 6100 kc.—Mon.-Wed.-Sat. 4 p.m. to 12 mid.
- VE9GW—Bowmanville, Canada, 49.22 m., 6095 kc.—Mon.-Tues.-Wed. 1 p.m. to 10 p.m., Thurs. 2 p.m. to 12 mid., Fri.-Sat. 6-11 mid., Sun. 10:30 a.m.-7 p.m.
- CP5—LaPaz, Bolivia, 49.03 m., 6085 kc.—Daily 7:30 to 10:30 p.m.
- W9XAA—Chicago, Ill., 49.31 m., 6080 kc.—Daily 7-11 p.m., 7-9:30 a.m.
- W8XAL—Cincinnati, Ohio, 49.50 m., 6060 kc.—Daily 7-10 a.m., 6-12 mid.
- W3XAU—Philadelphia, Pa., 49.50 m., 6060 kc.—Daily 12 noon to 8 p.m.
- W1XAL—Boston, Mass., 49.67 m., 6040 kc.—Sun. 6:30 p.m. to 9:30 p.m.
- DJA—Berlin, Germany, 49.83 m., 6020 kc.—Daily 7-11:15 p.m.
- HJ4ABE—Medellin, Colombia, 50.06 m., 5930 kc.—Daily see letter.
- WPN—Rocky Point, N. Y., 58.00 m., 4555 kc.—See letter.
- HCJB—Quito, Ecuador, S. A., 73.00 m., 4109 kc.—Fri. 9-11 p.m.

SHORT WAVES and

Tip-Top Ham Station Operated by

R. B. Parsons, W8BXV

"Prize-winning" station photo awarded One year's subscription to SHORT WAVE CRAFT.



Here's a dandy short-wave transmitting and receiving station, duly licensed and operated by Riley B. Parsons, Amateur call W8BXV, and located at Old Forge, N.Y.

Editor, SHORT WAVE CRAFT:

The transmitter is crystal-controlled using a 210 xtal oscillator, 210 first buffer, 203 a doubler, two 852's in class "C", modulated with a pair of 849's. The modulators are being pushed with a "Pam." 19 amplifier with a 2-stage pre-amplifier coupling the "mike."

The transmitter operates on 20, 75, and 160 meter phone, and has "contacted" all states and districts in U. S. and most of those in Canada. The final output is 740 watts, modulated.

Three receivers are used, each covering all bands, but each working on different bands at all times.

The present layout is the result of twenty-two years in amateur radio!

Radio Station W8BXV,
RILEY B. PARSONS,
P. O. Box 81,
Old Forge, N. Y.

(Fine business, Riley, and a swell-looking station too.—Editor.)

HE BUILT 50 OF OUR SETS!

Editor, SHORT WAVE CRAFT:

I have been putting off this letter for a long time. The object of this letter is to tell you just what I think of your SHORT WAVE CRAFT! I have built at least fifty (50) of your short-wave sets. At the present time I have 8 sets in good shape, all taken from your diagrams. They are all battery sets except the 2-tube Oscillodyne which uses a 47 and a 56. All the sets work fine and when I build a set and it doesn't work, I just take all the wire off and start all over, never getting disgusted. I always figure that I am more apt to make a mistake than you are.

In your last two "mags." I didn't see so many diagrams of sets. Please do not forget that most of the fellows that buy your magazine buy it for the diagrams and not to see Medical Applications in Europe, etc. I know about 20 "fans" that buy your "mag." and they have been disappointed at times.

I built the Harrison 2-Tuber in February and can get England and Cuba when they are on. The reason I built this set was because it was the only set in the book that used type 30 tubes; I am glad I built it now. I could give you a list of all the sets, I have made, but what good would they do you? I would be pleased to see a hook-up of a set (3 tube) using 24 and 27's. You know they still sell them and cheap, too.

C. H. DELLINGER,
12701 Bartfield Ave.,
Cleveland, Ohio.

(For Pete's sake, Mr. Dellinger, you seem to have cleaned up all the "medals" available this month—and we bow real low in salute to your perseverance and interest in building

at least "50" of the short-wave sets described in this magazine! We have built a few ourselves—but 50, well now, that's a poser. Judging from the comments made by our many readers, or at least those that write to us right along, the magazine seems to be fairly well balanced at present, with descriptions of the latest scientific achievements such as medical applications, new manufactured sets, new experimental receivers and also transmitters. We believe that every student of short waves should certainly want to read about the latest scientific applications of these waves, such as the treatment of human ills, etc., and we also feel that we have published more diagrams of new sets in the past 12 issues, than any other short-wave magazine in existence. Thanks for your remarks, and let's hear from you again when you feel in the mood to write.—Editor)

SAYS WE UNDER-RATED OSCILLODYNE 1-TUBER

Editor, SHORT WAVE CRAFT:

Just a word of appreciation in regard to SHORT WAVE CRAFT and Mr. Worcester's brain child, the Oscillodyne, one-tube wonder set.

I find that you have not over-rated the set in your article published in the 1933 April issue, in fact you were rather modest in your recommendation. I have built the model according to specifications with the exception of the 3-9 meg. grid-leak, which I have replaced with a 1 meg.

Within two hours I have heard four National Anthems, French, Spanish, Italian and British today. I have built several sets

in the two-tube class, but I feel that this last is the best achievement by far. No body capacity, no squeals and "one hand" tuning. What a set!

I cannot recommend it too highly to those that would like to build a small set, which is so simple in construction and at such small cost.

I have had the most success with a 27 tube after trying a '30 and a '57. All the above stations came in strong and very clear!

HARRY ARNOLD,
227 Chesterfield Road,
Pittsburgh, Pa..

(We have been accused many times by some of our friends of "over-rating" certain receivers, and it certainly is a pleasant surprise to hear you state that we have "under-rated" the "Oscillodyne" 1-tube receiver. Yes, Harry, the 1-tube "Oscillodyne" has made many thousands of friends and it really is remarkable how "alive" the tuning dial on it really is—there seems to be a million "carriers" around the dial, and the editors found, as you did, that some of the most astonishing long-distance stations come "bouncing" in.—Editor)

AGAIN THE "TRIPLEX 2" WINS!

Editor, SHORT WAVE CRAFT:

Just a line to let you know really how good your sets work out that are diagrammed in SHORT WAVE CRAFT. In reading through your February issue of said "mag." I became interested in Geo. Shuart's Triplex 2-Tuber.

The first week I had it on the air I became interested in police broadcast, and by the end of the week I had "logged" police stations from Miami, Florida, to your fair city, and they totaled 63 in all. After becoming more used to short wave receiving I began pulling in stations galore.

During the past two weeks I have logged broadcast stations in Japan, Bogota, Columbia, South America, GSC in Daventry, England, Buenos Aires on the Byrd Broadcast, 20 meter phones in Honolulu, Porto Rico, and Cuba, and last evening I had the big thrill of hearing VK3ME in Melbourne, Australia. And I haven't even got started yet. Hi!

Have been reading your "CQ" call for station photos, but want to wait until I get another receiver or two to make it look real scientific. Hi! A little later on, I hope to have a photo to send you, but I really want to wait until I get my maps a little more "tacked" up with stations. I wish that you could see my U. S. map showing police and 20 meter phone stations. You see, I use colored thumb tacks, and boy! That map looks like its got the measles.

I am inviting all Hams, S-W fans and "What Have You" to write me; I will answer all letters.

RICHARD B. DUGDALE,
Member of Short Wave
League,
Care Box 66,
Anaheim, California.

(Swell results, Richard, and we shall await the photo of your short-wave listening station with much interest. We are proud, indeed, that you have been able to establish such long wave reception "right off the bat" using the "Triplex" 2-tube receiver. Your exceptionally fine results show, for one thing, that the "Triplex 2" tunes smoothly and also that it has a remarkably fine pick-up.—Editor)

One Year's Subscription to
SHORT WAVE CRAFT
FREE

for the "Best" Station Photo

Closing date for each contest—60 days preceding date of issue; Oct. 1 for Dec. issue, etc. The editors will act as judges and their opinions will be final. In the event of a tie, a subscription will be given to each contestant so tying.

LONG RAVES • • • OUR READERS' FORUM

WANTS MORE "2-SUPER-HET" DOPE

Editor, SHORT WAVE CRAFT:
You're putting out a swell magazine; I hope it lasts. Also I would like to see more of your "fiction"—I think it is swell.
I haven't my "Ham Ticket" (license) as yet, but I hope to have it soon. (W6-s please copy). The trouble lies in that I have not the right receiver. The two-tube "Super-Het" looked good to me, but I am afraid that the distance on the ham stations would not be so good.
So how about a PART II on the super-het job with a good beat oscillator, tuned R.F. and an extra A.F. amplifier. I live about five miles from the San Francisco Bay and there are no highways or heavy auto traffic, but behind the house there are three Eucalyptus trees about fifty feet high and ask any "Aussie" what that will do to radio reception.
VINCENT BASHORE,
707 Rosemount Rd.,
Oakland, California.

(Thanks for your letter, Vincent, and we'll endeavor to get one of our technicians busy on the "Part II" addition to the 2-tube super-het receiver.—Editor.)

EVERETT DILLINGHAM, W9LMJ, HAS A NEAT STATION

Editor, SHORT WAVE CRAFT:
Herewith a picture of my station. The transmitter, located on the left, is xtal-controlled using a 47 Tri-tet circuit, 46 Buffer, and 210 push-pull final stage.
The receiver is the "A.C. Band-spread" described in the February 1933 issue of SHORT WAVE CRAFT. The receiver is a dandy and its method of band-spreading is still the leading method. I have been following SHORT WAVE CRAFT and George W. Shuart's articles ever since.
The monitor is next in line and my home-made bug (also from SHORT WAVE CRAFT) appears in the foreground.

The microphone is a double-button type that I have used only for 10-meter work. I intend to use it on 160 meters this fall; for modulating my 210's.
I will appreciate any correspondence from amateurs or SWL's or any questions about the photo. I would have liked to have asked a lot of questions about some of the photos published. That department sure is interesting.

Well, 73 and Best of DX for SWC's receivers. EVERETT DILLINGHAM, W9LMJ,
612 E. Jefferson St.,
Bloomington, Ill.

(We are glad that you found the data given in SHORT WAVE CRAFT valuable, Everett, and we hope to present many new features which you will find both interesting and worth while building.—Editor.)



Everett Dillingham's "Ham" station, equipped for transmitting and receiving, is typical of the thousands of experimental short-wave stations in daily operation across the country, and which handle traffic messages over unbelievable distances.

J. B. Vassallo—A Live Short-Wave Fan

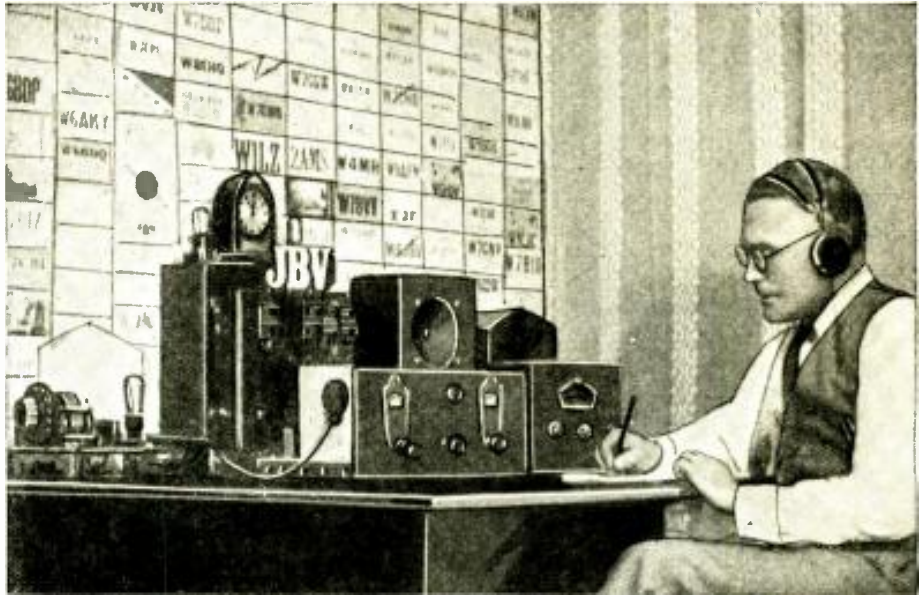

Mr. Vassallo occupies his spare moments when not listening to short-wave programs from stations thousands of miles away, by pounding out the dots and dashes of the radio code by means of the key and oscillator shown on the left of the table. He expects to obtain an amateur license soon.

Editor, SHORT WAVE CRAFT:
Being desirous of joining in with the other contestants of SHORT WAVE CRAFT for the prize of one year's subscription to that wonderful magazine and awarded monthly to the "best" station photo, I take pleasure in sending you herewith a very recent picture of my receiving "shack."
The instrument on the extreme left corner of the table, is an oscillator and key used for code-sending practice. The receiver next to the Super-Wasp, is the Detroit S.W. converter which works in conjunction with the B.C. midget shown right behind it.

I am very interested in Amateur ("Ham") work and I earnestly intend to join the great "Ham" fraternity in the near future, and before I am too old to "pound brass." I can copy code at a little higher speed than it is required to pass the government test, but I would like to reach up to the 20-word mark before I go on the air.

As I have stated once previously, I have the honor of being one of the very first readers of SHORT WAVE CRAFT, having bought its first issue. And I have been getting my copy at the stand regularly

every month ever since. Other publications of yours I have in my possession are the two issues of OFFICIAL SHORT WAVE LOG AND CALL MAGAZINE and HOW TO BECOME AN AMATEUR RADIO OPERATOR. The latter, I think, is the greatest book of its kind ever published. And every prospective Amateur should get one without delay.

Whether a winner or not in this contest, I would like very much to have the enclosed photo published in *Short Waves* and *Long Raves* section of SHORT WAVE CRAFT for the benefit of my many friends of the Amateur fraternity who were so kind and courteous in answering my SWL cards, and who probably would like to see what this short-wave listener and his "receiving den" look like.

J. B. VASSALLO,
966 Pennsylvania Ave.,
San Francisco, Cal.

(Congratulations J. B. V., and we are sure you will soon be "pounding brass" and the proud owner of one of Uncle Sam's amateur station "tickets" (licenses). Its great sport. Thanks for your good word on our book on amateur operating and let's hear from you again.—Editor.)

HE ROLLS 'EM IN ON A "REVAMPED" SET

Editor, SHORT WAVE CRAFT:
I bought my first issue of SHORT WAVE CRAFT way back in the summer of 1930, and I still think that it is the best "mag." on the market, bar none. This is the first time that I have written to you, but I have been getting such good results from the set that I built, I thought you might like to hear about it. Here's a few stations that I have "logged" with it:

- | | |
|-------------------------------|------------------------------|
| W1XAL—Boston, Mass. | GSC—Davenport, Eng. |
| OX7RL—Copenhagen, Denmark | OXY—Skamleboak, Denmark |
| WOY—Lawrenceville, N. J. | FYA—Pontoise, France |
| RW15—Khabarovsk, Siberia | GBC—Rugby, England |
| VE9BY—London, Ontario, Canada | VQ7LO—Nairobi, Kenya, Africa |
| XD—Mexico City, Mex. | VUC—Calcutta, India |
| HJ4ABE—Medellin, Colombia | TI4NRH—Heredia, Costa Rica |
| EAQ—Madrid, Spain | CT1AA—Lisbon, Portugal |
| LSG—Buenos Aires, Argentina | RV59—Moscow, U. S. S. R. |
| | J1AA—Tokio, Japan |

- | | |
|------------------------|---------------------------|
| HVJ—Rome, Italy | PRAG—Porto Alegre, Brazil |
| PCV—Kootwijk, Holland | DJA—Berlin, Germany |
| DJB—Zeessen, Germany | HBP—Geneva, Switzerland |
| CP4—Lapaz, Bolivia | land |
| CT3AQ—Funchal, Madeira | FTM—St. Assise, France |
| PHI—Huizen, Holland | FZS—Saigon, Indo-China |

Also a large number of other stations from every state in the United States, also from Canada and Mexico. This set I am speaking about is one that I developed from one of the old battery sets, so that I could use it on A.C. I use it as an adapter for my Crosley "Dual 5" broadcast receiver. If any of your readers would like to try this set out, I will be glad to give them all the information they want if they will send me a stamped envelope. I call this set, "The Depression Surprise." As I do not care to have my real name in print if you should care to publish this, I will sign,

RADIO "IKE,"
Lancaster, Mass.

P. S. If anybody wants the hook-up, you (Continued on page 492)

S-W Receiver

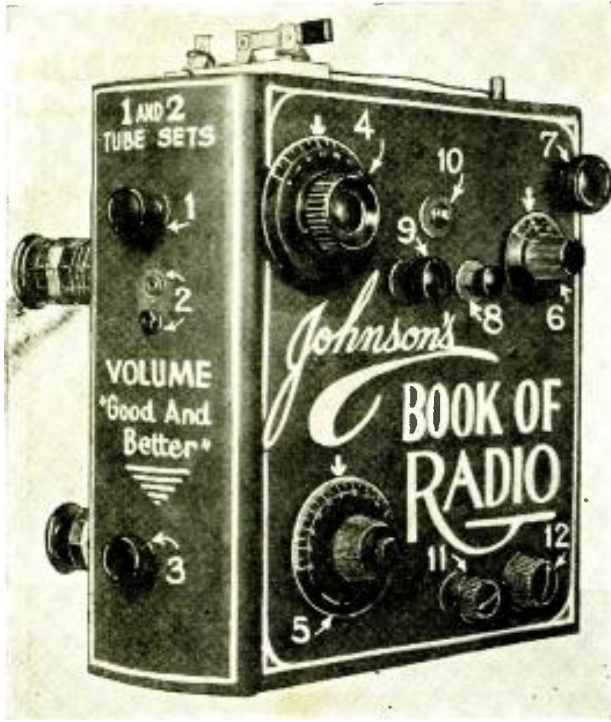

● The author here provides a design for a very novel, as well as useful "Book of Radio." Two complete sets are incorporated in Mr. Johnson's "book" cabinet, the first being a 2-tube hook-up and the second, a Duo-Amplidyne circuit using a 19 tube.

The short-wave "Book of Radio." The controls: 1—Duo-Amplidyne (D-A) "tank," 2—D-A phone jacks, 3—2-tube "tank" control, 4—D-A Band-Spread, 5—2-tube Band-Spread, 6—Antenna Control (2-gang condenser), 7—Switch on Antenna Coupler, 8—Filament Switch on D-A set, 9—50,000 ohm potent., 10—rheostat, 11—potent., 12—rheostat with switch.

pet circuits in one "table space" or set space. Both powered by one set of batteries, one to operate a *speaker* if desired and one for *headphone* use in the "wee small hours."

It allows us to enclose our sets, keeping out dust, etc., and gives us outside coil mounting, but the big feature lies in the fact that it automatically shortens those vital leads to a minimum and affords proper layout for high efficiency. We don't have to worry about our plate leads being too close to our grid circuit, et cetera.

Then, too, we find our coils are shielded from our condensers, which in turn are enclosed in a metal case.

We have been able to keep our tubes setting upright, our condenser knobs in a handy position, our coils easy to mount—without opening a lid or door—and have shortened our leads to a further extent than circuits which were designed for "lead shortening," at a

● DID you ever stop to think how inconvenient it is to have a table full of short-wave sets to move around when cleaning the house daily? Of course you didn't, but I'll bet your wife or mother did! I'll also bet she wished they looked a little neater, as if they belonged in the living room. When the Missus brought these things to my attention, I began to

figure out another style of set, and in so doing hit upon an idea which provided so many methods of improving efficiency in reception that I want to pass it on to you. To start with, a cabinet built to resemble a *book* looks good in any living room or den, and this book-shaped cabinet opens up real possibilities. It permits us to house two of our

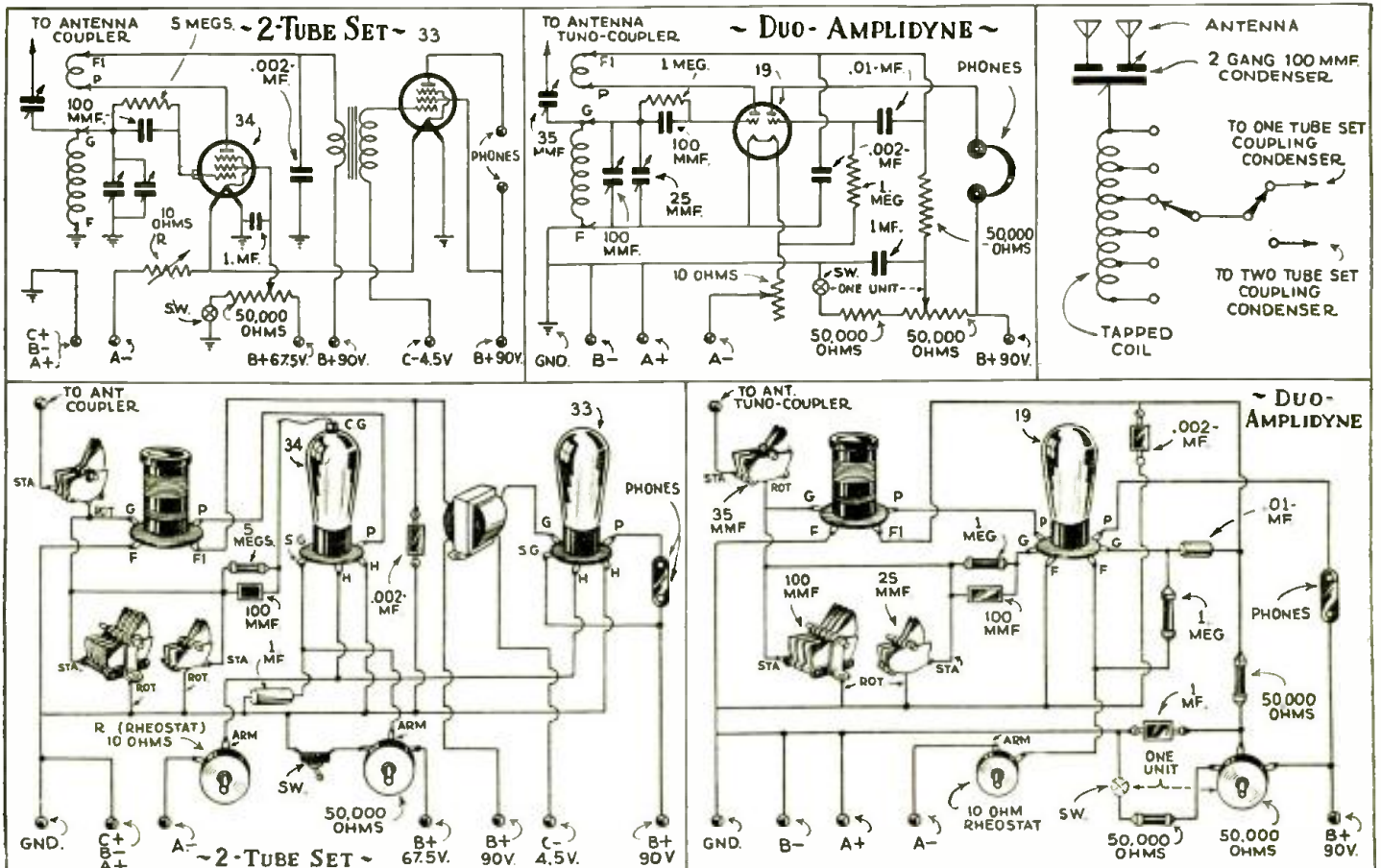

Schematic, as well as "picture" wiring diagrams for the 2-tube battery receiver and also the Duo-Amplidyne "19" receiver appear above

In BOOK FORM

How 2 Complete Sets Were Housed in Book Style Cabinet

By HEINIE JOHNSON

THIS MONTH'S \$20.00 PRIZE WINNER



sacrifice of some of the above features.

Duo-Amplidyne Circuit Used

While any circuit could be used, the writer selected the *Duo-Amplidyne* (recently described in the pages of *SHORT WAVE CRAFT* by George W. Shuart, its designer), to grace the upper shelf of the case, and a very simple 2-tube circuit employing a 34 detector, with transformer-coupled 33 audio to set on the bottom shelf.

The only changes made in Mr. Shuart's *Duo-Amplidyne* circuit were the insertion of a 100 mmf. and a 25 mmf. condenser instead of the 140 mmf. condenser, and the use of a 1 mf. bypass condenser instead of 0.1 mf. between the rotor of the regeneration control and "B" minus.

The first change was made to afford *band-spread*, as shown in diagram, while the other was necessary to reduce noise caused by the regeneration control.

These two circuits were chosen to facilitate complete coverage of all bands, inasmuch as the *Duo-Amplidyne* will operate at a higher frequency than will most circuits, while the set on the

The "innards" of the dual short-wave receiver built in "book" form by Mr. Johnson. The "C" battery is included with the other apparatus housed in the metal cabinet shaped to resemble a book.

bottom shelf will serve "mighty fine" for listening to frequencies between 25 and 200 meters.

Band-Spread Provided

It will be noted that band-spread is incorporated in both circuits. Some trouble may be encountered with the 34 tube going microphonic in the 2-tube circuit, but this is not as apt to happen as when the same circuit is wired on an ordinary chassis; in most cases it can be stopped by slight adjustment of the filament voltage. If this fails a change of tube is advised. A 32 will operate fine and nearly equal

the results of the 34; no wiring changes being necessary. The grid-leak and condenser in the grid-lead is suspended between the stator of the tuning condenser and grid cap of the detector tube. No wire other than condenser "pig-tails" will be needed here. This is a feature of the entire hook-up in either circuit (meaning *short leads*) made possible by the unique shape of cabinet.

(Continued on page 496)

An Ultra-Simple Modulation System

● IN order that I may show you that this will really work, and work well, I will merely say that I have QSL cards from a station in Bondsville, Mass., and one in Lorain, Ohio, which I worked one night in a three way contact on 160 meter phone a year or so ago from Chicago, from my station W9KRI. The reports were—from W1KK QSA 4 R 6 Tone quite good; from W8HBI T8, QSA 5 R 6. That is the only dx I can show, as I never tried it again. I built it that night, and tore it apart the same night fired by my luck to make a more pretentious modulator. The other day I hooked it up again, to test it before writing this article, and it worked fine during a few local contacts. The surprising thing was that during the first mentioned contact with Bondsville and Lorain I was using a 45 oscillator and a 45 final (not crystal), with 180 volts on them and my input was less than *two watts!* I know of a case where another ham used it on 20 meter phone, and worked several foreign countries with it, modulating a 50 watt tube in the final.

The total material necessary to change from CW to phone is one microphone, 1 microphone transformer, one 56 tube (or a 27), one 2000 ohm resistor, one 1/2 mf. condenser, and one socket for the tube. All of these parts are cheap, and most hams probably have them on hand. The circuit is

By Jerrold A. Swank, W8HXR

self explanatory, I think. The two leads are inserted in place of the regular grid-leak resistor. In the case of

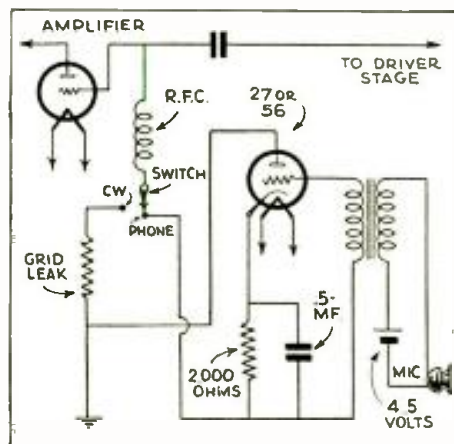

A Simple 1-tube Modulator for MOPA transmitter.

a pair of 46s in a final, the grid-leak resistor is only 1000 ohms or less, and therefore you may leave it in, and merely insert the leads in place of the key if it is being keyed in the grid lead, as most operators key their 46s. As you can see, the tube becomes a variable

grid leak, with the variations in grid current being changed by the voice currents applied to the grid of the 56 tube. It is very easy to obtain high percentage modulation. In fact, it must be carefully watched to prevent overmodulation. The drawback to it is the same as with all forms of grid modulation, that you must run the tube at 25 per cent of its rating so that there will be capacity for the modulation peaks of 4 times the carrier power. So a pair of 46s that normally run at 50 watts input on CW will only give 12 1/2 watts on phone, but that 12 1/2 watts will be fully modulated. Overmodulation can be detected easily in two ways. First, the plate meter must not flicker. Flickering of the needle indicates overmodulation. Also, by listening to the speech (as you talk) with a pair of phones attached to a monitor, the quality will show overmodulation quickly with this method. It will get a rough rasping quality. The proper way to adjust it is to set the excitation for your final stage so that modulation gives the maximum *increase* in current when you talk. However, I have always had good luck just sticking it in the keying jack and talking and listening on my receiver. This may not give you all the efficiency obtainable, but everyone does not have an antenna ammeter. My experience has been that the tube drops the input very nearly

(Continued on page 493)



Model boats, as well as planes and other moving objects, can be controlled or "directed" from a small transmitter as here described.

A Simplified RADIO CONTROL System

By REX E. LOVEJOY, W5AFC*

● An ingenious system of "radio control" suitable for directing model boats or other moving objects. Control signals of different pitches or sounds are transmitted by a self-modulated oscillator, while several suitably tuned audio-receiver circuits are employed, together with sensitive relays, to interpret the received signals.

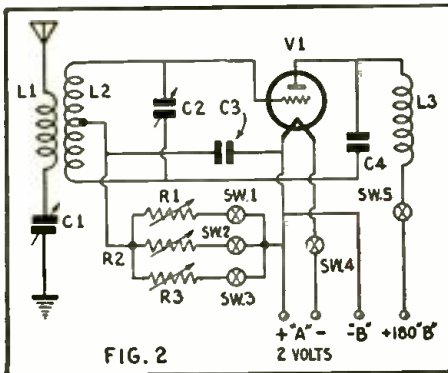

Self-modulated oscillator used at transmitter, showing how different values of grid-leaks are used to obtain signals of various pitches.

● Radiodynamics, or the study of control by radio of moving objects such as cars, planes, etc., at a distance, has had little mention in radio annals during the last few years.

There are several reasons for this. Remote control by radio has been heretofore too costly, too slow, and above all, too unreliable and troublesome.

Herein is described a method that is actually simple and inexpensive. Most of the relays with sticking contacts have been eliminated, there is no revolving switch-arm to slow down the action, no signal lights necessary, and action is *instantaneous!* This is of vital importance since radiodynamics deals with moving bodies.

While the apparatus described here was entirely battery operated, in view of the fact that a radio-controlled car or boat must of necessity fall into this class, there is little that cannot be altered or changed to fit a particular contingency. Change over to a.c. operation would be easy if the case permits, and a substitution of tube types would not alter operation in the least.

There is no trickiness, no crank circuits. The important point is the

theory of operation (which has been proved practical to a very satisfactory degree), and the apparatus includes no special equipment that cannot be found in stock at any radio parts dealer.

The Transmitter

Figures 1 and 2 give schematic diagrams of the receiver and transmitter, respectively. At first glance, it is seen the forepart of the receiver is the old reliable regenerative detector with two stages of audio. Following the two audio stages, are two or more tuned audio amplifiers arranged in isolated circuits. These are designated in Fig. 1 as V4, V5, and V6.

The theory of operation now becomes apparent. Since the input to one of these amplifiers is tuned to an audio frequency entirely its own, a relay placed in the plate circuit will operate

(Continued on page 489)

*President RADIO TECHNOLOGICAL COLLEGE.

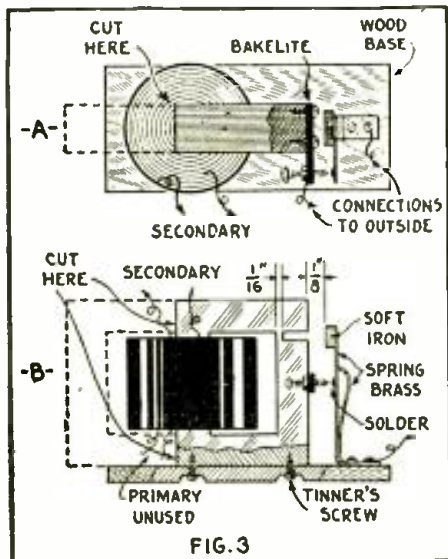

Fig. 3, above, shows simple yet effective design of relays used in radio control system.

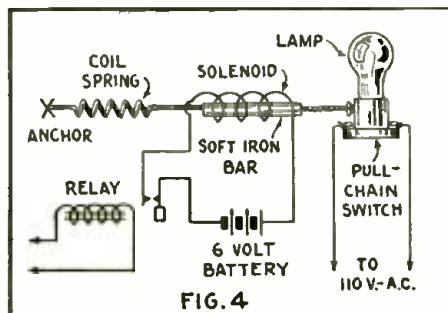
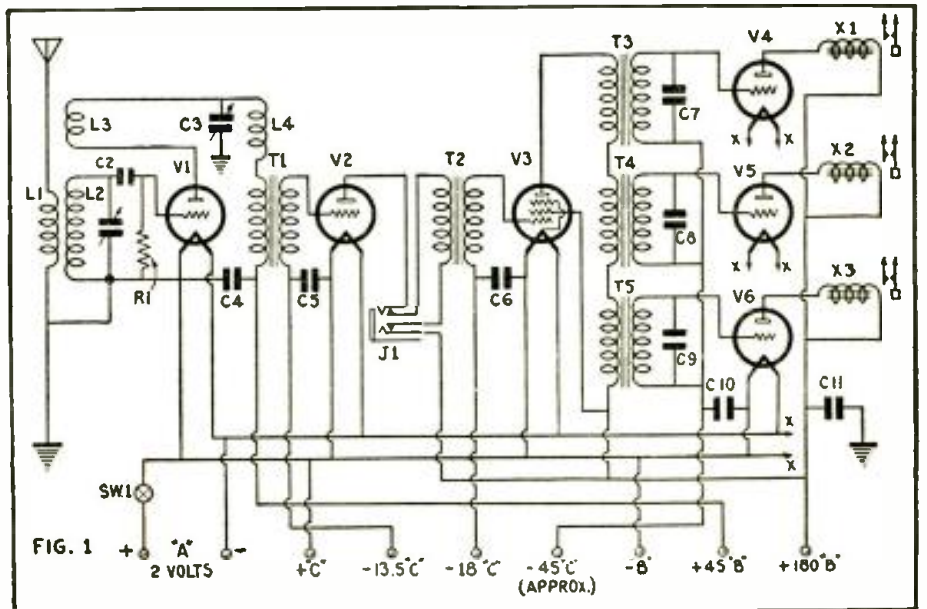

Fig. 4—Detail of solenoid magnet suitable for operating pull-chain sockets, etc.



Wiring diagram of the radio control receiver showing three tuned audio circuits with their respective relays.

A Low-Powered De Luxe Transmitter

By JERROLD A. SWANK, W8HXR

● Mr. Swank here presents a modern crystal-controlled transmitter, having an output of approximately 25 watts. It is crystal-controlled and is designed to work on either 80 or 160 meters. By substituting other coils and crystals this transmitter can be worked on all bands.

● This transmitter was inspired by a desire to prove that a transmitter need not be a bread-board outfit, "strung all over the table," in order to be efficient, and that it could be *good-looking* as well as *efficient*, and in several ways its good looks actually contribute to its efficiency. I have called it a *low-powered transmitter*, but it has an input to the final stage of 35 watts, and can be run as high

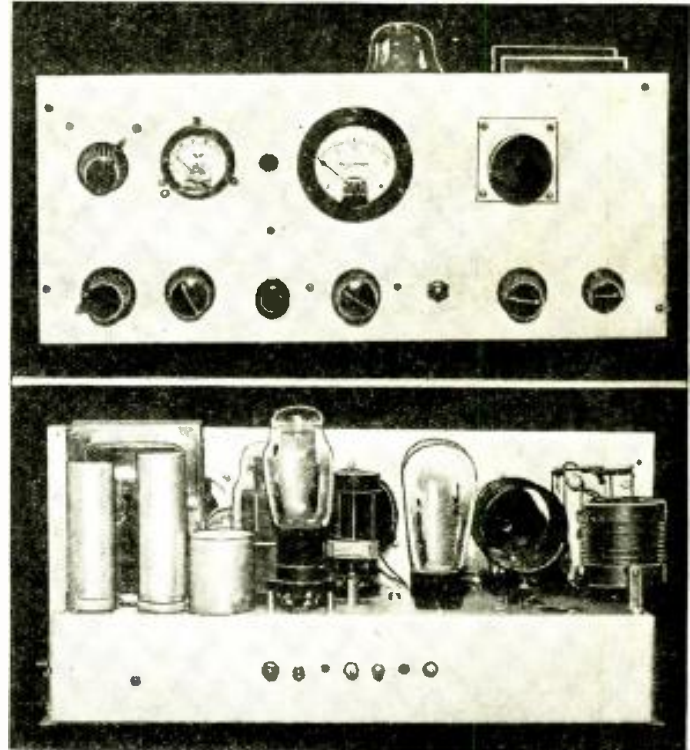

The above front and rear views clearly show the placement of the various parts in this modern, crystal-controlled transmitter.

as 50 watts. However, I never actually use it regularly any higher than 35 watts input. The reason for this is that the tubes run better, the note is better, and the difference in input does not make any appreciable difference in the reports from stations worked. The output is such that it lights a 25-watt lamp bulb to full brilliancy when connected as a dummy antenna to the final tank.

Tests Proved Signal Quality

Three out of four stations comment on the unusual pureness of the crystal note. I have never received less than R7 anywhere in the USA, on 80 meters and have several R9's in western Canada and California. This was done with a single wire antenna, 118 feet long (and loaded to the necessary 133 feet with a coil), 7 feet high at the near end, and 20 feet high at the far end, and it runs 30 feet of its length through two maple trees with the leaves cut away so as not to touch it. This is the practical proof that it does get out in spite of antenna disadvantages and the fact that it apparently violates all the rules of efficiency in a transmitter. I say "apparently" because when I finish you will see that great care has been taken to make it fully as efficient as the bread-board type. It is the result of two years of building and testing and rebuilding, and is the eighth transmitter I built in this time before I got one that completely satisfied me.

Chassis Details

The chassis is of sheet steel; and the dimensions are shown in Figure 1. Figure 2 shows the completed chassis with locations of socket holes and other necessary holes. Have a tin shop cut and bend the chassis for you and you will get a very neat job at a small expense. Figure 3 shows a bottom view of one corner. The corners are fastened to aluminum angles the same height as the chassis height—3". Figure 4 shows the corner view with the machine screws holding the angle to the chassis. This makes a very strong chassis. On the front side, of course, the panel and chassis and corner piece are all bolted together. Here is a simple and very satisfactory way to cut all socket holes. Get a good 1 1/4" wood bit and file it as shown in the sketches in Figure 7. Then drill a pilot hole big enough to admit the point of the wood bit in the chassis, insert the point of the bit, and take a few turns so that a groove is started in the metal. Then put a little oil in the groove and drill with moderate pressure evenly until it cuts through. It cuts almost as if the chassis were cheese instead of steel. It takes less than a minute per hole. I also used a similarly filed bit 3/4" in size to drill holes for the electrolytic condensers. These two bits are always useful in building any transmitter, receiver, or power pack, and will repay their cost many times over in labor saved, and make you resolve

(Continued on page 485)

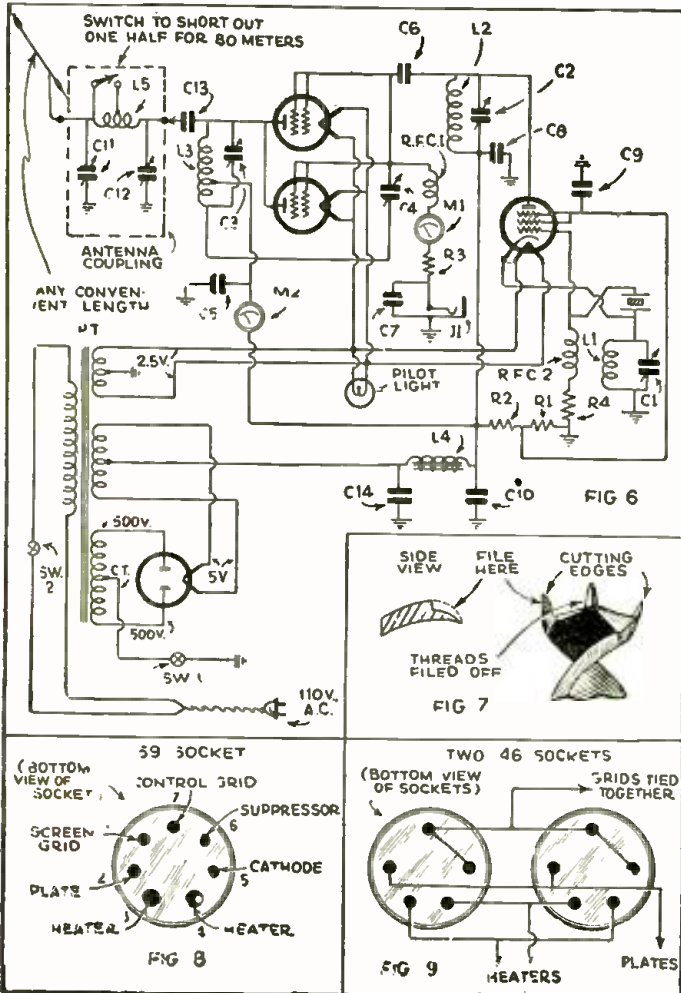

Here we have a complete drawing of the Swank 25-watt, crystal-controlled transmitter.

WHAT'S NEW In Short-Wave Apparatus

The short-wave apparatus here shown has been carefully selected for description by the editors after a rigid investigation of its merits

All-Wave 8-Tube Super Has Band-Spread

• This 8-tube superhet uses type 57 tubes for separate I.F. oscillator and first detector, two stages of high-gain intermediate frequency amplification on 465 kc., using 58s, a 56 second detector, a 56 C.W. beat oscillator, and a single power pentode 2A5 output. The rectifier tube is an 80.

The antenna is inductively coupled to the first detector through a low-loss tuned circuit, which has been designed to minimize image interference. The coils are doubly shielded from external pick-up, there being a heavy metal shield around the coils themselves, this in turn being inside the all-metal cabinet. Thus the only way a signal can reach the grid of the first detector is through the circuits provided for this purpose. This results in

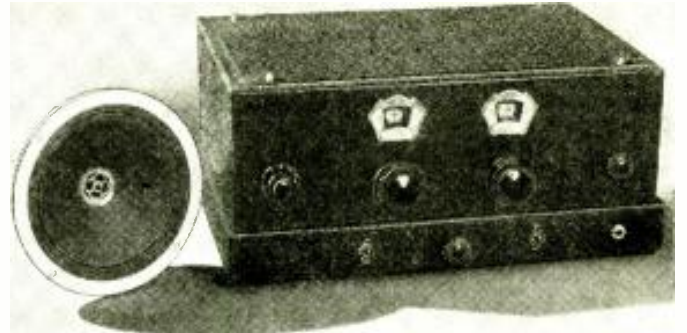

Above—the new Sargent 8-34 superhet; diagram below. (No. 227)

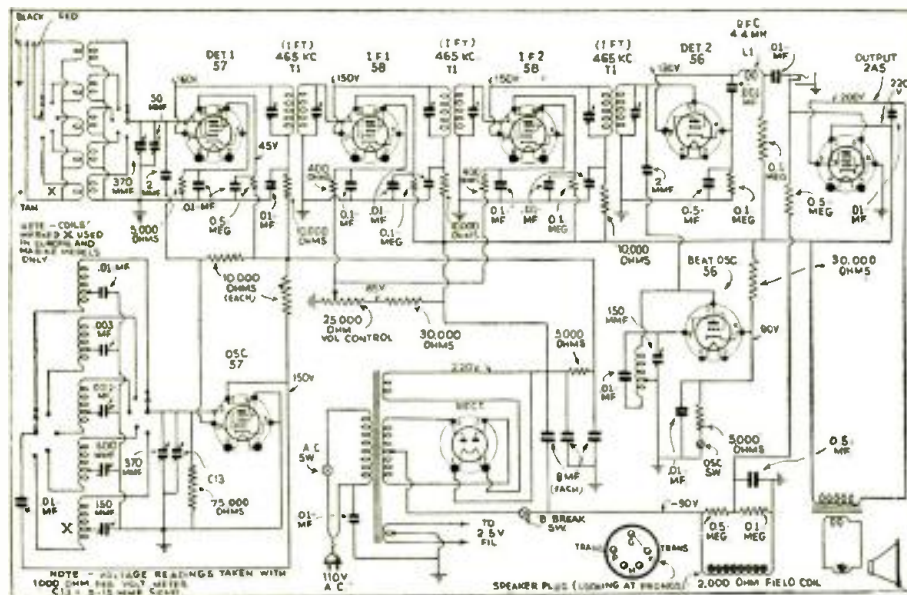

reduction of background noise and great improvement of the signal-to-image ratio.

The H.F. oscillator is electron-coupled to the first detector. The oscillator itself is very stable, there being no adjustments which could cause frequency creep.

Unusual care has been taken in the design of the intermediate frequency amplifier. This is the heart of any super, the I.F. amplifier determining the selectivity, gain and noise-level of the entire receiver. Almost complete freedom from feed-back in the I.F. circuits gives a degree of stability that is surprising in a high gain 465 kc. amplifier; the I.F. coils are Litz wound.

The 56 second detector is extremely sensitive and supplies enough power to the audio stage to work the 2A5 to its limit of undistorted output. Resistance coupling is used between the detector and output stage for good quality.

The standard model of the 8-34 receiver covers a tuning range of 20,000 to 540 kc. or 15 to 560 meters. For those desiring also to cover the airplane beacon and weather report frequencies, the Marine model is available. This has a continuous tuning range of 20,000 to 200 kc.



3-Tube Set Has Own Power Supply

Left: This front view clearly shows the neat appearance of the 3-tube "Anker Cruiser." Circuit diagram of the "Anker Cruiser" appears below together with the values of the various parts. (No. 228)

nections to a speaker, if one is desired. The jack in the front of the set cuts off the terminals in the back when the phone plug is inserted. The circuit diagram and values of various parts are also shown.

The large full-vision tuning scale is illuminated by the tuning light, which is shunted across the 500 ohm section of the line voltage-dropping resistor. The tuning dial is of a high-ratio variety, affording a form of band spread. Four coils are used to cover the short-wave range from 15 to 200 meters. Other coils, of course, are necessary to cover regular broadcast band.

• The set shown in the photograph is a completely self-contained receiver, including the power supply. The tubes used are 6C6, as detector, a 43 pentode, as the amplifier, and a 25Z5 rectifier. The circuit of the Anker Cruiser is of the A.C.-D.C. variety and is exceptionally well-filtered, reducing the hum to an extremely low value. The convenient method of changing the plug-in coils, by inserting them through the front of a panel, overcomes considerable inconvenience inasmuch as the operator does not have to reach into the cabinet each time the wave-bands are changed.

There is no danger of damaging the winding of the plug-in coils as they are inserted or removed from the socket because the winding is contained within the coil form. The coils are wound on a small bakelite tube which fits snugly inside the coil form, thus providing a thoroughly protected coil.

It covers a complete range of approximately 15 to 550 meters. A phone jack is provided in front of the cabinet and there is also an output terminal strip on the rear of the chassis for con-

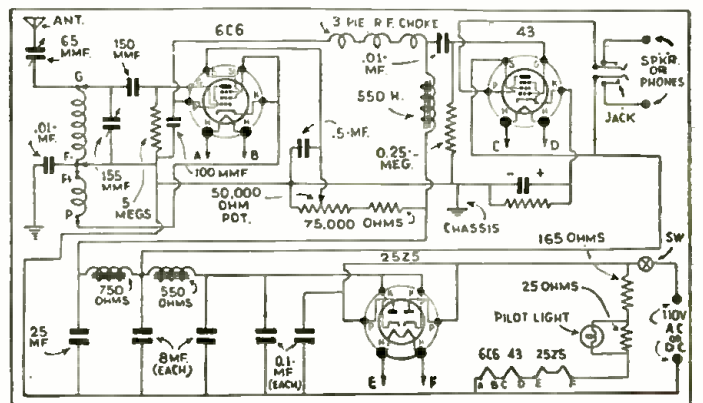

Names and addresses of manufacturers of sets described on this and following pages furnished upon receipt of stamped envelope; mention No. of article.

Mascot-5 Has "Band-Spread"

● THIS modern 5-tube short-wave receiver is exceptionally well-designed. Some of its features are: one stage of tuned R.F., two-gang tuning condensers; a phonograph pick-up attachment by which phonograph records can be played through the audio amplifier portion of the set. It has a phone-jack which provides earphone reception on the first stage of audio. It is all A.C. operated and is capable of working a dynamic speaker at full volume. It has *band-spread* on any portion of the range that this receiver will cover. It also has provisions for using either the conventional or "doublet" antenna. The tubes used are as follows: a 78 "high-gain" tuned R.F. pentode, which is inductively coupled to the 37 regenerative detector. The detector is resistance-coupled to a 77 pentode audio amplifier and this in turn is resistance-coupled to a 42 power output pentode. All the tubes, except the 280 rectifier, are of the 6.3 volt variety. All the circuits in this set are carefully isolated with resistors, eliminating all possibility of reaction or feed-back, either in the radio frequency or audio frequency portion of the circuit. Regeneration is controlled by a 2000-ohm variable resistor, which is connected in series with a .001 mf. plate by-pass condenser. The power supply is designed to provide excellent regulation with complete filtering eliminating any danger of A.C. hum. In the power supply, provisions are made for the use of a dynamic speaker, the field of which operates as one of the filter chokes. If a dynamic speaker is not used, a 2,500 ohm resistor is connected

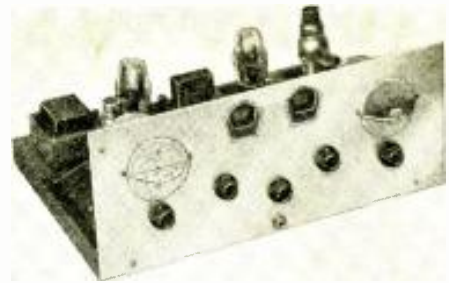

Right-front and rear views of 5-tube Mascot receiver; has a stage of tuned R.F. detector and two stages of audio, completely A.C. operated. Dynamic or magnetic speaker can be used.

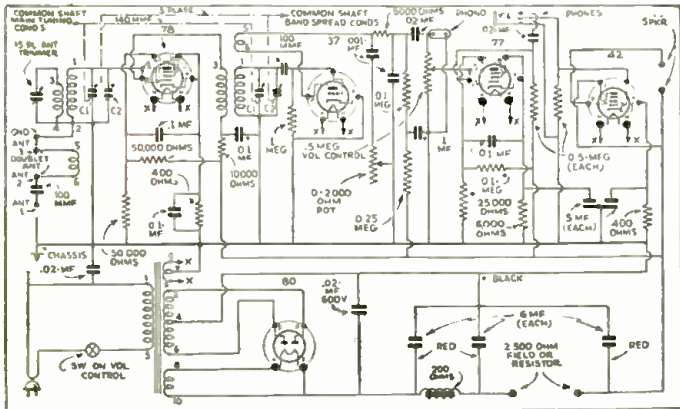

Above—wiring diagram showing the values of the various parts used in this 5-tube band-spread, short-wave receiver. (No. 229.)

in place of the field. In this case, of course, a regular magnetic affair would be used. A one-half megohm potentiometer is conveniently placed in the input circuit of the first audio amplifier and very effective control of volume can be obtained. The plug-in coils, there are two for each wave band, plug in directly through the front of the panel. Thorough shielding of the coils is obtained with the aluminum housing surrounding each coil. Each plug-in coil has its winding protected by a bakelite case in order that no damage may be done to the winding while they are being changed. Two dials are situated on the front of the panel; one controls the 140 mmf. *band-setting* two-gang tuning condenser, while the other controls the two-gang, 5 plate band-spread condensers. The tuning is accomplished by setting the left-hand dial to the band in which you wish "band-spread"; further tuning then is done with the band-spread dial. Each of these dials is thoroughly illuminated.

A Pre-Amplifier With Band-Switch— By H. B. Russ, W2QZ

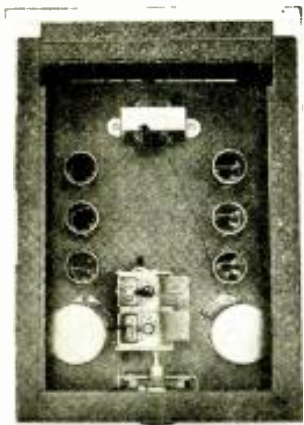

Looking into the Peak pre-amplifier unit. (No. 230)

● PRE-AMPLIFICATION, and its inherent pre-selection, is the only known method today of accomplishing our long-desired results. This it does to the extent of a very marked increase in overall gain. The word "pre-amplification" is almost self-explanatory. Pre-amplification is that process whereby a feeble radio-frequency current (picked up via the antenna) is increased in magnitude by virtue of the associated circuits in the pre-amplifier.

Pre-selection, which is a characteristic produced by pre-amplification due to its highly resonant circuit constants, is that definite and highly desirable characteristic of selecting a signal of a particular frequency and discriminating against signals of frequencies other than

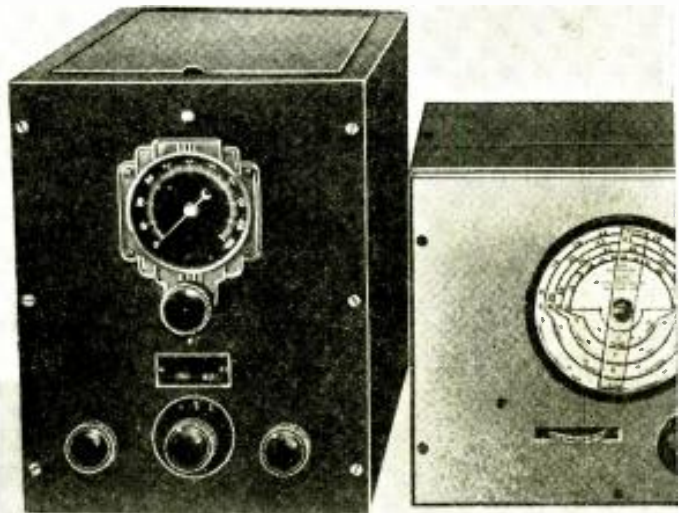

Here's the pre-amplifier connected to a short-wave receiver.

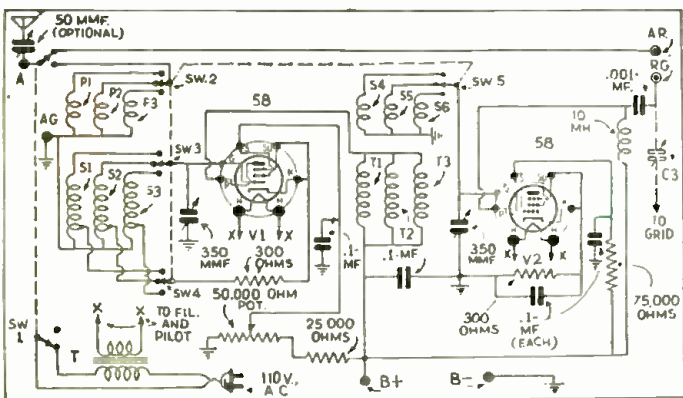

Wiring diagram for the new pre-amplifier with band-change switch.

the frequency tuned to in pre-amplification. Thus by pre-amplification and pre-selection we have at once accomplished several important and desirable results: 1. Tremendous increase in signal gain. 2. Consequent increase in sensitivity. 3. Absolute rejection of image or repeat spots. 4. Considerable increase in selectivity, and 5. Reduction of noise to signal ratio. Looking back on radio history we find that regeneration has been one of the greatest developments in radio, and until today remains so. The technical definition of regeneration follows: "The process by which a part of the output power of an amplifying device reacts upon the input circuit, in such a manner as to strengthen the initial power, its result being an increase in amplification."

So with the addition of a variable re- (Continued on page 491)

Improved S-W Booster

● IN order that greater gain and selectivity could be obtained in the *Postal Booster*, a change was made in the power supply. Instead of using the well-known, A.C.-D.C. principle, this new *booster* is designed to operate entirely from A.C., enabling a considerably higher plate voltage to be obtained for the tubes. In a previous model, little more than 90 volts was applied to the plates while in the new booster, close to 200 volts is applied to the

This booster has its own volume control which is located in the cathode circuit of the first detector, thus affording excellent control of gain in the booster itself, regardless of the setting of the volume control in the receiver. The tubes used are of the 6.3 volt type. 78's are used in the R.F. stages, and a 37 is used as a half-wave rectifier in the power supply. Sufficient filtering is incorporated in the power supply to render the booster entirely



This photograph clearly shows the neat appearance of the improved "Postal Booster." (No. 231)

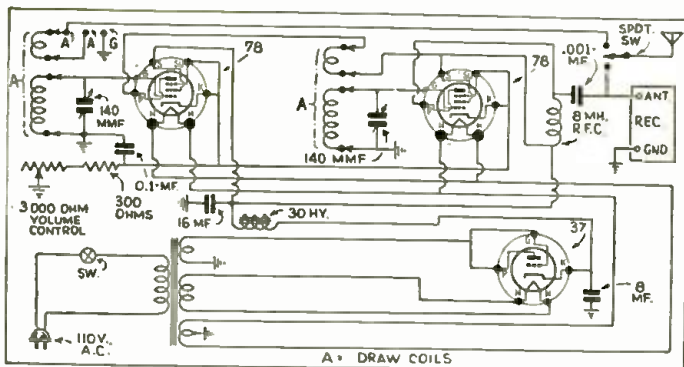

Above, we have the circuit diagram showing the improvements brought about in this new "Booster."

two R.F. tubes, providing a considerable increase in effectiveness in so far as *gain* and *selectivity* are concerned. Its general appearance is the same as the original booster, although the cabinet is slightly larger. The draw type coils, of course, are still retained for changing bands.

ceiver. In the other position the antenna is disconnected from the receiver and attached to the *input* circuit of the booster. The *output* of the booster is then connected to the *input* circuit of the receiver. The ground connections are left intact at all times. The *output* of the booster is coupled

"humless." it is a single-control affair, using a two-gang, 140 mmf. condenser controlled by a large illuminated "air-plane" type dial. The switch located on the front of the panel will throw the booster either "in" or "out" of operation. When the switch is thrown in one position, the booster is disconnected from the receiver, and at the same time, the antenna is transferred from the booster over to the input of the receiver.

to the receiver through a .001 mf. mica condenser, the 8 m.h. R.F. choke providing the necessary load circuit for the 78 second R.F. amplifier. Inductive coupling is used between two R.F. stages for maximum selectivity and highest "gain."

The use of this booster will aid considerably in bringing in those extremely weak stations and should also serve efficiently where normal background noise is very high, inasmuch as the signal strength will be far higher than that normally obtained with the receiver.

"Steatite" Insulation Featured in New Products

● HERE we have three new products all of which use *steatite* insulation. In the upper left-hand corner we have the plug-in coil-form made of this very efficient insulation and they are supplied in either 5- or 6-prong models to fit the new National *steatite* sockets. These coil forms should aid considerably in constructing low-loss plug-in coils. To the right of the coil form is the new flexible coupling for use with 1/4 inch shafts. This is especially useful where transmitting condensers are

ganged and where very high voltage insulation is necessary. They can also be used in receivers where the rotors of the condensers are above ground potential and where a very high grade of insulation is necessary. The variable condenser shown in the lower part of the illustration is the new type TMC transmitting condenser in which *steatite* insulation is used. The plates of this condenser are highly polished to reduce any possible losses which would occur if the plates were left rough. The voltage rating of this condenser is 3,000 and can be used in medium-power transmitters of small dimensions where the larger type condensers would take up too much space.

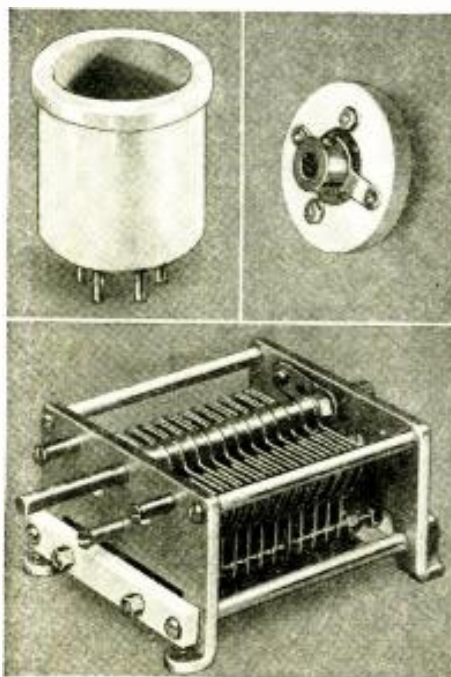

Three of the latest National products using the new "steatite" insulation. (No. 232.)

New Positive Contact Switch

● The accompanying illustration shows the newest short-wave band switch introduced by a leading radio manufacturer. This switch represents a very excellent model of an anti-capacity switch, so necessary to switching circuits in the vicinity of 10 to 20 meters, which are encountered in *all-wave*, as well as *short-wave* receiver circuits nowadays. The round contacts on the moving switch disc are fitted with springs, insuring a very firm contact at all times. Also, the progressive movement of the switch rotor is sharply defined and precise. The metal switch members are mounted on the highest grade insulation and the switch is one-hole mount.

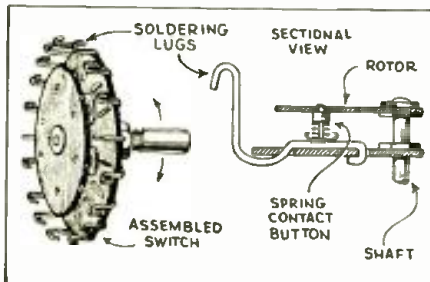

Newest short-wave "band" switch of excellent anti-capacity design. (No. 233.)

Dynamic Speaker Has "Night" Switch

● A recent addition to the dynamic speaker family is this new 115-volt, A.C., dynamic speaker chassis and baffle assembly. It uses a 25Z5 as a rectifier furnishing the field excitation. On the front of the speaker is a switch which controls the A.C. line. This is very convenient inasmuch as in the late evenings this switch can be turned off, thus reducing the volume of the speaker to a point where the signal is quite weak and will not disturb other members of the family. The cone diameter is 10 inches with an over-all diameter of 12 1/4 inches for the cone bracket. The depth of the chassis is 8 3/4 inches and it has a height and width of 14 inches. The design of this speaker should make it particularly well-suited to S-W reception

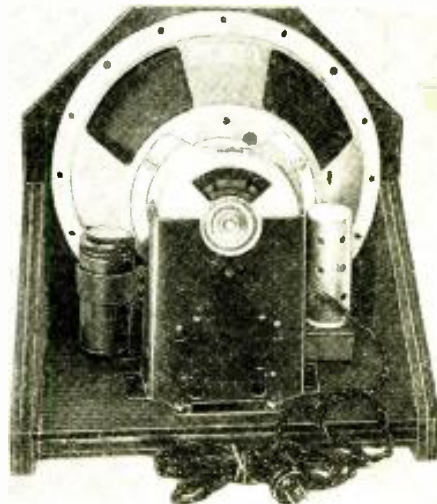

Here we have the rear view of this new dynamic speaker which has its own power supply and filter for field excitation. (No. 234.)

Short Wave Stations of the World

Complete List of Broadcast, Police and Television Stations

We present herewith a revised list of the short-wave broadcasting, experimental and commercial radiophone stations of the world. This is arranged by frequency, but the wavelength figures are also given for the benefit of readers who are more accustomed to working with "meters." All the stations in this list use telephone transmission of one kind or another

and can therefore be identified by the average listener.

Herewith is also presented a very fine list of police as well as television stations. Note: Stations marked with a star ★ are the most active and easily heard stations and transmit at fairly regular times.

Please write to us about any new stations or other important data that you

learn through announcements over the air or correspondence with the stations themselves. A post card will be sufficient. We will safely return to you any verifications that you send in to us. Communications of this kind are a big help.

Stations are classified as follows: C—Commercial phone. B—Broadcast service. X—Experimental transmissions.

Around-the-Clock Listening Guide

Although short wave reception is notorious for its irregularity and seeming inconsistency (wherein lies its greatest appeal to the sporting listener), it is a good idea to follow a general schedule as far as wavelength in relation to the time of the day is concerned. The observ-

ance of a few simple rules will save the short wave fan a lot of otherwise wasted time.

From daybreak till noon and particularly during bright daylight, listen between 13 and 19 meters (21540 to 15800 kc.).

To the east of the listener, from about 1 P.M.-6 P.M., the 25-35 meter will be found very

productive. To the west of the listener this same band is best from about 7 P.M. until shortly after daybreak. (After dark, results above 35 meters are usually much better than during daylight. These general rules hold for any location.

Short-Wave Broadcasting, Experimental and Commercial Radiophone Stations

<p>21540 kc. W8XK -B- 13.93 meters WESTINGHOUSE ELECTRIC PITTSBURGH, PA. 7 a. m.-2 p. m.; relays KDKA</p>	<p>19220 kc. WKF -C- 15.60 meters LAWRENCEVILLE, N. J. Calls England, daytime</p>	<p>18040 kc. GAB -C- 16.63 meters RUGBY, ENGLAND Calls Canada, morn. & early aftn.</p>	<p>16233 kc. FZR3 -C- 18.48 meters SAIGON, INDO-CHINA Calls Paris and Pacific Isles</p>	<p>15200 kc. ★DJB -B- 19.73 meters BROADCASTING HOUSE, BERLIN, GER. 12:15-2 a. m., 8-11:30 a. m. Also 4-5:30 a. m. on Sundays</p>
<p>21420 kc. WKK -C- 14.01 meters A. T. & T. CO. LAWRENCEVILLE, N. J. Calls Argentina, Brazil and Peru, daytime</p>	<p>19160 kc. GAP -C- 15.66 meters RUGBY, ENGLAND Calls Australia, early a. m.</p>	<p>17810 kc. PCV -C- 16.84 meters KOOTWIJK, HOLLAND Calls Java, 6-9 a. m.</p>	<p>15880 kc. FTK -C- 18.90 meters ST. ASSISE, FRANCE Phones Saigon, morning</p>	<p>15140 kc. ★GSF -B- 19.82 meters BRITISH BROAD. CORP. DAVENTRY, ENGLAND See "When to Listen In" Column</p>
<p>21060 kc. WKA -C- 14.25 meters LAWRENCEVILLE, N. J. Calls England noon</p>	<p>18970 kc. GAQ -C- 15.81 meters RUGBY, ENGLAND Calls S. Africa, mornings</p>	<p>17790 kc. GSG -B- 16.86 meters BRITISH BROAD. CORP. DAVENTRY, ENGLAND See "When to Listen In" Column</p>	<p>15810 kc. LSL -C- 18.98 meters HURLINGHAM, ARGENTINA Calls Brazil and Europe, daytime</p>	<p>15120 kc. HVJ -B- 19.83 meters VATICAN CITY ROME, ITALY 5:00 to 5:15 a. m., except Sun- day. Also Sat. 10-10:30 a. m.</p>
<p>21020 kc. LSN6 -C- 14.27 meters HURLINGHAM, ARG. Calls N. Y. C. 8 a. m.-5 p. m.</p>	<p>18830 kc. PLE -C- 15.93 meters BANDONG, JAVA Calls Holland, early a. m.</p>	<p>17780 kc. ★W3XAL -B- 16.87 meters NATIONAL BROAD. CO. BOUND BROOK, N. J. Relays WJZ, 10 a. m.-4 p. m. every day</p>	<p>15760 kc. JYT -X- 19.04 meters KEMIKWA-CHO, CHIBA- KEN, JAPAN Irregular in late afternoon and early morning</p>	<p>15055 kc. WNC -C- 19.92 meters HIALEAH, FLORIDA Calls Central America, daytime</p>
<p>20700 kc. LSY -C- 14.49 meters MONTE GRANDE ARGENTINA Tests irregularly</p>	<p>18680 kc. GAX -X- 16.06 meters RUGBY, ENGLAND</p>	<p>17760 kc. DJE -B- 16.89 meters BROADCASTING HOUSE BERLIN Irregular 8 a. m.-2 p. m.</p>	<p>15410 kc. HC1FG -B- 19.47 meters RIOBAMBA, ECUADOR 4:30-6 p. m. Sun.</p>	<p>14980 kc. KAY -C- 20.03 meters MANILA, P. I. Phones Pacific Isles</p>
<p>20380 kc. GAA -C- 14.72 meters RUGBY, ENGLAND Calls Argentina, Brazil, mornings</p>	<p>18620 kc. GAU -C- 16.11 meters RUGBY, ENGLAND Calls N. Y., daytime</p>	<p>17760 kc. IAC -C- 16.89 meters PIZA, ITALY Calls ships, 6:30-7:30 a. m.</p>	<p>15330 kc. ★W2XAD -B- 19.56 meters GENERAL ELECTRIC CO. SCHENECTADY, N. Y. Relays WGY daily, 2:30-3:30 p. m.</p>	<p>14950 kc. HJB -C- 20.07 meters BOGOTA, COL. Calls WNC, daytime</p>
<p>19900 kc. LSG -C- 15.08 meters MONTE GRANDE, ARGENTINA Tests irregularly, daytime</p>	<p>18340 kc. WLA -C- 16.38 meters LAWRENCEVILLE, N. J. Calls England, daytime</p>	<p>17310 kc. W3XL -X- 17.33 meters NATIONAL BROAD. CO. BOUND BROOK, N. J. Relays WJZ irregularly</p>	<p>15300 kc. CP7 -B- 19.6 meters LA PAZ, BOLIVIA</p>	<p>14590 kc. WMN -C- 20.56 meters LAWRENCEVILLE, N. J. Phones England morning and afternoon</p>
<p>19820 kc. WKN -C- 15.14 meters LAWRENCEVILLE, N. J. Calls England, daytime</p>	<p>18310 kc. GAS -C- 16.38 meters RUGBY, ENGLAND Calls N. Y., daytime</p>	<p>17120 kc. WOO -C- 17.52 meters A. T. & T. CO., OCEAN GATE, N. J. Calls ships</p>	<p>15270 kc. ★W2XE -B- 19.65 meters ATLANTIC BROADCASTING CORP. 485 Madison Av., N.Y.C. Relays WABC daily, 11 a. m.-1 p. m.</p>	<p>14500 kc. LSM2 -B- 20.69 meters HURLINGHAM, ARGENTINA Calls U. S., evening</p>
<p>19650 kc. LSN5 HURLINGHAM, ARGENTINA Calls Europe, daytime 15.27 meters</p>	<p>18250 kc. FTO -C- 16.43 meters ST. ASSISE, FRANCE Calls S. America, daytime</p>	<p>17120 kc. WOY -C- 17.52 meters LAWRENCEVILLE, N. J.</p>	<p>15250 kc. W1XAL -B- 19.67 meters BOSTON, MASS. Irregular, in morning</p>	<p>14470 kc. WMF -C- 20.73 meters LAWRENCEVILLE, N. J. Phones England morning and afternoon</p>
<p>19600 kc. LSF -C- 15.31 meters MONTE GRANDE, ARGENTINA Tests irregularly, daytime</p>	<p>18200 kc. GAW -C- 16.48 meters RUGBY, ENGLAND Calls N. Y., daytime</p>	<p>17080 kc. GBC -C- 17.56 meters RUGBY, ENGLAND Calls Sh.ps</p>	<p>15243 kc. FYA -B- 19.68 meters "RADIO COLONIAL" PARIS, FRANCE Service de la Radiodiffusion 103 Rue de Grenelle, Paris 7:30-11 a. m.</p>	<p>14440 kc. GBW -C- 20.78 meters RUGBY, ENGLAND Calls U.S.A., afternoon</p>
<p>19380 kc. WOP -C- 15.48 meters OCEAN GATE, N. J. Calls Peru, daytime</p>	<p>18135 kc. PMC -C- 16.54 meters BANDONG, JAVA Phones Holland, early a. m.</p>	<p>16270 kc. WLK -C- 18.44 meters LAWRENCEVILLE, N. J. Phones Arg., Braz., Peru, daytime</p>	<p>15210 kc. ★W8XK -B- 19.72 meters WESTINGHOUSE ELECTRIC & MFG. CO. PITTSBURGH, PA. 10 a. m.-4:15 p. m. Relays KDKA</p>	<p>13990 kc. GBA -C- 21.44 meters RUGBY, ENGLAND Calls Buenos Aires, late afternoon</p>
<p>19355 kc. FTM -C- 15.50 meters ST. ASSISE, FRANCE Calls Argentine, mornings</p>	<p>18115 kc. LSY3 -C- 16.56 meters MONTE GRANDE, ARGENTINA Tests irregularly</p>	<p>16270 kc. WOG -C- 18.44 meters OCEAN GATE, N. J. Calls England, morning and early afternoon</p>	<p>15210 kc. ★W8XK -B- 19.72 meters WESTINGHOUSE ELECTRIC & MFG. CO. PITTSBURGH, PA. 10 a. m.-4:15 p. m. Relays KDKA</p>	<p>13610 kc. JYK -C- 22.04 meters KEMIKAWA-CHO, CHIBA- KEN, JAPAN Phones California 1111 p. m.</p>

(Time given is Eastern Standard Time)

<p>13585 kc. GBB -C- 22.08 meters RUGBY, ENGLAND Calls Egypt & Canada, afternoons</p>	<p>11730 kc. PHI -B- 25.57 meters HUIZEN, HOLLAND Daily ex. Tue. & Wed. 8:00-9:30 or 10:30 a. m.</p>	<p>10055 kc. ZFB -C- 29.84 meters HAMILTON, BERMUDA Phones N. Y. C. daytime</p>	<p>9540 kc. LCL -B- 31.45 meters JELOY, NORWAY Relays Oslo 10 a. m.-4 p. m.</p>	<p>7901 kc. LSL -C- 37.97 meters HURLINGHAM, ARGENTINA Calls Brazil, night</p>	
<p>13415 kc. GCJ -C- 22.36 meters RUGBY, ENGLAND Calls Japan & China early morning</p>	<p>11720 kc. *CJRX -B- 25.6 meters WINNIPEG, CANADA Daily, 8 p. m.-12 m. Sunday, 8-10:30 p. m.</p>	<p>9950 kc. GCU -C- 30.15 meters RUGBY, ENGLAND Calls N.Y.C. evening</p>	<p>9530 kc. *W2XAF -B- 31.48 meters GENERAL ELECTRIC CO. SCHENECTADY, N. Y. Relays WGY 7:25-11 p. m. Sundays, 7:25 p. m.-12:30 a. m.</p>	<p>7880 kc. JYR -B- 38.07 meters KEMIKAWA-CHO, CHIBA-KEN, JAPAN Relays WGY 7:25-11 p. m. Sundays, 7:25 p. m.-12:30 a. m.</p>	
<p>13390 kc. WMA -C- 22.40 meters LAWRENCEVILLE, N. J. Phones England morning and afternoon</p>	<p>11720 kc. *FYA -B- 25.6 meters "RADIO COLONIAL" PARIS, FRANCE 6:15-9 p. m. 10 p. m.-12 midnight</p>	<p>9890 kc. LSN -C- 30.33 meters HURLINGHAM, ARGENTINA Calls New York, evenings</p>	<p>9510 kc. *GSB -B- 31.55 meters BRITISH BROAD. CORP. DAVENTRY, ENGLAND See "When to Listen In" Column</p>	<p>7832 kc. OAAC -B- 38.3 meters LIMA, PERU (P. O. Box 853) Irregular in evening</p>	
<p>12840 kc. WOY -C- 23.36 meters LAWRENCEVILLE, N. J.</p>	<p>11680 kc. KIO -X- 25.68 meters KAHUKU, HAWAII Tests in the evening</p>	<p>9870 kc. WON -C- 30.4 meters LAWRENCEVILLE, N. J. Phones England, evening</p>	<p>9510 kc. *VK3ME -B- 31.55 meters ANALGAMATED WIRELESS, Ltd. G. P. O. Box 1272L, MELBOURNE, AUSTRALIA Wed., 5-6:30 a. m.; Saturday, 5:00-7:00 a. m.</p>	<p>7799 kc. *HBP -B- 38.47 meters LEAGUE OF NATIONS, GENEVA, SWITZERLAND 5:30-6:15 p. m., Saturday</p>	
<p>12840 kc. WOO -C- 23.36 meters OCEAN GATE, N. J. Calls ships</p>	<p>10770 kc. GBP -C- 27.85 meters RUGBY, ENGLAND Calls Sydney, Austral. early a. m.</p>	<p>9860 kc. *EAQ -B- 30.43 meters P. O. Box 951 MADRID, SPAIN Daily except Saturday, 5:15-7 p. m.; Saturday, 1-3 p. m. 5:15-7:30 p. m.; Tues. and Thurs. 5:15-7:30 p. m.</p>	<p>9500 kc. *PRF5 -B- 31.58 meters RIO DE JANEIRO, BRAZIL Daily except Sun. 5:45-6:15 p. m.</p>	<p>7400 kc. HJ3ABD -B- 40.54 meters P. O. Box 509 BOGOTA, COLOMBIA Daily 12-2 p. m.; 7-11 p. m. Sunday, 5-9 p. m.</p>	
<p>12825 kc. CNR -B, C- 23.39 meters DIRECTOR GENERAL Telegraph and Telephone Stations, Rabat, Morocco Broadcasts, Sunday, 7:30-9 a. m.</p>	<p>10740 kc. JVM -C- 27.93 meters NAZAKI, JAPAN Phones California evenings Broadcasts Irregularly</p>	<p>9840 kc. JYS -X- 30.49 meters KEMIKAWA-CHO, CHIBA-KEN, JAPAN Irregular, 4-7 a. m.</p>	<p>9415 kc. PLV -C- 31.87 meters BANDONG, JAVA Phones Holland, 7:40-9:40 a. m.</p>	<p>7220 kc. HKE -B- 41.55 meters BOGOTA, COL., S. A. Tue. and Sat. 8-9 p. m.; Mon. & Thurs. 6:30-7 p. m.</p>	
<p>12800 kc. IAC -C- 23.45 meters PIZA, ITALY Calls Italian ships, mornings</p>	<p>10675 kc. WNB -C- 28.1 meters LAWRENCEVILLE, N. J. Calls Bermuda, daytime</p>	<p>9800 kc. LSE -C- 30.61 meters MONTE GRANDE, ARGENTINA Tests Irregularly</p>	<p>9330 kc. CJA2 -C- 32.15 meters DRUMMONDVILLE, CANADA Phones England irregularly</p>	<p>7140 kc. HJ4ABB -B- 42.02 meters MANIZALES, COL., S. A. P. O. Box 175 Mon. to Fri. 12:15-1 p. m.; Tues. & Fri. 7:30-10 p. m.; Sun. 2:30-5 p. m.</p>	
<p>12780 kc. GBC -C- 23.47 meters RUGBY, ENGLAND Calls ships</p>	<p>10660 kc. JVN -C- 28.14 meters NAZAKI, JAPAN Tests 2-7 a. m., relaying JOAK Tokio</p>	<p>9790 kc. GCW -C- 30.64 meters RUGBY, ENGLAND Calls N.Y.C., evening</p>	<p>9280 kc. GCB -C- 32.33 meters RUGBY, ENGLAND Calls Can. & Egypt, evenings</p>	<p>7000 kc. HJ1ABE -B- 42.86 meters CARTAGENA, COL. P. O. Box 31 Daily 11:15 a. m.-1 p. m.; Sun. 9-11 a. m.; Mon. at 10 p. m. Wed. 8-10 p. m.</p>	
<p>12290 kc. GBU -C- 24.41 meters RUGBY, ENGLAND Calls N.Y.C., afternoon</p>	<p>10550 kc. WOK -C- 28.44 meters LAWRENCEVILLE, N. J. Phones Arge., Braz., Peru, nights</p>	<p>9750 kc. WOF -C- 30.77 meters LAWRENCEVILLE, N. J. Phones England, evening</p>	<p>9170 kc. WNA -C- 32.72 meters LAWRENCEVILLE, N. J. Phones England, evening</p>	<p>6977 kc. EAR110 -B- 43 meters MADRID, SPAIN Tues., Sat., 5:30 p. m.</p>	
<p>12150 kc. GBS -C- 24.69 meters RUGBY, ENGLAND Calls N.Y.C., afternoon</p>	<p>10530 kc. GBX -X- 28.49 meters RUGBY, ENGLAND</p>	<p>9710 kc. GCA -C- 30.89 meters RUGBY, ENGLAND Calls Arge. & Brazil, evenings</p>	<p>9020 kc. GCS -C- 33.26 meters RUGBY, ENGLAND Calls N.Y.C., evenings</p>	<p>6905 kc. GDS -C- 43.45 meters RUGBY, ENGLAND Calls N.Y.C. evening</p>	
<p>12000 kc. RNE -B- 25 meters MOSCOW, U. S. S. R. Sat. 10-11 p. m. Sun. 6-7 a. m., 10-11 a. m.</p>	<p>10520 kc. VLK -C- 28.51 meters SYDNEY, AUSTRALIA Calls Rugby, early a. m.</p>	<p>9660 kc. *CT1AA -B- 31.25 meters LISBON, PORTUGAL Tues. and Friday, 4:30-7 p. m.</p>	<p>8920 kc. GCX -X- 33.63 meters RUGBY, ENGLAND</p>	<p>6860 kc. KEL -X- 43.70 meters BOLINAS, CALIF. Tests Irregularly</p>	
<p>11950 kc. KKQ -X- 25.10 meters BOLINAS, CALIF. Tests, irregularly, evenings</p>	<p>10430 kc. YBG -C- 28.76 meters MEDAN, SUMATRA 5:30-6:30 a. m., 7:30-8:30 p. m.</p>	<p>9595 kc. *HBL -B- 31.27 meters LEAGUE OF NATIONS GENEVA, SWITZERLAND Saturdays, 5:30-6:15 p. m.</p>	<p>8775 kc. PNI -C- 34.19 meters MAKASSER, CELEBES, D. E. I. Phones Java around 4 a. m.</p>	<p>6755 kc. WOA -C- 44.41 meters LAWRENCEVILLE, N. J. Phones England, evening</p>	
<p>11880 kc. *FYA -B- 25.25 meters "RADIO COLONIAL" PARIS, FRANCE 11:15 a. m.-2:15 p. m., 3-6 p. m.</p>	<p>10420 kc. XGW -C- 28.79 meters SHANGHAI, CHINA Calls Manila and England, 6-9 a. m. and California late evening</p>	<p>9590 kc. *VK2ME -B- 31.28 meters AMALGAMATED WIRELESS LTD., 47 YORK ST. SYDNEY, AUSTRALIA See "When to Listen In" Column</p>	<p>8760 kc. GCQ -C- 34.25 meters RUGBY, ENGLAND Calls S. Africa, afternoon</p>	<p>6666 kc. *HC2RL -B- 45.00 meters P. O. BOX 759, GUAYAQUIL, ECUADOR, S. A. Sunday, 5:45-7:45 p. m. Tues., 9:15-11:15 p. m.</p>	
<p>11870 kc. *W8XK -B- 25.26 meters WESTINGHOUSE ELECTRIC & MFG. CO. PITTSBURGH, PA. 4:20-10:00 p. m. Sat. 11:1 a. m. Relays KDKA</p>	<p>10410 kc. PDK -C- 28.80 meters KOOTWIJK, HOLLAND Calls Java 7:30-9:30 a. m.</p>	<p>9590 kc. W3XAU -B- 31.28 meters NEWTOWN SQUARE, PA. Relays WCAU 12 noon 7:50 p. m.</p>	<p>8730 kc. GCI -C- 34.36 meters RUGBY, ENGLAND Calls India, 8 a. m.</p>	<p>6650 kc. IAC -C- 45.1 meters PIZA, ITALY Calls ships, evenings</p>	
<p>11860 kc. *GSE -B- 25.29 meters BRITISH BROAD. CORP. DAVENTRY, ENGLAND See "When to Listen In" Column</p>	<p>10410 kc. KES -X- 28.80 meters BOLINAS, CALIF. Tests evenings</p>	<p>9580 kc. *GSC -B- 31.31 meters BRITISH BROAD. CORP. DAVENTRY, ENGLAND See "When to Listen In" Column</p>	<p>8680 kc. GBC -C- 34.56 meters RUGBY, ENGLAND Calls ships</p>	<p>6620 kc. PRADO -B- 45.30 meters RIOBAMBA, ECUADOR Thur. 9-11:30 p. m.</p>	
<p>11830 kc. *W2XE -B- 25.36 meters ATLANTIC BROADCASTING CORP. 485 MADISON AVE., N. Y. C. 3-5 p. m. Relays WABC</p>	<p>10350 kc. *LSX -C- 28.98 meters MONTE GRANDE, ARGENTINA Tests Irregularly 8 p. m.-12 mid- night. Used in Byrd Broadcasts</p>	<p>9580 kc. *VK3LR -B- 31.31 meters Research Section, Postmaster Gen'l. Dept., 61 Little Collins St., MELBOURNE, AUSTRALIA 3-8 a. m. except Sun.</p>	<p>8560 kc. WOO -C- 35.05 meters OCEAN GATE, N. J. Calls ships irregular</p>	<p>6611 kc. RW72 -B- 45.38 meters MOSCOW, U. S. S. R. 1-6 p. m.</p>	
<p>11810 kc. I2RO -B- 25.4 meters ROME, ITALY</p>	<p>10300 kc. LSL2 -C- 29.13 meters HURLINGHAM, ARGENTINA Calls Europe, evenings</p>	<p>9570 kc. *W1XAZ -B- 31.35 meters WESTINGHOUSE ELECTRIC & MFG. CO. SPRINGFIELD, MASS. Relays WBZ, 7 a. m.-1 a. m.</p>	<p>8560 kc. WOY -C- 35.05 meters LAWRENCEVILLE, N. J.</p>	<p>6500 kc. HJ5ABD -B- 46.14 meters MANIZALES, COL. 12-1:30 p. m., 7-10 p. m.</p>	
<p>11790 kc. W1XAL -B- 25.45 meters BOSTON, MASS. Irregularly in the evening</p>	<p>10260 kc. PMN -C- 29.24 meters BANDONG, JAVA Calls Australia 5 a. m.</p>	<p>9560 kc. DJA -B- 31.38 meters GERMAN S-W STATION, BROADCASTING HOUSE, BERLIN 8-11:30 a. m., 5:15-9:15 p. m. also 4-5:30 a. m., Sundays</p>	<p>8214 kc. HCJB -B- 36.5 meters QUITO, ECUADOR 7:14-10:15 p. m. except Monday</p>	<p>6447 kc. *HJ1ABB -B- 46.53 meters BARRANQUILLA, COL., S. A. P. O. BOX 715, 11:30 a. m.-1 p. m.; 5-10 p. m.</p>	
<p>11760 kc. *DJJ -B- 25.51 meters BROADCASTING HOUSE, BERLIN 12-4:30 p. m., 5:30-10:30 p. m.</p>	<p>10250 kc. LSK3 -C- 29.27 meters HURLINGHAM, ARGENTINA Calls Europe and U. S., after- noon and evening</p>	<p>9560 kc. VUB -B- 31.36 meters BOMBAY, INDIA 11 a. m.-12:30 p. m., Wed., Sat.</p>	<p>8185 kc. PSK -C- 36.65 meters RIO DE JANEIRO, BRAZIL 7-7:30 p. m. Relays PRA3</p>	<p>6425 kc. *W3XL -X- 46.70 meters NATIONAL BROADCASTING CO. BOUND BROOK, N. J. Tests Irregularly</p>	
<p>11750 kc. *GSD -B- 25.53 meters BRITISH BROAD. CORP. DAVENTRY, ENGLAND See "When to Listen In" Column</p>	<p>10220 kc. PSH -C- 29.35 meters RIO DE JANEIRO, BRAZIL</p>	<p>8036 kc. *CNR -B- 37.33 meters RABAT, MOROCCO Sunday, 2:30-5 p. m.</p>	<td></td> <td></td>		

(Time given is Eastern Standard Time)

<p>6316 kc. HIZ -B- 47.5 meters SANTO DOMINGO DOMINICAN REPUBLIC Daily except Sat. and Sun. 4:40-5:40 p. m.; Sat., 9:40-11:40 p. m.; Sun., 11:40 a. m.-1:40 p. m.</p> <p>6275 kc. HJ3ABF -B- 47.81 meters BOGOTA, COLUMBIA P. O. Box 317 12-1:30 p. m.; 7-11 p. m., exc. Sunday, Wed. and Sat. 6-11 p. m., Tues. and Fri. 6:30-11 p. m.</p> <p>6272 kc. H11A -B- 47.84 meters P. O. BOX 243, SANTIAGO, DOMINICAN REP. 11:40 a. m.-1:40 p. m. 7:40-9:40 p. m.</p> <p>6150 kc. *CJRO -B- 48.78 meters WINNIPEG, MAN., CANADA 8 p. m.-12 m. Sun. 8-10:30 p. m.</p> <p>6150 kc. *YV3RC -B- 48.78 meters CARACAS, VENEZUELA Generally 4:00-10:00 p. m.</p> <p>6140 kc. *W8XK -B- 48.86 meters USE ELECTRIC CO. PA. with whom you should use a form like the one in the photograph with beautiful to live. If so, it was she for there never was another half so fair. I was working on a portrait one afternoon in May, and I saw a fair-haired boy, a friend of mine, who lived across the way.</p> <p>6120 kc. *W -B- 49.02 meters ATLANTIC BROADCASTING CORP. 485 MADISON AVE., N. Y. C. Relays WABC. 6-11 p. m.</p>	<p>6112 kc. *YV2RC -B- 49.08 meters CARACAS, VENEZUELA Sundays, 9-11:30 a. m.; 1:30-10:30 p. m.; Weekdays, 11:30 a. m.-1 p. m.; 5:30-9:30 p. m.</p> <p>6110 kc. *VE9HX -B- 49.10 meters HALIFAX, NOVA SCOTIA 9:30 a. m.-1 p. m.; 6-12 p. m.</p> <p>6110 kc. VUC -B- 49.1 meters CALCUTTA, INDIA Daily except Sat., 3-5:30 a. m., 9:30 a. m.-noon; Sat., 11:45 a. m.-3 p. m.</p> <p>6100 kc. HJ1ABD -B- 49.18 meters CARTAGENA, COL. 11:30 a. m.-12:30 p. m.; 7-9 p. m.</p> <p>6100 kc. *W3XAL -B- 49.18 meters NATIONAL BROADCASTING CO. BOUND BROOK, N. J. Relays WJZ Monday, Wednesday, Saturday, 5:30 p. m.-1 a. m.</p> <p>6100 kc. *W9XF -B- 49.18 meters DOWNERS GROVE, ILL. Relays WENR, Chicago Daily except Mon. Wed. & Sat., 4:30 p. m.-2 a. m.</p> <p>6095 kc. *VE9GW -B- 49.22 meters BOWMANVILLE, ONTARID, CANADA Sun. 1-9 p. m. Mon.-Wed., 3 p. m.-12 m. Thurs.-Sat., 7 a. m.-12 m.</p> <p>6090 kc. VE9BJ 49.26 meters ST. JOHN, N. B., CAN. 7-8:30 p. m.</p> <p>6080 kc. CP5 49.34 meters LAZ, BOLIVIA 10:30 p. m.</p> <p>6080 kc. *W9XAA 49.34 meters LABOR CHICAGO, ILL. Relays WCFL Sunday 11:30 a. m.-9 p. m. and Tues., Thurs., Sat., 4 p. m.-12 m.</p> <p>6072 kc. OER2 -B- 49.41 meters VIENNA, AUSTRIA Mon. and Thurs., 9 a. m.-5 p. m.</p>	<p>6070 kc. *YV5RMO -B- 49.42 meters MARACAIBO, VENEZUELA 5:15-9 p. m.</p> <p>6070 kc. VE9CS -B- 49.42 meters VANCOUVER, B. C., CANADA Fri., 12:30-1:45 a. m.; Sun., 12 noon-12 midnight</p> <p>6065 kc. HIX -B- 49.46 meters SANTO DOMINGO DOMINICAN REPUBLIC Tues., and Fri., 8-10 p. m.; Sun., 7:45-10:40 a. m., 3-5 p. m.; Sat., 10:40-11:40 p. m.</p> <p>6060 kc. OXY -B- 49.50 meters SKAMLEBOEK, DENMARK 1-6:30 p. m.; also 11 a. m.-12 n. Sunday</p> <p>6060 kc. *W8XAL -B- 49.50 meters CROSLY RADIO CORP. CINCINNATI, OHIO 7:30 a. m.-6 p. m.; 11 p. m.-1 a. m. Relays WLW</p> <p>6060 kc. VQ7LO -B- 49.50 meters IMPERIAL AND INTERNATIONAL COMMUNICATIONS, Ltd. NAIROBI, KENYA, AFRICA Mon., Wed., Fri., 5:45-6:15 a. m., 11 a. m.-2 p. m. Tues., 3-4 a. m., 11 a. m.-2 p. m., Thurs., 8-9 a. m., 11 a. m.-2 p. m., Sat., 11 a. m.-3 p. m., Sun., 10:50 a. m.-2 p. m.</p> <p>6060 kc. W3XAU -B- 49.50 meters NEWTOWN SQUARE, PA. Relays WCAU, Philadelphia 8 p. m.-11 p. m.</p> <p>6050 kc. *GSA -B- 49.59 meters BRITISH BROADCAST CORP. DAVENTRY, ENGLAND See "When To Listen In" Col.</p> <p>6040 kc. W1XAL -B- 49.67 meters BOSTON, MASS. Very irregular</p> <p>6025 kc. CQN -B- 49.79 meters MACAO, CHINA Mon., Fri., 7-9 a. m.</p> <p>6020 kc. *DJC -B- 49.83 meters BROADCASTING HOUSE, BERLIN 12 N.-4:30 p. m.; 5:30-10:30 p. m.</p>	<p>6020 kc. XEBT -B- 49.83 meters MEXICO CITY, MEX. P. O. Box 79-44 7 p. m.-1 a. m.</p> <p>6012 kc. ZHI -B- 49.9 meters RADIO SERVICE CO., 20 ORCHARD RD., SINGAPORE, MALAYA Mon., Wed., Thurs., 5:40-8:10 a. m.; Sat., 12:10-1:10 a. m., 10:40 p. m.-1:10 a. m. (Sunday)</p> <p>6000 kc. EAJ25 -B- 50 meters BARCELONA RADIO CLUB, BARCELONA, SPAIN 3:30-4:30 p. m., Saturday</p> <p>6000 kc. RW59 -B- 50 meters MOSCOW, U. S. S. R. 4-6 p. m., daily</p> <p>5990 kc. YV4RC -B- 50.25 meters CARACAS VENEZUELA 7:30-9:30 p. m.</p> <p>5970 kc. HJ2ABC -B- 50.27 meters CUCUTA, COL. 11 a. m.-12 n.; 6-9 p. m.</p> <p>5968 kc. HVJ -B- 50.27 meters VATICAN CITY (ROME) 2-2:15 p. m., daily, Sun., 5-5:30 a. m.</p> <p>5930 kc. HJ4ABE -B- 50.6 meters MEDELLIN, COLOMBIA Mon., 7-11 p. m.; Tues., Thurs., Sat., 6:30-8:00 p. m.; Wed. and Fri., 7:30-11:00 p. m.</p> <p>5880 kc. HJ2ABA -B- 51.02 meters TUNJA, COL. 1-2 p. m., 7:30-10 p. m.</p> <p>5853 kc. WOB -B- 51.25 meters LAWRENCEVILLE, N. J. Calls Bermuda, nights</p> <p>5714 kc. HCK -B- 52.5 meters QUITO, ECUADOR, S. A.</p> <p>5660 kc. HJ5ABC -B- 53 meters CALI, COLOMBIA 11 a. m.-12 n. Tues. and Thurs. 8-10 p. m. Sun. 12 N.-1 p. m.</p>	<p>5077 kc. WCN -C- 59.08 meters LAWRENCEVILLE, N. J. Phones England irregularly</p> <p>5025 kc. ZFA -C- 59.7 meters HAMILTON, BERMUDA Calls U.S.A., nights</p> <p>4975 kc. GBC -C- 60.30 meters RUGBY, ENGLAND Calls Ships, late at night</p> <p>4820 kc. GDW -C- 62.24 meters RUGBY, ENGLAND Calls N.Y.C., late at night</p> <p>4752 kc. WOO -C- 63.1 meters OCEAN GATE, N. J. Calls ships irregularly</p> <p>4752 kc. WOY -C- 63.1 meters LAWRENCEVILLE, N. J.</p> <p>4320 kc. GDB -C- 69.44 meters RUGBY, ENGLAND Tests, 8-11 p. m.</p> <p>4273 kc. RW15 -B- 70.20 meters KHABAROVSK, SIBERIA, U. S. S. R. Daily, 3-9 a. m.</p> <p>4272 kc. WOO -C- 70.22 meters OCEAN GATE, N. J. Calls ships irregularly</p> <p>4272 kc. WOY -C- 70.22 meters LAWRENCEVILLE, N. J.</p> <p>4107 kc. HCJB -B- 73 meters QUITO, ECUADOR 7:14-10:15 p. m., except Monday</p> <p>4098 kc. WND -C- 73.21 meters HIALEAH, FLORIDA Calls Bahama Isles</p> <p>3600 kc. CT2AJ -B- 83.5 meters PONTA DELGADA, SAO MIGUEL, AZORES Wed. and Sat. 5-7 p. m.</p> <p>3490 kc. PK1WK -B- 85.96 meters BANDONG, JAVA Daily except Fri., 4:30-5:30 a. m.</p>
--	--	---	--	---

Television Stations

<p>2000-2100 kc.</p> <p>W2XDR—Long Island City, N.Y. W8XAN—Jackson, Mich. W9XK—Iowa City, Ia. W9XAK—Manhattan, Kansas. W9XAO—Chicago, Ill. W6XAH—Bakersfield, Calif.</p> <p>2750-2850 kc.</p> <p>W3XAK—Portable W9XAP—Chicago, Ill.</p>	<p>W2XBS—Bellmore, N.Y. W6XS—Los Angeles, Calif. W9XAL—Kansas City, Mo. W9XG—W. Lafayette, Ind. W2XAB—New York, N.Y.</p> <p>42000-56000, 60000-86000 kc.</p> <p>W2XAX—New York, N.Y. W6XAO—Los Angeles, Calif. W9XD—Milwaukee, Wis. W2XBT—Portable W2XF—New York, N.Y.</p>	<p>W3XE—Philadelphia, Pa. W3XAD—Camden, N. J. W10XX—Portable & Mobile (Vicinity of Camden) W2XDR—Long Island City, N.Y. W8XAN—Jackson, Mich. W9XE—Chicago, Ill. W9XAT—Portable W2XD—New York, N.Y. W2XAG—Portable W1XG—Boston, Mass.</p>
---	---	--

Police Radio Alarm Stations

<p>CGZ Vancouver, B.C. CJW St. Johns, N.B. CJZ Verdeen, Que. KGHC Las Vegas, Nev. KGHK Palo Alto, Cal. KGHM Reno, Nev. KGHO Des Moines, Iowa KGHX Santa Ana, Cal. KGHY Whittier, Cal. KGHZ Little Rock, Ark. KGJX Pasadena, Cal. KGLX Albuquerque, N.M. KGOZ Cedar Rapids, Iowa KGPA Seattle, Wash. KGPB Minneapolis, Minn. KGPC St. Louis, Mo. KGPD San Francisco, Cal.</p>	<p>2452 kc. KGPE 2416 kc. KGPG 2452 kc. KGPH 2474 kc. VYR 1674 kc. VYW 2474 kc. WCK 1682 kc. WEY 2430 kc. KGPI 1712 kc. KGPJ 2406 kc. KGPK 1712 kc. KGPL 2414 kc. KGPM 2466 kc. KGPN 2414 kc. KGPO 2430 kc. KGPQ 1706 kc. KGPQ 1674 kc. KGPS</p>	<p>Kansas City, Mo. Vallejo, Cal. Oklahoma City, Okla. Montreal, Can. Winnipeg, Man. Belle Island, Mich. Boston, Mass. Omaha, Neb. Beaumont, Tex. Sioux City, Iowa Los Angeles, Cal. San Jose, Cal. Davenport, Iowa Tulsa, Okla. Portland, Ore. Honolulu, T.H. Bakersfield, Cal.</p>	<p>2422 kc. KGPW 2422 kc. KGPX 2450 kc. KGPY 1712 kc. KGPZ 2416 kc. KGZA 2414 kc. KGZB 1558 kc. KGZC 2466 kc. KGZD 1712 kc. KGZE 2466 kc. KGZF 1712 kc. KGZG 1674 kc. KGZH 2466 kc. KGZI 2450 kc. KGZJ 2442 kc. KGZL 2450 kc. KGZM 2414 kc. KGZN</p>	<p>Salt Lake City, Utah Denver, Colo. Baton Rouge, La. Wichita, Kans. Fresno, Calif. Houston, Tex. Topeka, Kans. San Diego, Cal. San Antonio, Tex. Chanute, Kans. Des Moines, Iowa Klamath Falls, Ore. Wichita Falls, Tex. Phoenix, Ariz. Shreveport, La. El Paso, Tex. Tacoma, Wash.</p>	<p>2406 kc. 2442 kc. 1574 kc. 2450 kc. 2414 kc. 1712 kc. 2422 kc. 2490 kc. 2482 kc. 2450 kc. 2466 kc. 2382 kc. 2458 kc. 2430 kc. 1712 kc. 2414 kc. 2414 kc.</p>
--	--	--	--	---	---

(Time given is Eastern Standard Time)

Short Wave Stations of the World

KGZO	Santa Barbara, Cal.	2414 kc.	WPDS	St. Paul, Minn.	2430 kc.	WPFL	Gary, Ind.	2470 kc.
KGZP	Coffeyville, Kans.	2450 kc.	WPDT	Kokomo, Ind.	2490 kc.	WPFM	Birmingham, Ala.	2382 kc.
KGZQ	Waco, Tex.	1712 kc.	WPDU	Pittsburgh, Pa.	1712 kc.	WPFN	Fairhaven, Mass.	1712 kc.
KGZR	Salem, Ore.	2442 kc.	WPDV	Charlotte, N.C.	2458 kc.	WPFO	Knoxville, Ten.	2474 kc.
KGZS	McAlester, Okla.	2458 kc.	WPDW	Washington, D.C.	2422 kc.	WPFV	Clarksburg, W. Va.	2490 kc.
KGZT	Santa Cruz, Cal.	1674 kc.	WPDY	Detroit, Mich.	2414 kc.	WPFQ	Swathmore, Pa.	2474 kc.
KGZU	Lincoln, Neb.	2490 kc.	WPDZ	Atlanta, Ga.	2414 kc.	WPFZ	Johnson City, Tenn.	2470 kc.
KGZW	Lubbock, Tex.	2458 kc.	WPEA	Fort Wayne, Ind.	2490 kc.	WPGA	Asheville, Md.	2458 kc.
KGZX	Albuquerque, N.Mex.	2414 kc.	WPEB	Syracuse, N.Y.	2382 kc.	WPGH	Portland, Me.	2422 kc.
KSW	Berkeley, Cal.	1658 kc.	WPEC	Grand Rapids, Mich.	2442 kc.	WPGI	Pawtucket, R.I.	2466 kc.
KVP	Dallas, Tex.	1712 kc.	WPEE	Memphis, Tenn.	2466 kc.	WPGJ	Palm Beach, Fla.	2442 kc.
WKDT	Detroit, Mich.	1558 kc.	WPEF	Arlington, Mass.	1712 kc.	WPGK	Miami, Fla.	2442 kc.
WKDU	Cincinnati, Ohio	1706 kc.	WPEG	New York, N.Y.	2450 kc.	WPGM	Bay City, Mich.	2466 kc.
WMDZ	Indianapolis, Ind.	2442 kc.	WPEH	New York, N.Y.	2450 kc.	WPGN	Port Huron, Mich.	2466 kc.
WMJ	Buffalo, N.Y.	2422 kc.	WPEI	New York, N.Y.	2450 kc.	WPGO	S. Schenectady, N.Y.	1658 kc.
WMO	Highland Park, Mich.	2414 kc.	WPEJ	Somerville, Mass.	1712 kc.	WPGP	Rockford, Ill.	2458 kc.
WMP	Framingham, Mass.	1666 kc.	WPEK	E. Providence, R.I.	1712 kc.	WPGQ	Providence, R.I.	1712 kc.
WPDA	Tulare, Cal.	2414 kc.	WPEL	New Orleans, La.	2430 kc.	WPGR	Findlay, Ohio	1682 kc.
WPDB	Chicago, Ill.	1712 kc.	WPEM	W. Bridgewater, Mass.	1666 kc.	WPGS	Albany, N.Y.	2414 kc.
WPDC	Chicago, Ill.	1712 kc.	WPEP	Woonsocket, R.I.	2466 kc.	WPGT	Portsmouth, Ohio	2430 kc.
WPDD	Chicago, Ill.	1712 kc.	WPEQ	Arlington, Mass.	1712 kc.	WPGU	Utica, N.Y.	2414 kc.
WPDE	Louisville, Ky.	2442 kc.	WPER	Saginaw, Mich.	2442 kc.	WPGV	Cranston R.I.	2466 kc.
WPDF	Flint, Mich.	2466 kc.	WPEU	Lexington, Ky.	1706 kc.	WPGW	Binghamton, N.Y.	2442 kc.
WPDG	Youngstown, Ohio	2458 kc.	WPEV	Northampton, Mass.	1666 kc.	WPGX	South Bend, Ind.	2490 kc.
WPDH	Richmond, Ind.	2442 kc.	WPEW	Newton, Mass.	1712 kc.	WPGY	Huntington, N.Y.	2490 kc.
WPDI	Columbus, Ohio	2430 kc.	WPEX	Muskegon, Mich.	2442 kc.	WPGZ	Mineola, N.Y.	2490 kc.
WPDJ	Milwaukee, Wis.	2450 kc.	WPEY	Reading, Pa.	2442 kc.	WPHB	Boston, Mass.	1712 kc.
WPDK	Lansing, Mich.	2442 kc.	WPEZ	Jacksonville, Fla.	2442 kc.	WPHC	Mobile, Ala.	2382 kc.
WPDL	Dayton, Ohio	2430 kc.	WPF0	Baltimore, Md.	2414 kc.	WPHD	Cleveland, Ohio	2458 kc.
WPDN	Auburn, N.Y.	2382 kc.	WPF1	Columbus, Ga.	2414 kc.	WPHI	Toledo, Ohio	2474 kc.
WPDO	Akron, Ohio	2458 kc.	WPF2	Hammoud, Ind.	1712 kc.	WPHJ	GrossePt.Village, Mich.	2414 kc.
WPDQ	Philadelphia, Pa.	2474 kc.	WPF3	Hackensack, N.J.	2430 kc.	WPHK	E. Lansing, Mich.	1666 kc.
WPDW	Rochester, N.Y.	2382 kc.						

When to Listen In

By M. Harvey Gernsback

Havana

• Station COC in Havana, as most listeners know, burned down several months ago. This station has now been rebuilt and is back on the air again. It operates near 50 meters, on approximately 6010 kc. It has been reported frequently of late as being on in the afternoon and evening. It is heard best around 5 p.m.

Rome

• I2RO, the Italian station at Rome, Italy, which has been silent since early June, will return to the air in late November according to a letter just received from the station directors. The new plant will consist of 4 new transmitters, each with a power of 20 kw. These transmitters will operate on a variety of waves and will employ directional antennae for sending programs to all parts of the world in a fashion similar to the English and German S-W broadcasters. A special program for N. America is being planned which will be heard in the U.S.A. during our evening hours. Another woman announcer, an Italian-American miss who was brought up in England, will do most of the announcing in English, according to the present plans.

Sydney

• VK2ME at Sydney, Australia, on 9590 kc., will operate every Sunday from 1-3, 4:30-8:30 and 9-11 a.m. in November. In December the schedule is Sundays, 1-3 and 5-11 a.m. We have reports that VK3LR at Melbourne is now on 9588 kc. instead of 9580 kc. We have not been able to verify this.

Daventry

• For November the British station will operate as follows: Transmission 1; on GSD and GSB, 2:15-4:15 a.m. (Till Nov. 10); 3-5 a.m. after Nov. 10. Trans. 2; on GSF and GSG, 6-7:30 a.m. (exc. Sun.), and on GSF and GSB from 7:30-9 a.m. Trans. 3; on GSE and either GSF or GSB from 9:15-10:45 a.m., and on GSB and either GSE or GSA from 10:45 a.m.-12:45 p.m. Trans. 4; on GSD and GSB from 1-3 p.m., and on GSB and either GSD or GSA from 3-5:45 p.m. Trans. 5; on GSC and GSA from 6-8 p.m.

Winter Reception

• With the return of fall and winter in the Northern Hemisphere *short-wave* reception has made its usual seasonal change. Europe is best heard on 19, 31, and especially 25 meters in the forenoon, while in the afternoon 19 and 25 meter signals fade out at an early hour and good reception is had on 31 meters from about 2-6 or 7 p.m. The 49 meter Europeans begin to come in around 4 p.m. now and by 6:30 they are at good strength. Our old friends the South Americans in the 40 and 49 meter bands are heard almost every evening after 5 with good strength. The stations around 70 and 80 meters are worth investigating in the evening now and some good catches should be the reward of the careful tuner. CT2AJ in the Azores is on every Wednesday and Saturday from 5-7 p.m. on 83.5 meters (3600 kc.).

Canada

• The winter schedule of VE9GW at Bowmanville, Ont., on 6095 kc. is: Monday to Wednesday 3 p.m.-12 m.; Thursday to Saturday 7 a.m.-12 m.; Sunday 1-9 p.m. By the time this is printed VE9DN at Montreal will probably be back on the air. This station operates on 6005 kc.

Brazil

• The new station at Rio de Janeiro, S.A., mentioned two months ago, has been identified as PRF5. It is on 31.58 meters and broadcasts daily except Sunday from 5:45-6:15 p.m. We wish to thank our readers who sent us information on this station. PSK on 36.65 meters, which formerly relayed the programs of PRA3 every evening, seems to be very inactive now. It is heard infrequently and at odd hours.

Belgium

ORK at Ruysselede, Belgium, is now heard at good strength every day. It broadcasts a program for the Belgian Congo daily from 2:45-4:15 p.m. The first 15 minutes are occupied by news bulletins in French. The last 15 minutes are given over to a Flemish news bulletin. All programs originate with the Brussels station; the remainder of the program is musical. At other hours of the day ORK is used for

commercial telephone service to Africa.

CJRX

CJRX at Winnipeg, Canada, has now returned to its assigned wave length (25.6 meters) after being down on 25.47 meters for three or four months. Incidentally it is now right on top of FYA, the French station on 25.6 meters. FYA was formerly on 25.63 meters but about seven months ago received authority to operate on 25.6 meters with the result that the two stations heterodyne each other. Fortunately FYA usually operates on 25.6 meters from 6:15 p.m. on, and at this time of the year it is seldom audible so late in the day.

Mexico

XETE, at Mexico City, is no longer "on the air"—according to late reports. The company who owned it went into bankruptcy after the station staff were paid several months' back salary at the conclusion of a hunger strike in the studios for several days. They broadcast over the long wave *sister* station of XETE during their strike and refused to stop till they were paid. A novel form of picketing!

Colombia

HJ1ABE announced that they would on 49.05 meters instead of 42.86 meters after the first of October. This station is at Cartagena.

Manila

• KZRM at Manila in the Philippine Islands is reported back on the short waves according to Australian dispatches. This station relays the program of the long wave broadcast station, KZRM in Manila. It is heard in the early morning hours and as late as 9 a.m. It operates on about 9570 kc., very close to the frequency of W1XAZ in Springfield, Mass.

Holland

• PCJ the famous Dutch s-w station in Eindhoven, Holland, which has been silent for several years has been used recently in some special broadcasts. It was heard operating in the 19 meter broadcast band on several occasions.

ALL TIME QUOTED IS EASTERN STANDARD.

A Low-Powered Transmitter

(Continued from page 473)

that metal-chassis construction is really easier than bread-board style. I have used both of mine constantly for over two years and have never had to even resharpen them. If you use light sheet steel, it is well to place a block of wood under the hole to prevent bending the metal, but I use fairly heavy sheet, and do not find this necessary.

Let us next consider the schematic circuit in Figure 6. As you can see, it uses very few tubes: an 83 rectifier, a 59 crystal oscillator-doubler-buffer, and two 46's in parallel in the final amplifier.

Crystal Oscillator

A great deal of the success of the transmitter and its simplicity depends on the crystal oscillator. The 59 tube serves not only as an oscillator, but as a frequency-doubler and a buffer. The fact that the plate circuit is operated on the second har-

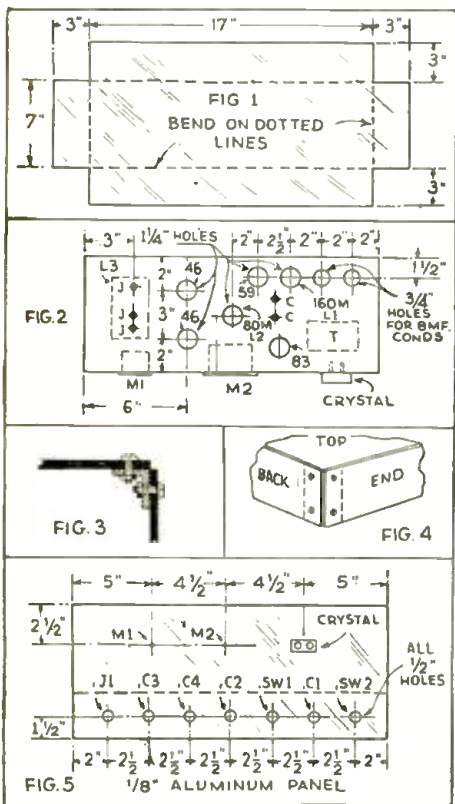

Various mechanical details of chassis construction.

monic of the crystal so isolates it from the frequency control portion of the circuit that full buffer action is obtained without the use of a separate tube. L1 and C1 are tuned to the crystal frequency, which is somewhere in the 160-meter band between 1750 and 2000 kilocycles. If you would like to work 160-meter phone and 80-meter CW, then get the crystal between 1800 and 1950 kilocycles, so that it will be in the 160-meter phone band, and when doubled will be in the 80-meter CW band between 3600 and 3900 kilocycles. L1 may be a regular plug-in type receiver coil with the tickler removed. C1 is a .00014 mf. variable condenser. C2 and C3 are the same as C1. L2 is also a plug-in receiving coil, but for the 80-meter band. L3 is a specially wound coil which will be described later. The screen and suppressor grids of the 59 are tied together. Refer to figure 8, which is a bottom view of the 59 socket. The numbering is standard and would be a good thing for the reader to memorize. Here is the way it is done. Start with the second hole to the left of the two large heater

SHORT WAVE OPERATORS KNOW—



YOU DON'T HAVE TO "BABY" BURGESS BATTERIES

You Can Use Them 7 or 8 Hours a Day and Get FULL Service!

BURGESS and Amateur Radio have grown up together, and Burgess has kept pace with the new demands. ● Burgess Batteries still retain the outstanding performance that made the phrase "Ask Any Radio Amateur" one of full significance. In fact, just as Amateur Radio has grown from infancy to a widespread force, so have Burgess Batteries developed to still greater value. ● The most important development in Burgess Batteries is their ability to withstand long daily service. Test after test has proved they will deliver just as many ampere hours of service on an eight hour day as they will on the more customary three hour schedule. This feature means that not only will you get maximum service from Burgess Batteries, but you can make more contacts and maintain more regular schedules every day without increasing your hourly cost of operating. ● The Eight Hour Day performance is built into all Burgess Radio Batteries including the

BURGESS POWER HOUSE

This is a distinct Burgess development, a dry "A" Battery for use with 2-volt tubes. Costs only \$3.20 and delivers 200 ampere hours. On typical service, this means a cost of *less than one cent per hour.*



World Famous "B" and "C" Batteries

Burgess Batteries have been taken to the North and South Poles and all around the world by explorers who would have only batteries built to "take it" hour after hour, without any decrease in the total hours of service delivered. The next time you buy "A", "B", or "C" batteries, ask for and insist on the familiar black and white striped Burgess Batteries. You can maintain many more schedules per day at no increase in cost. BURGESS BATTERY COMPANY, FREEPORT, ILLINOIS.



BURGESS BATTERIES and FLASHLIGHTS

Please mention SHORT WAVE CRAFT when writing advertisers

If it's a **POWER TONE** Receiver You are assured the **BEST** Short Wave Reception

Universal AC-DC
S.-W. Receiver



QUIET, hum-free reception
Tubes: '78, '43 and 25Z5
Tunes from 15 to 550 meters.

Complete Kit.....\$7.95
Shielded Metal Cabinet.....1.00
Wired and Tested, extra.....2.00
RCA Licensed Tubes.....3.25
Bruno Broadcast Coil......79

5 TUBE
T.R.F. A.C. Operated
Short-Wave Receiver

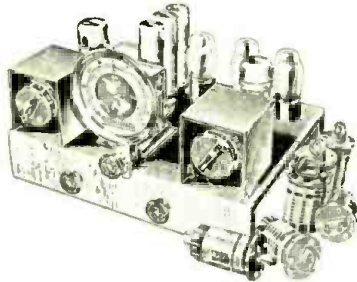

THIS most modern short-wave receiver is extremely efficient. It will receive foreign stations with great consistency. The tubes used are of the latest design—a '58 H.F. stage for amplification, a '53 detector, two 2A5's for the push-pull stage and an '80 rectifier.

Kit of Parts with 8 Bruno coils.....\$17.95
Wired and tested, extra.....2.00
Kit of RCA licensed tubes.....\$2.95
Special Shielded Metal Can.....1.75

Duo-Wonder
S.-W. Receiver



THIS simple circuit will give beginners a splendid course in radio construction and operation. Uses '19 tube.
Kit of Parts.....\$4.95
Wired, extra......85
RCA Licensed tube.....1.00
Broadcast Coil......39

REGENT
4 Tube A.C.
S-W Receiver

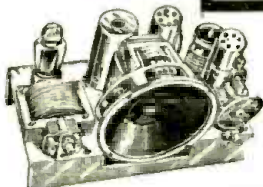

Complete Kit, with speaker.....\$11.50

Wired, extra.....2.00
Modernistic Cabinet.....1.50
RCA Licensed tubes.....2.50
BRUNO Broadcast coil......79

A COMPLETE receiver with built-in dynamic speaker. Will tune from 15 to 550 meters. Tubes: 2-'58's, 1-'80 and 1-2A5 power pentode output.

COVERS the short-wave range from 15 to 550 meters. Power-tone is the first to use the new '79 tube. Extremely light in weight.

"SCOUT"
Portable AC-DC
Receiver

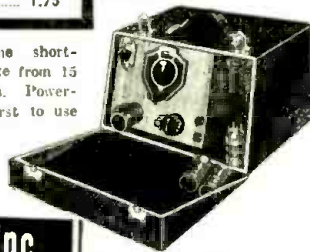

Complete Kit of Parts.....\$6.95
Carrying Case.....1.46
RCA Licensed Tubes 2.25
Wired, extra.....2.00

TRY-MO RADIO CO., Inc.
85 CORTLANDT ST., Dept. S NEW YORK CITY

New 192 Page S.W. and P.A. Manual. \$.50

holes and count counterclockwise so that the heater holes will be numbers 3 and 4. This holds good for numbering any tube socket. On the 59 socket, which is a large 7-prong socket, number 6 is the suppressor grid, and number 1 is the screen. These are connected together. This is contrary to the usual procedure of grounding the suppressor, so don't make a mistake about it. They are then connected to a tap on the voltage divider which gives about 100 volts, but *not over that!* Any attempt to use more than 100 volts on the screen in order to increase the output will make you wish you had never seen a 59. They really act up. I use 5000 ohms in R1, and 20000 ohms in R2. This gives only about 70 volts on the screen when the final is keyed, but is necessary because when the load is taken off, the voltage rises so that there would otherwise be more than 100 volts on the 59, and it would soon have a white-hot screen grid and run very high plate current, and cease oscillating. Note that the cathode is not grounded directly, but through L1. R4 is the oscillator grid-leak and is 50,000 ohms 1 watt carbon. RFC2 is a choke, preferably National R100 or equivalent without which the oscillator may refuse to oscillate. Connect it as close as possible to the grid of the 59. C8 is a plate by-pass to pass the RF to ground and should be connected as close as possible to L2. C9 is the screen by-pass condenser and should be connected as close as possible to the screen prong on the socket.

May I call your attention to an unusual and very desirable feature from the standpoint of expense in this transmitter. Besides the voltage divider, there are only two resistors, R3, and R4, and only two RF chokes. This is very noticeable when you look at the underside of the chassis. It almost looks as if it hadn't been completed. As a matter of fact, there isn't a lot of equipment in the whole "rig," which is what I like about it. The by-pass condensers C9, C8, and C5 can be any size from .002 mf. to .01 mf. but must be of sufficient voltage rating to stand the peak voltage of the transformer. In the one shown here they are 500-volt condensers. C6 is a small but very important condenser. Its value is .00004 mfd. and *do not use a larger one!* In fact, a .000035 mf. postage stamp equalizing condenser is plenty large enough. A larger one will affect the stability and furnish too much excitation to the 46's. It also must be of the 500-volt variety as the plate voltage of the 59 is on one side of it, and a breakdown will burn up the grid meter. C7 is a .25 mf. by-pass condenser and takes out the small key click when keying the grid of the 46's. No other *key click eliminator* is necessary—another advantage of the transmitter. C4 is a 50 mfd variable neutralizing condenser. C13 is a .002 mfd coupling condenser, from the plate of the 46's to the antenna coupling unit to be described later. The resistor R3 is 1000 ohms and should be of 5 watts rating. J1 is the key jack and need not be insulated from the panel, since one side of it is grounded anyway. M1 is the grid meter and should be of about 0-100 MA size. It is optional, but is very desirable, since it eliminates the necessity for neon lamps to neutralize, and at all times shows presence of RF, and also makes it possible to locate resonance peaks easily. It eliminates the necessity for a plate meter in the 59-plate lead to indicate oscillation, since to obtain maximum oscillation, instead of using the dip of the 59-plate current, we use the peak of the grid current shown by M1. RFC1 is a good RF choke. A National R100 or its equal will serve admirably. It should be placed as close as possible to the grids of the 46's. Figure 9 shows the *bottom view* of the 46 sockets. They are wired in parallel. M2 is the final plate meter and should have a range of at least 0-200 MA, and preferably 0-300, as peaks when the 46's are off resonance are often that high. With reasonable care, a 0-200 MA. meter will serve, however.

Power Supply

The power supply is simple, since the isolating effect of the 59 circuit and the

Packed full of S.W. DOPE!

Yes, Clifford E. Denton's book on short-wave has everything—complete s. w. coil-winding data for all size forms and condensers, wire tables, dope on A-F amplifiers, R-F systems, band spreading, superhets, single-signal receivers, electron-coupled oscillators etc., etc.—the whole "lowdown" on construction of latest s. w. sets by a man who really knows it. 128 pp. Over 150 charts and diagrams. MAIL COUPON FOR YOUR COPY NOW.

only \$1.00

DENTON'S Short Wave Radio HANDBOOK

Radio & Technical Publishing Co., 45 Astor Place, New York. Dept. C-1.

Enclosed find \$1. for 1 copy of Denton's SHORT-WAVE HANDBOOK.
 Send free circular.

NAME _____

ADDRESS _____

I GUESS I'M A FAILURE AT THE CODE-CANT MAKE ANY HEADWAY

I SAID THE SAME THING UNTIL I GOT WISE TO THE INSTRUCTOGRAPH

Passed Code Exam. Easily

Like many others, I fooled away months trying to learn the code from a Short Wave Receiver, without making any headway. Then I got wise to the Instructograph Automatic Code Teacher, and in almost no time passed code exam. easily. Don't be misled. Every Residence as well as Extension Schools use a machine with a perforated tape to teach their classes. Government examinations for Amateur and Commercial tickets are always given by a machine using a perforated tape. If there was a better way, the large schools and Government would have it.

Provides Necessary Code Practice

No waiting for code schedules which you can seldom tune in when wanted—no annoyance trying to keep the station tuned in and copying. Instructograph provides all the code practice needed to become a real operator. Instructions accompanying Instructograph show how to practice to the best advantage just like an instructor would do. Failure impossible.

Terms as Low as \$2 per Month

Anyone wishing to learn the code and qualify for Amateur or Commercial examinations, or increase their speed to the Standard of a real operator—should get an Instructograph without delay. Rent it for a month. Be convinced it is the best way to learn the code and become a real operator. If not, send it back. Terms as low as \$2.00 per month. Write for details NOW!

INSTRUCTOGRAPH COMPANY Dept. SW-12
912 Lakeside Place Chicago, Ill.



RADIO ENGINEERING,

broadcasting, aviation and police radio, servicing, marine radio telegraphy and telephony, Morse telegraphy and railway accounting taught thoroughly. Engineering course of nine months' duration equivalent to three years of college radio work. All expenses low. Catalog free. School established 1914.
Dodge's Institute, Turner St., Valparaiso, Ind.

Please mention SHORT WAVE CRAFT when writing advertisers

crystal control makes first-class regulation unnecessary. The tube used is an 83, which takes a 5 volt, 3 ampere winding, for its filament supply. I use a winding intended for an 80 with no heating of the transformer. You can use an 80, but it will drop the delivered voltage about 50 volts. The filter (L4) is a single choke, 30 henry, which will carry at least 160 mls (MA.) steadily, and two 8 mf. electrolytic condenser C10 and C14 connected as shown. The transformer has a high-voltage winding giving 500 volts each side of center tap, a 5-volt, 3-ampere winding for the 83, and a 2½-volt winding delivering at least 5½ amperes for the filaments of the two 46's and the 59. The pilot light P is also connected to this winding, to indicate when the transformer is on. Note that SW1 is connected directly between the center tap of the high voltage winding and ground. This takes all high voltage off the set when not transmitting. SW2 opens the 110 volt AC line. The filament center tap of the 2½-volt winding is grounded. The voltage divider, being of high resistance, draws little current (20 mls), making only a 10-watt resistor necessary, or two of them in series, a 20000 and a 5000 if you have no tapped resistor of the correct value.

Reason for High Efficiency

Now for a few remarks on the reason for the set's efficiency. Note that all coil fields are above the chassis, while all wiring is below. All RF is by-passed to ground right at the coil so that practically no RF gets below the chassis except in the short leads to the condensers C1, C2, and C3. The leads to C4 are a bit long, but this is reverse RF voltage fed back to the grid for neutralization, and is very small for a 46-tube. The wiring beneath the chassis is regular point to point style as practically all of it carries DC only, and therefore has no effect on neighboring wires. Filaments are all twisted as in a receiver.

The crystal is mounted in jacks placed on a bakelite strip mounted behind a hole cut in the panel to the right of the meter M1.

L3 is wound on a piece of tubing 2½" in diameter, and 4" long. It is wound with 25 turns of No. 12 enameled wire with no spacing between turns, and tapped at the ninth turn. This is for 80 meters. For 160 meter, use about No. 16 wire and wind 50 turns, tapped at the eighteenth turn. When you wish to operate on 160 meters, take out the 160-meter coil from the 59-cathode circuit and replace it with a tube base which has the prongs shorted together inside with a piece of wire so that the cathode of the 59 goes direct to ground. Then place the 160-meter coil in the socket of the 59-plate circuit as L2, and put the 160-meter coil you have wound on the tubing into the jacks of L3. The 59 then operates as a straight pentode without doubling and gives very high output.

The tuning up procedure follows. Place all tubes in the sockets, and the 160-meter coil in L1 socket, 80-meter coil in L2 socket, and the 80-meter final tank coil in its three jacks. Close SW2. Close key. Disconnect plate voltage lead from M2. Then wait about a minute for the 59 to warm up. Then close Sw1. Turn C1 till M1 shows peak current. The crystal is then oscillating. Then rotate C3 slowly and the needle of M1 will kick slightly at one point. Adjust C4 from zero to maximum slowly and back until a point is found where there is no kick in M1 when C3 is rotated throughout its range. The set is now neutralized. Open Sw1 again, to cut high voltage, and reconnect the plate lead on M2. Close Sw1. and quickly rotate C3 until M2 shows a dip. This indicates resonance. If this should stop the oscillator from oscillating, open C1 slightly, and again tune C3 for the dip. That's all there is to it. Connect the antenna, and you are ready to transmit.

Now for the antenna. With this outfit as shown, you can use a single wire 133 feet long for 80 meters, or a single-wire feed matched impedance Hertz. These have

Shhh! Shhh!

QUIET

Please!



Individually TESTED for NOISE

ELECTRAD Perfects a QUIET VOLUME CONTROL

Built on a Radically New Engineering Principle

FOR the first time, absolute quiet, smooth, positive control of radio volume is accomplished. Electrad's new 16-feature Volume Control is GUARANTEED QUIET—and its quietness and smoothness increase with use. A radically improved engineering principle assures even distribution of current around the flat outer rim of a Bakelite ring, over which gently glides a floating contact of special alloy, tracking perfectly with the baked-on resistance element.

The molded Bakelite case with metal end cover projects, when mounted, only ½ inch back of panel. Loosening a single screw removes the end cover and a new type power switch (approved by underwriters) may be instantly attached. The shaft is extra long aluminum. Cuts easily—saves time. All standard values available. Special descriptive folder FREE on request.



Contact glides over resistance element in straight path.



Standard Replacement Volume Control with power-switch attached.

from **RESISTOR** Headquarters

ELECTRAD Inc.
175 Varick St. New York, N.Y.

Please send new 1935 Resistor Catalog. Check here for folder on new QUIET Volume Control.

Name

Address

MAIL COUPON FOR 1935 CATALOG

175 Varick St. New York, N.Y. **ELECTRAD** INC.



VARIOHM



10-WATT



TRUVOLT

Please mention SHORT WAVE CRAFT when writing advertisers

CABLE ADDRESS: "UNCLEDAVE" INCLUDE 20% DEPOSIT WITH C.O.O. ORDERS
 WRITE IN FOR OUR NEW HAM CATALOG—JUST OFF THE PRESS!
UNCLE DAVE'S RADIO SHACK
 356 BROADWAY FOREIGN TRADE SOLICITED Long Distance Phone: 4-5746 ALBANY, N. Y.

PEERLESS "40-DX" COMBINATION PHONE-CW TRANSMITTER

... a low priced crystal controlled transmitter with all the latest refinements—59 Dow oscillator—link coupled to 2-46's—output 40 watts on CW and 10 watts on phone on two bands—standard 19" bakelite panel—folded aluminum chassis. COMPLETE with microphone, tubes, crystal to your frequency in 160 and 80 meter band. Weston milliammeter, power supply—just plug into 110 AC 60 cycle, attach antenna and it is ready to go. WRITE FOR SPECIAL INTRODUCTORY LOW PRICE!

New! National Type HRO Receiver

Nine tubes, not including rectifier
 Two Preselector stages
 Single Signal (Crystal Filter) standard equipment
 Ganged Plug-in coils, with each coil individually shielded
 Strictly single-control Tuning
 Calibration for each range mounted on coil
 Four gang precision condenser, with preloaded worm-drive tuning, 20-1 ratio
 Micrometer Dial, spreading tuning over 500 divisions, numbered every 10 divisions, direct reading
 Automatic or Manual volume control
 Vacuum Tube voltmeter with instrument calibrated in R scale of carrier intensity
 Electron coupled, air padded oscillators
 Two IF stages with litz-wound coils, air condenser tuned
 Beat frequency oscillator for "offset" C. W. tuning
 Phone Jack on panel
 2½ volt AC and 6 volt AC or Battery models
 Relay Rack mounting available
 Built-in power supply available

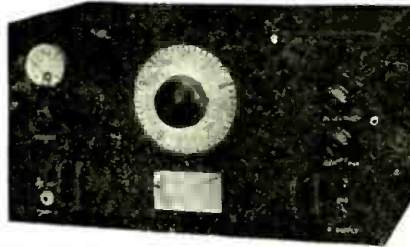

2 volt or 6 volt AC model, with coils, less tubes, speaker, power supply, net.....\$139.80
 2 volt with built-in power supply 115 v. 60 cy., with coils, less tubes and speaker, net.....\$154.50
 NATIONAL RECEIVERS AND APPARATUS IN STOCK

NATIONAL TRANSMITTING CONDENSERS
 TMC-100 100 mmf. 3000 v.....\$2.55
 TMS-100 100 mmfd. 1000 v.....1.35

HAMMARLUND SUPER-PRO RECEIVER
 2-preselector stages, bandsread tuning at all fre-

quencies from 15 to 560 meters no plug-in coils—15 tubes in ultra modern circuit. WRITE US FOR ADDITIONAL INFORMATION AND PRICES!

HAMMARLUND PRODUCTS IN STOCK AT ALL TIMES.

Red Hot Specials!

5"x6"x9" black crystalline finish metal cans with cover, special.....\$ 1.18
 EXTRA SPECIAL, Weston meters model 301 slightly used, 0-5, 10, 25, 50, 100, 150, 200, 250, 300, 300 Milliammeters, each.....\$ 3.69
 140 mmfd. PEERLESS midset variable condensers, extra special, each.....69c
 4 mfd. 1000 volt filter condensers, cased with leads, NET.....1.18
 Power Transformer 600 volts CT; 5 volts 3 a; 2½ volts 5 a; BARGAIN AT.....98c

DELCO TUBES guaranteed firsts, SPECIAL, 832 49c 231 39c

CG-1162 Navy 5-wattets, while they last, per dozen.....\$1.00

Amperite velocity microphone beautifully cased, complete with output transformer.....\$14.70
 TELEPLEXES, slightly used, excellent condition, complete with 3 tapes.....9.95
 TELEPLEXES, same as above but with three tapes and audio oscillator.....12.50
 OMNIGRAPHIS, 15-dial, slightly used, good condition, special each.....12.00

WRITE FOR INFORMATION ON RENTALS OF CODE-LEARNING APPARATUS

both been described in past issues of this magazine, and will therefore not be repeated. For other types it will be necessary to add a coupling coil to be placed at one end of the tank coil. However, I will now describe a new system of antenna coupling which in my humble opinion is destined to replace all other systems for short-wave work. It is so simple, and so flexible, and so highly efficient, and so eliminates harmonics that no other can compare with it. Because it was first called to the attention of the amateur fraternity by Arthur Collins, W9CXX, it has been widely called the Collins' Impedance Matching Unit. The parts required are two .00025 variable condensers (out of an old broadcast receiver) and a coil. The size of the coil depends on the band to be used. For this transmitter we will use 30 turns for 160, and then short out half of them for 80 meters. I will only describe here the method used to couple to a single wire of any length, or a single-wire feed Hertz of any frequency. See Figure 1. You now have the transmitter tuned to resonance. Do not change the setting of any dial on the transmitter. Adjust C11 until the plate current goes to 100 mills or so. Then tune C12 quickly till the plate current dips. Then if necessary readjust C11 to bring the plate current up to 100 mills again, and again tune C12 for a dip. Continue until the dip falls as nearly as possible at 100 mills, which is the proper current for the 46's. That is all there is to it. If the antenna is too long or too short, the unit will match it anyway, and furnish the necessary inductance to make it the right size. Then if you will disconnect the antenna unit from the transmitter, you will see that the current will fall back to its original value, which will be about 20 or 30 mills, and as soon as you attach the unit again, the current will go back up to 100, thus showing that the antenna is taking the "soup" in fine shape. Put a light bulb in the antenna lead and be further convinced—a 25-watt bulb.

STATEMENT OF THE OWNERSHIP, MANAGEMENT, CIRCULATION, ETC., REQUIRED BY THE ACT OF CONGRESS OF MARCH 3, 1933

Of Short Wave Craft published monthly at Mount Morris, Illinois, for October 1, 1934.
 State of New York
 County of New York

Before me, a Notary Public in and for the State and county aforesaid, personally appeared Hugo Gernsback, who, having been duly sworn according to law, deposes and says that he is the Editor of Short Wave Craft and that the following is, to the best of his knowledge and belief, a true statement of the ownership, management (and if a daily paper, the circulation), etc., of the aforesaid publication for the date shown in the above caption, required by the Act of August 24, 1912, embodied in section 411, Postal Laws and Regulations, printed on the reverse of this form, to wit:

1. That the names and addresses of the publisher, editor, managing editor, and business managers are: Publisher, Popular Book Corp., 99 Hudson Street, N. Y. C.; Editor, Hugo Gernsback, 99 Hudson Street, N. Y. C.; managing editor, H. Winfield Secor, 99 Hudson Street, N. Y. C.; business managers, None.
 2. That the owner is: (If owned by a corporation, its name and address must be stated and also immediately thereunder the names and addresses of stockholders owning or holding one per cent or more of total amount of stock. If not owned by a corporation, the names and addresses of the individual owners must be given. If owned by a firm, company, or other unincorporated concern, its name and address, as well as those of each individual member, must be given.) Popular Book Corp., 99 Hudson St., N. Y. C.; H. Gernsback, 99 Hudson St., N. Y. C.; H. Winfield Secor, 99 Hudson St., N. Y. C.

3. That the known bondholders, mortgagees, and other security holders owning or holding 1 per cent or more of total amount of bonds, mortgages, or other securities are: (If there are none, so state.) None.

4. That the two paragraphs next above, giving the names of the owners, stockholders, and security holders, if any, contain not only the list of stockholders and security holders as they appear upon the books of the company but also, in cases where the stockholder or security holder appears upon the books of the company as trustee or in any other fiduciary relation, the name of the person or corporation for whom such trustee is acting, is given; also that the said two paragraphs contain statements embracing affiant's full knowledge and belief as to the circumstances and conditions under which stockholders and security holders who do not appear upon the books of the company as trustees, hold stock and securities in a capacity other than that of a bona fide owner; and this affiant has no reason to believe that any other person, association, or corporation has any interest direct or indirect in the said stock, bonds, or other securities than as so stated by him.

H. GERNSBACK, publisher.
 Sworn to and subscribed before me this 29th day of September, 1934.
 MAURICE COYNE,
 [Seal.] Notary Public.
 (My commission expires March 30, 1936.)

NEW!!!

SUPERTONE 5 TUBE Universal Short Wave and Broadcast Receiver

This New Universal 5 tube A.C.-D.C. Short Wave & Broadcast Receiver uses the latest type tubes. A 6D6 is used as one stage of high gain T.R.F. inductively coupled to a CG6 regenerative screen grid detector—regeneration is controlled by a potentiometer. It has two stages of audio, providing sufficient volume to operate its 5 inch dynamic speaker to full volume on even those hard-to-get stations. The first audio stage is a 37, the second stage is a 43 power output pentode and works on either A.C. or D.C.

Chassis, completely wired, tested, with tubes & coils, **\$20.00**
 15-500 meters.....

Cabinet only—\$2.50
 Complete Kit of parts, with tubes, coils and diagram—\$18.00

If you have any parts which may be used in building this set, send for our price list on additional parts.

Send for literature on our other receivers.

SUPERTONE PRODUCTS CORP.
 35 Hooper Street, Dept. S-12, Brooklyn, N. Y.

WANT A TELEVISION JOB?

Radio and Television are packed with romance. Every hour interesting and immensely profitable. For free details write First Nat'l Television, Power & Light Bldg. Kansas City, Mo., Dept. B-12

1935 RADIO CATALOG

Free Book

All models: AC-DC midsets; dual and world-wide all-wave, farm, battery and car—at factory prices! Write for 24-page Bargain Catalog and 30-DAY TRIAL plan. Prices from \$9.95 UP.

AGENTS WRITE!

GOLDENTONE RADIO CO.,
 113 Oakman Bldg. Detroit, Mich.

ENLARGED S-W QUESTION BOX IN JANUARY ISSUE.

A Simplified "Radio Control"

(Continued from page 472)

only when a radio signal modulated at its resonant audio frequency is received. Since we have a great number of audio frequencies at our disposal, the number of controls available is determined entirely by the limitations of the controlling transmitter and the response curves of the audio transformers employed.

The transmitter described (Fig. 2) is the simplest possible, using a grid-leak-modulated Hartley circuit with an adjustable grid-leak for every control. Different values of grid-leak, of course, produce different audio frequencies modulating the carrier, and they are inserted in the circuit at will by simply pressing push buttons!

Because of their low filament consumption, tubes of the 2-volt series were used throughout both receiver and transmitter. As stated before, almost any types of tubes may be used without detriment to operation. The 2-volt tubes are more suited, however, in radio control for filament batteries of light weight and small dimensions cut down unnecessary bulk and awkwardness—something to think about when in a radio controlled car, everything must be crammed into the smallest of space and yet operate efficiently.

The Receiver

Referring again to Fig. 1, a 30 tube is used as regenerative detector in the original set-up. It is grid-leak-condenser type, this being preferable to one of power detection for it is more sensitive to weak signals—a good feature since the receiving antenna on a moving car or boat, for example, must be of mean proportions.

Following the detector is transformer-coupled a 30 tube Class A amplifier. Following this, also transformer-coupled, is a power amplifier stage using a 33 pentode. This type tube is used for two reasons: its large amplification factor and high plate resistance. Three audio transformers, T3, T4, and T5, placed in series in the 33 plate circuit very nearly reach optimum for greatest gain. The transformers should be of the same make and value so as to realize equal distribution of power and voltage between them.

C battery bias is used throughout—it not only gives slightly more gain per stage than self-bias, but a C battery is necessary for bias of distributor tubes V4, V5, and V6.

Tuned Audio Circuits Used

Across the secondaries of T3, T4, and T5 are shunted tuning condensers C3, C4, and C5; they are mica. Their capacity values will be determined by the audio transformers used, though they will not be found critical. Condensers of 0.0001, 0.001, and 0.01 mf. were used in the original receiver. They are fixed—audio tuning being accomplished at the transmitter.

Distributor tubes V4, V5, and V6 are type 31 power amplifier tubes, battery-biased very nearly to cut-off. The exact amount of bias necessary will depend upon the low current relays X1, X2, and X3 used in the plate circuits. The best way to adjust this is to apply plate voltage with zero bias (the relays will then close) and increase the grid bias until the relays open. This is a critical point, and the closer it can be adjusted, the more sensitive will be operation of the unit.

Relay Construction

The relays originally used were factory-made and operated on a current of 1 milli-ampere. Suitable relays can be made, however, by rewinding 6-volt types with No. 40 gauge enameled wire. If good (platinum or silver) contacts are soldered on the armature of an ordinary buzzer and the electromagnets rewound, a workable relay will result.

A more highly sensitive homemade relay and one that will measure up to the best is made from an old audio transformer. The only requisite is that the secondary wind-



The MARK of QUALITY and Dependability in Radio Parts

For 15 years this trade mark on radio products has been a sign of Quality. Today, more than ever, you can be assured of reliable, precision built parts and accessories if you ask for ICA products. The following are but a few of the hundreds of items which we manufacture and are an in-

dication of the value which we offer. The list prices shown are subject to a discount of 40% when purchased through your Jobber or favorite Mail Order House—or send your order direct naming your Jobber and we will see that you are promptly supplied.

<p>Universal Midget Condensers</p>  <p>Removable shaft with lock nut provides permanent condenser alignment. Insulex insulation. Spacing .026". 15, 25, 50, 100 and 140 mmf. capacities. List prices: 55c, 95c, \$1.05, \$1.15, \$1.50</p>	<p>Coils for 5 M. Transceivers</p> <p>Interruption Frequency Oscillator with 4 lugs. List price \$1.00. 5 Meter 11F Choke with two mounting feet. List price 60c. 5 Meter Dual Tuning coils and mounting base. List price 75c. Complete as above with blue print. List price \$2.25</p> 		
<p>Shielded "Handle Type" S.W. Coils</p> <p>Low loss ribbed shielded and protected by insulated tubink. Set of 4 coils covering 16-217 meters. 4 prong, 2 winding. List price \$6.50</p> 	<p>Insulex Ribbed S.W. Coils</p> <p>Non Hygroscopic ceramic compound developed by ICA. Low loss at high frequencies. Slotted construction. 4 Prong, 2 winding. Set of 4 coils covering 16-217 meters. List Price \$4.00</p> 		
<p>X'Mitting Coil Forms</p> <p>Low loss Insulex material. Fine for 20, 40, 80 M. oscillators and amplifiers. List price without support legs \$2.50. With legs and hardware \$3.00</p> 	<p>Insulex X'Mitting Plug in Coil</p> <p>To fit prong large UX socket. Made of Insulex. Diam. 2 1/2" x 1" high. Fine for winding for high frequencies. Holes drilled for easy winding. List price \$1.50</p> 	<p>Flexible Coupler</p> <p>Efficient and inexpensive. Of flexible fiber. Diam. 3/8"; two 1/4" bushings mounted on flexible phosphor bronze spring. List price 35c</p> 	<p>Dial and Pointer Knobs</p> <p>Direct drive. Heavy brass, black finish, silver etched lines and numerals. 3/4" diam. (calibration 100 to 0 or 0 to 100). List price 75c. 2" diam. (calibration 100 to 0 or 0 to 10). List price 50c</p> 
<p>S. W. COILS WOUND ON LOW LOSS SMALL BAKELITE RIBBED FORMS</p> <p>4 prong, 2 windings. 4 coils cover 16-217 meters. Have low loss wire for primary and tickler. Will tune with 140 mmfd. condenser. List price \$1.90</p> 		<p>S. W. COILS WOUND ON SMALL BAKELITE RIM TYPE FORMS</p> <p>Fit UX sockets. 1 1/4" diam. x 2 1/4" high. Primary and secondary windings. 4 coils cover 16 to 217 Meters. Will tune with 140 mmfd. condenser. List price \$1.65</p> 	
<p>Standoff Insulator With Jack</p> <p>Will take banana or G.R. Type plug. 1 1/2" high; base 1" x 1 1/2". Takes standard screws. Black or white. List price 12c</p> 	<p>"Little Pete" Standoff Insulator</p> <p>Very small. Made of Insulex. Handy where small space is available. Only 1" high. Base 1/2" x 3/4". Ready for mounting. Black or white. (50 to box). List price ea. 6c</p> 	<p>Sub Panel Standoff Insulator</p> <p>Size 3/4" high x 3/4" diam. It also requires 5/16" hole for mounting. Uses 6/32" screw threaded both ends. Black or white. (25 to box). List price, Ea. 10c</p> 	<p>Jack Insulator for Panel Mounting</p> <p>Fine for high frequency work when mounting on metal sub panel. 1" high x 3/4" diam. Needs 7/16" mounting hole. Complete with Jack. Black or white. (25 to box). List price, Ea. 20c</p> 
<p>Handle Type Coil Forms</p> <p>Consists ribbed form drilled and tapped for handle (supplied) and insulating tubing to protect winding. 4 or 5 prong. List price 95c; 6 or 7 prong. List price \$1.00</p> 	<p>5 M. Transceiver Kits</p> <p>Choice of 3 models: 2 volt, 6 volt or A.C. model. Easy to build. complete instructions, diagrams. List prices (respectively) \$19.50, \$19.25, \$19.75</p> 		<p>Crystal Holder</p> <p>Made of Insulex. Accommodates crystals to .250 thick x 1 1/4" square. Accurate and compact. List Price \$1.75</p> 
<p>Full Line of S.W. RECEIVER KITS</p> <p>America's greatest line of SHORT WAVE KITS! One and two tube battery sets, and three, four, five tube all electric models. Listing from \$9.95 up. All licensed under RCA and Hazeltine patents. World's easiest to build with our point-to-point wiring diagrams. Send for complete details.</p> <p>BIG New CATALOG</p> <p>Send 10c stamps or coin to cover cost of handling and mailing big new 1935 catalog listing hundreds of parts and accessories as well as our complete line of receiver kits. Supply limited. Send now to avoid disappointment!</p> <p>INSULINE CORP. of AMERICA 23-25 Park Place Dept. W-124, New York, N. Y.</p> 			

Please mention SHORT WAVE CRAFT when writing advertisers

Scientifically Produced

BUD COMPONENTS are specified by **AMATEURS, EXPERIMENTERS** and **ENGINEERS** for **QUALITY, EFFICIENCY, and ECONOMY.**

Bud Easy-Starting Screw Holders



BUD EASY STARTING SCREW HOLDER has a positive **GRIPPING ACTION**, will **START ANY SIZE SCREW** in the **HARD TO GET AT AND MOST INACCESSIBLE PLACES.** Releases itself from screw after screw has been properly placed. Priced so low that no one can afford to be without a set of Bud Easy Starting Screw Holders.

The handle has the new **DOUBLE GRIP FEATURE** and is constructed of high grade moulded Bakelite. The screw gripping fingers are made of the finest quality of **Blued Spring Steel.**

NO TOOL KIT IS COMPLETE WITHOUT A SET OF BUD EASY STARTING SCREW HOLDERS.

Cat. No.	Size Dia. Length	Size of Screw	Price
852	1/2" x 4 3/4" overall.	No. 2 to 6 incl.	\$.15
853	5/8" x 7" overall.	No. 6 to 12 incl.	.20
854	3/4" x 9 1/4" overall.	No. 10 to 18 incl.	.25
856	1 1/2" x 8 3/4" overall.	No. 2 to 8 incl.	.25

Bud Hy-Freq. Crystal Holder



No. 763 Price \$1.50

is ideal for use with transmitters operating on high frequencies. Recommended for use with crystals covering frequencies from 4,000 to 15,000 KCS. Will hold crystals up to 1-1/32" square and .25" thick. Crystal housing is made of moulded bakelite with nickel plated brass fittings. Adjusting screw permits very fine pressure adjustment of floating plate to crystal. Tube prong contacts are spaced 3/4" apart. Mounts in 5 or 6 prong tube socket.

Listed above are but a few of the items in the complete BUD line. Write for New 1935 Catalog! All list prices shown in this advertisement are subject to 40% discount when purchase is made from an authorized BUD jobber. If your jobber cannot supply BUD parts, send your order direct to us together with your jobber's name and we will make shipment direct.

BUD RADIO INC.

1937 E. 55th STREET CLEVELAND, OHIO



The Breakers

ATLANTIC CITY, NEW JERSEY
On the Boardwalk



SITUATED DIRECTLY ON THE OCEANFRONT AND CONVENIENT TO ALL PIERS AND AMUSEMENTS

\$6 WITH MEALS *Daily* **WITHOUT MEALS \$3**
PRIVATE BATH *Per Person* **PRIVATE BATH**

Hot and Cold Sea Water in all Baths

EXCELLENT FOOD

GARAGE ATTACHED

Look for Our Next Month's Advertisement Announcing

IMPORTANT NEW MODELS AT POPULAR PRICES

ALAN RADIO CORP.

High Frequency Pioneers
New York U.S.A. Los Angeles

PATENTS — TRADE MARKS

All inventions submitted held confidential and given personal attention by members of the firm.
Form "Evidence of Conception" and Instructions
"How to Establish Your Rights"—Free
LANCASTER, ALWINE & ROMMEL
PATENT LAW OFFICES
475 Bowen Bldg. Washington, D. C.

CHEMICAL
Outfits **10** **Scientists**
Amateur **PHOTO**
SUPPLIES
Brings You the complete catalog listing hundreds of items of interest to the amateur experimenter.
SPECIAL 30 DAY OFFER for those who send immediately

J. H. WINN MFG. CO., Dept. 87, 124 West 23 St., New York

ing is good and the primary is not "shorted" (short-circuited). The primary may be open or burned out for it is not used, but if "shorted," a relay made from the transformer will have a definite *time-lag* on opening. Such action would make it useless for radio control purposes.

As shown in detail in Fig. 3, a little less than one half the iron core is cut away with a hack-saw, leaving a core with only one window and the winding on one leg. Take care not to cut too close to the center so as to reduce the core area next to the winding.

Now, opposite from the end that has been cut away, saw a 1/4-inch gap in the core as indicated. The easiest method is to place three or four blades in the saw at once and saw the gap out cleanly. This will save bending the metal back and forth to remove it and will make a neater-looking job.

Notice the gap *does not cut the core entirely through.* One sixteenth-inch of the laminations is left to support the core and keep it rigid. Should the gap be cut through, the core will immediately fall apart unless some method of holding it together is employed. (The gap causes sufficient magnetic flux leakage to attract the armature.—Editor.)

About halfway between the gap and the bottom of the core is fastened a bakelite strip with tinner's self-threading screws. These screws work easily if a hole a fraction smaller than they is first drilled into the core. On the end of the bakelite strip is screwed an ordinary brass bolt and lock-nut. The end of the bolt is filed to a point and acts as one of the contacts.

The whole core is fastened to a wooden base by counter-sunk tinner's screws.

On one end of the base, bent up at right angles, are mounted with wood screws two strips of spring brass. To the tip of one is soldered a 3/8-inch square block of soft iron (armature) 1/8-inch thick, and the brass is bent so the iron block armature is about 1/8-inch from the gap. This same brass strip also has an arm about halfway down on which is put a lump of molten solder (best results are obtained with platinum or silver contacts), and this arm is bent so the solder will make contact with the pointed contact bolt upon slight movement of the armature. The second brass strip is brought up even with the arm on the first and bowed toward the core so as to make a tension against the armature. Accurate adjustment is made by bending these strips so as to vary the tension. Use very light brass, though it must be stiff enough to support the weight of the iron block and have enough flexibility to open the circuit once it has been closed. Brass such as automobile mechanics use for shims will answer the purpose.

The secondary of the transformer is the magnetizing winding, and its leads are placed in the plate circuit of one of the distributor tubes. The primary, of course, is unused, and the leads are clipped and taped up.

The more care used in constructing these relays, the more successful will be their operation, for their sensitivity almost directly determines the distance over which reliable control can be accomplished.

Method of Adjustment

It may be found in operation that a note intended to operate one relay will also operate another. This is remedied by tuning the circuits of the distributor tubes to farther separated audio frequencies (by changing values of the condensers shunting the grid inputs—C7, C8, and C9), by increasing grid-bias of the distributor tubes, or, if necessary, completely shielding each distributor unit so that no stray magnetic flux will permeate a neighboring transformer. In any event, whether shielded or not, mount transformers T3, T4, and T5 so that they are at right angles to each other.

Getting back to the transmitter and Fig. 2, we see it is quite simple. Although a Hartley oscillating circuit was originally employed, any type of oscillator will work just as well as long as it may be leak-modulated.

2 new BOOKS on SHORT WAVES

HERE are two brand new books which you have been looking for for a long time. They contain everything that you have been asking for for many months. These new books will give you the latest information of everything you wish to know in two respective fields. Be sure to order them today. You will not regret it.

They make excellent companions to our other handbooks, which you may have.

7" x 10"

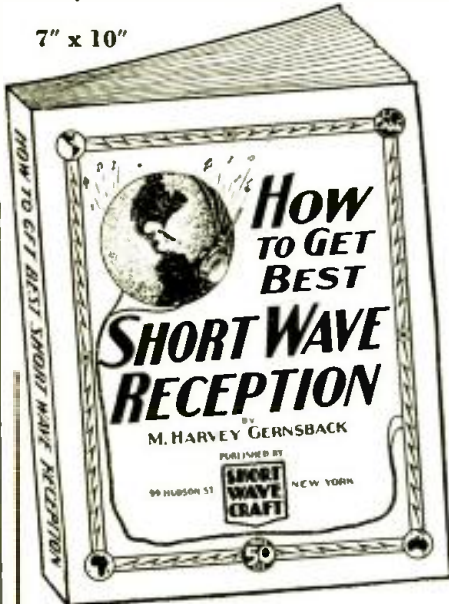

TWO BRAND NEW BOOKS WHICH EVERY ALERT SHORT-WAVE FAN SHOULD HAVE IN HIS LIBRARY

7" x 10"

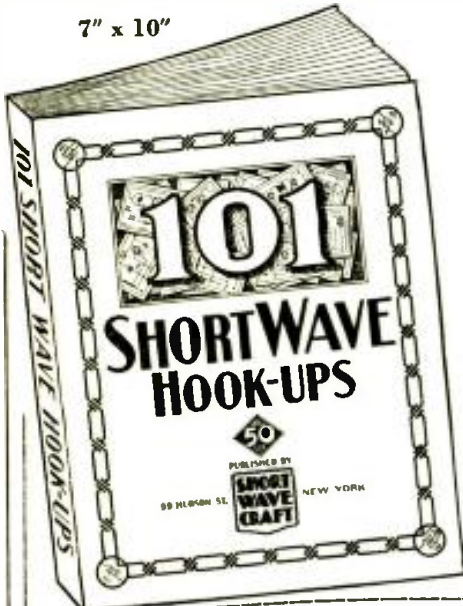

SHORT WAVE CRAFT, 99 Hudson Street, New York City.

Gentlemen: I enclose \$ for which you are to send to me, postpaid, immediately upon publication, the books checked below:
 "How to Get Best Short Wave Reception"
 "101 Short Wave Hookups"

Name
 Address
 City and State.....
 (Send check or money order. If you send cash or uncanceled U. S. Postage Stamps, register it.)
 SWC-12

"How to Get Best Short Wave Reception"

By M. HARVEY GERNSBACK

Here is a book that gives you everything you have ever wanted to know about short-wave reception.

The author, a professional radio listener and radio fan for many years, gives you his long experience in radio reception and all that goes with it.

Why is one radio listener enabled to pull in stations from all over the globe, even small low wattage, 10,000 miles away, and why is it that the next fellow, with a much better and more expensive equipment, can only pull in the powerful stations that any child can get without much ado?

The reason is intimate knowledge of short waves and how they behave. Here are the chapters of this new book:

1. What are Short Waves and what can the listener hear on a short-wave receiver or converter?
2. How to tune and when to listen in on the short waves.
3. How to identify short-wave stations.
4. Seasonal changes in short-wave reception.
5. Types of receivers for short-wave reception.
6. Aerial systems for short-wave receivers.
7. How to get verifications from short-wave stations.
8. Short-wave hints.

The book is profusely illustrated with the best kind of illustrations that it was possible to obtain.

Please note that this is not a re-hash of anything that has appeared before. Everything in the entire book has been written to order, and there is no duplication of anything here that has appeared in print before.

The book will make excellent reading matter, whether you are a rank beginner or whether you have been at it for a long time. There are many tricks in short-wave reception that even some of the "old-timers" do not know. That is the reason for this book. Be sure to get it.

Place your order at once.
 72 pages, over 40 illustrations.
 Price

50c

101 SHORT WAVE HOOKUPS

Compiled by the Editors of SHORT WAVE CRAFT

Here is a worthwhile book that every short-wave listener, every short-wave fan, and every short-wave amateur has wanted for a long time. It gives you the 101 best short-wave hook-ups which have appeared heretofore. It is a veritable encyclopedia of the best in short-waves when it comes to hook-ups.

And do not run away with the idea that we just give you a few plain hook-ups. Each and every hook-up and diagram illustrated is also accompanied by a thorough explanation of what this particular hook-up accomplishes, what parts are required, coil-winding information, values of resistors, etc.. In fact, everything you want to know in order to build the set or to look up the data required.

To be sure, all of the important sets which have appeared in print during the past five years are in this valuable book. Sets such as the Doerle, Dinsmore, the "19" Twinplex, Oscillodyne, Duo-Apodyne, Deinton "Stand-by," Megadyne Triplex 2, "Globe-Trotter," 2-Tube Superhet, Minkdyne, "Loop" Receiver, "Doerle" 2-tube Battery, "Doerle" 3-tube Battery, "Doerle" 2-tube A.C., "Doerle" 3-tube A.C., Doerle "Signal Gripper," "Tutrol" Band-Spread 2-tube Receiver, 3/4 Meter Portable Transmitter and Receiver, Duo R.F. 4-tube Receiver, The Sargent 4-33 Tapped Coil Receiver, Globe-Girdler 7, The 2-Tube "Champ," 2 Tubes Equal 3, Ham-Band 3, 2-tube Pee-Wee, Wyeth All-Wave 6, "Tex" Portable Super-het Receiver, The "53" 1-tube Twinplex, Smart Band-Spread S.W. Converter, The "Ace" Band-Spread 3, Deinton Economy 3, 2-Tube "Regenerative-Oscillodyne" will be found here, with full descriptions. In many cases, where it was necessary, we have also included a picture hook-up for those who do not wish to follow the regular symbolic hook-up, but wish to have a regular wiring diagram.

Also note, that in many cases, we have not just reproduced old hook-ups or diagrams. In many cases they have been brought up-to-date, to give you the latest information available in such sets.

This is a very handy volume, especially for those "fans" who wish to study the best sets in the short-wave art, from one tube up to ten tubes. Instead of leafing through a dozen magazines and going through back numbers.

The present volume brings you everything in a clarified manner, leaving nothing to your imagination. The book is thorough, and up to date, and will be a welcome addition to your radio library.

72 pages, over 100 illustrations.
 Price

50c

- V3—type 33 pentode power amplifier, R.C.A.-Radiotron, (Sylvania).
- V4, V5, V6—type 31 power amplifier tubes, R.C.A.-Radiotron (Sylvania).
- J1—closed-double-circuit jack.
- SW1—filament toggle switch.
- X1, X2, X3—1 milliamper type relays—see text.

Legend for Fig. 2

- C1, C2—0.0005 mf. variable condensers—receiver type, National.
- C3, C4—0.002 mf. by-pass condensers, Aerovox.
- L1, L2—to be determined by frequency band employed—for 165-meter amateur phone band, L1—15 turns; L2—35 turns; 2" forms; No. 18 enameled wire.
- L3—radio-frequency choke, National, (Hammarlund).
- R1, R2, R3—0.5 megohms variable grid leaks—see text.
- SW1, SW2, SW3—push buttons.
- SW4—filament toggle switch.
- SW5—plate power switch—a telegraph key may be used instead.
- V1—type 31 power amplifier tube, R.C.A.-Radiotron (Sylvania).

Short Waves and Long Raves

(Continued from page 469)

can get any letters to me through my friend, Mr. J. H. Irving, Box 44, Lancaster, Mass.

(Well! Well! Ike. Just shows what a good man can do, if given half a chance. That is a mighty fine list of short-wave stations you have logged with your revamped Crosley "broadcast" receiver. We'll bet a new hat that you will get plenty of mail after the publication of this letter.—Editor.)

WANTS LOOP "DIRECTION-FINDER" SET

Editor, SHORT WAVE CRAFT:

Of all the sets described, I must say that one thing has been left behind, which I'm sure would interest a good many thousand amateurs, and short-wave fans; and that is a real *honest-to-goodness short-wave receiver* that would be portable and operated with a loop for direction finding.

As it is apparent so many amateurs have formed clubs and as evident the boys all get together and agree on a "hidden transmitter hunt" for some recreation from time to time, (and I have participated in a few myself), and I must say that in each case, nine-tenths of the boys had inefficient receivers and never did find the transmitter; simply because their equipment consisted of some old "broadcast" receivers, remodeled to fit the purpose after a fashion. Now, I have scanned all the issues of SHORT WAVE CRAFT and RADIO-CRAFT, and the only thing I found was a circuit in the October issue of RADIO-CRAFT used by some English Amateurs. This circuit I tried and even took pains to completely shield the receiver, but the results were nothing to blapp about. My idea of a good set would be either a *super* or a *regenerative circuit*, to have at least two stages of R.F. in front of a regenerative detector, and one good high-gain audio, the set to be completely shielded, even to batteries and battery cable. This is important, as I have found if this is not done, you cannot get a correct reading for a hearing with the loop, especially when nearing the transmitter. I'm sure an article such as I've described here would benefit thousands of amateurs, create more interest in "Transmitter Hunts," which I think is very fine sport.

THOMAS A. CONSALVI,
 Bryn Mawr, Pa.

(Thanks very much for your letter, Thomas, and we will endeavor to have one of our staff develop a sensitive loop receiver which could be used to advantage as you state in the very interesting sport of finding a "hidden" short-wave transmitter. We described a very successful loop aerial type short-wave receiver in the August, 1933, issue, but the loop, in that particular case, was not very directional but with a little modification could be made so.—Editor)

Please mention SHORT WAVE CRAFT when writing advertisers

CLAREMONT BRASSPOUNDERS CLUB

Editor, SHORT WAVE CRAFT:

As per your publicity advice, we, the Claremont Brasspounders Club, located at 1557 Fulton Avenue, Bronx Headquarters (this will be of interest to short-wave fans located in New York City), formed by W7DZK, now in New York (Portable) formed by and for young fellows who would like to learn code and knowledge of Federal Radio Commission Laws and License procedure. We know that regular fellows will cooperate with us to make this a real club. We will have a booklet if the club's activity warrants its publication. The dues are very liberal, being at present 50 cents a month, stamps or cash. A button and certificate will be sent. We also would like to hear from foreign correspondents who wish to cooperate with us in opening branches. For information, please write to headquarters. We wish to thank your publication for this publicity obtained.

F. FELDMAN,
Secretary, C. R. S.

STARTS A CLUB IN CALIFORNIA

Editor, SHORT WAVE CRAFT:

As a starter, my brother and I wish to say that SHORT WAVE CRAFT is a dandy magazine and it happens to be the medium that started us in "Radio." We have built the *Globe Trotter*, 12,000 Mile Binnevog, and a long-wave receiver. Now we have a 4-Tube A.C. Receiver taken from the January, 1933 issue. The circuit used is taken from Mr. Ewald Zischewsky's 3-tube set. We made a few changes such that we now have a T.R.F., and we also added a 27 tube, first audio. Pretty soon we are going to put in a 47 push-pull stage and try it.

The town we live in is quite small, but we are starting a Radio Club, and have 15 members. The purpose of the club is to help the fellows get their licenses, etc. So far, we have one "transmitter" and hope to have more soon. All of us here sure like SHORT WAVE CRAFT and hope we can always get it. Also wish to say the three receivers we have built sure have been "dandies." Up to date, have had no foreign reception but hope to soon. Have had plenty of amateurs, police, airplane, and broadcast in U. S. A. though.

Well, will say 73 to you and hope to have more news shortly. The fellows are going to join the SHORT WAVE LEAGUE soon.

RAYMOND F. SUTHER,
Box 583, Cocoran, Calif.

(More power to your short-wave radio club and we shall be glad to hear from you right along as to how it is growing. The receivers you mention in your letter have been highly commended by several thousand readers at various times; Mr. Zischewsky's set will undoubtedly provide many a pleasant hour of DX hunting.—Editor)

An Ultra-Simple Modulation System

(Continued from page 471)

to the right amount for proper operation, and I have used 46s, 45s, and a 210 in the final, each with the 56 modulating it. The system is only offered for those who would not otherwise be able to afford a phone, and those who use it so little that it would not be worth the added expense, as it admittedly is not as efficient a method as plate modulation.

WARNING

Recently, an individual who names himself Robert Carey, Jr., has been traveling in the middle west, taking subscriptions to this and other magazines. This man is a swindler and all monies which he collected he kept for himself, giving a FAKE receipt.

Do not pay money to strangers for subscriptions unless he can produce a letter signed by the publisher of the magazine and show you other credentials.

Heads of Police Departments—If the individual referred to above should be apprehended, please telegraph us collect and we will immediately appear to prosecute him.

—THE PUBLISHERS.

FREE The BIGGEST Latest, Most Complete 1935 RADIO CATALOG



● This amazing new 1935 Radio Catalog is the last word . . . the greatest Bargain Book of Radio ever published. There are more pages, more items listed, more nationally known lines, more Specialized Departments. Over 50,000 items make this great 192-page book the Sensation of the Radio Industry!

There is a Special Department on the latest Broadcast and All Wave Receivers from 2 to 12 tubes.

You'll find an entirely new Department on REFRIGERATION PARTS AND ACCESSORIES . . . a new money making field for Servicemen. A whole section on PUBLIC ADDRESS is the most complete and all inclusive thing of its kind. Then there is our matchless SPECIALIZED SHORT WAVE DEPARTMENT which constitutes a complete catalog listing everything the Ham, Brasspounder and Experimenter will ever need; Sets, Kits, Transceivers, Pre-Selectors, Converters, 5 meter Equipment as well as other Short Wave parts and accessories. For 13 years the "WHOLESALE" Catalog has been the Serviceman's "Bible". Today—this greatest Radio Catalog ever printed in which everything is listed at lowest wholesale prices—is yours for the asking. Write for YOUR FREE COPY today!

REFRIGERATOR PARTS FOR ALL STANDARD MAKES

● After months of research and investigation in the field of refrigeration we announce the creation of a Refrigerator Parts Department . . . a Department which will double your profits!

Our investigations have revealed that there are few men better qualified in ability and skill and experience to service refrigerators than the Radio Servicemen. This year 'round business is wide open. There are no "slack" times! The field is Big! 5 million homes have refrigeration. The "live wire" Radio Serviceman will give this field serious thought and study for now

each home can be made a 2-way source of profit—Radio and Refrigeration. Here at Wholesale Radio Service Company you will find all parts for every leading make of refrigerator at lowest WHOLESALE prices. You can be assured of the same high quality and service as you have been accustomed to receiving on Radio Supplies.

WHOLESALE RADIO SERVICE CO.,
100 Sixth Ave., Dept. SW-124, New York City.

Send me your new free 1935 Catalog No. 56, which includes refrigeration section.

NAME _____
STREET _____
CITY _____ STATE _____

WHOLESALE RADIO SERVICE CO. INC.
NEW YORK ATLANTA
100 Sixth Avenue 430 W. Peachtree St., N.W.
Local Branch 219 Central Ave., Newark, New Jersey.

STOPPANI COMPASS

A Precision Instrument made in Belgium. Purchased by the U. S. Government at more than \$30.00 each. Ideal for Radio Experimenters Laboratory, also may be used as a Galvanometer for detecting electric currents in radio circuits. Ruby, jeweled, solid bronze, 4 inches square, fitted in a hardwood case.

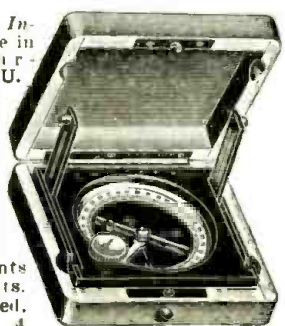

Our price prepaid \$4.50 each
GOLD SHIELD PRODUCTS CO
98 Park Place New York City

LEARN CODE in HALF the Usual Time!

It's Easy to do at Home with

The NEW MASTER Teleplex



Code Teaching Machine
As a child, you understood spoken English long before you could read or write. You learned by hearing. CODE is the same way! Why make it hard for yourself, trying to learn with old-fashioned printed lessons alone? HEAR as you learn, and learn in half the time, with The New Master Teleplex. This world-famous instrument records your sending visibly—then sends back to you through headphones! The natural method! beginners learn faster, see speed up their work amazingly. Used by U. S. Army and Navy, I.C.A., A. T. & T., and others. We give you Complete Course, lend you instrument, instruct you personally—all under MONEY BACK GUARANTEE. Low cost, easy terms. Write now for folder S-24—no obligation.

TELEPLEX COMPANY
78 Cortlandt Street New York, N. Y.

Please mention SHORT WAVE CRAFT when writing advertisers

100% Short Wave Book and it's

FREE!

A Pre-Amplifier With Band-Switch

(Continued from page 475)

generation control with a pre-selector and pre-amplifying device that delivers the peak of performance. Actual performance of a two-stage pre-selector with the regenerative feature in the first stage will be described later.

The P-11 is contained in a heavy gauge steel black-crackle finished cabinet, 7 1/4 x 9 1/4 x 10 inches. It covers all frequencies with ample overlap from 14 to 200 meters with three sets of built-in coils, thus doing away with the undesirable "plug-in" method. The obvious convenience of this switch system brings itself to the fore when one is "DX-ing" over a wide range of frequencies. This unit utilizes two tuned stages of high-gain 58 type tubes, the first stage being electron-coupled regenerative. Electron coupling lends greatly to stability in operation. The regenerative control is, of course, variable to obtain maximum gain. This control, if advanced past the point of maximum regeneration, will allow the first stage to oscillate. This control is used at the point just before oscillation occurs—never in the oscillatory position. The gain is very high at the point of maximum regeneration, but falls off after oscillation begins.

The tuning unit is the popular illuminated airplane type dial with black background and white graduations and pointer. The escutcheon is oxidized silver. The smooth-working regenerative control is the lower left-hand knob. The center control is the changeover switch. On the right is the double-pole double-throw quarter turn "on and off" switch. This latter switch in the off position automatically throws the antenna from the pre-selector to the receiver proper. The unit contains its own filament supply and it is only necessary to tap positive plate supply from the receiver it is used with for operation. The B plus may be obtained from any point at the filtered side of the plate supply. The negative connection can be obtained from the chassis or ground terminal of the receiver.

Coil Data Table for Peak Booster

Winding	No. of Turns	Size Wire	Tap From Bot.
P1} Primaries	15	34 enam.	
P2} 1st Stage	7	34 enam.	
P3}	4	34 enam.	
S1} Secondaries	40	26 d.s.c.	5
S2} 1st Stage	12	26 d.s.c.	2 1/2
S3}	6*	26 d.s.c.	2 1/2
T1} Primaries	30	34 enam.	
T2} 2nd Stage	30	34 enam.	
T3}	30	34 enam.	
S4} Secondaries	40	26 d.s.c.	
S5} 2nd Stage	12 1/2	26 d.s.c.	
S6}	7*	26 d.s.c.	

*Space wound 1-16" between turns. All other windings are close-wound.
Spacing between antenna coils and secondaries are 1-8".
Spacing between plate coils and secondaries are 1-16".
All coil forms are 1" in diameter.

\$20.00 PRIZE MONTHLY FOR "BEST" 1-TUBE SET

Or other short-wave set article accepted and published. Send diagram first or set if you prefer.

Sets must be sent PREPAID and should be CAREFULLY PACKED in a WOOD-EN box!

The closing date for each contest is sixty days preceding date of issue (Dec. 1 for the Feb. issue, etc.). In the event of a "tie" an equal prize will be paid to each contestant so tying.

The judges will be the editors of SHORT WAVE CRAFT, and George Shuart and Clifford E. Denton, who will also serve on the examining board. Their findings will be final.

Address your entries to:

Editor,
SHORT WAVE CRAFT,
99-101 Hudson St.,
New York City.

Exclusively Short-Waves From Beginning to End
52 PAGES 50 HOOK-UPS 500 ILLUSTRATIONS

A Real Text Book On Short-Waves
ANOTHER GREAT EVENT! This special edition of our famous Treatise is exclusively short-wave from beginning to end. Packed between its two covers is a wealth of information covering the entire short-wave field. Every word in it is new.

This Short-Wave Treatise contains 52 solid pages of useful short-wave information, diagrams, illustrations, short-wave kink, and real live short-wave radio merchandise. It contains more valuable short-wave radio information—more real live "meat"—than many text books on the subject. Special attention has been given to the short-wave beginner. Numerous articles are devoted entirely to his interest. Yet, we have not forgotten all you of—timers. There is plenty of real "dope" for you too.

PARTIAL LIST OF CONTENTS

Getting Started in Short-Waves—Helpful Short-Wave Kink—Principles of Short-Wave Converter Operation—Band-reading Explained—How to Build the "19" Unimount Twinplex For Less Than \$5.00—How to Tune For Foreign Short-Wave Stations—How to "Band-spread" the 2-Tube Electrified Doerle Set—How to Build a 5 and 10 Meter Phone and C.W. Push-Pull Transmitter—How to Build a Medium Power Transmitter Using the New 203-A Tubes—All About the New Short-Wave Transmitting and Receiving Antennas—Notes On Short-Wave Operation (Effect of Time of Day and Season of Year on Short-Wave Reception)—Complete Up-to-Date Characteristics of Transmitting Tubes, etc., etc.

Enclose five cents coin or U. S. stamps for postage—Treatise sent by return mail. PRINT NAME AND ADDRESS CLEARLY.

WRITE TO-DAY

RADIO TRADING CO.

101A Hudson St.

New York City

LOWER PRICES!
Every item a bargain.
You SAVE when you buy from us.

- Hammarlund S.W. coils, 15-330 meters, 4 phones, 4 coils, \$1.76; 6 phones \$2.20
- Na-Ald S.W. coils, 4 coils, 4 min. \$1.17; 5 pin \$1.47; 6 pin 2.05
- Victor chokes, 30 hys., 150 mils., 200 ohms .33
- Victor power trans. for models R-32, R-53; etc. 1.49
- Otocolls 16-200 meters, 4 coils to set, 4-pin \$1.47; 6 pin 2.05
- Universal model-X mikes. 5.88
- Bruno Velocity mikes, list \$25; your price...14.70
- NATIONAL parts and receivers in stock—10% off list.
- Bliley type BC-3 mounted Xtals. 7.0, 3.5 Mc band 3.95
- Sangamo input and output transformers...each .65
- Mershon wet electrolyte condensers, 18 mfd. .25
- Midket radios, 4-tube, broadcast band, complete 9.75

20% with order, balance C.O.D., postage extra. No stamps accepted. Distributors of standard radio equipment. Write for quotations.

M. SCHWARTZ & SON
710-712 Broadway Schenectady, N.Y.

ANKER-CRUISER
3-TUBE A.C.-D.C. SET

WORLD-WIDE RECEPTION

KIT \$10.45 NET

OUTSTANDING FEATURES

Electron coupled feedback, 3 tubes, 6C6, 43, and 25Z5 humfree built-in 110 V. AC-DC power supply, front panel plug-in coils, front panel phone plug, automatic speaker cutoff, hinged cover black crackled metal cabinet 13 to 200 meters—complete kit of parts, including 4 front plug-in coils, hardware, diagram, instructions, etcetera. List, \$17.41; net \$10.45. Wiring and testing, list \$3.40; net \$2.05. Broadcast coil, list, \$9.99; net \$5.99. Kit of Arcutrus Tubes, list, \$3.95; net, \$2.37. Ankerlite phone, list, \$1.75; net, \$1.05.

Order from this page. Free Anker Catalog on Request

ANKER LABS
20 W. 22nd St. DEPT. S-12 New York City

Announcing Amazing Typewriter Bargain

New Remington Portable only 10c a Day

10-DAY FREE TRIAL OFFER

Only 10c a day buys this latest model Remington Portable!

Not a used typewriter. Not a rebuilt machine. It's a brand new, regulation Remington typewriter. Simple to operate, yet does the finest work. Full set of keys with large and small letters.

Try this typewriter in your home or office on our 10-day FREE TRIAL OFFER. If at the end of 10 days you do not agree that this Remington is the finest portable at any price, you can return it at our expense. Don't delay. Don't put it off. Mail the coupon today. Or use postcard if you prefer.

Write for our new catalogue showing the most complete line of portable and desk models ever offered.

FREE TOUCH TYPEWRITING COURSE

MAIL COUPON
for full facts about this astounding offer

REMINGTON RAND INC., Dept. 214-12, BUFFALO, NEW YORK.

Please tell me how I can buy a new Remington Portable Typewriter for only 10c a day. Also enclose one of your new catalogues.

Name

Address

Please mention SHORT WAVE CRAFT when writing advertisers

3 Tubes Equal 5 In This Battery Receiver

(Continued from page 463)

units are now on the market and are ideal for the purpose.

Circuit Easy to Follow

The circuit diagram shows the set to be really very simple to build and extremely economical, so far as parts are concerned. The r.f. stage used a small r.f. choke in the grid circuit and the antenna is coupled directly to it through a small condenser which can be adjusted to reduce broadcast band harmonics on the 160 meter coil. The output of the r.f. stage feeds through three condensers before it gets to the grid of the detector tube. In this case there is no danger of any of the plate voltage of the r.f. tube getting onto the grid of the detector. The plate of the 34 is shunt-fed through a 2.5 mh. r.f. choke.

In the detector stage we have the two triodes operating, one as the detector and the other as the feed-back tube. Two grid condensers are connected in series and the grid of the regeneration tube connects to the mid-point. The grid-leaks of both tubes are returned directly to the "A" plus lead instead of across the condensers. A high resistance rheostat is connected in series with the plate supply of the regeneration tube in order to vary the voltage and thus control the amount of feed-back. The output of the detector feeds the audio stages. Fifty thousand ohm resistors are used in the plate circuits of the detector and audio triodes. The grid-leak values, together with other necessary data is given in the drawings.

Operation, as we have mentioned before, is very simple and should gratify the most critical short-wave "fan." Tune the set the same as any other regenerative set, by adjusting the detector into oscillation first and then, after the station has been located, it is backed off until the carrier wave heterodyne disappears. This is for phone reception. For c.w. code reception the detector should oscillate at all times.

Take great care in building the set, using a layout similar to the one described, make no unnecessary connections and keep all leads as short as possible consistent with good construction. There should be a ground used at all times and not the slightest sign of body capacity effects will be noticed. The antenna should be about 100 feet long and as high as possible.

Alden Plug-in Coil Data

Meters Wave-length	Grid coil turns	Tlekler turns	Distance between 2 coils
200-80	52 T. No. 28 En. Wound	19 T. No. 30 En. Close wound (C.W.)	3/8"
80-40	32 T. per inch. 23 T. No. 28 En. Wound	11 T. No. 30 En. C. W.	3/8"
40-20	16 T. per inch. 11 T. No. 28 En. 3-32" between turns	9 T. No. 30 En. C. W.	3/8"
20-10	5 T. No. 28 En. 3-16" between turns	7 T. No. 30 En. C. W.	3/8"

Coilform—2 3/8" long by 1 1/4" dia. 4-pin base.

Parts List for Separate Reg. Set

- 1—metal chassis and panel, see text, Blan.
- 1—set of 5 prong plug-in coils, Na-Ald.
- 3—2.5 mh. R.F. chokes, National.
- 3—1 mf. by-pass condensers, Aerovox.
- 2—.01 mf. by-pass condensers, Aerovox.
- 1—.001 mf. mica condenser, Aerovox.
- 1—.0005 mf. mica condenser, Aerovox.
- 3—.0001 mf. mica condensers, Aerovox.
- 1—140 or 150 mmf. tuning condenser, National.
- 2—3 meg. resistors, Ohmite (Aerovox).
- 2—1 meg. resistors, Ohmite (Aerovox).
- 2—50,000 ohm resistors, Ohmite (Aerovox).
- 1—200,000 ohm variable resistor, Electrad, (potentiometer can be used.)
- 1—10 ohm rheostat, Ohmite.
- 1—4 prong Isolantite socket, National.
- 1—5 prong Isolantite socket, National.
- 1—6 prong Isolantite socket, National.
- 1—6 prong Bakelite wafer socket, Na-Ald.
- 1—antenna ground terminal strip, Na-Ald.
- 1—phone terminal strip, Na-Ald.
- 1—6 wire battery cable.
- 1—type 34 tube, RCA Radiotron.
- 2—type 19 tubes, RCA Radiotron.
- 1—dial (Vernier), National.
- 1—34 tube shield, National.

Sargent 8-34 All Wave Receiver

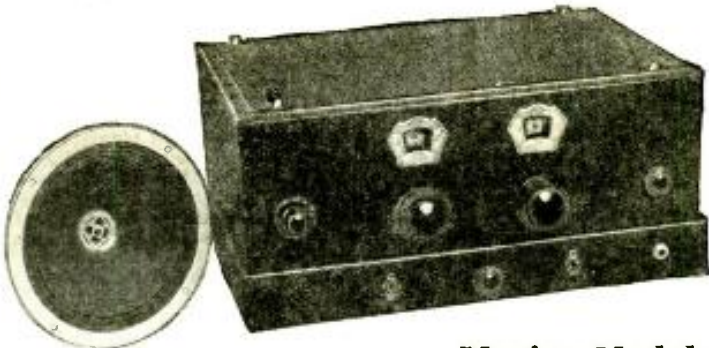

\$49.50

Complete with Tubes and Dynamic Speaker

Look at These Features

- Tunes 15 to 550 meters
- All Wave Band Spread
- Power Supply Self-Contained
- Separate C.W. Beat Oscillator
- A Sensational Short Wave Value
- Tremendous Sensitivity on Short Wave Broadcast
- Hairline Selectivity
- Fractional Microvolt Sensitivity
- Sold on 5-Day Money-back-Trial Order Yours Today

Marine Model—

For only \$8.00 extra, \$57.50 complete, we can supply the Marine Model 8-34 Receiver. This covers all wavelengths from 15 to 1500 meters. Gets the ship waves and airplane beacons in addition to usual "All-Wave" features.

3 TUBE AMATEUR SPECIAL

One stage r.f., detector, one audio. A neat and highly efficient Sargent circuit. Complete kit \$15.75, wired \$19.75. Write for full details. Has illuminated dials and band spread.

E. M. SARGENT CO.
212 Ninth St., Oakland, Calif.



The 'Little Red'

In this one-room cottage at Saranac Lake, N. Y., called "Little Red," the modern treatment of tuberculosis began in 1885 because Dr. E. L. Trudeau discovered the value of rest in curing tuberculosis. » Progress has been made in the fight against tuberculosis, but it still kills more persons between 15 and 45 than any other disease. » Help conquer it by using Christmas Seals on your holiday letters and packages.



The National, State and Local Tuberculosis Associations of the United States

BUY CHRISTMAS SEALS

GET THE WORLD NOW! with radio's greatest sensation the WORLD TROTTER



Complete KIT assembled including built-in POWER SUPPLY. Cords to cover from 14 to 210 meters and full size diagram. NOW ONLY... \$6.50
Extra for wiring..... \$1.95
Broadcast band coil..... .90
Special loud speaker..... 1.35
Uses 70, 30A power pentode and 6D6 pentode detector.
Arturion tubes. Guaranteed matched kit..... 2.45
SPECIAL black crackle finished metal cabinet as illustrated, only..... 1.95
FOREIGN RECEPTION GUARANTEED! ORDER NOW!
World Trotter Radio Labs.
168 Washington Street, New York, N.Y.
Division C. Circular free on request.

Learn CODE The CANDLER Way PRACTICE EQUIPMENT Furnished FREE With SCIENTIFIC CODE COURSE

Complete Training in Code, Radio Fundamentals and Theory to enable you to pass the Exam., build your own station and operate it.

All skilled amateurs and com'ops will tell you CANDLER Training is the best that can be had, and that our students read fast press and traffic as easily as they read a newspaper, and copy behind with "mill" or pencil.

FREE—CSG SCHEDULE. Listing all CSG stations broadcasting daily practice programs from every district. Listen to CANDLER trained ops on your s. w. receiver.

"Work your former student, Watson, Chief Op. BEAR OF OAKLAND, WHEW, every night. One of finest ops I ever worked. We hit up to 45wpm right along. I work Candler men in all parts of world. They're fast—plenty! CANDLER COURSE best investment I ever made." 73. L. S. HENDERSON, Op., KFS, M.R.T. Half Moon Bay, Calif.

CANDLER signed GUARANTEE (not promise) protects you. Money back if you "flunk."

Get your training where the champions and world's fastest ops got theirs. Small cost, easy payment plan. FREE BOOK OF FACTS gives details. A card will bring it.

CANDLER SYSTEM Co. Dept. 8-12
6343 S. Kedzie Ave., Chicago



BIG RADIO VALUES 1935 MODELS!

Amazing bargains in the newest and finest of 1935 models! BUY DIRECT from us and SAVE UP TO 50%. Factory prices on the complete line, every set guaranteed: AC-DC midgeets; worldwide all-wave; dual wave; consoles; car, farm and battery models. Also 2, 6 and 32 volt. Beautiful modern cabinets; illuminated airplane type dials; separate short wave switch control; foreign reception bands marked; greater power and selectivity. Get our low prices from

\$9.65 up
30-DAY HOME TRIAL, you risk nothing! Satisfaction guaranteed. Try your Fordson 30 days before deciding. Send TODAY for complete, FREE information!
FORDSON RADIO INC., Dept. 37-12
Oakman Bldg., Detroit, Mich.

OUR AGENTS MAKE MONEY! Openings for several active representatives. Write now!

The All-Electric All-Wave Receiver

Greatest Value On The Market

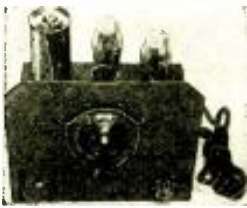

A completely electrified all-wave receiver capable of world-wide reception. Uses one each of the 6F7 (2 tubes in 1 bulb), 37 and 12Z3 tubes, in special circuit as screen-grid regenerative detector. 2 stage rectifier and complete to the use of the dual-circuit produces 4 tube

audio frequency amplifier, built-in power supply. Due purpose tube, the 6F7, this performance from 3 tubes. Operates entirely from 110 volt ac or dc house lighting circuit. Very sensitive and produces excellent volume. Wavelength range approx. 10-600 meters. Mounted on heavy black crackle finish metal chassis & panel. Beautiful appearance. Only additional apparatus needed are tubes and phones. Coils for 10-205 meters & instructions included. **FOREIGN RECEPTION GUARANTEED.**

KIT ASSEMBLED and ready to wire \$5.95

- Wired & tested, extra.....\$1.35
- Arcturus tubes 2.25
- Broadcast coils (2)..... .95
- Acme 4000 ohm phones..... 1.35
- Attractive metal cabinet for above..... 1.35

THE DC ALL-WAVE RECEIVER



One of the most powerful battery operated sets on the market. Owners report England & Germany on loudspeaker. Uses one each of types 19 (2 triode tubes in 1 bulb) and 33 tubes in special circuit as regenerative detector and 2

stage audio frequency amplifier. Due to the use of the dual-tube, the 19, this circuit produces 3 tube results. Special filament circuit produces a low filament current drain. Tremendous volume. Operates loudspeaker on many stations. Wavelength range 10-600 meters. Mounted on heavy black crackle finish metal chassis and panel. Constructed of highest grade parts. Coils for 10-205 meters & instructions included. **FOREIGN RECEPTION GUARANTEED.**

KIT ASSEMBLED and ready to wire \$5.75

- Wired & tested, extra.....\$1.35
- Arcturus tubes 1.95
- Broadcast coils (2)..... .95
- Metal cabinet, hinged lid..... 1.35

The EILEN Masterpiece

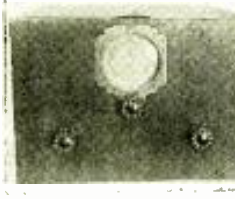

Designed for those who demand the maximum in results & appearance. No plug-in coils to change. 4 point switch enables one to cover the entire range 10-205 meters. Uses one each of 6F7 (2 tubes

in 1 bulb), 43, & 12Z3 tubes as screen-grid RF amplifier, regenerative detector, power pentode audio amplifier, rectifier & complete built-in power supply. Operates entirely from 110 volt ac or dc house lighting circuit. No aerial condenser to adjust. Tremendous volume. Works loudspeaker on many stations. Due to use of the 6F7 dual-purpose tube this circuit produces 4 tube performance from 3 tubes. Mounted in beautiful black crackle finish metal chassis and panel. Illuminated, airplane type vernier dial. **FOREIGN RECEPTION GUARANTEED.**

KIT ASSEMBLED and ready to wire \$12.95

- Wired & tested, extra.....\$2.00
- Arcturus tubes 2.95
- Loudspeaker, in beautiful wooden cabinet, equipped with output transformer to match above receiver.....\$5.95

COD orders filled. Prompt shipment! Circulars on request. **EILEN RADIO LABORATORIES** Dept. SC7, 463 Fourth Avenue, New York, N.Y.

Have You Seen the New BROWNIE All-Wave Aerial Kit?

Balanced Doublet System. Anyone can install. Outstanding efficiency in operation. Local noises eliminated. Priced most attractively. Ask your nearest jobber or write us for complete information.

PORCELAIN PRODUCTS Inc. FINDLAY, OHIO

See Page 503 for Special Subscription Offer.

Short Wave Receiver in "Book Form"

(Continued from page 471)

It will be noted by referring to photo No. 2, that the important detecting circuit is up close to front of "book," leaving plenty of room on the top shelf for the "C" battery employed in lower set, while on the lower shelf we have plenty of room for our audio transformer and audio tube. The extra space on the top shelf is used to mount the new and exceedingly effective antenna coupling and tuning apparatus. As shown in photo, and in the antenna circuit-diagram, this consists of a 2-gang 100 mmf. condenser (variable) and a tapped loading coil with switch arrangement. By use of this handy antenna "stunt" we find our antenna coupling condensers on the sets are no longer critical and do not need to be adjusted for various bands; therefore we can mount them directly on the stator of the tuning condensers inside the case, inasmuch as we do not have to touch them after being once adjusted for maximum volume.

Doublet Antenna Can be Used

This "hook-up" is well worth inserting in any home-made circuit. It allows the use of both leads of a doublet antenna, without interfering with our coil connections in the set. But the big feature really is the fact that it makes it possible to tune our antenna to any desired frequency. By use of switch and loading coil we can bring the antenna close to the exact frequency we wish to hear. Then by use of the knob controlling the condensers we can peak the antenna exactly. Thus by this arrangement we have brought about "non-critical antenna coupling" plus the advantages of "noise-free" doublet and a tuned antenna, as well as a more or less true method of knowing just where to tune our dials to receive a given signal best. Calibration of the dial is a thing long desired on small sets using antenna coupling condensers, but has heretofore been almost impossible. To accomplish all of the above features has up until now been a dream "too good to be true."

As shown in the diagram the leads of the doublet antenna are brought to the stators of the 2-gang condensers, one to each stator; then a single lead is taken from the common rotor of this condenser to one end of our loading coil, which consists of sixty turns of No. 18 enameled copper wire wound on a form an inch and one half in diameter and three inches long, tapped at seven, fourteen, twenty-three, forty, and sixty turns. The leads from taps are taken to a six-point switch mounted on the panel or face of the book. Then the lead from this switch is taken to a single-pole double-throw switch located out on top of the "book" in an easy-to-reach place, while a lead is taken from either side of this switch to the different sets enclosed. Thus we have the advantage of using either set with a throw of the antenna and power switches.

To sum it all up, we find we have the following:

Latest type antenna, connected to small battery sets, tuned to frequency we desire, a method of calibrating our dial, with non-critical coupling which allows us to throw away our screwdriver, and we have followed these advantages with two highly efficient sets, both of which are dependable to a degree to be proud of. Due to the ultra short leads, the shielding features, etc., each circuit is a "specialist" for certain frequencies. The convenience of coil mounting makes us wonder how we ever got along with those outfits which demanded we raise lids, reached over or behind, etc. Then too, we can practice battery economy without the need of changing the connections for change of receivers, and to "top it off," we have band-spread on all frequencies. Well, the wife has stopped complaining and the neighbors remark what a "cute and novel" radio we have, so I guess it's pretty good.

(Continued on page 498)

WE HAVE DECIDED TO GO ALL THE WAY

Insulator	Dielectric Factor	Power Factor
Victron AA.....	.02%	at 877 kc.
Transparent Fused Quartz.....	.02%	at 100 kc.
Sealite.....	.18%	at 825 kc.
Isolantite.....	.18%	frequency not given
Bakelite (laminated).....	3.6 %	frequency not given



Here is the Na-Ald Condenser insulated with Victron "AA" whose p.f. at r.f. is only 0.002. Note these outstanding features. Silver pressure contact on rotor. No grease or film or oxide akin as in bearing contacts. Self centering, self tightening cone bearing cannot loosen or produce noise. Minimized metal gives extremely low minimum capacity. Most practically shaped plates for station separation. Soldered brass plates precision spaced, 140 mmf. max. cap. Universal mounting. Two double solder tabs. No. C-140 Na-Ald VICTRON "AA" Insulated S.W. Condenser. List price..... \$2.50



No. 702R—Na-Ald VICTRON R.F. Choke. List Price..... \$.70



Here are the Victron "AA" Sockets. Contacts are out in air, touching VICTRON only where mounted. Ultra low-loss. Mounts easily with use of hand-drill. Jack-top binding posts. Overhanging solder tabs for below chassis wiring. Nos. 494V, 495V, 496V, 497V and 497VA 4, 5, 6, 7 and small 7 contact respectively. List price..... \$1.00



New 700 COIL SELECTOR takes any four 4, 5 and 6 prong coils for selection by turning knob. Mounts on chassis and panel. Modernizes old sets—eliminates handling and d storing coils. Simple—compact—rugged—highly efficient—reliable self cleaning pressure contacts. Without coils. No. 700 List price \$3.50

No. 700V NA-ALD VICTRON "AA" Insulated Coil Selector..... List Price \$7.50

No. 700CPL Complete Coupling Hardware for banking No. 700 Coil Selectors in tandem..... List price 25c

All coils listed below are boxed with diagrams and directions and use 140 mmf. size condenser.

Each of the following three S.W. Coil Sets (13 to 200 meters) have 3 coils wound on the special Na-Ald Processed Synthetic Molded Forms and the fourth coil—13 to 31 meters—is wound on VICTRON "AA", the ultimate in low-loss insulation. Precision wound coils with convenient color-coded grip-rim for easy insertion and removal from socket.

- 704SWS 4-pln Coils..... List \$2.00 set
- 705SWS 5-pln Coils..... List \$2.50 set
- 706SWS 6-pln Coils..... List \$3.50 set
- Set of 2 Coils for 100-550 meters.
- 704BCS 4-pln Coils..... List \$1.50 set
- 705BCS 5-pln Coils..... List \$1.75 set
- 706BCS 6-pln Coils..... List \$2.00 set
- Band Spreading Coils with ceramic padding condenser mounted on each coil. Simplifies tuning. Spreads stations.
- 705SWB-20-40-80-160 m. Amateur Coils.
- 705SWBC-19-25-31-49 m. S.W. B.C. Coils. List price \$4.00 per set, \$1.00 per coil.
- Long Wave Coils for S.W. Sets using 140 mmf. and 4-prong Coils.
- 704LW1 450-960 meters..... List \$1.00
- 704LW2 940-2000 meters..... List \$1.00
- 704LWS Set of 2 Coils..... List \$2.00 set

Now you can get the Extra Value of the Na-Ald Processed Synthetic Molded Coil Forms at these new low prices. 1 1/2" dia x 2" winding space. Color-coded grip-rim—red, yellow, green and blue.

No. Prongs	List price	No. Prongs	List price
704 4-pln.....	20c	707 7-pln.....	30c
705 5-pln.....		707A 7-sm.....	
706 6-pln.....		708 8-pln.....	

Tie up your weak signals by using coils wound on the ultimate in low-loss insulation!

NA-ALD VICTRON "AA" COIL FORMS

- 704V 4-pln..... List \$1.00
- 705V 5-pln..... List \$1.00
- 706V 6-pln..... List \$1.00
- 707V 7-pln..... List \$1.00
- 707VA 7-sm..... List \$1.00
- 708V 8-pln..... List \$1.00

For consistency use LIQUID VICTRON coil dope on your Victron coils and for better operation use it on the regular coil forms.

No. LV2 LIQUID VICTRON Coil Dope..... List price 35c can Be sure to send for new 16 page catalog listing new items, including S.W. VICTRON Parts. When writing, include the name and address of your parts supplier.

ALDEN PRODUCTS CO. Dept. SW 12 BROCKTON, MASS.



The Short Wave Fan's Bible



NEARLY 9,000 WORLD WIDE Short Wave Stations Listed in this Book!

Here is the second issue of the OFFICIAL SHORT WAVE LOG AND CALL MAGAZINE—just off the press. It has been entirely revised and reprinted. Thousands who used the first issue as reference will find in the second book entirely new material, with many additional features not previously included. There are nearly 9,000 listings of radio phone short wave stations from all parts of the world.

ONLY MAGAZINE OF ITS KIND

The OFFICIAL SHORT WAVE LOG AND CALL MAGAZINE is the only publication which publishes exclusively ALL the short-wave 'phone stations of the world. Thousands of stations that the average listener hears are listed in this book. No longer need you be puzzled as to whence the call emanates. The book is the same size as SHORT WAVE CRAFT monthly—it has a durable cover to stand long service.

PARTIAL CONTENTS

This magazine contains the largest list of short-wave stations ever published; log sections give you dial settings, time, date, call letters, location and other information; another section contains squared-paper pages on which you can fill in frequency curves; World Air-line distances on charts showing distances from city to city; "meter to kilocycle" conversion chart; list of international abbreviations used in radio transmission; chart of complete Morse and Continental International Code Signals; world time chart; improving short wave reception; Identification chart of stations by call letters; map showing standard time zones of the world; 'phone stations of ocean liners; "Q" readability systems; "T" tone systems; "R" audibility systems. Invaluable to amateurs. New straight-line world distance chart; international prefixes which enable you to recognize foreign countries.

Not Sold on Newsstands **25c a Copy**

SHORT WAVE CRAFT
99-101 Hudson Street, New York, N. Y.

Gentlemen: I enclose herewith 25c for which send to me prepaid, immediately a copy of your new OFFICIAL SHORT WAVE LOG AND CALL MAGAZINE. (Send money order, check, cash, or new U. S. Stamps. Register letter if it contains stamps or currency.)

Name

Address

City..... State..... SW-12-31

— MAIL THIS COUPON TODAY! —

Micro-Waves Will Transmit Pictures

(Continued from page 457)

many times as desired; finally the image signals are picked up at the desired receiving station and recorded on another reel of film. It is then only necessary, after developing this film at the receiving station, to pass the film through a regular motion picture projector onto a screen.

Referring to the transmission by micro waves of a handwritten letter, Mr. Sarnoff stated that while the cost might be somewhat more than the cost of a postage stamp, it would certainly be worth 50 cents or even a dollar to receive a letter from your friend or business partner, possibly transmitted halfway around the world, when it is to be considered that you received the letter the same day it was written and did not have to wait a month for its arrival from Australia, for example. Mr. Sarnoff said, "I believe thousands of letters and messages will fly from city to city, country to country, by facsimile radio tomorrow."

Simply explained the present facsimile picture transmission apparatus works as follows: A pin-point beam of light is arranged to pass through lenses onto the photo, drawing, or letter, which is fastened around a cylinder which slowly revolves at a constant speed. The light beam falling on the various light and dark sections of the picture, line by line, as the cylinder revolves, is reflected onto a photo-electric cell and the varying strengths of reflected light values affect the photo-cell proportionately. The variations of light intensity recorded by the photo-cell are suitably amplified and caused in turn to modulate the radio transmitter. Thus the image is projected through the ether to the receiving antenna, which for ultra short-wave transmission, may comprise a tiny antenna or collector rod and tube placed in the focus of a parabolic reflector, the transmitting antenna being likewise arranged in the focus of a reflector.

At the receiving apparatus the picture or message is reconstructed line by line as the incoming radio signals are caused to modulate a light beam falling on a piece of sensitive photographic bromide paper or a photographic film secured around a cylinder, rotated at the precise speed of the transmitting cylinder. As soon as the picture has been entirely scanned the film or photo sensitive paper is passed into the dark-room for development by regular photographic methods, and after drying it is ready for delivery to the customer.

A second means of reproducing the picture or handwriting, check, etc., now in use involves a special ink spray which plays on a revolving piece of special paper fastened on a cylinder, progressively moved upward past the ink nozzle. The incoming radio image signals operate a tiny shutter placed across the mouth of the ink nozzle so as to cause light and dark ink impressions to be recorded on the moving paper. By means of suitable electro-mechanical gear, the ink spray jet is moved horizontally also.

It is believed that eventually, thanks to the ultra high speed transmission of script messages, drawings, etc., that telegrams will be written and transmitted by facsimile, thus doing away with code transmission as now practiced and relegating the telegraph or radio key to the limbo of forgotten things. Small towns and suburbs of cities will be linked with the micro-wave transmitting and receiving stations in the larger cities, by special wire or ultra short-wave circuits.—H. Winfield Secor.

HAMMARLUND

Low-Loss COILS and COIL FORMS



PERFECTION of the remarkable "XP-53" low-loss dielectric now makes it possible to offer highly-efficient S-W Coils and Coil Forms at the lowest prices in Hammarlund history. They are rugged and free from loss-causing artificial coloring. Ribbed for air-spacing and equipped with easy grip and "Meter-Index." Four, five or six prongs. Coil Forms, 35c and 40c each. Coils, \$3. and \$3.75 per set of four.

Several new types of compact Hammarlund Condensers are now available for trimming, balancing, padding and transformer-tuning.



"IBT" Mica-Dielectric Trimming or Padding Condenser

Some are made to mount inside of coil forms or shields (see illustration). You will find them accurately rated, constant and reliable under the most severe conditions.



"APC" Air-Dielectric Trimming or Padding Condenser

HAMMARLUND MFG. CO.,
424-438 West 33rd St., New York.



Check here and attach 10c for 16-page Hammarlund 1935 Short-Wave Manual illustrating and describing most popular S-W circuits of past year, with schematic and picture diagrams and parts lists.

Check here for FREE information on XP-53 Coil Forms and Coils.

Check here for FREE General Catalog.

Name

Address

..... SW-12



More About 955 "Acorn" Tube Sets—In Next Issue!

Please mention SHORT WAVE CRAFT when writing advertisers

**ALL ELECTRIC
ALL-WAVE AIR SCOUT
ONLY SET OF ITS KIND IN THE WORLD**

Invented by
H. G. Cline
Pat. Pending
U.S. Serial No.
592,586

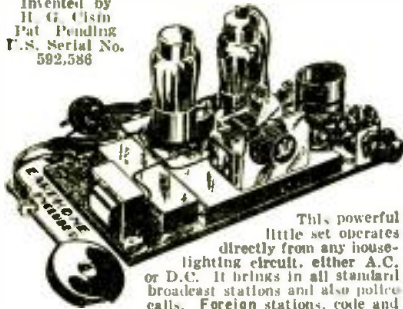

This powerful little set operates directly from any house-lighting circuit, either A.C. or D.C. It brings in all standard broadcast stations and also police calls. Foreign stations, code and trans-Atlantic phone conversations. Uses five plug-in coils to cover band from 10 to 550 meters. Compact and light—Makes an ideal portable. Will operate several headsets simultaneously and will work on a short indoor aerial. Complete Set, with two tubes, earphone, two coils covering band from 70 to 550 meters. **Ready to plug in and use. Postpaid... \$8.50**
Same as above, less earphone. **\$8.00**

Battery-Operated All-Wave Air Scout—complete with tube, earphone, two coils, ready to use (less inexpensive batteries) **\$5.95**
Three extra plug-in coils to cover band from 10 to 70 meters, 50¢ each.

**SUPER DELUXE MODEL
All Electric ALL WAVE AIR SCOUT**



Pat. Pending U. S. Serial No. 592586

This amazing set incorporates the latest developments in radio engineering, including the new two-in-one 6F7 tube—FOREIGN RECEPTION, OF COURSE—Loud Speaker operation on most local broadcast stations. Equipped with illuminated vernier dial, crackle-finish cabinet, metal chassis, variable selectivity control. Easy to tune. Works on any A.C. or D.C. house-lighting circuit. **COMPLETE SET—READY TO USE—with earphone, genuine Arcturus tubes, and five coils covering band from 10 to 600 meters... \$13.50**
Same as above, less earphone... **\$13.00**
5" Magnetic Speaker for Super Deluxe Model 1.25

DELUXE MODEL ALL ELECTRIC ALL WAVE AIR SCOUT

Similar in appearance to the Super Deluxe Model, but for earphone operation only. Crackle finish cabinet, metal chassis, illuminated vernier dial. **FOREIGN RECEPTION!**
Complete—READY TO USE with earphone. Genuine Arcturus Tubes and two coils covering band from 70 to 600 meters... **\$10.75**
Same as above, less earphone... **10.25**
Three extra plug-in coils to cover band from 10 to 70 meters, each... **.50**

**ALL ELECTRIC AIR SCOUT
AMPLIFIER**

Can be used with all Air Scout Models. Including Battery-operated set. Standard \$8.50 All Electric Model, Deluxe and Super Deluxe Models. Will also work on any other set.
Contains two powerful audio stages, with 77 tube in first stage and 43 power output tube. Uses a 25Z5 rectifier. Self-contained Power Supply.
Operates from any A.C. or D.C. socket. Full-toned dynamic speaker. Chassis and wood baffle. Enormous volume. Foreign stations on speaker. Price Complete, less tubes... **\$9.95**
Kit of Three Matched Arcturus Tubes... **2.55**
Free Circulars Available.

ALLIED ENGINEERING INSTITUTE
98 Park Pl. Dept. S-12 New York, N. Y.

**CHASSIS
for YOUR PORTABLE**



All drilled and with handle attached. Beautiful crackle **\$2.95** finish....

We also make chassis for any receiver. Send drawing or give complete dimensions for estimate.

KORROL MFG. CO., Inc. Dept. S-12
232 GREENWICH ST. NEW YORK CITY

S-W Set in Book

(Continued from page 496)

Parts required for the complete "Book of Radio" are as follows:

Cabinet made of 22 gauge metal, size 11 inches high, 10 inches deep, 4 inches wide in front, 8 inches wide at back.

- 1—2-gang 100 mmf. condenser, National.
 - 1—loading coil, (see text).
 - 1—6 point switch.
 - 1—single-pole double-throw switch.
 - 1—2-volt filament or "A" battery.
 - 1—22½ volt "C" battery.
 - 2—45 volt "B" batteries.
- Plus parts of each circuit, as follows:
Duo-Amplidyne on top shelf:
1—antenna trimmer condenser, 35 mmf. max., National.

- 1—100 mmf. tuning condenser, National.
- 1—single-throw switch for filament line.
- 1—25 mmf. tuning condenser, National.
- 1—.01 mf. condenser, fixed; Aerovox.
- 1—.0001 mf. condenser, fixed; Aerovox.
- 1—.002 mf. condenser, fixed; Aerovox.
- 1—1 mf. condenser, fixed; Aerovox.
- 2—50,000 ohm, 1 watt resistor, Ohmite.
- 1—50,000 ohm potentiometer, with switch, Electrad.
- 2—1 meg. fixed resistors, Ohmite.
- 1—10 ohm rheostat, useful even if you employ a 2-volt battery and necessary with 3-volt battery, Ohmite.
- 1—6 prong socket wafer, Na-Ald.
- 1—4 prong wafer socket, Na-Ald.
- 1—pair phone jacks, insulated.
- 1—type 19 tube, R.C.A.-Radiotron (Sylvania).
- 1—set of coils; Na-Ald, (Bud, I.C.A., or Hammarlund, etc.). Note: A few turns may have to be added to tickler windings for best operation.

As explained by Mr. Shuart in the June issue, when describing this circuit, "care should be taken to use a potentiometer provided with switch, in order to avoid running down 'B' batteries when set is not in use." Also in winding coils make sure the outside winding of the grid coil is connected to grid-leak and condenser with end nearest to the tickler connected to positive filament and the outside connection of tickler connected to plate of tube, with end nearest grid coil going to the 50,000 ohm plate resistor and the .01 mf. audio coupling condenser. Then there will be no trouble with set not working due to improper coil connections, etc.

Parts for 2-tube circuit on lower shelf:
1—antenna trimmer condenser 35 mmf., National.

1—100 mmf. tuning (Variable) condenser; National.

- 1—50 mmf. variable condenser; National.
- 1—insulated grid cap.
- 1—3 to 1 audio transformer.
- 1—5 megohm grid-leak; Ohmite.
- 1—100 mmf. grid condenser; Aerovox.
- 1—50,000 ohm potentiometer, with switch; Electrad.

- 1—1mf. condenser, fixed; Aerovox.
- 1—.002 condenser, fixed; Aerovox.
- 2—4 prong wafer sockets; Na-Ald.
- 1—5 prong wafer sockets; Na-Ald.
- 1—set coils—any regular 4 prong make; Na-Ald (or Bud, I.C.A., Hammarlund).
- 1—ground post.
- 1—2 contact phone strip.
- 1—10 ohm rheostat with switch; Ohmite.

The wafer sockets used for tubes in both sets are set up one inch above shelf floor on mounting legs of bakelite tubing.

Practically every continent has been heard on one or the other of these circuits by the writer since building the set, a matter of three months. The Japanese signal on 27 meters is listened to quite often over the Duo-Amplidyne circuit, as are also the 19-meter European signals and the 14-meter Pittsburgh (W8XK) signal comes in extra well over this circuit.

The writer found it advisable to have separate coils for the two circuits, because of heavy tickler windings required on the Duo-Amplidyne, which averages ½ more turns than that found in standard make coils.

It must be remembered that above results were secured here in Texas and are therefore quite a feat.

**NEW
Reduced Prices
on ARCO Tubes**

HIGHEST QUALITY BUILT INTO ARCO TUBES

Our Sales Policy Is: First Quality Merchandise, Rapid Service, Low Price, and a Square Deal. All Tubes are—

- 1—GUARANTEED FIRST QUALITY
- 2—R.C.A. LICENSED
- 3—FULLY REPLACEABLE UNDER R.M.A. STANDARD POLICY
- 4—UNIFORMLY WITHIN R.C.A. TEST LIMITS
- 5—ATTRACTIVELY PACKED

**Complete Stock Ready for
Immediate Shipment**

Order from this page—Remit 20% with order, balance C. O. D. All prices are F. O. B. FACTORY, Newark. Shipments go forward express or parcel post. No order for less than \$3.00 accepted.

Type No.	Fil. Voltage	Your Cost	Type No.	Fil. Voltage	Your Cost
1V	6.3	.50	75	6.3	.50
00A	5.0	.40	76	6.3	.45
01A	5.0	.30	77	6.3	.50
10	7.5	1.10	78	6.3	.50
12A	5.0	.40	79	6.3	.60
19	2.0	.60	80	5.0	.35
20	3.3	.40	81	7.5	1.10
22	3.3	.60	82	2.5	.45
24A	2.5	.45	83	5.0	.50
26	1.5	.30	84	6.3	.50
27	2.5	.30	85	6.3	.50
30	2.0	.45	89	6.3	.50
31	2.0	.45	X199	3.3	.45
32	2.0	.60	V199	3.3	.45
33	2.0	.60	1A6	2.0	.85
34	2.0	.60	1C6	2.0	.85
35/51	2.5	.50	2A3	2.5	.85
36	6.3	.50	2A5	2.5	.60
37	6.3	.40	2A6	2.5	.60
38	6.3	.50	2A7	2.5	.60
39/44	6.3	.50	2B6	2.5	1.10
40	5.0	.40	2B7	2.5	.60
41	6.3	.50	5Z3	5.0	.50
42	6.3	.50	6A4/1A	6.3	.60
43	25.0	.50	6A7	6.3	.60
45	2.5	.35	6B7	6.3	.60
46	2.5	.50	6C6	6.3	.60
47	2.5	.50	6D6	6.3	.60
48	30.0	1.10	6F7	6.3	.60
49	2.0	.50	12A5	6.3	.85
50	7.5	1.10	12Z5	6.3	.85
53	2.5	.60	25Z5	25.0	.60
65	2.5	.50	12Z3	12.6	.50
56	2.5	.35	PZH	2.5	.85
57	2.5	.50	WD11	1.1	.85
58	2.5	.50	WD12	1.1	.85
59	2.5	.60	21B6	7.5	.85
71A	5.0	.30	21C	5.0	.60

● SPARTON TYPE TUBES ●		
182B	5.0	.60
183	5.0	.85
484	3.0	.60
	485	3.0
	586	7.5
	686	3.0

● KELLOGG TYPE TUBES ●		
101	3.0	1.50
	403	3.0
	403	2.00

● MAJESTIC TYPE TUBES ●		
2A7S	2.5	1.10
2B7S	2.5	1.10
2S/4S	2.5	1.10
2Z2/G84	2.5	.85
6A7S	6.3	1.10
6B7S	6.3	1.10
6C7	6.3	.85
6D7	6.3	.85
6E7	6.3	.85
6F7S	6.3	.85
6Y5	6.3	.85
6Z4	6.3	1.10
	675	6.3
	24S	2.5
	25 25S	0.2
	27S	2.5
	35S 31S	2.5
	35S	2.5
	56S	2.5
	57S	2.5
	58S	2.5
	75S	6.3
	85S	6.3

● RECTIFIER AND CHARGER BULBS ●

125 Mil. rectifier tube B.H. (Raytheon type).....	\$1.25
6-10 Amp. trickle charger Bulb (Tungar type).....	2.00
2 Amp. charger Bulb (Tungar type).....	2.00
5 and 6 Amp. charger Bulb (Tungar type).....	3.75
15 Amp. charger Bulb (Tungar type).....	7.50
UX-280M—5.0 Full Wave Mercury Vapor Rectifier.....	1.10
UX-281M—7.5 Half Wave Mercury Vapor Rectifier.....	1.90
UX-866—2.5 Half Wave Mercury Rectifier.....	2.75
UX-871—2.5 Half Wave Mercury Vapor Rectifier.....	1.10
UX-872—500 Volts Half Wave Merc. Vap. Rectifier.....	11.00
TELEVISION TUBES and PHOTO ELECTRIC CELLS	
Photo Cell (Potassium), 2¼" Length Overall.....	\$1.75
Photo Cell (Potassium), 3¼" Length Overall.....	2.10
Photo Cell (Caesium Type), 4¼" Length Overall.....	7.90
Photo Cell (Caesium Type), 3" Length Overall.....	5.90
Photo Cell (Caesium Type), Same as UX 868.....	4.90
Television Tube (Neon Reflector), 1" Sq. Cathode.....	2.85
Television Tube (Neon), 1" Sq. Cathode.....	2.85
Television Tube (Neon), 1¼" Sq. Cathode.....	3.85
Specifications and quotations on TRANSMITTER TUBES, CRATER TUBES, GLOW LAMPS, HIGH VACUUM TYPE CATHODE RAY TUBES, suitable for television and standard oscillographic uses. SUBMITTED ON REQUEST.	

ARCO TUBE COMPANY

232 Central Avenue Newark, N. J.

DATAPRINTS

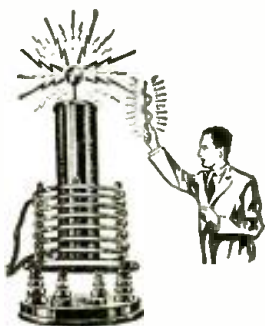

Just the
Technical
Information
You Need
To Build
Electrical
Apparatus

Dataprint containing data for constructing this 3 ft. spark Oudin-Tesla coil. Requires 1 K.W. 20,000 volt transformer as "exciter"; see list below. Includes condenser data. . . . **\$0.75**

- TESLA OR OUDIN COILS**
- 36 inch spark, data for building, including condenser data **\$0.75**
 - 8 inch spark, data for building, including condenser data; requires 1/4 K. W. 15,000 volt transformer; see list below. **0.75**
 - Violet type high frequency coil data; 110 volt A.C. or D.C. type; 1" spark; used for "violet ray" treatments and "Experiments" **0.50**
 - How to operate Oudin coil from a vacuum tube oscillator **0.50**
 - 3 inch spark Tesla coil; operates on Ford ignition coil **0.50**
 - 3 inch spark Oudin coil; 110 volt A.C. "Kick-Coil" **0.50**
 - 20 Tricks with Tesla and Oudin Coils. **0.50**

- TRANSFORMER DATA**
- 1 k.w. 20,000-volt transformer data, 110-volt, 60-cycle primary. Suitable for operating 3 ft. Oudin coil **0.50**
 - 1/4 k.w. 15,000-volt transformer data, 110-volt, 60-cycle primary. Suitable for operating 8-inch Oudin coil **0.50**
 - Electric Welding Transformer (State secondary voltage) **0.50**
 - Induction Coils—1 to 12 inch spark data. **0.50**

HOT! ARTIFICIAL "FEVER" APPARATUS—Ultra Short Wave Apparatus—
Sold only to Physicians and Bacteriologists. Constructional Data for Small, Medium and Large Apparatus. **\$0.75**

- NEW! RADIO AND TELEVISION. \$0.50 Each**
(Minimum Order 2 prints!)
- The Find-All Pentagrid A.C.-D.C. "Short-Wave" Converter (3 Tubes).
 - "All-Wave" Find-All Four (A.C.; no plug-in coils).
 - 3-Tube Battery Operated Personal Receiver, 2 V. tubes.
 - "Pal" Portable, Sr. (Universal A.C.-D.C., 38 Out put, Magnetic Speaker).
 - The "Short Wave" Triple Pentode with 44 and 42 Tubes (A.C.).
 - The 2-volt Superheterodyne with Latest 2-volt Pentodes (8 tubes).
 - Nine Easy Ways to "Modernize" the Radio Set.
 - 7-Tube Television Receiver.

TELEGRAPHONE — Records Voice or "Code" signals on steel wire by magnetism. Code can be recorded "fast" and translated "slow." Construction data (special) **\$0.50**

MAGNET COIL DATA

- Powerful battery electro-magnet; lifts 40 lbs. **\$0.50**
- 110 Volt D.C. magnet to lift 25 lbs. **0.50**
- 110 Volt D.C., 300 lb., Lift electromagnet. **0.50**
- 110 Volt D.C. solenoid; lifts 2 lb. through 1 in. **0.50**
- 110 Volt D.C. solenoid, lifts 6 lb. through 1 in. **0.50**
- 12 Volt D.C. solenoid, lifts 2 lb. through 1 in. **0.50**
- A. C. Solenoid, powerful, 110-volt, 60-cycle. **0.50**
- MOTOR**—1 1/2 H.P., 110 volt A.C., 60 cycle (suitable for driving 12" fan, etc.)—Data. **0.50**
- 60 or 1,200 cycle Synchronous motor. **0.50**

MISCELLANEOUS DATAPRINTS

- Treasure Locator **\$0.50**
- 2 K. W. 110 vt. to 18 vt. transformer data. **0.50**
- 20 motor circuits—hook-ups **0.35**
- 20 practical telephone hook-ups **0.35**
- 100 mechanical movements for inventors. **0.50**
- Polarized Relay—Ultra Sensitive **0.50**
- Electro-medical coil (shocking coil) **0.50**
- Water-Wheels—How to Build and Light your house **0.50**
- 20 Electric Bell circuits. **0.50**
- Public Address System **0.50**
- Electric chime ringer; fits any clock. **0.50**

20 "Electrical Tricks" for LODGES and PARTIES \$0.50

How to Fry Eggs on Cake of Ice Electrically. **\$0.50**
"Rewinding" Small Motor Armatures. **0.50**

"ENGINEERING SERVICE BY MAIL"
Send Sketch of Your Problem for Estimate.

(20% off on orders for \$3.00 or more. No C.O.D.)

The DATAPRINT COMPANY

Leak Box 322 RAMSEY, N. J.

3.1 Meter Receiver

By DR. W. MÖLLER, Germany

(Concluded from last issue)

Experimental Results

The receiving experiments were conducted within a radius of 5 to 6 kms. (3 to 3.6 miles), around the transmitter, which, with its direct coupled horizontal antenna (third harmonic) was located in a tall building of a large city, a location which is extraordinarily unfavorable for transmission. The receiver was mounted on a car which covered the 6 km. (3.6 mile) circle in various directions. A plain Litz (stranded) wire, 1 to 2 meters (3.2 to 6.4 feet) long was used as a receiving antenna.

Observed Facts

The following facts were observed during the experiments while traveling with the car: The ignition system of the car, of which no care was taken to eliminate radio interferences, was causing such a weak crackle in the earphones that the reception of the ultra short waves was hardly affected.

Atmospheric disturbances could not be detected at all. The quietness of the reception was not disturbed even during a thunder-storm. Also, the passing street cars did not cause any disturbances.

In the immediate neighborhood of the transmitter the surprising fact could be observed, that the signal strength was increasing while moving away from the transmitter.

Numerous fading points, due to local conditions were observed between the building groups of the city. The signal strength used to go down when the receiver was located immediately behind a group of tall

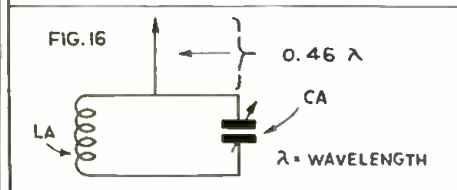
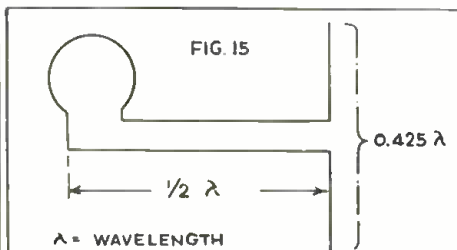

Fig. 15 shows method of coupling radiator to oscillator. Fig. 16—coupling 46 wavelength aerial to receiver.

buildings which was in the path between the transmitter and receiver.

A cross street, with an open path to the transmitter, caused a marked improvement of the signal strength. By moving away from the building group, which means by going out of its "shadow", the reception became normal again.

A direct optical sight between transmitter and receiver was not necessary. However, the conditions were very favorable when the space between the transmitter and the receiver was an open field, which enabled us to move out from the "shadow" of the buildings.

The signal strength was lower under trees and behind tree groups.

Darkness or bright light, cloudy sky or sunshine had no influence on the reception!

It seems that the manner of mounting the receiver antenna is very essential: whether it is vertical, or inclined and in which direction it is inclined. Often the signal strength was considerably increased by changing the position of the antenna.

With the few exceptions mentioned above, the transmitter was heard clearly all over the "experimental zone". It is emphasized

LATEST TECHNICAL INFORMATION

Yours
for
10c.



● NOW AVAILABLE. A convenient 104-page Manual containing essential information users must have to get optimum performances from any device using vacuum tubes.

Complete data on over 90 receiving tubes. Base Symbols. Recommended Operating conditions, circuit applications, amplifier classifications. Over 150 cuts and diagrams. Represents months of painstaking research by Sylvania's famous technical staff.

This Manual is as necessary as your voltmeter. Just fill in the coupon, attach 10c in stamps and mail.

YOURS! FOR 10c IN STAMPS

Makers of
SYLVANIA TUBES
HYGRADE LAMPS
ELECTRONIC PRODUCTS
(© H. S. Corp., 1934)

Factories
EMPORIUM, PA.
ST. MARY'S, PA.
SALEM, MASS.
CLIFTON, N. J.



10c—TECHNICAL MANUAL—10c

Hygrade Sylvania Corporation
Emporium, Pennsylvania (D-3)

Please send me the new Sylvania Technical Manual.
I enclose 10 cents in stamps.

NAME

ADDRESS

CITY STATE

Please mention SHORT WAVE CRAFT when writing advertisers

FREE RADIO'S LEADING CATALOG for 1935!

Send for the most complete and truly timely book in Radio. It will keep you ahead of the field and save you money. Why buy from skimpy seasonal catalogs whose usefulness is confined to a few weeks—or from books a year old? Write today for radio's most valuable catalog—the ALLIED Radio Guide—always timely because of its remarkable completeness, always up-to-the-minute because of its strategic publication date geared to radio progress.



SEND FOR THIS BOOK IT WILL SOLVE YOUR RADIO NEEDS AT CONSISTENT SAVINGS!

All-wave and European range sets, battery, 32 volt, and electric models — Short Wave Transmitters and Receiving equipment—an amazing P.A. listing—test instruments—thousands of replacement parts, tubes and accessories — are packed into the 1935 ALLIED Catalog. Also "Build-your-own" kits. (As kit specialists we can quote for any circuit appearing in any magazine or handbook.) Write today for your FREE copy of the 1935 ALLIED Catalog.

Allied Radio

833 W. Jackson Blvd., Chicago, Dept. E

- Please send me your FREE 1935 Catalog
- Please quote for Kit described in.....

NAME

ADDRESS

CITY STATE.....

THE SHORT-WAVE SET YOU ALWAYS WANTED

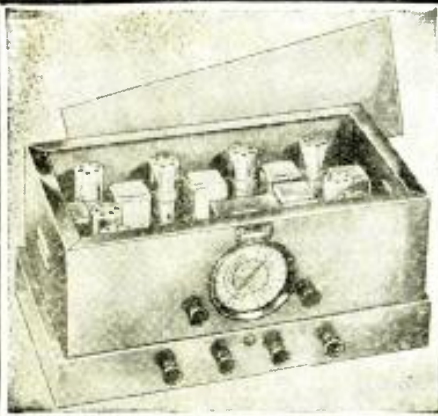

the "MJ" for the truly critical
 There is no finer Short-Wave Receiver!
 Write for details, No. 80-S
PIONEER SOUND LABORATORY
 135 Liberty St. New York, N. Y.

Just Off the Press!

RADIO'S GREATEST VALUES

100 Pages. Filled with Latest Design Portable, Mobile and Rack & Panel, Public Address Amplifiers, Short-Wave and All-Wave Receivers and Converters, Inter-Office Call Systems, Test Equipment, Replacement Parts, Kits, Tubes, and Accessories—all at Unbeatable Rock Bottom Prices! Send For Your Copy To-Day!



COAST TO COAST RADIO CORP.
 125 S. WEST 17th STREET NEW YORK, N. Y.

here that it follows from our experiments, that there is no doubt, that direct optical sight is not required!

Following results were obtained while testing the modulation performances of the three above described systems:

The best results were obtained with the parallel tube method (Heising). Nearly as good results were obtained with the grid modulation method. The difference with regard to the loudness of the received signals between this and the Heising method was so small, that whenever it is desired to spare tubes, there could be no objection to the use of the grid modulation method.

Considerably worse were the receiving results with the plate modulation method. These results were to be expected beforehand, because generally this method requires a higher plate voltage. It is necessary to introduce an A.P. transformer between the audio generator and the plate circuit of the transmitter tube.

The object of another series of tests was to establish the efficiency of three antenna types. A comparative test was to be made: 1, between the direct-coupled antenna, which is tuned up to the third harmonic; 2, between an inductively coupled dipole, using a feeder; and (3) finally a Fuchs antenna.

The construction and coupling manner of the first type were already given in connection with the description of the transmitter and there is nothing else to add.

In the second type of antenna it is important to transfer, if possible, without any losses to a feeder system a certain amount of energy from the oscillator to the radiator. On account of this, care must be taken to adjust its length carefully to the wavelength of the transmitter. Fig. 15 shows the arrangement which was used and gives also the corresponding values. The coupling coil which is seen on the extreme left was approximately 16 cms. (6.4 inches) in diameter and serves to couple the oscillator to the parallel wire system. The distance between these wires is 5-8 cms. (2 to 3.2 inches). When the length of the feeders between the coupling coil and the radiator is exactly λ over 2, their ends become current antinodal points (current maxima) through which the middle of the dipole is excited.

The excitation of the third type of antenna comes from the voltage antinodal point (voltage maxima).

The length of the radiator is exactly $.46 \lambda$ and it is connected, as shown in Fig. 16, to the condenser Ca of the oscillatory coupling circuit. The voltage variations which is formed across the tuning condenser during resonance of the oscillatory circuit LaCa are transferred to the antinodal voltage point of the radiator. It is therefore important to dimension the elements of the circuit LaCa so as to have the highest possible tension. La is thus relatively large and Ca accordingly smaller. In the circuit used by the author, La consisted of 2 turns of 7.5 cm. (3 inches) in diameter (copper tubing .6 cm. (1/4 inch) in diameter.) A very small value of the capacity of Ca (a neutralizing condenser of 20 mmf. max.) was necessary for the resonance tuning.

A hot-wire ammeter which is often used for resonance tuning is here not needed. The tuning of this type of antenna is done by observing the milliammeter, which is in the grid circuit of the oscillator. When the entire system radiator—oscillatory circuit LaCa (Fuchs antenna) is in resonance with the frequency of the transmitter, the reading of the milliammeter drops very sharply.

A comparison between the three types of antennas will give us a perfect picture of their performance only then, when the condition of operation will be identical for each antenna. Also we have to take into consideration the degree of coupling between the antenna circuit and the oscillatory circuit. The coupling shall be adjusted with the aid of the crystal receiver for the best value of each antenna type.

During all these experiments the antennas were mounted vertically. The problem which antenna radiates better, a vertical or a horizontal, is still to be determined finally. According to all indications the vertical antenna seems to be superior to the horizontal.

HERE IT IS

SHORT WAVE SET BUILDERS MUST HAVE THIS BOOK

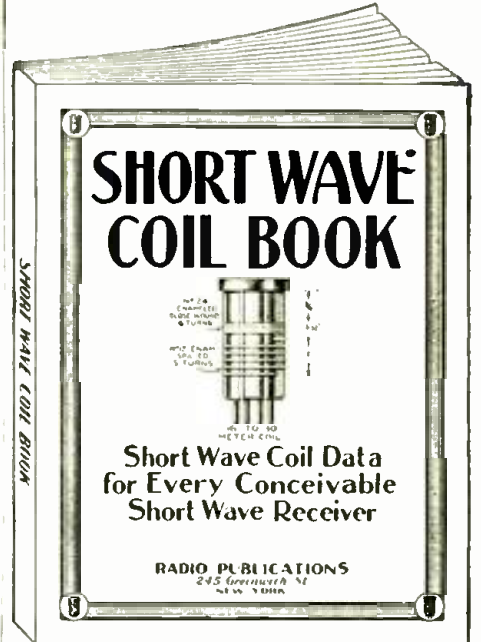

SHORT WAVE COIL BOOK

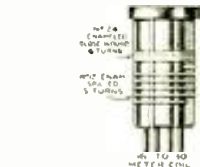

Short Wave Coil Data for Every Conceivable Short Wave Receiver

RADIO PUBLICATIONS
 245 Greenwich St.
 NEW YORK

FOR the first time, it is now possible for the experimenter and short wave enthusiast to obtain the most exhaustive data on short wave coil winding information that has ever appeared in print.

As every experimenter who has ever tried to build a short wave set knows only too well by experience, the difference between a good and a poor receiver is usually found in the short wave coils. Very often you have to hunt through copies of magazines, books, etc., to find the information you require. The present data has been gotten up to obviate all these difficulties.

Between the two covers of this book you now find every possible bit of information on coil winding that has appeared in print during the past two years. Only the most modern "dope" has been published here.

No duplication. Illustrations galore, giving not only full instructions how to wind coils, but dimensions, sizes of wire, curves, how to plot them, by means of which any coil for any particular short wave set can be figured in advance, as to number of turns, size of wire, spacing, etc.

There has never been such data published in such easy accessible form as this.

Take advantage of the special offer we are making today, as due to increasing costs, there is no question that the price will increase soon.

RADIO PUBLICATIONS
 97 HUDSON STREET
 NEW YORK, N. Y.



Radio Publications,
 97 Hudson Street,
 New York, N. Y.

12-34

Please send immediately, your Short Wave Coil Book, for which I enclose 25c herewith (coin, U. S. stamps or money order acceptable). Book is to be sent prepaid to me.

Name

Address

City and State

Please mention SHORT WAVE CRAFT when writing advertisers

BARGAINS

ORDER DIRECT FROM THIS ADVERTISEMENT—WE DO NOT ISSUE ANY CATALOG

G. E. Phonograph Motor

ONLY
\$3.95

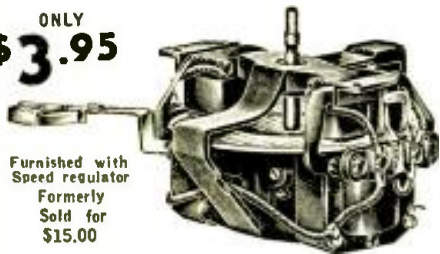

Furnished with Speed regulator
Formerly Sold for \$15.00

Variable speed induction type self-starting, 110 volt, 60 cycle, A.C. with lever control. Speed range from 5 to 200 R.P.M. Can be installed in place of old-fashioned hand-winding speed motor. Fits any cabinet. Also ideal for display turn-table, and a hundred other uses. These G. E. Electric Motors are brand new, in original factory cartons. Same motor that formerly sold for \$15.00, only \$3.95 as long as supply lasts. Manufacturers and dealers, please write for special quantity prices.

Shipping Weight, 11 lbs.

G. E. MOTORS

These Motors were manufactured by the General Electric Company and originally intended for use by a large manufacturing company.

Here are the specifications: 1/30 H.P.—4500 R.P.M. Universal A.C. and D.C. 110 volts instant reverse. Size: Diameter 3 inches, length overall 4 inches. Diameter of shaft 3/4 inch. Shipping weight, 3 lbs.

\$2.45 Each

Add 25c for special packing and mailing anywhere in U. S. A.

Original Price. \$12.00

WHILE THEY LAST

Westinghouse Power Generators

Manufactured by Westinghouse for U. S. Signal Corps.

Built-in commutator takes off the generated D.C. Three leads extend through the casing to permit a 4 1/2 V. flashlight-type battery to be switched into circuit for starting, and to control the A.C. output. Rotated at its normal speed of 4,500 r.p.m., the output is 200 W., at 115 to 125 V. (on open circuit), 200 cycles. The rotor turns in ball bearings. Shaft length (driving end) 2 1/2 in.; diameter 9/16 in.; the end is threaded for a distance of 5/8 in. Base dimensions exclusive of the shaft, 4 1/2 x 6 1/4 in. in diameter. Guaranteed new and perfect.



While They Last!
\$4.95

Here is what one of our customers writes:

"These generators are being used in a small fishing village, where the only current is supplied from a 2K.W.-D.C. generator.

"As it was impossible to use A.C. sets and especially my short-wave transmitter using two 45 tubes, one of the generators is used to supply my two A.P. receivers and the other to supply power for the transmitter. Both generators are run by a 1/4 horsepower motor. These generators perform perfectly and have been absolutely trouble free. The voltage and current regulation is remarkably stable, taking a considerable overload."

(Name supplied on request)

Remit by check or money order for full amount of each item—Shipped Express Collect if sufficient money is not enclosed for parcel post. No C.O.D. order accepted—Money refunded if not satisfied.

WELLWORTH TRADING COMPANY
560 W. Washington Street CHICAGO, ILL.

WELLWORTH TRADING COMPANY SW-12-34
560 W. Washington Street, Chicago, Ill.

Enclosed you will find my remittance of \$..... for which please send me

- () G. E. Phonograph Motor, \$3.95 each.
- () Power Generator, \$4.95 each.
- () G. E. Motor, \$2.70 (including packing and postage).

Name

Address

City, State,

Latest "DOERLE" Set Uses "Acorn" Tubes

(Continued from page 461)

Amplification Factor.....25
Plate Resistance.....12,500 ohms

Referring to the photographs of the set we find that there is really no undue crowding of the parts. The center dial is the main tuning control and the antenna trimming condenser is mounted to the left (looking at the front of the panel) with the regeneration control on the right side. As there is no filament con-

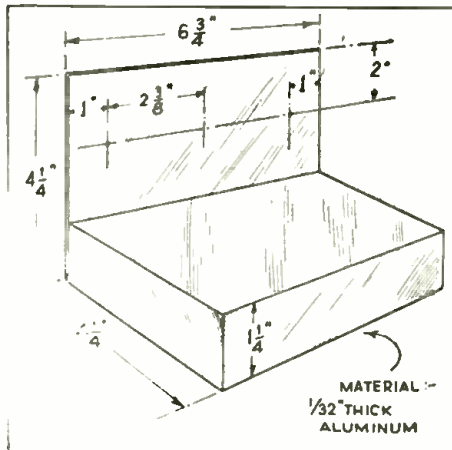

Dimensions of "Midget Doerle" Receiver chassis.

trol rheostat (there was not enough room on the panel for one anyway) the regeneration control has a separate switch incorporated in it, and this is used to turn off the heaters when the set is not in use. The switch and regeneration control are both operated by the same shaft. Looking at the rear of the set the detector tube and plug-in coil are mounted to the right and the tube to the left is the audio frequency amplifier. The audio transformer is directly behind the tuning condenser.

In assembling the "B" battery it is necessary to remove the two small cells from the cardboard tube and solder a very short connection between the two terminals, in order that a good connection will be maintained. These batteries are designed for a flashlight, where there is a constant pressure against the ends of the battery to maintain contact between the two cells. So don't forget to do this or you will have no end of trouble with an open "B" circuit.

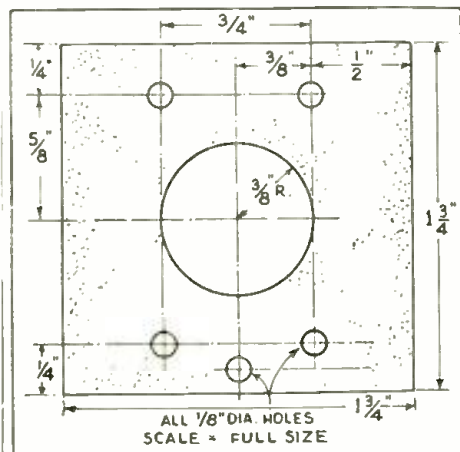

Details of "Acorn" Tube socket made by the author. Thus far the socket has to be specially made.

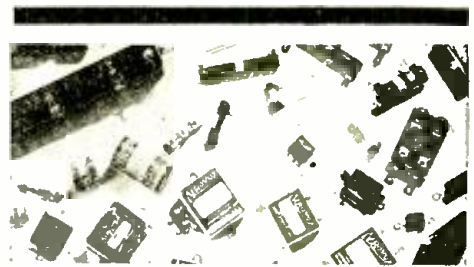

AEROVOX



for . . . Condensers
. . . Resistors
. . . and practical data

You can meet any condenser requirement from the vast variety produced by Aerovox . . . any type . . . capacity . . . working voltage.

Likewise with resistors . . . from carbon type to large wire-wound units . . . wide range of wattages and resistance values.

And what's more, you can count on Aerovox for latest engineering information on condensers, resistors, circuits and applications.

Get Your Copy!



Monthly publication . . . fresh from laboratory and engineers . . . the cream of the crop of advanced radio information. Sample copy on request. Also latest Aerovox catalog. Write today!

AEROVOX

72 Washington Street, Brooklyn, N.Y.



FOREIGN RECEPTION GUARANTEED with the world's famous International DX

World Wide All-Electric All-Wave Receiver



- Built-in speaker.
- Plenty of volume.
- Built-in power supply.
- Very Selective.
- Amazing performance.
- Uses 37A, 38A and 6D6 tubes.
- The best value on the market. Order Now.

COMPLETE ASSEMBLED KIT.....
Extra for wiring.....\$1.75
Kit of Arc-turus tubes.....2.25
Broadcast band coil......75

\$6.75

SPECIAL black crackle finished metal cabinet.....1.95

● Order now! or send for FREE circular 107 Dept. SWC 12.

EXPERIMENTAL RADIO LABS.
168 WASHINGTON STREET NEW YORK N.Y.

Two Short-Wave Standbys ★★ ★

Famous "19" Twinplex Kit
For Short-Wave Foreign Reception
15-550 Meters



Economical
2-VOLT
Operation

ONLY \$4.90

with
Earphone and Two Plug-in Coils
Less Tube

The TWINPLEX is ACTUALLY A TWO-TUBE SET; yes, we repeat, A TWO-TUBE SET. JUST IMAGINE TWO TUBES IN ONE GLASS ENVELOPE. That is the glory of the new "19" tube, which has a DOUBLE SET OF ELEMENTS.

The "19" TWINPLEX is available ONLY in kit form. Shipping weight 5 pounds.

It is now possible, with a single tube of this type, to receive short-wave stations from all over the world, loudly, clearly—REGULARLY—night after night, whenever they are on the air. Two coils are furnished, one for the 40-meter foreign broadcast band and the other for the regular broadcast band.

No. SW-308 Famous Twinplex Short-Wave Receiver Kit with all parts INCLUDING SINGLE HEADPHONE AND BAND—But no tube **\$4.90**

YOUR PRICE

No. SW-309 Complete Accessories for TWINPLEX Receiver, comprising 1 Type "19" Tube, 2 No. 6 Dry Cells, 2 45-volt "B" Batteries. Shipping weight 20 pounds. **\$3.50**

YOUR PRICE

Additional Plug-in Coils for the 20, 80 and 160 meter bands—45¢ each. We'll wire the set for you for \$1.50 additional.

-DOERLE-
AMATEUR BANDSPREAD GLOBE-GIRDLER



Every Short-Wave Amateur Band Spread Over 100 Degrees on the Dial.

No more maze of shrieking, incoherent stations one on top of the other! No more ear-splitting, nerve-wracking bedlam of noise—like half dozen managers suddenly turned loose.

Any particular amateur band may now be spread over practically the entire tuning scale of the dial. Stations which before were closely crowded or passed by entirely, can now be spread over the entire dial and thus be easily intercepted. Not only that but through the use of the powerful 2A5 pentode in the output stage, most of these short-wave stations will now come in on the loud speaker.

The circuit incorporates the new Alden 5-prong band-spread plug-in coils. These coils are specially designed for this particular work, each having a padding condenser mounted to the top. This condenser is shunted across the entire secondary winding, whereas the main tuning condenser is across only part of this winding.

The same standard of high quality parts used in other Doerle receivers is maintained here. All component parts are mounted on a beautiful black, crackle-finish chassis with the official Doerle nameplate bolted to the front panel. Although this receiver may be used with batteries it is recommended for A.C. operation. A good, well-filtered power supply such as the one we recommend for our other Doerle receivers should be used. The set uses 1-57 and 1-2A5. A set of 4 bandspread plug-in coils are furnished with the receiver. Shipping weight, 8 lbs.

No. 307. Official Doerle Amateur Bandspread Receiver, Less Tubes But Including Coils.

YOUR PRICE \$11.75
FREE See pages 494 and 505 for our free catalogs.

ONLY \$11.75

RADIO TRADING CO., 101A Hudson St., New York City

Short Wave League Members

IDENTIFY THEMSELVES WITH THE ORGANIZATION



In order that fellow members of the LEAGUE may be able to recognize each other when they meet, we have designed this button, which is sold only to members and which will give you a professional appearance.

If you are a member of the LEAGUE, you cannot afford to be without this insignia of your membership. It is sold only to those belonging to the LEAGUE and when you see it on another, you can be certain that he is a member.

See Page 508

- Lapel Button, made in bronze, gold filled, not plated, prepaid. 35¢
- Lapel Button, like one described above, but in solid gold, prepaid. \$2.00

Tuning the set is just the same as for any other 2-tube regenerative set and no difficulty will be encountered if care is used in the adjustments. The antenna used with the set was 75 feet long and signals from all over the world were heard with good head-phone volume.

Coil data for shoe button tube set:

Band	Grid	Tickler
49 meters	18 turns	3 turns
25-31 meters	10 turns	3 turns
19 meters	5 turns	2 turns

No. 26 D.S.C. wire close wound for both grid and tickler coils, space between tickler and grid coils 1/8 inch; wound on 1" dia. National midget forms.

Parts List for 2-Tube Midget Doerle Receiver

- 1—chassis, see drawing. Blan.
- 1—50 mmf. antenna trimmer, I.C.A.
- 1—100 mmf. midget condenser, see text; Hammarlund.
- 1—100 mmf. mica condenser, Aerovox.
- 1—500 mmf. mica condenser, Aerovox.
- 1—3 meg., half-watt grid-leak, Aerovox.
- 1—75,000 ohm potentiometer with switch, Electrad.
- 1—3:1 midget audio transformer.
- 1—4-prong wafer socket; Nu-Ald.
- 1—National 3-inch vernier dial.
- 2—special 955 sockets, see drawing. Blan.
- 2—955 RCA Radiotrons, (Acorn Tubes)
- 14—"Pen" flashlight cartridges, Burgess.
- 4—"Baby" flashlight cells, Burgess.

Health Ray Carbon Lamp



PAYS FOR ITSELF IN A FEW TREATMENTS.

Everyone in the family needs the health giving Violet Rays.

Send for interesting literature FREE. List Price with Screen and Goggles, \$19.00.
YOUR COST—F. O. B., N. Y. \$3.38
GOLD SHIELD PRODUCTS CO.
98 PARK PLACE NEW YORK

KNOW THYSELF!

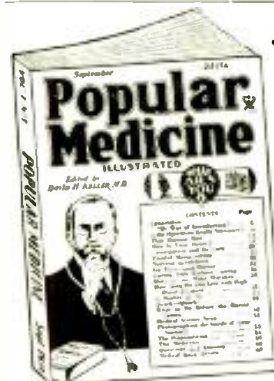

This new monthly magazine is also your medical guide. WHAT AILS YOU? POPULAR MEDICINE tells and advises you thoroughly. Written for you by doctors. Non-technical, yet authoritative for all laymen. Many anatomical illustrations. At All News Stands.

SPECIAL OFFER!
8 Months for \$1

Send 15¢ for Sample Copy
Popular Medicine
97C Hudson Street
New York, N. Y.

SPECIAL FOR THIS MONTH ONLY
Send \$1.00 (\$1.25 Canada and foreign) and we will send you SHORT WAVE CRAFT for Eight months. **DO IT NOW!**

SHORT WAVE CRAFT
99-101 Hudson Street New York

TRANS-CEIVER!

NEW! A complete Midget Transmitter and Receiver combined in this simple one-tube set. Foreign reception, local transmission. Tunes 4 to 200 meters. Uses two small inexpensive batteries, (3 and 45 volt) key and phones. Results Guaranteed.



Prepaid-Only **\$3.95**

Wired, tested, with coil and instructions; less 230 tube. Extra coils 50¢ ea.
Remit \$1.00. C.O.D. \$2.95. ORDER NOW, write—

THE BURKS RADIO CO.
1448 W. Decatur St. Decatur, Ill.

In Next Issue!

An Inexpensive 160 meter
PHONE Transmitter by W. A. Woehr, W9PTZ.

WORLD WIDE RADIO



A real powerful long and SHORT WAVE Radio Receiver that actually gets local and foreign broadcasts, police, amateur, airplane and transmissions direct! Thousands now in use. Owners report reception of Foreign Stations with amazing volume. Works on two inexpensive batteries. Not a toy! BEST LITE (14-A-K-7E-F)

See construction kits have all necessary parts mounted on attractive metal chassis and panel, all ready for wiring. Clear picture diagrams. Wire it yourself. It's easy. Range 15 to 600 meters. Complete Kits, with coil—

- ONE TUBE KIT, \$1.95 ● TWO TUBE, \$2.85
- ALL ELECTRIC 105-125 Volt AC-DC two-tube house current set. No batteries needed! Complete Kit, \$3.65
- Kits wired, 75c extra. Tubes, 85c ea. Double phones, \$1.25 ORDER NOW! \$ and \$1. balance C.O.D., or if full remittance with order, we pay postage. Free literature.

FREE!! Large color map of the World. Valuable Short Wave data, etc.! Send 10c for handling, NOW!!

ACE RADIO LABORATORIES
1619 Broadway Dept. C-12 New York City



HAVE YOU A HEADACHE

trying to find out where you can obtain certain parts that you need for your short wave radio or your station? Stop worrying. This is the "House of a Million Parts", where you can obtain the most up-to-date or any obsolete part. Send us a list of your needs and we will quote our lowest prices.

Interesting literature mailed free.

LEOTONE RADIO CO.

63 DEY STREET Dept. S-12 NEW YORK CITY

Admiral Byrd Opens Radio Show

(Continued from page 455)

gram shows there is also a return short-wave circuit provided, so that the announcers in charge of the program could cue the operators in Little America and also Admiral Byrd at his advance post. The return short-wave cuing link passed from New York City over a telephone circuit to Rocky Point, the RCA transmitting station on Long Island, from which point, thanks to the high power of the transmitter, the messages jumped direct over 10,000 miles of space to Little America and Admiral Byrd. In the event that the signals sent to Admiral Byrd could not be picked up direct from the Rocky Point transmitter on the short-wave receiver in use by the Admiral at his advance post, the Rocky Point signals were relayed to the Admiral through an emergency transmitter at Little America.

FREE "Ham" Transmitter Data

● WOULD you like to have complete data on a "Modern Amateur Transmitter" with wiring diagrams, list of parts and all their values, if you could obtain it ABSOLUTELY WITHOUT CHARGE?

The Aerovox Corporation has recently published a very informative "up-to-the-minute" article by Stanley P. McMinn, W2WD, which was printed in the AERVOX RESEARCH WORKER. The publishers of that publication will be glad to send you, free of charge, a sample copy containing the article "A Modern Amateur Transmitter," by Mr. McMinn. Simply address your requests for copy No. 500 to:

Service Department,
SHORT WAVE CRAFT
99-101 Hudson Street
New York City

QUALITY APPARATUS FOR Short Waves

GEN-WIN POLICE AND SHORT WAVE ADAPTER
Convert your broadcast set into a short-wave set tuning from 80 to 200 meters. Get exciting police alarms from 80 to 200 meters. Get exciting police alarms from 80 to 200 meters. Get exciting police alarms from 80 to 200 meters.



Amateur phone and international code communications. The biggest thrill and fun for so little money. Installed in a jiffy. Plugs directly into the detector tube socket. Specify the detector tube in your set, or if uncertain as to detector tube, advise make and model number of set when ordering.

- Price
Detector Tube..... \$1.39
No. 191—for '32 or '34 Detector Tube..... 1.39
No. 200—for '27, '37 or '56 Detector Tube..... 1.39
No. 201—for '24, '35, '51, '36, '39 or '44 Det. Tube 1.49
No. 206—for '57, '58, '57, '78, '60 or '616 Det. Tube 1.49



GEN-WIN SHORT WAVE COIL KIT
The GEN-WIN Short Wave Plug-in coils have stood the test. They have been in great demand for the past three years, and are still selling strongly to the thousands of discerning experimenters who appreciate the remarkable results they are getting from these excellent coils. The GEN-WIN Short Wave coils can be used in any one of the many circuits published each month in Short Wave Craft magazine. The coils have plate and secondary windings so designed that they will oscillate over the entire short wave band, 15 to 225 Meter with .00014 or .00015 Mfd. Condenser.

Price
No. 404E—4 prong—4 coil kit (15-225 meters)... \$1.50
No. 404B—4 prong—Broadcast coil (200 to 550 M.) .55
No. 406E—6 prong—4 coil kit (15-225 meters)... 1.95
No. 406B—6 prong—Broadcast coil (200-550 M.) .65

ALL-WAVE COIL KIT—Range 25 to 550 Meters
Comprises a precision wound tuner and R.F. coil, both having tapped secondaries, which permits you to enjoy both SHORT WAVE and BROADCAST PROGRAMS. If you own an Ambassador or any other three circuit tuner receiver, you can easily convert the set into an all-wave receiver, by replacing the coils with these new GEN-WIN ALL-WAVE coils. Coils may be had for use with either .00035 or .0005 Mfd. condenser. Specify which when ordering. Wiring diagram included free with coils. Separately 10c.
All Wave Tuner (as illustrated)..... 90c
All Wave R. F. Coil..... 75c
Send remittance in check or money order.
Register letter if it contains currency.



GENERAL WINDING COMPANY

Incorporated
254 W. 31st St. Dept. 12-S NEW YORK, N. Y.

World Short Wave Set

Correct Engineering and Superior Parts, Hammarlund, Philo, make the World Short Wave Sets outstanding in their field.

- Foundation Kit: 2 tube set—World Wide Reception with 4 Plug-in Coils—10 to 200 Meters. Simple to Assemble..... \$4.65
- 3 Tube Kit..... 6.75
- Separate Power Pack..... 4.45
- Broadcast Coils—200-500 meters..... .59

Wired and Tested \$1.25 extra.
These kits also in A.C. at same price.

We manufacture a Complete Line of Short Wave Sets at the Lowest Prices.
Write for full information.
25% deposit with mail orders.
Save by dealing direct with the manufacturer.

NATIONAL RADIO DIST. CO.
406 W. Communipaw Ave., Dept. S, Jersey City, N. J.

Radio Colonial

(Continued from page 456)

tions and also for checking up on the transmission from the French stations. The main studios of this station are in Paris. Pontoise is about 25 miles from Paris. All the programs which originate with the different French long wave stations are brought to these studios in Paris and from there sent on through telephone lines to the transmitter. All announcements for the station are made from the Paris studios, and interesting feature of the studios is the chiming clock, which is located right in the studio; it can frequently be heard striking the hour or quarter hour above the announcer's voice.

2-Way Police Calls

(Continued from page 454)

use of standard French type hand telephone units in the cars, which enable the police officers to place the system in operation by merely removing the combination mouthpiece and head-phone unit from the hook that supports it when not in use. Lifting it up closes the circuit as in regular French type telephone sets. The 5-meter short-wave transmitter is housed in the rear trunk compartment and the receiving equipment underneath the dashboard. The phone unit is attached to the dashboard by means of a clamp. The transmitter has a power of 15 watts and both sending and receiving is handled on wavelengths of above 5 meters.

NEXT ISSUE!

The "Economy 2" uses new 2-volt heater type, screen-grid tubes. By George W. Shuart, W2AMN.



GUARANTEED PERFORMANCE

BLILEY BC-3 Mounted Crystals

Mc Band	Precision	Supplied to Exact Freq.	specified frequency within:	± 1Kc	± 5Kc	± 10Kc
7.0, 3.5	0.03%	\$7.50	\$5.90	\$4.90	\$3.95*	
1.7	0.03%	8.40	6.80	5.80	4.80	

*Or your choice from distributor's stock.
Crystals manufactured between 20 Kcs and 15 Mcs. Prices on request.

Bliley Crystals are sold at all progressive distributors of amateur equipment and manufactured under NRA.

BLILEY ELECTRIC COMPANY
236 Union Station Bldg. Erie, Pa.



UNIVERSAL MODEL "G"

A completely assembled, ready-to-use condenser microphone unit—all A.C. operated—nothing to add—no batteries or battery expense; yet guaranteed as silent as batteries. Two-stage amplifier with No. 230 tubes—barometric adjustment—temperature compensator—shielded diaphragm—frequency response, 70 to 7,000 cycles—engineered by Universal to guarantee maximum results at the lowest price consistent with Universal standards.
Dealers Net Cash—\$49.39

UNIVERSAL MICROPHONE CO., Ltd.
424 Warren Lane, Inglewood, Calif., U.S.A.

SEXOLOGY

THE MAGAZINE OF SEX SCIENCE
SEXOLOGY, foremost educational sex magazine, is written in simple language and can be read by every member of the family. It is instructive, enlightening—not a risqué book contains no offensive matter.
Contains 25 important articles on Sex Science, 68 pages, with attractive two-color cover. Here are a few of the more important articles:
"Sex Appetite"—Women's Strike Against Childbirth (Illustrated)—Sex Nervousness in Men (Illustrated)—Hygiene of Menstruation (Illustrated)—Should I Be Cysto-scope? (Illustrated)—Science Turns Girl Into Boy (Illustrated)—Mechanics of Childbirth (Illustrated)—Circumcision Among Savage Peoples (Illustrated)—Thyroid Gland and Pregnancy—Sex Education Before Marriage (Illustrated)—Unusual Forms of Sex Organs—Predetermination of Sex (Illustrated)—A New Theory of Homosexuality (Illustrated)—Sex and Punishment (Part I) (Illustrated)—Questions and Answers.
SEXOLOGY, 95 Hudson St., NEW YORK, N. Y.

Get a copy of SEXOLOGY on any newspaper, or if your dealer cannot supply, send 25c cash or stamps for current issue.

SPECIAL

FOR THIS MONTH ONLY.

Send \$1.00 (\$1.25 Canada and foreign) and we will send you SHORT WAVE CRAFT for Eight months. DO IT NOW!

SHORT WAVE CRAFT
99-101 Hudson Street New York

Please mention SHORT WAVE CRAFT when writing advertisers

The 4 ESSENTIAL SHORT WAVE BOOKS

'ROUND THE WORLD FANS USE THESE GREAT SHORT WAVE BOOKS

These great books contain everything on short waves that is really worth knowing—they are books which have been most enthusiastically welcomed by short-wave fans. The cost of the books is extremely low in comparison with the valuable material which they contain.

There is not a short-wave fan, experimenter or interested radio-minded reader who will not want these books. Right up-to-the-minute with new material on outstanding developments in the short wave field. The books are authoritative, completely illustrated and not too highly technical.

Ten Most Popular Short Wave Receivers. How to Make and Work Them

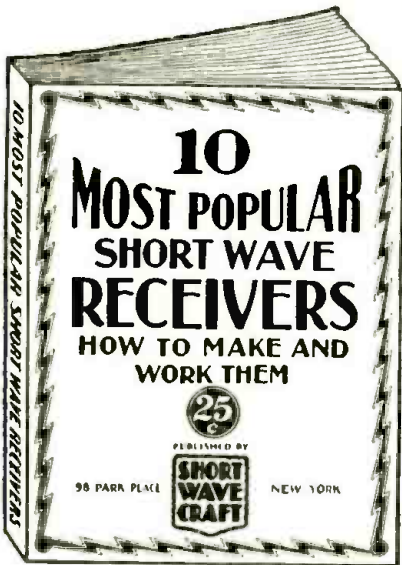

This new volume is a revelation to those who wish to build their own short wave receivers. The editors of SHORT WAVE CRAFT have selected ten outstanding short wave receivers and these are described in the new volume. Each receiver is fully illustrated with a complete layout, electrical representation, photographs of the set complete, hookup and all worthwhile specifications. Everything from the simplest one tube set to a 5-tube T. R. F. receiver is presented. Complete lists of parts are given to make each set complete. You are shown how to operate the receiver to its maximum efficiency.

CONTENTS

- The Doerle 2-Tube Receiver That Reaches the 12,500 Mile Mark, by Walter C. Doerle.
- 2-R.F. Pentode S-W Receiver having two stages of Tuned Radio Frequency, by Clifford E. Denton and H. W. Secor.
- My de-luxe S-W Receiver, by Edward G. Ingram.
- The Binneweg 2-Tube (2,000 Mile D.X. Receiver, by A. Binneweg, Jr.
- Build a Short Wave Receiver in Your "Brief-Case," by Hugo Gernsback and Clifford E. Denton.
- The Denton 2-Tube All-Wave Receiver, by Clifford E. Denton.
- The Denton "Stand-By," by Clifford E. Denton.
- The "Stand-By" Electrified, by Hugo Gernsback.
- A COAT-DROCKET Short Wave Receiver, by Hugo Gernsback and Clifford E. Denton.
- Do They Roll In on this One-Tube Set, by C. E. Denton.
- The S-W PENTODE, by H. G. Cisin M. E.
- Louis Martin's Idea of a GOOD S-W RECEIVER, by Louis Martin.

25c

The Short Wave Beginner's Book

Here is a book that will solve your short wave problems—leading you in easy stages from the simplest fundamentals to the present stage of the art as it is known today. It is the only low-priced reference book on short waves for the beginner.

The book is profusely illustrated with all sorts of photos, explanations and everything worth while knowing about short waves—the book is not "technical." It has no mathematical, no "high-faluting" language and no technical jargon. You are shown how to interpret a diagram and a few simple sets are also given to show you how to go about it in making them.

It abounds with many illustrations, photographs, simple chart-hookups, etc., all in simple language. It also gives you a tremendous amount of very important information which you usually do not find in other books, such as time conversion tables, all about aerials, noise elimination, how to get verification cards from foreign stations, all about radio tubes, data on coil winding and dozens of other subjects.

Partial List of Contents

- Getting Started in Short Waves—the fundamentals of electricity. Symbols, the Short Hand of Radio—how to read schematic diagrams. Short Wave Code—various types and kinks in making them. Short Wave Aerials—the points that determine a good aerial from an inefficient one. The Transposed Lead-in for reducing Man-Made Static.
- The Beginner's Short-Wave Receiver—a simple one tube set that anyone can build. The Beginner's Set Gets an Amplifier—how the volume may be increased by adding an amplifier.
- How to Tune the Short-Wave Set—telling the important points to get good results. Regeneration Control in Short Wave Receivers.
- Audio Amplifiers for S. W. Receivers. How to Couple the Speaker to the set. Learning the Code—for greater enjoyment with the S-W set.
- Wave length to Kilocycle Chart.
- Wire Chart—to assist in the construction of coils.
- Kinks in the construction of S-W Receivers.

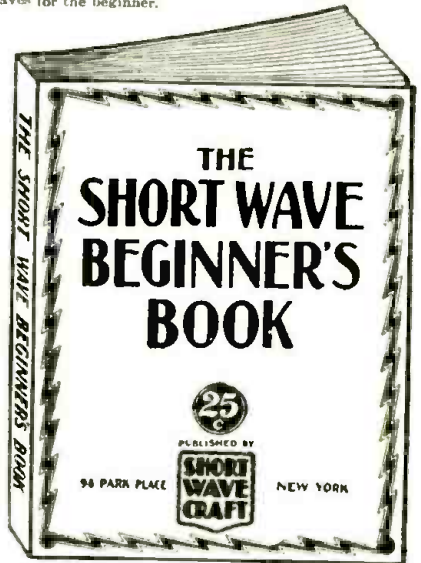

40 PAGES OVER 75 ILLUSTRATIONS 25c

How to Build and Operate Short Wave Receivers

is the best and most up-to-date book on the subject. It is edited and prepared by the editors of SHORT WAVE CRAFT, and contains a wealth of material on the building and operation, not only of typical short-wave receivers, but short-wave converters as well. Dozens of short-wave sets are found in this book, which contains hundreds of illustrations; actual photographs of sets built, hookups and diagrams galore.

The book comes with a heavy colored cover, and is printed throughout in first-class matter. No expense has been spared to make this the outstanding volume of its kind. The book measures 7 1/2 x 10 inches.

This book is sold only at such a ridiculously low price because it is our aim to put this valuable work into the hands of every short-wave enthusiast.

We know that if you are at all interested in short waves you will not wish to do without this book. It is a most important and timely radio publication.

Over 150 Illustrations 72 Pages 7x10 Inches

50c

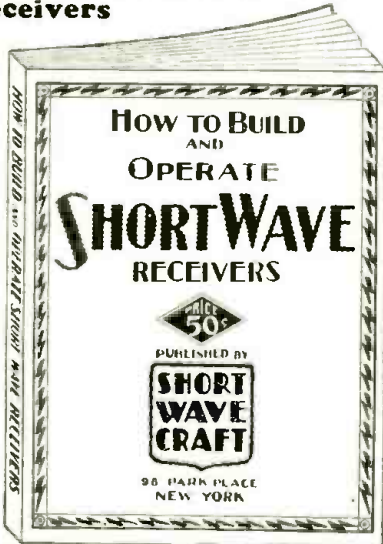

How to Become an Amateur Radio Operator

We chose Lieut. Myron F. Eddy to write this book because his long years of experience in the amateur field have made him pre-eminent in this line. For many years he was instructor at radio telegraphy at the R.C.A. Institute. He is a member of the I.R.E. (Institute of Radio Engineers), also the Veteran Wireless Operators' Association.

If you intend to become a licensed code operator, if you wish to take up phone work eventually, if you wish to prepare yourself for this important subject—this is the book you must get.

Partial List of Contents

Ways of learning the code. A system of sending and receiving with necessary drill words is supplied so that you may work with approved methods. Concise authoritative definitions of radio terms, units and laws, brief descriptions of commonly used pieces of radio equipment. This chapter gives the working terminology of the radio operator. Graphic symbols are used to indicate the various parts of radio circuits. General radio theory particularly as it applies to the beginner. The electron theory is briefly given, then waves—their creation, propagation and reception. Fundamental laws of electric circuits, particularly those used in radio are explained next and typical basic circuits are analyzed. Descriptions of modern receivers that are being used with success by amateurs. You are told how to build and operate these sets. Amateur transmitters. Diagrams with specifications are furnished so construction is made easy. Power equipment that may be used with transmitters and receivers, rectifiers, filters, batteries, etc. Regulations that apply to amateur operators. Appendix which contains the International "Q" signals, conversion tables for reference purposes, etc.

Over 150 Illustrations 72 Pages 7x10 Inches

50c

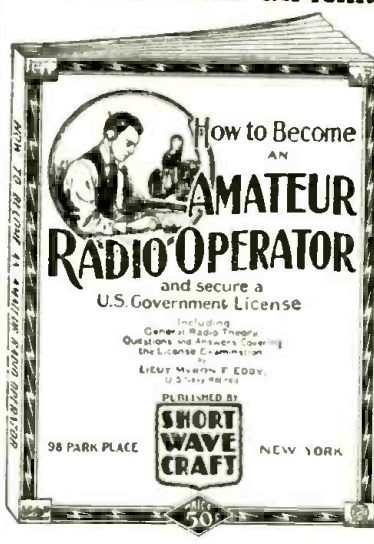

All the books shown on this page are published exclusively by

SHORT WAVE CRAFT

99-101 Hudson Street, New York, N. Y.

CLIP-MAIL

SHORT WAVE CRAFT 99-101 Hudson Street, New York, N. Y.

Gentlemen: I enclose herewith my remittance for the amount of \$..... for which you are to send me, postpaid, the books checked below.

- () Ten Most Popular Short Wave Receivers, How to Make and Work Them..... 25c each
- () The Short Wave Beginner's Book..... 25c each
- () How to Build and Operate Short Wave Receivers..... 50c each
- () How to Become an Amateur Radio Operator..... 50c each

Name..... Address..... City..... State.....

(Send remittance in form of check or money order. If letter contains cash or unused U. S. Postage Stamps, register it.)

These Books are Authentic For All Short Wave Work and LOW in Price

COUPON TODAY!

Please mention SHORT WAVE CRAFT when writing advertisers

FREE!

1935 EDITION

108 Page RADIO

and
SHORT WAVE
TREATISE

Over 100
Hook-Ups

More Than
1,500 Illustrations

A Veritable
Text Book



NOT JUST ANOTHER CATALOG

This completely revised and enlarged 1934 edition contains 108 solid pages of useful radio information, diagrams, illustrations, radio kinks and real live radio merchandise. It contains more valuable radio information—more real live "meat"—than many textbooks on the subject. As usual considerable space has been devoted to the beginner in radio.

PARTIAL LIST OF CONTENTS

Chapter Two of "Fundamental Principles of Radio for the Beginner"—The New Tubes, Their Uses, and Their Fundamental Circuits—How to Make Money with Public Address Systems. How to Install and Maintain Them—How to Revamp Six-Volt Battery Sets to Use Two-Volt Tubes—Prize Winning Kinks and Short Cuts in Radio—How to Build the "K T" Beginner's Transmitter—How to Build the Famous Triplex Short Wave Receiver—How to Construct an Amateur Radio Transmitter—A Most Modern and Complete Tube Chart Including Socket Connections for all Tubes—Numerous Free Offers, etc., etc.

WRITE TODAY

Enclose 5c coin or U. S. stamps for postage. Treatise sent by return mail.

RADIO TRADING CO.
101A Hudson Street, New York City

SLIDE RULES . . .

Midget 5 in 1 Circular Type:

Metal 4" Dia.
Price \$1.50
Case 50c extra



- 1.23² = ? √50.41 = ?
- 1.24³ = ?
- Tan 8° 5' = ?
- Cot 79 1/2° = ?
- 4 1/2 × 2/3 = ?
- Log 56.25 = ?
- 6% of 145.9 = ?
- 5.16 - 2 1/4 + 1.78 = ?

Solve easily all these and dozens of other mathematical problems without pencil and paper—by means of the Midget Slide Rule. This rule solves any problem in multiplication, division, addition, subtraction, and proportion. It also gives roots and powers of numbers. The "Trig" scales give the sines, cosines, tangents and cotangents of all angles; also logs of numbers. Adds and subtracts fractions. Approved by colleges.

10" Dia., 27" Scale "Special" Rule, \$3.00.
Multiples and Divides, but has no "Trig" Scales.

RADIO Slide Rule—Short Wave Type
Price \$1.00 Prepaid

Printed on white bristol board: Size 8 1/2" x 11". Every short wave and radio student must have this inductance, capacity, and "coil-dimension" slide rule. It will answer such questions as: What is inductance of coil one inch in diameter, winding two inches long and having 30 turns per inch? What winding length of No. 24 S. C. C. wire must be put on a form two inches in diameter, to obtain an inductance of 100 microhenries? To what frequency and wavelength will 35 microhenry coil tune with a 50 mmf. condenser?



NEW! "OHM'S LAW" CALCULATOR
Solves All Problems of Voltage, Current and Resistance. Price.....\$1.00 Prepaid
DATAPRINT CO., Box 322, Ramsey, N. J.

Short Wave League

(Continued from page 481)

ing bodies will be composed of those actively interested and essentially familiar with the problems that we have to meet before we can accomplish our purpose.

At the time of the state convention a delegation will be elected to attend the district convention (district conventions to be called once a year). A district association of leagues will be comprised of a number of states, according to the U. S. Inspection Districts (for example, the Fifth District is comprised of the States of Arkansas, Oklahoma, Louisiana, Texas, New Mexico and Mississippi). The number of delegates to attend the district convention is to be in proportion to the number of members in their respective states. From these delegates the District League Manager will be elected, the duties of the District League Manager to be representing the districts that they are managers of, and the forming and passing of national laws, as well as representing us at Washington and at radio conventions.

In the formation of all local, state or district organization of leagues all dues will be determined and managed by each of the leagues. For instance, in the formation of a local league all dues will be based only upon the cost of operating this local league. When all of the leagues in the state form a "state organization of leagues" they will determine the cost of operating the state organization of leagues and distributing the cost according to the members of the leagues, so when we form our district and national organization of leagues the same procedure will be used. This will mean that there will be an equal distribution of the cost of operating our national organization of leagues. No member of a league will, under any circumstances, pay money, dues or fees to anyone except to treasurer of his local league.

At no time will more monies be paid in to local league than that required to defray the operating expense of the local and district association of leagues, and of that, re-invested in the league for the betterment and furtherance of all that the league stands for.

These monies shall be employed for circularizing new members in the district, state and district conventions, state and district printing expenses, representation, and the incidental handling expenses of the state and district correspondence. There will be no salaries paid to anyone and none of the officers shall derive any financial benefit from the league.

At the time of the state convention a state secretary and a state treasurer shall also be elected, the task of the state secretary to be keeping a record of all business of the state, organization of leagues, issue notices, collect all monies 3 to 5 days after each convention of the state association of leagues, taking the treasurer's receipt therefor, attending to all correspondence and issuing all cards and certificates of membership for the state. He shall have charge of the books and records of the state organization and shall render a written report at the annual convention of the state organization of leagues, to be audited and presented at next convention. Immediately upon expiration of his term of office he shall transmit to his successor all properties of the state association of leagues.

The treasurer shall receive all monies from the secretary and deposit same in a bank to the credit of the organization of leagues in the state, bank to be selected by the officials of the league association. He shall pay all bills by checks signed by the treasurer and countersigned by the state manager on warrants signed by state manager and secretary.

He shall keep such books as pertain to his office and render a written report at the state convention once a year, which shall be audited and presented at next state convention. Immediately upon expiration of his term of office he shall turn over to his successor all properties of the league association.

What we must do, and do soon, is get a system like the one I have just outlined into

(Continued on page 507)

WHEN CHOOSING A RADIO SCHOOL

RCA Institutes, with its reputation firmly established by 25 years service, is an institution recognized as an important factor in the radio industry.

Whether elementary radio principles or advanced subjects, sound applications, mathematics or practical radio engineering, RCA Institutes is prepared to give you the instruction you need.

Resident Schools at New York and Chicago
Modern Apparatus and Laboratory Equipment—Conveniently Located—Day and Evening Classes—Tuition Rates \$3 to \$10 Weekly.

Extension courses for home study on convenient "no obligation" plan. Examination and technical advisory services. Free post-graduate practical training at resident school with modern equipment under instructing engineers.

Write for Catalog.

RCA INSTITUTES, Inc.

Dept. SW-34

75 Varick Street
NEW YORK

1154 Merchandise Mart
CHICAGO

Recognized Standard in Radio Instruction Since 1909.

A hit! The 7-POINT MICROPHONE

Here's why the Amperite Velocity Microphone gives you the best in quality and value: (1) Wider frequency range. No peaks; no distortion. (2) Directional quality makes it easy to eliminate feedback. (3) Wider area of coverage. One Amperite Vel. Mike will replace several diaphragm type mikes. (4) Not affected by temperature, weather conditions or age. (5) Rugged construction. (6) Best value in mikes, or money refunded. (7) Fully guaranteed for two years against any service costs. Order from your wholesaler.

AMPERITE (Circled) 561 B'WAY N.Y.C.

AMPERITE VELOCITY MICROPHONE

STILL Another Reason Why



THE TRIMM FEATHER-WEIGHT phones are accepted as best on the market. All Featherweight double headsets are now equipped with a specially developed moisture proof cord, giving unparalleled durability and service. 10X more efficiently with Trimm Featherweight phones.

Buy from your local dealer

TRIMM RADIO MFG. CO

1528 Armitage Avenue Chicago, Illinois

"HAM" ADS

Advertisements in this section are inserted at 5c per word to strictly amateurs, or 10c a word (7 words to the line) to manufacturers or dealers for each insertion. Each word in a name and address to be counted. Cash should accompany "Ham" advertisements. Advertising for January issue should reach us not later than November 5.

WANTED—USED TRANSMITTING PARTS—W9SFX, Manly, Iowa.

QSL's 75c A 100 2 COLORS, W9DGH, 1816 5th Ave. N., Minneapolis, Minn.

SWL's-QSL's. HAM PRINTING. MAC PRINT, 3536 Roland Ave., Baltimore, Md.

TELEVISOR COMPLETE \$10.00. ARTHUR POHL, 2135 Hubbard Ave., Detroit, Mich.

QSL CARDS, NEAT, ATTRACTIVE. REASONABLY priced, samples free. Miller, Printer, Ambler, Pa.

COLONIAL A.C. RADIO, 7 TUBES \$15. NEED Cash. Morris Goldstein, 916 DeKalb Avenue, Brooklyn.

CELLULOID SW COILS. MORE DX GUARANTEED. 30c Each. Modern Radiolabs, 151-A Liberty, San Francisco.

INSULATION, WIRE, VARNISHES, SUPPLIES, etc. Send 3c stamp for bulletin. AUTOPOWER, 414 S. Hoyne Ave., Chicago.

COMPLETE TRAINING FOR AMATEUR LICENSE \$1.50 weekly. N.Y. Wireless School, 4 West 105 Street, Clarkson 2-7456.

SHORT WAVE EQUIPMENT BUILT TO ORDER. Satisfaction guaranteed. Write for prices. Virgil Darnell, Emerson, Ga.

TELEPLEX WITH OSCILLATOR \$12. COST \$28 new six months ago. Also Converter for \$8. M. Leib, 210 Condon, Buffalo, N.Y.

NEW TUBELESS 1850 MILE RADIO. OPERATES Speaker. Blueprint, 17 Others. 25c Coin. Modern Radiolabs, 151-A Liberty, San Francisco.

FOR SALE—NEW AND USED SHORT WAVE sets of all types—Hammarlund, Nationals, Scotts, Pattersons, etc. Edward Schwarz, Dumont, N.J.

\$4.95—25W TRANSMITTERS. DESIGNERS, manufacturers of short wave receiving, transmitting equipment. Radio Service Laboratories, Fort Wayne, Indiana.

RADIO: SHORT, ALL-WAVE. FACTORY prices—Catalog Z. Free large Short Wave World Map. (postage ten cents). Radio City Labs., 1217-30 Rockefeller Plaza, New York.

RADIO TRANSFORMERS, AUDIOS, CHOKES. Special Transformers & Windings. Write for catalog. Dealers wanted. Skiles Transformer Co., 1707 California Ave., Fort Wayne, Indiana.

LINCOLN DC31 S-W SUPERHET COMPLETE with RCA tubes \$15.00. RCA single 250 Photophone amplifier complete with RCA tubes \$10.00. M. Watson, Brooks School, No. Andover, Mass.

IN STOCK—LOWEST WHOLESALE PRICES: Silver 5C receivers \$74.70 complete shipped prepaid. All National, Hammarlund, Patterson, RME9D, receivers. All other short-wave apparatus. Trade-in your receiver. Code machines rented. Write—Henry Radio Company, Butler, Mo.

SENSATIONAL BARGAIN: NATIONAL AC-SW3. 2 Weeks old; with 6 coils, Philco tubes, power supply, push-pull 45 amplifier, and genuine Amplion speaker with cabinet. Everything in original cartons. First money order for 25 dollars takes it. W2EUN, 619 Leland Ave., Bronx, N.Y.C.

4—LOW-LOSS COILS 15-200 METERS. TALL forms. Four colors \$75. Broadcast coils, set of 2—200-550 meters \$40. Pilot Midget Variable Condensers—.0001 each \$59. Short Wave Maps \$10. Write for special list No. 1—5c stamp. Short Wave Accessories, 121 Derby St., Valley Stream, New York.

OHM'S LAW CALCULATOR—LIGHTNING Slide Rule; solves all problems of Voltage, Current and Resistance, Power, Wire Sizes, etc. Range: 1 micro-amp, to 1000 amps; 1 micro-volt to 10,000 volts; 1 micro-ohm to 10 megohms; 1 micro-watt to 10 megawatts; wire sizes 0 to 36 B. & S. gauge. Introductory price \$1.00 prepaid. The Dataprint Co., Box 322, Ramsey, N.J.

TEN PRACTICAL AND INEXPENSIVE changes converting Dodge 12-V. Ford T.A., Chevrolet Delco 6-V generators, into 100-500 watt capacity A.C. generators, or into 32—110 volt D.C. motor or generator. Dodge is 500-W. self-excited. All in one book illustrated with complete simplified instructions and drawings for only \$1. AUTOPOWER, 414 S. Hoyne Ave., Chicago.

Short Wave League

(Continued from page 505)

operation. This system will operate very smoothly and prove to be a very powerful organization, and power is what we must have before we can complete the third step and demand recognition and the abolishment of the code test below 6 meters from the Federal Communications Commission in Washington, D. C.

We must have a system like this if we are going to get anywhere and accomplish what we have set out to do, or, are we going to let the "code fiend" that says, "I learned the code" (and that's about all he knows, and they can learn it, too, or stay off the air, which shows a very selfish nature), cause the downfall of our purpose, not only in getting the code test abolished below 6 meters, but the loss of thousands of kilocycles in our 5 meter band, as well as thousands of kilocycles in all of the other amateur bands? Are we going to let this type finally cause the downfall of amateur radio?

Let's quit this argument and get busy at getting something done, as we will never get anywhere by arguing all the time. Let's use our space in SHORT WAVE CRAFT for constructive ideas in our campaign instead of a "1912 Code Argument". These fellows that are arguing for the code all the time should know that this is 1934 and that there have been a "few" improvements in radio since 1912. Anyway, in time code will prove to be of no use below 6 meters, as the 5 meter band will be used for experimental and research purposes, also for communication between amateur, IF we have any of this band left after the "commercials" get through.

A railroad has been experimenting with 5 meter phone equipment for the communication between engineer and conductor on a long freight train and it has proven to be very successful. I can mention numerous other commercial interests that are experimenting with 5 meter equipment. It won't be long until commercial interests will demand a big cut of our 5 meter band, as it has very few occupants according to the room we have there, and it will be many years before we can get enough stations on this band to hold it if we don't get the code test abolished below 6 meters.

So, come on fellows! Let's get together and build up an organization that will give us power, and in the end, accomplish our purpose.

The foregoing is an answer to the general run of questions asked in the hundreds and hundreds of letters and postcards that I have received since my article in the August issue of SHORT WAVE CRAFT on why we need codeless 5 meter license.

Since the questions asked were of a nature to be of general interest to all, I have answered them in the above article.

To each and every one that wrote me I am sending a hand-colored post card of a scene taken here in the beautiful Ozark Mountains of Arkansas.

I will appreciate letters of suggestions or criticism in regard to the above article. All of you fellows that are interested in the abolishment of the code test below 6 meters drop a line to the address below. I will answer all letters or post cards, so write me, and be sure of getting a reply.

I will sign with the best of wishes for the future of amateur radio and SHORT WAVE CRAFT.

PAUL LOMASTER,
Bentonville, Arkansas.

I to 5 Meter Super-het Receiver Using 5 Tubes—In Next Issue!

WORLD-WIDE RECEPTION

ANKER

ALL-WAVE SUPERHETERODYNE
"DREADNAUGHT"



QUICK FACTS

- ✓ Continuous band spread.
- ✓ Standard parts used throughout.
- ✓ Easily lined up. I.F.'s prealigned.
- ✓ 7 tube all wave super-het circuit.
- ✓ Built in Beat oscillator.
- ✓ Power supply also built in.

- ✓ 9 1/2 to 550 meter range.
- ✓ Hi-ratio airplane dial tuning.
- ✓ Tone and static control.
- ✓ Hi signal to noise ratio.
- ✓ Front panel phone jack.
- ✓ automatic speaker cutout.

Foundation Kit consisting of drilled "Dreadnaught" chassis and black cracked panel, coil shield, and complete directions including schematic and pictorial diagrams. **Net Price \$1.95**
The remaining material can be bought when needed.

Complete Kit, including all necessary parts, 4 pair of plug in inductances 9.5 to 200 meters, hardware, diagrams, etc. List \$49.85

\$29.91

NET

ACCESSORIES

Wiring and testing list \$11.25. Net \$6.75

2 pair of broadcast coils, 200 to 550 meters, list \$2.60. Net \$1.56

Anker high fidelity dynamic speaker in cabinet to match receiver. list \$8.25. Net \$4.95

Kit of genuine Arcturus tubes for "Dreadnaught", list \$7.15. Net \$4.29

Black cracked metal cabinet with hinged cover, ventilating louvers, etc., list \$5.26. Net \$3.15

If rack panel is desired instead of regular panel, additional list \$2.00. Net \$1.20

Order Direct from This Page—Free Catalogue of Anker Products on Request

ANKER LABS

20 W. 22nd St., Dept. S-12, New York City

RADIO

THEORY PHYSICS

SHORT WAVES — BROADCAST TELEVISION

Are you a beginner or amateur in the field of radio? Would you like to become an operator, technician or engineer at a good salary?

Prepare yourself at home for big-money jobs with a future and really understand your work!

Our easy, step-by-step PERSONAL INSTRUCTION gives you real information you can USE!

One of the finest courses ever offered at a price you can afford. Less than

\$1.25 A WEEK

for a few short weeks! Write

RADIO TECHNOLOGICAL COLLEGE
1202 Omar Avenue, Houston, Texas

New Streamlined ELECTRIC TRAIN "Silver Bullet"

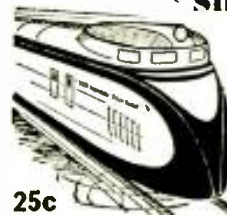

25c

At last! The streamlined Electric Train you have always wanted at a fraction of the usual cost. Needs no track or transformer—a big saving. Runs equally well indoors or outdoors on ordinary dry cells. The Silver Bullet is finished in black and silver—neat and flashy. Complete kit requiring but a few minutes to assemble—only 25c, plus 10c postage & packing. Rush your order to:

INTERSTATE ELECTRIC COMPANY
Dept. 4 Madison, Wisconsin

••• SHORT WAVE ESSENTIALS FOR MEMBERS OF THE SHORT WAVE LEAGUE •••

A FEW WORDS AS TO THE PURPOSE OF THE LEAGUE

The SHORT WAVE LEAGUE was founded in 1930. Honorary Directors are as follows: Dr. Lee de Forest, John L. Reinartz, D. E. Replogie, Hollis Baird, E. T. Somerset, Baron Manfred von Ardenne, Hugo Gernsback, Executive Secretary.

The SHORT WAVE LEAGUE is a scientific membership organization for the promotion of the short wave art. There are no dues, no fees, no initiations, in connection with the LEAGUE. No one makes any money from it; no one derives any salary. The only income which the LEAGUE has is from its short wave essentials. A pamphlet setting forth the LEAGUE'S numerous aspirations and purposes will be sent to anyone on receipt of a 3c stamp to cover postage.

FREE MEMBERSHIP CERTIFICATE

As soon as you are enrolled as a member, a beautiful certificate with the LEAGUE'S seal will be sent to you, providing 10c in stamps or coin is sent for mailing charges.

Members are entitled to preferential discounts when buying radio merchandise from numerous firms who have agreed to allow lower prices to all SHORT WAVE LEAGUE members.

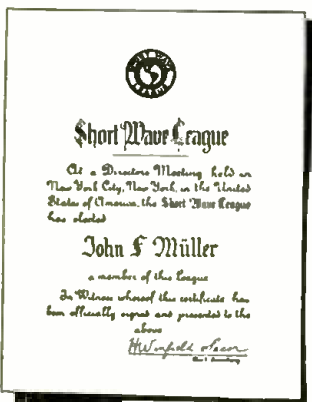

SHORT WAVE ESSENTIALS LISTED HERE SOLD ONLY TO SHORT WAVE LEAGUE MEMBERS

They cannot be bought by anyone unless he has already enrolled as one of the members of the SHORT WAVE LEAGUE or signs the blank on this page (which automatically enrolls him as a member, always provided that he is a short wave experimenter, a short wave fan, radio engineer, radio student, etc.).

Inasmuch as the LEAGUE is International, it makes no difference whether you are a citizen of the United States or any other country. The LEAGUE is open to all.

Application for Membership SHORT WAVE LEAGUE

SHORT WAVE LEAGUE 99-101 Hudson Street, New York, N. Y. 12-34

I, the undersigned, herewith desire to apply for membership in the SHORT WAVE LEAGUE. In joining the LEAGUE I understand that I am not assessed for membership and that there are no dues and no fees of any kind. I pledge myself to abide by all the rules and regulations of the SHORT WAVE LEAGUE, which rules you are to send to me on receipt of this application.

I consider myself belonging to the following class (put an X in correct space): Short Wave Experimenter Short Wave Fan Radio Engineer Student I own the following radio equipment:

Transmitting
Call Letters
Receiving
Name
Address
City and State
Country

I enclose 10c for postage and handling for my Membership Certificate.

SHORT WAVE LEAGUE LETTERHEADS

A beautiful letterhead has been designed for members' correspondence. It is the official letterhead for all members. The letterhead is invaluable when it becomes necessary to deal with the radio industry, mail order houses, radio manufacturers, and the like; as many houses have offered to give members who write on the LEAGUE'S letterhead a preferential discount. The letterhead is also abroad. It automatically gives you a professional standing.

A—SHORT WAVE LEAGUE letterheads, per 100..... 50c

OFFICIAL SHORT WAVE LEAGUE LOG AND CALL MAGAZINE

Here is the finest book of its kind ever published. It contains the largest listing of short wave stations in the world, much larger in fact than the list published in SHORT WAVE CRAFT and other magazines. All experimental stations, no matter where located, are listed. A large section is provided where calls can be listed in a proper manner. This log section gives dial settings, time, date, call letters, location, and other information. Another section has squared-paper pages on which you can fill in your own frequency curve for your particular receiver. It helps you to find stations which otherwise you could never log. It is the only book of its kind published.

B—Official Log and Call Magazine.....Prepaid 25c

RADIO MAP OF THE WORLD AND STATION FINDER

The finest device of its kind published. The world's map on heavy board is divided into 23 sections, while the rotary disc shows you immediately the exact time in any foreign country. Invaluable in logging foreign stations. Also gives call letters assigned to all nations. Size 11"x22".

C—Radio Map of the World and Station Finder.....Prepaid 25c

GLOBE OF THE WORLD AND MAGNETIC COMPASS

This highly important essential is an ornament for every den or study. It is a globe, 6 in. in diameter, printed in fifteen colors, glazed in such a way that it can be washed. This globe helps you to intelligently log your foreign stations. Frame is of metal. Entire device substantially made, and will give an attractive appearance to every station, emphasizing the long-distance work of the operator.

D—Globe of the World.....Prepaid \$1.25

SHORT WAVE LEAGUE LAPEL BUTTON

This beautiful button is made in hard enamel in four colors, red, white, blue and gold. It measures three quarters of an inch in diameter. By wearing this button, other members will recognize you and it will give you a professional air. Made in bronze, gold filled, not plated. Must be seen to be appreciated.

E—SHORT WAVE League lapel button.....Prepaid 35c

EE—SHORT WAVE LEAGUE lapel button, like the one described above but in solid gold.....Prepaid \$2.00

SHORT WAVE LEAGUE SEALS

These seals or stickers are executed in three colors and measure 1 1/4 in. in diameter, and are gummed on one side. They are used by members to affix to stationery, letterheads, envelopes, postal cards and the like. The seal signifies that you are a member of the SHORT WAVE LEAGUE. Sold in 25 lots or multiples only.

G—SHORT WAVE LEAGUE seals.....per 25, Prepaid 15c

SHORT WAVE MAP OF THE WORLD

This beautiful map, measuring 18x26 in. and printed in 18 colors is indispensable when hung in sight or placed "under the glass" on the table or wall of the short wave enthusiast. It contains a wealth of information such as distress stations is located, etc., and from the manner in which the map is blocked off gives the time in different parts of the world at a glance.

F—SHORT WAVE Map of the World.....Prepaid 25c

PLEASE NOTE THAT ABOVE ESSENTIALS ARE SOLD ONLY TO MEMBERS OF THE LEAGUE—NOT TO NON-MEMBERS.

Send all orders for short wave essentials to SHORT WAVE LEAGUE, 99-101 Hudson Street, New York City. If you do not wish to mutilate the magazine, you may copy either or both coupons on a sheet of paper.

SHORT WAVE LEAGUE 99-101 Hudson St., New York, N. Y.



G—15c for 25



F—25c each

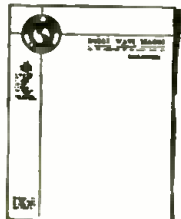

A—50c per 100



B—25c per copy



C—25c each



D—\$1.25 each



E—35c each

SHORT WAVE LEAGUE, 99-101 Hudson Street, New York, N. Y.
Gentlemen:
I am already an enrolled member in the SHORT WAVE LEAGUE
I am a new member and attach my application to this coupon
Please send me the following short wave essentials as listed in this advertisement:
.....
.....
.....
for which I enclose \$ herewith.
(The LEAGUE accepts money order, cash or new U. S. Stamps in any denomination. Register cash and stamps.)
Name
Address
City and State
Country

Please mention SHORT WAVE CRAFT when writing advertisers

Vest Pocket SOLDERING IRON



Smallest good iron now on the market. Will do the work of irons twice its size. Only 10 inches long, 1/2 inch in diameter. By using the highest grade elements, it heats up in half the time of ordinary irons. Guaranteed to give satisfaction or money back. We issue no catalog on this item. Enclose \$1.20 and iron will be sent postpaid in U.S. 10c extra in Canada.

GOLD SHIELD PRODUCTS CO.
98 Park Place, S. W., New York

S-W Scout News

(Continued from page 484)

If you stay over a night or so he will take you out to meet other local "DX" hunters who use various makes of receivers.

The I.D.A. is different from other Radio organizations in as much as a person has to qualify as a real "DXer" to gain membership. Their monthly pamphlet seems to contain plenty of the real "hot tips" and we were mighty glad to get the copies he gave us. "Glad we met you and your friends Charlie."

A general check-up of comparative receiving conditions show us that Illinois' affords a more pleasant evening of entertainment over 49-meter band due to lower "noise-level" and maybe better reception of some European signals such as the Russian and Swedish signals for the same reason, while we in Texas appear to be better located for receiving the China, Jap, and Australian signals.

The above is based on what was heard together with reports of listeners related to us while visiting Illinois.

And speaking of that 49-meter band reminds us of the fact that COC in Havana has returned to the air with a dandy signal. We salute you COC on your rare good quality and look forward to several pleasant hours of listening to your signal.

Now that DX-ing is beginning to be "just possible" on the 49-meter band again we suggest you S-W hounds go fishing for HJIABE who will be found between GSA and WIKAL on your dial. Conditions will have to be good for you to make the catch but it's a real good signal when heard, with a program of well-planned musical numbers as a rule. The call number will be announced at end of program which is usually about 9:15 p.m., C.S.T.

The 31-meter band is getting better fast right now at this post and we expect to make some good catches between 30 and 38 meters soon.

Results on 25-meter band are unique. When we get them we get them good but reception is by no means dependable, day to day.

The same proves partly true on 19 meters. On this particular band we find the period of good reception is getting short. Signals which were heard from 7:30 a.m. to 9:30 a.m., C.S.T., a month ago are now only heard for a period of about 30 minutes with equal quality. This is of course, not the case with our American signals as much as the foreign ones, yet a keen ear will notice the difference even on locals.

Nineteen and 16 meters while fairly close on our dials must be plenty far apart in reality for conditions on the two bands differ greatly. While it is true European signals are getting a little ragged on 19 meters we have to admit that PHH and GSG on 16 meters are not thus affected. In fact September has proved a banner month on these signals.

During November we can expect to hear CT2AJ on 85 meters as noise level will be lower than we have had for some months. As we have stated before in this column this is one real catch.

Also we can better enjoy RV15 on 70.2 meters. No use writing this station for confirmation.

The writer once kept a 6-month's check on their signal and sent it all in at once in an effort to get an answer and failed.

This post has made no notable catches this month.

Reception Report From Herman Borchers, Greenfield, Mass.

● SHORT-WAVE reception during September was very erratic, and varied from day to day, due to the many rain-storms and atmospheric conditions, which we have had here at this post.

The European stations on the 19-meter band were excellent in the morning, up until noon.

(Continued on page 511)

ALL-WAVE Noise Reducing ANTENNA SYSTEMS

Lynch Materials Used Exclusively

Complete Ready to Hang Up. No Labor On Your Part But To Attach To Your Masts. Complete with new Universal Coupler and Double Lightning Arrester, net..... **\$10.95**
Kit Lynch materials to build 884, net..... **\$7.25**

No. 873—Inverted L (78 ft. flat top) and 25 ft. transposed lead-in with 10 ft. Giant Killer cable. Complete with new Universal Coupler and Double Lightning Arrester, net..... **\$8.95**
Kit Lynch materials to build 873, net..... **\$6.95**
Other types available. Send for additional information. Include sketch of location.

THE "MISSING LINK"
Phone Receiver for Receiver Without Phone Jack
Inserting phone plug automatically silences speaker. No disturbing of receiver wiring..... **\$3.95**

AMPLIVOX LABORATORIES
227 Fulton St., Dept. SW-12, New York, N. Y.
Chief Engineer—Sol. Perlman, E. E., Consulting Engineer on Antenna Problems to A. H. Lynch, Inc.

"SIGNAL HOP"

Beyond Your Fondest Hopes With PEAK Pre-Selector and Pre-Amplifier

The last word in Pre-Amplification! Two tuned stages of hi-gain 58 type tubes. Hundreds of tests prove that signals of R3 to R5 audibility are consistently boosted to R9 and R9+. Besides tremendous signal gain, PEAK gives increased sensitivity; absolute rejection of image or repeat spots; reduction of background noise; increased selectivity!

Operates with any S.W. or All-Wave set. Comes complete with 3 sets of built-in coils (none to plug in) covering all frequencies with overlap from 14-200 M. Other features include airplane type dial, smooth regeneration, automatic change-over switch, self-contained filament supply, etc. For 110-120 V. 50-60 Cycles, A.C.

ATTENTION!
Hams and S.W. Fans! Order or get all the facts TODAY! List price \$33, less 40%: your price \$19.80 complete, less tubes. Order through your Dealer or M.O. House.

EASTERN RADIO SPECIALTY CO.
Peak Products Dept. SC-124, New York, N. Y.
113 E. 168th St.,

The DX2 All-Wave Receiver



A sensitive, powerful and well-engineered 2 tube receiver capable of world-wide short-wave reception. Uses 30 and 33 type tubes. Possesses the sensitivity and high gain that is characteristic of sensitive regenerative detectors, the excellent tonal qualities of the resistance coupled amplifier, and an extremely smooth regeneration control. Beautiful black crackle finish. Weight 5 lbs. Highest quality parts and simple to build. Operates on 1-45 Volt B battery and 2 dry cells. Coils for 10-200 meters and instructions included. Foreign reception is Guaranteed. C.O.D. orders filled promptly. Circular on request. Kit . . . **\$4.45**
Wired and tested, extra..... **\$1.35**
Arcuturus tubes..... **1.50**
Broadcast coils..... **.85**
Acme 4000 ohm phone..... **1.35**

CENTRALLION ENGINEERING CO.
461 Fourth Ave. Dept. SWC-2 New York, N. Y.

It's NOW

EVERYDAY SCIENCE AND MECHANICS is the finest scientific-technical - mechanical - constructional magazine in the field. Up-to-the-minute with news flashes of scientific events. Dozens of constructional articles and many popular experiments. Ideas from which you can make things to sell.

10¢

Edited by **HUGO GERNSBACH**

A HOST OF INTERESTING SUBJECTS COVERED:—Aviation—Radio—Woodworking—Astronomy—Patents and Inventions—Home Hints—Metalworking—Chemistry—Engineering—Microscopy—Electrical Experiments—Household Hints—Shop Hints and other subjects.

Get your copy today! on all newsstands 10c the copy

Over 150 Illustrations

WHY MEN GET BALD



READ FREE OFFER

Full particulars of an amazing new discovery that enables people who have dandruff, scalp itch, falling hair or baldness, to harmlessly remove the congested thin outer layer of scalp skin and activate the dormant hair roots to grow new hair. WILL BE SENT ABSOLUTELY FREE, to any reader of this magazine who will write to Dermolay Lab. Desk 64-A, 1700 Broadway, New York, N. Y. This FREE Treatise explains anatomy of your hair and tells what to do. It is positively amazing. Send no money. If pleased, tell friends.

Please mention SHORT WAVE CRAFT when writing advertisers

The best crop of the year! in Short Wave Receivers

Presenting the Advanced Doerle!

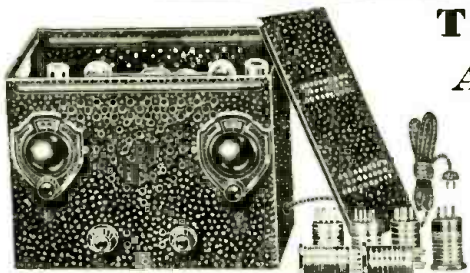

THE NEW Advanced "DOERLE A.C. Five"

15 to 200 Meters

Built-in Power Supply and Dynamic Speaker COMPLETE—NOTHING ELSE TO BUY

Well, you Doerle Enthusiasts, isn't this what you've been waiting for? A powerful 5-tube Doerle Receiver, complete with its hum-free power supply and dynamic speaker; all mounted on a single chassis and contained in a beautiful, black, crystalline-finished metal cabinet! Two tuned stages, two A.F. stages with powerful 2A5 output and perfectly matched dynamic speaker; all contribute to the enormous power and superlative performance of this "top-notch" of the Doerle line.

During its initial test, in one sitting, this receiver pulled in on its loud speaker, at good room volume, the following available logs: D.D. D.C. and D.A. Germany; J.A.A. Japan; G.S.P. and G.S.C. England; C.I.R.X. C.I.R.O. and V.E.G.W. Canada; E.A.Q. Spain; H.J.3.A.R.F. Bogota, Colombia; X.D.A. Mexico; P.Y.A. France; W.Q.O. and W.E.F. testing with the Byrd Expedition and a whole flock of amateurs in practically every radio district of the United States. After that we could no longer keep our eyes open, so we "signed off" to bed.

The receiver employs a 58 as RF amplifier, a 57 as detector, a 56 as first audio amplifier, a 2A5 as power output tube and an 80 as full-wave rectifier. The antenna is coupled inductively to the first tuned circuit through the medium of the three-winding, 6-prong plug-in coils used in the first RF stage. This effectively eliminates the bothersome antenna tuning condenser. Provisions are made for plugging in earphones. The entire set measures 11 1/2" wide x 8 1/2" deep x 8 1/2" high. Ship. Wt. 19 lbs.

\$26⁹⁰

No. 332—The Official "Doerle A.C. Five." self powered, ready to use, complete with tubes, 2 sets of plug-in coils and dynamic speaker, as illustrated.

FREE!
CATALOGS

See our ads on pages 494 and 505

LOWEST PRICE IN THE WORLD

Anyone can assemble this simple, yet efficient short-wave receiver in a half-hour's time. All major component parts come to you all ready mounted on a plated metal chassis. No previous experience, in, or knowledge of, radio required to build it. The set was designed especially for beginners and, as such, is the simplest on the market—yet simple as signed European short-wave stations. It pulls in **NIGHT AFTER NIGHT**—whenver they are on the air. The receiver uses 2 type 30, 2 2-volt tubes for operation and requires but 2 number 6 dry cells and 2 45-volt "B" batteries. Complete diagram included. Sold with 4 plug-in coils covering the range of from 15 to 200 meters. Come see all you short-wave beginners! Get started in short-waves while opportunity knocks. Shipping weight 3 lbs.

ONLY \$375

No. 334 World-Wide Two-Tube Receiver. YOUR PRICE.....\$3.75
Set of 2 No. 6 Dry Cells and 2 45-Volt "B" Batteries.....\$1.50

Short-Wave PRE-SELECTOR AND BOOSTER

Can be added to any short-wave receiver from a 1 tube battery set to a 10 tube superhet. No rewiring of your set is necessary. Just connect directly to the Aerial and Ground points of your present receiver and you are all set for greatly improved reception on all bands. This booster has its own power supply which connects directly to the A.C. or D.C. Line. Just the pre-selector owners have been looking for to reduce image response to a minimum. Boost-finished cabinet with hinged top for easy changing of plug-in coils.

ONLY \$8⁹⁵

No. 354 Booster with coils.....\$8.95
Tubes—6D6 and 25Z5.....\$1.95

Mono-Coil Converter
Featured in Oct. Short Wave Craft Magazine

Designed for one specific purpose—THE RECEPTION OF FOREIGN SPEECH AND MUSIC—this new converter is, naturally, the most efficient ever designed. Therefore, such equipment has been made to cover the tremendous range of from 10 to 200 meters, and hence could not function very efficiently on any one particular band. This Mono-Coil converter will work with any receiver, battery, A.C.-D.C. or A.C., having at least one R.F. stage.

NO PLUG-IN COILS OF ANY KIND ARE EMPLOYED. Set measures 9 1/2" wide x 8" deep x 2 1/2" high. Battery or power pack operation. Ship. wt. 1 1/2 lbs. No. 229 New Mono-Coil Converter Kit, less tubes. Your Price.....\$14.95

Trans-Atlantic Two
Featured in Oct. Short Wave Craft Magazine

15 to 200 Meters

The "Trans-Atlantic Two" is so well designed that it actually gives 4-TUBE PERFORMANCE. The set uses a 6P7 as combination untuned RF stage and regenerative detector. A 79 is employed as two stages of resistance-coupled AF amplification. Its regeneration is very smooth, being controlled by a New Band-Switching Arrangement—By merely turning a knob on the front panel any one of the four bands from 10 to 200 meters may be switched into the circuit. The switch itself is of unique design, permitting the use of any type of plug-in coils. This receiver uses the 3-winding, 6-prong type plug-in coils. Ship. Wt. 9 lbs.

\$10⁹⁵

No. 228 "Trans-Atlantic 2" Kit, less tubes. Your Price \$10.95

DOERLE GLOBE-GIRDLING Receivers—

Important Notice WE ORIGINALLY brought out the now justly famous DOERLE short wave receivers in 1932. Since that time, we have always followed the policy of making these receivers just as good as it was humanly possible to do irrespective of price. In our Grade A receivers, we have steadfastly maintained the "quality first" policy. We, however, realized that many wished to get lower priced sets, and we are now offering such a popular priced line to our many friends and followers.

This new line still uses excellent materials, although we use somewhat lighter chassis, and in other respects we have effected considerable savings which are now passed on to you. Even at these low prices, however, we could not afford the risk of cheapening the main parts. We still use HAMMARLUND TUNING CONDENSERS, and other equally well-known components. The sets we offer here are not quite as rugged as our standard DOERLE sets on which we never skimp, but if you are looking for a low-priced set, a receiver that will do the work and do it well, here are the sets for you.

This new line of DOERLE receivers may be likened to low-priced automobiles as compared with the more luxurious and expensive ones. Both types will get you to the same places, yet one will outlast the other and will be easier to handle. Our usual guarantee goes with these lower-priced sets, the same as with our higher-priced ones. The electrical circuits, wiring, etc., are exactly the same as our higher-priced sets.

You will make no mistake in getting any one of these sets. These "Globe Girdling" DOERLE sets are guaranteed to bring in short-wave broadcast stations from all over the world and you will get music and every kind of entertainment from all 5 continents.

The excellent performance of these 2-Tube Doerle receivers has already become traditional. Mass production of chassis, the use of good "over-flow" parts from manufacturers and tube-base plug-in coils, make it possible for us to sell these competitive receivers at the **LOWEST PRICES ON THE MARKET.**

- NO. 349 2-VOLT BATTERY MODEL DOERLE KIT—This receiver uses 2 of the new economical 30 tubes. Batteries required are 2 No. 6 dry cells (or a 2 volt storage cell) and 2 45 volt "B" batteries. Sold complete with instructions and diagram. Shipping weight 5 lbs. YOUR PRICE, Less Tubes.....\$1.25
- NO. 350 ALL-ELECTRIC-A.C.-D.C. DOERLE KIT—This model requires no battery or power pack at all. It works anywhere and on any type of current at 110 volts. Has a self-contained power supply. Uses 3 type 37 tubes. Shipping weight 8 lbs. YOUR PRICE, Less Tubes.....\$5.95
- Three Matched 37 Tubes.....\$1.75
- NO. 351 STRAIGHT A.C. DOERLE KIT—This model uses either 2 58's or 2 27's. It may be used in conjunction with our own power pack, listed below. The set may also be run on a 2 1/2-volt filament transformer or a "B" eliminator or, instead of the "B" eliminator, 2 45-volt "B" batteries. Shipping weight 6 lbs. YOUR PRICE, Less Tubes.....\$4.45
- Pair of Matched 58 or 27 Tubes.....\$1.30
- NO. 352 COMPETITIVE A.C. POWER PACK KIT—A compact power unit delivering 2 1/2 volts at 5 amps for filament supply and 250 volts D.C. at 50 mls for plate supply. Requires a type 80 as rectifier. YOUR PRICE, Less Tubes.....\$4.70
- Rectifier Tube.....\$.40

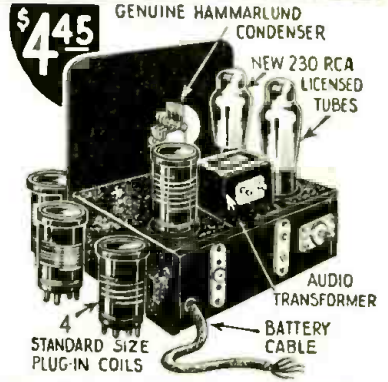

\$445

WE WILL WIRE AND TEST ANY OF THESE KITS WHEN ORDERED FOR \$1.25
Send money order or certified check. C.O.D. only when 20% remittance accompanies order.

RADIO TRADING CO., 101-A HUDSON ST., NEW YORK CITY

Please mention SHORT WAVE CRAFT when writing advertisers

● Index to Advertisers ●

A	
Ace Radio Laboratories.....	503
Aerovox Corporation.....	501
Alan Radio Corporation.....	490
Alden Products Co.....	496
Allied Engineering Institute.....	498
Allied Radio Corporation.....	500
Amperite Corporation.....	505
Amplivox Laboratories.....	509
Anker Labs.....	494, 507
Arco Tube Company.....	498
B	
Bliley Electric Company.....	503
Breakers, Hotel.....	490
Bud Radio Inc.....	490
Burgess Battery Company.....	485
Burks Radio Company.....	502
C	
Candler System Co.....	495
Centrallion Engineering Co.....	509
Coast-to-Coast Radio Corp.....	509
Coyne Electrical School.....	451
D	
Dataprint Company.....	499, 505
Dermolay Lab.....	509
Dodge's Institute.....	486
E	
Eastern Radio Specialty Co.....	509
Ellen Radio Laboratories.....	496
Electrad, Inc.....	487
Everyday Science & Mechanics.....	509
Experimental Radio Labs.....	501
F	
Fordson Radio Incorporated.....	495
First National Television, Inc.....	488
G	
General Winding Company, Inc.....	503
Goldentone Radio Company.....	488
Gold Shield Products Co.....	493, 502, 509
H	
"Ham" Advertisements.....	507
Hammarlund Manufacturing Co.....	497
Harrison Radio Company.....	491
Hygrade Sylvania Corporation.....	499
I	
Instructograph Company.....	486
Insuline Corp. of America.....	489
Interstate Electric Company.....	507
K	
Korrol Mfg. Co., Inc.....	498
L	
Lancaster, Allwine & Rommel.....	490
Leotone Radio Co.....	503
Lynch, Arthur H., Inc.....	511
M	
Midwest Radio Corp.....	Back Cover
N	
National Company, Inc.....	Inside Back Cover
National Radio Dist. Co., Inc.....	503
National Radio Institute.....	449
National Tuberculosis Association.....	495
P	
Pioneer Sound Laboratory.....	500
Popular Medicine.....	502
Porcelain Products, Inc.....	496
Postal Radio Corp.....	491
R	
Radio & Technical Publishing Co.....	486
Radio Publications.....	500, 506
Radio Technological College.....	507
Radio Trading Co.....	494, 502, 505, 510
RCA Institutes, Inc.....	505
RCA Radiotron Co.....	Inside Front Cover
Remington-Rand, Inc.....	494
S	
Sargent, E. M., Co.....	495
Schwartz, M., & Son.....	494
Sexology Magazine.....	503
Short Wave Coil Book.....	500
Short Wave League.....	502, 508
Short Wave Log & Call Magazine.....	497
Short Wave Radio Manual.....	452
Supertone Products Corp.....	488
T	
Teleplex Co.....	493
Thor's Bargain Basement.....	511
Trimm Radio Mfg. Co.....	505
Try-Mo Radio Co., Inc.....	486, 511
U	
Uncle Dave's Radio Shack.....	488
Universal Microphone Co., Ltd.....	503
W	
Wellworth Trading Company.....	501
Wholesale Radio Service Co., Inc.....	493
Winn, J. H., Mfg. Co.....	490
World Trotter Radio Labs.....	495

(While every precaution is taken to insure accuracy, we cannot guarantee against the possibility of an occasional change or omission in the preparation of this index.)

S-W Scout News

(Continued from page 509)

The 25-meter band came in good from about 10 a.m. to 1 p.m., only a little noisy, but this band is excellent after dark until 8 or 9 p.m.

The South American stations were mostly lost in static, except that new Brazilian station PRE5, on 31.58 meters. This station is on the air from about 5:45 to 6:30 p.m. It relays the programs of the *Radio Club of Brazil*.

LSX on 28.98 meters is still relaying the broadcasts from and to "Little America" on Wednesdays. Their signals came in very weak.

JVM on 27.93, located at Nagoya, Japan, is broadcasting almost every day from about 2 to 8 a.m. I also have heard them in the evening from 10:30 to 11:10 phoning California.

ZFB on 29.02 meters was on the air Sept. 5 at 5:55 E.S.T. phoning U.S. It has a two-tone whistle which identifies this particular station.

HJ1ABB, 46.53 meters, Barranquilla, came in with good volume.

SRI around 31 meters Poznan, Poland, was back on the air again (a very rare occasion). Sept. 8 at 5:45 p.m. it was broadcasting the Granada Synagogue Concert, and was received fine here.

On Sept. 7 from 6 to 7 p.m. Germany sent a special broadcast to PSK Rio de Janeiro; this concert was transmitted on three different wave-lengths, namely DJD, DJA, and DJC, which were heard here with tremendous volume.

JYT on 19.03 meters, Japan, phoned California on Sept. 14 at 7:40 p.m. Signals were very weak and noisy.

HBP and HBL, League of Nations, Geneva, was very fine.

VK2ME, Sydney, Australia, came in like a "local" on Sept. 16 from 4:30 to 8:30 a.m. It is now broadcasting a special program to each different state in the U.S.A. every Sunday.

OER2 on 49.4 meters seems to be back on the air again. I picked this station up on Sept. 3 at 11 a.m. broadcasting the Military Marché.

There is one station just above the German DJC, 49.83 meters, which I can't seem to identify. It is only possible to hear this station after DJC signs off. It announces quite frequently, but the talking is all done in Spanish. It's on the air almost every night and as late as 1:15 a.m., and it plays a two-tone high frequency signal something like an auto-horn, before announcing. I think it must be XEBT, 49.88 meters, Mexico, or TGX, 49.9 meters.

All the time given is *Eastern Standard Time*.

Trophy Contest Entry Rules

• THE rules for entries in the SHORT WAVE SCOUT Trophy Contest have been amended and only 50 per cent of your list of stations submitted need be verified. If, for example, you send in a list of 100 stations with 50 verification cards, you will receive credit for the other 50 per cent or 100 stations total. The trophy will be awarded to the SHORT WAVE SCOUT who has logged the greatest number of short-wave stations during any 30 day period; (he must have at least 50 per cent verified) this period need not be for the immediate month preceding the closing date. The complete list of rules appeared in the August issue of this magazine.

In the event of a tie between two or more contestants, each logging the same number of stations, (each accompanied by the required 50 per cent verified) the judges will award a similar trophy to each contestant so tying. Each list of stations heard and submitted in the contest must bear the list of stations heard were "logged" over a given 30 day period, that reception was verified and that the contestant personally listened to the station announcements as given in the list.

Only commercial "phone" stations should be entered in your list, no "amateur" transmitters or "commercial code" stations. This contest will close every month on the first day of the month, by which time all entries must be in the editor's hands in New York City. Entries received after this date will be held over for the next month's contest. The next contest will close in New York City, December 1.

The judges of the contest will be the editors of SHORT WAVE CRAFT, and their findings will be final. Trophy award will be made every month, at which time the trophy will be sent to the winner. Names of the contesting SCOUTS not winning a trophy will be listed in Honorable Mention each month. From this contest are excluded all employees, and their families of SHORT WAVE CRAFT magazine. Address all entries to SHORT WAVE SCOUT AWARD, 99-101 Hudson Street, New York City.

Never Before!
Foreign reception like this!

You Change Your Wave Band in a Jiffy

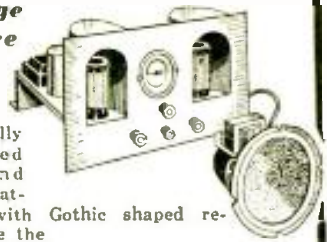

The specially constructed chassis and Cadmium Plated panel with Gothic shaped recesses, make the

RGH-5 ALL WAVE A.C. RECEIVER

Bob Herzog's latest Short Wave sensation a convenience as well as a joy

Marvelous World-Wide Selectivity—Extremely Simple to Wire—Dynamic Speaker \$2.50 Extra. **\$12.95**

FREE KITS MOUNTED FREE

Kits Shipped Redi-Mounted for Easy Wiring It's a Cinch to Build It—You Can't Go Wrong

THOR'S BARGAIN BASEMENT

167 Greenwich St., Dept. S., New York

MAIL ORDERS FILLED FREE TECHNICAL DATA



"No Radio Can Be Better Than Its Aerial"

LYNCH HI-FI (High Fidelity)

ANTENNA SYSTEMS

Guaranteed to improve reception with any receiver, in any location.

LYNCH "HI-FI" aeriels are necessary with the new High Fidelity receivers. There are LYNCH "HI-FI" antenna kits for every purse and purpose.

They're easy to install and they work like nobody's business.

From \$3.50 to \$7.90, list

Full Information on Request

ARTHUR H. LYNCH, Inc.
227 Fulton St., New York, N. Y.

FREE Catalog



180 Pages full of all types of radio and electrical apparatus including: Short-Wave Receivers; All-Wave Receivers; Public Address System; Replacement Parts; Tubes; Short-Wave Products and thousands of items too numerous to mention.

The greatest radio catalog for the general radio trade. **GUARANTEED LOWEST PRICES—GUARANTEED QUALITY.** Send For Your Free Copy TODAY!

An All Around Radiobook

A general book covering every line of radio, including Short-Waves, All-Waves, Public Address and Transmitting. Hundreds of illustrations and schematics. Every article is a gem. For the low price every radio man—serviceman, dealer or experimenter—can find this book an indispensable asset to his radio library. Bound in Cardinal Red Leatherette Cover. Send For Your Copy Today!



TRY-MO RADIO CO.
85-5 Cortlandt St. New York, N.Y.

Please mention SHORT WAVE CRAFT when writing advertisers

WORLD GLOBES

FOR SHORT WAVE ENTHUSIASTS

AT UNPRECEDENTED LOW PRICES

THESE remarkable globes, executed in fourteen colors, are absolutely indispensable for short wave fans. Notable among the numerous features of these world globes, is that a damp cloth quickly removes all dust and water does not harm the surface.

Short Wave fans are enabled to determine correct time in various centers of the world with the aid of these maps; distances from city to city can be accurately established.

There is a graduated "Meridian" scale of black enameled metal with the 9" and 12" globes. An additional feature is the movable hour scale found at the north pole—this facilitates determining the hour in any part of the world.

Only on a globe of this size is it possible to get an accurate picture of countries and their relative positions to each other. You will actually be amazed when you compare distances—from New York to Moscow from Cape Town to Tokio; from Los Angeles to Rio de Janeiro, etc. A flat map is deceptive for measuring, but take a small string and stretch it across the globe, from city to city, and you have the correct distances.

Here are globes that add dignity to home, office, studio or laboratory—a globe that everyone would be proud to possess.

Each world globe contains a listing of over 7,500 cities in nations the world over—spellings conform to International geographic standards—all globes are of 1934 production. GET ONE OF THESE FINE WORLD GLOBES TODAY!



World Globe No. 147

12" Globe, New model—equipped with wooden floor stand finished in walnut. Height overall 35". Globe constructed with half meridian. New World Globe Handbook included FREE. A marvelous buy. Never has a floor model Globe been sold at such a low price. Shipping weight 9 lbs. PRICE

\$4.15

F.O.B. Chicago.

World Globe No. 99

9" Globe, equipped with sturdy, black metal base and full meridian. Same ball as our No. 139 but reduced 1/4 in size and scale. Included with globe is newly printed World Globe Handbook FREE. Shipping weight 6 lbs.

PRICE
\$2.05

F.O.B. Chicago.



Gentlemen:

I received the World Globe and am certainly well pleased with its completeness, appearance and its usefulness.

Short wave listening has become a hobby with me, and this World Globe is a necessary accessory to any short wave listener or, for that matter, to any home.

P. C. ELLIS, Supt.
Laboratory—19th and Campbell Streets, Kansas City, Mo.



World Globe No. 47

7" Globe, equipped with sturdy metal base and half meridian. Index to countries of the world by latitude and longitude shown on base. Shipping weight 2 lbs. PRICE

\$0.90

World Globe No. 139

12" Globe, equipped with sturdy, black metal base and half meridian. Contains over 7,500 names and cities. Spellings conform to authoritative world standards. Hundreds sold to many short wave fans during the last year. Copy of World Globe Handbook included FREE. Shipping weight 8 lbs. PRICE

\$3.25

F.O.B. Chicago.



ORDER YOUR GLOBE TODAY!

SHORT WAVE CRAFT 59 HUDSON STREET, NEW YORK, N. Y. SWC-12-34

Gentlemen: Enclosed you will find my remittance of \$..... for which please ship me the following World Globe.

- () World Globe No. 99 @ \$2.05
- () World Globe No. 147 @ \$4.15
- () World Globe No. 47 @ \$0.90
- () World Globe No. 139 @ \$3.25

Name

Address

City State

Send remittance in check or money order—register letter if it contains cash, stamps or currency. GLOBES ARE SHIPPED FROM OUR WAREHOUSE IN CHICAGO—F. O. B. FROM THAT CITY.

All globes are carefully packed in original cartons assuring safe delivery. ORDER BY NUMBER. Send check or money order, plus sufficient postage for delivery by parcel post. Globes are shipped from our Chicago warehouse. Register letter if it contains cash, or currency or stamps. If preferred, specify that shipment be sent express collect. ALL ORDERS ARE FILLED PROMPTLY.

ALL GLOBES SHIPPED IMMEDIATELY

SHORT WAVE CRAFT 99 HUDSON STREET, NEW YORK, N. Y.

Please mention SHORT WAVE CRAFT when writing advertisers

Your Copy

IS READY!

NEW NATIONAL CO. CATALOGUE

Just Off the Press

GET YOUR COPY TODAY

NEW RECEIVERS!

NEW PARTS!

Ask Your NATIONAL Dealer or Use Coupon Below

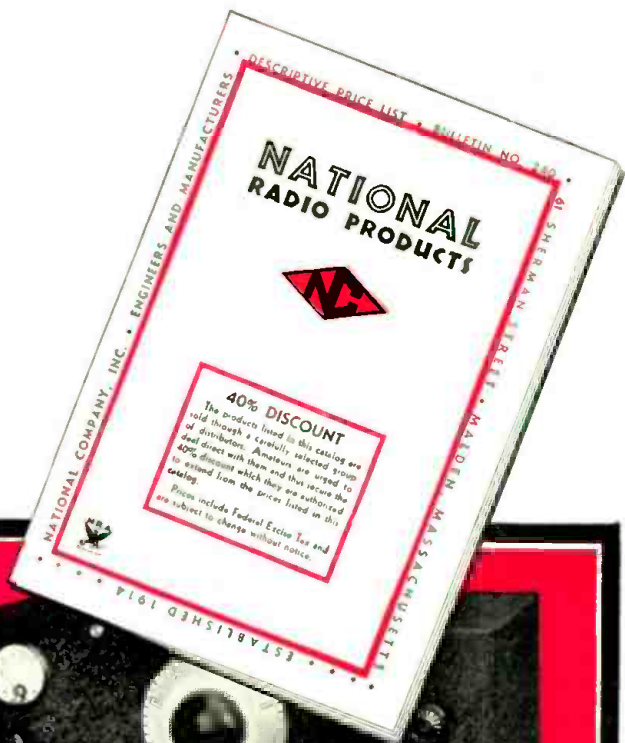

NEW TR 56 MC TRANSCEIVER
 A portable combination 5 meter receiver and transmitter (special booklet available). Uses two tubes.

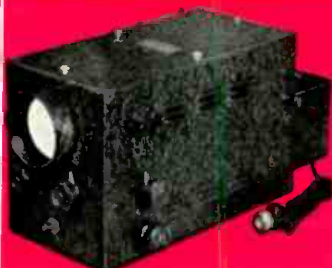

New Cathode Ray Oscilloscope
 Provides instantaneous graphic picture of actual operating conditions in transmitter circuits. (Booklet available).



NEW TYPE HRO AMATEUR RECEIVER
 Two stages of pre-selection, two air-tuned IF stages, calibrated band spread, automatic volume control, 4-gang condenser, micrometer dial, single signal filter, new ganged plug-in coils, vacuum tube voltmeter, and many other new features.



New TMS Transmitting Condenser
 For low power use. Steatite-Isolanite insulation. Compact, inexpensive.

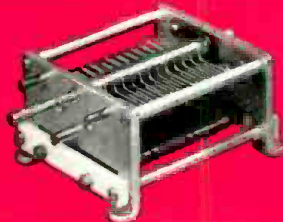

New TMC Transmitting Condenser
 For power stages where peak voltages do not exceed 3000. Compact, rigid.



New NC 800 Neutralizing Condenser
 For high voltage use, especially with RCA-800.



New M30 Mica Padding Condenser
 Steatite mounting. Max. capacity 30 mmf.



New Type XR-9 Five-Meter Coil
 Copper coil, air-spaced winding on Steatite base.

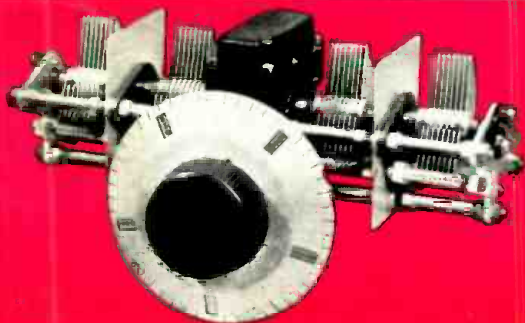

NEW PW PRECISION CONDENSER & MICROMETER DIAL UNIT
 A new and entirely self-contained ganged condenser unit for high frequency receivers. Worm-gear drive 20:1 ratio. Full of new and advanced features.



New Type CH Crystal Holder
 Holds crystal vertically. 2 forms, for transmitting or for resonator use.



New XT-8 Choke Coil Form
 Steatite form for small choke coils and resistances



New TX-9 Shaft Coupling
 Steatite insulation, for isolating circuits.

Illustrated above are just a few of the items shown in the new National Catalogue No. 240. National Radio Products include these and many other new items, and of course the well-known National Velvet Vernier Dials, Transmitting Condensers, Receiving Condensers, IF Transformers, RF Chokes, Sockets, Coil Forms, Coil Shields, Transformers, and HF Dielectrics. Included also are the famous NATIONAL AGS and AGSX Re-

ceivers, the FB-7A and FB-XA Amateur Receivers, the SW-3 High Frequency Receiver, the PSK Preselector, the SRR 5 Meter Super-Regenerator Receiver, the HFC 5 Meter Converter,—as well as the power units for operating these receivers. Call at your National Dealer's today for a free copy of this new catalogue, or send coupon below, enclosing 6c to cover mailing costs.

NATIONAL COMPANY, Inc., 61 Sherman Street, Malden, Mass.

Gentlemen: Please send me your new catalogue No. 240. I enclose 6c to cover mailing costs.

Name

Address

SWC-12-34



SAVE up to 50% by BUYING DIRECT

from LABORATORIES

Thousands Thrill to **GUARANTEED**
World-Wide **HIGH FIDELITY**
Performance
with this

Amazing
New
MIDWEST
1935
SUPER

16 TUBE
ALL-WAVE Radio
(ALL FIVE WAVE BANDS)

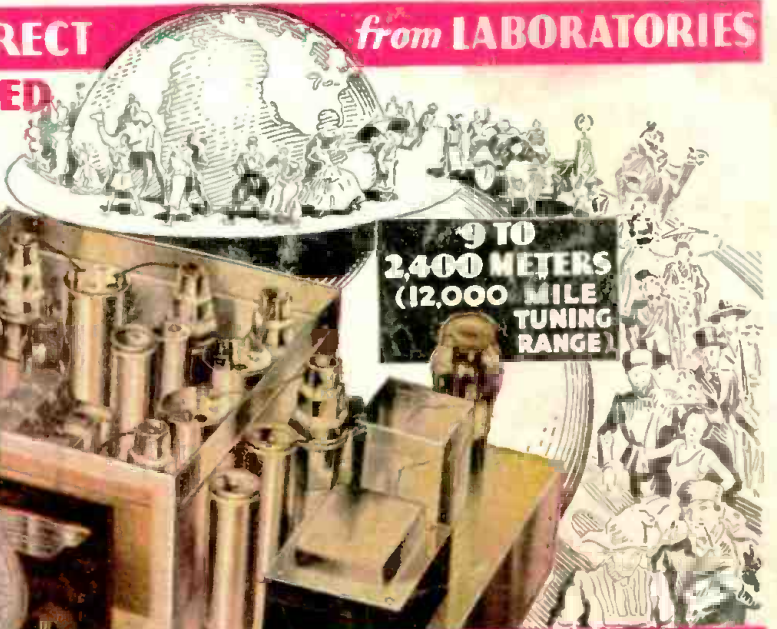

9 TO
2400 METERS
(12,000 MILE
TUNING
RANGE)

WORLD'S GREATEST
RADIO VALUE

\$ **57.50**
with
New
Deluxe Auditorium-Type
SPEAKER
... LESS TUBES ...

TERMS AS LOW AS \$5.00 DOWN

30
DAYS
FREE
TRIAL

OVER 110,000 SATISFIED
CUSTOMERS SAVED 1/3
TO 1/2 BY BUYING DIRECT

World-Wide Entertainment
Springfield, Ill.—I investigated all makes of radios, and I chose the Midwest. No radio made can equal it. I logged with ease and good volume: LSX, LSN, HJABB, HJ5ABD, YVIBC, VK2ME, Australia—GSC, QSB, GSA, Eng.—DJA, DJC, Ger.—EAQ, Spain, etc. W. C. Geiser, 2200 Yale Blvd.

Admires Wonderful Tone
Conneaut, O.—There is not a better radio than the Midwest. Everyone says they never heard such a wonderful tone. We have gotten many foreign stations very clearly. Our Midwest is worth more than we paid for it.
Mrs. M. C. Moody, 179 Marshall St.

Gets Byrd at Pole Direct
Hammond, La.—The greatest distance I have received so far is Byrd at the Pole direct, not a relay through LSX. EAQ and VK2ME come clearly as locals. DJB, GSC, QSB, come in extremely well.
R. T. Pursley.

BEFORE you buy any radio write for the new FREE 1935 Midwest "Fifteenth Anniversary" catalog and see for yourself the many reasons why 110,000 satisfied customers bought their radios direct from the Midwest Laboratories and saved from 1/3 to 1/2. Why pay more than the direct-to-you laboratory price?

You, too, can make a positive saving of from 30% to 50% by buying this more economical way. Learn why Midwest outperforms sets costing up to \$200.00 and more. Never before so much radio for so little money! Midwest gives you triple protection with: One-year guarantee, foreign reception guarantee, money-back guarantee.

SENSATIONAL HIGH FIDELITY RECEPTION
This bigger, better, more powerful, clearer-toned, super selective radio gives you absolute realism—assures you of life-like, crystal-clear tone—unlike anything you have ever experienced before! You will hear one more octave—over-tones—that cannot be brought in with ordinary radios. Now, hear every instrument, every voice, every shade and inflection of speech. Take advantage of the amazing 30-day FREE trial offer. Send coupon today for FREE catalog.

ALL FIVE WAVE BANDS
Only Midwest covers a tuning range of 9 to 2400 meters (33 Megacycles to 125 KC.)—enabling you to easily and successfully tune in foreign stations up to 12,000 miles away with crystal-clear, loud-speaker reception.

All 5 Wave Bands enable you to enjoy today's finest High Fidelity American programs. In addition, you get Canadian, police, amateur, commercial, airplane and ship broadcasts and derive new delight and new excitement from unequalled world-wide broadcasts... England, France, Germany, Spain, Italy, Russia, Australia, etc. Send today for money-saving facts!

DEAL DIRECT WITH LABORATORIES
Increasing costs are sure to result in higher radio prices soon. Buy before the big advance...NOW... while you can take advantage of Midwest's sensational values...no middlemen's profits to pay. You can order your High Fidelity radio from the new Midwest catalog with as much certainty of satisfaction as if you were to select it in our great radio laboratories. You save 30% to 50% when you buy this popular way... you get 30 days FREE trial... as little as \$5.00 down puts a Midwest radio in your home. Satisfaction guaranteed or money back. Write for new FREE catalog.

NEW STYLE CONSOLES



The Midwest 36-page 1935 catalog pictures a complete line of beautiful, artistic deluxe consoles and chassis, in four colors. Write for new FREE catalog today! Midwest long-range radios are priced as low as... **\$27.50**

50 ADVANCED 1935 FEATURES... and 16 tubes make this Super High Fidelity Radio today's most powerful long distance receiver. Its many exclusive features include: Micro-Tenuator... Fidel-A-Stat... Separate Audio Generator... Ceramic Coil Forms, etc.

- FEATURES OF NEW-TYPE MIDWEST DIAL**
This dial takes the guesswork out of tuning. Now Midwest guarantees that inexperienced persons can secure good foreign reception. Send for FREE miniature of actual rotating dial—which clearly shows the advantages of these sensational features:
1. Dial calibrated in Kilocycles, Megacycles and Meters;
 2. Call letters of American Broadcast Stations printed on dial and illuminated;
 3. Slow-Fast, Smooth-Action Tuning;
 4. Station Group Locator;
 5. Simplified Tuning Guide Lights;
 6. Automatic Select-O-Band Indicator;
 7. Illuminated Pointer Indicator;
 8. Silent Shadow Tuning—Improvement on Meter Tuning;
 9. Centralized Tuning.

SEND NO MONEY!
MAIL COUPON TODAY! FOR
AMAZING 30-DAY FREE TRIAL OFFER AND NEW 1935 CATALOG

MIDWEST RADIO CORP.,
Dept. 794,
Cincinnati, Ohio.

Without obligation on my part send me your new FREE 1935 catalog, FREE Miniature Dial, and complete details of your liberal 30-day FREE trial offer. This is NOT an order.

User-Agents Make Easy Extra Money
Check Here for Details

Name.....
Address.....
Town..... State.....

MIDWEST RADIO CORP.
DEPT. 794 — CINCINNATI, OHIO, U. S. A.
Established 1920 Cable Address Miraco... All Codes