

TWO-WAY  
MINIATURIZATION  
ANTENNAS

# SERVICE

THE TECHNICAL JOURNAL OF THE TELEVISION-RADIO TRADE

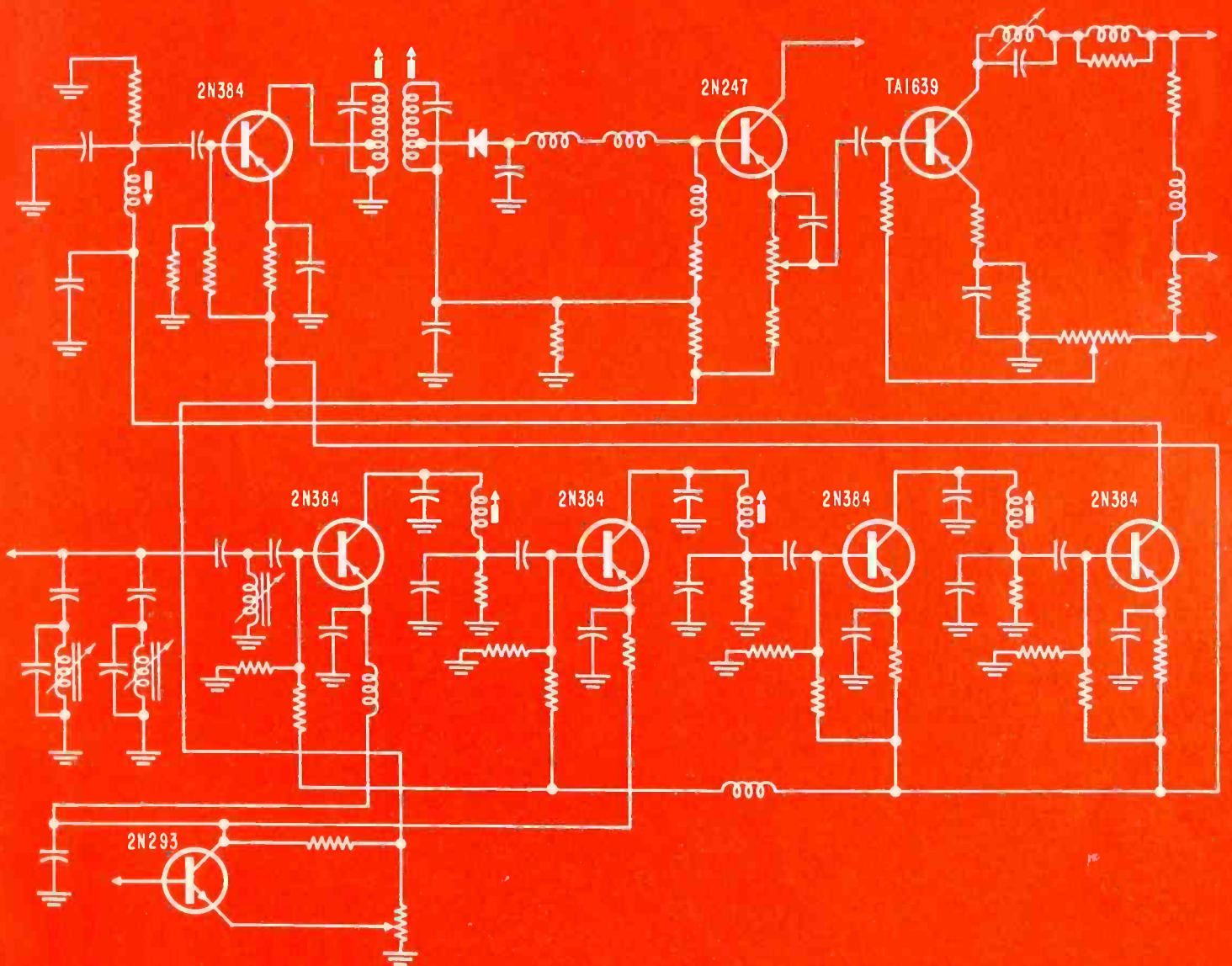

Video IF amplifier section of first  
all-transistorized TV receiver.  
See circuit analysis, this issue.

F H FINGADO  
 1653 CALIFORNIA S  
 DENVER 2, COLO  
 3RS S 3-28-57

NEW  
NEW  
NEW

Sprague **PRINT-LOK**\* 'lytics  
with **universal bases**  
for printed wiring boards  
simplify servicing  
...reduce inventory

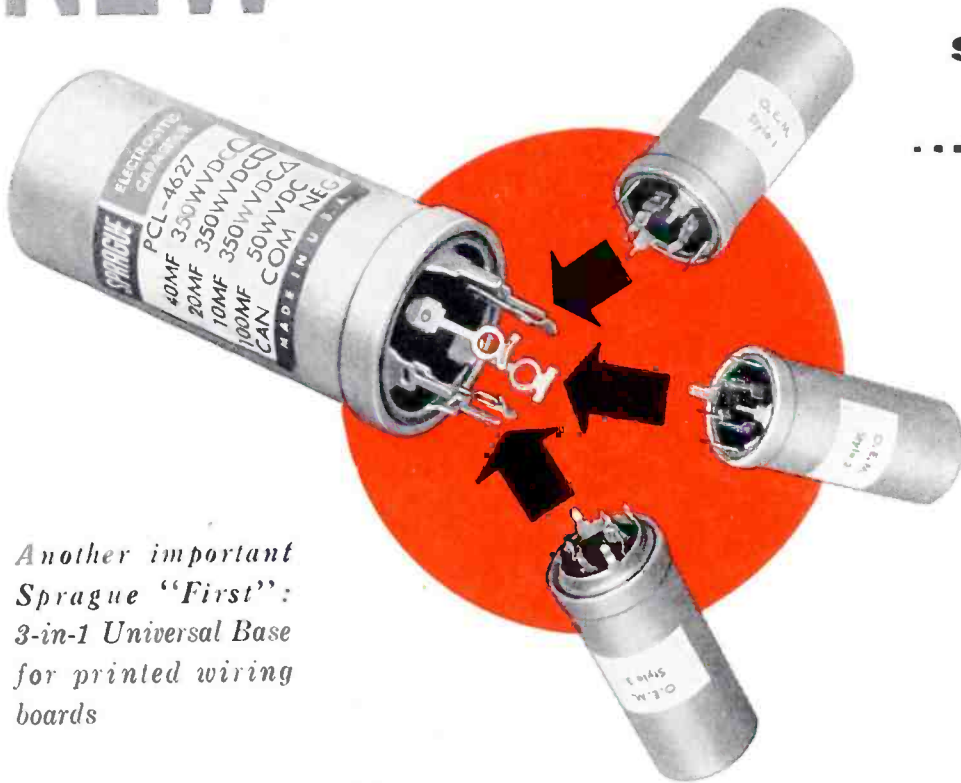

*Another important  
Sprague "First":  
3-in-1 Universal Base  
for printed wiring  
boards*

Sprague's new PRINT-LOK Electrolytic Capacitors have a newly-developed universal base that's designed to fit all sets. A touch of your pliers is all that's needed to adapt PRINT-LOK capacitors to any one of three different types of printed circuit bases!

How's that for simplified servicing? And just as important, you need only stock a third as many 'lytics as were required previously. Still another feature—PRINT-LOK capacitors also replace standard twist-base electrolytic capacitors.

\*Trademark

PRINT-LOK capacitors are hermetically sealed in aluminum cases to give extra long life and top performance under extremely high temperatures and high surge voltages, as well as in high ripple selenium rectifier circuits.

Sprague's new TV Electrolytic Capacitor Replacement Guide K-103 gives complete listings for PRINT-LOK 'lytics as well as standard TWIST-LOK capacitors. Get your free copy from your distributor, or send 10c to cover handling to Sprague Products Co., 61 Marshall Street, North Adams, Massachusetts.

**don't be vague...insist on**

**SPRAGUE**<sup>®</sup>

*world's largest capacitor manufacturer*

SPRAGUE RESEARCH IS CONSTANTLY PRODUCING NEW AND BETTER CAPACITORS FOR YOU

# HOW TO CREATE MORE CONFIDENCE IN YOUR SERVICE BUSINESS

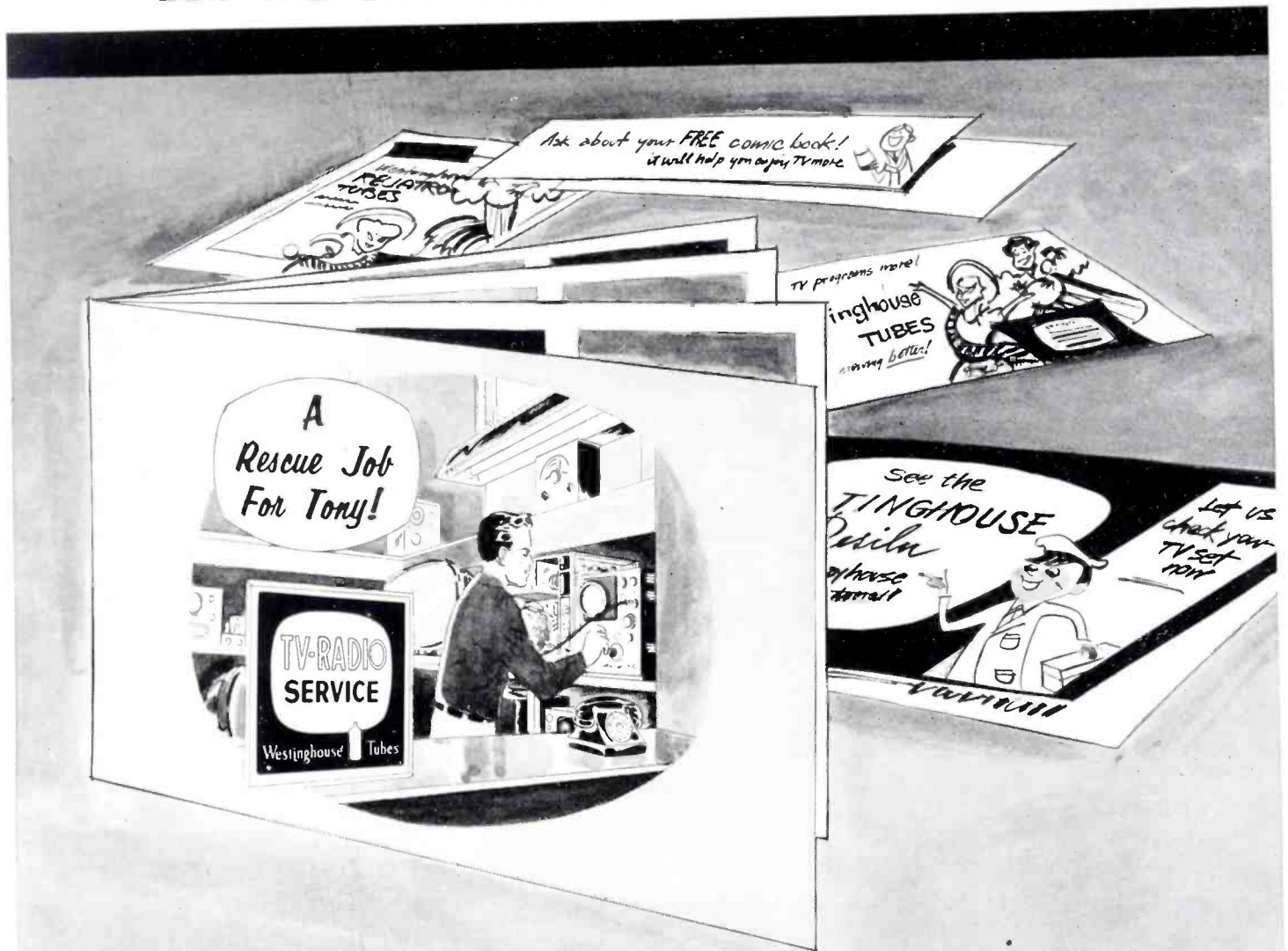

**FREE!** Colorful comic books, window streamers, window display to help tell your customers all that goes into servicing TV sets!

It takes a lot of work, costly equipment and know-how to be a radio and TV serviceman. No one knows this better than you. But, chances are, your customers *don't!*

But now you can give them an insight into your work with this free "The Story Behind TV Service" kit that tells how complicated your job is . . .

how much study it required to learn . . . and how expensive it was getting started. Told in interesting cartoon technique, the booklets are something everyone will read—and understand!

So put these good-will ambassadors to work building consumer confidence for you.

## CALL YOUR WESTINGHOUSE DISTRIBUTOR

YOU CAN BE SURE...IF IT'S **Westinghouse**

Electronic Tube Division • Elmira, New York

**SMALL  
ENOUGH TO FIT  
INTO THE  
SMALLEST  
POCKET PORTABLE**

40K

**WITH ENOUGH  
POWER FOR THE  
BIGGEST  
COLOR TELEVISION  
RECEIVER**

**Tarzian**

SERIES

**Silicon Rectifiers**

- ✓ **COMPACT**—no special holder required . . . supported by pigtail leads
- ✓ **PROVED-PERFORMANCE**—in all electronic applications
- ✓ **ECONOMICAL**—Tarzian's mass production means lower cost to you
- ✓ **PACKAGED** for your convenience in pocket-size "5 Paks".



Send for data sheets.

**SPECIFICATIONS**

	40K	K-200
MAX. AC INPUT VOLTAGE	130	130
MAX. PEAK INVERSE VOLTAGE	400	360
MAX. PEAK CURRENT (MA)	7500	2000
MAX. DC CURRENT (MA)	750	200
APPROX. RECTIFIER VOLTAGE DROP	2	2
MAX. OPERATING TEMP.	100°C	100°C
MAX. SURGE CURRENT (AMPS)	30	20
MIN. SURGE LIMITING RESIS. (OHMS)	7.5	10

**DIMENSIONS**

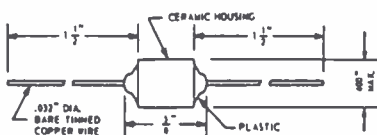

**Sarkes Tarzian, Inc.**

DEPT. S-4

RECTIFIER DIVISION, 415 N. COLLEGE AVE.  
BLOOMINGTON, INDIANA

IN CANADA: 700 WESTON RD., TORONTO 9, TEL. ROGERS 2-7935  
EXPORT: AD AURIEMA, INC., NEW YORK CITY

27th YEAR  
OF  
CONTINUOUS  
PUBLICATION

**SERVICE**

THE TECHNICAL JOURNAL OF THE TELEVISION-RADIO TRADE  
Including RADIO MERCHANDISING and TELEVISION MERCHANDISING.  
Registered U. S. Patent Office.

Page

**FEATURES**

- 9 This Month in SERVICE
- 10 First All-Transistorized TV Receiver Powered by Rechargeable 12-Volt Battery . . . Neil Frihart
- 12 Multi-Set Home Systems for TV and FM . . . Jack Beaver
- 15 Association News
- 16 New Two-Way Communication Portable Utilizes Transistorized Receiver . . . G. A. Svitek and R. L. Manahan
- 18 Printed Circuit Miniaturization Techniques . . . Rudolph T. Plemich
- 20 Troubleshooting Vertical Oscillator and Integrator . . . Jesse Dines
- 23 New Semi-Flat 110-Degree Picture Tube . . . C. F. Otis
- 30 Latest Stereophonic Sound Equipment
- 32 New Replacement Components
- 36 Catalogs—Books
- 40 Tips on Effective Servicing of Stereo Tone Arms and Needles

**CIRCUIT DIAGRAMS**

- 11 Motorola 14-Inch All-Transistorized Portable TV Chassis
- 12 TV-FM Amplified Antenna Distribution System
- 16 General Electric HB-11W Portable Two-Way Communication Receiver Block Diagram
- 20 Admiral 23A1 Vertical Oscillator and Integrator
- 20 General Electric 805/6/7/9 Vertical Oscillator and Integrator
- 25 TV-FM Distribution System Employing Line Splitter

**39 ADVERTISERS IN SERVICE**

© 1958 by Bryan Davis Publishing Co., Inc. All rights reserved.

Second-Class mail privileges authorized at New York, N. Y.; additional entry at the Post Office, Norwalk, Conn. . . . Subscription price: \$2.00 per year (\$5.00 for 3 years) in the U.S.A. and Canada; 25 cents per copy. \$3.00 per year in foreign countries; 35 cents per copy.

Subscription orders, notices of change of address and undeliverable copies should be sent to Bryan Davis Publishing Co., Inc., 52 Vanderbilt Ave., New York 17, N. Y.



Editor  
Solomon R. Kunis

Industrial Electronics Editor  
Leo G. Sands

Associate Editor  
David E. Pearsall II

Consulting Technical Editors  
Howard Jennings  
Arnold Gewirtz

Field Editor (Midwest)  
Rudolph T. Plemich

Art Director  
Anthony R. Aliff

Supervisor, Circuit Diagrams  
Michael D. Bellezza

**BUSINESS DEPARTMENT**

Advertising Manager  
Paul Gilbert

Assistant Advertising Manager  
Astrid Kelly

Business Manager  
B. S. Davis

Assistant Business Manager  
B. Earley

Circulation Manager  
A. Goebel

Assistant Circulation Manager  
A. Kiernan

Mailing Supervisor  
L. Trubia

**CHICAGO AND MIDWEST**

Jim Summers  
Suite 556  
Pure Oil Building  
35 E. Wacker Drive  
Chicago 1, Ill.  
ANdover 3-1154

Published Monthly by  
Bryan Davis Publishing Company, Inc.  
52 Vanderbilt Ave., New York 17, N. Y.  
Tel.: MURRAY HILL 4-0170

B. S. Davis, Pres.                      A. Goebel, Secy.

5

Printed in U.S.A. by  
O'Brien Suburban Press, Norwalk, Conn.

IN ALL THE WORLD

# NO BETTER CAPACITOR

than the Newest Miniaturized

# ELMENCO



## Tubular

Another ELMENCO "first" is announced with the introduction of the new dipped tubular capacitor. The "DP" series is designed for use in a variety of circuits ranging from TV by-pass to critical industrial applications requiring stringent electrical and environmental characteristics. New high levels of ruggedness, stability, and reliability have been achieved. The new ELMENCO DP Tubulars are miniaturized for transistor circuitry yet compare favorably in price with commercial general purpose units.

**FEATURES:**

- HIGH TEMPERATURE OPERATION
- SUPERIOR MOISTURE RESISTANCE
- LONG LIFE AND HIGH RELIABILITY
- HIGH INSULATION RESISTANCE
- ALL VALUES ± 10% TOLERANCE
- TRANSISTOR AND PRINTED CIRCUIT APPLICATION

Look For The  
**ELMENCO**  
"EM"  
Brand Name  
On All  
DP CAPACITORS



See Your Local

# ARCO

Distributor

ARCO ELECTRONICS INC. • NEW YORK 13, NEW YORK

Mr. Service Dealer

# PHILCO offers you a program of COMPLETENESS!

Here is a program of completeness designed to increase your volume and profit. In products and services, Philco and Philco Distributors are

doing everything possible to help you in the successful and profitable operation of your business. See your Philco Distributor today!

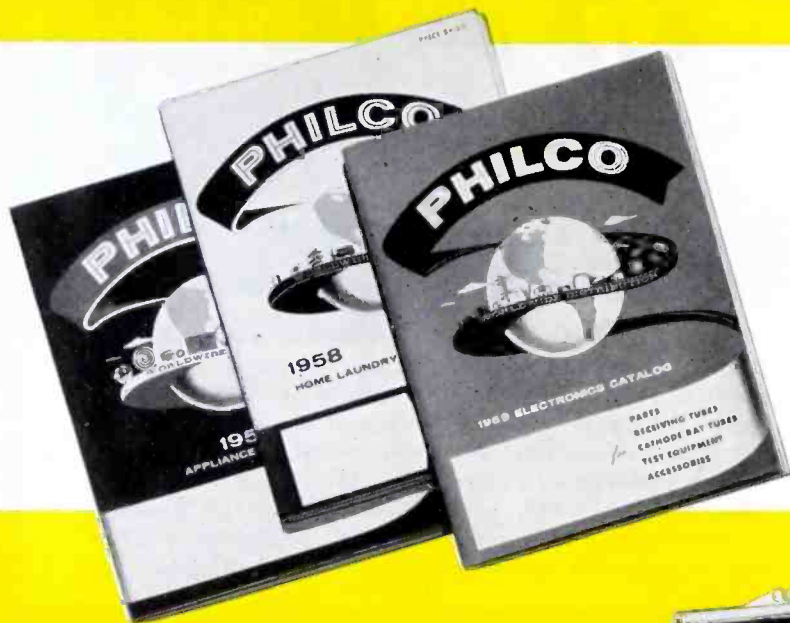

## Complete Parts Catalogs

Over 60,000 items are cataloged in 3 separate books . . . one for each product line: electronics, appliances and laundry equipment. Here is complete information, up-to-date and put together in a way that's designed to save you time and effort.



## Universal Service Parts

Your Philco Distributor has available for you a complete new line of electronic universal parts that not only fit all Philco receivers but many competitive make and model as well. All Philco Universal parts are precision engineered and quality tested to insure superior operation and longer life.



## Universal Full Fidelity Needles

Now, one complete line of precision engineered and custom designed needles to fit every make and model phonograph and High Fidelity receiver. Also available . . . the most accurate, up-to-date, cross-reference catalog in the industry. Ask your Philco distributor how you can get the beautiful needle counter dispenser free!

**SEE YOUR PHILCO DISTRIBUTOR TODAY!**

# Don't Gamble with your Reputation!

FOR DEPENDABILITY, FOR QUALITY INSIST ON  
GENUINE **PHILCO-Bendix** WASHER PARTS

Your Philco Distributor maintains a complete stock of parts and accessories designed especially for Philco-Bendix

washer products. As a qualified Serviceman you may obtain these genuine parts at any time from your local Philco Distributor.

Now, Factory-Remanufactured



Washer Micro-Transmissions

The only genuine Micro-Transmissions factory remanufactured to the latest and most exacting quality engineering specifications. Six months' warranty from the date of installation.

PHILCO • PHILCO-BENDIX • CROSLEY  
Washer and Dryer Parts

Your Philco Distributor carries a complete stock of these various parts to enable you to offer quick and efficient service in this big, profitable business.

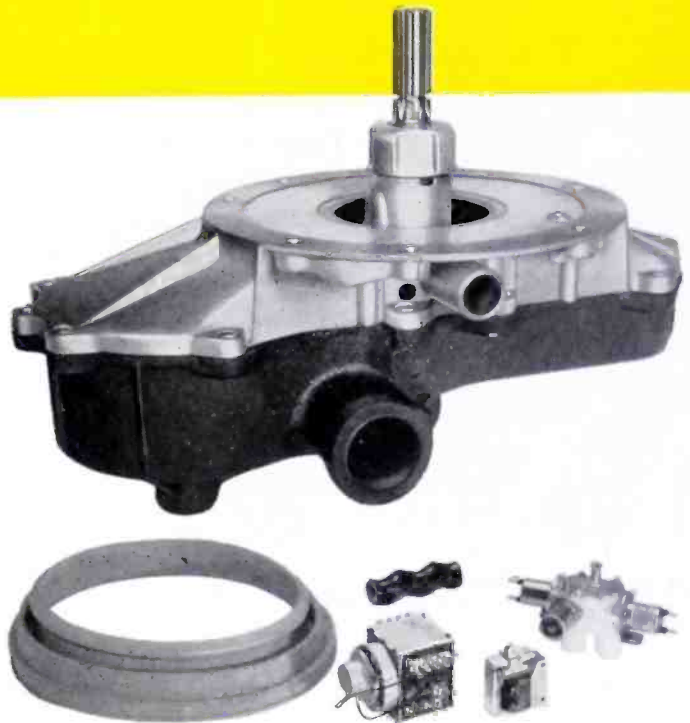

## INSIST ON GENUINE PHILCO APPLIANCE PARTS

Don't gamble with cheap imitations. See your Philco Distributor for a complete line of quality-built, quality-tested appliance parts. He has everything you might need from a door hinge to a liner, from a gasket to a compressor. Don't settle for less.



## See Your Philco Distributor Today!

**PHILCO**  
*Accessory Division*

World-Wide Distribution

Service Parts • Power-Packed Batteries • Universal Components • Long-Life Tubes • Heavy-Duty Rotors • Star Bright 20/20 Picture Tubes • Long Distance Antennas • Appliance Parts • Laundry Parts • Universal Parts and Accessories

# ***SPEED REPAIRWORK***

# ***FIELD-TESTED TV SERVICE***

Time saved is money saved when repairing television sets. Because of this, General Electric has developed a whole series of original tools and devices to cut your servicing time and costs. They've been exhaustively field-tested, field-proved. They add profit hours to the work week of the television technician.

Read about these ingenious aids below! See them on your next visit to your G-E tube distributor's! Only General Electric makes available this group of special service devices—each and every one a time and trouble saver. They're easy to use . . . and easy to obtain. Ask your G-E distributor how to get them! *Distributor Sales, Electronic Components Division, General Electric Company, Owensboro, Kentucky.*



**TWIN-X WRENCH SET (ETR-752)**—designed and built expressly for TV-radio repairwork. Replaces eight hex-head socket wrenches  $\frac{1}{32}$ " to  $\frac{1}{2}$ ". Sizes are clearly marked for quick selection. Hollow shafts permit wrench to grip the nut over protruding end of bolt. Chrome-plated case-hardened steel—will stand up in long, hard service.

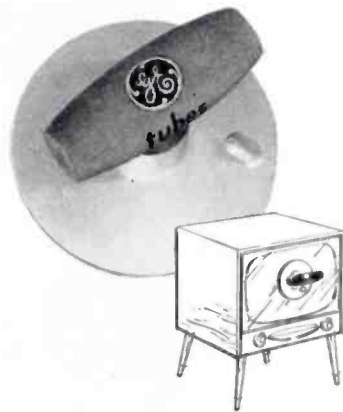

**SAFETY-GLASS PULLER (ETR-1592).** Now you can remove the television safety glass easily, without risk of cracking or chipping. Handle of this device controls a three-inch rubber suction cup with vacuum-release tip.



**NEW TUBE-FUSE-LAMP CHECKER (ETR-981A).** Only  $3\frac{1}{2}$ " by  $2\frac{3}{4}$ " by  $1\frac{7}{8}$ ". Can easily be carried in pocket. Powered by 3 "C" flashlight batteries. Will check 7- and 9-pin miniature tubes, also lock-in and octal-base types . . . picture-tube heaters . . . all TV and radio fuses . . . all filament-type pilot lamps. A "must" for technicians.

# ***PLUS...***

New G-E Chassis-Jack (ETR-1470)

Picture-Tube Nek-Rest (ETR-1169)

Picture-Tube Pillow (ETR-1469)

All-Type Tube Puller (ETR-1094)

Service Drop Cloth (ETR-1021)

Adjustable Bench Mirror (ETR-1275)



# WITH G-E AIDS!

## SEE THEM ON THIS PEG-BOARD COUNTER DISPLAY!

Your G-E tube distributor features this large peg-board display of TV-service aids. Inspect them in detail! All are safety-packaged in heavy transparent plastic, which keeps them clean, protects them from scratches or other injury. Be sure to look for this display at your distributor's—be sure to study the useful service aids. You'll want them all!

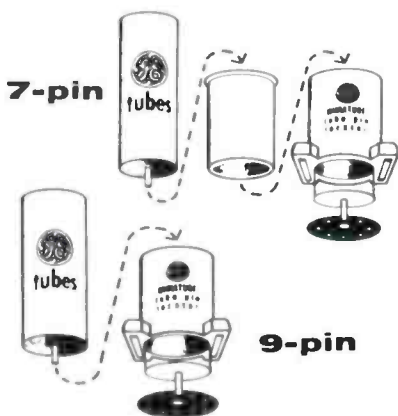

**PIN-LOCATOR FOR MINIATURE TUBES (ETR-1540).** Use it to place miniatures in hard-to-reach sockets. Centering plug positions the locator above pin holes. Magnets then hold locator while tube is turned till pins drop into socket.

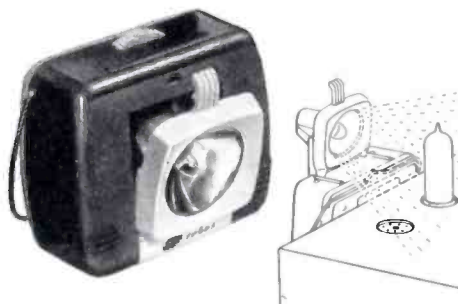

**MAGNETIC SWING-BEAM SERVICE LIGHT (ETR-1593).** Magnet holds the light securely to chassis of set, so that both your hands are free for work. Swing-beam design puts illumination just where you need it. A time-saving aid you'll want on every job. Small, fits easily in your service case. Strongly made, durable . . . uses standard flashlight bulb and batteries.



**TRI-PLEX EXTENSION LEAD (ETR-1527).** New in design. Compact for your service case, with only one lead plus adapter. Practical and easy to use. Like other G-E service aids, the Tri-Plex Extension Lead comes in a protective, reusable polyethylene container.

*Progress Is Our Most Important Product*

**GENERAL  ELECTRIC**



**a RAYTHEON designed tube**



**the OZ4**

***has set the most spectacular record in receiving tube history***

Way back in 1937, the Raytheon Manufacturing Company introduced and produced the Raytheon OZ4 — a gas-filled rectifier tube designed specifically for car radios. So nearly perfect is this tube in design, construction and operating ability, that it has never been equalled. For more than 21 years it has withstood performance challenges from many prototypes, but, one by one, all have fallen by the wayside and the Raytheon designed OZ4 remains the ideal tube for the job it was designed to do.

We point with pride to the OZ4 triumph because it is engineering and design know-how like this, teamed with production skill and craftsmanship, that goes into the design and manufacture of the complete line of Raytheon TV and Radio Tubes. That's why you can use Raytheon Tubes for replacement work with complete confidence that you are giving your customers tubes that are second to none in design, in quality, in performance — tubes that are truly RIGHT...for SOUND and SIGHT!

***And Now From Raytheon, The "Voice" of The Satellites***

Today, as yesterday, Raytheon leads the way. Raytheon Transistors help send coded messages from America's Satellites to receiving stations on earth. 14 of America's major guided missiles use Raytheon Tubes and Semiconductors — further proof of the superior performance, dependability and manufacturing excellence of Raytheon products.



<b>RAYTHEON MANUFACTURING COMPANY</b>			
DISTRIBUTOR PRODUCTS DIVISION			
NEWTON 58, MASS. 55 Chapel Street	CHICAGO, ILL. 9501 Grand Ave. (Franklin Park)	ATLANTA 6, GA. 1202 Zonolite Rd. N.E.	LOS ANGELES 7, CALIF. 2419 So. Grand Ave.
Raytheon makes all these	Receiving and Picture Tubes, Reliable Subminiature and Miniature Tubes, Semiconductor Diodes and Transistors, Nucleonic Tubes, Microwave Tubes.		
			 <i>Excellence in Electronics</i>

# THIS MONTH IN SERVICE

FIRST TRANSISTORIZED TV SET--This issue of SERVICE features an exclusive report on the first all-transistor TV receiver. . . . Another triumph of miniaturization described in the current issue, is a new portable two-way communications unit whose receiver section is completely transistorized. . . . Engineers predict increasing use of transistors in radio and TV sets will change established pattern of servicing and urge Service Men to bone up on transistor circuitry and miniaturization techniques.

ANTENNA CHECK-UP CAMPAIGN CONTINUES--A number of other TV stations are expected to follow the lead of New York's WPIX in broadcasting spot announcements urging television set owners to have antennas checked by local Service Men. . . . Antenna manufacturers are cooperating with stations in this program. . . . In keeping with this campaign a series of articles on new and important developments in antenna field are scheduled to appear in SERVICE this Fall.

WESCON SHOW TURNS ON HEAT--An experimental thermoelectric heat pump which can produce heat or make frost electronically was demonstrated by the Radio Corporation of America at the Western Electronics Show and Convention last month. . . . Another electronic device that can determine whether a person standing before it is a man or woman was displayed by International Telephone and Telegraph Corporation. . . . As show visitors stood in front of the specially designed unit, a "magic eye" measured the amount of radiated body heat. . . . The catch is that men's trousers inhibit heat radiation reaching the detector, while women's stockings do not.

COOPERATION STRESSED AT TEXAS SHOW--The need for closer co-operation between the parts distributor and service dealer was stressed by Col. Gail S. Carter, executive officer of the National Electronic Distributors Association, in an address delivered at the sixth annual Texas Electronic Association Fair and Clinic staged at the Statler Hotel, in Dallas last month. . . . The NEDA official said the Service Man should establish himself as a competent and reliable technician and sell his professional knowledge along with replacement parts. . . . Introduction of subscription TV, by bringing box office entertainment to home viewers at low cost and increasing the total amount of "free" TV available, will benefit the independent TV service dealer and give a shot-in-the-arm to all phases of the television industry, Ted Leitzell, director of public relations for Zenith Radio Corporation, stated at this meeting.

TV RECEIVER SHIPMENTS UP--TV receiver manufacturers shipped more sets in June compared with May, but fewer during the first half of this year compared with the same 1957 period, the Electronic Industries Association announced last month. . . . Olympic Radio & Television, a Division of The Siegler Corporation, reported that shipments of television sets for the fiscal year ending June 30th showed an increase of over 17% as compared to a like period a year ago. . . . The nation's radio-TV manufacturers, who marked the early part of 1958 with cutbacks and layoffs of employes, have begun rehiring workers, and stepping up production schedules, according to a recent survey.

HI-FI SHOW TO FEATURE STEREO--The 1958 New York High Fidelity Music Show will open at the Trade Show Building, 500 Eighth Ave., on September 30th and run through October 4th. . . . There will be a special preview for dealers on September 29 from which the public will be excluded. . . . The Age of Stereo is the theme for this year's Show.

NATESA CONVENTION HELD--The 10th annual convention of the National Alliance of Television & Electronic Service Associations was held at the Congress Hotel, in Chicago, August 21 to 24. . . . President Eisenhower forwarded a telegram extending his best wishes to NATESA, and Mayor Daley, of Chicago, proclaimed the week of the convention as "Home Electronics Service Week" in Chicago in honor of the occasion.

LOUISIANA LICENSES SERVICE MEN--A Louisiana law going into effect as a result of the recent legislation provides that radio and television repairmen in cities of more than 20,000 population will have to take an examination and be licensed by a new State radio and television technicians board. . . . The board is to include eight members named by companies and three members named by the electrical union. . . . All TV repair shops in New Orleans will come under this law.

# First All-Transistorized TV Receiver Powered by Rechargeable 12-Volt Battery



by NEIL FRIHART

Chief Engineer, Advanced Television Engineering, Motorola Inc.

ALTHOUGH TRANSISTORIZED RADIO SETS are now commonplace, the development of an all-transistor television receiver has presented a very formidable problem. The standards of good sensitivity, adequate *if* gain and bandwidth, and proper *agc* action, now met by conventional tubes, must be maintained. In addition, the transistorized video amplifier must provide a sufficient output signal to drive the picture tube and the all-transistor vertical and horizontal sweep outputs must adequately provide the relatively large power drive signals. Generating high-voltage for the second anode of the picture tube is another problem requiring additional development. Finally each of these situations must be solved with a minimum power drain if the set is to remain truly portable.

## First Transistor TV

These engineering problems have been overcome to a large extent in a new cordless, portable 14-inch TV receiver,\* the first all-transistor set to be placed on the market, which is shown above. A detailed description and circuit analysis of this unusual TV set is contained in this report, prepared exclusively for SERVICE.

\*Manufactured by Motorola Inc.

Certain portions of the overall circuit, which the manufacturer is not yet ready to reveal, are not covered in this article. These sections are indicated by blocks in the schematic diagram of the chassis, Fig. 1. As soon as information on these circuits is available, it will be covered in a supplementary report.

One of the outstanding features of this set is that the batteries may be recharged and reused. The batteries are 12-volt nickel-cadium type and provide six hours of portable operation before recharging. The weight of the set, including batteries, is 30 pounds and the size is 14 inches.

The total of 31 transistors are used in the receiver. While this is more than twice the number of tubes normally found in a TV receiver, it must be remembered that many tubes serve more than one function, and, at present, this is not true with transistors. The base material in the transistors used is germanium in all cases, and about 30% of these are of the graded-base type. Two of the thirty-one transistors are NPN types, and were used to answer a specific polarity problem.

Although seven tetrode-type transistors were used in the tuner and *if*, it is felt that future designs would be made with triode types because of the decreased circuit complexity and the

rather severe problem of overload encountered with tetrodes.

The frequency cutoff of transistors is higher for the grounded base, but, in almost all cases, the grounded emitter connection was used because the higher low frequency gain of this connection more than compensates for the frequency response. The two limitations most frequently encountered in the process of transistorizing TV were frequency response and voltage breakdown. Good progress has been made in overcoming both of these problems.

## Transistorized Tuner

The tuner circuit in this receiver is a transistorized equivalent of a miniature four-wafer tube tuner. Circuit-matching conditions are different in order to meet the power-matching requirements of transistors. There are three tetrode PNP-type transistors used as an *rf* amplifier, a local oscillator and a mixer.

The maximum frequency of oscillation of these transistors is approximately 250 megacycles. With this upper frequency limit, it is necessary to operate the oscillator above signal frequency on the low channels and below signal frequency on the high channels. The *rf* amplifier gain varies from approximately 14 db on the lowest channel to 0 db on the highest channel. The output or intermediate frequency of the tuner is 44 megacycles, the same as on conventional receivers.

The video *if* amplifier (see Fig. 1) consists of six stages tuned approximately to the same frequency. The individual stages are single-tuned with the tuning in the collector circuit. Additional capacity of 5 to 15 micro-microfarads has been added in each stage to adjust the operating Q and increase circuit stability. There is a small untuned secondary winding on the tuned primary to match the relatively high impedance collector circuit of each stage to the base of the following stage.

The first four stages contain the same high-frequency tetrode PNP-

(Continued on page 26)

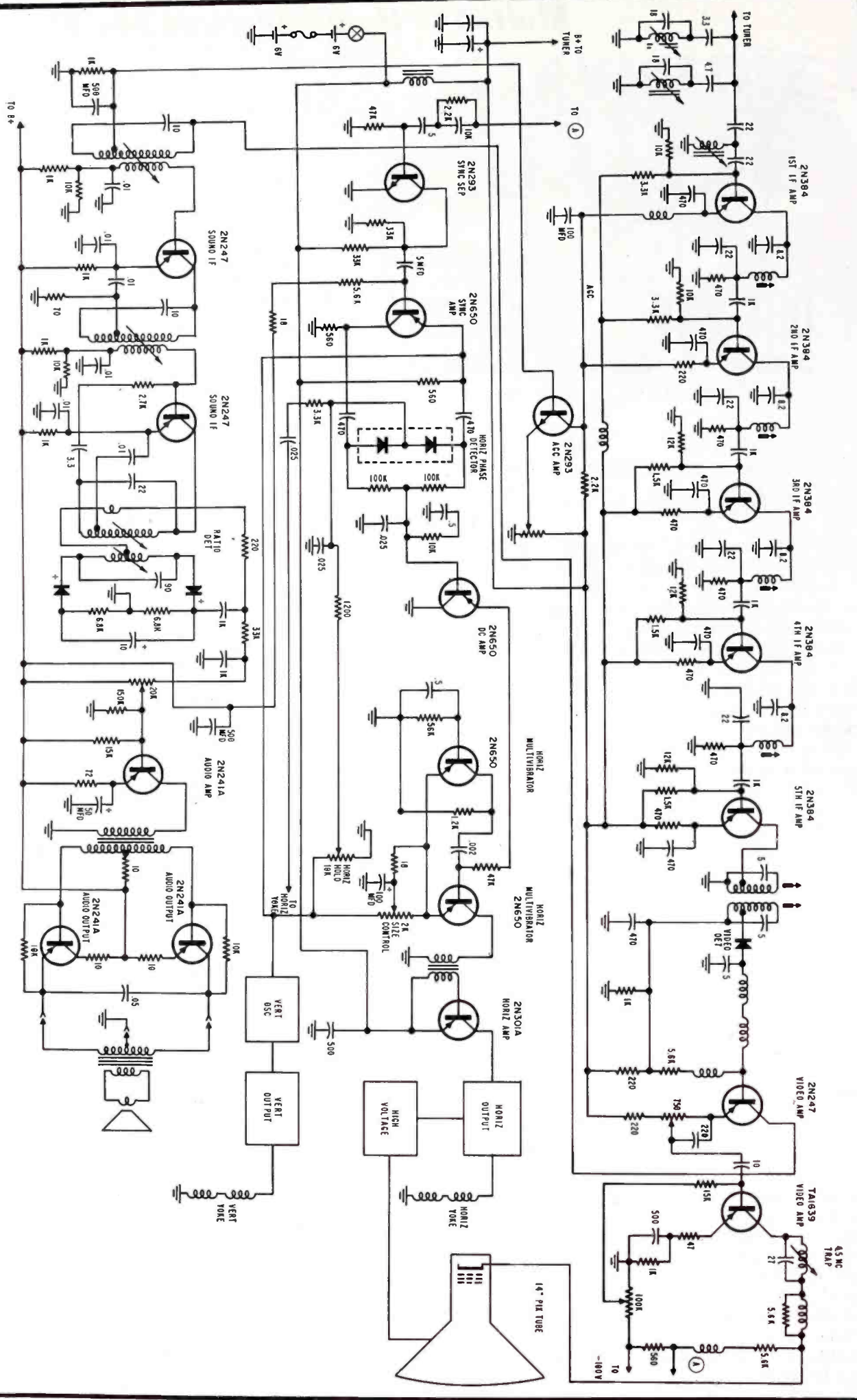
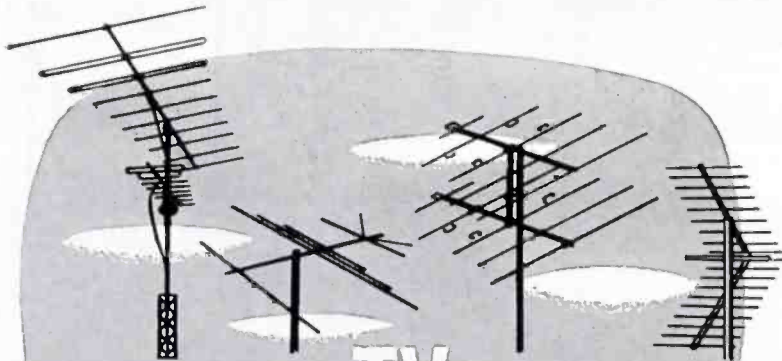

FIG. 1: SCHEMATIC DIAGRAM OF MOTOROLA 14-inch portable television set which employs 31 transistors to perform all the standard tube functions of conventional TV receiver. Portions of the circuit which the manufacturer is not yet ready to reveal are indicated by blocks.

# Multi-Set Home Systems for TV and FM



## UHF-VHF TV ANTENNA DIGEST

DESIGN • APPLICATION • INSTALLATION • SERVICE

by JACK BEEVER

Applications Engineer  
Jerrold Electronics Corp.

THERE IS A SCHISM in the thinking of many Service Men which separates TV and FM and places them in different categories. This distinction is invalid and may prove costly to the Service Man. The basic difference between the two may be summed up in the words of the little boy who described his radio as "a television set without pictures."

FM and TV broadcasts occur in the same band of frequency, between 54 and 216 mc, and may be received on the same antenna. They are distributed on the same kind of down-lead and have approximately the same broadcast coverage.

The fantastic development of FM, plus the equally fantastic rise in the number of multi-TV set homes, opens a market for TV-FM signal distribution in the home. The problem brought about by this changing market results from a misunderstanding as to the fundamental nature of the input of a television receiver.

Basically the input of a television receiver is not like the input of an audio amplifier. It is not voltage operated but consumes power which is developed by the antenna. The antenna is actually a generator since it consists of conductors placed in moving electrostatic and electromagnetic fields, the radiation from the transmitter. It looks electrically like a generator with an internal impedance of 300 ohms. It feeds a set whose input looks like a resistive load of 300 ohms.

Now, these circumstances set up a condition of maximum transfer of energy between antenna and set. This condition is called *matched* since gen-

erator impedance and load impedance are the same.

Consider, now, feeding two sets from the same antenna. If we do it perfectly, we can only give *half* the power of the antenna to each set—and we can only do this if we can maintain impedance match all around. It so happens that half power represents a voltage change of 3 db, which is a drop of about 30%. This can only happen when the division is perfect, without loss of any kind. Usually, a drop of about 6 db voltage can be expected with commercial couplers, depending on the type and design of the coupler.

By the same reasoning, using the 6 db figure, if four sets are to be fed from one antenna, we can expect a drop of 12 db per set, supplying one fourth the antenna voltage to each set. All the above presupposes that the sets represent 300-ohm loads. This is true, however, only at the channel tuned to and only when the sets are turned on. Off-channel and when they are turned off many variables are introduced into the hook-up, resulting in ghosting and standing waves on the line. These, in turn, make the final results hard to predict.

Such systems also require that each leg of the system be loaded, or else

the impedance matching will be destroyed, with no possibility of knowing what will happen. These systems, then are *tied down*. We must fix the location of the sets, and we can wire only for the existing sets. Also, we must have sufficient power available from the antenna to afford this splitting of energy among a group of receivers.

### Home Distribution System

Recently, a home distribution system<sup>1</sup> has been developed which overcomes these objections. This is based on multi-set master antenna system used in the large hotels and motels, but considerably simplified and reduced in cost. The new home system has the same ability to ignore the circumstances of whether or not a set is attached to its outlets. Briefly, it consists of a line from the signal source, either antenna or amplifier, which is loaded at its end with a resistive load, showing a match to the source at all times and all frequencies. This loaded line is then tapped with *tap-off* units which feed sets, providing a minimal disturbance to the line, and isolation between sets. The schematic diagram of a typical system is shown in Fig. 1.

Looking at this system as it would exist without the loads plugged into the tap-off units, we can see that the amplifier (or antenna, if sufficient signal is available) will see only a line whose end is a termination or load equal to the source's impedance. This represents a *sink* into which all the available energy can be poured. Since no energy reflects back along the line, there are no standing waves or ghosts. This is an ideal condition.

Now, if we connect a TV or FM set to one of these taps, some of the en-  
(Continued on page 24)

<sup>1</sup>Model HSK, Jerrold Electronics Corp.

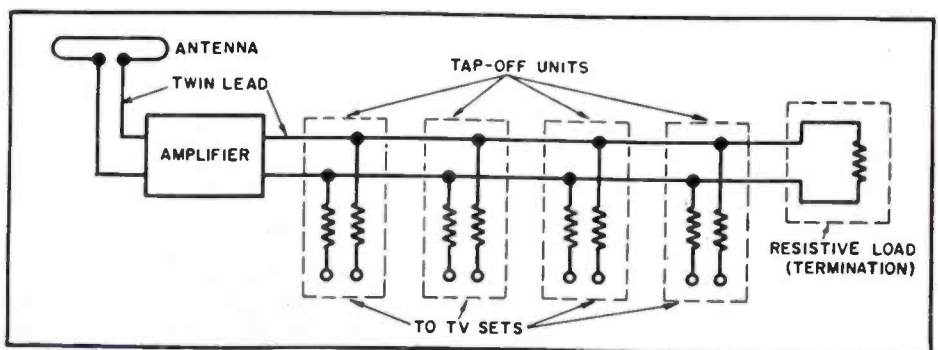

FIG. 1: SCHEMATIC DIAGRAM of amplified TV-FM antenna distribution system, especially designed for home use.

**NEW  
COMPLETE**

**DIRECT  
VIEWING**

# TELEVISION ANALYST

*test each stage*  
**SEPARATELY**

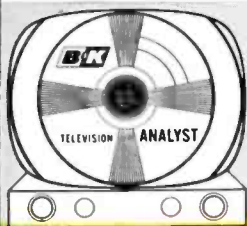
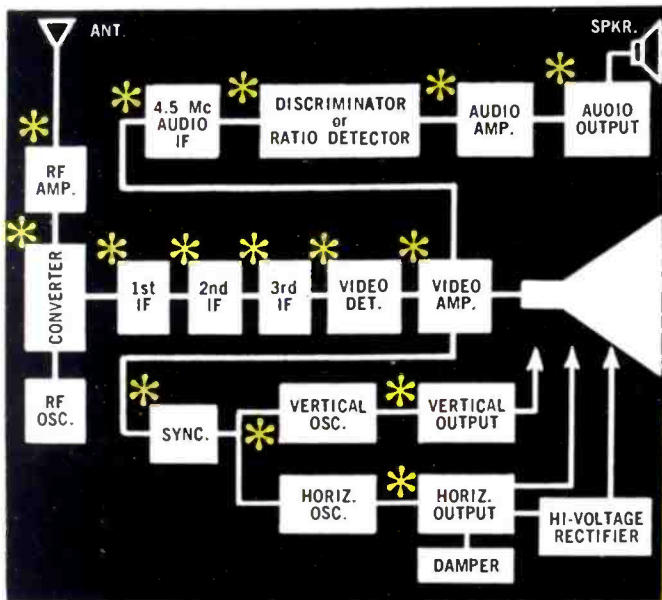

← and watch the  
result on the  
TV set itself

**UNIQUE NEW SIGNAL-INJECTION TECHNIQUE**  
*Saves TV Trouble-Shooting Time and Work*

- \* **R.F.** Supplies complete r.f. and i.f. signals with video and audio modulation to quickly trouble-shoot each stage in each of the sections of the TV receiver. Enables you to check the r.f. sensitivity and AGC settings of TV receivers.
- \* **I.F.**
- \* **VIDEO** Reproduces a complete test pattern on the screen of the TV picture tube and injects signals into each video stage of the TV receiver for fast, visual trouble-shooting and correction—anywhere, anytime. Makes it easy to check bandwidth, resolution, shading and contrast capabilities of the TV set.
- \* **SYNC** Provides composite signal, sync positive and negative.
- \* **SWEEP CIRCUIT DRIVING PULSES** Provides separate vertical and horizontal driving pulses for trouble-shooting deflection circuits.
- \* **INTERMITTENTS** Test signal injection also aids in locating intermittent troubles.
- \* **AUDIO** Provides a 4.5 mc sound channel, FM modulated with approximately 25 kc deviation. (This audio carrier is modulated either from a built-in 400 cycle tone generator, or from your own external audio source.) Injection of the 400 cycle tone signal simplifies trouble-shooting of the audio section.
- \* **COLOR** Enables you to trouble-shoot and signal trace color circuits in color TV sets.  
Generates white dot and crosshatch patterns on the TV screen for color TV convergence adjustments.  
Generates full color rainbow pattern of orange, red, magenta, blue, cyan, green to test color sync circuits, check range of hue control, align color demodulators, etc.
- \* **SET ADJUSTMENT** Enables you to check and adjust the vertical and horizontal linearity, size and aspect ratio of television receivers.

**NEW**



**MODEL  
1075**



**QUICK, DIRECT, COMPLETE TV TROUBLE-SHOOTING**

Now, by point-to-point signal injection and test pattern reproduction, you can easily trouble-shoot and signal trace *any stage throughout the video, audio and sweep sections* of black & white and color TV receivers. With the remarkable new Model 1075 B&K TELEVISION ANALYST, you can quickly isolate and diagnose TV troubles (including intermittents). By use of the generated test pattern, you can *actually see* the condition directly on the picture tube of the television set itself. No external scope is needed. The TELEVISION ANALYST is practically a *complete TV service shop in one instrument!* **Net, \$259<sup>95</sup>**



See your B&K Distributor or write for Bulletin AP12-S

**B & K MANUFACTURING CO.**  
3726 N. Southport Ave. • Chicago 13, Illinois

Canada: Atlas Radio Corp., 50 Wingold, Toronto 10, Ont.

Export: Empire Exporters, 458 Broadway, New York 13, U.S.A.

# up goes another *CHANNEL MASTER® T-W*

On more  
fringe area  
roof tops  
than any other  
TV antenna

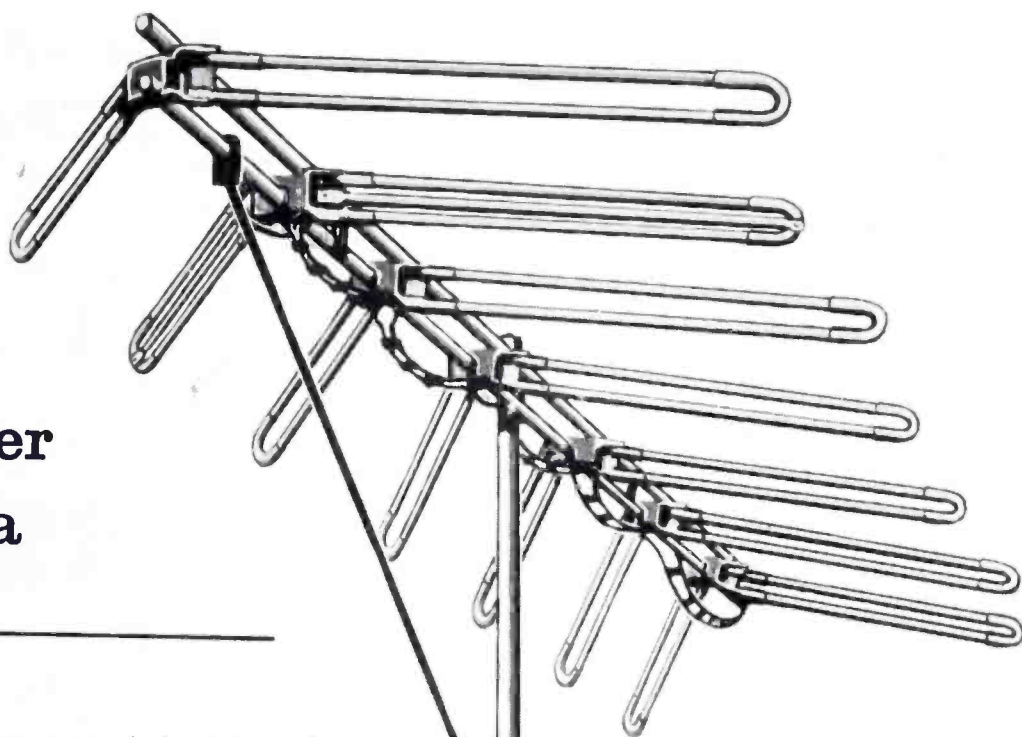

**Best Performance** — highest gain and front-to-back ratios of any VHF antennas



**Strongest Construction** — ruggedized in every detail for more years of trouble-free performance



**Greatest Consumer Preference** — created by consistent major-league national advertising... widest array of attractive point-of-purchase material and sales producing mats... and eye-appealing packaging.

Copyright 1958 Channel Master Corp. Reg. U.S. Pat. Off. and Canada

Now, more than ever,  
**CHANNEL**



# Association News

## ETG, Boston, Mass.

V. Warren Gagosian has been elected president of the Electronic Technician's Guild of Boston. Other new officers include George Catavolo, vice president; James Kelley, secretary; and Hyman Leve, treasurer. Lawrence McEvoy was chosen as NATESA director. NATESA alternates are Harold Fitzgerald and Harold Stevens.

## CSEA, San Carlos, Calif.

Jim Wakefield of Fresno was elected president of the California State Electronic Association at its recent annual convention. Ray Warthen was reelected vice president. Art Blumenthal was asked to act as secretary pro tem.

One session at the convention was devoted to a panel discussion of credit problems. Glen D. Ruddy, state secretary of Associated Credit Bureaus of California; Allan Mason, attorney, Earl Carlson, manager, Credit Bureau of Kings County; and Joel Bigerstaff, secretary, Merchants Association of Fresno, served as the panel of experts.

Other sessions at the convention featured the showing of a technical film on antennas by Lee Naylor of Channel Master Corp.; a discussion of service industry problems by Robert Thomas of Westinghouse Electric Corp.; an outline of NARDA's efforts on behalf of service dealers on the problem of warranties on new sets and parts presented by Harold Wilhaus; a talk on servicing horizontal sweep circuits by Irving Tjomslund of Triad Transformer Corp.; a discussion of the how and why of transistors by Bud Tomer of CBS-Hytron; and a demonstration of ceramic capacitors by Sprague Products Co.

Manufacturers displaying products at the convention were Triad Transformer Corp., Sprague Products Co., Sylvania Electric Products, Fresno Electronics Co., Philco Corp., Raytheon Manufacturing Co., Winegard Co., Radio Corporation of America, CBS-Hytron, Channel Master Corp., Westinghouse Electric Corp., Calvideo Tube Corp. and Pioneer Electronics Corp.

## RTA, Santa Clara Valley, Calif.

The Radio TV Association of Santa Clara Valley took the first firm steps toward sponsorship of an apprentice training program in its area at a recent meeting when President Richard J. Kelso appointed a fact-finding committee. Al Limberatos was named to head the committee which includes Kelso, Frank Ingeneri and Charles Mulkey, RTA educational advisor and electronics coordinator of the San Jose Unified School District, who will represent both the association and the school district.

(Continued on page 39)

Model No. 6506  
6 transistors,  
1 thermistor, 1 diode  
5 3/4" long, 3" high,  
1 3/8" deep

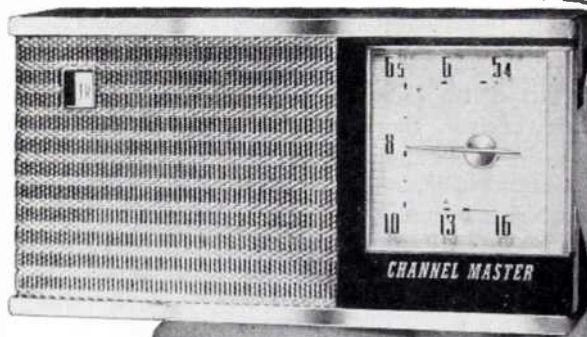

## New!

# CHANNEL MASTER® Transistor Radios

Behind every one of these tiny electronic marvels stands Channel Master's outstanding reputation for quality and dependability. These radios make sweet music for profit-minded dealers.

**DESIGNED** for powerful, satisfying performance.

**BUILT** for rugged use, in unbreakable "Impac" case.

**STYLED** to sell on sight.

**PRICED** to give the consumer today's greatest value in radios.

Special 4" Dual Range Extension Speaker Available.

**Extra: Free Replacement Warranty.** See your Channel Master distributor for full details.

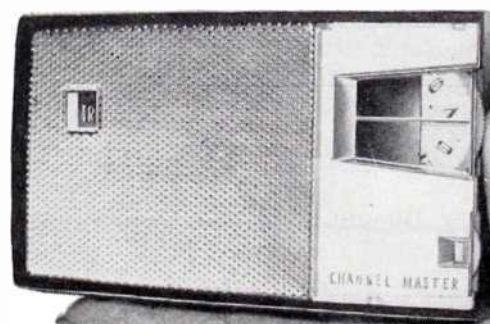

Model No. 6501  
6 transistors, 1 diode  
4 3/4" long, 2 3/4" high, 1 1/4" deep

## the big news is coming from

# MASTER

# New Two-Way Communication Portable Utilizes Transistorized Receiver

by GEORGE A. SVITEK and ROBERT L. MANAHAN  
Product Service Headquarters, Communication Products Dept., General Electric Co.

IN DESIGNING a transistorized communications receiver, the engineer is faced with the problem of maintaining the system's reliability without impairing its serviceability. This is not a particularly easy thing to do, for the two concepts are somewhat opposed to each other. A review of the approach to reliability will show why this is so and why it is necessary to be deliberate in designing for serviceability.

Probably the greatest contribution to circuit reliability in recent years has been the transistor. Complete absence of filaments and cathodes eliminates the failures associated with these elements. In addition, the low voltage at which transistor circuits operate permits a much greater safety factor for passive circuit elements, even at reduced size.

Life expectancy of the vacuum tube is normally measured in hours or months, whereas it is anticipated that transistor life will be measured in years. In order to utilize the great reliability afforded by them, transistors have been applied wherever possible in a newly developed portable transceiver,<sup>1</sup> shown in Fig. 1, which includes the mobile industry's first fully transistorized receiver. A block diagram of the receiver section appears in Fig. 2.

Complete transistorization of the receiver has only recently become possible following refinements on tetrode transistors, such as the 3N37, which displays considerable gain at

frequencies in excess of 175 mc. Prior to this time it was necessary to use vacuum tubes in *rf* amplifiers and high-frequency mixers and local oscillators. Because of the high frequency response of the 3N37, however, it is possible to fully transistorize the high-band receiver. The resultant sensitivity is considered to be as good as that obtained in mobiles with tubes and better than that presently available in other portables which use tubes in the *rf* section.

The type 3N36 transistor shown in the block diagram, Fig. 2, was designed originally for frequencies up to 100 mc, and thus may be used in 25 to 54 mc portables. Units intended for high-band use (144-174 mc) are equipped with type 3N37 transistors which were originally engineered for use at frequencies up to 200 mc.

## Circuit Miniaturization

Since *rf* power obtainable from transistors is limited in the present state of the art, tubes have been retained for the most part in the transmitter section. Only a single transistor is used in the modulator. This is consistent with design for reliability, since the extra *rf* power obtained from tubes results in reserve gain in the driver stages and permits satisfactory operation of the driver stage over a wider range of battery voltage.

In keeping with the trend toward higher reliability the type 6397 tube has been used in the power amplifier. This tube will have longer life than the 3B4 miniature commonly found



FIG. 1: NEWLY DEVELOPED PORTABLE transceiver, shown in use above, utilizes mobile industry's first transistorized receiver.

in portables. To ease the tube-stocking problem, all other tubes are type 1AD4, resulting in a unit in which only two tube types are used. These tubes are instant heating types, and the filament supply is keyed by the push-to-talk button. Thus battery drain is held to a minimum, for transmitting time is normally a very small portion of portable operating time.

The receiver is battery powered at 12 volts and on standby draws less power than the pilot light in a mobile. The transmitter power requirements are 120 volts for the PA and multipliers, 60 volts for the modulator and oscillator, -12 volts for the limiter, and 1½ volts for filaments.

While reliability and power economy are the characteristics of transistors which most recommend them, the

<sup>1</sup>General Electric Model HB-11W.

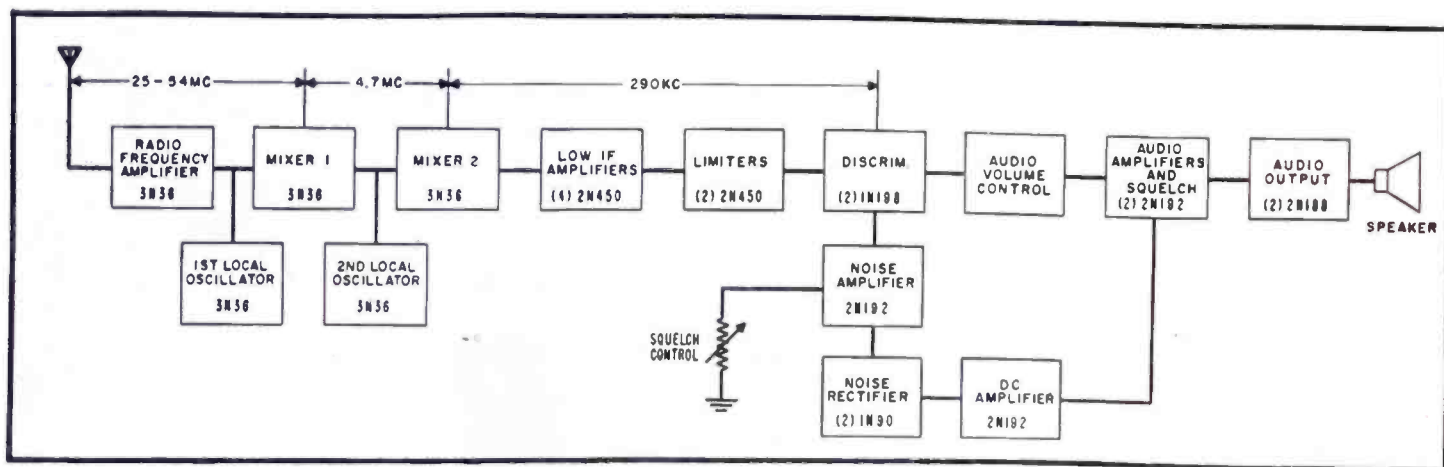

FIG. 2: BLOCK DIAGRAM of all-transistorized receiver section of General Electric model HB-11W two-way portable transceiver.

circuit miniaturization that results from their use makes their application in portables a natural. As the circuits shrink, however, there is a tendency to sacrifice serviceability to achieve the resultant manufacturing simplicity. In this portable, however, a number of steps have been taken to prevent compromising the serviceability of the set.

A new type of mechanical design helps solve the basic servicing problem. The printed boards comprising the transmitter and receiver are hinged at the back of the case like pages in a book. (See Fig. 3.) This construction permits access to both sides of the circuit *pages* at the same time. Simultaneous access to all these circuit components is a real help in servicing.

In addition the top of the unit containing the control panel is similarly hinged, permitting access to these circuits. But above all the unit is *fully operative* when out of the case and in the unfolded position. This permits metering and tuning of the unit *under full power*.

#### Plug-In Transistors

Another service feature of outstanding importance is the use of sockets and plug-in transistors, a feature which saves considerable time and trouble for the Service Man. One of the best ways to isolate troubles in a communication receiver is to disable sections of the receiver by pulling tubes and noting the effect at selected metering points. In a unit which has soldered-in transistors, this requires unsoldering the transistor.

One of the greatest enemies of transistors is heat, and without the plug-in approach the possibility is al-

(Continued on page 38)

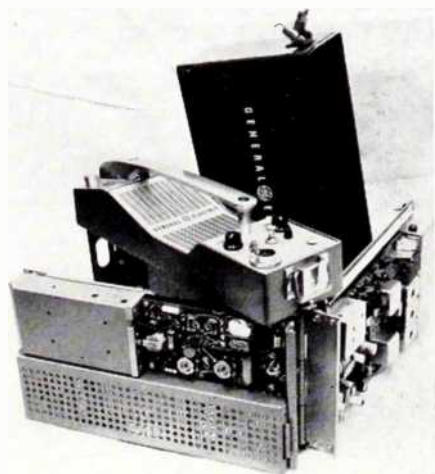

**FIG. 3: NEW TYPE OF mechanical design aids in servicing unit. Printed boards comprising transmitter and receiver are hinged at back of case like pages in a book.**

# ANOTHER ADVANCE FROM SONOTONE

—world leader in ceramic cartridges:

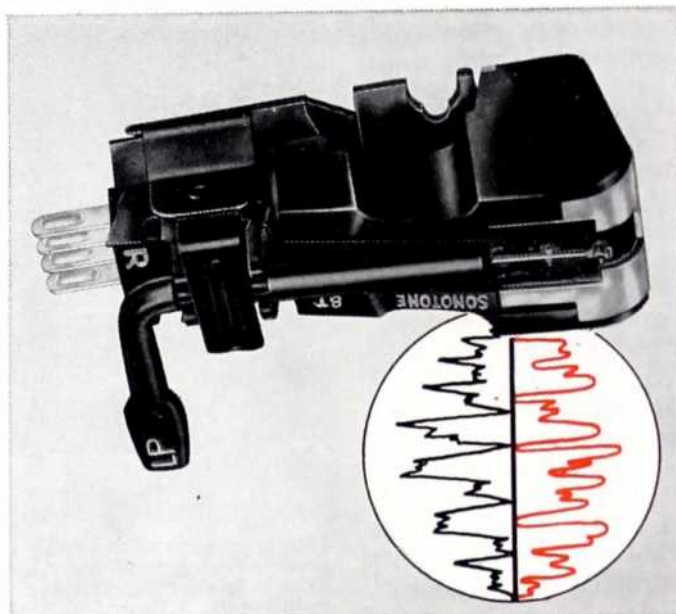

## STEREO MODEL 8T COMPATIBLE CERAMIC CARTRIDGE

*Plays both stereo and regular discs!*

- Opens the door now to the biggest equipment boom since LP!
- Plays all 4 speeds—does *not* obsolete present equipment!
- Has Sonotone's unique, built-in vertical rumble suppressor so vital to stereo use! Doesn't need pre-amp!
- Famous Sonotone quality with top specifications!

#### The best thing that's happened to stereo discs!

Response ..... Smooth from 20 to 12,000 cycles, gradual rolloff beyond.  
 Output Voltage ..... 0.3 volt.  
 Compliance .....  $2.0 \times 10^6$  cm/dyne.  
 Recommended Load .... 1-5 megohms.  
 Tracking Pressure ..... 5-7 grams.  
 Cartridge Weight ..... 7.5 grams.  
 Channel Isolation ..... 20 decibels.  
 Stylus ..... Dual jewel tips, 0.7-mil microgroove and 3-mil 78 rpm.  
 Mounting Dimensions.... Standard 7/16 to 1/2 inch centers.

Priced at only

**\$14<sup>50</sup>**  
LIST  
sapphire

**\$24<sup>50</sup>**  
LIST  
diamond sapphire

**Sonotone** CORP.  
Electronic Applications Division, Dept. CS-98

ELMSFORD, NEW YORK

# Printed Circuit Miniaturization Techniques

by RUDOLPH T. PLEMICH

MODERN TRENDS in engineering indicate that the miniaturized and printed-circuit components are being used in equipment wherever feasible. It has always been considered good engineering practice to reduce the size and weight of equipment and components if this can be done without sacrificing any operational qualities. The steps taken in the direction of reducing component size have made it possible to miniaturize complete equipments.

An important element in the field of miniaturized components has been the printed Couplate<sup>°</sup> which appeared about the same time as printed wiring. Other types of non-printed automatic wiring have also appeared and contributed to making equipment smaller and lighter.

Most Service Men are familiar with Couplates<sup>°</sup> containing resistors and capacitors. Some of them, however, may not be aware of the wide variety of other small and lightweight miniaturization components such as the micro-miniature Couplate<sup>°</sup> now available for printed board insertion.

Potted and molded circuits can be produced for any application, including those meeting military specifications. Diodes, coils, and sockets can be incorporated to make up complete circuit assemblies. This reduces assembly errors and testing of individual components and facilitates handling and stocking of parts.

One of the latest products in the miniaturization field is the multiple variable resistor<sup>°°</sup> shown in Fig. 3. These are ideal for use in TV receivers as amplifier controls, electronic organ pitch controls, test equipment, and transistor bias applications.

These components are adjustable, despite their small size, with an internal or external hexagon wrench, ordinary screwdriver, or with the finger tips. They may be mounted either vertically or horizontally. These potentiometers are nominally rated at  $\frac{1}{4}$  watt at 70° C, with a breakdown voltage between adjacent sections of

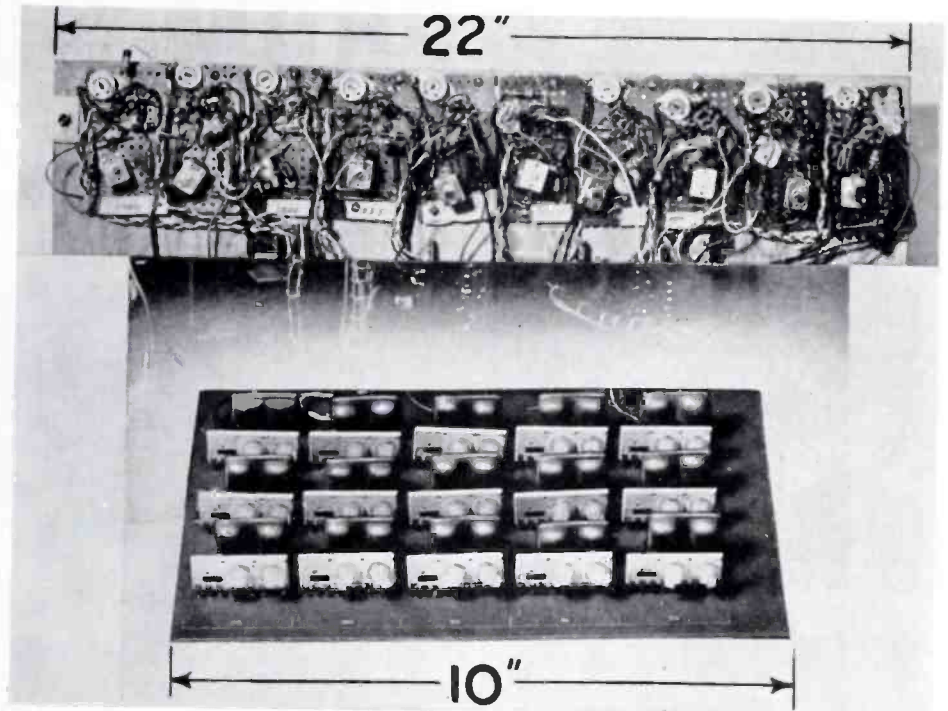

FIG. 1: MINIATURIZATION OF A GROUP of bridge-T filters. The top section shows a group of 10 single-bridge T filters, in the original design. The etched board below it contains 10 triple-bridge T filters. Here, in addition to the PEC<sup>°</sup> packaged circuit with fixed components, a Centralab Model 5 multiple miniature variable resistor (lighter colored units) with four fixed resistors attached to its steatite base plate, forms a second packaged circuit that combines both fixed and variable components. The number of solder connections of the components involved were reduced from 330 to 195 on this board.

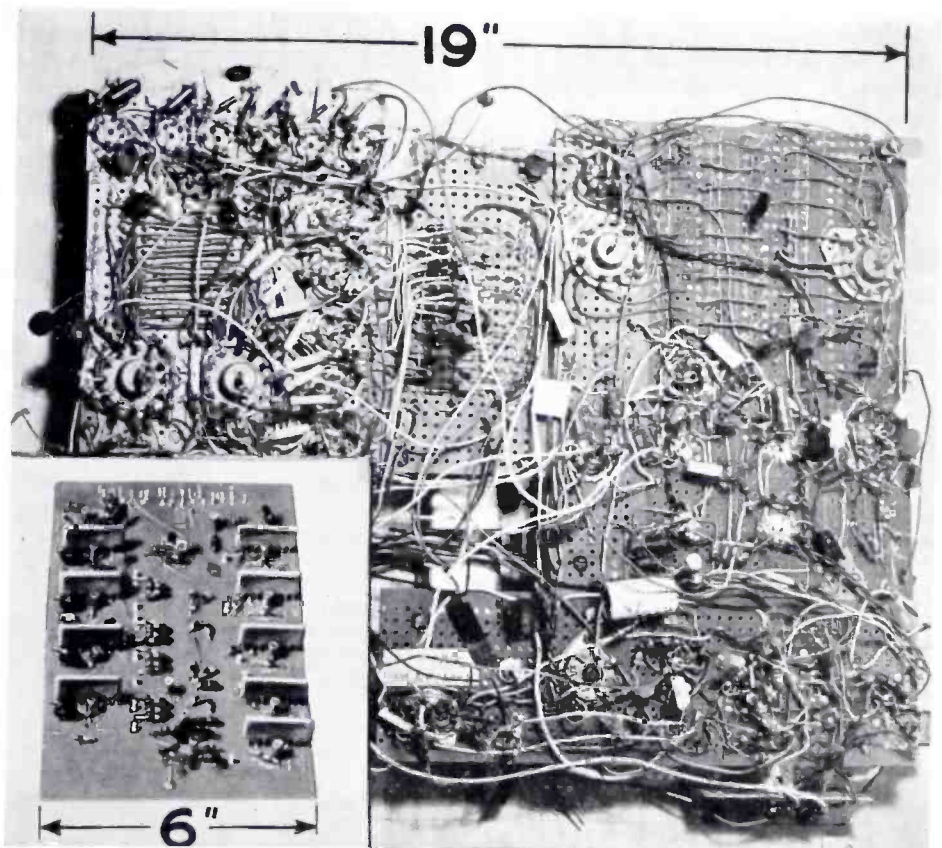
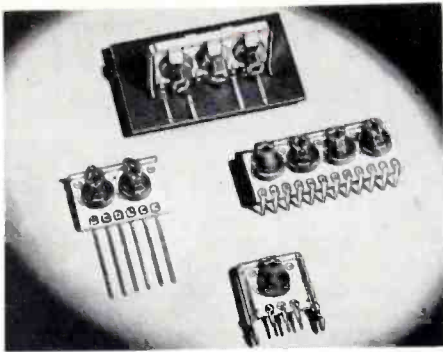

FIG. 2: LARGE BOARD in upper part of the photograph consists of four 8-stage counters, two with binary control, driven to coincidence. The entire section is replaced by two boards of the type illustrated in the lower left corner of the photo. The nine PEC<sup>°</sup> packaged circuits contain 81 components and reduce the number of solder connections from 162 to 72.

<sup>°</sup>Registered trademark, Centralab.

<sup>°°</sup>Manufactured by Centralab, a division of Globe-Union, Inc.



**FIG. 3: MULTIPLE VARIABLE RESISTORS** employed in miniaturization of printed circuits. Components are adjustable with wrench, screwdriver or finger tips.

1250 volts RMS. Fixed resistors and capacitors can be incorporated in the units to make a complete operating circuit.

An application of these latter type components has been made in the miniaturization of computer equipment called the Alphatype. This machine is an electronic typesetting device utilizing binary system circuits to automatically count the spacing between letters and lines of type. These operations and others are currently being performed manually by the typesetter.

Originally the equipment was developed with vacuum tubes and individual components. Prior to actual production it was miniaturized through the use of transistors, packaged circuits and variable resistors of the type illustrated in Fig. 3. High reliability at minimum cost rather than size reduction was the chief aim in this changeover. Reliability is absolutely necessary because schedules in the graphic arts field are sometimes measured in minutes.

The first step was to replace electron tubes with transistors, improving reliability and reducing overall size. The next step was to lower the cost of the unit and at the same time achieve even higher reliability by reducing the number of components and connections in the Alphatype.

Binary computer circuitry in the machine is repetitive, making for easy adaptability to packaged circuits. A series of packaged circuits with plug-in terminals suitable for etched board installation were designed. One of these was the PEC° flip-flop, a modified flip-flop with speed-up capacitors to count faster, and two circuits combining the functions of a triple-bridge T filter circuit. This technique, illustrated in Figs. 1 and 2, reduces the size of the equipment an additional 20% by decreasing both the number and size of the required etched wiring boards.

*get ready for tomorrow...today*

with **RCA COLOR TEST EQUIPMENT**

The alert service technician knows that his big future is not just around the corner—it's here today—in color-TV servicing! To get your share of this fast-growing market, you need the right kind of equipment. Get the right start! Make the right kind of investment with

**RCA PROFESSIONAL COLOR TEST EQUIPMENT**



- WR-46A VIDEO/DOT CROSSHATCH GENERATOR** for making static and dynamic convergence adjustments in color-TV sets.
- Video output adjustable in amplitude on all patterns from 0 to 45 peak v across 4000-ohm load
  - Vertical bars continuously adjustable from 10 to 25 (approx.) bars
  - Cable connections on back of cabinet
  - Reversible video output polarity
  - Simple connections to TV receivers

**WR-61B COLOR-BAR GENERATOR**—essential for checking overall operation of color-TV receivers and for adjusting and troubleshooting color phasing and matrixing circuits.

- Amplitude of color subcarrier and colorburst signal adjustable from front-panel for checking color synclock action of set
- Both rf and video output available—video output has both "+" and "-" polarity
- RF output voltage, at least 0.01 volt peak to peak; video output voltage—at "Lo" connector, at least 0.25 volt peak to peak across 75 ohms; 8 volts peak to peak across 4700 ohms at "High" video output terminal



Write for technical literature describing these RCA Test Instruments and for the line flyer describing RCA's complete line of both color and black-and-white test instruments.



**RADIO CORPORATION OF AMERICA**

© Electron Tube Division

Harrison, N. J.

RCA Commercial Engineering, Section 1-44-W  
Harrison, New Jersey

Rush me the following literature on RCA professional Test Equipment!

- CD-57-6 (RCA WR-61B Color Bar Generator)     3F764 (RCA Test Equipment Line Flyer)  
 CD-57-7 (RCA WR-46A Video/Dot Crosshatch Generator)

Name .....

Company .....

Address .....

City ..... Zone ..... State .....

# Troubleshooting Vertical Oscillator and Integrator\*

by JESSE DINES

\*Part II of Trouble Shooting Chart. For Part I, see SERVICE, March, 1958. Before troubleshooting, make sure that the Sync separator and video circuits operate normally, that line voltage, B+ and boost (when fed to vertical oscillator plate) voltages are normal, and that vertical hold, linearity and height controls are properly adjusted.

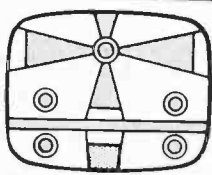
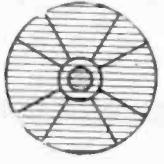
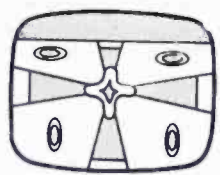
Trouble	Picture Indication	Cause	Remedy
Critical vertical hold adjustment or loss of vertical sync.		Any component indicated in circles 1, 2, 3 and 4 in Figs. 1 and 2.	Replace defective component. If these components are good, connect a 10,000-ohm resistor across the plate winding of T401; circle 1 in Fig. 1.
Poor interlace or line-pairing.		Trouble is due to a faulty vertical integrator— See circle 2 in Fig. 1. Also check R295 (82,000 ohms), R308 (39,000 ohms), C306 (.001 mfd) and C307 (.002 mfd)— See circle 4 in Fig. 2.	Replace defective component. If these components are good, then connect a 330-mmfd capacitor, as shown in circle 3 of Fig. 1.
Vertical non-linearity and improper vertical linearity and height controls do not correct trouble.		Following components should be checked: C414 (1 mfd—sawtooth-forming network), R406 (1.8 megohms) and R408 (2.5 megohms)— See circles 4 and 5 in Fig. 1. Also check C296 (1000 mmfd), R295 (100,000 ohms), R296 (4.3 megohms) and R302 (3 megohms)— See circles 2 and 3 in Fig. 2.	Replace defective component. If components are good, insert pot and trimmer (whose ranges cover fixed component values) in place of sawtooth-forming network, vary for best linearity and height, measure, and replace with fixed components.

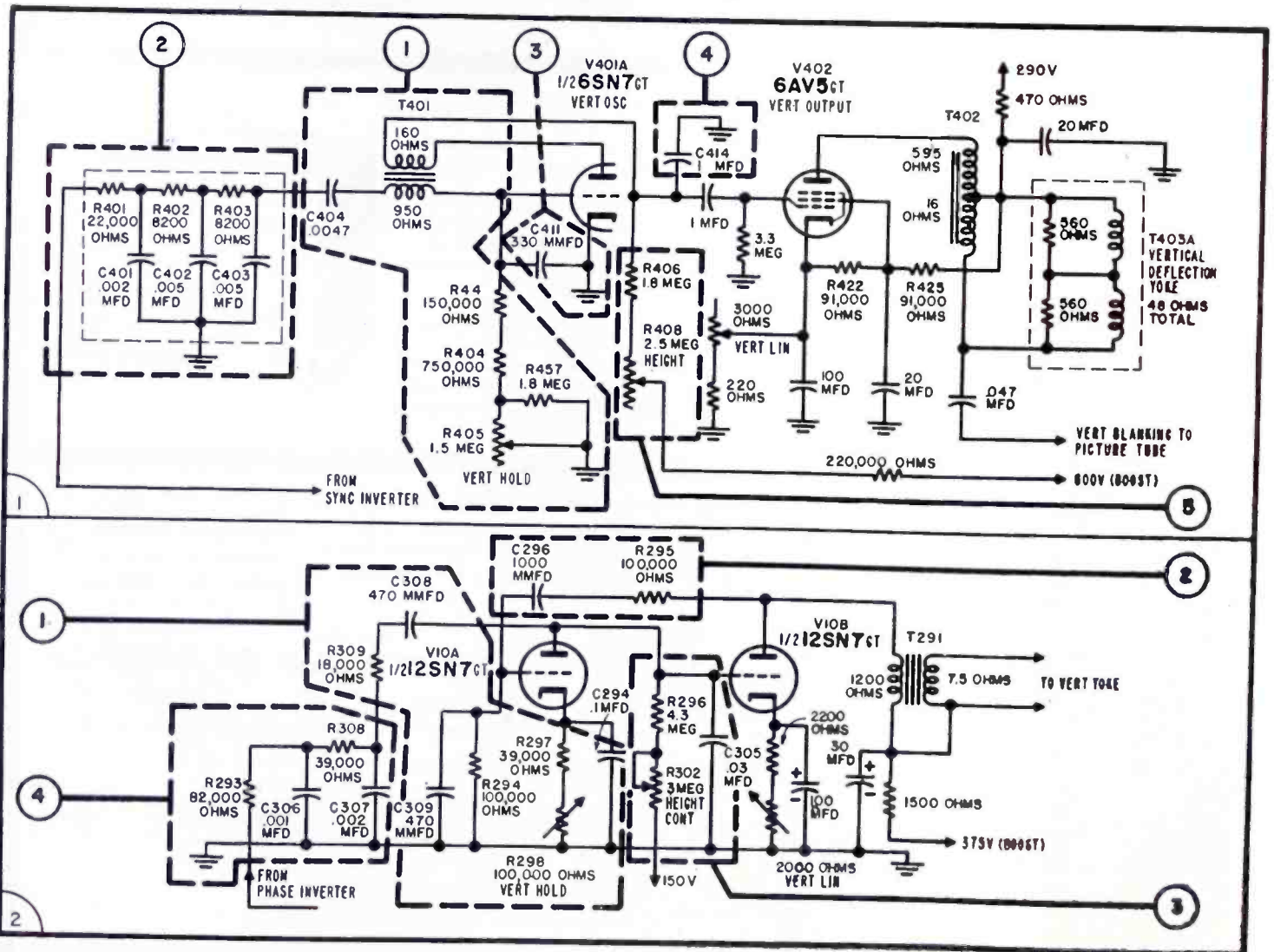

FIGS. 1 AND 2: Fig. 1 illustrates circuit of vertical oscillator and integrator in Admiral 23A1. In Fig. 2 we have the schematic of the vertical oscillator and integrator system in the GE 805/6/7/9.

mounts in seconds!

completely waterproof! highest "Q"!

**NOW...**

**LOK-MATIC by WARD!**

It's today's most revolutionary antenna!

Truly a "fingertip" installation—done in seconds—by one man—entirely from the outside!

So advanced, it will fit all cars—even '59 and '60 models.

Positive . . . easy . . . fool-proof. New exclusive triple interlocking parts fall into place *automatically*—provide tighter, easier installation. The *only* completely waterproof mount—highest "Q" ever. The Lok-matic antenna extends to 56" from 19½" collapsed. Has 3 sections. Adjusts to 43°. 54" low-loss Elektran lead cable. Fits any hole from ⅛" to 1¼". Popularly priced. Put the easiest mount of all at *your* fingertips—order the Lok-matic antenna (Model L-1000) from your distributor today! Pre-assembled — no loose parts. *Only* Ward has it!

Self-locating rocker locks automatically, can't spread. Positive ground. Self-aligning pad. Completely waterproof. Interlocking features of insulator and cap prevent twisting. Dome-shaped nut.

Pat. App. For

watch **w a r d** WARD  
PRODUCTS  
CORP.

1148 Euclid Ave., Cleveland 15, Ohio • Division of The Gabriel Company  
In Canada: Atlas Radio Corp., Ltd., 50 Wingold Avenue, Toronto, Canada



All-American 1957 Award winners met December 10 at Washington, D. C. The Hon. Walter Williams, Undersecretary of Commerce—center, front row—was guest speaker at the presentation ceremony and banquet. Winners came from nine states. Each winner received a handsome trophy, and a check for \$500 for community-activity or charity use. In addition, his expenses to Washington were paid.

# 1958 ALL-AMERICAN AWARDS AGAIN WILL SPOTLIGHT COMMUNITY SERVICE BY TV TECHNICIANS!

In LIFE on September 22, General Electric will advertise to 25,000,000 readers how they can help honor the many unselfish activities of TV technicians the nation over.

Afterwards—with its climax the December All-American Award presentations—a three months' General Electric advertising and public-relations campaign will underscore the message so forcefully presented in 1957: that the technicians who render television service, always are first to respond when public need arises.

Your professional standing—your service volume—will benefit from the recognition the 1958 All-American Award campaign brings you. Identify yourself closely with this nationwide program! Ask your G-E tube distributor for display and other material to help make your shop All-American headquarters! *Distributor Sales, Electronic Components Division, General Electric Company, Owensboro Ky.*

*Progress Is Our Most Important Product*

**GENERAL ELECTRIC**



11-11-126



**YOUR TV SERVICE TECHNICIAN...**  
*Helping others is his hobby!*

General Electric sponsors the annual All-American Awards for Television Service Technicians who have distinguished themselves in public service. It has the necessary funds, a judging panel, the TV Technicians of America a single year of their time and skills. Last year, G.E. was named the All-American Award sponsor in their area for their many public service activities, honoring the service technicians on that day along with seven others. This year, the TV Technicians will be the recipients of the Judge, for to honor the most distinguished service in public service in the 12 months ending September 30, 1958 will present the All-American Award recipient plus \$500 for his use to be further their community activities.

General Electric All-American Award judges for 1958 will be: **W.F. Williams, Undersecretary of Commerce** and **Walter Williams, Undersecretary of Commerce**. For more information, contact your distributor, General Electric Company, Owensboro, Kentucky.

Don't keep it a secret... you know a TV Service Technician is the volunteer for one of these... with his time, address, and drive system of his community activities in all America. For more information, contact your distributor, General Electric Company, Owensboro, Kentucky.

**WINNERS TO BE ANNOUNCED IN DECEMBER**

**GENERAL ELECTRIC**





# New Semi-Flat 110-Degree Picture Tube

by C. F. OTIS

Television Section, Engineering Dept., Philco Corp.

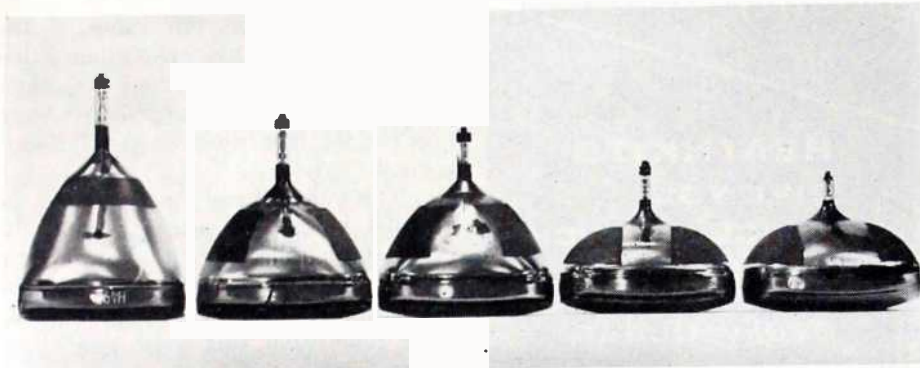

**FIG. 1: EVOLUTION OF PICTURE TUBE** to present-size is illustrated above. Note progression from the 1950 70-degree tube at extreme left to the two 90-degree tubes used in 1956 and 1957, the 110-degree tube of 1957 and finally, at the right, the semi-flat tube developed this year.

PICTURE-ON-THE-WALL television is firmly implanted in the public's mind as the TV form for the near future. The changes which have taken place in CR tube construction over the past few years, as shown in Fig. 1, encourage this concept. Now the new SF (semiflat) line of picture tubes<sup>o</sup> has taken a significant step in this direction. Up to two inches have been removed from the overall length of conventional 110 degree cathode-ray tubes. Three new tube types, 17AWP4, 21EAP4 and 24AVP4, have been registered with the Electronic Industries Association.

The reduction in tube length was achieved in three stages of engineering development. First, the upper section of the gun, including  $G_3$ ,  $G_4$ , and  $G_5$ , as shown in Fig. 2, was shortened by reducing the length of the  $G_3$  and  $G_5$  cylinders. Secondly, an entirely new gun structure was developed in the cathode,  $G_1$  and  $G_2$  region, which reduced the distance required between  $G_2$  and the base of the tube. Finally, the entire gun structure was moved forward in the neck of the tube.

The extent to which the upper section of the gun can be shortened is limited by the amount of spot magnification that can be tolerated. To keep the magnification at a minimum most of the shortening process was done in the  $G_5$  electrode. The distance between the top of the  $G_2$  electrode and the top of the  $G_5$  cylinder was reduced  $\frac{1}{8}$  inch relative to the corresponding distance in a 21CQP4 gun.

Fig. 2 shows the details of the new SF gun structure which permits a reduction of  $\frac{1}{8}$  inch in the distance between the top of the  $G_2$  structure and

the bottom end of the CR tube base. Note that the filament, cathode, and  $G_1$  are mounted horizontally, rather than vertically as in the standard 110 degree gun. The cathode structure is similar to that used in a receiving tube. Two spaced mica plates provide support for the elements. Tabs on the electrodes are inserted in the mica plate holes.

By using the receiving tube type of cathode, more efficient transfer of energy from the heater to the cathode was obtained. The lower heater power has resulted in the odd heater volt-

ages specified for the SF tubes. The 17-inch tube, which is used in a 450 ma heater string, requires a heater voltage of 2.68 volts. Similarly the 21-inch tube, which is designed for a 600 ma string, employs a 2.35 volt heater. The 600 ma heater is also used in the 24-inch tube.

Contributing to the shorter  $G_2$ -to-base dimension is a shorter tip-off length. An entirely new tipping technique was developed which permitted forming the tip within the circle of base pins. In a conventional 110-degree tube this distance is 1 inch, but it is only  $\frac{9}{16}$  inch for the SF tubes. A special plastic base was designed to take full advantage of the short tip-off. This base is compared with a conventional base in Fig. 3 (p. 34).

Several problems become immediately apparent when the gun is moved forward in a cathode ray tube. Unless proper precautions are taken, the focus at the edge of the tube deteriorates. The deflection sensitivity is reduced since gun parts short-circuit some of the deflection field, and the focus quality becomes critically dependent upon the strength and direction of the picture-centering field. The final position of the gun inside the neck is usually a compromise with respect to all three factors.

The deterioration of edge focus which would result from simply moving the gun forward is a result of the yoke deflection field entering the

(Continued on page 34)

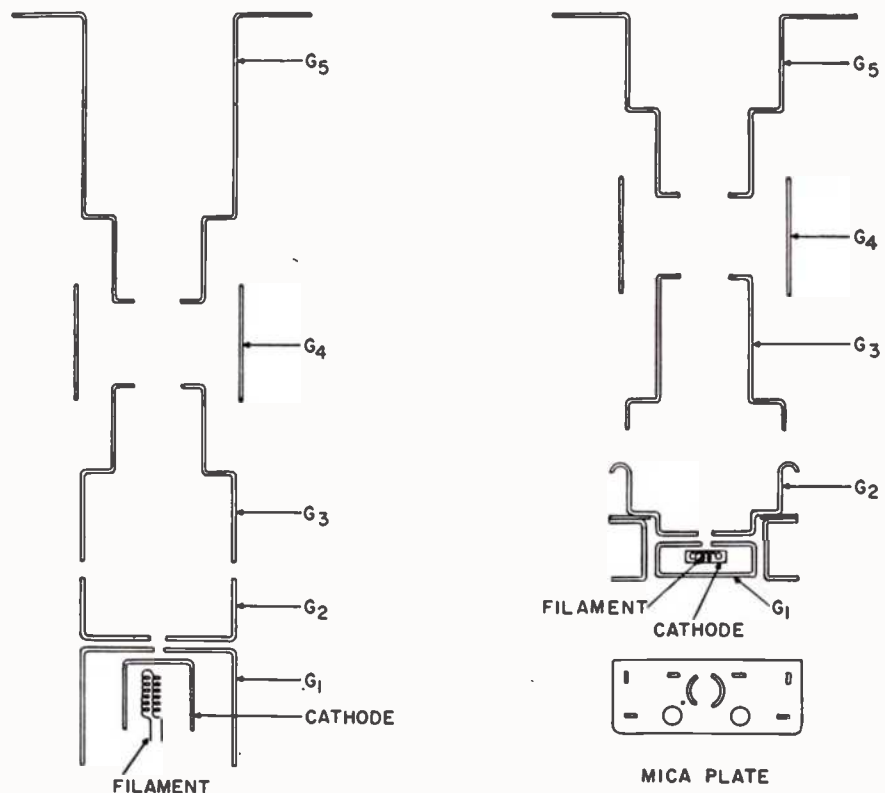

**FIG. 2: COMPARISON OF GUN STRUCTURES** of conventional and SF tubes. Note that the filament, cathode and  $G_1$  are mounted horizontally in the SF tube on the right, rather than vertically as in the standard tube at left.

<sup>o</sup>Developed by Philco Corporation.

look what **\$24<sup>50</sup>** buys  
in test equipment!



**HEATHKITS  
GIVE YOU  
TWICE AS MUCH  
equipment for  
every dollar  
invested**

The famous model V-7A Vacuum-Tube-Voltmeter is a perfect example of the high-quality instruments available from Heath at 1/2 the price you would expect to pay! Complete, only **\$24<sup>50</sup>**



Get the most out of your test equipment budget by utilizing HEATHKIT instruments in your laboratory or on your production line. Get high quality equipment, without paying the usual premium price, by dealing directly with the manufacturer, and by letting engineers or technicians assemble Heathkits between rush periods. Comprehensive instructions insure minimum construction time. You'll get more equipment for the same investment, and be able to fill your needs by choosing from the more than 100 different electronic kits by Heath. These are the most popular "do-it-yourself" kits in the world, so why not investigate their possibilities in your particular area of activity! Write for the free Heathkit catalog now!



Contains detailed descriptions of Heathkit models available, including VTVM's, scopes, generators, testers, bridges, power supplies, etc.

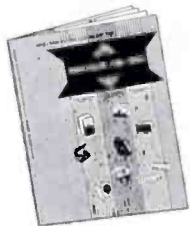

Also describes Heathkit ham gear and hi-fi equipment in kit form. 100 interesting and profitable "do-it-yourself" projects!

**FREE** catalog

Mail coupon below for  
your copy—Now!

**HEATH COMPANY**  
A SUBSIDIARY OF DAYSTROM, INC.,  
BENTON HARBOR 11, MICHIGAN

Name

Address

City & Zone

State

## Home Antenna System

(Continued from page 12)

ergy in the line will appear across the set's terminals. The amount of the energy depends on the value of the series resistors. It has been found that there cannot be less than 300 ohms resistance in these tapping resistors, or else the line disturbance will be too great.

This value of resistance reduces the signal voltage appearing across the set's terminals by 10 db, to about a third of what would otherwise be present in the line at that point. At the same time, this absorption of energy from the system causes a loss in the line, averaging about 1½ db.

Now, if all the taps are loaded with sets tuned to the same channel and operating, then each tap, at that channel, will cause a loss of 1½ db in the line. The last tap will see the sum of the losses introduced by the previous taps. In the example given, the last tap will see the losses caused by the preceding three taps, a total of 4½ db. The set on that tap will see the loss of the resistors, 10 db, plus the 4½ db *feed-through* loss of the preceding tap-off units, or 14½ db.

### Use of Amplifiers

14½ db represents a ratio of about 5.3 to 1. Therefore, the antenna must deliver a signal 5.3 times as much as required to feed a single set in order to properly feed the last set under the worst conditions. This condition is usually met within a radius of 10 to 15 miles of the transmitter under normal conditions from typical outdoor antennas, and sometimes up to 30 miles under more ideal conditions. Much depends on the abilities of the TV sets themselves—good sets performing quite well on signals which are quite snowy on inferior sets.

A notable feature of this type of system is that more outlets can be added, so long as no more than four or five are used at one time.

Line losses, inherent in the twin lead itself, have been ignored. This is justified, since we are not dealing with antenna signals themselves, but only with those signals delivered at the end of the line. In this case, the line loss has already been taken into account.

When not enough signal is available, some means must be used to raise the signal levels. Higher-gain antennas will provide some increase, but doubling the efficiency of an antenna only provides a 3 db gain in voltage. The best solution is an amplifier, but

this amplifier must fit stringent specifications. It must have a noise figure equal to, or better than, any receiver it is likely to feed. It must cover all the VHF television bands (2 to 6, 7 to 13) and should also cover the FM bands. Its frequency response must be flat across all these frequencies, in order not to distort the relationships between visual, aural and color carriers. And if it is to feed twin-lead transmission line, it cannot have too much gain since such lines radiate part of their energy.

An amplifier<sup>3</sup> for this purpose is now on the market. It has a noise figure of 6 db low band and FM, 8.5 db high band. It has a response curve flat within 1½ db from 54 to 108 mc and 174 to 216 mc, and a gain of 15 db low band, 16 db high band. The circuitry consists basically of neutralized triodes, using 6BK7 tubes.

On the basis of the circuit analysis, this amplifier will deliver enough signal to feed four sets, if its input sees enough signal to keep a clean picture on one set. FM reception will be greatly improved because of the tremendous advantage of an outdoor antenna. The manufacturer has included a method of extending the use to 5 sets, although if any excess signal exists, this is not necessary. The technique consists of reducing the isolation (loss from line to set) to 6 db by short circuiting one of the isolating resistors. This can only be done at the last tap on the line.

The methods discussed and illustrated up to this point utilize only a single line, which covers most homes quite well. When the home layout is such as to render one-line wiring impractical, the line can be split, as in Fig. 2. The line splitter is a two-set coupler, but of a special kind, one which shows *source* match, so that all terminals look like 300-ohm impedance. In this installation, both lines are terminated, as indicated by the zig-zag lines at the ends.

<sup>3</sup>Model HSA, Jerrold Electronics Corp.

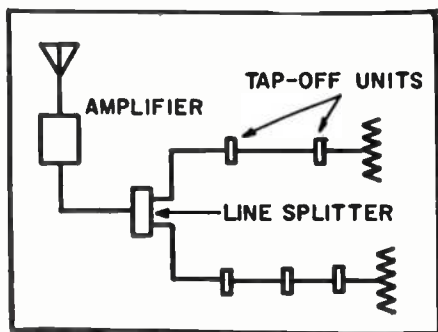

FIG. 2: SCHEMATIC DIAGRAM of distribution system employing line splitter for use in homes where one-line wiring is impractical.

# 33 American MICROPHONES

listed in our new catalog

IN EVERY PRICE RANGE!  
FOR EVERY APPLICATION!

## for example—the versatile DR330 Dynamic Cardioid and Ribbon

with multiple impedance and cardioid, bi-directional, and omni-directional polar patterns. A handsome unit made to fulfill the most exacting requirements of radio-tv broadcasting and film recording. Smooth frequency response from 30 to 15,500 c.p.s. List Price \$250.00.

## DR332 Dynamic and Ribbon Cardioid

Professional model with cardioid polar pattern and variable impedance. Frequency response 40-13,000 c.p.s. List Price \$162.50.

## for example—the handsome D22 Omni-directional Dynamic

Smooth peak-free response from 40 to 13,000 c.p.s. means you virtually eliminate feedback problems and get wonderful sound reproduction of both voice and music. "Slide-Lock" permits easy removal from stand for hand or suspension use. Variable impedance. List Price \$99.50.

## for example—the low cost 204 Series Tape Recording-Conference Microphones

Sleek, modern, and versatile, with wide frequency response (from 70 to 10,500 c.p.s. in the crystal model). Also available in ceramic and dynamic types. High or low impedance. Push button allows "Selective Recording." List Price from \$16.00.

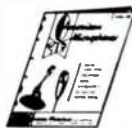

Write for your free copy of the handsome new AMERICAN MICROPHONE catalog, giving complete specifications on these and other fine AMERICAN microphones, handsets, cartridges, and tone-arms.

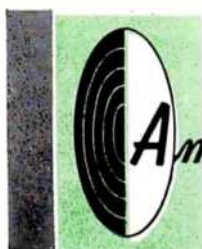

American Microphone MANUFACTURING COMPANY  
a division of GC-Textron Inc.

West Coast Plant: Los Angeles 18, California  
MAIN PLANT: 418 SOUTH WYMAN STREET, ROCKFORD, ILLINOIS, U.S.A.  
Export and Canada: Telesco International Corporation, 36 W. 40th St., New York, N.Y.

# When Converting Your Phono to Stereo... Use

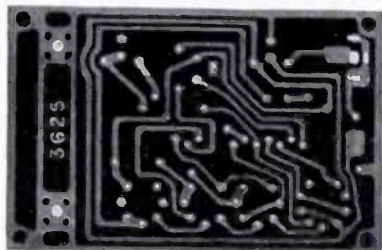

## The ERIE AUDIO-AMPLIFIER KIT featuring "PAC" and an ERIE Printed Wiring Board

### With these Plug-in Components:

- ERIE "PAC" (Pre-Assembled Components)
- ERIE PRINTED BOARD
- OUTPUT TRANSFORMER
- FILTER CAPACITOR
- VOLUME CONTROL and SWITCH
- TUBE SOCKETS
- CAPACITORS
- TONE CONTROL
- TUBES

### SPECIFICATIONS FOR ERIE STANDARD AUDIO-AMPLIFIER

- Frequency Response: 30 cycles to 12,000 cycles +0, -3.5 db.
- Sensitivity: 0.56 volt RMS (input at 1 KC) for 2 watt output.
- Power Output: 2 watts • Input Impedance: 2 megohms.
- Output Impedance: 4 ohms • AC Power Consumption: 17 watts.
- Overall Dimensions: 6 1/4" L x 4 1/4" W x 3 1/4" H • Shipping Weight: 2 lbs.

MODEL  
PAC-AMP-1

See and hear it at  
your local distributor  
or *Write* for  
nearest source.



## Transistorized TV Receiver

(Continued from page 10)

type transistors as utilized in the tuner and there is automatic gain control applied between the base one and base two connections. The last two *if* stages contain high-frequency graded-base PNP triode type transistors with 44 mc gains of approximately 14 db. They are operating at full gain at all times.

Tetrode-type transistors leave something to be desired in power-handling capability. They are capable of handling signal levels of approximately 50 microwatts at which level cross-modulation problems are encountered. However, impedance variation of these transistors with gain control causes a minimum frequency response variation as the gain control is varied.

The *if* amplifier 6 db bandwidth at 44 megacycles is 3.5 megacycles. The overall gain from the transistor base of the first stage to the second detector output is approximately 85 db. The gain of this *if* strip is somewhat higher than that of a tube receiver *if* strip. This is done to bring the overall receiver sensitivity, tuner and *if* in line with the tube receiver. The *if* response is symmetrical with a sound trap on either side of the response to permit operation of the local oscillator above and below the signal frequency.

### Video Amplifier

There are two transistors in the video amplifier circuit both of which are medium-frequency graded-base PNP types with an alpha cutoff frequency of approximately 30 megacycles. The first stage is direct-coupled to the second detector load and is operated as an emitter follower. It provides an impedance match between the relatively high detector output impedance and the low input impedance of the video output stage. It also provides the sound take-off for the sound *if* amplifier and a low impedance source for the automatic gain control circuit. A series trap across the emitter load resistor removes the 4.5 megacycle sound *if* signal from the picture signal.

The video output stage in the receiver must provide an output signal sufficient to drive a picture tube. While some picture tubes now available can be driven with signals as low as 40 volts peak-to-peak, the type of tube used in this receiver requires approximately 70 volts. This amount of drive can be obtained with a transistor if the voltage breakdown of the trans-

# Perma-Power



## TRANSISTOR POWER SUPPLY

MODEL A-400

Especially designed to operate, service and test transistor portable radios and low power transistor circuits.

Highest quality components combined with careful engineering make this instrument extremely reliable and useful for laboratory and service applications.

**\$64.50** from Electronic Parts Distributors only

"TRULY A  
VARIABLE BATTERY"

### SPECIFICATIONS

- Input: 115 Volts 50/60 cycles
- Output Voltage: 0-15 Volts and 0-30 Volts
- Output Current: 0-15 MA and 0-60 MA
- Accuracy: 2% on both voltage and current
- Ripple: Less than 500 microvolts (.002% at full output)
- Regulation: 1.2 Volts Maximum; Zero to full load current
- Internal Impedance: Less than 20 ohms DC to Radio Frequencies (including 7.0 ohm Meter Fuse, optionally removable)
- Terminals: 5-Way Binding Post
- Size: 10" x 6 1/2" x 5 3/4"
- Weight: 16 pounds

### FEATURES

- Continuously adjustable output using variable autotransformer control.
- Two output voltage ranges for accurate setting of all transistor battery voltages.
- Two output current ranges monitor current for single transistor or entire set.
- Extremely low ripple for testing lowest level transistor circuits.
- Very low internal impedance providing excellent regulation.
- Precision D'Arsonval meters provide laboratory accuracy.
- Milliammeter protected by front panel fuse; additional internal line fuse.
- Output isolated from line and case.
- Attractive Slope - Front, Maroon Hammerloid Cabinet - Rubber feet.

# Perma-Power

Manufactured by

COMPANY 3100 N. ELSTON AVENUE CHICAGO 18, ILL

There's always something new being developed by Perma-Power

istor is well above the required peak-to-peak voltage and the permissible collector dissipation is sufficiently high. A transistor which has a collector to emitter breakdown in excess of 100 volts and a collector dissipation of over 200 milliwatts is available.

The supply voltage necessary in order to obtain 70 volts peak-to-peak output signal is approximately 70 volts, and gain variation or contrast control is accomplished by a partially bypassed variable resistor in the emitter of the output stage. The frequency response is very nearly flat to 3.5 mc with a slight rise in the region of 3.5 mc. Series-shunt peaking is provided in the detector circuit and the video output circuit. None is required in the emitter follower stage. The cathode rather than the grid of the picture tube is driven in order to keep the output signal voltage to a minimum.

The picture tube used in the receiver is a slightly modified version of a 14RP4A. This is a 14-inch aluminumized tube requiring 90 degree deflection. The modification consisted in changing the heater-voltage from 6-volt to 12-volt operation. In addition, a slight modification of the gun structure was made to improve focusing.

The automatic gain control circuit for maintaining constant signal level at the second detector, consists of a two-stage dc amplifier using one PNP and one NPN transistor. The input to the *agc* is de-coupled through an ac filter network from the emitter of the first video amplifier. Since the first video amplifier is direct-coupled to the second detector, the dc voltage at the input to the *agc* amplifier varies as the dc voltage developed by the signal at the second detector.

The output of the second *agc* stage is connected to the tetrode bias circuits of the first four *if* stages. The polarities of the voltage in the *agc* circuit are arranged in such a way as to cause an appropriate change in gain in the *if* to oppose any change in the second detector output. The second detector output is held to approximately 1 volt over a receiver signal variation of 40 db.

#### Sync Separator

Synchronizing signal separation from the video is accomplished in a two-stage separator. The video signal for driving the sync separator is obtained from a tap on the video output load resistor. Approximately one-tenth of the video output signal is applied to the sync separator input. The video signal at this point is positive in polarity, and the first separator stage to

# JERROLD

announces **The First  
AMPLIFIED**

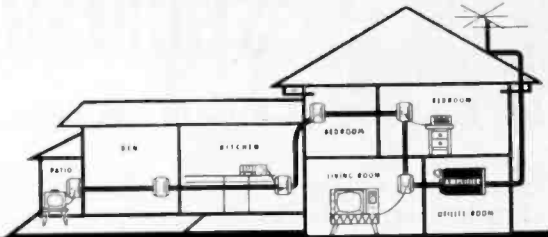

## Plug-In TV-FM HOME SYSTEM



## Now in Complete, Easy-To-Install Kit!

Now the world's first fully amplified home system comes in a lightweight kit that's a handsome selling tool with everything you need to bring *hi fidelity* TV and FM reception to every room of a home!

Each kit contains a broadband VHF (TV & FM) amplifier, sufficient 300 ohm Twin-Lead, and 5 outlets for surface or flush mounting, creating a complete system for any new or existing home.



HOME SYSTEM COMPONENTS AVAILABLE SEPARATELY. FOR COMPLETE DETAILS SEE YOUR JERROLD DISTRIBUTOR OR WRITE DEPT. PD82

# JERROLD

**ELECTRONICS CORPORATION**  
The Jerrold Building, Philadelphia 32, Pa.

Jerrold Electronics Corp., Ltd., Toronto, Canada  
Export Representatives, CBS International, New York 22, N.Y.  
**LOOK TO JERROLD FOR AIDS TO BETTER TELEVIEWING**

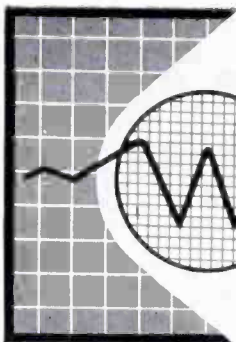

# TIME SAVING MULTIPLE USE Walsco STICKLEBACK TOOLS

FOR HUNDREDS OF JOBS IN THE SHOP—AT HOME—IN INDUSTRY

Cut any size or shape hole in wood, plaster, plywood, plastic, masonite, etc., twice as fast as any conventional tool. Can be used for drilling, sawing or routing. Try one at your parts distributor.

## DRILL ROUTERS



DRILL  
OR  
SAW

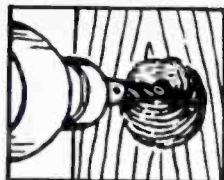
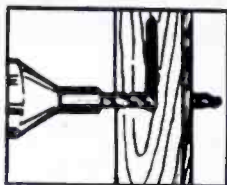

ROUT

For power tools, fit any  $\frac{1}{4}$ " chuck. Six sizes from  $2\frac{3}{8}$ " long,  $\frac{1}{4}$ " diam. (No. 588-01, \$2.35 List) to 7" long,  $1\frac{1}{2}$ " diam. (No. 588-06, \$5.40 List)

## DRILL SAWS



For hand use. Five sizes from  $4\frac{3}{4}$ " long,  $\frac{1}{8}$ " diam. (No. 586-00, \$1.63 List) to 15" long,  $\frac{1}{2}$ " diam. (No. 586-04, \$5.40 List)

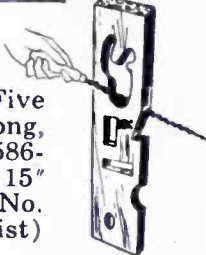

## FILE RASP



Three times as fast as an ordinary file. Can be used as a plane. Has coarse side for rough work, fine side for finishing. Part No. 587, List Price \$3.25.



## STRIP-ER-CLIP WIRE STRIPPER

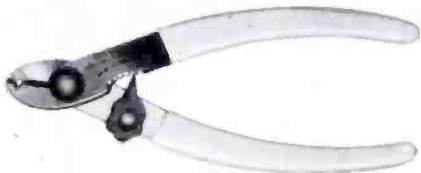

Compact, efficient unit that is perfect for your tool case. Gets into tight places and does a clean, fast job without damaging the wire strands. Special 7-stop gauge quickly adjusts to any wire size from 14 to 26 gauge. Has heavy insulated grips. Part No. 595, List Price \$2.30.

## TEKNI-LABELS

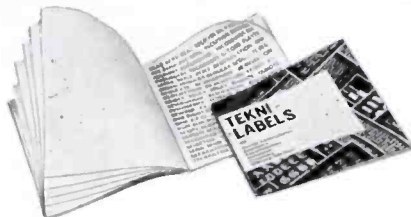

Handy decals that give your electronic equipment a professional appearance. Sets in black or white (each with hundreds of titles) for receivers, transmitters, television, dial marking, audio-hi-fi, panel markings (gold only), receiving tubes, etc. Only \$1.35 net per set.

**FREE:** Walsco's new 64 page catalog with thousands of tools, chemicals and items for hi-fi, radio and TV servicing. Ask your distributor or write Walsco for your copy.

Walsco—ELECTRONICS MFG. CO.

A Division of Textron Inc.

West Coast Plant: Los Angeles 18, California

MAIN PLANT: 108 W. GREEN ST., ROCKFORD, ILL., U.S.A.

In Canada: Atlas Radio Corporation, Toronto 10, Ontario

which this signal is applied is an NPN-type transistor. The positive polarity sync signal drives this stage, which is operating in class C, into conduction. When the driving signal reaches an amplitude of about 1 volt, only the sync pulses appear in the collector circuit.

The second stage separator utilizes a PNP-type transistor. When the negative polarity sync pulses from the first separator drive the second stage into conduction, this stage removes any remaining video signal and noise peaks. Some forward bias is applied to the second stage in order to assure saturation or bottoming in the transistor, and also some leveling of the peaks of the sync pulses. The output of the second separator stage is 9 volts, more than ample to drive the horizontal phase inverter and the vertical integrating network.

### Horizontal Synchronization

A transistorized horizontal scanning synchronization circuit in this receiver is similar to recent tube versions. The sync and scanning signals are compared in phase in a diode phase detector. The two phases of sync pulse are provided by a driver stage acting as a phase splitter. Equal and opposite pulses appear at the emitter and collector. The scanning sawtooth voltage is obtained by integrating the pulses appearing across the horizontal yoke winding.

In order to obtain a sufficient dc output voltage from the horizontal phase detector, the relatively high output impedance of the detector is coupled to the low impedance multivibrator circuit through a common collector transistor stage serving as a dc amplifier. The horizontal oscillator is a two-transistor multivibrator circuit with L-C stabilization.

The horizontal frequency or hold control is a bias adjustment in the base circuit of the dc amplifier stage. The size control increases or decreases the collector-to-emitter voltage of the multivibrator stages. The horizontal scanning pull-in range of this circuit is approximately six bars or  $\pm 200$  cycles. The output voltage or drive for the scan output stage is essentially a square wave.

The vertical scanning circuit, which consists of a blocking oscillator, a driver amplifier and a push-pull output stage, utilizes four PNP-type transistors. The synchronizing pulses from the second sync separator are integrated and coupled to the blocking oscillator through a separate winding on the blocking oscillator

transformer. Vertical hold control is accomplished by a bias adjustment on the base of the blocking oscillator transistor. Ringing and excessive retrace time are eliminated by two diodes connected in the proper phase across the collector winding of the blocking oscillator transformer.

The output pulse of the oscillator is only partially integrated; the peaking provided drives one of the output transistors far into conduction and drives the other to cutoff, producing minimum retrace time. The vertical size control is a variable resistor in series with the drive to the amplifier stage. The output of the driver is coupled through a push-pull transformer to the bases of the output transistors. A variable resistance in the emitters of the output transistors varies their conduction periods and thereby affects the linearity of scan only at the center of the picture.

The sound intermediate frequency amplifier consists of two high-gain stages employing medium-frequency NPN triode transistors operated in the grounded emitter connection. The receiver is designed for intercarrier sound so the intermediate frequency is 4.5 megacycles. The 4.5 megacycle signal for driving the sound *if* amplifier is extracted from the composite video-sound signal in the collector of the first video amplifier and applied to the base of the first sound *if*. The output of the second *if* stage drives a conventional double-diode ratio detector.

The recovered sound output of the ratio detector is coupled through a conventional de-emphasis network and volume control to a sound amplifier driver stage. The output of the driver stage is transformer-coupled to a push-pull sound output stage operating as a class B amplifier. The sound output at 10 percent distortion is slightly over 350 milliwatts. The speaker used in the receiver is a 4-inch permanent magnet type.

#### Battery Power Supply

The power supply for the receiver is a 12-volt storage battery. This terminal voltage is quite suitable for a transistor supply and is well adapted to the battery-charging facility of the modern automobile.

The storage battery used is a nickel-cadmium type. While this may not be the ultimate battery choice for this application, it does possess some unusually attractive characteristics. The initial cost is high, but averaged over the life of the battery, the cost per hour of operation is less than half a cent.

# Mr. Dealer PHILCO

## offers you a Complete and Universal line of FULL FIDELITY NEEDLES

- DIAMOND
- SAPPHIRE
- OSMIUM

Now, one complete line of precision-engineered and custom-designed needles to fit every make and model phonograph and High Fidelity receiver. Every Philco needle measures up to the highest quality and life test standards. All Philco needles are individually packaged for absolute protection.

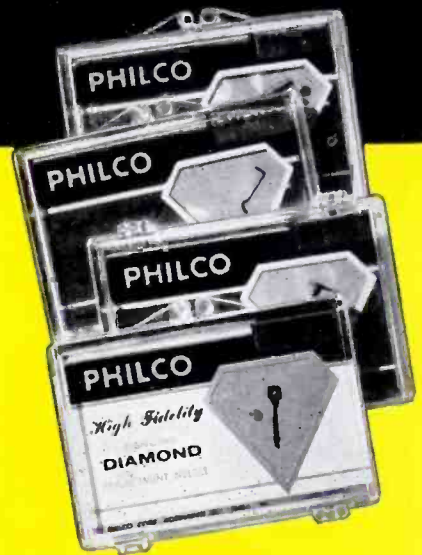

#### FREE! NEEDLE COUNTER DISPLAY!

Ask your Philco Distributor how you can get this sparkling, jewel case needle dispenser free. It's a sales-maker for you right on your counter at the point of sale.



#### COMPLETE PHILCO NEEDLE CATALOG

The most accurate, up-to-date, easy-to-read needle catalog in the industry. Cross references are complete... Illustrations are big... Makes selling easy.

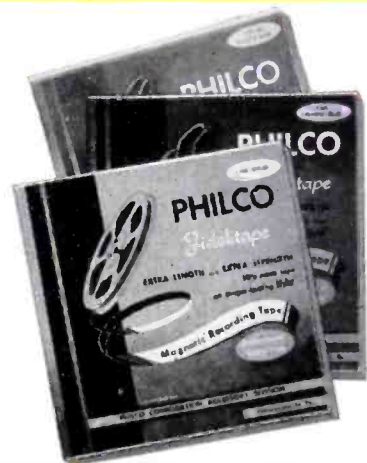

#### PHILCO FIDELITAPE

will bring new customers into your store. Unequaled in uniformity of output. Guaranteed splice free. Extra strength and extra length.

**See Your Philco  
Distributor Today!**

**PHILCO®**  
*Accessory Division*

#### World-Wide Distribution

Service Parts • Power-Packed Batteries • Universal Components • Long-Life Tubes • Heavy-Duty Rotors • Star-Bright 20/20 Picture Tubes • Long-Distance Antennas • Appliance Parts • Laundry Parts • Universal Parts and Accessories

Eliminate call backs...  
use dependable,  
industry-preferred...

**OHMITE**<sup>®</sup>  
QUALITY  
Components

3 WATT SIZE  
5/16" x 1/4"



5 WATT SIZE  
1 1/8" x 1/2"

AXIAL-LEAD RESISTORS

Vitreous-enameled, power-type, axial-lead units designed to withstand high temperatures.



**LITTLE DEVIL**<sup>®</sup>  
COMPOSITION RESISTORS

Meet all MIL-R-11A requirements. Available in 1/2, 1, and 2-watt sizes in all standard RETMA values.

**BROWN DEVIL**<sup>®</sup>  
RESISTORS



Vitreous-enameled. In 5, 10, and 20-watt sizes.



**TYPE AB**  
POTENTIOMETERS

Resistance material is solid-molded, noise-free. Rated at 2 watts.



**FR-7.5 FUSE**  
RESISTOR

For easy replacement in many television receivers. 1 1/2" Tinned wire leads.

WRITE FOR STOCK CATALOG

**OHMITE**<sup>®</sup>  
DEPENDABLE RESISTANCE UNITS

OHMITE MANUFACTURING COMPANY  
3642 Howard Street • Skokie, Illinois

30 • SERVICE, SEPTEMBER, 1958

## Latest Stereophonic Sound

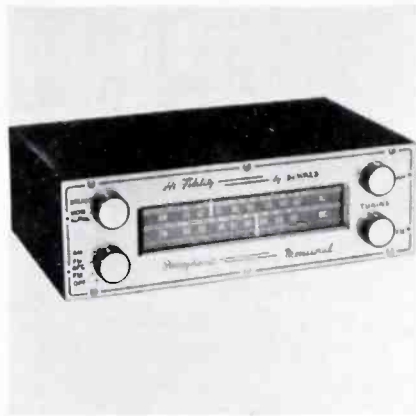

Stereo AM-FM tuner containing 8 tubes plus diode and rectifier, 4 stages of if including discriminator, afc and Stereomatic dual fly wheel slide rule tuning. (M-1000; DeWald Radio, Div. of United Scientific Laboratories, Inc., 35-15 37th Ave., Long Island City 1, N. Y.)

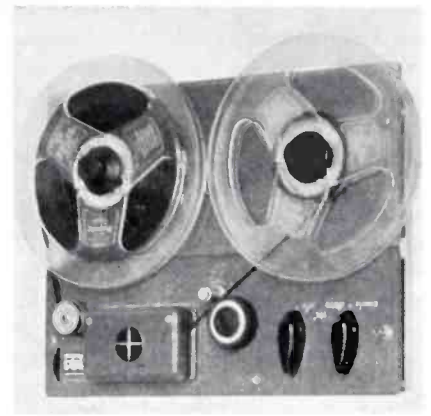

Tape transport mechanism featuring hysteresis-synchronous motor. Complete shielding of stacked stereo heads is said to provide a signal-to-noise ratio of 60 db and response flat within  $\pm 1$  db from 40 to 10,000 cps or  $\pm 2$  db from 30 to 15,000 cps. (Starlight 120; Metzner Engineering Corp., 1041 N. Sycamore Ave., Hollywood 28, Calif.)



Self-contained and self-powered stereo pre-amp and equalizer designed for remote operation. With modification unit may be used as a preamp for direct connection from stereo tape playback heads or as a two-channel preamp for microphones. (PR-66; Fisher Radio Corp., 21-21 44th Drive, Long Island City 1, N. Y.)



Kits for conversion of existing tape recorders to stereo. Kit SK-100 allows reproduction of standard 1/2 track two-channel stereo tapes on present single-channel tape recorders. Kit SK50 provides for reproduction of newer 1/4 track four-channel stereo tapes. (Stereo-Kits; The Nortronics Co., Inc., 1011 S. Sixth St., Minneapolis 4, Minn.)



Four-speed stereo record changer featuring instant changeover from stereo to single-channel cartridge with a turn of a knob. Stereo-monaural switch on changer deck provides full stereo sound in one position; directs sound from a single-channel LP record to both speakers of stereo system in the other. (GS Seventy-Seven; Glaser-Steers Corp., 20 Main St., Belleville, N. J.)

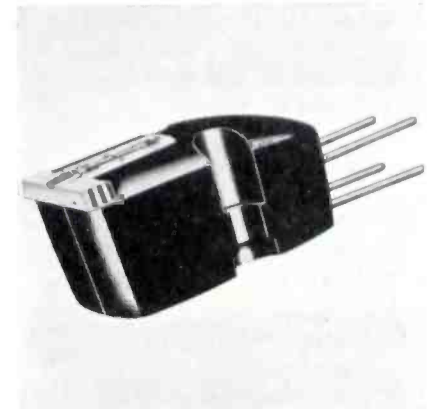

Stereo cartridge containing two magnetic systems with magnetic discriminator which attenuates inter-channel interference by more than 20 db. Frequency response is  $\pm 2$  db over the stereo range;  $\pm 2$  db from 10 to 30,000 cps for single-channel operation. (371D; Pickering and Co., Inc., Sunnyside Blvd., Plainview, L. I., N. Y.)



# Equipment



Dual-channel stereo preamp featuring ganged controls; individual bass and treble controls; 6 channel A and 6 channel B inputs; audio and tape outputs; frequency response of  $\pm 1$  db from 20 to 20,000 cycles and a low-impedance tape recording output. (SP-210; Pilot Radio Corp., 37-06 36th St., Long Island City 1, N. Y.)

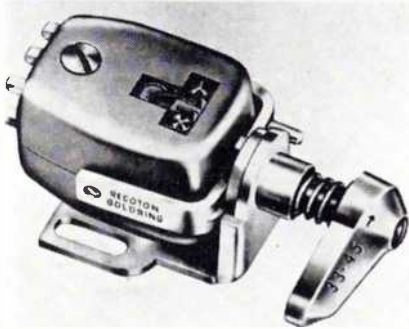

Magnetic stereo turnover cartridge for use on all turntables and changers, for all speeds and types of existing phonograph records. Available in two versions; for stereo-monaural LP use or stereo-monaural 78 rpm use. (RG745; Recoton Corp., 52-35 Barnett Ave., Long Island City 4, N. Y.)



Stereo record changer featuring a two-piece arm with 5-terminal plug in head. Counter balanced transcription type tone arm will accept any standard stereo or monaural cartridge. Automatic intermix plays 7, 10 or 12 inch records in any order. (TSC-840; Rockbar Corp., 650 Halstead Ave., Mamaroneck, N. Y.)



# HELPS YOU CASH IN ON THE GROWING MOTEL MARKET

**MASTERLINE Amplifiers** — proven top performers in leading motel master TV system installations. **FREE** engineering service — provides actual system layouts. **POWERFUL** ads in leading motel publications build business for you...

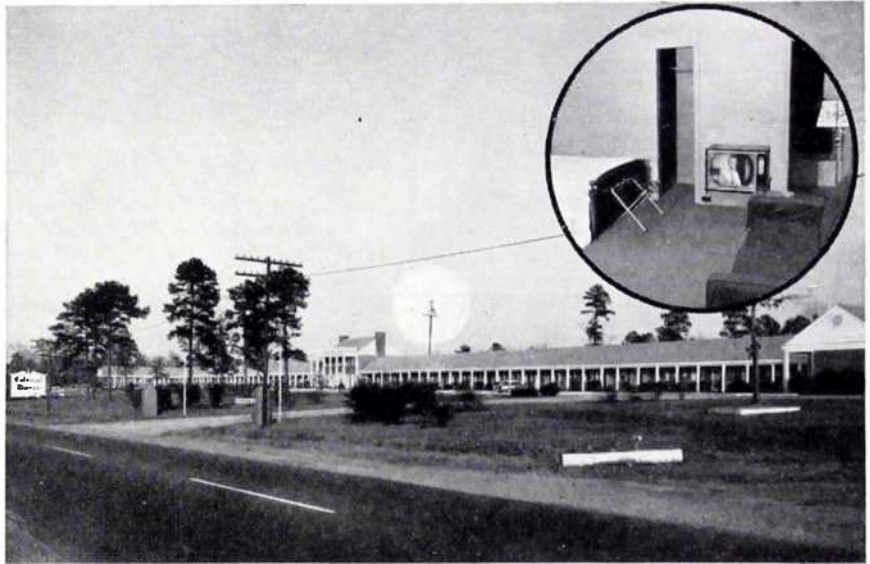

INSTALLATION BY LIVESAY S ROANOKE RAPIDS, N. C.  
ENGINEERING BY WOMACK ELECTRONICS, INC ROCKY MOUNT, N. C.



## MASTER TV SYSTEM BRINGS COLONIAL MANOR HOTEL GUESTS 100 MILE TV RECEPTION

Modern Colonial Manor Motel on busy highway 301 in Weldon, North Carolina offers its guests traditional warm southern hospitality and all the modern conveniences to make their stay comfortable. Free television in 36 of its units is one of the modern conveniences that helps build business for this motel.

Blonder-Tongue amplified master TV system equipment is the heart of the installation that brings Colonial Manor guests sharp, trouble-free reception on three channels. Channel 3 in Norfolk is 100 miles away; Channel 5 in Raleigh 80 miles away; and Channel 9 in Greenville is 60 miles away.

The Colonial Manor arranged for the installation of its master system utilizing the vast engineering know-how of Blonder-Tongue and two local electronics firms. The system includes B-T Masterline master TV equipment (amplifiers, line couplers, TV wall outlets) and a single master antenna. Besides providing the best TV reception possible regardless of distance and terrain, B-T equipment is economical. Per outlet cost is low; maintenance

Write today for **FREE** information on how to cash in on this market.



**BLONDER-TONGUE LABORATORIES, INC.** Dept. S-9  
9 Alling Street, Newark 2, N. J.

Name \_\_\_\_\_  
Company \_\_\_\_\_  
Address \_\_\_\_\_  
City \_\_\_\_\_ Zone \_\_\_\_\_ State \_\_\_\_\_





AT LEAST THEY AGREE ON FIDELITONE — Tempers can flare between Servicemen over technical disagreements. But it's mind over emotion when it comes to Fidelitone. Servicemen everywhere recognize the long standing superiority of Fidelitone Phonograph Needles. If their customers don't ask for Fidelitone — and most do thanks to Fidelitone's national advertising and promotion — the servicemen recommend Fidelitone. Stock the fastest selling, easiest selling needle line on the market. Promote Fidelitone for profitable sales. Fidelitone, Inc. — Chicago 26, Illinois, Export Dept., 13 E 40th St., New York 16, N.Y.

**Fidelitone**  
*"Best buy on records"*

**MORE** *ACTIVE!*  
*EFFECTIVE!*



**KESTER**  
**"RESIN-FIVE"**  
**CORE**  
**SOLDER**

**THE BEST FOR TV-RADIO WORK . . . EVERYTHING ELECTRICAL** — Kester "Resin-Five" Core Solder is better and faster than any solder ever developed. It has an activated flux-core that does a perfect job on all metals including zinc and nickel-plate. The flux residue is absolutely non-corrosive and non-conductive.

Available in all practical Tin-Lead Alloys; 40/60, 50/50 and 60/40 in diameters of  $\frac{3}{32}$ ",  $\frac{1}{16}$ ",  $\frac{3}{64}$ ",  $\frac{1}{32}$ " and others.

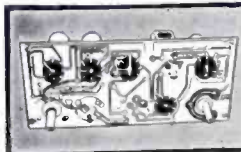

Printed Circuit Soldering On Copper-etched boards use 60% Tin - 40% Lead Alloy . . . for those that are Silver-surfaced use 3% Silver-61½% Tin-35½% Lead

**KESTER SOLDER COMPANY**

4248 Wrightwood Avenue, Chicago 39, Illinois • Newark 5, New Jersey, Brantford, Canada

**New**

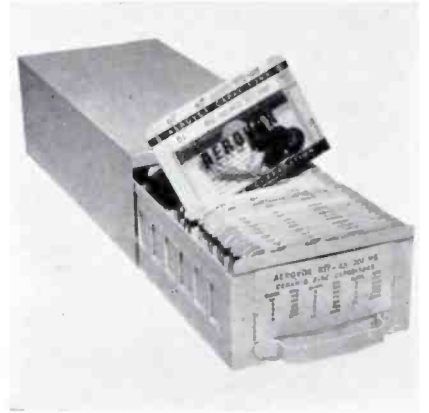

Kit containing an assortment of ceramic disc capacitors packaged on Vue-Pack 3x5 cards. Cards are housed in a free metal file cabinet. Available in two assortments: AK-200 with 135 capacitors in 24 popular values and AK-201HS with 95 capacitors in 16 most frequently used values. (Distributor Div., Aero-vox, Corp., New Bedford, Mass.)



Dipped tubular capacitor designed for uses ranging from TV bypass to critical industrial applications. Axial leads are crimped to facilitate use in printed circuits. Standard tolerance is  $\pm 10\%$ . Tolerance of  $\pm 5\%$  is available on request. (dp; Arco Electronics, 64 White St., New York 13, N. Y.)

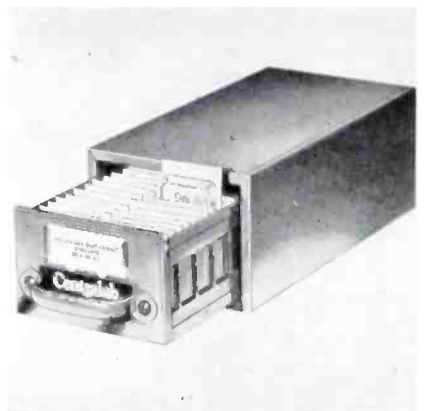

Packaged electronic circuit kit containing 40 units divided among the 14 most frequently used types. Each unit is packed in a rigid plastic package, arranged for instant identification in a metal cabinet. (PCK-40; Centralab, 900 E. Keefe Ave., Milwaukee 1, Wis.)

# Replacement Components

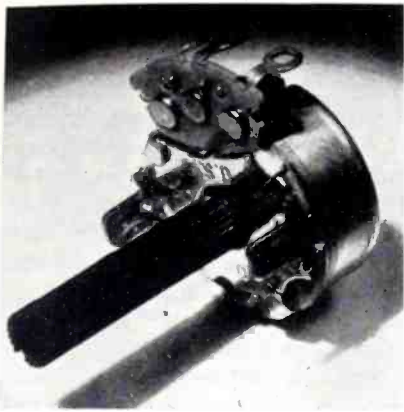

Tap-mount replacement control available in 25 resistance values. Each unit has a 1-in. long, knurled and slotted, phenolic shaft that can be used as is or readily altered to fulfill most applications. (B47; Clarostat Manufacturing Co., Inc., Dover, N. H.)

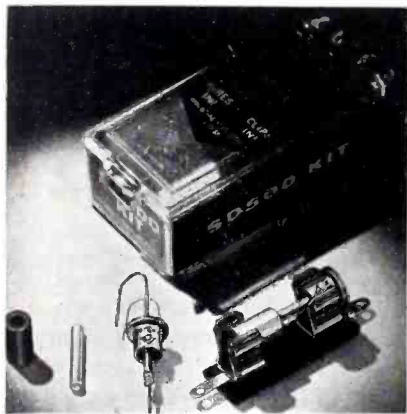

All-purpose silicon rectifier replacement kit. Contains a hermetically sealed, pigtail style diode which may be wired in to replace axial lead type units, or plugged into existing fuse-clip type sockets. May also replace existing selenium rectifier types. (SD-500; International Rectifier Corp., 1521 E. Grand Ave., El Segundo, Calif.)

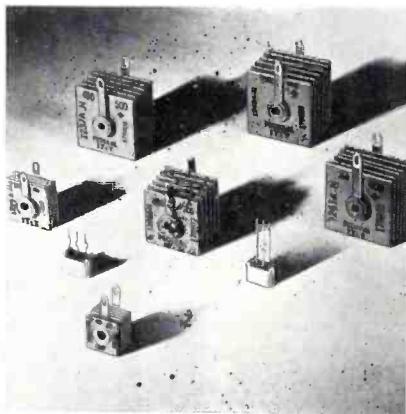

Selenium rectifier replacement line featuring units for 130-v input, half-wave and voltage-doubler B+ supply circuits from 65 to 600 ma. Center-tap, doubler-connected dual diodes for horizontal-sync phase-discriminator control circuits are also included. (Golden Eight; ITT Components Div., 100 Kingsland Rd., Clifton, N. J.)

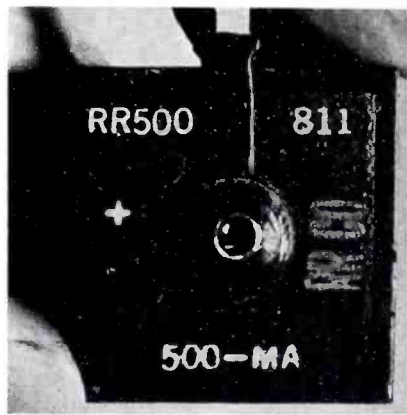

All-purpose, high-density replacement selenium rectifier line consisting of six types. With the exception of a 650-ma, 195-v ac unit intended for color-TV replacement, types cover all current ratings up to 650-ma and are rated at 130 v ac. (Radio Receptor Co., Inc., 240 Wythe Ave., Brooklyn 11, N. Y.)

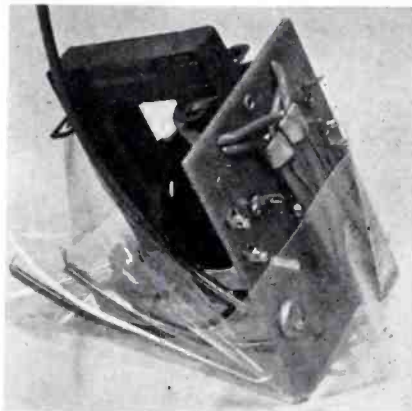

Replacement flyback transformer for Bendix TV receivers. Model EFR 134 replaces Bendix 265075-1. Model EFR 135 replaces part number 265078-3. Units are designed for use in Bendix T14-4, -6, -7, -15, -16, MA, MB, MC, MD and 2051 chassis. (Rogers Electronic Corp., 49 Bleecker St., New York 12, N. Y.)



Shirt-pocket size, match-book style package holding five K series replacement silicon rectifiers. Five packages of the pigtail mounted units are enclosed in a three-color carton for shipment and storage. (5-Pak; Rectifier Div., Sarkes Tazian, Inc., 415 N. College Ave., Bloomington, Ind.)

the specs are the proof...  
the BEST BUYS are **EICO**<sup>®</sup>  
for COLOR & Monochrome TV servicing



## COLOR

and Monochrome  
dc to 5 mc lab & tv  
5" OSCILLOSCOPE

#460  
Factory-wired \$129<sup>95</sup>  
Kit \$79<sup>95</sup>

### • Features DC Amplifiers!

Flat from DC-4.5 mc, usable to 10 mc. VERT. AMPL.: sens. 25 rms mv/in; input 2.3 megs; direct-coupled & push-pull thruout; K-follower coupling bet. stages; 4-step freq-compensated attenuator up to 1000:1. SWEEP: perfectly linear 10 cps-100 kc (ext. cap. for range to 1 cps); pre-set TV V & H positions (30 & 7875 cps); auto. sync. ampl. & lim. PLUS: direct or cap. coupling; bal. or unbal. inputs; edge-lit engraved lucite graph screen; dimmer; filter; bezel fits std photo equlpt. High intensity trace CRT. 0.06 usec rise time. Push-pull hor. ampl., flat to 400 kc, sens. 0.6 rms mv/in. Built-in volt. calib. Z-axis mod. Sawtooth & 60 cps outputs. Astig. control. Retrace blanking. Phasing control.



## TV-FM SWEEP

GENERATOR

& MARKER #368

Factory-\$119<sup>95</sup>

wired \$69<sup>95</sup>

Entirely electronic sweep circuit (no mechanical devices) with accurately-biased inductor for excellent linearity. Extremely flat RF output: new AGC circuit automatically adjusts osc. for max output on each band with mln. ampl. variations. Exceptional tuning accuracy: edge-lit hairlines, 6:1 vernier. Sweep Osc. Range 3-216 mc in 5 fund. bands. Variable Marker Range 2-75 mc in 3 fund. bands; 60-225 mc on harmonic band. 4.5 mc Xtal Marker Osc., xtal supplied. Ext. Marker provision. Sweep Width 0-3 mc lowest max. deviation to 0-30 mc highest max. dev. 2-way blanking. Narrow range phasing. Attenuators: Marker 5'ze, RF Fine, RF Coarse (4-step decade). Cables: output, 'scope horiz., 'scope vertical.

## DYNAMIC CONDUCTANCE

Tube &  
Transistor  
Tester

#666  
Factory-\$109<sup>95</sup>

wired \$69<sup>95</sup>



## COMPLETE with steel cover and handle.

SPEED, ease, unexcelled accuracy & thoroughness. Tests all receiving tubes (& Color & Monochrome pic tubes with adapter). Composite indication of Gm., Gp & peak emission. Simultaneous sel of any 1 of 4 combinations of 3 plate voltages, 3 screen voltages, 3 ranges of continuously variable grid voltage (with 5% accurate pot). New series-string voltages: for 600, 450, 300 ma types. Sensitive 200 ua meter. 5 ranges meter sensitivity (1% shunts & 5% pot). 10 SIX-position lever switches: free-point connection of each tube pin. 10 pushbuttons: rapid insert of any tube element in leakage test circuit & speedy sel. of individual sections of multi-section tubes in merit tests. Direct-reading of inter-element leakage in ohms. New gear-driven rollchart. Checks n-p-n & p-n-p transistors: separate meter readings of collector leakage current & Beta using internal dc power supply.

See the 50 EICO models  
IN STOCK at your neighborhood distributor.  
Write for  
FREE Catalog B-9  
33-00 Northern Boulevard, L. I. C. 1, N. Y.

# CORNELL-DUBILIER CAPACITORS



## The extra values are "on the house"

Want more capacitor for your dollar? Here's how: Cornell-Dubilier has originated a "preferred-type" program on twist-prong electrolytics. Now, a relatively few types fill over 90% of all replacement requirements. You need less - to do more. Fewer types means improved production efficiency, lowered costs - savings to you. How is it done? Instead of producing hundreds of types with odd and critical capacitance and voltage ratings, each "preferred type" carries the highest value and rating called for in each category. In most cases you get more capacitor at lower cost - plus added safety factor, improved performance and "call-back" protection. It's on the house! To get more capacitor for your dollar, ask your C-D Distributor about Preferred Type Twist-Prong Electrolytics or write Cornell-Dubilier Electric Corporation, South Plainfield, New Jersey.



# CORNELL-DUBILIER CAPACITORS

Consistently Dependable

## Semi-Flat Tube

(Continued from page 23)

focus lens. To prevent this interaction, a special shield was devised for the SF tubes consisting of aluminum material for shielding the horizontal yoke field and silicon iron for shielding the vertical yoke field. The two different materials are necessary to keep the deflection losses at 15 kc and 60 cycles to a minimum. The shields are placed directly in back of the yoke. Since the shields result in a loss of deflection sensitivity, this must be made up in the yoke design or additional deflection power provided. A new yoke with improved sensitivity has been developed which gives the SF tube assembly a deflection sensitivity comparable to the 110 degree deflection system used previously. In this tube the gun is moved approximately  $\frac{3}{8}$  inch farther forward than in the standard 110 degree tubes. Ultimately the amount the gun can be moved forward is determined by the deflection power available.

### New Centering Device

Not only did the conventional centering rings produce excessive defocusing with centering motion, but physically there was not enough tube neck projecting beyond the yoke to provide satisfactory mounting. As a result a new centering device was engineered. It was found that the silicon shield required behind the yoke could also be used as pole pieces for the

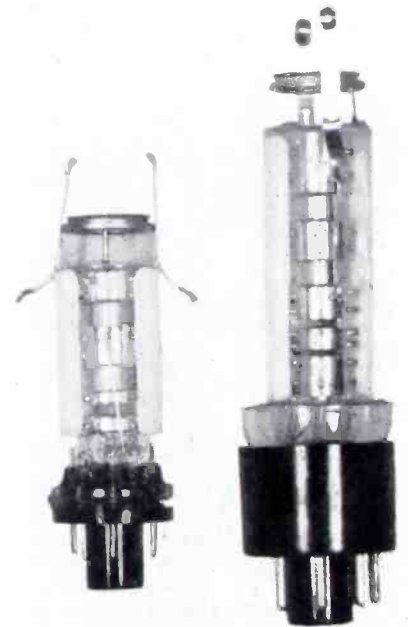

FIG. 3: COMPARATIVE SIZE of gun assembly on two types of picture tubes is illustrated above. At the left is the SF gun assembly and base, while conventional 110-degree assembly appears at right.

# CDR ROTORS

centering devices. Fig. 4 shows the physical shapes of these pole pieces and the fields which are set up in the neck of the tube when they are used in conjunction with the ceramic magnet discs.

It should be remembered that the beam motion is perpendicular to the direction of the magnetic field. The discs are magnetized across the flat surface in a direction shown by the drawing and the indicating mark on the disc. However, only one surface is magnetized, the side adjacent to the pole pieces or opposite to the side with the indicating mark. The two edge indentations, 180 degrees apart, facilitate rotation of the magnet by a tool. With the discs in the position shown, maximum deflection in one direction will be obtained. A rotation of 90 degrees reduces the deflection to zero, while an additional 90 degrees produces maximum deflection in the opposite direction.

## Back Cover Unit

The back cover unit is assembled like a sandwich, starting from left to right. The plastic cover is added between the parts shown in Fig. 4. The entire assembly is then riveted together, using the holes shown in the pole pieces. The odd-shaped pole pieces are required to prevent the vertical pole pieces from shunting the horizontal centering field and vice versa.

Some centering defocusing still exists but this has been kept to a minimum by controlling the strength of the centering magnets. About 1¼ inches of total horizontal centering motion and ¾ inch of vertical motion are produced. This amount of centering motion is adequate for the tube which has been designed so that the undeflected spot falls within a ¾ inch diameter circle centered at the geometric center of the tube face.

The new SF tube is used in the extra-thin Predicta® television receiver, which was introduced this summer and has created a great deal of interest. Full details of the circuitry of this chassis will be discussed in a subsequent issue of SERVICE.

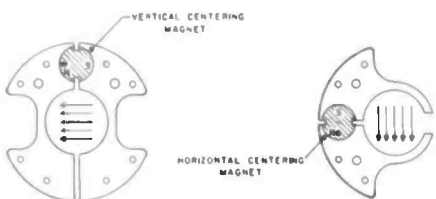
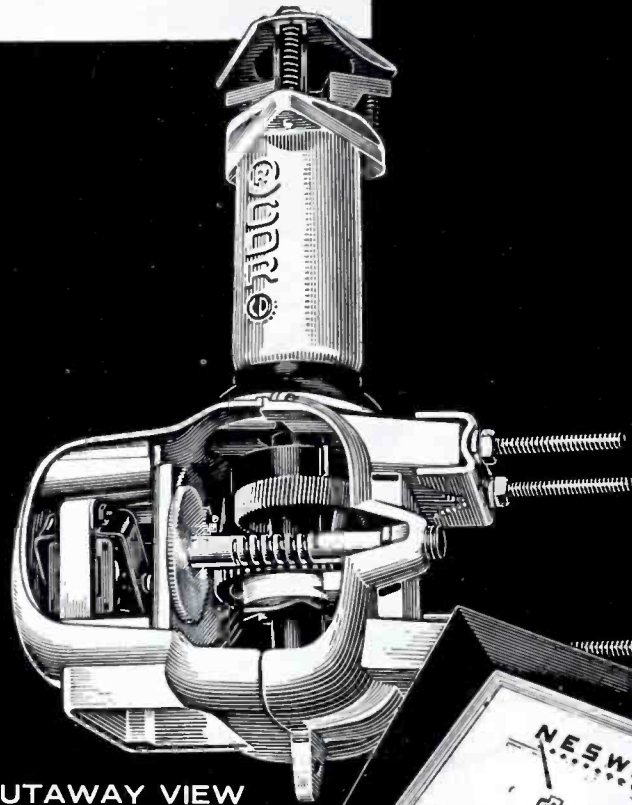

FIG. 4: SILICON CENTERING POLE pieces used with ceramic magnet discs in new SF picture tube. Arrows indicate the direction of fields set up in the neck of the tube. Vertical centering pole piece is at left, horizontal at right.



CUTAWAY VIEW



## All new features

Completely designed from the ground up, CDR Model TR-15 and TR-16 Rotors have features never before available in the popular price range. Check these refinements and you'll see why: Quick mounting mast collet... speedy installation (no loose parts to assemble)... self-centering sawtooth clamps take masts up to 1½" O.D. ... instant locking prevents drift... mechanical brake releases magnetically... instantly reversible... makes complete revolution in 45 seconds... meets JAN salt water test... great strength thrust bearing support... low weight... completely weather-sealed... fits standard towers... streamlined to reduce wind resistance... mahogany or blonde finish control box. Get full details today from your local CDR distributor.

CORNELL-DUBILIER ELECTRIC CORP  
South Plainfield, New Jersey

THE RADIART CORPORATION  
Indianapolis, Indiana



# CDR Antenna Rotors

Old Hands at Dependability

# RADIART VIBRATORS



## Consistently dependable power

Next time an auto-radio vibrator replacement is called for, try Radiart. There's a complete line for all 6-volt and 12-volt applications. And no waiting for the type you want, because your local Radiart Distributor maintains a full stock for your convenience. Ask him for your free copy of the Radiart Vibrator Replacement Guide, or write to Dept. S-9, The Radiart Corporation, Indianapolis 5, Indiana.



# RADIART TOBE Vibrators

Old Hands at Dependability

## CATALOGS—BOOKS

Alpha Wire Corp., 200 Varick St., New York 14, N. Y., has released a catalog sheet covering a complete line of stereo wire for all stereo cartridges (ceramic, crystal, magnetic) and tone arms.

Amperex Electronic Corp., 230 Duffy Ave., Hicksville, L. I., N. Y., has issued a brochure containing detailed descriptions of premium quality frame-grid tubes. Contains an explanation of the tube construction and specific application information.

Blonder-Tongue Laboratories, Inc., 9-25 Alling St., Newark 2, N. J., has announced a 4-page booklet, *Upgrade Your Motel*, designed to give dealers and installers a forceful tool for use in the motel market. A typical master antenna system is shown in a block diagram. Low cost, long life, better motel appearance and improved TV reception are stressed.

CBS-Hytron, Parker St., Newburyport, Mass., has released bulletin E-289 giving complete specifications, an outline drawing, a frequency response curve and installation instructions for the *Columbia* constant displacement stereo cartridge.

Centralab, 900 E. Keefe Ave., Milwaukee 1, Wis., has issued a catalog sheet itemizing the contents of four ceramic capacitor kits. Ratings and quantities of all of the capacitors in each kit are listed. Also included are listings for a *PEC* packaged circuit kit.

Chicago Standard Transformer Corp., 3501 Addison St., Chicago 18, Ill., has announced bulletin 545 listing detailed electrical and physical specifications on three transistor transformers. Covers low impedance microphone matching transformer, a driver unit and a modulation transformer.

Continental Electronics Corp., 1900 W. Allegheny Ave., Philadelphia 32, Pa., has released an illustrated brochure outlining the company's facilities for manufacturing replacement TV picture tubes.

Cornell-Dubilier Electric Corp., South Plainfield, N. J., has issued a 52-page twist-prong capacitor guide listing over 3,300 manufacturer's part numbers, ratings and sizes for twist prong replacements used by 97 TV set makers. Also included are complete pricings and listings of *C-D Twist-Prong* and *Blue Beaver* electrolytic capacitors.

Eagle Electric Manufacturing Co., Inc., 23-10 Bridge Plaza South, Long Island City 1, N. Y., has announced a 76-page catalog illustrating over 1,500 electrical wiring devices, lamps and specialty products. All products are grouped in categories, cross-indexed to facilitate quick and easy finding.

General Electric Co., Semiconductor Products Dept., Syracuse, N. Y., has published two brochures, GP-176, containing specifications and application information on silicon unijunction transistors. One brochure contains 6 pages of information on the 6 types now available; the other contains a summary of unijunction transistor circuits.

**Sprague Products Co.**, 231 Marshall St., North Adams, Mass., has issued the ninth edition of its *TV Replacement Capacitor Manual*, K-103, with complete up-to-date listings of all replacement capacitors used in all TV sets manufactured from 1946 through 1957—priced at 10¢.

**Supreme Publications**, 1760 Balsam Rd., Highland Park, Ill., has announced the 1958 Master Index to all radio and TV publications issued by the firm. Includes listings of material in 17 radio servicing manuals and 13 TV servicing manuals. Available to readers of *SERVICE* for 5¢ in stamps to cover postage.

**Sylvania Electric Products, Inc.**, 1100 Main St., Buffalo 9, N. Y., has released a booklet describing electrical characteristics and listing interchangeability features of a wide variety of transistors by type number and manufacturer. Included are maximum ratings, typical values and applications for all transistors in the Sylvania line.

**Technical Information Corp.**, 41 Union Square, New York 3, N. Y., has published an *Oscilloscope Spec List* with an up-to-date listing of more than 150 stock item 'scopes made by 39 manufacturers. List is arranged primarily by frequency range and sensitivity. Similar 'scopes are listed on adjacent lines to allow ready comparison of all specifications—priced at \$10.00.

**Tung-Sol Electric, Inc.**, 95 Eighth Ave., Newark 4, N. J., has issued a 30-page flip-style chart, T-24, showing electrical and physical characteristics for the most important industrial, special purpose and military electron tubes. Industrial tubes are indexed by class with brief explanations of the use of each class and technical information pertinent to each type within the class. Special design features and specific application information is included.

**University Loudspeakers, Inc.**, 80 S. Kensico Ave., White Plains, N. Y., has released a 64-page manual, *The University Technilog on Loudspeakers*, with practical technical and product information, charts and tables. Includes discussion on how to apply driver unit specifications, overload protection, line matching problems, correct phasing, best use of available power and effects of mismatch, adjusting power capacity and cut-offs, how and which type of speaker to apply where, control of reverberations, using speakers as high output microphones and baffling cone speakers—priced at \$1.00.

**Vaco Products Co.**, 317 E. Ontario St., Chicago 11, Ill., has announced illustrated catalog T-70 with complete information and specifications on solderless terminals for automotive, radio-TV, appliance, electrical, aircraft, electronic, hi-fi, refrigeration and missile applications.

**Waterman Products Co., Inc.**, 2445 Emerald St., Philadelphia 25, Pa., has released engineering data on its complete line of *Pocketscopes*. Included are technical information, detailed descriptions and typical applications.

# TOBE

## America's Fastest-Growing Service Capacitor Line...



# NEW!

### TOBE MYLAR\* MOLDED TUBULAR CAPACITORS

- *Molded of DuPont Mylar*, one of the finest insulation materials ever developed.
- *Thermoset Case Construction* secures leads and sections firmly to withstand extremes of handling, vibration, shock and soldering temperatures.
- *High Insulation Resistance*: Average megohm values per unit 10,000 at 25°C. Small capacitance variation with thermal change.
- *Temperature Operating Range*: -55° to +130°C.
- *Moisture Resistant*: Exceeds JAN-C-91 requirements.
- *Non-Inductive*: Extended foil construction insures low resistance connections and low RF impedance.



DESIGNED FOR SERVICE DEALERS

NEW TOBE MYLAR\* CAPACITOR KIT

FREE KIT CONTAINS  
80 CAPACITORS  
ONLY  
**\$15.84**

Today, order your Tobe Mylar Kit from your Tobe Distributor

Compact, clear-plastic dispenser contains an assortment of 80 Tobe Mylar capacitors in the most popular sizes, ratings and quantities for quick, efficient servicing. Covers over 60 different ratings at 200, 400 and 600 working volts and from .0001 to 1.00 mfd. Dealer pays only for the Tobe Mylar capacitors, kit is free.



# TOBE RADIART CAPACITORS

\*DuPont trademark

TOBE DEUTSCHMANN CORPORATION, NORWOOD, MASSACHUSETTS

# STEREO PROFITS START HERE

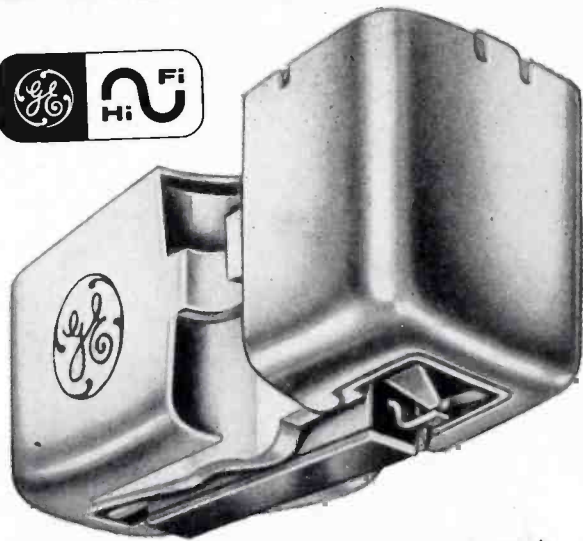

## New G-E "Golden Classic" Stereo-Magnetic Cartridge

Easier to sell...because it's magnetic  
...and because it's G-E!

Stereo installations and conversions can open up a whole new field of profitable business for you. And you can start your customers converting to stereo *right now*—with G.E.'s new "Golden Classic" stereo-magnetic cartridge (fully compatible with LP monaural records). It's easy when you tell them how a magnetic cartridge can best provide the high compliance, low distortion, and channel separation required by the new stereo discs. Just as important, General Electric is the name *all* your customers know and trust.

- Compatible with both stereo and monaural records
- Full frequency response, 20 through 20,000 cycles
- "Floating armature" design for increased compliance and reduced record wear. Effective mass of stylus approximately 2 milligrams
- High compliance in all directions—lateral compliance  $4 \times 10^{-6}$  cm/dyne; vertical compliance  $2.5 \times 10^{-6}$  cm/dyne
- Recommended tracking force with professional-type tone arm 2 to 4 grams
- Consistently high separation between channel signals. (Specifications for Model GC-5.)

GENERAL  ELECTRIC

Specialty Electronic Components Dept., W. Genesee Street, Auburn, N. Y.

## Transistorized Two-Way (Continued from page 17)

ways present that more trouble will be created by the soldering iron even before the cause of the original problem is found. In addition there is a maxim in the communication service business to the effect that "the best tube checker is a brand new tube." This also applies to transistors, and the plug-in feature facilitates circuit checking in this manner.

### Printed Board Removal

More attention to the Service Man's problems is evident in the method by which the printed board sub-units can be removed. The board guide pins are run through tabs and soldered. When removing the sub-unit, each guide pin and tab is heated and the tab is lifted off the pin with a screwdriver blade. Since each tab is unsoldered separately, the complete sub-unit can be removed with any ordinary soldering iron. The guide pin comes through a hole without the copper pattern around it, so that solder does not remain in the hole. This makes it equally easy to put the sub-unit back in place.

The servicing factor has also been considered in the design of the

metering system. This transceiver, therefore, can be serviced with conventional meters. A standard 0-3 volt, 20,000 ohm-per-volt scale, such as is found on common voltohmmeters, will serve to tune the receiver and transmitter. All usual test points have been brought out to jacks on the transmitter and receiver chassis.

Because of the relatively small current flowing in transistor circuits, it is difficult to obtain sufficient meter deflection for accurate tuning. In order to overcome this situation, diodes are used at important test points so that meter deflection is increased.

Any signal generator which is suitable for use on mobile communication receivers can be used for tuning the transistorized portable receiver. Some precaution should be taken, however, to assure that all ac-operated test equipment is connected to a common ground point to prevent damage to the transistors. Isolation transformers are highly recommended to prevent line voltage from being accidentally applied to the transistor circuit.

### Tuning Receiver

Tuning the transistorized receiver is quite simple and follows much the same procedure as used for the tubed

receivers. The first oscillator collector tank circuit is adjusted for peak at the first oscillator test point and detuned slightly, for increased stability, on the high side of resonance. A signal is then fed or radiated to the antenna jack on the proper frequency, and the *rf* and antenna transformers tuned for a first limiter peak (unsaturated) on a 0-3 volt *vom*. A signal-input test jack is provided in the high *if* transformer, and data is given for signal input versus limiter volts. There is also a crystal trimmer on the first and second oscillator to set the receiver frequency exactly in step with the received signal.

Tuning the transmitter follows conventional practices. The multipliers are peaked at their respective test points using a *vom*. The power amplifier plate tuning is adjusted for a dip, and the antenna coupling is then adjusted for rated current. Modulation is set by using conventional modulation meters.

While the circuitry in this miniaturized portable represents a large-scale change in many cases, the servicing of the set is based on conventional patterns which have been proven so successful in the past and with which Service Men who have handled mobile equipment are already familiar.



## ADVERTISERS IN SERVICE

SEPTEMBER, 1958

<b>A</b>	
American Microphone Manufacturing Co. ....	25
Arco Electronics Inc. ....	3
<b>B</b>	
B&K Manufacturing Co. ....	13
Blonder-Tongue Laboratories, Inc. ....	31
Bussmann Manufacturing Co. ....	Inside Back Cover
<b>C</b>	
Cornell-Dubilier Electric Corp. ....	34, 35, 36
Channel Master Corp. ....	14, 15
<b>E</b>	
EICO ....	35
Erie Resistor Corp. ....	26
<b>F</b>	
Fidelitone, Inc. ....	32
<b>G</b>	
General Cement Manufacturing Co., Div. of Textron, Inc. ....	39
General Electric Co., Electronic Components Div. ....	6, 7, 22
General Electric Co., Specialty Electronic Components Dept. ....	38
<b>H</b>	
Heath Co. ....	24
The Hickok Electrical Instrument Co. ....	40
<b>J</b>	
Jerrold Electronics Corp. ....	27
<b>K</b>	
Kester Solder Co. ....	32
<b>O</b>	
Ohmite Manufacturing Co. ....	30
<b>P</b>	
Perma-Power Co. ....	26
Philco Corp., Accessory Div. ....	4, 5, 29
<b>R</b>	
The Radiart Corp. ....	34, 35, 36
Radio Corp. of America, Electron Tube Div. ....	19, Back Cover
Raytheon Manufacturing Co. ....	8
<b>S</b>	
Service Instruments Corp. ....	39
Sonotone Corp. ....	17
Sprague Products Co. ....	Inside Front Cover
<b>T</b>	
Sarkes Tarzian, Inc., Rectifier Div. ....	2
Tobe Deutschmann Corp. ....	37
<b>W</b>	
Walsco Electronics Manufacturing Co. ....	28
Ward Products Corp., Div. of The Gabriel Co. ....	21
Westinghouse Electric Corp., Electronic Tube Div. ....	1

## ASSOCIATION NEWS

(Continued from page 15)

### MEA, Chicago, Ill.

The Midwest Electronic Alliance, Inc., was formed recently at a meeting of Service Men's associations in Toledo, Ohio. The group consists of service associations in Ohio, Indiana, Illinois and Missouri.

Verne LaPlante has been elected president of the new group. Other officers are Robert Sickles, vice president and Howard Wolfson, secretary-treasurer. The board of directors consists of the officers and George Roberts, Carl Stallfuss, Robert Maxwell and Wilbur Pecht.

Member associations include the Electronic Technicians Association of Toledo, Inc.; Indianapolis Television Technicians Association; Indiana Electronics Service Association; the Associated Radio and Television Servicemen of Illinois; and the Television Electronic Association of Missouri.

• • •

The Tri-City Television Service Association has adopted a code of ethics for TV installation and service. Members who violate the code will be expelled from the group which represents Service Men and Dealers in Saginaw, Bay City, and Midland, Mich. The code also sets work standards and guarantees for 90 days all parts sold which are not covered by a warranty.

• • •

### ETAT, Toledo, Ohio

At a recent meeting of the Electronic Technicians Association of Toledo, Howard Hillman, midwestern regional director of Massachusetts Casualty Company, and George Brown, of Dwyer-Gilley Associates, presented suggestions for a group hospitalization, accident and sickness program which was adopted by the group.

A committee representing ETAT recently met with Toledo City Manager Rink to discuss a licensing proposal which had appeared in a local newspaper. Rink said that he and the city council would welcome any help the association could offer regarding licensing but that he felt such an ordinance was not necessary at the present time. He asked the group to express its views on licensing to the city council.

• • •

### TSDAV, Philadelphia, Pa.

The new Jerrold TV-FM amplified home system was introduced to the service industry for the first time at a recent meeting of the Television Service Association of Delaware Valley. The group's next meeting will feature a discussion on stereo conversion of existing audio equipment by representatives of V-M Corp.

• • •

### TSA, Seattle, Wash.

William Lamphear of William Lamphear Co., factory agent for Electro-Voice, showed a color slide series highlighting the easy conversion of tone arms to E-V Power Points at a recent meeting of the King County Television Service Association. He emphasized the advantages of selling and stocking these items. Lamphear was invited to return in the fall to explain the field of stereo reproduction to the group.

WILL YOUR REPLACEMENT

FUSE RESISTOR  
BURN OUT AGAIN?

Not if you use—  
The NEW SENCORE  
"FUSE-SAFE"  
CIRCUIT TESTER

Another  
Sencore  
Time-Saver

Save costly call backs by testing the circuit before replacing fuse, fuse resistor or circuit breaker.



Individual scale for each value fuse resistor — no interpretation, just read in red or green area.

- ★ Measures line current and up to 1100 watts of power at 115 volts using line cord and socket.
- ★ Two convenient current ranges — 0 to 2 amps and 0 to 10 amps. Test leads clip in place of fuse or fuse resistor.
- ★ 5 ohm, 10 watt resistor prevents TV circuit damage and simulates operating conditions.

As Recommended by Leading Manufacturers



**\$8.95** DEALER NET  
MODEL FS-3  
AC-DC or both as needed for Fuse Resistor Circuits

Mfg by **SENCORE SERVICE**  
INSTRUMENTS CORP.  
171 OFFICIAL RD., ADDISON, ILL.

Cut out this ad now for further information



# TEST LEADS

## KLIPZON & STANDARD

Complete line of quality test leads for every application. Choice of prods, tips and handles.



**G-C UNIVERSAL TYPE TEST LEADS**  
50" leads with 6" unbreakable plastic handles. Heavy duty; complete set of tips. No. 8463. List \$3.00

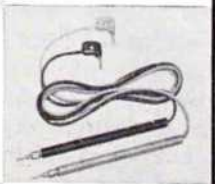

**G-C MASTER LINE TEST LEADS**  
Heavy duty, 6,000 volts; solderless type. Well-insulated handles. No. 5050. List \$1.85

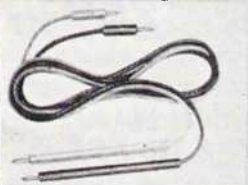

**G-C KLIPZDN TEST PRODS & LEADS**  
4' leads with Tenite handles. Clip-on jaws of prods free both hands. No. 5608. List \$3.25

FREE CATALOG...  
WRITE TODAY!

## GENERAL CEMENT MFG. CO.

division of **TEXTRON INC.**  
Western Plant: Los Angeles 18, Calif.  
Main Plant **ROCKFORD, ILLINOIS, U.S.A.**

# NEW

# HICKOK

## Low-Price PORTABLE CARDMATIC TUBE TESTER

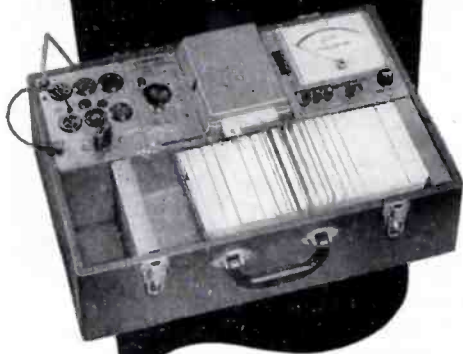

121

### Fully Automatic

Tests any tube in 8 to 12 seconds . . . including handling of tube test data card.

Here is the new, low cost version of the famous Hickok Cardmatic so popular with leading lab engineers. Especially designed for high speed service work, this new 121 is high quality in a lightweight portable . . . and the price is low, too.

The Hickok Cardmatic switch sets up all tests automatically and eliminates fussing around with adjustments. You can accurately check a tube for dynamic mutual conductance, controlled emission, cutoff point "Knee" point, shorts, leakage, gas and voltage drop . . . and rectifier tubes at their rated loads. Any way you look at it, this new automatic tube testing machine will be helpful to you in your work. It will pay for itself in a very short time . . . and give you many years of accurate dependable service.

**\$249<sup>50</sup>**  
**NET**

(includes 300 cards)

Now is the time to . . .  
**TRADE UP TO A HICKOK**

Ask for a demonstration of the new 121  
or write for descriptive literature.

**THE HICKOK ELECTRICAL INSTRUMENT CO.**

10521 Dupont Ave. • Cleveland 8, Ohio

## Audio

### Tips on Effective Servicing of Stereo Tone Arms and Needles

WITH THE ENTRANCE of stereophonic, high-fidelity phonograph discs onto the market, it is important that the Service Man keep abreast of new developments in this system. For instance, stereo tone arms are new to the service field. New types of cartridges, and additional leads will be found mounted in these arms to accommodate the wiring to the left and right amplifier channels.

An easy way to identify the wiring in the tone arm is to look at the color coded wires. Usually the left channel wire is black, and the right channel is red. This will save considerable identification time. Both channel wires, generally No. 32AWG, are run through a common shielded cable which is generally grounded to the amplifier channels.

These wires should always be connected to the proper terminals on the cartridges, otherwise the sounds emanating from the stereo output speaker system will be reversed. The right ear will be attempting to listen to what was recorded on the left channel, and vice-versa for the left ear. Volume and tone relationships will be confused.

Absence of or reduced sound in either channel at the tone arm output indicates that the cartridge or wire may be the cause. Whenever either is the case, the tone arm has generally been mishandled by the customer. Often it may be that the leads have been pulled off the cartridge or they are merely hanging by a thread.

Wire for uses in stereo arms can be conveniently stored on rectangular spools and rack mounted as shown in Fig. 1. A work bench hook-up wire dispenser kit\* for all types of wire is

\*Produced by Belden Mfg. Co.

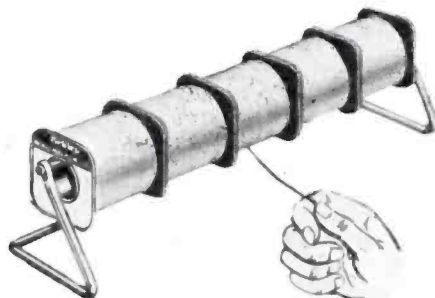

Fig. 1: Hook-up wire dispenser.

now available on the market. Narrow spools can be purchased separately to store wire odds-and-ends neatly. A solder spool can be easily mounted to the rack which may be pulled open at either end.

The rack may be wall mounted, or placed underneath the bench where the wire and solder are easy to reach. A survey was conducted to determine the most popular wire types for the kit, and the 20 to 26 gauge wires were chosen. As many as ten 25-foot spools may be mounted on the rack.

Wire supplied with the rack is rated at 1000 volts and therefore is safe to use in many types of circuits in radio, TV, audio and communications. Same types of wire also meet military specifications. Colors in the insulation are well-established standards, and hence are distinctly identifiable.

#### Needle Servicing

Audio fans who invest in stereophonic sound systems will generally be concerned with the needle in their stereo cartridge and will not stint on servicing it properly. As pointed out in a recent report,\*\* the needle in a stereo cartridge is usually of the diamond type. This needle has a relatively long life, but it does require checking for excessive wear and eventual replacement.

When working on a stereo set, the Service Man should have an assortment of needles on hand in the event that a replacement is necessary. One manufacturer† of phonographs and hi-fi sets has now made available to Service Men a complete line of needles, including osmium, jewel-tipped and diamond. In this assortment there is a replacement needle to fit every make and model of its own or its competitors' sets. Each needle type is individually packaged in a plastic case to assure maximum protection for the needle.

This manufacturer has also published a 24-page *Needle Catalog* containing visual identification of every needle type.

\*\*Diamond Needles for Stereo Pick-ups, Douglas F. Hudson, SERVICE, August, 1958.

†Philco Corp., Accessory Division.

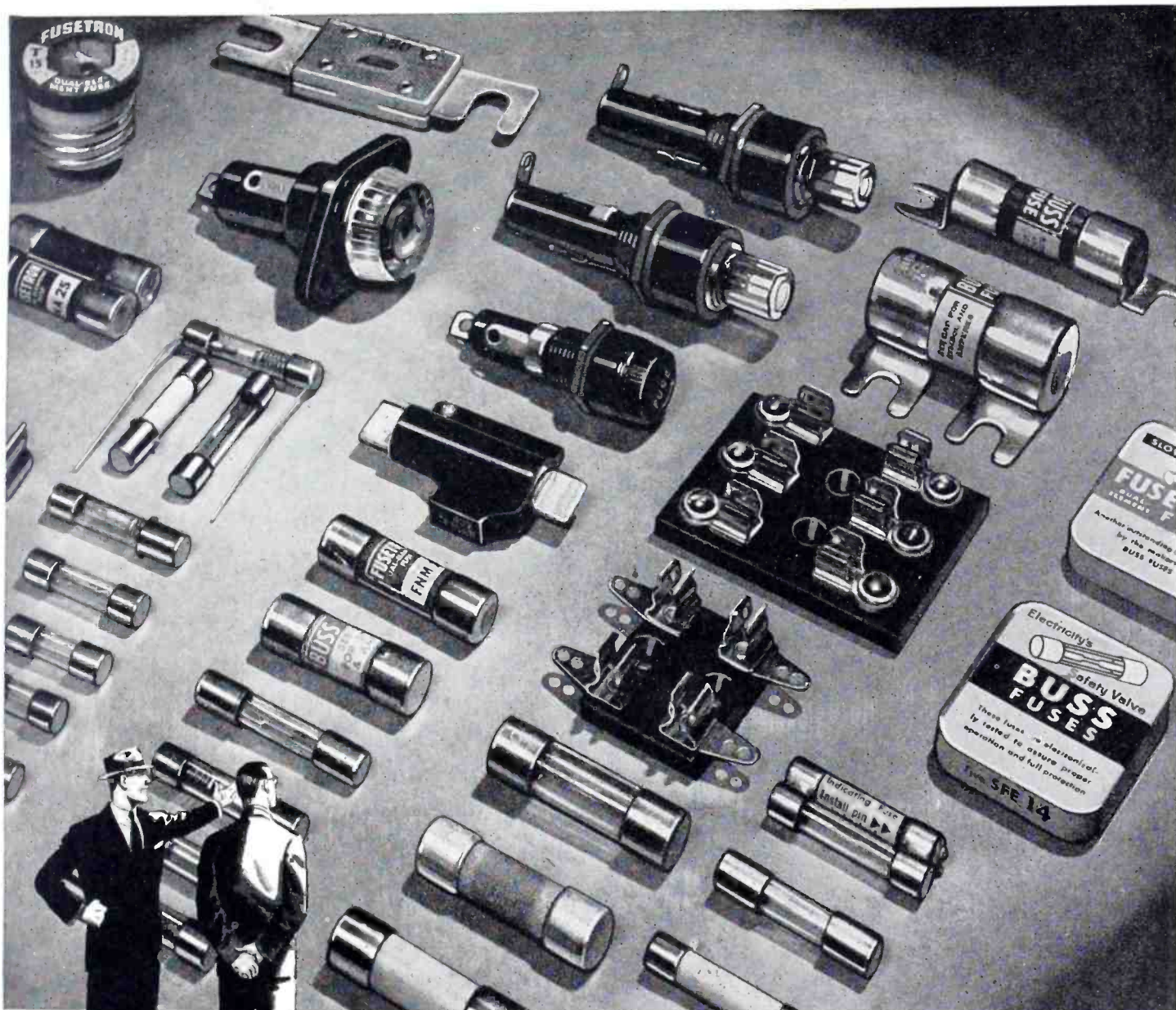

## **BUSS FUSES** help you avoid adjustments and call-backs.

Faulty fuses can cause trouble for you and your customers by failing to protect — or by blowing needlessly . . . but, with BUSS fuses you can be sure of dependable protection under all service conditions.

Every BUSS fuse you sell or install is tested in a sensitive electronic device. Any fuse not correctly calibrated, properly constructed and right in all physical dimensions is automatically rejected.

That's why BUSS fuses provide maximum protection against damage due to electrical faults. Users are safeguarded against unnecessary repair bills, — and your reputation for quality and service is protected.

Equally important, BUSS fuses eliminate needless blows that irritate users and require adjustments or call-backs on the part of sales and service organizations.

Protect yourself against faulty fuses causing trouble by relying on BUSS fuses. To meet service needs, there is a complete line of BUSS fuses available.

For more information on the complete line of BUSS and FUSETRON Small Dimension Fuses and Fuseholders . . . Write for bulletin SFB. Bussmann Mfg. Division McGraw-Edison Co. University at Jefferson, St. Louis 7, Mo.

**BUSS fuses are made to protect — not to blow, needlessly**



BUSS MAKES A COMPLETE LINE OF FUSES FOR HOME, FARM, COMMERCIAL, ELECTRONIC, AUTOMOTIVE AND INDUSTRIAL USE.

Diagnosis...  
A Long and  
Healthy Life!

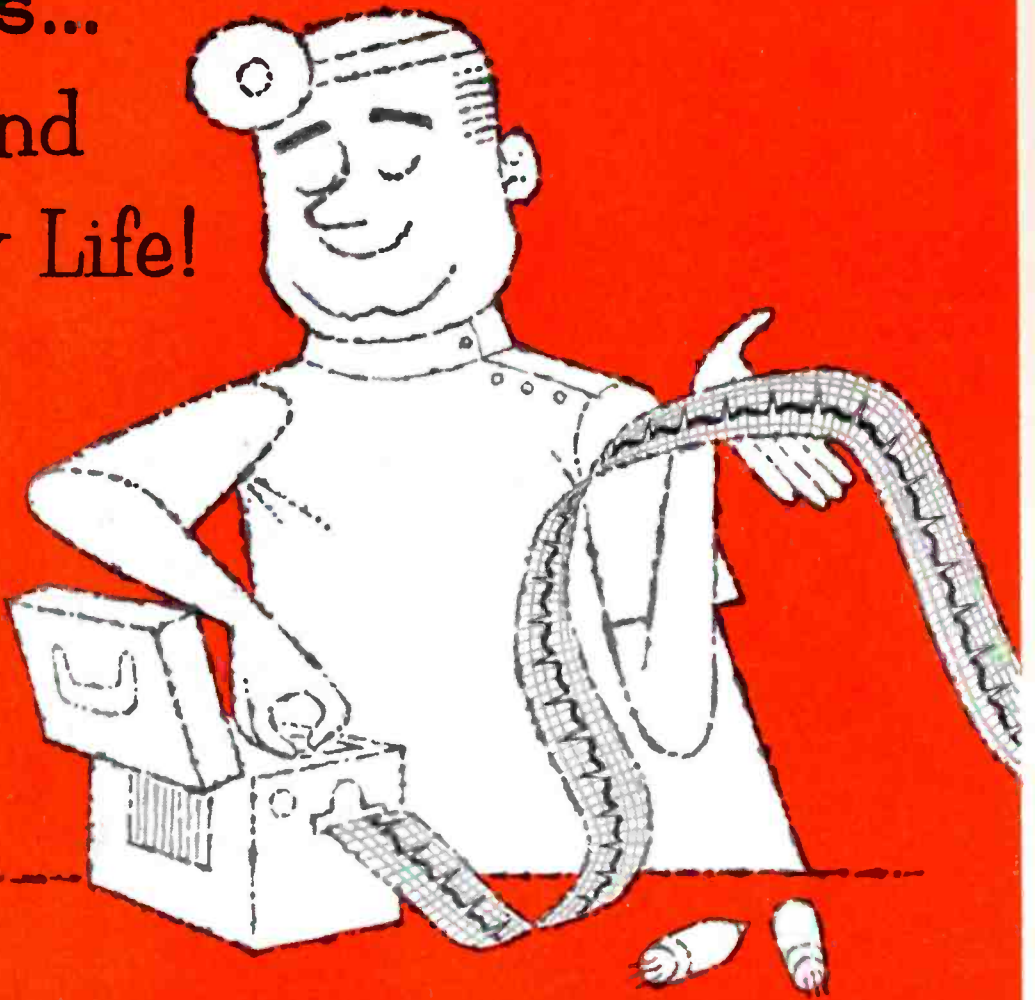

...for the RCA-6AU4-GTA

A "diagnosis" of the RCA-6AU4-GTA shows why it gives top performance for extended hours of operation.

*Tube life is increased* through improved heat dissipation, achieved with an increased bulb area, new plate shape, and the use of special "clad" plate material. *Early-hour failure is minimized* by elaborate precautions against internal contamination during production. *Borderline tubes are eliminated* through emission tests at extremely low heater voltage, and by aging and life tests at increased plate dissipation. The result is a tube with an unusual ability to resist plate-to-cathode arcing and internal breakdowns.

RCA-6AU4-GTA—*preferred* for TV damper circuits by original equipment designers—is a tube you can rely upon for replacement purposes. Do the same as *all* experienced TV technicians do, always ask your RCA Tube Distributor for RCA tubes!



Speed Up and Simplify Your  
Color-TV Servicing With  
RCA's New PICT-O-GUIDE

It's chock-full of practical information and illustrations—just what you need for profitable color-TV servicing. Available through your RCA Tube Distributor or send check or money order for \$4.50 payable to Radio Corporation of America, to RCA Commercial Engineering, 415 South 5th St., Harrison, New Jersey.



**RADIO CORPORATION OF AMERICA**  
Electron Tube Division  
Harrison, N. J.