

*Srivats*

# SERVICE

THE TECHNICAL JOURNAL OF THE TELEVISION-RADIO TRADE

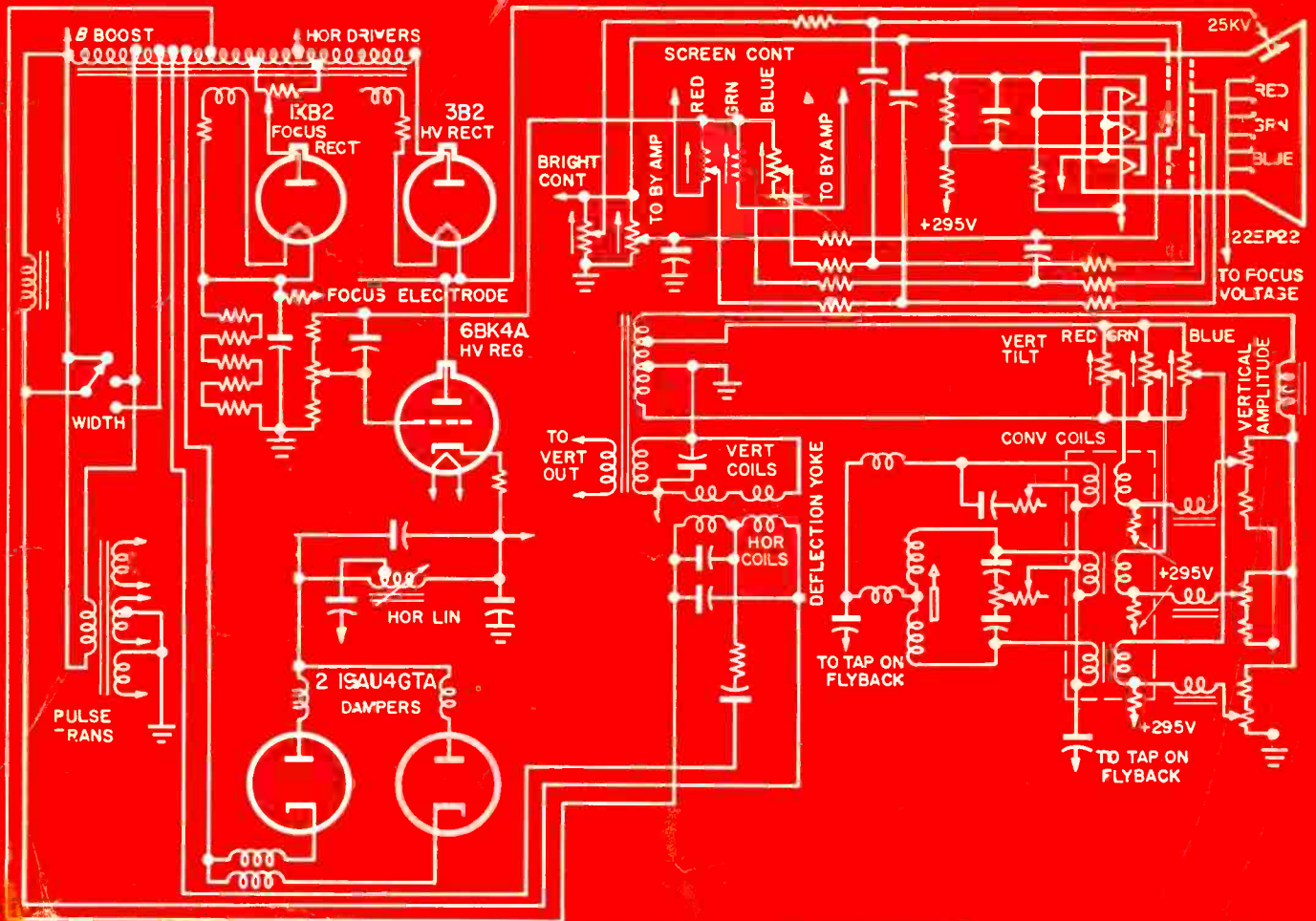

deflection, dynamic convergence and  
 umbrance-circuit sections of 22-inch  
 rectangular 3-gun tube color-TV chassis.  
 See circuit analysis, this issue

R TURSE  
 CLARKE LANE, N.J.  
 POMPTON LAKES, N.J.  
 10-57

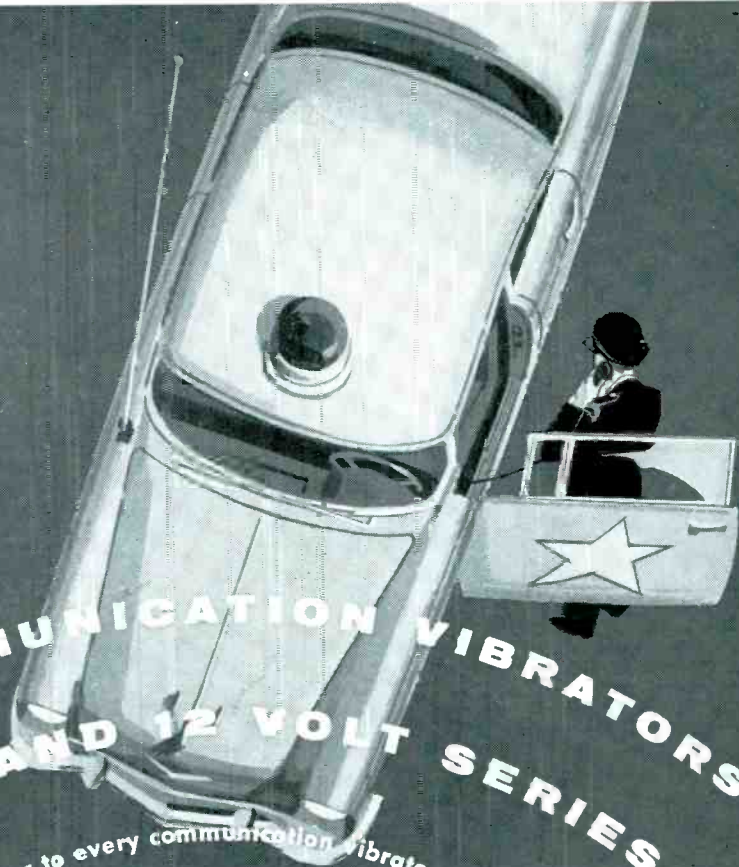

# RADIART COMMUNICATION VIBRATORS IN 6 VOLT AND 12 VOLT SERIES

Here is the ABSOLUTE answer to every communication vibrator replacement ...  
 because NOW ... you are ABSOLUTELY CERTAIN of the proper vibrator  
 replacement for EACH original type! And QUALITY you can depend  
 upon because of superior engineering ... long lasting  
 dependable service because of quality controlled  
 manufacture which means MORE  
 performance hours per dollar!

## These 10 Types Offer Proper Replacement For Original Communication Equipment

Here is a 6 volt vibrator for EACH 6 volt operation  
and a 12 volt vibrator for EACH 12 volt operation!

Old Number	New Number	New Number
	6 volt	12 volt
5515	<b>5715</b>	<b>6715</b>
5518	<b>5718</b>	<b>6718</b>
★	<b>5721</b>	<b>6721</b>
★	<b>5722</b>	<b>6722</b>
★	<b>5725</b>	<b>6725</b>
5605	<b>5805</b>	<b>6805</b>
5620	<b>5820</b>	<b>6820</b>
5621	<b>5821</b>	<b>6821</b>
5622	<b>5822</b>	<b>6822</b>
★	<b>5824</b>	<b>6824</b>



THE **RADIART** CORPORATION  
 CLEVELAND 13, OHIO  
 VIBRATORS • ALTO AERIALS • TV ANTENNAS  
 ROTORS • POWER SUPPLIES

# RCA

# SELENIUM

# RECTIFIERS

Now, RCA offers you a top-grade line of selenium rectifiers for general replacement use in TV, radio receivers, and phonographs. Advanced design, select raw materials, and superior workmanship give you a *dependable* line of selenium rectifiers for *virtually* all service jobs.

### Advanced Design for Dependable Performance and Long Life

Note the wide-open plate spacing for elimination of solid center "hot spot." Design utilizes corrugated spacers for *excellent heat dissipation and rigid construction for rugged service.*

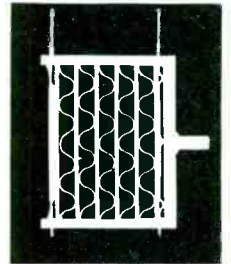

**NEW**—smaller size . . . for any given current, they are smaller than other types.

**NEW**—quicker installation . . . integral mounting stud.

**NEW**—wide-open design . . . insures maximum heat dissipation, cooler operation . . . no center "hot spots."

**NEW**—rigid construction . . . for rugged service.

**RCA SELENIUM RECTIFIERS**—a *comprehensive line*—for consistently good performance, easier installation, longer life and customer satisfaction. **ORDER FROM YOUR RCA DISTRIBUTOR TODAY!**

**-one comprehensive line for virtually all replacement requirements!**

#### WIDE SELECTION OF 12 TYPES

Max. Output ma	Max. Input volts	RCA Type
65	130	205G1
75	130	200G1
100	130	206G1
150	130	201G1
200	130	207G1
250	130	208G1
300	130	202G1
350	130	209G1
400	130	203G1
500	130	204G1
400*	130	210G1
500*	130	211G1

\*Special thin types for use where available space will not permit the use of type 203G1 or 204G1.



**RADIO CORPORATION of AMERICA**  
ELECTRONIC COMPONENTS  
HARRISON, N. J.

**NEW!**

*Technician's*  
**Quickie bench**

"GREATEST  
TIME-SAVER  
SINCE THE TUBE CADDY"

**Speeds Repairs On the Spot  
Increases Profit Per Call  
Builds Customer's Satisfaction**

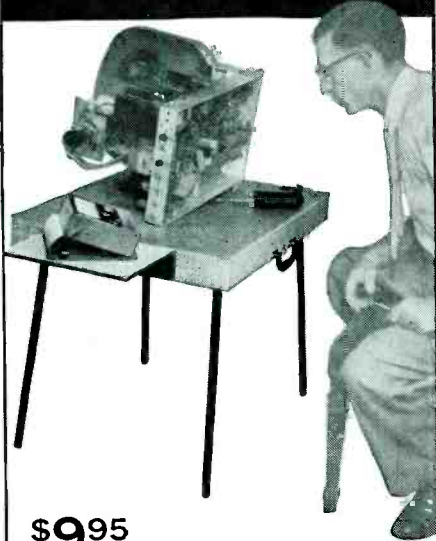

**\$995**  
Dealer Net

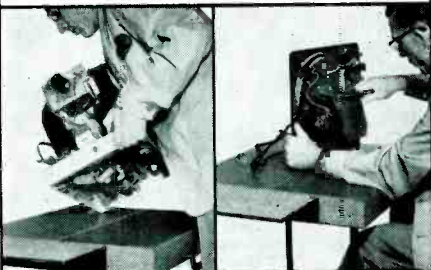

**STRONG** .....  
with "Craftsmanship in Cabinets."

**VERSATILE** ....  
use for any repairs.

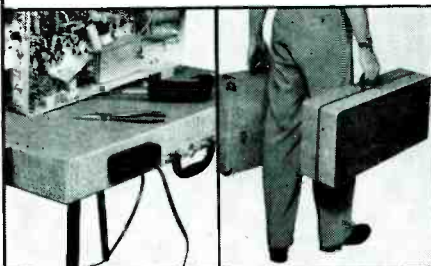

**EXTRA GADGETS**  
can easily be added. Not incl.

**CARRIES EASILY**  
only 26x11x6 1/4"  
Can fit under arm.

**ASK YOUR PARTS DISTRIBUTOR  
OR WRITE FOR FOLDER**

**Argos**  
PRODUCTS COMPANY  
310 MAIN STREET - GENOA, ILLINOIS

**SERVICE**

The Technical Journal of the Television-Radio Trade

Including SERVICE—A Monthly Digest of Radio and Allied Maintenance; RADIO MERCHANDISING and TELEVISION MERCHANDISING. Registered U. S. Patent Office.

**COVER CIRCUIT**

Rectangular Tube (22-Inch) Color-TV Chassis (Westinghouse 2292-1) . . . . . 18

**FEATURES**

Editorial . . . . .	Lewis Winner	9
Sound-System Installation-Repair on Pacific Coast . . . . .	Walter Flagler	10
Color-TV Receiver Servicing (Chicago Area Field Report) . . . . .	R. C. Janzow	14
This Month In SERVICE . . . . .		17
22-Inch All-Glass Rectangular Picture-Tube Color-TV Chassis (Cover; With Complete Circuit) . . . . .	Orval H. Jordan	18
Remote Control System Relays . . . . .	Lee Scott	22
White Dot-Bar Color Display Generator . . . . .	Robert D. Wengenroth	24
2-Way High-Band Installation Notes (Service Engineering) . . . . .	A. R. Sinclair	30
Community-TV Antenna-System Maintenance . . . . .		33
TV Snivets: Causes and Cures (Servicing Helps) . . . . .	W. O. Hamlin	34
Mobile Sound Systems (Equipment-Installation Requirements) . . . . .		38
Acceptance Tube Tests To Minimize Callbacks (Tube News) . . . . .		46
NCTA Fifth Annual Convention Highlights . . . . .		56

Degaussing Color-Tube Coil . . . . .	14	Hickok Color Display Generator . . . . .	24
Color/B-W TV Signal Splitter . . . . .	14	G.E. 144-152 Mc Receiver . . . . .	30
Westinghouse 2292-1 Color Set (Cover) . . . . .	20, 21	2-Way Car Noise Source-Cures . . . . .	30
Relay Bounce 'Scope Check . . . . .	22	TV-Line Amp Fil Adjuster . . . . .	33
Remote-Relay Circuitry . . . . .	23	Six-Horn Switching Array . . . . .	40

**DEPARTMENTS**

Industry News . . . . .	26	Latest in Audio . . . . .	42-45
Personnel . . . . .	27	TV Antenna-Accessory Developments . . . . .	52
Catalogs, Bulletins and Books . . . . .	28	Instruments . . . . .	53
Ten Years Ago in SERVICE . . . . .	28	Bench-Field Tools . . . . .	54
Association News . . . . .	29	TV Parts . . . . . Accessories . . . . .	54
		Components . . . . .	55

Index to Advertisers . . . . . 55

Entire Contents Copyright 1956, Bryan Davis Publishing Co., Inc.

Second-Class mail privileges authorized at New York, N. Y.; additional entry at the Post Office, Norwalk, Conn. . . . . Subscription price: \$2.00 per year in the U.S.A. and Canada; 25 cents per copy. \$3.00 per year in foreign countries; 35 cents per copy.



EDITOR and PUBLICATION DIRECTOR

**Lewis Winner**

Associate Editor: **David E. Pearsall II**  
Assistant Editor: **Robert D. Wengenroth**  
Editorial Assistant: **Eli Cohen**

Art Director: **Anthony R. Aliffi**

Supervisor, Circuit Diagrams:  
**Michael D. Ballezza**

Ass't Supervisor, Circuit Diagrams:  
**Norman Cohen**

Editorial Production: **Astrid Kelly**

**CIRCULATION DEPARTMENT**

Circulation Manager: **A. Goebel**

Ass't Circulation Mgr.: **A. Kiernan**

**ADVERTISING DEPARTMENT**

Advertising Mgr.: **Aaron L. Lafer**

Business Mgr.: **F. W. Boyd**

East-Central Rep.: **James C. Munn**  
2253 Delaware Dr.  
Cleveland 6, O.  
Tel.: ERievew 1-1726

Pacific Coast Rep.: **Brand & Brand**  
1052 W. 6th St.  
Los Angeles 17, Cal.  
Tel.: MADison 6-1371

Published Monthly By  
**Bryan Davis Publishing Company, Inc.**  
52 Vanderbilt Ave., New York 17, N. Y.  
Tel.: MURray Hill 4-0170

B. S. Davis, Pres. F. W. Boyd, Sec'y



REPLACE WITH

# General RADIO BATTERIES



General batteries are factory-fresh . . . shipped from 11 conveniently located warehouses. They test "Good" on your meter, and always give your customers *dependable service*. Your customers will rely on *you* to supply these top-quality replacement radio batteries. Ask your jobber about General Batteries.

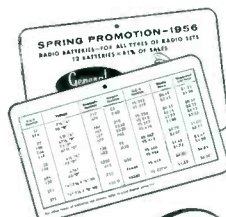

**FREE**— We would like to give you, for your day-to-day use, General's handy new pocket-size replacement batteries cross reference. It shows specifications and list prices of batteries, and covers all of the most popular types of batteries. Send in the coupon below—today!



EXPORT OFFICE: 431 5th Ave., New York 16, New York  
IN CANADA: General Dry Batteries Ltd., Toronto 4, Canada

J. J. Langlois, General Sales Manager

**GENERAL DRY BATTERIES, INC.**  
13000 Athens Ave., Cleveland 7, Ohio

Please send me General's new radio replacement batteries pocket-size cross reference.

Name \_\_\_\_\_

Firm Name \_\_\_\_\_

Address \_\_\_\_\_ (street) \_\_\_\_\_ (city) \_\_\_\_\_ (state)



SEE US IN BOOTH NO. 213 AT MAY PARTS SHOW

Baron Brann / New York

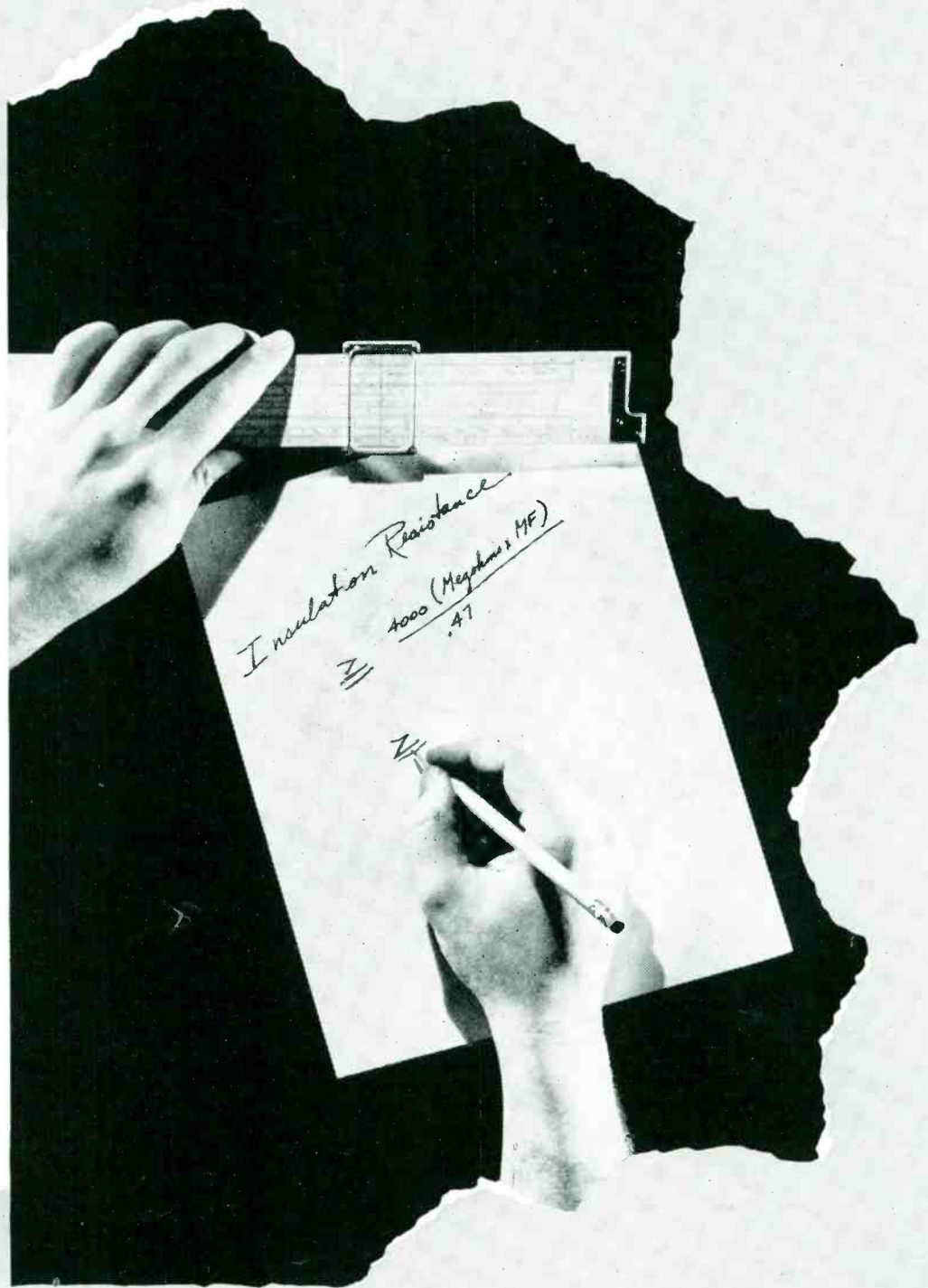

## HE PROVED IT FOR HIMSELF!

The new Pyramid Imp is smaller, yet better than any other molded paper tubular capacitor; Operates at full rating of 100°C (212°F—boiling point); Exceeds moisture resistance requirements of U. S. Government specifications MIL-C-91A; Copperweld leads are securely imbedded to withstand 4 360° bends without breaking.

These features, plus an almost indestructible thermo-setting plastic encasement make Pyramid Imps your best molded paper tubular capacitor.

*For full information on Pyramid capacitors and rectifiers, see your local distributor or write to*



DISTRIBUTOR DIVISION

**PYRAMID** ELECTRIC COMPANY

1445 Hudson Blvd., North Bergen, N. J.

# Directronic<sup>®</sup> TV ANTENNA SYSTEMS

*the Ultimate in Antenn-gineering*

by **Snyder**  
PHILADELPHIA

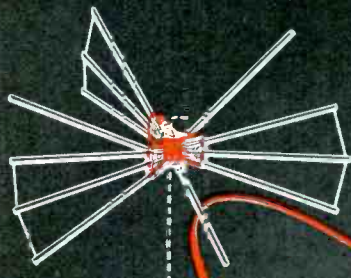

**AX-520 METROPOLITAN**  
SINGLE BAY  
SUPER DIRECTRONIC

22.<sup>50</sup> LST

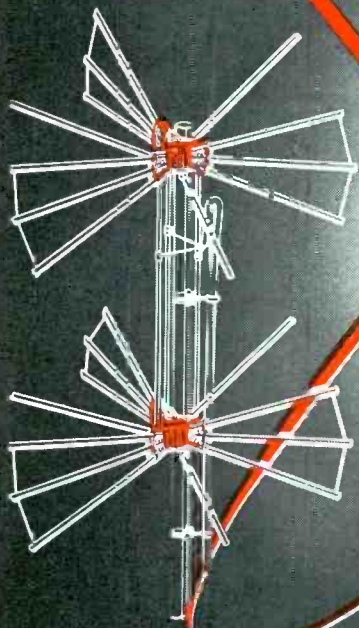

**AX-524 FRINGE AREA**  
TWO BAY  
SUPER DIRECTRONIC

47.<sup>50</sup> LST

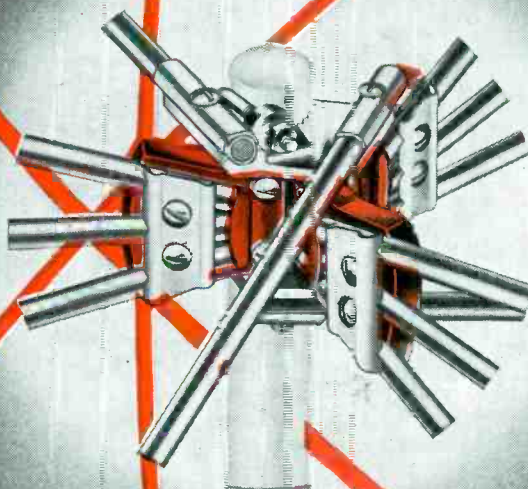

**DIRECTRONIC**  
6-POSITION BEAM SELECTOR  
CLEARS PIX INSTANTLY ON ALL CHANNELS



**K-80 DIRECTRONIC**  
"DO-IT-YOURSELF"  
TV TENNA KIT

COMPLETE! Nothing Else to Buy

24.<sup>75</sup> LIST



# SNYDER

SNYDER MFG. CO., PHILADELPHIA 40, U.S.A.  
BELLEVUE TUBE MILL INC., PHILADELPHIA  
SNYDER ANTENN-GINEERS, LTD., TORONTO 14, CANADA  
WORLD EXPORT: ROBURN AGENCIES, INC., N. Y.  
VAN DER HOUT ASSOC., LTD. NEW TORONTO, CANADA  
SNYDER ANTENN-GINEERS, INC., LOS ANGELES 58

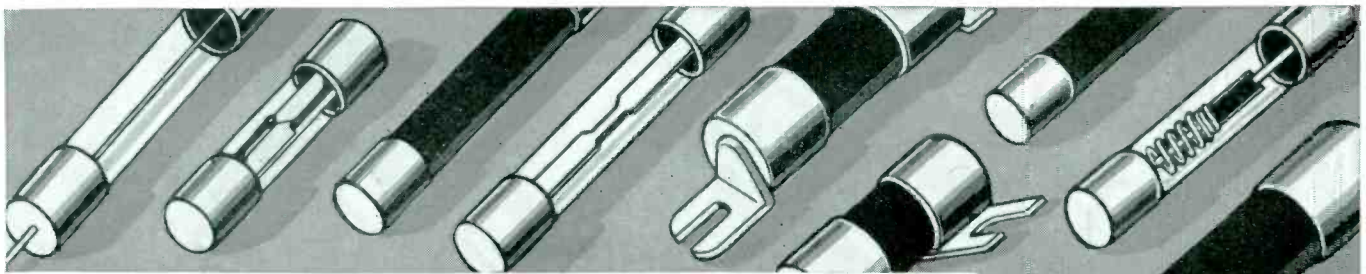

# Be sure of dependable electrical protection — Standardize on BUSS Fuses

## Here's why —

To assure you of safe and trouble-free electrical protection — BUSS fuses are tested in a sensitive electronic device. Any fuse not correctly calibrated, properly constructed and right in all physical dimensions is automatically rejected.

That's why you can rely on BUSS fuses to operate properly and protect completely. This unflinching dependability under all service conditions helps safeguard the good name of your service against loss of customer goodwill.

## One source for all types and sizes of fuses —

It's easy for you to select the fuse to meet your requirements. The com-

plete BUSS fuse line includes: standard types, dual-element (slow blowing), renewable and one-time types — in sizes from 1/500 amp. up . . . plus a companion line of fuse clips, blocks and holders.

## BUSS fuses have ready customer acceptance —

BUSS is the Known brand of fuses. This reputation is built on the millions upon millions of BUSS fuses used over the past 41 years in homes, farms and industry, as well as in electronic equipment. Handling quality products, as BUSS fuses, can help you maintain your reputation for quality and service.

*For more information on BUSS and Fusetron small dimension fuses and fuseholders . . . Write for bulletin SFB.*

9-658

Makers of a complete line of fuses for home, farm, commercial, electronic, automotive and industrial use.



**BUSSMANN MFG. CO.**  
(Div. of McGraw Electric Co.)  
UNIVERSITY AT JEFFERSON, ST. LOUIS 7, MO.

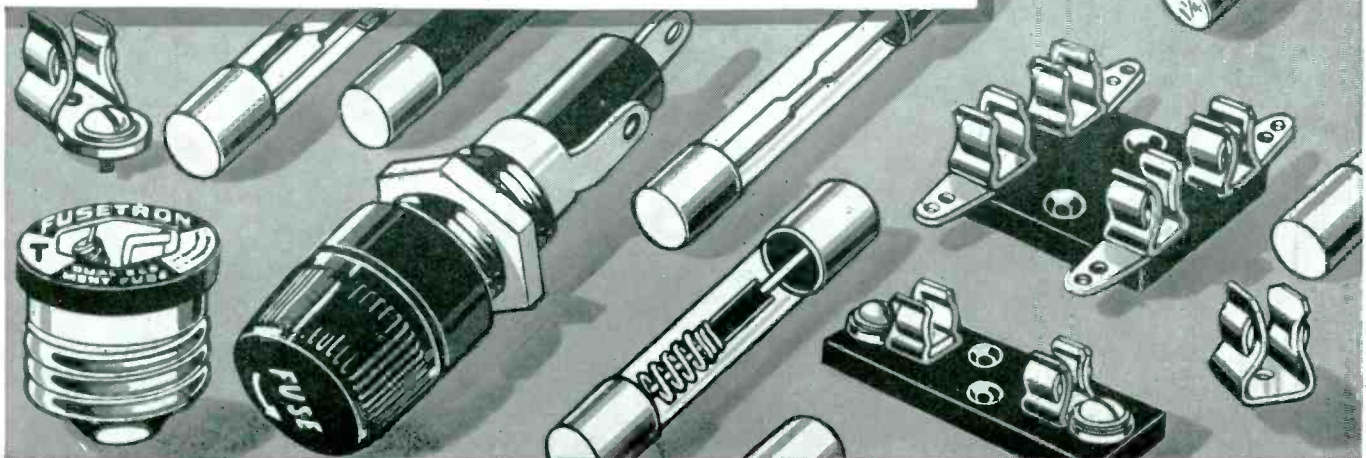
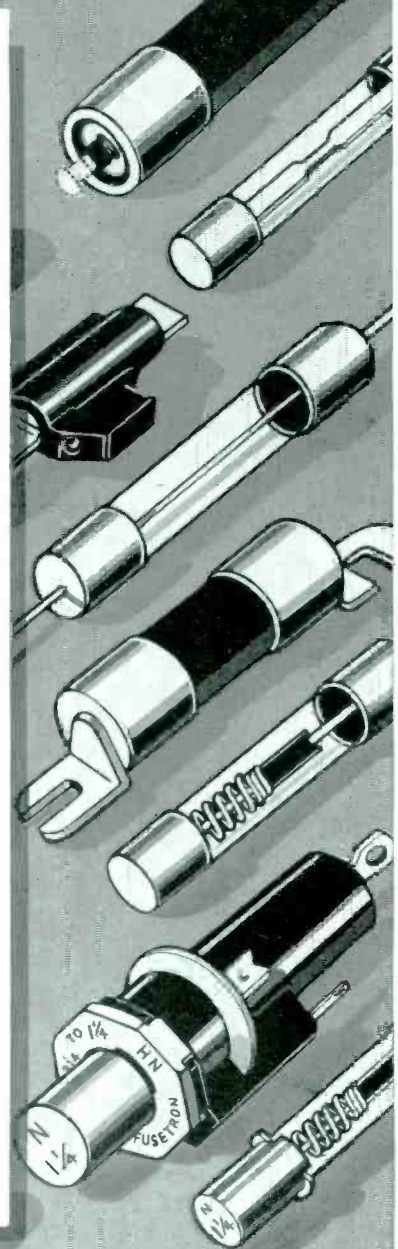





# 100% FULLY SATURATED NTSC\* STANDARD TV COLOR BAR GENERATOR

\* National Television Systems Committee as approved by Federal Communications Commission.

## MODEL 656XC

Absolutely necessary for accurate color TV receiver servicing. **\$495<sup>00</sup>** NET

Designed for use with all TV color systems approved by F. C. C.

- ✓ Completely self-contained . . . no complicated external synchronizing connections.
- ✓ Crystal controlled: (0.05% accuracy). Sub carrier and horizontal framing.
- ✓ Produces clearly defined wave forms to provide ease of alignment and assure minimum possible error.
- ✓ NTSC standard phase and brightness: This NTSC standard signal was used in designing all color TV receivers, and is now used by TV manufacturers.
- ✓ Self Checking: Assures operator that generator is producing accurate NTSC standard signal at all times.
- ✓ Generates 3 primaries, 3 complements plus black and white. (An important feature of this equipment is that white is produced by adding the 3 primaries.)
- ✓ In addition to color bars this instrument generates the necessary signals for I, Q, R-Y and E-Y for demodulator alignment.
- ✓ Also, White-Dot-Crosshatch patterns: (20 vertical and 15 horizontal, less those in blanking). (Vertical lines only or horizontal lines only). (Small size white dot pattern of 300 dots, less those in blanking).
- ✓ 3.58 MC sub-carrier output of 1 volt peak-to-peak is pro-

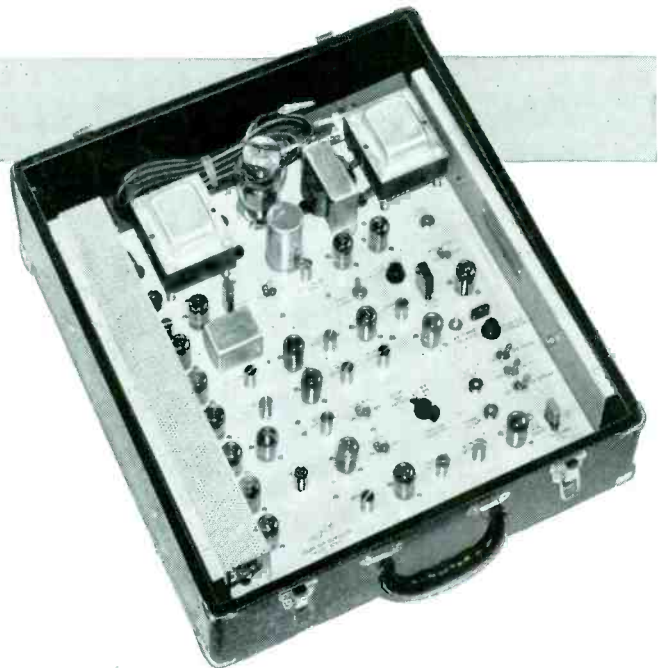

vided for trouble shooting and alignment of color synchronizing circuits.

- ✓ Output is either R.F. or Video. Equivalent vestigial side band modulation.
- ✓ The Model 656XC is preferred for its accuracy, stability and long trouble-free operation. This instrument was designed and built in cooperation with leading color TV receiver manufacturers, and is specified by them for their field service engineers.

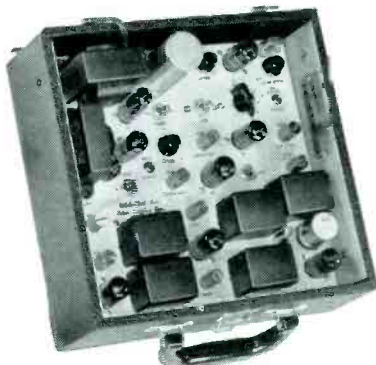

## MODEL 660

# WHITE DOT COLOR DISPLAY GENERATOR

Provides either of 3 patterns on the screen of any color TV receiver:

White Line Crosshatch; 20 vertical and 15 horizontal, less those in blanking.

White Dot (small size); 300 dots, less those in blanking.

Color Display Pattern; crystal-accurate blended in sequence of orange, red, magenta, blue, cyan, green.

Model 660 features the necessary high degree of stability not found in Variable White-Dot generators. In the 660, all frequencies generated are crystal controlled and locked together with extreme stability.

Frequency of chrominance (color) signal is exactly crystal controlled to reduce possibility of alignment errors. This feature permits increased accuracy over ordinary color generators which use a free-running oscillator.

RF output frequency is in preset channels, 2 thru 6, to allow easy selection through a built-in switching arrangement.

Small dot and crosshatch size down to two lines in both horizontal and vertical planes.

THE HICKOK ELECTRICAL INSTRUMENT COMPANY

10521 Dupont Avenue • Cleveland 8, Ohio

Ask your Electronic Distributor for a demonstration today, or write direct for additional technical details.

**\$229<sup>50</sup>** NET

ANOTHER **FIRST** FOR **RAYTHEON**

**BONDED ELECTRONIC TECHNICIANS**

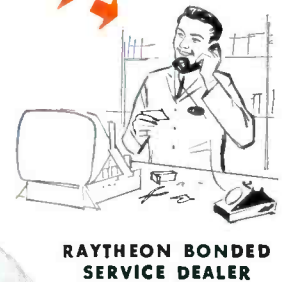
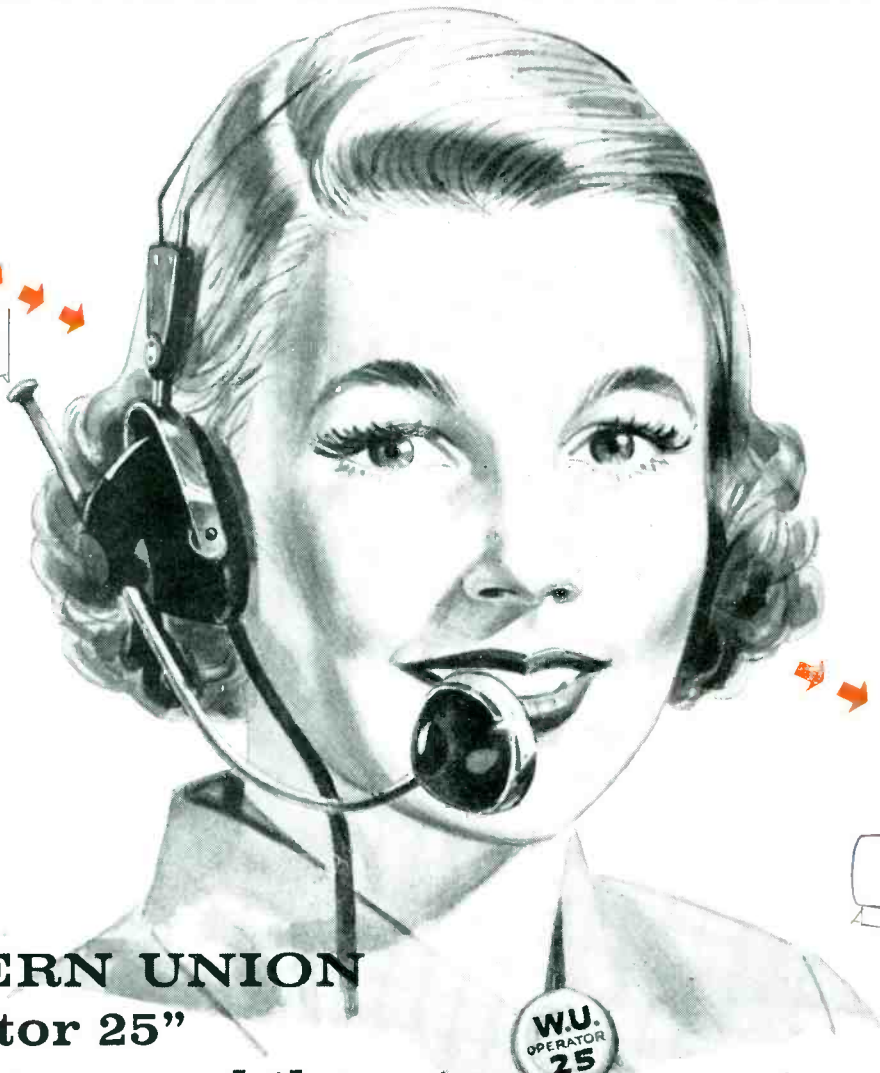

**WESTERN UNION**  
**"Operator 25"**  
**will recommend them to more customers**

Something new — and very important — has been added to the sales force of Raytheon Bonded Electronic Technicians. It's "Operator 25". Customers seeking Radio-TV Service simply call Western Union by number and ask for "Operator 25". In answer to their request for a reliable source of bonded service, "Operator 25" gives them the name and phone number of the nearest Raytheon Bonded Dealer. That means more business — exclusive business — for Raytheon Bonded Electronic Technicians.

This customer producing new sales advantage, plus the cash-protection of the Raytheon Bond,

the Raytheon Bonded Certificate, ID Cards, Decals, Raytheon Creed Displays, the Raytheon Code of Ethics, Classified Telephone Directory listings, all backed by sound, hard-hitting national advertising in LIFE, TIME, NEWSWEEK and TV GUIDE — make the Raytheon Bonded Electronic Technician Program the most powerful sales force a service dealer can have.

Call your sponsoring Raytheon Tube Distributor and ask him if you can qualify as a Raytheon Bonded Dealer.

If you can, you're well on your way to more volume and profit.



**RAYTHEON MANUFACTURING COMPANY**

*Receiving and Cathode Ray Tube Operations*

Newton, Mass. • Chicago, Ill. • Atlanta, Ga. • Los Angeles, Calif.

Raytheon makes all these { Receiving and Picture Tubes, Reliable Subminiature and Miniature Tubes, Semiconductor Diodes and Transistors, Nucleonic Tubes, Microwave Tubes

## Progress on Parade

FOR OVER A DECADE, at the Parts Show in Chicago, industry has presented a bright array of developments that has served not only to simplify and expedite installation and repair, but improve the performance of equipment on which servicing is required. At the exhibit, held last month, industry once again scored with an impressive display of engineering advancements that will truly make life more pleasant for Service Men in the days ahead.

THE IMPROVEMENTS appeared on every front: Instruments for color and b-w TV and radio, too, miniaturized components, audio, antennas and accessories.<sup>1</sup>

Test-gear row sparkled with ingenious design creations.<sup>2</sup> On view, for the first time, were flying-spot scanners for service work, heretofore found only in broadcast stations and labs, but now patterned for the bench and field. One instrument, tagged as a picture-pattern video generator and supplied with three slide transparencies, has been built to provide Indian head test, white-dot and white-line cross-hatch images on the screen of TV chassis for monochrome or color-TV adjustments. A fully-modulated *rf* carrier containing sync pulses, plus video information, is developed in the generator's circuit to drive the TV set. Heart of the device is an automatic-focusing five-inch scanner tube whose phosphor is matched spectrally to that of a photocell pickup tube. Application possibilities of the unit were described as varied to include adjustments of linearity and brightness, aspect ratios, convergence and video amplifiers; also installation as a video page-system transmitter for closed-circuit work.

ALSO ON STAGE were color-bar generators<sup>2</sup> designed for adjustment of color phasing and matrix networks, and the supply of basic signals required for testing of the *rf* carrier, color subcarrier, sound carrier, horizontal sync pulses, luminance and brightness. An analysis of one model designed for such color-set service appears in this issue.<sup>3</sup>

<sup>1</sup> See May SERVICE for preview reports describing a number of these new innovations.

<sup>2</sup> Complete exclusive technical field reports on these developments will appear soon in SERVICE. <sup>3</sup> See page 24.

TUBE TESTERS also revealed new intriguing trends in design. One piece of equipment featured a transconductance-type circuit that simulates actual operating conditions for tube checks. Employed in the test circuit is a 400-cycle oscillator that feeds a signal to the tube being tested and a tuned output indicator; this arrangement, in effect, serves to isolate the test signals from the supply voltage.

Another novel tube checker offered use of IBM type cards, coded for, it was said, all possible tube combinations; insertion of the card in a slot in the instrument, while a tube is under test, was claimed to provide vital information about the tube's performance capabilities. A chart, accompanying the tester, provides top-efficiency comparison data.

ANOTHER PRACTICAL INSTRUMENT shown, based on the use of signal-tracing principles for both visual and aural tracing, included an *rf* probe with an amplifier-detector tube effective, it was said, up to 300 mc, and an audio channel with a three-stage preamp, featuring a cascode circuit plus overall feedback. The preamp, it was claimed, provides wide-band response and an additional voltage gain of 400 for a 'scope or *vtvm*.

ANTENNAS bristled with new design ideas, too, at the May show. The recent discovery that it is possible to receive reliably beyond-the-horizon signals, has prompted the development of antennas that can be used in the deep-deep fringe zones, where scatter-signal-reception conditions obtain.

One antenna, designed for such applications, exhibited in Chicago, uses three vee'd elements in combination with four parasitic reflectors, plus a tilt control for trans-horizon peaking. Commenting on the tilt feature, the designer of the antenna said that field studies have disclosed that the angle of signal arrival departs markedly from the horizontal and varies in degrees of departure from location to location. Accordingly, it was said, a method of antenna tilting to allow for improved pickup was suggested; the tilt technique included was found to add substantial signal gain.

INDUSTRY CAN well be proud of the products they unveiled at the May show; a genuine display of progress on parade.—L.W.

# A Field Report

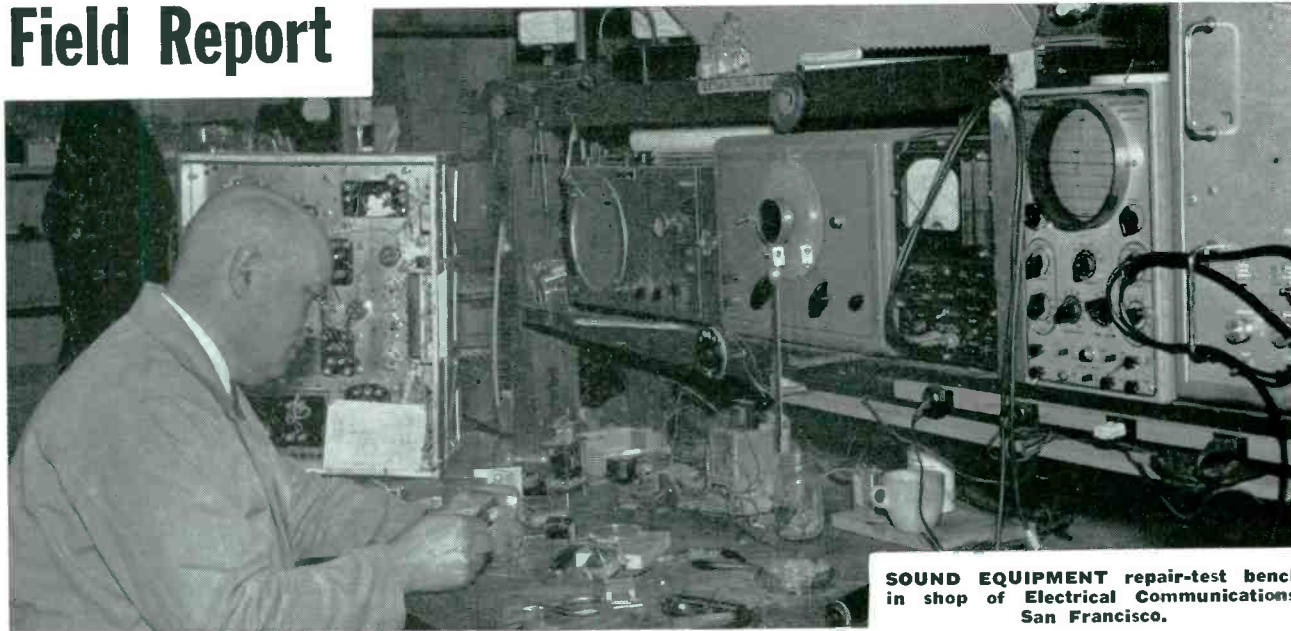

**SOUND EQUIPMENT** repair-test bench in shop of **Electrical Communications**, San Francisco.

## Sound-System Installation-Repair On the Pacific Coast

OURS IS A SERVICE ENGINEERING business, specializing in the maintenance and repair of intercom and sound systems. We have served over 500 different customers, primarily industrial and commercial over a seventeen-year period. At present we maintain equipment for approximately 200 different customers.

Our staff includes electrical, electronic, mechanical engineers and serv-

ice engineers, in addition to a three-man field force, all working under the direction of our chief engineer, Eric Cogill.

### *Versatile Crew*

Our field crew are familiar with almost every make of intercom equipment including private telephone systems. Most of the service work is done in the field, although equipment

must be brought to the shop when extensive repairs are necessary.

Tubes are the main cause of failure. Total tube replacements run approximately 100 per month.

### *Extensive Use of Cables*

When making new installations, we make it a practice to employ cables with more pairs than required initial-

**SOUND SERVICE** truck crew of **Electrical Communications**: Jack Plaa, William Voreyer, Larry Buttei and Don Maben.



**LOADING SOUND** - installation - service truck for a field job.

by **WALTER FLAGLER**

*Electrical Communications, Inc.  
San Francisco, Calif.*

ly, to permit easy expansion and to have spare conductors available in case of cable troubles. Although cable troubles are infrequent, we have had to replace cables which were damaged by vermin. Our installation problems are much the same as those of the telephone companies, since we too have to run cables over wide areas in existing buildings. Thus, our men must be familiar with building construction, municipal and regional codes and telephone techniques, in addition to being well grounded in electronics.

#### *Special AF Test Gear*

We do not service television or radio receivers, except FM and FM-AM tuners used in centralized sound systems; thus, our test equipment requirements differ from those of the average radio-TV service operation. We are mainly concerned with audio frequencies and low power electrical circuits. Our shop is provided with laboratory grade instruments including a wave analyzer, audio signal generators, scope, vacuum tube voltmeters and a digital counter.

#### *Typical Sound Jobs*

We designed and built the intercom system for the San Francisco-Oakland Bay Bridge. We also designed a 200 line automatic telephone switchboard.

Currently, we find a great deal of activity in super-market sound systems.

#### *Other Shop Activities*

In addition to servicing and installing intercom and sound systems, we design and custom-build telephone switchboards, electrical and electronic control systems, dial operated openers for electric door locks, dial and magneto telephone signaling systems and special control and selective calling systems for mobile radio operations.

#### *30 Years of Progress*

In this age of specialization, we are at one and the same time diversified,



**SOUND SYSTEM** for a super-market using ceiling speakers and check-stand units designed and installed by Electrical Communications.



**MACHINE-TOOL** setup in rear of shop used to design and build special equipment for sound installations.

as well as specialists in a narrow segment of an industry which has very broad applications.

While we are relatively large, because of our dollar volume in the specialized field of intercom service, we nevertheless are a small company.

Our relatively small size permits us to be flexible, so we can move quickly and not have all our eggs in one basket. We have been in business for 30 years, weathered the depression, and now are growing on a solid foundation.

(Right)

**CONSTRUCTING** special sound gear developed by design crew of shop.

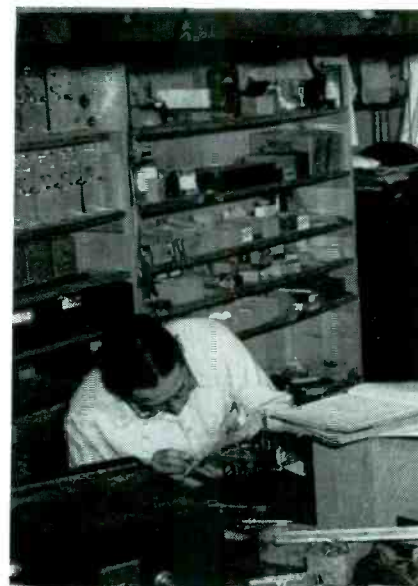



**NEW SERVICE-DESIGNED 1X2-A/B**



**NEW SERVICE-DESIGNED 6AL5**

**NOW**

**G-E SERVICE-  
54% OF YOUR**

**With 20 popular types you cut call-backs,**

**Ready: 6 brand-new Service-Designed Tubes for increased volume!**

**NEW 1X2-A/B.** *New filament shield post* ("lightning rod") helps to neutralize electrostatic pull of anode, reducing filament pull-outs to a minimum.

- Filament has special new coating that adheres closely, and will not flake off and expose the wire. Cuts tube arc-overs.

- Tubes are life-tested under actual operating conditions, including peak voltages that will be encountered. Assures dependable performance!

**PROTECTS AGAINST FILAMENT PULL-OUTS.**



**NEW 6BK7-A, 6BQ7-A, 6BZ7.** *Improved heater design* provides better heater-cathode insulation. Cuts shorts to a minimum, acts to prevent tube burn-outs.

- Heater-cathode leakage is greatly reduced. Gives improved tube operation, and stabilizes tube performance.

- High zero-bias Gm. This increases tube gain and improves TV reception in fringe areas, giving a clearer, sharper picture.

**YOU CAN CROSS OFF HEATER-CATHODE SHORTS!**



**NEW 6AL5.** *New, advanced heater design* limits initial voltage surges when tube is used in early-model series-string receivers. Same advantage applies in parallel-connected circuits. Tube flash burn-outs are greatly reduced. Vertical bars at right show approximate drop in initial voltage surges between heater of old tube and new Service-Designed 6AL5.

- New heater design also minimizes heater-cathode leakage. This is an important "plus" in AGC and video-detector applications.

**HEATER VOLTAGE SURGES REDUCED.**



**NEW 6CB6.** *New sprayed micas* combat interelement leakage, improving AGC performance by reducing any tube leakage in the controlled 6CB6 stages.

- Special-alloy screen grid gives superior heat dissipation. Result: freedom from G<sub>1</sub> and G<sub>2</sub> grid distortion and shorts.

- High zero-bias Gm, for improved fringe-area reception. Helps make the new 6CB6 a better-performing, more dependable tube!

**REGULAR MICA DEPOSITS WILL CAUSE LEAKAGE.**

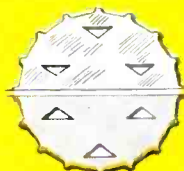

**NEW, SPRAYED G-E MICA IS LEAK-AGE-RESISTANT!**

**NEW SERVICE-DESIGNED**



**6BK7-A**

**6BQ7-A**

**6BZ7**



**NEW SERVICE-DESIGNED 6CB6**

# DESIGNED TUBES MEET REPLACEMENT NEEDS !

please customers on more than half your TV tube sales!

**E**VERY new General Electric Service-Designed Tube increases your profit opportunity. The 6 new types now available give you 20 Service-Designed Tubes in all . . . and by actual sales count for the year 1955, these 20 tubes meet 54 percent of your total TV replacement requirements!

Customer goodwill gets a big boost when you can put long life, improved performance into over half the tube sockets you fill! Call-back costs drop sharply. Your tube inventory needs are consolidated — for General Electric Service-Designed Tubes give top performance in *all* chassis!

G.E.'s first group of Service-Designed Tubes met 29 percent of all TV replacement needs. Now your sales potential is nearly doubled. Still more Service-Designed Tubes are in development . . . will increase your share of the tube market further.

Stock and install G-E Service-Designed Tubes! They cost no more than other tubes, are fully interchangeable with prototypes. They're widely advertised, nationally popular. Your G-E tube distributor has them. Phone him today! *Tube Department, General Electric Co., Schenectady 5, N. Y.*

**THESE 20 TUBES ARE "MONEY IN YOUR POCKET"!**

Clip out this list of General Electric Service-Designed Tubes . . . it will fit neatly in your wallet. A handy guide to types available!

1B3-GT	6AV5-GA	6BQ7-A	6CD6-GA
1X2-A/B	6AX4-GT	6BX7-GT	6J6
5U4-GA/GB	6BG6-GA	6BZ7	6SN7-GTB
5Y3-GT	6BK7-A	6CB6	12SN7-GTA
6AL5			25CD6-GB
	6BQ6-GA/6CU6		25BQ6-GA/25CU6

*Progress Is Our Most Important Product*

**GENERAL  ELECTRIC**

161-1A3

# COLOR-TV Receiver Servicing

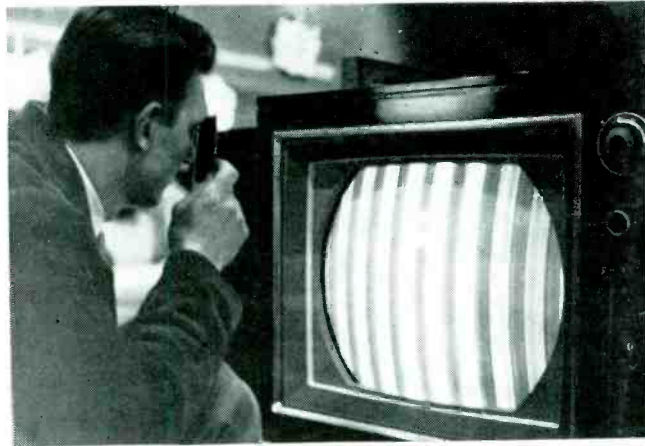

by **R. C. JANZOW**  
Western Area Engineer, RCA Service Company

## Based On Field Experiences in Chicago

(Above)

**CHECKING** with a codaviewer\* to adjust color phase, saturation and matrix.

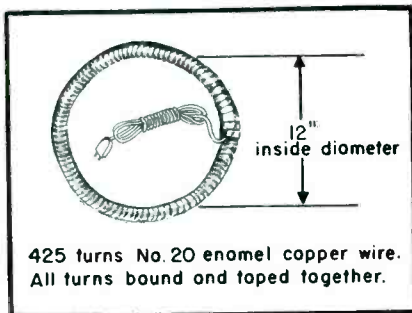

(Above)

**AN AC coil** designed for degaussing the metal picture-tube bell and associated hardware to obtain good purity.

(Below)

**RESISTIVE network** for dual b-w and color-chassis operation, that serves as a reactive signal splitter to prevent color loss due to mismatch.

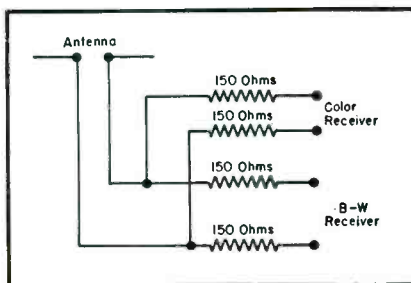

THERE ARE FOUR major problems that must be resolved in color servicing:

(1) Receiver adjustments for b-w reception; (2) antenna and transmission lines for color and b-w; (3) color rendition; and (4) alignment of color and monochrome circuits.

The usual height, width, centering and linearity adjustments, must be made for normal black and white reception. In addition, the high-voltage supply must be adjusted so that it delivers the required regulated voltage. It is important that these circuits function properly before proceeding with purity and convergence adjustments.

Color picture tubes can be readily adjusted to obtain good purity. Recent improvements in the light source used to expose the phosphor dots in the color tube have minimized the time required to obtain good purity. The metal picture-tube bell and associated hardware will at times become magnetized. In this case, one must degauss the picture tube and mounting hardware to obtain good purity. Degaussing can be done with an *ac* coil. The field-equalizing magnets around the outer edge of the picture tube need not be withdrawn into their keepers during degaussing; they need only readjust mount, if necessary, to obtain good edge purity. Care also should be taken not to expose the convergence or purity assembly on the neck of the picture tube to the *ac* demagnetizing field. To prevent remagnetizing of the picture tube by the *ac* coil, the current through it should be

cut off only when the coil is well removed from the receiver.

Unless a color receiver is moved from its adjusted location, purity will shift very little. Purity, however, can shift appreciably when heavy external fields are present. This effect was noted when several receivers were to be installed in a meeting room several floors above the main route of a subway. The heavy direct current through the subway supply lines set up an intense magnetic field which fluctuated widely with traffic conditions. The final solution was to move the receivers to a higher floor in the hotel in order to be out of the field of the subway electric lines.

Convergence adjustment can be speeded if a dot-bar generator<sup>1</sup> is used. This generator develops dots, vertical and horizontal bars, and a cross-hatch pattern. Each of these patterns can be used to expedite a segment of the convergence adjustment.

To illustrate: *Dots* can be used for center dot convergence before adjusting purity, and a check of convergence in a specific screen location; *vertical bars* permit adjustment of four red and green dynamic controls (vertical amplitude, vertical tilt, horizontal phasing, horizontal amplitude); *horizontal bars* provide adjustment of the blue dynamic controls (vertical tilt, vertical amplitude, horizontal phase and horizontal amplitude); and *cross hatch* serves to give a complete

<sup>1</sup>Such as the RCA WR36A.  
<sup>2</sup>See p. 37 for design details.



RIGHT: **Gordon Hattel, chief Service Man for RCA Service, checking out alignment for a color set.**

BELOW: **View of test equipment required for color-set alignment (left to right); video marker box, sweep generator, rf modulator, vhf signal generator and wide-band 'scope.**

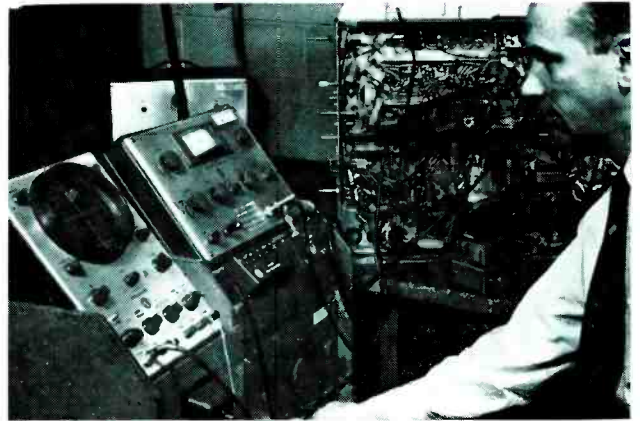
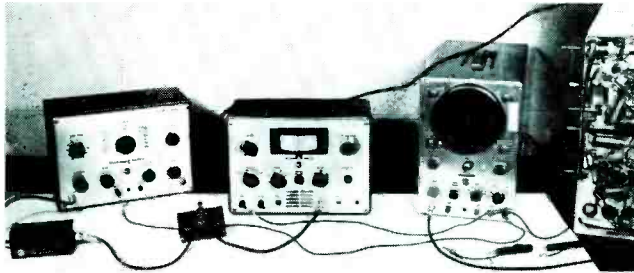

## Area Where Daily Daytime-Nighttime Color Programs are Now Being Broadcast

picture of convergence. Once skill has been obtained in the convergence operation, the cross-hatch pattern can be used alone because it contains elements of vertical and horizontal bars and dots.

A note of caution about convergence: When convergence patterns at either video or *rf* are used it is important that an off-the-air picture be locked-in vertically and horizontally with the convergence pattern. This is necessary because the horizontal and vertical scanning frequencies must be the same during convergence adjustments as they are during normal reception. If they are not, the dynamic convergence voltages obtained from the vertical and horizontal scanning circuits would be different during normal reception and misconvergence would result at a particular brightness level.

Picture-tube tracking is an additional adjustment which must be

made for good color as well as monochrome. This series of adjustments is made on the screen and control grid voltage of the color picture tube, so that normal changes in brightness and contrast of a typical televised scene will not cause the entire screen to shift color.

The antenna requirements for *good* color reception are much the same as those for black and white. Gain and directivity must insure adequate signal, clear of cochannel and multipath interference. A multipath or reflected signal will usually show as a color different than the desired image. In addition, the antenna response must be reasonably flat, within 2 db over a given 6-mc channel. Antenna response that departs from this value to a large degree can cause degradation of color or even complete loss of color information. *Orientation* of the antenna must be done in the usual careful manner. However, in some

cases it will be found that a seemingly perfect orientation for a black and white picture will deliver poor or no color information. The usual cause of this is a close-in reflection with phase opposite that of burst, reducing or cancelling color.

Another source of non-uniform response that can affect color is the transmission line and its termination. This is especially true when the present antenna and transmission line is fed to the color receiver, as well as the black and white receiver. Reactive signal splitters are available for this purpose. Any unused terminals of the splitter must be terminated with the proper non-inductive resistor to prevent severe line mismatch. A simple signal splitter, using resistors, which will prevent color loss due to mismatch, can be made. Sufficient signal, however, must be available at the resistive splitter from the antenna to

(Continued on page 37)

**TEST setup to determine mismatch on coax cable serving several receivers through a master antenna is shown below. At right is a typical color-chassis alignment setup in block form.**

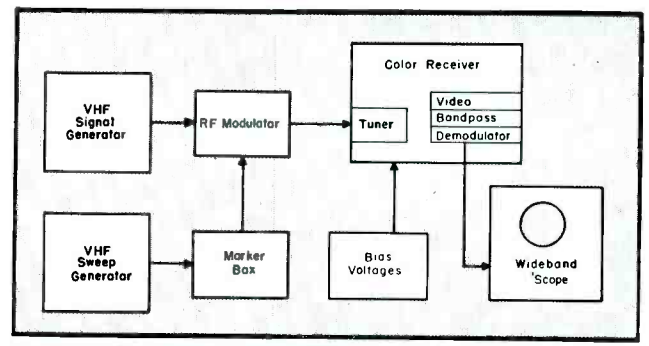
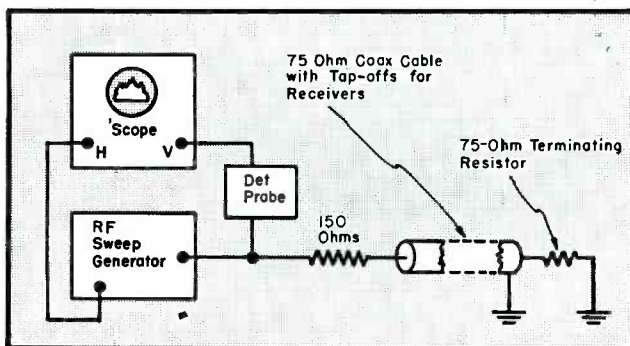



A fuse caddy for your tube caddy

**LITTELFUSE**, *Des Plaines, Illinois*

# THIS MONTH IN SERVICE

MOST SET OWNERS WELL SATISFIED WITH QUALITY OF TV SERVICE, SURVEY SHOWS--A majority of the nation's 38,000,000 TV-receiver owners are pleased with the promptness, quality, prices and courtesy of TV Service Men: So reported an independent market research expert recently upon the conclusion of a nationwide survey. . . . The study disclosed that over 90 per cent of the set owners interviewed approved the quality of the service work, the same percentage indicated that Service Men were pleasant and courteous, over 80 per cent stated that they were satisfied with price, and nearly 90 per cent thought that their call for service was answered promptly. . . . Over 80 per cent said that they would continue to do business with the same service shop. . . . These findings, the report declared, represent a solid vote of confidence on the part of the public in the skill and integrity of Service Men throughout the country.

FCC OKEHS LOW-POWER UHF TRANSLATOR STATIONS--The Federal Communications Commission has issued rules and regulations permitting the operation of ultrahigh translator stations as a . . . "further means of bringing TV service to small isolated communities and sparsely-settled areas outside the range of existing television stations". . . . Such stations, with a power of 10 watts and a possible effective radiated power of 100 watts (or more depending upon the gain of the antenna), will be allowed to pick up programs of existing TV stations (either uhf or vhf) and rebroadcast them on the upper fourteen ultrahigh channels (70 to 83) to serve areas now not adequately served by existing TV stations. . . . Only a single channel will be assigned to a TV station; however, more than one station can be used in any given area to provide multiple services. The new stations will not be required to adhere to any specified hours of operation. Also, remote-control operation will be permitted. According to the present interpretation of the ruling, one telecaster will be able to operate more than one translator station, but each outlet will function independently. . . . Commenting on the relationship between community antenna systems and translators, FCC spokesmen said that community antennas, although not established under authorization of the Commission. . . . "have contributed significantly in providing TV reception to isolated areas without service from regular stations. . . . However, community antenna service is limited . . . and the Commission is obligated to provide an . . . equitable distribution of service." Translators, it was said, are expected to provide that additional coverage. . . . It was recognized, however, that community-antenna systems provide multiple service and on a high-gain basis, whereas the translators will be single-station units, operating on limited powers.

PORTABLE RADIO-TV MARKET SOARING--Portables, both tube and transistor style, are now being groomed for their biggest year, with 25 to 30 per cent sales increases predicted. . . . Transistors are expected to account for most of the rising purchases. The trend to transistors has been underscored in the booming sale of the pea-sized units to set makers. According to RETMA, nearly two-million transistors, with a dollar value of about \$6-million, were sold to set makers during the first quarter of the year. A contributing factor to the swing has been the price cuts in transistors, narrowing further the gap between the prices of transistor portables and their tube counterparts. . . . One expert said that if the present interest continues, and it is expected that it will, it seems probable that practically all portable radios and a large percentage of table-model radios will be transistorized within the next eighteen months. . . . Also in the portable swing are the miniaturized TV chassis. If the present accelerated rate of sales holds here, and everyone believes that this movement will continue, TV portables should reach a sales peak of at least 3-million in '56 and 5-million in '57.

NATIONAL ASSOCIATION OF STATE GROUPS FORMED--An association of state service groups, the American Electronic Service Council, was formed a few weeks ago at a meeting in Kansas City. . . . Forrest L. Baker, representing the Texas Electronic Association, was named president; B. A. Bregenzer of FRSAP was elected executive vice prexy. Others elected included Howard Wolfson, secretary, and Murray Barlowe, treasurer.

# 22-Inch All-Glass Rectangular Picture

by ORVAL H. JORDAN

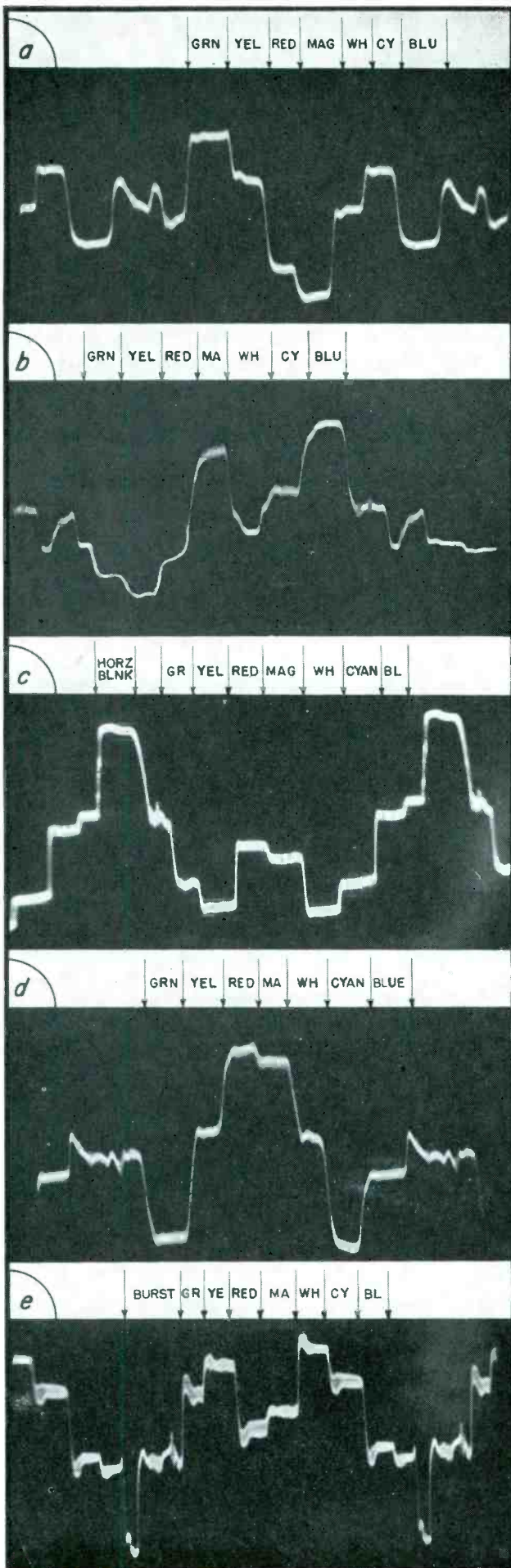

See Front Cover  
and pages 20,  
21 for Complete  
Circuit Diagram

**COLOR difference and luminance signal patterns.** (a): G-Y green color difference signal at green grid of picture tube. (b): B-Y color difference signals at blue grid of picture tube. (c): Luminance signal at red and green cathodes of picture tube. (d): R-Y red color difference at red grid of picture tube. (e): Luminance signal at detector test point.

THE DEVELOPMENT OF a 22-inch all-glass rectangular tricolor tube has made it possible to design a sub-assembly type<sup>o</sup> color chassis, with many circuit innovations, including a convergence system that requires no tubes.

Dynamic convergence voltages, vertical and horizontal, are supplied from the deflection circuits. Center convergence is accomplished by the use of magnets which are part of the convergence-yoke assemblies. These magnets rotate across the air gap between the two sections of ferrite core material. Each magnet is polarized in opposition across the cylindrical portion. By rotating the magnet, the polarity can be changed and proportioned for the correct beam positions. Each gun has a convergence yoke assembly and there is no interaction of one upon the other. The three electron beams are converged at the center of the raster by the magnetic forces and polarities set in preliminary adjustments of convergence. The blue gun has an additional magnetic assembly. This is for positioning the blue electron beam on a horizontal plane to converge with the red and green beams. The magnetic setting and adjustment of each assembly moves the beam at right angles to the gun position in respect to the screen. This is due to the fact that the magnetic field from the convergence yoke is continued in the picture tube by small ferrous metal pieces that are part of the accelerating anode. With the guns positioned 120° apart, only the blue beams will be moved up and down on a vertical plane, and the red

<sup>o</sup>Chassis contains four subassemblies: If power transformer and rectifiers; sweep board; chroma board; and horizontal drive, dampers, high voltage and audio output.

**AUTHOR** in lab adjusting color chassis using 'scope, adder, sweep generator, marker generator and color-bar generator.

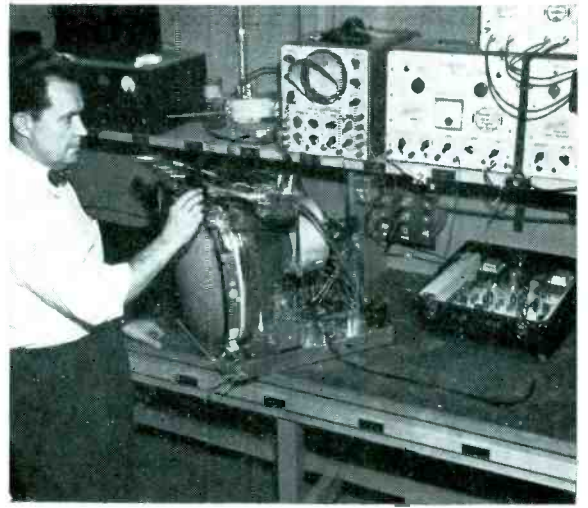

# Tube COLOR-TV Chassis

Color Lab Supervisor, TV-Radio Division, Westinghouse Electric Corp.

and green at 120° from each side of the blue. The red and green guns are on the same horizontal plane, and their beams will converge as the guns are at a 120° angle from each other. With the red and green converged the blue beam can be moved up and down to a point of convergence. If the blue beam can be positioned to the same horizontal plane, but will not converge, it is then necessary to adjust the blue-beam-positioning magnet for lateral positioning to have all three beams converged. It will be noted upon a visual inspection of the blue gun that the magnetic field is continued in the picture tube by two metal pieces and attached to the gun structure, one to the top and the other to the bottom. The magnet of the blue gun beam-positioning assembly can be changed by rotation; therefore changing the magnetic force upon the beam. This magnet can also be rotated 180° and change the direction of the beam deflection, but always on a horizontal plane.

Each convergence yoke has two sets

of windings; one for the application of vertical dynamic convergence and the other for horizontal dynamic convergence. The vertical output transformer has additional windings, or a second secondary; part of this winding is center-tapped and equal but opposite square waveform is on each, with reference to ground. One of the windings is continued and a higher square wave is the source for the development of a sawtooth voltage. The square wave shape is applied to a 1.2-henry reactance; this develops a sawtooth voltage across the vertical amplitude controls. The wave shape developed by combining the vertical tilt and sawtooth wave will be a parabola. The amplitude will be proportional to the setting of the control, since it is a variable divider. By adding the square wave shape from the vertical tilt control, which controls the polarity and amplitude to the parabola wave, the shape of the parabola can be changed to effect the rise and fall of the wave shape. The combined vertical tilt and parabola are applied

to the vertical windings of the convergence assembly. The horizontal transformer supplies a pulse at a horizontal rate.

The red and green guns of the picture tube are on a horizontal plane. The amplitude of the parabola is set to satisfy both, and the balance between them by adjustment of the red and green amplifier balance. The tilt of red and green are also balanced, and the amount of tilt by the horizontal-tilt control is adjusted for overall horizontal convergence of red and green. The blue-gun convergence circuit will have the same effect upon the blue beam, as stated, for red and green. The vertical convergence windings have a small amount of *dc* current flowing. The amount of current is proportioned to B+ to correct the convergence for variations of line voltage.

A four-stage staggered-tuned strip is used for *if*. The first and second stages employ 3BZ6s; semi-remote cutoff type of *rf* amplifiers. A wide

(Continued on page 48)

**TOP (left) and bottom (right) views of color-TV chassis sweep board.**

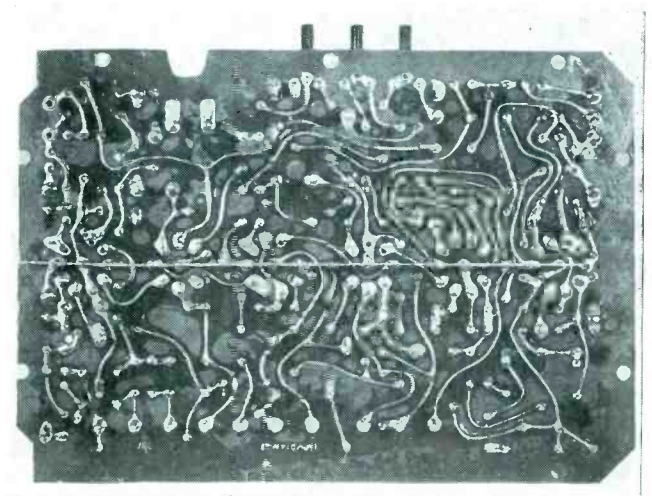
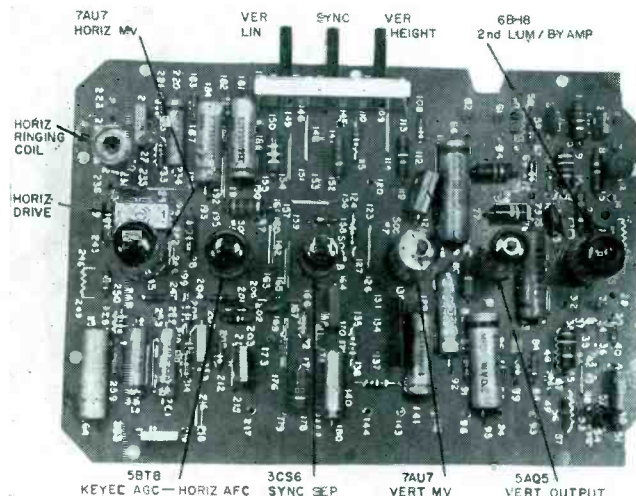

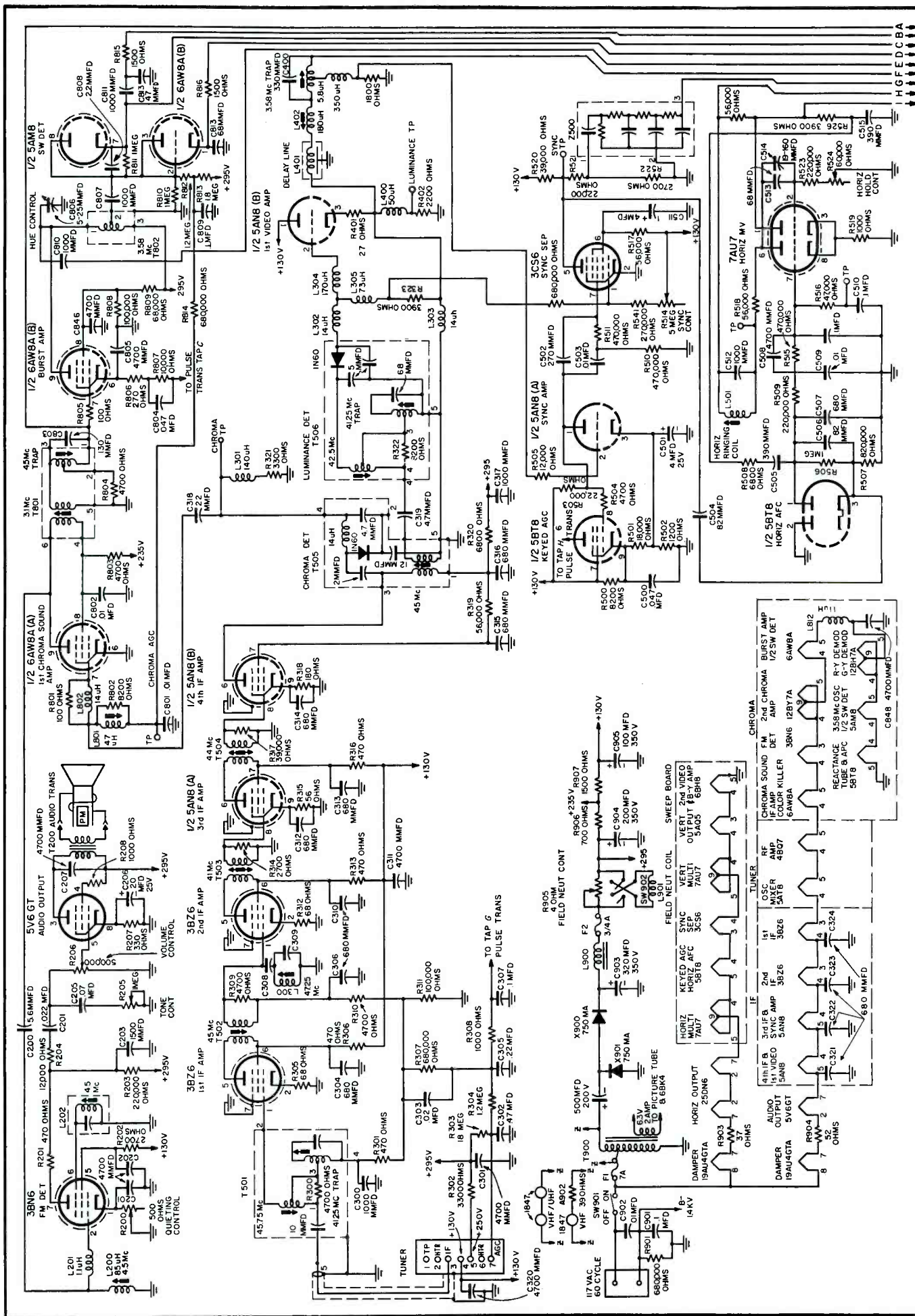

COMPLETE circuit diagram of Westinghouse 2292-1

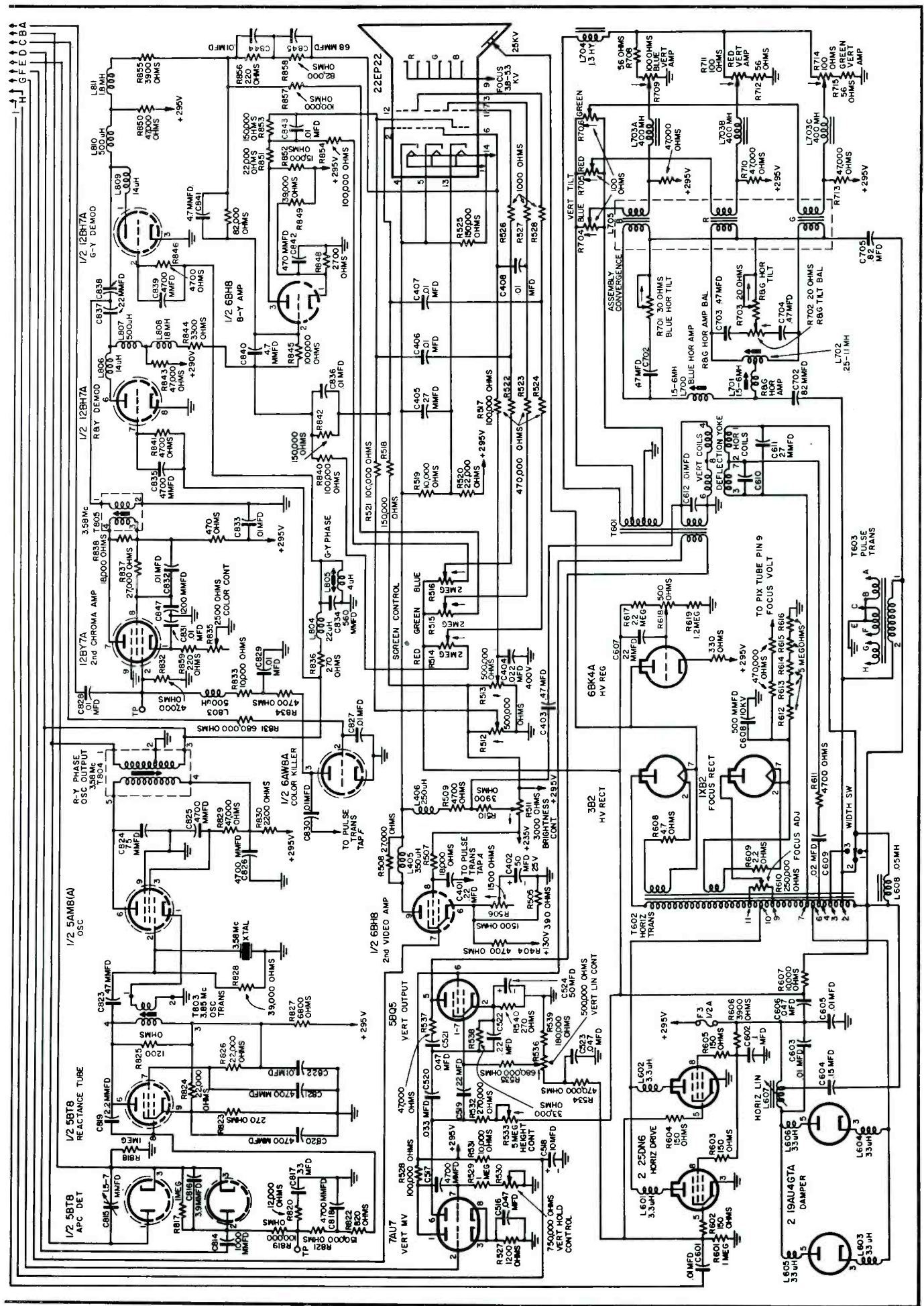

color-TV chassis using a 22-inch all-glass rectangular picture tube.

# Remote-Control System RELAYS

Now Found in Car Radios, Tape Recorders and TV Sets

by LEE SCOTT

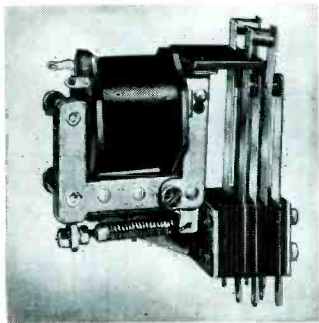
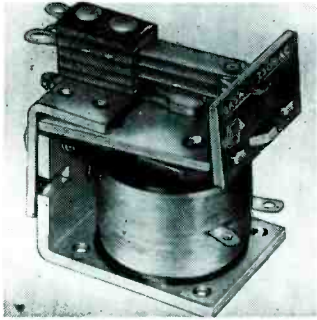

**RELAY types which may be found in TV remote-control units.** (Courtesy Potter and Brumfield, and Guardian Electric)

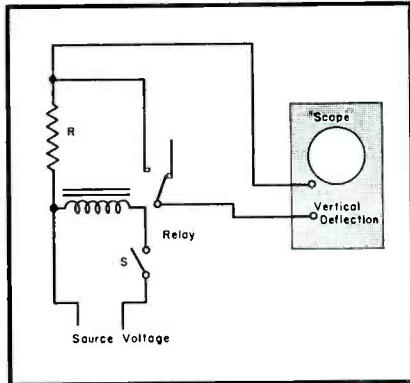

**CONNECTION of a relay to a 'scope to determine bouncing.**

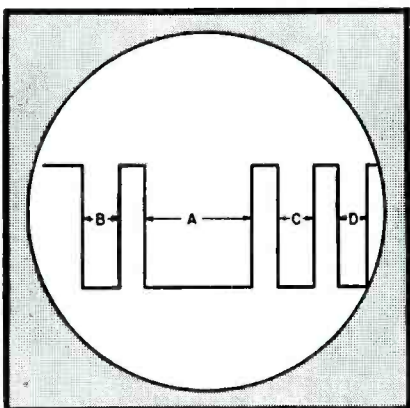

THE RELAY, once found only in power and telephone equipment, has become a vital component in the radio-TV-electronic industry. It will now be found in circuits which control automatically headlights of a car, opening of garage doors, and particularly in car radios for automatic signal seeking (by foot control), tape recorders (which are automatically shut off when not in use) and in TV remote-control units.

A typical relay used in a TV receiver remote-control unit\* is shown on page 23, at top. A *spsno* type (single - pole - single - throw - normally-open), it has a 33-ohm coil, operates at 20-v ac, and uses 1/8" diameter silver contacts.

### Relay Operation

The elements which comprise the relay are illustrated at upper right on page 23.

A source voltage permits current to flow through the coil which sets up a magnetic field around it. The direction and magnitude of the field are such that the field attracts the armature in the direction of the core. This closes the armature gap which, in turn, provides electrical contact between the armature and lower contact. Once electrical contact is established, a controlling current is permitted to flow through a separate circuit, since the armature and lower contact are connected in series with the circuit. In other words, this separate circuit (such as in a remote-control unit) can function only when the relay is activated, since the latter

determines whether or not current is permitted to flow through the circuit.

When the source voltage is removed, the armature pulls away from the lower contact, thus opening the circuit and rendering it inoperative. The coil spring, supported by a spring hook and armature, returns the armature to its original position and holds it there until the source voltage is permitted to activate the relay once again.

A stationary arm and moving blades (and armature lifter) form supports for the relay contacts. The stop bracket prevents the armature from hitting the core too hard. The necessary contact tension is provided by the contact blade tails which are held in place by contact mounting screws. The coil lug serves as a connection to the coil and is insulated from the field piece by a lug insulator.

In *dc* relays, residual magnetism (magnetic flux existing in a material after the magnetizing force is removed) usually causes the armature to adhere to the core face when the current from the coil is removed, thus keeping the contacts closed. To prevent this, a non-magnetic shim (referred to as the residual in illustration) is spot-welded to the armature or core face. Some types use a non-magnetic screw in the armature, thereby permitting the air gap to be adjusted for the best removal of the residual flux. Another way to minimize residual magnetism is to use a stronger coil spring; however this necessitates the use of more power to the coil. For very sensitive relays,

**PULSE waveform produced by a relay which bounces.**

\*Sentinel 21101 (61E24); SERVICE, Nov. '55. Relay is a Relay Service Co. product; X1F30F.



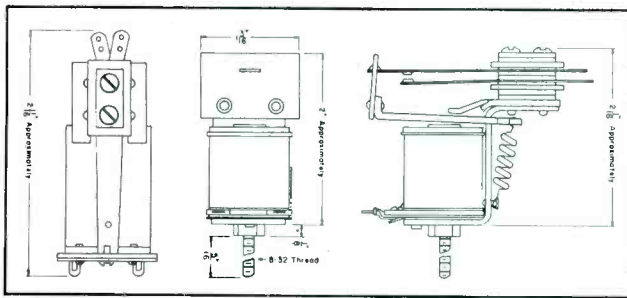

(Above)

**CROSS-SECTIONAL views of relay used in Sentinel 21101 remote-control TV receiver.** (Courtesy Relay Service Co.)

(Right)

**CONSTRUCTION of ac and dc relays showing all of their elements.** (Courtesy Guardian)

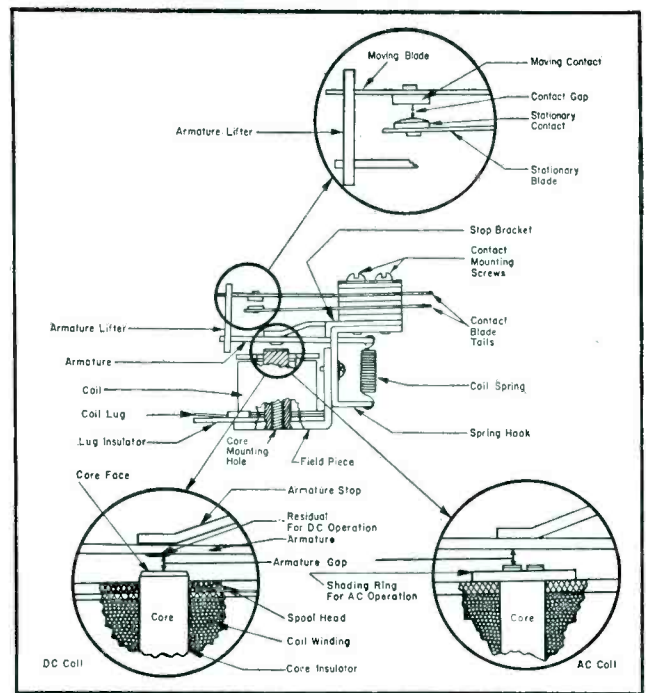

where the air gap must be kept relatively small and where residual magnetism has a greater effect, the core is made of special alloy (as permalloy) which has low residual magnetism. Such materials also help to increase the relay efficiency, by virtue of their high permeabilities.

Inasmuch as a sine wave in an *ac* relay reaches a zero point twice during each cycle, the armature often does not have any pull every time these points are reached. By the same token, the armature pull is greatest when the sine wave peaks occur. This causes chatter and hum. To eliminate this in *ac* relays, a copper shading ring is used. The ring causes the flux to take two different paths at the core; one through the slug and the other through the core, as before. The flux through the ring is delayed; the flux through the core, therefore, is, relatively speaking, advanced. This delay and advance varies in accordance with the sine wave. The arrangement is such that each portion of the flux will pull on the armature when it is going through either a peak positive or negative point, but will not, however, pull on the armature during zero points on the sine wave. The result is that the armature remains steady.

### Arcing Problems

Relay contact defects are the greatest source of failures. In fact, the life of the contacts usually controls relay life, provided the relay does not run unduly hot. When relays are first in-

stalled, contacts should be accessible for inspection and repair. Where this cannot be done, as with hermetically-sealed relays, great care must be taken to keep arcing at contacts at a minimum; the latter is one of the main reasons why contacts are ruined.

A ruined contact is one suffering from a loss of most of the contact surface material due to wear or vaporization (mainly due to arcing); or where the contact has developed a hole in it (such as by arcing), so that the base material under the contact becomes visible.

In practically all cases (except where the relay load is negligible), some arcing will be noted at the relay contacts. As long as the arcing is not excessive, this may be considered as normal. Arcing is excessive when it occurs the instant the contacts close, or when the arc prevails after the relay contacts have opened. Thus, the duration of the arc, rather than

its intensity, is the main cause of contact ruination. Some loads cause an abnormally high current flow in the relay circuit only at the instant the power is turned on. This may cause the contacts to *bounce*, with arcing at the contacts as the result. This type of arcing may be minimized, or removed, by reducing the gap between contacts. Other methods of reducing arcing include the use of an arc-suppressing circuit across the contacts, which consists of a series *rc* network. Examples of network values here are .5-mfd and 15 ohms for 24-volt *dc*, or less; 1-mfd and 225 ohms for 24 to 115 volts. Different values must be tried experimentally for minimum arc observation. Electromagnetic or permanent-magnet *blowouts*, placed in the vicinity of the contacts, will also minimize or eliminate arcing. Once the electrical circuit to the relay, which contains a blowout, is removed, the magnetic field of the magnet serves to displace the arc by lengthen-

\*\*The Sentinel relay operates on *dc*; in the Emerson (120257) remote-control system, *ac* is used to operate the relay.

(Continued on page 51)

Right

**CIRCUIT operation of a relay.**

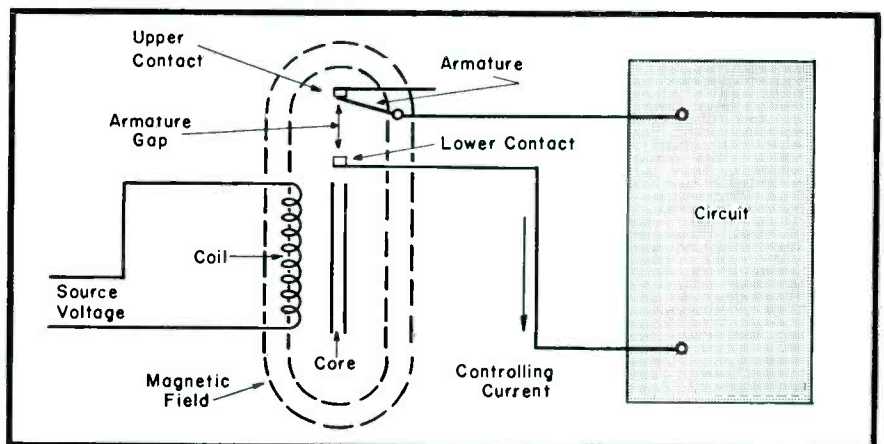

# A White Dot-Bar Color Display Generator

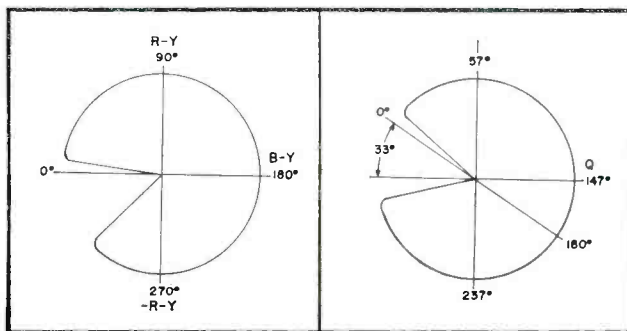

**CIRCLE patterns for color-demodulator adjustments: At left, for R-Y and B-Y demodulators and at right, for I, Q demodulators.**

IN THE INSTALLATION of a color chassis, there are a number of picture-tube and circuitry adjustments that must be carefully made. It is not only necessary, for instance, to adjust for convergence and linearity, but check the high-level color demodulators now being used.

Signals and patterns, suitable for such tests, are available from white dot-bar color-display type generators as diagrammed below.

Such an instrument provides video signals consisting of sync and either bars or dots, and a color pattern which gives one complete variation in color in a line of sweep, or an *rf* signal in channels 2, 3, 4, 5, or 6, modulated by this video. The modulation and the *rf* signal strength can

be controlled, to provide suitable test signals.

### Crystal Control

The generator includes a 3.563795 *mc* crystal which permits alignment of the color demodulators. This frequency is 15,750 cycles lower than the color carrier frequency; on the picture tube a full spectrum from reddish orange, through red and blue to green can be produced. By utilizing a 'scope with horizontal and vertical amplifiers having identical response to 100,000 cycles, the patterns shown above can be produced. The 'scope's vertical input is connected to the output of the *I* or the *R-Y*

°Hickok 660.

demodulator, and the horizontal amplifier to the *Q* or *B-Y* demodulator. The quadrature transformer must be adjusted to obtain as perfect a circle as possible. (The 'scope gain controls may have to be adjusted to provide equal amplitude; the transformer only corrects for *tilt* of the pattern.) A portion of the circle will be cut out by the gating pulse which blanks the color circuits during horizontal retrace. The hue control must be adjusted to bring the cut-out to the location shown. An internal coarse phase adjustment will be necessary so that the front panel control is centered with the pattern as shown.

With recent high-level demodulators the amplifiers in the 'scope may not be required. When the signal is inserted through *direct* connections in this generator, phase shift in the amplifiers is eliminated. If difference in phase shift between the two 'scope amplifiers is suspected, the same signal must be connected to both inputs, and the pattern then observed. It should be a single line at a 45° angle when the gain controls are set for equal horizontal and vertical deflection. If an ellipse appears, the direct connection should be tried; this will eliminate the amplifier phase shift and is useful if the deflection is large enough.

In the generator's circuit the video signal is controlled by a 315-*kc* crystal. Pulses at this rate generate the dots and vertical bars of the dot and bar patterns. The signal is divided by 10 to secure a 31.5-*kc* signal, which provides control of both the vertical and horizontal sync. The horizontal sync is obtained by dividing the signal by 2 in a blocking oscillator. Vertical sync is developed by

(Continued on page 36)

**BLOCK diagram of the white dot-bar color display generator. (Hickok 660)**

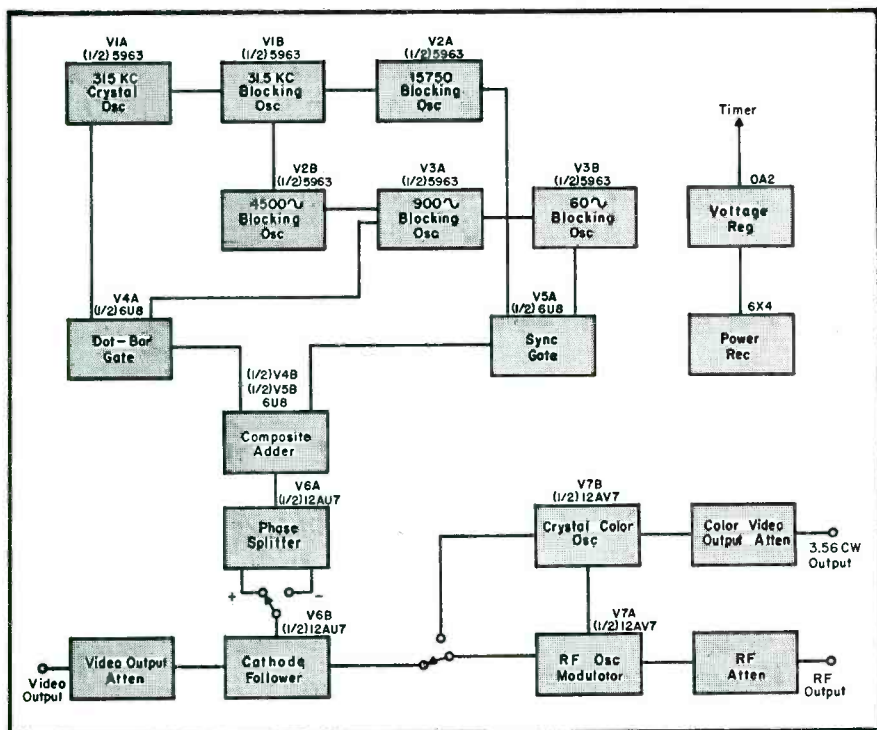

# Today's Fastest-selling Garage Door Operator



**ALLIANCE "GENIE" LIFT-A-DOR**

*-and here's the reason!...*

**TV Advertising that Packs a Powerful Punch!**

Millions see Alliance Lift-A-Dor TV demonstrations right in their homes!

**National Magazine and Newspaper Advertising!**

**Intensive Sales Promotion!** Trained Alliance experts work closely with dealers — customers. Help you sell!

**Thousands of New Home owners and builders are ready for Alliance Lift-A-Dor!** Cash in now on this huge new home market!

**Alliance Lift-A-Dor is Pre-sold for You!**

**ALLIANCE "GENIE" AUTOMATIC GARAGE DOOR OPERATOR** is the first low-cost, quality, automatic operator! Opens, closes, locks, unlocks garage door; turns lights on or off. List prices from \$79.95 to \$189.95 plus installation.

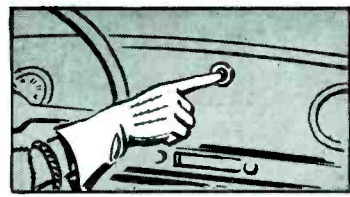

**RADIO CONTROL** operates from push button or car dash.



**KEY-LOCK CONTROL** operates from driver-level box.



**THE ALLIANCE MANUFACTURING CO., Inc.**  
**ALLIANCE, OHIO**

**ROTATOR EXCHANGE PROGRAM**

The electronics division of Thompson Products, Inc., 2196 Clarkwood Road, Cleveland, O., has announced a field exchange program on its *Superotor* line of TV antenna rotators.

All Service Men who require service on *Superotors*, produced at any time since they were first put on the market, will be able to obtain exchange service at duly appointed distributors.

Distributors will carry a factory serviced stock of units and all repairs will be made through the factory, but immediate replacement, it was said, will be available on both in or out of warranty units.

**INDUSTRY NEWS**

**NAME CHANGE**

The American Phenolic Corp. has changed its name to the Amphenol Electronics Corp.

The change was voted by stockholders at an annual meeting.

At the annual board meeting following the stockholders' session, the directors promoted *Rodolfo M. Soria*, from director of engineering to vice president in charge of engineering.

**3-YEAR TUBE PROMOTION PROGRAM**

A three-year promotion plan, that, it is said, will reflect expected changes in the service industry, has been developed by the Westinghouse Electronic tube division.

Featured will be a premium program which will include promotion of the names of manufacturer, jobber and Service Man through use of signs, decals and banners; use of various local advertising media to promote shop and jobber service to customers; letterheads, envelopes, business cards and other materials to exploit the jobber's and Service Man's need for identification with his customers.

**SEMICONDUCTOR DIVISIONS MOVE**

The Radio Receptor Co., Inc., has announced that its semiconductor sales department (selenium and germanium divisions) are now located at 240 Wythe Ave., Brooklyn. The company's New York office at 251 W. 19th St. will be occupied entirely by its *matron* division.

**Instrument-Audio Displays**



Counter display for series string-filament checker designed to check receiver tube filament continuity, picture tube continuity, TV and radio set fuse continuity. Has a built-in pin straightener. (Model SS-10; Precision Apparatus Co., Inc., 70-31 84th Street, Glendale 27, L. I., N. Y.)

Point-of-purchase cards, window and wall streamers, phono records and envelope stuffers, aimed at consumers, designed to promote sale of E-V power-point cartridges; nylon-encased units combining a ceramic cartridge and two jeweled (synthetic sapphire or natural diamond) playing tips.



Now Available! NEW...

**VACO**  
Hollow Shaft  
**NUT DRIVERS**  
in Color

Nothing else like them anywhere! Choice of 28 types and sizes! New plastic kit at right contains 7 most popular drivers in self-standing bag for service work or bench use.

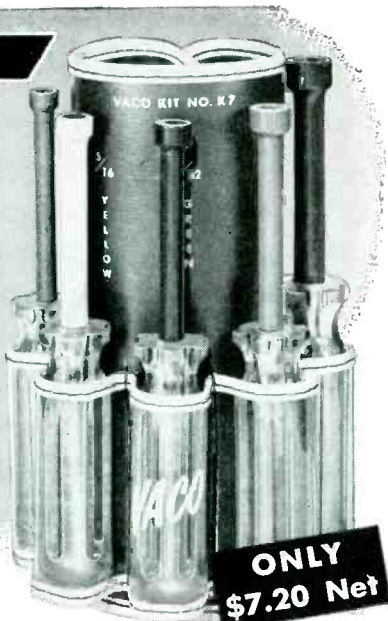

**ONLY \$7.20 Net**

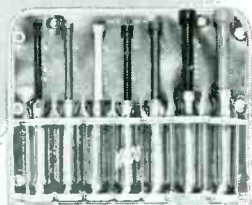

**No. K7 Self-Standing Service Kit Stands Up! Hangs Up! Folds Up!**

Stands upright for easy accessibility. May be hung flat on wall or may be folded. Each driver fits in individual holder marked for size, color.

*Check These 6 Important VACO Features*

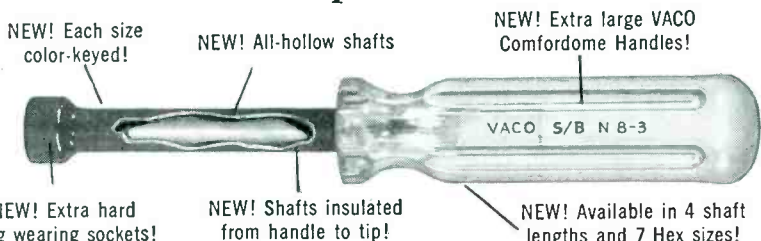

- NEW! Each size color-keyed!
- NEW! All-hollow shafts
- NEW! Extra large VACO Comfordome Handles!
- NEW! Extra hard long wearing sockets!
- NEW! Shafts insulated from handle to tip!
- NEW! Available in 4 shaft lengths and 7 Hex sizes!

**THIS COUPON WORTH \$1.20**

Name..... S  
Street.....  
City..... Zone..... State.....

**VACO PRODUCTS COMPANY**  
317 E. Ontario St., Chicago 11, Ill.  
In Canada: **Vaco-Lynn Products Co., Ltd.**, Montreal 1, Que.

Coupon only valid for use as stated below. Not valid in states where prohibited.

Take this coupon to your jobber. It is worth \$1.20 when filled in and used to purchase one VACO K7 Kit. If your jobber cannot supply you, write direct.

# PERSONNEL

ARTHUR L. CHAPMAN is now vice president-manufacturing of Sylvania Electric Products, Inc. . . . BENNETT S. ELLEFSON and MARION E. PETTEGREW have been appointed vice presidents of Sylvania, ELLEFSON as v-p of engineering and research, and PETTEGREW v-p of tungsten-chemical and parts operations.



Chapman



Ellefson



Pettegrew



Munroe

DAVID J. MUNROE has been elected president of the Webster Electric Co., succeeding PRESTON G. CREWE, who was chairman of the board of directors. ARTHUR C. KLECKNER was reelected chairman of the board.

\* \* \*

SIDNEY HARMAN, president of Harman-Kardon, Inc., has been elected chairman of the Sales Managers Club, succeeding CHARLES GOLENPAUL, vice president of Aerovox. HARRY ESTERSOHN of Jerrold Electronics has been named vice chairman; WALTER JABLON, Presto Recording, is now secretary-treasurer.

\* \* \*

EARL H. KIRK has been named distributor sales manager of Regency Division, I.D.E.A., Inc. Kirk has been with Regency since '51, when he joined the company as assistant sales manager.

## At Parts Show



Witch doctor at the Astron Chicago parts-show booth proffering counsel on cures for inventoryitis to step up capacitor stock turnover.

keep your servicing  
on-the-go  
profitably with  
**RCA SERVICE PARTS**

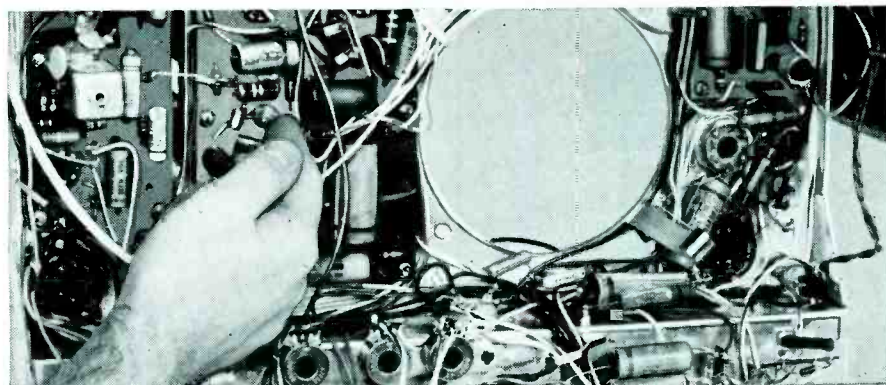

This is a peaking coil. It is an exact electrical replacement for the high-Q original used in RCA Victor TV receivers. Replacement peaking coils with improper inductance values can cause "trailing reversals" and "smearing." But, with this RCA peaking coil—as with all RCA Service Parts—you get maximum assurance that original performance will be restored—in quick bench-time. This is why successful servicemen everywhere depend on RCA Service Parts to keep their servicing on-the-go, profitably. RCA Service Parts for RCA Victor radios, TV receivers, record-changers, and "Victrola" phonographs are factory-tailored to fit right, install fast, and do their job precisely. So, when it's an RCA Victor home instrument you're repairing, insist upon an RCA Service Part—available from your local RCA distributor.



**SERVICE PARTS**

RADIO CORPORATION OF AMERICA, HARRISON, N. J.

**RCA VICTOR PRODUCTS • RCA SERVICE PARTS—made for each other!**

to  
be  
**SURE!**

buy  
**VOKAR**

the original-  
equipment  
**VIBRATOR**



Leading manufacturers of original-equipment auto-radios specify Vokar vibrators as components for installation on the production-line. Why? They're sure Vokar quality never varies — will always contribute to top performance demanded of today's radios.

You too can depend on Vokar vibrators—for sure starts, longer life, silent operation. For all replacement jobs, buy Vokar Imperial or Quality Brand vibrators to be sure of satisfied customers.

Now is the time to stock up on 12-volt vibrators—**ONLY TWO VOKAR IMPERIALS ARE NEEDED TO FILL ALL REPLACEMENTS!**



**VOKAR CORPORATION**  
DEXTER 2, MICHIGAN

## CATALOGS — BULLETINS BOOKS

PHILCO CORP., Philadelphia 34, Pa., has published a 50,000-word textbook on *Color Television—Simplified Theory and Service Techniques*, edited by Donald G. Fink, director of research. Book, with 288 b-w and color illustrations, includes a review of b-w TV and sections on colorimetry, transmission and reception methods and standards, receiver circuitry, color pix tubes, adjustment and alignment, installation and troubleshooting. Copies are available direct at \$5 each.

COLUMBIA WIRE AND SUPPLY CO., 2850 Irving Park Rd., Chicago 18, Ill., has released a 40-page illustrated catalog, 106, listing specifications of TV transmission lines, rotor cables, intercom and telephone wire, hookup wire, power cord and cable.

LAFAYETTE RADIO, 100 Sixth Ave., New York 13, N. Y., has issued a 32-page illustrated transistor brochure. Included are diagrams of transistorized devices, data on test equipment and miniaturized parts.

PHOTOCIRCUITS CORP., Glen Cove, N. Y., has published a technical bulletin on *Standard Printed Circuit Tolerances (P-9)*, covering diameter tolerances of unplated and plated holes, location tolerances between holes, hole-to-hole pattern tolerances, holes to outside dimension tolerances, line width and spacing tolerances, and plating tolerances.

CLAROSTAT MANUFACTURING CORP., Dover, N. H., has released a 28-page illustrated catalog, 56, listing specifications of composition and wirewound controls, field-attached shafts and switches, power rheostats, sound-system controls, wirewound fixed and adjustable resistors, carbon resistors, ballasts, line-voltage regulators, fuse-type resistors and power resistor decade box.

**Don't just say  
capacitors**

Ask For Sprague By  
Catalog Number

Know what you're getting... get exactly what you want. Don't be vague... insist on Sprague. Use complete radio-TV service catalog C-610. Write Sprague Products Company, 61 Marshall Street, North Adams, Mass.

**SPRAGUE**  
WORLD'S LARGEST  
CAPACITOR MANUFACTURER

FEDERAL TELEPHONE AND RADIO CO., 100 Kingsland Rd., Clifton, N. J., has released illustrated bulletin *MI*, describing selenium rectifiers for printed-wiring applications in radio, TV, phonos and recorders.

BLONDER-TONGUE LABORATORIES, INC., 526-36 North Ave., Westfield, N. J., have announced a bi-monthly publication, *B-T Labs Bulletin*, for distributors and Service Men. Issues feature technical product specifications, installation and service data and information on master and industrial TV systems. Available free on request.

CBS-HYTRON, Salem, Mass., has announced a new edition of *Reference Data for Transmitting and Special-Purpose Tubes*. Data are indexed and cover small transmitting pentodes, triodes and rectifiers, gaseous voltage regulators and reference tubes, and special receiving and military types. Also available is a new edition of a *Reference Guide for Television Picture Tubes*, listing all magnetically deflected b-w and color tubes.

### TEN YEARS AGO IN SERVICE

AN EXCLUSIVE HIGHLIGHT report on the May, 1946, Radio Parts Show in Chicago, described postwar lines of component, accessory and instrument manufacturers. Among the new developments reviewed were dipole-type TV and FM antennas, mutual-conductance tube testers, coax cables, rooftop antenna mounts, automatic record changers, hi-Q wirewound resistors and ceramic capacitors, dynamic and crystal microphones, pocket-type *vom*'s and neonized screwdrivers. . . . The advance information from the Parts Show, disclosing industry trends, was used by associations to plan Fall clinic and conference meetings. . . . A metal

lens antenna for microwave relay systems, developed by Dr. Winston E. Kock of Bell Telephone Labs, was detailed for the first time. . . . Julius Haber was appointed ad and sales promotion manager of the RCA Victor division tube department. . . . Tim Alexander was named manager of the service and parts department of Motorola. . . . A color dynamic paint system (similar to the methods described in the March, 1946, issue of SERVICE) was found so effective that it was adopted by a set manufacturer to expedite production and minimize accidents. . . . Cornell-Dubilier purchased an eight-story plant in Worcester, Mass.

# Associations



J. Earl Templeton, Mallory distributor division manager, in center, receiving the NATESA 1955 Friends of Service award at the recent Omaha, Neb. meeting in the Blackstone Hotel from (at left) Vincent J. Lutz, West Central vice president of NATESA, and (at right) Frank J. Moch, NATESA president. The award was made to Mallory in recognition of outstanding service to TV-radio service management in creating better customer relations. For several years Mallory has been sponsoring a series of ads in a national weekly explaining why TV service is a job for expert, highly trained Service Men and how these Service Men have kept millions of sets in good operating condition.

## ARTS, Chicago, Ill.

THE ASSOCIATED RADIO and Television Servicemen has been incorporated under the laws of the state of Illinois.

The association is entering its fourth year of group activity, with all original charter members, but one. *Howard Wolfson* is chairman of the group.

## CSEA, California

THE NEWLY FORMED California State Electronics Association held its first annual election meeting recently in Bakersfield, Calif. One hundred and twenty-five state association members attended.

*Harry B. Coolidge*, president of the Pasadena RTA and also chairman of the Los Angeles RTA president's council, was elected president. Elected vice president was *H. Lawrence Schmitt*, president of the Santa Clara Valley Radio-Television Association. Re-elected secretary was *James Wakefield*, president of the Central Valley Electronics Association. *John Blackwood* was elected treasurer; he is president of the Television Service Dealers Association of Kern County.

## NTSDA, Philadelphia

AT AN ELECTION MEETING of the Northeast Television Service Dealers Association, *Reginald H. Cherrill* was reelected president for his fourth term; *Charles Settle* was reelected to the office of vice president; *Harvey Morris* was renamed secretary, and *Ralph Newby* was chosen treasurer.

**D. M. Branigan, manager, distributor sales, RCA tube division, hanging up Friends of Service plaque presented to the division by NATESA at their Omaha spring conference.**

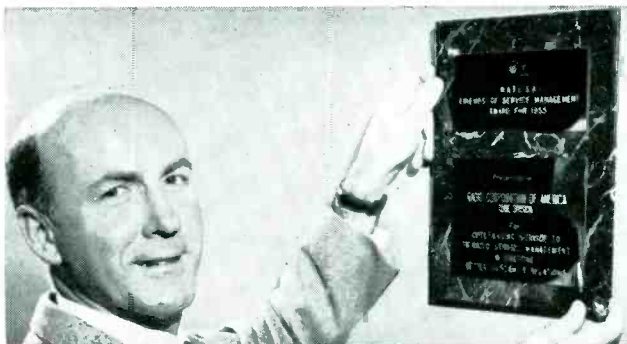

# A-M-P

## terminals

your best  
connection  
for  
dependability  
and  
quality

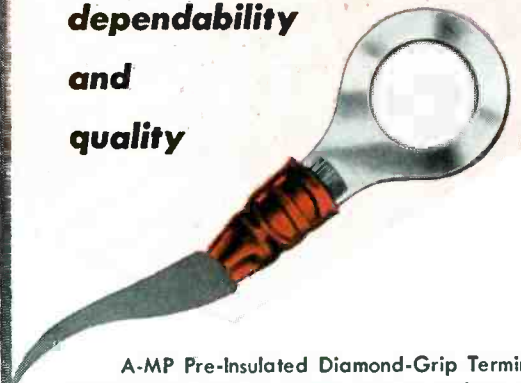

A-M-P Pre-Insulated Diamond-Grip Terminals with built-in wire insulation support reduce your maintenance cost... because they insure perfect electrical connections under the most exacting conditions. You don't have to worry about replacement.

The A-M-P Pre-Insulated Diamond-Grip Terminal is not affected by heat or cold, and vibration won't cause broken strands. Moreover, PIDG colored insulation shows you at a glance which wire size it accommodates and which tool connects it. No errors... no loss of time... and a lot of saving!

API branch warehouses in major cities stock popular A-M-P terminals and tools for maintenance and repair purposes. An API representative can prepare a Custom Fitted Kit containing just the items you need. Contact your nearest API office.



# api

TRADE MARK

**AMERICAN PAMCOR, Inc.**  
Subsidiary of Aircraft-Marine Products, Inc.  
181 Hillcrest Ave., Havertown, Pa.

Atlanta, Ga.  
Boston, Mass.  
Chicago, Ill.  
Cleveland, O.  
Dallas, Texas  
Detroit, Mich.  
Hawthorne, Cal.  
Maplewood, N. J.  
Philadelphia, Pa.  
Pittsburgh, Pa.  
St. Louis, Mo.  
San Francisco, Cal.

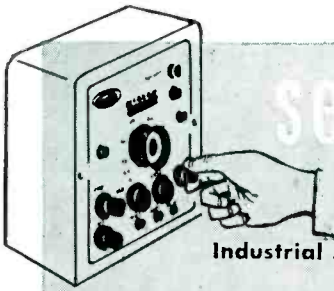

# service engineering

## FIELD AND SHOP NOTES

Industrial . . . Commercial . . . Institutional

Communications . . . Audio . . . Television Installation . . . Maintenance . . . Repair

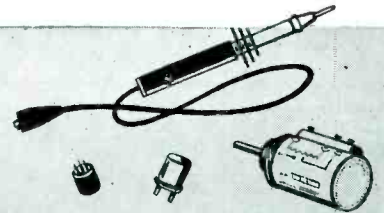

### Installation Hints . . . Curbing Noise On 2-Way High-Band

Mobile Systems by **A. R. SINCLAIR**, Communications Engineer, General Electric Company

To SIMPLIFY installation and minimize spare component inventory, our mobile line utilizes the same receiver and transmitter as does an *ac*-powered station.

The power supply for the mobile unit is available with either vibrator or dynamotor depending upon the customer's requirements. The vibrator supply uses a single split-reed dual-interrupter unit in the low-power transmitter, and in the case of the 50-watt transmitter it utilizes two each of the split-reed dual-interrupter vibrators. This feature means that only one type of vibrator need be stocked for both the low or high-power mobile combinations. The power-supply chassis has metering jacks to measure the input voltage, receiver *B+* and the power-amplifier plate voltage. The dynamotor supply contains a vibrator power system for the receiver and the transmitter multipliers, the dynamotor

being utilized for the *p-a* plate voltage only. Extreme caution must be used when working on any power supply, for dangerous voltages are present. One should never key the transmitter with one hand and work on the unit with the other; to do this is to flirt with death. To be safe, one should keep one hand in the pocket and someone should always be present when working on the *hv* supply. All of our mobile supplies can be used on either 6 or 12 volts input.

As noted earlier, there are many sources of noise that may be encountered and can cause considerable trouble. These noises might be due to the electric instruments, electric thermostats, loose body parts, loose tail pipe, and static generated by tires.

further away from the base station. This means that if your customer is going to operate in areas where he must get the most out of the receiver, then you must spend more time in debugging the vehicle for noise. There are no set rules; however, one should always use an orderly and systematic approach. If this is done, one will rarely go astray.

Noises in the high-band equipment are more easily reduced than those in lower frequency equipment.

If your customer expects to work in the fringe areas, give him a little more effort on your part by debugging the noise in his vehicle.

#### Preventive Maintenance Program

The main thing to remember in making a 2-way installation is that every operation should be completed in a neat and orderly fashion. In doing this comebacks will be practically non-existent.

After having made the installation there is yet one thing that remains to be done.

The customer must be sold on the idea that the high-band mobile requires a certain amount of preventive maintenance, and a program should be organized for this project.

#### Noise Debugging

The foregoing noises will become more objectionable as the mobile gets

(Left)

**CIRCUITRY** illustrating source of generator regulator noise (top) and method used to eliminate noise through installation of coax and standard capacitors.

(Below)

**BLOCK** diagram of 144-152 mc communications receiver.

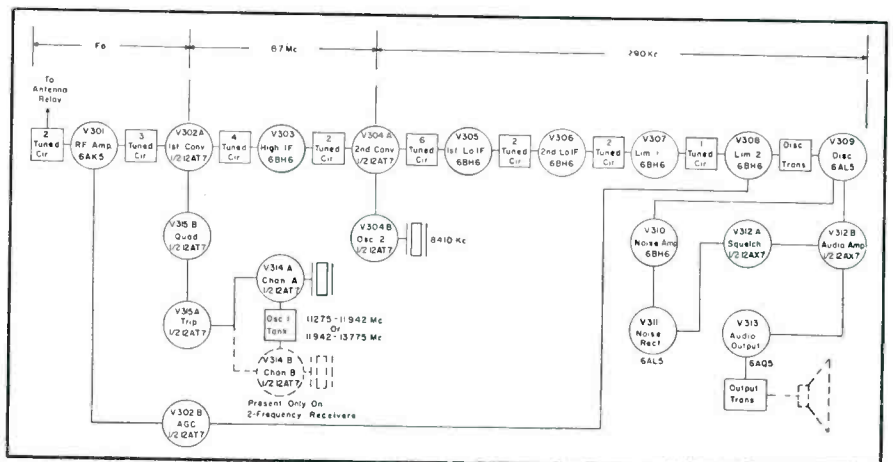
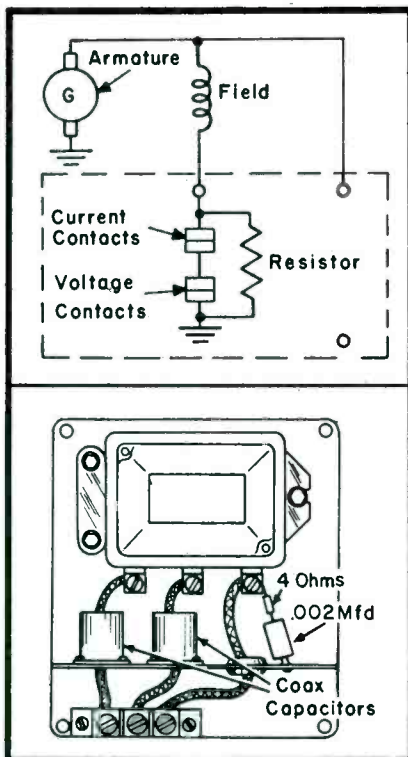



# abacus



昨日之最好者

## honorable ancestor of the UNIVAC

In theory many centuries have gone into the development of the Univac.<sup>®</sup> Only recently, at Remington Rand Univac, has it achieved product perfection. The tremendous strides forward in the past few years are due to the imagination and creative genius of the scientists and engineers of Univac. Recognized leaders in the field of electronic computer systems, they are the men *who set the standards for others to follow*. You can become a member of this team

... where ambition and professional skill find their reward in limitless opportunities in an expanding organization.

### Immediate openings for:

**FIELD LOCATION ENGINEERS** with a college degree in a scientific or engineering field and experience in electronics. Extensive electronic background may substitute for some college. Many opportunities for rapid advancement.

**FIELD LOCATION TECHNICIANS** with technical school background and preferably some experience in electronics. These positions can lead to full engineering responsibility.

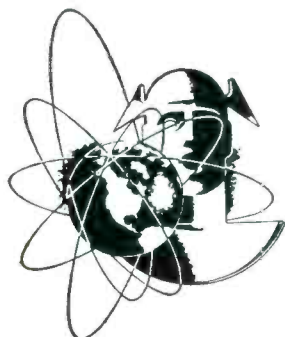

Send complete resumé to

## *Remington Rand Univac*

DIVISION OF SPERRY RAND CORPORATION

AT ANY ONE OF THESE THREE PLANT LOCATIONS

MR. D. A. BOWDOIN  
Dept. AP-32  
2300 W. Allegheny Ave.  
Philadelphia, Pa.

MR. KURT PINKE  
Dept. AS-32  
1902 W. Minnehaha Ave.  
St. Paul W4, Minn.

MR. FRANK KING  
Dept. AN-32  
Wilson Avenue  
South Norwalk, Conn.

® Registered in U. S. Patent Office

**MOST ACCEPTABLE**

FROM DELCO RADIO

come the **transformers**  
with high acceptability.

You trust them...  
so do your customers!



Universal vibrator transformers, produced through the combined electronic skills of Delco Radio and General Motors, meet the requirements of nearly every model of auto radio. Each is designed for easy installation and complete customer satisfaction. Laminated core inserts are stamped out of low-loss silicon steel and heat treated to maintain correct magnetic properties. Coils are precision-wound on special machines. All models have ample leads. Your UMS-Delco Electronic Parts Distributor can supply you with all models. Call him today. Remember, the Delco Wonder Bar Radio is being nationally advertised in leading consumer publications . . . so you are tuned in on a constantly increasing service.

**Uncased Models 6055, 6065, 6067**  
do not include filter network

Cased Models 6060, 6064 and 6066 are made with "A" line filter network consisting of an "A" choke and .5 mfd. capacitor. Easy-mount drilling template, plus three self-tapping screws are included for your convenience.

**DELCO**

WONDER BAR

**RADIO**

DIVISION OF GENERAL MOTORS, KOKOMO, INDIANA



A GENERAL MOTORS PRODUCT — A UNITED MOTORS LINE  
Distributed by Delco Electronics Parts Distributors

A complete line of original equipment service parts from the  
**WORLD LEADER IN AUTO RADIO**

# Community-TV Antenna System Maintenance\*

TO THE OPERATOR of a community-antenna system, maintenance is extremely important, because of the relative inaccessibility of the various pieces of equipment. Line amplifiers are mounted high on poles, strip and main amplifiers at the antenna site, far from the center of town, and other parts are scattered over the whole of the far-flung system of cables, poles and wire. Every problem involves much time and work, not only in replacing the defective parts or units, but in locating the trouble. For this reason, any maintenance hint, no matter how trivial, that will increase the service life of any piece of equipment, is indeed worthwhile.

Even the smallest line amplifier uses at least four tubes. Frequent outages of signals due to tube failures disrupt operation, inconvenience subscribers and can result in loss of viewers. In one installation, due to constantly varying line voltages, tube life in much of the equipment was far from satisfactory; often a set of 6BQ7s would give only a few weeks before developing short circuits, low emission, and other troubles, even though the tubes were the best makes obtainable and thoroughly tested before replacement in amplifiers. In checking, amplifiers were removed and studied for gain and response curves; then installed in accessible locations, where they could be rechecked. Still the short tube life continued.

Although all voltages appeared to be well within tolerances, it was decided to try reducing the filament or heater voltage and lowering the cathode temperature, in an effort to obtain longer life. This was done, initially, by inserting a small 20-ohm/50-watt variable resistor in series with the filament circuit. The filament potential was reduced to around 5.5 v.

This reduction of filament voltage caused a drop in the overall gain of the amplifier, but by raising the *gain-control*, with which most amplifiers were equipped, it was possible to compensate for the loss. Actual performance, as far as the gain of the amplifier was concerned, was quite satisfactory, by actual viewing and metering tests. And the approach served to extend tube life. It was found that amplifiers, which had previously required tube replacement every six or eight weeks, would now operate for six and eight months with-

\*From notes prepared by Jack Darr.

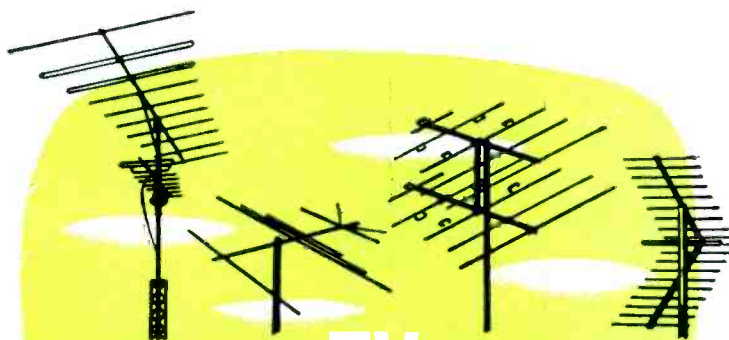

## UHF-VHF TV ANTENNA DIGEST

DESIGN • APPLICATION • INSTALLATION • SERVICE

out the need for tube replacement; one amplifier was run unattended for eleven months, and when removed for test, was found to be in excellent shape, with the tubes only slightly low.

With the tube-life extension test program a success, it was decided to make the voltage-reduction change on all the amplifiers in the system. A small two-terminal strip, similar to the type used on the back of TV receivers for antenna connections, was mounted on a standoff inside the amplifier. A 6-32 mounting bolt, used to hold one side of the power-transformer, was removed, and a 1" bolt with a nut on the bottom, substituted. A 1/2" spacer was slipped over the bolt, the terminal strip placed over that with a pair of flat washers, and another nut used to hold the assembly in place. Only one end needed support, because of the mount's light weight. The filament circuit was broken, and the two leads connected to the soldering lugs of the terminal strip. A strip of resistance-wire was used. Depending upon the

resistance of the wire used, the piece of wire will run from one to three inches long. It is recommended that wire having a fairly high resistance be used to cut down on the length of wire needed. It is not possible to solder to resistance wire; this is the reason for the use of the screw-type terminal strips. The ends of the resistance wire are fastened under the two screws, the voltage drop checked, and the wire either lengthened or cut off, according to the voltage drop measured.

In this case, the method was tested on line amplifiers of several different makes, and a voltage drop of not over 1 volt was found to be approximately correct. Experiments may be made, by setting up sweep-generators and scopes to measure the gain of the amplifier, while adjusting the filament voltage. The filament voltage may then be lowered by very small increments, until a point, which reduces the gain of the amplifier excessively, is found; the voltage can then be run

(Continued on page 52)

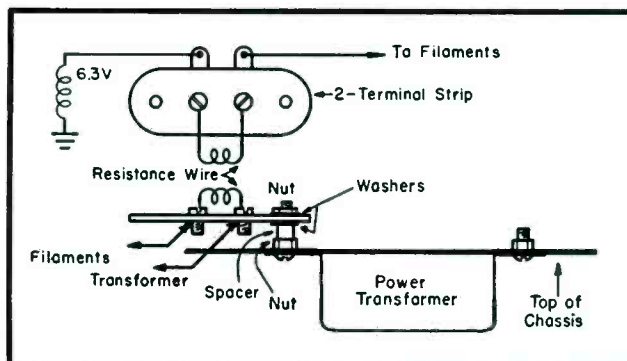

**DETAIL OF a filament voltage adjuster for line amplifiers. Replacement type resistance wire is supported on small two-terminal strip. Filament wires are soldered to lugs; since resistance wire cannot be soldered, it must be fastened under screws of the terminal strip.**

# SERVICING HELPS

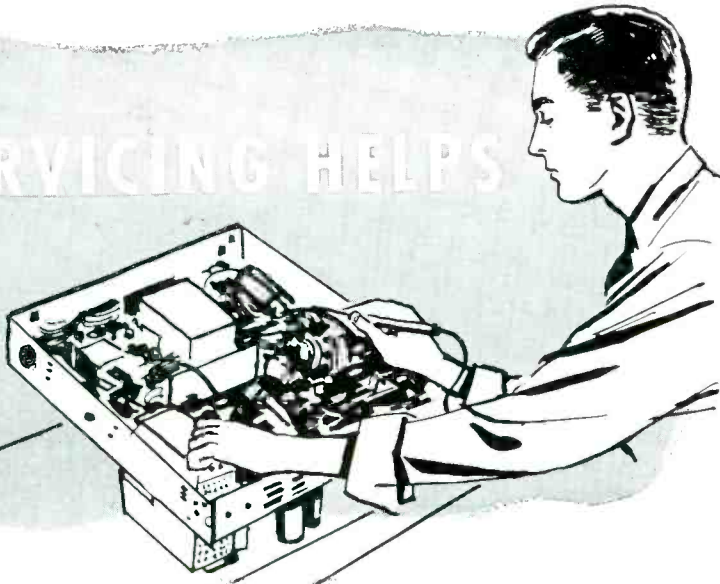

## TV Snivets: Causes and Cures

by **W. O. HAMLIN**, Supervisor, CBS-Hytron Tech. Information Service

OF ALL THE DIFFERENT blobs, streaks, lines, and distortions on TV screens that provoke Service Men, the *snivet* is probably the worst. It appears, then disappears. It may be a thin line or a wide spearhead, but unfailingly a *snivet* always runs vertically from just left of center to the middle of the right half of the screen. It may be tuned in and out by changing channels.

*Snivets* are as unpredictable as the bugs caused by a TV do-it-yourself

enthusiast. If you are stuck with a set plagued with *snivets* try following these instructions:

- (1) Don't tear the tuner apart or change tubes madly.
- (2) Try different horizontal output tubes.
- (3) Check all channels for *snivets*.

If these simple steps do not cause the *snivet* to expire, relax and read further. *Snivets* are born in the horizontal output tube when the plate

voltage is low. The temporarily higher potential of the screen grid causes electrons to oscillate about that grid. The result is the generation of a broad band of frequencies that causes disturbances on many channels.

Thus, anything you do to change the resonance, damp the oscillations, or minimize the oscillation effects by shielding will relieve the headache. Try these next:

- (1) Slip a beam bender magnet over the tube and adjust it.
- (2) Shield the antenna lead-in or move it away from high-voltage circuits.
- (3) If there is a built-in antenna, move it around or change its shape.
- (4) Shield the flyback transformer and tube if the set doesn't have shielding.

(5) Place an *rf choke*<sup>1</sup> or small resistor in series with the tube's plate lead.

By this time you will probably have killed the *snivet*. It is important to remember, however, that the flyback transformer is the silent partner in *snivet* generation, and strangely enough the higher the transformer's Q, the more likely it is to cause *snivets*. A transformer with a higher load impedance also aids in the generation of *snivets*, because a lower plate voltage may occur. These factors point out the importance of using the correct horizontal output transformer replacement.

<sup>1</sup>Such as an Ohmite Z144.

**WAVEFORMS** of the horizontal output stage which show how *snivets* are generated appear at right. In 1 is a grid-voltage waveform, where  $S_t$  = time in which *snivets* can occur if plate voltage is low enough. Ringing of the hv winding is illustrated in 2; note increased rate of damping as the horizontal amplifier goes into conduction. A drop in effective plate voltage, due to loading of the  $E_{bb}$  supply or drop across load is illustrated in 3. In waveform 4, the net plate voltage is shown. Here the voltage is equal to the sum of 2 and 3. *Snivets* will occur at a, b and c, and may occur at d, because of the lowered plate voltage. A photo of a TV pix with a *snivet* streak is shown below.

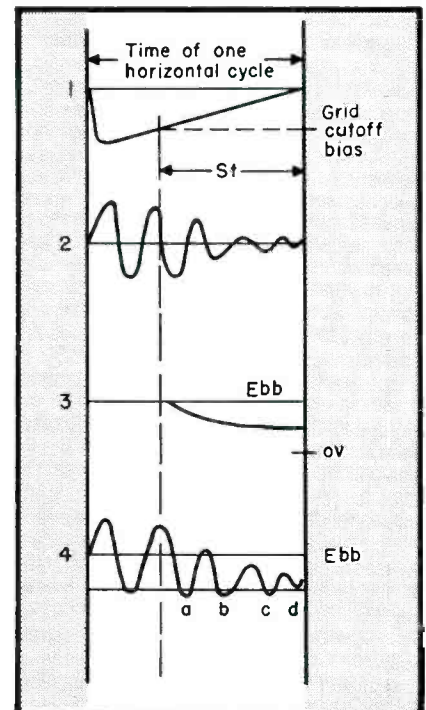

# PRECISION

presents...the **New Model E-420**  
**DOT and BAR GENERATOR**  
 for Color Convergence - Linearity Patterns



**YES!**  
**The NEW Model E-420**  
 is compatible for Color  
 and Monochrome TV.

It is the one Dot and Bar Generator that offers at a reasonable price, every desirable feature for color convergence and linearity testing.

Model E-420 Deluxe (illustrated): In custom-styled, blue-grey, hooded steel cabinet and four-color, satin-brushed aluminum panel with contrasting dark-blue control knobs. Dimensions 13 x 11½ x 6½ inches. Complete with tubes, output cables and comprehensive instruction manual.

Net Price: \$150.00

Model E-420 Standard: Electrically identical to above, but in standard black ripple finished cabinet with black anodized aluminum panel. Case dimensions 10½ x 12 x 6 inches. Complete with tubes, cables and manual as above.

Net Price: \$145.00



**PRECISION Apparatus Company, Inc.**

70-31 84th Street, Glendale 27, Long Island, New York

Export: Morhan Exporting Corp., 458 Broadway, New York 13, N.Y., U.S.A.

Canada: Atlas Radio Corp., Ltd., 50 Wingold Ave., Toronto 10, Ontario

● it's a  
**WHITE DOT** generator

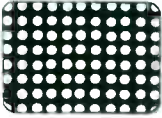

● it's a  
**VERTICAL BAR** generator



● it's a  
**HORIZONTAL BAR** generator



● it's a  
**CROSS HATCH PATTERN** generator

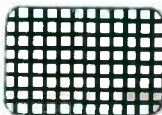

● it has  
**VARIABLE DOT SIZE and NUMBER**



● it has  
**VARIABLE 'V' and 'H' BAR WIDTH and NUMBER**



● it provides  
**DIRECT VIDEO OUTPUT**

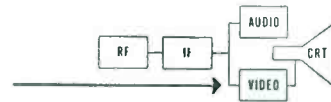

● it provides  
**MODULATED TV CHANNEL OUTPUT**

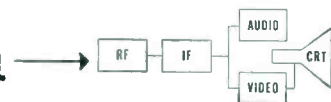

# TENNA

PROUDLY PRESENTS

THE WORLD'S FINEST AND MOST COMPLETE LINE OF DUAL ANTENNA SETS

MATCHES THE STREAMLINED BEAUTY OF MODERN CARS

EASILY, QUICKLY INSTALLED. ALL OUTSIDE MOUNTING

HANDSOMELY CHROME PLATED FROM BASE TO TIP

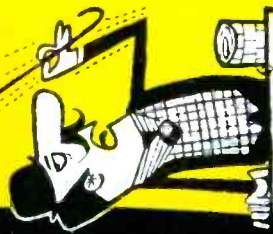

**DON'T MISS 'EM!**

# TENNA

## Aero FIREBALL

DUAL ANTENNA SET

Sweeps back at 50° angle to match speed lines of modern cars

Model FBD-35A

List \$12.50

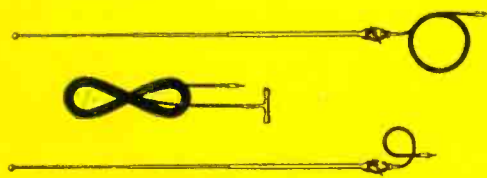

# TENNA

## "NAUTILUS"

DUAL ANTENNA SET

Tear Drop Mounting Base with 25° Sweep Back Antennas.

Model NTD-14

List \$14.95

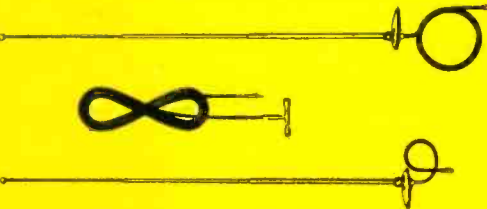

# TENNA

## "MONARCH"

DUAL ANTENNA SET

Disappears into Seamless Shield Tube. Adjustable flat to 30°. Collapses to 3".

Model RD-35

List \$13.50

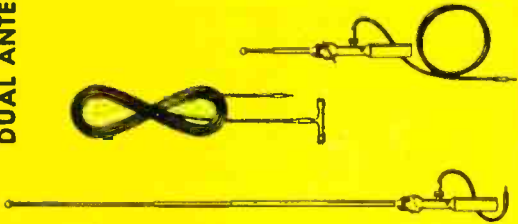

**IMPORTANT:** TENNA "DUAL" Antenna Sets are handsomely chrome plated from base to tip. Each set has 2 antennas, one with 1' cable and other with 6' cable, plus 15' cable with built-in 75MMF condenser. T-Connector and cable clips also furnished. Each set is individually boxed and packed 10 boxes to a master carton.

**TENNA** Manufacturing Co.  
CLEVELAND 25, OHIO

## Color Display Generator

(Continued from page 24)

dividing by 7, 5 and 15 to obtain the 60-cycle vertical sync. After the division by 7 and 5, the 900-cycle pulse obtained is used to gate the 315-*kc* pulses for the dots, or to produce the horizontal bars. In the *bar* position, all the 315-*kc* pulses are passed to form the vertical bars. The sync generator timing is very similar to that in a studio pulse generator, except that *front* and *back* porches are not produced, since they are not required. However, precision interlace is obtained by the timing system employed.

The video output, consisting of both sync and dot or bar waveforms, is produced in an adder. A phase splitter makes either positive- or negative-sync video signals available, and a cathode follower provides a low-impedance output which preserves the sharpness of the waveforms. A video output of 0 to 4 *v* peak-to-peak, adjusted by a front-panel attenuator, is available for troubleshooting a video amplifier. The same signal, taken from before the output attenuator, modulates the *rf* oscillator. A separate control permits adjustment of the percentage modulation. It should not be set for more than 60 per cent modulation, because the oscillator is modulated and operation would be unstable.

A color signal is generated by a separate crystal oscillator operating at 3.563795 *mc*. Its output can be obtained directly at a separate output jack, with an output attenuator providing a range of output levels from 0 to 1 *v* peak-to-peak. The color signal can be used to modulate the *rf* oscillator in place of the video signal; no sync is available in this position.

The *rf* oscillator operates in any one of the low *vhf* channels, as selected by a rotary selector switch.

## Auto Rear Speaker Package

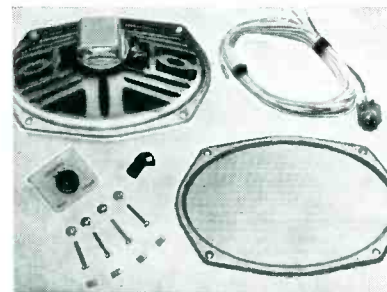

GM-Delco auto rear seat radio speaker package which features speaker with a 1" voice coil, a three-position selector switch for dash board installation and one-piece grill. Three position selector allows for rear speaker operation, front speaker operation, or both.

## Color-TV Servicing

(Continued from page 15)

operate the two receivers through the loss of the resistive splitter.

A quick check to determine mismatch on a coax cable serving several receivers through a master antenna system can be made by a test setup using a 'scope, *rf* sweep generator and detector probe. A perfectly matched cable will give a 'scope pattern that is the same as when the detector probe is connected directly to the output of the *rf* sweep generator.

### Field Checks for Correct Color Rendition

To assist in the field adjustment of color phase, saturation and matrix, a *codaviewer*<sup>2</sup> has been developed. Color bars such as those obtained from a color bar generator<sup>3</sup> are needed for this adjustment, since it is made when correct colors are not obtained. Assuming the receiver to be an RCA 21CT660 series model, the contrast, color saturation, fine tuning and brightness controls must first be adjusted to obtain a normal pattern. One then looks through the red window of the *codaviewer* and adjusts the hue control until the sixth bar is the same brightness as the background. Then we look through the blue window and adjust the top core of  $T_{115}$  until the third bar is the same brightness as the background. Checking with the green filter, the first bar should be the same brightness as the background. Use of the *codaviewer* in this manner has been found to speed the setting of phase and matrix.

The output of the color bar generator used in our tests was on channel 3. Bars can be obtained on other *vhf* channels by taking the video output of the generator and feeding it to the modulator input of a TV calibrator.<sup>4</sup> The calibrator is then adjusted to the picture carrier frequency of any *vhf* channel and color bars are available at the *rf* output terminal.

### Bench Alignment of Color Receivers

The alignment technique of a color receiver differs in two major respects from conventional monochrome alignment. These are, first, the use of video frequency markers and, secondly, the use of a *rf* modulator to provide an *rf* carrier, video sweep modulated.

In aligning, the *vhf* signal generator is set to the picture carrier of the TV receiver; the *vhf* sweep generator to 50 kc (5-mc output). The video marker box has several absorption

# PAYS ITS WAY every day

TESTS and  
REPAIRS  
TV PICTURE  
TUBES



**Makes Customers Happy  
— Creates New Profits**

Servicemen now earn new servicing dollars in minutes and build satisfied customers—with B&K Deluxe Portable CRT 400.

Spots and corrects picture tube troubles in a few minutes, right in the home, without removing tube from set! Restores emission, stops leakage, repairs inter-element shorts and open circuits. Grid cut-off reading indicates picture quality customer can expect. Life-test checks gas content and predicts remaining useful tube life. Cuts operating costs, eliminates tube transportation. Also saves money on TV set trade-in reconditioning. Profits start the very first day.

Send for Bulletin 104-5



**ECONOMY CRT 200**  
Every serviceman can cash in on picture tube repairs with this low priced quick profit maker. Performs most of the functions of the CRT 400. Has 3" meter. In leatherette carrying case.  
Size: 11 x 7½ x 5".  
Weighs 5 lbs. Net \$39<sup>95</sup>

**DELUXE CRT 400  
with 4½" Plastic Meter**  
Weighs only 5 lbs. mounted in rugged, luggage style, carrying case covered with handsome, durable leatherette.  
Size: 11 x 7½ x 5". Net \$54<sup>95</sup>



**CATHODE  
REJUVENATOR  
TESTERS**

**PROVEN IN  
THE FIELD  
EVERY DAY  
BY OVER  
20,000  
SERVICEMEN**

Made by the Makers of the DYN-A-QUIK Tube Tester

**B & K MANUFACTURING CO.**  
3726 N. Southport Ave. • Chicago 13, Illinois



traps tuned to key video frequencies. These traps cause a slight dip in the 'scope waveform. The key frequencies can be identified by touching the exposed terminal of a trap on top of the video marker box.

The output of the *rf* modulator is an *rf* signal at the picture carrier frequency of the receiver and modulated at frequencies between 50 kc and 5 mc. This type of sweep output is required because overall *if*, video, band-pass and demodulator response must be checked.

During the alignment process it is

necessary to disable the horizontal deflection circuits to eliminate horizontal interference on the 'scope. A dummy load must be provided for this loss in power consumption, so that the receiver voltages are the same during alignment and actual operation. A dummy load can be constructed of four 25-watt bulbs in series, connected from the +380-volt bus to the -20 volt terminal.<sup>5</sup>

<sup>2</sup>Hazeltine.

<sup>3</sup>RCA WR61A.

<sup>4</sup>Such as the RCA WR39C.

<sup>5</sup>This technique applies to the RCA 21CT660 chassis.



# Mobile Sound Systems

## Equipment-Installation Requirements for In-Motion and Stationary Applications

IN MOST AREAS the law has something to say about the proper operation of sound equipment outdoors. To maintain control, sound truck permits are issued by the police department. So the first thing a sound truck operator must do is to apply for such a ticket. You will learn, when permission is granted, whatever restrictions apply in your locality, as to where and how you can use your *pa* equipment.

It is obvious that a sound truck cannot be operated within the vicinity of a hospital, or near a church around the time when services are being held. Also, certain residential districts have restrictions on the operation of the truck. It will often be permissible to operate the sound truck in shopping districts or main thoroughfares, but restrictions may apply to points where traffic congests.

Having sorted out these details, one should then investigate the equipment requirements for a truck in motion and stationary.

To equip a sound truck for in-motion use the loudspeaker should be a projection type pointing forward in

the direction of travel. Its angle of distribution should be comparatively narrow. The main purpose in operating a sound truck in this fashion is to provide blanket coverage of an area with announcements or messages. You may or may not use music to call attention to the announcement, but the principal object is to provide adequate coverage, so that all within hearing range can hear clearly the whole of a single announcement or message, as the truck is traveling.

While the truck is on the move the distance between the loudspeaker and any individual listener will be continuously changing. Obviously, anyone located in a side turning, as the van passes, will only hear a very brief snatch of the sound, even if it is directed towards him, so he will not be able to get the complete message. Thus, sound distributed in this direction is virtually wasted and can, in fact, do more harm than good.

For maximum effectiveness, sound should be directed forward from a moving vehicle, and the program played while traveling along a straight

or almost straight street. If a maximum amount of sound energy is directed in a narrow angle down the street it will be heard for a greater distance. The sound will thus be heard while the truck is a considerable distance away and will get progressively louder until the truck is almost level with the individual listener. This will provide the maximum useful message time and conserve the available output power.

The next question to be resolved is the manner in which the message should be presented. Should you carry a live announcer with a microphone and, if music is used, should it be recorded, or should a complete recorded message be prepared?

Many prefer to use a live announcer, who is versatile in message delivery, because he can time his comments according to the location at the moment. A *canned* message cannot readily be changed at short notice.

On the other hand, from the viewpoint of quality of presentation, the completely prerecorded message has

(Continued on page 40)

**ASSORTMENT of amps, speakers, mike, recorder-playback and accessories required for effective sound-truck work.**



**INTERIOR OF SOUND-truck with mixer, amplifiers, inverter, tape equipment and mike for live and recorded public-address work.**

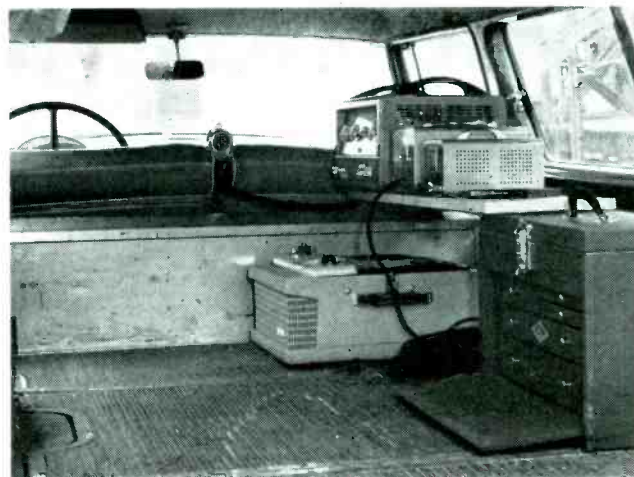



Burton Browne Advertising

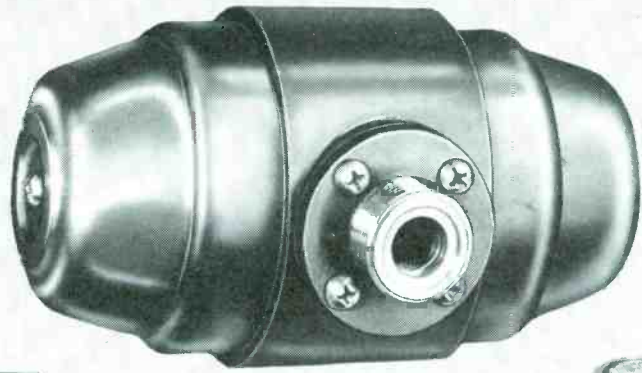

DD-100



D-30



D-40

**NEW Hypex  
DRIVER UNITS  
LIFETIME  
GUARANTEED  
BY  
Jensen**

**HIGHER POWER RATING...HIGHER EFFICIENCY, TOO!**

Designed to pack a terrific sound "punch"...to penetrate high noise levels...to project sound over great distances, the new Jensen LIFETIME Driver Units will do the job better, more dependably, and more economically than ever before.

The D-30 (30 watts) and D-40 (40 watts) have higher power ratings than comparable previous units. This means that the projector can deliver more sound output and better coverage when called upon to do so. Moreover they are more efficient although their cost is approximately the same. This means more sound output per dollar...more sound output per watt input...saves amplifier power and cost too.

DD-100 Superpower Driver (100 watts) is a new advance in packaged sound power, for an integrated unit with such a high power rating has never been available before. It makes possible concentrated projector arrays

with a power capacity of 1600 watts or even more.

We are so confident of the excellence of design, skilled craftsmanship, precision materials and careful inspection that go into every Jensen Hypex Lifetime Driver unit that we are taking the unprecedented step of guaranteeing each and every one against electrical failure indefinitely. Should any Driver Unit fail at any time when used under normal operating conditions, we will either repair or replace it at our option without service charge.

Jensen LIFETIME Driver Units are standout members of the new Jensen Professional Series...a group of speakers covering every requirement for effective sound communication and entertainment in commercial, industrial and institutional sound systems. We'd like to send you Catalog 1070 which contains complete information.

SPECIFICATIONS						
MODEL	POWER RATING*	IMPEDANCE OHMS	FREQUENCY RANGE	LENGTH	DIA.	LIST PRICE
D-30	30 w.	16	75- 7,000	4 1/16"	4 1/2"	\$27.50
D-40	40 w.	16	75-10,000	4 1/16"	4 1/2"	\$36.00
DD-100	100 w.	8 1/32	75-10,000	5 1/16"	8 1/2"	\$96.50

\*Integrated speech and music program material. For sine wave or siren signal input, reduce ratings one-half. Ratings apply only for frequencies above horn cutoff.

**LIFETIME GUARANTEE**  
D-30; D-40 and DD-100 Lifetime Driver Units.

Every Lifetime Driver Unit is unconditionally guaranteed for life against failure when operated according to the instructions accompanying the unit.

Should any Lifetime Driver Unit become inoperative at anytime under these conditions, it will be repaired or replaced at our option entirely free from any service charge.

The instruction sheet supplements and is a part of the warranty under which the Lifetime Guarantee is extended.

JENSEN MANUFACTURING COMPANY

**Jensen** MANUFACTURING COMPANY

6601 S. Laramie, Chicago 38, Illinois · Division of The Muter Co. · In Canada, Copper Wire Products, Ltd. Licensee

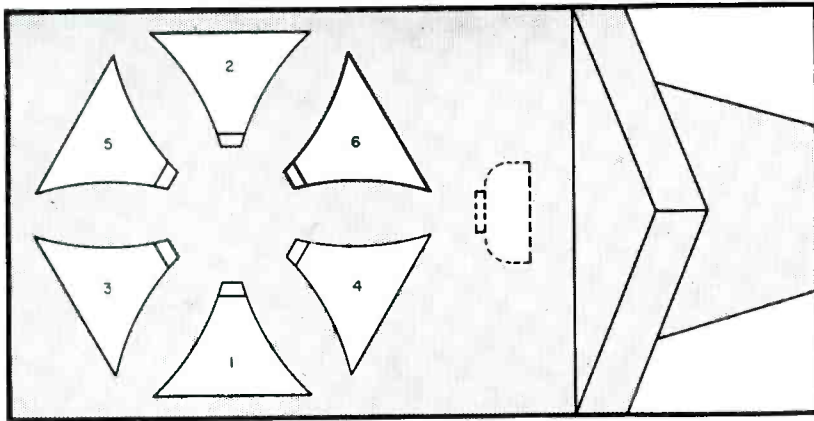

**Fig. 2 (right).** A switching arrangement to give versatile sound distribution patterns with the six horns shown in Fig. 1. The proportions of sound delivered in different directions for various switch-position combinations are given in table 1. The dpdt switch is used to change over from the radial horns (when the truck is stationary) to the projection unit (while cruising along streets).

an advantage, because it is possible to monitor the quality of en-route speech going into the recording much more carefully.

Another advantage of prerecording is that through use of duplicate copies, announcements by a top-notch performer can be used in several sound cars at the same time.

Whichever method is used, one must make sure that the equipment is not overloaded. Surprisingly, sound trucks are operated often with the volume control so far up, that the message becomes almost unintelligible due to extreme distortion. This often occurs because the operator cannot hear the sound going out, and believing that more gain is necessary, turns the control up.

Probably the best way to guard against this is to arrange for preliminary checks as to the loudness and quality with the volume control at different settings. In actual operation,

therefore, the operator will know the correct volume setting to give the required results.

Halting of the mobile truck at a specific location to broadcast a program or message from a stationary position is another key service rendered by the sound van. For this purpose it is usually desirable to have some control over sound distribution in different directions. The only alternative to having good control of sound distribution is to use suitable sites so that the sound distribution built into the system suits the positions chosen. In view of the possible restrictions on the use of different sites it is much better to have a versatile distribution arrangement, so that any site can be used.

This means that loudspeakers having relatively wider angles than those used for mobile broadcasting should be chosen and faced outwards so as to cover the entire 360° around the

**Fig. 1 (left).** Layout of horns for mounting on truck to give 360° coverage, or any desired part of it. Numbered horns identify the connections to be made in Fig. 2. Shown dotted is a possible position for a projection unit for mobile message-casting.

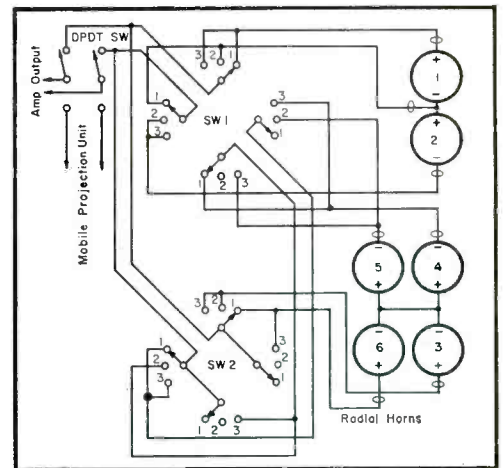

truck. If each unit covers say 60° satisfactorily, then 6 units will cover the entire area.

A basic arrangement that would be suitable for this purpose is illustrated in Fig. 1. A switching arrangement, utilizing two readily obtainable switches, of the four-circuit-three position type, that will give considerable variation in the distribution pattern, is shown in Fig. 2. As each switch has three positions, there are  $3 \times 3$  possible combinations, and each of these can be useful under certain circumstances.

Care should be taken in connecting the horns; they must be correctly phased in all combinations. This can prove to be an important feature in achieving the maximum use of the audio power available from the equipment. The relative distribution in each of the nine possible arrangements that can be used in conjunction with the switch and the plan of Fig.

**Fig. 3.** Partial cross section showing essential feature of the type of horn suited for wider angle (up to 60° total angle) sound distribution.

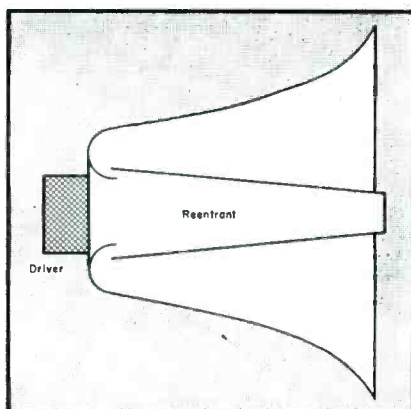

Speakers Connected and Proportion of Total Power to Each		
Switch Positions	Sw 1 Sw 2	Total Power to Each
1	1	No. 1: 100%.
1	2	No. 1: 66%. Nos. 3 and 4: 17% each.
1	3	No. 1: 60%. No. 4: 26%. Nos. 3 and 6: 7% each.
2	1	No. 2: 66%. Nos. 5 and 6: 17% each.
2	2	No. 2: 100%.
2	3	No. 2: 60%. No. 5: 26%. Nos. 3 and 6: 7% each.
3	1	Nos. 1, 2, 4 and 6: 25% each.
3	2	Nos. 1, 2, 3 and 5: 25% each.
3	3	All equal proportion.

**Table 1: Distribution patterns.**

**Fig. 4.** Partial cross section illustrating essential shaping of unit suited for long distance projection, as when used for mobile message-casting.

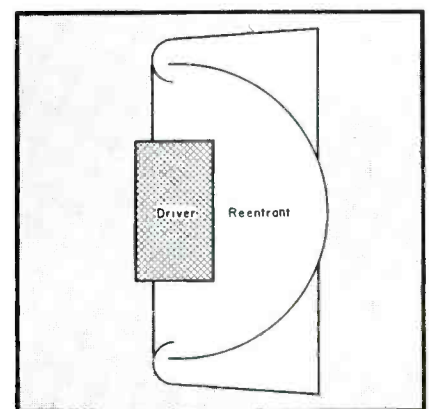

Rectangular horns designed so that they can be stacked in plane or circular arrays. Eight units, each with a geometric sector angle of 45°, form a complete circle with a diameter of 5' 9½", giving 360° horizontal coverage. (Jensen)

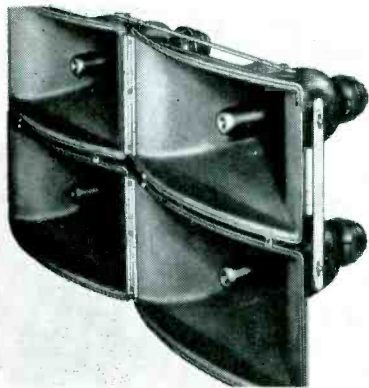

1, to select the best switching position for any given circumstance, is detailed in table I.

To illustrate the use of this table, let us take a sound truck parked with its rear toward a flanking wall, the audience area occupying an entire semi-circle towards the front of the truck. The best combination would be switch 1 in position 3 and switch 2 in position 1. This would feed loudspeakers 1, 2, 4 and 6 at uniform level, while 3 and 5 would not be connected.

A simple double-pole double-throw switch can be put in ahead of these combination switches to change over from this distribution system to a single horn used for mobile announcing work.

For distribution in a stationary position a horn that provides a wider angle dispersion is best. The straight horn is quite good for this, but because of its bulk, it is not popular. Of the reentrant patterns, the type which comes nearest to producing the

(Continued on page 42)

**A 100-watt superpower driver with a double-acting integrated sound chamber. Can be used with single projector or an array.** (Jensen)



# 3+3=410

when you use  
the **NEW**

## SHURE RK-56

LIST PRICE \$22.95 Including technical data, replacement chart and 5" x 3" x 1¼" plastic box.

## REPLACEMENT CARTRIDGE KIT

as a companion to the RK-54

The 3 CARTRIDGES in the RK-56 Kit provide dependable, quickly-installed replacements for 218 cartridges of seven manufacturers.

When used with the RK-54 Kit (where 3 cartridges replace 192) you will have profitable replacements for 410 of the most frequently used phono cartridges!

**Here is broadest coverage for the lowest investment.**

The RK-56 Kit contains:

Cartridge	Application	Type	OUTPUT LEVEL		Needle Force	Net Weight	Response To
			MG	78			
WC10	Extended range, Improvement- Replacement cartridge for 132 3-speed, plastic-cased cartridges, crystal or ceramic, single needle or turnover.	CERAMIC	.78v	1.0v	7 grams	7 grams	12,000 cps
W70	All-Purpose Single-Needle cartridge. For Webster C and CX series.	CRYSTAL	3.0v	3.8v	10-15 grams	16 grams	5,000 cps
W72	Dual-Voltage 3-speed Turnover cartridge for Webster FX and Astatic LQD series cartridges.	CRYSTAL	4v or 2v*		8-12 grams	7.5 grams	5,000 cps

\*Model W72 has a slip-on capacitor furnished as an accessory. With the capacitor, output is 2 volts without the capacitor, output is 4 volts.

Available at your Shure Distributor . . . or write to Shure for complete information on this new profitable replacement kit.

**SHURE** *The Mark of Quality*

**SHURE BROTHERS, INC.**

222 Hartrey Avenue • Evanston, Illinois



# anything to trade?

As a subscriber\* to the CORNELL-DUBILIER monthly magazine "THE CAPACITOR" you can use its famous "TRADING POST" section to run an advertisement\* to SELL-SWAP-or BUY all sorts of electronic equipment and services helpful to you in your business.

**\*NO CHARGE FOR THE AD!**

**\*NO CHARGE FOR THE SUBSCRIPTION!**

"THE CAPACITOR" comes prepaid direct to your home every month—12 times a year. 16 to 24 pages, including full technical or constructional article.

A service of

**CORNELL-DUBILIER**  
world's largest manufacturers of capacitors

**FREE EVERY MONTH**

Just fill in coupon below and mail today. Our new subscription list limited so get your request in now!

Editor—"The Capacitor"  
CORNELL-DUBILIER ELECTRIC CORP.  
Dept. S-66, South Plainfield, N. J.

— Yes Sir! Put me down for a FREE Subscription to Cornell-Dubilier's "THE CAPACITOR"

name \_\_\_\_\_  
please print

address (home) \_\_\_\_\_

city \_\_\_\_\_ zone \_\_\_\_\_ state \_\_\_\_\_

my occupation or job title is \_\_\_\_\_

## Audio

(Continued from page 41)

same result is the one whose cross-section is similar to that shown in Fig. 3; also in the photos. The reentrant part in the center looks like a small blunt spike in the center of the horn mouth.

For greater direction, when using the mobile arrangement, another type of reentrant, in which the center is a large rounded piece and the sound comes out in a ring at the periphery, as shown in section at Fig. 4, is better. This kind of construction affords concentration of sound distribution into quite a narrow angle.

The horns must be mounted very securely. A variety of mount constructions can be used; a welded frame, tubular steel (or aluminum) frame or even a wooden frame, but the essential feature is to make certain that the mounting is secure, so that the horns cannot break loose during transit. To insure distribution flexibility the horns should be mounted so that their direction can be adjusted quickly.

A complicating factor can be the demand for large display boards by a sponsor. This can restrict the available distribution angle of the loudspeakers: if the boards are at the side, the speakers have to be at front and back only. Even if the display is written on canvas mounted on an open frame, it will present a considerable obstacle to the sound; it is not advisable to try and shoot the sound through it.

Meeting the musical program requirements represents another mobile truck problem that the sound man must solve. Most mobile arrangements require music to develop attention before the announcement or message is made. When the truck is stationary, there isn't much difference in the results obtained from disc or tape. But when the truck is in motion, one has to consider the possible effect of the movement of the truck on the reproduced sound.

With a turntable rotating in a horizontal plane, as invariably used for disc playing, if the truck turns a corner or swerves to negotiate traffic, the pitch will change. The motor-board, which carries the pickup arm, will be rotated one way or the other relative to the turntable. Because of the large mass of the turntable this tends to continue rotating at constant speed. Consequently, if the pickup rotates for a moment in the same direction as the turntable, as when the vehicle



*"Now the next time I come into your store perhaps you'll stock JENSEN NEEDLES, eh?"*

makes a right turn, the pitch of the music will drop, while if the vehicle makes a left turn the pitch will rise. This can produce a very pronounced wow effect in the reproduction of music.

A tape recorder, placed in a position so that capstan rotates in a vertical plane, or on a horizontal axis, completely avoids this difficulty and enables the music to be played at truly constant pitch. It also enables suitable selections from program material to be put on to a piece of tape, so

**Constant-voltage transformer designed for 70-volt cv distribution system. Equipped with adjustable terminal board with pin-jack adjustment for desired input power. (Jensen)**

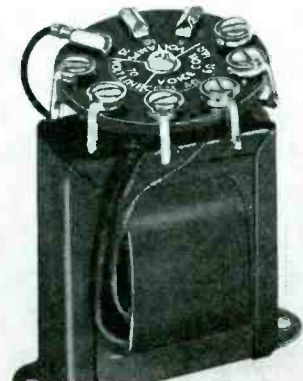

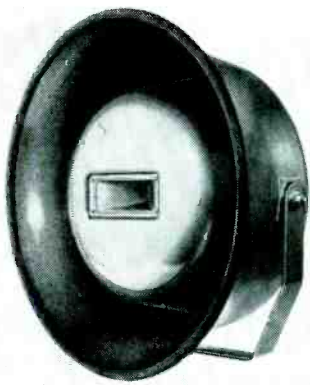

Two-way projector consisting of a heavy-duty 8" woofer feeding a folded horn, plus a horn-loaded compression driver tweeter. Low-frequency unit feeds horn by a combination of direct radiation and phase-inversion bass reflex ports. High frequency horn has a 90° fold and is mounted so that the driver unit is at the top, thus providing self-draining, removing danger of rain, sleet or snow entering the driver unit. (Jensen)

the best effect can be guaranteed during the actual operation.

When discs are used only, an excerpt from a complete disc is usually required; this has to be found by dropping the pickup on at the right place and taking it off after the required excerpt has been played. The use of tape enables the correct excerpt to be found in the comfort of studio operation, instead of having to find it under sometimes awkward operating conditions, while the truck is in motion.

The final problem in operating a mobile sound truck is the generation of enough audio power to give good quality sound, without unpleasant distortion so often noticed, because the volume has been turned up too far. While it is possible to obtain equipment designed for operation from 6, 12 or higher voltage battery supplies,

(Continued on page 44)

A 50-power pocket microscope display card. Microscope has grooved lip that lets you place the 'scope against needle. Makes it possible to inspect needle without removing it from cartridge. (Duotone Co., Inc., Keyport, N. J.)



# Sonotone's 2-model line simplifies cartridge replacement!

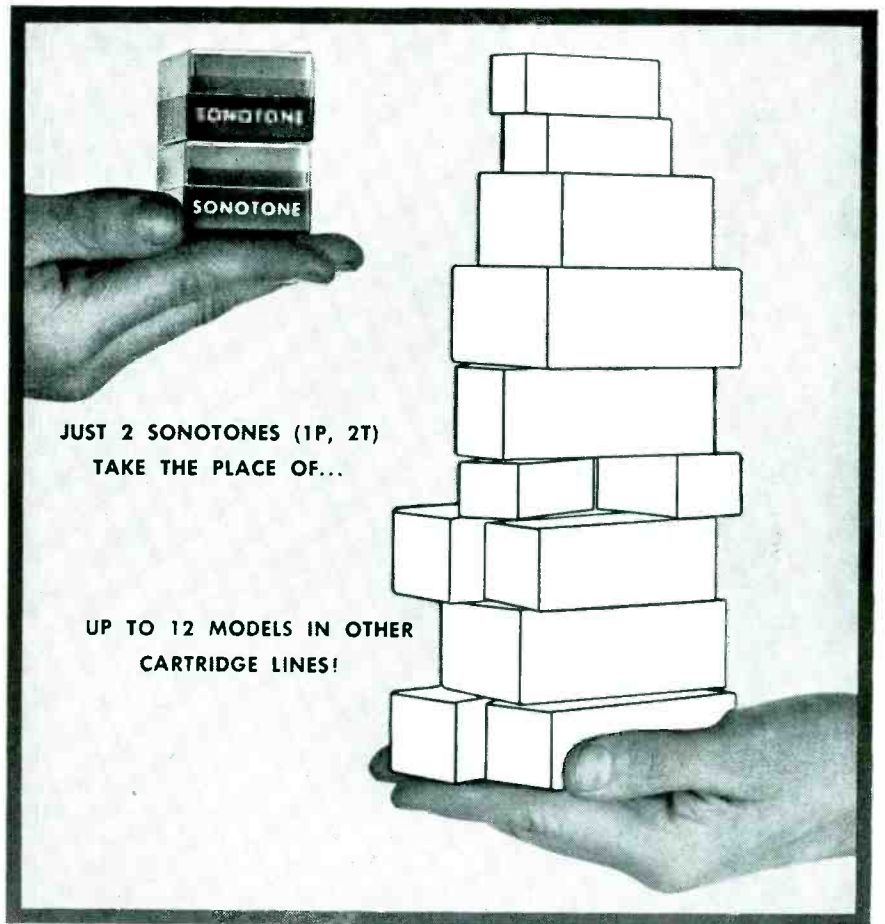

*You finish jobs faster, please customers more, when you standardize on Sonotone Ceramics*

Why juggle a handful of different cartridges, when it's so much easier and faster to stick to just *two*? Sonotone single-needle 1P and turnover type 2T are all you need for over 90% of quality replacement jobs.

These two Sonotone cartridges fit practically any arm. They're quick to install. And remember, Sonotone cartridges are *more* than replacements. They'll give *better* response than original equipment...enhancing your reputation for quality work.

#### New standard of the phono industry

In more than half the quality phonographs made today by leading manufacturers, you'll find one of these Sonotone cartridges. All the more reason why *you* should standardize on Sonotone.

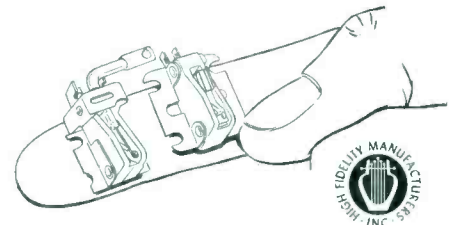

## SONOTONE CERAMIC CARTRIDGES

ELMSFORD, N. Y.

In Canada, contact Atlas Radio Corp., Ltd., 50 Wingold Avenue, Toronto

MERIT, first in exact and universal replacement transformers, yokes, coils—the only manufacturer of transformers, yokes and coils who has complete production facilities for all parts sold under their brand name.

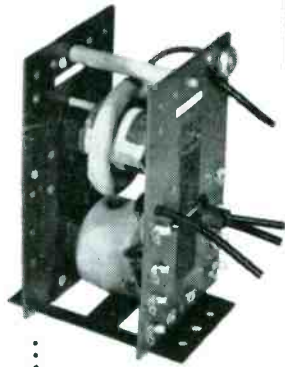

HVO-41 FOR EXACT REPLACEMENT IN AIRLINE, CORONADO, TRUETONE, ARLINGTON, FIRESTONE, WELLS-GARDNER, SILVERTONE, WARWICK. Another in the complete MERIT line of exact and universal replacements—the only single source for all your transformer and coil requirements.

# Merit

MERIT COIL & TRANSFORMER CORP.  
4427 NORTH CLARK STREET  
CHICAGO 40, ILLINOIS



## Audio

(Continued from page 43)

to suit the battery voltage available on whatever truck is used, the best systems are designed to operate from 115 volts, 60 cycles *ac*. To transform the battery voltage available into an *ac* source a converter can be used.

### Vibrator Packs

Vibrator packs which will convert *dc* to *ac* in this fashion are available, but hi-power output types are necessary. For particularly large outputs rotary type units will be found effective; these are, however, somewhat less efficient than the vibrator pack.

A converter working from a 6-volt supply will take a very heavy drain on the battery. It is preferable to use a *dc* supply of 12 volts or even higher. If the truck does not normally have a higher voltage than this available, then several storage batteries can be connected in series to produce say 24 or 36 volts, according to the converter that can be obtained.

### Power Requirements

A 50-watt amplifier will require about 120 to 150 watts of supply power, while auxiliary equipment, such as a tape recorder, will bring the total power drain up to the region of 200 watts. Allowing for the efficiency of the converter, the input would have to be in the region of 240 watts. So, from a 6-volt battery the current drain would be about 40 amperes. From a 12-volt battery the current drain would drop to 20 amperes, while a 24-volt battery would only need to give 10 amperes.

Arrangements will have to be made to charge the storage batteries and care will have to be exercised to insure sufficient charge to cover the operation. This may mean the establishment of a charging system at headquarters and frequent trips back to headquarters to replace storage batteries.

An alternative scheme that may cost a little more and require a little more installation involves the use of a 115-volt 60-cycle generator driven from the truck motor. This kind of generator has to have some device that maintains constant speed in the generator, because the frequency is dependent upon this constancy of speed. So this generator is equipped with a governor, that allows the drive to slip, after the speed required to

(Continued on page 45)



**Priced to Sell!**



At  
All  
Distributors



**DON'T JUST SAY  
CAPACITORS**

Ask For Sprague By  
Catalog Number

Know what you're getting  
... get exactly what you  
want. Don't be vague ...  
insist on Sprague. Use Com-  
plete radio-TV service cata-  
log C-610. Write Sprague  
Products Company, 61  
Marshall Street, North  
Adams, Massachusetts.

# SPRAGUE®

WORLD'S LARGEST  
CAPACITOR MANUFACTURER

**AES ANNUAL MEETING SCHEDULED  
FOR N. Y. HIGH FIDELITY SHOW**

The Audio Engineering Society will participate in and hold its annual meeting at the forthcoming New York High Fidelity Show, sponsored by the Institute of High Fidelity Manufacturers.

The show is scheduled to run from September 26-30, 1956 at the New York Trade Show Building, N. Y. C.

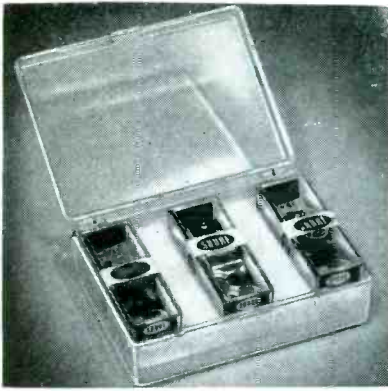

Replacement cartridge kit with three cartridges said to replace 218 cartridges of seven manufacturers. Kit contains model WC10 ceramic cartridge (for replacing 132 3-speed, plastic-cased cartridges, crystal or ceramic, single-needle or turnover); model W70 crystal single-needle cartridge; and model W72 crystal dual-voltage 3-speed turnover cartridge. (RK56; Shure Brothers, Inc., 222 Hartrey Ave., Evanston, Ill.)

produce 60 cycles has been reached. Usually the generator is coupled to the motor in such a way that the idling speed of the motor is sufficient to produce the generator rpm required for 60 cycles. When the motor revolves at speeds faster than this, as in normal cruising, the excess speed is allowed for by slipping in the drive; the generator is maintained at constant speed by the action of the governor, allowing sufficient friction in the drive just to keep the generator revolving at the required speed for 60 cycles.

Light-tracking tone arms recently developed that can be used as a replacement on all-speed, single play electric phonos. Has a miniature crystal cartridge which can be replaced by using, it is said, only the fingers as illustrated upper left. The needles, one-mil for long play records and three-mil for 78-rpm records, slip into slots on opposite sides of the cartridge and are held in place by a spring clip as shown upper right. Hairpin needle used on a Retract-o-matic tone arm can be replaced by using the fingers as shown at the right. (Webster Electric Co., Racine, Wis.)

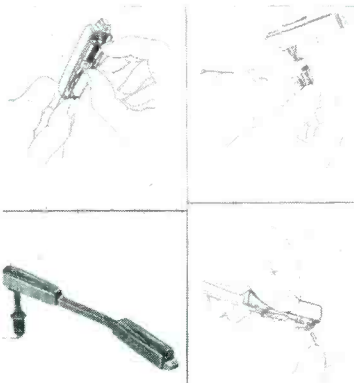

"The jack of all trades  
is master of none . . ."  
*That's why*

# QUAM

*Adjust-a-Cone*<sup>®</sup>

REPLACEMENT  
SPEAKERS

are EXACT REPLACEMENTS

Each one is designed to do a specific job—and to do it as well—or better—than the original speaker.

QUAM speakers are built for quality—not compromise. They are exact replacements—every one of them—with the right magnet, the right power handling capacity, and the right size to do the job you—and your customer—want them to do.

**FREE** The  
QUAM catalog  
listing over 100  
exact replacement  
speakers.

*ask for QUAM, the quality line for all your speaker needs*

## QUAM-NICHOLS COMPANY

232 East Marquette Road • Chicago 37, Illinois

### N. Y. C. TV-Reception Trouble-Spot Study

Channel Master sales manager Sam Schlüssel (seated) reviewing with Daniel Roher, ad counsel, materials being distributed to Service Men in and around New York City in a neighborhood-by-neighborhood survey to pinpoint TV problem areas throughout the metropolitan zones. To gather the necessary reception data, about 5,000 Service Men are being asked to provide information on the problems encountered in their own areas of operation. The results of the survey will be published in a booklet entitled *How to Cure TV Reception Problems in the New York Area*.



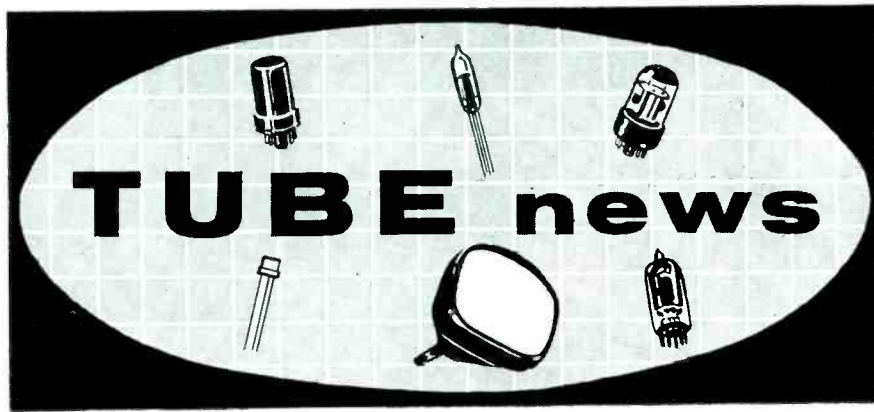

## Acceptance Tube Tests to Minimize Callbacks

**TUBE TESTING** not only serves to find defective tubes, but prevent the use of defective *new tubes*.

While only a small percentage of new tubes are defective, the installation of one bad tube during a service call can lead into an expensive search for circuit difficulties which do not exist. A routine program of acceptance-testing can save time, curb annoyance and a customer's suspicion, since the installation of a tube and its removal, because of a defect, can destroy servicing-ability confidence.

The number of defective tubes in the stock of reputable suppliers is very small. However, tubes, can be damaged in handling and by the time they are to be installed any one of a number of defects may have developed. The most common trouble, and unfortunately the most serious one, is a shorted element. If the shorted element grounds a high-voltage lead, a component may burn out, causing repair delay and, in the case of a receiver being repaired in the home, the embarrassment of pulling a dead chassis when the original complaint was not serious. Another defect is an open heater. Loss of emission or low transconductance are seldom found and high resistance shorts are only slightly more common.

An analysis of all of the faults found in new tubes indicates that most are probably caused by internal mechanical failure during handling, and few result from failure of the manufacturer's inspection.

A routine practice of testing all tubes before they are installed is good insurance. Even though the cause of failure is obvious, as in the case of an open heater, good practice is still to check the new tube. In each case, a complete test should be given; the short and filament checks are only part of the test procedure, and trans-

conductance and gas tests take very little longer and will save trouble in the long run.

To reduce the likelihood of finding that the last tube of a type in your stock is bad, it is wise to run *acceptance* tests on all tubes when they are received. Complete tests are important here, too. The first check should be mechanical inspection, for loose or broken parts of the tube. Then the tube should be checked electrically. While the manufacturer could recommend special tests, and the military services specify their own tests, transconductance and gas tube testers can be used to weed out tubes which should not be used in servicing. With

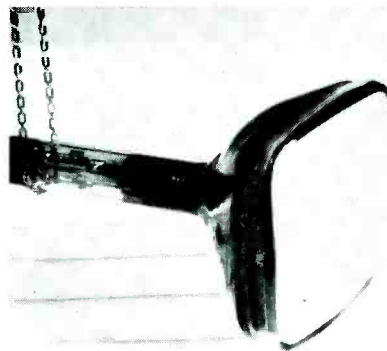

**TV RECEIVER** check tube which, it is said, can be used to test picture tubes from 10 to 27 inches. Designated the 8XP4, the tube is an 8½" rectangular, featuring automatic self-focusing, and parallel-mounted electron gun, thereby eliminating the need for an ion trap. As a safety feature, no external conductive coating is used, eliminating the necessity for discharging before handling. Tube may be used in receivers designed for either magnetic or electrostatic focus picture tubes. Rated deflection angle is 90°, but when employed in 50° or 70° deflection circuits, a smaller raster will be obtained. (Sylvania)

a regular routine of new-tube testing, one is in a good position to get credit for defective units from a distributor; he wants to make good on defective tubes, but he does not want to replace tubes damaged through carelessness, and he must protect himself. His knowledge of your good practice will establish your reliability with him, as your good service practices establish your reputation with your customers.

Manufacturers' tests, as noted, have been designed to keep the percentage of defective tubes small; every tube is subjected to a number of tests, and samplings of a lot receive very complete tests to ensure quality performance. Typically, all tubes are tested for shorts and continuity, grid current (gas, grid emission, and leakage), emission, transconductance, noise and microphony. Then, after a waiting period to permit defects from manufacturing techniques to develop, all or at least sample groups are retested. The entire lot may be retested completely if test standards for the samples are not met. In addition, spot checks are also made on capacity tolerances and mechanical dimensions.

Often puzzling to Service Men is the procedure required to select tubes for balanced circuits such as push-pull power amplifier stages. Tests that will permit the selection of pairs of tubes for such service are available, but only as lab projects. The best practical approach is the transconductance test. Tubes with equal transconductance will probably perform adequately. A more desirable test would measure both plate current and transconductance at a particular grid voltage. The best test would be measuring of the cutoff bias, and plate current and transconductance at a low grid bias. Tubes matched under these conditions should perform well in a push-pull amplifier.



# "best shop investment I've ever made..."

## PHOTOFACT

saves me time,  
helps me earn  
extra profits  
every day..."

SAYS Charles Tanner  
of Lindenhurst, L. I., N.Y.

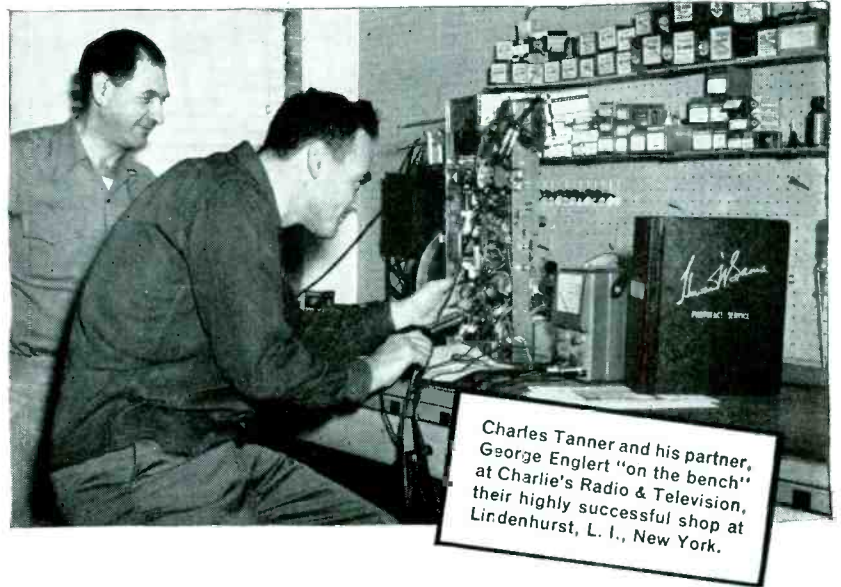

Writes Mr. Tanner: "The use of Sams' PHOTOFACT data saves me time on bench jobs, and that means *extra* profits every day, profits I can really measure. The big time-savers I especially like are the convenient Voltage Data\* and Waveforms\* shown directly on every PHOTOFACT TV schematic diagram. Because of PHOTOFACT's size, too, it's possible to work on a set with that very fine Standard Notation Schematic\* lying easily accessible in front of the technician. In my opinion, PHOTOFACT is the best shop investment I've ever made."



George Englert stands near the shop's complete PHOTOFACT Library. Charles Tanner refers to his handy Sams PHOTOFACT Index for the time-saving Folder covering his next bench job.

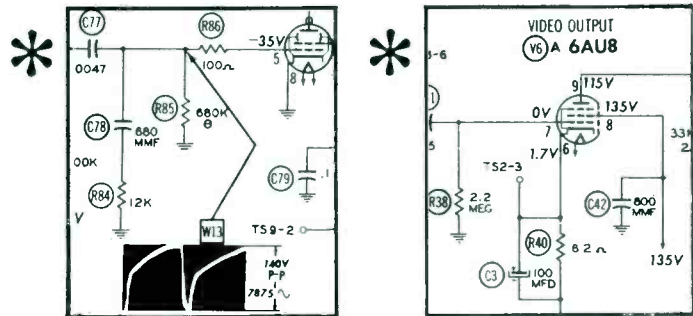

From start to finish, you solve your service problems in just minutes... you service more sets and earn more daily with PHOTOFACT by your side!

\*One of 32 features found exclusively in Sams' PHOTOFACT—the world's finest service data covering over 20,000 TV and radio models

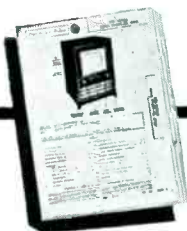

**MONEY BACK GUARANTEE!**

Got a tough repair? Try this—at Howard W. Sams' own risk: see your Parts Distributor and buy the proper PHOTOFACT Folder Set covering the receiver. Then use it on the actual repair. If PHOTOFACT doesn't save you time, doesn't make the job easier and more profitable for you, Howard W. Sams wants you to return the complete Folder Set direct to him and he'll refund your purchase price promptly. **GET THE PROOF FOR YOURSELF—TRY PHOTOFACT NOW!**

free



Send for Sams' INDEX TO PHOTOFACT FOLDERS—your guide to virtually any receiver model ever to come into your shop; helps you locate the proper PHOTOFACT Folder you need to solve any service problem on any model. You'll want this valuable reference guide. Send coupon now.

**HOWARD W. SAMS & CO., INC.**

Howard W. Sams & Co., Inc.  
2207 E. 46th St., Indianapolis 5, Ind.

Send FREE Index to PHOTOFACT Folders  
 I am a Service Technician

Name \_\_\_\_\_

Address \_\_\_\_\_

City \_\_\_\_\_ Zone \_\_\_\_\_ State \_\_\_\_\_

# TELCO SELF-SUPPORTING tripod MAST TOWERS

FOR FAST, EASY INSTALLATION

ALL ASSEMBLED—NO GUY WIRES

Real profits on any antenna installation—Bolt the tower to the roof and that's it! No bothersome, time consuming screw eyes, guy wires and rings or turn-buckles. Get sturdy, dependable, weatherproof installations. Telco Tripod Towers are a whole roof installation in one! All assembled—ready to install. Get them at your Telco distributor now.

AVAILABLE IN 3 MODELS FOR  
ANY SIZE INSTALLATION

- Model No. 9063  
2 foot heavy steel gauge, plated tower
- Model No. 9144  
3 foot electro-galvanized tubing tower
- Model No. 9145  
5 foot electro-galvanized tubing tower

REMEMBER  
THE NAME



3 Ft. Model  
No. 9144

5 Ft. Model  
No. 9143

2 Ft. Model  
No. 9063

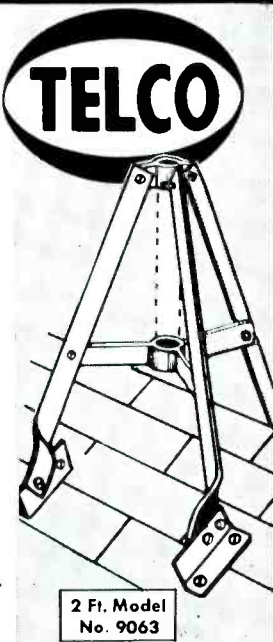

TELEVISION HARDWARE MFG. CO.

Division of General Cement-Texton American, Inc.  
ROCKFORD, ILLINOIS

SEE YOUR TELCO DISTRIBUTOR NOW!

Stand-offs, mounts, arrestors . . . everything you need for every kind of TV installation . . . all at your Telco distributor.



## 22-Inch Color-TV (Continued from page 19)

range of *agc* voltage allows for close control to prevent sync and white level crushing or cross modulation on strong local signals, and permits high signal gain on weak signals. The third and fourth *if* stages use dual purpose tubes; as *if* amplifiers, the pentode sections of the 5AN8 are used.

The chroma side-band burst and 4.5-mc intercarrier sound are derived from the upper bandpass of *if* response and demodulated by a 1N60 as a shunt detector. These signals are amplified by the first chroma amplifier and then separated.

The luminance (or brightness) and sync signals are demodulated by a 1N60 luminance detector. This portion of the *if* response up to 3.1 mc from picture carrier is essentially flat.

The first luminance amplifier, a triode section of the fourth *if* (5AN8), a bootstrap amplifier with a gain of approximately 3, supplies a high-level video signal across the cathode load of the same polarity as the luminance-detector output. The cathode load matches the necessary terminating impedance of the delay line; a delay of .8 microsecond is necessary to match the delay of the chroma signal, due to the delay caused by the narrow bandpass of the chroma-amplifier stages. The delay line is terminated by a matching load and a 3.58-mc trap to remove chroma and burst signals from the luminance signal.

The second luminance amplifier, a pentode section of a 6BH8 amplifier, inverts the luminance signal. The red and green picture-tube cathodes receive the full output of video, direct coupled. The blue cathode signal is attenuated to approximately 65% of the Y signal supplied to the red and green cathodes; 10,000 and 22,000-ohm resistors serve as a signal divider network. This has been found necessary, as the blue phosphor, being more efficient requires less drive for the same light output.

Contrast control in the cathode of the 6BH8 controls the setting of a 50-mfd cathode-bypass capacitor. Degeneration caused by signal voltage appearing on the cathode is controlled by bypass coupling; that is, minimum gain with the control at 1500 ohms in series with the cathode-bypass capacitor.

Brightness control is used to set the cathode voltage, in respect to the grids of the picture tube.

Horizontal blanking by a negative pulse is applied to the screen grid of the 6BH8 second luminance amplifier. This causes the tube to be cut off

for service and lab. work

## Heathkit PRINTED CIRCUIT OSCILLOSCOPE KIT FOR COLOR TV!

① Check the outstanding engineering design of this modern *printed circuit* Scope. Designed for color TV work, ideal for critical Laboratory applications. Frequency response essentially flat from 5 cycles to 5 Mc down only 1½ db at 3.58 Mc (TV color burst sync frequency). Down only 5 db at 5 Mc. New sweep generator 20-500,000 cycles, 5 *times* the range usually offered. Will sync wave form display up to 5 Mc and better. Printed circuit boards stabilize performance specifications and cut assembly time in half. Formerly available only in costly Lab type Scope. Features horizontal trace expansion for observation of pulse detail—retrace blanking amplifier—voltage regulated power supply—3 step frequency compensated vertical input—low capacity nylon bushings on panel terminals—plus a host of other fine features. Combines peak performance and fine engineering features with low kit cost!



## Heathkit TV SWEEP GENERATOR KIT ELECTRONIC SWEEP SYSTEM

② A new Heathkit sweep generator covering all frequencies encountered in TV service work (color or monochrome). FM frequencies too! 4 Mc—220 Mc on fundamentals, harmonics up to 880 Mc. Smoothly controllable all-electronic sweep system. Nothing mechanical to vibrate or wear out. Crystal controlled 4.5 Mc fixed marker and separate variable marker 19-60 Mc on fundamentals and 57-180 Mc on calibrated harmonics. Plug-in crystal included. Blanking and phasing controls—automatic constant amplitude output circuit—efficient attenuation—maximum RF output well over .1 volt—vastly improved linearity. Easily your best buy in sweep generators.



during horizontal retrace; the plate voltage goes to a high positive value. The picture tube cathodes are direct coupled and the high positive cathode causes the picture tube to go well beyond cutoff.

Vertical retrace blanking by a positive pulse from the vertical output transformer is coupled through a .47-mfd capacitor to the second luminance amplifier plate load.

The vertical and horizontal sync signals are taken off at the second luminance amplifier grid load. The sync amplifier is a triode, half of the third *if* 5AN8. A 3CS6 serves as a sync separator with noise signals fed to control grid 1.

A 7AU7 serves as a vertical multi-vibrator; a 5AQ5 as vertical output. A vertical output transformer supplies deflection and also vertical convergence voltages and currents.

For horizontal *afc*, one-half of a 6BT8 is used; another 7AU7 is used as a horizontal multivibrator. Two 25DN6s, in parallel, have been included for horizontal drive.

The first chroma amplifier, tuned to 4.1 mc, amplifies the sound of 4.5 mc, that is fed to a 3BN6 FM detector.

The chroma signal from the chroma detector is amplified by the 6AW8, the first chroma amplifier. In this stage the gain is controlled by a chroma *agc* voltage from the switching detector; the gain is proportional to the amplitude of burst. Since this is a strong burst a higher bias must be applied to the first chroma grid.

The first chroma amplifier, one-half of a 6AW8 pentode section, amplifies 4.5 mc *if* sound, chroma side bands and burst; input is tuned to 4.1 mc. The gain of the first chroma is controlled by *agc* voltage developed by one-half of the switching detector on color reception. The applied *agc* is proportional to the magnitude of the burst signal; that is, the gain is reduced on a high level of burst, similar to *agc* on the *if* that has been gain keyed and proportioned to the magnitude of the sync pedestal.

The plate transformer of the first chroma is tuned to 3.1 mc to give the required bandpass of  $\pm 500$  kc from 3.58. In addition, a 4.5-mc trap circuit strips off the sound portion of the signal and sharpens the upper chroma bandpass slope.

The second chroma amplifier, a 12BY7A, is needed to handle the high amplitude of chroma signals that are necessary for the high level demodulators. On black and white reception a high negative voltage is applied to

(Continued on page 50)

THE VERY BEST IN CUSTOM TELEVISION

BY **TECH-MASTER**



FOUND IN THE FINEST OF INTERIORS

As the custom installation signifies the ultimate in well-chosen decor, so the name Tech-Master stands for the utmost in Custom television. The reputation established with the manufacture of the renowned Model 630 chassis is further enhanced by the outstanding Tech-Master Audiophile and Sound Theatre.

See your Custom hi-fi dealer today... or write  
**TECH-MASTER CORPORATION**  
75 FRONT STREET, BROOKLYN, NEW YORK

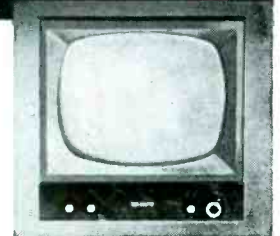

**ONLY TECH-MASTER HAS THESE OUTSTANDING PLUS FEATURES:**

- World-famous 3 tube synchrolok picture circuit for constant picture stability.
- 30 tubes fully used.
- "Full Frame Mounting" ... just a simple cutout is required for installation.
- High fidelity picture as well as exceptional audio reproduction.

**what you want ... when you want it with**



**ERIE**  
**DISC and GP CERAMICON®**  
**SERVICE KITS**

**HERE'S WHAT YOU GET**

- 1 100 High Stability ERIE Disc or Tubular Ceramicons
- 2 18 Popular Values
- 3 Handy, Convenient 18 Section Plastic Storage Case
- 4 Exceptional Value

**HERE'S WHAT YOU SAVE**

	REGULAR PRICE
100 ERIE Disc or Tubular Ceramicons	\$15.00
18 Section Plastic Case	1.75
<b>Total Value</b>	<b>\$16.75</b>
<b>YOU PAY</b>	<b>\$10.65</b>
<b>YOU SAVE</b>	<b>\$ 6.10</b>

ERIE Ceramicon TV Kits are also available

**ORDER NOW**  
From Your  
**ERIE**  
**DISTRIBUTOR**



**ERIE ELECTRONICS DISTRIBUTOR DIVISION**  
**ERIE RESISTOR CORPORATION**  
Main Offices: ERIE, PA.  
Factories: ERIE, PA. • LONDON, ENGLAND • TRENTON, ONT. RIO

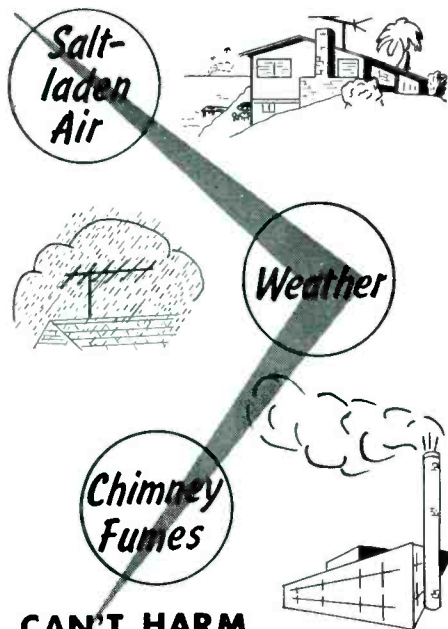

**CAN'T HARM**  
**TV Antennas • Hardware**  
*Protected with*

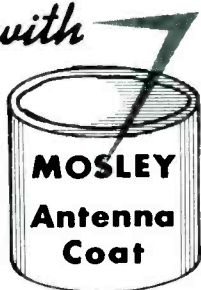

ALSO IDEAL FOR:

- Masts
- Rotor Housings
- Terminals
- Ham Beams

MOSLEY ANTENNA COAT keeps TV and FM antenna installations in brand new operating condition—For Years!

Easy to apply with brush or spray. Forms tough, long-lasting protective coat that resists all corrosive atmospheric conditions.

No. E-101 — ANTENNA COAT. Enough to protect Several antennas.

Dealer Net, \$1.94

At Radio and Television Parts  
 Distributors, Coast-to-Coast.

**Mosley Electronics, Inc.**

9627 ST CHARLES ROCK ROAD, ST LOUIS 14, MISSOURI

**When . . .  
 You Change Your Address**

▶ Be sure to notify the Subscription Department of SERVICE at 52 Vanderbilt Avenue, New York 17, N. Y., giving the old as well as the new address, enclose address labels from your last SERVICE copy, and do this at least four weeks in advance.

▶ The Post Office Department does not forward magazines unless you pay additional postage, and we cannot duplicate copies mailed to the old address.

▶ We ask your cooperation.

**22-Inch Color-TV**

(Continued from page 49)

the control grid, causing the tube to be cut off. This negative voltage is supplied from a controlled-rectifier circuit as a color killer; half of a 6AW8A. The controlling voltage to the color killer is from half of the switching detector (5AM8), rectifying the output of the reference oscillator and developing a positive voltage to the grid of the color killer. With burst signal present, the color killer is cut off and the second chroma amplifier is allowed to conduct. The gain is controlled by changing the cathode bias; this is a color or saturation control on the control panel.

The burst amplifier, half of a 6AW8A, is keyed only during horizontal retrace. On color transmission the burst signal is amplified and a burst signal of approximately 100 volts peak-peak is developed across a burst coil. This tuned circuit is peaked to 3.58 mc. and the plate is controlled by a small tuning capacitor serving as a hue control.

Part of the burst is supplied to the switching detector and to the phase detector (*apc*) for controlling the phase of the local oscillator, by developing a correction voltage to control the reactance tube.

The local oscillator, half of the pentode section of a 5AM8 color reference oscillator, is crystal controlled for its mean frequency and corrected for lockin phase by a reactance tube that serves as a capacitive reactance across the oscillator-tuned circuit.

The output of the oscillator is electron coupled to a buffer transformer. The secondary of the buffer supplies *R-Y* and  $-(R-Y)$  to the phase detector through an *apc* loop, also with additional phase shift of the oscillator reference to the switching detector.

The *R-Y* oscillator output of approximately  $-40$  volts peak-to-peak is supplied to the *R-Y* demodulator grid for synchronous detection on the *R-Y* axis or  $90^\circ$  from burst. The  $-(R-Y)$ , from the opposite end of the secondary, will be at  $180^\circ$  from *R-Y*. A leading phase shift of  $33.2^\circ$  is introduced by a phase shift network; this supplies a color reference oscillator signal  $303.2^\circ$  from burst. This is the correct axis for *G-Y* sync demodulation.

The sync demodulators, *R-Y* and *G-Y*, are in effect shunted across the chroma-output transformer and sample, for very short duration, the amplitude and phases of the chroma signal applied to the plate of the demodulators. The demodulators conduct for a very short interval of each

**COLOR TELEVISION**

*Home Study for  
 Technicians*

**NOW AVAILABLE THE MOST  
 COMPLETE, COMPREHENSIVE  
 COLOR TV HOME STUDY  
 COURSE ILLUSTRATED WITH  
 NEW BLOCK-A-MATICS**

This new seven-lesson HOME STUDY COURSE in COLOR TELEVISION was compiled by Albert C. W. Saunders, internationally noted author-lecturer on Radio and TV Servicing, and is the best course available today. It is just off the press with the latest technical information. Lessons are fully illustrated with simplified diagrams including BLOCK-A-MATICS — *The New Look in Schematics*. Also Color Illustrations.

**COST OF COMPLETE COURSE ONLY \$25.00**

*For Particulars Write*

**SAUNDERS ELECTRONICS  
 CORRESPONDENCE SCHOOL**

**137 FEDERAL STREET  
 BOSTON 10, MASSACHUSETTS**

positive cycle of the 3.58-mc reference oscillator signal; during this period of sampling, the plate is clamped at the voltage appearing at the instant both positive and negative color difference voltages are developed, in reference to the average voltage of demodulator plate. These color-difference signals are passed through a low-pass circuit, removing 3.58 mc, as color signals are up to only 500 kc or less.

The color-difference signals applied to the grids are also *ac* coupled to their respective screen grids. In this method less drive is needed to achieve a higher light output.

The adjustments necessary to set up the correct phase of *R-Y* and *G-Y* require a color bar generator. For the color difference displays,\* as illustrated (p. 18) the sequence of the color bars are: *green, yellow, red, magenta, white, cyan and blue*. The luminance or brightness values are .59, .89, .30, .41, .1, .7 and .11.

In making these tests, with the hue control at center of range, the burst transformer was adjusted for *R-Y* display; the scope to *R-Y* grid of the picture tube. *G-Y* phase was adjusted by observing the correct wave pattern on the blue grid of the picture tube.

\*Hickok model 655X was used to obtain these patterns.

## Remote-Control Relays

(Continued from page 23)

ing it and, thus helps to extinguish it.

Wear and tear also represent a major cause of contact failure. Assuming that the contacts are not being overworked, good care of the contacts will often increase their life considerably. The discoloration of contacts (unless caused by sulphur) should not be removed. If the contacts become badly pitted, sandpaper or crocus cloth may be used to smooth out the contacts; care should be taken to remove as little of the contact material as possible, lest there remain insufficient contact material for normal contact life. Where the contacts are only slightly marred, the end of a screwdriver may be used to scrape (*gently and carefully*) the contact to remove the dirt. A file should not be used, for permanent damage could result.

Large relays have provisions for replacing contacts; however, this is not practical for smaller relays. When the contacts render the relay useless, it is best to replace the entire relay, rather than to service it. This is advisable, since spring leaves on most relays (especially the telephone types) are fragile and may easily be bent out-of-shape permanently.

If the coil develops an open circuit, the armature will fail to close when power is applied to the relay circuit. The armature will also fail to close if insufficient power is supplied to the relay coil; the voltage must be measured across it with a 20,000 ohm/volt meter or a *vom* to obtain an accurate reading. When the coil develops a short circuit, the coil will overheat and burn, and relay will be rendered useless. In an *ac* coil, a partial short, say of a few turns, will cause it to overheat; if a *dc* coil overheats an appreciable number of turns are shorted. Shorts may occur from electrical, mechanical or chemical mistreatment of the coil, or from inherent coil defects.

It is common practice to operate a relay coil at a relatively high temperature, and a coil which may be thought to be running too hot, is probably operating at a normal temperature. High ambient temperatures, heat from associated equipment, and low barometric pressure may cause a coil to operate at a higher-than-normal temperature. Excessive current through the coil will also cause it to overheat; most coils will operate at a current which is about 10% greater than the one for which they were designed, without producing any serious damage to them.

# KESTER



FASTER  
ACTING



Absolutely non-corrosive and non-conductive, KESTER "RESIN-FIVE" CORE SOLDER contains an activated type of resin that gives you that fast, positive action on all your jobs . . . including the most difficult.



THE  
BEST

LONGER  
LASTING

KESTER SOLDER COMPANY  
4248 Wrightwood Avenue • Chicago 39, Illinois  
Newark 5, New Jersey • Brantford, Canada

# SOLDER

THE  
NEW

No-Noise  
TUNER TONIC

Volume  
Control  
and  
Contact  
Restorer  
with  
Perma-  
Film

2 oz. bot-  
tle. Net  
to serv-  
icemen

\$1.00



Cleans, lubricates, protects . . . not a carbon-tet solution. Still available in the new 6 oz. spray can.

Net to servicemen—\$2.25

"NO NOISE"

Also available in 6 oz. bottles and quart cans. At your nearest distributor.

with PERMA-FILM

Cleans, lubricates, restores all tuners including wafer type. Won't change or affect capacities, inductance or resistance. Won't harm insulations or precious metals, nor attack plastics. For television, radio and FM. Eliminates all noise, oxidation and dirt indefinitely.

Non-toxic, non-inflammable, insures trouble-free performance.

\$3.25

Extra economical because a small amount does the job!



ELECTRONIC CHEMICAL CORP.

813 Communipaw Avenue

Jersey City 4, N. J.

Some types of hum in a relay are due to a slight opening and closing of the armature. This, in turn, is caused by the application of insufficient voltage to the coil. The source voltage should be checked in this case. Excessive resistance in the coil circuit will also cause hum.

If the armature fails to close when power is applied to a relay, a check must first be made to make sure that the coil is energized. If the coil does receive the proper power and it is not faulty, then the armature itself should

be checked, by operating by hand, to make sure that no obstruction is barring its movement. Some other causes of the armature's failing to close include: Incorrect wiring of the coil in the circuit; low line voltage; open, shorted, or grounded coil; defective coil terminals; normally-closed contacts welded together due to overloading; alien matter existing between pole face and armature; improperly-adjusted air gap; mechanical binding due to a deformed hinge or some other mechanical element.

## Now... From KAY ELECTRIC...



A NEW, LOW-COST  
LAB QUALITY  
ALL-ELECTRONIC  
SWEEPING OSCILLATOR  
for service use

*Ligna-Sweep*

MODEL C

### FOR ALIGNMENT OF TV, FM RADIO, VIDEO AND COMPLETE VHF BANDPASS WITH AUTOMATIC GAIN CONTROL

Designed and manufactured to the same high quality standards which have made Kay the leader in instruments for laboratory and production line, the new Kay Ligna-Sweep, Model "C" gives variable center frequency and sweep with high output automatically held constant over frequency sweep and frequency band. The following frequency ranges are covered by six switched bands.

Television: All IF and VHF channels with fundamental frequency output of 1.0 V rms into 75 ohms. Sweep width variable to at least 20mc at VHF, 15 mc at IF.

FM Radio: Range 80-120 mc with fundamental frequency output of 1.0 V rms into 75 ohms. Sweep width variable 100 kc to at least 20 mc. 10.7 mc IF band pass with beat frequency output of 0.25 V rms into 75 ohms sweep width variable 100 kc to 2 mc.

VHF Band: Range 30 to 220 mc with fundamental frequency output of 1.0 V rms into 75 ohms. Sweep width variable to at least 15 mc.

Video: Range 100 kc to 12 mc with beat frequency output 0.25 V rms into 75 ohms. Sweep width variable 100 kc to 12 mc.

#### OTHER SPECIFICATIONS:

Flatness: Flat within  $\pm 0.4$  db over widest sweep.

Sweep rate: Variable around 60 cps. Locks to line frequency.

Attenuators: Switched 20 db, 20 db, 10 db and 6 db, plus continuously variable 1/2 db.

Frequency Indication: Direct reading calibrated dial.

Deflection Voltage: Linear sawtooth separately available. No phasing control.

Power Supply: Electronically regulated 105 to 125 volts ac, 50-60 cycles.

Price: \$350.00 F. O. B. Plant.

WRITE FOR NEW KAY CATALOG

## KAY ELECTRIC COMPANY

Dept. S-6 14 MAPLE AVE., PINE BROOK, N. J. CA'dwell 6-4000

## Community-TV Antennas

(Continued from page 33)

back up to the last step on the resistance and left at this point.

In another instance, selenium rectifiers used in high-voltage supplies were found to be short-lived. The major cause of this defect was traced to insufficient ventilation, allowing the ambient temperature of the amplifier to rise above the allowable limits. The remedy for this was simple; it was only necessary to provide more ventilation, by cutting the larger vents in the case. The bottom plates of the amplifier were removed and replaced with a copper screen; more vent holes were made in the weatherproof housings which contained the amplifiers. These were covered with a disc of copper screen on the inside of the case to prevent excess radiation, and provided with *eaves* or *awnings* cut out of sheet metal, that were soldered to the outside of the case, to prevent entry of rain. Added vents in the bottom of the case were also used and covered with screening in most cases.

In some cases, due to peculiarities in cable runs and other factors, it was found that certain frequencies were being discriminated against, with the result that subscribers on the ends of these particular lines were getting bad pictures, or even, in some instances, no pictures on some channels, usually the higher channels. Attempts to remedy this situation by increasing the overall gain of the line amplifiers resulted in objectionable overloading on the lower channels, with crosstalk between low channels occurring in some sets. The appearance of *windshield-wiper* interference and smearing, due to a too-high adjacent-channel signal, also gave trouble.

With a wide-band sweep-generator and scope, a response curve check was made on the line amplifiers feeding this particular run. It was possible to put markers on the curve showing the relative gain of each channel and adjust accordingly.

### TV Antenna-Accessory Developments

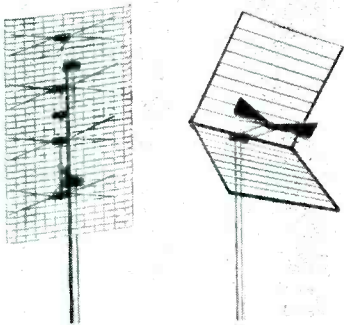

**ULTRAHIGH** antennas. At left is an all-aluminum corner reflector. A solid aluminum inline dipole is said to create proper wavelength relationships with reflector assemblies. Unit is factory assembled. Has reinforced aluminum castings. Constructed of No. 8 (.162") solid aluminum rods staked into  $\frac{1}{2}$ " x .091" aluminum flat strips. At right is a 4-stack bowtie said to feature a rigid 1-piece preassembled design. Also incorporated is custom-channel calibrator. Construction is of No. 12 (.080") welded galvanized grid wire screen with  $\frac{1}{8}$ " od solid aluminum rod bowties. (Models UHF410 and UHF202; JFD Manufacturing Co., Inc., 6101 16th Ave., Brooklyn 4, N. Y.)



**OUTDOOR** matching transformer for use in the remote operation of rf amplifiers over twinlead and open-wire transmission lines. Transformer connects rf output of a 72-ohm preamp with twinlead or open-wire, while supplying 24-volt power over the same line. Can be used to match a 300-ohm antenna to a 72-ohm line for mounting on mast directly under antenna. (TO-374; Jerrold Electronics Corp., 23d and Chestnut Sts., Philadelphia, Pa.)

(Right)

**COMPLETELY SOLDERLESS** and semi-solderless uhf plugs. Both connectors are said to eliminate operation of soldering cable braid to the connector shell. Solderless unit eliminates necessity of soldering center conductor of cable to connector contact. Both connectors are reusable. Made of brass with a cadmium plate finish; contacts are silverplated. (Models 83-850 and 83-851; Amphenol Electronics Corp., Chicago 50, Ill.)

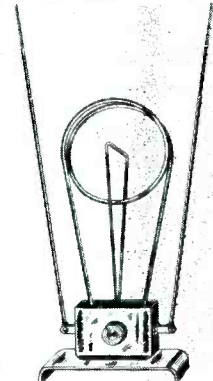

**INDOOR TV** antenna which is claimed to have a built-in, hi-pass filter and a variable 12-position channel attenuator. (Filter-Tenna model DB-500; Dynamic Electronics—N. Y., Inc.; 73-79 Woodhaven Boulevard, Forest Hills, L. I., N. Y.)



# INSTRUMENTS

## GRID-CIRCUIT TUBE TEST KIT

A grid-circuit tube-tester kit, GCT-5, with components identical to those in the factory-wired GCT-5 model, has been announced by Seco Manufacturing Co., 5015 Penn Ave. S., Minneapolis, Minn.

Unit, it is said, tests more than 125 tube types for control grid emission, grid-to-cathode shorts, gaseous conditions and cathode-to-heater shorts. Tester features seven wired sockets and one spare and replaceable panel etched with tube lists. Offers .35 microwatt grid emission; grid-to-cathode leakage, 125 megohms; gaseous condition, 125 megohms; grid to plate or screen, 125 to 250 megohms; cathode to heater leakage, 1 megohm; and plate or screen to suppress, .1 megohm. Can be used as a capacitor leakage checker with sensitivity available to 5000 megohms; also crystal divide tester, and as a *dc* voltmeter with a range up to 500 v.



## TRANSISTOR AUTO-RADIO POWER SUPPLY

An *ac*-powered *dc*-power supply, D612T, designed to operate, test and service transistor auto radios, has been introduced by Electro Products Labs, 4500 N. Ravenswood Ave., Chicago 40.

Unit handles 6/12-v tube radios as well as transistor models. Filter circuit is said to keep *ac* ripple below critical level for testing of transistor auto radios. Features conduction-cooling system. Supply can also be used to service or operate aircraft and marine radios, phone circuits and relays.

## PIX TUBE TESTER

A TV picture tube tester, Videochek CR5, for checking electron guns, has been announced by The Hickok Electrical Instrument Co., 10521 Dupont Ave., Cleveland 8, O.

Unit tests for shorts and opens in electrodes of gun through use of the pix tube and neon lamp in a bridge circuit, as a peak reading *vtom*. Beam current principal of test is employed for *em*-focussed (tetrode) tubes; for triode-types a peak emission check is used to determine condition of the cathode. Tube socket furnished provides for tubes having 6.3 v heaters, utilizing duodecal basing.

When signal conditions demand a **TOWER...**  
choose one built by **AERMOTOR**

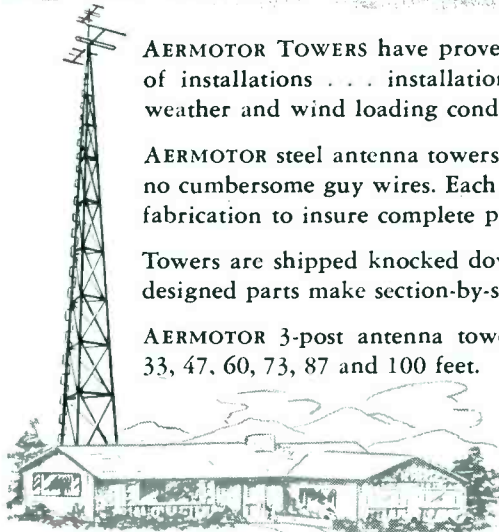

AERMOTOR TOWERS have proven their excellence in thousands of installations . . . installations exposed to the most severe weather and wind loading conditions.

AERMOTOR steel antenna towers are self supporting . . . require no cumbersome guy wires. Each part is heavily galvanized *after* fabrication to insure complete protection from exposure.

Towers are shipped knocked down in convenient bundles; well designed parts make section-by-section assembly easy.

AERMOTOR 3-post antenna towers are available in heights of 33, 47, 60, 73, 87 and 100 feet.

**WRITE FOR ADDITIONAL INFORMATION ABOUT THE AERMOTOR TOWERS AND A DEALER FRANCHISE IN YOUR TERRITORY.**

SINCE 1888, MANUFACTURERS OF QUALITY BUILT TOWERS

# • AERMOTOR COMPANY •

2500 W. ROOSEVELT RD.—CHICAGO 8, ILLINOIS U.S.A. DEPT. 14U6

## House Current Anywhere

with

# Trav-Electric CONVERTERS

Enjoy house current anywhere in car, truck, boat. Just plug into cigarette lighter and operate any A.C. electric tool or appliance, up to 125 watt load. Built for both 6 and 12 volt batteries. List, from \$11.95.

## SUMMER SALES Booster

(See chart below). Trav-Electric's peak months are in summer. They help sell phonographs, small radios, electric shavers, etc. For use at beach, camp, picnic. Let Trav-Electric change summer slump into summer sales.

"101" USES

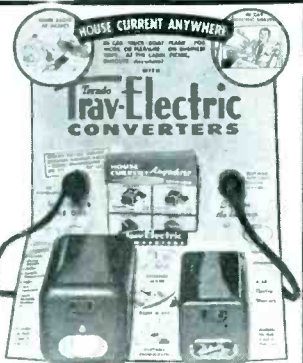

**Free**

**DEALER DISPLAY**

(Small — 8" x 5" on Counter)

FREE LITERATURE

**ORDER NOW**

Receive free dealer display, free literature and two models from stock, as shown above, at quantity discount. Shipped direct through your favorite jobber. Order now. . . Be ready for summer sales.

Write for Particulars

**TERADO Company**

Designers & Mfrs. of Electronic Equipment Since 1927

1066 RAYMOND AVE.  
ST. PAUL 14, MINN.

Trav-Electric SALES WILL FILL THE LOW SPOTS

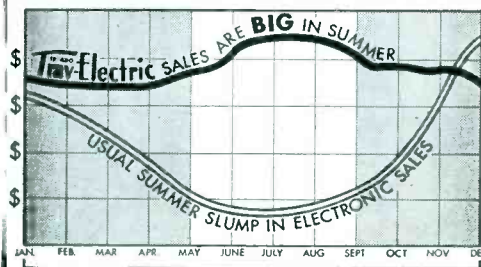

**EICO** 84 Withers St., Brooklyn 11, N. Y. S-6

SAVE ME 50% on precision instruments —  
send **FREE CATALOG** on EICO's 46 models  
in factory-wired and kit form.

My Name .....  
Address .....  
City ..... Zone ..... State .....



**NEW! COLOR**  
and Black-&-White  
DC to 5 MC LAB & TV  
5" OSCILLOSCOPE

#460  
Factory-wired  
and tested \$129.50  
Also available as kit \$79.95

• Features DC Amplifiers!

Flat from DC-4.5 mc, usable to 10 mc. **VERT. AMPL.:** sens. 25 rms mv/in; Z 3 megs; direct-coupled & push-pull thruout; K-follower coupling bet. stages; 4-step freq-compensated attenuator up to 1000:1. **SWEEP:** perfectly linear 10 cps-100 kc (ext. cap. for range to 1 cps); pre-set TV V & H positions (30 & 7875 cps); auto. sync. ampl. & lim. **PLUS:** direct or cap. coupling; bal. or unbal. inputs; edge-lit engraved lucite graph screen; dimmer; filter; bezel fits std photo equip. High intensity trace CRT. 0.06 usec rise time. Push-pull hor. ampl., flat to 400 kc, sens. 0.6 rms mv/in. Built-in volt. calib. Z-axis mod. Sawtooth & 60 cps outputs. Astig. control. Retrace blanking. Phasing control.

**BEFORE** you buy ANY instruments—get the **FACTS** on the money-saving, high-precision EICO line. Fill in coupon for **FREE** catalog & name of your nearby distributor.

**EICO** 84 Withers St., Brooklyn 11, N. Y.  
Prices 5% higher on West Coast

# HUSH

Reg. U.S. Pat. Off.

**Chemically engineered  
for tuners and switching  
mechanism**



Hush comes in a 6 oz. pressure can with sufficient pressure to reach all contacts to wash-away that dirt, leaving clean and positive contacts, protected with a lasting lubricant film. Hush does not affect inductance, capacitance or resistance. Hush also available in 2 oz., 8 oz. and 32 oz. containers.

6 oz.  
Spray  
can  
**\$2.25**  
net

Free literature available.  
See your distributor  
or write to

**CHEMICAL ELECTRONIC  
ENGINEERING, INC.**  
Matawan, N. J.

## BENCH-FIELD TOOLS ...

### SOLDERLESS TERMINAL KIT

A solderless terminal kit, 395, has been announced by Vaco Products Co., 317 E. Ontario St., Chicago 11, Ill.

Kit includes cutting, stripping and crimping tool; pack of assorted solderless terminals; a 3/16" x 3" plastic handle screwdriver; and plastic carrying pouch.



### WIRE CUTTER-STRIPPER

A pocket-size wire cutter-stripper, featuring a wire size adjustment, has been developed by Jo-El Co., 14209 Leroy Ave., Cleveland, O.

Tool uses 5" ground blades for cutting; for stripping, a stop adjustable to the proper wire size is used.

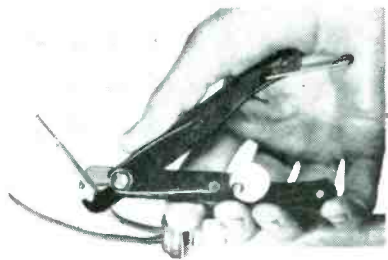

### SOLDERING AID

A probe-type soldering aid has been introduced by Weller Electric Corp., 601 Stone's Crossing Rd., Easton, Pa.

Item is a pencil-shaped colored plastic holder with pointed metal-probing and slotted-wiring ends for holding work being raised to soldering heat, twisting wires into tight connections, untwisting wires and holding sensitive components clear of points being soldered.

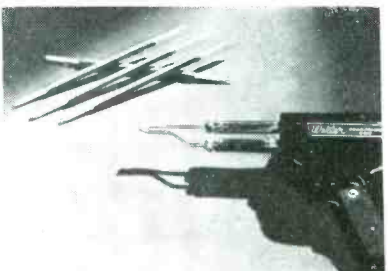

## DON'T JUST SAY CAPACITORS

Ask For Sprague By  
Catalog Number.

Know what you're getting ... get exactly what you want. Don't be vague ... insist on Sprague. Use complete radio-TV service catalog C-610. Write Sprague Products Company, 61 Marshall Street, North Adams, Massachusetts.

# SPRAGUE

WORLD'S LARGEST CAPACITOR MANUFACTURER

## TV PARTS ... ACCESSORIES

### INVERTERS FOR PORTABLE TV

Inverters, for operating portable TV sets in autos, buses, trucks, boats and planes, have been announced by the American Television and Radio Co., 300 E. Fourth St., St. Paul 1, Minn.

Units operate from 6 or 12-v storage batteries and deliver 110 v ac, 60 cycles at output capacities of 100-150 w. Installation can be made under dash or in trunk compartment of vehicle.

### PIX TUBE CONVERSION KITS

Two metal-to-glass picture tube conversion kits, C4 and C5, have been introduced by Colman Tool and Machine Co., Box 7026, Amarillo, Tex.

C4 is for 21-inch Stewart-Warner sets and can also be used for many Coronado, Truetone and Silvertone models. C5 is for sets using Silvertone 110-821 chassis and some Firestone and CBS-Columbia models.

### ALIGNMENT TOOLS

Seven alignment tools, 2541 through 2547, for servicing both color and late model b-w TV sets, have been introduced by Walsco Electronics Corp., 3602 Crenshaw Blvd., Los Angeles 16, Calif.

Included are double-ended, molded nylon iron-core aligners with hex end diameters from .075" to .125" to fit all currently-used slug openings. Ends of tools are undercut on one side to reach and align bottom slugs. Alignment tool 2541 is designed for sets using if cans with smaller than standard openings. Tools 2544 through 2547 are 11" long to permit alignment in difficult spots without undesirable hand capacity.



## ADVERTISERS IN SERVICE

JUNE, 1956

	Page
Aeromotor Co. ....	53
Alliance Mfg. Co. ....	25
American Pamcor, Inc. ....	29
Argos Products Co., Inc. ....	2
<b>B &amp; K Mfg. Co. ....</b>	<b>37</b>
Blender-Tongue Labs., Inc. ....	56
Bussmann Mfg. Co. ....	6
<b>Chemical Electronic Engineering Co. ....</b>	<b>54</b>
Cornell-Dubilier Electric Corp. Inside Front Cover, 42	
Delco Radio Div. General Motors Corp. ....	32
Electronic Chemical Corp. ....	51
Electronic Instrument Co., Inc. (EICO) ..	54
Erie Resistor Corp. ....	49
General Electric ....	12, 13
General Dry Batteries, Inc. ....	3
The Heath Co. ....	48
The Hickok Electrical Instrument Co. ....	7
Jensen Industries, Inc. ....	42
Jensen Mfg. Co. ....	39
Jersey Specialty Co. ....	55
Kay Electric Co. ....	52
Kester Solder Co. ....	51
Littelfuse, Inc. ....	16
P. R. Mallory & Co., Inc. Inside Back Cover	
Merit Coil & Transformer Corp. ....	44
Mosley Electronics, Inc. ....	50
Perma-Power Co. ....	44
Precision Apparatus Co., Inc. ....	35
Pyramid Electric Co. ....	4
Quam-Nichols Co. ....	45
The Radiart Corp. .... Inside Front Cover, 42	
Radio Corporation of America 1, 27, Back Cover	
Raytheon Mfg. Co. ....	8
Remington-Rand Div Sperry-Rand Corp. ....	31
Howard W. Sams & Co., Inc. ....	47
Saunders Radio & Electronic School ....	50
Shure Bros., Inc. ....	41
Simpson Electric Co. ....	56
Snyder Mfg. Co. ....	5
Sonotone Corp. ....	43
Sprague Products Co. ....	28, 44, 54
Tech-Master Corp. ....	49
Television Hardware Mfg. Co. ....	48
Tenna Mfg. Co. ....	36
Terado Co. ....	53
Vaco Products Co. ....	26
Vokar Corp. ....	28

# COMPONENTS

### PW WIREWOUND CONTROLS

Wirewound controls, series 39, for printed-wiring applications, have been announced by Clarostat Manufacturing Co., Inc., Dover, N. H.

Units mount on *pw* boards with two tabs for positive locking. Controls are rated at 2 *w*; resistance available in range from 4 to 5000 ohms; and measure 3/4" in diameter by 3/8" deep. Adjustment is by screwdriver slot. Further details in bulletin 754303.

### MIDGET MICA CAPACITORS

Two series of hi-temp molded midget mica capacitors, for operation up to 130° and 160° C, respectively, have been introduced by Cornell-Dubilier Electric Corp., S. Plainfield, N. J.

Maximum capacitance is 15,000 mmfd in 130° C types and 7,500 mmfd in 160° C types. Voltage ratings are 300 and 500 *vdc*. Further details in bulletin 422-4.

### PW SNAP-IN VARIABLE CONTROLS

Self-supporting, snap-in variable resistors, LR-70, for use in printed wiring in radio and TV chassis, have been developed by Stackpole Carbon Co., St. Marys, Pa.

Controls are rated at .75 *w* for values above 10,000 ohms; .50 *w* for values below 10,000 ohms. Units, measuring 57/64" in diameter and standing 7/8" off mounting board, are supported by four legs; three voltage taps and a case ground leg. Terminals are tin-lead coated for dip soldering. *Sp* or *dp* snap switches are available in ratings from 15 amps, 15 *v dc* to 6 amps, 125 *v dc*.

### MERCURY BATTERY MERCHANDISING KIT

A merchandising kit for mercury batteries designed as replacements for miniature transistorized portable radios, has been announced by P. R. Mallory and Co., Inc., Indianapolis 6, Ind.

Included in kit are 20 batteries in six different voltages and sizes mounted on a two-color display panel. Each kit is supplied with cross reference information for battery types used in popular portables.

### FERRITE COIL ANTENNA

A variable ferrite core coil, VL-15, for use as a replacement antenna, has been announced by Vidair Electronics Manufacturing Corp., Lynbrook, N. Y.

Unit is adjustable for tracking with small radio variable capacitors. Supplied with universal bracket for installation.

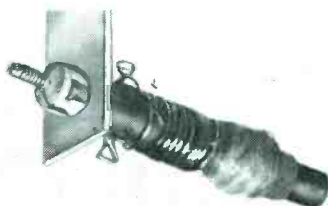

**INSTALLERS!  
DEALERS!  
SERVICEMEN!**

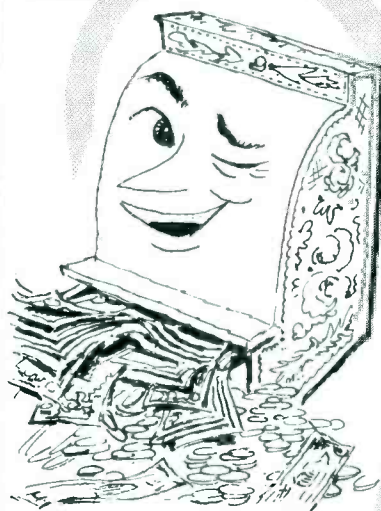

**Clean Up With  
J. S. C.  
TV Wire**

## TELE-RAMA

**More Money In Your Pocket  
When You Switch Your Customers  
To This New, Colored Wire!**

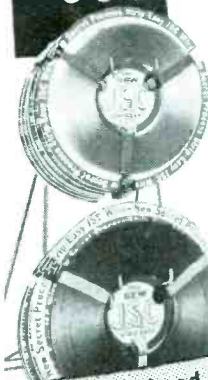

Don't get left while the rest of the boys are cleaning up profits in bushel barrels! Easy as pie to convince your customers to replace present TV antenna wire with new, colorful JSC TELE-RAMA . . . to match home interiors or outside paint.

**A Sizzling Sensation!  
A Terrific  
Money-Maker!  
PRICED FOR  
FAST SELLING,  
EASY PROFITS!**

**Fashion-Primed In These  
GORGEOUS COLORS**  
Pink Pastel Blue Red  
White Silver Pastel Green  
Pastel Yellow Gold

**BUY IT TODAY**

in handy card mounted 50 ft.,  
75 ft., 100 ft. coils in assorted colors.

At Most Distributors or Write

## JERSEY SPECIALTY CO.

Burgess Place, Mountain View, N. J.

# ALL-CLEAR TV PICTURES

with the new

## **B-T LABS ANTENNA BOOSTER**

(BROADBAND VHF)

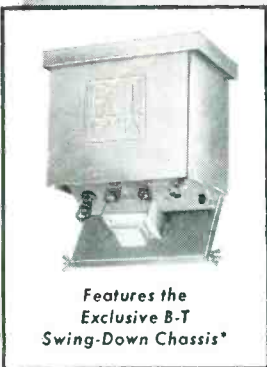
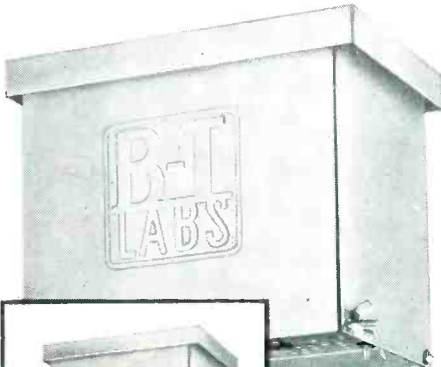

Features the Exclusive B-T Swing-Down Chassis\*

- Low-noise, all-triode circuit
- Easy mast-mounting
- Automatic 'on/off' from set
- 24 and 110v AC available plus step-ups for long-line drop
- Single lead line carries power 'up' and signal 'down'

\*For Servicing and Maintenance... chassis swings down - trap door fashion - for easy handling and tube replacements.

For complete details, use this coupon

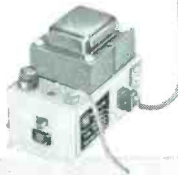

**MODEL AB**  
4 TUBES  
25DB GAIN  
**\$95.00** LIST  
WITH MULTI VOLTAGE POWER SUPPLY

CLONDER TONGUE LABORATORIES, Incorporated

Dept. C.F.P. Westfield, New Jersey  
Please send complete specs of your new Antenna Booster. I am also interested in:

- TV Amplifiers  UHF Converters  
 Master TV Systems

Name.....

Address.....

City..... Zone..... State.....

## Highlights of the NCTA Fifth Annual Convention-Trade Show

SHIRT-SLEEVE panel discussions of technical, government and industry problems, with earthy information from veteran system operators, leading CATV manufacturers, and public officials have been scheduled for the fifth annual meeting of the National Community TV Association at the William Penn Hotel, Pittsburgh, Pa., June 12-14. Experts will present the latest thinking on such matters as FCC jurisdiction, public utility regulation by states, the new *translator* ruling,<sup>o</sup> closed circuit TV, and technical developments.

Featured, too, will be an exhibit hall, where the latest in community TV equipment will not only be displayed, but demonstrated. On view will be ruggedized antennas and coax lines, amplifiers, connectors, tapoffs, microwave links, closed-circuit equipment, test gear, *chf/ulif* accessories, tower-line-subscriber installation hardware and system components.

Technical sessions will be of a clinic nature, with panel talks by specialists on maintenance, radiation-control, closed-circuit ties, *ulif* dish transmission and reception, including over-the-horizon possibilities.

Community-TV pickups as viewed by TV broadcasters and the Commission will be reviewed in talks by spokesmen of the National Association of Radio and Television Broadcasters and the FCC.

Views of TV film distributors whose films are used over the air and closed-circuit lines will also be offered by a panel of community-TV owners and film distribution heads. Among the topics on tap for discussion are ownership and repeat performance rights, programming, methods of pickup, and transmission-distribution policies.

<sup>o</sup>See This Month in SERVICE, page 17, for report on translator-stations.



**BILL DANIELS**, chairman of the annual NCTA meeting in Pittsburgh.

# BEST BUY IN SCOPES

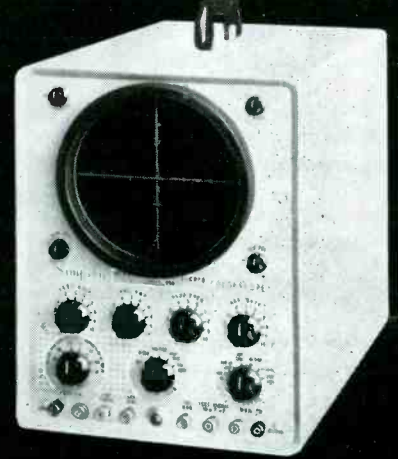

new!  
**Simpson**  
**7"**  
**COLORSCOPE**  
MODEL 458

Compare the new Simpson Colorscope Model 458 with any oscilloscope on the market. It is an advanced, seven-inch, high-gain, wide-band scope especially designed for color-TV service. Ideal for black and white, too.

**100% RESPONSE** at 3.58 mc color-burst!

**DUAL bandwidth**—narrow or wide!  
**FLAT FREQUENCY RESPONSE**, within 1 db to 4.5 mc!

**RISE TIME** less than 0.05 microsecond (wide band)!

**FULL RANGE** compensated vertical attenuator!

Free with shielded input cable, \$229<sup>95</sup> manual...

Four accessory probes available for extra utility!

See your distributor for details or write—

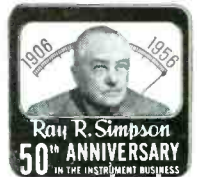

## SIMPSON Electric Company

WORLD'S LARGEST MANUFACTURER OF ELECTRONIC TEST EQUIPMENT

5200 W. Kinzie St., Chicago 44, Illinois  
Phone: ESTebrook 9-1121

In Canada: Bach-Simpson Ltd., London

... another  
**MALLORY**  
service-engineered  
product



## To power transistorized miniature portables...

- *make it mercury—*
- *make it MALLORY!*

You're selling the best in performance and value, when you offer your customers Mallory Mercury Batteries for their transistorized miniature portables.

First, because these batteries give the extra long life and constant discharge service that you get only in the unique mercury battery. They actually *cost much less* per hour of operation than ordinary batteries.

And second, because Mallory Mercury Batteries have all the exclusive features of stability, dependability and quality that come from Mallory's fifteen years of experience in pioneering the mercury battery field.

Get set to snare your share of this growing market. Order a stock, in ratings for popular sets, from your Mallory distributor today.

P. R. MALLORY & CO. Inc.  
**MALLORY**

P. R. MALLORY & CO. Inc., INDIANAPOLIS 6, INDIANA

- Capacitors
- Vibrators
- Resistors
- Power Supplies
- Controls
- Switches
- Rectifiers
- Filters
- Mercury Batteries

MISS COLOR-TV OF 1956 AND YOUR RCA TUBE DISTRIBUTOR

*présent:*

*The Famous RCA Institutes'*

# COLOR-TV HOME STUDY COURSE\*

free of extra charge when you buy RCA Receiving Tubes



*Expanded RCA course—includes two new lessons, never before offered, giving you all the latest information on "Big Color" TV*

Now is the time to enroll in RCA's extended Color-TV Home Study Course. Be set to cash in on the tremendous opportunity Color-TV holds for you. It is a practical and down-to-earth course—prepared by Color-TV experts just for service technicians.

Go to your regular RCA Tube Distributor and ask for full details.

P.S.: If you're one of the thousands who has completed RCA's previous 9-lesson course, bring yourself up-to-date with the new advanced lessons. Special "Certificate" awarded.



This offer is for a limited time only. Enroll now and receive this durable binder for your lessons.

## 11 Steps to Profit in Color-TV Servicing

### THE BASIC 9 LESSONS

- Introduction to Color-TV
- Principles of Two-Phase Modulation and Colorimetry
- Principles of Color-TV Receivers
- Color Kinescopes
- The Color-TV System
- Color-TV Receiver Circuits
- Set-up and Adjustment of Color-TV Receivers
- Servicing and Alignment of Color-TV Receivers
- Test Equipment for Color-TV Servicing

### PLUS 2 Brand New Advanced Lessons

- 10 Large Screen Color
- 11 New Color-TV Circuitry



**RCA RECEIVING TUBES**

RADIO CORPORATION OF AMERICA HARRISON, N. J.