

RADIO • TELEVISION • ELECTRONIC

SERVICE

The Technical Journal of the Television-Radio-Audio Trade

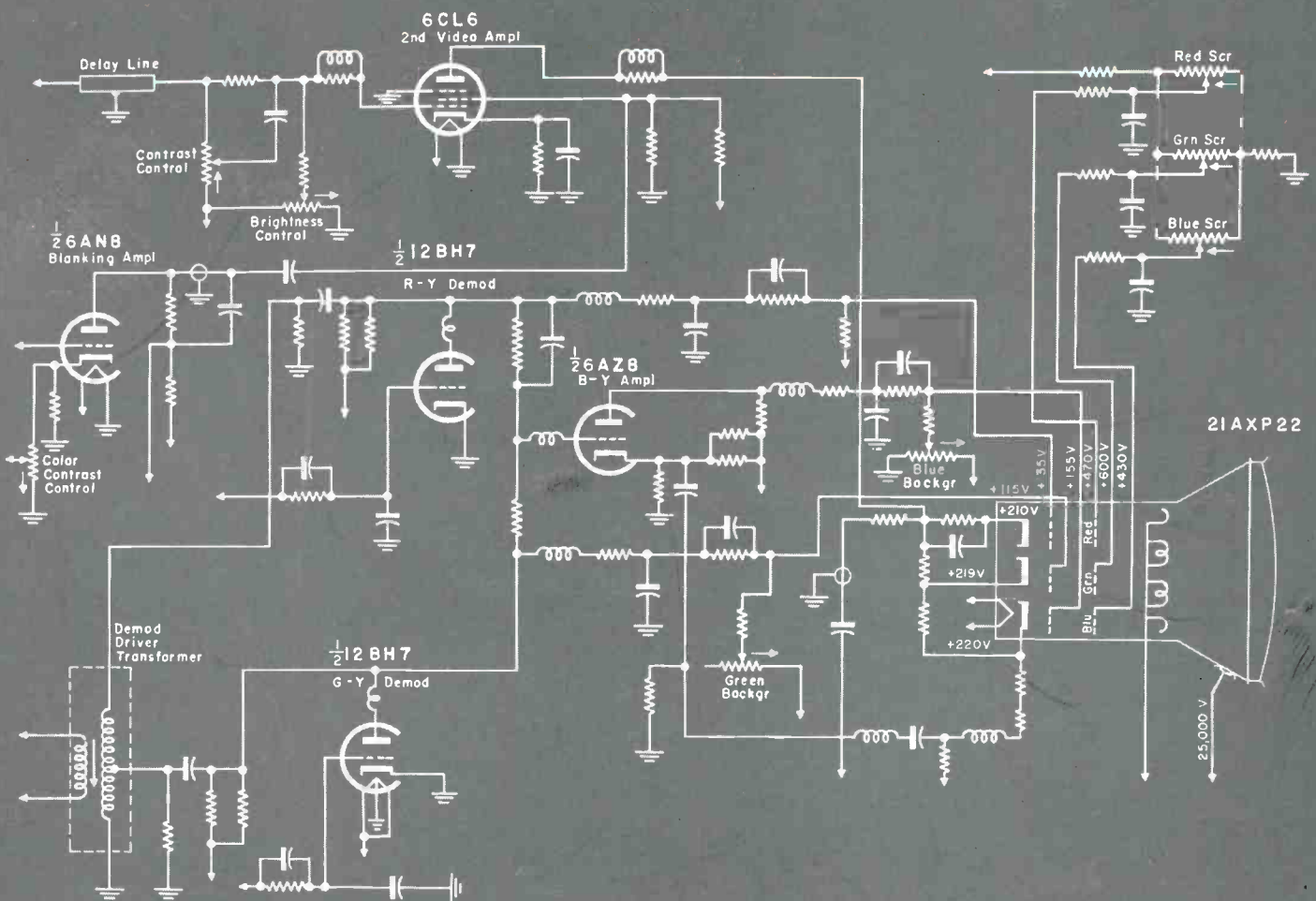

Picture-tube circuitry in 21-inch
26-tube color-TV receiver.
(See circuit analysis, this issue)

SS SAR 3-9-53 B
GREAT BEND, N.Y.
C A MARTIN
BOX 251
4-58

a complete **NEW** line!

RADIART SEAL·VENT Communication Vibrators

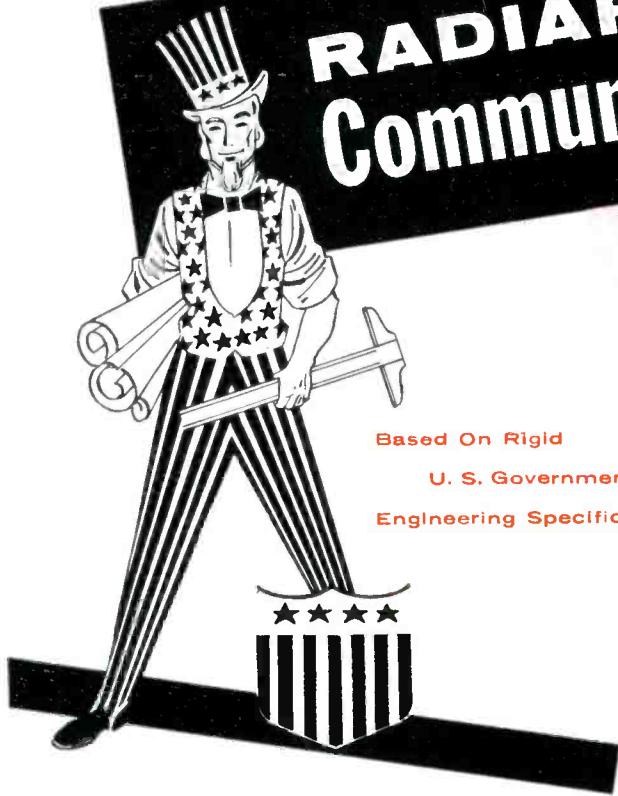

Based On Rigid
U. S. Government
Engineering Specifications

NOW... RADIART makes available to commercial users of communications equipment, a new line of vibrators based upon experience of producing over 2 million similar units to the exacting requirements of U. S. Signal Corps Specifications.

These Eight Types Offer Complete Replacement for ORIGINAL Communication Equipment:

Old No.	New No.
5515	5715
5518	5718
★	5721
★	5722
5605	5805
5620	5820
5621	5821
5622	5822

It's ready now!
The new 1955
Radiart Vibrator
Replacement Guide



THE **RADIART** CORPORATION
CLEVELAND 13, OHIO

TV ANTENNAS • AUTO AERIALS • VIBRATORS • ROTORS • POWER SUPPLIES



**Week after week
Godfrey tells
the ladies ...**

**There are
no finer tubes
than CBS tubes...**

**And more and more
women are asking
for the tubes with the
Good Housekeeping
Guaranty Seal.**



Be sure YOU have
CBS tubes in your tube caddy.

**Arthur Godfrey's Talent Scouts
now selling CBS Tubes
on both TV and Radio**

*Quality products through **ADVANCED-ENGINEERING***

CBS-HYTRON, Danvers, Massachusetts . . . A DIVISION OF COLUMBIA BROADCASTING SYSTEM, INC.

SERVICE, JULY, 1955 • 1



Including SERVICE—A Monthly Digest of Radio and Allied Maintenance: RADIO MERCHANDISING and TELEVISION MERCHANDISING. Registered U. S. Patent Office.

LEWIS WINNER
Editor

D. E. PEARSALL II
Assistant Editor

Less than 1% ripple AT 15 AMPS!



model "NF" specially filtered



DC POWER SUPPLY
continuously variable
0-28 VOLTS UP TO 15 AMPS

This all-purpose unit is widely used in service shops, industrial plants and laboratories for testing electronic equipment. Its high quality components and practically limitless utility are unmatched at the price.

A single control offers continuous voltage adjustments for different load conditions over the entire range. Patented EPL application of selenium rectifiers assures long life.

FOR TESTING, SERVICING, AND OPERATING radios and electronic units in aircraft, autos, marine craft . . . relays and solenoids . . . telephone circuits . . . laboratory and research instruments . . . low voltage devices. For plating operations and battery charging.

Model "B"
DC Power Supply

Specified by manufacturers for servicing 2-way mobile radios.

- 1-20 amps. continuous duty — 35 amps. — peak rating
- Twice the rectifier power rating
- Lowest cost per amp. output
- Withstands continuous overloads

WRITE TODAY FOR DETAILS!

Send Bulletins
 "B" "NF"

ELECTRO PRODUCTS LABORATORIES
4501-S North Ravenswood, Chicago 40, Ill.

Name _____
Street _____
City _____ Zone _____ State _____

Association News	60
Audio Maintenance and Service Tips. By Fred R. Sailes	34
(Tape Squeal Causes and Cures . . . 3-Speed V-R Record Changer Repair)	
Audio Installation and Service. By Jesse Dines	40
(Horns in the Audio System: Shapes, Drivers, Response Characteristics)	
Community TV Coax Temperature-Variation Control System. By F. E. Huggin	18
(New Technique to Correct Line-Attenuation Variations)	
Direct Schematic to Chassis Servicing. By C. R. Cantonwine	16
(Application of Color-Coding Method to Expedite Troubleshooting)	
Latest In Audio	42
Microphones for Initial or Replacement Installations. By Norman Crowhurst	44
(Factors to Consider in Choosing Mikes)	
Outdoor Sound System Installation . . . Maintenance. By Michael Anthony	22
(Amplifier Control . . . Speaker Hookups . . . Locations for Speakers—Mikes)	
Schematics in This Issue	58
Ser-Cuits—Cover. By W. W. Cook	20
(Analysis of RCA 21-Inch 26-Tube Color-TV Model)	
Service Engineering. By Maxwell Alberts	50
(Photoelectric Systems for Supervisory Control)	
Service . . . The National Scene	29
Servicing Helps. By T. L. Gilford	32
(Series-String Chassis Repair . . . Demagnetizing Color Pix Tubes)	
Ten Years Ago in SERVICE	60
Tube News. By A. M. Kelwood	36
(Transistor-Tube Circuitry for Pocket Radios)	
TV Repairs in the Home. By M. Martynech	15
(On-the-Spot Servicing Field Report)	
UHF/VHF Antennas . . . Accessories	25
(Pictorial Review of New Developments)	
UHF/VHF TV Antenna Digest. By Louis E. Raburn	24
(Dual-UHF Antenna Installations Using Filter-Couplers)	
Variable Damping Factors in Audio Amplifiers. By Mark Vino	26
(Effect of Control Circuitry on AF Output Performance)	
Views and News. By Lewis Winner	13
COVER	
21-Inch 26-Tube Color Chassis (RCA CTC4-CTC4A)	21
Index to Advertisers	63
Departments	
Bench-Field Tools . . . Accessories	62
Catalogs and Bulletins	59
Components	63
Instruments	59
Jobs and Flashes	64
News	59
Personnel	57
TV Parts . . . Accessories	61



Entire Contents Copyright 1955, Bryan Davis Publishing Co., Inc.

Published monthly by Bryan Davis Publishing Co., Inc.

52 Vanderbilt Avenue, New York 17, N. Y. Telephone: MURRAY HILL 4-0170

Bryan S. Davis, Pres. F. W. Boyd, Secy. and Business Mgr. A. Goebel, Cir. Mgr.

Eastern Rep.: Jerome J. Brookman 299 Madison Ave. New York 17, N. Y. Tel.: MU 7-6530	Mid-West Mgr.: Stuart J. Osten 333 N. Michigan Ave. Chicago 1, Ill. Tel.: DEarborn 2-3507	East-Central Rep.: James C. Munn 2253 Delaware Dr. Cleveland 6, O. Tel.: ERiewick 1-1726	Pacific Coast Rep.: Brand & Brand 1052 W. 6th St. Los Angeles 17, Cal. Tel.: MADison 6-1871
--	---	--	---

Entered as second-class matter June 14, 1932, at the Post Office at New York, N. Y., additional entry at the Post Office, Norwalk, Conn., Oct. 22, 1954, under the Act of March 3, 1879. Subscription price: \$2.00 per year in the U.S.A. and Canada; 25 cents per copy. \$3.00 per year in foreign countries; 35 cents per copy.

Battery Business is REPEAT Business!

... if YOU keep repeating, "Does your Portable need new Batteries?"

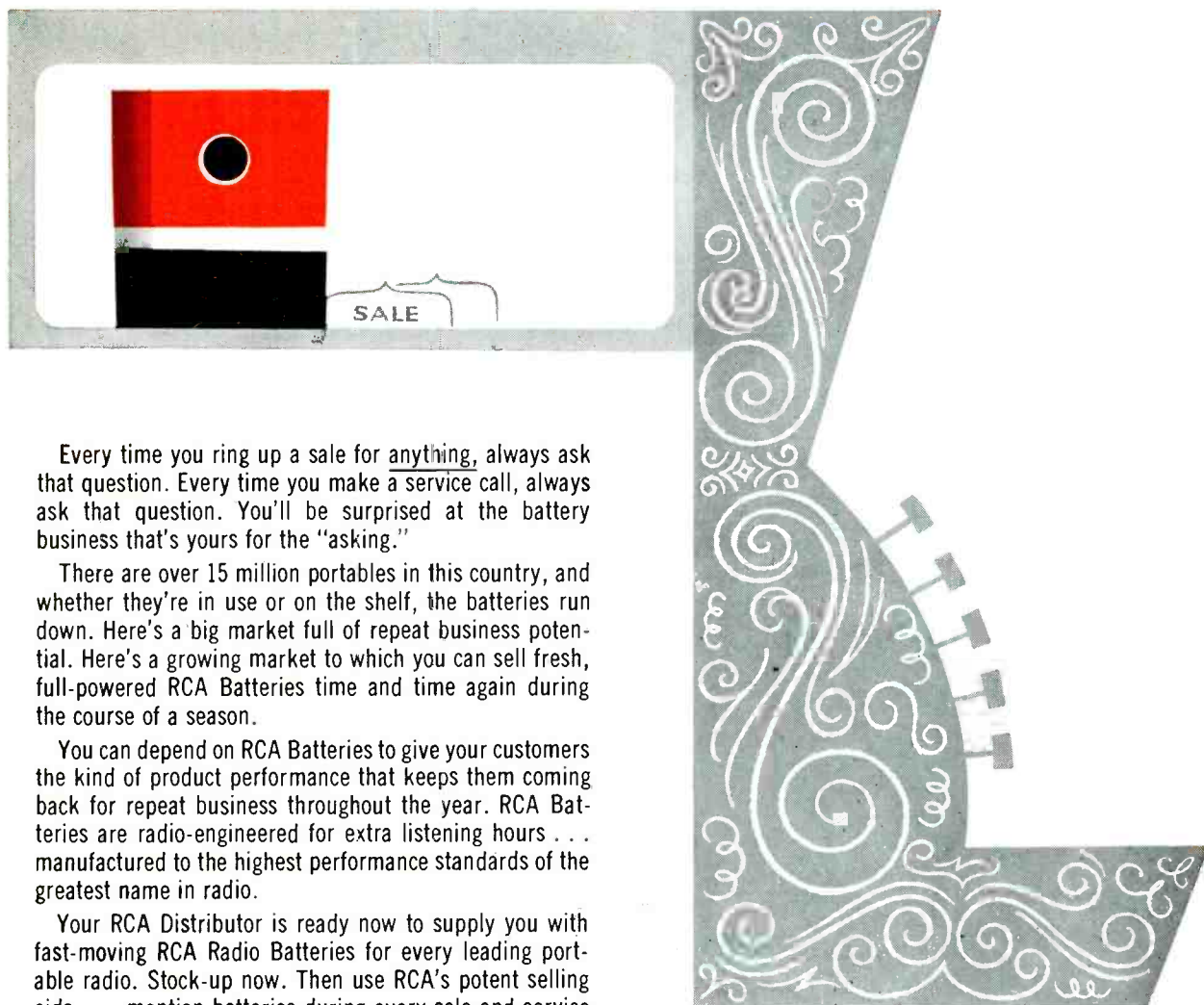

Every time you ring up a sale for anything, always ask that question. Every time you make a service call, always ask that question. You'll be surprised at the battery business that's yours for the "asking."

There are over 15 million portables in this country, and whether they're in use or on the shelf, the batteries run down. Here's a big market full of repeat business potential. Here's a growing market to which you can sell fresh, full-powered RCA Batteries time and time again during the course of a season.

You can depend on RCA Batteries to give your customers the kind of product performance that keeps them coming back for repeat business throughout the year. RCA Batteries are radio-engineered for extra listening hours . . . manufactured to the highest performance standards of the greatest name in radio.

Your RCA Distributor is ready now to supply you with fast-moving RCA Radio Batteries for every leading portable radio. Stock-up now. Then use RCA's potent selling aids . . . mention batteries during every sale and service call . . . and you'll be in this business of selling batteries—RCA Batteries—in a big way, profitably.

FREE! "This Business of Selling Batteries." It's loaded with hot selling tips and promotional ideas. Ask your distributor or write RCA Commercial Engineering, Section G44, Harrison, N.J.

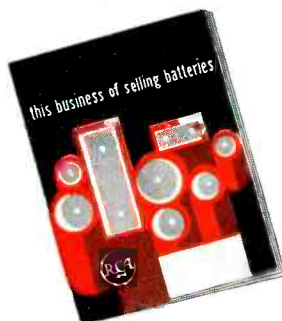

RADIO CORPORATION of AMERICA
RADIO BATTERIES
HARRISON, N.J.



SPEAKERS



VIBRATORS

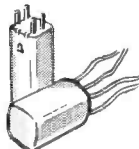

COILS



RECEIVING TUBES



CONDENSERS



AUTO RADIO AERIALS



CONTROLS



CAPACITORS



PICTURE TUBES

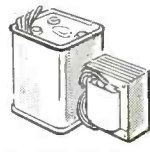

TRANSFORMERS

*Here are two
Well-Known Names
that want to
work for you!*

References? These well-known names—Delco and General Motors—have long been a symbol of business integrity, customer assistance and fine products. They can add a degree of prestige to your electronics business that is unexcelled in the industry.

Delco also has a unique service to offer you. Delco is the sole source for that vital group of special application parts used for original equipment replacement in Delco auto radios. This represents a ready-made market of well over 13 million car radios! In addition,

Delco is an important and reliable source for the most used universal replacement parts for electronic equipment.

AND sales assistance doesn't stop here. Delco also issues current bulletins and maintains field schools to keep you posted on the latest developments in the electronics industry. Check your Delco Electronics Parts Distributor today and get all the details on how these two great names can help you and your electronics business—then, put 'em to work!

A GENERAL MOTORS PRODUCT



A UNITED MOTORS LINE

TUNG-SOL "Magic Mirror"

ALUMINIZED

PICTURE TUBE

**BRIGHTER-SHARPER
MORE DETAIL
MORE CONTRAST**



The "Magic-Mirror" Aluminized Picture Tube creates the brightest, most realistic TV picture you can bring into the homes of your customers. The "Magic-Mirror" tube effectively utilizes *all* the light generated by the phosphor screen.

Tung-Sol has developed a unique "fogging" method of backing up the phosphor screen with a mirror-like aluminum reflector. This reflector prevents light radiating uselessly back into the tube. It brings out all the detail of which the receiver circuit is capable. So smooth and true is the Tung-Sol aluminum reflector that mottling, streaks, swirls, "blue-edge", "yellow-center" and other objectionable irregularities are eliminated.

Tung-Sol pin-point-focused electron gun assures a steady, brilliant picture—free from alternate fading and overlighting. Tung-Sol's exacting standards of quality control, manufacture and testing further guarantee the high uniformity and maximum performance of the "Magic-Mirror" TV Picture Tube.

For further details, including Tung-Sol's sales aids and advertising support, call your Tung-Sol supplier today.

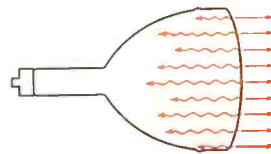

ORDINARY TUBE—Only *half* the light produced by the phosphor screen is utilized in the picture. Other half radiates wastefully back into tube.



RESULT—A light background within the tube which reduces picture contrast.

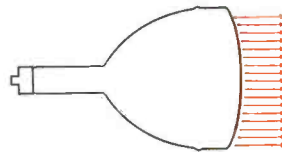

MAGIC-MIRROR ALUMINIZED TUBE—Aluminized reflector allows electron beam through. Blocks wasted light from backing up into tube. Reflects *all* the light into picture.



RESULT—Pronounced increase in contrast to make a bright, clear, more realistic picture.

TUNG-SOL ELECTRIC INC., Newark 4, N. J.

Sales Offices: Atlanta, Chicago, Columbus, Culver City (Los Angeles), Dallas, Denver, Detroit, Montreal (Canada), Newark, Seattle.

Tung-Sol makes All-Glass Sealed Beam Lamps, Miniature Lamps, Signal Flashers, Aluminized Picture Tubes, Radio, TV and Special Purpose Electron Tubes and Semiconductor Products.

KINGS of the TV FRONTIER!

Unmatched for power and performance!

This extraordinary fringe-area powerhouse is still the most sensitive all-channel antenna made today—bar none! The SUPER RAINBOW's many "years-ahead" engineering features include the triple-powered Tri-Pole, separate high and low band operation, 100% aluminum construction, and "Snap-Lock" pre-assembly. Also in great demand . . .

The RAINBOW, Model No. 330.

Model No.
331

SUPER RAINBOW

Extra elements, extra performance!

There may be antennas that resemble our TRAILBLAZER, but none can top its blazing performance. The TRAILBLAZER features *extra* High and Low Band directors, and *full-wave* directors on the High Band. It installs faster than any similar antenna, and—it's all aluminum! Especially recommended for areas with front-to-back interference problems, particularly on the Low Band. Count the elements . . . then compare the prices!

Model No.
335

TRAILBLAZER

Advanced design — and "Super-Sembled"

Look to the LANCERS for Channel Master "extras": extra elements and extra gain — at no extra cost. Completely "Super-Sembled." The SUPER LANCER gives 1½ db more gain on both the Low Band and the High Band than similar types. The LANCER, Model No. 333, has an extra director that provides 1½ db more Low Band gain. Count the elements . . . then compare the prices!

Model No.
334

SUPER LANCER

CHANNEL MASTER®

All-Channel Yagis

Unrivalled for power, popularity and price!

Servicemen everywhere are discovering an entirely new answer to the problem of multi-channel fringe-area reception: *Channel Master all-channel yagis.* These are the antennas that have what it takes to bring top TV performance to the most distant, isolated locations. And, they're ready for color, too!

Today's leading all-channel yagis are designed — and improved — in the Channel Master Antenna Development Laboratories. Isn't it logical to use Channel Master's famous engineering skill to solve your reception problems?



CHANNEL MASTER CORP. ELLENVILLE, N. Y.
The World's Largest Manufacturer of TV Antennas and Accessories

Copyright 1955, Channel Master Corp.

®-Trade Mark Reg. U.S. Pat. Off.

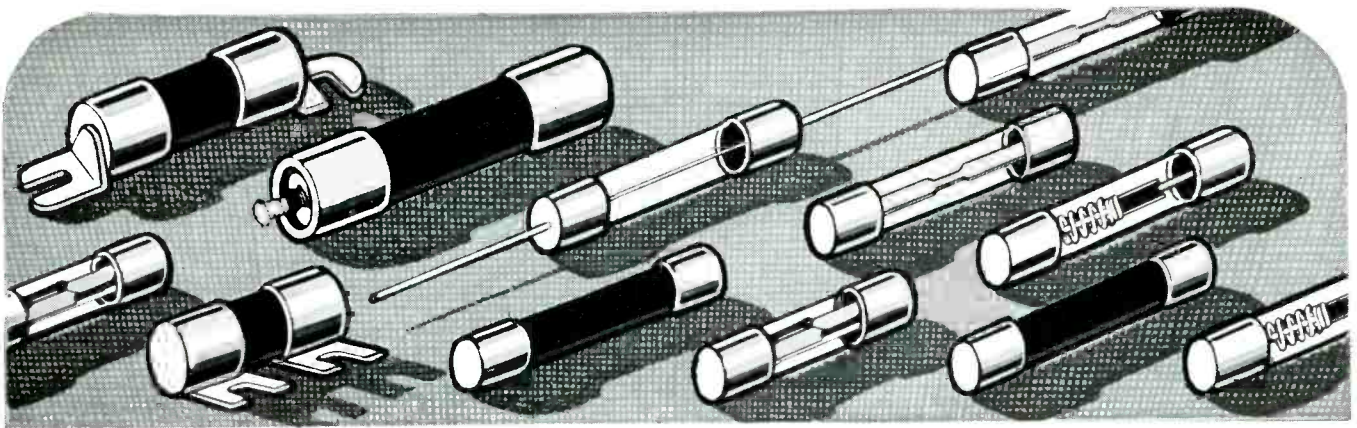

"WHATEVER YOUR FUSE NEEDS MAY BE -

YOU CAN TURN
TO BUSS FOR THE
RIGHT FUSE!"



You can quickly and easily select a BUSS fuse that's right for your fuse application. The complete BUSS line includes fuses in sizes from 1/500 ampere up, plus a companion line of fuse clips, blocks and holders.

And standardizing on BUSS fuses helps safeguard the product and your reputation because . . . BUSS fuses are made to protect — not to blow needlessly.

Every BUSS fuse, normally used by the Electronic Industries, is tested in a sensitive electronic device that automatically rejects any fuse not correctly calibrated, properly constructed and right in all physical dimensions.

Let BUSS fuses help protect your profit

BUSS fuses stay sold because your customers stay satisfied. The unfailing dependability of BUSS fuses helps prevent irritating and costly "kicks" and call-backs. That's why so many leading sales and service organizations refuse to take a chance with anything less than BUSS quality in fuses.

More information is available on BUSS and FUSETRON small dimension fuses and fuse holders . . . Write for bulletin SFB.

S-755

BUSSMANN MFG. CO. Div. McGraw Electric Co.
University at Jefferson St. Louis 7, Mo.

Makers of a complete line of fuses for home, farm, commercial, electronic, automotive and industrial use.

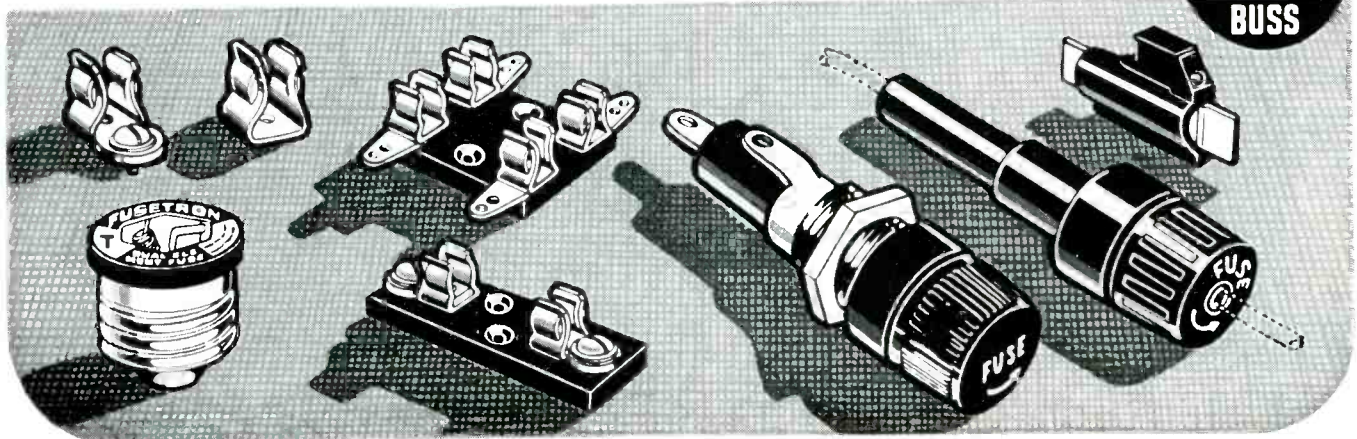

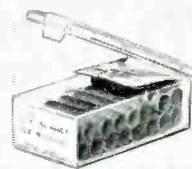

G-C TV LINE SEAL

Prevents corrosion on wires, etc.
No. 17-2 NET \$0.39

G-C SCRATCH REPAIR KIT

Remove cabinet scratches.
No. 915 NET \$0.99

G-C REAR SPEAKER BAFFLE KIT

Has 3-way switch, bronze grille.
No. 9180 NET \$2.70

G-C 7.5 OHM FUSE RESISTOR

For series-wired TV sets.
No. 9207 NET \$0.33

G-C BAKELITE CEMENT

Repairs cabinets, knobs, panels.
No. 32-2 NET \$0.51

G-C AUTO FUSE INSULATOR SLEEVES

Box of 16: 1 1/2" long x 1/4" I.D.
No. H640-F NET \$0.30



G-C RUBBER GROMMETS

Box of 15 assorted grommets.
No. H025-F NET \$0.30



G-C MAG-NETIK HEAD CLEANER

Remove oxide from tape heads.
No. 53-1 NET \$0.51



G-C CARBON-X

Quiet noisy carbon volume controls.
No. 1205 NET \$0.72



G-C REK-O-DOPE

All-purpose recording lubricant.
No. 126-2 NET \$0.39

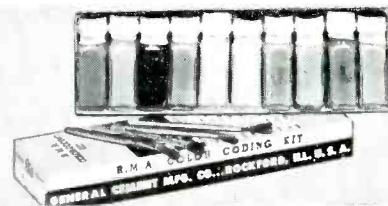

G-C COLOR CODING KIT

Includes 10 standard colors, brushes.
No. 677 NET \$1.29



G-C GLO-BAR THERMISTORS

Resistors for series heater tubes.
No. 9135 NET \$1.44

GENERAL

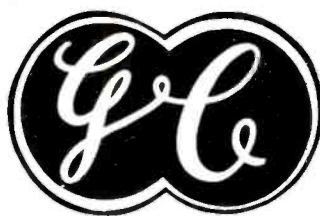

Ask For These

RADIO-TV SERVICE AIDS

CEMENT

... at Your Jobber



G-C LIQUID NON-SLIP

Prevent slipping on drive cables.
No. 1211 NET \$0.21



G-C STREAMLINE POINTER

Black 2" long, also red, ivory, etc.
No. 1171 NET \$0.25



G-C AC-DC INDOOR ANTENNA WIRE

Flexible copper, insulated.
No. 840 NET \$0.27

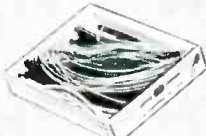

G-C SPAGHETTI ASSORTMENT

Variety of sizes and colors.
No. 551 NET \$0.84



G-C ASSORTED SPACERS, BUSHINGS

Kit in jar; many chassis uses.
No. 6617 NET \$0.51

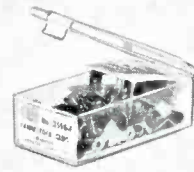

G-C FAHNESTOCK CLIPS

Box of 12 assorted plated clips.
No. H590-F NET \$0.30



G-C AUTO STATIC CHASER KIT

Injector and tire static powder.
No. 5606 NET \$1.65



G-C PRINTED CIRCUIT REPAIR KIT

Contains Silver Print, Silicone Resin, Solvent and all tools.
No. 680 NET \$5.85



G-C TV CORONA DOPE

Prevent corona shorts in TV sets.
No. 47-2 NET \$0.72



G-C 300-OHM WALL PLATE

Brown plate and plug.
No. 8595 NET \$0.75



G-C WESTINGHOUSE TV ALIGNER

Fits openings in West'gse coils.
No. 9089 NET \$0.54



G-C SLUG RETRIEVER TOOL

For Standard Coil tuner slugs.
No. 9096 NET \$2.22



G-C TELEVISION ALIGNING WRENCH

Socket 3/8" square; 6" long.
No. 5080 NET \$0.51



G-C NON-MAGNETIC ALIGNER

Tough, heat-treated beryllium.
No. 9105 NET \$0.75



G-C ADJUSTABLE SHORTY

Adjusts from 1 1/2" to 2"
No. 9090 NET \$0.42

FREE! Send postcard for your big G-C CATALOG.



GENERAL CEMENT MFG. CO.

901 Taylor Avenue
Rockford, Illinois

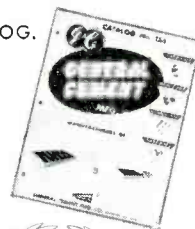

ASK YOUR JOBBER FOR THESE G-C SPECIALS OF THE MONTH



G-C 3-for-2 CHEMICAL SPECIAL

No. B-1 Pack of 3 NET \$0.69



TELCO 6-PACK LIGHTNING ARRESTORS

No. 8642-6P Pack of 6 NET \$2.25



G-C SPRA-KLEEN

No. 8666 6-oz. can
NET \$1.00

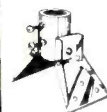

TELCO HINGED ROOF MOUNT

No. 9021 NET \$1.17

“Financial Security Is Based On Savings . . .”

ARTHUR B. HOMER

*President
Bethlehem Steel Corporation*



“ . . . and the purchase of U.S. Savings Bonds through the Payroll Savings Plan is one of the easiest ways for any individual to save for economic security.”

If you agree with Mr. Homer that “. . . the Payroll Savings Plan is one of the easiest ways to save for economic security.”—

If you believe with millions of other Americans that there is no safer investment than U.S. Savings Bonds—

Why not take a *really personal* interest in your employees and your Payroll Savings Plan?

Pick up the phone, now, and ask the man in charge of your Payroll Savings Plan three questions:

- How many of your employees are enrolled in the Payroll Savings Plan?
- What is the percentage of employee participation?

- When did your company last conduct a person-to-person canvass?

If less than 50% of your employees are enrolled in the Plan . . . if you have not conducted a person-to-person canvass in the past two years (*or if you do not have the Plan*), act now! Telephone, wire or write to Savings Bonds Division, U.S. Treasury Department, Washington, D. C. You will hear promptly from your State Director, U.S. Treasury Department who will be glad to help you conduct a person-to-person canvass that will put an application blank in the hands of every employee. That is all you have to do. Your employees will do the rest. They want to save for their economic security.

The United States Government does not pay for this advertising. The Treasury Department thanks, for their patriotic donation, the Advertising Council and

SERVICE



LITTELFUSE

EASY TO MOUNT

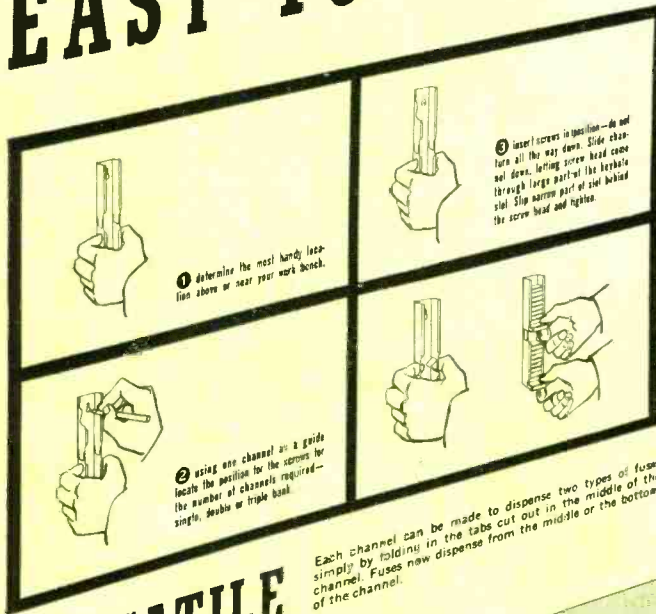

VERSATILE

Each channel can be made to dispense two types of fuses simply by folding in the tabs cut out in the middle of the channel. Fuses now dispense from the middle or the bottom of the channel.

3AG - 1/4A

3AG - 1/4A

3AG - 1/4A

3AG - 1/4A

3AG - 1/4A

3AG - 1/4A

3AG - 1/4A

3AG - 1/4A

3AG - 1/4A

3AG - 1/4A

3AG - 1/2A

3AG - 1/2A

3AG - 1/2A

To serve you . . . to increase your profits . . .

LITTELFUSE again streamlines your fuse service operation with a program that makes sure you have the right fuse at your fingertips at all times—time saved, effort saved build up your service profits.

ASK YOUR JOBBER about the Littelfuse Single Channel Fuse "Stocker." Package: 10 single (double dispensing) fuse channels, 10 boxes (50) 3 AG 1/2 fuses and 10 boxes (50) 3 AG 1/4 fuses in one complete package FOR THE COST OF THE FUSES ALONE.

SERVICE DEALERS:

ask your



Tube Distributor for these wonderful sales helps...

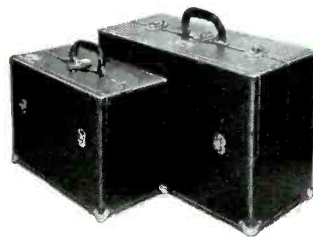
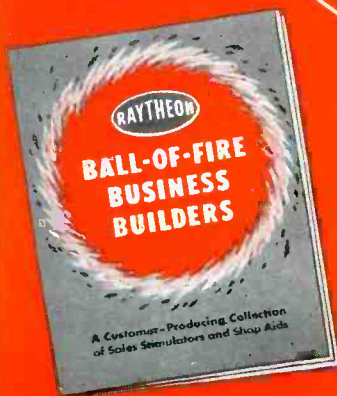

Tube and Tool Carrying Cases
Two sizes — hold both tubes and repair tools



Cardboard Cutout Trucks
With your name — give them to the children



Aluminum Snap-Out-Form Pocket Case
Protects forms, looks businesslike



Triplicate Invoice Sets
Provides 3 copies of each bill



14-Point Check-Up Card
Hang on set to show adjustments made



Drop Cloth
To show customers you care



Illuminated Outdoor Sign
A real traffic stopper



Go-Getter
Picks up small parts where hands can't reach



Window Streamer
Sells check-up service



Window Displays
To sell your service to passersby



You ain't seen nuthin', until you see the sensational collection of sales and shop aids in the new Raytheon BALL-OF-FIRE BUSINESS BUILDERS booklet. Pictured are a few of the new additions to Raytheon's already famous collection of tried and tested promotion items. For years, Service Dealers from coast-to-coast have been relying on Raytheon sales aids to help them get more than their share of business, using Raytheon Shop Aids to help them work more efficiently, and effectively.

Many items are free, the rest are 'way below normal cost. Ask your Raytheon Tube Distributor for a free copy of the new Raytheon Booklet or write to Department D, Raytheon Manufacturing Company, Receiving and Cathode Ray Tube Operations, Newton 58, Mass.



RAYTHEON MANUFACTURING COMPANY

Receiving and Cathode Ray Tube Operations

Newton, Mass. • Chicago • Atlanta, Ga. • Los Angeles, Calif.

Raytheon makes all these:

Receiving and Picture Tubes • Reliable Subminiature and Miniature Tubes
Semiconductor Diodes and Transistors • Nucleonic Tubes • Microwave Tubes



Excellence in Electronics.



Invitation to Scorching Trouble: The Fixit-Yourself Books

A FEW YEARS AGO, industry was struck with a blizzard of TV home-repair manuals, emblazoned with bold guarantees that anyone now could fix a sight and sound set, if they followed the book's gilded instructions. The promoters of this scatterbrained scheme surely thought that they'd make a killing; everyone would run to the nearest book, department or drug store and buy these amazing guides.

Fortunately the books were too costly, there weren't too many TV sets around, chassis were too complicated to interest too many in home fixing, and those who were brave enough to invest in the texts found that the recommended changes only served to create more circuit troubles. So the market for these gems collapsed, and a resounding sigh of relief was heard from coast to coast.

The advent of the simplified vertical chassis and the mounting interest in you-can-do-it-yourself programs has returned our home-fixit entrepreneurs. This time, though, the price for the reading matter has been brought way down, the claims are noisier than ever, gala instruction packages are being made up for complete series of all of the popular TV models, and phonos and radios have been included in the elaborate plans.

Set owners are being told now that they can easily diagnose all troubles and make the necessary repairs themselves, with nothing more than a screwdriver. The guides, ads and circulars say, contain no confusing, unimportant information, applicable to hundreds of other makes. It's just in one easy-to-read folder, the announcements add, and you just look at the tube layout diagram, replace the defective tube and all your troubles will vanish. What brazen statements!

Too many, who have bought these amazing story books, have learned, to their dismay, like those early fixit-book buyers, that there's more to getting a TV or radio or phono back in shape, than just changing some tubes. Circuitry and the exact position of the tubes must be considered carefully. Even in the streamlined chassis, the tubes are located in tight, hot and shock areas, where there are also a number of critical components. Disturbance of lead dressing or the components' adjustments can generate a parade of problems, involving feedback and alignment. And since these kitchen mechanics have no test gear nor are they familiar with the chassis circuitry, there is no way that they can determine the extent of the damage. Often troubles multiply every time another tube maneuver is made.

The high-voltage section represents a typical zone where the home fixit-tube changer runs into trouble. Here we have several tubes in the circuit, all interrelated in their operation; and the failure of any one of these tubes can not only cause identical symptoms, but also affect component performance. Oddly enough, the tube that is not defective, can show up as faulty, because its operating characteristics are dependent upon the performance of the tubes in the previous stage. There is absolutely no way for a home-fixit-manual-trained tube changer to detect this. One must use instruments to trace the trouble and make the required repairs.

Another critical situation arises when the rear cover of a TV set is removed. All of the fixit-yourself books state that one need only touch each of the tubes in the receiver until a cold one is reached; then that tube is the one to replace. But the high-voltage section, in many instances, is either still operating, or if it has temporarily ceased, the conductive coating on the picture tube (which is in effect a large capacitor) and the related wiring still stores (often for many hours) an extremely high voltage, usually in the neighborhood of 15,000 volts, enough to cause severe shock and injury. Under these conditions, it is impossible for the home-fixit boys to avoid getting a sharp jolt when looking for trouble in this area. Often during an attempt to home repair a set, the ion trap is dislodged from its proper setting; this trap functions to control the electron beam through a small aperture. Thus, when the trap is moved, ions strike the side of the aperture, tearing away a portion of the small opening, releasing a gas and ruining the efficiency of the tube. These vital facts are never mentioned in the quickie-repair wonder books.

When the Service Man is finally called in to repair the sets that have been tampered with, he is rarely told about the home-fixit attempts, and he is sharply criticized for his analysis of the trouble and the ensuing charges for service.

The fixit-yourself books, now being sold nationally everywhere, including super-markets, have maligned the reputation and ability of the Service Man, affected service shop income and reflected on the quality of brand-name merchandise.

The repair and maintenance of TV, radios and phonos is a job for competent Service Men, not the kitchen mechanics armed with nothing more than tube-layout notebooks. Only the Service Man has the knowledge and the equipment to do the job properly.—L.W.

5 Megacycles Bandwidth 10 Millivolts per Inch Sensitivity

in the NEW *PRECISION* ES-550

5 inch OSCILLOSCOPE

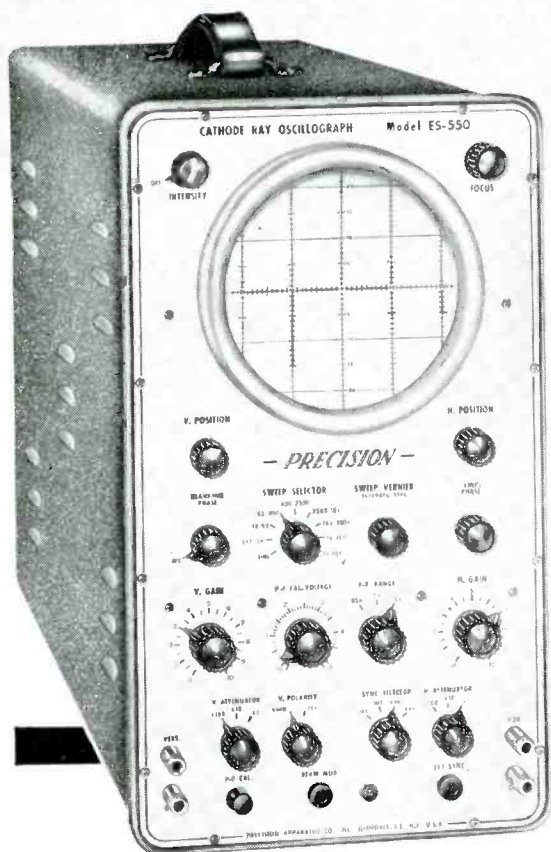

Engineered to cover a wide range
of modern electronic applications including
MONOCHROME and COLOR TELEVISION

The Model ES-550 is the *PRECISION* answer to laboratory, industrial and technician requirements for a rugged, dependable instrument for broad coverage of modern electronic oscillograph applications, INCLUDING COLOR TV. It provides a new and unparalleled standard of high sensitivity with single, overall wideband frequency response, plus other special performance features—at most sensible selling price.

- ★ **Push-Pull, Wide-Band Vertical Amplifier:** 10 MV/inch sensitivity. Input Characteristics: 2 Megohms, 22 mmfd. Response: One DB from 10 cps. to 3.5 MC—3 DB at 5 MC. Attenuator: 3 step freq. compensated plus a continuously variable gain control in cathode follower circuit.
- ★ **Direct Reading, Peak to Peak Voltage Calibrator**
- ★ **Vertical Pattern Reversal Switching Facility**
- ★ **Push-Pull, Wide-Range Horizontal Amplifier:** 100 MV/inch sens. Input Characteristics: 2 Megohms, 25 mmfd. Response: One DB from 10 cps. to 1.0 MC—3DB at 2 MC. Attenuator: 3 step, freq. compensated, plus a continuously variable gain control in cathode follower circuit.
- ★ **Linear, Multi-vibrator Sweep Circuit:** 10 cycles to 100 KC plus automatically synchronized 30 cycles and 7875 cycles sweep for TV sync-pulse analysis. Amplified sweep retrace blanking.
- ★ **Amplified Auto-Sync Circuit** active on all internal sweep ranges
- ★ **Four Way Sync. Selector Switch** provides for Internal Negative, Internal Positive, External and Line Synchronization.
- ★ **3,000 Volt Intensifier Power Supply** assures utmost visibility of 'scope traces. Essential to high frequency and pulsed waveform analysis.
- ★ **"Z" Axis Input Terminal** for blanking, timing and marking.
- ★ **Built-in 60 cps Phasing and Blanking Controls** especially designed for more convenient FM, Monochrome and Color TV alignment and sync pulse analysis.
- ★ **All 4 Deflection Plates Available** with full beam centering facilities.
- ★ **Tube Complement:** 12AV7 "V" Cathode Follower-Amplifier. 6U8 "V" Amplifier-Phase Splitter. Two 6CL6 Push-Pull "V" Drivers. 6U8 "H" Cathode Follower-Amplifier. 6C4 "H" Phase Splitter. Dual 12BH7 Push-Pull "H" Driver. 12AV7 Linear-Sweep Multivibrator. 6BH6 Auto-Sync Amplifier. 12AU7 Sweep Retrace Blanking Amplifier. OA2 Voltage Regulator. 5V4 Low Voltage Rectifier. Two 1V2 High Voltage Rectifiers. 5CP1/A CR Tube.
- ★ **High Contrast, Filter Type, Removable Calibrating Screen**

Model ES-550 Deluxe: (Illustrated) In custom-styled, blue-grey ripple finished steel cabinet; 2 color satin-brushed aluminum panel and contrasting dark blue control knobs. Case Dimensions 8¼ x 14½ x 18½ inches. Complete with all tubes, including 5CP1/A CR tube. Comprehensive Instruction Manual. Net Price: \$215.00

Model ES-550 Standard: Electrically identical to above but in standard black cabinet with black anodized aluminum panel. Case dimensions 8¼ x 14½ x 18½ inches. Complete as above. Net Price: \$210.00

MODEL SP-5 OSCILLOSCOPE TEST PROBE SET

for TV Signal Tracing, Alignment, Trouble-Shooting and Waveform Analysis

Engineered for use with all *PRECISION* Cathode Ray Oscillographs, Models ES-500, ES-500A, ES-520 and ES-550. Model SP-5: In vinyl carrying case, complete with four different detachable probe heads, universal coaxial cable, and operating instructions. Net Price: \$23.50



See the new Model ES-550 at your favorite Electronic Parts Distributor. Ask for new 1955 catalog describing the complete line of *PRECISION* Test Instruments for all phases of AM, FM, TV.

***PRECISION* Apparatus Company, Inc.**

70-31 84th Street, Glendale 27, L. I., N. Y.

Export: 458 Broadway, New York 13, U. S. A. Cables: Morhanex
Canada: Atlas Radio Corp., Ltd., 50 Wingold Ave., Toronto 10

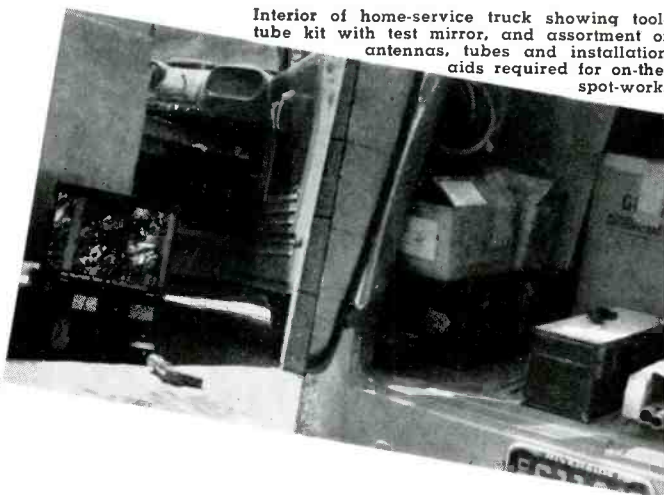

Interior of home-service truck showing tool-tube kit with test mirror, and assortment of antennas, tubes and installation aids required for on-the-spot-work.

TV REPAIRS In The Home

THE REPAIR OF RECEIVERS in the home has always been recognized as an ideal approach to service. For years the practice has been widespread in the servicing of radios. But the advent of TV caused many to discard the technique, because of the chassis' complexities. However, years of field experience with TV receivers have instilled more know-how and confidence, and helped to bury the belief that TV repair in the home was impossible; now more and more are returning to the original concept that specializing in home service represents a very practical program for the independent Service Shop.

Generally, it has been found that it is possible to provide better service, because one can use the exact signal and line input voltages that exist in the home for tests. In the case of weak or strong areas, one can apply the tricks of the trade to the degree necessary for the best results. Alignment can be tailored to fit front-end and video *if* circuits. It is true that more time may be consumed per job, but each assignment will be completed to the satisfaction of the set owner.

Since tube failures constitute a major problem in service, one must always have a complete stock available. Tube caddies (at least three or four) have been found to be the ideal source of such a supply. In our oper-

by **M. MARTYNEC**

ation, two of the caddies contain all TV types, fuses, dial lamps, bottle of window cleaner, furniture polish, coupling cables for yoke, *hw* line, pix-tube boost and isolation units. The other two caddies contain frequently-used radio tubes and a spare stock of TV types. We also carry a tool caddy, with a mirror in the lid, which contains those components that normally fail frequently; small resistors ($\frac{1}{2}$, 1, and 10 ω in popular sizes), glo-bar resistors for series-parallel circuits, small type capacitors (ranging from 10 to 10,000 mmfd in small units, including silver and *hw* type for horizontal circuits), and molded 600-*v* capacitors (.001 to .5 mfd) for coupling and bypassing, along with a few high-capacity filters for bridging *lv* supply filters or decoupling applications. A quick-heat soldering gun, multi-meter with *vwm* adapter, drop cloth, cleaning cloths, chemicals, such as plastic cement, machine oil, contact cleaner, anti-corona cement, rubber cement, contact lube and tube pin cleaner, complete the complement.

Test Equipment Needs

A mutual conductance tube checker, with provision for gas checks, has served our needs, enabling us to find

the odd combinations of weak and shorted tubes, so often the cause of stubborn problems. Servicing on the location often eliminates the need to check all tubes, since one generally knows signal conditions; therefore it is possible to check tubes in critical circuits. Another key instrument required for home servicing is the 'scope. After a tube replacement or repair in, let us say, a horizontal circuit, waveform checks must be made to be sure maximum noise immunity obtains. Checking out loss of sync pulses or other voltage waveforms also make the 'scope a very necessary and frequently-used piece of equipment. Next on the list of required test gear is a capacitor checker to catch those leaky units either in the sound output power-conserving circuits or other coupling links throughout the receiver. Troubles that can be solved by replacement of defective capacitors include heavy trailing edges, caused by a low-frequency phase shift.

As mentioned earlier, alignment also represents a major home operation. For this work, a number of portable instruments are available.

General Stock Requirements

In addition to the tools, tubes and components included in the caddies and kits one should also carry an in-

(Continued on page 39)

Field Report on Servicing Techniques and Tubes, Components, Tools, Antennas, Hardware and Instruments Found to be Best for On-The-Spot Operations

Direct Schematic to

by C. R. CANTONWINE

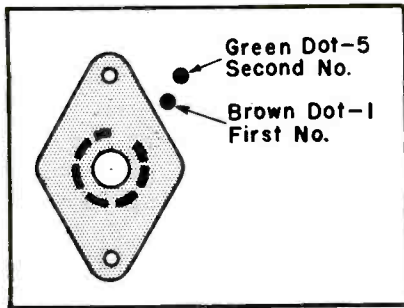
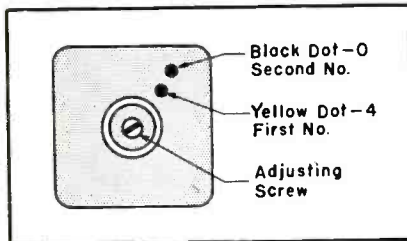

Fig. 1. Tube socket code for a tube that carries a V15 identification on the schematic.



(Above)

Fig. 2. Code for adjusting screw, which, in this case, would be item No. 40.

(Below)

Fig. 3. Code for junction test point; in this instance test point No. 50.

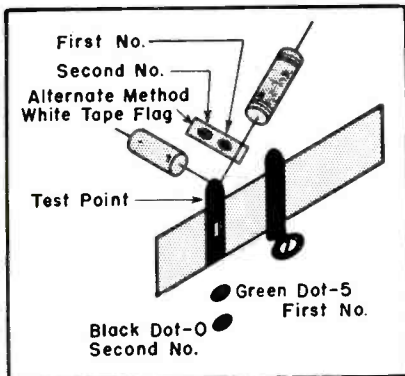

(Below)

Fig. 4. Multisection electrolytic code for capacitors that would be indicated as C51 or 61A on circuit drawing.

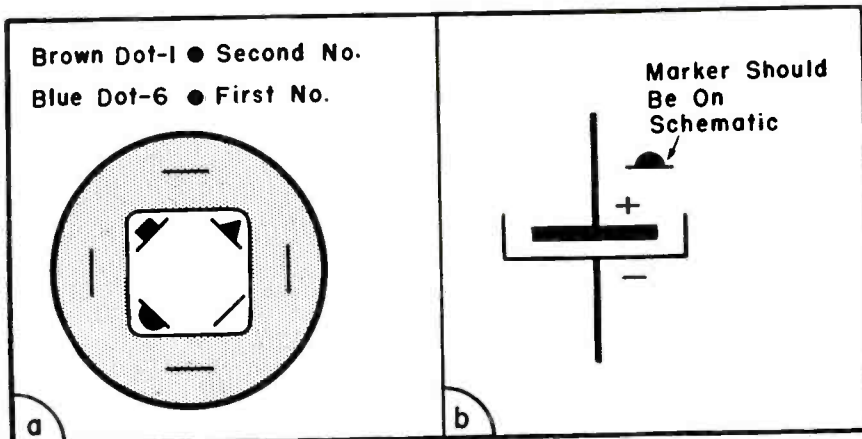

IN THE EARLY days of the simple radio set, with its limited tube complement, circuit-tracing was not too involved a problem. However, with the arrival of TV, its multiplicity of tubes and complex circuitry, we found ourselves steeped in a maze of wires. Wouldn't it be wonderful, we felt, if all chassis were on *breadboard* layouts, with all components arranged according to the schematic? A system has been developed that is almost that simple; it uses the familiar RETMA color coding method. Each tube socket, adjusting screw, test point, and multi-section electrolytic capacitor, is color coded to conform to numbers found on the schematic and alignment notes. Thus, it becomes possible to trace without interruption, troubleshoot, check or make complete alignment with increased speed and accuracy.

Most Service Men are general practitioners who have to work on all makes and models. They have few opportunities to become familiar with just one make of chassis as does the specialist or distributor bench man. There is a crying need for a quick and easy way to locate, within the chassis, the major components and points of interest so easily located on the schematic. There is no other single factor, it is believed, that could do so much

for so little, than to have this identification provided at the time of assembly.

Until such time that such a method or an equivalent is adopted by the set makers, we have found that the next best thing that can be done is to color code each individual set as required. Any receiver that cannot be repaired by the usual preliminary procedures, or simple obvious repairs, should be color coded. It is, of course, not necessary to color code all components unless required. Obviously, if you were not going to realign a chassis, there is no need to code the adjusting screws or test points. Your judgment will dictate what components to code for each individual job.

We all know, that at this stage, we can waste a lot of time in tracing that elusive defect (or defects), if we are not thoroughly familiar with chassis layouts. An ailing TV set can put to utter shame the old familiar *lame duck* trick of diverting attention and leading us on a wild goose chase. So it will pay off in the long run to take a little time to prepare the chassis for quick and easy troubleshooting. We can then concentrate on what we have been trained to do, without taking our

¹Such as 677 (fast drying lacquers), General Cement Co.; or 43N112 as listed in the Allied Radio catalog 140. This kit includes 10 bottles (1 bottle of each color, from 0 to 9) brushes, and chart. In place of the brushes, a tool has been found preferable; such as a blunt ice pick or the reamer end of a soldering aid, to pick up only enough paint to make dots 1/8" to 3/16" in diameter. It can easily be wiped clean between colors with only a dry cloth.

Chassis Servicing

Method Developed to Expedite Circuit Tracing and Troubleshooting Features Color-Coding Scheme for Components, Adjusting Screws and Test Points to Conform to Schematic and Alignment Notes

mind off our work to locate or re-locate a component or test point.

This effort will be appreciated, even more, when we are called upon to service this same set at a later date. This should be explained to your customer; it is a good selling point. Future service will cost the customer less if *you* are called.

To color code the chassis, a RETMA color coding kit of prepared paints should be used.¹

Systematic Approach

In the first step, we must prepare a tabulation (as shown in tables 1 to 5) based on schematic and alignment notes. Conflicting designations or symbols must be changed to a uniform numbering system for coding purposes. It is possible, of course, to use the numbers without change, even if there were duplicates, such as *V-10* tube and *A-10* adjusting screw. It has been found, however, that this can be more confusing than helpful in a crowded chassis. These vivid colors stand out more prominently than the components themselves, so it is better to have no duplicate numbers.

Locating And Coding Tube Sockets

The under chassis position of each tube should be located, using a service manual, if available. If a manual is not about, the following suggestions should be followed. From table 1, using the *V* number as shown on the schematic, each socket should be coded according to the RETMA standards; black for 0, brown for 1, red for 2, etc. One should place a dot of paint, corresponding to the first number of the tube, nearest the base and progress outward with the second number, as shown in Fig. 1. Where dual purpose tubes are used, designated as *V-11A* and *V-11B* for example, they are in the same envelope; hence they use the

same socket, and *V-11* can be used. Time can be saved if tubes *V-1*, *V-11*, and *V-10* to *V-19* are marked with a brown dot, while the bottle of brown paint is open. Likewise *V-2*, *V-22* and *V-20* to *V-29* can be marked with a red dot while the bottle of red paint is open. Then we can go back over and apply the second dot where required.

If only a schematic is available to work from, it may be necessary to make a tube layout on a sheet of paper, showing the relative location of all sockets as viewed from the bottom of the chassis. Then as you determine the identity of that socket, it can be marked by a *V* number as determined from the schematic or table 1. We must not overlook the help it is possible to get from the tube layout usually found inside the cabinet, showing location by *types*. Most tubes can be quickly identified by tracing in sections and groups. The *rf*, mixer and oscillator tubes, of course, are found in the tuner section. The audio group should be traced back from the speaker. Then we can follow the video amplifier, detector and video *if* back from the picture tube. The vertical section can be traced back from the vertical output transformer. Then we must locate the horizontal section near the high-voltage compartment. The power supply, high-voltage rectifier and damper should offer no problem. The *agc* and other tubes can be traced to the nearest associated circuit. At this point, the process of elimination is helpful.

If you wish, the top chassis side of the tube sockets can be color coded for convenience in future home service.

Adjusting-Screw Coding

Each adjusting screw should be located and numbered, that are higher

(Continued on page 55)

Schematic symbol	Assigned number
<i>V-1</i>	1
<i>V-2</i>	2
<i>V-3</i>	3
<i>Etc.</i>	<i>Etc.</i>

Table 1: Tube socket code assignments.

Schematic symbol	Assigned number (even)	Or assigned number (first digit even)
<i>A-4</i>	30	40
<i>A-5</i>	32	41
<i>A-6</i>	34	42
<i>A-7</i>	36	43
<i>A-8</i>	38	44
<i>A-9</i>	40	45
<i>A-10</i>	42	46
<i>A-11</i>	44	47
<i>A-13</i>	46	48
<i>A-15</i>	48	49

Table 2: Code for adjusting screws; top of chassis.

Schematic symbol	Assigned number (odd)	Or assigned number (first digit odd)
<i>A-1</i>	31	30
<i>A-2</i>	33	31
<i>A-3</i>	35	32
<i>A-12</i>	37	33
<i>A-14</i>	39	34

Table 3: Codes for adjusting screws; bottom of chassis.

Schematic symbol	Assigned number
<i>A</i>	50
<i>B</i>	51
<i>C</i>	52
<i>D</i>	53

Table 4: Code for junction test points.

Schematic symbol	Assigned number	Marker
<i>C1-A</i>	61	Semi-Circle
<i>C1-B</i>	61	Triangle
<i>C2-A</i>	62	Semi-Circle
<i>C2-B</i>	62	Square
<i>C2-C</i>	62	Triangle
<i>C2-D</i>	62	Underscore

Table 5: Code for multi-section electrolytics.

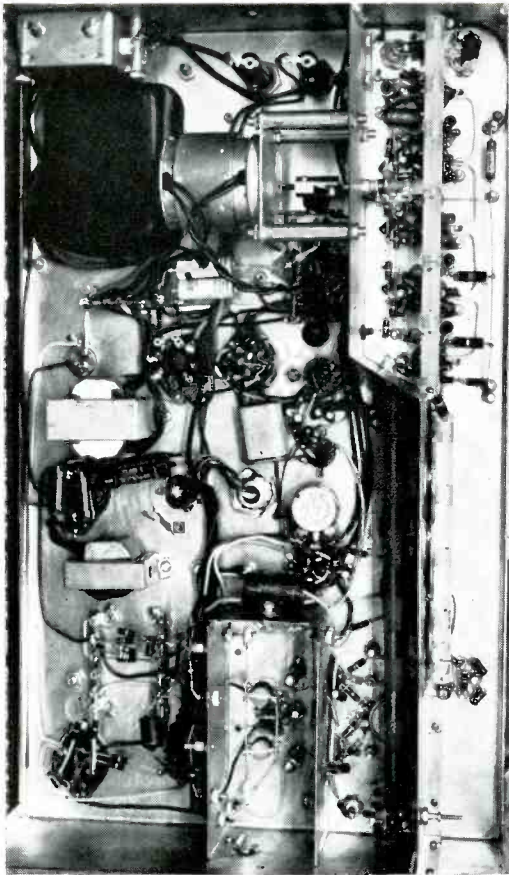

Community TV Coax Temperature-Variation Control System ‡

**New Technique, Employing Variable
Equalization AGC Amplifiers, Found to Correct
Variations in Attenuation of Coax Lines,
Caused by Temperature Changes**

by F. E. HUGGIN, Senior Project Engineer, Entron, Inc.

THE PURPOSE of all community TV systems is to provide constant amplitude signals into a customer's home, regardless of signal strength variations at the antenna, in the line voltage, or in the attenuation of coax cables. Variations of signal strength at the antenna point can be taken care of by *agc* at the head-end site. Voltage variations can be taken care of by regulated power supplies. But, up until now there has been no complete solution for variations in the attenuation of coax cables used for distribution. Temperature variations are the greatest cause of coax attenuation changes. It has therefore become necessary to provide some means of correction for these excessive changes.

Using RG-11 cable, the attenuation per mile on channel 6 has been found to increase approximately 16 db, if the temperature of the cable increases from 0° to 120° F, which is normal winter-to-summer variation. Since the RG-11 cable has a black vinyl jacket and is installed on poles, subjected to direct sunlight, the internal temperature will be many degrees higher than the outside air temperature. In addition,

the insulating properties of the jacket will cause a time delay of several hours for the interior to reach the maximum temperature. This same effect takes place upon cooling, and minimum temperature is reached several hours after the minimum air temperature. Because of this time delay, it is therefore not feasible to devise means for controlling gain of line repeater amplifiers directly by outside air temperature.

Since the attenuation of channel 2 is only about 80 per cent of that of channel 6, variation in the attenuation of the cable will cause a change in the required amount of equalization. In a normal system equalization is fixed; and, therefore, any changes in attenuation will upset the equalization, causing what is known as *tilt*. With a temperature increase from 0° to 120°, the *tilt* between channels 2 and 6 can be as great as 3 db per mile. Therefore, it becomes necessary to provide also some means for automatically correcting for *tilt*. For example, under these conditions, if the trunk line is 10 miles long the attenuation increase on channel 6 will be approximately 160 db, and *tilt* between channels 2 and 6 will

be approximately 30 db, caused by the temperature change alone. This is, of course, more than enough to make the system inoperative. It can be seen that all the corrections cannot be made at the end of the line, because the signal will have been completely and totally lost by this time, and obscured by noise long before it reaches the end.

The attenuation of RG-11 at 67° F on channel 6 is approximately 40 db per 2000'. Using broadband repeater amplifiers having 40 db gain on channel 6, approximately three amplifiers will be required per mile, or with the foregoing example of a ten-mile trunk line, a total of 30 amplifiers. One solution to the problem of attenuation change in the cable would be to require each of the line amplifiers to have some built-in device to maintain its output level constant, regardless of the amplitude of the input signal. Such a device would be unnecessary in each amplifier, however. It would therefore be desirable to let the variation accumulate and then correct before the signal becomes either too large or too small to be corrected. As a system is normally set up, the input to each

(Above)

Inside view of the variable equalization *agc* amplifier with shield cover removed from the dynamic pickoff circuit.

‡From a paper presented at the fourth annual convention of the National Community TV Association in New York City.

amplifier is approximately 1 *mv* or 0 db. A low-noise amplifier can accept a 16-db reduction in signal from this value and still be well above noise, so only every third amplifier need have a correcting device.

There are several methods which can be used to control the output level of the broadband line amplifiers. One of these methods is the so-called composite *agc*. In this method, a bias voltage proportional to the sum of all signals in the pass band is developed at the amplifier output, and this voltage is used to control one or more tubes in the amplifier. One disadvantage to this method is that the system gain varies with the number of channels in the pass band; it is possible for the gain of one amplifier to increase over 20 db if the number of channels changes from 5 to 1. Another disadvantage is that it provides no intelligence for *tilt* correction. Since the composite *agc* does not fulfill the requirement, another method has to be used. A method found to be most effective incorporates two peak-reading devices, tuned to the outside channels, the voltage from these pick-offs being used to control the output level, as well as to provide tilt information.

To determine the requirements of a five-channel broadband self-correcting amplifier, it is necessary to consider the entire system to discover how it is affected by all disturbing factors. At the antenna site, the head-end amplifiers or converters must contain an *agc*, so that all output channels are fixed in level and tuned to channels 2 through 6. These five channels are mixed and applied to the coax cable. The output level of the mixer is such that over 2000' of RG-11 cable can be installed between the head-end and the first repeater amplifier and still have a level of at least 1 *mv*. The amplitudes of each channel at the head-end are adjusted so that they are all of equal level at the input to the first broadband repeater amplifier. This amplifier is then equalized, so that the signals to the input of amplifier 2, 2000' down the cable, are also equal, and so on to amplifier 3, which it was noted will be self-correcting. Since there is approximately one mile of cable between the head-end and the *agc* amplifier, the signal levels into this amplifier will vary with temperature; the attenuation being greater on channel 6 than on channel 2. Therefore, when the total line attenuation changes, the change will be larger on 6 than on 2. If the system is set up at a given temperature, then the temperature rise increases the attenuation more on channel 6 than on 2. If the mile of cable were subjected to a 120° temperature

Block diagram of variable equalizing *agc* amplifier.

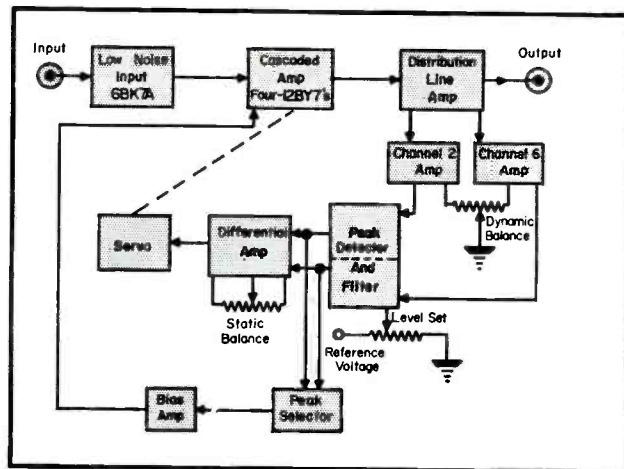

rise, the attenuation on channel 6 will increase 16 db and on channel 2 it will increase 13 db, causing a tilt of 3 db and a loss of 16 db.

Experimental tests on cables of different manufacturers have shown that variations of tilt can be more or less than the expected amount from the foregoing value, but in all cases the greatest changes in attenuation occur at the outside channels with approximately a linear variation between. Of course, some cables have small bands of very high attenuation in the required frequency range which are referred to as *notches*, but these cables are considered bad before installing and are therefore rejected. The small irregularities remaining in the cables in use do not seem to get worse with temperature cycling. Therefore, to correct for tilt, it is necessary only to measure the difference between channels 2 and 6, and use this difference to alter the response of the amplifier to make the outputs equal. Accordingly, the self-correcting amplifier must have a gain of at least 56 db and be able to tilt its response curve 3 db either way. The time constants of the correcting devices can be quite slow because they correct for temperature changes, and indeed they must be slow to make a stable system.

The variable equalizing *agc* amplifier found to fulfill the foregoing requirements is illustrated, in block form, in Fig. 1. The input section consists of two cascaded broadband grounded-

grid triodes, with a flat response over the passband to obtain a low noise figure. Following the input section are four broadband-cascaded pentodes connected in a stagger-damped, double-tuned circuit to obtain maximum gain and minimum bandwidth shrinkage. The final pentode of this group uses the grid line of the distributed line output stage as a plate load. The output stage is a distributed line to provide high-level output signal with low-intermodulation distortion and also to provide a means of picking off *agc* signals without distorting the signal from the amplifier. This combination of broadband cascaded stages followed by a distributed line output has many advantages. It provides low noise input, high-level output, easy control of frequency response, and economy of tubes. The grids of the pick-off tubes are connected to the plate line in such a manner as to extend the line by two sections, thereby causing negligible loss or discontinuity. The plate circuits of these tubes are tuned to channels 2 and 6, respectively. There is a dynamic-balance control which provides a differential gain adjustment between the two amplifiers. This is necessary because any mismatch in the cable following the amplifier will be reflected back into the plate line causing a difference in signals on 2 and 6. The *rf* signals on the plates are rectified by a twin diode biased to a

(Continued on page 54)

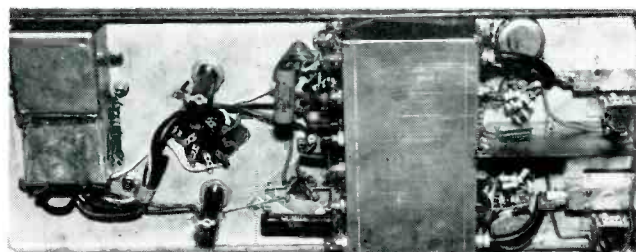

View of the dual-gated oscillator in the *agc* amplifier. Note shielding over the *rf* circuitry to minimize stray radiation.



[See Front Cover]

by W. W. COOK, RCA Service Company, Inc.

THE COLOR-TV CHASSIS, which it was once said, would always be a massive affair bristling with from 35 to 45 tubes, has gone streamline and not only become a 26-tube package, but it now boasts a 21-inch picture tube.

Developed by RCA, the new model (21-CT-661/2 U), provides *vhf* and *uhf* channel coverage, magnetic convergence and electrostatic focus, crystal controlled *afc* color sync, high-level color demodulation, automatic color control and a color *killer* circuit to disable the color channel during black and white reception.

A switch-type *rf* tuner replaces the turret type used in earlier RCA color receivers. Special circuits have been incorporated for counteracting the tendency of the tuner to detune with a change in *rf* bias. The frequency response of the tuner is maintained between close limits for a large range of *rf* biases.

The tuner is link-coupled to a three stage picture *if* amplifier, whose *if* response is flat to 42.75 mc. Below 42.75 mc, the response falls off to 10 per cent at the extreme end (41.75 mc) of the color bandpass. This places the color subcarrier (42.17 mc) at the 50 per cent response point. As a result, the color frequencies appear with reduced amplitude at the output of the picture *if*. The correct amplitude relationship between chrominance and luminance frequencies is restored in the chrominance amplifiers.

The output of the picture *if* is applied to a 1N60 crystal detector. The video output developed by the crystal detector is *dc* coupled to the first video amplifier stage.

The first video amplifier provides signal information to five other cir-

cuits. The luminance signal is obtained from the cathode, and the sync, *agc*, sound and chrominance signals from the plate of the first video amplifier. The luminance signal is amplified in a second video stage which is *dc* coupled to the cathodes of the tri-color picture tube.

The sound *if* discriminator and audio amplifiers are of conventional design. The cathode circuit of the audio output stage provides the +140 volts plate supply for the picture *if*, sync and sound stages.

A noise-inverter stage is utilized to immunize sync and *agc* from noise disturbances. Composite video, with sync negative, is applied to the cathode of this stage. The inverter is biased to cut-off at the tips of sync. Noise appearing above sync tips is amplified and is used to cancel any noise which appear on sync before it enters the sync amplifiers.

Chrominance information from the output of the first video amplifier is applied to the grid of the bandpass amplifier. The amplitude relationship of the color signal is restored in this stage. Gain is controlled by an *acc* (automatic chroma control) voltage on the grid. The *acc* voltage, which is developed in the phase discriminator, maintains proper color saturation of the viewed color picture. This action is similar to *agc* action on black and white picture contrast. The chrominance signal is further amplified by the demodulator driver which supplies drive to the demodulators. The demodulators provide color difference signals which are of sufficient peak-to-peak amplitude to drive the grids of

the picture tube directly. In the demodulators, *R-Y* and *G-Y* signals appear across the plate load resistors. The *B-Y* signal is formed by matrixing portions of positive *R-Y* and *G-Y*. A negative *B-Y* signal is thus produced, which is then phase inverted to form the positive *B-Y* signal, which is *dc* coupled to the blue picture-tube grid.

The burst keyer tube selects the burst signal from the composite chrominance signal, through the action of the high-voltage flyback pulse, which gates the keyer tube into conduction during burst time.

The killer circuit biases the bandpass amplifier to cutoff during monochrome transmissions. A negative horizontal flyback pulse, applied to the grid, produces a large positive pulse on the plate, which causes the bandpass amplifier to draw grid current during retrace time. The negative bias, which is produced, is sufficient to bias off the bandpass amplifier, and the time constant in the grid circuit is long enough to maintain cutoff bias during trace time. When burst is present, a negative voltage from the phase discriminator biases the killer near cutoff. With the killer near cutoff, only a small positive pulse is applied to the bandpass amplifier, and the low grid bias which is produced permits the tube to conduct and amplify the chrominance signal. The color control is located in the plate circuit of the killer. This control varies the amplitude of the flyback pulse applied to the bandpass amplifier grid, thus determining its developed bias and controlling its gain.

The phase discriminator in this color model functions similarly to the
(Continued on page 52)

*From forthcoming supplement to *Practical Color Television for the Service Industry* to be published by RCA.

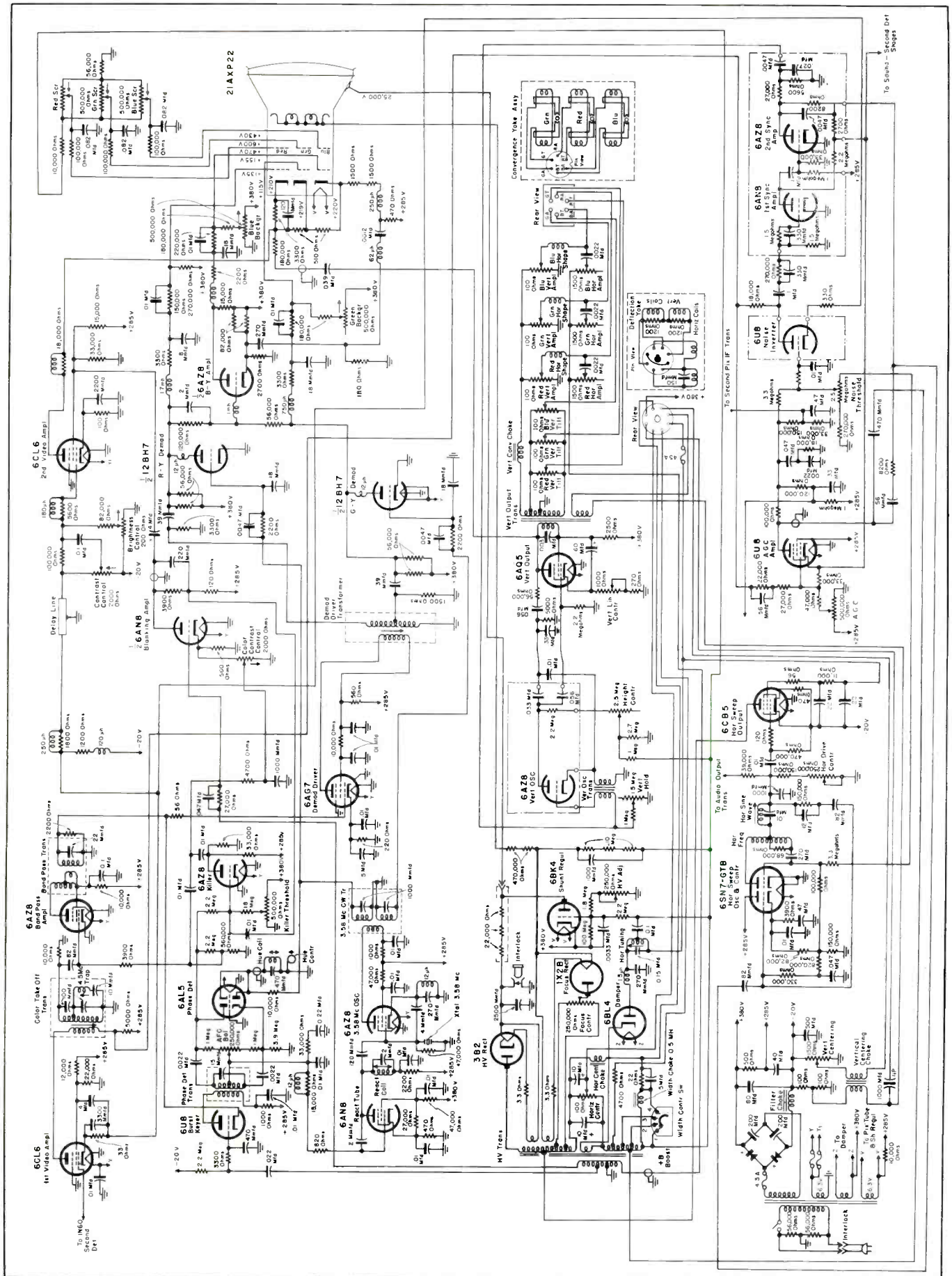
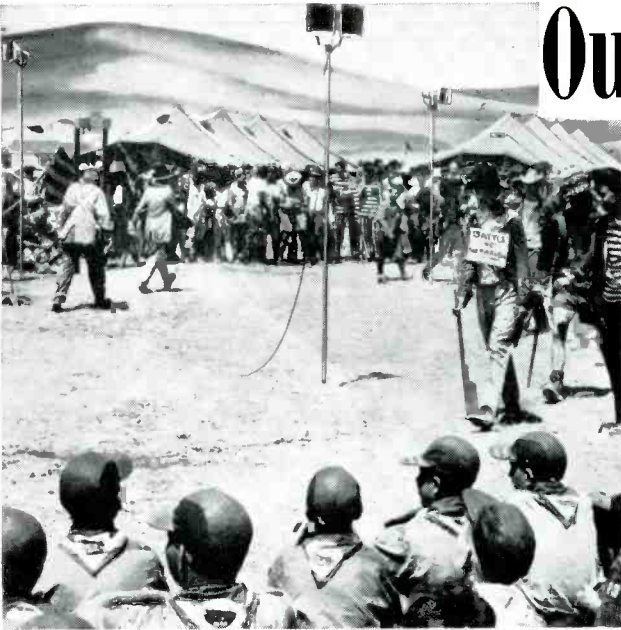

Fig. 1. Schematic of the color and power-supply circuitry in RCA 21-inch chassis CTC4 or CTC4A (models 21-CT-661/2 U).

Outdoor Sound System

by MICHAEL ANTHONY



(Left)

Wide-angle speaker setup at camping site. (University Loudspeaker)

IN OPEN-AIR sound-system installations the locale influences frequency-response requirements, and in a manner different from that for interior applications. These requirements, which entail less bass generally, can be satisfied by equalization controls on the amplifier. Equalization becomes important, and very effective use of bass and treble boost can be employed. Where amplifiers have no controls, external equalization can be introduced.

Directional control also plays an important role in the outdoor *pa* setup. In stadiums, for instance, we must consider the random distribution of sound to avoid disturbing of neighboring residents. Sound must be confined to the actual audience area. Ball parks are noted for lack of intelligibility due to reflections from far signboards and half-filled bleachers.

When there is more than one speaker in a sound system, two formulas must

be used to obtain the total speaker impedance, to insure best matching.

(a) For series connection of speakers, the individual speaker impedances are added together to obtain the total matching impedance: $Z_t = Z_1 + Z_2 + Z_3 \dots$ etc.

(b) For parallel connection, the reciprocal of the individual speaker impedances are added together to obtain the reciprocal of the total matching impedance: $1/Z_t = 1/Z_1 + 1/Z_2 + 1/Z_3 \dots$ etc.

(c) For series/parallel connections, the two formulas should be combined as the speaker-connections indicate.

Power Distribution Without Transformers

In a series system of speakers, with like voice coil impedances, equal power distribution will occur. However, if one speaker has 4-ohms impedance and

another 8-ohms, the power consumed by the 8-ohm speaker will be twice that of the 4-ohm speaker.

In parallel systems of speakers with like voice coil impedances, equal power consumption will result. When speakers of different impedances are connected in parallel, the smaller impedance speaker will receive the greater power. If one speaker is 8-ohms and one is 16-ohms, the 8-ohm speaker will consume twice as much power as the 16-ohm speaker.

When operating speakers on voice coil impedance (without transformer), the wire used should be as heavy as possible. On speaker cable runs of 100' or over at least No. 16 wire should be used; on runs of from 50-100' No. 18 wire or larger should be used.

Impedance Matching With Transformers

The proper use of transformers with speakers far from the amplifier prevents the occurrence of comparatively larger power losses in the transmission lines. In complex installations having large numbers of speakers, the use of transformers simplifies power distribution.

There are two types of transformers commonly used in sound-system installations: The constant-voltage transformer, and the impedance-matching transformer. The constant-voltage transformer is secondary tapped for different values of power (watts) for the speaker, and the primary matches the constant voltage line.

The impedance-matching transformer is primary-tapped for different impedance values and the secondary matches the speaker voice coil.

These transformers are employed in

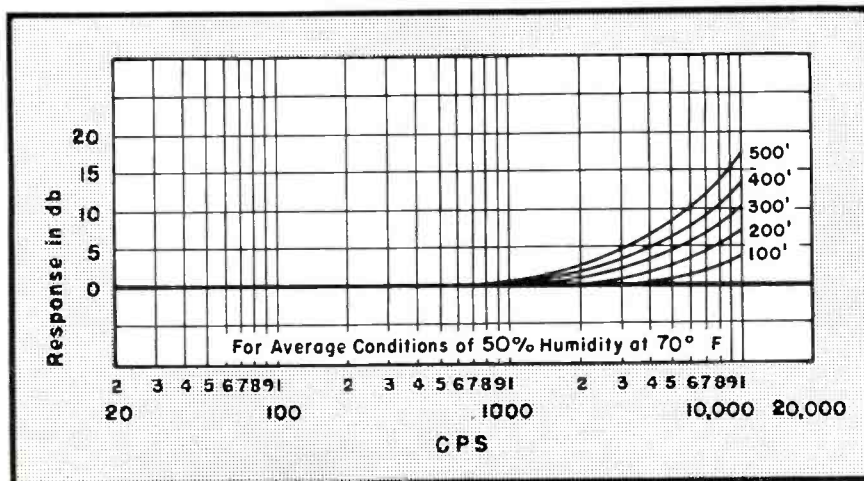

Graph illustrating equalization necessary for flat response at various distances because of attenuation of high frequencies through air. (Courtesy E-V)

Installation . . . Maintenance[‡]

two different types of sound systems:

(a) The constant-voltage system was developed particularly for use in large multi-speaker installations; but that does not prevent smaller installations from employing its advantages.

This method greatly reduces the amount of computation necessary to determine the proper transformer taps when varying sound levels are required. It also permits the addition to, or changing of, an existing system without recalculation of the total impedances and the power required.

A favorable load condition will exist, if the total power consumed by the loudspeakers is always less than or equal to the amplifier rating.

When the constant voltage transformer taps are marked in watts, one must:

(1) Choose the transformer with a matching secondary (i.e., 8-ohm secondary for an 8-ohm speaker).

(2) Select the power tap desired, and connect to speaker.

(3) Connect the constant voltage line to the primary.

For transformers marked in impedance the following procedure applies. The calculations are based on the simple relation: $Z = E^2/P$. . .

Where: Z = required transformer impedance; E = amplifier output voltage (in this case 70 v); and P = desired power at the speaker.

Using the 70 v amplifier output tap, E^2 roughly becomes 5,000 and the formula reduces to:

$$\text{Required impedance} = \frac{5,000}{\text{Desired Power}}$$

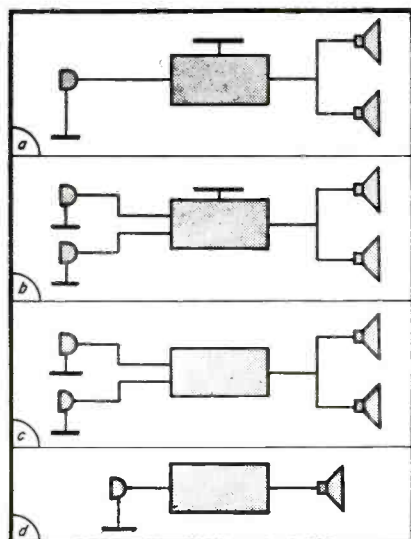

Amplifier Control Techniques . . . Series-Parallel

Speaker Hookups . . . Power Distribution Without

Transformers . . . Impedance Matching . . . Selecting

Best Location for Speakers and Microphones

(b) Constant impedance transformers are normally employed in simple sound-system installations where the speakers are located at a distance from the amplifier. Required impedances are calculated as already shown.

In selecting the proper transformer, the three major factors to be considered are:

(1) Primary impedance (determined by the requirement of a given installation).

(2) Secondary impedance (to match the speaker impedance(s)).

(3) The transformer must be capable of handling the power to be consumed by its associated speaker(s).

When the speakers to be matched by a transformer are close to each other, but yet distant from the amplifier, one transformer can handle a group of speakers. The transformer secondary

matches the total impedance of the speaker group.

On the other hand, when speakers are not only located at a distance from the amplifier, but are also distant from each other, a matching transformer is needed for each individual speaker.

Effects of Mismatch Upon Power Transformer

Generally, mismatching of impedances results not only in loss of power, but in a distorted output and poor tone quality.

For example, a mismatch of 2 (i.e., a 32-ohm speaker connected to the 16-ohm tap on the amplifier) would reduce the power to the speaker by approximately 25%. Where the loss of power is not critical, it must be remembered that the greater the mis-

(Continued on page 53)

(Left)

Four typical pa setups using combination phono-amps and amplifiers only. The system in (a) represents a mobile arrangement, using a three-speed phono-amplifier (23-watt), dynamic mike and a pair of reflex trumpets. Arrangement in (b) can be used for indoor or outdoor work and features use of two dynamics with speakers in portable carrying cases. Standard outdoor setup is shown in (c), where an amplifier (about 30 watts) feeds a pair of trumpets on stands. A small pa system is illustrated in (d); here we have a 10-watt amplifier, dynamic mike on studio or desk stand, and reflex air column speaker.

(Courtesy Bogen)

[‡]Based on field notes supplied by Mortimer Sumberg, David Bogen Co., Inc., and the engineering departments of Electro-Voice, Inc., University Loudspeakers, Inc., and Astatic Corp.; E-V data extracted from their Public Address Handbook.

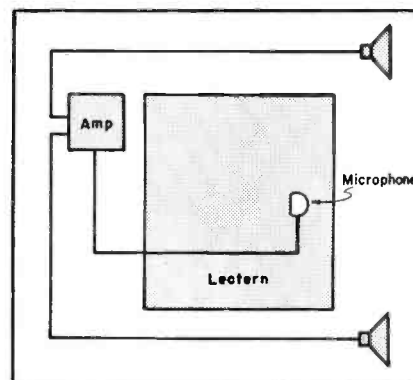

Block diagram illustrating location of speakers and microphone in a typical outdoor pa system. Speakers, which should be at least 15' away from mike to avoid feedback, should be mounted on stands to provide approximately 75° dispersion. (Courtesy Bogen)

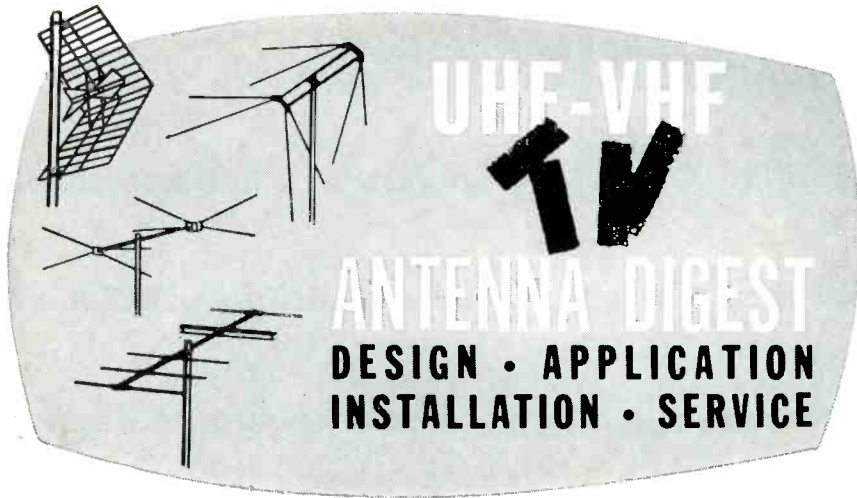

by

LOUIS E. RABURN

Dual-UHF Antenna Installations Using Filter-Couplers

DURING A RECENT two-channel *uhf* assignment, it was found necessary to install a pair of antennas to insure best pickup. Bringing the output to a common set-entry point, without a coupler, was found to be unsatisfactory; signal strength decreased and ghosts were predominant.

To solve the problem, a dual-band filter, operating on a frequency multiplex principle, was evolved. A pair of high-*Q* filters precision tuned to the desired TV channels were built into the coupler.

In some *uhf fringe* locations, when two antennas are used, both receive some pickup from the same station because of overlapping patterns or reflections from buildings, trees and so on. These signals could arrive out of phase at the junction and cancel each other or one signal could travel

a longer path, causing a ghost or pattern smear.

A solution to this difficulty is the crossover-frequency band-filter which will pass only one channel in one branch and only the other in another branch.

The two-antenna filter has been found to operate best when it is used with antennas which are matched in both channels, because of the use of two reactive filters designed for 300-ohm lines.

The filter unit, enclosed in a plastic case silvered to reflect heat and sunlight, may be located anywhere between antennas and receiver, but excess leadin is eliminated when the installation is made near antennas; each antenna must be positioned in both height and heading, using a field

strength meter to obtain strongest signal on its own channel.

Circuit of the duo-antenna filter is shown in Fig. 2. Each channel branch has an inductively-coupled parallel-line notch filter or *trap*. This filter is tuned to the *stop* channel frequency, placing an effective short circuit across the branch line at a point near the shorted end of the filter. Each filter is located so that the short in the branch line is a quarter-wave away from the common terminals at the stop frequency.

Branches and *traps* are sections of flat twinlead with a propagation velocity constant of 82% free space. *Traps* are spaced away from the branch leads by $\frac{1}{16}$ " thick plastic strips, and the complete sandwich is taped or cemented together. Traps for
(Continued on page 56)

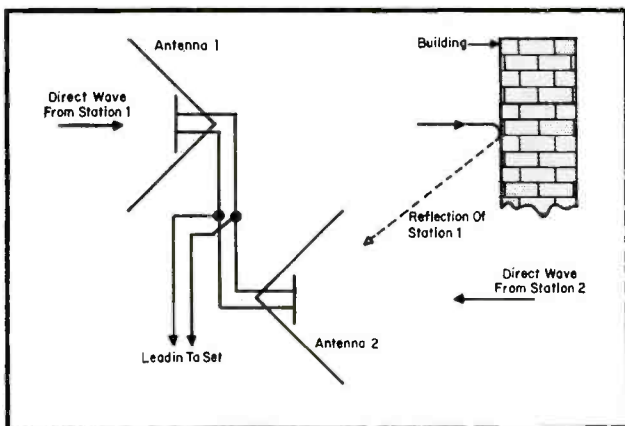

(Above)

Fig. 1. Two-station installation of ultrahigh filter with a pair of tied-in antennas.

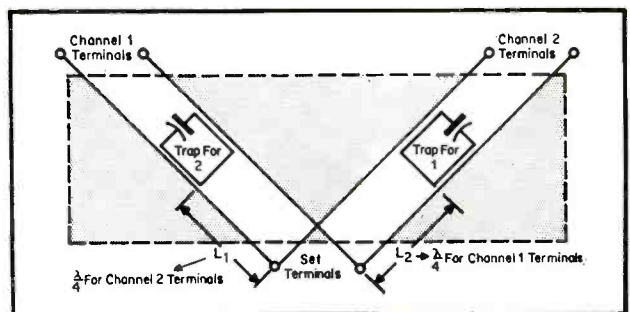

(Above)

Fig. 2. Circuit of ultra-high coupler.

(Right)

Fig. 3. Frequency response of typical two-antenna coupler for channels 50 and 62.

UHF/UHF Antennas . . . Accessories

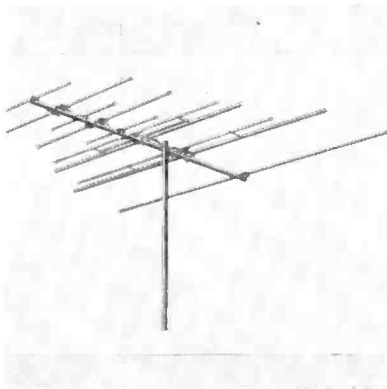

TV antenna featuring anodized aluminum coloring in seven colors. Anodizing process is said to make the antenna corrosion resistant and impervious to salt air, dampness, dust and natural atmospheric gasses. Stainless steel snaps are used in place of bolts, and red plastic-end plugs seal element ends. Antenna also features electro-lens focusing. (Interceptor models; Winegard Co., 3000 Scotten Boulevard, Burlington, Iowa.)



Three section high-pass filter designed to remove interference below 54 mc; diathermy, amateurs, industrial, ignition, heating devices, etc. The filter, a balanced 300-ohm unit, consists of six precision inductances and eight capacitors. Each half of the line is internally isolated and shielded to eliminate interfilter coupling. (Model No. WT-300A; Tele-Matic Industries, Inc., 16 Howard Ave., Brooklyn 21, N. Y.)

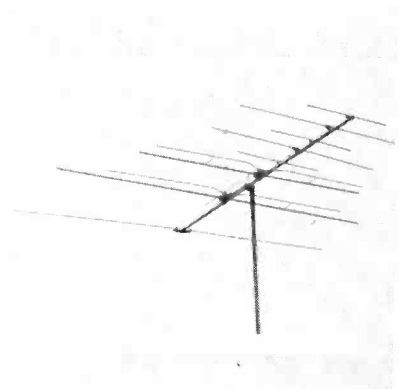

Broad-band, all-channel vhf inline-yagi type antenna designed for deep-fringe installations. Features diamond phasing loops that are said to multiply director element functions. In addition, it also utilizes broad-band T-matched elements for both low- and high-band vhf reception. Preassembled all-aluminum construction. (Constellation, model C-1, and Super-Constellation, model C-2; T-V Products Co., Springfield Gardens, N. Y.)

TV conical with a dipole-head designed to snap preassembled dipole elements into place and lock them there. Has internal aluminum dowel reinforced elements. (Zip line; JFD Manufacturing Co., Inc., 6101 16th Ave., Brooklyn 4, N. Y.)

Indoor antenna that can be oriented. Supplied with compass-action indicator and strip of pressure-sensitive tabs for noting antenna positions. (Paragon Products Co., 2033 Franklin Ave., St. Louis 6, Mo.)

Broad-band array featuring J match and phasing network. J element acts as additional reflector for folded element on some channels; folded elements act as director for J element over band. (Model VI; Hy-Lite Antenna, Inc., 242 East 137 St., N. Y. 51, N. Y.)

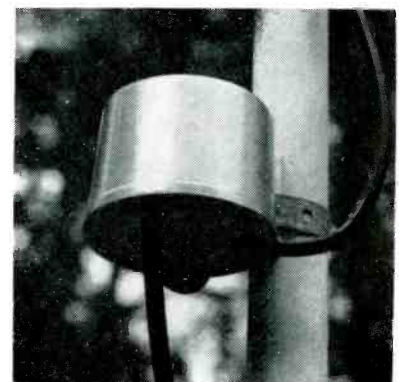
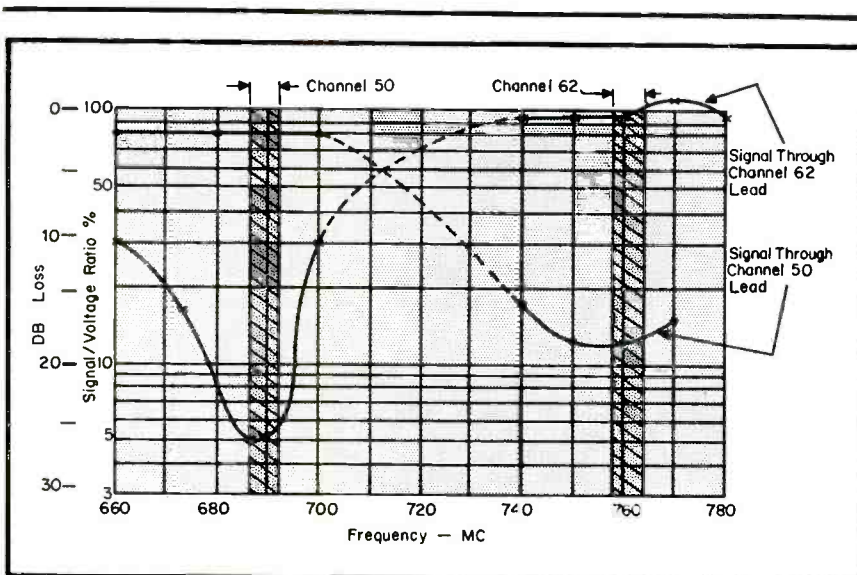
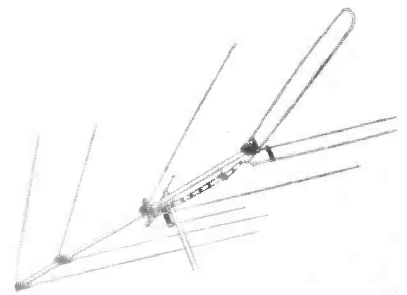
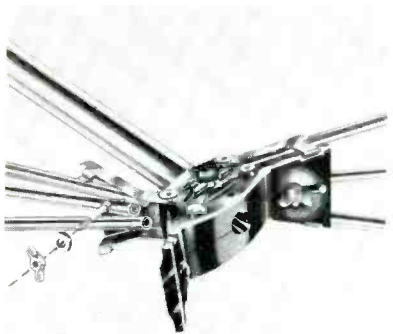

(Above)

Fig. 4. Two-antenna uhf filter installed.

Variable Damping Factors In Audio Amplifiers

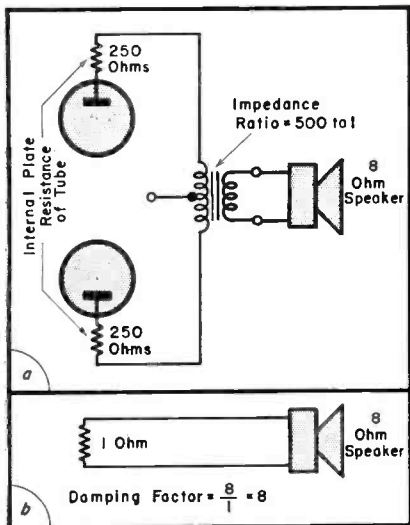

Fig. 1. Circuitry illustrating how the damping factor of an amplifier is determined.

DURING THE past year a number of audio amplifiers have appeared with a new feature; *variable damping factor*.

The *damping factor* of an amplifier is the relationship between the speaker impedance and the internal source impedance of the output stage. In other words, if an 8-ohm speaker *sees* an impedance of 8 ohms looking into the amplifier, the damping factor is 1; if the same speaker sees an impedance of two ohms, the damping factor is 4. Thus, the lower the source impedance of the amplifier the higher the damping factor.

The amplifier-source impedance is composed of the plate resistance of the output tubes (whose effective value is reduced by negative voltage feedback, and increased by negative current feedback), stepped down by the impedance ratio of the output transformer. To illustrate; let us suppose that the effective plate resistance of a given pair of output tubes is 250 ohms each, as in Fig. 1. The primary circuit of the output stage sees 500 ohms. If the impedance ratio of the output transformer is 500:1 (as it would be

if the tubes required a load impedance of 4,000 ohms, and the transformer secondary were connected to an 8-ohm speaker), then the speaker would see one ohm, and the damping factor would be 8.

Effect of Damping Factor

The damping factor has two related and pronounced effects on speaker performance. First, it controls the amount of bass produced in the region of resonance and through approximately one octave up. Bass output at resonance can be caused to be accentuated, flat, or severely attenuated. Second, *df* controls the bass transient response of the speaker, which may or may not exhibit *hangover*; the tendency of the speaker cone to continue to vibrate after the signal has stopped. We will see that accentuated response at resonance and hangover go together, and that good transient response accompanies a flat bass-frequency response.

Speaker Resonance

In an electrical resonant circuit, such as an *if* transformer, energy transmission reaches a maximum at the resonant frequency, and the nature of the resonant peak is controlled by the amount of resistance in the circuit. Relatively high resistance produces a low *Q* circuit, with a resonant peak that is flattened and broadened; relatively low resistance gives us a high *Q* circuit whose resonance is sharp and narrow.

Exactly the same principles prevail in the speaker-amplifier system, although the resonance involved is mechanical rather than electrical. At speaker resonance, which occurs towards the bottom of the frequency

spectrum to be reproduced, the mechanical system of the speaker produces maximum acoustic energy for a given electrical input. Obviously, then, if we furnish the speaker with the same amount of electrical power at all frequencies we will have maximum sound output at resonance.

It is the damping factor which determines the amount of power fed to the speaker as resonance is approached. A high-damping factor reduces electrical power progressively as the frequency is lowered. It does this by keeping constant voltage across the terminals of the speaker, whose effective impedance is continually increasing. Lower damping factors can keep the power going into the speaker constant, or can strike a compromise for optimum operation. Fig. 2 illustrates, by analogy, the operation of a variable damping factor in the speaker-amplifier system.

The effect of the damping factor on the speaker output over the resonance region can be predicted almost as accurately as the effect of *Q* on a given electrical resonant circuit. This effect is illustrated in Fig. 3, where theoretical response curves for the same speaker are plotted for different values of damping factor. The curves are labeled by the equivalent *Q* value of the total mechanical system, rather than by the values of damping factor, because a given damping factor will create different values of *Q* with different loudspeakers, or with the same loudspeaker mounted in different ways. Mechanical or acoustic resistance in the speaker system itself has the same damping effect as the internal impedance of the amplifier. Actual measured response curves will not be

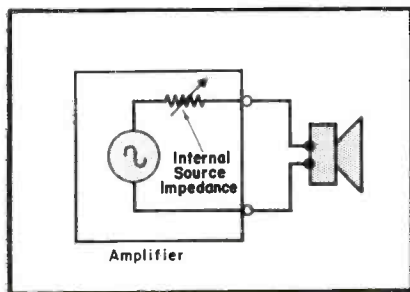

Fig. 2. Operation of a damping factor control. The generator represents the output stage of the amplifier, and the variable series resistor is the amplifier internal impedance.

Effect of Damping Factor on Speaker Performance (Bass Response Control) Methods Available to Adjust the DF System . . . Circuitry Features

by MARK VINO

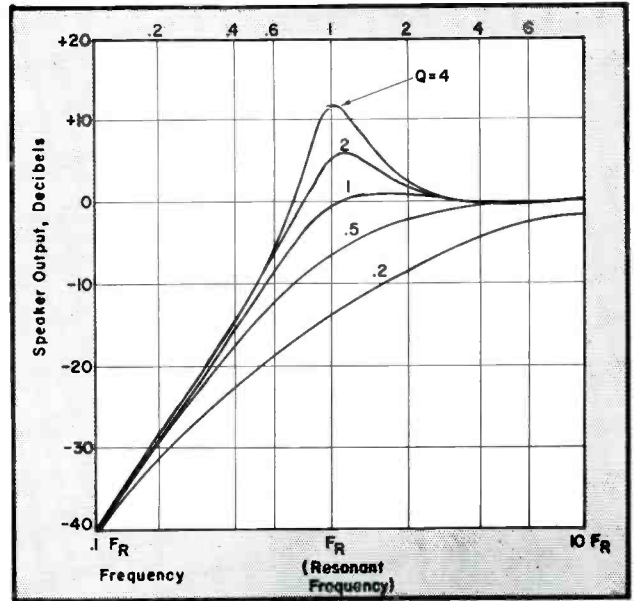

Fig. 3. Bass response of a loudspeaker where the Q of the speaker amplifier system is varied: Q = 1 represents optimum operation.

as smooth as those of Fig. 3, but will follow the same basic shape.

Hangover

The response curve representing the condition of $Q = 1$ is the most desirable. This is so for more reasons than are immediately apparent. In addition to this curve representing the most uniform steady-state frequency response, it also represents the virtual disappearance of hangover.

The resonant peaks of the upper curves necessarily predict *ringing*, when the speaker is stimulated by signals at or near the resonant frequency. This creates the well-known boomy quality which, although on occasion may be used to simulate the effect of genuine bass, is a most objectionable feature, destroying the fidelity of a reproducing system. A proper value of amplifier source impedance acts as an electrical brake on any unauthorized motions of the speaker voice-coil. Like all motors the speaker also acts as a generator, which the amplifier source impedance loads down.

The lower curves of Fig. 3, for Q values less than one, indicate the results in bass-frequency response when the speaker is overdamped and the amplifier source impedance is braking the speaker more than it should. The bass will be weak, but the transient response will still be good. With modern speaker mechanisms using several pounds of Alnico 5, and with amplifiers supplying damping factors of 10 and higher, an overdamped condition may easily occur.

The bass losses, due to magnetic damping, may be compensated for by the way in which the speaker is

mounted. Resonant-type enclosures like bass-reflex cabinets bring up the bass, as do horns, and mounting the speaker system in the corner has the same effect. (The smaller the solid angle into which the speaker faces, the better will be the acoustical bite in the bass. Thus mid-wall mounting affords the least bite, and placement at the junction of two surfaces, such as the floor and the wall, will result in increased low bass.) The speaker enclosure also introduces different amounts of acoustic resistance, which changes the amount of electrical damping required from the amplifier.

It is thus obvious that adjustment of a variable damping factor, to give $Q = 1$ for a speaker system, must be in terms not only of a given speaker and enclosure, but also in terms of the placement of the enclosure in the room.

Methods of Adjusting Damping Factor Control

Once the effect of varying the amplifier damping factor is understood, it is not too difficult to make the adjustment for optimum performance by ear, provided one can recognize the proper musical effect. The damping factor should be adjusted for full bass, consistent with clean low-frequency sound; that is, natural sound without boominess. Speech, which normally contains no acoustic energy in the region below 100 cycles, should not have a resonant, rain-barrel quality; as a matter of fact, the reproduction of program material consisting solely of the human voice should not give any hint that the speaker system is capable

(Continued on page 49)

Fig. 4a, b and c. The response of an ideal speaker to square wave is shown in (a). The fundamental square-wave frequency should be at least an octave below speaker resonance. In (b) we have the response to a square wave, showing slight overshoot, while (c) illustrates the response to a square wave, showing undesirable hangover.

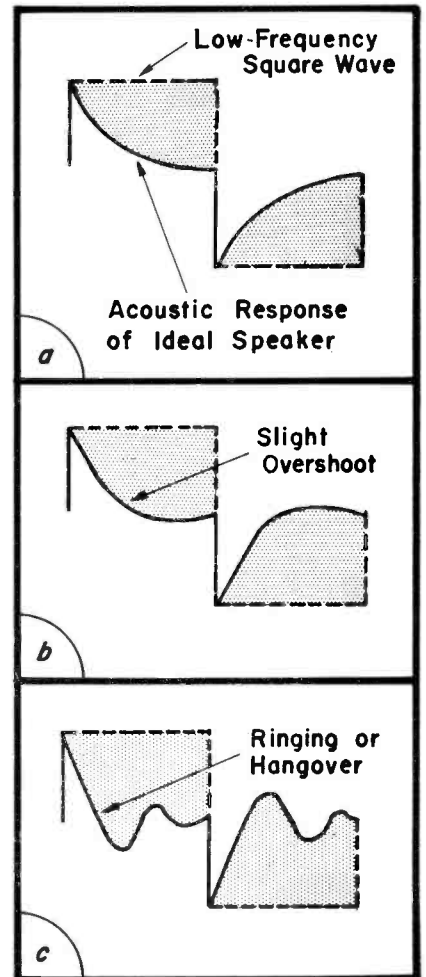

you can't argue with acceptance

proven quality
100% inspected
accurate replacement
prompt delivery

the most
complete
line
of twist mount
dry electrolytic capacitors

Better than any claims we could make is the unqualified and enthusiastic acceptance by engineers and servicemen alike. These are some of the features on which this acceptance is based:

- Aluminum containers provide maximum protection against moisture.
- Low leakage, long shelf life.
- Designed for 85° C. operation.
- Complete with metal and bakelite mounting plates.
- Easy to mount.
- Extremely compact—yet highly dependable.

Pyramid capacitors are listed in Sams' Photofacts

Burton Browne / New York

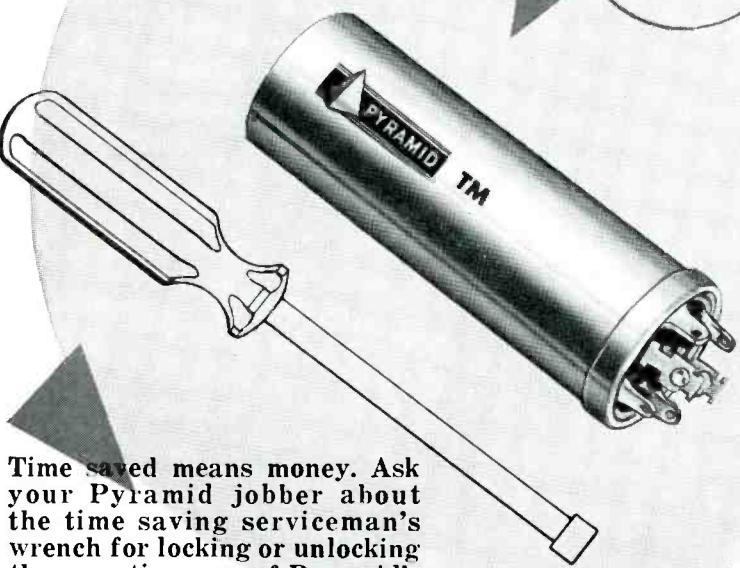

Time saved means money. Ask your Pyramid jobber about the time saving serviceman's wrench for locking or unlocking the mounting ears of Pyramid's twist mounts.

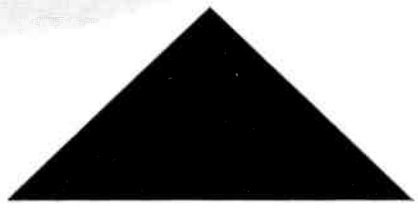

DISTRIBUTOR DIVISION
PYRAMID
 ELECTRIC COMPANY
 1445 Hudson Blvd., North Bergen, N. J.

SERVICE... *The National Scene*

TV REPAIR COMPLAINTS DISAPPEARING BBB SURVEY REVEALS--The annual report of the Better Business Bureau, issued recently, highlighting the results of a survey of BBB's around the nation, has disclosed that in nearly fifty cities, TV service complaints are rapidly disappearing from the books. . . . The improvement, the association's prexy noted, can be attributed to better training and more experience gained through field and shop operations. And, he added, when one considers that the nation's annual TV and radio servicing bill is now over \$1.5 billion, and that there are more than 36-million TV sets and over 130-million radios and auto receivers in use, the improvement is certainly a very gratifying one.

RETMA SET TO ISSUE SEALS FOR TV CHASSIS MEETING RADIATION-CONTROL STANDARDS--The spurious-radiation control program has now reached a stage where it appears likely that the Radio-Electronic-Television Manufacturers Association will be able to establish a procedure, whereby a set manufacturer whose receivers comply with the association's radiation standards may stamp a RETMA seal on each set, for the guidance of the purchaser, and the information of the FCC and the trade. . . . This industry effort to reduce radiation not only will improve reception and thus make set owners more satisfied, RETMA's prexy declared, but it will assure the maximum utility of the limited air space, furthering the development of a host of new electronic products for reception purposes. . . . In Canada, the TV industry has also organized a control program. It has been recommended that set makers endeavor to reduce horizontal sweep oscillator radiation to 200 microvolts by Jan. 1, and in another year further limit the radiation to 100 microvolts.

NEW COLOR SETS TO CONTAIN NEARLY 30 PER CENT MORE PARTS THAN B-W MODELS--The streamlined 21-inch color chassis, with from 26 to 28 tubes, will use about 30 per cent more components (resistors, capacitors and transformers) and two to three times the number of coils, than are found in black and white models, receiver designers have indicated. . . . For the high-voltage section, a new family of hv resistors, potentiometers and capacitors has been developed. In addition, the color sets will include delay lines, crystal filters, magnetic control loops for the picture tubes, and the normal complement of yokes, horizontal and power transformers and chokes. Ganged potentiometers are being developed in an effort to reduce the array of 27 to 28 single-control units, now used, to around a dozen.

UHF TROUBLES MAN-MADE TELECASTER DECLARES--Most of the ultrahigh problems now on deck are the result of a negative approach to the situation, the owner of an uhf station in Virginia pointed out recently. He said that we don't need toll TV, government subsidization or any other outside aid to make the high-band operation successful. . . . "What we do need," he emphasized, "is a little more work, attention to programming, a little ingenuity, and above all, a better sales job about uhf to make the American people understand that the ultrahighs are not an electronic stepchild, but quite possibly may be the answer to the 'whither goest television' question." . . . Accusing the government agencies of a lack of vision, the high-band broadcaster pointed out that their attitude has . . . "further heightened the clouds of confusion that tend to obscure the true uhf picture from the public eye." . . . Firing away at the prophets of doom and the trend of too many to ignore the success of the ultrahighs in many areas, the high-band enthusiast said: "It is this type of negative approach that has been used to undermine continually the confidence of the people in the uhf picture. . . . It certainly does not help those active in uhf . . . and it demeans television as a progressive industry." . . . In the meanwhile, an industry coordinating committee has proposed to the Commission that it establish a 90-day freeze on grants for new stations, where such authorizations would result in aggravating uhf and vhf station intermixture situations; and in the interim explore the complete problem with the assistance of a special engineering committee.

SERVICE... *The National Scene*

TRANSISTORS NOW BEING MADE AT 1,500,000-YEAR RATE--Industry is stepping up its production of transistors and set a goal of about 1,500,000 for the year. So noted a group of experts at a recent component-engineering conference on the Pacific coast. And, it was forecast, next year, at least 6,000,000 of the pea-sized units will be made, with a substantial quantity using silicon, instead of germanium, for the higher frequencies. . . . A number of the transistors now being made, the experts revealed, will be featured not only in radios, but in auto sets and in portable phonos. In one phono, a 45-rpm disc model, which will be available early this fall, there are three transistors operating from four flashlight batteries, a 4-volt motor weighing less than three ounces, a printed-wired chassis and 4-inch speaker. According to the designers of this transistorized phono, a speed control has been included to compensate for power loss as batteries grow old, and the tone arm has been so constructed that it serves as an on-off switch and automatically stops the turntable, turning the equipment off after each record, thereby eliminating waste of battery power. . . . Commenting on the advantages of transistors, one of the specialists at the meeting said that they have achieved a failure rate of only 1/10 of 1 per cent per 1000 hours, in contrast to the 7/10 of 1 per cent for many types of tubes in common use. Of course, it was emphasized, one cannot discount the tube now nor in the immediate future, for the tube does offer many outstanding operational features that can't be matched by the transistor; witness the recently-announced portable radio with transistors as audio amplifiers, but tubes for conversion, if and detector-avc-af input, because they perform more efficiently in these circuits.

COMMUNITY TV HAILED BY FCC COMMISSIONER--If TV stations can't reach out and provide adequate coverage to areas blacked out by hills, and multi-channel community-TV links can do the job, then such a service should be welcomed by everyone, a member of the Federal Communications Commission declared at the recent conference of the Community TV Association. Criticizing those who would curb extensions of this intermediate pickup-relay system, the Commissioner said that in his opinion, it would be more consistent with American philosophy to lend a hand and provide opportunity, rather than impose artificial restraints or outright prohibition of such a service by government fiat.

TV SETS NOW BEING COUNTED BY GOVERNMENT EXPERTS--The first census of TV homes since '50, when about 5-million sets were in the field, has been undertaken by the U. S. Census Bureau. . . . Applying the sampling treatment in 230 areas (in the Northeast, Southeast, Central and West) among 25,000 homes, government agents are asking occupants if they have a TV set and if so, how often is it used. . . . The survey is being co-sponsored by the networks, broadcasters and industry associations.

THREE EXPERIMENTAL METHODS USED TO BRING TV SIGNALS TO SHADOWED CITY--Emporium, nestled in a deep narrow valley in the Alleghenies of western Pennsylvania, has become a field lab for sight-sound pickup techniques. It has been found that vhf signals from the nearest TV towns, Buffalo, Johnstown and Altoona, can't be received without an assist. So three methods are being used to relay the signals to set owners in the valley. One features use of an antenna erected on a hill 1100' above the town to pick up signals, which are demodulated and retransmitted on an uhf channel. In a second approach the signal is relayed by microwave to a central location where it is rebroadcast on a uhf channel. The third system features an on-channel booster; here the signal from the station is picked up in the valley, amplified and then reradiated on the same channel to provide better coverage.

TV ANTENNA REPLACEMENT BUSINESS BRISK SERVICE MEN AND JOBBERS REPORT--The sales and installation of rooftop antennas for replacement are mounting and represent a rosy activity for distributors and Service Men across the nation, field reports indicate. Consumers, it was noted, have become sold on the idea that such factors as rust, corrosion and wind eventually have a detrimental effect on the antennas, and you just can't get best results from the TV set unless the old frayed model is replaced.--L.W.

RCA announces a NEW line of...

"UNIVERSAL"-TYPE SELENIUM RECTIFIERS

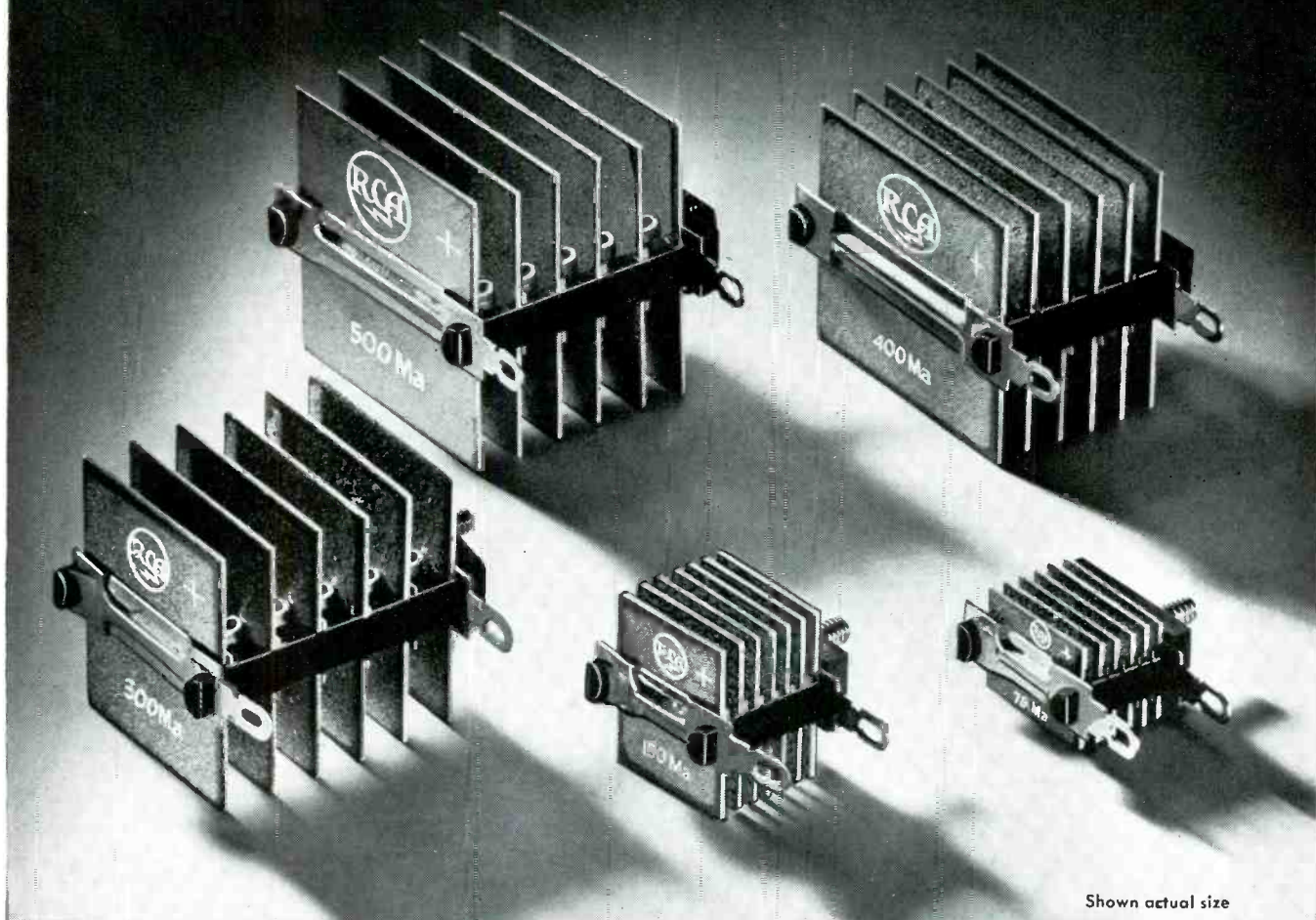

Shown actual size

**Just 5 types meet virtually all replacement requirements
... in TV, radio receivers, and phonographs!**



Look at the "wide-open" design of RCA Selenium Rectifiers. Benefits: Maximum cooling, dependable performance.

Again, RCA sets the pace—with an *all-new* line of "Universal"-type selenium rectifiers.

NEW—Improved heat dissipation . . . "Wide-open" design permits maximum air circulation.

NEW—Smaller size . . . For any given current, they are smaller than other types (installation is a "snap").

NEW—Versatility . . . Only five types needed to cover the range from 50 to 500 milliamperes.

Always replace with an RCA Selenium Rectifier — for *consistently* good performance, faster customer service! Order RCA All-New Selenium Rectifiers from your RCA Distributor TODAY. Stock up on new, RCA "Universal"-type Selenium Rectifiers, — competitively priced for profitable, fast turnover.

5 Types Cover Your Replacements			
RCA Type Number	Max. Output Current	Max. Input Volts	Suggested List Price
200 G1	75 MA	130V	\$1.85
201 G1	150 MA	130V	2.25
202 G1	300 MA	130V	3.30
203 G1	400 MA	130V	4.25
204 G1	500 MA	130V	4.40



RADIO CORPORATION of AMERICA
ELECTRONIC COMPONENTS
HARRISON, N. J.

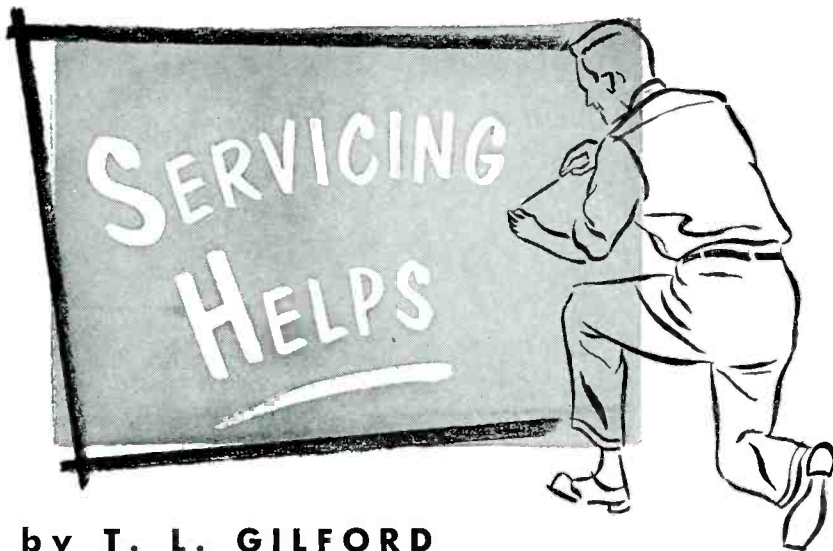

by T. L. GILFORD

UNDER CERTAIN reception conditions it has been found that Hoffman TV receivers with sync stability controls may show loss of horizontal sync when changing channels. If this trouble is experienced, *pin 1* of the first sync separator should be grounded. This will remove the sync stability control from the circuit. This problem will occur only in areas with strong signal where the sync stability control is normally set at the extreme counterclockwise position. Removal of the control from the circuit will not, therefore, cause any vertical sync problem. It is important that the ground connection be placed at the socket of the tube. One must not place the jumper across the control as this will not ground out the out-of-phase sync pulse and results will be unsatisfactory.

Series-String Chassis Repair

SERIES-CONNECTED tubes with 600 *ma* filaments are used in the RCA KCS-93 chassis, and since all of the tubes have the same filament current, there can be no tube burnouts due to non-uniform filament warmup.

However, when a tube does burn out in a series-string chassis the voltage is removed from all of the tubes. Therefore it is advisable to locate quickly the open filament. Checking the continuity of the filament string with an ohmmeter is probably the most practical method. As many tubes and resistors as possible should be checked from the top of the chassis.

Tubes and resistors in the filament string that may be checked easily are

R_{204} (36 ohms), R_{200} (450 ohms-cold), 12AX4GTA, 12BQ6GTB and the picture tube. This should be done first, as follows:

The ac plug should be disconnected. Then the picture tube socket should be removed and the filament pins (1 and 12) checked. Next the 12BQ6GTB should be removed and its filament pins (2 and 7) checked. Continuity from pin 7 of the 12BQ6GTB socket to R_{200} (approximately 485 ohms) should then be checked.

At this point more than 25% of the components in the filament string will have been checked. If continuity was obtained in the foregoing tests,

Diagram of focus socket in Stromberg-Carlson 21-22 TV series, illustrating addition of 425-volt tap to improve focus. The ion trap on the fixed focus-type tubes (21FP4C and 21XP4) has a noticeable effect on the focus of the picture tube. After peaking for maximum brightness, one must also adjust for best focus. If the focus area is not satisfactory, the focus anode voltage can be changed by means of a plug on the rear of the Stromberg-Carlson chassis, as shown.

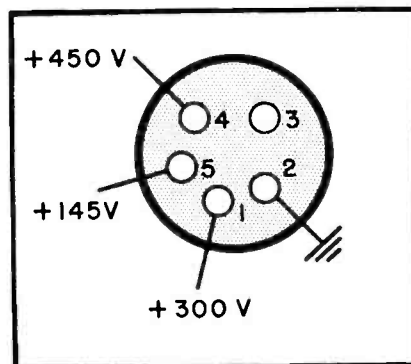

the filament burnout must be in the balance of the string.

The chassis will then have to be removed from the cabinet and the open circuit isolated by checking continuity from pin 4 of the 3CB6 (V_{107}) (the half-way point) to pin 12 of the picture tube socket.

When one portion of the filament string shows no continuity, it should be divided in half and continuity rechecked until the open filament is discovered.

Troubleshooting AGC Circuits*

When troubleshooting keyed *agc* circuits, the following conditions must prevail:

(1) A positive sync pulse of 15,750 cycles must appear on the grid of the *agc* tube.

(2) A *dc* connection must exist between the grid of the *agc* tube and the video amplifier.

(3) The grid of the *agc* tube should be approximately 8 *v* negative in respect to the cathode.

(4) The 'scope should show a positive pulse on the plate of the *agc* tube. The peak amplitude of this should be higher than the cathode voltage.

(5) The screen should show a *dc* voltage normally less than the peak plate voltage.

(6) The *agc* bias should be *dc* only varying from 3 to 7 *v* negative, depending on the input signal.

(7) Changing the signal at the antenna should produce a change in *agc* voltage.

(8) *Agc* will not operate properly if the horizontal sweep voltage is not in sync with the incoming signal.

Demagnetizing Color Picture Tubes¹

COLOR PICTURE TUBES can become magnetized when subjected to magnetic fields of a steady or alternating nature. This often occurs when the receiver is transported from one location to another. The effect of a magnetized picture tube upon the operation of the set is to produce poor purity, so that good white uniformity cannot be obtained.

The magnetic effect can usually be removed by introducing a strong alternating magnetic field close to the picture tube for a short time and then

*Based on notes compiled by service department of Stromberg-Carlson.

¹From RCA Service Company field notes.

Troubleshooting AGC Circuits . . . Demagnetizing Color Picture Tubes . . .

gradually decreasing the strength of the field. It is possible to make up a demagnetizing coil for this application for shop or field use. The coil should be wound approximately 12" in diameter with 425 turns of number 20 enamel wire. All of the turns should be bound together and taped with insulating tape. The ends of the wire should be connected to an 8' ac line cord.

If it is apparent that the white raster is contaminated with color due to poor purity it is possible that the picture tube has become magnetized. The demagnetizing coil should then be used in the following manner.

The ac cord of the coil should be plugged in, taking care that the coil is at least 6' from the receiver. The coil should then be moved *slowly* over the front and sides of the cabinet, as well as inside the cabinet near the top and sides of the tube. After about a minute or two the coil should be withdrawn *very slowly* to a distance of at least 6' and then the ac plug can be disconnected.

The purity adjustments should now be readjusted for best purity.

VTVM Application Notes

A DUMMY MULTIPLIER is sometimes ganged with the input multiplier in a vtvm to obtain greater immunity from pointer shift when switching from range to range. Contact potential draws a small amount of grid current which can be practically balanced out with this arrangement.

This vtvm arrangement can be used with an auxiliary high-voltage dc probe to measure the second-anode voltages of picture tubes. When used with ohmmeter circuits ahead of the vtvm, the meter is protected electronically to some extent against overload

damage, both on the ohmmeter and on the dc volt ranges.

In some vtvm arrangements, individual series resistors are used in the cathode circuits to assist in reducing the effect of tube tolerance in case the tubes have to be replaced. The non-linear and unequal plate resistances of the tubes become linearized and equalized to some extent.

These refinements have been found to improve accuracy and maintenance. When excessive negative input voltages are applied, the meter is protected somewhat by the plate-current cutoff which occurs in the first tube. The pointer of the meter will be slammed, however.

Isolating Resistors

There are some vtvm's that feature a second series isolating resistor at the grid of the tube, assisted by a shunt bypass capacitor. This filter arrangement insures that no ac voltage can be impressed upon the grid of the tube with the dc input voltage, to impair the accuracy of indication.

The additional series resistance at the grid of the first tube protects the meter somewhat when excessive positive input voltages are applied; as soon as the first tube starts drawing grid current, the grid voltage cannot be further increased, because the grid current produces a very large voltage drop across the series resistor, even when the multiplier is set to the lowest position.

Figs. 1, 2 and 3. Fig. 1 illustrates use of a dummy multiplier in a vtvm to obtain greater immunity from pointer shift when shifting from one range to another. The application of individual series resistors to reduce the effect of tube tolerance, in case the tubes have to be replaced, is illustrated in Fig. 2. An additional vtvm refinement is shown in Fig. 3: A second series isolating resistor at the grid of the tube, assisted by a shunt bypass capacitor. This filter prevents application of ac voltage upon the grid of the tube with the dc input voltage.

Vertical Linearity Adjustment

THERE ARE OCCASIONS in the field when it becomes necessary to make a critical adjustment of vertical linearity and height, and test pattern or bar generator is not available. Vertical linearity can be checked by adjusting the vertical hold control until the picture starts to roll slowly upward. As the picture rolls from the bottom to the top of the screen, the width of the black vertical blanking bar should be noticed. Any non-linearity of the vertical scan will be seen as a change in the size of the blanking bar.

When adjustments are made to the vertical height and linearity controls, it is very important that the centering control be adjusted for proper vertical centering. In many cases, difficulty encountered with vertical linearity is due to improper vertical centering.

Whenever size and centering adjustments are made, it is sometimes advisable to adjust the vertical and horizontal adjustments so that the screen area is overscanned slightly. This should be done when the ac line voltage is normal, otherwise the picture will not fill the screen when the voltage drops. Deflection circuits are usually designed with some consideration for low line voltage operation. Enough reserve deflection is provided in the circuit to insure good linearity and adequate size under low voltage conditions. However, instead of adjusting the receiver each time the voltage changes from normal to low, the adjustments should be set to overscan the picture area when the voltage is normal. Then, adequate size and good linearity will be maintained when the line voltage becomes low.

Width Modification

WHERE ADDITIONAL width is desired in RCA KCS92 chassis, because of
(Continued on page 38)

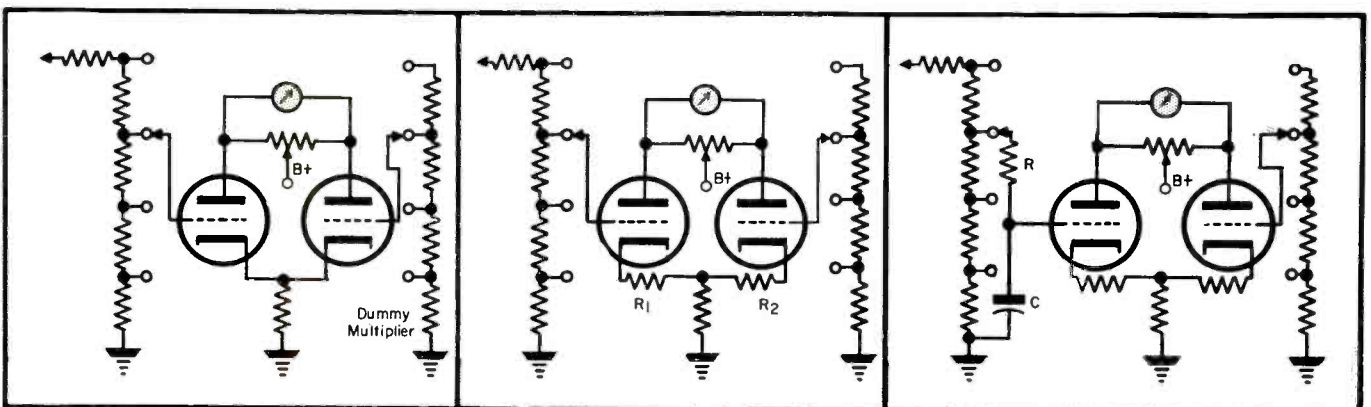

AUDIO Maintenance and Service Tips

by FRED R. SAILES

ON MAGNETIC playback-record equipment, *tape squeal* has been found to be a particularly exasperating problem, because of its broad possibilities of source.

Generally, the condition appears in the tape medium and the tape transport.

Minute magnetic irregularities can be detected and exaggerated in playback by varying the amplitude of the recorded signal. Irregularities in the width of the tape can be manifested when the tape guide is narrowed by wear or adjustment; the pinch or pressure on the edge of the tape will cause squeal.

Tape that has been abused in storage or use may cause an excessive accumulation of iron oxide particles to adhere to the tape guides, pressure pads, or recording head. This resistance to smooth tape transport causes a friction squeal. Usually cleansing these components with alcohol or replacing them, if necessary, will correct the trouble.

The varying frictional forces can be a source of frequency-modulation noise that may be introduced when recording, and subsequent playback. This frequency-modulation noise is most pronounced on high audio frequencies.

The most common causes for this difficulty are misaligned heads or tape

Causes and Cures of Tape Squeal* . . . Care and Handling of Tape . . . Three-Speed RCA Variable-Reluctance Record-Changer Repair Notes . . . Four-Pole Shaded-Pole Motor Cycling Operation

guides; dirty pressure pads, guides or head pole pieces; excessive tape tension; worn or grooved guides or head pole pieces; hardened or worn pressure roller binding; excessive tape width or softening of binder from heat and humidity; and excessive pad pressure or acute angle.

Pressure pad springs can be stretched to reduce tension, but can affect output. Pressure pad arms are formed of soft metal than can be easily bent to change pad angle or position.

Care and Handling of Magnetic Recording Tape*

MAGNETIC SOUND recordings are considered to have indefinite rententivity

**Based on notes prepared by Webster-Chicago service department.*

unless altered by accidental or deliberate magnetic means (erasure).

Exposure of the tape to strong magnetic fields, which appear in transformers, permanent magnets or high current wires, is detrimental to tape activity. Tapes can be replayed many times without affecting their quality provided the mechanism and contact area are in good condition. Temperature and humidity can affect tapes and thus must be considered to preserve them for indefinite periods.

The ideal storage area for tapes is a room with relative humidity maintained between 40-60%. Since most actual conditions vary from this standard, it is recommended that tapes be enclosed in metal containers, such as an 8 mm film can and sealed with a layer or two of electrical or plastic tape.

Prolonged exposure to low humidity can cause tape to become brittle. Subsequent exposure to normal humidity will usually restore the tape properties.

Tape that has excessive winding tension can cause stretch and distortion, especially to the portion closest to the reel hub. Uneven winding and accumulated pressure at the hub may cause greater distortion on that portion, than at the outside layers where the pressure is not as great.

To obtain the best results from tape, the following precautions and suggestions are recommended: Tape should not be exposed to extreme temperature, humidity, or strong magnetic fields; material should be stored in

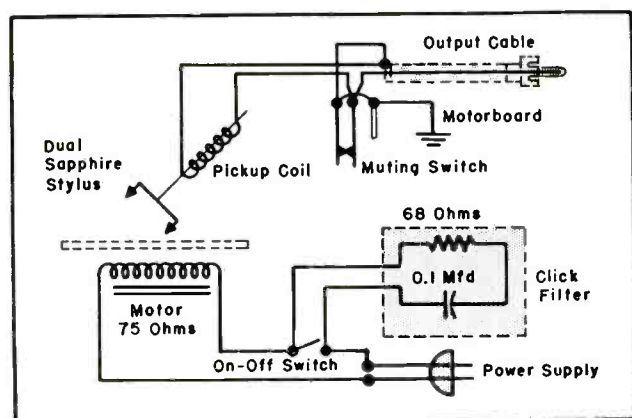

Fig. 1. Schematic of RCA 6-JSH-1 three-speed record changer system using a variable-reluctance cartridge and click filter.

metal containers; to relieve strain or adhesive action between layers, the tapes should be used occasionally; dust and loose particles should be cleaned from tape with a soft cloth or cotton (can be done during fast rewind; unprotected reels should not be stacked on top of others, and one should avoid placing weighted objects on reel edges; also warped plastic or metal reels should not be used, since they scrape tape edges.

Three-Speed VR Record Changer Repair

THE RECENTLY announced RCA 6-JSH-1 3-speed changer attachment, employs a variable reluctance pickup (with a dual sapphire stylus) designed for use with a preamp.

The *vr* pickup is used without a loading resistor or equalization of any kind. Since the output voltage is relatively low, it is necessary to use a preamp having equalization.

Frequency response of the pickup will vary according to the characteristics of the input circuit to which it is connected. A nearly uniform output (proportional to recorded velocity) is possible, if the pickup is connected into a resistive load of 50,000 to 100,000 ohms; lower values will decrease output of the higher frequencies. This load resistor is generally incorporated in the preamp.

Equalization in the preamp is necessary to compensate for recording characteristics. To provide a frequency check *orthophonic* test records have been developed.

Available for this study are 10" 33 $\frac{1}{3}$ and 7" 45 test discs. When using either of these records a properly-adjusted system will produce an essentially-constant voltage output at all frequencies from 10,000 to 30 cycles. Also included is a band of frequencies from 15,000 to 10,000 cycles for those interested in checking system response in this range.

To obtain the basic *orthophonic* reproducing characteristic, two preamp-equalization circuits have been designed. One is for a triode and the other is for a pentode. Minor amplifier tone-control adjustments may be required to achieve best results.

The Change Cycle*

IN THE Webcor phono models (126 and 1126 basic chassis), 4-pole shaded-pole motors are used to drive the changer mechanism. To be able to repair these mechanisms, one should be familiar with their cycling operation. Power is transmitted to the turntable by a rubber rim idler wheel;

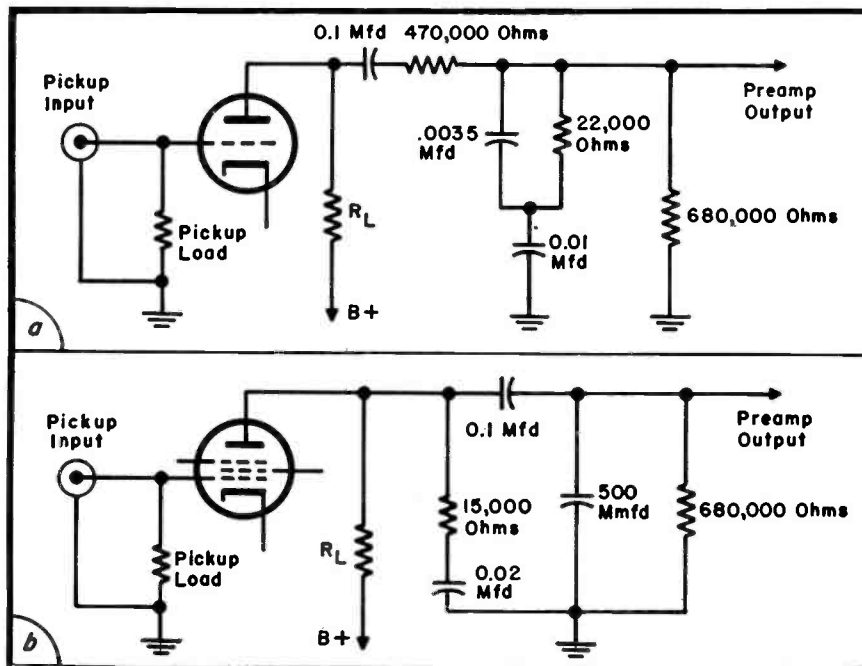

Figs. 2 and 3. Triode (top) and pentode (below) equalizer-preamp circuits designed for 3-speed changer to obtain basic *orthophonic*-reproducing characteristic.

turntable speed is determined by the positioning of the wheel on one of three *steps* of the drive sleeve on the rotor shaft. When the speed selector is turned to 33 the idler wheel is positioned on the 33 *step* or contacts the smallest diameter portion of the sleeve. Turning the speed selector to 78 positions the wheel on a larger diameter of the sleeve.

As the tone arm tracks on the record toward the spindle, the velocity trip arm is moved inward by the action of the weighted friction clutch on the tone arm shaft. When the tone arm follows the eccentric groove at the finish of the record the velocity trip arm is also moved suddenly inward and *trips* the velocity trip.

In this tripping action the actuating pawl on the main cam is released from the velocity trip and is able to engage the cam drive gear, which is continuously rotating with the motor-driven turntable. The drive gear, now locked with the cam, drives the changer through the change cycle; the main cam is the heart of the change mechanism.

The main cam actuates the raising level causing it to raise and pivot outward. Motion is transmitted to the tone arm by a clutch action between the raising disc and a set-down plate which is attached to the tone-arm shaft. Tone arm is then raised and carried on its outward excursion.

When the tone arm has reached its farthest outward excursion, the roller

assembly, following the contour of the main cam, transmits a forward motion to a rocker arm, and record shelf. In moving toward the spindle, the shelf pushes the bottom record of a stack from the spindle step, resulting in a gentle lowering of record to the turntable.

After the record has been lowered, the raising arm (following the recessed contour of the main arm) carries the set-down plate and consequently the tone arm inward. Inward travel of the tone arm is stopped when the 7", 10" or 12" extension of the set-down plate contacts an ear on the stop lever.

The stop lever is a function of the record-selector shaft. Therefore, when the record selector is rotated to the proper record-size position, the stop lever is positioned automatically to stop the set-down plate at the correct set-down point.

Although the inward travel of the tone arm is stopped at one of the set-down positions, a slipping clutch allows the raising lever and raising disc to continue their inward travel. When the raising arm lowers to its normal position, the tone arm lowers and correctly sets down on the lead-in groove of the record.

The velocity trip is also returned to its normal position by reset points on the drive gear. The hooked end on the trip disengages the actuating

(Continued on page 43)

TUBE

News

Transistor-Tube Circuitry for Pocket Radios . . .

and inverse resistance of each section individually.

When the negative terminal of the ohmmeter (set on $R \times 10$ scale) is connected to the base (B) terminal of a good transistor and the positive terminal of the meter is connected to the collector (C) or emitter (E) terminals, a low-resistance should obtain; 500 ohms or less.

Positive Terminal Check Results

When the positive terminal of the ohmmeter is connected to the base (B) terminal of a good transistor and the negative terminal of the meter is connected to the collector (C) or emitter (E) terminals, a high inverse resistance should appear; 50,000 ohms or higher.

In the event that results are opposite from those described, it is possible that the plus side of the meter is con-

(Continued on page 38)

EVER SINCE the invention of the transistor, it has been believed that it should be possible to develop a combined tube-transistor circuit to gain the unique advantages offered by both devices. Recently, the first receiver employing such a circuit was designed. A portable, evolved by Emerson Radio (model 838), it employs a pair of *matched* plug-in 2N108* class B *pnp* transistors in the audio system.

Selected for use in low power, push-pull audio stages where low battery drain is important, these transistors are capable of producing 35 milliwatts of low distortion output at an efficiency of over 50% from a 3.5 v battery source.

The transistors are supplied as a

matched pair, to optimize performance.

Thus in replacement, matching is an extremely important factor. Before a new pair of transistors is inserted, the old pair should be removed and the transistor socket voltages checked. A resistance check should also be made from the transistor sockets. If no defects have appeared a new pair of matched transistors can be inserted.

If it is impossible to secure a matched pair for replacement the foregoing checks should be made, followed by a test checked with a *v/vm* type ohmmeter.

In this check the transistors are tested as two separate crystal diodes might be, by measuring the forward

*CBS-Hytron.

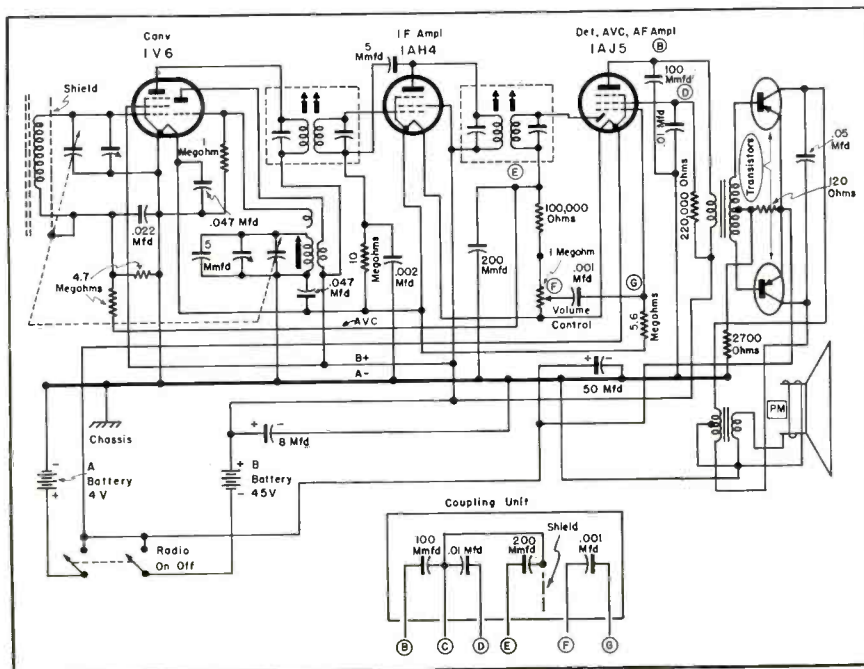
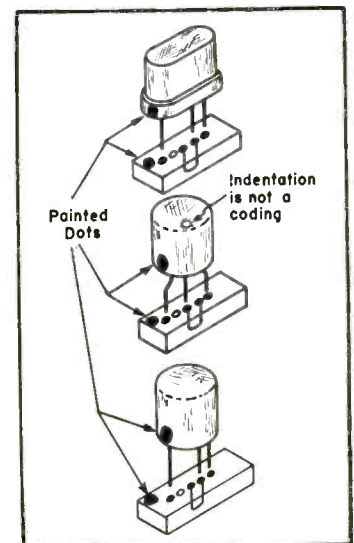
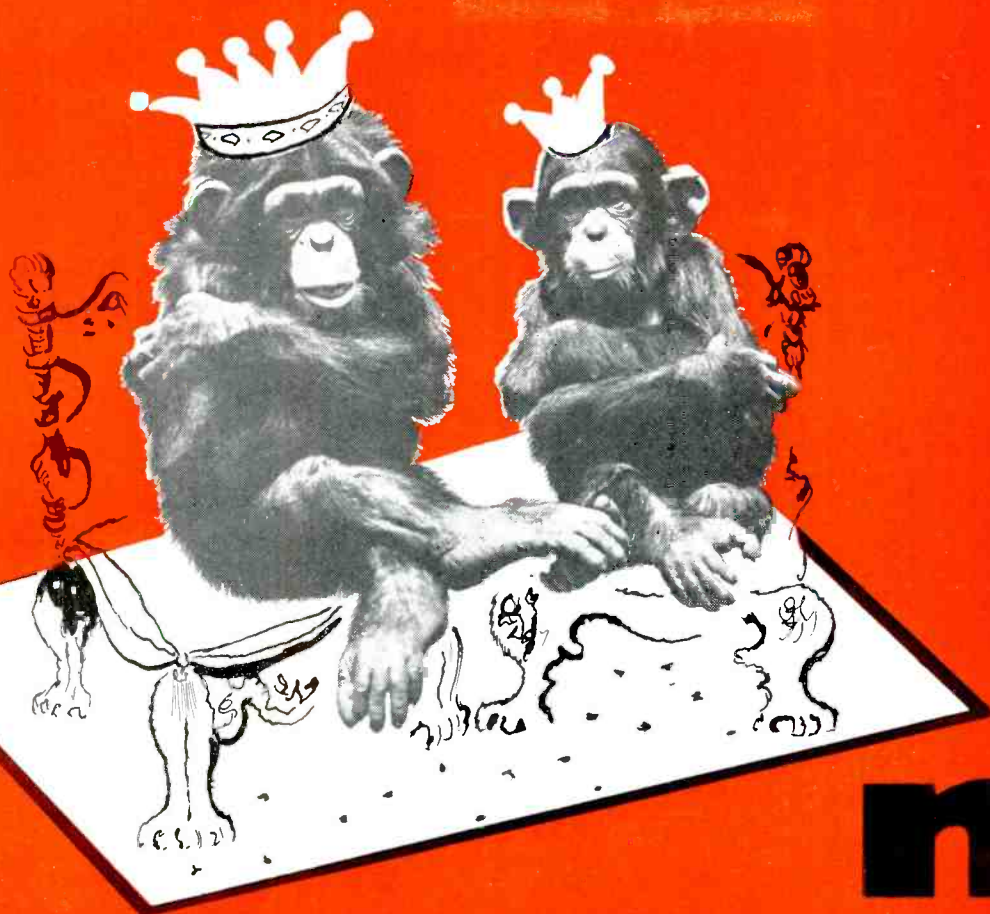

Fig. 1 (left, below). Circuit of Emerson 838 transistor-tube portable.

Fig. 2. Three types of audio transistors available for portables, with their socket positions.





no!

NOTHING BUT
"STAMINIZED" CAPACITORS
 WILL DO...

The consumer is king!

Catering to his wishes is the way to bigger servicing profits.

Set owners depend upon you as a "specialist" to install top-quality replacement parts that will give long, satisfactory service... for this reason, Astron developed "Staminized" capacitors... a special process imparts extra-ruggedness to each unit... it's the protection that lets you install with complete confidence.

This royal quality gained immediate and widespread acceptance among service technicians... it's why Astron "SM"* Safety Margin Electrolytics can successfully withstand surge voltages and overloads without permanent damage... their reputation for durability is the sure key to increased consumer satisfaction and faster, more profitable servicing for you.

Easy-to-install, exact replacement Astron "SM" Electrolytics are available in a wide range of styles... one for every servicing requirement... meticulously assembled by contamination-free techniques for dependable 85°C operation, low leakage and long shelf life.

They're backed by the famous Astron guarantee—result of TEN individual production tests and 100% final inspection.

See your local jobber for Astron capacitors—Today!

FREE SERVICING AID—Write for your copy of **NEW** handy pocket-sized replacement capacitor and pricing guide — Now!



ASTRON "SM" MINIMATE



ASTRON "SM" TWIST-PRONG



CROWN PRINCE OF
 MOLDED PLASTIC PAPER TUBULARS
 ASTRON BLUE • POINT R

ASTRON

C O R P O R A T I O N

255 GRANT AVENUE EAST NEWARK, N. J.



Goes up EASY... Stays up RIGHT

There's no better mast made than ALPRODCO'S telescoping slip-up mast.

It is designed for easy installation and dependable performance. It's made of top-quality tempered steel and engineered to provide the greatest possible strength at the lowest possible weight. Guaranteed unconditionally to withstand winds up to 90 mph.

Sections fit tight, with handy thumb-bolts and tube nuts for fingertip locking; notched bell-bottom section-ends automatically align tower mast over snap-in clips.

Available from authorized ALPRODCO distributors everywhere

Buy, recommend, install ALPRODCO
slip-up masts with confidence

PROVEN THE BEST MAST VALUE

Comes complete with optional base—rotating guy rings for 3 or 4 guy points. MB-1 Standard Base for mounting on flat, vertical, sloping, or peak roofs.

Alprodco, Inc.

Mineral Wells, Tex.

Kempton, Ind.

Dublin, Ga.

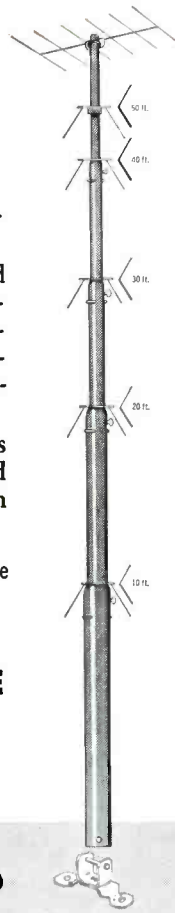

Tube News

(Continued from page 36)

ected to the negative side of its internal battery.

Only a *vtvm* type ohmmeter should be used. The $R \times 10$ scale must be used for all forward (low) resistance measurements. Use of the $R \times 1$ scale could damage the transistor. A shunt-type ohmmeter should not be used. If in doubt as to the type of vacuum-tube ohmmeter you have, a 1,000-ohm resistor should be placed in series with it; then subtract the 1,000 ohms from the reading obtained.

If these recommendations are not followed, damage to transistors may result, since some non-electronic type ohmmeters use high-internal battery voltages.

In the input of the receiver, where tubes are used, a 1V6 serves as the converter, a 1AH4 as an *if* amp and a 1AJ5 as the detector /*avc* /*af* amplifier.

The *A* (4 *v*) battery current drain is .045 to .065 *a*, depending upon audio output power. The *B* (45 *v*) battery drain is .0025 *a*.

Fig. 3. Ohmmeter check for transistors.

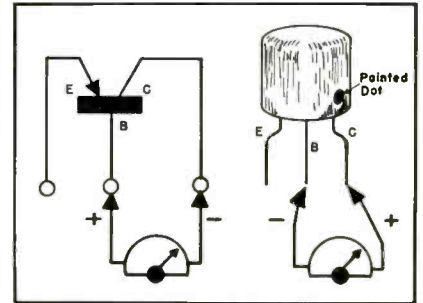

Servicing Helps

(Continued from page 33)

low line voltage condition, a modification to the horizontal output circuit is possible. The screen resistor (R_{100}) can be changed from 10,000 to 6,800 ohms, 2 *w*, 10%. If this value resistor is not readily available a 22,000, 1 *w*, 10% resistor can be used to shunt R_{100} . This modification will result in about one-half inch additional width.

Insufficient Width Cure

INSUFFICIENT WIDTH may occur in RCA TV receivers using *KCS-92* or *KCS-93* chassis due to a change in inductance of the width coil.

If the width shrinks about 3" it is possible that the inductance of the width coil has been changed because of core heating and should be replaced,

KESTER

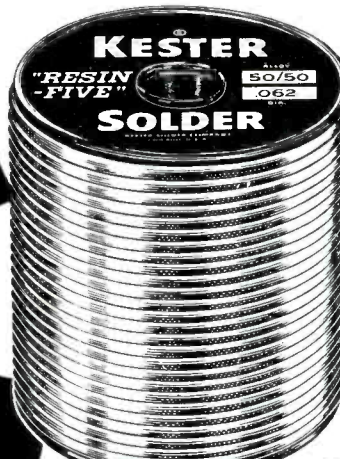

Absolutely non-corrosive and non-conductive, KESTER "RESIN-FIVE" CORE SOLDER contains an activated type of resin that gives you that fast, positive action on all your jobs . . . including the most difficult.



KESTER SOLDER COMPANY
6248 Wrightwood Avenue • Chicago 39, Illinois
Newark 5, New Jersey • Brantford, Canada

SOLDER

TV Home Repair

(Continued from page 15)

ventory of capacitors, blocking oscillator transformers (both vertical and horizontal) flybacks, yokes, single and dualpots in usual values, and general hardware parts such as ac interlocks, ac caps, cube outlets, knobs (which break often), and a few crystal diodes. All should be carefully assorted and labelled, and carried in a truck or house wagon.

Particularly handy, too, is a 7" test receiver for checking antennas and leads. The chassis has served to indicate relative signal strengths by direct comparison, ghost conditions, interference difficulties and so on.

We also carry a supply of fringe and standard antennas plus accessories which include 10' sections of pipe, roof mounts, guy wire, standoffs, 300-ohm line and the other smaller hardware. Such an assortment makes it possible to tackle most installations, and facilitates the repair of existing installations.

To avoid repair delays due to parts shortages, a detailed check on the more frequently-used items must be kept. Such a control in our operation has reduced our callbacks to less than 1 per cent.

The problem of intermittents can be minimized by asking the set owner to describe the trouble when the call for service is made. To illustrate, consumers should be asked how long it takes for the trouble to occur, whether it occurs in the day or evening, and if only some channels are affected. A short time drift can be stirred into action by the use of a heat lamp or applying carbon-tet to the suspected component. Long time drift problems can be handled by instructing the customer to turn on the receiver in advance to preheat the receiver to the temperature necessary for trouble to occur. The rare instances where receivers cut out only, let us say, once a week and then for a short duration, can be resolved by explaining that it would be best to wait, perhaps until the frequency of the intermittent condition increases, before a call is made; otherwise the set will have to be pulled and placed on the bench for examination. It has been found that most set owners will be patient and report back when the trouble reoccurs, detailing just what happens and how often.

We have found home servicing to be a very profitable operation, even though we are in competition with about forty Service Shops in our city which has a population of some 60,000.

Simpson...the most Complete Line of VOM's

Select the one that fits your needs!

MODEL

260

world's most popular!

Over half a million Model 260's have been sold to date! 20,000 Ohms per volt. You'll find it wherever quick, accurate, electrical checks are needed. It's so handy, so dependable, so sensibly priced! Ask your jobber. Price, including Adjust-A-Vue Handle, only ... **\$38.95**

Carrying Cases from **\$6.75**

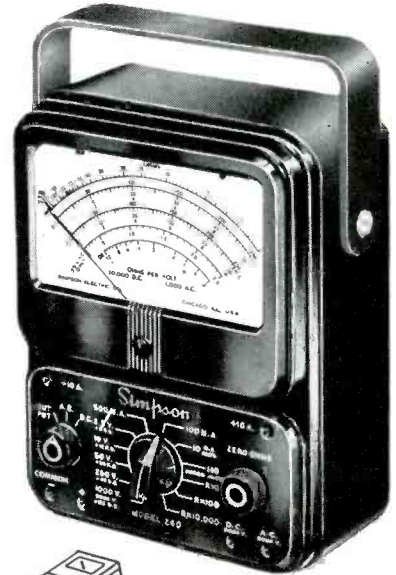

MODEL 262

Deluxe!

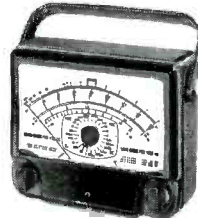

the new VOM with a 7" meter

20,000 Ohms per volt DC and 5,000 Ohms per volt AC sensitivity ... 33 ranges ... compact 7" case with Adjust-A-Vue Handle ... **\$59.50**

Carrying Case ... **\$ 9.95**

MODEL 269

100,000 Ohms per volt!

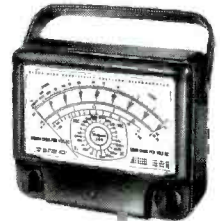

Most sensitive VOM

available! A Volt-Ohm-Microammeter with a big 7" meter in a compact 7" case ... 33 ranges ... Adjust-A-Vue Handle ... **\$88.00**

Carrying Case ... **\$ 9.95**

NEW!



MIDGETESTER Model 355—New shirt-pocket size Volt-Ohmmeter **\$29.95**

MODEL 240—Small VOM; 14 ranges; up to 3000 volts AC or DC **\$26.35**

MODEL 230—Small VOM; 12 ranges; up to 1000 volts AC or DC **\$24.95**

ROTO RANGER Model 221—25 Separate meters at turn of a switch **\$75.00**

LABORATORY STANDARD—For instrument calibration. Price on application.

Simpson ELECTRIC COMPANY

World's Largest Manufacturer of Electronic Test Equipment

5220 W. Kinzie St., Chicago 44, Ill. • Estebrook 9-1121
In Canada: Bach-Simpson, Ltd., London, Ontario

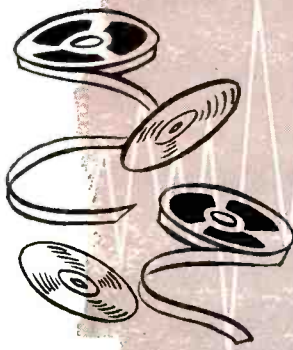

AUDIO

INSTALLATION AND SERVICE

Hi-Fi - Phono - Tape - P A
Amplifiers - Speakers

by JESSE DINES

THE HORN represents an advancement over the *cone* type of speaker because of the latter's limitations. In a speaker, the diaphragm is coupled directly to the medium it activates, namely air. To impart motion to the air the diaphragm must be relatively rigid and, therefore, it must have appreciable weight. Radiation efficiency can be increased by making the size of the diaphragm larger. However, where a relatively large amount of sound radiation is needed, as in large auditoriums, the mass of the diaphragm would have to be extremely large; too large, in fact, for practical purposes.

The horn solves the problem of obtaining this increased radiation efficiency. The *cone* does, of course, have a number of features that make it ideal for many applications.

Piston Action Relative to Horns

To understand how a horn operates, let us consider the action of a piston in an open-end cylinder, as shown in

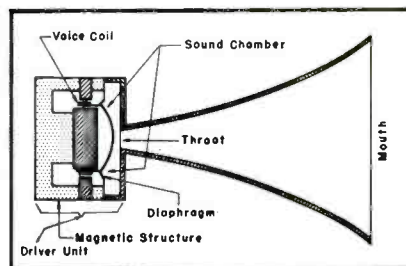

Fig. 2. Basic structure of horn and driver unit.

Fig 1. In (a), the piston is not in motion and the air molecules around it are motionless. When the piston is pushed in, as in (b), the air molecules directly in front now have less space to occupy and are forced to collide with those previously undisturbed. In effect, this compressed portion of the medium thus transmits this disturbance down the cylinder. This phenomenon is characterized by a forward motion

* Based on information supplied by Jensen Manufacturing Co.

of the densely-compressed air molecules. When the piston is pushed out, as in (c), there is a low concentration of air molecules adjoining the piston; this action is transmitted down the cylinder resulting in a forward motion of rarefied air molecules.

The entire action produces an expansion and rarefaction of air molecules, even though the molecules involved do not actually move very far from their normal random positions.

Horn Shape (Flare) and Mouth Diameter

If the cylinder is replaced by a horn, the operation is essentially the same as described, with one important difference; the air expansions and rarefactions are increasing continuously in volume as they pass down the horn because of the horn flare. When the air disturbances reach the horn mouth (widest part of flare; Fig. 2), the guiding effect of the flare no

(Continued on page 43)

Fig. 1. Cross sectional views of pistons, illustrating action in an open-end cylinder.

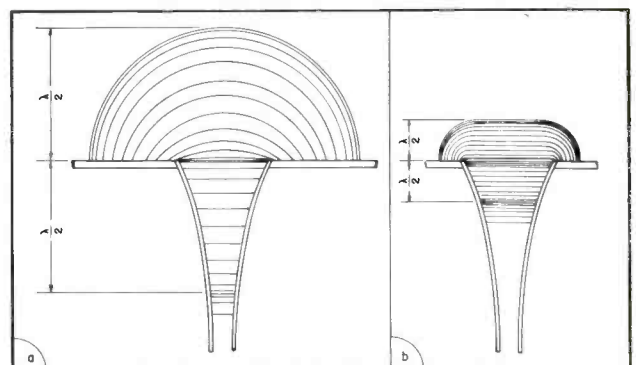
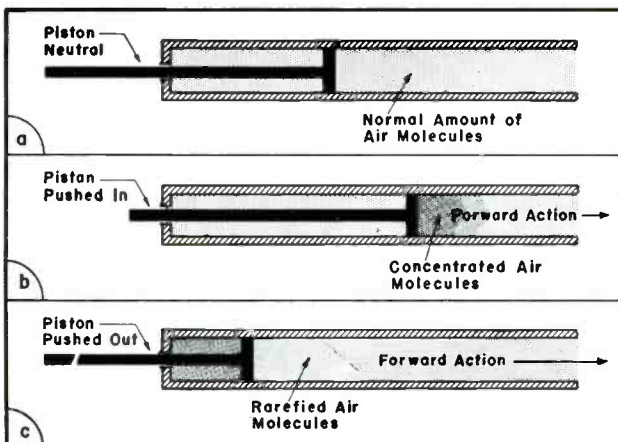
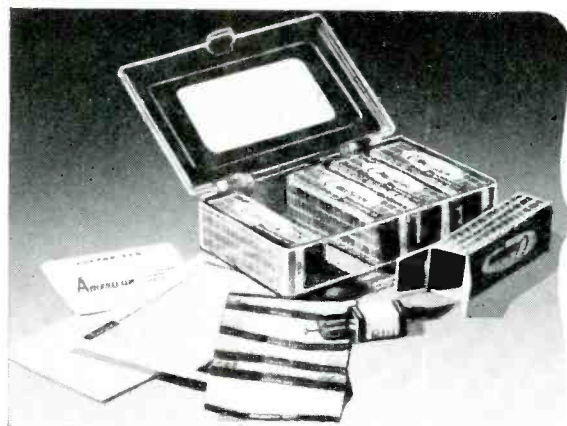

Fig. 3. Approximate representation of forward-traveling wave conditions in horn at low and high frequencies. At (a) we have excessive expansion of the emerging wave at low frequencies (near cutoff) causing a reflected wave which reduces output. Only slight expansion is shown in (b); here the frequency is three times that indicated in (a), producing small reflection with little effect on output.

Meet 90% of your phonograph
replacement cartridge needs — and save money!



With AMERICAN'S new "5-PAK" Service Kit



Every thing you need in one package!

- A 3¼x5x1¼" clear plastic box—reusable as a small-parts container
- Holds five popular AMERICAN "Clear as Crystal" replacement cartridges
- Authorized repair service window decalcomania
- Five identification cartridge labels for your company name
- Handy crystal cartridge replacement chart

Here's a new idea that will meet 9 out of 10 of your replacement cartridge service requirements . . . a new idea that puts more money in your pocket! It's AMERICAN'S new "5-PAK" Service Kit. It contains 5 of the most used replacement cartridges—all in one handy reusable box—together with other necessary items for more complete service. And you buy it all at a money-saving price. Don't forget, too, that you offer your customers the very

finest quality obtainable when you use AMERICAN "Clear as Crystal" replacement cartridges. The famous name of AMERICAN is now backed by the vast experience and resources of Elgin National Watch Co. Together, they're your greatest assurance that AMERICAN cartridges give you and your customers more for the money. Why not see your nearby AMERICAN distributor now and see the wonderful new "5-PAK" for yourself.

full vision...full sound



...where Fidelity speaks for itself!

AMERICAN MICROPHONE CO.

370 South Fair Oaks Ave., Pasadena 1, California

AN ELGIN NATIONAL WATCH COMPANY AFFILIATE

Latest in Audio



Phono needle identification chart (8" x 10"), featuring name of phono manufacturer as the key reference, and precious-metal phonograph needles. To aid needle identification, a number of the most popular needle and cartridge types are illustrated. (Ident-I-Graf; Electrovox Co., Inc., 60 Franklin St., East Orange, N. J.)



Push-button tape machine designed for 30 minutes of dictation-recording and transcribing. Five push-buttons provide control of recording, listening, forward and reverse speed winding, and stopping. Dictation corrections or playback are facilitated by automatic scale indicator. Microphone-speaker is equipped with a start-stop button to control the tape during pauses or interruptions while dictating. (Stenorette; DeJur-Amsco Corp., 45-01 Northern Blvd., L.I.C., N. Y.)



Automatic record changer that plays intermixed stack of 7, 10 or 12-inch records at turntable speeds of 33 1/3, 45 or 78. Adapter is available for playing a 1-inch stack of 7-inch 45s without the use of individual record inserts. Other features include balanced and centered ball bearing turntable with deep pile electrostatic flocking that is said to cushion record drop and prevent slippage. Available with ceramic and variable reluctance cartridges. (Models 141 and 141-270; Webster-Chicago Corp., 5610 W. Bloomingdale Ave., Chicago 39, Ill.)



Four-speed record changer designed for 78, 45, 33 and the 16 rpm talking book discs. Has auxiliary output, with 8-ohm impedance, for external speakers. (Model 1250; V-M Corp., Benton Harbor, Mich.)



Wide-angle paging and talk-back speakers with a reflexed cobra air column for wide-angle horizontal dispersion of sound. One model has a built-in hermetically sealed driver unit integrally assembled to a reflex air column terminating in a cobra shaped wide angle bell. Cobra bell is a one-piece mold of fiberglass reinforced polyester resin. Driver unit employs a rim-centered linen-base one-piece molded phenolic diaphragm. Second model is of similar construction except that a screw-in driver unit with 7/8"-18 screw thread is used. (Models CIB [12 watts] and CMI [3 watts]; University Loudspeakers, Inc., 80 South Kensico Ave., White Plains, N. Y.)



Counter display for needles that, it is said, will not bend or break; designed for careless small-fry and overly enthusiastic teen-agers for their recreation room phonos. (Jensen Industries, Inc., 7333 West Harrison, Forest Park, Ill.)

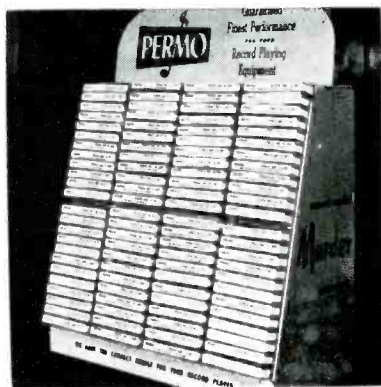

(Right) Auto rear seat speaker grill available for round and oval speakers. Designed with 32% opening; constructed of .030 gauge metal, rimmed with 1/8" turn. (Aud-O-Grill; Parkway Specialties Co., Box 5795, Beech Branch, 9861 Appleton, Detroit 39, Mich.)

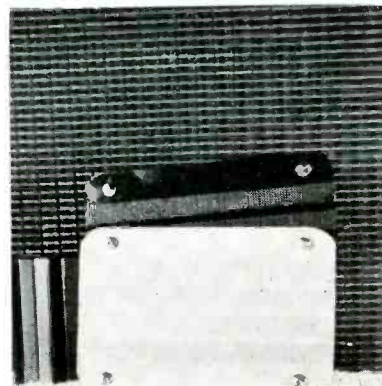

(Left) Needle cabinet which stocks 192 packages of needles; can be so placed on counter that its open side with slanted chutes can face inward for clerk use or outward for customer self-service. (Permo, Inc., 6415 N. Ravenswood Ave., Chicago 26, Ill.)

Horns

(Continued from page 40)

longer exists and their air wavefront tends to act independently and propagate itself in all directions.

One may term a horn as an impedance-matching device which couples the comparatively heavy, vibrating diaphragm (comparable to the piston shown in Fig. 1) at its throat, to the comparatively light medium of air at its mouth. The mouth, which terminates the acoustic medium, must be large (about $\frac{1}{3}$ wavelength in diameter), as compared with the longest wavelength (lowest frequency) of sound to be transmitted. For greater wavelengths, the wavefront travelling down the horn reaches the mouth and is reflected back into the horn flare. Fig. 3a (p. 40), which shows the horn mouth to be a half wavelength in diameter, illustrates this point. As the wave reaches the mouth, it expands there in the approximate manner shown. The volume occupied by this wavefront is appreciably greater than that occupied by the wave within the horn behind the mouth. This expansion creates an excessive rarefaction which travels back down the horn and produces undesirable resonances at the throat, depending upon the phase.

If the operating audio frequency increases (wavelength decreases), the mouth diameter becomes several wavelengths; Fig. 3b, discloses this condition. Here the emerging wavefront is nearly a plane. And the expanded volume occupied by it is only a small percentage greater than that just within the horn mouth; thus, the wave which is reflected back into the horn is relatively small.

Horn Flare

The foregoing indicates that the mouth diameter of a horn actually in use sets a lower limit to the frequency range which can be produced. The horn flare, and its area, as well as the characteristics of the driver unit, also help determine the *lf* cutoff point.

The horn flare is important, in that its function is to produce a smooth and continuous increase in sound as the wavefront progresses from the throat to the mouth.

[To Be Continued]

Audio Maintenance

(Continued from page 35)

pawl from the drive gear, thus unlocking the main cam and drive gear. Thus, the changer completes its change cycle.

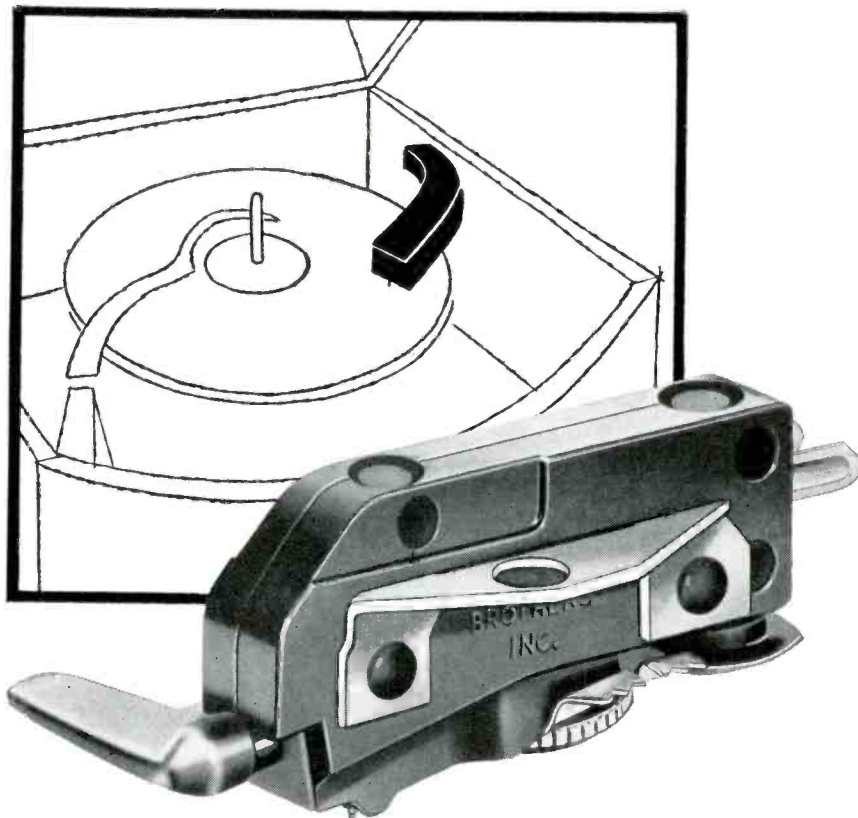

It's Dramatically New!

SHURE 'TWIN-LEVER' Ceramic Phono Cartridge

The most important advance in phono replacement cartridges since the introduction of 3 speeds!

- To improve the quality of all conventional home phonographs!
- To replace 128 3-speed, plastic-cased, ceramic and crystal, turnover and single needle cartridges!

We make these strong claims: the "Twin-Lever" is the finest replacement cartridge ever developed! It sets a new high, leaving all other replacement cartridges far behind its brilliant level of tone superiority . . . individual needle compliance for superior 78 rpm and microgroove response . . . unique needle shift design . . . amazingly simple needle replacement.

The "Twin-Lever" offers you maximum replacement coverage with minimum investment because it handles the replacements for practically all 3-speed phonos using plastic-cased cartridges. New business and greater profits can be yours — because this "Twin-Lever" cartridge costs only \$9.50 list — yet it can make conventional 3-speed phonos sound better than when they were new!

See your Shure Distributor today — he has the "Twin-Lever" in stock. And here's a tip: buy more than you think you will need — or you'll have to go back for more mighty soon. That's how good this cartridge is. And don't take our word for it — ask your first "Twin-Lever" customer what *he* thinks!

MODEL WC10

List Price **\$9.50**

(including two synthesized sapphire-tipped needles)

MODEL WC10D

List Price **\$34.00**

(including a 1-mil diamond-tipped needle and a 3-mil synthesized sapphire-tipped needle)

SHURE

----- The Mark of Quality

by **NORMAN CROWHURST**

MICROPHONES For Initial Or Replacement Installations

Analysis of Factors Which Must Be Considered in

Choosing Microphones: Directional Response,

Frequency Range and Sensitivity

IN SELECTING A MICROPHONE, for initial or replacement installation, there are three basic factors that must be considered: Directional-response requirements, frequency range, and sensitivity.

Resolving the directional problem requires an evaluation of the types of microphones that are now available. Microphones can be divided into three main classifications:

Omnidirectional; uniform in all pickup directions.

Bidirectional; two directions of maximum pickup — at right angles to these two directions the pickup is almost zero.

Unidirectional; one direction of maximum pickup—in the opposite direction its pickup is almost zero.

Directionality Patterns

No microphone can satisfactorily duplicate the performance of a pair of human ears, which at once com-

bine omnidirectional properties with extreme directional sensitivity; the ears are picking up continuously sounds from all directions, while by conscious effort attention can be directed to sound in one particular direction. No microphone can be discriminatory in this sense. So the choice of microphone for any particular application, or group of applications, depends considerably on the kind of program material one wishes to pick up.

In the use of microphones, unwanted sounds can take one of two forms. If the microphone is being used for sound reinforcement purposes in an auditorium, the loudspeakers may feed back to the microphone and cause acoustic feedback or howl. And then we have the condition where the microphone is not in the same room with the loudspeakers, but there are other sounds which the microphone

can pick up besides the desired program material.

In a theatre, the audience may be making sounds which should only be picked up at very low level compared with the sound from the stage. Another example is where a room is considerably reverberant. In this case the amount of reverberant or reflected sound which the microphone picks up, will be controlled by its directional patterns. If the directional pattern favors the original sound above other directions, then the direct original sound will be picked up at a slightly higher level than the reverberation sounds.

With careful use, the bidirectional pattern of a velocity type microphone can be extremely useful. It has a directional pattern like a figure 8, and picks up on-axis in both directions, while at right angles to this axis there is a region that is completely dead. This is very convenient for conversation or interview work, and particularly in planning programs on short notice.

Many have believed that careful setting of the direction of the bidirectional microphone can considerably reduce acoustic feedback in a room or auditorium. It has been found that the microphone is not as sensitive to direction in this regard. When acoustic feedback occurs, a complete standing-wave pattern is built up in the room, and the microphone and loudspeakers are part of this standing-wave pattern. When the gain of the system, from microphone to loudspeaker, is sufficient to maintain acoustic oscillation in the room, it is relatively unimportant just which way the pattern builds up. So rotating a velocity type microphone through different angles will not usually stop the oscillation, but may set it off at a different frequency.

The real advantage in using a velocity-type microphone, from the viewpoint of acoustic feedback, rests

(Continued on page 46)

Fig. 1. Directional patterns of standard types of microphones.

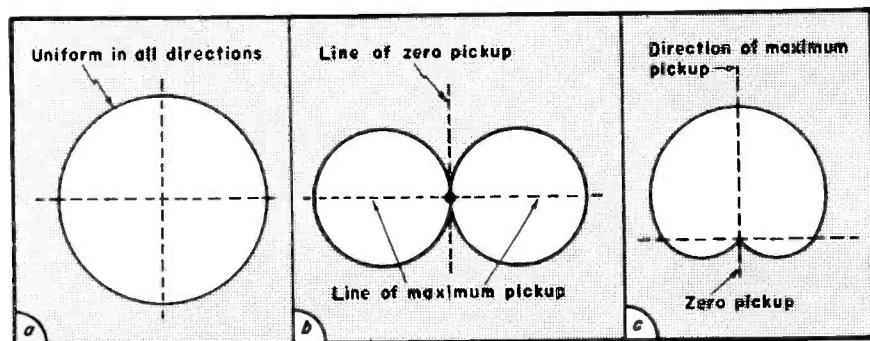

from

DELCO RADIO...

High-Quality POWER TRANSFORMERS for Car Radios

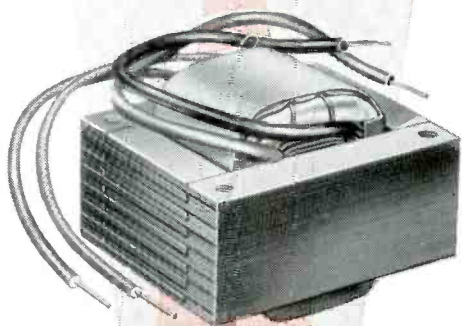

UNCASED MODEL 6055, ABOVE
BELOW, CASED MODEL 6060.

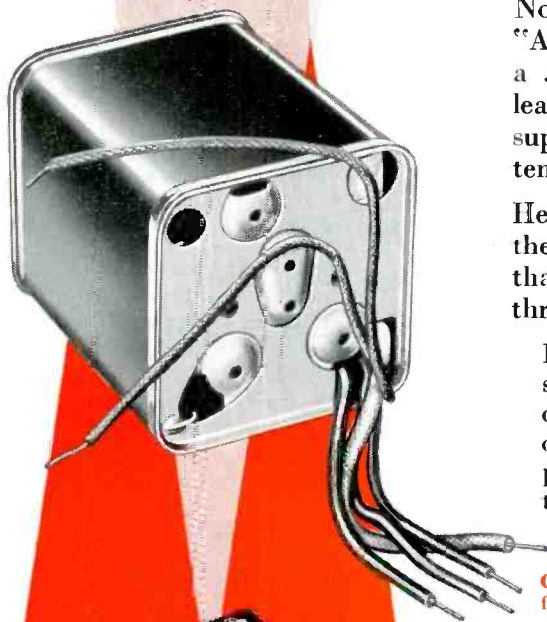

Developed by Delco Radio and General Motors electronics specialists, and built under a strict quality control, Delco Universal Vibrator transformers have the kind of built-in customer satisfaction that can do a lot for your business.

And there's a model to replace the vibrator transformer in just about every model of car radio.

Three—Model Nos. 6055, 6065 and 6067—are *uncased* and *do not* include a filter network. Three others—Model Nos. 6060, 6064 and 6066—are *cased* and *do include* an "A" line filter network consisting of an "A" choke and a .5 mfd. capacitor. All six models have long-enough leads for universal application, and cased models are supplied with three self-tapping screws and a drilling template for easy mounting.

Here are some more of the features that prove this is the power transformer line to fill your needs . . . one that's competitively priced all the way, quality-made through and through . . . the Delco line:

Laminated core inserts stamped out of low-loss silicon steel and heat-treated so magnetic properties will not change • Primary and secondary coils wound by skilled operators using special machines • Hot asphalt compound poured into cased models to hold components in position, transfer heat and protect quality and performance.

Order these quality products of a volume electronics manufacturer through your UMS Electronics Parts Distributor today.



This is the newly developed package for Delco transformers and other electronics parts . . . brighter, stronger, easier-to-find.



DELCO RADIO

DIVISION OF GENERAL MOTORS, KOKOMO, INDIANA

A GENERAL MOTORS PRODUCT



UNITED SERVICE MOTOR

A UNITED MOTORS LINE

DISTRIBUTED BY ELECTRONICS DISTRIBUTORS EVERYWHERE

take
Phono
Cartridges
for
example



RCA Phonograph Cartridges for RCA Victor record-changers and "Victrola" Phonographs are specifically designed to save you time and money—by fitting right, installing fast. Cartridges are just one example of how every RCA Service Part is FACTORY-TAILORED to keep your servicing "on the go" profitably.

Remember: RCA Service Parts are the only genuine replacement parts for RCA Victor TV receivers, radios, and phonographs.



Microphones

(Continued from page 44)

in the fact that its sensitivity in the maximum directions is higher at the feedback point, then the all-round sensitivity of an omnidirectional microphone. This means that sound may be picked up effectively by means of a bidirectional microphone at approximately twice the distance from the microphone that can be used with an omnidirectional type. The unidirectional, or cardioid pattern, microphone is useful for picking up sounds from one side only. It has a slightly better discrimination against unwanted sounds than the bidirectional microphone, and may be particularly useful where the unwanted sounds, instead of being of a general nature such as to fill the room, may be particularly located on the opposite side of the microphone from the wanted sound. Stage work is a good example of this.

An important point to realize with any directional type of microphone is that it has a frequency characteristic that varies according to the distance it is from the sound source. An omnidirectional microphone has sensibly the same frequency characteristic, at whatever difference it is from the sound source, whether it be a musical instrument or a person's voice. But a bidirectional, or a unidirectional microphone, does have a tendency to emphasize the low frequencies when addressed closely, or when placed close to a musical instrument. This can be an advantage, but it can also be a disadvantage, if it is not expected.

Frequency Response

All microphone specifications carry some statement about their frequency response. So the question naturally arises, what frequency response does one need? This is not an easy question to answer, because the response is not always directly related to the specification of its frequency range. For satisfactory output, a microphone should have a *smooth* frequency response, free of any noticeable peaks.

But the response curve should be weighed against performance. One way to check this balance is to multiply the high frequency rolloff by the low frequency rolloff; this should give a product of about 400,000 (anywhere between 250,000 and 650,000). The response quoted as being 40 cycles to 12,000 cycles results in a product of 480,000, which can be considered a well-balanced response.

The foregoing response result does not always insure realism. In one

(Continued on page 47)



"We're in luck, Boss
A JENSEN NEEDLE"

Don't just say
"capacitors"

Ask For Sprague By Catalog Number

Know what you're getting . . . get exactly what you want. Don't be vague . . . insist on Sprague. Use complete radio-TV service catalog C-610. Write Sprague Products Company, 61 Marshall Street, North Adams, Massachusetts.

SPRAGUE[®]

WORLD'S LARGEST CAPACITOR MANUFACTURER

**CONSOLIDATED DIESEL ELECTRIC
BUYS IFS**

Consolidated Diesel Electric Corp., Stamford, Conn., has acquired control of Instruments for Service, Inc., 380 Woodcleft Ave., Freeport, L. I., N. Y.

Instruments for Service will continue to operate as a separate corporation and design, manufacture and market test equipment. *Edward Berliant* will continue as IFS president and general manager. Other officers are *Norman Schaffler*, vice president, and *David Brady*, secretary-treasurer.

(Continued from page 46)

field test, it was found that the acoustic design of the microphone produced a single large peak, rising to about 30 db above the general level. This was corrected by means of an electrical-equalizing network included in the microphone housing, that absorbed the peak and gave an over-all response that was extremely flat. However, it was found that this microphone showed coloration on transients at the frequency of the peak, which was about 500 cycles.

Since the housing can modify considerably the response of the microphone, manufacturers normally check the frequency range of prototypes with and without housings, to establish a base. At times, such quality-control tests might be bypassed. Thus, it is usually a good practice to conduct listening studies, preferably under a variety of operating conditions, different program materials and acoustic surroundings. If possible it is also wise to get some experience by handling a number of different microphones in this way, or alternatively you may get advice from someone who has had such experience.

Sensitivity

Generally speaking there are three different impedances for microphones: 50 ohms, 250 ohms and grid. Some do use a fourth, 600 ohms; since 600 ohms is an input impedance for a normal line-to-grid transformer, this value can be accommodated.

Microphones that use 50 and 250-ohm impedance, normally have their sensitivity noted in terms of the output from the microphone, referred to a level of either 1 milliwatt or 6 milliwatts, in a sound field usually of intensity specified as 10 dynes per square centimeter, or 10 microbars, which are two ways of saying the same thing.

For those microphones designed to operate directly into grid, the output is usually specified with reference to a volt at the grid for an input to the microphone of 1 dyne per square centimeter, or 1 microbar, or sometimes for 10 dynes per square centimeter, or 10 microbars.

Of course, in judging the ability of the microphone to provide enough output to load a preamp we are concerned with the amount that will be supplied to the grid of the first tube in the preamp. So the best thing to do is to transform whatever figure the manufacturer gives into terms of volts on the grid, for an acoustic input of the same amount. Since 10 microbars or 10 dynes per square centimeter, is the figure most often given, it is best

(Continued on page 48)

TRY ONE
FREE!



Forget claims and counterclaims. When it comes to picking the BEST molded plastic tubular, there's only one sure way — your own tests. That's why Aerovox offers you a free DURANITE.* You be the judge and jury.

*Trade-mark



AEROVOX CORPORATION

DISTRIBUTOR SALES DIVISION

NEW BEDFORD, MASS.

FILL OUT AND PRESENT THIS COUPON TO YOUR LOCAL AEROVOX DISTRIBUTOR . . .

I'm trying a DURANITE for myself . . .

NAME _____

FIRM _____

ADDRESS _____

CITY _____ STATE _____

S NOT VALID AFTER SEPTEMBER 30, 1955

PAYS ITS WAY from the VERY FIRST DAY

The only unit
Proved in the Field
OVER 20,000
CRT 350's NOW IN USE
ACROSS THE NATION



QUICKLY CHECK AND CORRECT TV PICTURE TUBE TROUBLES

*in a few minutes, right in the home
without removing tube from set!*

Daily use by more and more servicemen proves the CRT builds profits and customer satisfaction! Compact, portable CRT quickly *locates* and *corrects* picture tube troubles, due to low emission, inter-element shorts, leakage and open circuits—gives new life to weak and inoperative tubes. *Life-Test* feature checks gas content and predicts remaining useful tube life, while *Grid Cut-Off Reading* indicates picture quality customer can expect. So simple to operate, one glance tells the story. Earns servicing dollars in minutes, cuts operating cost, eliminates tube transportation. Saves money on TV set trade-in reconditioning, too. CRT costs so little, it pays its way from the very first day!

Weights only 5 lbs.
Size 11" x 7½" x 5"

MODEL 350
\$54.95
ONLY NET

Send for Bulletin 102-3

Watch for another
brand new B&K
money-maker coming
your way soon

B&K MFG. CO. 3731 N. Southport
Chicago 13, Illinois

Microphones

(Continued from page 47)

to use this value, particularly because it is representative of normal speech input, talking at a reasonable distance from the microphone.

As an example let us consider a microphone specified as giving an output level of -57 db, referred to 1 milliwatt, with an input of 10 dynes per square centimeter. We will assume that a transformer is used to raise the referred impedance of the microphone to 50,000 ohms: 1 milliwatt

across 50,000 ohms equals $\sqrt{50}$ or 7.07 volts, or $+17$ db. Thus a level of -57 db referred to $+17$ is a net of -40 from 1 volt, or 10 millivolts.

Using the 6 milliwatt reference level across 50,000 ohms, we arrive at $\sqrt{300}$ volts or 17.32, which corresponds with $+25$ db. Accordingly, in the microphone specified as -53 db referred to this level, -53 is -28 referred to one volt, or 40 millivolts.

Sometimes the low-impedance variety mikes are also specified in level referred to a volt, instead of the power

across the operating impedance of the microphone. For example, there is one type¹ that is specified as having an average impedance of 40 ohms and giving an open-circuit output for 10 dynes per square centimeter of 64 db below one volt. Transformation from 40 ohms up to 50,000 ohms is 31 db; 64 db below $+31$ db equals -33 db, or approximately 22 millivolts.

All of the microphones in another range², in which high-impedance windings are available on the microphones, specify the output relative to a volt for an input of 1 microbar. Since 10 microbars have been chosen as a reference, the specified level must be raised by 20 db, and converted to volts, which is quite a simple transformation.

Matching

If the preamp is provided with a transformer input suitable for 50 ohms or 250 ohms, use of a microphone with this impedance is beneficial, especially when the microphone has to run at a considerable distance from the preamp. Use of the low-impedance line avoids excessive high-frequency loss and also makes it easier to avoid hum pickup in the lead.

Transformers are available with various different ratios for microphone- or line-to-grid, 50,000 ohms being a good working figure for wide-range operation. Some may step up to a higher figure, such as 100,000 ohms, or even 200,000 ohms, but this will result in restriction of the higher frequencies and possibly, if the transformer is of inferior design, also restriction of the lower frequencies. Some microphone-to-grid transformers only step up to 25,000 ohms. This decreases the apparent sensitivity of the microphone, but does insure the condition that a maximum frequency range is available.

High-End Peaks

A microphone-to-grid transformer working straight into the grid without termination may show a peak toward the high end, due to the inductance of the microphone voice coil, or the leakage inductance of the transformer, resonating with the grid input capacitance of the first tube. It will be noticeable in reproduction as a tendency to be rough in the highs. Where this happens a loading resistor of about 100,000 ohms should be sufficient to hold this down; a value as low as 68,000 ohms can be tried.

Crystal microphones, of course, are only usable at high impedance, be-

¹Alltec 639.

²Shure.

cause their source impedance is like a capacitor. To get wide range frequency response from them they should be terminated at the grid with an impedance of at least a megohm, and preferably higher. However, for speech purposes, there may be no disadvantage in using a lower value resistor, because this will give a low frequency rolloff that may clean up the sound of speech by removing some of the low-frequency flutter components.

For crystal microphones, the input lead should always be shielded, otherwise there will be severe pickup due to the high impedance. If an input lead of any considerable length is used the capacitance of the lead will have some effect. But since the source impedance of the microphone is virtually a capacitor, it will not have the same effect as with other microphones, rolloff of the highs, but will attenuate the entire frequency band. As crystal microphones have fairly good sensitivity, a certain amount of this attenuation can be tolerated.

Variable Damping

(Continued from page 27)

of reproducing very low-frequency sound. On the other hand, organ pedal tones, the lower strings of the bass viol, and bass drums should have as much of the *feel* of low-frequency fundamental energy as the speaker is designed to give. A low damping factor will produce more bass and a greater danger of hangover. It will also tend to produce a rising treble characteristic, but this effect is usually not as significant.

The application of negative feedback, whether current or voltage controlled, has the same effect on gain and distortion, but opposite effects on effective amplifier source impedance. Negative-voltage feedback, where the feedback signal is made dependent on the output voltage by a parallel connection across the output circuit, decreases source impedance and raises the damping factor. Negative current feedback, where the feedback signal is made dependent on the output *current* by a series connection in the output circuit, increases source impedance and lowers the damping factor.

A damping-factor control circuit can be designed to vary the relative amounts of negative voltage and current feedback, but not to affect the total amount of feedback, so that overall amplifier gain remains the same. This may be done by a pair of ganged controls, one for the voltage-feedback circuit and one for the current feedback circuit.

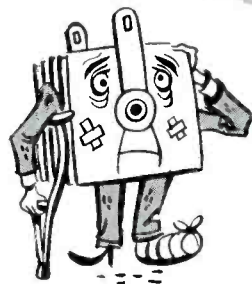

Replace those
played out units

with "SAFE CENTERS"

RADIO
RECEPTOR

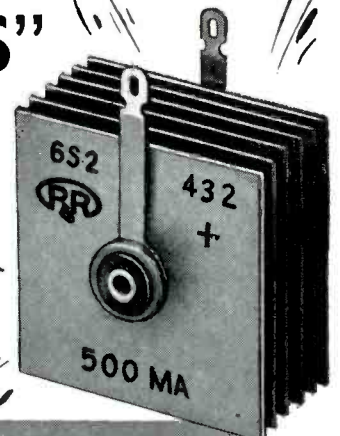

SELENIUM RECTIFIERS

There's a complete range of standard sizes and types for every radio and TV replacement need. Insist on RRco. rectifiers when you order from your parts jobber.



Semiconductor Division
RADIO RECEPTOR COMPANY, INC.

In Radio and Electronics Since 1922

SALES OFFICE: 251 WEST 19th STREET, NEW YORK 11
WAtkins 4-3633 • Factories in Brooklyn, N. Y.

SELENIUM RECTIFIERS • GERMANIUM TRANSISTORS • GERMANIUM AND SILICON DIODES
DIELECTRIC HEATING GENERATORS AND PRESSES • COMMUNICATIONS, RADAR AND NAVIGATION EQUIPMENT

Service Engineering

field and shop notes

Photoelectric Systems for Supervisory Control*

by MAXWELL ALBERTS

ELECTRONIC - SUPERVISION systems, through the use of light beam-photocell-relay links, are being used today in a variety of applications, which the Service Man can readily handle as a package, providing installation, maintenance and service.

The selection of the light source and photocell is governed by the task to be performed. Thus when systems are designed, the following factors must be considered:

- (1) Rate of speed at which the object to be supervised is traveling.
- (2) Size and shape of the object to be supervised. If, for example, an object is under 2" square, a crossover beam would be applied. If the object was larger than 2" square, it would then be necessary to use a directional beam for the application.
- (3) Physical characteristics of the object; that is, transparency or type of material to be supervised.
- (4) Distance between the exciter lamp and the photocell units. This distance may be governed by the size of the object to be supervised or the space required by the equipment.
- (5) Method of feed or travel of the object to be supervised.
- (6) Unwanted light. If extraneous

(unwanted) light reaches the photocell directly, the result is the same as the raising or lowering of the exciter lamp's light output brilliance which could cause a variable in operation. To reduce the effect of this light, the photocell unit must be placed so that the direct ray of unwanted light appears at the rear side of the unit. Frequently, artificial lighting can be redirected or shielded from direct interference. Where necessary, extraneous light rejectors are built into the photocell unit.

Directional Beams

Directional beams are straight beams from the exciter lamp to the photocell. They provide control over the area covered by the beam. This type of beam is particularly useful where the point of supervision fluctuates within the area supervised, and is most generally specified for supervising objects that are more than 2" square.

The crossover beam is ideal for supervising small objects, precision control and high speed operations. It

*Based on application data prepared by Worner Electronic Devices.

supervises at a fixed crossover point, and is generally applied to controlling objects smaller than 2" square.

Reflective Beams

There is a third type of beam, reflective, which is used to supervise objects on flat, opaque surfaces that do not permit penetration of the light beam. This beam is produced by projecting it to the point of supervision from which it is reflected to a photocell, the recommended distance from lens to point of supervision being 1½" maximum.

For precision crossover beam supervision, as well as for directional beams supervising over various areas, where fast moving objects are involved, relays in photocell chains operate up to a maximum of 600 times a minute; in this application the light falling upon the photocell, has an *on period* of light of 180°, provided the conductor wires to the photocell have zero capacity.

For long range operations such as timing automobile or motorcycle races or track meets, there are photocell chains which operate a beam up to a range of 250' and 500'.

Photocell systems can also be used to operate automatically artificial lighting, indoor or outdoor, at any predetermined fluctuation of natural light.

Photocells may be so regulated that any predetermined amount of change in light density falling upon the photocell will activate a remotely located electronically - operated relay unit, thereby turning artificial lights on or off automatically.

The Electronic Receptionist

An extremely popular application of the photocell is in the announcing system; when a light beam across a

(Continued on page 56)

(Right)

Electronic receptionist system featuring use of a photocell, mirror and light beam; latter projects beam which is reflected by a mirror back to photocell.

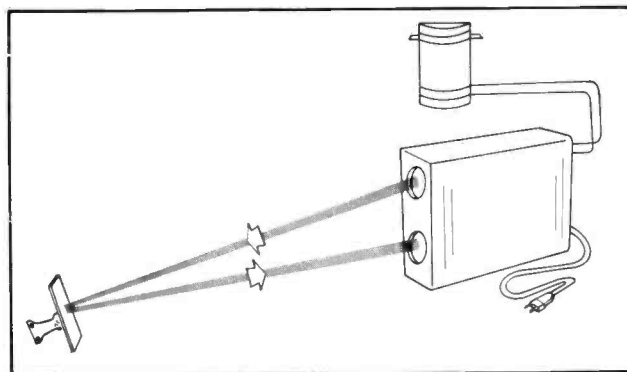
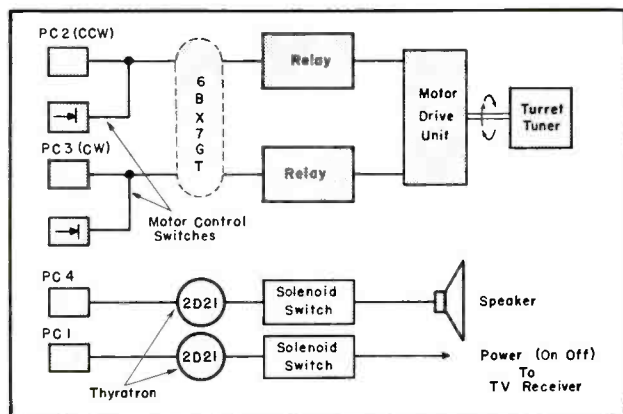

(Left)

Block diagram of photoelectric TV-set remote control system, using four cadmium-sulfide crystal photocells to trigger thyratrons and a motor control tube (6BX7GT). Device, which automatically controls operation with beam of light from a convenient location within viewing range of the screen, turns receiver on and off, selects stations and turns sound on and off. (Zenith Flash-Matic)

WHAT'S YOUR SERVICE PROBLEM?

PHOTOFACT HELPS YOU SOLVE IT FASTER, EASIER, BETTER, MORE PROFITABLY!

THE WORLD'S FINEST SERVICE DATA

PHOTOFACT Service Data is the *only* service information based upon first-hand examination of the actual production-run receivers and equipment. It is authentic, uniform data developed through actual study and analysis by service engineers in the Howard W. Sams Laboratories. PHOTOFACT is the *only* data prepared from the practical point of view of the Service Technician.

Thousands of Service Technicians use PHOTOFACT daily for time-saving, profit-boosting service operations. If you've never used PHOTOFACT, you've never realized your full earning power—you've never given such complete customer satisfaction. So get the proof for yourself. Try PHOTOFACT—use it on any job. Your Parts Distributor has the Folder Sets you need for any of the 17,000 TV and radio receivers, changers, recorders, etc., covered in PHOTOFACT. Once you use this great service, we know you'll want the complete PHOTOFACT Library.

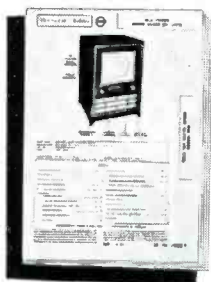

THESE GREAT FEATURES ARE EXCLUSIVE IN PHOTOFACT—THEY HELP YOU EARN MORE DAILY, HELP INSURE CUSTOMER SATISFACTION

FULL SCHEMATIC COVERAGE

1. Famous "Standard Notation" uniform symbols are used in every schematic.
2. The same standard, uniform layout is used for each schematic.
3. Diagrams are clear, large, easy to read, easy to handle.

4. Wave forms are shown right on the TV schematics for quick analysis by 'scope.

5. Voltages appear on the schematics for speedy voltage analysis.

6. Transformer lead color-coding is indicated on the schematic.

7. Transformer winding resistances appear on the schematic.

8. Schematics are keyed to photos and parts lists.

FULL PHOTOGRAPHIC COVERAGE

9. Exclusive photo coverage of all chassis views is provided for each receiver.

10. All parts are numbered and keyed to the schematic and parts lists.

11. Photo coverage provides quicker parts identifications and location.

ALIGNMENT INSTRUCTIONS

12. Complete, detailed alignment data is standard and uniformly presented in all Folders.

13. Alignment frequencies are shown on radio photos adjacent to adjustment number—adjustments are keyed to schematic and photos.

TUBE PLACEMENT CHARTS

14. Top and bottom views are shown. Top view is positioned as chassis would be viewed from back of cabinet.

15. Blank pin or locating key on each tube is shown on placement chart.

16. Tube charts include fuse location for quick service reference.

TUBE FAILURE CHECK CHARTS

17. Shows common trouble symptoms and indicates tubes generally responsible for such troubles.

18. Series filament strings are schematically presented for quick reference.

COMPLETE PARTS LISTS

19. A complete and detailed parts list is given for each receiver.

20. Proper replacement parts are listed, together with installation notes where required.

21. All parts are keyed to the photos and schematics for quick reference.

FIELD SERVICE NOTES

22. Each Folder includes time-saving tips for servicing in the customer's home.

23. Valuable hints are given for quick access to pertinent adjustments.

24. Tips on safety glass removal and cleaning.

TROUBLE-SHOOTING AIDS

25. Includes advice for localizing commonly recurring troubles.

26. Gives useful description of any new or unusual circuits employed in the receiver.

27. Includes hints and advice for each specific chassis.

OUTSTANDING GENERAL FEATURES

28. Each and every PHOTOFACT Folder, regardless of receiver manufacturer, is presented in a standard, uniform layout.

29. PHOTOFACT is a *current* service—you don't have to wait a year or longer for the data you need. PHOTOFACT keeps right up with receiver production.

30. PHOTOFACT gives you *complete* coverage on TV, Radio, Amplifiers, Tuners, Phonos, Changers.

31. PHOTOFACT maintains an inquiry service bureau for the benefit of its customers.

ONLY \$25 DOWN

Puts a Photofact Service Data Library in Your Shop. Ask Your Photofact Distributor—He Has the Full Easy-Pay Details.

FREE PHOTOFACT CUMULATIVE INDEX

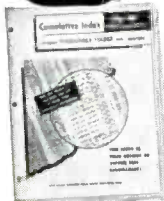

Send for it! Your guide to virtually any model ever to come into your shop; helps you locate the proper PHOTOFACT Folder you need to solve any service problem on any model. Once you have the make and chassis number, it

takes just 60 seconds to find the applicable PHOTOFACT Folder. Send coupon now for your FREE copy of the valuable Cumulative Index to all PHOTOFACT Folders.

HOWARD W. SAMS & CO., INC.

Howard W. Sams & Co., Inc., Dept. 5-G5
2201 E. 46th St., Indianapolis 5, Ind.

Send FREE Photofact Cumulative Index.

Name.....

Address.....

City.....Zone...State.....

HELPS YOU EARN MORE DAILY

The DE-SNOWER Line

... for TV RECEPTION where boosters have failed!

Here, for home use, is the same high quality antenna-mounted Preamplifier used in hundreds of community TV systems serving as many as 5000 receivers from a single antenna.

The De-Snower Preamplifier's maintenance-free cascode circuit combines a whopping 25 db gain with exceptionally low noise—only 6 db—to give the best TV reception attainable even with long lead-ins.

Available in two models—Channels 2-6, or 2-13. Flat response for color.

... for profitable MULTIPLE INSTALLATIONS

Make extra sales by providing clubs, motels, and apartments with small-size Jerrold community TV systems of their own. The De-Snower all-channel Distribution Amplifier provides 15 db gain to each of its 8 outlets—like having a preamp at each receiver. Extremely low noise cascode circuit using 3-6BQ7-A's, 1-6AK5, & 1-6CB6 tubes handles 72 or 300 ohm inputs from one all-band antenna, separate hi-lo arrays, or from De-Snower Preamplifier. Distributes clear, snow-free signals to remotely located sets.

JERROLD ELECTRONICS CORP.

2220 Chestnut Street
Philadelphia 3, Pa.

JERROLD

See the De-Snower Line at Leading Distributors or write direct for copies of illustrated brochure.

ONE Generator covers 150 kc—435 mc!
WORLD'S BEST GENERATOR BUY!



New! EICO SIGNAL GENERATOR #324
KIT \$26.95 Wired \$39.95

- 6 fundamental bands: 150-400 kc, 400-1200 kc, 1.2-3.5 mc, 3.5-11 mc, 11-37 mc, 37-145 mc, 1 harmonic band 111-435 mc. Covers AM, FM, TV, & Amateur freqs.
- $\pm 1.5\%$ frequency accuracy; 6:1 vernier tuning knob & excellent spread at most important alignment frequencies.
- Etched tuning dial, plexiglass windows, edge-lit hairlines.
- Variable depth of int. mod. 0-50%, by 400 cps Colpitts osc.
- Variable gain ext. mod. ampl.; only 3.0 v for 30% mod.
- Colpitts RF oscillator plate-modulated by cathode follower.
- Turret-mounted, slug-tuned coils.
- Fine & Coarse (3-step) RF attenuators; 50-ohm output Z.
- RF output 100,000 uv; AF output to 10 v.

46 each Kits & Instruments to choose from.

In stock at local parts distributors coast to coast.
Write for free Catalog S-7

EICO

Prices 5% higher
on West Coast

84 Withers Street • Brooklyn 11, N.Y.

© 55

Don't just say
"capacitors"

Ask For Sprague By Catalog Number

Know what you're getting
... get exactly what you
want. Don't be vague ... in-
sist on Sprague. Use com-
plete radio-TV service cata-
log C-610. Write Sprague
Products Company, 61
Marshall Street, North
Adams, Massachusetts.

SPRAGUE

WORLD'S LARGEST CAPACITOR MANUFACTURER

Coming Events

Sixth Annual Convention, NATESA
August 19 to 21
Morrison Hotel, Chicago, Ill.

Annual Audio Fair
October 12 to 15
Hotel New Yorker, N. Y.

Ser-Cuits

(Continued from page 20)

phase detector in the CT100 chassis. Burst and a sample of the 3.58-mc cw signal is applied to this circuit. Its output is a dc-control voltage which, when applied to the grid of the reactance tube, shifts the frequency of the 3.58-mc cw oscillator in accordance with the polarity and magnitude of the dc control voltage. When burst and the 3.58-mc cw oscillator are in phase, zero control voltage results. The hue control, located in the 3.58-mc cw input circuit of the phase discriminator, varies the phase of the 3.58 mc cw supplied to the phase discriminator. Varying the phase of this 3.58-mc input causes the 3.58-mc oscillator to change frequency until the oscillator is again in step with the reference signal.

The vertical oscillator and output stages are of conventional design. A special winding on the vertical output transformer supplies a sawtooth of 60-cycle current to the convergence circuits. Two taps on this winding supply sawtooth shaping currents to the vertical convergence circuit.

The convergence circuit is of the tubeless type. Sinewaves for dynamic-horizontal convergence are obtained from a ringing circuit. A flyback pulse from the horizontal output transformer rings a tuned circuit providing the necessary waveform. The vertical parabola is obtained by integrating a sawtooth of current supplied by the vertical output stage.

A horizontal-blanking amplifier is incorporated in this receiver. This amplifier is required since the color demodulators receive the entire composite signal. The burst signal would produce a yellow stripe during horizontal retrace. To overcome this color presentation during retrace, the blanking amp supplies a large negative pulse to the screen grid of the second video amp, causing the picture tube to cutoff during horizontal retrace time.

The tri-color picture tube performs an additional function in this receiver. Since there is no external matrix, the luminance and chrominance signals are matrixed within the picture tube. The luminance (Y) signal, sync positive, is applied to the cathode, and positive chrominance (R-Y, G-Y, B-Y) signals are applied to the grids. Matrix takes place between the grid and cathode of the picture tube. Background controls are located in grid circuits of the green and blue guns.

The low-voltage power supply is composed of two selenium rectifiers providing +285, +380 and -20 volts.

Outdoor Sound

(Continued from page 23)

match, the greater the distortion and poorness of tone quality; 25% loss of power is generally allowable for most *pa* systems. The mismatch mentioned is *upward* mismatch. Downward mismatch (connecting an 8-ohm speaker to the 16-ohm tap on the amplifier) should be avoided, if at all possible, since it would result in excessive loss of power and poor low-frequency response.

Open Air Sound Requirements

In open air locations, *public address* is normally the goal rather than sound reinforcement. Here, we are usually concerned with the single point source of the sound; this means that the speakers should be as close together as possible and should spray the far points evenly from the location where the actual sound and action is taking place.

Generally speaking, speech frequencies are the most important under these conditions; music is used on many occasions, and under these circumstances, combination cone-trumpet speakers can be used.

Under open air conditions, we are fortunate in that reverberation seldom constitutes a problem. It is in the open air that augmented bass response is required to keep the music from sounding *pinched*. The reverberation time is virtually zero; whereas, for music, the optimum should be around two seconds. To overcome this, all the bass possible will assist in the illusion of increased reverberation. To augment the bass response, low-frequency cone speakers or the combination cone-trumpets can be used and judiciously placed.

When placing horns, under conditions of high reverberation and feedback, the top of the speakers should be aimed to the opposite wall, no higher than 5' above the floor of this far wall.

The microphone should be placed in back of the speakers if at all possible; about 15' has been found to be the best distance. If this cannot be done, the speakers should be placed as high as possible over the microphone area.

Lapel and breast microphones are highly effective in reducing feedback, because the announcer is ideally placed with respect to the microphone. The close direct signal from the announcer's voice will override the reflected signals from the public address system. As much as 6 db more level is possible before feedback occurs.

HOW YOU CAN ADVANCE IN ELECTRONICS

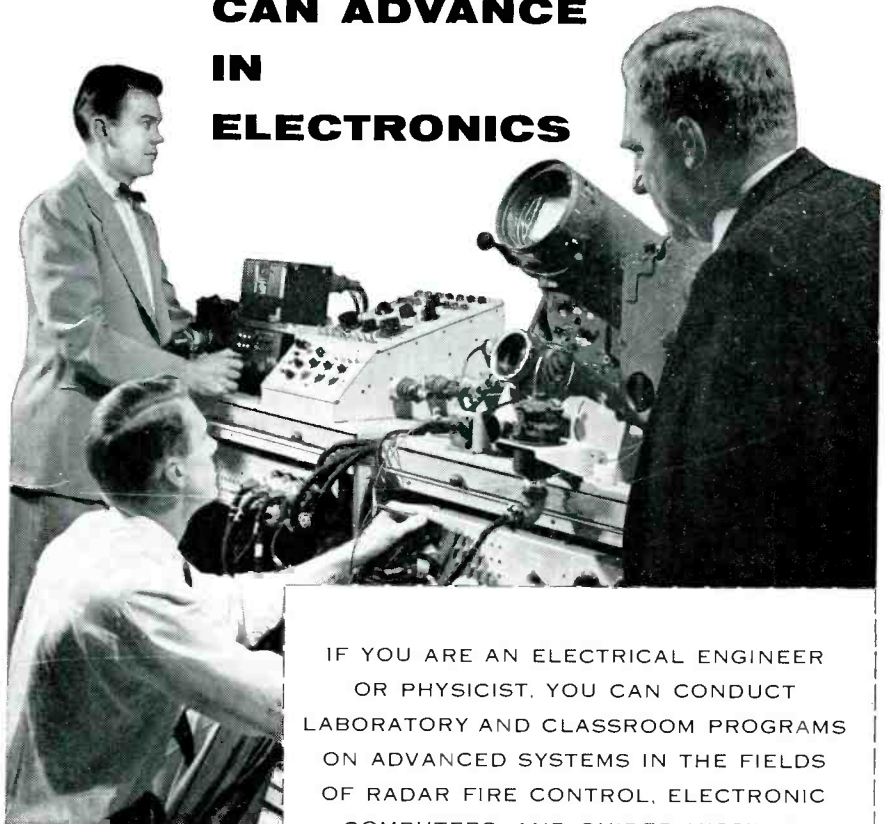

Maintenance instruction on an advanced Hughes fire control system.

IF YOU ARE AN ELECTRICAL ENGINEER OR PHYSICIST, YOU CAN CONDUCT LABORATORY AND CLASSROOM PROGRAMS ON ADVANCED SYSTEMS IN THE FIELDS OF RADAR FIRE CONTROL, ELECTRONIC COMPUTERS, AND GUIDED MISSILES.

As a training engineer you will become familiar with the entire systems involved, including the most advanced electronic computers. With this advantage you will be ideally situated to broaden your experience and learning more quickly for future application to advanced electronics activity in either the military or the commercial field.

At Hughes Research and Development Laboratories in Southern California you, as an engineer assigned to this program, will be a member of the Technical Staff. Prior to instructing you will receive technical training to become familiar with the latest Hughes equipment.

THE TIME WAS NEVER MORE OPPORTUNE THAN NOW FOR BECOMING ASSOCIATED WITH THE FIELD OF ADVANCED ELECTRONICS. BECAUSE OF MILITARY EMPHASIS THIS IS THE MOST RAPIDLY GROWING AND PROMISING SPHERE OF ENDEAVOR FOR THE YOUNG ELECTRICAL ENGINEER OR PHYSICIST.

HUGHES

RESEARCH AND DEVELOPMENT LABORATORIES

Culver City, Los Angeles County, California

SCIENTIFIC AND
ENGINEERING STAFF

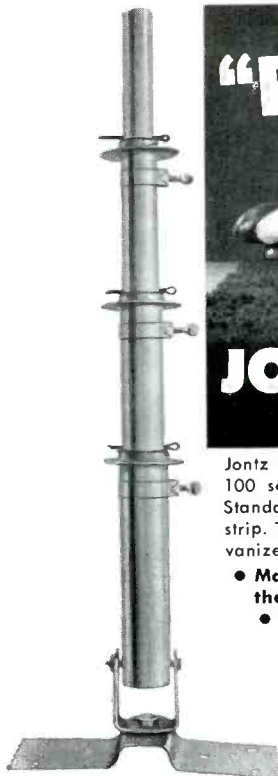

JONTZ Kwick-Up Telescoping Masts

Jontz Kwick-up telescoping masts are available in 3 lines: The De Luxe 100 series, made from hot-dipped galvanized 16 gauge tubing. The Standard 200 series, made of 16 gauge tubing rolled from galvanized strip. The Standard 300 series made of 18 gauge tubing rolled from galvanized strip with 1 1/4", 16 gauge top.

- Mast sections will not pull apart with the exception of the top section which enables easier antenna mounting.
- New type locking device for faster erection and locking without tools.
- Revolutionary new guy ring eliminates all strain, tension, and friction on the next section to be erected.
- Newly designed companion base assures definite locking, will not turn in the wind.

Sell the Line that is "Really Built" to do the job Available at better jobbers everywhere



JONTZ MANUFACTURING CO.
1101 East McKinley, Mishawaka, Indiana
IN CANADA: Active Radio & TV Distributors
60 Spadina Ave • Toronto, Canada

Community TV

(Continued from page 19)

voltage determined by a level-set control. The voltage out of the rectifier will be zero until the peak of the *rf* signal exceeds this voltage. Since the detector is followed by a filter, with a long discharge time constant, the voltage will charge up to the peaks of the sync pulses. The peak selector, another double diode, selects whichever *dc* level is the larger, and then the bias amplifier (a cathode follower) supplies a bias voltage to the cascaded amplifier, thus maintaining the output fixed. The two *dc* voltages from the filters also are fed to a difference amplifier having a polarized relay connected between its plates. This relay is used to control a servo motor, which through a mechanical link adjusts the tuning of the interstage transformer between cascaded pentodes. This adjustment can change the response of the amplifier so that channel 2 is 3 db higher than channel 6, or channel 6 is 3 db higher than channel 2. The phase relation is such that the servo always tries to keep channels 2 and 6 equal. The gear ratio of the servo has been chosen to give very slow response; twelve minutes are required for travel from one limit to the other. The tilt correction is required only to follow changes caused by temperature and the servo response is sufficiently rapid for this purpose.

The performance of the system has been found to be such that a 10-db change in the input causes a 1-db change in the output, and the difference between 2 and 6 will be less than 1/2 db. This *agc* amplifier has been found to be ideally suited for use with any system operating in the 54 to 88-mc frequency range. A separate dual oscillator for installation at the antenna site has been developed to substitute automatically a standby carrier of controlled amplitude on channels 2 and 6, whenever stations go off air.

Thus, it can be seen that regardless of the length of the trunk line the output of the system will remain constant and *tilt* will remain in the order of ± 1 db. The exact value depends upon the distance from the amplifier, but will never, under the worst conditions, exceed 3 db.

The combination of these variable equalizing *agc* amplifiers, and the dual oscillator at the head-end site, forms a constant gain system regardless of the number of channels on the air. All five channels will be of constant level throughout the system regardless of the temperature variation, loss of gain in amplifiers due to tube aging or line voltage variations.

THE NEW MODEL TV-11

TUBE TESTER



- Uses the new self-cleaning Lever Action Switches for individual element testing.
- Because all elements are numbered according to pin number in the RMA base numbering system, the user can instantly identify which element is under test. Tubes having tapped filaments and tubes with filaments terminating in more than one pin are truly tested with the Model TV-11 as any of the pins may be placed in the neutral position when necessary.
- Uses no combination type sockets. Instead individual sockets are used for each type of tube. Thus it is impossible to damage a tube by inserting it in the wrong socket.
- Free-moving, built-in roll chart provides complete data for all tubes.
- Phono jack on front panel for plugging in either phones or external amplifier detects microphonic tubes or noise due to faulty elements and loose external connections.

EXTRA SERVICE—The Model TV-11 may be used as an extremely sensitive Condenser Leakage Checker. A relaxation type oscillator incorporated in this model will detect leakages even when the frequency is one per minute.

Operates on 105-130 Volt 60 Cycles A.C. Hand rubbed oak cabinet complete with portable cover.

\$47.50

SHIPPED ON APPROVAL NO MONEY WITH ORDER — NO C. O. D.

Try it for 10 days before you buy. If completely satisfied send \$11.50 and pay balance at rate of \$6.00 per month for 6 months.—No Interest or Finance Charges Added. If not completely satisfied, return to us, no explanation necessary.

MOSS ELECTRONIC DISTRIBUTING CO., INC.
Dept. D-142, 3849 Tenth Ave., New York 34, N. Y.
Please rush one Model TV-11. I agree to pay \$11.50 within 10 days after receipt and \$6.00 per month thereafter.

NAME

ADDRESS

CITY..... ZONE..... STATE.....

Direct Servicing

(Continued from page 17)

than tube numbers, should be assigned so that you can determine quickly if the screw is accessible from the top, or bottom, of the chassis. One easy way to do this, is to assign even numbers for those accessible from the top of the chassis, and odd numbers for those accessible from the bottom of the chassis. If there are not more than ten adjusting screws, either above or below the chassis, you can use numbers such as 40 to 49, whose first digit is even, for screws above the chassis. Likewise, you can use numbers such as 30 to 39, whose first digit is odd, for screws below the chassis; see tables 2 and 3; p. 17. The assigned numbers should be entered in ink on the schematic and alignment notes.

Now each junction test point, as covered in the alignment procedure, should be located. If letters are used, new numbers, higher than other numbers should be assigned to avoid confusion; table 4. This number should be entered in ink on the schematic and alignment notes. The junction should be color coded to conform to the assigned number. The code can then be applied on the chassis near the point, or a white tape flag, on which the code is applied, can be used. Code should always read outward from the test point; Fig 3 (p. 17). When the test point is on a tube socket terminal, it is unnecessary to code it separately. The tube socket has already been coded and it can be quickly located; for example pin 1, V-3.

Each multi-section electrolytic should then be located and color coded according to the C found on the schematic, or a new number can be assigned if it conflicts with other numbers; table 5 and Fig. 4A (for coding). If a new number is assigned, this should be entered in ink, on the schematic. At this time we must be sure that the capacitor sections are marked on the schematic with the correct marker, such as semi-circle, square, triangle, or plain underscore. In some cases these individual sections are identified on the schematic by letters, such as C_{2A}, C_{2B}, etc., instead of by markers as shown in Fig. 4B. You will usually find the correct marker that corresponds to the A, B, etc., section, in the parts list: table 5. The semi-circle, square, triangle or plain marker should then be entered on the schematic corresponding to the letter designation. This will save a lot of time when troubleshooting.

When confronted with a background color that matches one of the colors being used, (such as brown dot on

the
complete
line!



Cornell-Dubilier
Communication
Vibrators



Based on
Rigid U. S. Government
Engineering Specifications

NOW... Cornell-Dubilier makes available to *commercial* users of communications equipment a new line of vibrators based upon the experience of producing over two million similar units to the exacting requirements of U.S. Signal Corps specifications.

These Eight Types Offer Complete Replacement for ORIGINAL Communications Equipment:

old	new
5515	5715
5518	5718
—	5721
—	5722
5605	5805
5620	5820
5621	5821
5622	5822



CONSISTENTLY DEPENDABLE

CORNELL-DUBILIER

SOUTH PLAINFIELD, NEW JERSEY

ROTORS · CAPACITORS · VIBRATORS · ANTENNAS · CONVERTERS

brown bakelite, or grey dot on grey chassis) a contrasting stripe of paint can be applied with a brush. When the stripe partially dries, in a few seconds, the code can be dotted in on the stripe. The color of the stripe should not be of the same color as any used in that code. Concentric dot coding may also be used. This can be made by placing a large dot for the first number, and a smaller dot in the center of this for the second number, if not of the same color.

With the chassis color coded, it is then possible to concentrate on diagnosis, tracing, and testing without

having your train of thought interrupted by the annoying trouble of locating what you are seeking.

This may sound like a time-consuming project, but it has been found that only a short time is involved, compared to the old time-wasting approach. It is well worth the effort, to be able to sit back and relax as you study the schematic to determine the next move, and then go right to the chassis, directly to the point you want. Furthermore, after coding the chassis, you can remember approximately where to find the point you want and the color code verifies the exact point.

Non-Snarling, Pre-Measured Wire Strand

WRIGHT Wire Strand uncoils like this →

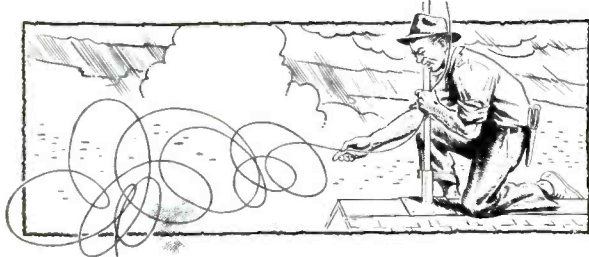

WRIGHT unique process prevents this ←

Besides the important factor of no snarling, WRIGHT TV GUY WIRE is pre-measured. Every concentric coil measures two feet —time and money saver in guying antennas. WRIGHT TV GUY WIRE has great flexibility and is heavily galvanized . . . continuous connected coils.

Prompt deliveries from stocks in Worcester, Chicago, Atlanta, New Orleans, Houston, Dallas and Los Angeles.

G. F. WRIGHT STEEL & WIRE CO.
249 Stafford St. • Worcester, Mass.

Service Engineering

(Continued from page 50)

door is broken by one entering, a relay actuates a chime or other type of signal.

The installation also serves as a valuable alert where immediate attention to entrant, customer, patient or client is advisable; or as a necessary warning where privacy is mandatory. These installations have been found indispensable for unattended outer offices, experimental departments, cashiers' quarters, etc.

There are scores of other possibilities for the photocell chain; but all employ basically the same principle of using an exciter lamp source to project a light beam, and a photocell designed to pick up that beam and convert its light into electrical energy by means of an electronic relay, which amplifies the current flow of the photocell so as to operate any number of relays.

TV Antenna

(Continued from page 24)

the channels up to about 45 should have end-loading capacitors of 1 or 2 mmfd. For the higher channels it is necessary to use self-resonant lengths of twinlead, slightly less than a quarter-wave long due to end effect. Typical trap lengths are: channel 28 (554-560 mc), $2\frac{3}{16}$ " with a 1-mmfd end-loading capacitor; channel 50 (686-692), $3\frac{5}{16}$ " with no capacitor; and channel 62 (758-764), $2\frac{5}{16}$ " also with no capacitor. The traps may shift tuning 10 or 15 mc when curved and inserted into a small case. Final tune-up should be made with branches in the case. To tune the traps one should use a *uhf* grid-dip meter or signal generator, a 300-ohm load resistor for other branch terminals, and a matched-load crystal detector with a *vern.*

Correction

THE *All-Channel* indoor antenna, the *Rembrandt*, because of an engraving defect, was only partially shown in last month's issue; complete view of model appears below.



for service and lab. work

Heathkit PRINTED CIRCUIT OSCILLOSCOPE KIT FOR COLOR TV!

① Check the outstanding engineering design of this modern *printed circuit* Scope. Designed for color TV work, ideal for critical Laboratory applications. Frequency response essentially flat from 5 cycles to 5 Mc down only $1\frac{1}{2}$ db at 3.58 Mc (TV color burst sync frequency). Down only 5 db at 5 Mc. New sweep generator 20-500,000 cycles, 5 times the range usually offered. Will sync wave form display up to 5 Mc and better. Printed circuit boards stabilize performance specifications and cut assembly time in half. Formerly available only in costly Lab type Scope. Features horizontal trace expansion for observation of pulse detail — retrace blanking amplifier — voltage regulated power supply — 3 step frequency compensated vertical input — low capacity nylon bushings on panel terminals — plus a host of other fine features. Combines peak performance and fine engineering features with low kit cost!



MODEL 0-10

\$69.50

Shpg. Wt. 27 lbs.



MODEL TS-4

\$49.50

Shpg. Wt. 16 lbs.

Heathkit TV SWEEP GENERATOR KIT ELECTRONIC SWEEP SYSTEM

② A new Heathkit sweep generator covering all frequencies encountered in TV service work (color or monochrome). FM frequencies too! 4 Mc — 220 Mc on fundamentals, harmonics up to 880 Mc. Smoothly controllable all-electronic sweep system. Nothing mechanical to vibrate or wear out. Crystal controlled 4.5 Mc fixed marker and separate variable marker 19-60 Mc on fundamentals and 57-180 Mc on calibrated harmonics. Plug-in crystal included. Blanking and phasing controls — automatic constant amplitude output circuit — efficient attenuation — maximum RF output well over .1 volt — vastly improved linearity. Easily your best buy in sweep generators.



PERSONNEL

RICHARD KLEINE has been named TV sales manager for Baker Manufacturing Co., 221 N. Bassett St., Madison 3, Wisc.



Richard Kleine Don Workman

DON WORKMAN, formerly sales manager of Workman TV, Inc., has entered the electronics manufacturing field as president of Dunwell Manufacturing Co., Carlstadt, N. J.

* * *

JACK L. HOBBY has been promoted to a new post as publicity and institutional advertising manager for Raytheon Manufacturing Co., Waltham 54, Mass. . . .

LEE A. ELLIS is the new art and photography manager.



Jack L. Hobby F. J. Kirkman

FRED J. KIRKMAN has been appointed executive vice president of Burgess Battery Co., Freeport, Ill. . . . JOSEPH J. COLEMAN is now vice president of engineering. . . . HIRAM S. CRAMER has been named production vice president.

* * *

FRANK VAN GILDER has become assistant sales manager, merchandise division, at International Resistance Co., 401 N. Broad St., Philadelphia 8, Pa.

* * *

RICHARD A. HYER has become head of a newly formed community-TV cable service section of Federal Telephone and Radio Co., 100 Kingsland Rd., Clifton, N. J.

* * *

REP SALES CHAMP



(Left)

Jack Heimann of The Heimann Company, upper midwest sales rep for IRC, receiving IRC distributor sales champ award, a giant-size resistor inscribed and mounted on a mahogany plaque, from Harry A. Ehle, vice president, during a meeting at recent parts show in Chicago.

(Right)

At recent Chicago parts show distributor conclave sponsored by Channel Master Corp., left to right: Henry Spolane, Sterling Radio, Houston, Texas; Phil Rothstein, Bill Hartenstein, and Al Rothstein, Southeastern Radio Supply Co., of North Carolina; Mickey Spolane, Sterling Radio, and Pete Messina, comptroller, Channel Master Corp.

AT CHICAGO PARTS SHOW



INADEQUATE WIRING A MAJOR PROBLEM AFFECTING TV PERFORMANCE

One of the greatest problems of the electrical industry is that of inadequate distribution and insufficient wiring. Systems that are planned to standards that existed years ago when the average residential load was only 25% or less of today's demand are inadequate to main-

tain the capacity and maintain the voltage necessary for the proper performance of all the *usual* appliances and equipment available in the average American home. The extreme sensitivity of a TV receiver is instantly effected in performance by a low voltage condition. This problem

CAN BE SOLVED WITH THE ACME ELECTRIC T-8394M VOLTAGE ADJUSTOR

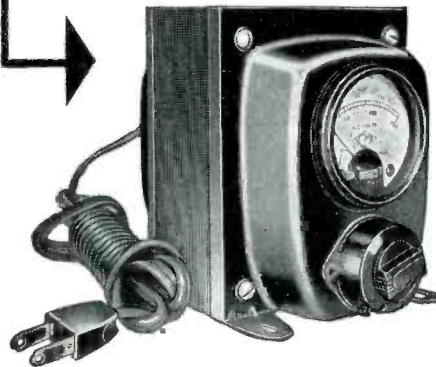

The T-8394M Voltage Adjustor can be used by the service man to reproduce the operating condition about which the customer complains by turning tap switch to the voltage which simulates such condition. For example, customer complains that evening program pictures flicker and shrink. When service man calls next day all operation appears normal — voltage tests out properly. But, by adjusting voltage to 97 volts the condition about which the complaint was made is reproduced. This indicates low voltage condition during evening that can be corrected with a T-8394M Voltage Adjustor.

ORDER FROM YOUR JOBBER

ACME ELECTRIC CORPORATION
MAIN PLANT: 477 Water Street • Cuba, N. Y.
West Coast Engineering Laboratories: 1375 W. Jefferson Blvd. • Los Angeles, Calif.
In Canada: ACME ELECTRIC CORP. LTD. • 50 Northline Road • Toronto, Ont.



"Atomic Radiation

Detection and

Measurement"



The basic new book
on this important
subject by
Harold S. Renne

This is the clearly written book that gives you a basic understanding of nuclear science and its applications, together with a full discussion of the equipment and techniques required for detecting and measuring atomic radiation. Covers the subject in 10 definitive chapters:

- 1. Atomic Structure:** Describes the atom, the types of particles in various nuclear reactions; atomic and nuclear structure; types of atoms; isotopes, energy and the electron volt, nuclear reactions.
- 2. Atomic Radiation and Effects:** Types of rays emitted by radioactive materials; methods of measuring radiation; radiation effects on humans.
- 3. Radiation Detection Devices:** Basic devices and techniques used for detection; cloud and ionization chambers, Geiger tubes; electroscopes and electrometers, scintillation crystals, chemical indicators and photographic emulsions.
- 4. Commercial Geiger Counters:** Circuit description and operation of many types now available.
- 5. Scintillation Counters:** Circuit description and operation of types now on the market.
- 6. Home-Built Counters:** Designs for simple Geiger Counters; build-your-own instructions.
- 7. Dosimeters:** Description and operation of various types now in use.
- 8. Applications of Nuclear Science:** Industrial applications, generation of power, nuclear reactors; application of radioactive isotopes.
- 9. Civil Defense:** Problems confronting civil defense authorities in event of atomic attack.
- 10. Prospecting:** Methods for uranium or thorium prospecting; characteristics of radioactive ores.

Here's the ONE book that covers the whole subject of atomic radiation and detection in easy-to-understand language. You'll want this book. 200 pages, 5 1/2 x 8 1/2"; illustrated.

ORDER TODAY

ORDER ADR-1 **\$3.00**
Only

HOWARD W. SAMS & CO., INC.

Order from your Parts Jobber today, or write to Howard W. Sams & Co., Inc., 2207 E. 46th St., Indianapolis 5, Ind.

My (check) (money order) for \$..... enclosed.
Send copy(ies) of "Atomic Radiation Detection & Measurement" (ADR-1, \$3.00)

Name.....

Address.....

City..... Zone..... State.....
(outside U.S.A. priced slightly higher)

NEWS

RAYTHEON TUBE SALES MEETING

Fifty reps attended the recent annual Raytheon distributor tube sales meeting in Chicago. Talks on the industry picture for receiving and picture tubes, tube promotion campaigns, sales aids, '55-'56 advertising plans and a summary of transistor activity were reviewed by C. R. Hammon, D. T. Lucas, E. I. Montague, F. B. Simmons, J. J. Slateritz, and F. E. Anderson.

* * *

RCA TREASURE CHEST CAMPAIGN

RCA has announced a tube promotion campaign featuring a tube carrying case, *Treasure Chest*, which holds 54 miniature, 56 regular and 24 large tubes. A small tool compartment is provided. Also in the campaign is a *multicord*, a harness which includes cord connectors to fit all TV receivers; a three-way power outlet for use with test equipment and tools near chassis, and a clamp-on work light for chassis illumination.

Company is using *teaser* postcards, fliers, floor displays and samples of *Treasure Chest* and *multicord* to spark the drive.

* * *

TACO EXPANDS

Technical Appliance Corp., Sherburne, N. Y., has announced completion of its fourth plant addition. Manufacturing space now totals more than 70,000 square feet on one floor.

* * *

DICK MORRIS CELEBRATES 18TH YEAR WITH SNYDER

Dick Morris, sales manager for Snyder Manufacturing Co., observed his 18th anniversary with the company recently.

Morris joined the firm when it was located at Noble and Darien Sts. as a member of the small sales staff. During World War II, Morris was assigned to government liaison work and directed the development of military equipment for Snyder.

* * *

PARTS SHOW GET-TOGETHER



Herb Cornelius, sales manager for Littelluse (center) chatting with (left to right) Jerry Martin, Lima, Ohio; Marc F. Miller, also of Lima, John E. Liedtke, and Howard Bear, both of Cleveland, at recent electronic parts show held in Chicago.

Standard Type Tuners stay cleaner longer when cleaned with

Contact-Kleen



by the makers of GEMCO Thermal Replacements for glo-bar filament resistors.



Great Eastern M'fg Co.
B'klyn 12, N. Y.

Don't just say "capacitors"

Ask For Sprague By Catalog Number

Know what you're getting ... get exactly what you want. Don't be vague ... insist on Sprague. Use complete radio-TV service catalog C-610. Write Sprague Products Company, 61 Marshall Street, North Adams, Massachusetts.

SPRAGUE

WORLD'S LARGEST CAPACITOR MANUFACTURER

Schematics In This Issue

	Page
Audio Damping Factor Analysis Circuitry	26
Emerson 838 Transistor-Tube Pocket Radio	36
Color-TV 21-Inch 26-Tube Receiver; Cover (RCA CTC4-CTC4A)	21
Community TV Variable-Equalizing ACG Amplifier	19
RCA 6-JSH-1 3-Speed Changer With VR Cartridge	34
Stromberg-Carlson 21-22 TV Chassis Focus Socket	32
Triode-Pentode Equalizer-Preamp Circuitry for 3-Speed Changers	35
UHF 2-Channel Dual-Antenna Coupler-Filter	24
VTVM Circuitry Refinements	33
Zenith Flash-Matic TV-Chassis Photoelectric Remote Control	50

This is the
2-Set TV COUPLER

Rated No. 1

• • • by a nationally known independent product quality rating group as the result of tests made on 10 leading two-set couplers for:

- IMPEDANCE MATCH
- SIGNAL TRANSFER
- TWO-SET ISOLATION

MOSLEY 902



List Price \$3.95

Rated **FIRST** in overall quality for weak signal reception means; the MOSLEY 902 Dual Match 2-Set TV Coupler can be sold and installed in practically any TV area with full confidence that your customers will be completely satisfied!

Available at Radio and Television Parts Distributors — coast-to-coast.

Mosley
Electronics, Inc.
 8622 ST. CHARLES ROCK ROAD
 ST. LOUIS 14, MISSOURI

WHEN YOU CHANGE YOUR ADDRESS

Be sure to notify the Subscription Department of SERVICE at 52 Vanderbilt Avenue, New York 17, N. Y., giving the old as well as the new address, and do this at least four weeks in advance. The Post Office Department does not forward magazines unless you pay additional postage, and we cannot duplicate copies mailed to the old address. We ask your cooperation.

TV Parts... Accessories

B-T TV MASTER AMP WITH AGC

A single-channel TV amplifier with *agc*, model *MCS*, for amplifying, mixing and equalizing individual *vhf* channels, is now available from Blonder-Tongue Laboratories, Inc., 526-536 North Ave., Westfield, N. J.

Features built-in power supply, *ac* receptacle for external power cord, and 75-ohm coax fittings. Tube complement: two 6CB6s; one 6BK7A and one 6AM8.

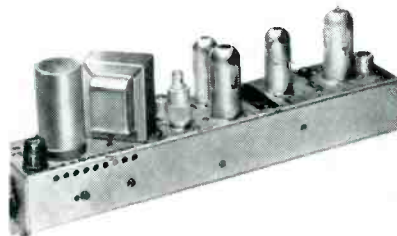

PERMA-POWER TUBE BRIGHTENER

A picture tube brightener, model C201, adaptable to either parallel or series-string filament circuits via a self-contained reversible plug, has been developed by Perma-Power Co., 4727 N. Damen Ave., Chicago 25, Ill.

Accommodates both electrostatic and magnetic focus tubes.



COL-R-TEL COLOR CONVERTER

A color TV converter, *Col-R-Tel*, operating on the scanning-disc principle, has been announced by Color Converter, Inc., Columbia City, Ind.

Unit produces 14-inch color picture. Scanning disc consists of segments of colored plastic revolving at 600 *rpm*.

Translates compatible color telecasts by means of an electronic unit which is installed at the back of b-w TV set.

Speed of scanning wheel is controlled by the vertical sweep of the TV set. Converter uses the following tubes: 6U8, gated color burst amplifier; 6U8, color burst amplifier and limiter; 6BC7, phase-selection diode; 6BE6, chroma detector; two 12BH7s, one serving as a chroma amplifier and another as a scanning-wheel sync control-amp; 6BL7, scanning-wheel motor control, and 6X4, power rectifier.

INTERNATIONAL



Selenium Rectifiers

the Replacement Rectifier that's Right!

all TV and RADIO types available from your parts distributor

INTERNATIONAL

RECTIFIER CORPORATION

El Segundo, Calif. ORegon 8-6281

NEW YORK • CHICAGO

World's Largest Supplier of Quality Industrial Rectifiers

Snyder
PHILADELPHIA

**Auto
Antennas**

**WORLD'S
MOST
COMPLETE
LINE**

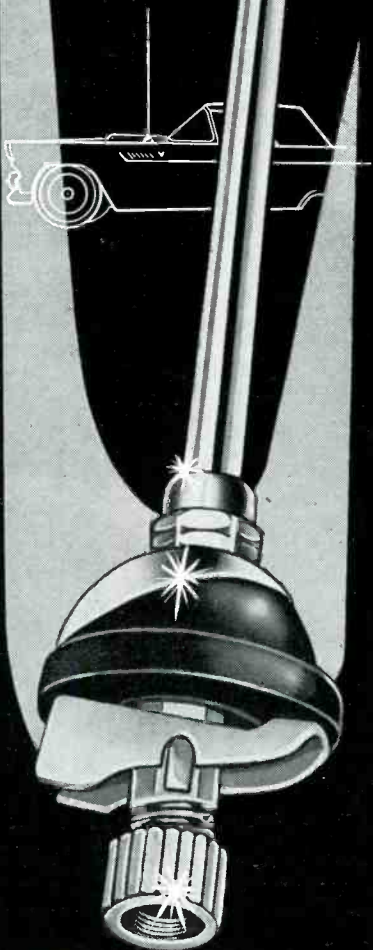

40 MODELS+

Bench-Field Tools . . .

G-C TUNER CLEANER

A TV tuner contact cleaner, *Kleen-O-Matic*, designed to clip on all Standard Coil tuners to clean contacts with a few turns of the selector knob, has been announced by General Cement Mfg. Co., 919 Taylor Avenue, Rockford, Illinois.

Linen webbing inside brass housing constantly polishes contacts.

Supplied in three styles; 9221 for the Standard *Standard* tuner; 9222 for the *U-type* and 9223 for *T-Type* tuner.

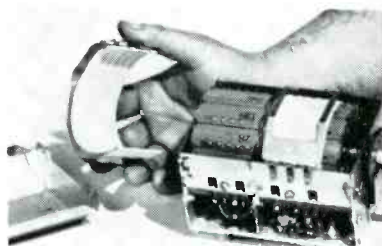

AMERICAN ELECTRICAL BANTAM SOLDERING IRONS

A small soldering iron, *Bantam*, featuring a tapered spool nose and projection-free casing for access to hard-to-reach spots, has been announced by American Electrical Heater Co., Detroit 2, Mich.

Units have stainless steel casings. Heating elements are mica-insulated nickel-chromium. Diamond point tips are $\frac{1}{8}$ " or $\frac{3}{16}$ " in diameter; chisel type tips also available. Supplied in pencil type or standard handles and long or short casings.

ADJUST-A-VOLT VARIABLE TRANSFORMERS

Two variable transformers, *500B* and *500BU*, are now available from Standard Electrical Products Co., 2240 E. Third St., Dayton, O.

Model *500B* unit is cased for lab and industrial use, and features extractor type fuse, pilot light, output receptacle cord, plug and off-on switch; *500BU* unit is uncased for back-of-panel mounting and has tap wired to terminal board to provide 6 ν for pilot light. For input voltage of 115; maximum load rating of 1 kva; output voltage from 0-115 and 0-145, and maximum output of 7.5 amp.

CONTOUR SCREW DRIVER AND SOCKET WRENCH SET

A screw driver and a socket wrench set, featuring a spotlight, have been developed by Contour Marker Corp., 1843 E. Compton Blvd., Compton, Cal.

Both feature hardened chrome steel shafts, and blue plastic handles which serve as battery cases. Socket set has six detachable heads; $\frac{1}{4}$ ", $\frac{3}{16}$ ", $\frac{7}{32}$ ", $\frac{9}{32}$ ", $\frac{5}{16}$ ", $\frac{11}{32}$ " and $\frac{3}{8}$ ".

**Joe
Serviceman
says:**



**"You can't get somethin'
for nothin', especially
Quality and Reliability"**

QUIETROLE

TRADE MARK REG. U.S. PAT. OFF.



the original lubricant and cleaner for quieting noisy controls and switches, costs little more than the cheapest imitations, but the name assures you are getting the best.

INSIST ON QUIETROLE

THE CHOICE OF
BETTER SERVICEMEN
"EVERYWHERE"



manufactured by
**QUIETROLE
COMPANY**

Spartanburg, South Carolina

STEEL ANTENNA TOWERS

**need no
GUY WIRES**

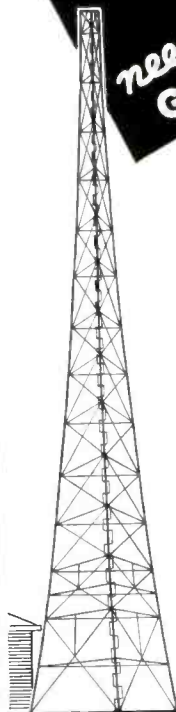

Improve radio and TV reception. Easy to erect . . . self-supporting 3 post towers . . . last a lifetime. Built of galvanized steel sections—no guy wires necessary—safe and resistant to high wind.

Available in heights of 33, 47, 60, 73, 87, and 100 feet.

**TERRITORIES OPEN FOR
JOBBER-DEALER FRANCHISE**

Write for dimensions, structural details, prices, discounts, and available territorial assignments.

AERMOTOR COMPANY

Dept. 6607, 2500 Roosevelt Rd., Chicago 8, Ill.
BUILDERS OF STEEL TOWERS SINCE 1888

ADVERTISERS IN SERVICE

JULY, 1955

	Page
Acme Electric Co.	57
Aermotor Co.	62
Aerovox Corp.	47
Alprodc Co.	38
American Microphone Co.	41
Astron Corp.	37
B & K Mfg. Co.	48
Bussmann Mfg. Co.	8
CBS-Hytron (Div. Columbia Broadcasting System)	1
Channel Master Corp.	7
Chicago Standard Transformer Corp.	59
Columbia Wire and Supply Co.	63
Cornell-Dubilier Electric Corp.	55
Inside Front Cover, 55	
Delco Radio Div. Genl. Motors Corp.	45
Electronic Instrument Co., Inc. (EICO)	52
Electro Products Laboratories	2
General Cement Mfg. Co.	9
Great Eastern Mfg. Co., Inc.	58
The Heath Co.	56
Hughes Research & Development Labs. (Hughes Aircraft Co.)	53
International Rectifier Corp.	61
Jensen Industries, Inc.	46
Jerrold Electronics Corp.	52
Jontz Mfg. Co.	54
Kester Solder Co.	38
Littlefuse, Inc.	11
P. R. Mallory & Co., Inc.	Inside Back Cover
Mosley Electronics, Inc.	61
Moss Electronic Dist. Co., Inc.	54
Phalo Plastics Corp.	64
Planet Sales Corp.	60
Precision Apparatus Co., Inc.	14
Pyramid Electric Co.	28
Quietrole Co.	62
The Radiart Corp.	Inside Front Cover, 55
Radio Corporation of America	3, 31, 46, Back Cover
Radio Receptor Co., Inc.	49
Raytheon Mfg. Co.	12
Howard W. Sams & Co., Inc.	51, 58
Shure Bros.	43
Simpson Electric Co.	39
Snyder Mfg. Co.	62
Sprague Products Co.	46, 52, 58
Triad Transformer Corp.	64
Tung-Sol Electric Inc.	6
U. S. Treasury Dept.	10
United Motors Service Div. Genl. Motors Corp.	4, 5
G. F. Wright Steel and Wire Co.	56
Xcelite, Inc.	60

Components

ERIE DISC AND CERAMICON KITS

Two ceramic capacitor kits have been made available by Erie Resistor Corp., Erie, Pa.

Each kit consists of an 18-section plastic storage case containing 100 disc Ceramicons or 100 GP tubular Ceramicons in 18 values.

* * *

GRAMER-HALLDORSON MINIATURE TRANSFORMERS

Miniature interstage transformers, *Miniformer 100W72*, designed for hearing aids, pocket radios, FM transceivers and telephone recorders, have been developed by Gramer-Halldorson Transformer Corp., 2734 N. Pulaski Rd., Chicago 39, Ill.

Unit has primary impedance of 20,000 ohms; secondary 1,000 ohms; primary *dc* resistance, 1,030 ohms and secondary, 167 ohms.

* * *

RCA SELENIUM RECTIFIERS

Five universal-type rectifiers (*200G1*, *201G1*, *202G1*, *203G1*, and *204G1*), for replacement use in TV receivers, radios, phonos and other electronic equipment, have been announced by Tube Division, RCA, Harrison, N. J.

Units feature corrugated metal separators between each pair of plates that are anchored to a U-clamp surrounding plate stack. Model *200G1* has a maximum output current of 75 ma; *201G1*, 150 ma; *202G1*, 300 ma; *203G1*, 400 ma; and *204G1*, 500 ma.

* * *

CLAROSTAT WIRE-WOUND CONTROLS

A wiper arm, insulated from shaft and mounting bushing, has been incorporated into type MH wire-wound controls produced by Clarostat Manufacturing Co., Inc., Dover, N. H.

Units are rated at 1 *w* and can be had in values from 2 to 1,000 ohms. Complete details in *bulletin 753812*.

* * *

AEROVOX CERAMICS

Ceramic capacitors designed to serve as ring types to fit around metal tube sockets, or multiple-section rectangulars in metal cans for bypass applications, have been announced by the Hi-Q Division, Aerovox Corp., Olean, N. Y.

* * *

C-D LOW TEMPERATURE ELECTROLYTICS

Two electrolytics, *BRX* and *BBRX*, for service at low ambient temperatures, have been developed by Cornell-Dubilier Electric Corp., South Plainfield, N. J.

Units are made of etched aluminum foil in hermetically sealed metal cases. Positive terminal wire on *BRX* is connected through a rivet fastened to vented rubber-bakelite insulating washer spun-sealed into case. *BBRX* positive terminal is connected through crimped stud passing through rubber-bakelite insulating washer. Features temperature range from -55° to + 65° C; available in 25, 50 and 150 *wvdc* ratings.

AVAILABLE through all jobbers!

AT NO EXTRA COST

All packaged "Columbia" 300 ohm line now has open spade terminals securely attached to one end of line for perfect antenna attachment . . . PLUS 2 loose terminals for set attachment . . . AT NO EXTRA COST.

A wonderful time saver for the serviceman . . . 60 ft., 75 ft., and 100 ft. coils of high quality 300 ohm television line. Terminals slide easily under screw heads in seconds. Loose terminals are easily attached with a pair of pliers.

Television line and terminals are packed in a heat sealed, clear polyethylene bag, insuring a clean, dry, dust free item until used.

ORDER this money and time-saver TODAY!

Columbia WIRE & SUPPLY CO.
2850 Irving Park Road • Chicago 18, Ill.

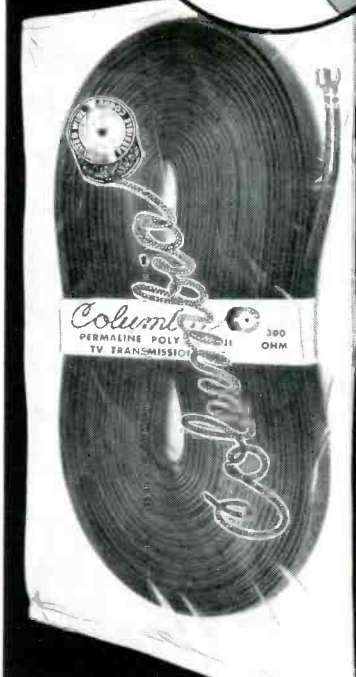
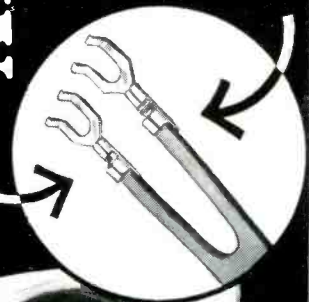

Have you received your FREE COPY of "Columbia's" newly enlarged 36-page catalog?

3 **CR**
MORE NEW
TRIAD
***CORRECT**
REPLACEMENT
FLYBACKS

These three new flybacks are mechanically correct and electrically correct, ruggedized versions of manufacturer's items — precisely engineered by TRIAD for specific makes and models — to give exceptionally high performance and long, trouble-free service.

 D-52 List Price \$7.15 *Correct Replacement for RCA 75519, 75585, 76381.	 D-53 List Price \$7.45 *Correct Replacement for RCA 76501, 76672.	 D-56 List Price \$9.50 *Correct Replacement for Airing, CBS, Silver-tone, 10104, 10107, 10108, 10110, 10126, 10135.
--	--	--



****COMPOSITE**
REPLACEMENT

Triad flybacks wherever possible are COMPOSITE items designed to provide correct electrical and mechanical characteristics for as many television chassis as possible.

Ask your distributor, or write, for Catalog TV-155L

Triad *CR Transformers are listed in Sams Photofact folders and Counter-Facts.



4055 Redwood Ave. • Venice, Calif



JOTS AND FLASHES

OVER 230 components, including resistors, capacitors and sockets, are mounted on printed circuit sections of Admiral TV receivers now being produced, and more than 70 per cent of these components are inserted by automation on automatic assembly machines. The new technique, it is said, has eliminated 400-odd hand-soldered connections; after assembly by automation, each section is dipped briefly in solder to accomplish in a split second what formerly required several hundred individual connections, with hand soldering irons. Three printed panels contain 13 tubes and represent from 75 to 80 per cent of all the circuitry. . . . Informal *guess-estimates* at the recent RETMA meeting in Chicago indicated that 7 to 7.3 million b-w TV receivers and 12.5 to 13-million radios, including 4.5 to 5-million auto sets will be sold in '55, and 6.5 to 7-million b-w TV receivers will be retailed in '56. . . . In color, estimates ranged widely and were conditional on the extent of color TV broadcasting, but the prevailing view expressed was that around 35,000 color sets will be sold in '55 and between 250,000 and 300,000 in '56. . . . A new job has been found for closed-circuit TV; speeding and improving production at a cigarette paper plant. Peter J. Schweitzer, Inc., has installed an RCA TV Eye for remote observation of a paper-pulp washing tank to assure against jamming or plugging which would result in a costly shutdown for repairs. Camera, installed in the plant's pulp-washing room and connected by closed-circuit to a TV monitor two floors below, is focused on the pulp-washing tank and projects a continuous picture of operations to the monitor for remote observation. . . . *John F. Rider* delivered the key address during RETMA-course graduation ceremonies at the Madison (Wis.) Vocational and Adult School. This was the first course completed in the mid-west by students who took the TV Service Man training course developed by RETMA. . . . *Thomas R. Kennedy, Jr.*, formerly a member of the radio-television news and editorial staff of The New York Times, has joined the public relations staff of Allen B. Du Mont Laboratories, Inc. . . . *A Simplified TV Service Handbook* describing (in chart form) symptoms and checks for G.E.'s '54-'55 line of receivers, supplemented by chassis data sheets illustrating basic tube and rear console and table-model layouts, has been prepared by the G.E. service department. . . . *Jerrold Electronics Corp.* will soon begin construction of a lab on a six acre plot at Byberry Road and the Pennsylvania Turnpike, just outside Philadelphia. Lab will be a one-story cinder block building of about 5,700 square feet and is expected to be in use by the fall. . . . *Stephen E. McCallum* has become editor-in-charge of a new G.E. electronic tube news bureau. McCallum has for the past two years been editor of the *G.E. Ham News*. . . . Newark Electric Co., has purchased Acorn Radio and Electronics, 4736 West Century Blvd., Inglewood, Calif.; it will be operated as a wholly owned subsidiary under the name of Newark Electric Company of Calif. . . . The TV-antenna spot-announcement campaign,† developed by *Channel Master*, appealing to women to call for Service Men when the TV sets act up, has become a program feature of a number of TV stations.

†National Scene, SERVICE, June, 1955.

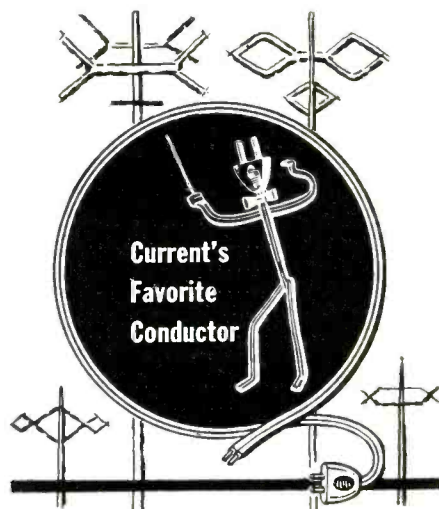

Stay Tuned To Quality
 in
Radio - Television Wires & Cables

PHALO
QUALITY



PHALO TUBULAR 300 OHM LINE



PHALO FLAT 300 OHM LINE

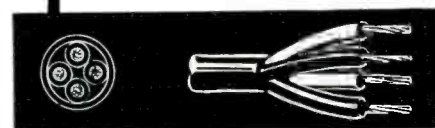

PHALO ROUND ROTOR CABLE

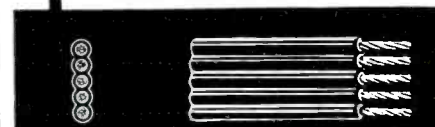

PHALO 4/C FLAT ROTOR CABLE



PHALO SOLID COAXIAL CABLE

For A More Complete Phalo Quality Story — Get This Catalog



PHALO PLASTICS CORPORATION
 25-3 Foster St., Worcester, Mass.

Insulated Wires, Cables and Cord Set Assemblies

P. R. MALLORY & CO. INC.
MALLORY

APPROVED PRECISION PRODUCTS

P. R. MALLORY & CO. INC.
MALLORY

APPROVED PRECISION PRODUCTS

P. R. MALLORY & CO. INC.
MALLORY

APPROVED PRECISION PROD



APP

M

APPROVED PRECISION PRODUCTS

HUM HUSHING DESIGN

*makes Mallory's
"25th Anniversary" model
the quietest vibrator ever*

TAKE a look inside the Mallory 25th Anniversary Vibrator*—and you'll see why it's so free of mechanical hum. The vibrator mechanism "floats" in a bell-shaped rubber liner. Noise produced by the vibrating element just doesn't have a chance of getting to the case or mounting plug.

That's not all. The rubber cup at the plug end also "floats" in place... never touches the can at more than one point. Even the leads are designed to minimize transmitted noise.

The net result is the quietest-running vibrator you've ever seen... or heard. Its mechanical hum is actually less than the electrical noise emitted by the speakers of most auto radio sets. And it costs no more than previous Mallory models.

On every vibrator replacement job, treat your customers to the quietest performance on the market. Check your stock today... and call your local Mallory distributor for quick delivery.

*Pat. Pending

P. R. MALLORY & CO. INC.
MALLORY

CAPACITORS • CONTROLS • VIBRATORS • SWITCHES • RESISTORS
RECTIFIERS • POWER SUPPLIES • FILTERS • MERCURY BATTERIES
APPROVED PRECISION PRODUCTS

P. R. MALLORY & CO. Inc., INDIANAPOLIS 6, INDIANA



BY POPULAR DEMAND!

... the new

... the improved

RCA "TREASURE CHEST"



LARGER—
holds more tubes!

STRONGER—
built to last longer!

MORE PROFESSIONAL LOOKING—
helps build your prestige!

Here it is—the *new, improved* RCA "Treasure Chest"! Use it to carry a full selection of receiving tubes with you on your service calls. Use it to carry small tools. Use it to display the world-famous brand name—RCA—and let it work for you to build your business by instilling customer confidence.

STARTING NOW . . . For each RCA Picture Tube, or every 25 RCA Receiving Tubes you purchase, your RCA Tube Distributor will give you one RCA "Treasure Note." Save 20 "Treasure Notes" and your RCA Tube Distributor will trade them for the *NEW* RCA "TREASURE CHEST." This rugged, custom-built tube-carrying case is *not for sale* anywhere, at any price!

*Here's more
treasure . . .
the RCA
"MULTICORD"!*



It's an all-in-one power cord with two popular types of "cheater" receptacles; a hard-rubber, 3-way power outlet for test equipment, soldering gun, etc.; and a clamp-on work light. A real time-saver for busy service technicians! It's yours **FREE** of extra cost for only 5 RCA "Treasure Notes."

These offers expire at midnight, August 31, 1955 so act promptly. Don't miss out . . . Order your RCA Picture Tubes and RCA Receiving Tubes and start collecting valuable "Treasure Notes" now!



RADIO CORPORATION of AMERICA
TUBE DIVISION

HARRISON, N. J.