

for the
new 12 volt
auto circuit

RADIART

announces its
6300 series...

an addition
to the full line of



Seal-Vent

RED SEAL VIBRATORS

Faster Starting

The exclusive RADIART design permits the briefest possible "Warm-up" period, thereby making the RADIART vibrators practically instantaneous starting. This added feature means greater performance.

Longer Life

There's more for your money in every RADIART vibrator—they last longer! Precision manufacture, using only the finest materials, assures long lasting, trouble-free performance.

Complete Replacement Line

RADIART has a CORRECT replacement vibrator for every original equipment vibrator. 12 Radiart vibrator types serve over 89% of all popular replacements. NOW...THE NEW 6300 SERIES IS READY FOR THE NEW '53 car MODELS with radios having 12 volt circuits.

Seal-Vented

Sealed at the factory to prevent the formation of an insulating film on the points while the vibrator is on the shelf...the sealed vent automatically opens when put in use to allow the vibrator to "breathe".



SUBSIDIARY OF



preferred by Servicemen Everywhere

THE RADIART CORPORATION CLEVELAND 13, OHIO

VIBRATORS • AUTO AERIALS • TV ANTENNAS • ROTORS • POWER SUPPLIES

SM Means



ASTRON SAFETY MARGIN CAPACITORS

Yes, ASTRON's *Safety Margin* means there's an extra margin of safety built into every ASTRON Capacitor. SM means an improved electrolyte, an exceptionally high purity anode foil, rigid quality control and step-by-step testing . . . all assuring longer life, greater dependability, extra resistance against voltage surges, heat, moisture. SM means fewer call-backs, more satisfied customers, a better reputation for you. So buy the best—buy ASTRON SM Capacitors—a complete line of electrolytic and molded paper capacitors.

Individually tested—individually guaranteed

Write For Catalog AC-3 and Name of Jobber Nearest You

ASTRON

CORPORATION

255 Grant Avenue, E. Newark, N. J.

TV Technicians —

Show your Skill

Let your customers SEE that GOOD service is your business. Your skill is your most precious asset. Dress it up with the right tools to make sure it's appreciated.



NEW
De Luxe
tube caddy

\$14.95*

Carries TOOLS and TUBES, Saves TIME, MONEY

PAYS for ITSELF

Technicians who carry the Tube Caddy make the right impression. Handy top tray for tools, soldering gun, or meter. Regimented drawers give tube inventory at a glance. Slip-apart hinges on cover, with clips inside for price list or mirror.

Its efficiency saves time, its neatness inspires confidence—builds business. Con pay for itself in three weeks time. Size 18 x 14 1/2 x 9 1/4 in. Ask your Parts Jobber or write.

*Not to Dealer. Higher on West Coast. Other Models \$13.50 and \$7.75.

Craftsmanship in Cabinets

Argos
PRODUCTS COMPANY

310 MAIN STREET • GENOA, ILLINOIS

SERVICE

LEWIS WINNER
Editor

B. BLOCK
F. WALEN
Assistant Editors

Including SERVICE—A Monthly Digest of Radio and Allied Maintenance, Radio Merchandising and Television Merchandising. Registered U. S. Patent Office

A 'Scope Amplifier With VTVM. By James S. Kendall	54
Association News	80
Audio Installation and Service (Preamp Equalizers and Control Amps). By Kenneth Stewart	50
Dip Meter With 1.75 to 260-Mc Range (Cover). By Wyn Martin	33
In the Field (Db and Alignment . . . Matching . . . Mirror Image Distortion Analyses)	74
Pickups, Needles and Tone Arms. By Mark Vino	40
'Scope Improvements for Service Engineering. By Ronald L. Ives	56
Ser-Cuits (UHF/VHF Continuous Tuning Booster-Converter). By M. W. Percy	42
Service Engineering Field and Shop Notes. By Thomas K. Beamer	66
Service . . . The National Scene	29
Servicing Helps (Line-Voltage Variation Correction). By M. A. Marwell	70
Steelton, Pa., UHF/VHF Community TV (Equipment Details). By Mark Houtz	72
Stocking Up for UHF Service. By Harold Schulman	34
Ten Years Ago	81
Tube News (Point-Contact and Junction Transistors). By L. M. Allen	46
TV Antenna Digest (New Developments for UHF). By Ralph G. Peters	76
TV Troubleshooting Tools (Probe-'Scope Applications). By C. K. Sterling	36
UHF/VHF Tuners. By Henry R. Hesse	38
Views and News. By Lewis Winner	27
Weak Chassis Complaints (Curing Troubles in Portables and Battery Sets). By Jack Darr	62

AUDIO INSTALLATION AND SERVICE

Control Amplifiers	50
Preamp Equalizers	50
Speaker Enclosures	51
Variable Speaker Crossovers	51

CIRCUITS

Barker and Williamson Model 600 Dip Meter (Cover)	33
Brociner A100 and A100P Preamp-Equalizer	50
Brociner CA-2 Control Amplifier	51
Capehart-Farnsworth CX-37 Horizontal Phase Detector	45
Capehart-Farnsworth Horizontal AFC in CX-37	49
Community TV High-Band Preamp	72
Community TV Isolation Unit	72
Full Coverage U/V Tuner	38
Hot-Cathode Phase Inverter	58
Junction-Transistor Circuitry Operation	47
Mobile Transmitter-Receiver Primary Power Circuit	68
Motorola UHF Tuner	43
Peaking-Coil Circuitry	56
Phase Inverter With Dual Cathode-Follower Output	58
Phase-Split Amplifier Circuitry	54
Oscillator Using Pentagrids	62
Point-Contact Transistor Circuitry Operation	47
Retrace Blanking Amplifier	58
'Scope Amplifier Stage	56
'Scope Amplifier With Gain of 10-100	54
'Scope Amplifier With VTVM	54
Screen Booth System Circuitry	66
Service Instrument Voltage Booster	70
Sulco UHF/VHF Converter-Booster Model 21-A	42
Transistorized Audio Amplifier	46
Typical U/V Tuner of Future	39
Turret Tuners Equipped With UHF and VHF Strips	38
UHF Balun Construction	39
Z-Axis Input Circuit	61

SERVICE ENGINEERING FIELD AND SHOP NOTES

Field and Shop Instruments . . . Audio Consoles . . . Speakers	69
Installing 25-50 Mc Quarter-Wave Antennas	69
Mobile Dynamotor Relay Life Checks	66
Screen Booths for VHF and UHF Testing and Measurements	66

Index to Advertisers

	104
--	-----

Manufacturers

Catalogs and Bulletins	82
Jots and Flashes	104
News	87
New Parts . . . Tools . . . Instruments	100
On Book Row	83
Personnel	85
Rep Talk	84
TV Parts . . . Antennas . . . Accessories	103



Entire contents Copyright 1953, Bryan Davis Publishing Co., Inc.
Published monthly by Bryan Davis Publishing Co., Inc.

52 Vanderbilt Avenue, New York 17, N. Y. Telephone MUrray Hill 4-0170

Bryan S. Davis, Pres. Paul S. Weil, Vice-President F. Walen, Sec. A. Goebel, Cir. Prom. Mgr.
Mid-West Representative: Stuart J. Osten, 333 N. Michigan Ave., Chicago 1, Ill. Telephone: DEarborn 2-3507
East-Central Representative: James C. Munn, 2253 Delaware Dr., Cleveland 6, Ohio. Telephone: Erievue 1-1726
Pacific Coast Representative: Brand & Brand, 1052 W. Sixth St., Los Angeles 14, Calif. Telephone: Michigan 1732
Metropolitan District Manager: Donald C. Weill, 52 Vanderbilt Ave., New York 17, N. Y.

Entered as second-class matter June 14, 1932 at the Post Office at New York, N. Y., under the Act of March 3, 1879. Subscription price: \$2.00 per year in the United States of America and Canada; 25 cents per copy. \$3.00 per year in foreign countries; 35 cents per copy.

SPRAGUE

presents...

THE NEW

SERVICEMAN'S DIARY... by Ben Grim

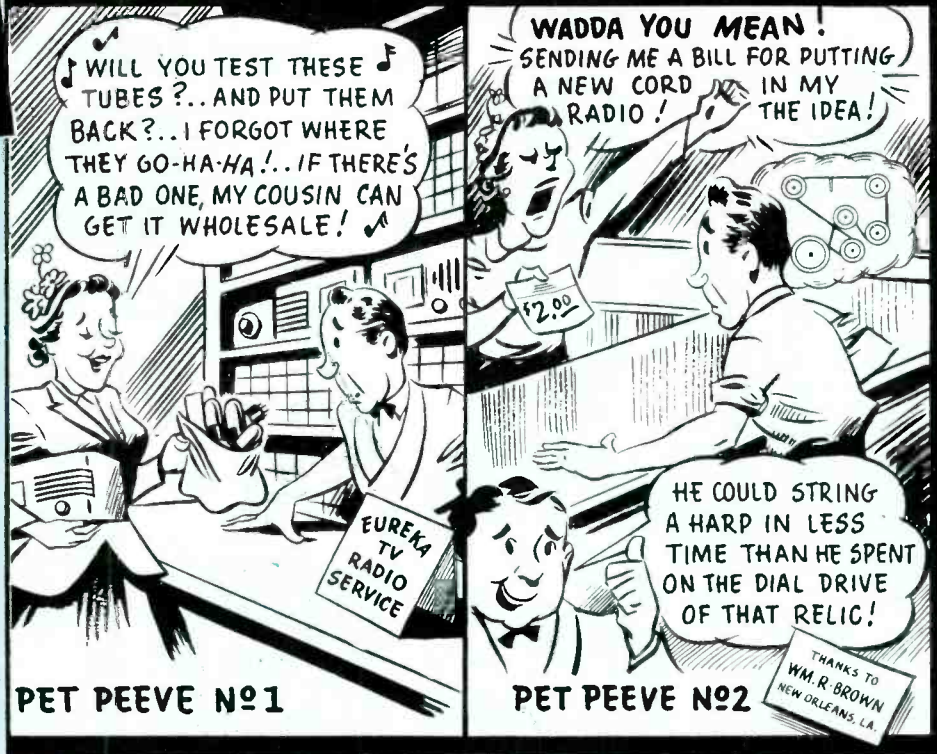

TO-4 TEL-OHMIKE[®]

CAPACITOR-RESISTOR ANALYZER



Here's a compact, reliable, and simple-to-use instrument designed for general laboratory use, yet priced right for every TV and radio service technician. The New TO-4 is made for testing every capacitor from the lowest to the highest capacitance units. Modern service shops find the New TO-4 a must with its instant push-button range selection, magic-eye bridge balancing, direct meter readings of leakage current and insulation resistance, and the continuously adjustable test voltage for checking electrolytics at exact rated voltage.

Three especially valuable *new* features of the TO-4 include, (1) provision of a special low capacitance circuit for checking small ceramic and "gimmick" capacitors down to 1 mmf (in addition to a top capacitance range of 2000 mmf), (2) a simplified insulation resistance circuit with high reading of 20,000 megohms, (3) Safety-First! Automatic discharge of capacitors after test by releasing all push-buttons.

See a demonstration of this sparkling new instrument at your distributors without delay. Or write for descriptive circular M-499 to Sprague Products Company, 61 Marshall Street, North Adams, Massachusetts.

ONLY \$73⁵⁰

SPRAGUE

WORLD'S LARGEST CAPACITOR MANUFACTURER

SPRAGUE PRODUCTS COMPANY IS THE DISTRIBUTORS' DIVISION OF SPRAGUE ELECTRIC COMPANY

SERVICE, APRIL, 1953 • 3

THE BIGGEST THING
IN **UHF**
ALLIANCE TENNA-ROTOR



Alliance Tenna-Rotor opens up the UHF television market. Meet the coming changes in TV with this top TV accessory. UHF is critical—more directional! For good reception from many stations—many channels, Tenna-Rotor, properly installed with a directional all-channel antenna is the **answer!**

The Buying Impulse is there—why not Tap it?

Alliance TV spots Convince, Demonstrate and pre-sell! Newspaper ads fit each market! Alliance TV products are sold the most because they're seen the most!



Important Notice: Changes in television demand changes in antennas. New UHF and VHF stations mean more channels! Current FCC rulings changing channels on nearly 1/3 of existing VHF stations—make many 'stay-put' single channel antennas obsolete! Turning your antenna with Tenna-Rotor eliminates alterations—assures universal, high-gain reception from many stations!

Place your orders now for the NEW Alliance Cascamatic Booster with the Famous "California Circuit!"

This Fully Automatic, 3-tube TV Booster pre-tuned to all VHF channels mounts instantly on back of set—another companion item to Alliance Tenna-Rotor and Tenna-Scope, the selective, single-control Booster.

Sold by Television Dealers Everywhere

ALLIANCE MANUFACTURING COMPANY • ALLIANCE, OHIO

Look! New small size Adashaft Radiohms!

®

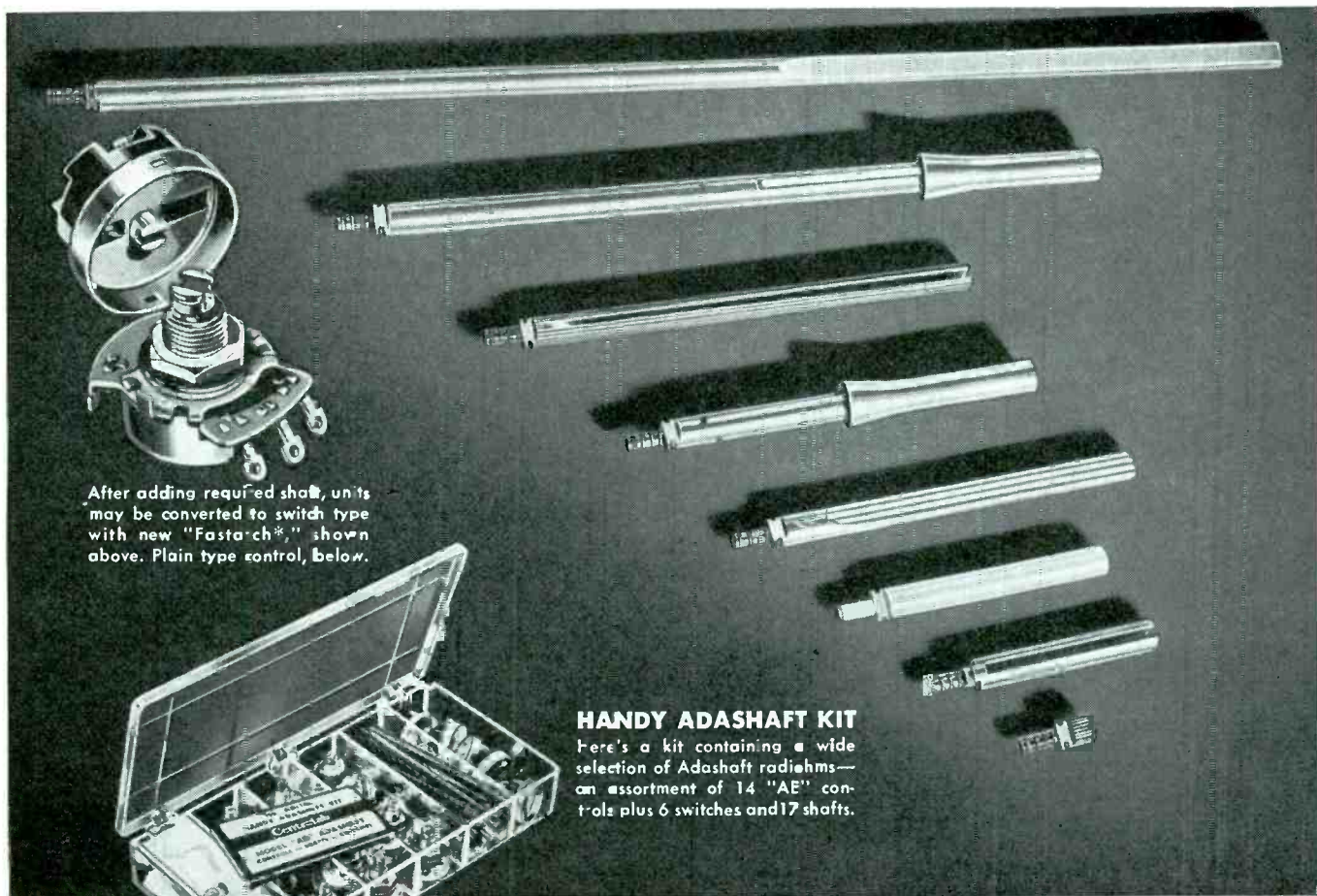

After adding required shaft, units may be converted to switch type with new "Fastach*," shown above. Plain type control, below.

HANDY ADASHAFT KIT

Here's a kit containing a wide selection of Adashaft radiohms—an assortment of 14 "AE" controls plus 6 switches and 17 shafts.

*See your Centralab distributor
for these new guaranteed servicing controls*

Centralab

A Division of Globe-Union Inc.
Milwaukee 1, Wisconsin
In Canada, 635 Queen Street East, Toronto, Ontario

NOW — you can select the new Centralab "Adashafts" from a completely new line. All new Adashafts are in the popular new smaller size — 15/16" in diameter. What is more, you will find there are 43 additional values never before included in the line. Yes, and there are 10 new dual-tap models.

If you're looking for a way to speed your service and reduce your inventory, you'll find Centralab's new, smaller size Adashafts the answer.

Centralab Adashaft Radiohms are unique. Their patented design allows you to easily attach any of nine types of shafts to a basic control. The control unit has a patented stub shaft which permits instant, positive locking. You get a solid, well aligned unit every time!

Shafts range from 3/8" to 10" in length, and include auto types, insulating nylon and many others. In addition, you can convert these units to a switch type by using the new Centralab "Fastatch" type KB line switches.

You'll like the price of cost-saving Adashafts. You pay for exactly what you need. That means money saved for you and your customers. And they're available in all the values you use in radio and television service.

Centralab Adashaft Radiohms are among the more than 470 new items listed in Centralab's new Catalog No. 28. Get your copy of this new 32-page index to the latest developments in the fast-changing electronic field. See your distributor, or use the coupon.

*T. M.



CENTRALAB, A Division of Globe-Union Inc.
908 E. Keefe Ave., Milwaukee 1, Wisconsin

Please send me my copy of the new Centralab Catalog 28 at once and without charge.

Name.....Position.....
Company.....
Address.....
City.....State.....

**Make your Centralab Distributor
headquarters for
exact electronic replacement**

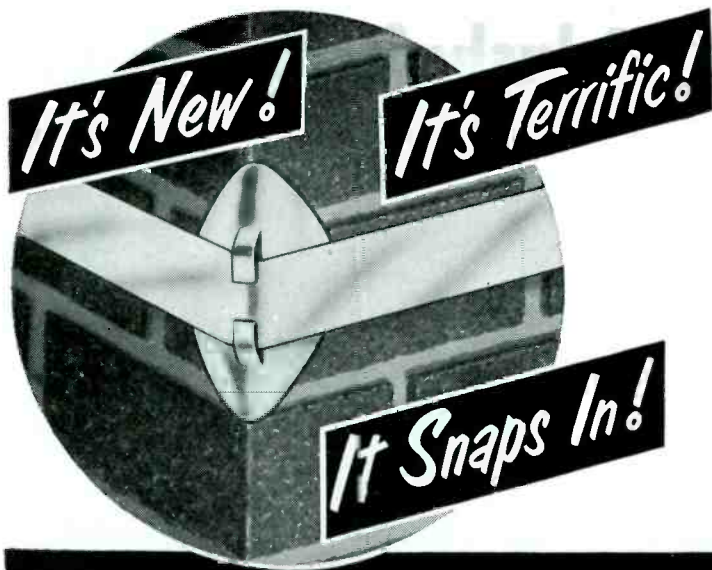

SOUTH RIVER CHIMNEY
CORNER-GUARD®

For every chimney . . . old or new . . . it safeguards mounting equipment, strengthens installations, permits uniform tightening of banding, enables you to make a trouble-free installation on any chimney without fear of chimney-chipping.

MOST IMPORTANT! For a thoroughly practical, protective device, it's so inexpensive, you can't afford to overlook its possibilities. It's a "natural" for building customer goodwill . . . and guarding your own reputation, too.

Protect Every Installation—Guard Your Reputation with

SOUTH RIVER CHIMNEY
CORNER-GUARD®



Box of 6
 On Your
JOBBER'S
COUNTER
49¢
 List

Service men everywhere are praising this bright, new idea for chimney and installation protection. It's the newest in a long line of South River devices created and manufactured to benefit you, the service man.

South River
METAL PRODUCTS CO., INC.
 SOUTH RIVER, NEW JERSEY



Pioneer
and Outstanding
Producer of
the Finest Line
of Antenna
Mounts

Booth 780—Display Room 632A, Chicago Show



how you can sell **more**
automotive
aerials

here's what **WARD** will do to help you



booklet—"How to sell replacement aerials"

After extensive research WARD has prepared a most helpful booklet that explains how you — the dealer — can sell many, many replacement Automotive Aerials. It is a dealer's booklet 100 per cent and gives tips and new slants on how you can tap this tremendous replacement market, — how important are the teen-agers and the "hotrod" enthusiasts, — what the service stations and the car-washers mean to you, — many other valuable ideas. Don't fail to get your copy of this FREE Booklet now.



die-cut cards: — Here's the idea you've been looking for, — a die-cut card you can have boys of your neighborhood slip on bent and rusted Automotive Aerials of parked cars. They're made to look like an "eightball" and direct attention to your service in Ward's famous "Eight-Ball" Antennas.



mailing card: — It's an attractive mailing card specially prepared for your personal mailing to your customers; just what you need to direct your own clientele to their need of Replacement Antennas.

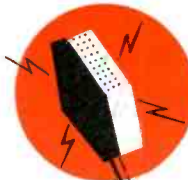

window streamer: — Designed by WARD in eye-catching colors and with the added feature of "day-glo", the modern "cold fire" that makes them pop right out, — they're just what you'll want for your windows.

decals: — Another item for your windows and doors, specially prepared by WARD to put this campaign over with a "bang".

radio announcements: — Just the copy you want for sure-fire announcements on your local radio station. They're ready for you now and waiting to help you make your Replacement Sales zoom.

newspaper mats: — 3 well-prepared and well written newspaper ads in mat form, ready for you to hand to your local newspaper and start the profits rolling in. You'll need every one of them.

Each of these helpful items is in a special "kit" that WARD has prepared for you. It's FREE for the asking. Get yours today from your distributor. If he can't supply you, write to us for WARD'S all-out Auto Aerial Sales Kit.



THE WARD PRODUCTS CORP.

DIVISION OF THE GABRIEL COMPANY

1148 EUCLID AVENUE • CLEVELAND 15, OHIO • In Canada: Atlas Radio Corp., Ltd., Toronto, Ont.

SERVICE, APRIL, 1953 • 7

THE NEPCO LINE

New Standard

UHF

NEPCO announces a complete line of Ultra High Frequency antennas. These antennas meet the most rigid specifications of mechanical design. Vibration—the most critical factor to be considered in UHF antennas—is held to a minimum through advanced design features, thus producing the clearest picture possible.

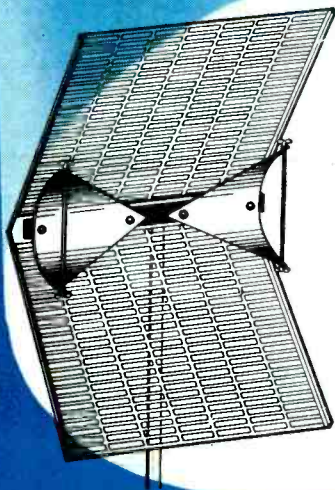

CORNER ARRAY TYPE

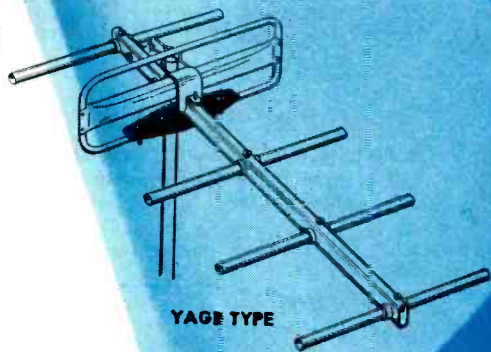

YAGI TYPE

VHF

The NEPCO Line of antennas is designed to give optimum results for full band width. The superior mechanical features maintain the electrical effectiveness and performance **CONSTANTLY**, regardless of weather conditions.

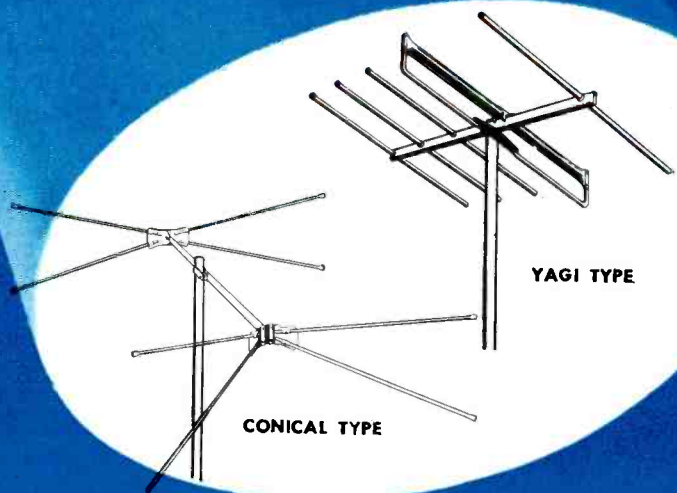

CONICAL TYPE

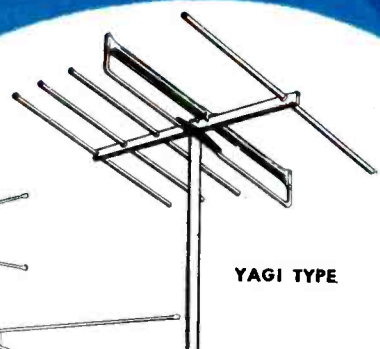

YAGI TYPE

ANTENNAS

of Quality

All NEPCO-Yagi antennas incorporate full channel coverage. They have maximum front-to-back ratio with maximum admittance—all possible because there are no wing-nuts, flutes or slots to destroy inherent impedance and induce corrosion, the bane of all antennas operating at high frequencies.

The NEPCO-Conical antenna features the same mechanical strength design needed to guarantee top performance. Aluminum elements are permanently secured with patented "Vibration-proof" imbedding screws. Erection is speeded due to fewer bolts and mechanical parts to assemble and tighten.

New "Glastic" antenna insulator

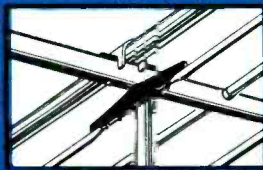
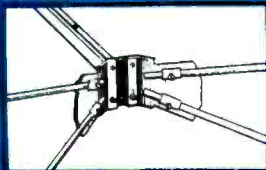

- Withstands very high mechanical stress.
- Best possible electrical characteristics.
- Lightweight.
- Stronger, more rigid, more weather resistant than materials 3 times its thickness.

The NEPCO Line includes:

Yagi Antennas • Conical Antennas
UHF Antennas • Mastings • Eave mounts
Wall Brackets • Vent Mounts • Guy Rings
Chimney Banding • Chimney Mounts • TV Wire
Banding & Mast Clamps • Add-a-Tower Plates

National Electric Products

RADIO & TELEVISION DEPARTMENT, PITTSBURGH, PA.

NEPCO *Telescoping Masts*

- Heavily electro-galvanized with baked enamel finish.
- Swedged for accuracy and close fit.
- $\frac{3}{8}$ " bolts to assure rigidity.
- Full 16 gauge metal.
- Complete with full rotating guy rings.
- Installation up to 40 feet.
- Lightweight, easily erected by two men.
- Packed in individual cartons.

NEPCO "Zee" Line



- Low-loss UHF TV receiving wire, mechanically perfect for maximum signal.
- Constant impedance under all conditions.
- Comes in strong, flat cartons.
- Easy to stock, easy to handle, easy to pull out for cutting to any desired length.

UHF Antenna Mast Adaptor Bracket



- Quick, adjustable method for installing UHF antennas on existing masts.
- Same rugged features as Nepeco Mounts.
- Electro-galvanized plus baked enamel finish.

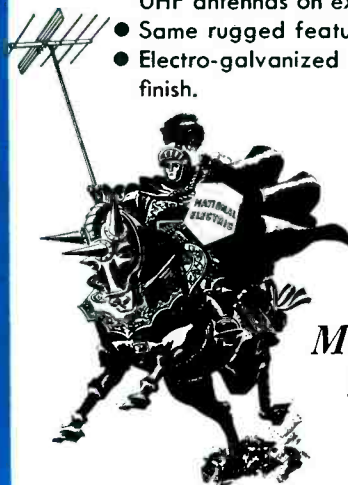

*Master of
the Elements*

THE NEPCO LINE

YOU CAN

ADJUST

THIS NEW 'V' ANTENNA FOR

UHF

VHF

UHF - VHF

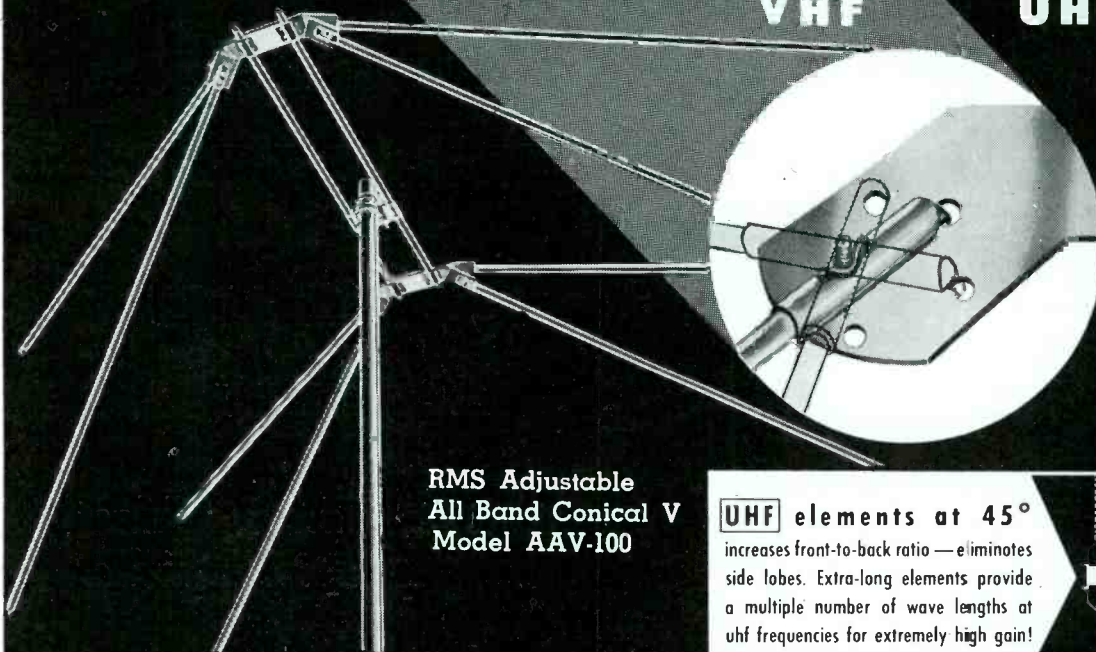

Not 4 elements
but 8! . . .
any one
or all of them
adjustable to
answer your
own local problem!

RMS Adjustable
All Band Conical V
Model AAV-100

Here it is . . . the first, high gain, 8 element, completely adjustable all band V antenna that lets you answer your customers' reception problems the most efficient, practical way. Adjustment of elements for uhf, vhf and vhf-uhf are made in seconds . . . and even without tools! Look at its construction features too . . . elements are dowel-reinforced, sealed 3/8" aluminum, 99.2 purity clad for still greater corrosion resistance. Q-bars are dowel-reinforced at the double U-bolt mast attachment. Completely preassembled!

Plus this Feature!

All antennas need protection at the signal take-off. RMS . . . first to recognize this . . . is first to answer it! With each antenna you get a tube of RMS Tenna-Tek; remarkable new corrosion-proofing substance!



See Your
RMS
Jobber
Today!

UHF elements at 45°

increases front-to-back ratio — eliminates side lobes. Extra-long elements provide a multiple number of wave lengths at uhf frequencies for extremely high gain!

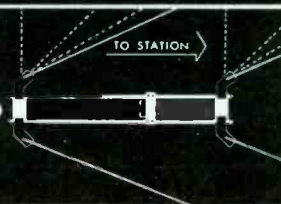

UHF-VHF elements at 60°

reduces side lobes at uhf frequencies — gives high gain performance over entire band (2-83) — eliminates dual antenna installations!

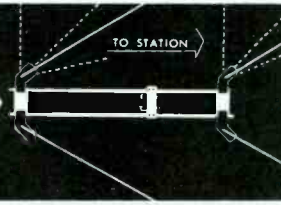

VHF elements at 90°

broadens receptive pattern — gives excellent gain over the complete vhf band!

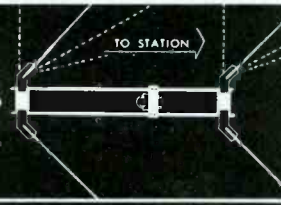

AAV-100 an RMS First & Exclusive . . . Gives You Unlimited Installation Possibilities!

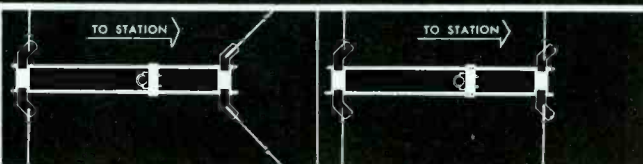

Avoid rear pick-up in mountain areas by using rear elements at 180° with front end as a V.

Use all elements at 180° to get vhf stations from widely separated points but in same general direction.

In every position, AAV-100 retains its end-fire array characteristics!

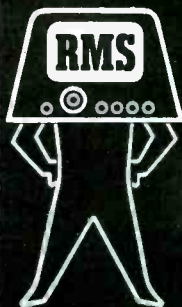

RMS



2016 Bronxdale Avenue New York 60, N. Y.

A set is no better than
its Tuning Mechanism!
...and, there's
no better tuner than the
TARZIAN TUNER

It's no happen-so that so many of the nation's leading set manufacturers—the makers of the best-known receivers—use the TARZIAN TUNER in their products.

No other commercial unit possesses so many desirable features found in the TARZIAN TUNER. It's a small, precision-built instrument, expertly designed to provide unsurpassed selectivity and improved reception in ALL areas.

And, the practical, full band—all-channel—approach to UHF (another first for Tarzian)—is making the TARZIAN TUNER more popular than ever. It's popular with the manufacturer as well as the ultimate consumer who wants "everything" on the television set he buys.

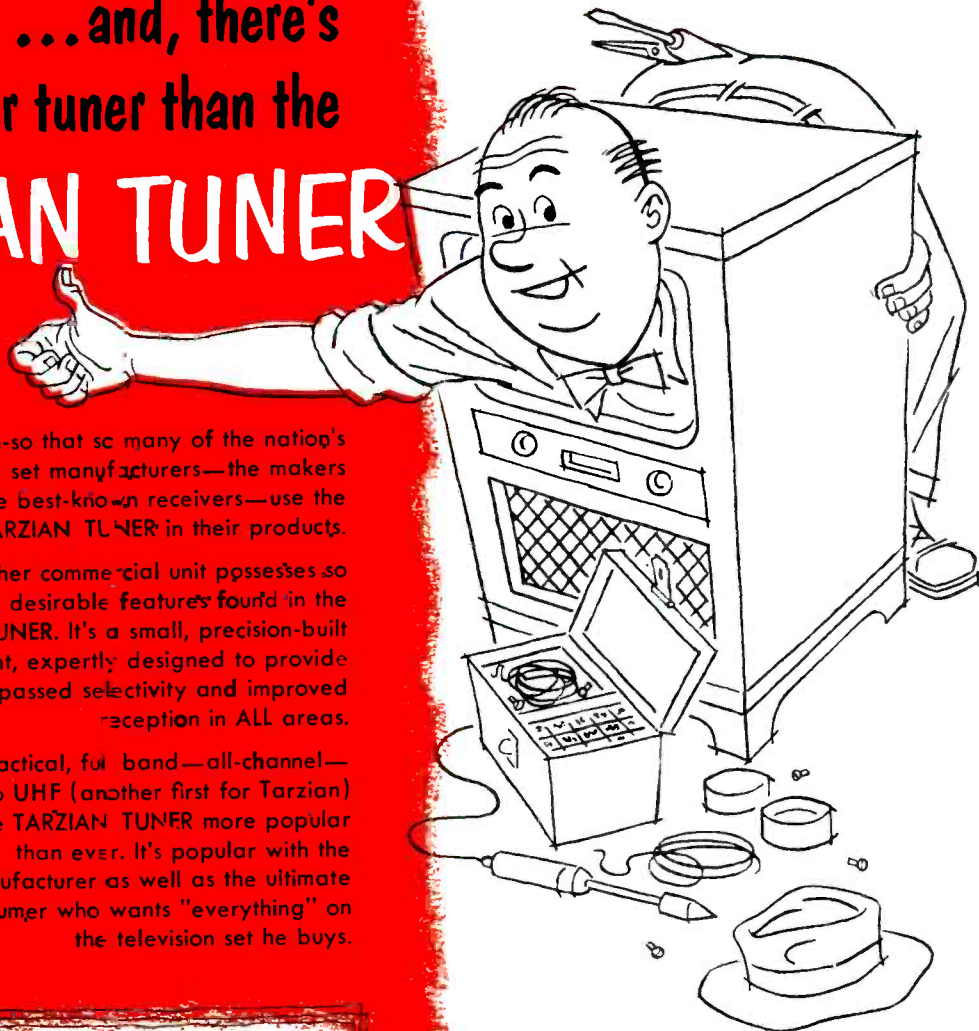

 **SARKES
TARZIAN, Inc.**

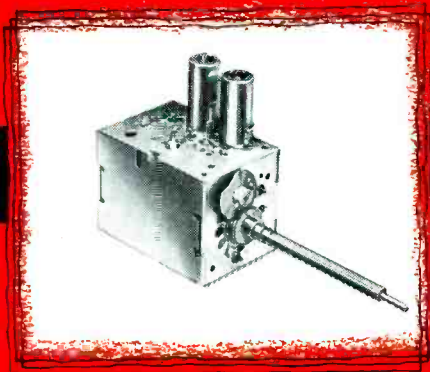

Tuner Division • Bloomington, Indiana

VEE-D-X does it again!

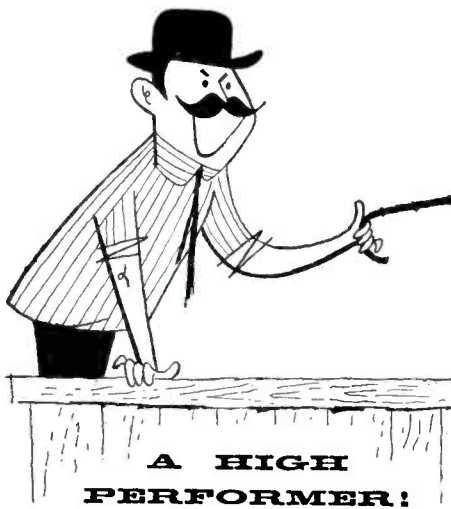

A HIGH PERFORMER!

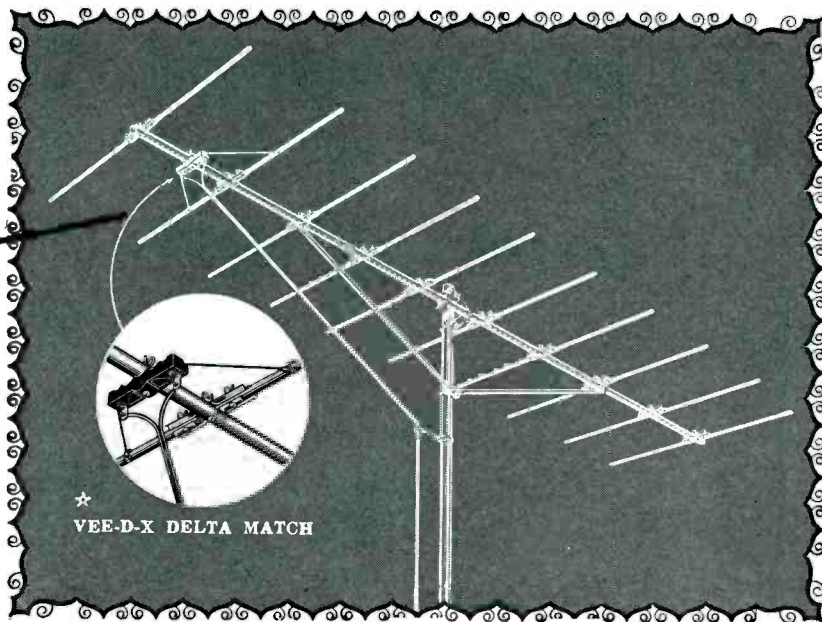

★ VEE-D-X DELTA MATCH

THE NEW 10-ELEMENT YAGI

DELTA X

PICTURE POWER
WHENEVER YOU NEED IT

30% Higher Gain
ON HIGH CHANNELS

AND LOOK AT THE LOW PRICE

ONLY **\$15.50** Channels 7 - 13

Channel 6 . . . \$24.30 list
Channels 4-5 . . . 26.50 list
Channels 2-3 . . . 29.15 list

HERE is the hottest antenna in the 10-element yagi class. The Delta-X has everything you want in a super power yagi. That's because the Delta-X has been engineered and built literally to your specifications—and after exhaustive comparison tests with other 10-element yagis.

Front-to-back ratio minus 18 db. The Delta-X can be stacked for additional gain. Individually boxed.

NOT JUST ANOTHER 10-ELEMENT YAGI
IT'S THE BEST

THE FACTS ABOUT THE DELTA-X

HIGHER GAIN*—Comparison tests with other 10-element yagis positively prove the superiority of the Delta-X. On high channels it produces 30% higher gain as a result of 20% (wide) spacing. The Delta-X produces 12% greater gain than the VEE-D-X DLJ and equal or better gain on low channels over all other 10-element yagis.

LOWER PRICE—The Delta-X with its Delta Match principle of construction permits a lower price than any other 10-element yagi. Compare!

LIGHT WEIGHT, ALL-ALUMINUM—Yes, the Delta-X is all-aluminum, with preassembled construction. There is no heavy cumbersome steel boom. All elements are doubly reinforced at boom. All booms are of two piece construction to reduce carton lengths for ease of handling. Low channels have 1 1/4" seamless boom with heavy duty CL-11 mast clamp. High channels have 1" doweled lock seam booms of the new TV alloy #41. Boom struts are used on all models.

★ **The Famous VEE-D-X DELTA MATCH**
VEE-D-X pioneered and perfected the Delta Match driven element. It is the ideal method of matching to get proper 300 ohm termination. The Delta Match reduces weight in the antenna and makes possible lower cost with absolutely no sacrifice of gain or performance.

VEE-D-X

MANUFACTURED BY

LaPointe **ELECTRONICS INC.**

* The World's Most Powerful Antenna Systems.

ROCKVILLE, CONNECTICUT

Here's how to increase your Auto Radio Repair Business!

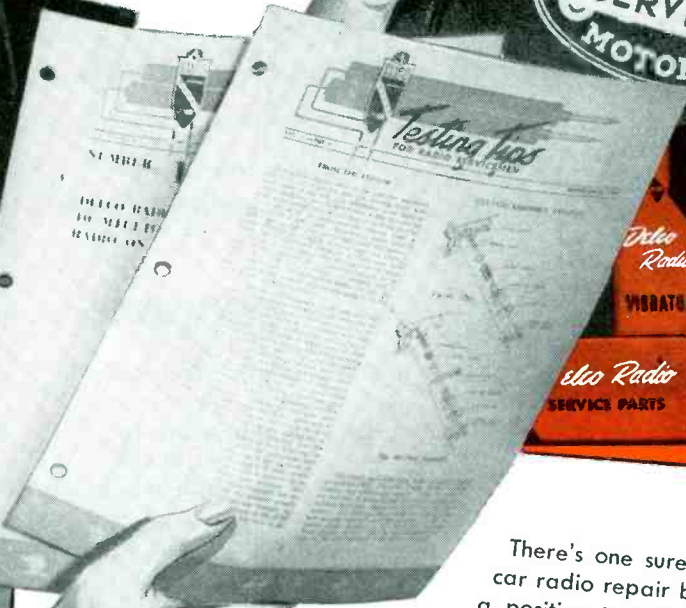

There's one sure way to get ahead in the car radio repair business, and that's to be in a position to tap the vast market of Delco Radio-equipped cars and trucks that daily passes your door! To do this you need only sign up with Delco Radio, through your United Motors Electronics Distributor. Then, automatically, you have a reliable source for Delco Radio original equipment replacement parts, and for universal replacement parts. You will receive a complete and comprehensive Delco Radio Service Manual. You will regularly receive monthly issues of "Testing Tips," a bulletin giving the very latest factory information on testing and repairing Delco car radios. So if you want to increase your business—permanently—get on the Delco Radio team. Don't delay . . . contact your United Motors Electronics Distributor right away!

DISTRIBUTED BY
ELECTRONICS
WHOLESALEERS
EVERYWHERE

DELCO RADIO
DIVISION OF GENERAL MOTORS CORPORATION, KOKOMO, INDIANA

A GENERAL MOTORS PRODUCT   A UNITED MOTORS LINE



New! another Channel Master development!

beats 'em all on UHF!

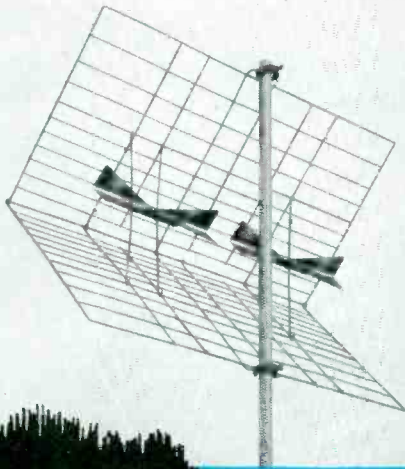

**CHANNEL MASTER'S
TWIN CORNER REFLECTOR**

Model No. 406

Gives the brilliant performance of **2** antennas!

up to **16** db gain

THE MOST SENSITIVE UHF ANTENNA EVER DEVELOPED!

Extremely narrow forward lobe, with no side lobes and negligible rear lobe

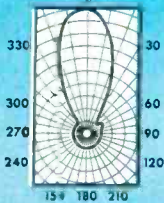

Twice the gain of the BEST standard UHF Corner Reflector

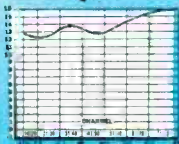

Excellent 300 ohm impedance match over the entire UHF range, provided by built-in, pre-cut matching harness

because Channel Master's Twin Corner Reflector really is 2 antennas . . .

stacked side by side into one simple structure

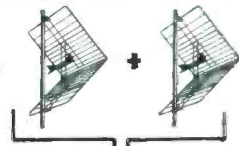

exclusive **DUBL-DIPOLE** design

- 2 antennas, electrically
- 1 antenna, mechanically
- One simple structure . . . one simple installation . . . highest gain, all-channel UHF coverage!



In any area you pick, the Twin Corner Reflector will out-perform any other antenna available today!

Ties together all 3 TV reception bands!

CHANNEL MASTER'S New!

TRIPLE-TIE model no. 9035

electronic inter-action filter

Combines up to 3 antennas with only 1 lead to the set.

1. Low Band VHF
2. High Band VHF
3. All UHF (Broad Band or Yagi)

Eliminates inter-action between all 3 antennas.

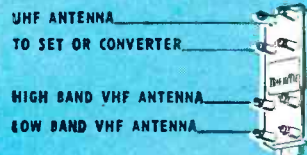

Designed to adapt all HI-LO VHF installations to UHF — quickly and economically

"Free space" terminals. Impossible for dirt or rainwater to accumulate between the terminals, which can short out the picture. Assures you of brilliant, steady reception in ANY KIND OF WEATHER!



**SINGLE LEAD • NO SWITCHING
ELIMINATES INTER-ACTION • NO SIGNAL LOSS ON VHF OR UHF**

ULTRA FAN series — Complete VHF-UHF coverage

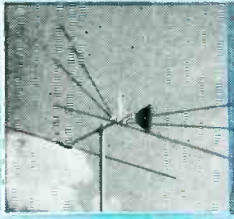

single bay — model no. 413

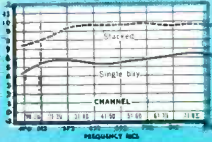

Today's most sensitive All-VU* antennas! The Ultra Fans actually operate on three separate electronic principles — automatically:

1. Low Band VHF (Channels 2-6) . . . Conical antenna with parasitic reflector
2. High Band VHF (Channels 7-13) . . . Large diameter V antenna
3. UHF (Channels 14-83) . . . Triangular dipole with sheet reflector

One set of All-VU* stacking rods provides highest VHF and

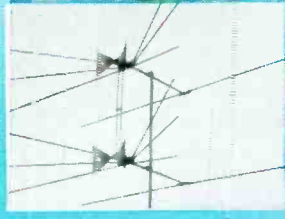

stacked — model no. 4132

UHF gain. Each Ultra Fan has its own 2-stage inter-action filter, so that only one transmission line to the set is required.

*All VHF, all UHF

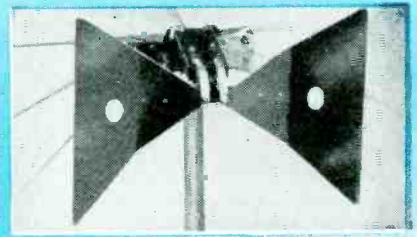

**ULTRA
DAPTER**
model no. 414

Instantly converts all Channel Master Super Fans into high gain, all-channel, VHF-UHF antennas. Features a built-in inter-action filter.

Your best bet for UHF!

CHANNEL MASTER Ultra-Tennas

America's most complete — most effective — UHF antenna line.

Channel Master's advanced engineering pays off again! While rain caused hundreds of UHF antennas to FAIL recently in Portland, not one Channel Master antenna dimmed or shorted out a picture! The facts speak for themselves: Rain or shine, Channel Master antennas out-perform all others.

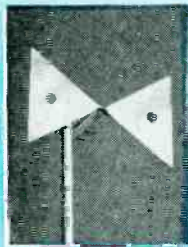

**ULTRA
BOW**
model no. 401

The basic UHF antenna for primary signal areas, and the outstanding member of the bow-type antenna family.

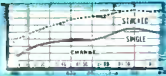

Only Channel Master Antennas are designed to eliminate the "TWIN TERRORS" OF UHF RECEPTION:

- Vibration, which causes picture flicker.

Eliminated by Channel Master's Ultra-Rigid construction and advanced mechanical design.

- The accumulation of dirt or moisture around the antenna terminals, which dims and eventually shorts out the TV picture.

Eliminated by Channel Master's sensational "free-space" terminals which prevent the accumulation of foreign deposits at the feed points.

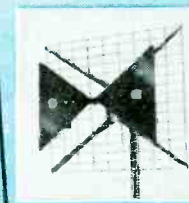
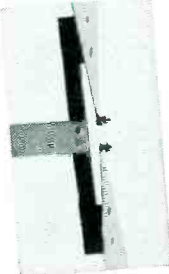

**ULTRA
BOW**
with
SCREEN
REFLECTOR

model no. 403

Can be stacked in 1, 2, and 4 bays. High, all-channel UHF gain, excellent front-to-back ratio.

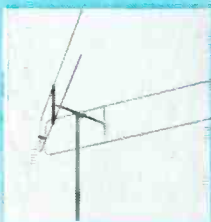
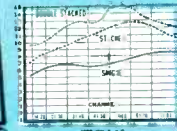

**ULTRA
VEE**
model no. 404

- Good UHF gain
- Low VHF gain
- The most rigid UHF antenna of its type and size.

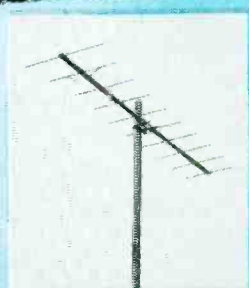
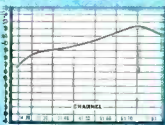

**DELTA
WELD**

Wide Band
10 Element
UHF Yagi

Custom-Designed for full coverage of your specific area! Brilliant high gain performance across as many as 23 different channels.

Gain: 11 DB, single
14 DB, stacked

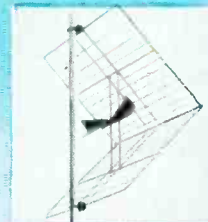

**CORNER
REFLECTOR**
model no. 405

The outstanding all-channel UHF FRINGE antenna.

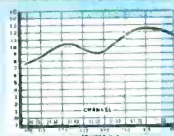

Sold through the nation's leading distributors

CHANNEL MASTER CORP.
ELLENVILLE, N. Y.

Write for complete technical literature



ULTRA-TIE model no. 9034
Electronic Inter-Action Filter

JOINS separate antennas into a single VHF-UHF antenna system, for use with a single transmission line.

SEPARATES VHF and UHF signals at the set or converter where separate inputs are provided.

The only filter with "free-space" terminals.

MERCHANDISE YOUR IDEAS FOR EXTRA PROFITS

WIN PRIZES FOR YOUR IDEAS

Selling more TV sets and accessories helps you — helps us. Let's exchange our proven ideas for extra profits. If we print them, we'll send you your choice of a case of 12 Radion antennas or 24 lightning arresters. In case of duplication, first letter received wins. Send your idea now for this month's contest.

Tailor-made for Plus Sales

The 20 million TV sets now in operation will require a possible 65 million service calls this year... and every set with an outside antenna can mean a sale! Just carry a Radion arrester with you. Show it to the customer. He'll buy fire insurance; why wouldn't he buy lightning insurance, especially since it's only a dollar.

All Hardware Included

It's a matter of minutes to install a Radion arrester on an outdoor antenna installation. You don't even have to carry any extra parts. Both a pipe-mounting strap and wood-mounting screws are right in the package!

Keeps Inventory at a Minimum

You know your business operates best on low inventory. Keep it low, and profits high with the *one* arrester that fits most installations... Radion!

Sells Over the Counter

Don't neglect those easy counter sales. Radion's display package helps sell arresters for you, takes up very little room. The appeal is there for your customer to see... "Protect Your Home!"

Sales... 2¢ each!

Try a post card mailing to your old customers. In many areas people are not aware that lightning arresters exist. Tell 'em and you'll sell 'em!

The Indoor Antenna Leader

The Radion Lightning Arrester is a product of Radion, makers of the "Metropolitan", the original and still best-selling indoor TV antenna. There are many imitations but none excels Radion performance and quality construction. Watch Radion for sensational news of new products for 1953!

SEND THIS HANDY COUPON TODAY

The Radion Corp., 1130 W. Wisconsin Ave.
Dept. S-4, Chicago 14, Ill.

Please send me free Radion profit plan folder. _____

"Ideas" entry enclosed. _____

Name _____

Firm _____

Address _____

City, State _____



ARRESTING
profit
NEWS

QA-2 "Champion"
(Shown) Deluxe
model in hi-dielectric porcelain, \$1.50
list.

LA-2 "Challenger"
Similar except is in
low-loss phenolic.
Sells fast at \$1 list.

NOW, CARRY ONE ARRESTER!

FITS ALL TWIN LEADS

MOUNTS ANYWHERE

The Radion Corporation

1130 W. Wisconsin Ave. • Chicago 14, Ill.

You'll reap a harvest of sales...

with these RCA Radio Battery Sales Aids

RCA Radio Battery Tester and Tester Display Unit

With this RCA Battery Tester displayed on your sales counter, you'll cultivate and close *more* sales of RCA Batteries. You can demonstrate, on a plainly marked scale, the actual playing condition of popular types of radio batteries.

The specially designed Battery Tester WV-37A comes straight from the famous line of RCA Test Equipment.

Ask your local RCA Radio Battery Distributor how you can obtain the Radio Battery Tester and Counter Display Unit at an amazingly low cost, with your RCA Battery purchases.



Counter Merchandiser (3F439)

You'll see plenty of sales action with this RCA Radio Battery point-of-purchase merchandiser on your counter. Three-tier, step-back shelves for battery stock and forceful sales messages remind portable-radio owners to buy batteries—now. Sturdily constructed of steel wire reinforced to support more than 50 pounds of batteries.



Floor Stand (3F438)

Put this self-selling and supermarket-type floor stand to work on your sales floor and watch RCA Radio Battery sales zoom. It's a self-contained sales department that occupies only 18 inches x 18 inches of floor space, stands 44 inches high. Three-tier, step-back shelves and two lower shelves display batteries and suggest impulse purchases to prospective customers. Constructed of sturdy steel wire reinforced for extra strength.



Window Display (3F443)

This modern window display unit with hanging sign will tell sidewalk traffic your store is the headquarters for RCA Radio Batteries. Display it in your window and watch radio battery and portable radio sales grow. Size 15 inches wide x 10 inches deep.



Repeat-Business Stamp and Pad (3F413)

Stamp your name and address on all radio batteries you sell. It will remind customers to come to your store again for radio battery replacements and service. Three-line stamp.

See your local RCA Battery Distributor for the battery line and the battery sales aids that are geared to radio trade distribution

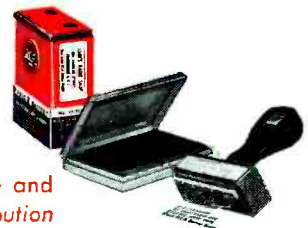

RADIO CORPORATION of AMERICA
RADIO BATTERIES
HARRISON, N. J.



Mr. Newton Cook

Manager, -Standard Products Section

CHICAGO TRANSFORMER

says: "You can see the difference with the Regency Booster"

Regency

largest selling Booster at any price.

5 ft. and 10 ft. self-coupling

**immediate
delivery
from your
Admiral
distributor**

MASTS

Television

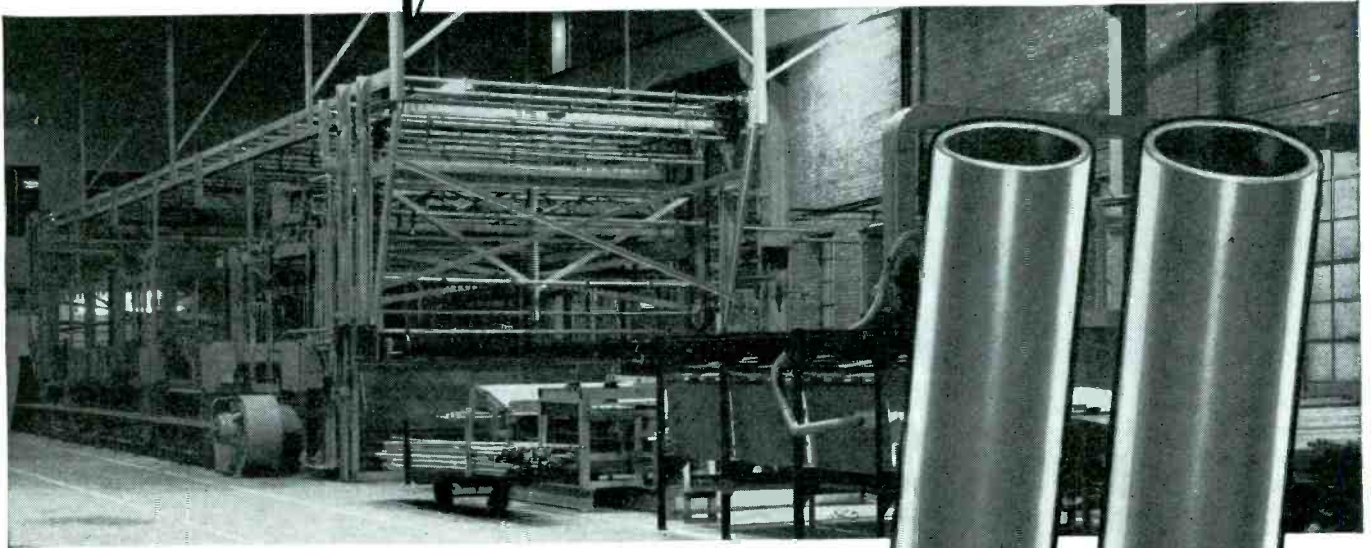

The greatly increased need for outside antennas in new station areas has just about soaked up the supply of masts. Now Admiral is ready to help you meet the demand with these new 5 and 10 foot masts . . . available at once from your Admiral Distributor.

Admiral's huge production brings you these masts at the industry's lowest prices. Finest quality, too . . . made of cold-rolled seamless steel tubing, heavily electrogalvanized for utmost rust resistance. Both 5 and 10 foot masts are available with one end flared to take extensions . . . eliminates the need for separate mast couplers. Order from your Admiral Distributor by part number:

	20 gauge	18 gauge	16 gauge
5 ft. plain end	M 40		
5 ft. flared end	M 40A		
10 ft. plain end	M 41	M 42	M 43
10 ft. flared end	M 41A	M 42A	M 43A

Admiral Corporation, Accessories and Equipment Division, Chicago 47, Ill.

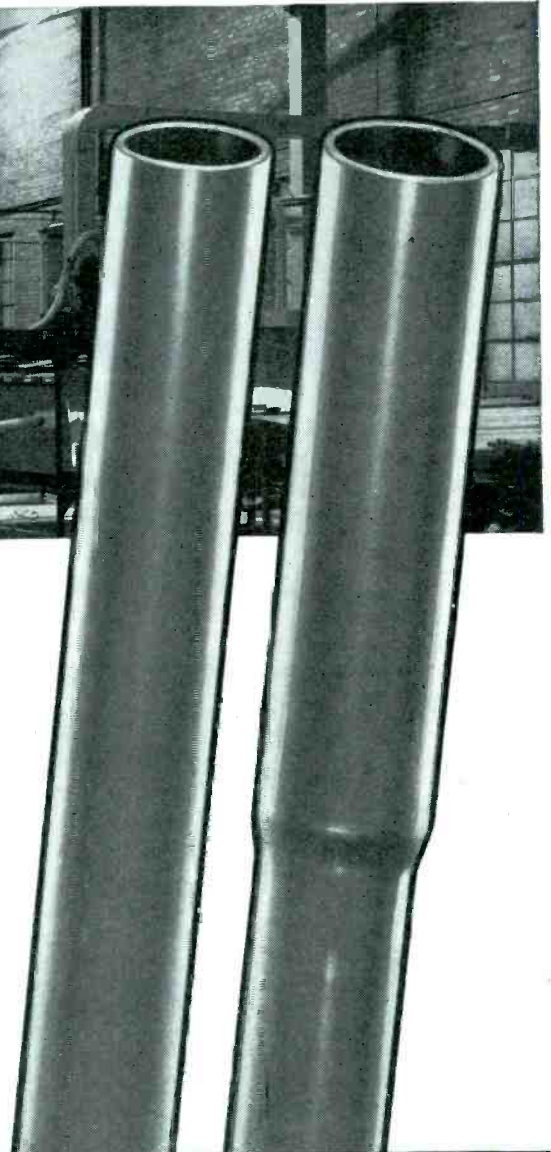

A COMPLETE LINE OF ADMIRAL TV ANTENNAS . . . NOW AVAILABLE FROM YOUR ADMIRAL DISTRIBUTOR

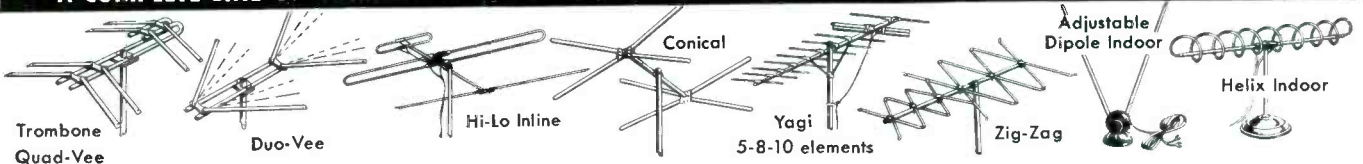

Bill Clemens says—

Midget Radio Service (a 3-Man Shop)
129 S. Elizabeth St., Lima, Ohio

*"TRIPLITT 660 saves us
50 to 100 man hours
per month."*

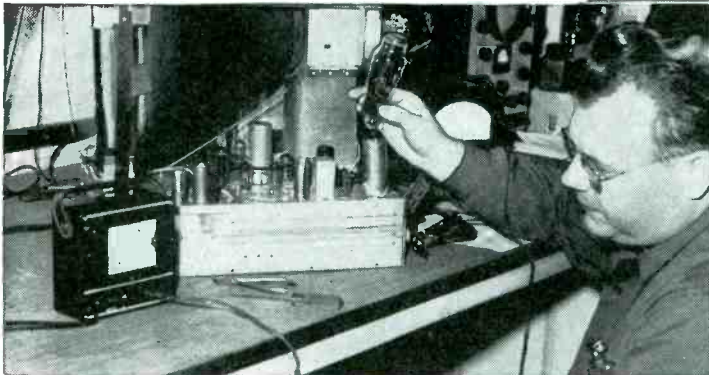

1. **ISOLATING THE TROUBLE**—Plug the power cord of the chassis into LOADCHEK and note the reading. With your eye on the large meter remove the rectifier tube and you can tell immediately which side of the tube the trouble is on. You have already eliminated 50% of your probing time.

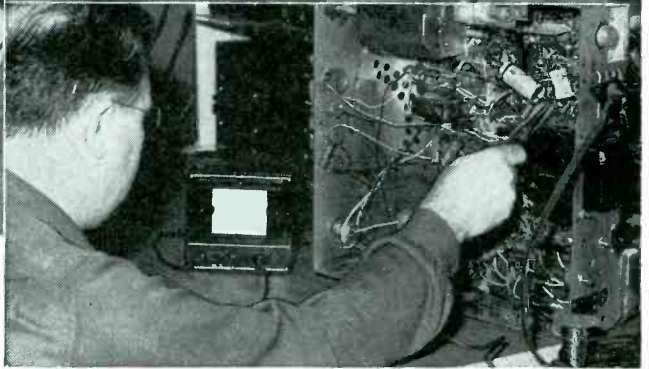

2. **LOCATING THE SHORT**—With Loadchek you can quickly check the shorted side, part by part, without laying down tools or picking up test leads. Here, the trouble was a short in the transformer, spotted without having to warm up set. Overloads are found the same way.

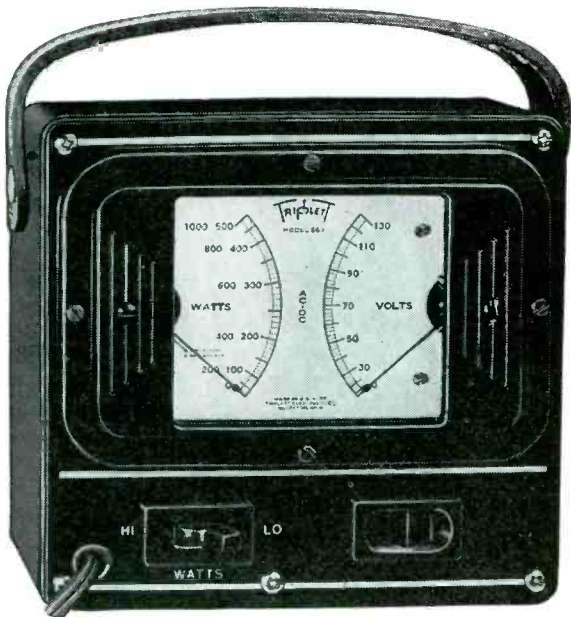

Locates trouble in a hurry

The above pictures illustrate but one of the many time-saving uses of Triplitt 660 Loadchek. This versatile instrument accurately measures power consumption, enables you to see instantly any deviation from normal load, without disconnecting a single part... finds trouble in a hurry.

For Radio and TV servicing—for almost any kind of electrical trouble-shooting—LOADCHEK saves hours of painstaking work every day. At its moderate cost no service technician can afford to be without it. Try one today—and see! Write for free booklet.

TRIPLITT ELECTRICAL INSTRUMENT CO., BLUFFTON, OHIO, U.S.A.

Suggested U. S. A. DEALER NET \$29.50

Price subject to change without notice.



Triplitt

A NEW CBS-HYTRON CTS-RATED* TUBE

***CTS-RATED:** Rated for Continuous Television Service. In TV receivers, five tubes work . . . like transmitting tubes . . . *hard!* Account for almost 90% of your replacements. You know them: rectifiers, deflection amplifiers, damper diode. Larger-screen sets aggravate this problem. CBS-Hytron recognizes your need for huskier tubes for these sockets. Brand new designs, not just improved tubes. CTS-Rated 5AW4 . . . another CBS-Hytron first . . . is your answer for the low-voltage rectifier socket. It is CTS-Rated: (1) For heavier average (250 ma. max. d-c) and peak (750 ma. max. d-c) currents, (2) With big safety margins at these currents. You can depend upon the 5AW4 for continuous, trouble-free service. Yes, more CBS-Hytron CTS-Rated tubes are coming. Watch for them.

CBS-HYTRON 5AW4

**NEW HEAVY-DUTY WORK HORSE
CUTS 5U4G CALL-BACKS**

Worried about slumping TV set performance, because of heavily loaded 5U4G's? Forget it. Use new CBS-Hytron CTS-Rated* 5AW4. A replacement for the 5U4G, the 5AW4 recaptures . . . and keeps . . . that new-set sparkle. Maintains full voltage, despite heavy load. Minimizes burn-outs. Avoids filament shorts while testing chassis on side. Loafs on tough jobs. Gives long, long, trouble-free life. The 5AW4 will cut your call-backs. Boost your profits. See it . . . buy it . . . soon. At your CBS-Hytron jobber's.

†Patent applied for

COMPLETE 5AW4 DATA FREE

See your CBS-Hytron jobber. Or write direct today.

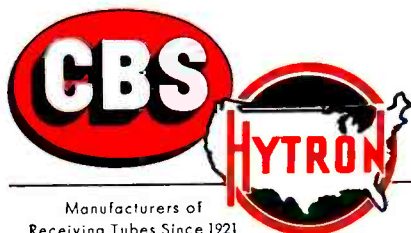

Manufacturers of
Receiving Tubes Since 1921

CBS-HYTRON Main Office: Danvers, Massachusetts

A Division of Columbia Broadcasting System, Inc.



MECHANICAL ADVANTAGES

PLATE — Note formed A-frame construction. Each plate of 5AW4 is formed into two cylinders containing the filament. Uniform filament-to-plate spacing and uniform filament performance avoid hot spots on filament, plate . . . and bulb. Oversize radiating fins and extra large surfaces between formed cylinders dissipate heat faster. Sturdy structure is rigidly supported at eight points.

FILAMENT — Massive, heavy-duty, 20-watt filament offers generous reserve of emission. Cuts burn-outs due to ionization attack and back emission. Transmitting-tube-type filament hook and spring suspension prevent sagging — yet reduce stresses on filament. Permit mounting 5AW4 in any position. Useful filament area is contained within formed cylinders of plate . . . to minimize internal voltage drop.

New...Free DECAL

sells for you! *Sells* your magic ability to recapture new-set sparkle. Let this decal pull customers to you. Get it from your CBS-Hytron jobber today.



RECEIVING . . . TRANSMITTING . . . SPECIAL-PURPOSE AND TV PICTURE TUBES • GERMANIUM DIODES AND TRANSISTORS

NOW! ULTRA-HI "CONICAL-V-BEAMS"

by *telrex* ©

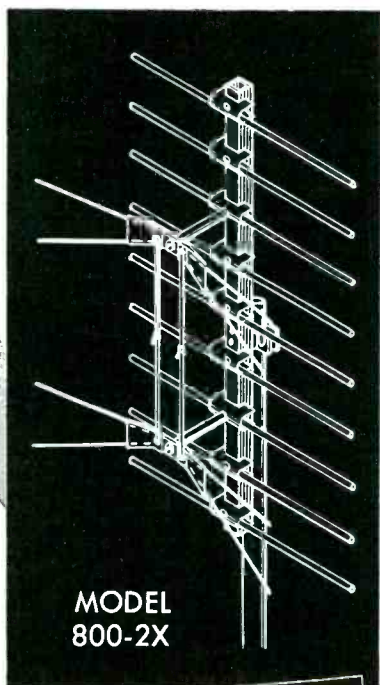

MODEL 800-2X

Outstanding Broadband UHF Antennas featuring—

- **STACKED HI-GAIN "CONICAL-V-BEAM" DIPOLES** — Ultra sensitive stacked array with excellent directivity for clean, snow-free, ghost-free long distance reception.
- **BROADBAND** — Stacked "CONICAL-V-BEAM" dipoles insure flat hi-gain response with full video and tone fidelity on any UHF channel, plus freedom from flicker or flutter!
- **HURRICANE DESIGN — FACTORY ASSEMBLED** — Light weight, ruggedized construction of the finest, most durable materials available today. Easily installed in a minimum of time.

NEW!

ULTRA "BOW-TIE" SERIES

- Peak efficiency — no "dead" spots
- Gain over 13db (stacked)
- Front-to-back ratio over 25db
- Simplicity of installation
- Rugged, all aluminum "Hurricane" construction
- Sectionalized design — basic units interchangeable for single bay, stacked or parabolic assembly

MODEL 750

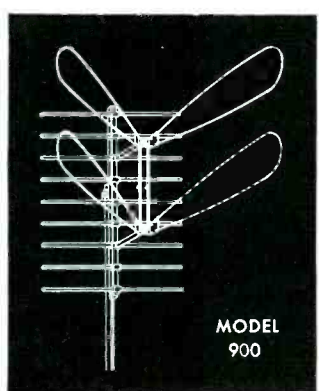

MODEL 900

OTHER MODELS AVAILABLE
for every ultra-hi frequency need in every price range—write for catalog.

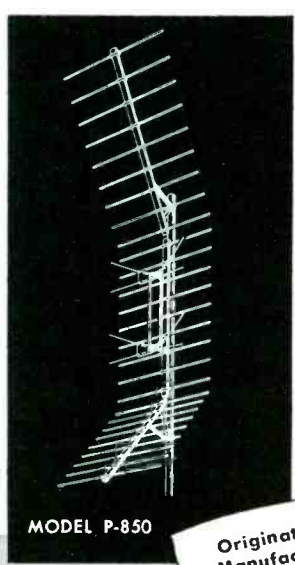

MODEL P-850

TELREX — TESTED, TRIED AND PROVEN FOR EVERY RECEPTION AREA, NEAR OR FAR!
"CONICAL-V-BEAMS" are produced under Re-issue Patent Number 23,346.

telrex INC.
CONICAL-V-BEAMS



Originators and Manufacturers of "CONICAL-V-BEAMS" — insist on the Original!

ASBURY PARK 4, N. J.

In a Class by Itself!

THE AMAZING NEW **RCP·AM·FM·TV SERVISHOP**

Series 8010

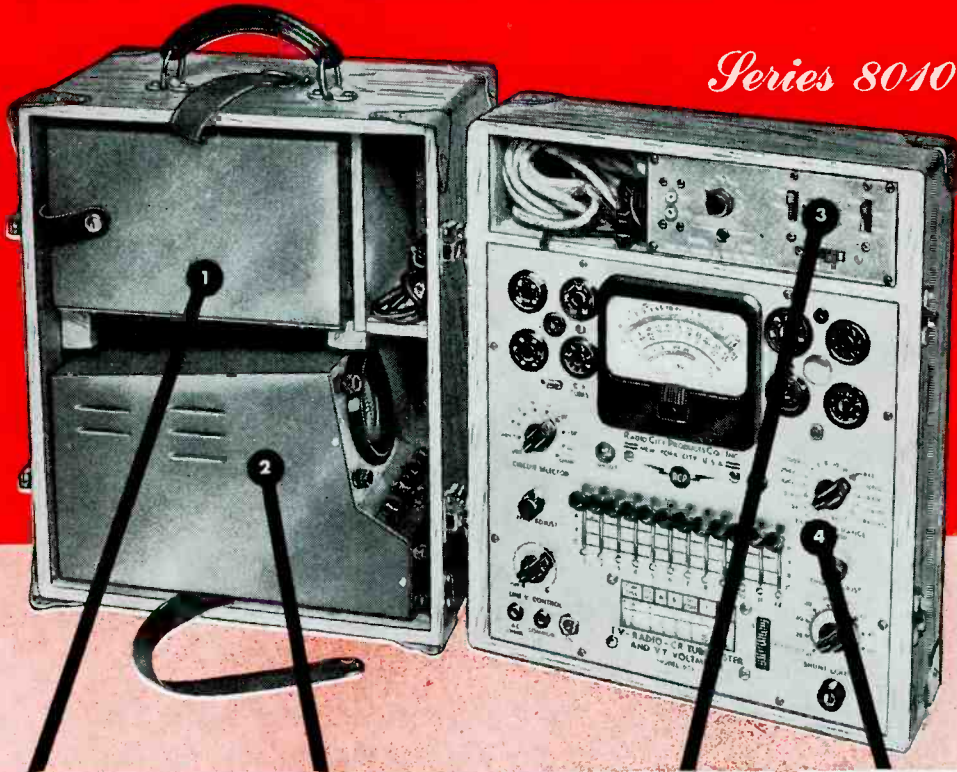

MODEL 740A



MODEL 533M



MODEL 730



MODEL 808

THE ONLY COMPLETE PORTABLE TV·FM·AM SERVICE SHOP

A LONG TIME COMING — Worth waiting for! This complete TV-FM-AM Service outfit can go with you to the receiver — or use the units individually in your shop at home. Check, test and align the set quickly, from antenna to picture tube or speaker. All the instruments for necessary measurements right at your fingertips. The Series 8010 Servishop includes:

1. MODEL 740A . . . TV "DO-ALL" GENERATOR
2. MODEL 533M . . . MIDGETSCOPE (A High Sensitivity 3" Scope)
3. MODEL 730 . . . UNIVERSAL SIGNALIGNER (AF-AM (RF)-FM Signal Generator).
4. MODEL 808 . . . TV-RADIO-CR TUBE TESTER, REACTIVATOR AND VTVM
5. MODEL HVMP-1 . . . A High Voltage Multiplier Probe
6. HAND RUBBED — FINELY FINISHED NATURAL OAK CASE

If bought separately these units would cost over \$30.00 more

In ONE practical portable case of finely finished hand rubbed natural oak, with a compartment for tools, tubes, leads, etc.; SIZE: 15-3/4" x 13-5/16" x 11". WT. 35 lbs. (approx.) SERIES 8010 — Complete, ready to operate.

\$310.00 NET

SEE IT AT YOUR JOBBER TODAY!

Write for the new, colorful fully illustrated 1953 RCP catalog giving detailed specifications on the Series 8010 and other top-quality instruments in the RCP line. Address all requests to Dept. SM-4.

JAMAN ADVERTISING, INC.

RADIO CITY PRODUCTS CO., Inc.
152 WEST 25th STREET • NEW YORK 1, N. Y.

RCP

You can win
3 ways in

Olin's Great \$10,000

EXTRA Store Traffic

More opportunities to sell portable radio batteries and everything else you handle.

EXTRA "Bonus" Deals

To step up your profits.

PARTICIPATING PRIZES

for dealers whose names are on top winning entries.

Order
one of these 3
Bonus Deals

This is your contest. Everybody who enters must get an entry blank from an Olin Radio Battery Dealer. There's no other way.

It's the hottest traffic and sales building promotion ever offered in the radio battery business.

Get in on it now—

	Regular Display Kit	Contest Display Kit	Floor Display Stand	Number of 1710 Batteries at No Charge	Dealer's Extra Profit	Per Cent Extra Profit
With order of \$50 you get:	1	1		1	\$2.50	5%
With order of \$100 you get:	1	1	1	3	\$7.50	7.5%
With order of \$200 you get:	1	1	1	7	\$17.50	8.75%

MAKE UP YOUR OWN ASSORTMENT

from the Olin line of Portable Radio Batteries—51 batteries for every need, including these popular stand-bys:



1710



6210



614

Radio Battery Contest

FIRST PRIZE

FREE TRIP to HAWAII
VIA PAN AMERICAN CLIPPER (or \$1500)
Plus 167 OTHER EXCITING PRIZES!

This is the kind of contest that really pulls in the entries!

And remember, every contestant must get an entry blank from an Olin Radio Battery Dealer.

Make them come to you—with these tie-in displays—as part of your "bonus" order!

ENTER OLIN PORTABLE RADIO BATTERY \$10,000 "GREAT DISCOVERERS" CONTEST!



Win a Free Trip to HAWAII
VIA LUXURIOUS PAN AMERICAN CLIPPER!

ALL EXPENSES PAID FOR 2 PERSONS FOR 10 GLORIOUS DAYS! or **\$1500 CASH**

SUN! - SWIM! - LOAF!
on beautiful Waikiki Beach in Honolulu

167 ADDITIONAL PRIZES

SECOND PRIZE	\$1000
FIFTH PRIZE	\$500
FOURTH PRIZE	\$200
THIRD PRIZE	\$150
NEXT 20 PRIZES OF \$100 EACH	
NEXT 20 PRIZES OF \$50 EACH	
NEXT 20 PRIZES OF \$25 EACH	
NEXT 100 PRIZES...	

FAMOUS HALICRAPTER PORTABLE RADIOS

Get One Sheet and Entry Blank from your Olin Portable Radio Battery Dealer

It's something to feel! Every member of the family can get it. Also, featuring colorful design to attract other Portable Radio Battery dealers today. We will give you a "Clue Sheet" and "Entry Blank" containing prizes and what a famous explorer will have to help you identify them. Send in your entries—with a statement of 25 words or less who you prefer an Olin Portable Radio Battery. The only other Olin's great discovery is... IT'S ALL TODAY! NOTHING TO SEE!

OLIN'S Great Discovery "CRYPTOLITE"!

There's an OLIN PORTABLE RADIO BATTERY for every radio need!

OLIN INDUSTRIES, INC. • ELECTRICAL DIVISION • NEW HAVEN 4, CONN.
Hours of Day Telephone • License • and the Pattern for Telephone • License • Hearing Aids • Farm and Industrial Uses.

CONTEST WINDOW DISPLAY

Big, colorful eye catcher, around which to build a display of Olin Radio Batteries. (We supply dummy cartons.)

COLORFUL WINDOW POSTER

A stopper that makes your store "contest headquarters"—brings 'em in for entry blanks, makes new friends for you.

WIN A FREE ALL-EXPENSE TRIP TO HAWAII via Luxurious Pan American Clipper

65 CASH PRIZES Plus 103 HALICRAPTER PORTABLE RADIOS

OLIN'S \$10,000 Great Explorers Contest

Get Your CLUE SHEET and ENTRY BLANK INSIDE nothing to buy!



CONSUMER ENTRY BLANKS
 Every contestant needs one. You get a liberal supply, with space to stamp your name. Remember, if one of your entrants wins a top prize, you get a prize too!



JUMBO WALL CHART
 An additional contest reminder and a practical selling aid for the right Olin Battery for any portable.



FLOOR DISPLAY STAND
 You get this with order of \$100 or more. A whiz of a salesman that never shows up on your payroll!

Get your order in to your wholesaler NOW—Contest begins at the start of your peak selling season!

OLIN INDUSTRIES, INC. • ELECTRICAL DIVISION • NEW HAVEN 4, CONN.
 Makers of Olin Flashlights • Lanterns • and Olin Batteries for Flashlights • Lanterns • Hearing Aids • Farm and Industrial Uses.

**BUILDING BOATS
IN BOTTLES
IS A CINCH...**

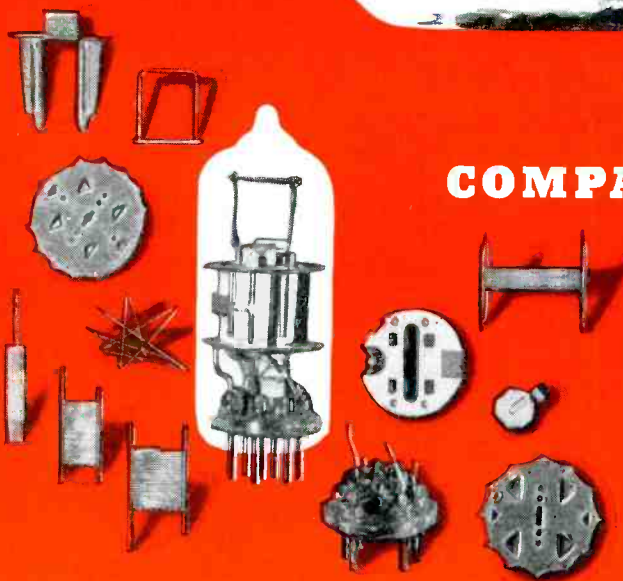
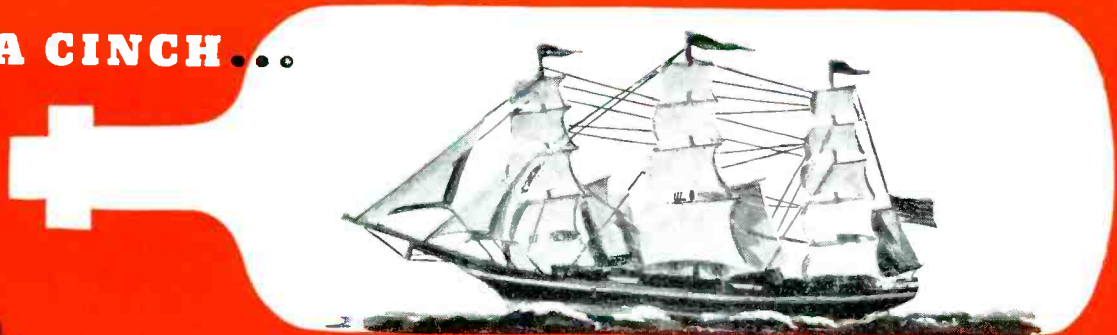

**COMPARED TO
ASSEMBLING
RECEIVING
TUBES**

Assembling the components of Raytheon Electron Tubes is a thousand times more exacting than building boats in bottles, yet Raytheon has hundreds of skilled technicians who (we think) assemble tubes better than anyone else in the world.

They do it better because Raytheon has specialized in the design, development and *manufacture* of highest quality Electron Tubes for *thirty years*. The skill, experience and "know-how" gained through dealing with every phase of quality tube production have been passed on to make these highly trained technicians the best in the business.

This precision assembly is a mighty important reason why Raytheon Radio and Television Tubes are Right for Sound and Sight!



RIGHT... FOR SOUND AND SIGHT



RAYTHEON MANUFACTURING COMPANY

Receiving Tube Division
Newton, Mass., Chicago, Ill., Atlanta, Ga., Los Angeles, Calif.

Excellence in Electronics

RAYTHEON MAKES ALL THESE:
RECEIVING AND PICTURE TUBES • RELIABLE SUBMINIATURE AND MINIATURE TUBES • GERMANIUM DIODES AND TRANSISTORS • NUCLEONIC TUBES • MICROWAVE TUBES



Three Decades of Success

EVER SINCE the days of the slick, varnished bread-board radios, independent service shops have had to vie with large operators, be they contractors, department stores or chains. In the '20s, local Service Men were truly surrounded by assorted production-line service operations, many promoted by the city's leading furniture and general stores.

But, notwithstanding the grandiose claims proffered by these merchandising giants and their installation and service staffs, the departments did not flourish too long. For not only was it found impossible to accommodate all who then clamored for rapid service when the set failed, as TV set owners do today, but the system was found to be unwieldy, impractical and extremely costly. There just weren't enough men, equipment or travelling facilities available for the job. Installation and service depots set up by some radio makers also found themselves buried in similar trouble.

And thus, the shops around the corner, well staffed for their size, and originally established in the belief that a local operation could provide the quick and efficient service set owners wanted, came to the rescue. Providing prompt, equitably-priced service, the neighborhood shops became the sole, accepted, trouble-curing clinics practically everywhere, from coast to coast.

With the arrival of TV, contractors and large-scale operators roared onto the scene once again, to the chagrin of the small boys down the street. While some of those who issued contracts did so with honest and professional intent, too many did not, and there were calamitous results. Fortunately, those stalwart, neighborhood shop men pitched in again, and came through as everyone knew they could and would.

Today, the community Service Man in some large cities again faces the threat of department store service. While numbers of large stores have chosen to discontinue their radio and TV divisions and service departments, some are still trying to stay on, and are waving away with blazing promises. But, the city-wide *at-your-service* plan which did not work 30 years ago, is still only a weak and crumbling idea; too many trained field men are urgently needed and not available

—certainly there is now more than ever a scarcity of such talent—and equipment requirements, a dozen times more complex and involved than in the '20s, cannot always be met for field assignments. As a result, chassis pulling and corresponding expensive repair bills are common, despite the claims that charges will always be minor.

But, more important is the fact that rarely do those involved in a city-wide service exhibit that friendliness and community pride in their work, so typical of the neighborhood shop. For over three decades the man down the street has proved his worthiness, earning a sterling reputation for sincerity, good judgment and expert workmanship at just prices. Everyone, including setmakers who originally subscribed to the premise that only controlled and contract service would work in TV, have conceded that community service represents a practical and profitable approach to the business of radio and TV servicing.

For many decades to come, neighborhood clinics will continue to serve, and serve well, the communities throughout the country.

Helping Hands¹

THE WAVE of fix-it books, hawking easy at-home repairs, has riled not only Service Men, but setmakers, and part and tube producers, too. To combat this destructive campaign one member of industry has published a unique plea to consumers, in the form of a compact booklet, asking for the complete support of all Service Men.

Noting that only Service Men are qualified to perform installation and repair on a TV set, the manufacturer reports that these men are so qualified because they have gone through specialized training, and only they have the tools and test equipment necessary to perform the delicate job of servicing. Declaring that the Service Man's investment in shop equipment alone is usually more than \$3000, the booklet adds that with this type of equipment Service Men are able to diagnose accurately set troubles to effect a repair in a minimum of time and at the least cost to the consumer.

¹With apologies to G.E. and Electronic Wholesalers, Inc.

Explaining home repairs, the leaflet adds . . . "Your Service Man will make most repairs right in your home, but some will have to be made in the shop . . . because some troubles are caused by a combination of circuit problems which can only be detected through the use of precision test equipment too large and complex to be brought into the home." Continuing, consumers are told that whether the work is done in the home or in the shop, Service Men will do their best to serve promptly and at a fair cost. "His charges—which reflect the time he spends serving you, plus any necessary tubes and parts—are your best investment in TV satisfaction."

"Tampering with a TV set can be a personal hazard," the booklet warns. "Only the skilled hands of a TV Service Man can safely probe for faults and make repairs."

The booklet, a pocket-sized 8-page affair, now available for public distribution to set owners, is truly a noteworthy contribution, which will be of immeasurable aid to every Service Man.

A Simple Formula for Progress²

YOU CAN'T help but succeed if you follow these *ABC* rules, recently adopted by an audio center in Washington: Don't *Argue* with a customer; don't *Begin* a sales effort without an adequate knowledge of the prospect's needs; be sure you are not *Careless* in dress, appearance, speech habits, and your sales pitch; don't *Dodge* a prospect's objections or questions—meet them head on; don't *Emphasize* the wrong thing at the wrong time—timing is vital to a sale; don't *Fail* to follow through after a service call; and don't *Guess* the answers to a prospect's or customer's query. Supplement these *ABCs* with *initiative, ambition, perseverance, determination* and a *passing knowledge*, and you'll hit the bell.

The Chicago Parts Show

NEXT MONTH, May 18 to 21, the all-important annual *radio parts and electronic equipment show* will be held at the Conrad Hilton Hotel, Chicago. We'll be in booth 26 and room 636.

—L. W.

UHF for present
VHF installations

UHF-VHF for
new installations



Jazz Trombone
Pat. No. 2538915

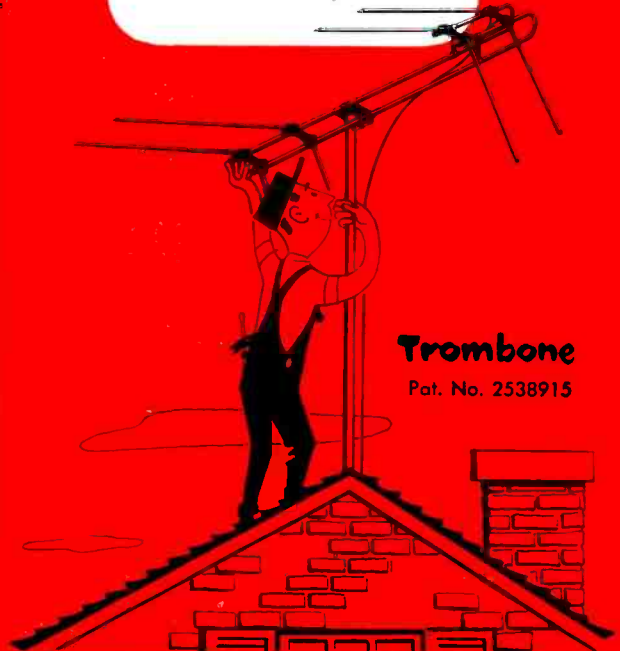

Trombone
Pat. No. 2538915

new **WARD** antennas give everybody
everything in television **UHF** and **VHF**!

WARD'S newest, exclusive contribution to Television — the JAZZ TROMBONE — is a small, light-weight, auxiliary antenna designed for UHF only. When attached to any present day VHF antenna, it creates a complete UHF-VHF antenna. Low cost, streamlined, fully preassembled, easily installed. JAZZ TROMBONE is the ideal change-over auxiliary Antenna for all present installations.

For all new installations, nothing compares with the sensational, new WARD TROMBONE, engineered and designed to bring in all channels, all frequencies, both UHF and VHF, with one single antenna. — The WARD TROMBONE is the completely universal Antenna that provides clear, sharp reception in any location; outstandingly effective in fringe areas.

Write for Catalog Sheets

THE DIPLEXER



Another new WARD exclusive — the DIPLEXER — completely solves the problem of two lead-in lines, where separate UHF and VHF Antennas are used. — Simply connect the two lines to the DIPLEXER and extend one single line to the Television receiving set.



THE WARD PRODUCTS CORP.
DIVISION OF THE GABRIEL COMPANY

1148 EUCLID AVENUE • CLEVELAND 15, OHIO • In Canada: Atlas Radio Corp., Ltd., Toronto, Ont.

SERVICE... *The National Scene*

STRIKING TV AND TRANSISTOR ADVANCEMENTS UNVEILED AT IRE CONCLAVE--Many notable improvements in TV circuitry and transistor systems, scheduled to appear soon in receivers, were disclosed at professional-group sessions conducted during the recent IRE meeting in New York City. One new circuit, described as a comparatively low-cost sync and agc development, was said to provide unusual picture stability. In an analysis of the system, it was pointed out that under certain adverse conditions, when for instance high-energy ignition-type interference occurs, the picture may become unsteady or completely unsynchronized, even though the picture content itself would still be usable if sync were stable. The failure is often the result of noise pulses, charging up the sync separator and agc circuits, causing useful sync output to be suppressed and obscured. To overcome this failure, the self-biasing sync separator circuit has been replaced with one in which bias is set by circuits in the set that are relatively immune to interference. The bias or reference level for this separator is common to both sync separator and agc system, and is derived from the agc output in such a manner that a high-gain negative feedback loop is formed which automatically holds the bias at the correct level for proper sync separation, regardless of the magnitude of the incoming signal. Constants in the feedback loop are such that the first sync separator is held near cutoff on sync tips; thus, noises cannot drive the tube much further into cutoff, and are clipped at a level only slightly above sync-tip level. And, since agc is derived following this noise limiting, it is substantially immune to charge up. . . . In another report, a packaged adjacent-channel, series-shunt, m-derived band-pass, rejection filter, which can add 40 db of additional adjacent-channel attenuation, permitting interference-free reception of, for instance, channels 2, 4, 5, 7, 9, 11 and 13, plus 3, 6 and 10, was also disclosed for the first time. Filter serves as a link between receiver tuner and if amplifier to be inserted in the receiver when adjacent-channel interference is known to exist. The filter, it was said, exceeds the performance of multi-tube, multi-tuned circuit designs common some years ago. . . . In another revealing paper, it was pointed out that oscillating vhf transistors can be produced and used in TV chassis. A single transistor, it was claimed, can serve as a sync separator and sync amplifier. In addition, the symmetrical properties of transistors can be used to develop a reliable horizontal afc system. Point-contact transistors were said to be useful as economical and efficient pulse and sawtooth oscillators. It was noted also that while the video-amplifier problem is complicated by the need of a high input impedance, a combination of junction and contact transistors can be used to provide a stable high-gain video amplifier with a comparatively high input impedance. The circuits described were included in an experimental transistorized TV chassis, with 36 lab-type transistors.

UHF STATION APPROVAL LIST GROWS--Twenty-six more broadcasters have received authority to build ultrahigh stations*. Among those accorded the privilege are: KAGR-TV (channel 52), Yuba City, Calif.; WDAK-TV (28), Columbus, Ga.; WMRI-TV (29) and WRAY-TV (52), Marion and Princeton, Ind.; WTAO-TV (56), Cambridge, Mass.; WCBI-TV (28), Columbus, Miss.; WHKP-TV (27) and WPAQ-TV (55), Hendersonville and Mt. Airy, N. C.; WCHA-TV (46), Chambersburg, Pa.; and WKNA-TV (49), Charleston, W. Va. . . . According to the Commission, fifty-six new vhf and uhf operators have received temporary authority to telecast since the freeze lift*. Included in this list are: WKJF-TV (53), Pittsburgh, Pa.; WSUN-TV (38), St. Petersburg, Fla.; WBAY-TV (2), Green Bay, Wis.; WLOK-TV (73), Lima, O.; WFTL-TV (23), Fort Lauderdale, Fla.; WWLP-TV (61), Springfield, Mass.; WKST-TV (45), New Castle, Pa.; KDZA-TV (3), Pueblo, Colo.; WAFB-TV (28), Baton Rouge, La.; KTTS-TV (10), Springfield, Mo., and KRTV (17), Little Rock, Ark.

*According to FCC rules and regulations, successful applicants are first granted authority to build a station, and then receive special permission to go on the air.

SERVICE... The National Scene

INDUSTRIAL ELECTRONIC SERVICING GROUP FORMED--A new service operation specializing in the installation, maintenance and servicing of electronic and communications equipment has been announced. The company proposes to provide a pool of qualified Service Men for the purpose, through a visual-sound training program, operated in cooperation with interested manufacturers. Trainees will receive a 50-hour course covering on-the-job problems and solutions.

LICENSING MEASURE INTRODUCED IN CALIFORNIA STATE ASSEMBLY--The California state legislature is now considering a bill proposing the licensing of radio, TV and phono Service Men. The measure has met with mixed reaction. One critic viewed the bill as a do-nothing piece of legislation which would merely create red tape and more bureaucratic jobs. However, according to the chairman of a Service Men's association, the bill is urgently needed and should help to stabilize the servicing profession in California. Admitting that legislation cannot guarantee honesty, the association headman noted however that . . . "by assisting the public in the selection of qualified Service Men and shops, it should be possible to aid the consumer in making a choice of an accredited technician." . . . Earlier a similar measure submitted as a city council project was shelved indefinitely, opponents declaring that the service trade had already been cleaned up by distributors, manufacturers and service associations.

CINCINNATI SERVICE MEN MAP PLAN TO HALT MALPRACTICES--In a concerted effort to curb any unethical service practices, a TV service group, recently formed in Cincinnati, Ohio, has set up an ambitious promotional campaign to advise consumers on approved servicing procedures. Advertisements and bulletins will warn set owners to demand all parts replaced, for a possible check with any other service company against fraudulent replacements, and also demand and keep an itemized bill of repair for any further questions. . . . Four types of membership have been established for the new association: 1 and 2-man shop, membership fee \$25; 3 and 4-man shop, \$50; 5 and 6-man operation, \$75; and \$100 for service groups with 6 or more men.

OPERATIONAL BLUE BOOK NOW BEING PREPARED BY PHILADELPHIA GROUP--A booklet, describing correct bookkeeping methods, inventory control, proved merchandising and advertising programs, and accepted auditing methods, is now being prepared by an association in Philadelphia¹. . . . Effort is also being supported by series of self-policing moves to build public confidence in servicing at home and in the field.

SERVICE MEN MUST EDUCATE PUBLIC, TRADE ASSOCIATION EXEC DECLARES--An educational program aimed at the consumer, and initiated by Service Men, is urgently needed to correct the public's misconception concerning TV Service Men, according to the executive vice prexy of NEDA. Supporting the recently organized Chicago Certified TV and Installation Servicing program, sponsored by NARDA, he declared that service groups should show more responsibility in developing educational programs. . . . The Chicago educational plan was described as extremely successful, with over 100 service shop owners having joined the program, agreeing to contribute 1% of their wholesale parts purchases to support the plan, and in addition, paying a \$10 annual assessment for membership dues.

IN THE SERVICE MAILBAG--Letters to ye editor continue to pour in with gratifying reports on the contents of SERVICE. In a note from A. B. Kanczes, of Pittsburgh, Pa., ye editor was told that of all the magazines purchased . . . "SERVICE tops them all." Kanczes declared that he looks forward to each issue . . . "with enthusiasm . . . as they contain many timely and down-to-earth facts on circuitry and servicing problems." And, according to D. W. McLimont, of Ottawa, Canada . . . "SERVICE is tops in servicing literature. Its coverage of the audio field, TV and auto antennas show that its interests are by no means restricted to common and narrow limits." It is certainly good to hear that SERVICE continues to be so helpful and do so complete a job.--L. W.

¹See Association News, page 81, this issue.

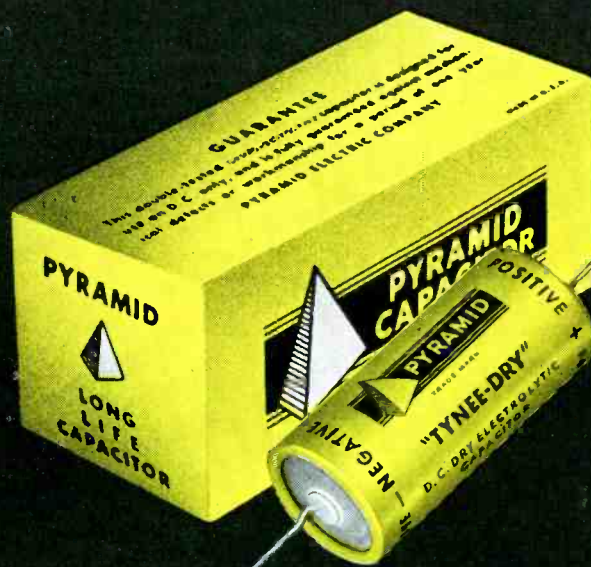

*In capacitors, your best bet,
your best buy, is*



PYRAMID

PYRAMID ELECTRIC COMPANY
NORTH BERGEN, NEW JERSEY

Write for free literature

Better 'n Ever!

6 pages classifying 572 Tube Types
 52 pages of Operating Characteristics
 23 pages cover 122 types of Cathode Ray Tubes
 NEW—8 pages on 101 Premium Type Tubes
 NEW—6 pages on 40 types of Germanium
 Crystal Diodes and 13 Silicon
 Crystal Diodes

Special Feature
 How to get your share
 of the \$953,500,000
 spent for service
 work . . . See
 page 133.

TUNG-SOL ELECTRON TUBES

special purpose



television



radio



75¢

Characteristics

18th Edition

More information . . . newer information
 . . . 18 sections . . . 152 pages . . . in the
 Tung-Sol Tube Manual. Your wholesaler
 can supply it. Phone him, write him, or ask
 his salesman. Bring your technical tube
 data up-to-date, now!

TUNG-SOL ELECTRIC INC., Newark 4, N. J.
 Sales Offices: Atlanta • Culver City (Los Angeles)
 Chicago • Dallas • Denver • Detroit • Newark • Seattle

TUNG-SOL makes All-Glass Sealed Beam Lamps,
 Miniature Lamps, Signal Flashers, Picture Tubes,
 Radio, TV and Special Purpose Electron Tubes.

NEW—and only listing in the industry of 115
 Obsolete Tube Types
 19 pages showing 337 Base Connections
 4 pages of Bulb Outline Drawings
 Dial lamps
 Color codes
 Ballast Tube numbering codes
 NEW—17 pages of Market and Selling
 Information

Stocking Up for

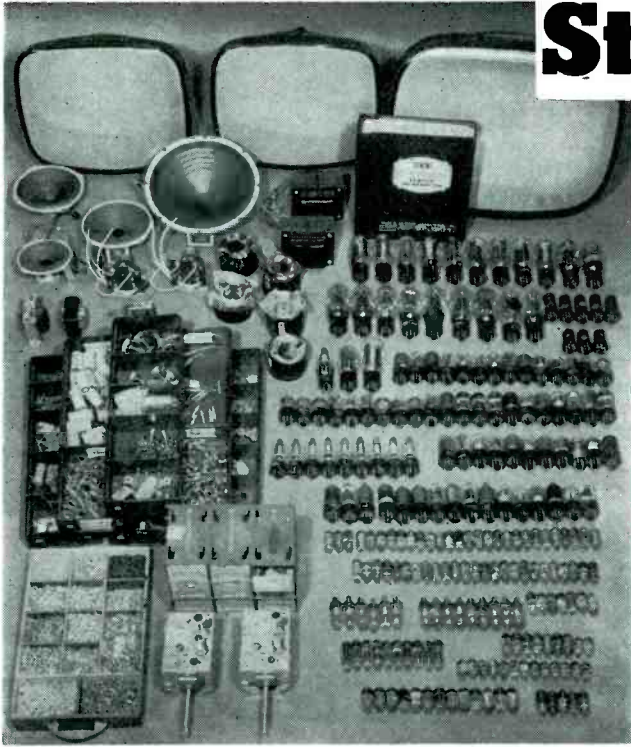

Representative display of a basic TV service parts inventory. Parts shown are vital for both *vhf* and *uhf* servicing.

(Right)

Display of the additional parts inventory needed for *uhf* television servicing. It will be noted that all units shown are for use in installation; other service inventory remains the same for both *uhf* and *vhf*.

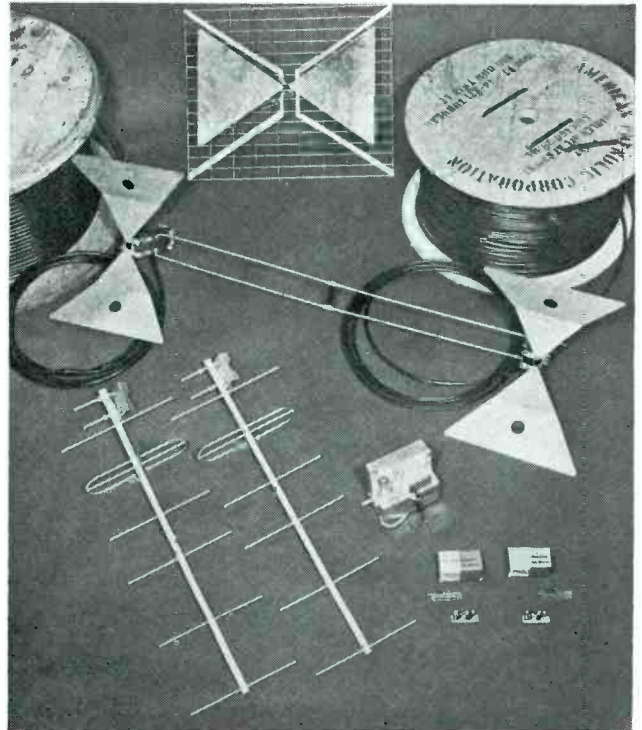

SERVICE SHOPS are successful because they offer know-how and experience, employ good test equipment and feature a substantial parts inventory.

TV service customers are never happy when they are kept waiting. If the family radio goes wrong, most will not be too disturbed if they have to wait a few days. They'll even carry it over to the Service Man's shop; but not if the TV picture goes out. Then they want immediate action. One should never run the risk of losing a customer—and his friends and neighbors—with that deadly line . . . "I'll have to wait until I get the part."

UHF Service Needs

In *uhf* servicing, it is necessary to expand the basic parts inventory mainly in only one department—installation.

Of course, wide-awake Service Men will obtain converters, strips, crystals, and other items that will also enable them to handle *vhf* conversion and service.

To avoid losing customer confidence over items like tubes or capacitors, a varied and versatile parts inventory, stocked partly in the shop and partly in the truck, is the best bet.

Probably eighty per cent of a shop's initial investment must go into small

tubes and small parts. The rest will be scattered. But the Service Man who doesn't want to let his competition out-service him will use his basic parts inventory merely as a take-off point. His stock will grow with his business.

Initial Parts Order

The first order for that all-important parts inventory should be a good one. It will stock you for service, and it will serve to introduce you to your jobber, a man who can be of enormous aid in the selection of your parts.

A minimum of three picture tubes should be included in your order. As the sets you work on get older, you will need more, but for an initial stock a pair of seventeen-inch and one twenty-one inch tube will do. Approximately one hundred dollars will take care of this bill.

The next item on your purchase list should be small tubes. Because television receivers utilize so many different types of these, a minimum inventory will usually run to about 350 tubes. No matter what kind of an operation you plan to have, small tubes will be important. In a new TV area, where the receivers are new, too, probably more than half the calls will consist of little more than replacing

defective small tubes. A good basic small tube inventory can be stocked for around \$350.00.

Tuner Requirements

It isn't often that a tuner must be replaced, but it's a good idea to keep one or two of these on hand, preferably a 21 and 40-mc type. For *uhf*, although tuners vary, at least one type should be around the shop. To determine the type, you should survey your area and note the most popular set or the brand that you seem to service most, and stock a tuner that fits. The cost will run to about sixty dollars. And your stock of resistors, capacitors and other small items like nuts and bolts and wire, etc., will cost perhaps seventy-five dollars. Again, as the operation expands, this inventory should grow, too.

You will find that, among the heavier items, if coils, vertical blocking tube oscillator transformers and deflection yokes will probably be very popular. However, these and focus coils and other transformers may be stocked moderately, compared with small tubes. An initial investment of about \$100.00 should cover this assortment.

If you are presently a one-man operation you may continue, but the varied and complex servicing facets of

UHF SERVICE

by HAROLD SCHULMAN

Director of Service; Receiver Division
Allen B. Du Mont Laboratories, Inc.

Types, Numbers and Cost of Tubes, Picture Tubes, Tuners, Strips, Special Parts, Standard Components, Leadin (Coax, Tubular, Open Wire) and Installation Tools Required for Average Service-Shop Operation

(Right)

The job ticket recommended by service executives at Du Mont. Top stub detaches and is fastened to receiver for customer identification. Bottom stub is given to customer as receipt. Center portion contains vital data for computing charges; back of card contains list of parts used. Cards may be used for complete inventory control, record of customer relations, and for mailing lists.

TV often compel one to team up. In this way, while one man makes calls, changing tubes and making minor repairs, others can work on the *problem* sets in the shop. Since many calls consist of little more than changing tubes, too much time spent by one man on difficult sets can easily cost the one-man operation its chief source of revenue.

It's important to keep track of stock, too. One may keep forty or fifty small tubes, plus varied amounts of resistors and capacitors in a truck. Should you continue to borrow from your main inventory without replacing the items systematically, you will suddenly find that you don't have the right parts and can lose customers because you cannot complete the repair on time. In addition, continued trips to your supply source, because of stock shortages can reduce your efficiency and consume valuable time.

An automatic parts inventory is great, but usually it works well only for a large service outfit with a full time stock attendant. It is best to start with good basic inventory and an order pad. One should keep a pad on hand at all times and jot down the parts used.

Another assist to efficient servicing is the *job ticket*. This card, filled out during the customer's first service request, *travels* with the Service Man, who notes what parts have been used, what repairs have been made, etc. This type of card can be used for billing, for a permanent customer record, or for mailing lists.

Once a week it will be found wise to study all of the cards returned during the week. You will be able to

determine whether your stock needs replenishment and to what extent. The cards can be filed for further reference. It also is important to go through your stock proper at least once a week and build your inventory.

Of course, if you have set up an arrangement with a dealer or a distributor, one of your major functions will be installation. For this type of work, about \$250.00 worth of antennas, antenna equipment and installation tools will be necessary. Even if you do not expect to do any great amount of installation work, it's still a good idea to keep a supply of leadin wire, tools and mounting brackets on hand.

If you are now in an area where *uhf* is expected, but where *vhf* is already in operation, you will need plenty of additional installation equipment. Due to certain *uhf* installation problems, it has been found that the best type of leadin cable is tubular 300 ohm, costing about \$40.00 per thousand feet; the average installation will require approximately 100'.

For the average location, where *uhf* conversions and new *uhf* sets will be installed, about 1000' of tubular lead will be necessary as an initial stock.

Where there is a great deal of metal about (roofing, girders, etc.) it will be necessary to use coax leadin; about 1000' of RG11/U (for long lines, 50' to 75') and another 1000' of RG59/U, for shorter runs. All told, the three *uhf* lines should cost about \$300.00.

Now, if a great many fringe-area sets are being serviced it will be necessary to use 450-ohm open wire

leadin, for long runs. About 1000' will be required for stocking; cost will be about \$150.00.

For every ten feet of leadin in *uhf* installations some kind of standoff insulator will be necessary. In *uhf*, for best results, it has been found that the leadin cable should be at least 6" away from the wall; cost here will be about \$10.00 per thousand feet of leadin.

UHF Antennas

Antennas required for *uhf* differ from those used on the veryhighs, although at least one, the stacked V, can be used for both *vhf* and *uhf* reception. The only way to estimate antenna requirements is to estimate your anticipated business volume: A minimum would be five stocked Vs and five bow-ties; the latter strictly for *uhf*.

Strips, for conversion purposes, will be a negligible investment. Types will depend on sets to be serviced and channels involved. A few of these, for perhaps fifty dollars, should satisfy immediate needs.

The total extra minimum investment for *uhf* service will run from \$250 to

(Continued on page 89)

Service Shop Tag		No. 1025	
Name			
Address			
ALLEN B. DU MONT LABORATORIES, INC.			
NAME	LAST	FIRST	ADDRESS
DATE	PHONE	CITY	ZONE STATE
MODEL	SERIAL	WARRANTY DATE	CHECKED BY
CHASSIS	POWER PACK	TUBE	COMPLETE SET
DEALER	DISTRIBUTION	CONSUMER	EMPLOYEE
CHANGES	TM	T	M
REPAIRS		NC	APPROVED
CUSTOMER WILL CALL	POST CARD SENT (DATE)	BY	RECD BY
TO BE SHIPPED	TO STOCK ROOM (DATE)		
DATE PICKED UP	UACD INVOICE No.	AMOUNT REC'D	
	SIGNED		
ALLEN B. DU MONT LABORATORIES, INC.			
DATE	SERVICE MAN		
SERIAL No.	RECEIPT STUB	No. 1025	

Signal-Tracing Probes . . . Low-Capacitance Probes for IF Signal Tracing . . . Crystal Probe Circuits . . . Considerations of Crystal Polarity . . . Improving Reproduced Waveforms . . . Probes for Video-Amplifier Adjustment . . . Voltage-Doubler Probe Design

TV Troubleshooting

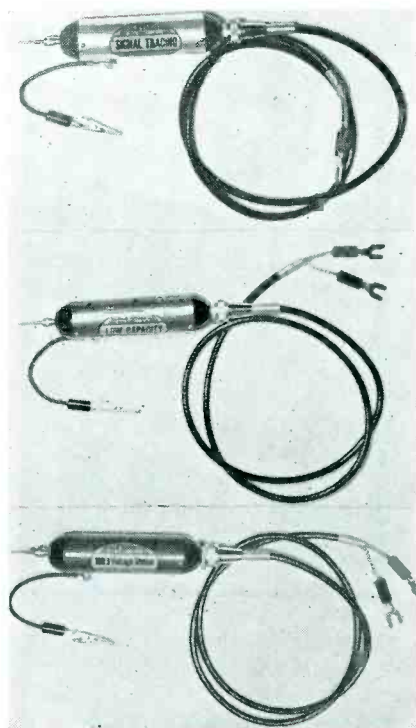

(Above)

Fig. 1. At top: a crystal signal-tracing, or demodulator type of accessory probe for 'scope is shown. In center is illustrated a 10-to-1 low-capacitance high-impedance probe, used to avoid disturbance of operation in high-impedance circuits when making waveform tests. A view of a high-voltage capacitance-divider probe, designed to make waveform checks without damage to 'scope, when testing high-voltage horizontal-frequency circuits appears at the bottom.

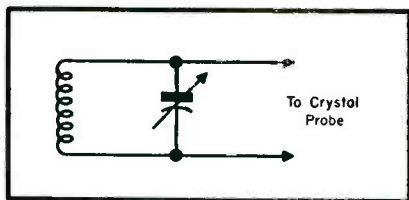

(Above)

Fig. 2. Simple tuned circuit which can be connected to the terminals of a crystal probe, for viewing interference of various types. Advantage of the tuned circuit is that the picture can be eliminated, for example, while the sound signal is inspected; or both sound and picture can be tuned out, and extraneous interfering frequency can be tuned in, and its frequency measured by checking the resonant frequency of the tuned circuit with a standard signal generator. The tuned circuit is used by coupling it inductively to the receiver coil under test.

TV SERVICE MEN have become fully aware of the versatile electronic tools available to them for the solution of a variety of service problems. Representative of the tools which have gained wide recognition recently are three probes for crystal signal-tracing, low-capacitance high-impedance checking and as a high-voltage capacitance-divider. These probes have found wide acceptance because they extend the fields of 'scope application into circuits which carry high frequencies, or have high internal impedances, and those circuits which carry high voltages. Such fields of application are closed to the service 'scope, unless such auxiliary probes are used.

It has been recognized that the field of crystal probe application can be enlarged by the use of tuned circuits ahead of the probe. By such means, as illustrated in Fig. 2, operators can check the waveform of a sound *if* signal, for example, in the presence of a picture *if* signal. The tuned circuit rejects the picture signal and accepts the sound signal for display on the 'scope screen. In this manner, an *if* signal can be checked for the presence of sync buzz, and the frequency of any *if* interference can be measured if the tuning facility is calibrated from a standard signal generator.

Because the *if* signal level is relatively low in the earlier stages, some sort of preamp is often required for use with the 'scope. When a crystal probe is used for signal tracing, any conventional audio amplifier serves the purpose quite satisfactorily, as illus-

trated in Fig. 3. To streamline the operation, a super marker injector (illustrated in Fig. 4) has been developed.

The application of this unit has been found practical because the marker injector comprises a wide-band input amplifier, followed by a demodulator and an audio amplifier, providing a tracing system well adapted to the checking of signals in *if* circuits. Use of the low-capacitance probe for signal takeoff will be found effective to minimize detuning of the stage under test.

The general plan of signal tracing in *hf* circuits with the marker injector and low-capacitance probe is illustrated in Fig. 5. The type of indication obtained, when using either a crystal probe and audio amplifier, or low-capacitance probe and marker-injector unit is illustrated in Fig. 6.

Circuits Used in Crystal Probes

A variety of circuits has been used at various times in TV-servicing crystal probes. The circuit which is *best* depends upon the intended application. Even the polarization of the crystal may affect the operation of the probe in certain situations.

As noted in Fig. 7, the simplest possible probe consists of a crystal diode feeding into a shielded cable. Like any oversimplified device, such a probe is normally subject to severe limitations, such as waveform distortion, hum-voltage conduction, and shift of operating point due to *dc* volt-

Fig. 3. When testing in low-level stages, a preamp may be required with the 'scope to obtain satisfactory signal voltage from the crystal probe. A conventional audio amp can be used for this purpose, since the frequency range of the probe output is relatively limited.

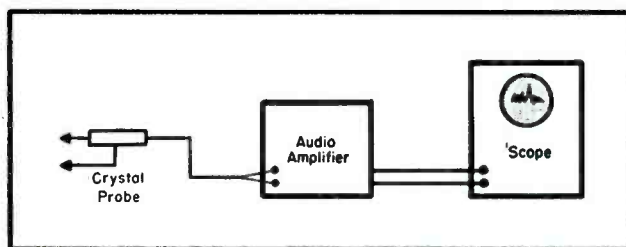

‡Based on notes prepared by the engineering staff of Scala Radio Co.

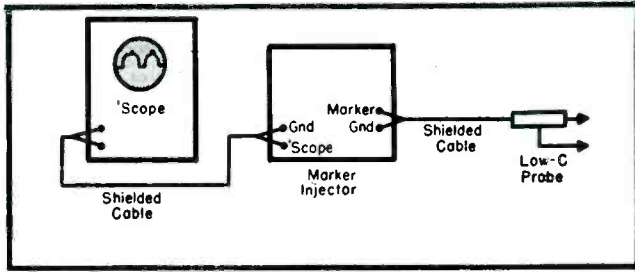

Fig. 5. Arrangement used to signal-trace an *if* amplifier, using a low-capacitance probe, marker-injector unit, and 'scope. Demodulation is accomplished automatically by the builtin facilities of the marker-injector.

TOOLS†

by C. K. STERLING



Fig. 4. A super marker injector whose primary purpose is to provide marker indications of equal size at any point on a response curve, in traps, or along the base line. Unit can also serve as a signal tracer, when used in combination with the low-capacitance probe illustrated in Fig. 1. (Courtesy Scala Radio Co.)

age leakage through the blocking capacitor in the 'scope input circuit.

In this simple arrangement, the crystal diode charges the cable capacitance as the modulation envelope rises, and little distortion is encountered in this portion of the operating cycle. Next, as the modulation envelope falls, the charged cable can discharge only through the back resistance of the crystal, and if the crystal is in good condition (has a substantial front-to-back ratio), negative peak clipping ensues, as in improperly-adjusted detectors of radio receivers.

Insensitivity may be encountered, as shown in Fig. 8, unless the blocking

Fig. 7. Simple type of crystal probe, in which a series crystal diode charges the cable capacitance. The charged cable discharges through the back resistance of the crystal and the circuit under test. The waveform distortion encountered in conventional TV test work will be considerable, as negative-peak clipping results from the long discharge time-constant. Other probe arrangements provide quite acceptable reproduction of negative peaks in the modulated waveform under test.

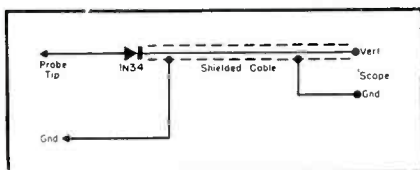

capacitor in the 'scope input circuit has good insulation resistance. Leakage resistance (R_L) causes any *dc* voltage present at the probe tip to flow to ground through the circuit provided by the leakage resistance, and the input resistance of the 'scope, R_{in} . Service 'scopes receive hard usage, and the blocking capacitor will often found to be in a defective condition. The flow of *dc*, which results from a defective blocking capacitor, produces a voltage drop or bias across the crystal diode which moves the operating point to a relatively insensitive portion of the crystal characteristic.

Considerations of Crystal Polarity

The output waveform from various signal generators may be non-sinusoidal, as illustrated in Fig. 9. Under such conditions, the positive peak voltage differs from the negative peak voltage, and the apparent sensitivity of the probe depends upon the polarization of the crystal diode. These considerations affect the sensitivity of signal-tracing operations when the modulation envelope of the generator output is non-symmetrical, as well as

Fig. 9. At (a) is illustrated a pure sine waveform normally obtained only from lab type generators. Typical shop generators usually have varying amounts of harmonic content in the output, which does not affect the utility of the instrument, as long as the operator is aware of the presence of the harmonics, and applies the instrument accordingly. A pulse-type of output, obtained from typical service generators, is shown in (b). Service Men find also that the modulation envelopes are often unsymmetrical; these factors influence the proper polarity of the crystal diode in the probe.

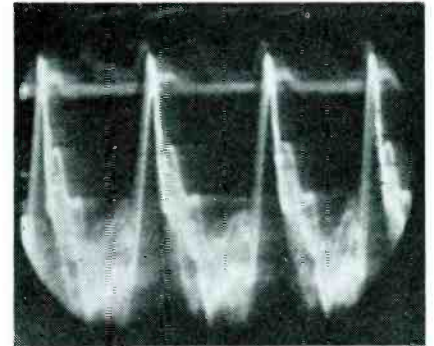
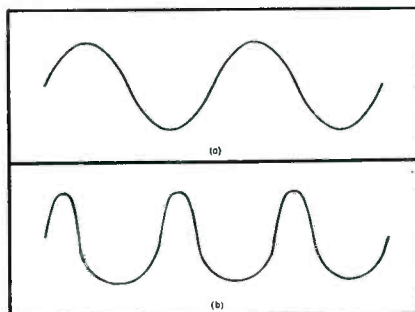

Fig. 6. Composite video signal as picked up half way along the *if* amplifier by a crystal demodulator probe and 'scope. Such signal tracing procedures make it easy to locate a dead or a weak stage.

when generators are being calibrated against crystal oscillators.

Service Men frequently find, therefore, that the apparent sensitivity of his crystal probe is greatly affected by the polarity with which the crystal diode is connected into the probe circuit. This consideration applies to probes utilizing a single crystal diode. It does not apply, however, to voltage-doubling probes which effectively add up the positive peak and the negative peak of the waveform.

Improving the Reproduced Waveform

One well-known method of improving the reproduced waveform is to make the input impedance of the probe

(Continued on page 97)

Fig. 8. The simplified type of crystal probe appears very insensitive if the 'scope input blocking capacitor C_B has appreciable leakage conductance, as indicated at R_L . A *dc* path for flow of current then is provided through R_L and the 'scope input resistance R_{in} . Capacitance C_C represents the cable capacitance and C_{in} represents the 'scope input capacitance.

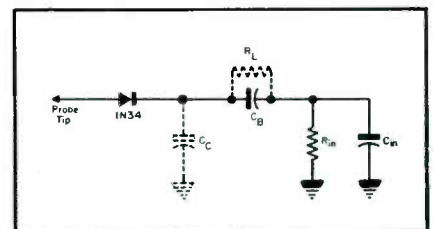

UHF / VHF

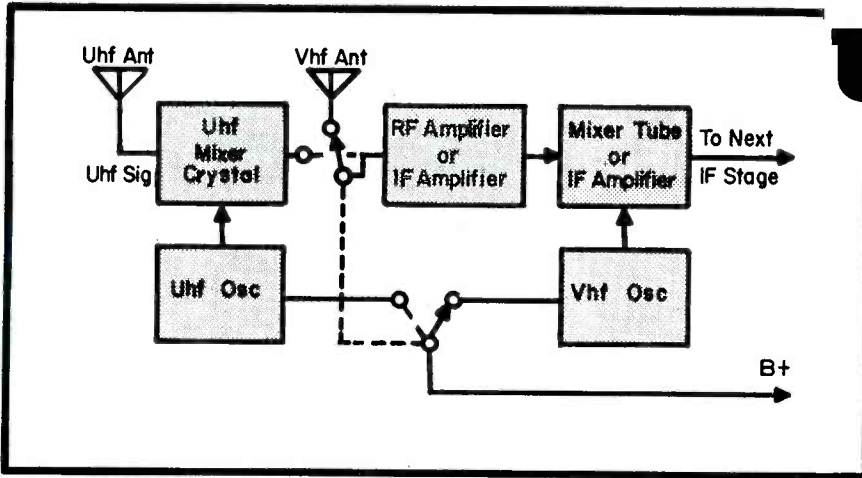

Fig. 1. Block diagram of a full coverage *U/V* tuner which consists of a continuously tuned *uhf* tuner and a 12-channel 13-position *vhf* turret tuner ganged together.

A TUNER is a unit which utilizes only a single conversion to change either *vhf* or *uhf* signals to intermediate frequency, as contrasted with a converter which utilizes a double conversion process to change *uhf* signals to *if**.

Practically all full-coverage *uhf/vhf* or *u/v* tuners currently available consist of two units, a *vhf* tuner and a separate ganged *uhf* tuner. There are also available replacement strips for turret tuners that utilize a single conversion process.

The full coverage *u/v* tuner which at this time is most popular, consists of a *vhf* tuner ganged to a *uhf* tuner. There are usually 13 positions on the selector switch for the 12 *vhf* channels, the 13th position being labeled *uhf* and serving to switch the *rf* and mixer tube circuits to operate as an *if* amplifier, and switch off the *B+* of the *vhf* oscillator tube. The fine tun-

ing control of the *vhf* tuner also serves as the *uhf* tuning control; in Fig 1 appears an illustration of a system using this method.

The *u/v* turret tuner, incorporated into most of the current TV receivers and using a single conversion principle is shown in *a* and *b* of Fig. 2. In *a* the operation of the *uhf* strip is indicated. In this case the *vhf* oscillator is operated at $\frac{1}{3}$, $\frac{1}{4}$ or $\frac{1}{5}$ of the required *uhf* oscillator frequency. The desired third, fourth or fifth harmonic of the crystal multiplier is tuned in the harmonic selector circuit to obtain the correct *uhf* oscillator frequency. In the case of single conversion, just as in *vhf* operation, the local oscillator must operate at a frequency above the signal frequency; see appendix 1 for calculation of correct oscillator and harmonic selector frequencies. A comparison of *a* in Figs. 2 and 3 will serve

to illustrate the difference in the operation of a converter and a tuner. One difficulty that may be encountered in the full coverage and turret tuners, when operated in the *uhf* band, is oscillation at *if* because of the increased *if* gain on this band. This oscillation is caused by radiation of high level *if* signal from the detector or first video stage back to the antenna leads and into the input of the *if* amplifier. The oscillation may be eliminated by moving the antenna leads as far from the chassis and second detector as possible and in addition bypassing and filtering the supply leads to the tuner. Another difficulty may occur; interference from transmitters (police, public utilities, etc.), operating in the 40 to 46-mc band, which might be severe because of the high gain *if* and lack of *rf* selectivity on the *uhf* portion of the tuner. The interference may be eliminated by an *if* trap in the antenna leads and possibly additional shielding of the tuner and *if* amplifier.

Present tuners and converters having full coverage are expensive because of the two separate units required. The turret tuners are limited in the number of stations they can receive, but they are inexpensive. All TV receivers of the future will be expected to provide full coverage of all *uhf* as well as *vhf* channels. According to present plans, *u/v* sets of the future will include a turret tuner covering a number of channels on each position, with a fine control tuning these channels along the lines of the band-switching all-wave receivers of years ago; or a continuously tuned *uhf* band with the *vhf* channels selected by means of switch positions. A grounded-grid *uhf* amplifier will certainly be incorporated in the better tuners.

Let us now examine a typical combination *uhf/vhf* tuner that might be

*Hesse, Henry R., *UHF Converters, SERVICE*; March, 1953.

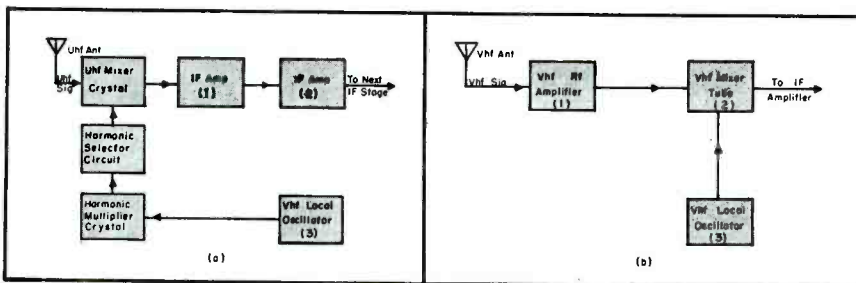

(Above)

Fig. 2 *a* and *b*. In *a* appears a layout of a system employing a turret tuner equipped with *uhf* strip. A turret tuner equipped with a *vhf* strip is illustrated in *b*.

(Right)

Fig. 3. Single-channel converter setup.

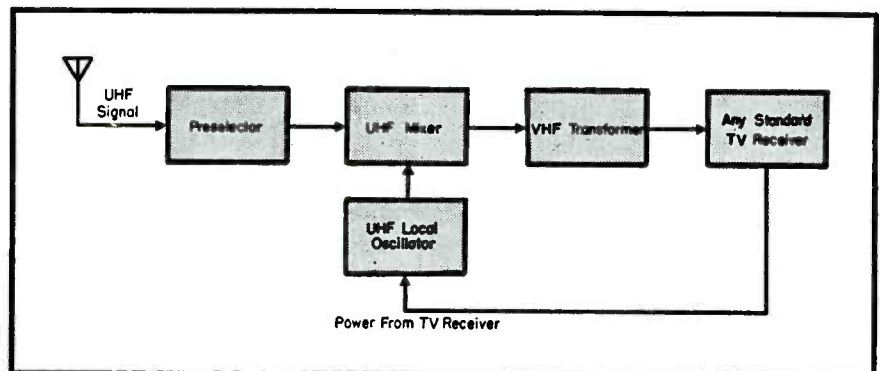

Tuners

by HENRY R. HESSE

Senior Engineer, TV Receiver Division

Allen B. DuMont Labs

Theory and Operation of Tuners Now Available and Highlights of Modified Types Which Will be Marketed in the Future

available next year. In Fig. 4 such a system is illustrated, with a separate *uhf* and *vhf* antenna connected to a common transmission line through a crossover network. An alternative would be an antenna suitable for both bands, in which case no crossover network would be required at the antenna end of the transmission line. The transmission line must be connected to another crossover network where *uhf* signals are separated from *vhf* signals and enter separate receiver input connections.

A crossover network is a special type of high and low-pass filter, connected together to permit passing of a certain band of high frequencies in a certain direction and a band of low frequencies in a different direction, without a loss of either signal due to the unused circuit being permanently connected in the system. A typical crossover network is shown in Fig. 5. The same crossover network may be used at the antenna or at the receiver. The schematic shows a high pass *T* filter on the left and a low pass *T* filter on the right. Each filter looks like an open circuit in its attenuation band, so that no *uhf* signal energy is lost, since the low-pass filter is connected to the transmission line and the high-pass filter looks like an open circuit at *vhf*, and no *vhf* signal energy is lost in the high-pass filter.

In the Fig. 4-system, a *u* and *v* division is indicated. In an actual tuner many of the components will be used on both bands; for clarity separate items are shown in the block diagram. The tubes will serve on both bands.

In Fig. 4 a receiver-crossover network is shown feeding elevator coils in the *vhf* portion and a *balun* in the *uhf* portion of the circuit. (A *balun* derives its name from *balanced* to *unbalanced* transformer, and is the *uhf* equivalent of the familiar elevator coils as used on *vhf*.) A simple *balun* may be made from 8" of 150 ohm twinlead as shown in Fig. 6. The twinlead should be folded in the middle and skinned at this point and at both ends, and carefully connected. The connection at the balanced end is most important; it must connect a grounded

lead on one end to an ungrounded lead at the other end of the twinlead. The *balun* can be tested with an ohmmeter which should show a short across both ends of the *balun*.

Filters represent the next important item in the *u/v* chain. In the *vhf* portion of the circuit an *if* band rejection filter is used to suppress pickup of signals in the *if* band. In the *uhf* portion of the circuit a high-pass filter is installed to prevent powerful *vhf* signals interfering with *uhf* signals. The crossover network also helps here, too.

Next in the Fig. 4 lineup is the tuned circuit for the *uhf* and *vhf* bands, followed by an *rf* amplifier in the case of *vhf*, and perhaps also at *uhf* for the better tuners. In some tuners the *uhf* amplifier might be omitted and the signals will pass directly to the crystal mixer. In the case of the local oscillator, most designs will use the same tube for both *uhf* and *vhf*.

f_s = *uhf* pix carrier frequency.*
 f_a = *uhf* oscillator frequency; *if receiver uses standard *if* follow appendix data published last month. Set harmonic selector circuit to this frequency.
 f_1 = intermediate frequency pix carrier; find from service manual of receiver.
 f_o = *vhf* oscillator frequency.
 n = harmonic number; use 3 for low *uhf*, 4 for middle *uhf*, and 5 for high *uhf*.

$$f_n = f_s + f_1$$

$$f_o = \frac{f_s + f_1}{n}$$

or

$$f_o = \frac{f_n}{n}$$

Appendix I

Calculation of frequencies in single-conversion superhet, as used in certain TV turret tuner strips.

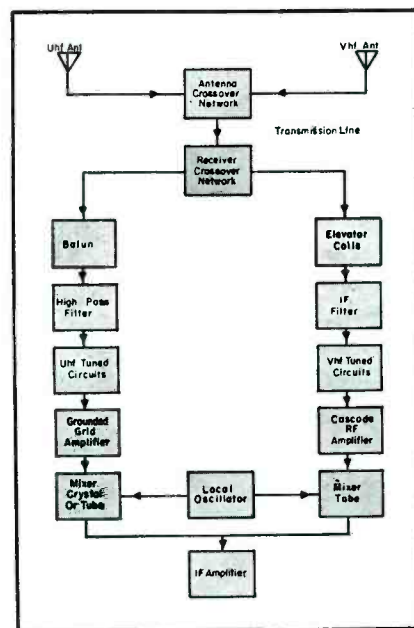

Fig. 4. Block diagram of a typical *U/V* combination tuner of the future.

Fig. 5. Crossover network circuitry; high pass *T* filter is at left, and a low-pass *T* filter is at right.

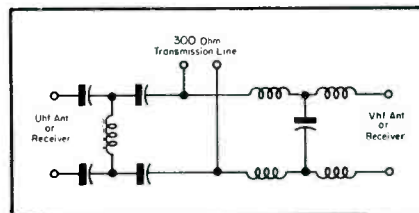
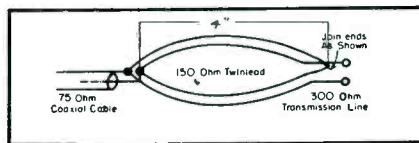
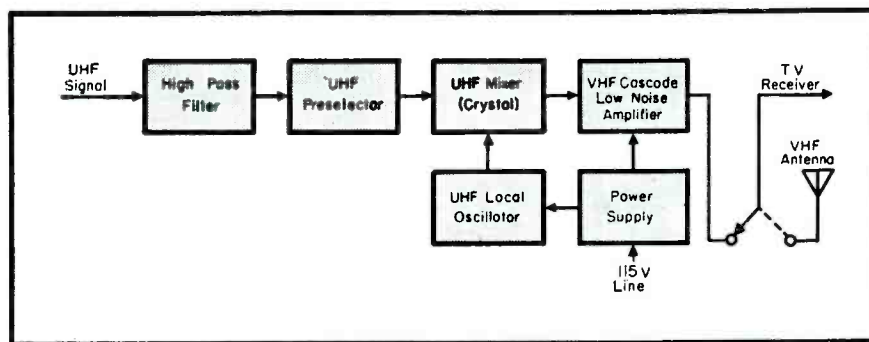

Fig. 6. Simple *uhf* balun made from a piece of twinlead.



(Below)

Fig. 7. Layout of separate tunable self-powered *uhf* converter which can be used with any TV receiver.



Comprehensive Analysis of the Design and Performance Characteristics of Crystal, Magnetic and Capacitive Pickups, Tone Arms, and Needles; Data on Tracking Force, Tip Radius, Stylus Material, Shafts and Replacement Problems

PICKUPS, NEEDLES and

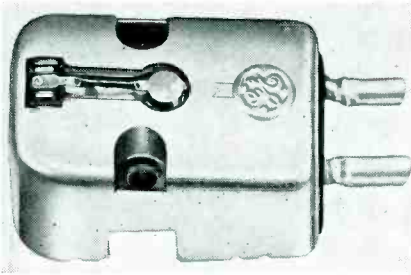

(Left and right)

Fig. 1. Magnetic pickup and stylus. The generating element is the stylus itself, vibrating between the two pole pieces. (Courtesy G.E.)

ALMOST ALL MODERN pickups used in home phonos are made in the form of cartridges that are detachable from the arm. Although the cartridges come in various types and with different commercial technical names, they can be divided into three main categories: the piezoelectric (crystal) cartridge, which contains an element of rochelle salts or ceramic; magnetic cartridge, which includes the variable reluctance and moving coil types, and the capacitive or frequency-modulation cartridge.

The Crystal Cartridge

The piezoelectric pickup operates on the principle that certain materials, when subjected to pressure, produce voltages at their surfaces. A stylus chuck holds the piezoelectric element in such a manner that lateral motion of the needle produces an axial twist in the material, and varying voltages are picked off by retaining plates and

Fig. 2. Narrowing of the groove produced by pinch effect. The periodic raising and lowering of the reproducing stylus has no adverse effect if the cartridge has little or no response to vertical stylus motion.

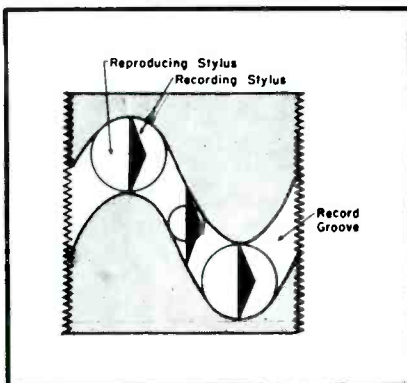

conveyed to the cartridge terminals. One of these terminals is usually clearly marked to indicate that it is to be connected to the braided shield of the pickup lead. This marking often consists of a metal strip connecting the lead to the metal case of the cartridge. If the pickup leads are reversed from their proper connection, increased hum will be evident, and touching the tone arm or cartridge case will produce a loud hum or buzzing noise.

The characteristics of crystal pickup cartridges are economy, high output voltage, and simplicity of installation. No preamp is required (the output of the cartridge is usually between .5 and 2 or 3 volts), and the special problems associated with high-gain circuits (hum, noise, microphonics, etc.) are not present. Furthermore, there is no danger, such as exists with magnetic cartridges, of hum pickup by the cartridge itself.

Properly compensated crystal cartridges, or cartridges designed to match particular recording characteristics, are capable of excellent quality. The crystal has been generally abandoned, however, in installations of the type found in broadcast stations.

The Magnetic Pickup

The magnetic type of pickup is normally found in professional installations. Its working principles are basically those of the electric generator, involving motion of a conductor in a magnetic field (or vice versa). The high quality that may be achieved with this unit must be paid for in increased expense and greater care in layout of the associated reproducing equipment. Once a preamp is properly connected, however, and the cartridge located in a position free from the hum fields of

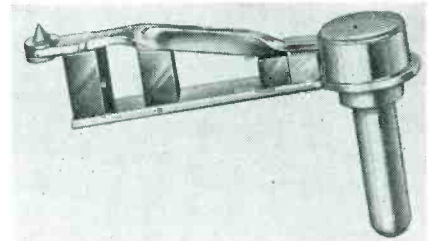

transformers or of the turntable motor, the magnetic pickup achieves a performance noted for low distortion and uniform, extended-range frequency response.

The output voltage of magnetic pickups is quite low; from 10 millivolts (.01 volt) for the low output types to about .1 volt for the relatively high output types. This voltage is normally balanced to ground, so that the terminals have no polarity and will take either shield or central conductor. The cartridge itself is susceptible to pickup of hum, and installation of a magnetic cartridge in an old record changer (which has been designed with only the crystal in mind) occasionally results in an unacceptably high hum level, caused by the improper location

Fig. 3. Recommended tracking force for various pickups.

Pickup	Manufacturers' Recommended Vertical Tracking Force
G.E. RPX-040 (78)	12 to 14 grams
G.E. RPX-041 (micro)	6 to 8 grams
G.E. RPX-050 and 052 (78 and micro)	6 to 8 grams
Pickering series 120 (78)	15 grams
Pickering series 140 (micro)	6 grams
Pickering 260 (78 and micro)	4 to 6 grams
Clarkstan 204 (78)	9 to 15 grams
Clarkstan 204 (micro)	6 to 9 grams
Fairchild series 200 (78)	15 grams
Fairchild series 200 (micro)	6 grams
Audax Polyphase (78 and micro)	6 to 8 grams
Weathers FM pickup (78)	1 gram
Weathers FM pickup (micro)	1 gram

Fig. 5. A few of the current reproducing stylus designs. (Courtesy Terminal Radio.)

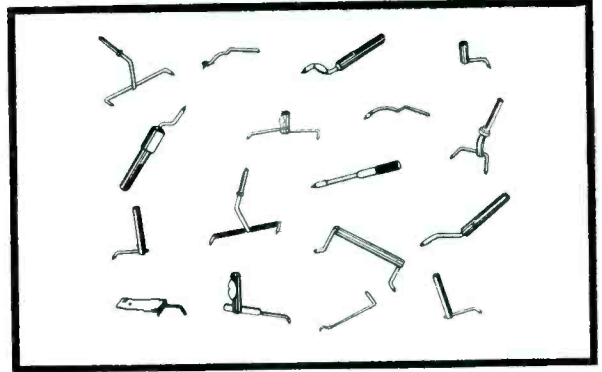

tone ARMS

of the motor relative to the tone arm.

Modern magnetic pickups have a *constant velocity* response. They definitely do *not* match recording characteristics. Bass boost and treble cut must be introduced in the electronic circuits following the pickup, to compensate for the constant amplitude characteristic used in recording of the bass, and for treble preemphasis.

The Capacitive Pickup

The capacitive pickup works on the principle of changing an instantaneous capacity between plates by stylus motion, thereby changing the resonant frequency of a tuned circuit, and frequency modulating a preamp oscillator. The output of this oscillator is thus a modulated supersonic carrier, and it must be detected, as in a radio receiver, prior to audio amplification. One of the distinguishing features of the capacitive pickup is the fact that the stylus has very little work to do, making possible extremely light vertical force on the groove and minimum record wear.

Low distortion and uniform, extended frequency range are usually incorporated in the performance characteristics of this type of cartridge also, although narrow frequency range units are produced for commercial radio-phonos.

As is true in the case of other audio components, the performance ratings of pickup cartridges, which are most significant, are low harmonic distortion (preferably under 2%) and a frequency response which is, first, uniform, and second, extended in range. Ratings relative to these characteristics are generally available from the manufacturer.

There is another cartridge performance characteristic which is not entirely covered by such ratings. This is the desirable absence of cartridge

by MARK VINO

response to vertical stimuli; that is, stimuli perpendicular to the plane of the record. *Pinch effect* (the periodic narrowing and widening of the record groove with each half-cycle), record warp, turntable rumble, and random groove irregularities impart vertical forces to the stylus which should not be represented in the output signal. Low vertical response is characterized by a particularly *clean* sound, absence of even harmonic distortion, and a minimum of surface noise for a given frequency range. A cartridge with a limited high-frequency range, but pronounced vertical response, may pick up more surface noise and distortion than an extended frequency range cartridge with very low vertical response. One of the advantages of magnetic cartridges over the piezoelectric types has been low vertical response, although in the past few years stylus assemblies with high vertical compliance have been used in conjunction with piezoelectric units, greatly reducing vertical sensitivity.

High lateral compliance is also very desirable. This improves performance by lowering the tone arm resonant frequency and by reducing the erosive forces at the stylus. If the stylus suspension is stiff a correspondingly

Fig. 4. Correct fit between reproducing stylus and groove.

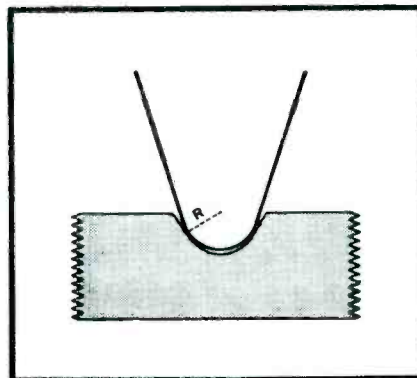

greater *vertical stylus force*¹ (created by weight on the pickup) is required to keep the needle in firm and positive contact with the groove at all times. The lower the vertical force necessary the better, since a cartridge that will *track* (maintain good stylus-groove contact) at very light vertical force reduces both record and stylus wear. However, the cartridge should always be used with the manufacturer's recommended tracking force. Reducing this force to a value lower than that necessary for proper tracking will cause groove skating or even groove jumping, distortion, and increased record wear. The more elaborate tone arms provide an adjustment for vertical force by means of variable spring tension or by a counterweight system. Most record changers supply extra weights which may be installed between the cartridge and the arm when necessary. A sensitive scale for vertical stylus force is a worthwhile purchase, and will probably result not only in reduced wear on records and needles, but in improved performance. Such scales usually come calibrated for weights up to 15 grams‡ or so.

The manufacturers' recommended vertical stylus force for various pickups is indicated in Fig. 3.

Needles

Needles, or styli, vary in several ways; radius of curvature of the tip, material of the tip, design of the shaft which communicates motion of the tip to the pickup mechanism, and the facility for attachment and replacement in the pickup.

Tip Radius

Standard 78 records use styli with a radius of curvature of 3 mils (.003") or slightly less. The tip is not pointed but is a section of a sphere, so that it engages the record at the groove walls only, as illustrated in Fig. 4, and does

‡The gram is equal to .0353 ounce.

(Continued on page 94)

¹This force is sometimes referred to as *tracking pressure*, although the American Standards Association discourages the use of such a term because pressure is measured in units of force per cross-sectional area.

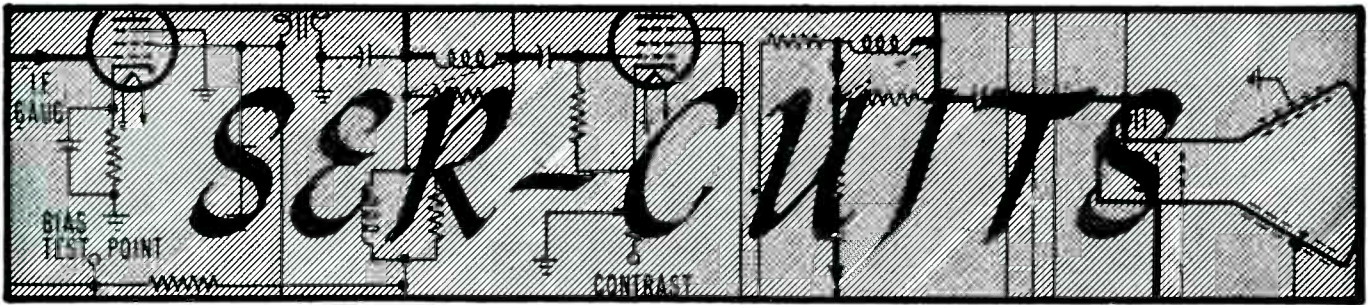

by M. W. PERCY

UHF Continuous-Tuning Converter-(VHF) Booster† and Converter/Tuner Circuitry Analysis . . . Horizontal AFC System Operation

CONSIDERING THE NUMBER of *uhf* stations which will be located in *vhf* fringe areas, a *uhf* converter incorporating a tuneable *if* stage which can be used as a *vhf* booster seems to fill a definite need.

In Fig. 1, the circuit of such a unit, a booster-converter,* is shown, featuring continuous *uhf* tuning; 270° rotation of concentric tuning elements.

†From data prepared by Arthur L. Morgan, Sutton Electronic Co., Inc.
*Sutco model 21A.

Two of these elements are used for *rf* preselection, and the other, shaped differently from the previous two, to provide proper tracking of the oscillator with the *rf*, maintains the oscillator frequency below the incoming signal, thereby providing heterodyne action for *if* amplification. To facilitate *uhf* tuning two knobs are used; one is connected directly to the tuning element for fast tuning and the other provides a speed reduction of 6:1 by means of a spring loaded dial cord.

Alignment adjustments are provided via three tubular ceramic capacitors and their connecting end inductances. Sufficient *rf* bandpass is maintained to enable use of either channels 5 or 6 as the *if*. Bandpass is controlled by varying the coupling between the antenna and mixer tuning element; approximately .25 mmfd.

Crystal mixer excitation is derived from capacity coupling between the

[See page 38 for additional data on *uhf* tuners]

Fig. 1. Circuit of Sutco *uhf* converter-booster; model 21A.

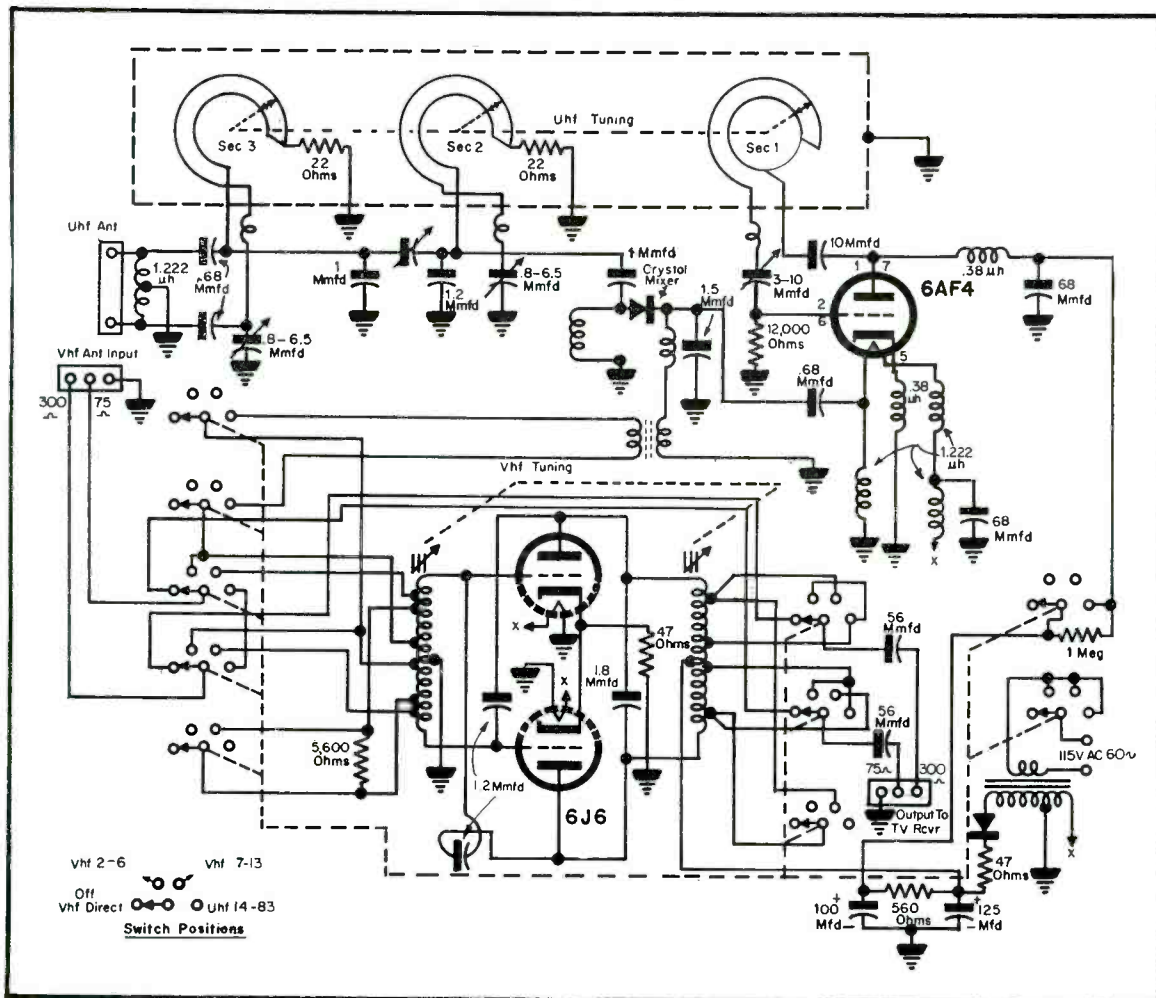

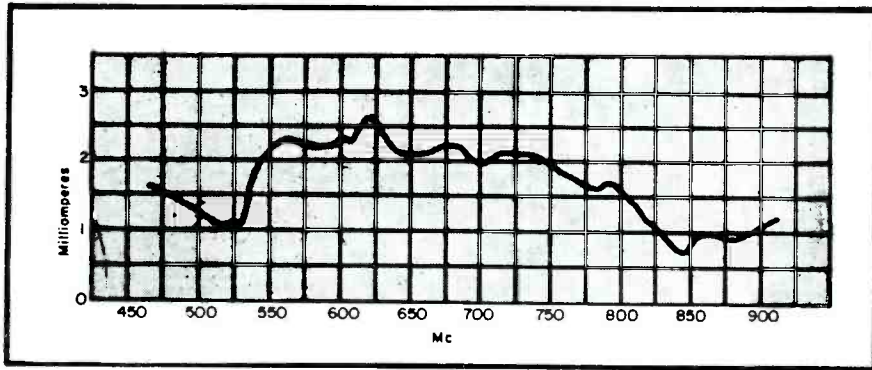

Fig. 2. Plot of converter-booster crystal current versus frequency.

Mc	Noise	Db Image
500	20 +	33
600	20	28
700	20 +	21.5
800	20 +	19.5
900	20 +	15.2

Table 1
Noise image data for booster-converter.

oscillator cathode and filament within the tube. A capacity divider network connected from filament to chassis produces a mixer takeoff point which is a relatively good impedance match to a CK710 crystal. Oscillator drift, due to temperature changes, is compensated for by the use of a 10-mmfd fixed ceramic capacitor, with a negative temperature coefficient, in the oscillator circuit. All oscillator circuit components and oscillator tube (6AF4) are shielded to reduce radiation.

The *rf* resistance of the crystal at the proper values of crystal current has been found to warrant the use of a 1:1 ratio transformer to couple to the input coil of the *if* amplifier. The impedance at this point, being on the order of 300 ohms, permits use of an untuned transformer, containing a powdered iron core, to obtain a high degree of coupling.

For *vhf* booster operation, the oscillator is disabled by insertion of a

Fig. 4. An *rf* response plot for converter-amp at approximately 800 mc**.

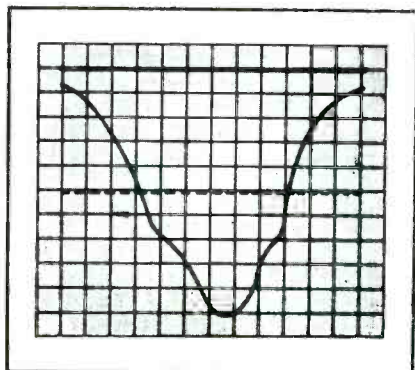

** (RCA WR40A generator and WO56A scope were used in preparing *rf* response plots.)

1-megohm resistor in the *B+* line supplying plate voltage. This switching arrangement prevents the possibility of the oscillator tube changing characteristics, as a result of operation over

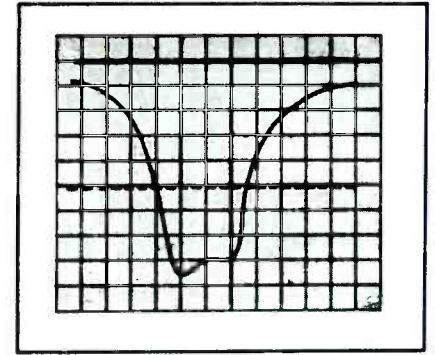

Fig. 3. Typical *rf* response of *vhf* converter-amp at approximately 475 mc; dashed lines indicate general output reference level**.

of bifilar wound multi-tapped coils, tuned by movable powdered-iron cores. To make *vhf* tuning a continuous operation, from a mechanical and dial calibration standpoint, a switching op-

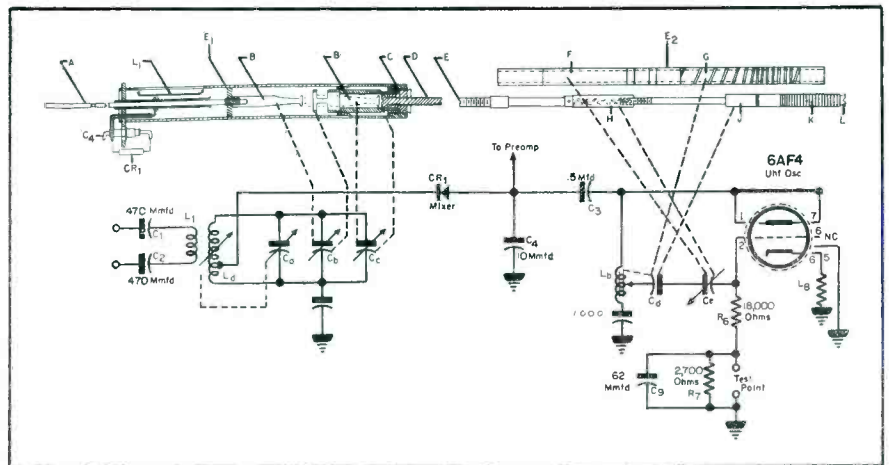

Fig. 5. Functional diagram of Motorola *vhf* converter.

long periods of time, with only filament voltage applied.

Signal amplification for *vhf* is realized by employing a 6J6 in a conventional push-pull neutralized circuit. The grid and plate inductances consist

of bifilar wound multi-tapped coils, tuned by movable powdered-iron cores. To make *vhf* tuning a continuous operation, from a mechanical and dial calibration standpoint, a switching op-

(Continued on page 44)

Fig. 6. Details of antenna transmission line and oscillator coil used in Motorola *vhf* converter.

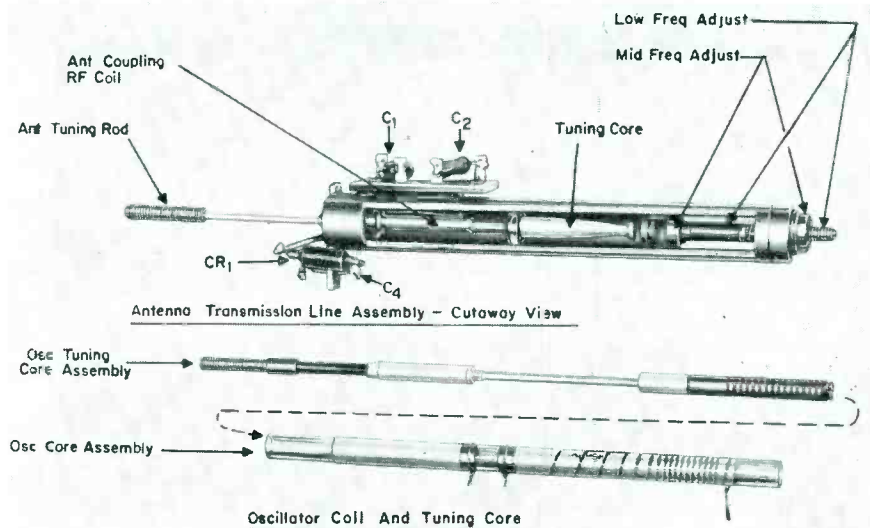

C-D does it again!

6 assortments of twist-prong electrolytic capacitors in beautiful plastic cases!

Ideal for storing screws, tubes, small parts of all sorts. Even fishing tackle. And you pay no more than if you bought the capacitors individually.

The majority of sets can be serviced with these six twist-prong electrolytic replacement kits. See your jobber today for full details. Cornell-Dubilier Electric Corp., South Plainfield, New Jersey.

- KIT #1 — UNIVERSAL
- KIT #2 — FOR RCA SETS
- KIT #3 — FOR PHILCO SETS
- KIT #4 — FOR MOTOROLA SETS
- KIT #5 — FOR GENERAL ELECTRIC SETS
- KIT #6 — FOR ADMIRAL SETS

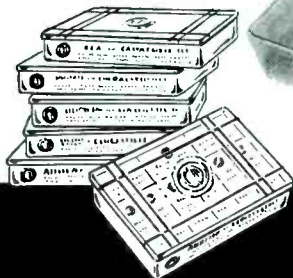
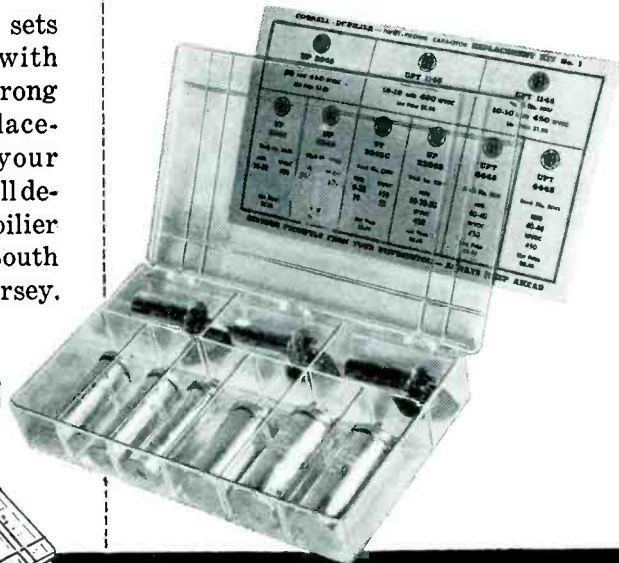

A service of

CORNELL-DUBILIER

world's largest maker of capacitors

PLANTS IN SO. PLAINFIELD, N. J. • NEW BEDFORD, WORCESTER AND CAMBRIDGE, MASS. • PROVIDENCE, R. I.
INDIANAPOLIS, IND. • FUQUAY SPRINGS, N. C. • SUBSIDIARY, RADIART CORP., CLEVELAND, OHIO

Ser-Cuits

(Continued from page 43)

lengths are employed in this assembly to eliminate additional high channel *vhf* resonance points that are not in agreement with the dial calibration. These undesirable resonance points have been eliminated by creating a drastic tracking error between the input and output circuits at all tuning positions, other than the correct alignment points.

The power supply is a transformer

type, using a selenium rectifier and a two section *rc* filter. Plate voltage on the oscillator is 85; the *if* stage is operated at 90 volts.

Continuous Tuning UHF Converter

Another type of *uhf* converter¹ designed to operate as a double superhet, in conjunction with a TV receiver, where the *rf* stage of the *vhf* tuner is used as the first *if*, is illustrated in the functional diagram of Fig. 5 (p.43). In this unit, the *uhf* signal enters the converter through the antenna coupling *rf* coil, then it is loop-coupled to the

transmission line, where a *uhf* mixer (losser type) crystal is tapped on. The incoming signal beats against the output of a series-tuned Colpitts oscillator and the resultant frequency is either channel 5 or 6. The output of the crystal mixer is then amplified by a low-noise cascode amplifier and the amplified signal is coupled to the *vhf* receiver tuner.

The *uhf* signal enters a 300-ohm balanced input and is loop-coupled into the transmission line by L_1 , which is inserted into a slot in the tubing.

The input is tuned by a capacity-loaded, shorted quarter-wave coaxial line. The tube wall, together with the rod and core assembly (*A* and *B*), form an inductance. C_a is the distributed capacity between core (*B*) and the tube wall. As the core moves into the transmission line tube, the line is lengthened and its resonant frequency lowered. The line is capacity-loaded by C_b and C_c to keep the line from becoming too long. C_b , formed by the core (*B*) and the capacitor tuning, and C_c , formed by the core (*B*) and screw adjustment (*D*), are actually part of C_a , but are adjusted to set C_a at a particular value at a particular frequency, i.e., C_c is the initial tracking adjustment at the low frequency end, while C_b is the initial mid-band adjustment. C_a is adjusted by a threaded bushing (*C*).

A crystal mixer, CR_1 , is tapped onto the transmission line, and the incoming signal beats against the output of a 6AF4 series-tuned, modified Colpitts oscillator. The difference frequency is either channel 5 or 6, depending upon which channel is unoccupied by a *vhf* station. The oscillator coil L_0 consists of a glass coil form with a metallized covering (*G*) cut to form windings. In addition to the windings, there is also a solid metallized section (*F*) which, with core (*H*), form the tuning capacitor C_e . Core *J*, in addition to tuning the inductance L_0 , combines with the windings to form capacitor C_d . As its capacitance varies only slightly with the position of *J*, C_d is effectively a fixed capacitor moving along the coil. Detuning slug *K*, a series of copper rings, raises the resonant frequency of the unused portion of the inductance to keep its self-resonance higher than the operating frequency, thus preventing *suck-out* in the tuning range. *E* and *L* are high and low alignment adjustments, respectively.

The crystal is a lossier type of mixer; its output is fed to a 6BK7 cascode preamp, used because of its good signal-to-noise ratio. It is a wide-band amplifier, passing both channel 5 and

¹Motorola.

channel 6 carriers. The output of the preamp is 300 ohms balanced, and coupled into the *vlf* receiver antenna terminals.

A two-position switch on a built-in model allows the *vhf* antenna to be bypassed during *uhf* reception settings, while it bypasses the *uhf* antenna during *vlf* reception.

The two-position switch also controls the B+ supply. During *uhf* the B+ is approximately 260 v, while during *vhf* the B+ supply is approximately 20 v due to a 180,000-ohm dropping resistor. As noted previously, low B+ is necessary to prevent deterioration of the *uhf* converter tubes which would occur if no B+ were present while filament voltages were supplied to the tubes. The filaments are lit so that either *ulif* or *vhf* stations can be viewed without any warm-up period.

Horizontal AFC in Capehart CX-37*

In the early stages of commercial TV receiver engineering, designers noted that to provide acceptable pictures, some method of automatically controlling the horizontal scanning circuit of the receiver had to be incorporated.

The original system of direct control of the scanning circuit, by using the horizontal sync pulse to trigger the horizontal oscillator, was found to be impractical, considering the varying signal and extreme noise conditions under which a TV receiver would operate. Because of these operating conditions, it was necessary to evolve automatic frequency control systems.

Early AFC Circuit Designs

The early *afc* circuits usually employed several tubes and a host of associated components. Through the years, the *afc* circuit has not only undergone many stages of simplification, but it has been substantially improved. In the Capehart CX-37 series, for instance, one half of a 12AU7, is used as a horizontal phase detector; this tube is shown in Fig. 7 as it would

Fig. 7. Basic *afc* circuit in which one half of a 12AU7 serves as a horizontal phase detector.

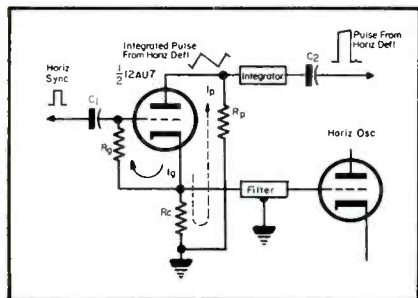

THE SIMPSON MODEL 260 VOLT-OHM-MILLIAMMETER

*outsells all others combined
because . . .*

- A** covers all ranges necessary for Radio and TV set testing
 - B** includes the Simpson 50 Microampere Meter Movement known the world over for its ruggedness
 - C** no bulky harness wiring, thus eliminating all intercircuit leakage at this high sensitivity
 - D** molded recesses for resistors, batteries, etc.
 - E** easy battery replacement
- all components—including case and panels—are specially designed and completely tooled for maximum utility . . . not merely assembled from stock parts

ranges 20,000 Ohms per Volt DC,
1,000 Ohms per Volt AC
Volts, AC and DC: 2.5, 10, 50,
250, 1000, 5000
Output: 2.5, 10, 50, 250, 1000
Milliamperes, DC: 10, 100, 500
Microamperes, DC: 100
Amperes, DC: 10
Decibels (5 ranges):
- 12 to +55 DB
Ohms: 0-2000 (12 ohms
center), 0-200,000 (1200 ohms
center), 0-20 megohms
(120,000 ohms center)

SIMPSON ELECTRIC COMPANY

5200 W. Kinzie St., Chicago 44 Phone COlumbus 1-1221

In Canada: Bach-Simpson, Ltd., London, Ont.

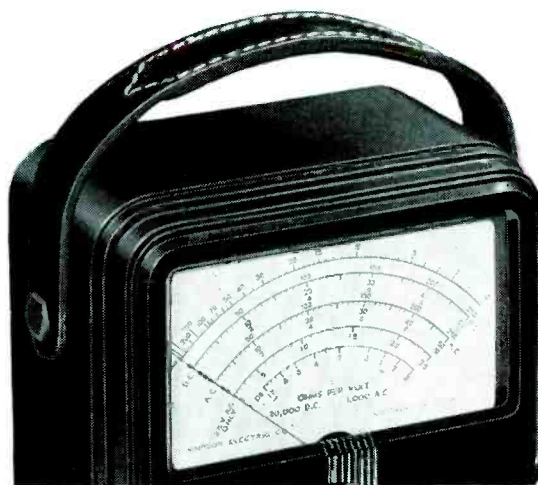

BURTON BROWNE ADVERTISING

prices

Model 260 \$38.95;
With Roll Top \$46.90.
Complete with test
leads and operator's
manual. 25,000 volt
DC Probe for use with
Model 260, \$9.95.

be connected in the basic circuit from which the actual circuit was developed. In this circuit, there are two pulses injected into the tube. The plate is pulsed by an integrated pulse derived from the horizontal deflection circuit, and the grid is pulsed by positive-going horizontal sync pulses coupled from the sync circuits. Plate return for this tube is through the resistor R_p .

The positive sync pulse applied to the grid of the tube causes a flow of

current from grid to cathode. This current develops a voltage across the grid resistor R_g which acts as self bias for this tube. This bias is approximately equal to the amplitude of the sync pulse and is sufficiently strong to hold the tube below plate current cut-off during the interval between pulses.

When the sync pulse appears at the grid, the tube will start to conduct plate current. Since the plate supply is also a pulse, the amplitude of the current that will flow from plate to

*Based on a report issued by the publications and training section of Capehart-Farnsworth service department.

(Continued on page 49)

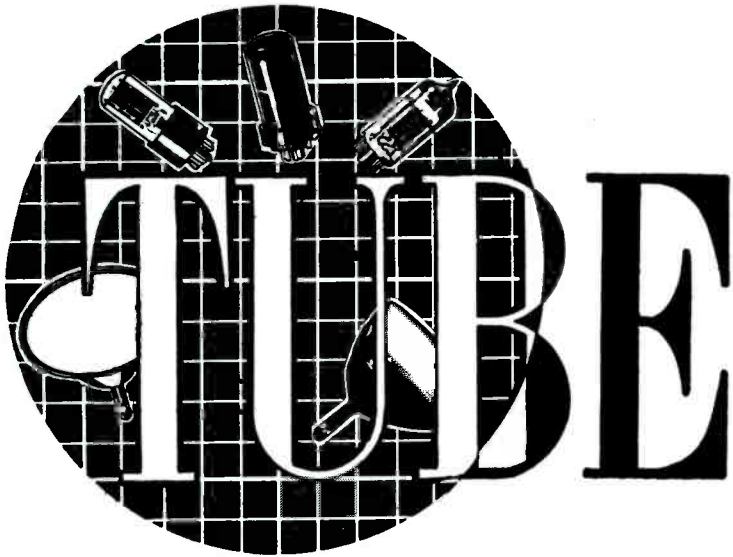

News

SINCE THE ANNOUNCEMENT of the discovery of transistors, researchers have made great strides in this field.

As indicated in these columns on several occasions, certain engineering and manufacturing difficulties still prevail which prevent complete acceptance of transistors for all types of equipment. At present, not enough is known about the makeup and behavior of the material itself. Thus the engineer cannot design properly a unit to do exactly what he wants. Then, transistors manufactured to be identical don't always act the same. Circuits must be designed for individual units. In addition, there is the difficulty of application. In dealing with vacuum-tube applications, the *constant-voltage* standpoint is employed. Power supplies and batteries are designed to provide a constant voltage, and the signals handled are in varying voltage form. The transistor works best from *constant-current* sources and amplifies a *signal current*.

Until very recently, the foregoing limitations made commercial transistor development appear remote. However, many of these difficulties are being overcome. Designers are rapidly finding answers to the limitations of noise level, frequency range, and operating temperature.

The transistor is an odd breed. It is made of germanium, a crystal material, which belongs to a class of semi-conductors, neither conductors nor insulators; the word, transistor, was derived from *transit resistor*. Semi-conductors have their conductivity considerably affected by the presence of slight traces of impurities. In some cases, a trace of 100 parts-per-million may increase the conductivity of a semi-conductor 10-million times. The trick is to start with absolutely pure germanium and introduce a controlled amount of the selected impurity to produce the effect needed. Different impurities produce different effects. One

class of impurities whose atoms will replace semi-conductor atoms in the crystal structure has an extra valence-electron. A semi-conductor with this impurity is called the *n*-type (negative), and the impurity atoms are called donors. Atoms of impurities with one less valence-electron may replace atoms of the semi-conductor with the result that a sort of hole is formed. The atom is missing an electron with respect to the number of electrons in the semi-conductor atom. These impurity atoms are called acceptors, and the material formed is called a *p*-type semi-conductor. Both holes and electrons are free to move about in the crystal under the influence of whatever electric fields may be set up. The holes give the effect of moving in the same way that a man without a bucket appears to move down the line of a bucket brigade, when actually the men are stationary and the buckets (electrons) move up the line. In addition, at normal room temperature germanium and silicon may have atoms dividing into holes and free electrons, and recombining all the time.

When a *p*-type semi-conductor is joined to an *n*-type semi-conductor, we have a *p-n* junction and the unit will work as a rectifier. If a potential difference is established across the combination with the *p*-end positive and the *n*-end negative, both holes and electrons will be driven toward the junction, where they will recombine. More holes will be created by the drawing off of electrons at the positive terminal, while more electrons are introduced at the negative end. Thus, a substantial current flows and the resistance for this direction of current is low. If the polarity of the voltage source is reversed, the opposite effect occurs. Both holes and electrons in the respective materials are drawn away from the junction

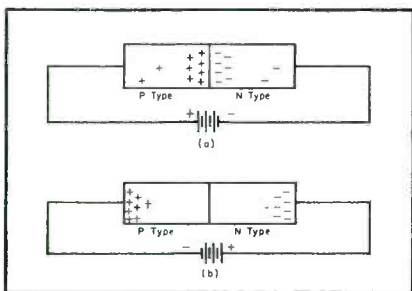

Above: Potential difference exhibited in transistor. In (a) battery polarity is such that holes and electrons go to center and recombine. In (b) the opposite is true, and thus we have an insulating effect.

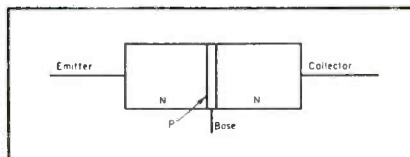

Above: Side view of sugar-loaf solid. This is an *n-p-n* transistor with three leads.

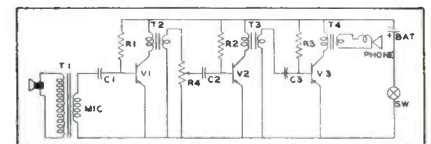
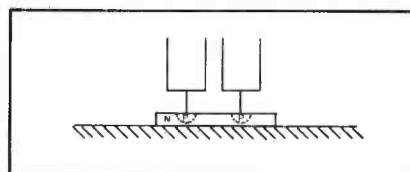

Typical transistorized audio circuit: T_1 , Stancor UM-112; T_2, T_3 , Stancor UM-110; T_4 , Stancor UM-111; C_1, C_2, C_3 are 2 to 5-mfd electrolytics; V_1, V_2 are Raytheon CK-718 junction transistors; V_3 is a Raytheon CK-718 or CK-721 junction transistor; R_1, R_2 are 10,000-15,000 ohm resistors*; R_3 is a 50,000-100,000 ohm resistor*, and R_4 is a volume control, 4,000-6,000 ohms.

Left: Construction of *p-n-p* point contact transistor. Points rest on germanium base crystal.

Operation and Application of Point-Contact and Junction Transistors†

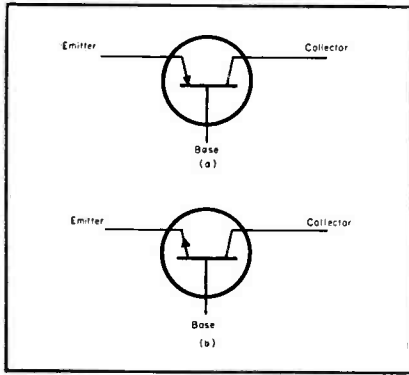

(Above)

Symbols of transistors: (a) point-contact; (b) junction type.

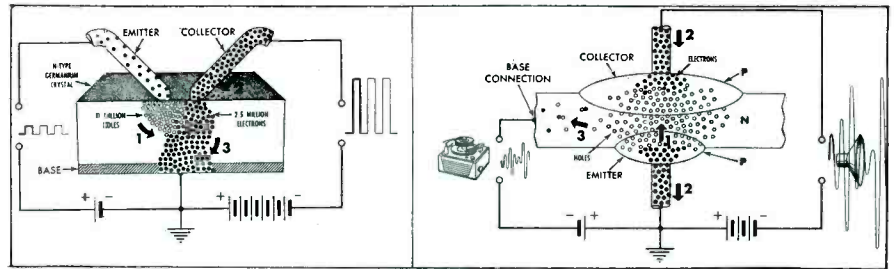

Left: Enlarged point-contact transistor: If a signal injects 1-million holes at emitter, they will be attracted towards collector (1). Near collector, holes reduce barrier to electron flow (2) allowing some 2.5-million electrons to pass into crystal. Of these, 1-million neutralize the holes; the others flow to base (3). Pulses at left and right are of type employed in computers. Right: Enlarged junction transistor: Small signal from phono is amplified to activate loudspeaker. If the signal changes by 1-million electrons, for example, there will be a voltage difference between emitter and base which starts 50-million holes flowing out of emitter (1). All but 1-million holes get to collector, inducing 49-million electrons to flow and carry current in collector circuit (2). The remaining holes flow to the base completing base-emitter circuit (3). (Courtesy RCA.)

point, and the combination acts like an insulator with a high resistance for current flow in this direction.

Crystal-Triode Transistor

If a sandwich of one *p*-type and two *n*-type semi-conductors is formed, we have a crystal triode transistor. In this combination, the *n*-type material is more negative than the *p*-type is positive; thus there will be an excess of free electrons when the assembly is biased, so current can flow. For this transistor one end of one *n*-part is the emitter, the other end of the other *n*-part is the collector, while the *p*-type center is the base. The crystal can be operated with any one of these parts grounded. Bias is established between the base and the emitter with the latter more negative. Thus, electrons can flow from emitter to base because the bias is applied in the low-resistance direction. In addition, extra free electrons will be released. The collector will be the same potential as, or more positive than, the base so that no electrons flow between the collector and base circuits. However, the extra, free electrons will pass from the emitter through the *p*-type center to the collector under the influence of the electric field between the collector and the emitter. Because the number of extra, free electrons depends upon the magnitude of the emitter current,

the collector current can be controlled by variations in the emitter current.

A similar effect is observed for a *p-n-p* combination, except that the polarities must be opposite, and the current now consists of the movement of holes instead of free electrons. This represents the point-contact type of transistor. It consists of a base-block of germanium with two pointed contacts very close together on the upper side of the block. During manufacture, a current pulse passes through the unit so that a small area of *p*-type material is formed under each of the point contacts. The whole unit is then sealed in wax for stability of contact locations.

Tetrode Transistor

Researchers have just announced a tetrode transistor with the added lead connected to the *p*-crystal of the *n-p-n* junction transistor on the opposite side from the base.¹ With a bias of -6 volts on this electrode, the base resistance is lowered enough so that operation of the transistor as an oscillator at 130 mc is possible. It has been found possible to achieve power operation to 2 watts maximum.

Service Men will probably first come in contact with transistors in personal-
(Continued on page 48)

¹Wallace, R. L., Jr., Schimpf, L. G., and Dickten, E., *A Junction Transistor Tetrode for High-Frequency Use*, Proceedings of the IRE; Nov., 1952.

†Based on a paper prepared by Henry M. Bissell, Jr.

(Right)

Ultra-miniature transistor transformer weighing less than one-tenth of an ounce, and measuring 1/4" x 3/8" x 3/8". Intended primarily for transistor audio applications. Useful below 1 mw level. (Model UM 110 to 114; Stancor.)

*In circuit at left values will vary with the individual transistor and should be adjusted for optimum performance.

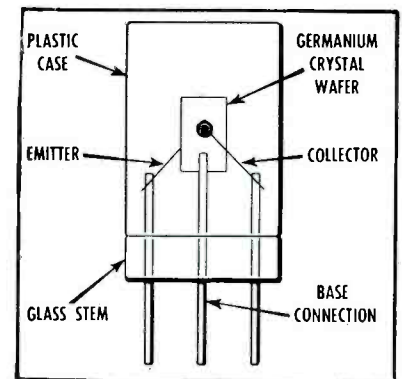
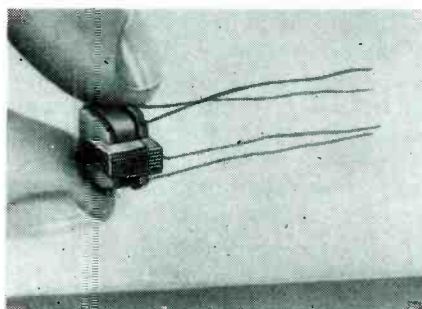

Elements of junction transistor built around a single-crystal sandwich of *n*- and *p*-type germanium arranged either *p-n-p* or *n-p-n*, with connections to each layer serving as emitter, collector and base. In a *p-n-p* junction transistor holes are injected by the emitter and flow through the center layer to the collector, which has a negative voltage applied to it to pull the holes through. A signal on the base-emitter circuit determines the number of holes sent on their way and it is the number of holes flowing through the two junctions at any instant which provides valve action for current flow in the collector circuit. Junction transistors are considerably more stable as amplifiers than the point-contact variety and are capable of greater power gain; a signal can be boosted 10,000 times (40 db) as against 100 times (20 db) with point-contact types. They also have considerably less noise (caused by undesirable but as yet uncontrollable electron activity in the crystal) than the point-contact types, which also enhances their use as amplifiers. (Courtesy RCA.)

(Below)

Elements of point-contact type. The two contacts are spaced about 1/500th" apart; they may be even closer together in *hf* types. The point-contact transistor is generally made of *n*-type germanium. In this case the emitter injects holes into the germanium which drift across the tiny distance, attracted by a negative voltage on the collector, and significantly lower the resistance of the germanium immediately around the point where the collector makes contact. (Courtesy RCA.)

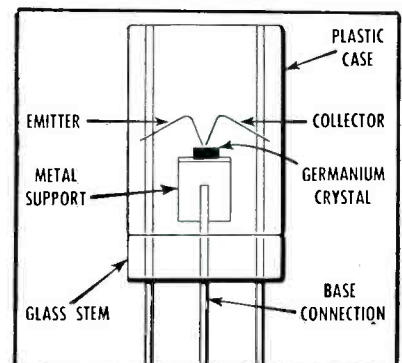

Everything From Admiral Zenith In TV Replacements

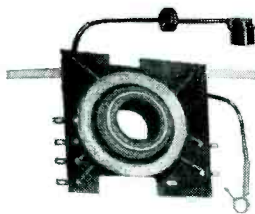

H. V. FLYBACKS

Exemplary of Halldorson's full coverage in this category are part numbers FB405 and FB406. Illustrated above, these two units are specific replacements in 115 different Admiral TV models.



DEFLECTION YOKES

A complete assortment from 50°-70°, cosign windings, Ferrite cores, complete with 20" leads and R-C networks for inductive, auto-former, and direct-drive applications. Illustrated, DF601, DF602 with Halldorson's exclusive external control of R-C network are used in over 80% of today's TV sets.

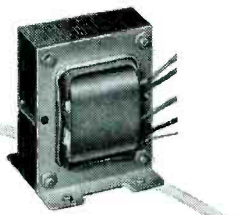

VERTICAL OUTPUTS

All useful ratios from 10:1 to 44:1 in all needed mountings for all types of vertical sweep circuits. Illustrated, Z1805 replacement for RCA #74950, Emerson #738044, and Capehart #650238A-1.

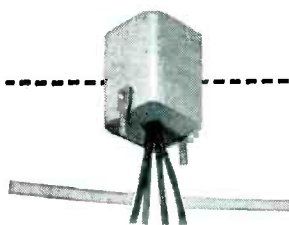

BLOCKING OSCILLATORS

Several variations for both horizontal and vertical circuits including special fully shielded mounting types. Illustrated, B6701 replacement for RCA 208T9 and also used by several other large TV manufacturers.

POWER TRANSFORMERS

Halldorson has them all including some with dual H V windings, shell-mounted rectifier sockets, horizontal and vertical mountings, and other variations. Example P9731, a versatile power unit applicable in approximately 500 different TV sets.

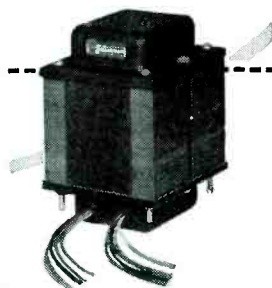

More and more Service Men are looking to Halldorson for a fresh approach to their replacement problems. They are discovering that Halldorson Products are designed for wider application through maximum circuit flexibility, easier and faster servicing through better

product presentation, and greater economy through Halldorson's working acquaintance with their technical needs. Contact our Sales Representative in your area for complete Halldorson service. Halldorson Transformer Co., 4500 N. Ravenswood Ave., Chicago 40, Ill.



New 21-inch spherical-screen picture tube with gray filter glass face plate. Two types, 21ZP4 and 21Z4A, are magnetically focused and deflected, while another, 21YP4, is designed for electrostatic focus. All three require an external ion trap magnet. By using a deflection angle of 70°, the overall length is 23". (Courtesy Sylvania.)

types in use would be staggering. And any such system would be at a sacrifice of flexibility, since manufacturers would have to standardize stages to certain types of circuits.

Regardless of the simplified chassis transistors may provide, Service Men will always be required to insure the continuous satisfactory performance of receivers.

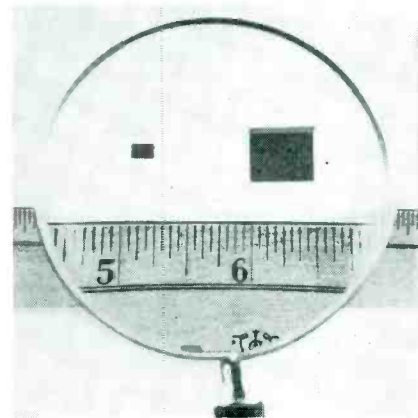

Left, above: View of small (1/8" x 1/8") pm built into picture tubes, to eliminate need for external focusing controls. In this tube, displayed at the annual meeting of the IRE, the external ion trap, focusing unit, and mechanical support have been replaced by simplified ion trap and focusing unit, both built within the tube as shown below. Former magnet shown at right, was rectangular, approximately 1/2" in length, 1/4" thick and 3/8" wide. (Courtesy Carboloy and G. E.)

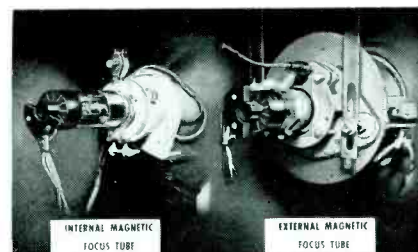

Halldorson

QUALITY Transformers SINCE 1913

EXPORT: Intex Co., Inc., 136 Liberty St., New York 36, N.Y. Cable Address: Intexcom, N.Y.

See us at the 1953 Electronics Parts Show, Booth No. 584, May 18-21, Conrad Hilton Hotel, Chicago

Tube News

(Continued from page 47)

type, portable radios. Since the power required is low, transistors might be used throughout and would probably work well in conjunction with compact printed circuits.

Service Men in Transistor Age

Some alarmists have warned that transistors will mean the end of business for Service Men. It is possible that transistors which last 15 to 20

times as long as tubes might be considered permanent circuit components. But other parts have a habit of failing. At present, transistors cost many times the price of the tubes they replace. This cost will prevent their general use except where other considerations such as space and power requirements may govern. If transistors did make possible a chassis that Mr. Public could repair simply by going to an appliance store and plugging in stages until he found the right one, would it be feasible? Hardly, for the unit cost and the expense of maintaining additional inventory to take care of all the

Ser-Cuits

(Continued from page 45)

cathode will depend upon the amplitude of the plate pulse at the time of the sync pulse. In other words, the current will be dependent upon the phase difference that may exist between the grid and plate pulses.

The flow of current from plate to cathode will develop a voltage across the cathode resistor R_c . This voltage is tapped off the cathode and is coupled to the horizontal oscillator grid, through a suitable filter, where it is used to bias automatically and hence control the oscillator. The value of this voltage will change in accordance with any change in phase between the horizontal oscillator and the incoming horizontal sync pulses.

In Fig. 8 is shown the relationship between the horizontal sync pulse, the plate waveform and the cathode waveform. If the sync pulse were to occur at a time corresponding to a less positive plate voltage, for instance during the valley of the sawtooth, the cathode voltage would be low (assuming a +1-volt reference). In this case, the horizontal oscillator would be low in frequency. In the reverse case, if the oscillator should speed up to the point where the peak of the sawtooth coincides with the sync pulse, the voltage across R_c would increase, say to +10 volts.

This circuit then is capable of producing only a positive control voltage, which is not desirable from a standpoint of stability and noise immunity. If the horizontal sync should be interrupted because of a strong noise burst, grid bias would be maintained on the tube by the capacitor C_1 for a time period equivalent to a few horizontal sync pulses. During this time, the tube would be cut off and hence the cathode voltage would be zero. The reduction in control voltage would cause the horizontal oscillator to increase frequency and fall out of sync.

Capehart Sync Circuit

The actual circuit used in this series of chassis is shown in Fig. 9. The main difference here is that the grid resistor R_g has been divided into two equal sections and the control voltage is taken off at the center of these two resistors instead of the cathode. This modification provides the noise immunity which did not exist in the basic circuit. By tapping R_g and obtaining the control voltage at this point, the horizontal oscillator can be designed so that the in-sync condition will occur with a control voltage approximately zero. In this way, the control voltage will vary from, say -5 to +5 volts

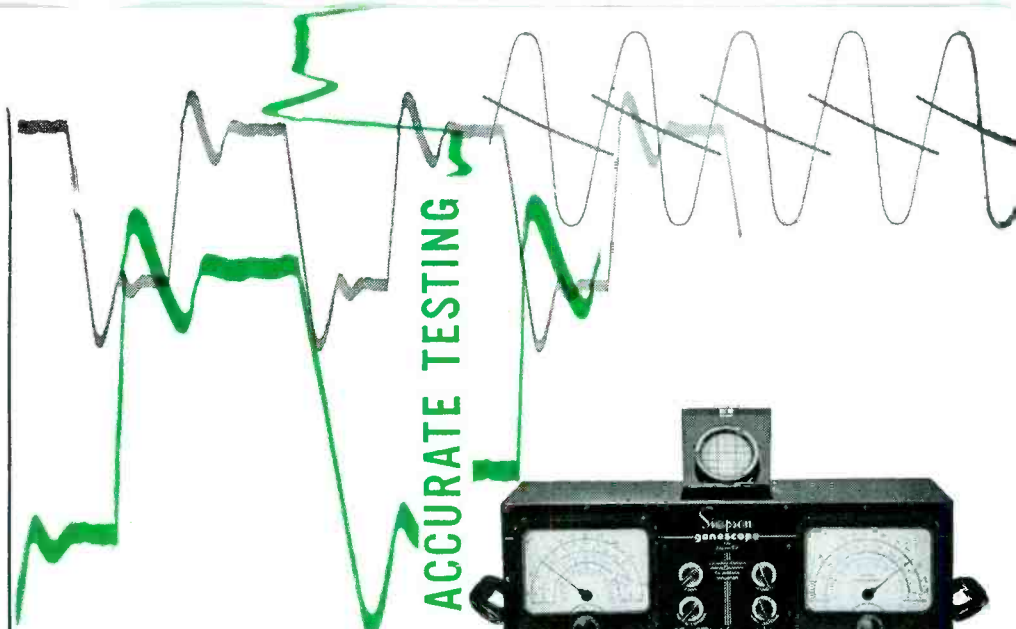

approved by
service managers of:

admiral
zenith
motorola
emerson
hoffman
hallicrafters

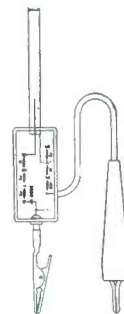

SIMPSON MODEL 480 GENESCOPE FOR ACCURATE TESTING

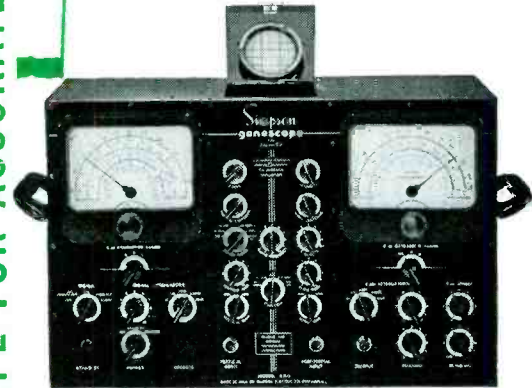

- All the necessary signal sources for alignment of FM and TV receivers • Includes the Simpson High Sensitivity Oscilloscope and high frequency crystal probe for signal tracing • Independent, continuously variable attenuators and step attenuators for both AM and FM units offer complete control of output at all times • 0.15 megacycle sweep is provided by a noiseless specially designed sweep motor based on D'Arsonval meter movement principles • The exclusive Simpson output cable (illustrated) includes a variable termination network, quickly adapted to provide open, 75 or 300 ohm terminations — the addition of a pad provides attenuation and isolation. Use of appropriate resistors across certain terminals will provide any other termination required. A .002 MFD blocking condenser can be added on any termination for use on circuits containing a DC component • The FM generator output voltage is constant within .2 DB per MC of sweep.

dealer's net \$395.00

SIMPSON ELECTRIC COMPANY

5200 W. Kinzie St., Chicago 44, Illinois • Phone: COlumbus 1-1228 • In Canada: Bach-Simpson, Ltd., London, Ont.

for similar out-of-phase conditions, as described for the basic circuit. With this modification, should the sync pulses be interrupted, the control voltage would again be zero; however, since this is the center value of the

Fig. 8. Relationship between the horizontal sync pulse, plate waveform and cathode waveform.

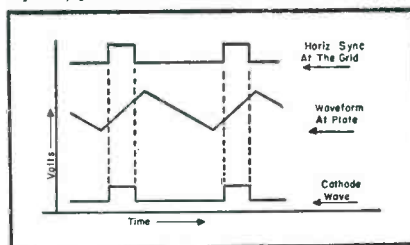

control-voltage variation, the oscillator will not be changed in frequency.

(Below)

Fig. 9. Horizontal afc circuit used in the Capehart CX-37 series chassis.

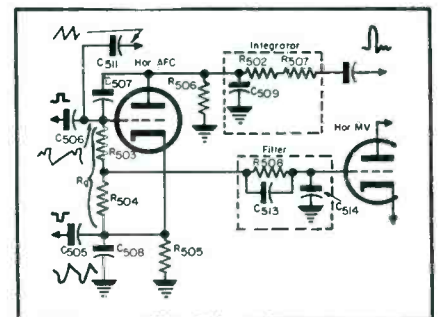

AUDIO installation and service

Phono-Tape-Wire-PA-Amplifiers-Speakers

by KENNETH STEWART

Mechanical and Electronic Design Features of Preamp-Equalizers, Control Amplifiers, Mixer Preamps, Wide-Angle Trumpets, Variable Speaker Crossovers . . . Phono Changer Service Notes

To PERMIT THE use of magnetic pickups having extremely low output, it is necessary to employ a preamp or preamp-equalizer to raise the level sufficiently to drive power amplifiers to full output. A number of types are available. An interesting example of one type[‡] is illustrated in Fig. 1. This model affords adjustable compensation for the deviations from flat frequency characteristics imposed on phono records at the time of their recording.* Independent settings can be made for turnover frequency (bass range) and roll-off (mid-range and treble).

For the first two stages in this unit, a 12AY7 is used; this is a low-hum, non-microphonic tube designed especially for preamp service. It has been

found to permit attainment of extremely low hum and noise level without requiring the use of *dc* on the heater.

The output stage uses a 6C4. In the power supply a miniature selenium rectifier is used to provide plate voltage.

Two input jacks have been included. One, *CV*, is for constant-velocity pickups and is used for magnetic and dynamic units. Proper terminations and a short-circuited phono plug are available for all makes of pickups. When the plug is inserted in jack *A* an .0008-mfd capacitor is shunted across the pickup, as required for one make pickup.¹ When the plug is in jack *P* an additional shunt resistor is con-

nected providing the proper termination for another series of pickups.² When the shorting plug is not used the pickup load resistance is 50,000 ohms; the correct termination for another model³ when a flat response is desired.

For constant-amplitude pickups such as crystals or FM types⁴ another input jack *CA* is available.

The series capacitor converts the constant-amplitude characteristic into a constant-velocity characteristic.

Self-Bias Input Stage

The input stage of the preamp is self-biased to insure that distortion is held to a minimum. Incidentally, deposited-carbon, low-noise resistors are used in both the cathode and plate circuits of the first stage and in the plate circuit of the second stage.

The first stage is followed by a loss-type *rc* network that provides bass boost. An adjustable turnover point is achieved by switching capacitors in the bass-boost network. For the Columbia *lp* characteristic one of the capacitors is shunted with a resistor of correct value to produce the required flattening of the curve below 100 to 200 cycles.

The signal level at the output of this bass-boost network is, in the mid-frequency range; only slightly higher than the input signal level. For this reason, a low-noise resistor is used in the second plate circuit.

The *rc* network following the second stage is used to provide rolloffs to compensate preemphasis. A 20-db rolloff is produced by two *rc* networks to provide a slightly greater slope at

Fig. 1. Schematic of Brociner A100 and A100P preamp-equalizer, a 3-stage triode amplifier with resistance-capacitance equalization, which is said to provide a maximum output of 10 volts undistorted.

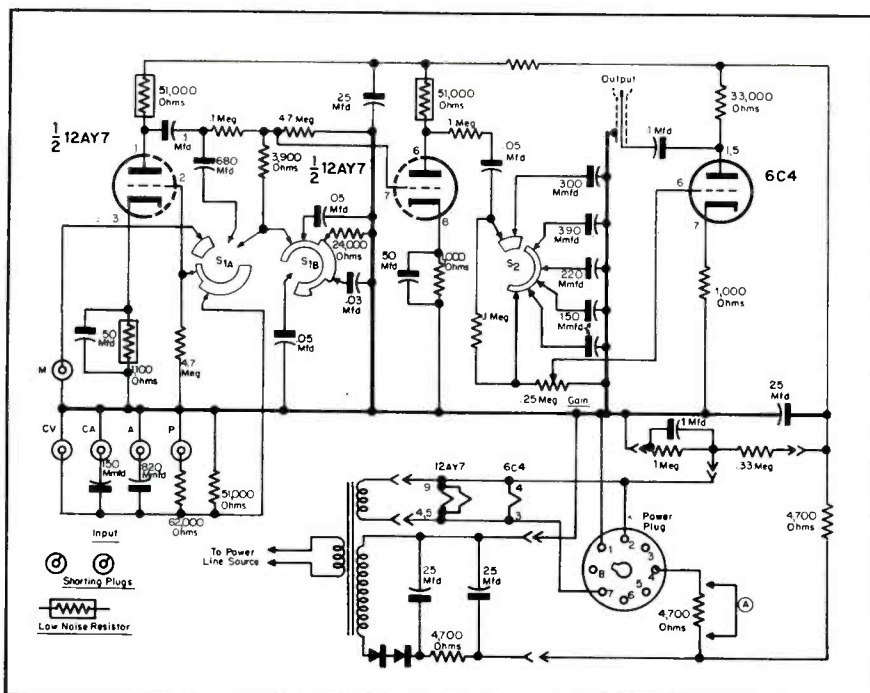

[‡]Brociner A100 and A100P.

*Included are the original Columbia LP curve, the AES (Audio Engineering Society) recommended playback characteristic, and special 800-cycle turnover used by RCA Victor.

¹Audak. ²Pickering. ³G. E. ⁴Such as Weathers.

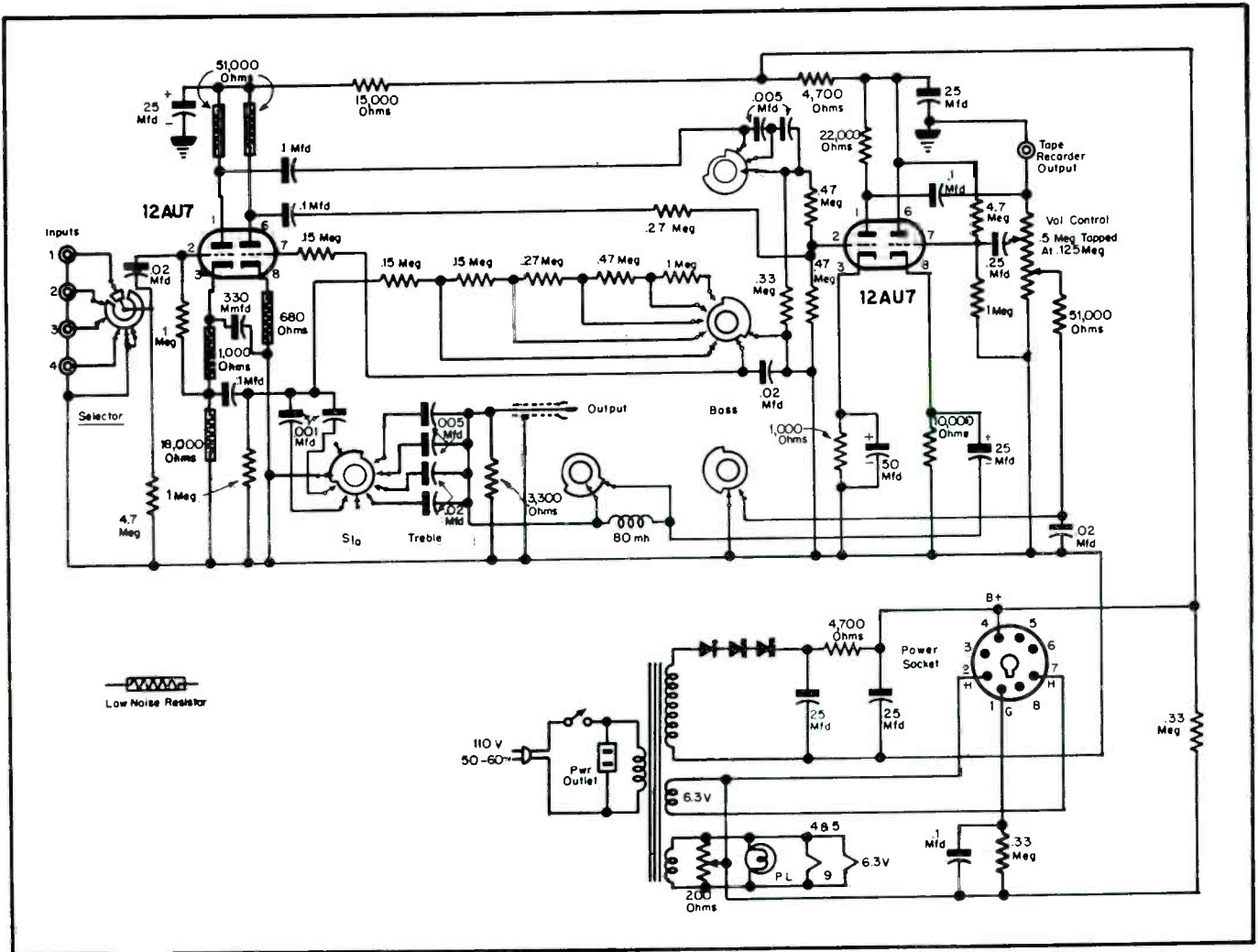
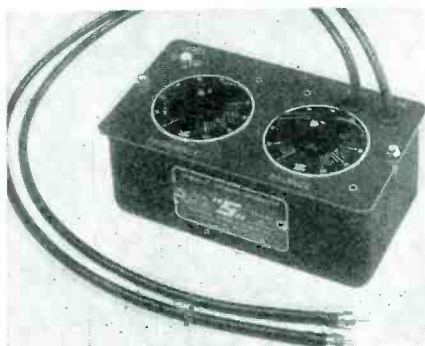

Fig. 2. Circuit of Brociner CA-2 control amplifier designed to furnish controls for input selection, adjustment of tone and volume, on-off switch and pilot light, for use with a basic power amplifier. Crystal and capacitance cartridges can be fed directly to any one of four inputs.

the extreme high end. This position has been found to be particularly useful with *lp* records that seem to have excessive preemphasis.

Immediately following the rolloff networks is a 250,000-ohm gain control, which is mounted on the back of the chassis, and is intended for adjustment of gain to suit the particular pickup and power amplifier used. The

Variable speaker crossover resistive-capacitive unit, with which effects of resonant under-damping are said to be eliminated. Two controls are provided: one offers continuous adjustment of crossover frequency from 175 to 3,000 cycles, and the other allows continuous adjustment of acoustical balance between *woofer* and *tweeter* to compensate for different speaker efficiencies. (214-X8; H. H. Scott, Inc.)



comparatively low value of resistance used in the control has been found to maintain the correct response at high frequencies, irrespective of the position to which the control is set. The output stage has an unbypassed cathode resistor which provides negative feedback to reduce distortion at this point. The source resistance of the output stage is sufficiently low to permit the use of moderately long cables. In one preamp model a cathode-follower output stage has been included to provide low-out-

Electronic mixer preamp which features electronic mixing of up to four microphones, plus radio tuner or phono. Amplification provided on all six inputs (four mixing channels) and cathode follower output is said to allow placement of the mixer preamp up to 400' from the amplifier. Output is claimed to be 1-volt rms; harmonic distortion less than 1/4 of 1%; response 50 to 15,000 cps \pm 2 db. Three 12AX7 tubes are used, plus selenium rectifier. (EMM-6; Mark Simpson.)

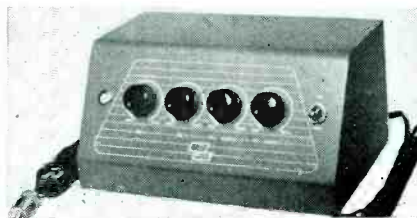

put impedance and permit the use of extremely long cables; in this model the output tube is a 12AU7.

The circuit also features an additional position of the turnover switch which removes the low-frequency equalization and increases the gain to permit the use of a high-impedance
(Continued on page 90)

Floor model R-J loudspeaker enclosure. Cut out to fit any standard 12" or 15" speaker. Enclosures are built of mahogany or korina veneers. (R-J Audio Products, 164 Duane St., New York 13.)

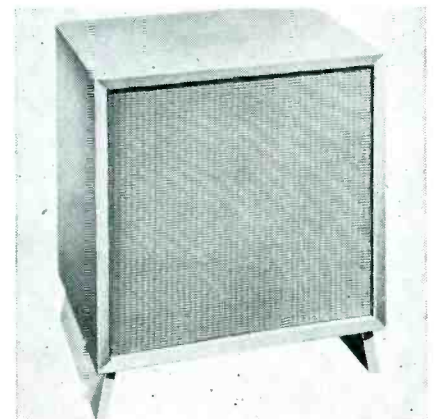

G.E. AGAIN TELLS AMERICA THE



● These ads, and those run in Life and Collier's last fall, are all part of the public relations program General Electric is sponsoring in the interests of the TV Service industry.



50,000 MEN LIKE "DUSTY" RHODES MAKE TV SERVICE A "PROFESSION"



"DUSTY" RHODES, owner of Rhodes Radio and Television, Paterson, N. J.



HE GIVES PATERSON, N. J., A PROFESSIONAL TEAM OF ACE SERVICE MEN

Across the country, TV service has become accepted as a new "profession." One of the reasons is this new industry's high calibre of men. Take "Dusty" Rhodes of Paterson, N. J. He's on the Chamber of Commerce's Board of Directors. He's president of the Radio and Television Service Men of N. J. He's active on the Community Chest. In other words, he's a credit to his calling and his community.



J. PALMER MURPHY, manager, Greater Paterson Chamber of Commerce, says: "'Dusty' Rhodes is the kind of man any community would be happy to have—a definite asset."



RICHARD E. KINN, salesman, says: "I've sent innumerable people to him—that shows how much I think of his service." Kinn's wife says: "His men are polite and efficient."



MRS. ROSE ZARROW, housewife, says: "Rhodes' service is wonderful. As soon as you call them they're here—no petty excuses—just like the minute-men."



BEN MERKER, Rhodes' service manager, is a graduate of DeForrest Training School and like all Rhodes' service men he regularly attends technical seminars and courses.

One of a series of informative advertisements on TV service. Tube Department, General Electric Company, Schenectady 5, N. Y.

GENERAL  ELECTRIC

TRUE STORY OF TV SERVICING

- Four powerful, informative ads in Look Magazine
- Reaching 13,187,140 readers
- Reporting the facts on typical TV Service Dealers
- Convince present and future set owners of the know-how and integrity of TV Service Dealers

THIS BOOKLET FOR SET OWNERS...

outlining the intricate requirements of TV servicing — was also made available to service dealers. And, through G-E tube distributors and tube dealers, hundreds of thousands of copies are finding their way into the homes of America.

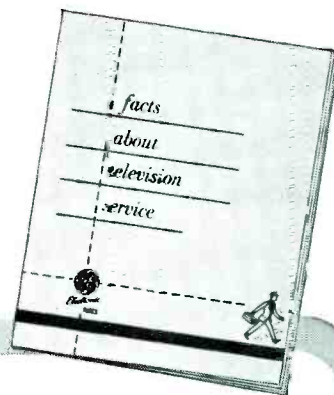

What are you doing to follow through on this effort in your own locality?

HERE'S WHAT YOU CAN DO:

- ① You can build customer goodwill through full explanation of service charges.
- ② You can endorse sound business practices in your own service associations.
- ③ You can actively "sell" service, to increase your income and prestige in your community.
- ④ You can support distributors and programs which advance the interests of the Service Dealer.

TUBE DEPARTMENT, SCHENECTADY, N. Y.

GENERAL  ELECTRIC

161-1A3

A 'Scope Amplifier With a VTVM

by **JAMES S. KENDALL**

Instructor in Radio and TV

Four Dwellings School, Birmingham, England

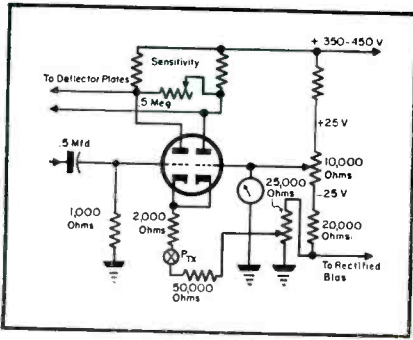

Fig. 1. The 'scope amplifier with vtvm. Voltmeter should be of 1000-ohms-per-volt type. Resistor between *h_v* and 10,000-ohm pot should supply 5 ma to circuit. The 10,000- and 25,000-ohm pots should be wire wound.

IN RADIO AND TV SERVICING it is often desirable to measure distortion and hum contents by direct means. To provide such results, there has been evolved a two-stage 'scope amplifier which makes it possible to measure a range of 0.4 and 0.04 volt, peak-to-peak.

In this circuit a 6SL7 tube is used in a Schultz phase-split system*, in such a way that there is available a maximum gain of about one hundred, with all of a 1/2-megohm deflection sensitivity control in the circuit; the gain can be reduced to zero by this control, an output of 200 volts peak-to-peak is provided with low distortion, and ample deflection voltage prevails for the *crt*. If the final anode of the *crt* is connected to the *h_v* positive line, and the output from the plates of the 6SL7 brought directly to the deflector plates, focus can be improved and the spot size reduced.

In the system developed a 350-0-350 type transformer was used, the positive line rectified by a 6X5 acting as a

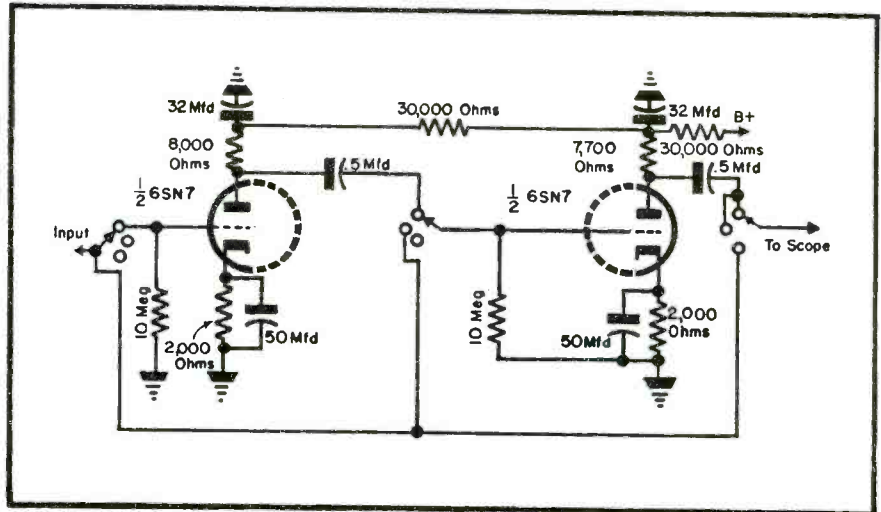

Fig. 2. Amplifier, which can be used to increase output, providing a gain of 10-100. Switch is shown in maximum gain position.

full-wave rectifier with the heater grounded; a 6X5 was also used for the negative supply, this time serving as a half-wave rectifier.

The system requires between 350 and 450 volts and a negative supply of 10 ma; if the latter is drawn from -450 the regulation will be improved and the brilliance control on the 'scope will be independent of focus. The only critical components in the circuit are a pair of 100,000-ohm resistors in the plate circuit of the 6SL7; their toler-

ances should be as close as possible.

The wiring will present no trouble, but balancing of the unit will require close attention. In the balancing operation the shift control (10,000-ohm potentiometer) should be set so that the voltmeter reads zero volts with the *h_v* switched on. Then with a microammeter between point X in the circuit and the chassis, the 25,000-ohm potentiometer should be adjusted so that there is no current flow; the

(Continued on page 92)

Figs. 3 and 4. At left appears basic circuitry of phase-split system. A modified version is illustrated at right, with common cathode bias and common feedback resistors.

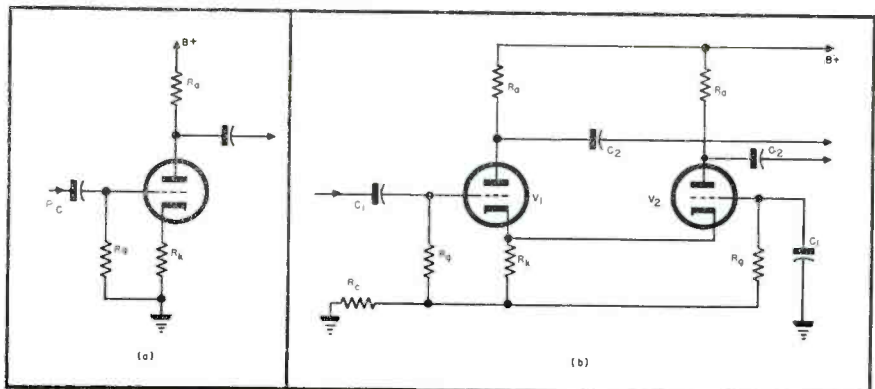

*The Schultz phase-split circuit, developed in England, operates in the following manner: If the normal resistance-capacity amplifier stage, as diagramed in Fig. 3 is examined, it will be noted that as the grid voltage changes, so does the cathode voltage. These two voltages oppose and reduce the gain of the amplifier by the introduction of an amount of negative feedback (degenerative feedback). This feedback also reduces the distortion of the stage by reducing the amount of harmonics generated. As the cathode resistor is increased, the stage gain is reduced, but the feedback is increased. The inventor of the circuit found that since there was a phase difference of 180° between the cathode and the grid voltages, the output from a resistance-capacity circuit could be taken out of the cathode as well as the plate, and if the cathode output was fed to the cathode of a similar type of tube, which had its grid at an ac ground potential, the tube could be used to amplify as well as introduce a phase reversal. The increase of the cathode resistor was satisfactory at first. Later, the circuit in Fig. 4 was devised with a common cathode bias resistor and a common feedback resistor. When a positive voltage is applied to the grid of *V₁*, a voltage is set up along *R_k* and *R_e* in series, so that the two cathodes become positive, but the grid of *V₂* remains at a constant potential. It is now negative to the cathode and the plate current through the tube is reduced. In the perfect circuit, that is where the feedback resistor is infinite, the input voltage would be divided equally between the two tubes.

R_e should be at least 10 times *R_k*; the larger the better. If it is excessive, it will reduce the *h_v* voltage fed to the stage, causing a reduced cutout voltage. (A comprehensive analysis of the circuit will appear in an early issue.)

RCA VoltOhmysts*

*outsell all other
VTVM'S*

RCA WV-97A
SENIOR VoltOhmyst

\$6750 Suggested
User Price

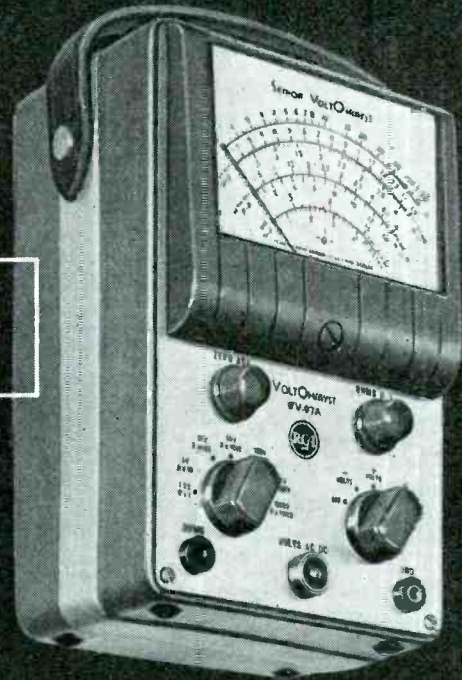

RCA WV-87A
MASTER VoltOhmyst

\$11250 Suggested
User Price

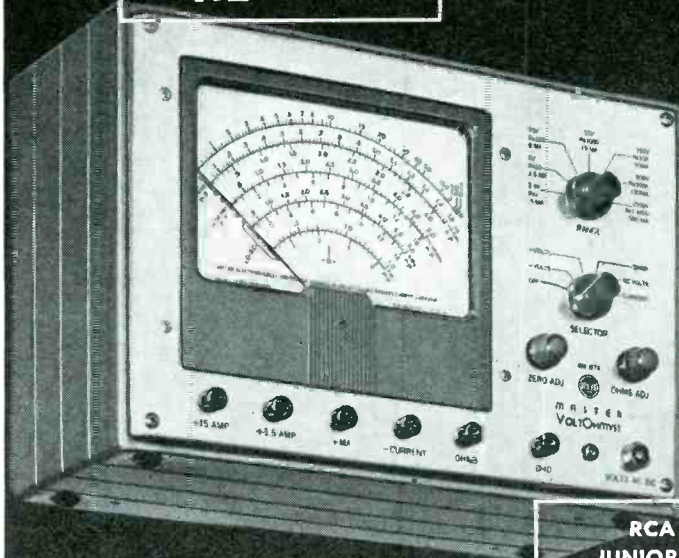

RCA WV-77A
JUNIOR VoltOhmyst

\$4750 Suggested
User Price



Because they're factory-calibrated under laboratory conditions... incorporate more features... have unusual accuracy and stability... in short, offer you more for your money—RCA VoltOhmysts outsell all other makes of vacuum-tube voltmeters.

All RCA VoltOhmysts employ a degenerative bridge circuit to compensate for line-voltage changes... a sturdy 200-microampere meter movement electronically protected against burn-out... large,

easy-to-read scales... metal shielding against external fields... and have an input resistance of 11 megohms on all dc ranges.

Before you buy a vacuum-tube voltmeter, be sure to get the full details on the RCA VoltOhmyst best suited to your needs. See your RCA Test Equipment Distributor today... or write RCA, Commercial Engineering, Section 56DX, Harrison, N.J.

*Tmk (R)



RADIO CORPORATION of AMERICA

TEST EQUIPMENT

HARRISON, N. J.

'Scope Improvements For SERVICE ENGINEERING

by RONALD L. IVES

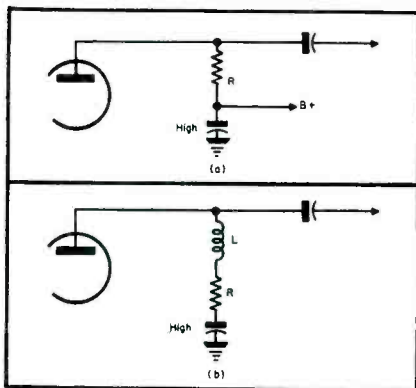

Second Installment of Series: Increasing Frequency Response and Sensitivity...Providing for Retrace Blanking...Installation of Additional Horizontal and Vertical Inputs for Industrial Applications

THE SENSITIVITY of some 'scopes begins to drop at frequencies above about 500 kc. In most instances, *hf* response can be increased somewhat by insertion of peaking coils in the plate circuits of the vertical amplifier tubes. With many conventional designs, this minor change raises the highest usable frequency of the vertical amplifier to somewhere between 1 and 2 mc. Some manufacturers provide a set of coils for this improvement.¹

Peaking coils increase the *hf* response of an amplifier because, within reasonable limits, the voltage output of an amplifier is a direct function of the plate load impedance. In a simple resistance-coupled amplifier (Fig. 1a), the plate load impedance is substantially the plate load resistance, at all frequencies (within reason). When a peaking coil is added (Fig. 1b), the plate load impedance becomes the sum of the *dc* resistances and the impedance of the peaking coil at the operating frequency. Because of the shunting effect of distributed capacity, which

increases with frequency, gain increases due to use of peaking coils never attain theoretical values, and may become negative at higher frequencies.

Most effective values of peaking coils for 'scope use are best found by experiment, but coils having an inductance of from 0.5 to 2 millihenries, kept well away from the chassis and other circuit elements, will improve *hf* response in most cases. When a push-pull stage is peaked, great care must be taken to insure that the two coils are identical. Otherwise wave-form distortion will increase with frequency. The need for exact balance is very much greater in 'scope amplifiers than in a *hi-fi* audio system, because the 'scope amplifier has no output transformer to act as an equalizer.

Recent developments of travelling wave tubes, which are actually a one-tube distributed amplifier, suggest that

a 'scope vertical amplifier which is flat from *dc* to 100 mc may become commercially available within the next decade.

Increasing Sensitivity

Increasing the overall sensitivity of an amplifier is usually accomplished by adding more stages. Increasing the useful sensitivity of the same amplifier is a somewhat more difficult task, because an additional stage increases the sensitivity of the amplifier to hum and other unwanted signals, and is likely to lower the stability of the system as a whole, making necessary extensive changes in supply circuits, to provide isolation, and installation of more shielding, to reduce unwanted coupling. Microphonic troubles also increase with amplifier sensitivity, as does input noise. In conse-

(Continued on page 58)

(Above, left)

Fig. 1. Circuits illustrating use of peaking coil.

Fig. 2 (right). Under-chassis view of modified 'scope, showing shielding, cabling and anchorage of power leads, and mounting of components. At c the additional amplifier stage is shown. Plate pot is shown at d.

¹D. C. Heath provides a pair of *rf* chokes, a capacitor and accompanying resistors and tie points to increase the frequency response of their 0-7 'scope.

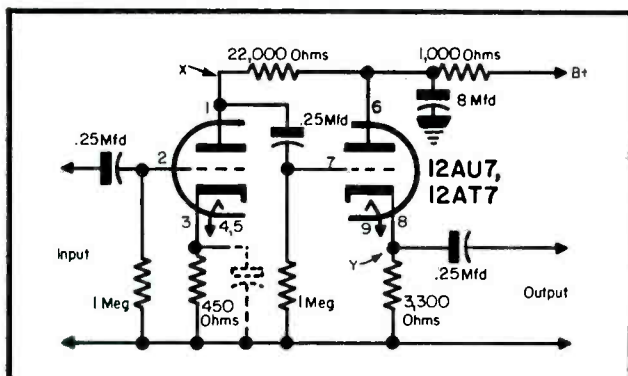

(Left)

Fig. 3. Additional amplifier stage for 'scope. Peaking coils can be inserted at x or y. Cathode of first triode can be bypassed; dotted capacitor.

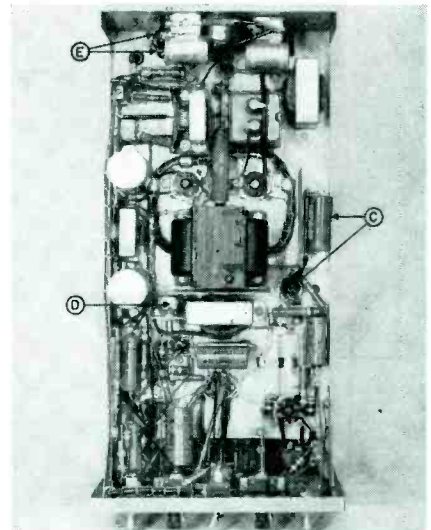



The Picture Tells the Story

TV Antennas exist for one reason — to provide a clear, strong, sharp picture!

TRIO ZIG-ZAG* TV Antennas perform so well in this all important respect that they are America's most wanted.

Yes, a picture — the TV picture — tells the TRIO story more eloquently than anything else! Where all other antenna designs fail, high gain TRIO ZIG-ZAG TV Antennas consistently lock in sharp, clear pictures — from Maine to Texas, in city or country!

TRIO TV antennas look different, work different — provide a magnificent DIFFERENCE in picture quality!

*Patent Pending



Also in the Picture

The TRIO Rotator and Direction Indicator are the most dependable ever built. Developed after \$50,000 research. Fully guaranteed for a FULL two years!

*New insulating sleeve, with longer leakage path and elimination of slip, does away with assembly errors — elements cannot short out. For maximum strength, new steel, electro-plated element clamps have been introduced.



Best Buy in UHF Antennas LOW IN COST — HIGH IN PERFORMANCE

NEW TRIO UHF BOW-TIE with reflector

Sturdy, broadband antennas of uniformly high gain that have been thoroughly field tested. Phasing strips installed, pre-assembled — a jiffy to attach reflector screen. Available in one, two and four bay models. Usual high-quality TRIO construction.



Model UBT-4
Supplied With
4 Foot Mast

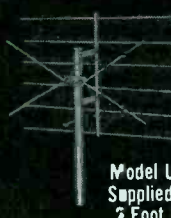

Model UBT-1
Supplied With
2 Foot Mast



Model UBT-2
Supplied With
3 Foot Mast

NEW TRIO UHF MULTI-CHANNEL YAGI ANTENNAS

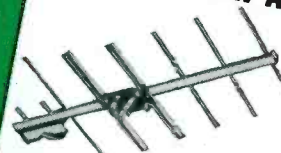

Broadband yagis developed by TRIO now successfully applied to UHF. Four models cover all UHF channels, rarely on any one area.

- Model 6-UBY 14-25 for Channels 14-25
- Model 6-UBY 27-42 for Channels 27-42
- Model 6-UBY 43-60 for Channels 43-60
- Model 6-UBY 61-83 for Channels 61-83

These high gain six element yagis have sharper directivity, thereby eliminating ghosts. Thoroughly field tested. Entire antenna mounted in front field of reflectors or antenna elements. Mast clamp supplied. Completely assembled.



TRIO MANUFACTURING CO.

GRIGGSVILLE, ILLINOIS

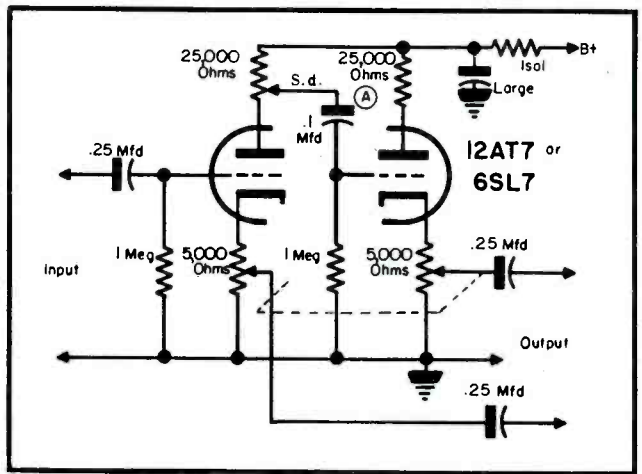
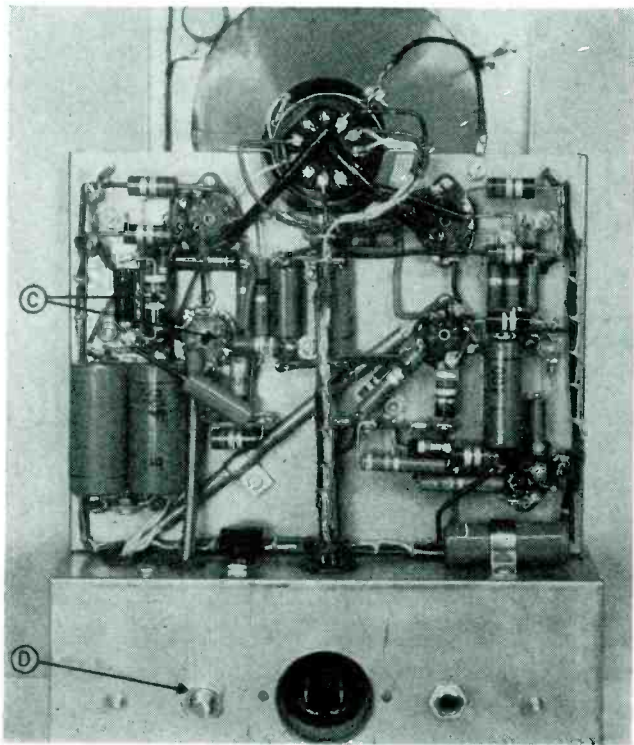

Fig. 4 (above). Improved phase-inverter with a dual cathode-follower output. A indicates point to be isolated from ground to improve hf response.

(Left)

Fig. 5. Rear view of modified 'scope. The general appearance of the blanker appears at c and d and at e in Fig. 2.

quence, any great increase in the theoretical sensitivity of a 'scope amplifier is likely to result in *empty* amplification, with the signal-to-noise ratio limiting the usefulness of the amplifier.

Amplifier Stage Circuitry

The circuit of a very satisfactory additional amplifier stage, suitable for either vertical or horizontal amplifier use, is shown in Fig. 3, and the appearance of the stage, installed, is shown in Fig. 2c. This particular design was chosen so that the amplifier would be compatible with other stages already installed; with stability of the entire system being of prime importance. None of the values are critical. When changes in frequency characteristics of the entire amplifier are desired, peaking coils can be inserted at either X or Y or both; values of coupling capacitors can be changed, and the cathode of the first triode can be bypassed (dotted capacitor).

When additional amplification is added to 'scope, special care must be taken to avoid overloading of the output stage, with resultant display of

badly distorted waveforms even when the input waveform is standard. When operating conditions call for an increase in vertical sensitivity by a factor of more than about ten, the additional amplification is best provided by an amplifying probe, or by a separate preamp, which will usually require very careful shielding and circuit isolation. Incidentally, a 'scope with a sensitivity exceeding .005 rms volts-per-inch is normally not very useful, because the entire screen will be filled with pickup waveforms at line frequency and several of its harmonics.

Phase Inversion

Most 'scopes now in use have a single-ended input, and a push-pull output. Transition from single-ended to push-pull operation can be made by

use of a phase inverter, commonly of the *hot cathode* type, as in Fig. 6. This works very well at the higher audio frequencies, but usually causes distortion at frequencies below 120 cycles. This distortion is caused by circuit unbalance, which varies inversely as frequency in the circuit shown. Because dependable low frequency operation is very desirable in industrial electronic work, improvement of this condition is in order.

Quite obviously, the circuit can be brought much nearer to balance if the plate capacitor, C_p , is increased, and would be in perfect balance if the capacity were infinite. Practically, the unbalance becomes negligible down to about ten cycles if we are able to insert about 100 mfd of pure capacity

(Continued on page 60)

Fig. 6. Hot cathode phase inverter.

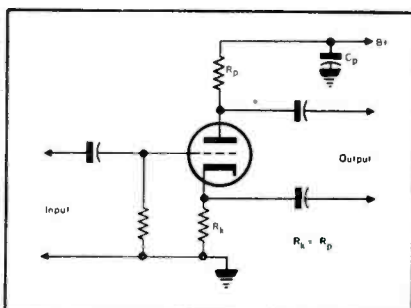

(Right)

Fig. 7. A retrace blanking amplifier. A is connected to a point in the horizontal amplifier circuit which goes negative on retrace.

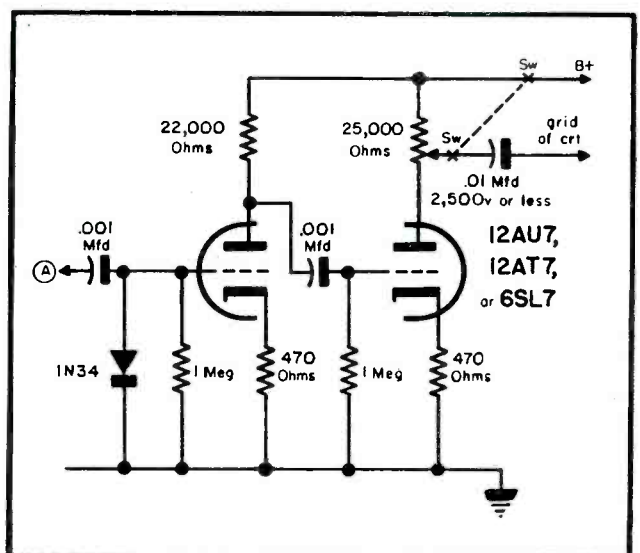



ONLY THE PHILCO TUBE CHECKER

Tests 'Em All!

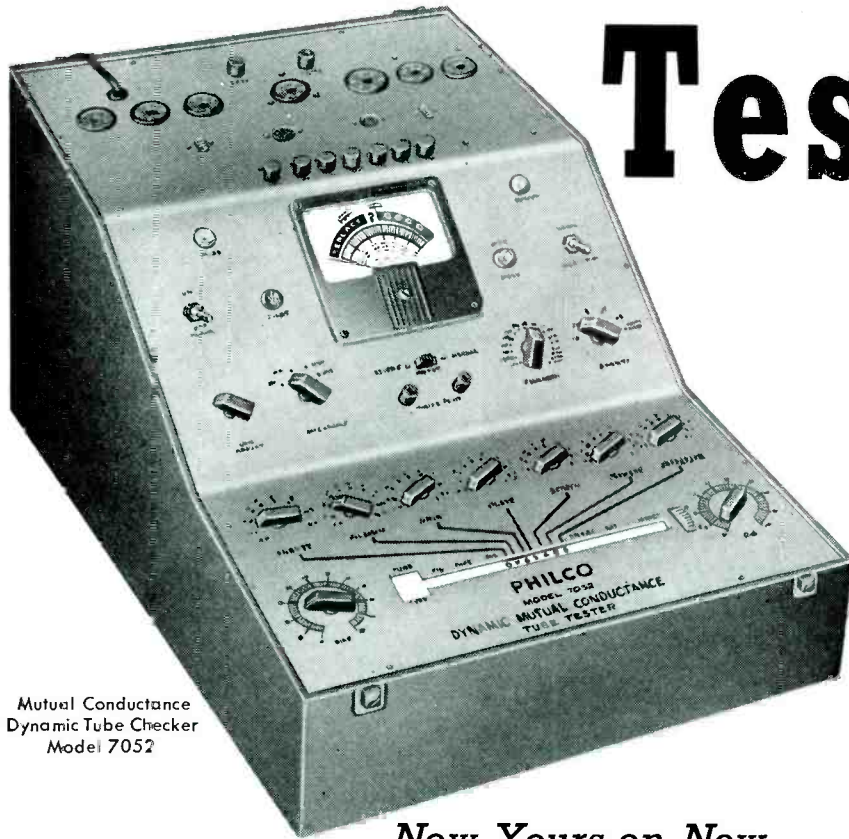

Mutual Conductance
Dynamic Tube Checker
Model 7052

Now Yours on New
SPECIAL PAYMENT PLAN



CATHODE RAY TUBE CHECKER

MODEL 7053. From Philco, the *only* emission CRT checker containing a built-in neon bulb calibrator for individual calibration of bulb sensitivity... for pin point accuracy and finest sensitivity each unit is individually calibrated... tests all picture tubes.



3-INCH OSCILLOSCOPE

MODEL 7020. The ultimate in portability... this Philco scope is 2½ times smaller than other 3" units... adaptable for bench use or field servicing... now, avoid guesswork with *pre-set* horizontal and vertical sweep rates. Provide measurements accurate to within 5%.

Here's Philco's answer to your tube checking problems... a mutual conductance tube checker that tests 'em all from subminiature to acorn low power transmitting tubes... featuring the most sensational roll chart yet designed for efficiency and speed of operation. Its compact design, finished in beautiful grey leatherette with blue panel, makes it adaptable for both portable and counter top use. *Size*—17" W x 18½" L x 10" D. *Weight*—21 lbs. (*Shipping Wt.* 24 lbs.). *Operating Voltage*—105-130 volts AC.

- ✓ Most complete, easiest to use roll chart ever designed.
- ✓ Mutual conductance readings given directly in Microhms.
- ✓ Forecasts remaining tube life!
- ✓ Checks shorts and leaks between elements of tubes.
- ✓ Determines noise characteristics and gas content of tubes.

**FILL OUT AND MAIL COUPON OR
SEE YOUR PHILCO DISTRIBUTOR NOW**

**PHILCO CORPORATION, Accessory Division
Allegheny & "A" Sts., Philadelphia, Pa.**

I am interested in the Philco Test Equipment shown here. Please send me details of your **SPECIAL PURCHASE PLAN** for obtaining these units.

Please send **FREE** copy of your new booklet on Philco Test Equipment.



NAME.....

ADDRESS.....

CITY..... STATE.....

PHILCO Test Equipment
SPECIFICALLY DESIGNED FOR THE SERVICEMAN

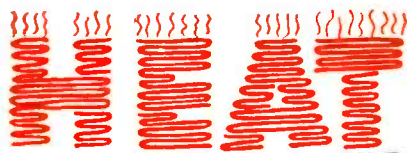
Instant 

that's "QUICK ON THE TRIGGER"
and "RIGHT ON THE TARGET"



WALL
TRIG·R·HEAT
SOLDERING IRON
READY TO SOLDER
IN SECONDS!



HEAT-CONTROL
Thermostatic Action guaranteed
for the life of the iron, or
DOUBLE your money back!

\$11.95

Heat is QUICK! Just touch the trigger, and in seconds TRIG-R-HEAT is ready to solder.

Heat is RIGHT! Exclusive thermostatic action, (without transformers or fragile thermostats) quickly brings TRIG-R-HEAT to "on-the-target" soldering temperature and keeps it there. Iron is never too hot. The result — tips last two to three times as long. Built-in spotlight makes dark, hard-to-reach places easy to solder. Wattage starts at 400 watts, and idles at 100 watts. Operates on 115-120 volts, AC or DC.

OVER 20,000,000 SOLDERING PRODUCTS SINCE 1864



WALL MANUFACTURING CO.
GROVE CITY • PENNSYLVANIA

Improving 'Scope

(Continued from page 58)

at C_p . If we use standard components, this calls for an electrolytic capacitor, which is certainly not a pure capacitor, as it neither accepts nor gives up its charge instantaneously.

A number of experiments with phase inverters showed that there was no device of this type which was perfect at all frequencies; this led to the development of the circuit of Fig. 4 (p. 58) which was found to work exceedingly well over a wide range of frequencies.

This circuit consists of a triode amplifier, having both plate and cathode outputs; driving, through its plate output, a cathode follower. The cathode resistors are a dual 5,000-ohm potentiometer, of good manufacture, which also functions as a level control. The arm of the 25,000-ohm plate load potentiometer of the first triode must be adjusted until the outputs of both phases are equal. As this adjustment, once made, needs no further attention until the two halves of the dual triode go out of balance, the plate pot can be mounted under the 'scope chassis, as in Fig. 2d. Care should be taken to keep

the coupling capacitor, which is between plate pot of the first tube and grid of the second, well away from other circuit components, including the chassis, so that shunt capacity to the ground is at a minimum.

As in the case of peaking coils, great care must be taken to secure phase balance in this circuit, as there is no output transformer or other equalizing device in the output circuit.

Retrace Blanking

Although the sweep retrace provides a convenient center line for some waveforms, it is undesirable in others. Elimination of the retrace is electrically quite simple for any moderate range of frequencies, and is accomplished by biasing the grid of the *crt* negative during retrace. As approximately 50 volts are required at most working intensities, the retrace blanker must include an amplifier.

Circuit of an effective retrace blanker for low to medium frequencies is shown in Fig. 7, p. 58. This is a fairly conventional two-stage resistance coupled amplifier, receiving a negative-going pulse from any convenient part of the sweep circuit that goes negative on retrace, and providing an amplified negative-going pulse to the grid of the *crt* through a capacitor. A 1N34 diode is used in the input to short out any positive-going pulses, which might otherwise intensify the beam during a part of its forward sweep. Amplitude of the blanking pulse is determined by the setting of the plate resistor of the second triode, which is a potentiometer: the same shaft also operates an off-on switch for the blanker, to reduce the number of controls.

General appearance of the blanker assembly is shown in Fig. 5, p. 58 at *c* and *d*. When in operation, the blanking pulse amplitude is adjusted, at the operating frequency, so that it just eliminates the retrace, and does not blank the beginning of the forward sweep. Values of the constants in this circuit are not critical, and several obvious alternative circuits will work just as well. In some 'scopes, the values of the coupling capacitors can be reduced markedly, while in others, the values shown are just adequate for satisfactory operation. It is important to be sure that the output coupling capacitor is rated at about twice the applied *dc* voltage, as a capacitor breakdown here, in many 'scopes, will put more than 1,000 volts across the *B* supply.

Additional Inputs

To this point, our major consideration has been minor changes in 'scope construction and circuitry, to improve

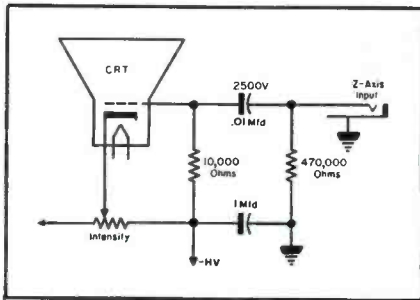

Fig. 8. A Z-axis input circuit.

performance, with special reference to field conditions. As supplied, whether or not modified for field use, the 'scope is a fairly adequate instrument for servicing a wide variety of amusement or communication type of electronic devices, using techniques that are well known.

In many branches of industrial electronic work, however, phase relations are of great importance. It is necessary to determine not only the input or output waveform, but also the phase relation of one or more dependent occurrences; or the time, in microseconds, between occurrence *A* and *B*. For this work, the 'scope must have one or more additional inputs.

Perhaps the simplest way of obtaining another indication from 'scope is by use of Z-axis modulation, which changes the intensity of the electron beam in the *crt*, and hence of the spot or trace on the screen.

Circuit of a simple Z-axis input is shown in Fig. 8. This is a perfectly straightforward circuit, is supplied on more than half of the commercial 'scopes of recent manufacture, but probably used on only a few of the 'scopes now owned. The input circuit consists only of a capacitor, a resistor, and a connector, such as a jack. When a signal is fed into the Z-axis input, it modulates the electron beam of the *crt*, the plus-going half cycles intensifying the beam, the minus-going half cycles dimming it.

As in the case of the beam-blanker, the coupling capacitor (in this case, .01-mfd/2,500 v) must have an ample margin of safety, to prevent insulation breakdowns and resultant extensive burnouts of other components.

By a rather obvious change in the switching circuit, the beam blanker, if one is installed, can be used as a Z-axis amplifier. For most 'scopes this procedure is not recommended, because of the danger of intercoupling of circuits and conflict of operating functions. A separate Z-axis amplifier, thoroughly isolated from the horizontal and vertical amplifiers in the 'scope, and powered from a separate supply, is recommended.

[To be Concluded in May issue]

Like money in the Bank...

WALSCO UHF-VHF

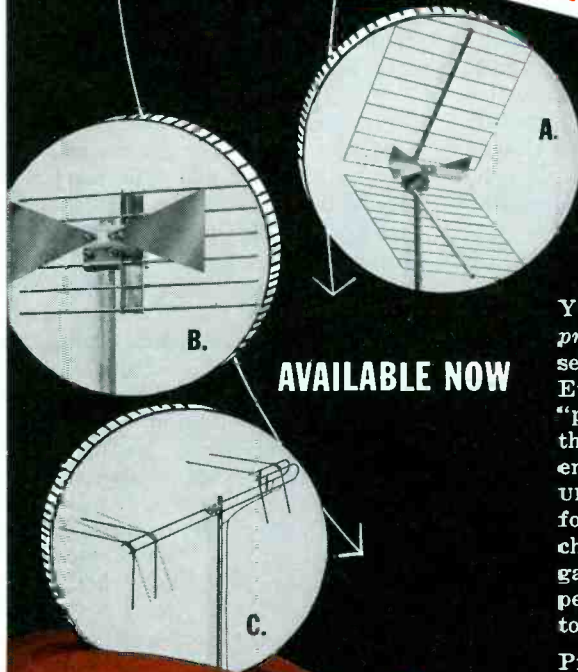

AVAILABLE NOW

- A. CORNER REFLECTOR**
For fringe and ghost area reception
- B. REFLECTO-FAN**
For local reception
- C. TROMBONE**
For combination UHF-VHF reception

YOU are completely protected when you buy, sell or install WALSCO. Every model is now a "proven performer"... thoroughly tested and endorsed in all the new UHF-VHF areas. Designed for all present and future channels. The best high gain, all channel performance and a model to fit every installation

Protect your profit... eliminate costly call-backs. Install WALSCO, America's most dependable TV antennas. It's like money in the bank!

WALSCO

Walter L. Schott Co.
3225 Exposition Place
Los Angeles 18, Calif.

Overseas Representative:
Ad Auriema, Inc., 89 Broad St.,
New York 4, N.Y.

WRITE FOR COMPLETE PRICE
AND CATALOG INFORMATION—Dept. P-53

WEAK Chassis Complaints

by JACK DARR

Ouachita Radio Service

Part II . . . Tracing and Curing Troubles in 3-Way Portables and Old-Battery Models Using External Antennas and Coils

Fig. 1. A typical oscillator circuit as used with pentagrids such as 6A7, 7A8, etc. Note the tickler winding on oscillator coil. The small capacitor shown in dotted lines will occasionally be found in these circuits to aid feedback. The oscillator trimmer (A) is usually adjusted to 1500 kc, while the padder is set to 600 kc.

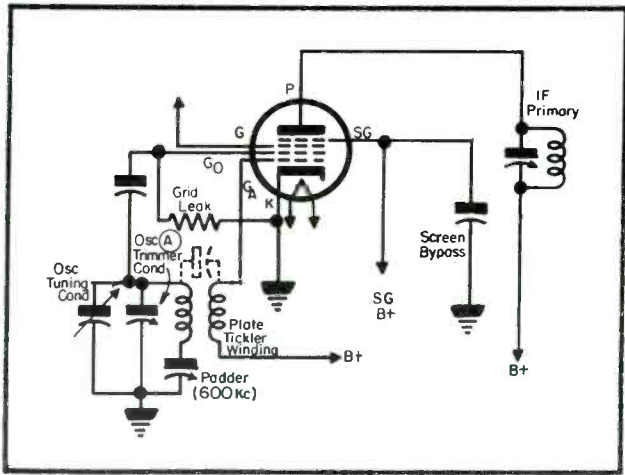

THE REPAIR of oscillator coils in tickler-feedback circuits is an important factor in weak-chassis problems. As noted earlier, exact oscillator-coil duplicates in older sets are usually quite difficult to find; thus it is necessary that the coil be rewound. After the new windings have been placed on the form, the ends must be cleaned and soldered well to the lugs; then the whole coil must receive a good coating of Q-dope (liquid polystyrene coil coating) and allowed to dry. The coil can now be reconnected into the circuit, and set realigned. If the oscillator refuses to work, the connections to the new winding should be reversed.

Occasionally, opens will be found in the grid or tuned windings of an oscillator coil. This is due usually to mechanical damage, breakage of the leads by rough treatment, and will be found near the end of the winding. The coil should be removed and examined with a magnifying glass, such as a jeweler's loupe. If you can locate the break, it should be repaired, doped, and realigned. Rewinding of these coils is not recommended, due to the impossibility of making an exact duplicate.

One should not overlook the other parts of the oscillator circuit, such as the oscillator tracking capacitor, if one is used, or oscillator slugs, if the set uses permeability tuners. Hygroscopic insulators or leakage through an accumulation of grease and dirt can reduce the efficiency of an oscillator tremendously. About the only positive test that can be made is a disconnect and check test with a high-range ohmmeter. No leakage at all should be found. Leakage of the order of 75,000-100,000 ohms will

seriously impair the operation of the circuit.

In 3-way portables if the filament voltage becomes low, oscillators can cause trouble. This is usually due to a drop in the high-voltage supply. It will manifest itself in the form of weakness, low-oscillator voltage, oscillator drop-out at low frequencies, etc. Although this difficulty will usually be found to be due to low-emission rectifiers, whether tube or selenium, occasionally the trouble might be in high-surge resistors connected between the rectifier cathode and the input of the filter system. An increase in the value of this resistor will decrease the apparent size of the input filter, resulting in low voltage.

High power factor in the input filter, leakage through bypass, or even coupling-capacitor leakage, will often cause enough of an overload on the power supply to cause oscillator trouble, especially with a *borderline* tube.

Rectifier Checks

Rectifiers can be best checked by substitution; a selenium rectifier which apparently has sufficient output may fail to deliver if the line voltage falls below normal. A small auto-transformer is invaluable for testing portables or battery sets for this trouble.† If the portable operates on any station at all down to an indicated line voltage of 100, it can be considered to be in perfect shape; cutting out at 105, for instance, could indicate a weakness somewhere. A new oscillator tube should be tried and a test made to see how much farther the set will go before it cuts out. This

†SERVICE, p. 68; September, 1951.

check will also show up weak rectifiers. If the receiver has a tube rectifier, it will be best to wait long enough for the filament to cool off before proceeding to the next step; this will usually be about 10-15 seconds.

Some portables develop a filament voltage for the battery tubes across the cathode resistor of a 50L6 or similar tube used as an output tube, when operating on *ac*. A low tube here, or a leaky coupling capacitor, will cause the filament voltages to be low or high, respectively.

One common cause of weakness, although not often suspected, is mistracking of the oscillator with the antenna tuner. If the set tracks at the high end of the dial but is seriously off at the other, a severe loss of sensitivity will result. At this point a signal tracer is almost essential. One should check the oscillator frequency at each end of the dial. The indicated frequency should be the dial reading plus the *if*; for instance, with a 1,550-kc dial reading and 455 kc *if*, the oscillator frequency should be 2,005 kc. Similarly, a 1,000-kc dial and 455-kc *if* should have an oscillator setting of 1,455 kc. If the oscillator does not agree with the computed values, it is not tracking, and should be corrected.

If the set's design includes a padder for low-frequency adjustments, or a variable-inductance oscillator coil, the trouble can be easily remedied, for most of the mistracking will probably be due to misalignment. If the set is one of the smaller varieties with a meagre oscillator trimmer, more work must be done. First, it will be important to see that the oscillator itself is tracking

(Continued on page 64)

SUPERIOR PERFORMANCE OF SYLVANIA PICTURE TUBES NOW PROVED BEYOND ALL DOUBT

HERE'S THE
FULL REPORT!

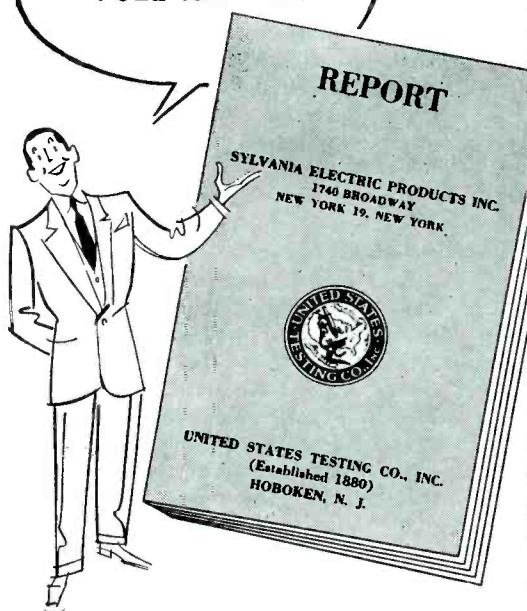

LIFE TEST MAGNETIC TUBES United States Testing Company Hoboken, N. J.			Test No. E-5526 Date 10-11-52 Engineer A.S.M.
Mfr.	Tubes Tested	Tubes Failed	Point Quality
A	8	3	76
B	8	4	79
C	8	6	62
D	8	4	74
E	8	4	67
F	8	5	42
G	8	4	52
H	8	5	30
SYLVANIA	8	0	93

**Exhaustive tests by United States Testing Company prove Sylvania
Picture Tubes out-last, out-perform all others tested!**

● Hour after hour for over 1,400 consecutive hours, Sylvania Picture tubes were tested side by side with tubes of 8 other manufacturers. The chart at right tells the remarkable performance record. Note that only Sylvania Picture tubes showed no failures. Here's the conclusion of the U. S. Testing Company Report: "On the basis of an ultimate Life Test Evaluation of the eight tubes of each brand tested, it can be

concluded that the averaged overall qualities measured on the Sylvania Tubes were superior to the averages of the other brands tested."*

*United States Testing Company, Inc., Test No. E-5526.

We'll be glad to send you full details of this report. Send your request to Sylvania Electric Products Inc., Department 3R-2404 1740 Broadway, New York 19, N. Y.

HERE ARE
THE
CONCLUSIONS!



SYLVANIA









RADIO TUBES; TELEVISION PICTURE TUBES; ELECTRONIC PRODUCTS; ELECTRONIC TEST EQUIPMENT; FLUORESCENT LAMPS, FIXTURES, SIGN TUBING, WIRING DEVICES; LIGHT BULBS; PHOTOLAMPS; TELEVISION SETS.



Famed Across the Nation

FOR QUICK, EASY INSTALLATION!

						
Model EZ-2 2 Sec. 49" List \$3.45	Model CO-3A 3 Sec. 57" List \$5.15	Model MH-3 3 Sec. 57" List \$5.65	Model FD-3 3 Sec. 4"-55" List \$7.45	RAD-3 \$5.15 3 Sec. 70" RAD-4 \$6.25 4 Sec. 92" RAD-5 \$7.25 5 Sec. 112"	Model CS-3 3 Sec. 60" List \$3.85	COMMUNICATION BASE and SPRING MB-2 \$7.25 STEEL MAST MM-72 72" List \$5.75

SEE YOUR PARTS JOBBER NOW FOR THOSE *Easy-to-Install RADELCO Antennas!*

No matter what your installation needs may be, you'll find exactly the aerials you want at your nearest Radelco jobber... and at prices that will please you! You'll like the high quality and fine workmanship found in every Radelco antenna. You'll like their smart styling and handsome finish... but best of all you'll like their speed and ease of installation. If you want more for your money when you buy antennas make it a point to say "Radelco!"

RADELCO
MANUFACTURING CO.

7580 GARFIELD BLVD.
CLEVELAND 25, OHIO



Weak Chassis

(Continued from page 62)

the dial scale or that it is exactly the dial reading plus the *if* at each end. If this is not the case, it will be necessary to try adjusting the plates of the tuning capacitor at the low end, then moving the high end and adjusting the trimmer. Next the alignment of the antenna tuning capacitor should be checked at both ends of the dial; it may be off, too.

Mistracking of the antenna circuit could be caused by defective antenna

coils, turns missing from loop antennas, misconnection of loop wiring, or mistuning. Open *avc* bypass capacitors, or high-leakage in these capacitors, can also cause tuning trouble. If the loop is in a bad shape, you should try installing one of the ferrous-cored loop-stick type antennas. These have a low-frequency adjustment, and can be made to track quite easily, sometimes with an astonishing increase in gain.

In troubleshooting one 3-way portable recently, signals were found to be very weak, but clear. All the customary tests were applied, but with no

results; filament and plate voltage, and tubes were found to be good. Re-alignment did not help. Finally, a *vacuum* was applied to the *avc*, and an odd condition was noted. On the 1R5 converter input grid, the *avc* voltage was found to be around 5 to 7 volts, negative, while the rest of the *avc* buss read only 1 to 2 volts. When the set was tuned from high to the low end of the dial, this *avc* voltage varied. The oscillator coil was coupled to the oscillator grid through a *gimmick*, an open-ended winding of only a few turns. The tuned coil was returned to the *avc* buss through a 10-megohm resistor. The *gimmick* had shorted to the coil, causing a leakage of about 50,000 ohms; thus the oscillator grid voltage was being fed back into the *avc* buss. This voltage, applied to the converter signal grid, was almost blocking the tube! Incidentally, the trouble was cured by disconnecting the *gimmick* and replacing it with a small ceramic capacitor of about 5 mmfd, connected to the *hot* side of the tuned coil. Another *gimmick* could be wound on the coil, of course, but the oscillator-coil connections in this small set were inaccessible and thus the capacitor installation was more practical.

Low gain in the front ends of older models or battery sets using outside antennas and antenna coils, can often be traced to open primaries or secondaries of the coil itself. If the secondary is entirely open, the usual *open grid buzz* will occur, but if it merely has a high-resistance joint, the gain will be lost. One universal symptom of this trouble is a *flat* trimmer reaction, just as in the *if* stages. While the antenna trimmer often does not have a true *two-sided* peak, still there should be a definite peak in its response, usually rising from a full-capacity position to maximum somewhere in the center of its range, and then flattening from there on up. This is normal, but if the trimmer has no effect at all, then the windings can be suspected. A quick check for trouble here is to place the antenna first on the converter grid, and then on the antenna post. If there is a noticeable loss from the grid to antenna, then the coil should be checked.

In sets using loops, usually no antenna-amplifier *rf* stage is used and the actual gain from *antenna-post* to grid is rather small. In testing it is important that the loop or antenna exhibit a definite increase in signal, or even in noise, when the hand is placed near it. If not, the *front end* is lacking in sensitivity. Misplaced loop wiring, due to unskilled servicing, or even to deliberate reversal of the leads, will be found to be a source of trouble. In

some sets, the loop is coupled to the converter grid through a small capacitor; therefore, the characteristic open grid buzz will not occur, but the set will be decidedly weak.

The average *dc* resistance of loops themselves will run from 3 to 5 ohms, although the low-impedance loops, of only three or four turns, will have no measurable resistance. If a high-impedance loop appears, it may have a separate *coupling-loop*, or one turn around the outside, for connection to an external antenna. One should check to see that this has not been connected up in place of the loop winding itself. This can lead to much confusion!

In our review, most of the common, and a few of the uncommon causes of loss of sensitivity have been discussed; still others will be found from time to time. On most of these sets, only thorough, careful work will disclose the cause of the trouble. A thorough knowledge of basic receiver circuitry is essential; this, coupled with a full set of test equipment and service manuals, can make weak-chassis jobs quite profitable. Of course, this type of work should command a higher price than a simple part-replacement. If you achieve a noticeable improvement in performance and a lasting repair job, your prestige will rise and so will your service income!

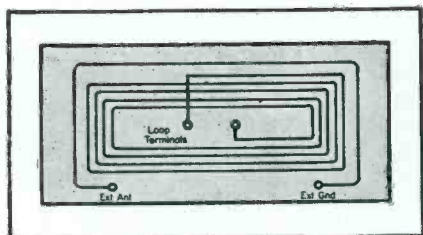

Fig. 2. A typical loop structure. The one-turn coupling loop is used for contact to outside antenna and ground. This may be returned to *ac/dc* chassis through an isolating capacitor.

SELLING SERVICE IN CHINESE



Billboard, adjacent to San Francisco's Chinatown, with Chinese symbols to attract the attention of San Francisco's Chinese-speaking population, as well as the curiosity of non-Chinese passersby. Shown with the board are, left to right: Eric Ledin, merchandising manager for Associated Radio Distributors, San Francisco; Wilfred Wong and John Lee of Marvel Television, 789 Broadway, San Francisco; and Louis M. Robb, district sales manager for G.E. replacement tubes.

by every test



ATR AUTO RADIO VIBRATORS

Have Ceramic Stack Spacers
A COMPLETE LINE OF VIBRATORS

Designed for Use in Standard Vibrator-Operated Auto Radio Receivers. Built with Precision Construction, featuring Ceramic Stack Spacers for Longer Lasting Life. Backed by more than 22 years of experience in Vibrator Design, Development, and Manufacturing.

"A" Battery Eliminators, DC-AC Inverters, Auto Radio Vibrators

- ✓ NEW MODELS
- ✓ NEW DESIGNS
- ✓ NEW LITERATURE



Free

See your jobber or write factory

AMERICAN TELEVISION & RADIO Co.

Quality Products Since 1931

SAINT PAUL 1, MINNESOTA—U. S. A.

Service Engineering

field and shop notes

by THOMAS K. BEAMER

**Design and Construction of Screen Booths for VHF and UHF Testing and Measurements . . .
Mobile Dynamotor Relay Life Checks...Installing
25-50 Mc $\frac{1}{4}$ -Wave Antennas for Best Results . . .
Highlights of New Products for Field and Shop Use**

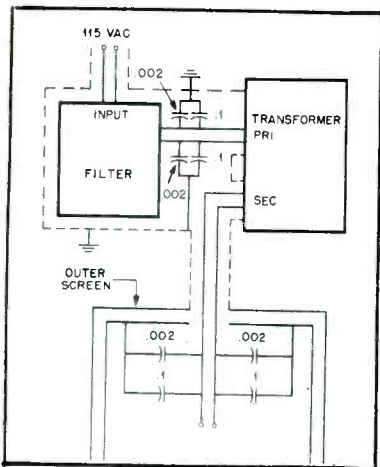

Fig. 1. Block diagram illustrating layout of screen test booth with isolation transformer, filter and bypass capacitors. (Courtesy Motorola.)

IN HF *rf* testing and measurement, it is necessary to shield equipment from spurious radiations, which can cause serious instrumentation error in the *vhf-uhf* range. Such protection can be provided by screened booths.‡

It has been found that the screening method is dependent on frequency. Where the equipment is operating below 20 mc, a 2-wire galvanized screen with $\frac{1}{2}$ -inch square mesh has proved very satisfactory. For frequencies above 20 mc, 3-wire screens with fine copper mesh have been found satisfactory.

Dimensions of screen booths are not critical. Two-wire installations require 6" spacing between screens, using 2" x 6" lumber. Screens can be spaced 2" in 3-wire booths.

In constructing, the floor is framed first, with the screen stapled tightly to prevent sagging. One screen is applied to the bottom of the floor frame, allowing about 4" for overlap to the outer side screen. All overlaps must be soldered at every mesh square. Lumber nailed over this overlap will protect the joints. The top floor screen can then be laid. It should be

6" shorter than the lower screen and have a 4" overlap to the inner wall screen.

After the framework of the walls and ceiling has been completed, the inner and outer screens can be stapled and soldered in the same manner. The door must be built in ice-box style and also fully screened. Phosphor bronze weather stripping, soldered to the screens, should be used in the door framework and on the door itself to provide a good electrical contact between the door screens and those on the walls. A standard flooring can be laid after the wall screens are in place. To prevent a short between screens, a continuity buzzer should be used during construction.

All *ac* wiring to the booth must be isolated from the power system, using a transformer and filter network.¹

The filter is mounted in a metal box on conduit leading from the transformer, which should be installed at the top of the booth. Input to the booth should be brought through heavy rubberized leads, metal shielded to the wall entry point. A handy-box should be mounted inside the booth, as near the top as possible, with the input lines again bypassed to ground, as shown in Fig. 1.

A 1" copper braid should be run from the handy-box to the inner bronze strip inside the door frame.

¹Based on data prepared by the technical information department of Motorola.

All equipment in the booth must be grounded to the nearest conduit. The switch box should be mounted on the outside of the booth and connected to the outer phosphor bronze door-frame strip with another 1" copper braid. A good electrical ground should be made to the transformer mount and to the outer screen at the top of the booth, connecting to a water pipe or sprinkler system. The ground lead must be kept short to minimize standing waves.

Mobile Dynamotor Relay Life Checks‡

Proper operation of the *A* power, transmit-receive and dynamotor relays are extremely important in 2-way system control as noted in a brief report last month. There are several common faults which can shorten vibrator, dynamotor, *A* relay and dynamotor relay life.

To trace a defect, a voltmeter should be set to a low voltage *dc* scale, and connected directly across the primary contacts of the *A* power relay. With the equipment turned *on*, the meter should read no more than a few millivolts; the drop across the relay contacts. However, the purpose of this test is not measurement of this drop. Now the push-to-talk button should be pressed. A noticeable de-

¹1-kva isolation transformers, statically shielded, and Mallory LC10 filters have been found excellent for this purpose.

G-C

YOUR HEADQUARTERS FOR THOUSANDS OF RADIO-TV SERVICE AIDS

Products of the Month

Here "all under one roof" is the place to get all those mighty important radio-TV service aids! Yes, G-C makes more of these quality products (and more of them exclusively) than anyone else in the entire industry. You'll find them all in the big illustrated G-C Catalog; if you don't see what you want at your favorite parts distributor, ask him to get them for you.

G-C DUPLEX TUBE PIN STRAIGHTENER

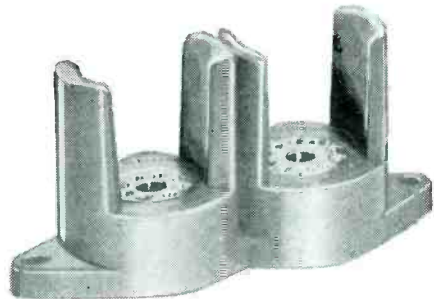

Handiest tube pin straightener you ever saw! Straightens pins on both miniature and jumbo miniature tubes, both 7- and 9-pin types. Precision made steel dies molded in durable plastic.
No. 8655 List \$2.50

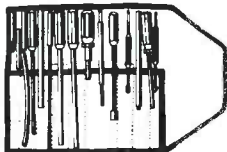

**G-C DELUXE
TV ALIGNMENT TOOL KIT**
Durable leatherette roll type case with 16 matched tools. Tools are finest quality, with tips of hardened spring steel; used and approved by leading TV set manufacturers. \$15.00 list value.
No. 8280 List \$12.90



**G-C AMO
MINIATURE TUBE PULLER**
Exclusive with G-C, AMO prevents tube breakage and burned fingers, speeds up production and repair. Easy to operate, works on suction and vacuum. Press down on tube to pull, press button to release!
No. 5093 List \$1.65
(for 7-pin tubes)
No. 8106 List \$1.65
(for 9-pin tubes)



**G-C SPEEDEX
AUTOMATIC
WIRE STRIPPER**
New model, fully automatic with "delayed return action" to prevent crushing fine stranded wires. Single squeeze action strips both solid and stranded wire. Interchangeable blades. Other models.
No. 766-1 List \$8.25



**G-C TELEVISION 2-IN-1
6" DUPLEX ALIGNER**
All-purpose, for trimmers, I.F. transformers, coils, etc. Spring steel tips, screwdriver and recessed tip for No. 4 and 6 studs.
No. 8276 List \$0.80



**G-C TELEVISION 2-IN-1
7" DUPLEX ALIGNER**
For No. 4 and 6 studs, color coded for easy identification. Spring steel recessed tips.
No. 8722 List \$1.05



**G-C TELEVISION 2-IN-1
9" LONG-REACH DUPLEX ALIGNER**
For hard-to-get-at No. 4 and 6 studs. Spring steel recessed tips, color coded; Unbreakable plastic.
No. 8721 List \$1.25



**G-C "SHORTY" TV
ALIGNMENT SCREWDRIVER**
Only 2" long overall, gets into cramped spots, under tubes, etc. Fits No. 4 and 6 studs. Unbreakable plastic, spring steel tips.
No. 8289 List \$0.70



**G-C K-TRAN
TELEVISION ALIGNER**
Specially made for K-Tran I.F. Transformer tuner slugs. Bone fibre with plastic handle. 6 1/2" long.
No. 8727 List \$0.85



NEW G-C LONG ARM TV TOOL
Extra-long-reach for Zenith sets and others where adjustments are hard to get at. Tool is 18" long overall.
No. 8821 List \$1.50

FREE Write today for G-C's big illustrated Catalog. Shows everything you need for profitable servicing. Send post-card now!



GENERAL CEMENT MANUFACTURING CO.
901 TAYLOR AVENUE
ROCKFORD, ILLINOIS

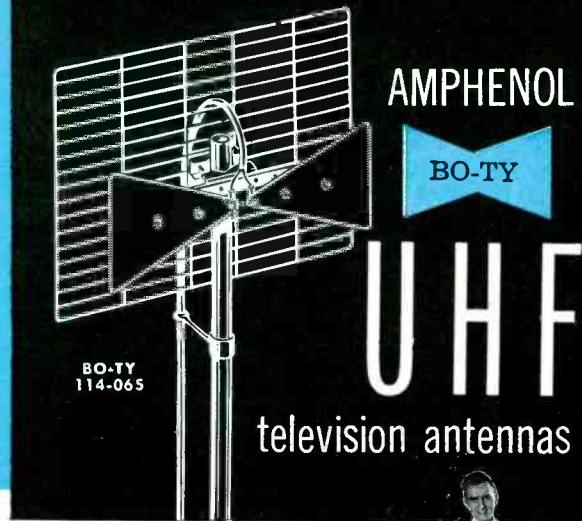

now packaged
preassembled

The AMPHENOL 300 ohm BO-TY Antenna, 114-065, is a UHF antenna and reflector that intercepts any of the UHF channels, 14 through 83. High signal gains of 5 db to 8 db plus excellent front-to-back ratio make the BO-TY Antenna ideal for both strong and weak signal areas. For extremely weak signal areas, two BO-TYs can be easily stacked. One stacking rod is provided with each 114-065 BO-TY making the necessary pair when two are bought for stacking.

All components of the AMPHENOL 114-065 BO-TY Antenna are completely preassembled for quick and easy mounting on the mast. Installation is a simple matter of tightening two wing nuts.



OTHER UHF TYPES AVAILABLE SOON. Designed and field tested by the same engineers who developed the famous INLINE VHF Antennas, the UHF Antennas previewed here will shortly be added to the AMPHENOL line. **YAGI UHF** Antenna for high gain on specific channels. **STACKED-V** combination UHF and VHF Antenna. **CORNER REFLECTOR** all-channel, high gain UHF Antenna. **RHOMBIC** Antenna for high gain, broadband UHF reception.



U.S. Pat. No. 2,543,696
AMPHENOL tubular twin-lead
Moisture, one of the greatest enemies of UHF signal strength, does not materially affect the impedance or electrical efficiency of AMPHENOL Tubular Twin-Lead. As illustrated, the concentrated field of energy is largely contained and protected by the tubular construction. Because flat twin-lead does not afford this protection, it is not recommended for UHF installations.



AMERICAN PHENOLIC CORPORATION *chicago 50, illinois*

Service Engineering

(Continued from page 66)

deflection of the meter needle on a 10-volt *dc* scale will indicate improper operation of the primary power system, since it indicates that the relay contacts have opened.

When the push-to-talk button is depressed the transmitter-receive relay and the dynamotor relay are energized in turn. The increase in current through the *A* relay will be found to be negligible. However, the dynamotor starting current surge will exceed 100 amperes even on 30-watt transmitter units. This high surge current flowing through a common ground lead, common battery and common *hot* lead with the filament and control currents causes considerable additional voltage drop. A small battery or battery in poor charge condition will increase the voltage drop. This voltage drop, increased by the loss in the cables and connections to the *A* relay can cause the relay to open if the low voltage hold-in limit is passed.

If the *A* relay opens, the other relays will also open, initiating a *chatter* cycle. The life of the dynamotor, vibrator, *A* relay and the dynamotor relay can be considerably shortened by the relay chatter during the high current surges.

The problem can be averted by holding the voltage drops to a minimum. All cable connections including the ground, battery, fuse and relay terminal connections must be tight and free of corrosion. The battery must be of adequate size and near full charge condition. In a well installed system, subjected to periodic maintenance checks, this difficulty can be averted.

Antenna Mounting‡

To make efficient use of 25-50 mc quarter-wave spring base antennas, the antennas must be resonant and present a

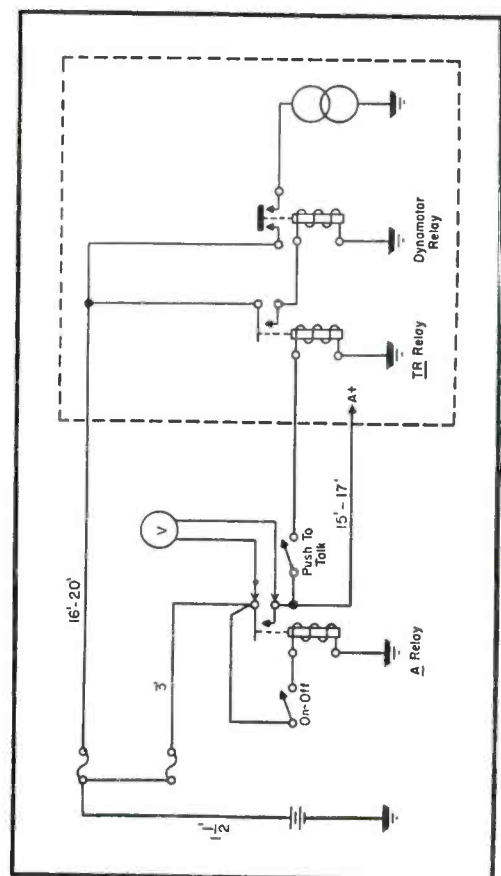

Fig. 2. Simplified primary power circuit for mobile transmitter-receiver, with dynamotor, *A* and transmit-receive relays, which must be carefully maintained to prevent not only damage to the relays, but to the vibrator and dynamotor. (Courtesy Motorola)

50-ohm resistance to the transmission line and transmitter output circuits. The lack of an adequate ground plane and proximity to the vehicle body make this difficult to achieve in most installations. Antennas therefore are broad-banded and the reactance is tuned out in the transmitter output circuits. The ground plane presented by the vehicle top preclude these difficulties in 150 and 450-mc rooftop antennas.

To obtain the most satisfactory performance, the antenna should be mounted as high as possible on the vehicle body. Then the antenna should be mounted on a portion of the vehicle body which is mechanically strong enough to withstand the whipping action. Any possible ground plane should be utilized to the fullest extent. It is important to avoid mounting the antenna rod in close proximity to the vehicle body for extended lengths. The antenna leadin must of course, be kept as short as possible. A field-strength meter or lamp bulb and leads should be used to assure maximum radiated power.

Service Engineering Products

A *fault-location* Wheatstone bridge for general lab use or field servicing of communications systems is now available.²

Bridge is said to measure resistance between 1 and 1,011,-000 ohms to an accuracy of $\pm 0.1\% + 0.01$ ohm.

In addition to measuring resistance, bridge locates grounds, crosses, opens, and shorts by the Murray, Varley, Hilborn, or Fisher loop and capacitance tests. Dial settings can be converted to show the exact distance to the fault.

The instrument includes a built-in battery operated power supply and galvanometer.

Commercial Audio Consolettes

A *consolette*³ for communications and administrative control of sound systems in schools, hospitals, hotels, and industrial plants has been developed. Unit serves up to 20 rooms or areas, but can be expanded to 60 rooms if required. Provision is also made for adaptation of the program channel for intercommunication use when desired. A separate intercommunication channel is optionally available. Radio tuner, record player, and transcription turntable may also be used with this consolette.

Explosion Proof Speaker-Drivers

Explosion-proof speaker-driver units,⁴ for indoor and outdoor pa and sound reinforcement uses in locations where inflammable liquids, gases, or dust creates explosion hazards, were announced recently.

One of these units has UL approval for use in such industries as dyeing, dry cleaning, paint spraying, and plastic, chemical, and gas manufacturing, or wherever inflammable liquids or gases are present.

The other unit has UL approval for use in such industries as flour, feed, grain, or starch processing, coal pulverizing, and coal mining, or in any location where metallic dust, grain, or similar foreign particles in the air present an explosion hazard.

Both units are watertight and weatherproof, are provided with alnico V magnets, and have fatigue-resistant beryllium-copper voice-coil leads. They have peak power ratings of 60 watts, and a frequency response of from 90 to 7,000 cps.

²Shallercross model 6100.

³RCA type MI-14937 single-channel desk-top consolette.

⁴RCA types MI-12461-1 and MI-12461-2.

AMPHENOL -INLINE- VHF television antennas

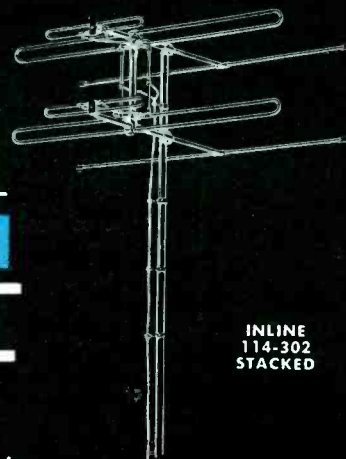

INLINE
114-302
STACKED

proven 10 ways better . . .

- 1 Wide, single forward lobe.
- 2 High front-to-back and front-to-side ratios.
- 3 No lobes off the sides—negligible ones off the back.
- 4 Uniformity of lobes at all frequencies.
- 5 High, uniform gain.
- 6 300 ohm impedance.
- 7 All-aluminum antenna construction.
- 8 3/4" Thinwall galvanized steel conduit mast.
- 9 Quick-Up assembly takes three minutes to erect.
- 10 Conveniently packaged with everything needed for the installation—antenna, mast, insulators, guy ring, mounting bracket and Twin-Lead (two bays and connecting rods included with stacked arrays).

*Reissue Pat. No. 23,273

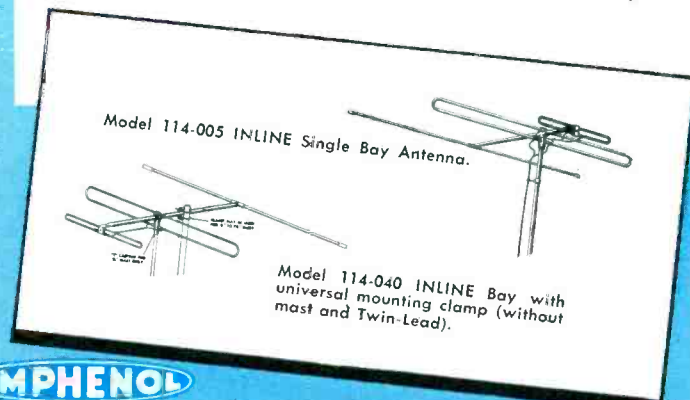

AMPHENOL

AMERICAN PHENOLIC CORPORATION *chicago 50, illinois*

Servicing Helps

by M. A. MARWELL

Correcting Line-Voltage Variations† . . . TV Chassis Hum Cures

TV RECEIVERS are normally designed to operate at peak performance when the power line voltage is 117. Most chassis will operate without difficulty at 110 volts and up to 125 volts. Line voltages above or below have been found to reduce not only receiver efficiency, but cause tube and component failures, the latter being particularly due to high voltage surges.

Although power line-voltage regulation is usually quite good in large cities during the day, in most cases, voltage will dip in the evening when great loads are placed on it. An interesting example of this variation appears in Fig. 3, which illustrates voltage changes in an apartment house near a busy business district in Chicago over a 16-hour period.

It will be noted that the line voltage during the day was quite constant. However, at 5 P.M. a voltage rise appeared (approximately 5 volts) because a small local factory shut down. And at 6 P.M. voltage fell, when the large store lights were turned on. One hour later, the drop increased. A survey revealed that the trouble was caused by the simultaneous operation of a number of TV sets, and especially the use of heater units and clothing irons. As a result pictures suffered

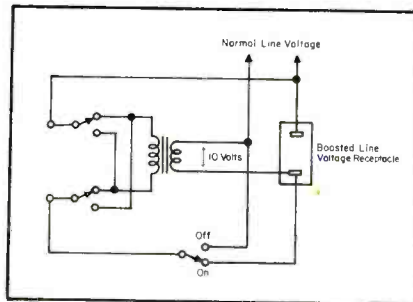

Fig. 1. Schematic of voltage booster.

from inadequate width and a lack of brightness.

It was found that the situation could be remedied by a voltage booster* which added approximately 10 volts to the line. This installation provided a voltage minimum of 115 and a maximum of 125; the latter voltage was applied only for a short period and did not have any adverse effects.

The booster used is not only able to boost the line ten volts, but reduce it ten volts, or restore it to normal when the unit is turned off. Thus, during the day, when normal or higher voltage might obtain, the unit can be shut off with a switch. When the switch is in the *off* position, the line is connected directly to a receptacle on the booster; another switch is marked

Up 10 volts and *Down 10 volts*. A center *off* switch serves to prevent arcing when switching from *up 10* to *down 10* on heavy inductive loads.

The unit uses a ten-volt transformer which is designed to work to 300 watts. The ten-volt addition or subtraction from the normal line voltage is achieved by reversing the phase of the voltage developed across the transformer secondary. Interchanging primary leads with a *dpt* switch provides this phase reversal.

It will be noted that the transformer primary is connected to a *boosted voltage receptacle*. The transformer is wound so that when 115 volts are applied to the primary, 10 volts are developed across the secondary. Let us assume that the normal line is 105 volts, and the booster is turned on. The secondary voltage would then be 9.1, instead of 10. However, the boosted voltage will be 105 plus 9.1, or 114.1 volts. Thus, connecting the transformer primary to the *boosted output* results in 10 volts across the secondary. The reverse is true when the unit is used to reduce abnormally high line voltage. At 125 volts, the voltage across the primary is 115 and,

(Continued on page 89)

†Based on notes prepared by R. Frier, Service Instruments Co., Chicago.

*Tests made with Measurements model 80 generator and Service Instruments Sensimeter.

*Service Instruments *Up-Down* booster.

Fig. 2 (right). Effects of low-line voltage in receiver in fringe area¹. Microvolt input for 1 volt at video detector.

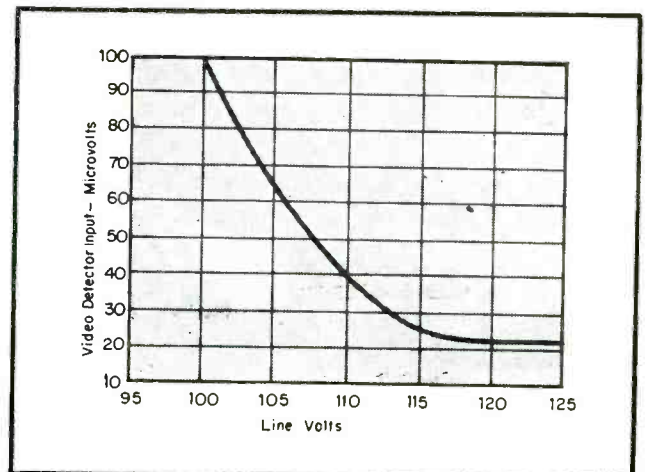
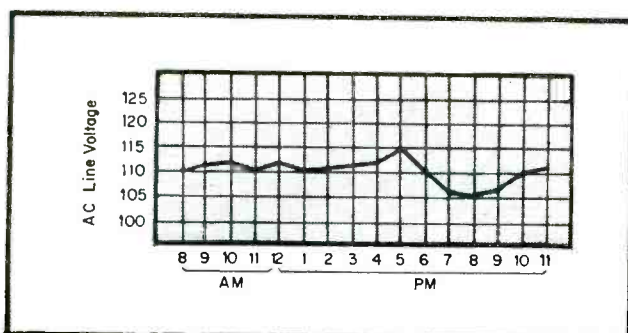
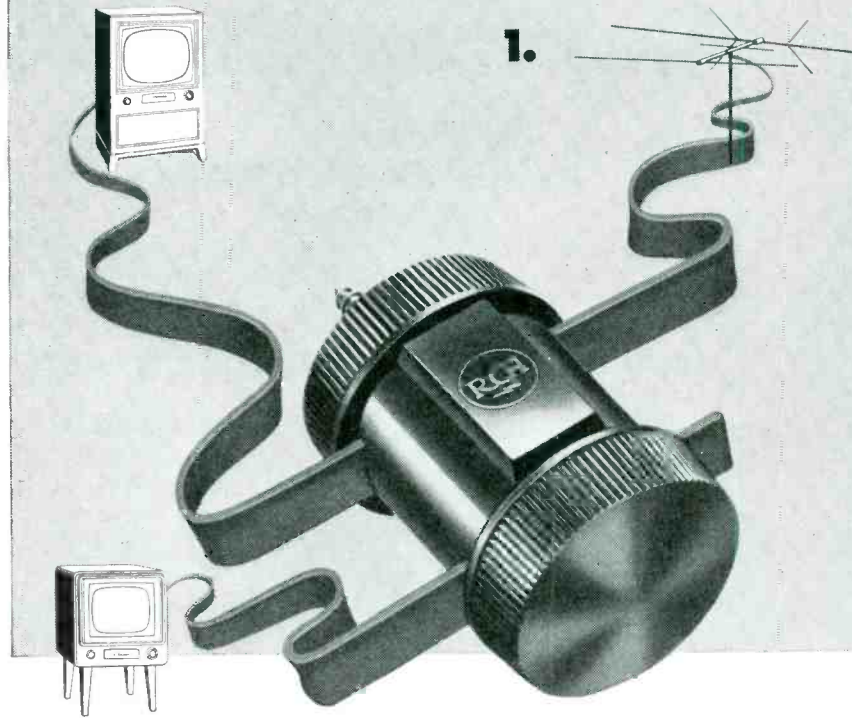

Fig. 3. Voltage variations in line over a 16-hour period.



It's new... it's simple... it's inexpensive!



Illustrations show four coupling arrangements. Method used depends on available signal, number of sets, and strength of local interference.

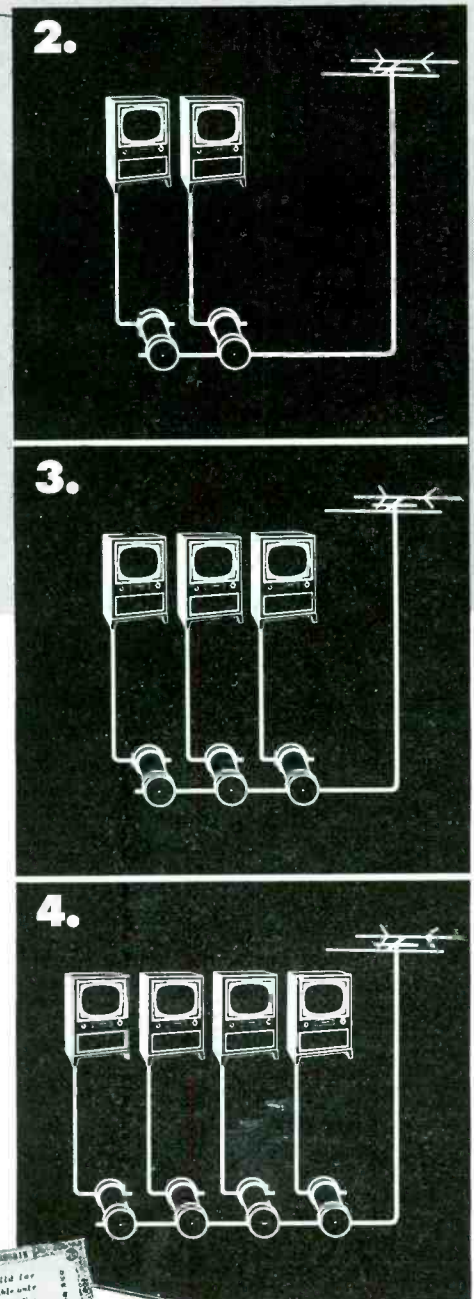

The RCA-240A1 TV Set Coupler

- ✓ Easy to install . . . self-contained wood screw
- ✓ Reduces oscillator interference between sets
- ✓ For 300-ohm ribbon-type line
- ✓ Only \$1.95 suggested list price

Now, it's a simple matter to operate two or more TV sets from a single antenna. The four illustrations show you how easy it is. There's no need to cut or splice the twin lead because connections to the coupler are automatically made when the screw caps are tightened. A wood screw in the base makes it easy to fasten the coupler to a wall or baseboard. You can make an installation in a matter of minutes.

The new RCA-240A1 coupler will help you sell customers a second set . . . let people "double up" on apartment antennas . . . provide a simple, inexpensive floor demonstration set-up for dealers. That's why you'll want a good supply on hand to take care of the *extra* business that will come your way. See your **RCA Parts Distributor** today for full details.

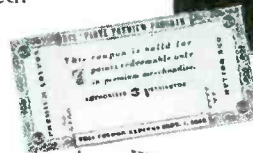

Earn Valuable Premiums!
When you purchase RCA TV Set Couplers—and other RCA Electronic Components—you receive coupons that entitle you to valuable premiums. RCA Parts Premium Program closes July 31, 1953 . . . so, hurry. Get full details from your **RCA Parts Distributor** today.



RADIO CORPORATION of AMERICA
ELECTRONIC COMPONENTS HARRISON, N. J.

Steelton, Pa. VHF / UHF

Community TV

by MARK L. HOUTZ

Better TV Company

Concluding Installment of Report With Data on Equipment Used¹

(Left)

Installation with TV cable mounted on pole, and amplifier on crossarm; an electric light bracket also is mounted on this pole.

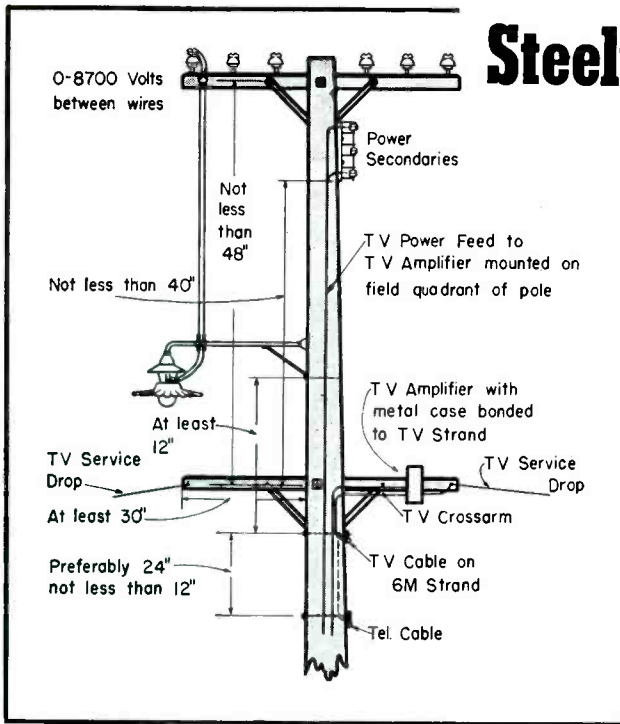

IN OUR STUDY of the amplifiers which would be best suited for this installation, it was found that low-output types would provide sufficient signal, with a minimum of radiation. Accordingly, we selected a combination² featuring a preamp which would boost signal 8 db or about 2½ times in voltage.

In actual operation signals from the antennas are fed to a common amplifier-mixer, or, if the signals are weak, to a preamp, first. The input amplifier (mixer) accepts the signals from each antenna and amplifies each channel separately; it is designed to amplify and mix up to 4 channels. Each channel has a flat top bandwidth greater than 6 mc. The gain of the mixer amplifier varies with frequency. Three tubes are used for the low-band channels and five for the high-bands. The gain of the mixer amplifier varies from about 27 db or 22 times in voltage at

channel 2 to 40 db, or 100 times in voltage at channel 13. Two outputs are available for branching.

(Input levels of over 2,000 microvolts will overload the mixer amplifier; therefore, the input signal must be dropped sufficiently to produce 2,000 microvolts.)

Mixer Amplifier Output Feed

The output from the mixer amplifier is then fed through coax cable to the next component in the system, the line amplifier. This unit performs the job of keeping the signal from the mixer amplifier constant in level after the signal has been attenuated by line loss. The normal input level to any line amplifier must be 4,000 microvolts.

Signal levels of 4,500 microvolts or over cause overload and thus sync

¹Based on copyrighted data prepared by Philco.
²Philco.

clipping on negative pictures when channel gain control is set at the minimum position.

Dual inputs are provided in the line amplifier for use when paralleling of amplifiers is required for more than 4 channels, or for branching into another trunk line.

Line Amplifier Gain

The gain of the line amplifier varies with frequency. Three tubes are used for the low-band channels and five for the high bands. Amplifier has a gain of about 15 db on channel 2 and 33 db on channel 13.

Isolation Units

To feed the individual subscriber receivers along the line, isolation units were used to provide isolation and proper matching for each receiver. They allow each receiver to operate individually of any other along the

(Continued on page 92)

Schematic of a typical high band preamp used in some systems now in the field. (Philco)

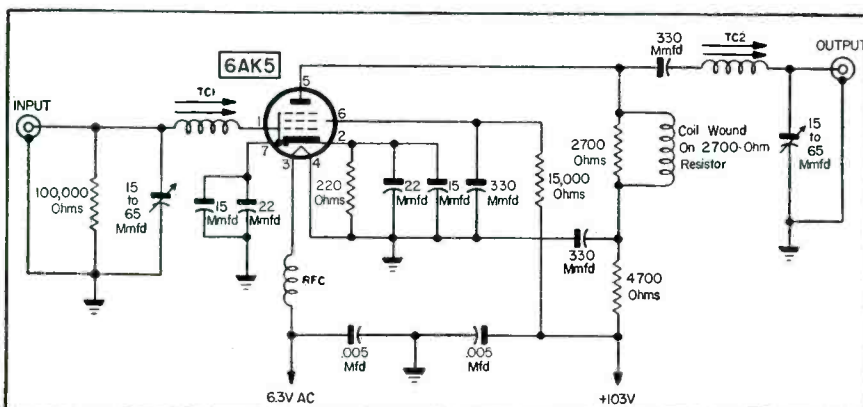

(Sketch of poles based on exhibits prepared by the Bell Telephone Co. of Pa.)

Circuit of isolation unit used in community system. (Philco)

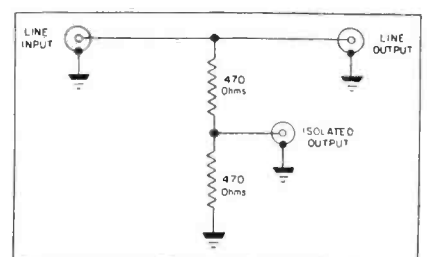

In The Field[†]

(Below)

Fig. 1. Wave form illustrating meaning of db notation in alignment.

Meaning of DB in Alignment . . . Tests for

Line to Antenna or Receiver Matching . . .

Characteristics of Mirror-Image Distortion . . .

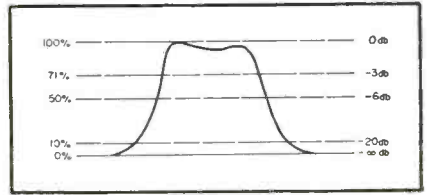

WHAT IS THE meaning of the db in alignment work?

When aligning a TV receiver, the top of the curve is the zero-db level. The bottom of the curve is the minus-infinity db level. The 50% point is the minus 6-db (-6 db) level. The 10% point is the minus 20-db (-20 db) level. Often the points are specified as *db down* instead of *minus db*, but the meaning is the same. For example, the 71% point on the curve, sometimes also called the half-power point, may be specified in service data as minus 3-db (-3 db), or as 3 db down. A further clarification appears in Fig. 1.

WHAT IS MEANT by mirror-image distortion in visual-alignment work?

Mirror-image distortion is developed as shown in Fig. 2. The remedy for this situation is apparent.

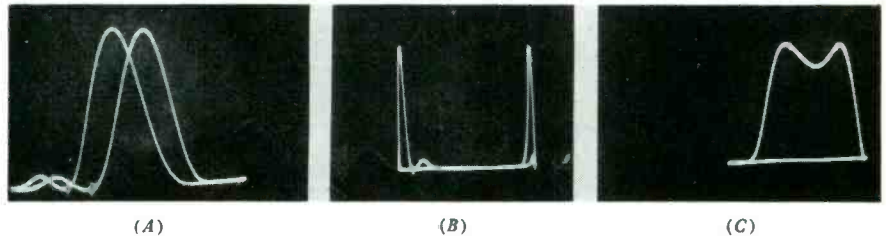

Fig. 2. False response curves (mirror-image distortion) caused by simultaneous mistuning of sweep-frequency oscillator and misphasing of 'scope sweep: *A* = trace and retrace partially out of phase, sweep-frequency oscillator tuning correct; *B* = trace and retrace completely out of phase, sweep-frequency oscillator tuning correct; *C* = false response curve when attempt is made to correct the display by mistuning the sweep-frequency oscillator, with 'scope sweep misphased as in *B*.

HOW CAN THE MATCH of a line to an antenna, or the match of a line to a receiver be tested?

The match of a 300-ohm twinlead to any load can be quickly and accurately checked with a setup as shown in Fig. 3. Typical displays for various degrees of mismatch are shown in Figs. 4 and 5.

HOW DOES ONE KNOW whether too much or too little station signal is being used for marking?

If too little signal is being used, the marker will be too small, or invisible. If too much signal is being used, the curve will be obscured with video signal, as shown in Fig. 8.

(Right)

Fig. 3. Arrangement which can be used to check the match of a line to an antenna or to a front end; line is swept through the desired channel by a sweep generator, and a 'scope is utilized to observe the standing-wave pattern. A double-ended detector is used with a balanced line, as shown. The detector can be used at the other end of the line, if desired.

(Below)

Fig. 4. 'Scope patterns obtained in line-match tests: *A* = standing wave on 30' length of 300-ohm twinlead, terminated with a 300-ohm carbon resistor (10-mc sweep through channel 3); *B* = standing wave on lead when a piece of tinfoil is wrapped around the line; *C* = standing wave on lead when terminating resistor and tinfoil are removed (line open-ended); *D* = standing wave on lead when end is shorted.

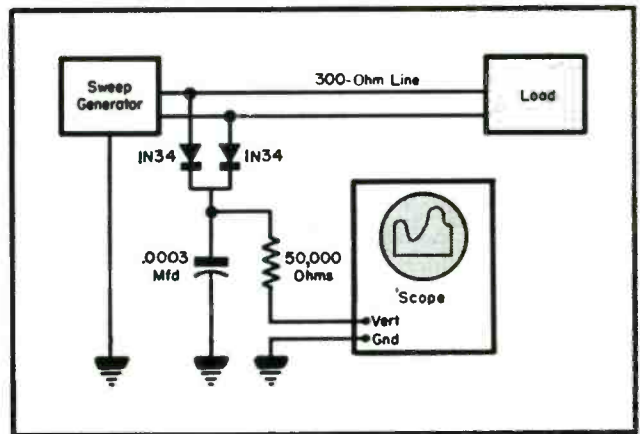
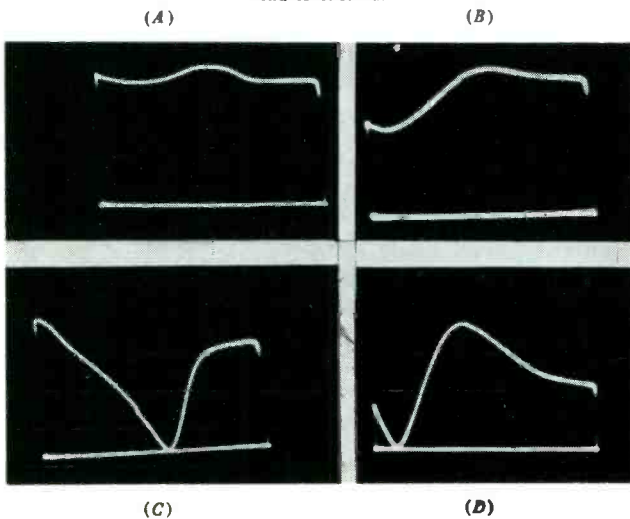

(Below)

Fig. 5. Additional 'scope examples of line-match tests: *A* (left) = standing wave on a 30' length of 300-ohm lead, terminated by a 150-ohm carbon resistor (10-mc sweep through channel 3); *B* (right) = sweep-frequency oscillator operating into 300-ohm carbon resistor, which illustrates that instrument contributes negligible distortion into the foregoing tests.

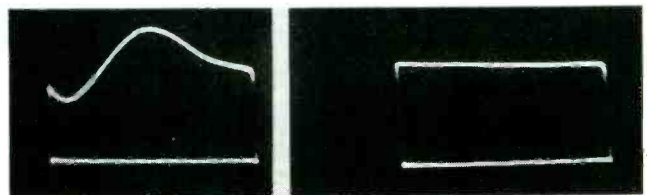

WHEN A CRYSTAL probe is used to signal-trace an *if* amplifier, what sort of indication will be seen on the 'scope screen?

The type of pattern depends upon the signal source used. If a sweep generator is used, a pattern of the type shown in Fig. 6 will appear. If the TV station signal is used, a video signal, as shown in Fig. 7, will be seen.

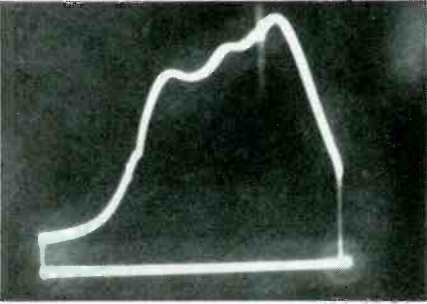

(Above)

Fig. 6. Appearance of a sweep-signal voltage on 'scope screen when crystal probe is utilized to trace an *if* amplifier. The sweep-signal voltage is more advantageous than a TV station signal in low-level stages.

(Below)

Fig. 7. Appearance of TV station signal voltage on 'scope screen when crystal probe is utilized to trace an *if* amplifier. The central portion of the display is occupied by the vertical sync pulse.

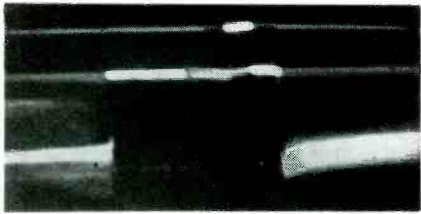

(Below)

Fig. 8. When too much station signal is used to mark a visual-response curve, the pattern becomes obscured by the video and sync-pulse voltages, as shown here.

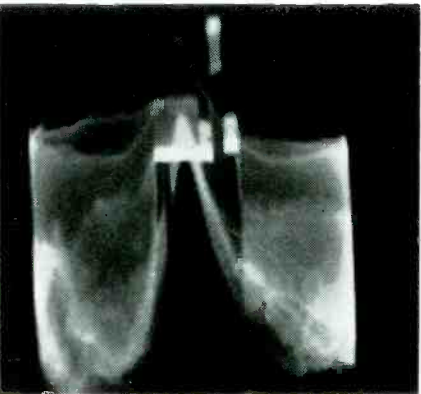

‡Based on questions posed during meetings conducted by R. G. Middleton, senior engineer at Precision Apparatus Co., Inc., and author of *TV Trouble-Shooting and Repair Guide Book*, published by John F. Rider.

HERE ARE 4 LEADS*

For a Real Boost in BOOSTER Sales

with the **B-T** Model HA-3
BOOSTER
in excess of 16db gain
Fully Automatic

only \$3950
LIST



1. **The Man With An Old Set**
He'll be thrilled at the amazing improvement you will demonstrate with the B-T Booster. You will show him how to get new set picture quality at a fraction of the cost of a new set.
2. **The Man With An Indoor Antenna**
He will laugh at his landlord problems when you show him the clear pictures to be had with the B-T Booster . . . whether he has a new set or old.
3. **The Man With An Old-Fashioned Tunable Booster**
He will be amazed at the performance and by the new "hands-off" convenience. His wife need no longer complain about the box on the receiver and the extra knobs to tune, because with the Model HA-3 there is no tuning, no band-switching . . . there are no knobs to turn and no switches to set.
4. **The Man in the Fringe Area**
He will welcome the channels he never received, and the elimination of snow and fading on the ones he did get. That is because the B-T Booster Model HA-3 increases the strength of the signal at least 6x before it reaches the set.

*These are only four of the many prospects for B-T BOOSTER Sales. There is a real profit in every B-T BOOSTER sale you make because it takes only one easy demonstration to close a sale.

Write for Free TV Installation Folder to Department HD-8

Available at Leading Distributors

Blonder-Tongue Laboratories make a complete line of TV amplifiers for signal distribution, line amplification, signal mixing and a complete line of accessories for all installations of low cost Master TV Systems.



BLONDER-TONGUE LABORATORIES, INC.
WESTFIELD, NEW JERSEY

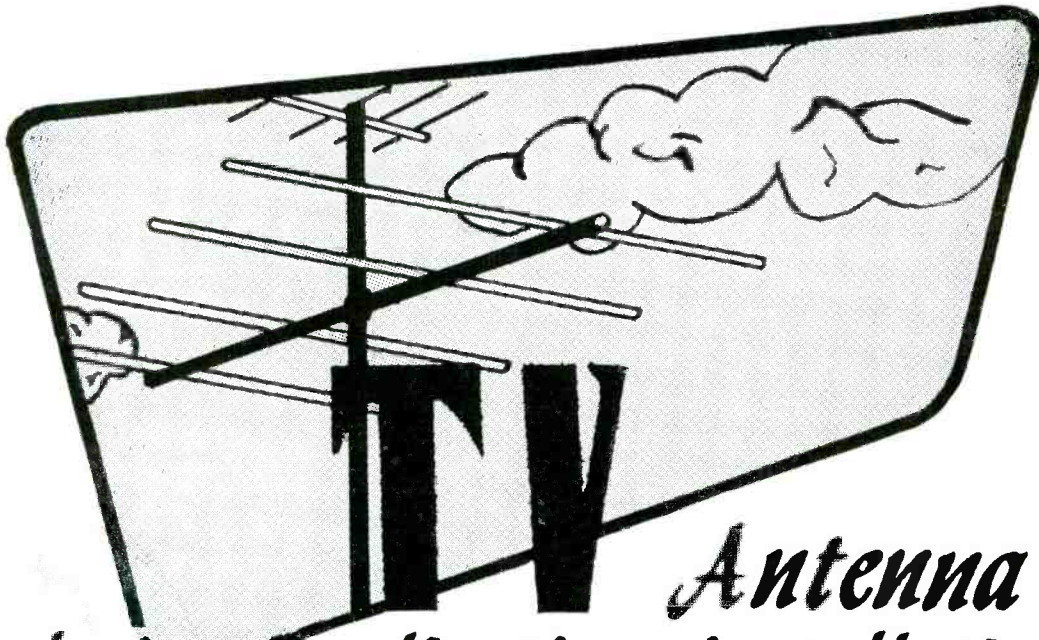

Antenna Digest

design.. application.. installation.. service

by RALPH G. PETERS

THE INCREASING NUMBER of operating *uhf* stations in many parts of the country, where practically all types of reception prevail, has provided everyone with an ideal field to evaluate not only a wide variety of antenna and allied system concepts, but lab and production-line models based on theory and practice.

It has been found,[‡] as originally believed, that ground reflections are very much more noticeable in the *uhf* spectrum, interfering with the direct signal that arrives from the station, and either reinforcing or reducing it, depending on whether the reflected signal from the ground arrives in or out of phase with the direct signal. This problem has accented the import of positioning. Height, as in *vlf*, has also been found to be a factor. On

Bow-tie with reflector, available in one, two and four stacks; data on p. 78. (Courtesy Trio)

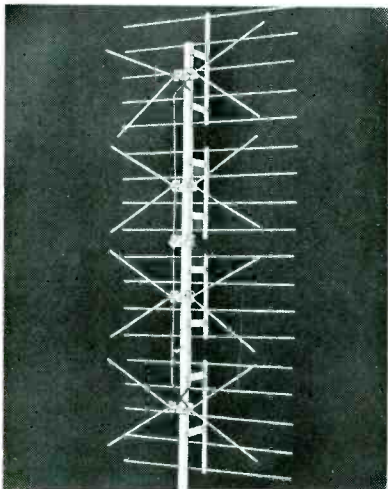

vlf, the recommended practice has been to put up the antenna as high as possible. This has not been found to hold true generally for *uhf*, although the basic rule of higher antennas for greater distances still applies.

For areas of good to medium signal strength, the *fan* or *bow tie* antenna, with reflector, has proved to be very effective. Its directivity pattern has been found to be good, especially in the horizontal plane. In addition, this type can be stacked for higher gain.

The *corner reflector* antenna with a *bow tie* receiving element has been found to be approximately equal in gain to a regular dual stack fan with reflector, with a directivity pattern somewhat sharper. Many have found

[‡]Based, in part, on notes supplied by Jack Carter of Walter L. Schott Co.

UHF bow-tie and reflector, featuring all-metal construction; details on p. 78. (Courtesy Vee-D-X)

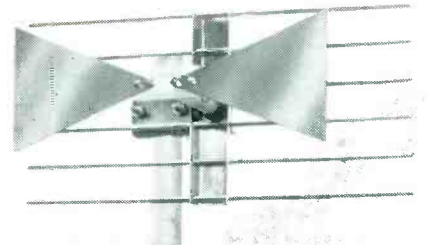
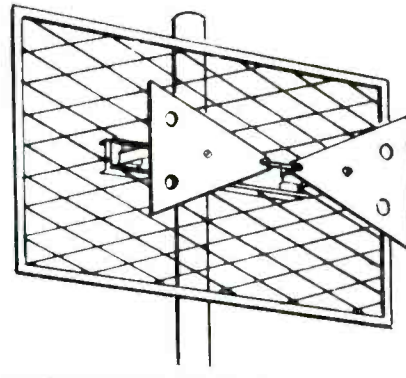

Bow-tie antenna produced in Pacific Coast plant. (Courtesy Walsco)

that this antenna offers good gain and substantial noise rejection and ghost elimination.

The *trombone* type antenna has also proved itself, serving as a good com-

A parabolic bow-tie *uhf* antenna system; design data on p. 78. (Courtesy Telrex)

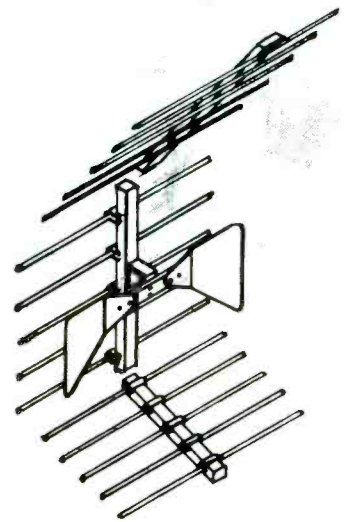



Interaction filter designed to combine separate antennas into a single vhf/uhf system for one-lead use; see p. 78 for details. (Courtesy Channel Master)

promise antenna for all-channel reception. Its directivity pattern varies with frequency, and in some part of the band the antenna will receive signals from the rear and from the side. Tests have shown, that for normal locations without excessive reflections, this will, however, not affect the performance to any appreciable degree.

Based on these findings, manufacturers have begun to feature these types, with modifications, in their new

(Continued on page 78)

Diplexer-type filter for uhf-vhf antennas which features a printed circuit; additional data on p. 78. (Courtesy Ward Products Corp.)



Latest TV Data!

JUST OUT

RIDER'S TV II

with

**dependable
replacement parts
listings**

**THE standard reference
for TV service technicians**

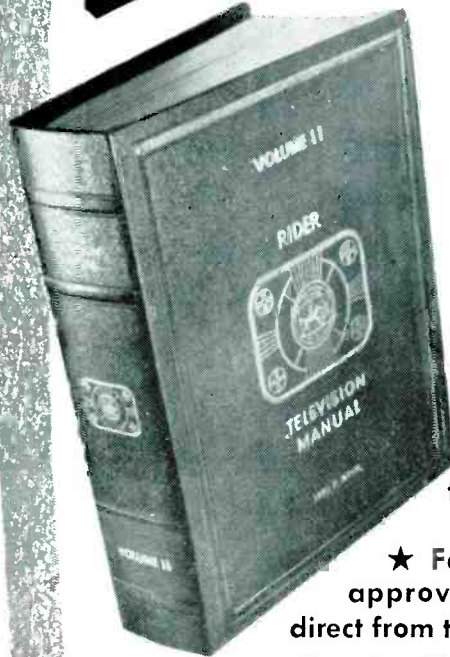

★ Factory-authorized! Factory-approved! ★ Servicing data—

direct from the manufacturer! ★ Now

sectionalized for most up-to-date coverage!

★ Schematics . . . waveforms . . . chassis views . . . circuit changes . . . different production runs! ★ Cumulative replacement parts listings include cross-reference by chassis and models! ★ Over 2,500 (8 1/2 x 11") pages in a (12 x 15") durable binder! Only \$24.00!

Order from your jobber today!

TEK-FILE

Packaged TV service information—the same as in the Rider Manuals—tailor-made for easy TV servicing...over 2800 models...new Packs monthly...try a TEK-FILE Pack at \$2.00 each. If you're not completely satisfied, return to us within 7 days and we'll refund your money!



★ Dependable replacement parts listings beginning with Pack 57

For easier radio servicing... use Rider's 22 AM-FM Radio Manuals

JOHN F. RIDER PUBLISHER, INC.
480 Canal Street, New York 13, N. Y.

West Coast Office:
4216-20 W. Jefferson Blvd.,
Los Angeles, California

Export Agent:
Roburn Agencies, Inc.
39 Warren Street
New York 7, New York

In Canada:
Charles W. Pointon
1926 Gerrard Street, East
Toronto, Ontario

Cable Address:
Roburnage N. Y.

TRIAD

offers an expanded line of TV components and industrial transformers—including toroids, pulse transformers, transistor transformers and additional miniatures—in CATALOG TR-53



More than 500 items

Triad's Catalog TR-53 covers practically every requirement in the electronic field. Also ready is Catalog TV-53 - Television Replacement Guide. Get your copies of these catalogs from your local distributor or write us direct.



TV Antennas

(Continued from page 77)

lines. In one bow-tie and reflector design, recently announced¹ insulators are said to have been eliminated, permitting all metal construction to provide higher gain and flatter response across the band.

The antenna also features a *flex-clamp* mounting method which is said to require a single screw to be tightened during installation. The clamp was designed for all masts including 1½".

Another *bow tie* series,² recently developed, features *sectionalized* design; the basic dipole assembly, it is said, can be employed as a primary area antenna without further accessories, and the same basic unit can be incorporated into a single screen reflector array, a stacked *bow-tie* screen reflector array, and into a *parabolic beam* array.

In still another *uhf* design series, *bow-ties* with reflectors are now available in single, dual and four stack types, with the assembly operation consisting of fastening on reflector, swinging bow-tie elements to correct position and tightening wing nuts.³

Antenna Feed Filters

Since, in many locations, *vhf* and *uhf* stations are in range, there has appeared the problem of installing two antennas and either feeding their outputs to two leads or a single lead. As a solution, filters have been produced. One antenna maker has announced the development of an interaction filter⁴ with separate high and low-pass filters that are claimed to combine separate antennas into a single *vhf-uhf* antenna system.

At the set or converter, the filter is said to separate *vhf* and *uhf* signals

In-the-field photo of broad-band *uhf* antenna with coating of ice and snow which it is reported did not impair antenna's performance. (Radiart; U-4 model)

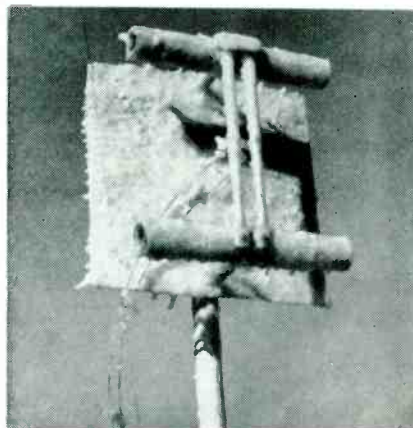

A Full Size LIGHTNING ARRESTER at the Price of a Midget



LIGHTNING ARRESTER

MODEL TA5 Real protection against lightning and static charges — the RADIART Lightning Arrester has all the features! Fits anywhere... inside or out... handles standard or jumbo leads... no wire stripping necessary... does not unbalance the line... low internal capacity... no loss of signal... internal resistance "leaks off" static discharges! UNDERWRITERS LABORATORIES APPROVED.

THE RADIART CORPORATION
CLEVELAND 13, OHIO

where separate *vhf* and *uhf* terminals are provided.

Another type of filter⁵ which permits the use of up to 3 individual antennas with only one lead to a TV set or converter has also been evolved.

Separate terminals are provided for a low-band *vhf* antenna (channels 2-6), high-band *vhf* antenna (channels 7-13), and a *uhf* antenna (broad band or yagi).

Still another type of antenna-lead filter⁶ is now available. It can be used

¹Vee-D-X BT-U. ²Telrex Ultra Bow-Tie. ³Trio. ⁴Channel Master Ultra Tie model 9034. ⁵Channel Master Triple-Tie, model 9035. ⁶Ward Diplexer DX-1.

TV attenuator that is said to eliminate overloading due to strong signals. Unit was designed to reduce buzz in intercarrier sets, and most cross modulation effects. (Vidaire Tel-Atten)



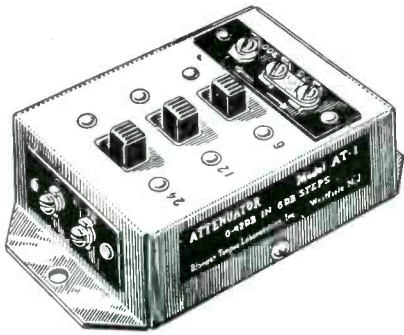

Variable TV attenuator which is claimed to provide proper attenuation levels for equalizing signal strengths in multi-antenna installations, for reducing TV signals to prevent overloading, and to simulate fringe area reception. Three switches allow variable attenuation of 6, 12, 18, 24, 30, 36 or 42 db. Requires no power and may be used for testing, or permanent installation at any point in a TV line. A 75-ohm terminal strip, and 75 and 300-ohm terminal strip are interchangeable as the input or output. (Blonder-Tongue; AT-1.)

in conversions of present *vhf* installations for *uhf*, where there are separate *uhf* and *vhf* antennas, and only one leadin to the set is desired. Since many sets and converters have separate *uhf* and *vhf* terminals, the unit

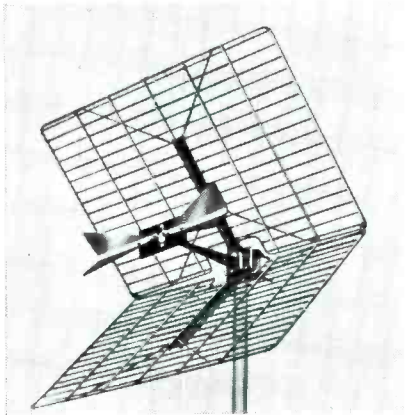

Preassembled corner reflector which features a heavy-duty 2-section mast bracket, 2½" long, for wide grippage over the mast. (JFD; *uhf* 400).

can also be used with only one antenna leadin. And, when necessary to have individual *uhf* and *vhf* antennas in
(Continued on page 102)

W. A. Hagén, general sales manager (left) and C. D. Wymer, Delco electronic parts merchandising manager, of United Motors Service of General Motors Corp., examining recently developed Delco *uhf* corner reflector antenna (type 4250).

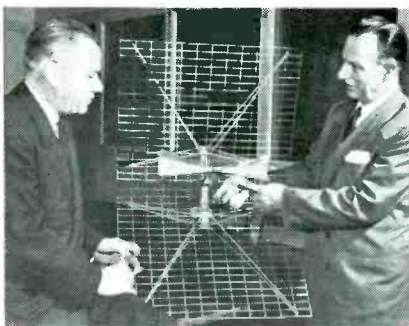

The only right way
to check picture tubes



MODEL
707

JACKSON Cathode Ray Tube Analyzer

- Final Anode Beam Test • All-Important Gas Test
- Grid Control Test • Complete Leakage Tests
- Tests All CR Tubes

When it comes to accurate testing, no single element in a TV set is more important than the picture tube. That's why Jackson has spared neither time nor money in developing an analyzer to give you straight, accurate answers every time. In the new Jackson 707, you have every kind of test to check the quality of any CR tube, magnetic or electrostatic.

Beam Current Test is made to the final anode, the only anode that really counts. High voltage, selected to be on the linear portion of the curve, is used for greater accuracy. **Gas Test** checks for gas current caused by air leakage, improper ion trap setting or other causes. Gives an indication of tube life and quality. This test is absolutely essential, for tube manufacturers report that as high as 95% of tube failures are caused by excess gas. **Grid Control Test** shows whether control grid is capable of cutting off beam current. Test voltage is ample for every type of tube. **Complete Leakage Tests.** Each element is tested for leakage. Highly sensitive circuit gives indication on neon lamp.

The Jackson 707 with its fully flexible switching arrangement and special base adapters will test any cathode ray tube—television, radar, oscilloscope, even multi-gun types. Don't leave your reputation up to haphazard testing methods or improvised harnesses, when for just a little more money you can be sure with a Jackson 707.

Tube Makers Vouch For It

The Jackson 707 is now being used by many tube manufacturers both for manufacturing and for checking returns. It has proved itself again and again as the only accurate cathode ray tube checker available to servicemen.

Get the complete story from your distributor or write for free literature.

JACKSON ELECTRICAL INSTRUMENT CO. • DAYTON 2, OHIO
"Service Engineered" Test Equipment
IN CANADA: THE CANADIAN MARCONI CO.

NEW DATA
in a
famous
service
aid



Mandl's Television Servicing

THE NEW REPRINT of this widely used service guide includes new data on the cascade tuner, servicing of newer types of i.f. systems, automatically focused tubes, UHF station listings and antenna calculations, transistors and other recent developments. Everything you need to know for quick, efficient servicing is given here in the most practical, useful way. You'll learn simple signal tracing procedures, how to improve reception in fringe areas, how to use all test equipment, and many trade tricks for diagnosing troubles accurately and in minimum time. All faults likely to occur, including those hard-to-find troubles, are dealt with; there are hundreds of helpful illustrations, and a complete master trouble chart to help you pin point the cause of trouble from the symptoms and turn quickly to the specific directions for correcting it.

BASIC TV BOOKS

Television for Radiomen

By E. M. Noll. Very clear, non-mathematical explanation of the function and operating principles of every part and circuit in TV reception, and the techniques of installation, adjustment and alignment.

Television and FM Antenna Guide

By E. M. Noll & M. Mandl. How to determine which type of antenna is best for a particular site; how to install it to insure peak performance. Full accurate data on all types of antennas and allied equipment.

Do you know enough about hearing aids?

Hearing Aids

By Matthew Mandl
A rapidly increasing number of the 15,000,000 hard-of-hearing people in this country are turning to hearing aids and **THEY ALL REQUIRE SERVICING!** This book explains the operation of modern hearing aids, the differences between the various types of earpieces, amplifiers, batteries, etc.; what may go wrong with them; how to locate trouble, and how to make adjustments and replacements.

SEE THEM ON APPROVAL

The Macmillan Company, 60 Fifth Ave., N. Y. 11

Please send me the books checked below. I will either remit in full or return the books in ten days.

Mandl's TV Servicing, \$5.50 TV & FM Antenna Guide, \$6.25

Hearing Aids, \$3.50 TV for Radiomen, \$7.75

Signed _____

Address _____

City _____ State _____

This offer good only within continental limits of U.S.A.

Associations

RTG, Rochester, N. Y.

AT AN ELECTION meeting of the Radio Technicians Guild, Rochester, N. Y., Harold Eskin was reelected president for the third year. Others named included Donald Lissow, vice president; Francis Stoffel, secretary; and Alfred Best, treasurer.

William Fay, general manager of WHAM, presented the WHAM leadership plaque to Bertram Lewis during the association's annual banquet, for his outstanding record of community service. Bert, who has served for two terms as treasurer of NATESA, and is at present regional vice president of the association for the eastern part of the country, also received an honorary membership plaque from RTG prexy Harold Eskin in recognition of his outstanding service to the profession. Al Saunders, founder of the Saunders Radio and Television School in Boston, was the principal speaker at the banquet.

TRT, Kansas City, Mo.

TWENTY-NINE members of the Television and Radio Technicians Association, Kansas City, Mo., received certificates indicating completion of the TRT course on basic television circuits and the TV sync generator.

O. O. Dixon and Marvin J. Lamb of Mid-Central Appliance Service were accepted as members of TRT recently.

Committee chairmen for '53 were named during an executive committee meeting: J. F. Lawrence will continue as chairman of the program committee; N. E. Vilander will be head of the education group; membership activities will be directed by George E. Bentley; advertising and publicity will be under the direction of Al Van Worman.

At the RTG banquet, during which Bert Lewis (standing left) received the WHAM leadership plaque from William Fay, the station's general manager (right). Looking on (seated), Harold Eskin, RTG prexy.



NOW GIVE - BETTER . FASTER SERVICE

INVEST in KAY INSTRUMENTS THAT SAVE YOU TIME AND INCREASE YOUR PROFITS

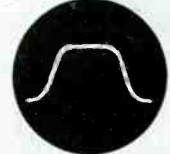

Calibrated MEGA-SWEEP 50 kc to 950 mc range Sweep width of least 30 mc

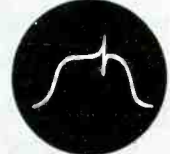

MEGALIGNER—a calibrated variable frequency IF marker pip generator

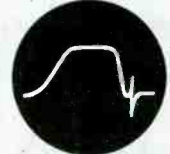

MEGA-MARKER SR. crystal controlled, 12-channel TV RF sound carrier generator

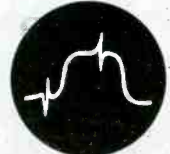

DUAL MEGA-MARKER Sr.—same as Mega-Marker Sr. with RF picture carrier generator added

Consult this latest 64-page catalog FREE



Write . . .

KAY ELECTRIC CO.
12 MAPLE AVE. PINE BROOK, N. J.

FREE

FREE — the latest issue of our "TV and ELECTRONICS NOTES". It presents

IMPORTANT FACTS EVERY SERVICEMAN MUST KNOW about

UHF

Vital Serviceman's information regarding Installation, Reception, Converting existing Sets, Tuners, etc.

FRINGE AREA RECEPTION

How to get best results at lower costs, improve performance, AND—OTHER IMPORTANT SUBJECTS

Get this special FREE copy, or for regular subscription to "TV and Electronics Notes" send 50c.

RUSH THIS COUPON NOW

TRANSVISION, INC., NEW ROCHELLE, N. Y. Dept. S4

Send FREE, the latest issue of "TV and Electronics Notes" on UHF, Fringe Area Recep., etc.

Enclosed find 50c for regular subscription.

Name _____

Address _____

City _____ State _____

TSDA, Philadelphia

A REPORT FROM *Dave Krantz*, president of the Television Service Dealers Association, Philadelphia, noted that the group is now engaged in a direct-mailing campaign, involving the eventual distribution of 100,000 bulletins, prepared by the association with the cooperation of local distributors. In addition, a cooperative newspaper ad program is now being completed, and special window displays will soon be supplied to all members.

The report also revealed that the educational committee of the group will soon complete a survey of the average charges made by members, which will be used to compile a standard rate chart.

It is expected, Krantz also declared, that the state licensing bill, and the measure introduced in Philadelphia, will be considered for adoption soon.

A business promotion program, now in full swing, is serving to suggest how to improve business methods, and how to keep simplified service records, standardize forms and records, adopt phone personality, and use streamlined bookkeeping methods in the small shop.

TET, Houston, Texas

A MEETING sponsored by the Texas Electronics Technician's, Inc., at the Recreation Playhouse, in Houston, recently, featured the appearance of the chief engineers, station managers, and producers and directors of KNUZ-TV scheduled to begin telecasting on *uhf* channel 39 on or about July 4, and three *vhf* stations (KPRC-TV, KUHT, and KGUL-TV), who are now on the air.

Described were the specific antennas required, problems of orientation and types of converters and tuners that will be required.

TEN YEARS AGO

AN ANALYSIS of *rf* input circuits was offered by Alfred A. Ghirardi. . . . A home-constructed all-wave test oscillator, covering a frequency range of from 50-20,000 kc, was featured. Circuit contained an electron-coupled *rf* oscillator; the output voltage could be either modulated or unmodulated, and covered a wide micro-volt range. . . . Electrolytic and paper capacitor test methods were discussed by T. R. Cunningham. . . . Front-cover circuit featured a 32-volt, 7-tube, two-band receiver that did not use a vibrator for plate supply (Wells-Gardner 7T5 models). . . . Design characteristics of the *V* line of power and audio transformers and reactors were presented. . . . *Fred D. Wilson* was appointed sales manager of the commercial sound division of the Operadio Manufacturing Co. . . . *Roy S. Laird* was named a vice president of the Ohmite Manufacturing Co. . . . *Vic Mueher*, of the Clarostat Manufacturing Co., was appointed consultant to the radio and radar division of WPB. . . . Companies receiving Army-Navy E awards this month were: National Union, Farnsworth (Marion, Ind., plant), General Ceramics and Steatite Corp., Thordarson Electric Manufacturing Co., International Telephone and Radio Labs., F. W. Sickles Co. Philco was awarded a white star to its Army-Navy E pennant.

American Beauty

makes perfect soldered connections for

SYLVANIA

RADIO and TELEVISION SETS

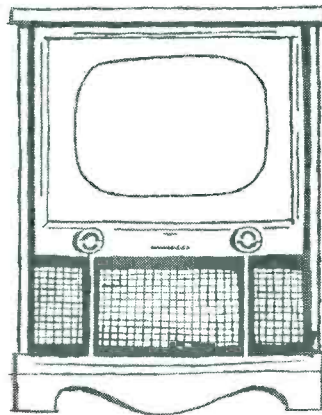

There are over 2,000 soldered connections in a good television receiver. Sylvania calls on American Beauty to help produce top quality products, maintain its reputation as a maker of expertly crafted receivers.

IN CHOOSING SOLDERING IRONS, look to the oldest, largest manufacturer in America. Look to AMERICAN BEAUTY, the Standard of Perfection on the world's production lines, and to these features that make AMERICAN BEAUTY the largest-selling of all soldering irons . . .

Pride of Brides for Three Generations, the famous American Beauty Electric Iron, made by the same specialists in electrical heating devices.



*Build better with Solder...
Solder better with
American Beauty
Electric Soldering Irons-Since 1894*

- Nickel-coated, corrosion-resistant tips, easily and quickly replaced
- Super-flexible cord, American Beauty-made, reduces worker fatigue
- Heating element of chrome-nickel ribbon resistance wire
- Insulated with pure mica
- Built-in connection for ground wire
- Six models . . . from 50 to 550 watts

AMERICAN ELECTRICAL HEATER COMPANY

DETROIT 2, MICHIGAN

KESTER

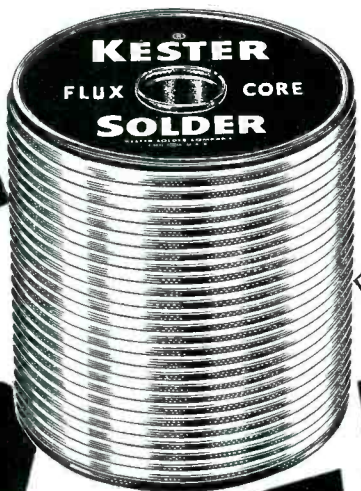

Since the most important single step in Radio-Television Servicing is soldering . . . it's just plain good sense to use the best — KESTER SOLDER . . . Key Name in Solder for More Than 50 Years.



KESTER SOLDER COMPANY
4248 Wrightwood Avenue • Chicago 39, Illinois
Newark 5, New Jersey • Brantford, Canada

SOLDER

CATALOGS, BULLETINS ETC.



Minnesota Mining and Manufacturing Co., 900 Fauquier St., St. Paul, Minn., has prepared a bulletin, 21, *Sound Talk*, which includes graphs covering operational characteristics of 12 different magnetic tapes, representing four basic tape constructions.

Supreme Publications, 3727 W. 13th St., Chicago 23, Ill., has released a circular, *How to Use Supreme Publications for Faster TV and Radio Repairs*.

Allen-Bradley Co., Milwaukee 4, Wis., has issued a 24-page wiring diagram bulletin, 709, describing various magnetic across-the-line starter applications. Diagrams are shown for all sizes of starters; 1-, 2- and 3-phase systems; jogging; two-wire control; thermostat control; sequence control, etc.

Transvision, Inc., New Rochelle, N. Y., has prepared a folder, K153, for television kits, describing six TV kits for home assembly. Chassis described have 22 tubes plus three rectifier tubes, *afc*, *agc*, retrace elimination, multi-stage sync, and may include *uhf* and remote control units. . . . A *Picture-Tube Interchangeability Replacement Guide* and a four-page folder, covering all Transvision TV service instruments, are also available.

Merit Coil and Transformer Corp., 4427 N. Clark St., Chicago 40, Ill., has issued a booklet, *form 33*, detailing four basic schematics used in most flyback transformer installations.

Centralab, 900 E. Keefe Ave., Milwaukee 1, Wis., has published a book, *Printed Electronic Circuit Guide Number 2*, that lists the 27 *pc* standard stock units available, and complete circuits, components and applications. Guide also lists over 100 users of *pc* circuits and 445 different manufacturers' part numbers.

Walter L. Schott Co., 3225 Exposition Place, Los Angeles 18, Calif., has released a catalog, 53, describing an assortment of electronic hardware, tools, chemicals, antennas and accessories.

Radio Corp. of America, Tube Dept., Harrison, N. J., has released a revised 24-page edition of the booklet, *RCA Receiving Tubes for AM, FM and TV Broadcast* (Form 1275-F), which covers more than 495 receiving tubes, including 45 picture tubes. Booklet includes tube characteristics and socket connections. Priced at \$15. . . . A 16-page booklet, *CTV-1016*, that supplies technical information on deflection-circuit components for the *vidicon* camera tube for industrial TV applications (RCA-6198), is also available.

CBS-Hytron, Danvers, Mass., has released its sixth edition of the *Reference Guide for Miniature Electronic Tubes*. Guide details typical operation and characteristics, circuit applications, dimensions and base connections.

†See *Wm Martin* circuit discussion, *SERVICE*; March, 1953.

The Bogen TWIN 2-Station Wireless Communo-Phone



The TWIN is: A 2 station intercommunicating system which requires no wiring or installation. It uses the regular power line as the transmission medium.

The TWIN is Flexible: Stations can be added at any time for a common call system. Two and sometimes 3 separate systems can be set-up on one circuit.

The TWIN is Quiet: Built in adjustable noise suppresser can be set at installation for optimum performance. The station is quiet when idle.

The TWIN is Safe: It is Underwriters' Laboratories Listed—Extremely important for equipment of this type.

The TWIN Works for YOU: It is an ideal package sale to consumers for use as baby sitter, office intercom, etc. It gives your industrial salesman a door opener he needs to excite the interest of new and old accounts.

LIST PRICE \$95.00
FOR 2 STATION SYSTEM

Write for complete details—address Desk V-4



DAVID BOGEN CO., INC.
29 NINTH AVE., NEW YORK 14, N. Y.

A Quarter Century of Electronic Equipment Specialization

On Book Row

TV Manufacturers' Receiver Trouble Cures, Volume 2: A 117-page volume, and like the first in the series, provides directions for correcting TV receiver performance bugs as developed by the receiver manufacturer. Servicing short-cuts and production changes that improve reception are also included.

Manufacturers covered in this volume include: Emerson, Fada, Firestone, Freed, Gamble-Skogmo, General Electric, Hallcrafters, Hoffman, Industrial, International and Jackson. The 110-page volume 1 covered the following manufacturers: Admiral, Air King, Andrea, Arvin, Belmont-Raytheon, Bendix, Calbest, Capehart-Farnsworth, CBS-Columbia, Certified, Crosley and DuMont.—Priced at \$1.80 a volume; John F. Rider, Publisher, 480 Canal St., New York, N. Y.

* * *

How To Pass Radio License Examinations . . . by Charles E. Drew: Third edition; this is a 464-page book which includes test questions and answers, regulatory and operational practices, and technical data on aeronautical communication and navigation gear, and radar in marine service.—Priced at \$5.75; John Wiley and Sons, Inc., 440 Fourth Ave., New York 16, N. Y.

* * *

UHF Converters: Book (44 pages) provides a report on the design and operation of new *uhf* converters and tuners; described are twenty-one popular converter designs and how they work with present *vhf* sets.

Converters of the following manufacturers are included: Arvin, Crosley, DuMont, General Electric, Mallory, Motorola, RCA, Raytheon, Regency, Sarkes-Tarzan, Standard Coil, Stromberg, Sutco and Sylvania.—Priced at \$1.00; Howard W. Sams and Co., Inc., 2201 E. 45th St., Indianapolis, Ind.

* * *

The Radio Amateur's Handbook: 1953 edition, with 27 chapters, and information on electrical laws and circuits, vacuum-tube principles, high-frequency communication receivers and transmitters, power supplies, *vhf* and *uhf* apparatus and communications techniques. Information is provided on propagation, receivers and converters, transmitters and antennas in the *vhf* and microwave regions.

Handbook also features a chapter on measurements, with data on equipment and procedures for accurate measurements of station equipment performance and operation. Also includes a tube-reference chart and base diagrams.—800 pages, priced at \$3.00; American Radio Relay League, Inc., West Hartford 7, Conn.

* * *

Vacuum-Tube Oscillators . . . by William A. Edson: A comprehensive text reviewing the behavior of all types of oscillators in circuits. Analyzed are the transient behavior of linear systems, negative resistance oscillators, nonlinear oscillators, feedback systems and stability criteria, and resonators. Discussions on linear, conventional harmonic, and crystal-controlled oscillators are also featured.

Other topics dealt with include locking and synchronization, frequency multiplication and division, tube and thermal noise, modulation of oscillators, *afc*, and long-line and multiple-resonance effects.—476 pages, priced at \$7.50; John Wiley and Sons.

WEBSTER ELECTRIC
Featheride®

model BX

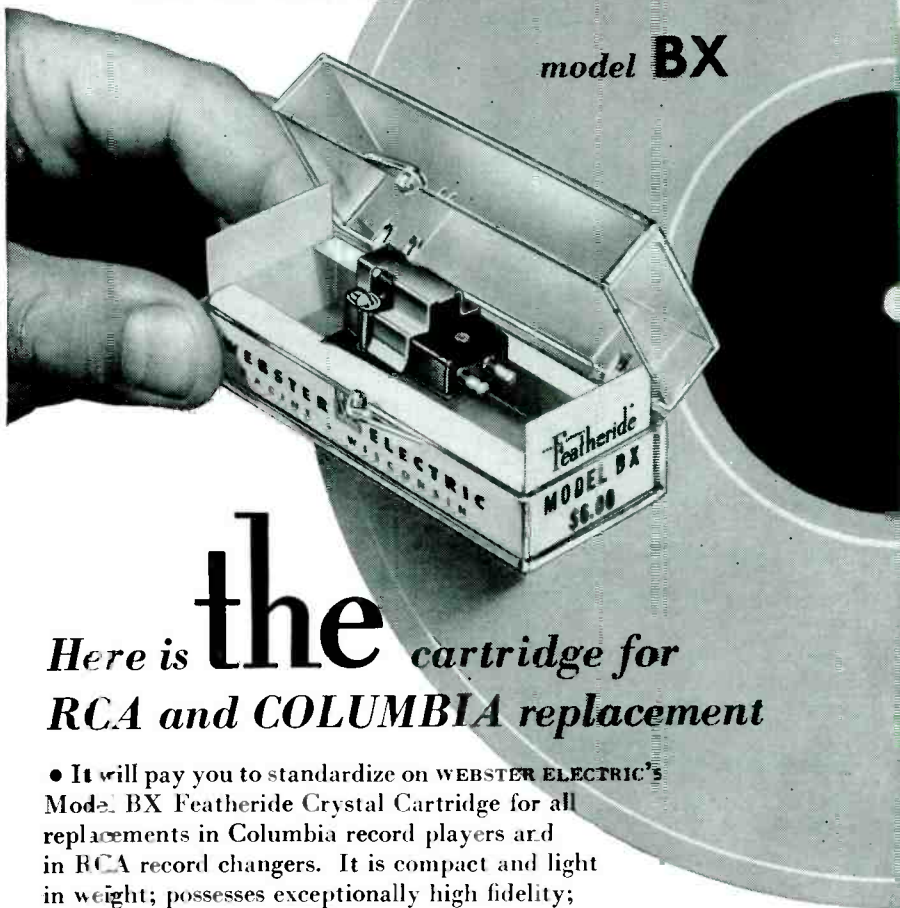

Here is **the** cartridge for
RCA and COLUMBIA replacement

- It will pay you to standardize on WEBSTER ELECTRIC'S Model BX Featheride Crystal Cartridge for all replacements in Columbia record players and in RCA record changers. It is compact and light in weight; possesses exceptionally high fidelity; and (like all WEBSTER ELECTRIC replacement cartridges) has the famous Dri-seal protection against moisture and humidity.

- Individually packed in a handsome, useful plastic "jewel case," the Model BX is furnished with 1-mil needle, bracket and spring for installing in RCS series RP168 and 190 changers, also spacer nut for installing in series 193-1 changers. Simply remove bracket and spring to install in Columbia or other 1/2" mounting arms. Write us for Catalog Sheet RC189.

specifications and data

Application: 33 1/2 and 45 RPM records	Construction: Moulded plastic half-shells
Output (1000 CPS): .5-.75 volts	Mounting: Universal for RCA record changers and Columbia record players
Tracking Pressure: 7 grams	Terminals: Pin Type
Cut-off Frequency: 7000 CPS	Needle: Osmium tipped, replaceable
Weight: 10 grams	

Webster Electric Co., Racine, Wisconsin • Established 1909

WEBSTER ELECTRIC
RACINE • WISCONSIN

"Where Quality is a Responsibility and Fair Dealing an Obligation"

Webster Electric Company, Clark and DeKoven Streets, Dept. S-4, Racine, Wis.
Please send me Catalog Sheet S-4 on Featheride Pick-up Cartridges for replacement use.

Name _____ (Please Print)

Address _____

City _____ State _____

Zone _____

Jobber Service Technician Other

what 25,000 Servicemen told Bill Anderson (SYLVANIA Sales Service Engineer) about PHOTOFAC...



W. J. ANDERSON
SYLVANIA Sales
Service Engineer,
Radio & TV Tube
Sales

SYLVANIA ELECTRIC PRODUCTS, INC.

"During the years of 1951 and 1952, Robert Grow and I have talked to approximately 25,000 servicemen located throughout the United States. We have an excellent idea concerning the response of these men to your PHOTOFAC Service and to your publications. In talking to servicemen, I have heard many fine compliments on the excellent job your organization is doing. Such comments as these are typical:

1. Very detailed and easy to read instructions on any set, as well as pictures and schematics.
2. The theory of operation of various stages and components is helpful, such as found in the PHOTOFAC INDEX.
3. The immense amount of useful information presented in such a short time after release of the manufacturer.
4. Pictures of the wave forms, as well as voltage measurements saves time and increases profit to the servicemen.

These and many more are typical of the comments from the servicemen. This may be of interest to you and your staff as you continue to lead the field in technical publications for the radio and television servicemen."

W. J. Anderson
Sylvania Electric Products Inc.

NOW! GET THE PROOF FOR YOURSELF!

FREE

We'll send you a Free Photofact Folder on any receiver listed in "PF Index & Technical Digest."

Learn for yourself—at our expense—how PHOTOFAC pays for itself by earning bigger repair profits for you! Select any Folder from the PF Index (if you haven't an index, get a copy from your distributor). When you write us for your Free Folder, be sure to state Photofact Set and Folder Number as shown in the Index. Get your Free Folder now. Examine, use, compare—see why you can't afford to be without PHOTOFAC!

HOWARD W. SAMS & CO., INC.
2207 E. 46th St., Indianapolis 5, Ind.

HOWARD W. SAMS & CO., INC.

Rep Talk

THE REPS membership now totals 601, 22 senior members and 33 associates having been added recently. N. Y. chapter is the largest single unit with 85 members, and Chicagoland chapter is second with 83. . . . New senior members and chapters with which they are affiliated include BUCKEYE: *Allen Nace*, 7601 Parkview Rd., Brecksville, O. . . . CHICAGOLAND: *William M. Lins*, 7115 N. Mobile Ave., *Harry A. Mouson*, 919 N. Michigan Ave., and *George Kniepfer*, 2650 W. Belden Ave., all of Chicago. Promoted from associate to senior status are *C. R. Bluzat*, 5949 W. North Ave., *Ted Felleisen*, 612 N. Michigan Ave., *Edward G. Magnuson*, 4258 W. Irving Park, and *Ray Hitchcock*, 1754 W. Madison St., Chicago, Ill. . . . DIXIE: *John T. Butters*, 4924 Oleander Dr., Wilmington, Del. Promoted to senior members from associate status are *Clark Adair*, 1426 High Point Place, N.E., Atlanta, Ga., and *W. T. Little*, 940 Lake Elbert Dr., Winter Haven, Fla. . . . LOS ANGELES: *Alfred W. Harris*, Western Electronic Enterprises, P. O. Box 1116, Alondra Station, Gardena, Calif., and *Frank A. Emmet*, 2837 W. Pico Blvd., Los Angeles 6, Calif. . . . NEW YORK: *William Garfinkle*, 17 E. 42nd St., New York; *Jerry Greenberg*, 1902 Ave. L, Brooklyn 30, N. Y.; *Jesse Markowitz*, 10 S. Middle Neck Rd., Great Neck, N. Y.; *Irv. Morse*, 150 Broadway, New York; *Robert Stang*, 79 Storer Ave., Peiham, N. Y., and *William W. Wiciss*, 509 Fifth Ave., New York City. . . . SOUTHWESTERN: *G. W. Delsell*, 643 Coombs Creek Dr., *Max N. Heidenreich*, 1801 Federal St., and *Alex A. Lassberg*, 5004 Ross Ave., all of Dallas, Texas. . . . Reps will handle an information and message center at the Electronic Parts Show, May 18-21. A complete registration directory, with all show attendees, hotel and room numbers, is planned to be published. . . . *Harrison J. Blind*, 1616 Cord St., Indianapolis 24, Ind., has been appointed rep for Crown Controls Co., in Kentucky. . . . *F. W. Moulthrop Co.*, 1406 S. Grand Ave., Los Angeles 15, Calif., has been named rep for Miller TV Co., in California. . . . *Henry Fine* has resigned as rep for RMS in Cuba and South America. . . . *Frederick J. Kantor* has opened sales offices at 4010 Saxon Ave., New York 63, N. Y., and will cover New York City, Long Island, Westchester county and northern New Jersey. . . . *Frank A. Emmet Co.*, Los Angeles, Calif., has been named rep for American TV and Radio Co., in southern California, Arizona and New Mexico. . . . *George Davis Sales Co.*, Los Angeles, has been appointed rep for Brook Electronics, Inc., in southern California, Arizona and Las Vegas, Nev. . . . *International Radio Corp.*, 39 Warren St., New York 7, N. Y., will handle all foreign sales for the Halldorson Transformer Co.

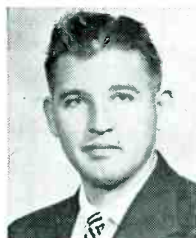

F. W. Moulthrop



"That reminds me . . .
Order a new JENSEN NEEDLE
for my record player."

Standard Brand Radio & T.V.

TUBES

Convince yourself.
Send TODAY for our
bi-weekly Bulletin
of Excellent Tube
Values • Dept. S-1

MANNFRED
Electronics Corporation

KMA Guarantees
Current Dating

8AV145 7 0565 0508

EFFECTIVE IMMEDIATELY: ALL TUBES INDIVIDUALLY
BOXED IN ATTRACTIVE TWO COLOR BOXES AT NO EXTRA CHARGE!

136 LIBERTY STREET N. Y.

PERSONNEL

B. Harold Miller, formerly with Doyle, Kitchen and McCormick, is now on the staff of Conti Advertising Agency, 170 E. Ridgewood Ave., Ridgewood, N. J. as assistant to the president. Previously, he headed the industrial and trade division of J. Walter Thompson Co., was president of the Industrial Advertising Association, secretary of the Direct Mail Association, and a founder of the Point of Purchase Institute.



B. H. Miller



Jerome Berger

Jerome Berger has been named jobber sales manager of the Brach Manufacturing Corp., 200 Central Ave., Newark, N. J.

* * *

Kenneth A. Hoagland, formerly assistant engineering manager, has been named chief engineer of the picture-tube division of the Allen B. DuMont Laboratories, Inc.



K. A. Hoagland



R. T. Cavanagh

Robert T. Cavanagh has been appointed assistant director of research of DuMont.

* * *

Herbert A. Sumz is now executive vice president of Webster-Chicago Corp.

Norman C. Owen has been named vice president in charge of sales.

* * *

John F. Quirk has been appointed director of purchases for Federated Purchaser, Inc., 66 Dey St., New York 7, N. Y. Quirk was formerly in charge of electronic and mechanical sub-contracting for the Sandia Corp.



John F. Quirk



H. C. Crawford

Harry C. Crawford has been elected president of the Radiart Corp., succeeding L. K. Wildberg. Crawford has been associated with Cornell-Dubilier and Radiart for the past eight years as works manager, as well as comptroller and assistant treasurer.

I didn't know what I was missing until I got a

SKYLINE

UHF

VHF

Patented

- ONE LEAD-IN
- ALL FREQUENCIES
- ALL CHANNELS
- PRE-ASSEMBLED

SKYLINE MFG. CO., 1458A9 E. 17th ST., CLEVELAND 14, OHIO



"Al doesn't worry at all since he's switched to using G-E radio dial lamps"

You don't have to worry about having "bad luck" with the dial lamps you use in your repair work when you use G-E lamps. Hundreds of laboratory tests guarantee top lamp quality. General Electric radio dial lamps have fewer early burnouts, won't cause annoying static. Always give your customers the best . . . always give them G-E.



GENERAL  **ELECTRIC**

BUILD YOUR OWN

Heathkit

TEST EQUIPMENT

Heathkits are completely engineered instruments supplied unassembled. Every kit goes together smoothly and easily. All drilling, punching, and painting has already been done for you. All parts are furnished and are of highest quality.

Detailed construction manual shows clearly where each wire and part goes and tells exactly how to build the kit. Write for free catalog.

AUDIO GEN. KIT
\$29⁵⁰

T.V. ALIGN. GEN. KIT
\$39⁵⁰

VACUUM TUBE VOLTMETER KIT
\$24⁵⁰

IMPEDANCE BRIDGE KIT
\$69⁵⁰

GRID DIP METER KIT \$19⁵⁰

R. F. SIGNAL GEN. KIT
\$19⁵⁰

5" SCOPE KIT
\$43⁵⁰

SIGNAL TRACER KIT
\$22⁵⁰

BATTERY ELIMINATOR KIT
\$24⁵⁰

TUBE CHECKER KIT
\$29⁵⁰

CONDENSER CHECKER KIT
\$19⁵⁰

HEATH COMPANY
BENTON HARBOR 11,
MICHIGAN

EXPORT AGENT
ROCKE INTERNATIONAL CORP.
13 East 40th Street
NEW YORK CITY (16)

Leon Podolsky has been appointed technical assistant to the president at Sprague Electric Co., North Adams, Mass. . . . **Carroll G. Killen** succeeds Podolsky as manager of field engineering. . . . **Allan J. Weinberger** has been named manager of the Dayton, O., application and engineering office of Sprague Electric.

* * *

Lawrence A. Hyland, who discovered the principle of radar detection of aircraft, has been elected vice president in charge of engineering of Bendix Aviation Corp.

* * *

Virgil M. Graham, director of technical relations of Sylvania, has been appointed chairman of the communications and electronics division of the Electrical Standards Board of the American Standards Association.

* * *

Jerome M. Hollander, formerly with DuMont Labs, has been appointed senior engineer of the Radio City Products Co.

* * *

John Mackey, for the past year distribution and sales manager, has been named general manager of Alproco, Inc., Mineral Wells, Texas, succeeding Eugene Cox, who has resigned.

* * *

Harold Becker, formerly a member of Hoyland-Lewis, Inc., has become an associate of George Gero Advertising, Paterson, N. J. Becker will be in charge of the New York City office at 366 Fifth Ave.

* * *

Edward C. Hughes, Jr., has been appointed assistant to **L. W. Teegarden**, executive vice president of RCA.

* * *

George F. Maedel has been elected president of RCA Institutes, Inc., 350 W. 4th St., New York, N. Y., succeeding Major General George L. Van Deusen (USA, Ret.), who has retired.

* * *

Donald W. Tait, formerly advertising manager for the Perlite division of Great Lakes Carbon Corp., has been appointed manager of sales promotion for the equipment sales division of Raytheon.

* * *

Joseph Schlig, formerly manager of advertising and sales promotion, has been named assistant to the sales manager of the electronic tube division of Westinghouse. . . . **Verne G. Rydberg** has been named assistant manager of application engineering for the division.

* * *

William Baldersten, president of the Philco Corp., has been elected to the board of directors of the National Industrial Conference.

* * *

Angus A. MacDonald, formerly a section manager with Westinghouse, has been appointed assistant chief engineer in charge of two-way radio development of the communications and electronics division of Motorola, Inc.

* * *

Robert W. Sanders, formerly general manager of the TV division of the D. J. Roesch Co., has been named chief TV engineer of The Magnavox Co. . . . **Frank R. Norton** has been appointed chief radar engineer.

* * *

Don G. Mitchell, president of Sylvania Electric, has been elected a member of the board of directors of Irving Trust Co.

Adjusto-Cone
SPEAKERS

REAR SEAT
AUTO SPEAKERS

High Fidelity
SPEAKERS

QUAM

QUAM
FOCALIZER
UNIT TRADE MARK

QUAM
ION TRAPS

Tru-Match
OUTPUT TRANSFORMERS

OUTDOOR THEATRE
SPEAKERS

Write for Catalog

QUAM-NICHOLS CO., 526 EAST 33rd PLACE, CHICAGO 16, ILLINOIS
VISIT BOOTH 405 AND ROOM 601, ELECTRONICS PARTS SHOW, CHICAGO, MAY 18-21

KIMBLE DEVELOPING TV BULB CENTER

Development of a TV bulb manufacturing center, at Sayreville, N. J., has been announced by the Kimble Glass Co., subsidiary of Owens-Illinois Glass Co., Toledo, O.

A plant, presently used by the Kaylo Division for the manufacture of calcium silicate insulation material, will be taken over by Kimble. Plant will handle every phase of TV bulb manufacturing from the production of glass to the forming and assembling of the bulb.

* * *

COMMUNICATIONS ENGINEERING EXPANDS

A 7,500-square-foot building is now under construction in the Trinity Industrial District at Dragon and Wichita Streets, for the Communications Engineering Co., Dallas, Tex., who specialize in servicing two-way gear for oil, power and industrial companies.

Building will have warehouse and shop facilities in addition to air-conditioned offices. Behind the plant will be a 6,000 square foot area for antenna testing.

* * *

RAYTHEON ERECTING PICTURE-TUBE PLANT

Plans for the erection of a 100,000-square-foot, one-story plant in Quincy, Mass., for the manufacture of the larger-size TV picture tubes, has been announced by the Raytheon Manufacturing Co., Waltham, Mass. Building will be adjacent to receiving tube plant on Centre Street in South Quincy.



TRIAD-TETRAD MERGED

Combined operations of Triad Transformer Manufacturing Co. and Tetrad Co., Inc., both of Venice, Calif., have been merged under the corporate name of Triad Transformer Corp.

Officers of the new corporation are: *L. W. Howard*, president; *O. D. Perry*, executive vice-president; *Thomas P. Walker*, vice-president; *Allan Wahlgren*, secretary-treasurer; *George Clark*, assistant to the president; *Ernest Clover*, manager of jobber sales; *E. M. Keittor*, chief engineer; and *Charles Shaw*, director of purchases.



L. W. Howard

DUMONT OPENS INSTRUMENT PLANT

An 118,000-square-foot plant, for the manufacture of cathode-ray instruments for industrial and defense use, has been opened at 760 Bloomfield Ave., Clifton, N. J., by Allen B. DuMont Laboratories, Inc.

WESTINGHOUSE APPOINTS TUBE DISTRIBUTORS

The electronic tube division of Westinghouse has appointed distributors for their *Reliatron* tubes throughout the country.

Those named include: Almo Radio Co., 412 N 6th St., Philadelphia, Pa. (eastern Pennsylvania, southern New Jersey, Delaware, Maryland); Karl-William Co., Inc., 404 S. Crouse Ave., Syracuse, N. Y.; and Emerson-New Jersey, Inc., 985 Broad St., Newark, N. J. (Essex county); Federated Purchaser Corp., 114 Hudson St., Newark, N. J.; Federated Purchaser, 66 Dey St., New York, N. Y. (N. Y. City); Variety Electric Co., Inc., 468 Broad Street, Newark, N. J.; Ace Electronics, 2610 E. 16th St., Brooklyn, N. Y. (Brooklyn); Electronic Laboratories and Supply Co., 1415-19 Oriskany St. W, Utica, N. Y. (Utica); McElhenney Co., Inc., 481 Union St., Spartanburg, S. C. (North and South Carolina); Sprague Electrical Supplies, Inc., Park and Railroad Aves., Bridgeport, Conn. (Southwestern Conn.); Continental Sales Co., Inc., 521 Bloomfield Ave., Newark, N. J.; Commercial Radio Corp., 36 Brattle St., Boston, Mass. (Boston metropolitan area); and Emerson Radio Westchester, Inc., 285 Mamaroneck Ave., White Plains, N. Y. (Westchester, Putnam counties of N. Y., and portion of Fairfield county, Conn.).

These practical books make TV servicing EASY



TV MANUFACTURERS' RECEIVER TROUBLE CURES VOL. 1., VOL. 2. AND VOL. 3

A brand new series of practical books. Gives you exact directions for correcting TV receiver "bugs". Each cure is official, factory-authorized, direct from the receiver's manufacturer. It is positive! Helps correct the most difficult faults—picture jitter, hum, instability, buzz, tearing, etc. Vols. 1 to 3 cover approx. 40 different manufacturers. One service job will more than pay the cost of these books!

Vol. 1 over 120 pages (5¼ x 8¼").....\$1.80
Vol. 2 over 120 pages (5¼ x 8¼").....\$1.80
Vol. 3 coming soon.....\$1.80

TV SWEEP ALIGNMENT TECHNIQUES

by Art Liebscher, *Test Equipment Specialist*
Never before has there been a book such as this on TV sweep alignment! Exclusive information not generally available to service technicians. Introducing the new Supermark method. Simplified procedures...time-saving...eliminates dual set-ups. Over 100 (5¼ x 8¼") pp., illus. \$2.10

UHF PRACTICES AND PRINCIPLES

by A. Lytel
New, up-to-the-minute. Clear, easy-to-understand book covers both theory and applications of UHF. TV devices, converters, UHF test equipment, circuit components, tubes. 390 (5½ x 8½") pages. Cloth cover.....\$6.60

TV TROUBLESHOOTING AND REPAIR GUIDE BOOK

by R. G. Middleton
The finest practical book to make your TV servicing easy. Spot TV receiver troubles rapidly. Includes receiver waveforms, visual alignment, test equipment kinks, etc. 204 (8½ x 11") pages.....\$3.90

VACUUM-TUBE VOLTMETERS

by J. F. Rider
Completely revised. Covers theory, operation and application — also probes, calibration and testing. Illus with 432 (5½ x 8½") pages. Cloth cover.....\$4.50

ENCYCLOPEDIA ON CATHODE-RAY OSCILLOSCOPES AND THEIR USES

by Rider & Uslan
Covers practically every scope manufactured during the past 10 years — and applications. 992 (8½ x 11") pages. 3,000 illus. Cloth cover.....\$9.00

FM TRANSMISSION AND RECEPTION

by J. F. Rider & S. D. Uslan
This 2nd edition covers FM from start to finish, including receiver servicing. 460 (5½ x 8½") pages. Cloth cover.....\$4.95
Buy these books now at your jobbers .. leading bookstores... or —

JOHN F. RIDER PUBLISHER INC.
Dept. S-4 480 Canal Street, New York 13, N. Y.

WALSCO 1½-MILLIONTH ANTENNA WINNERS

Gene Streight, Streight Radio, Gary, Ind, and Ken Starkey, Chauncey's, Inc., Chicago, Ill., who came up with the 1½-millionth Walso antenna, have won a trip to Florida for a full week, with all expenses to be paid by the Walter Schott Co., 3225 Exposition Pl., Los Angeles 18, Calif.

Four months ago Walso placed two certificates in a plain carton containing their 1½-millionth antenna. The jobber who sold that particular antenna, and the dealer or Service Man who bought it, each were to receive two free, all-expense vacation trips to anywhere in the United States.

* * *

ILLINOIS CONDENSER RECEIVES PATENT

Patent No. 2623101, covering a molded capacitor cap construction, has been assigned to the Illinois Condenser Co., Chicago, Ill.

Capacitor construction features molded-in terminals, complete separation of capacitor body and terminals, and is said to eliminate seepage of electrolyte and corrosion. Technique is used in UMP twist-prong capacitors, which are available in a wide range of voltages and capacities.

* * *

INSTRUMENT WINNER



Royal O. Tippetts, partially paralyzed Service Man, with signal generator, scope, and condenser tester, presented to him by Paul F. Jackson, president of Jackson Electrical Instrument Co., as a result of a TV program appearance, during which Tippetts noted his desire to equip a Service Shop in Spanish Fork, Utah. Arrangements were made with Standard Supply Co., Salt Lake City, to make presentation of instruments. Ray R. Larsen of Standard Supply acted as master of ceremonies for the presentation.

E-V PHONO-CARTRIDGE PROMOTION

A promotion, *Your Profit Key to '53*, to help Service Men cash in on the phono-cartridge replacement market, has been launched by Electro-Voice, Inc., Buchanan, Mich.

Promotion offers an all-metal six-unit cartridge dispenser, a *Professional Phonograph Service* decal and a *Set Model Phono-Cartridge Replacement Guide* at no additional cost with every purchase of six E-V cartridges purchased through distributors. Cartridge dispenser holds six cartridges in their yellow plastic boxes and can be fastened on a wall or shelf. Interchangeability chart on the sides tells which cartridge to use. Guide lists E-V cartridge replacements for all makes and models of record players, changer and phono-combinations.

* * *

RCP TO EXPAND

A 2½-acre tract of land, for the erection of a new one-story manufacturing plant to adjoin their present production center, has been leased by Radio City Products Co., at Easton, Pa.

Building will provide for an additional 13,000 square feet, and thus give the company a total production area of 27,000 square feet. Administrative, sales and engineering will continue to be located at New York City.

* * *

SERVICE-COMPARTMENT TRUCK

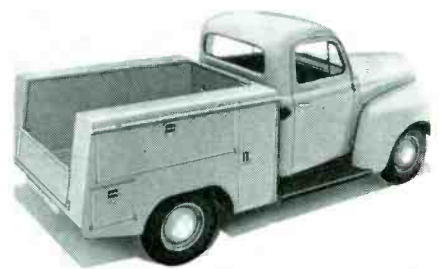

Pickup truck with tool and material compartment. Compartment doors are of double-panel construction and weathertight. Parts bins are provided for each compartment as standard equipment. Bins are equipped with removable dividers. Available in 74" and 84" lengths for installation on ½ and ¾-ton pickup trucks, respectively. (McCabe-Powers Auto Body Co., 5900 N. Broadway, St. Louis 15, Mo.)

SPEAKERS NEED REPAIRING

RECONE WITH A WALDOM CONE

Quicker, less expensive speaker servicing means greater profits. Speed up your speaker repair jobs... **FREE Waldom 24-page Replacement Cone Manual**... covers 750 different TV, FM and AM receivers.

WRITE FOR YOUR FREE COPY TODAY. THERE IS NO OBLIGATION

A Waldom Cone for the Finest Tone

WALDOM ELECTRONICS INC., 911 N. LARKBEE ST., CHICAGO 10, ILLINOIS

UHF Service

(Continued from page 35)

over \$500, depending on type of work one expects to do.

Not only is it necessary to have a strong inventory of parts, but a substantial supply of specific service information, prepared by manufacturers. In addition it is extremely important to keep constantly informed of *all* the technical developments in circuits, test gear, accessories, components and applications by reading such professional journals as SERVICE.

All in all, from \$700 to \$1,000 should be set aside for parts, *vlf* antennas and accessories, and an extra \$250 to \$500 for *uhf* installation equipment. This basic inventory must be kept up-to-date.

With *good test equipment* and *good parts inventory*, you will find that you've won half the battle.

Servicing Helps

(Continued from page 70)

therefore, the voltage reduction is 10 volts instead of approximately 11.

In remote areas, line-voltage variations are usually much more severe than in metropolitan centers, and usually can almost be corrected with a ten-volt boost or a ten-volt drop. Since many of these outlying zones are really fringe areas, low line voltage can cause not only inadequate picture width, height or picture brightness, but reduce video and audio sensitivity.

In Fig. 2 (p. 70) the ill effects of low-line voltage in a fringe area are illustrated.² It will be noted that receiver sensitivity began to fall rapidly at 105 volts.

Often, abnormally high-line voltage can cause failure of 5U4 rectifiers, 6BQ6 horizontal output tubes, etc. A reduction of ten volts will almost always reduce the line voltage adequately to prevent such tube failure.

Boosters can often be used to demonstrate the fact that low line-voltage might be the cause of trouble and not the receiver. Unit can also be used to check intermittents.

TV Chassis Hum Cures

It may be found that some Admiral 19 series chassis with a 10" electro-magnetic speaker have an objectionable residual hum level. Lead dress in the audio input circuits should be checked first, with particular attention paid to the *ac* leads to the *on-off*

²Tests made on Admiral 21B1 receiver.

Congratulations

Distributors—and Many Thanks!



It's only about a year since we introduced the Wen "Quick-Hot" Electronic Soldering Gun. The response has been tremendous. Today it's selling through thousands of stores here and abroad. Now a newly developed Extra Long Life Tip and a

Plastic Tile Cutting Tip are increasing the utility of the Gun and further expanding its market. We feel that our Distributors have done a terrific job in so short a time and we want to say "Thanks fellas."

A TIP FOR CUTTING PLASTIC TILE - 504 LIST-

EXPORT AGENTS, SCHEEL INTERNATIONAL, INC.—CHICAGO 18, ILL.

WEN PRODUCTS, INC.

5806 NORTHWEST HIGHWAY • CHICAGO 31, ILL.

switch. These leads should be well away from the audio amplifier grid circuit. The .01-mfd audio-coupling capacitor (C_{200}) should be dressed away from the *on-off* switch. In models with tone control, the lead between the control and the audio amplifier plate should be dressed away from the *ac* leads. The filter capacitors (especially the 60-mfd unit, C_{601}) should also be checked. If none of these are the source of hum, the speaker is probably at fault. This can be verified by sub-

stituting a PM speaker with choke attached.**

In early production Admiral 19 series chassis if the red lead to the horizontal deflection yoke is too near the grid circuit of the 6S4 vertical output tube (V_{402}) vertical jitter and poor interlace may occur. To eliminate, the red lead should be dressed against the chassis well away from the grid circuit.

**Admiral 78B80-1.

Cut out the TV NOISE...
Get more TV sales!

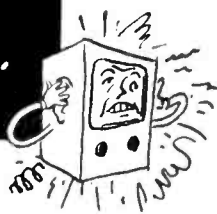

Vidaire FIL*TRAN

Don't let noisy interfering signals tear the TV (sales) picture. VIDAIRE's Fil-Tran, carefully designed and field tested on all TV sets, proves most interference can be eliminated.

Removes most hash in picture and sound caused by amateur radio, ship-to-shore transmissions, foreign broadcasts, diathermy, etc. Printed circuit high Q coils used for higher efficiency.

Sold only through authorized VIDAIRE distributors—send for catalog A

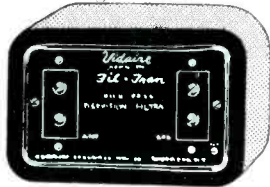

Manufacturers of:
• TV COLOR EQUIPMENT
• TV AMPLIFIERS
• ELECTRONIC DEVICES

Vidaire

ELECTRONICS MFG. CO.

Phone No.: LE 2-7372

Factory: LYNBROOK, N. Y., Nat'l Sales Office: 6 E. 39th ST., N. Y. 16, N. Y.

See us at the Parts Show

May 18-21—SERVICE—Booth 26—Room 636

AUDELS TV-RADIO SERVICE LIBRARY

HERE IS LATE INFORMATION IN A HANDY FORM FOR RADIO & TELEVISION REPAIRMEN, SERVICEMEN & STUDENTS

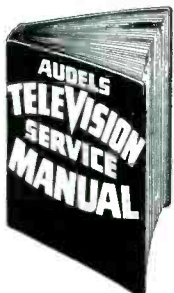
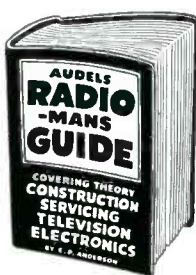

2 VOLS. \$6 COMPLETE \$1 A MONTH. IT PAYS TO KNOW!

AUDELS T.V.-RADIO SERVICE LIBRARY presents the important subjects of Modern Radio, Television, Industrial Electronics, F.M. Public Address Systems, Auto, Marine & Aircraft Radio, Phonograph Pick-Ups, etc. Covers Basic Principles—Construction—Installation—Operation—Repairs—Trouble Shooting. Shows How to get Sharp, Clear T.V. Pictures. Install Aerials—How to Test. Explains Color Systems & Methods of Conversion. 1001 Facts—Over 1260 Pages—625 Illustrations—Parts & Diagrams—Valuable for Quick Ready Reference & Home Study. Tells How to Solve T.V. & Radio Troubles—Answers T.V. & Radio Questions.

Get this information for Yourself.
7 DAY TEST—ASK TO SEE IT!

MAIL ORDER

AUDEL Publishers, 49 W. 23 St., N.Y. 10
Mail AUDELS T.V. RADIO SERVICE LIBRARY 2 Vols. \$6 on 7 days free trial. If O.K. I will remit \$1 in 7 days and \$1 monthly until \$6 is paid. Otherwise I will return them.

Name _____
Address _____
Occupation _____
Employed by _____ SER



Get Rid of
HASH in the
Picture—
Install a
Set of Gemco
Stray-X
Filament
Chokes



GREAT EASTERN
MANUFACTURING CO.
BROOKLYN 12, NEW YORK

Three-way crossover network designed to divide and separate frequencies between the low end (woofer), mid-range speaker, and high-end (tweeter). Crossover points are at 800 and 5,000 cycles; network is of constant resistance half-section construction. It is also fitted with a volume control across the high-end output terminals. Unit can also be used as a two-way crossover by ignoring the treble terminal. Maximum input is 30 watts. Attenuation is at the rate of 12 db per octave. Network unit is built in England by Wharfedale Wireless Works. (Model HS/CR/3; Dept. W, British Industries Corp., 164 Duane St., New York 13.)



Audio

(Continued from page 51)

microphone. In this position of the turnover switch, input jack *M* is automatically connected to the preamp in place of the pickup input.

Control Amplifiers

For basic power amplifiers, particularly the Williamson and *ultra-linear* types, and as a companion unit to the preamp-equalizer, control amplifiers⁶ have been designed. One model shown in Fig. 2 (p. 51), has a separate bass amplifier triode and mixer circuit, and a cutoff filter treble control which permits elimination of noise and distortion in program material with minimum loss of quality of reproduction.

In this unit, selection of any one of four identical inputs can be made by means of an input selector switch which shorts out automatically all unused inputs. The first triode section of a 12AU7 is used as a combination amplifier and cathode-follower stage. Its amplified output is fed through a mixing network to the first triode section of a second 12AU7. The output from its cathode is fed through an adjustable *rc* network to the grid of the second triode section which functions as a separate bass amplifier, the *rc* network being proportioned to attenuate the mid-frequency and treble range. The degree of bass boost at this point is controlled by switch section *S*_{2a}. The output of the bass amplifier tube is fed into a mixing network in the grid circuit of the third triode section. Additional bass boost is provided at low volume levels by means of switch section *S*_{2a}, which introduces bass compensation into the volume control circuit by means of a .02-mfd capacitor and 51,000-ohm resistor. Switch section *S*_{2c} provides bass cut in the 1 and 2 positions.

Third Triode Section

The third triode section is an amplifier stage, followed by a volume control. In the output stage is a cathode follower, providing low-output impedance. The output circuit contains a low-impedance *lc* adjustable *hf* cutoff filter, the operation of which is controlled by switch sections *S*_{1a} and *S*_{1b}. This filter provides 12-db per octave slope with a fairly sharp knee, and is proportioned for optimum reduction of noise and distortion with minimum effect on quality. In the 1 and 2 positions of the treble switch, small capacitors are switched across the unby-

⁶Brociner CA-2.

passed cathode of the first amplifier stage to provide treble boost.

As in the preamplifier-equalizer, low-noise resistors have been used at critical points.

Record Changer Production Changes

Since the introduction of the Admiral RC600 record changer, several improvements have been incorporated.

Occasionally an Admiral changer may have a worn down index finger rubber cap, causing the tone arm to index to 7-inch position when playing 10-inch records. This may be caused by the set-down arm assembly being bent or not parallel to the changer pan. Another cause could be burrs on the bracket of the set-down index assembly interfering with the sliding action of the index pin on the set-down arm.

Both of these difficulties have been corrected in production. Where they are encountered in early production changers, the set-down index bracket can be smoothed off with a small burnishing tool and the set-down arm can be bent.

On some early production Admiral changers the shielded lead from the pickup cartridge was too short or improperly dressed causing the tone arm to drag and resulting in groove skipping on 45 records. This can be corrected by dressing the lead to provide enough slack or by replacing with a new lead⁶ where necessary.

Record Changer Service Notes

Turntable noise in Capehart combinations have been traced to flat spots on the rubber-rimmed drive pulley.

To remedy, the spring cotter pin holding the drive pulley in place and the drive pulley should be removed. A screwdriver, or other round shaft, should be inserted in the pulley bearing. Pulley should be rolled back and forth firmly over flat surface, thus re-setting the rubber rim; it will be found when the pulley is replaced the turntable will run smoothly, without noise. This also applies to almost all makes of record changers.

Another factor affecting smooth operation is the tension of the drive pulley pull-back spring. Normally, adjustment of this spring is unnecessary; however, when needed, a slight increase in spring tension is desirable. This can be accomplished by bending the small metal ear on the motor body so as to slightly stretch the spring, thereby increasing the spring tension. This is especially effective in reducing wows on the 33 and 45-rpm positions.

It is important to make sure that the drive wheel, turntable, and drive pul-

⁶Admiral G400A529-1.

STANCOR *Exact* REPLACEMENT

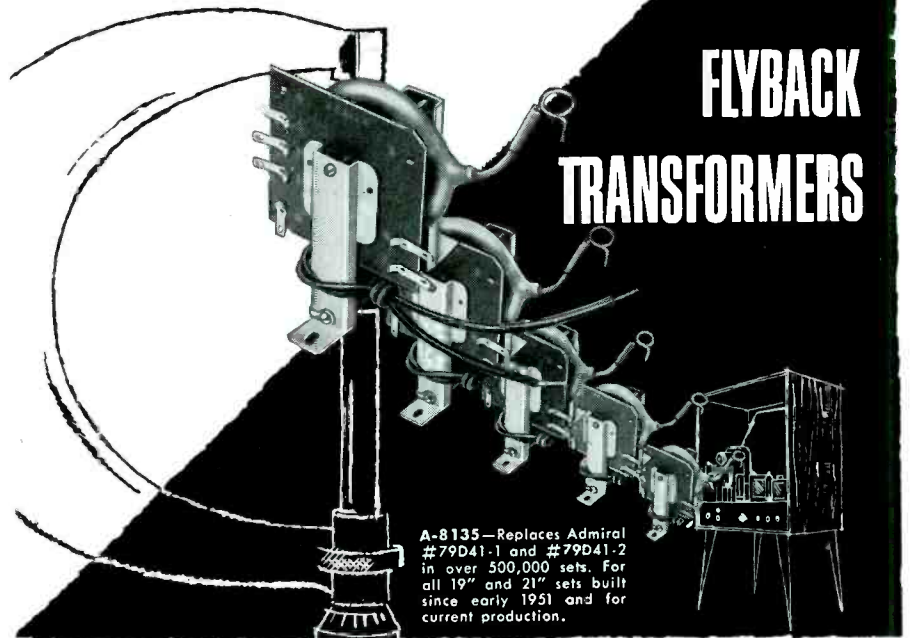

A-8135—Replaces Admiral #79D41.1 and #79D41.2 in over 500,000 sets. For all 19" and 21" sets built since early 1951 and for current production.

Ask your distributor for Stancor bulletins 461 and 465, listing replacement applications of these transformers—or write directly to Stancor for your free copy.



A-8132—Replaces Muntz #TO-0031; used in 1951 and 1952 production. Covers approximately 300,000 Muntz sets.

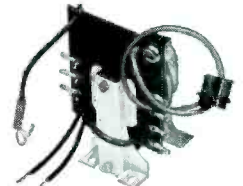

A-8136—Replaces Philharmonic #80-263, #80-265-2 and #80-265. Used in all sets built since early 1951 including AMC, Pathe, Silvertone, and other "private label" sets.

Stancor Transformers are listed in Howard W. Sams' Photofact Folders, John W. Rider's Tek-Files, and the Howard Company's Counterfacts.

STANDARD TRANSFORMER CORPORATION



3588 ELSTON AVENUE • CHICAGO 18, ILLINOIS

EXPORT SALES—

Roburn Agencies, Inc., 39 Warren St., New York 7, N.Y.

leys are completely free of grease or foreign material. Crocus cloth should be used to clean these parts.

(Right)

Wide-angle trumpet, which features a pair of exponential horns having twin air columns in a single assembly. Construction is said to retain full efficiency by permitting wave fronts from each mouth to form a single, uniform arc that is claimed to result in a smooth radiation pattern, free from cancellations that can occur in cellular and multi-mouth horns. Dispersion of sound, 120° horizontally and 60° vertically. Low frequency cutoff is 250 cycles. Of one-piece, heavy duty die-cast aluminum construction. Tone arm and reflectors are integral and comprise the complete horn assembly. (Cobreflex-2; University Loudspeakers, Inc.)

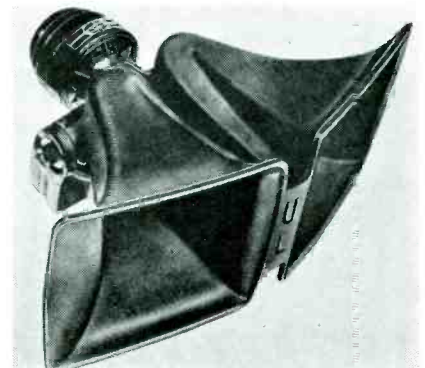

It's Here! It's New!

ELECTROX BATTERY ELIMINATOR

For Servicing Both
6 and 12 VOLT AUTO RADIOS



MODEL AR 56-12

Quality Built Throughout
Outstanding Value at \$57.50

Service both 6 and 12 Volt auto radios with this one, dependable power source. ElectroX Model AR 56-12 provides amply filtered, adjustable D.C. that will operate any type and size auto radio, either push-button or manually tuned.

OUTPUT: Low range: 7½ volts at 12 amps., continuous; 20 amps., intermittent. High range: 15 volts at 6 amps., continuous; 11 amps., intermittent. High and low range controlled by selector switch.

Built of quality components throughout. Selenium rectifiers. Equipped with accurate 0-20 V. and 0-20 A. meters.

ALSO AVAILABLE: Model AR 46-12, only \$44.95. Built to same quality standards as AR 56-12. Output not adjustable. Equipped with high-low switch to change from nominal 6-volt to nominal 12-volt power.

SEE YOUR ELECTROX JOBBER OR
WRITE FOR FULL DETAILS

Rectifier Division
SCHAUER MANUFACTURING CORP.
4512 Alpine Ave. Cincinnati 36, Ohio

'Scope Amplifier

(Continued from page 54)

unit will then be ready for immediate use.

To measure the peak-to-peak voltage of a complex waveform, the wave is applied to the 'scope and the shift control adjusted until the top of the wave is just level with the center of the tube face. Then, after noting the reading, the shift control should be moved until the bottom of the wave is level with the center line and a second reading should be taken. The sum of the two readings will be the peak-to-peak value of the complex wave; the first reading being the height of the positive peak and the second the depth of the negative.

Actual Hum Level Measurements

The device can also be used to measure the actual hum level in the output of an amplifier. It may be that hum is only present when the device is working at full output with a signal applied; normally accurate hum measurements are difficult to make under such conditions. To check the hum, the time base should be set to a multiple of the hum frequency, so that the hum content can be seen. Then the shift control should be altered so that the bottom of the hum pattern is against the centre line. After taking the voltage reading, the shift control should be adjusted so that the top of the hum wave is against the line. A second reading will disclose the difference between the two voltage readings representing the hum content.

If it is necessary to measure very low voltages, the circuit shown in Fig. 2 (p. 54) can be used. The gain of each section is 10, and by the use of a wafer switch it is possible to set the gain at 0-10-100 so that the reading of the meter has only to be multiplied by 1, 0.1 or 0.01 according to the amount of amplification used.

Community TV

(Continued from page 72)

line. Isolation of 17 db in voltage is provided by such units.

Branching networks were inserted in trunk lines to divide the line into two or three-branch lines. Each output of a two-branch unit is about 6 db less in voltage than the input level, and the output of a three-branch unit is 10 db less in voltage than the input level.

Branching networks can also be used for mixing signals from two or three antennas where the signal strength is sufficiently high to overcome the network losses, thus eliminating the need for a mixer amplifier.

Our first service tap was placed 20' from the tower; six taps were made within the first block. Thus far cable has been stretched in only about one-sixth of the town to serve over 130 subscribers.

Messenger cable ($\frac{5}{16}$ ") was used throughout the system in accordance with utility regulations. For trunk cable RG/11U was selected and for service connections, RG/59U was installed.

Free installations are provided for all schools and social rooms of churches. A 24" set was recently installed in the auditorium of our high school.

Channel Service Available

Originally we had channels 2, 4 and 6, Baltimore, Lancaster and Philadelphia, taking care of the three networks (CBS, NBC and ABC). Lancaster, 45 miles from Steelton, and Baltimore 90 miles away provided best reception.

With the establishment of a channel -43 uhf station at York, 30 miles away, it was decided to eliminate Philadelphia pickup and convert to 43. A converter* was installed and the 43 was converted to 6. On the first of the year Lancaster's channel 4 was changed to 8. This change had been anticipated and as soon as we were told that channel 8 would be used, line amplifiers were changed and uninterrupted service on the new channel was provided.

Additional service from local uhf stations will be offered as soon as these telecasters come on the air. Although a steel plant is located on one side of town and hills on the other the problems will be many, but at the tower site it should be possible to get line-of-sight reception from all uhf stations in our area.

The initial installation fee for the system is \$120.00, and monthly rental charges are \$3.50.

*Mallory.

MOSLEY 3-WAY TV ANTENNA SWITCH

for Multiple

UHF and VHF ANTENNA INSTALLATIONS

- Install anywhere. Extension rod supplied for back of set mounting.
- Constant impedance—Low loss—Solderless.
- Sturdy rotary switch making silver-to-silver contact.
- In brown or ivory polystyrene case.
- Also available in Flush Wall Plate style.



Cat. No. F-20 MOSLEY 3-Way
TV Antenna Switch
List Price..... \$3.75

At Radio Parts Jobbers

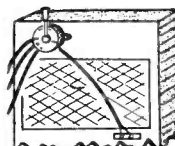

MOSLEY Electronics, Inc.

8622 St. Charles Rock Road
St. Louis 14, Missouri

Dip Meter

(Continued from page 33)

should be coupled to a shorted end of the transmission line and measurement made as for an *lc* circuit. A sketch of the probable current distribution is helpful in determining the harmonic mode of operation; Fig. 2. For instance, a quarter-wave transmission line with the far end open is similar to a half-wave antenna, and resonances will be found approximately at odd multiples of the fundamental frequency. When a transmission line is shorted at the far end, it may be considered as two quarter-wave transmission lines placed back to back. The resonant frequency is then approximately twice that found with the far end open.

When the transmission line is terminated in a pure resistance equal to its characteristic impedance, it will be found that the resonances will disappear. Any other load will cause resonances to reappear except at those frequencies at which the load of the transmission line is equal to its characteristic impedance. These facts can be used to load a transmission line to a high degree of accuracy.

Signal Generator Applications

As stated, the instrument can be used as a source of signal in the preliminary alignment of receivers. The amount of pickup by the receiver must be varied by adjusting the position or distance of the instrument. The output signal is unmodulated, so that an *rf* type of signal tracer is necessary for indicating the proper alignment of the tuned circuits. The *S* meter, in some receivers, may be used as an indicating device for alignment.

The instrument can also be used as a source of marker signals in the approximate adjustment of TV circuits when using a sweep generator. In this case, the intensity of the marker can be varied by adjusting the position or distance of the instrument from the circuit under test.

Fig. 2. Examples of resonant transmission-line current distributions. At *a* and *c* are the fundamentals, and in *b* the third harmonic is illustrated.

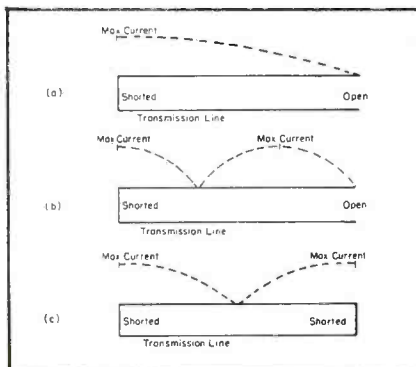

NOW



**..Wire Lead Micas
with 500 times better
moisture resistance
than ever before!**

Sangamo HUMIDITITE* Mica Capacitors

When you use Sangamo HUMIDITITE molded Mica Capacitors, you gain all the advantages of an amazing moisture seal that offers previously unheard-of moisture resistance characteristics for compression molded plastic-encased mica capacitor components.

*what is HUMIDITITE?

Humiditite is a remarkable new plastic molding compound, developed by Sangamo, that

gives Sangamo Mica Capacitors moisture resistance properties far superior to any others on the market.

HERE'S THE PROOF

... The standard moisture resistance test described in MIL-C-5A (proposed) Specification requires mica capacitors to offer at least 100 megohms of insulation resistance after ten 24 hour cycles in a humidity chamber at 90% to 95% relative humidity. The best competitive micas barely meet this requirement . . . but Sangamo HUMIDITITE Micas, under the same conditions, all tested in excess of 50,000 megohms! Continued tests, over and above requirements, with the same HUMIDITITE Micas, proved them capable of withstanding from 21 to 52 cycles (from the smallest sizes to the largest) before failure.

Humiditite is just another example of the advanced engineering that enables Sangamo to meet the existing and future needs of the electronic industry. For additional information about HUMIDITITE, write for Engineering Bulletin No. TS-111.

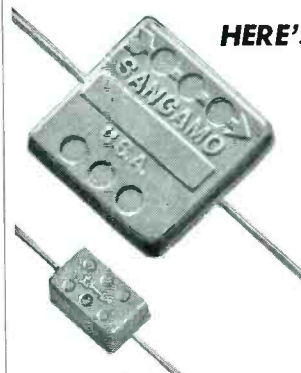

Those who know...  choose Sangamo

SANGAMO ELECTRIC COMPANY

MARION, ILLINOIS

SC53-5A

SURVEYING PLANT ADDITION PLANS



Simpson executives (left to right) Mel Buehring, sales manager; Bob Brand, factory manager; Wallace Carroll, president; and Jim Summers, ad manager, checking blueprints for plant addition which is expected to be completed in the late spring.

125-MILLIONTH STANDOFF



S. B. Valiulis, president of General Cement Mfg. Co., showing 125-millionth standoff to Richard G. Ellis, general sales manager.

To meet the strictest requirements of both
Government and Industry, specify

JAN TYPE

RP Germanium Diodes

Precision made, easy to handle, easy to assemble—the tapered shape shows polarity at a glance! Make Radio Receptor Germanium Diodes your first choice in the large variety of electronic circuits where JAN types are a must.

**1N69
1N70
1N81**

TYPICAL USES

- COMPUTER CIRCUITS
- CLAMPING CIRCUITS
- RF DETECTORS
- CONTROL CIRCUITS
- DISCRIMINATORS
- MODULATORS
- NOISE ELIMINATORS
- CLIPPERS
- LEVEL SETTERS
- RESTORER CIRCUITS



DETECTOR CIRCUIT

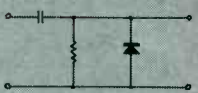

CLAMPING CIRCUIT

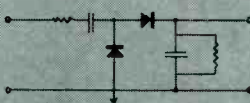

COUNTING RATE CIRCUIT

JAN TYPES - ALL VALUES MEASURED AT 25°C.					
CODE NO.	Min. Forward Current at 1 Volt (mA)	Max. Reverse Current (Micro-Amperes)	*Average Rectified Current (mA Max.)	Minimum Reverse Volts	Max. Cont. Reverse Operating Volts
1N69	5.0	50 μ -10V 850 μ -50V	40	75	60
1N70	3.0	25 μ -10V 300 μ -50V	30	125	100
1N81	3.0	10 μ -10V	30	50	40

Rectification efficiency: 35%, minimum in 100 MC test circuit.

* Average half wave rectified current at 60 CPS and 25°C. Consult us for ratings at other conditions.
† For zero dynamic resistance.

Radio Receptor Germanium Diodes may hold the answer to many of your problems. Our engineers will be glad to study your requirements and submit their recommendations. Many other types, both standard and special, are available... Write us!

**Seleton
and Germanium
Division**

RADIO RECEPTOR COMPANY, INC.

Since 1922 in Radio and Electronics
SALES DEPT. 251 West 19th Street, New York 11, N. Y. • FACTORY: 84 North 9th Street, Brooklyn 11, N. Y.

ANNOUNCING THE NEW

Scala **VOLTAGE DOUBLER PROBE**

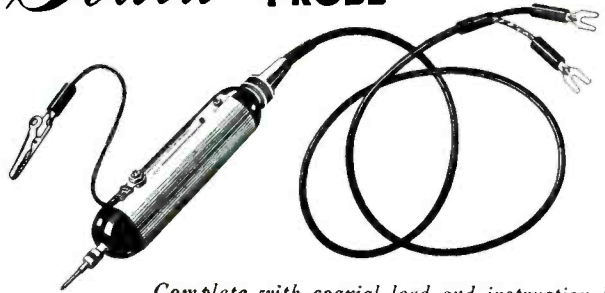

Complete with coaxial lead and instruction book

WITH THESE OTHER SCALA OSCILLOGRAPH

Probes, Make TV Servicing Easier, Faster

A teammate for the famous simplified, super-efficient SCALA oscillograph probes—the new BZ-4 Voltage Doubler, at \$10.75. Provides virtually double the deflection on scope screen provided by conventional half-wave probes. Offers a high degree of 60-cycle hum rejection. Contains dual demodulators of low-capacitance, high-impedance design, selected for balance and sensitivity, useful to 150 Mc. No probe marketed in this price field possesses a range anywhere near the range of the BZ-4.

Check with your local distributor or write about the BZ-4 and the other SCALA probes:

- BZ-1 SIGNAL TRACING PROBE . . . useful to 500 Mc.
- BZ-2 LOW CAPACITY PROBE . . . adjustable to any scope for minimum loading at laboratory accuracy.
- BZ-3 100:1 VOLTAGE DIVIDER PROBE . . . may be applied to horizontal output circuits without endangering oscilloscope.

SCALA RADIO CO., 2814 - 19th St., San Francisco 10, Calif.

Pickups, Needles, Arms

(Continued from page 41)

not touch the bottom of the groove. Microgroove records, both 33 $\frac{1}{3}$ and 45, use the same shape of styli, but with a radius of curvature of one mil. Certain compromise styli have been designed to be employed with either type of groove.

Stylus Material

The material of the stylus tip must be resistant to wear, must polish to a smooth surface for minimum friction, and must be rigid so that it does not bend with the vibrations induced in it. Osmium, sapphire, and diamond are, in the order mentioned, increasingly resistant to wear. It is generally considered that the greater initial investment required for diamond needles, in the long run, can be the most economical, not only in terms of stylus life but in terms of decreased record wear. It is a misshapen stylus which wears a record most, rather than a hard one.

Fiber or cactus needles, because they are so soft, reproduce the record grooves with a minimum of high frequency response and therefore with a minimum of surface noise. They

should only be used if the listener is willing to sacrifice the harmonic overtones of the music, the natural timbres of the brass, strings and woodwinds. Occasional use of fiber needles might be called for when playing valuable old records which have hardly any treble recorded into them anyway, and where it is desired to wear the grooves as little as possible.

The Stylus Shaft

The shaft that connects the stylus tip to the pickup moving element is ideally perfectly rigid to horizontal forces, so that none of the motion is lost in flexure, and perfectly compliant to vertical forces, so that vertical stimuli are not transmitted. Since no material can fulfill these requirements the design must compensate for the deficiency. The older, long needles projecting almost vertically from the cartridge are being replaced by designs in which the tip is a very short vertical appendage at the end of a near horizontal shaft. This design, besides providing high vertical compliance, reduces *needle talk* (sound radiated mechanically from the vibrating stylus mechanism and record itself), usually below audibility. Other designs are used which achieve the same effect by

a very short length of shaft and highly flexible vertical anchoring.

Stylus Replacement

The design of the stylus assembly and of its holder was once quite uniform. It consisted of a round shaft held in a chuck by a setscrew, the screw operated by a thumb and forefinger. Considerations described have changed the design of stylus and suspension, and since some of the modern pickups do not require any physical coupling between stylus and cartridge (the stylus itself being the moving element) the method of stylus pivoting can be made much simpler. Unfortunately, however, there are now many dozens of needle styles, differing only in method of installation; as a result needle replacement is often too skilled a task for the layman, and often is a headache even for the Service Man.

There is no fixed rule about when to change the needle, as the amount of wear depends upon the cartridge and tone arm used and the condition of the records played. In general, recommended stylus playing times have ranged from 20 to 100 hours for sapphire, while diamond needles may be expected to show little if any wear

after 1,000 hours. In all cases the tip should be checked periodically with a hand microscope, and the stylus replaced when the outline of its tip departs appreciably from the arc of a circle; a typical form of stylus wear is illustrated in Fig. 6. Since this is the most frequent cause of phono distortion (particularly of the high-frequency type) the needle should be the first component to be checked when distortion develops. For the Service Man who handles audio equipment, a pocket microscope is as necessary as a voltmeter.

Tone Arms

The main difficulties encountered with tone arms are resonance, insufficient pivot compliance in the vertical and horizontal plane, random play in other planes, and tracking error.

The major mode of tone-arm resonance takes place in the mass-elasticity system formed by the mass of the cartridge and arm, and the elasticity of the stylus suspension. At resonance the arm vibrates in the opposite instantaneous direction from the stylus, increasing output and the chances of groove skating. Below resonance the arm begins to follow the lateral stylus excursions, rapidly reducing output below the usable point. It is therefore desirable that the resonant frequency of the system (which cannot be determined without knowing the compliance of the cartridge needle suspension) be kept as low as possible, ordinarily in the subsonic or near subsonic region below 30 or 40 cycles.

It is desirable to keep all random friction or other impedances at the pivot to a minimum, so that the arm can move freely across the record, and can respond to vertical irregularities. Controlled viscous damping in the form of a friction producing semi-liquid may be purposely inserted at the pivot, however, to reduce the peak of arm resonance. This is done in certain professional type arms. Damping may be applied to an arm even though the resonant frequency may be well below audibility, to improve tracking under adverse conditions created by warped records, mechanical shock, etc., by reducing the violence of response to such stimuli. The added friction inserts a force which happens to be opposite to *side thrust*, the latter created by the necessarily imperfect alignment of pivot, stylus,

(Continued on page 96)

Fig. 6 (right). Worn stylus sapphire needle after 30 hours of play on *lp* record. (Courtesy Tetrad.)

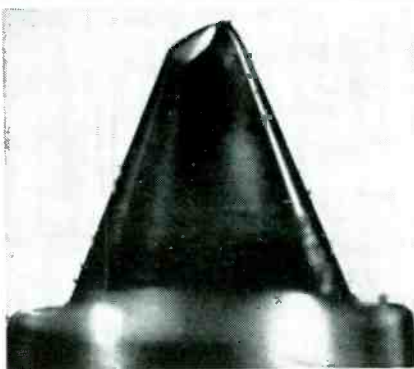
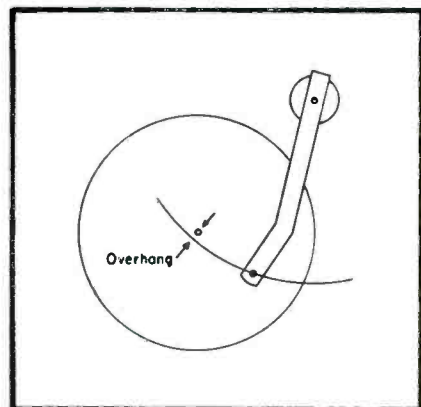

Fig. 7 (right). Proper mounting of offset arm, showing overhang. The amount of this overhang depends upon the length of the arm and the angle of offset, and the manufacturer's instructions should be followed exactly. Straight arms require a slight underhang.



Now...

the **6300** series
for the new 12-volt auto circuit
has been added to the full line

of



CORNELL-DUBILIER
SEAL-VENT
VIBRATORS

- ★ **Faster Starting**
- ★ **Longer Life**
- ★ **Complete Replacement Line**
- ★ **Seal-Vented**

Maintaining the reputation for the most complete replacement line, C-D now has available the new 6300 series of vibrators to take care of the 12-volt circuits on many of the new 1953 cars. Once again, this proves that all you need in vibrators for full coverage* in the replacement market is C-D... longer life, dependable and trouble-free performance. And *seal-vented*... even greater than ever!

*Ask your C-D Distributor about the NEW C-D plastic case VIBRATOR KIT.



CONSISTENTLY DEPENDABLE

CORNELL-DUBILIER
SOUTH PLAINFIELD, NEW JERSEY



- ROTORS
- CAPACITORS
- VIBRATORS
- ANTENNAS
- CONVERTERS

Get Your Buck\$ Worth! DOUBLE STRENGTH!! GET VALUE THROUGH VOLUME!

GET YOUR REPLACEMENT TUBES FROM VEE!
VEE stocks for immediate shipment branded merchandise, tested and aged for top-flight performance . . . individually boxed. EVERY TUBE TYPE AVAILABLE FOR RADIO, TELEVISION AND AUDIO CIRCUITS.

LOOK at our prices!

COMPARE our prices and prove they're lower!

TRY your next order with VEE
AND GET YOUR BUCK\$ WORTH IN
PRICE • PRODUCT • PERFORMANCE

NEW LOW PRICES

1B3	.63	6A15	.40	6J5	.40	12AV7	.79
1R5	.56	6AQ5	.46	6J6	.62	12BA6	.45
1S4	.61	6AT6	.38	6K6	.41	12BH7	.63
1S5	.47	6AU5	.78	6S4	.46	12SA7	.52
1T4	.56	6AU6	.43	6SA7	.52	12SK7	.50
1U4	.55	6AV5	.78	6SK7	.50	12SN7	.54
1U5	.46	6AV6	.37	6SN7	.54	12SQ7	.42
1X2	.67	6BA6	.45	6SQ7	.42	19BG6	1.30
3Q4	.60	6BC5	.53	6T8	.77	25BQ6	.89
3Q5	.65	6BE6	.46	6V6	.46	25L6	.48
3S4	.55	6BG6	1.34	6W4	.45	25W4	.48
3V4	.56	6BJ6	.48	6W6	.57	25Z6	.42
5U4	.40	6BK7	.88	6X4	.34	35L6	.47
5Y3	.29	6BQ6	.89	6X5	.33	35W4	.30
6AB4	.46	6BQ7	.98	12AT6	.48	35Z5	.30
6AC7	.75	6C4	.37	12AT7	.68	50B5	.47
6AG5	.54	6CB6	.53	12AU6	.43	50C5	.47
6AK5	.95	6CD6	1.85	12AU7	.53	50L6	.47
				12AV6	.37	117Z3	.39

All prices FOB New York

MINIMUM ORDER \$5.00. Prepaid shipments if check in full with order. C.O.D.'s Sure. 25% deposit required with order.

Jobbers—why not check with us for your fill-in requirements?

VEE

Dept. S-3

BOX 134, QUEENS VILLAGE 29, N. Y.

JSC Engineering Department, constantly on the alert for new developments in television transmission wire, has several new developments for showing at the

May Parts Show in Chicago

Tubular, UHF, Perforated, Open Line TV Transmission Wire, and many other new items will be on display.

Look for the JSC Orange and Blue Disc of Quality . . . and be sure to visit us at our Booth 105, May 18th to 21st—we will be looking for you.



(Continued from page 95)

and record groove tangent at the point of stylus contact.

Tracking Error

The tone arm cannot hold the cart-ridge parallel to all grooves as it sweeps across the record. The angle of deviation is called *tracking error*, and it results in increased harmonic distortion. This increased distortion is due to the fact that when the vibration axis of the pickup is turned from

the groove, the stylus vibrations cease to be perpendicular to the groove tangent. Tracking error may be reduced to very small values by the use of a tone arm with an offset head. The reduction is not due to the offset head itself, but to the new mounting position (in which the arc of the stylus sweeping across the record *overhangs* the turnable spindle), which the offset design makes possible. The exact mounting position of the tone arm pivot, within a very small fraction of an inch, is critical, and the manufacturer's directions should be followed

with extreme care; see Fig. 7 (p. 95). The use of offset arms involves a design sacrifice; that of accepting increased side thrust.

It is also important that the tone arm be mounted in such a way that the cartridge is held parallel to the plane of the record. Other considerations that may be involved are the minimum distance of the cartridge from the motor, and mounting of the tone arm approximately parallel, rather than perpendicular to any major mode of vibration of the motor board.

PREFERRED

because of their
dependable service
and overall economy

Copperweld

TRADE MARK

RADIO and TV PRODUCTS



Uniform
COPPER COVERING
gives you

RESISTANCE } Same as copper
REACTANCE } at Radio
IMPEDANCE } Frequencies
CAPACITANCE }

also RUST-RESISTANCE and
SOLDERING QUALITIES
of Copper

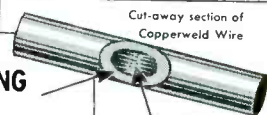

Tough
STEEL CORE
adds HIGH STRENGTH
MINIMUM ELONGATION
RESISTANCE TO FATIGUE

Perfect interlocking **MOLTEN-WELD**
between the copper and steel
eliminates electrolytic action.

NO OTHER WIRE HAS THIS MOLTEN-WELD

Write today for further details.

COPPERWELD STEEL COMPANY • Glassport, Pa.
SALES OFFICES IN PRINCIPAL CITIES

Copperweld GUY STRAND
ANTENNA WIRE • GROUNDING WIRE
GROUND RODS AND CLAMPS . .

also HOOK-UP WIRE, TWIN-LEAD AND COAXIAL CABLES,
AND MANY OTHER ELECTRONIC WIRE PRODUCTS

Your One Complete Speaker Source

UTAH REPLACEMENT SPEAKERS

Export Dept. Rocky International Corporation, N. Y. C.

utah

RADIO PRODUCTS CO., INC.
HUNTINGTON, INDIANA

A WHOLLY OWNED SUBSIDIARY OF NEWPORT STEEL CORPORATION

TV Tools

(Continued from page 37)

quite low, and the time constant quite short, as illustrated in Fig. 10. The low-input impedance tends to provide a more constant load to the circuit under test, and makes the flow of signal current into the probe essentially constant from one part of the cycle to another. The short time constant assures the operator that the probe will be able to follow the rapidly-changing voltages of a sync pulse; for example, without clipping the negative excursions.

At the same time, it must be recognized that the sensitivity of the probe is greatly lessened, and that appreciable signal voltage must be available, or the sensitivity of the 'scope must be sufficient to make up for the loss of signal which is incurred in the probe circuit. For this reason, Service Men usually prefer to make use of a probe which offers a compromise between sensitivity and waveform fidelity.

One advantage of the circuit shown in Fig. 10, is that the input blocking capacitor permits the use of the probe with 'scopes which may have appreciable *dc* leakage in the input circuit. The frequency response of the probe to carrier-wave frequencies is improved by inclusion of a *pi* filter, comprising a pair of .001-mfd capacitors with a 220-ohm series resistor; for video waveform reproduction, Service Men may prefer to use the probe without the filter.

Probes for Video-Amplifier Adjustment

When a sweep-frequency check is made of a video amplifier (that section of the TV receiver between the picture detector and the grid of the picture tube), Service Men find that the input capacitance of the crystal probe becomes a matter of some importance. The shape of the response curve will be distorted unless the input capacitance of the crystal probe is approximately the same as the capacitance of the grid of the picture tube. Thus, probes developed for signal tracing in *if* amplifiers will not be found suitable for video-amplifier adjustment.

The input capacitance of a crystal probe is determined by the mechanical construction; that is, the mounting of the probe components with respect to the shielded probe body, value of the blocking capacitor which is used, and the combined effective resistance of the crystal diode and its shunting resistor, as shown in Fig. 11 (p. 98). These

(Continued on page 98)

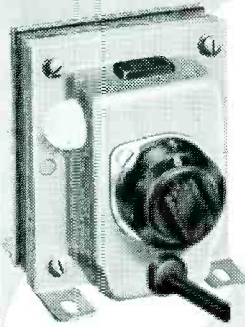

ends low line voltage hazard

CREST LVB-117 Line Voltage Booster

ACCURATE VOLTAGE BOOST!

A unique Line Voltage Booster engineered to restore peak performance to any TV set or electrical equipment. Insures full strength, width, and height of the picture when low line voltage weakens or shrinks picture. Corrects intermittent sync and oscillator drift caused by low line voltage.

350 Watt Rating . . . ample for most requirements on line voltages from 90 to 135 Volts.

Simple external Plug-in . . . 10 second installation aids over the counter sales.

Automatically operated . . . turns on and off with set or appliance. Multi-tap selector switch . . . permits exact voltage boost.

Visual Indicator . . . assures exact selection of required boost.

Overload fuse protection . . . minimizes hazards of unsafe line increases. Dealer Net Price \$10.77—List Price \$17.95

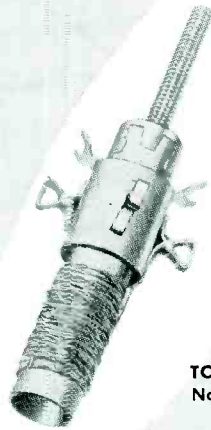

VARIABLE INDUCTANCE Universal Substitution Kit

TO SAVE VALUABLE SERVICE AND DEVELOPMENT TIME . . .
Now available for the first time . . . a complete Variable Inductance . . .
Universal Substitution Kit.

For Video Peaking . . . IF Circuits.

The unique replacement set of 8 variable inductance coils cover a range from 1 to 590 μ h.

Q-Max impregnation.

Full data enclosed on L min., L max., Q's, R, C dis., Freq. self-res.

Individual Calibration Charts permit adjustment to requirements of inductance value without test equipment.

Complete set Model 200K . . . Net Price \$4.75

Single Set Replacements Available

CREST

LABORATORIES, INC.

84-11 Rockaway Beach Blvd., Rockaway Beach, N. Y.

NEptune 4-3328

Fig. 10. Series type of arrangement which has good frequency response, but low input impedance. The 220-ohm input resistance loads the circuit under test heavily, and draws a substantially constant current. For reproduction of video waveforms, the *pi*-filter section comprising the two .001-mfd capacitors and 220-ohm series resistor can be omitted.

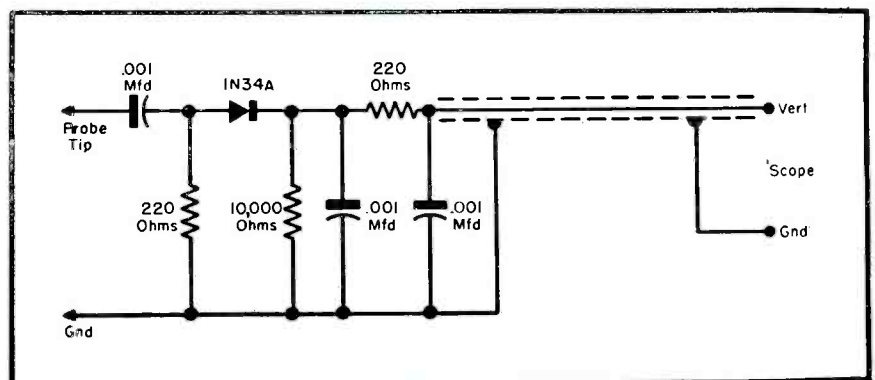

Kenco Mounts

...are engineered for the JOB!

.....

KENWOOD ENGINEERING CO., Inc.
265 Colfax Avenue
Kenilworth, N. J.



**KENCO
EAVE
MOUNTS**

Easily mounted on hanging rafters or trim boards of eave. Eliminates need for drilling into brick or masonry walls. Ideal for buildings with extended roofs. Hot dip galvanized.

Available in 3 sizes:
Model #122 .22" Eave Mount
Model #128 .28" Eave Mount
Model #148 .48" Eave Mount

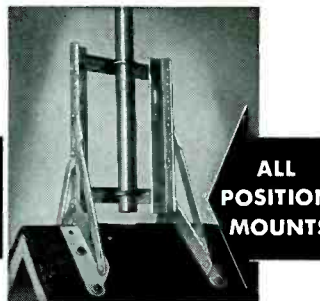

**ALL
POSITION
MOUNTS**

A strong, self supporting mount for peak, slope, side wall, corner or flat mountings. Positive locking braces eliminate need for guy wires in many installations. No blocking or shimming necessary.

Model #105 . . . For masts up to 1 1/2".
Model #101 . . . For masts up to 2".

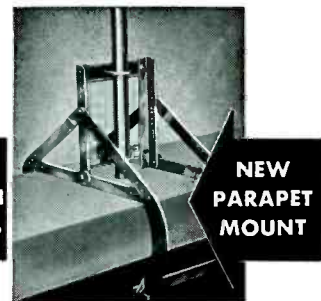

**NEW
PARAPET
MOUNT**

The KENCO Parapet Mount gives positive anchorage to apartment house walls without damage to building. Powerful clamping action insures safe installations. Shipped assembled. Quickly installed. Hot dip galvanized.

Model #106 . . .
For walls up to 13 1/2" thick.



Germanium



Diodes

ALL TYPES AVAILABLE
FOR PROMPT SHIPMENT
WRITE FOR BULLETIN GD-1

INTERNATIONAL RECTIFIER
CORPORATION
General Offices: 1521 E. Grand Ave., El Segundo, Calif. • Phone: ORegon 8-3778

THERE IS NO FASTER OR BETTER WAY TO MAKE TEST CONNECTIONS THAN OFFERED BY THE SIMPLIFIED GRAYHILL PANEL MOUNT, SPRING PRONG CLIP AND THE GRAYHILL FULLY INSULATED, TIGHT-GRIP TEST CLIP.

Ask for Samples.

Panel Mount Type No. 2-0

Insulated Alligator Type No. 16-1—Black No. 16-2—Red

Grayhill

533 Hillgrove Ave., La Grange, Ill.
Phone: La Grange 8000

(Continued from page 97)
 must be suitably adjusted, so that when the socket is removed from the base of the picture tube, and the crystal probe is inserted into the grid terminal of the socket, the output of the video amplifier will work into the same impedance as if the tube were connected.

Not only must one be concerned with the input capacitance of such probes, but with the probe response to video carrier frequencies modulated by a 60-cycle square wave, since the response curve is of the same general

family as 60-cycle square waves. The crystal diode must be matched within reasonable limits to the value of shunt resistance for good 60-cycle demodulation response.

General Purpose Crystal Probes

Service Men usually prefer to utilize a single crystal probe for all their work. Such a probe must meet the following requirements, in the order indicated: (1)—Input impedance; (2)—reproduction of demodulated 60-cps square wave; (3)—sensitivity;

Fig. 11. A shunt type of crystal probe. Here the input capacitance depends upon the mechanical construction, the value of C_c (coupling capacitor), value of R_p , and to some extent upon the front-to-back ratio of the crystal. The input capacitance varies slightly with the signal voltage which is applied. The isolating or series resistor R_s should be as large as possible not only to retain reasonably good 60-cycle demodulation response, but to isolate the input carrier signal to the components in the probe head, so that better high-frequency response can be realized.

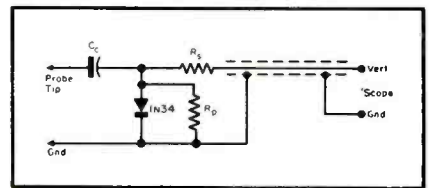

(4)—waveform fidelity (above 60-cps square wave); (5)—ruggedness to overload and mechanical shock; and (6)—hum suppression.

Because of the first and second requirements, most general-purpose crystal probes utilize the basic design shown in Fig. 11. Sensitivity will be found moderate, and not equal to that available from the elementary arrangement shown in Fig. 7. The crystal diode must be properly polarized in the shunt and series types of circuits, if maximum sensitivity is to be realized when testing non-sinusoidal signals.

Waveform fidelity above 60-cps square wave usually is only moderate, as an isolating resistance is generally desired between the probe and the shielded cable, so that the probe can be used with a *vvm* for measurement of *hf* voltages which are beyond the response capability of internal demodulating facilities. In this manner, the field of usefulness of the probe is extended further.

Ruggedness to overload and mechanical shock is achieved by suitable selection of crystal type, and by suitable mounting arrangements inside the probe shell. The crystal diode must usually be selected, as the front-to-back ratios of commercial diodes vary considerably, affecting both the sensitivity and the input impedance of the probe.

Voltage-Doubler Probe

For some applications, increased probe sensitivity is desired; this can be obtained by utilizing the voltage-doubler principle, as illustrated in Fig. 12. This circuit adds the positive peak of the applied waveform to the negative peak, and thereby delivers a doubled output when sine waves are

Fig. 12. Voltage-doubler type of crystal probe. Sensitivity of this arrangement is quite high, although the input impedance is relatively low, and waveform distortion is appreciable. It is a useful type of a probe for calibrating work, permitting utilization of the higher harmonics of a quartz-crystal oscillator. The voltage of the harmonics becomes progressively less as the frequency of the harmonic is greater.

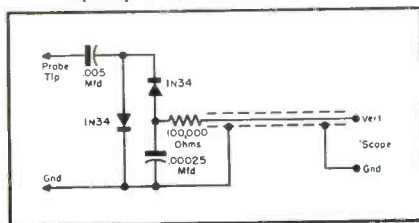

under test. When non-sinusoidal waves are under test, crystal polarity becomes a matter of inconsequence, since the output is proportional at all times to the peak-to-peak voltage of the waveform.

Hum Reproduction

Experienced Service Men are aware of the fact that considerable hum obtains in many video-amplifier circuits. The hum level may not be sufficient to affect the picture quality to an adverse extent, although it will be sufficiently high to interfere with video-amplifier adjustment procedures. The series type of probes, such as shown in Figs. 7 and 10 will be found to be quite susceptible to hum reproduction, although the blocking capacitor used in the Fig. 10 circuit does afford a considerable advantage. Of course, the input impedance is much too low for video-amplifier adjustment by the sweep-frequency method.

The shunt type of probe, with a relatively small coupling capacitor, will be found to be preferable for hum rejection, and it will be found possible to develop a video-response curve in a receiver having a relatively high hum level, without perceptible interference in the 'scope pattern.



336K Multimeter Kit \$12.90
Wired \$14.90
1000 ohms/volt

425K 5" Scope
Kit \$44.95.
Wired \$79.95.

YOU BUILD
EICO
KITS
IN ONE
EVENING-

but they
last a lifetime...
and you save
50%!*

22 Kits and 24 Instruments —
the industry's most complete
line of MATCHED
TEST INSTRUMENTS!

Over 1/4-million EICO Instruments are now in use the world over! That's the proof of EICO's leadership in **Value to the Serviceman!**

For latest precision engineering, finest components, smart professional appearance, lifetime performance and rock-bottom economy — see and **compare** the EICO line at your jobber's today **before you buy any higher priced equipment!** You'll agree with over 100,000 others that only EICO Kits and Instruments — no other — give you the industry's greatest values at lowest cost.

Write NOW for
FREE latest Catalog
S-4.



525K Tube Tester
Kit \$34.95.
Wired \$49.95.



221K VTM Kit \$25.95.
Wired \$49.95.



565K Multimeter Kit \$24.95.
Wired \$29.95.
20,000 ohms/volt.

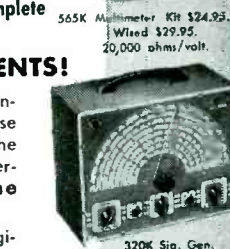

320K Sig. Gen.
Kit \$19.95. Wired \$29.95.



360K Sweep Gen.
Kit \$34.95. Wired \$49.95.



1040K Battery Elm.
Kit \$25.95. Wired \$34.95.

Laboratory
Precision
at Lowest Cost

Prices 5% higher on West Coast.

EICO

©1952 **INSTRUMENTS & KITS**
ELECTRONIC INSTRUMENT CO., Inc.
84 Withers Street, Brooklyn 11, N. Y.

ATTENTION! LONG ISLAND

SERVICEMEN • HAMS • ENGINEERS • INDUSTRIALS
EXPERIMENTERS • HOBBYISTS • MODEL RAILROADERS
for your convenience

ARROW ELECTRONICS

opens a new, complete store at
215 FRONT STREET
Hempstead, Long Island, N. Y.

Featuring complete stocks of RCA, Dumont, G.E., Sylvania and all other national lines of everything in Radio, TV and Electronic parts, equipment and components.

You are cordially invited to make Arrow, Hempstead your headquarters for all your needs in electronics. Experienced, courteous, personnel—unbeatable prices—unequaled service.

ARROW ELECTRONICS, Inc.

82 Cortlandt St., New York 7, N. Y.
215 Front St., Hempstead, N. Y.

FREE



TV

UHF
VHF

'TENNA TIPS

PRICE
\$1

**NEW
'53 EDITION**
COMPLETELY REVISED
INCLUDES { DIRECTRONIC
UHF DATA

**SIMPLIFIES ALL
TV ANTENNA
PROBLEMS**

NEEDED BY ALL IN TV

Outstanding authorities have completely revised this pocket size reference manual... packed it with clear, concise data on Directronics, UHF, all antenna types. A mine of information on many vital subjects including: Feed Methods, Channel Frequencies, Helpful Hints, Do's and Don'ts, Dimension Guide, Etc.

**LEARN ABOUT THE GREAT NEW
TV LINE
FOR '53**
Snyder
DIRECTRONIC • UHF • YAGI

PUBLICATION PRICE \$1. YOURS WITHOUT OBLIGATION IF YOU WRITE AT ONCE

**MAIL THIS COUPON TODAY—
SNYDER MFG. CO.**

Dept. A BOX #4465, Phila. 40, Pa.
Please send free copy of TV 'TENNA TIPS

Name _____

Address _____

City _____ Zone _____ State _____

Mention local jobber or dealer

Tools . . . Instruments Parts . . .

MALLORY VIBRATOR FOR 12-VOLT SYSTEMS

A vibrator, G874, for auto-radio sets designed to operate on 12-volt systems, has been announced by P. R. Mallory and Co., Inc., 3029 E. Washington St., Indianapolis 6, Ind.

Vibrator, which may be used as a replacement in auto-radio sets used in '53 Cadillacs, Buicks, Oldsmobiles and GMC trucks, measures 1½" x 3¼", and has a pin arrangement which serves as a guide for quick insertion of the vibrator into the set. Pins, which also prevent vibrator from being plugged into a 6-volt set by mistake, are arranged in a triangle formation with the longer pin connected to the reed.

* * *

VACO SCREW-DRIVER KIT

An all-purpose screw- and nut-driver kit, RT-14, in a leatherette roll, has been introduced by Vaco Products Co., 317 E. Ontario St., Chicago 11, Ill.

Kit includes seven nut drivers, two Phillips and three regular drivers with shank design for interchangeable use in one common handle. An extension piece included in the set is claimed to lengthen the reach of any of the drivers by 5".

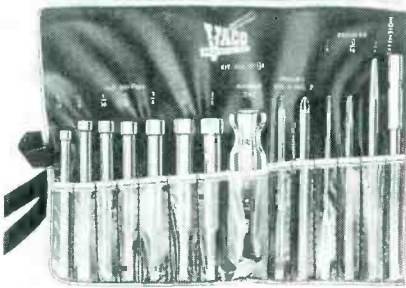

* * *

RAYOVOX 2-WAY INTERCOM

A battery-operated portable two-way intercom, *Handi-Talk*, that may be used at 50-foot distances in the installation and orientation of rooftop TV antennas has been announced by the Rayovox Manufacturing Co., 902 Albermarle Rd., Brooklyn, N. Y.

Complete unit, measuring 9¾" x 5¾" x 7", has two 4" pm speaker-microphones, two tubes, input-output transformers, 50' of extension wire with male plug at each end, and three batteries. Unit can initiate a buzzer call when the master is in the off position, and can't be closed in the case unless the listen switch is off. Also includes volume-control switch.

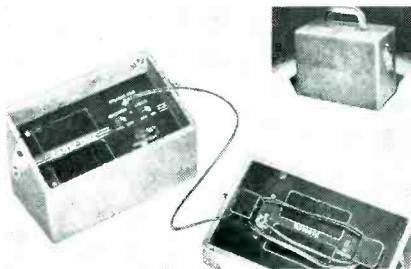

HICKOK TUBE TESTER

A portable tube tester, 533AP, that includes a test that is claimed to forecast future life expectancy of a tube, has been introduced by The Hickok Electrical Instrument Co., 10521 Dupont Ave., Cleveland 8, Ohio.

Tester is built with patented dynamic mutual conductance circuits to permit tube tests under simulated operating conditions. Contains micromho ranges of 0-3,000, 6,000, 15,000. Includes built-in bias fuse that is said to prevent accidental damage to bias potentiometer. Incorporates gas and noise tests.

Also available for permanent installations; models 533AP and 533AD.

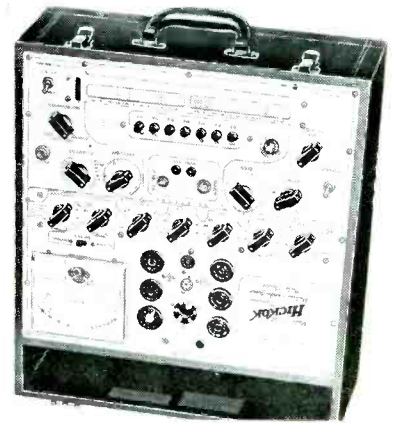

* * *

OHMITE TANDEM POTENTIOMETERS

Molded composition potentiometers, dual type AB, consisting of two units mounted in tandem and controlled by the rotation of one shaft, are now available from the Ohmite Manufacturing Co., 4897 Flournoy St., Chicago, Ill.

Two-watt pots are available in seven resistance values, linear curve, ranging from 10,000 ohms to 1 megohm. Units have a 2" long round shaft.

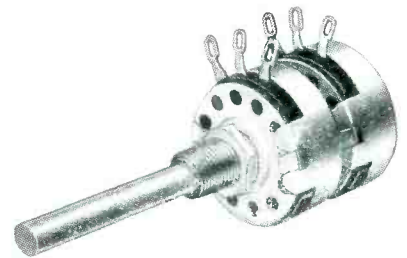

WANTED

**WE NEED YOUR SURPLUS
ELECTRONIC EQUIPMENT**

WE PAY TOP \$\$\$ FOR:

- ★ TUBES
- ★ TRANSFORMERS
- ★ COILS & PLUGS
- ★ ARC-1
- ★ ARC-3
- ★ ART-13
- ★ CLAMPS
- ★ RELAYS
- ★ RESISTORS
- ★ CONNECTORS
- ★ RADIO RECEIVERS
- ★ TRANSMITTERS
- ★ CONTROL BOXES
- ★ INDICATORS
- ★ CORDS
- ★ TELEPHONE MATERIALS

WE BUY ANYTHING!

Write, Wire today! Tell us what you have.

TALLEN CO., Inc., Dept. F
159 Carlton Ave., Brooklyn 5, N. Y.

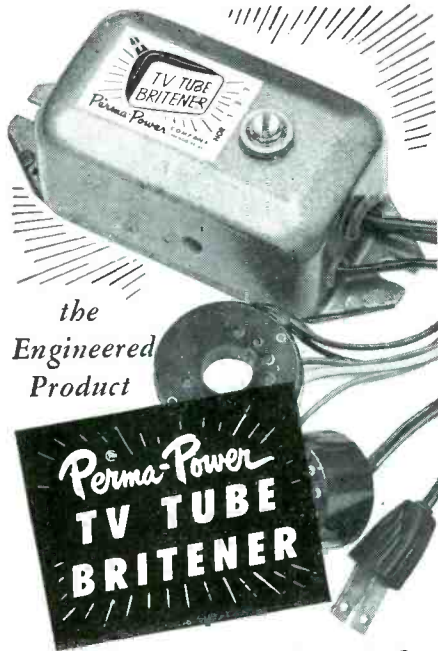

the
Engineered
Product

**extends useful life
of older TV tubes!**

manufactured by
Perma-Power COMPANY
Chicago 25, Illinois
Manufacturers of Electronic Equipment Since 1928

CARBON-TET

Finest Cleaner for Electrical Parts



1. Quickly removes oil, grease, tar and other soils from electrical parts!
 2. Safe, Won't burn! Won't explode!
 3. Won't harm finest surface or finish!
 4. Dries instantly—no odor or residue!
 5. Economical for cleaning sliding contacts, condenser plates and chassis. Also as a wash for carbon deposits.
- In gal. cans, qt. cans, 8-oz. bottles.
Order from your jobber.

THE KERDEN CHEMICAL CO.
5717 WALWORTH AVENUE • CLEVELAND 2, OHIO



For a
Classy
Chassis—
Install a
Set of Gemco
Stray-X
Filament
Chokes



**GREAT EASTERN
MANUFACTURING CO.**
BROOKLYN 12, NEW YORK

PHILCO TUBE CHECKERS AND 'SCOPE

Three test instruments, a mutual-conductance dynamic tube checker, 7052; picture-tube checker, 7053; and a 3-inch 'scope, 7020, are now available from the accessory division of the Philco Corp., C and Tioga Streets, Philadelphia, Pa.

Dynamic tube checker tests and measures mutual conductance of miniature, sub-miniature, and low-power transmitting tubes; provides a means of forecasting remaining tube life by simulating tube operation conditions; checks shorts and leakages between elements of tubes under test; and determines noise characteristics of tubes under test.

Picture-tube checker determines action of the electron gun, using a neon lamp to indicate shorts and open elements in the electrodes of the gun; also used as the indicating element in a bridge circuit to check cathode emission. Instrument is said to test all picture tubes used in home TV receivers; special picture tubes can be checked by using special adapters which can be plugged into the octal socket in the front of the tester.

The 3-inch 'scope is adaptable to either bench or field use. Vertical deflection amplifier is said to be a wide band, dc-coupled amplifier. Sweep oscillator has in addition to its variable sweep ranges, four pre-set sweep frequencies for black and white, and frame-sequential color TV servicing. Included also is a 60-cycle sine-wave sweep with phasing control for use in sweep alignment.

ELLIOTT VTVM

A vacuum-tube voltmeter, model 940, that is claimed to provide peak to peak or rms voltages with a frequency response of 25 to 100,000 cycles, has been developed by Elliott Laboratories, 50-34 201 St., Bayside, N. Y.

Voltmeter, which utilizes a dual-triode balanced-bridge circuit, features ac and dc voltages that are read on 6 ranges: 3, 15, 30, 150, 300, and 1,500 volts; also features a center position for discriminator alignment. Resistance is measured in five ranges from 0-1,000, 10,000, 1 megohm, 10 megohms, and 1,000 megohms. Included are five db ranges from -24 to -1.5, -8 to -15, +12 to +35, +21.5 to +44.5, +32 to +55 db.



CORRECTION

Patents 2,585,670 and 2,609,503, covering TV and radar antennas, reported in the February issue of SERVICE to have been granted to the All-Channel Antenna Corp., were actually granted to Marvin P. Middlemark, who has licensed All-Channel on a royalty basis.

ANACONDA UHF LINE

was adapted for use because it was found to be the most reliable available; had lowest losses under adverse weather conditions . . .

- high-strength conductor
- unique inner construction
- reliable over the entire range of both VHF and UHF channels

**ORDER TODAY! Carried
by leading jobbers.**

Manufactured by Anaconda
... supplied by "Columbia"



National distributors and warehouse for ANACONDA denseath television and radio wires and cables

Columbia

WIRE & SUPPLY CO. 2850 Irving Park Road Chicago 18, Illinois

New "UHF" Line
for the first commercial
UHF Telecasts

BIG PROFITS:

Repair CRTs his Easy Way



EVERY SERVICE SHOP CAN MAKE BIG MONEY with these PATENTED INSTRUMENTS for

1. TESTING picture tubes accurately.
2. REACTIVATING dim or worn out tubes.
3. SPARKING OUT electrical leakage.

CRT TESTER—REACTIVATOR—SPARKER

3 Instruments in 1, making a complete CRT testing and repair unit... It's a combination of the Transvision Tester-Reactivator and a Sparker in one handy unit. It TESTS picture tubes—measures Cathode emission, locates shorts between elements, locates high resistance shorts or leakage as high as 3 meg-ohms. REACTIVATES dim tubes. SPARKS OUT electrical leakage.



\$34.95 net

CRT TESTER—REACTIVATOR

2 Instruments in 1... As a REACTIVATOR it renews brightness and detail of dim CR Tubes, without removal of tube from set. It's also an accurate TESTER same as the above. 110V-60 cycles; wt. 3 lbs.

only \$19.95 net



CRT TESTER—SPARKER

2 Instruments in 1... As a SPARKER, it sparks out electrical leakage between

elements. Saves many picture tubes and small tubes which would usually be discarded. Cathode-grid leakage is an especially common occurrence. The Sparker also gives a rapid check of gas condition of the tube.

As a TESTER it provides a variable 8,000-14,000 V D.C. supply—useful for analyzing hard-to-solve deflection problems..... \$25.95 net



Order direct from factory:

TRANSVISION INC., NEW ROCHELLE, N. Y.

FREE: Sample copy of "TV and Electronics Notes". Or send 50c for year's subscription.

10 DAY TRIAL: Buy and try these fine instruments for 10 DAYS. Then, if you wish, you may return them. Your purchase price less 10% (our cost of handling and re-packaging) will be promptly refunded.



TRANSVISION, INC.

DEPT. SR-4 NEW ROCHELLE, N. Y.

() Send me _____ deposit. Balance C.O.D.

() Enclosed find \$_____ in full.

I accept your 10 Day Trial terms.

Name _____
Address _____
City _____ State _____

TV Antennas

(Continued from page 79)

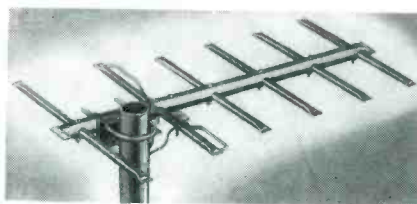

fringe areas, the filter again permits the use of but one leadin.

Employed is a printed circuit, using a twin-tee filter on which a patent is said to be pending. It is less than two inches square, and purposely small to prevent resonance on short uhf wavelengths. Factory sealed in a water-proof plastic case.

Snap-in chimney mount. Made of steel, 1/4" thick. Y-type construction is said to eliminate twisting or warping of brackets due to mast vibrations after installation. (T-V Products Co., Model CM-500.)

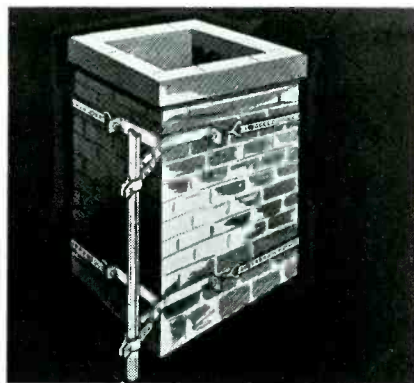

(Left)
A 6-element uhf antenna which uses 3/4" aluminum tubing for the boom and 1/2" for the elements. Ends are crimped. (Danforth Manufacturing Co., Monmouth, Ill.)



At recent display of Delta-Beam indoor antenna during music festival at Macy's in N. Y. C. At left, Gloria Ovis, TV starlet; center, Sam Gertz, president of K-G Electronics Corp., manufacturers of the antenna, and right, David Kubrick, N. Y. rep.

A 2-set coupler that is said to be automatic. Coupler is claimed to provide maximum gain for each receiver and minimize interaction. Utilizes long-line transformer arrangement. (Snyder Manufacturing Co.; AC-800).

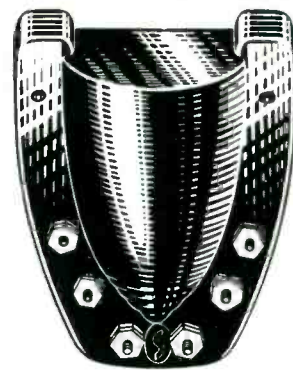

PAY LESS FOR TUBES

INDIVIDUALLY BOXED • FULLY TESTED • EACH TUBE GUARANTEED FOR SIX MONTHS

Type	Price	Type	Price	Type	Price	Type	Price
1B3GT	\$.69	6A55	\$.50	6L6G	\$.80	12BA6	\$.45
1H5GT	.46	6AT6	.38	6L6GA	.80	12BE9	.47
1L4	.57	6AU6	.43	6Q4	.46	12BH7	.43
1N5GT	.57	6AV6	.38	6SA7GT	.52	12BZ7	.75
1R5	.56	6B4G	.96	6SJ7GT	.47	12SA7GT	.52
1S5	.47	6BA6	.45	6SK7GT	.50	12SK7GT	.50
1T4	.56	6BC5	.53	6SL7GT	.82	12SL7GT	.61
1T5GT	.71	6BD5GT	.89	6SN7GT	.54	12SN7GT	.54
1X2	.67	6BE6	.47	6SQ7GT	.42	12SQ7GT	.44
3Q5GT	.85	6BF5	.80	6T6	.78	19B6G	1.39
3SA	.55	6BG6	1.34	6U8	.85	19C5	.94
3V4	.58	6BH6	.57	6V6GT	.46	19T8	.79
5U4G	.43	6B16	.48	6W4GT	.45	25BQ6	.89
5V4G	.73	6BK7	1.10	6W6GT	.57	25L6GT	.48
5Y3G	.34	6BL7	.83	6X4	.34	25Z6GT	.42
5Y3GT	.30	6BQ6	.89	6X5GT	.33	35A5	.48
6AB4	.46	6BQ7	1.10	6V8	.59	35B5	.47
6AF4	1.40	6BZ7	1.10	7N7	.52	35C5	.47
6AG5	.54	6C4	.34	12AT6	.68	35L6GT	.47
6AK5	.95	6CB6	.53	12AT7	.68	35W4	.31
6AK6	.63	6CD6	1.85	12AU6	.43	35Z5GT	.30
6AL5	.40	6F6GT	.45	12AU7	.55	50B5	.47
6AN4	1.30	6H6GT	.49	12AV6	.38	50C5	.47
6AQ5	.46	6J5GT	.40	12AV7	.80	50L6	.38
6AR5	.42	6J6	.82	12AX7	.61	11Z23	.58
		6K6GT	.41	12AZ7	.70	11Z26	.68

Motorola Ballast Tube #17A485459..... .30
Each tube is performance-proven. 25% deposit must accompany all orders. Balance C.O.D. All prices F.O.B., N.Y.C. If remittance is made with order, you can deduct 2%. \$1.00 handling charge for orders under \$10.00. Subject to Prior Sale. Importer Inquiries Invited.

PHILLIPS TUBE CO

2281 Nostrand Ave., Dept. 8
Brooklyn 34, N. Y. CLoverdale 3-8010-1-2

XCELITE Hand Tools

PREFERRED BY THE EXPERTS

You're Time—And Money—
Ahead with this
HAND-SIZE "TOOL CHEST"

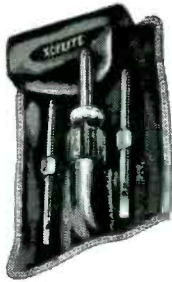

That big 1 3/16" diameter hand-fitting XCELITE handle fits those quick-change blades to give you No. 1, 2 or 3 Phillips or 3/16, 1/4 or 5/16 regular screwdrivers in a flash. And the handle is also a 7/16 hex nut RETAINER and driver for mounting TV antennas. Yet the whole kit rolls up to compact hand or pocket size. No wonder so many servicemen call it a hand-size "tool chest". And best of

all, you're getting 7 quality tools for only \$4.70 list! Ask your supplier TODAY!

XCELITE, INCORPORATED

Formerly Park Metalware Co., Inc.
Dept. V, ORCHARD PARK, N. Y.



RCP TV-AM-FM SERVISHOP

A test-equipment combination, for servicing TV-AM-FM equipment, 8010 Servishop, housed in a portable oak case, has been introduced by Radio City Products Co., Inc., 152 W. 25th St., New York 1, N. Y.

Included in the combination are: a TV signal marker and pattern generator; an AM, FM, af signal generator; a 3" scope; and a combination tube tester, picture-tube tester-reactivator and ac-dc vvm with hi-voltage multiplier probe.

MICRO-CIRCUITS SHIELDING PAINT

Conductive shielding paint, RS12, for static shielding of picture tubes, meters, hv power supplies, and hv generator windings, has been developed by Micro-Circuits Co., Dept. RT, New Buffalo, Mich.

Available in four-ounce bottles to five-gallon drums. Paint is said to have high conductivity, high adhesion and durability, heat resistance, mild pigment settling, and a viscosity suitable for spraying.



TV Parts . . . Accessories

WALSCO ANTENNA WALL PLATE AND CONNECTOR

A plastic TV-antenna wall plate, and a transparent antenna connector, have been introduced by the Walter L. Scott Co., 3225 Exposition Pl., Los Angeles 18, Calif.

Wall plate, which is designed to fit all standard junction boxes, may be mounted close to wall or base board. Available in brown or ivory plastic. Polarized connectors are molded of transparent low loss plastic with one male prong and one receptacle on each plug. A 300-ohm twin lead can be attached to the plug with set screws.

* * *

WOODCRAFTERS TV BASE AND TABLE

TV bases, of grained, 5-play veneer, with solid top, in mahogany, limed oak or blond finish, have been introduced by Universal Woodcrafters, Inc., La Porte, Ind. Bases are made for use with any TV set, including 21-inch models. Upper portion of 21-inch model table, top and rails, rotates on a ball-bearing center unit. Made of 5-ply veneer, legs of hardwood, and available in mahogany, limed oak or blonde finish.

* * *

BUD HIGH-PASS FILTER

A filter, that is said to eliminate or reduce TV interference from broadcast stations, amateur transmitters, diathermy and X-ray equipment, auto ignition systems, etc., has been developed by Bud Radio, Inc., 2118 East 55th St., Cleveland 3, Ohio.

Filter is designed to have a cutoff frequency at 42 mc. Size of the unit is 3 1/4" x 2 1/8" x 1 1/8"; it is housed in an aluminum case installed on the rear of the TV cabinet.

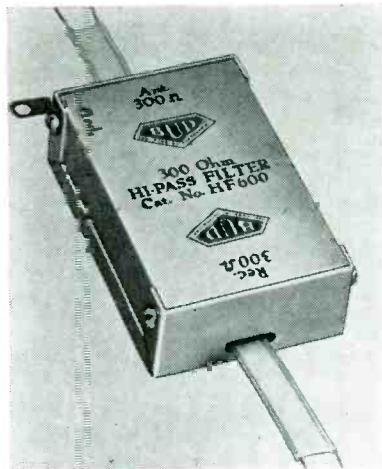

* * *

G-C FORMS DIVISION TO DISTRIBUTE TV HARDWARE

A manufacturing and distributing division, Television Hardware Manufacturing Co., to handle TV hardware items exclusively, has been announced by General Cement Manufacturing Co., 919 Taylor Ave., Rockford, Ill.

Division's products will be handled by regular G-C reps in most territories.



L. Veltri, busy service-dealer of Westchester, N. Y., reports:

I SAVED \$940*
by making a \$59 INVESTMENT
in a Transvision
FIELD STRENGTH METER

* Says Mr. Veltri: "... The way I figure, in the last 6 months I saved that much money in installation time alone ..."



FIELD STRENGTH METER
Saves 50% of Installation Cost
Pays for itself on 3 or 4 jobs

NO TV SET NEEDED

Works from antenna . . . Measures actual picture signal strength directly from antenna. Shows antenna orientation maxima. Compares gain of antenna systems. Measures TVI on all channels. Checks receiver re-radiation (local oscillator). Permits one man antenna installation.

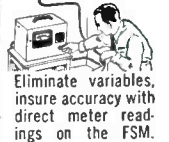

Eliminate variables, insure accuracy with direct meter readings on the FSM.

PREVENT WASTE OF SERVICING TIME! By checking antenna performance with the *Field Strength Meter*, the serviceman can determine whether the TV set or antenna, or both, are the source of trouble. Call backs are eliminated.



Don't lug sets. The Transvision FSM makes installation easy.

Wide range: Measures field strength from 10-50,000 microvolts. Has *Fringe Area Switch* for weak signal areas. 13 channel selector. Individually calibrated on every channel.

ADAPTABLE for UHF

Model FSM-2, for 110V AC only. Complete with tubes. Wt. 13 lbs. net \$59.

Model FSM-3B, for 110V AC and Battery Operation (all batteries and cables included). Wt. 22 lbs. net \$79.

Order direct from factory:

TRANSVISION INC., NEW ROCHELLE, N. Y.

FREE: Sample copy of "TV and Electronics Notes". Or send 50¢ for year's subscription.



10 DAY TRIAL

Buy and try this fine instrument for 10 DAYS. Then, if you wish, you may return it. Your purchase price less 10% (our cost of handling and re-packaging) will be promptly refunded.

TRANSVISION, INC.
DEPT. S3-F NEW ROCHELLE, N. Y.

() Send me _____ Model FSM-2; _____ FSM-3B

() Enclosed find \$ _____ deposit. Balance C.O.D.

() Enclosed find \$ _____ in full.

I accept your 10 Day Trial terms.

Name _____

Address _____

City _____ State _____



Industrial
Television Inc.

TECHNI-TOPICS

By **LEN MAZEL**

NEW IDEAS For Product Utilization

EVERY TV SET SHOULD HAVE A TENNA CLIP INSTALLED. Trying to clean in cramped quarters behind her TV set, the average housewife sometimes will accidentally tear the antenna lead. The lead usually has little if any slack, because servicemen know that slack lead-in, coiling upon itself or hanging against the receiver, invites severe signal losses, oscillation, and other troubles. The average housewife is reluctant to disconnect the antenna lead because she fears shock.

Her braver sister will locate a screw driver and remove and replace the lead-in wires. All too frequently, however, she will neglect to properly twist the wire strands together, and a strand will short over to the other terminal. Other times, the tip of the wire is insufficiently tucked under the screw, and shorts over to the other terminal.

Wise servicemen prevent such difficulties before they even start, by selling a Tenna Clip installation. Lead-in tipped with an ITI Tenna Clip is removed or replaced with a snap of the fingers! At the service bench, and for many other uses, the utility of ITI Tenna Clips has been proven, but millions of homes have not yet had a Tenna Clip installed.

Another product having many more uses than at first realized, is the IT-116B RECHARGEABLE BATTERY PACK. Acclaiming the IT-116B as a power source for the AC-or-Battery-Operable IT-105RB FIELD STRENGTH METER, many servicemen have not yet realized that it can also power receivers, amplifiers, and many other pieces of field equipment requiring 150 Volt DC and/or 6 Volt DC. The IT-116B has a 120 Watt-hour capacity, before charging is necessary.

COMPLETE is the word for the IT-116B. This compact pack not only contains batteries with charge indicators, but also recharger vibra-pack, ripple filter, etc. A hydrometer and a "cheater" line cord are also shipped with every IT-116B RECHARGEABLE BATTERY PACK. Units to be powered are simply plugged into the IT-116B. When recharging is needed, the "cheater" is plugged into the IT-116B, and into any AC wall outlet.

For free reprints of previous "Techni-Topics," illustrated literature on ITI Tenna Clips, IT-116B RECHARGEABLE BATTERY PACK, and on other helpful TV accessories, write now to Industrial Television Inc.

Industrial Television, Inc.

369 LEXINGTON AVENUE CLIFTON, N.J.
GRegory 3-0900

JOTS AND FLASHES

GRUELLING factory shock and bounce tests, subjecting TV chassis to far more punishment than they will ever get in normal use, are now featured in a quality-control program of a leading midwest setmaker. According to the superintendent of this operation, chassis are literally bounced along nearly one-quarter mile of steel roller racks to check for weak tubes, loose wires, poorly soldered connections or defective components. At various stations, inspectors troubleshoot for any defects in vertical and horizontal hold and linearity, width and height of picture, snow, etc. Chances are about three to one that any faulty parts will show up after the set comes off this line, it was noted. . . . Closed-circuit TV in American business and industry may become more widespread and important in the future than TV in the home, and a vital factor in the future of servicing, a video executive declared recently during a meeting of professional engineers. . . .

George's Radio and TV Co., Washington, D. C., is building a warehouse with 200,000 square feet of space, according to *George Wasserman*, firm's prexy. . . . *General Instrument* is enlarging its three plants, has acquired a fourth, and is said to be searching for a fifth in a large-scale expansion program. . . . The Fourth Annual Convention and Manufacturers' Conference, sponsored by NEDA, will be held in St. Louis, Mo., September 14, 15, and 16. . . . A two-way radio service clinic, sponsored by *Motorola Communications and Electronics Inc.*, convened recently at the Somerset Hotel, Boston, Mass. Service Men representing public utilities, forest products, industrial and emergency service operations from the states of Maine, Mass., N. H., Vt., R. I. and Conn. were present. . . . *Raytheon TV and Radio Corp.*, formerly Belmont Radio Corp., a wholly owned subsidiary of Raytheon Manufacturing Co., will be merged into the parent company as of the close of business on May 31. . . . It has been predicted that clock-radio sales by all manufacturers will run well over 2,000,000 in '53. Sales of clock-radios in '52, according to RTMA reports, were 1,700,359 . . . up 118% over '51s 770,000.

AIEE, IRE, RTMA and the West Coast Electronic Manufacturers Association are cooperating in the presentation of the '53 Electronic Components Symposium, which will be held on April 29, 30 and May 1, 1953, at the Shakespeare Club, Pasadena, Calif. . . . *The National Co., Inc.*, Malden and Melrose, Mass., has been awarded a contract from the Bureau of Ships, U.S. Navy department, for the manufacture of communication radio receivers. . . . *Hart Lehman*, veteran ad agency man, recently celebrated his 25th year in the agency business. . . . *Cameradio Co.*, Pittsburgh parts jobber for over 34 years, are now in their new four-story building at 1121 Penn. Ave. Samuel Zions is prexy, and Harry Caplan, vice prexy. . . . *Robert D. Winston* has been appointed sales manager—commercial products division, of the Audio and Video Products Corp., 730 Fifth Ave., New York 19, N. Y. . . . *C. Kenneth Hersey* has been appointed sales manager of the downtown sound department of Hudson Radio and TV Corp., 212 Fulton St., N.Y.C. . . . *Merit Coil and Transformer Corp.*, Chicago, Ill., has renewed with Howard W. Sams and Co., Inc., Indianapolis, Ind., for the listing of its coil and transformer products in Photofact manuals and other services.

ADVERTISERS IN SERVICE

APRIL, 1953

Admiral Corporation	19
Alliance Manufacturing Co.	4
American Electrical Heater Co.	81
American Phenolic Corporation	68, 69
American Television & Radio Co.	65
Argos Products Co.	2
Arrow Electronics Co.	99
Astron Corporation	1
Audel, Publishers	90
Blonder-Tongue Laboratories, Inc.	75
David Bogen Co.	82
Bussmann Manufacturing Co.	73
Centralab Division Globe-Union, Inc.	5
Channel Master Corporation	14, 15
Columbia Wire & Supply Company	101
Copperweld Steel Co.	96
Cornell-Dubilier Electric Corporation	44
Cornell-Dubilier Radiart	95
Crest Laboratories, Inc.	97
Delco Radio Division General Motors Corporation	13
Electronic Instrument Co., Inc.	99
General Cement Manufacturing Co.	67
General Electric	52, 53
General Electric Lamp Department	86
Grayhill	98
Great Eastern Manufacturing Co., Inc.	90, 101
Halldorson Transformer Co.	48
Heath Company	86
Hytron Radio & Electronics Co.	21
Industrial Television, Inc.	104
International Rectifier Corporation	98
Jackson Electrical Instrument Co.	79
Jensen Industries, Inc.	84
Jersey Specialty Co.	96
Kay Electric Co.	80
Kenwood Engineering Co., Inc.	98
Kerden Chemical Co.	101
Kester Solder Co.	82
LaPointe Electronics, Inc. (VEE-D-X)	12
The Macmillan Co.	80
P. R. Mallory & Co., Inc. Inside Back Cover	
Mannfred Electronics Corp.	84
Mosley Electronics	92
National Electric Products	8, 9
Olin Industries, Inc.	24, 25
Perma-Power Co.	101
Philco Corporation	59
Phillips Tube Co.	102
Pyramid Electric Co.	31
Quam-Nichols Co.	87
Radelco Manufacturing Co.	64
The Radiart Corporation	
Inside Front Cover,	78
Radio City Products Co., Inc.	23
Radio Corporation of America	
17, 55, 71, Back Cover	
Radio Merchandise Sales, Inc.	10
Radio Receptor Co., Inc.	94
The Radion Corporation	16
Raytheon Manufacturing Co.	26
Regency Division I.D.E.A., Inc.	18
John F. Rider Publisher, Inc.	77, 88
Howard W. Sams & Co., Inc.	84
Sangamo Electric Co.	93
Scala Radio Co.	94
Schauer Manufacturing Corp.	92
Walter L. Schott Co.	61
Simpson Electric Co.	45, 49
Skyline Manufacturing Co.	85
Snyder Manufacturing Co.	100
South River Metal Products Co., Inc.	6
Sprague Products Co.	3
Standard Transformer Corporation	91
Sylvania Electric Products, Inc.	63
Sarkes Tarzian, Inc.	11
Tallen Co., Inc.	100
Telrex, Inc.	22
Transvision, Inc.	80, 102, 103
Triad Transformer Manufacturing Co.	78
Trio Manufacturing Co.	78
Triplett Electrical Instrument Co.	20
Tung-Sol Electric, Inc.	32
Utah Radio Products Co., Inc.	96
Vee	88
Vidaire, Inc.	96
Waldom Electronics, Inc.	88
Wall Manufacturing Co.	60
The Ward Products Corporation Division The Gabriel Co.	7, 28
Webster Electric	83
Wen Products, Inc.	89
Xcelite, Inc.	103

*Depend on Mallory
for
Approved Precision Quality*



“Better Than Ever”

“I put a Mallory Vibrator in it. Used ’em for years on all my service work and haven’t had a call-back yet.”

That is the main reason you’ll find 5 out of 6 service men using Mallory Vibrators for all their service work. When you put a Mallory Vibrator in a set, the job stays sold . . . no call-backs . . . no wasted time to run up costs.



The patented, tuned mechanism in Mallory Vibrators is the secret of their dependability and long life . . . the reason they are more widely used as original equipment than all other makes combined.

These exclusive performance features give you better vibrators, available in a complete line, meeting or exceeding original equipment specifications . . .

Slow contact make . . . for less wear

High contact pressure . . . for low resistance

Fast clean break . . . for reduced arcing

Next time you order vibrators . . . ask for Mallory. It is a sure way to beat the call-back problem . . . be sure all your service jobs stay “sold”.

MALLORY

CAPACITORS • CONTROLS • VIBRATORS • SWITCHES • RESISTORS
RECTIFIERS • POWER SUPPLIES • FILTERS • MERCURY BATTERIES
APPROVED PRECISION PRODUCTS

P. R. MALLORY & CO., Inc., INDIANAPOLIS 6, INDIANA

A
good name
to live by...

THIS COULD BE YOUR SHOP . . . and your good name on the Dealer Identification Plaque—for everyone to see.

And this could be a *new* customer at the door—confident that, in dealing with you, his set will be in good hands.

And, he would be right . . . because you've learned from experience that the superior quality of RCA receiving tubes and kinescopes is your best measure of protection against premature tube failures.

Helping to safeguard *your* good name is a vital, everyday service of RCA Tubes. And that protection is yours at no extra cost.

Learn from your *RCA Tube Distributor* how *two* good names can prosper together . . . how *you* can qualify for a Registered Dealer Plaque.

**DYNAMIC NEW PROMOTION PLAN
 TO HELP YOU BUILD YOUR BUSINESS**

Ask your RCA Tube Distributor for a copy of the colorful, 16-page booklet "A Magic Pass-Key to Customer Confidence." A brand-new campaign is outlined, illustrated, and described in full detail. Be sure to get your copy. It's free!



RADIO CORPORATION of AMERICA
 ELECTRON TUBES

HARRISON, N. J.