

SERVICE

FEBRUARY
1952

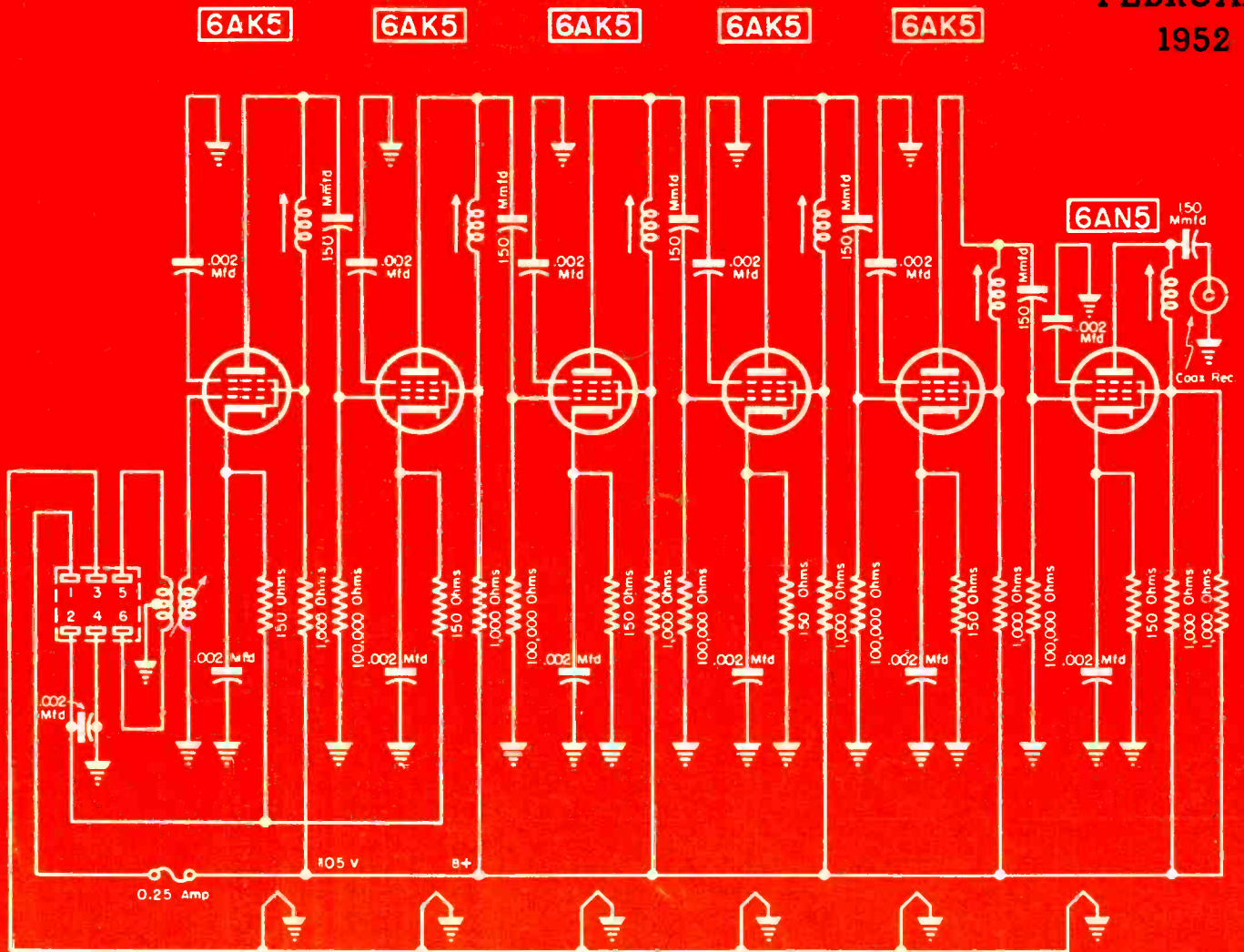

FM and TV high-channel strip of master-antenna amplifier which has an overall maximum voltage gain of about 4000.

[See page 2]

NOW

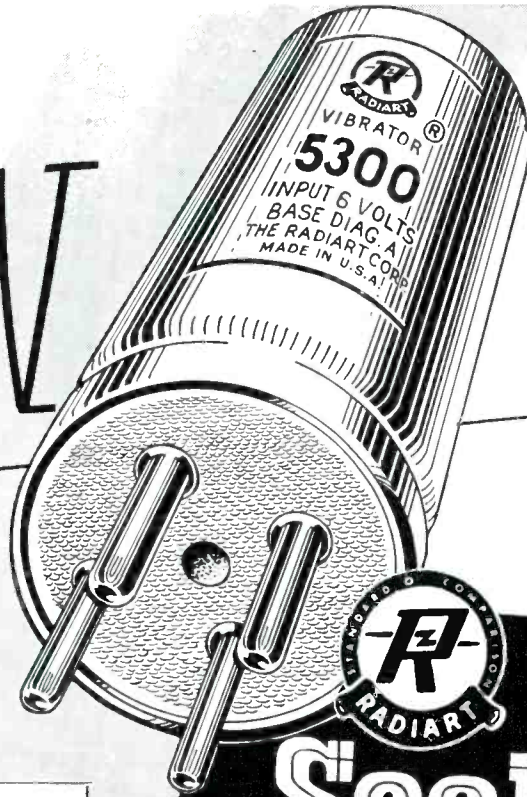

the greatest
improvement
in vibrators

in 17 years*

RADIART
Seal-Vent
RED SEAL VIBRATORS

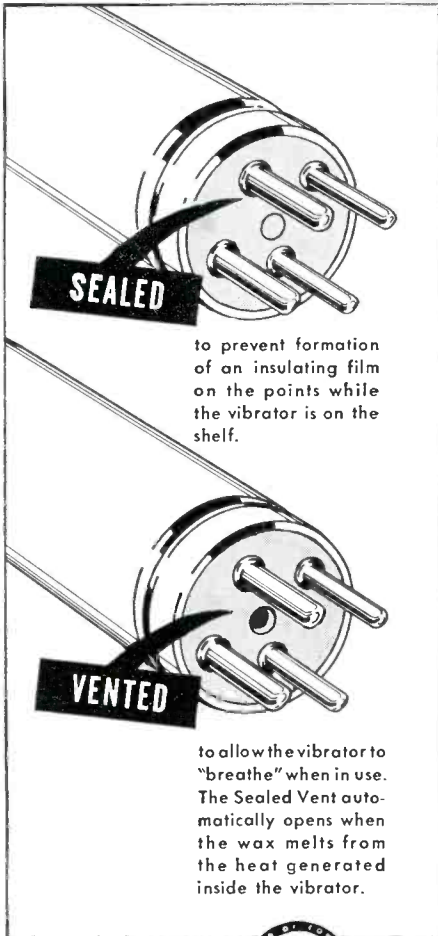

Who said you can't have your cake and eat it, too? WE'VE FOUND A WAY! The famous RADIART "RED SEAL" Vibrator that has been the standard of comparison of the industry for decades now is better than ever! The RED SEAL sandwich of rubber and bakelite NOW has a vent that is wax-sealed at the factory to prevent oxidation of the points. When the vibrator is put into use, the wax melts out and permits air circulation for EVEN GREATER PERFORMANCE AND STILL LONGER LIFE! Unquestionably, this is the GREATEST ADVANCEMENT IN VIBRATORS SINCE THE CHANGE TO PLUG-IN DESIGN . . . get yours NOW!

*in our opinion the greatest improvement since the change from a permanently-wired-into-the-set vibrator to the plug-in design.

for additional literature and catalog sheets, see your jobber or write



THE RADIART CORPORATION CLEVELAND 2, OHIO

VIBRATORS • AUTO AERIALS • TV ANTENNAS • ROTATORS • POWER SUPPLIES

THEIR CHOICE IS *Regency*

WALLACE E. CARROLL
PRESIDENT SIMPSON ELECTRIC COMPANY
RAY SIMPSON
CHAIRMAN OF THE BOARD
PHOTOGRAPHED IN MR. CARROLL'S HOME

LARGEST SELLING BOOSTER AT ANY PRICE



VIKING speakers by Jensen

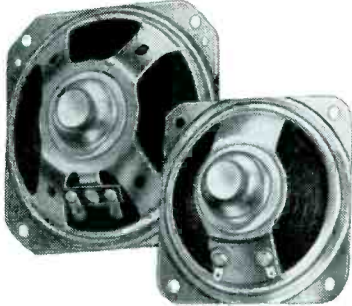

low cost replacement
speakers by Jensen . . .
makers of the World's
Finest Loudspeaker—
the G-610 Triaxial

Jensen

JENSEN MANUFACTURING COMPANY
DIVISION OF THE MUTER COMPANY
6601 S. LARAMIE AVENUE • CHICAGO 38, ILLINOIS

Viking speakers—
manufactured with the
same engineering and
production skills which go
into every Jensen product—
are designed especially for
low-cost replacement and
utility applications. The
Viking line includes 12
models from 3½" to 12"
with 4" x 6", 5" x 7" and
6" x 9" ovals, all P.M.
An accessory bracket,
designed especially for the
Viking series, solves
chassis and transformer
mounting problems.

BURTON BROWNE ADVERTISING

Vol. 21, No. 2



February, 1952

LEWIS WINNER
Editor

F. WALEN
Assistant Editor

Registered U. S. Patent Office
Including Radio Merchandising and Television Merchandising

Association News	50
Audio Installation and Service (Two-Speed Tape Recorders). By Kenneth Stewart	34
Business Aids (Estimating Operational Costs for New Shop)	52
Fast-Acting AGC Systems. By Charles E. Bowers	22
Master Amplified TV Antenna System (Cover). By Wyn Martin	20
Ser-Cuits (RF Chassis of TV Models). By M. W. Percy	38
Service . . . The National Scene	15
Servicing and Alignment of FM Chassis. By Rudolf F. Graf	42
Servicing Helps. By M. A. Marwell	30
Speeding Up TV Troubleshooting. By Cyrus Glickstein	18
Ten Years Ago in Associations	50
Training School for Service Men. By Walter Boiko	26
Tube News (Germanium Diodes). By L. M. Allen	46
TV Replacement Controls. By Fran Chamberlain	37
Views and News. By Lewis Winner	13

AUDIO INSTALLATION AND SERVICE

Magnetic Recording (Erasing—Playback—Equalization)	71
Tape Speed Controls	35
Two-Speed Tape Recorders	34

CIRCUITS

FM Detector Circuits and Test Points	43
FM Preemphasis and Deemphasis Circuits	42
Keyed AGC Circuit with Single Video Stage	22
Keyed AGC Circuit with 6AC7 Amplifier	22
Limiter Stage Circuitry	42
Philco 44 RF Chassis	39
Philco 7020 TV 'Scope	40
RCA Horizontal-Deflection Circuit and HV Supply for 20CP4 and 21AP4	47
Sylvania 1-502 TV Chassis Revised HV Section	30
Transvision-Amplitel FM and High-Channel TV Antenna Strip (Cover)	20
Video-Amplifier with Two Video Stages	22
Webster-Chicago 210 Tape Recorder	35

COVER

Master Amplified TV Antenna System (Transvision-Amplitel)	20
---	----

SERVICING HELPS

Area-Selection Switch Applications	30
Buffer Capacitors in Auto Radios	61
Centering and Focusing Electrostatically-Focused Tubes	30

Index to Advertisers

Manufacturers	80
Jobs and Flashes	80
News	62
New Parts . . . Tools . . . Instruments	55
Rep Talk	56
TV Parts . . . Antennas . . . Accessories	54



Entire contents Copyright 1952, Bryan Davis Publishing Co., Inc.

Published monthly by Bryan Davis Publishing Co., Inc.

52 Vanderbilt Avenue, New York 17, N. Y.

Telephone MUrray Hill 4-0170

Bryan S. Davis, Pres. Paul S. Weil, Vice-Pres., Gen. Mgr. F. Walen, Sec. A. Goebel, Cir. Mgr.
Mid-West Representative: Stuart J. Osten, 333 N. Michigan Ave., Chicago 1, Ill. Telephone: DEarborn 2-3507
East-Central Representative: James C. Munn, 2253 Delaware Dr., Cleveland 6, Ohio. Telephone: ERievview 1-1726
Pacific Coast Representative: Brand & Brand, 1052 W. Sixth St., Los Angeles 14, Calif. Tel.: Michigan 1732
Suite 1204, Russ Building, San Francisco 4, Calif. Telephone: SUTter 1-2251

Entered as second-class matter June 14, 1932, at the Post Office at New York, N. Y., under the Act of March 3, 1879. Subscription price: \$2.00 per year in the United States of America and Canada; 25 cents per copy. \$3.00 per year in foreign countries; 35 cents per copy.

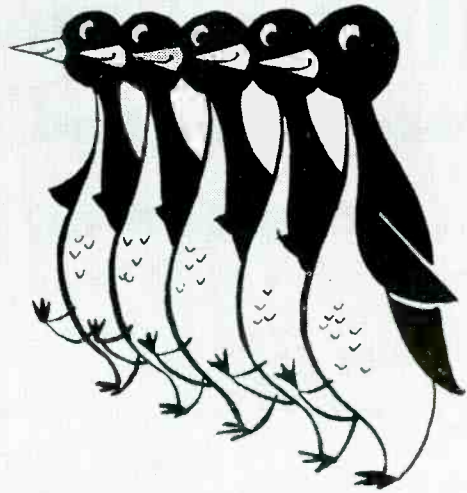

UNIFORM

KESTER "RESIN-FIVE" CORE SOLDER

UNIFORM control of soldering with different solder diameters

The two Solders that Kester offers for your use, "Resin-Five" Core Solder and Plastic Rosin-Core Solder, have a valuable feature with which you should be familiar . . . the many diameters or strand sizes available.

You are aware of the standard sizes of $3/32"$ and $1/16"$, but Kester can also give you the fine wire sizes of $3/64"$, $1/32"$ and others that so often prove far more practical for soldering "difficult to reach" spots.

If your jobber doesn't have these sizes in stock, he can get them quickly.



KESTER SOLDER COMPANY

4248 Wrightwood Ave., Chicago 39
Newark 5, New Jersey • Brantford, Canada



The Webcor[®] "106" recommended by servicemen

Custom
installation by
Voice & Vision, Inc.

There's good reason why radio service dealers are installing thousands of Webcor "106" Diskchangers every week.

First of all, the simplicity of the Webcor design enables the servicemen to make quick, easy installations.

And second, once installed there is an absolute minimum of adjustment and repair.

And the customer recognizes that the name Webcor by Webster-Chicago means that he is buying a nationally advertised product.

There's big promotion news on the Webcor Diskchangers—call your distributor today.

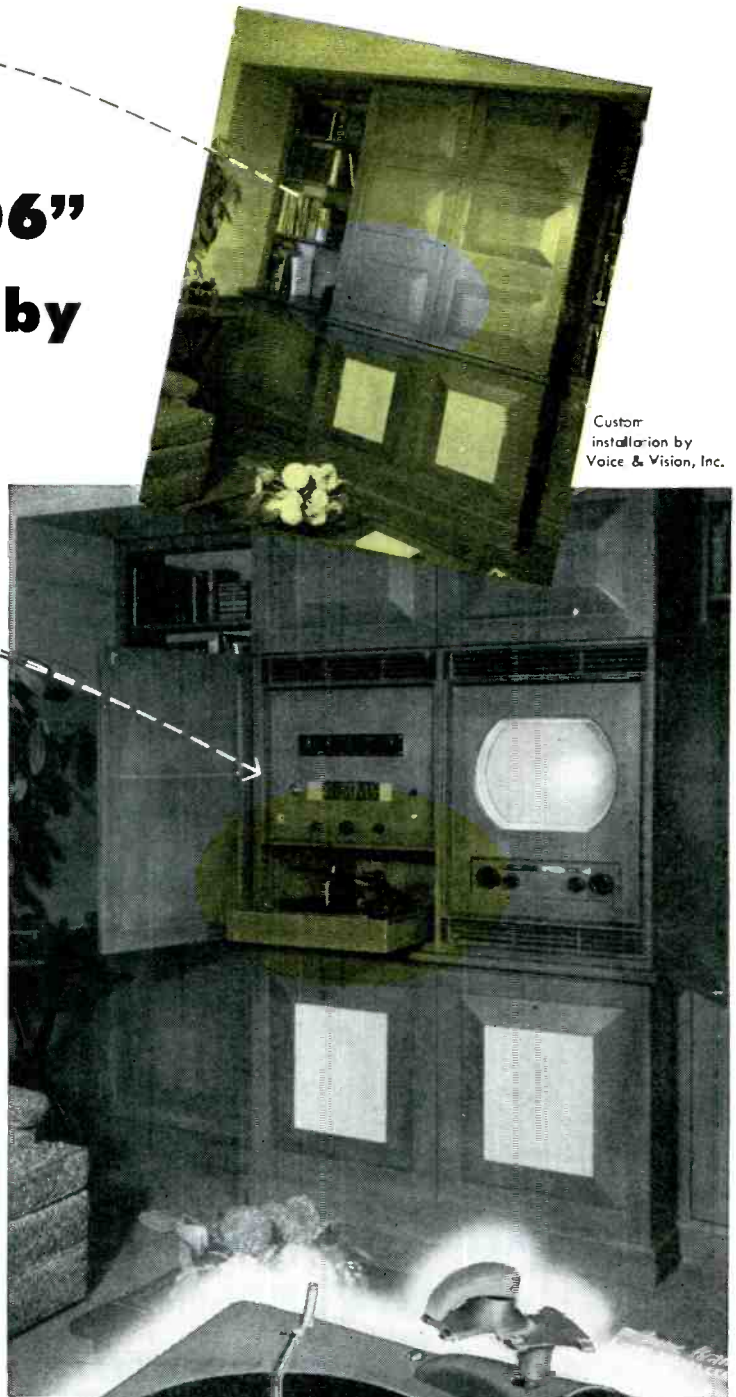

If it's made by Webster-Chicago,

*it's **Webcor***

... and if it's Webcor

it is the finest

*Webcor is a registered trade name for products manufactured by

WEBSTER-CHICAGO 

This TV team is what you need



for sure television capacitor replacements

When you replace television capacitors you want to *know* that your replacements won't cause "headaches" in unnecessary call-backs because of premature failure. You *can* be sure that these Sangamo TV replacements will live up to their reputation. Used as original equipment, they're "tops" for dependable replacements.



THE REDSKIN is a molded paper tubular, especially adapted to television. It's easy to work with—the leads are securely imbedded in a hard plastic case and have been especially designed to resist breakage. The REDSKIN is strong and it's dependable at 85° C, even under extreme humidity.

THE CHIEFTAIN is a dry electrolytic that fits anywhere! Tiny, but durable, it is ideal for application in tight spots beneath a chassis. Bare tinned-copper wire leads make it easy to mount. Maintains uniform capacity when subjected to high ripple currents at 85° C.

REMEMBER . . . these are only two of a complete line of mica, paper and electrolytic capacitors that will take care of practically any replacement requirement in the radio and television field.



Your Assurance of

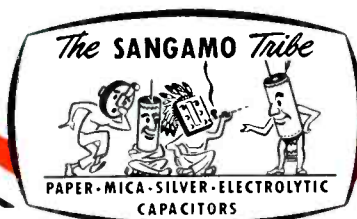

Dependable Performance

SANGAMO ELECTRIC COMPANY

MARION, ILLINOIS

IN CANADA: SANGAMO COMPANY LIMITED, LEASIDE, ONTARIO

8C41-10A

SYLVANIA NATIONAL ADVERTISING

**5 Stars Endorse
Your Business in these
Smashing Magazine
ads**

Jane Russell says:

"For the finest radio and television service, I advise my friends to depend on the man who displays the Sylvania sign. Believe me, he's a past master at keeping sets in splendid shape."



RADIO TELEVISION SERVICE
SYLVANIA TUBE TUBES
Sylvania Tubes

June Haver says:

"I've made a wonderful discovery. When I have trouble with my radio or TV set, I simply call the man who displays the Sylvania service sign. He gives me prompt, courteous and competent repair service. Try him and see if you don't agree."



RADIO TELEVISION SERVICE
SYLVANIA TUBE TUBES
Sylvania Tubes

Says Leo Durocher:

"Laraine and I don't fool around with just any radio and TV service. We like an expert who knows how to call things right. That's why we call the man who shows the Sylvania sign."



RADIO TELEVISION SERVICE
SYLVANIA TUBE TUBES
Sylvania Tubes

You, too, will appreciate the prompt, dependable service offered by the man who displays this Sylvania sign. He's a trained technician who will spot trouble instantly with Sylvania's precision test equipment and install long-lasting Sylvania Tubes.

SYLVANIA TUBES
RADIO AND TELEVISION PICTURE TUBES

Sylvania Electric Products Inc., 1740 Broadway, New York 19, N. Y.

Says Ann Blyth

"I've found a man who knows all the answers—at least to radio and TV troubles. He's the man who displays the Sylvania radio and television service sign. So whether I'm in Hollywood or in New York, I look for this sign for dependable service."



RADIO TELEVISION SERVICE
SYLVANIA TUBE TUBES
Sylvania Tubes

You, too, can enjoy true-to-life radio performance, and keep television reception clear on a polished mirror by calling the expert who displays this Sylvania sign. He uses those extra fine Sylvania Radio and Television Tubes.

SYLVANIA TUBES
RADIO AND TELEVISION PICTURE TUBES

Sylvania Electric Products Inc., 1740 Broadway, New York 19, N. Y.

Every one of your prospects will see and read these appealing ads in famous national magazines. These ads recommend your service . . . when you display the Sylvania Service Emblem, shown above. So, make sure these emblems are on your doors, your windows, and trucks. They're FREE from your Sylvania Tube Distributor NOW!

These ads will appear in the 4 famous magazines your prospects read most!



Will Sell Your RADIO-TV SERVICE in '52

Nation-wide weekly TV Show "BEAT THE CLOCK"
will sell your service to every TV set owner



You're an "expert, reliable service-man who does a tough job well," Bill Shipley, crack CBS-TV announcer, tells your prospects. And, he adds: "Always look for that Sylvania Service Emblem." That's how the hard-hitting, full-minute commercials on Sylvania's CBS-TV show, "Beat the Clock," put Bill Shipley, Roxanne, and Bud Collyer on your sales staff.

Roxanne and Bud Collyer are seen weekly over CBS-TV in 35 cities... selling your service... when you display the Sylvania Service Emblem.



Make this great national ad campaign pay off in your store

Mail the coupon below for FREE, full-color folder giving complete details about Sylvania's compelling Spring Service Dealer Advertising Program. It contains everything to identify you unmistakably as the dealer advertised in Sylvania's magazine and TV advertising. If you want more business, you can't afford to miss it. But, time's awastin'... get that coupon in the mail NOW!



SYLVANIA

RADIO TUBES; TELEVISION PICTURE TUBES; ELECTRONIC PRODUCTS; ELECTRONIC TEST EQUIPMENT; FLUORESCENT TUBES, FIXTURES, SIGN TUBING, WIRING DEVICES; LIGHT BULBS; PHOTOLAMPS; TELEVISION SETS

Sylvania Electric Products Inc.
Dept. R-3102, Emporium, Pa.

Please send me full details about Sylvania's powerful business-building campaign for Service Dealers.

Name _____

Street _____

City _____ Zone _____ State _____

The proven
fringe-area antenna...

the **TACO**
super 980
TWIN-DRIVEN YAGI

Proof of an antenna is in the performance and dependability in actual installations — that is why the Taco Super 980 is by far the NUMBER ONE CHOICE of servicemen in fringe-areas.

Taco makes a complete line of antennas for television, FM and AM. Over 80 different designs have been fully engineered and field-tested to assure you of top performance and dependability.

The Super 980 is perfectly matched for the Taco Super-charger Cat. No. 1628 Amplifier. For details on this unsurpassed fringe-area combination see your local jobber.

POWER

TACO
ANTENNAS • ANTENNA SUPERCHARGERS

TACOPLEX
ANTENNA SYSTEMS

TECHNICAL APPLIANCE CORPORATION, SHERBURNE, N. Y.



*How come you
sell so many
picture
tubes,
Sam?*

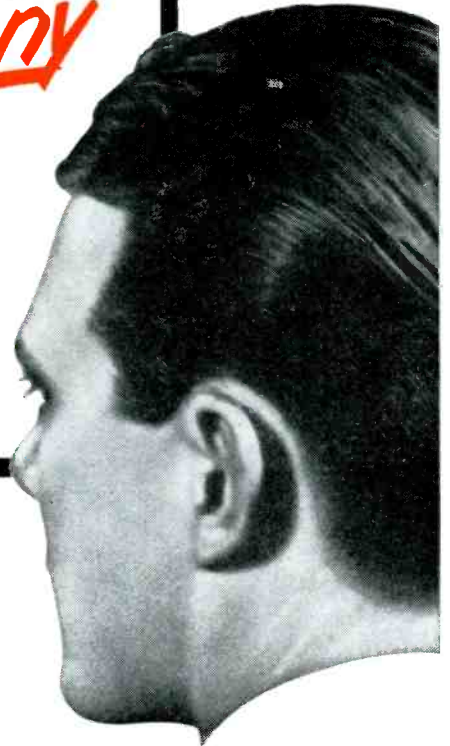

"I'm using the CBS-Hytron Easy Budget Plan, Joe. My CBS-Hytron distributor gave it to me."

"Tell me more."



"Well, CBS-Hytron's Plan helps me sell TV picture tubes and service to many a customer who just doesn't have \$50 cash. Now I make sales I'd lose otherwise. My customer pays for the job painlessly a few dollars a month. Yet I get my cash right away — and can discount my bills with my distributor."



"Fine! How does it work, Sam?"

"Simple. I introduce my customer to the finance company authorized by CBS-Hytron. The finance company does the rest. Acts as my credit department to secure me against losses. Takes care of all the details . . . paper work, collections, etc. My customer gets his tube and I get my cash — at once."



"That's swell, Sam. Now I can see why you always have plenty of working capital."

"That's right. And talk about service! This CBS-Hytron Easy Budget Plan has even brought me immediate cash from old accounts I'd written off as bad debts. CBS-Hytron is perfectly willing, too, that my regular budget loans include my service work and other components besides CBS-Hytron tubes. I owe my CBS-Hytron distributor a vote of thanks for letting me in on this wonderful Plan."



"Fair enough! I've sure been losing sales I shouldn't, Sam. I need the CBS-Hytron Easy Budget Plan. CBS-Hytron tubes are tops, too. Thanks for the tip. I'll see my CBS-Hytron distributor today."

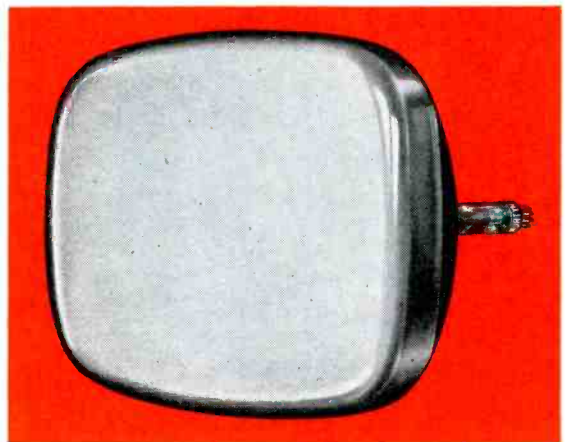

SAVE THE SALE No need for *you* to miss a single profitable picture-tube sale . . . just because your customer does not have the cash. Get the details on this original CBS-Hytron service for you. See *your* CBS-Hytron jobber . . . or mail this coupon . . . today!



MAIN OFFICE: SALEM, MASSACHUSETTS

**HYTRON RADIO & ELECTRONICS CO.
SALEM, MASSACHUSETTS**

Please rush me details on the CBS-Hytron Easy Budget Plan.

NAME.....
(Please print)

STREET.....

CITY..... STATE.....



NANTOOK MOOK WALSCO ONKO

(translation)

"BETTER FRINGE AREA RECEPTION WITH WALSCO MODEL M ANTENNA"

There's a magical difference in WALSCO Model M Signal King performance almost anywhere. In the fringe areas, or wherever weather is the roughest, the Model M will out-perform, out-last any competitive antenna.

Once you install... *that's all*. No costly call-backs that steal your profit. Model M is guaranteed sturdier, more dependable in any climate.

Chromate-coated magnesium cross-arms have a structural strength almost equal to steel, yet $\frac{1}{3}$ lighter than aluminum. Positive corrosion resistance even in severest weather. Elements are made of high-conductivity, super strength aluminum alloy, reinforced with Swiss "Permalum." WALSCO Model M is quality you can trust anywhere.

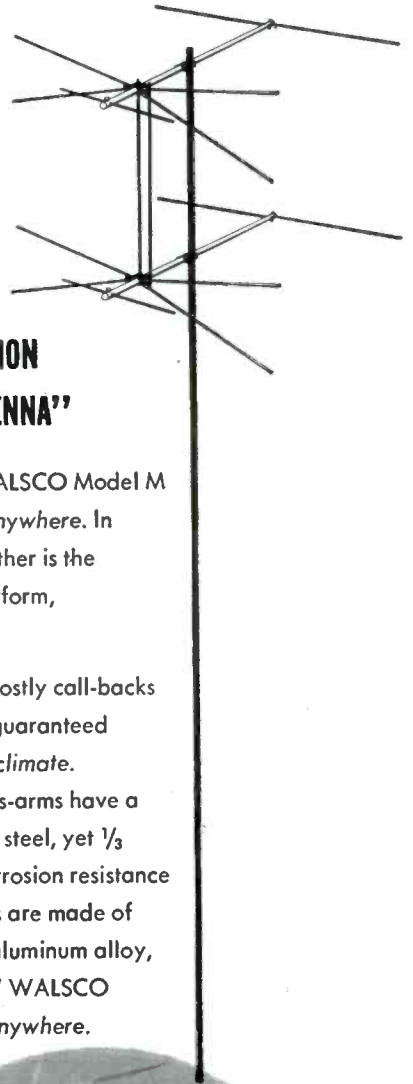

WALSCO

Walsco quality earned its reputation

WALTER L. SCHOTT CO.

3225 Exposition Place, Los Angeles 18, Calif.

Branch: Chicago 6, Illinois

130,000 qualified TV servicemen needed

Here is how you can be one of them

INDUSTRY EXPERTS HAVE ESTIMATED over 130,000 qualified TV technicians will be needed for the installation, trouble-shooting and repairing of the television receivers in use by 1955.

There are far fewer than 50,000 fully trained TV technicians available today. This means more jobs, unrivaled future for security, greater earning power for thousands and thousands of additional TRAINED and EXPERIENCED TV Servicemen. Will you be one of them?

OUTSTANDING FUTURE FOR QUALIFIED TV SERVICEMEN

Men now in radio servicing as well as men in the radio-electronics industry with no experience in TV servicing . . . here is your opportunity. The RCA Institutes Home Study Course in Television Servicing makes it possible for you to convert your skill in radio servicing, or interest in radio-electronics, to the important money-making field of TV servicing.

The RCA Institutes Course gives you a sound knowledge of television fundamentals . . . intensive practical instruction in the proper maintenance and servicing of complex TV receiver circuits—including color TV and UHF . . . teaches you the "short cuts" on TV installation and trouble-shooting, saving you many hours of on-the-job labor.

TRAINING MEETS MODERN REQUIREMENTS

This course is in step with the progress of the television industry. It is backed by RCA—pioneer in television development. It is based on the actual experience of the RCA Service Company in servicing thousands of home television receivers. The

course is constantly being revised, improved and kept up-to-the-minute. It will help you to a more profitable and productive future in these ways:

PREPARE YOU to take the required technical examination with confidence, in those areas that require a license or permit to engage in TV servicing.

TRAIN YOU, if you are a serviceman in a non-TV area, to become a qualified TV technician by the time TV comes to your area. In TV areas, TV servicing has substantially replaced radio servicing as the chief source of income.

IF YOU ARE A QUALIFIED TV SERVICEMAN, it will keep you in step with the latest industry developments including color TV and UHF.

IT DEVELOPS the latent talents of installers into skilled trouble-shooting TV technicians.

TRAINS MEN in radio-electronics with no previous servicing experience to fill jobs as TV technicians, to win promotions and better pay.

RCA INSTITUTES HOME STUDY COURSE PLANNED TO YOUR NEEDS

You keep your present job in radio—television—electronics. In your spare time, you study at home. You learn "How-to-do-it" techniques with "How-it-works" information in easy-to-study lessons prepared in ten units. Cost of RCA Home Study Course in Television Servicing has been cut to a minimum—as a service to the industry. You pay for the course on a "pay-as-you-learn" unit lesson basis. You receive an RCA Institutes certificate upon completion of the course. The RCA Institutes Home Study Course in Television Servicing is approved by leading servicemen's associations.

RCA Institutes conducts a resident school in New York City offering day and evening courses in Radio and TV Servicing, Radio Code and Radio Operating, Radio Broadcasting, Advanced Technology. Write for free catalog on resident courses.

Send for FREE BOOKLET

Mail the coupon—today. Get complete information on the RCA INSTITUTES Home Study Course in Television Servicing. Booklet gives you a general outline of the course by units. See how this practical home study course trains you quickly, easily. Mail coupon in envelope or paste on postal card.

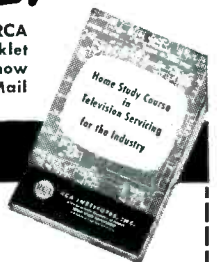

MAIL COUPON NOW!

RCA INSTITUTES, INC.
Home Study Department, S-252
350 West Fourth Street, New York 14, N.Y.

Without obligation on my part, please send me copy of booklet "RCA INSTITUTES Home Study Course in TELEVISION SERVICING." (No salesman will call.)

Name _____ (Please Print)
Address _____
City _____ Zone _____ State _____



RCA INSTITUTES, INC.
A SERVICE OF RADIO CORPORATION of AMERICA
350 WEST FOURTH STREET, NEW YORK 14, N.Y.

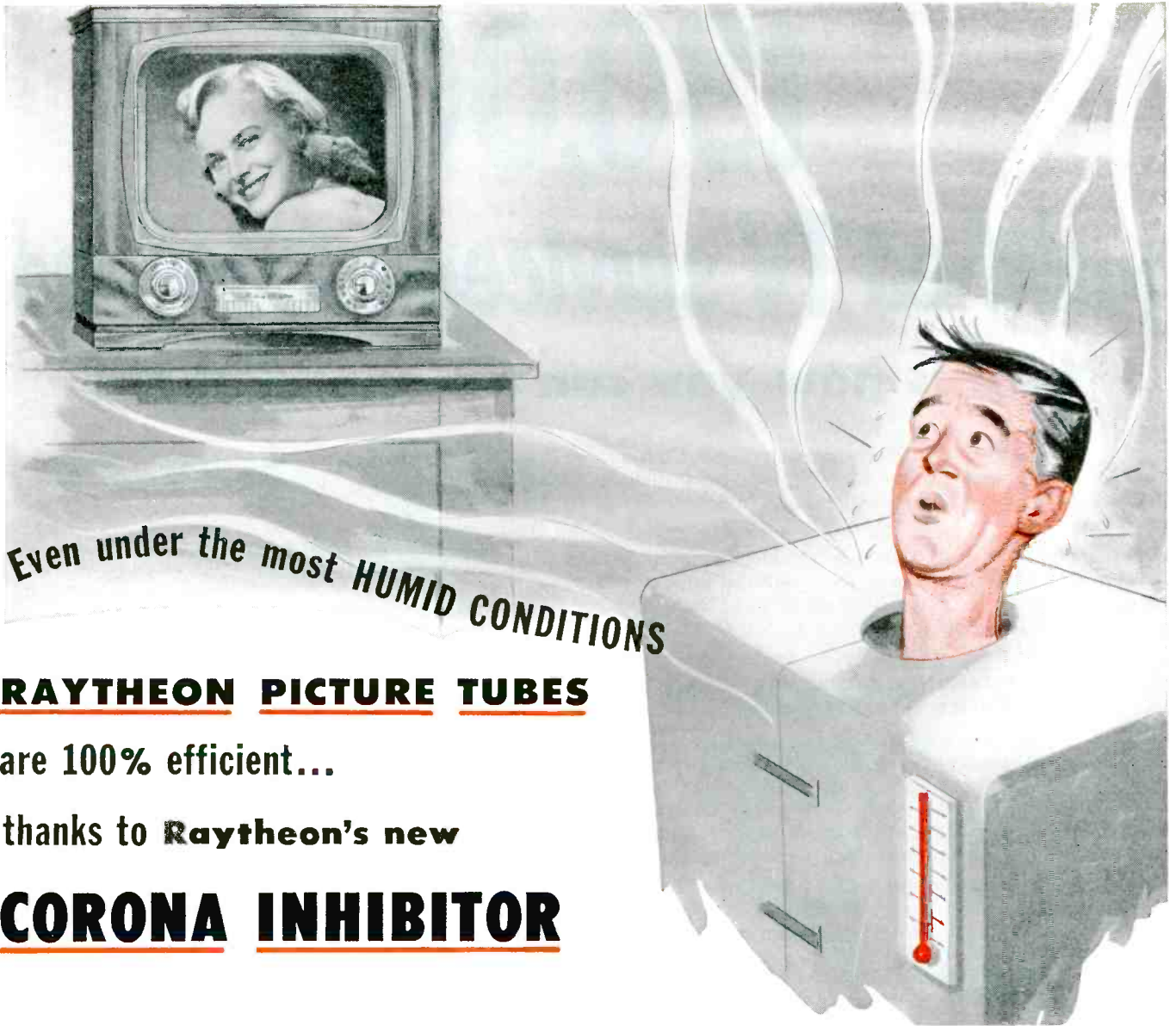

Even under the most HUMID CONDITIONS

RAYTHEON PICTURE TUBES

are 100% efficient...

thanks to Raytheon's new

CORONA INHIBITOR

Ordinary picture tubes are adversely affected by humidity and wet weather — may lose up to 10% of their brightness on damp days. Not so Raytheon made Television Picture Tubes with new CORONA INHIBITOR.

This amazing Raytheon development puts a "raincoat" on Raytheon Picture Tubes, guarantees the same *clear picture* rain or shine. Exhaustive tests proved conclusively that even under a water spray on the high voltage contact, Raytheon made Tubes showed *no loss of brightness*.

Give your customers the tubes that give constant clarity no matter what the weather. Ask your Raytheon Tube Distributor for Raytheon Television Picture Tubes.



Right for Sight!



RAYTHEON MANUFACTURING COMPANY

Receiving Tube Division

Newton, Mass., Chicago, Ill., Atlanta, Ga., Los Angeles, Calif.

Excellence in Electronics

RECEIVING AND PICTURE TUBES • RELIABLE SUBMINIATURE AND MINIATURE TUBES • GERMANIUM DIODES AND TRANSISTORS • RADIAC TUBES • MICROWAVE TUBES



A Sprightly Appraisal of TV Servicing*

IN TV SERVICING, many Service Men have found themselves faced with one problem that it has been felt could never be solved, at least to the complete satisfaction of the consumer. When confronted with this situation, most of the boys have declared that they'd just rather straddle the point and perhaps just talk about the weather. The vexing item has been that \$64 question: Why must TV sets be serviced even three times a year, if such pains are supposed to have been taken at the factory to produce a perfect package, which incidentally is so costly?

The query is actually quite forthright, and would probably be posed by a Service Man if they had to ask for help to keep their set going. The exaggerated claims made by some set manufacturers have on occasion made the situation more irritating. Set-makers have exclaimed that their chassis were not only . . . "as reliable and trouble-free as radio . . ." and . . . "engineered to outperform all others anywhere, anytime" . . . but they could . . . "pick up and amplify even the faintest TV signals" . . . and suffered from . . . "virtually no interference, overpowering interference and overriding distance."

In avoiding the question, Service Men, of course, reveal that they are simply unfamiliar with chassis design features, and are perfectly willing to admit this fact and lose the business of those who insist on a plausible reply. Fortunately, quite a few of the alert members of the servicing profession have the answers and are active in circulating them. In Chicago, an association has set a commendable pattern with a circular which offers an excellent appraisal of the needs for TV servicing. Describing the complexities of the chassis makeup, this circular notes that an average chassis can have as many

as 800 separate components, 700-odd soldered connections, over 7,000 separate assembly operations, and perhaps as many as a half dozen or more major subdivisions of the chassis to probe.

It is obvious, they say, that a device with such a variety of parts, connections and assemblies, should receive periodic service so that it can continue to make available the performance so proudly advertised by the set-makers. Of course, they note, one should not expect a Service Man to anticipate trouble, for he is not a crystal-ball gazer. And, they add, very often the same symptom can be caused by many different and unrelated faults.

Even the all-important topic of charges is well defined in the circular. Consumers are told not to expect something for nothing. Hasty bargain-type servicing can only result in a greater total cost and a badly mauled set, they warn, adding that the little that actually is spent for service makes TV entertainment the world's greatest bargain.

Our compliments to those who prepared this enlightening leaflet.

Job Specifications**

IN ANY ENTERPRISE it is wise to know an individual's makeup so that it can be matched against the characteristics of the work to be done.

Reviewing this requirement recently, a leading technical institute** posed twelve factors which it felt should serve as a guide in evaluating capabilities:

Scientific Interest—What degree of interest is shown in the experimental method and scientific attitude?

Creative Ability—Does a talent for originating ideas, discovering new facts or inventing prevail?

Ability to Get Things Done—Does the ability to solve problems with good

speed through logical sequence of experimentation exist?

Leadership—Does there appear an ability to work well with others, and delegate responsibility? Does there exist that property which makes people naturally come to you with problems concerning items on which they have responsibility?

Responsibility—Does there prevail an ability to accept responsibility and recognize that the overall success of the project depends on one's efforts in securing a satisfactory result?

Reliability—Does there exist the factor of reliance permitting the carrying out of an assignment regardless of personal inconvenience or obstacles which may be encountered from day today?

Judgment (Thoroughness) — Is there present a talent which can be used to evaluate the relative merits of a product or design on the basis of factual information? This involves getting all the facts.

Initiative—Does there exist the ability to find problems and take action on one's own initiative?

Aggressiveness—Does a competitive and self-assertive spirit exist?

Expression—Does there prevail the ability to convey ideas, facts and data in a clear concise, and convincing manner? Can these ideas be expressed clearly by the use of simple sketches, charts or diagrams?

Emotional Stability—Does there exist a faculty for remaining calm and analytical under pressure; are emotions free from wide fluctuation?

Physical Energy—Are the following physical attributes present—pep, and a vigorous and energetic manner?

General Appearance and Manner—Does appearance and manner inspire confidence?

Here are fifteen questions to which every Service Man should be able to say *yes*; a strong affirmative reply that can't help but add up to a flourishing business.—L. W.

*With apologies to TISA and NATESA.

**Rensselaer Polytechnic Institute.

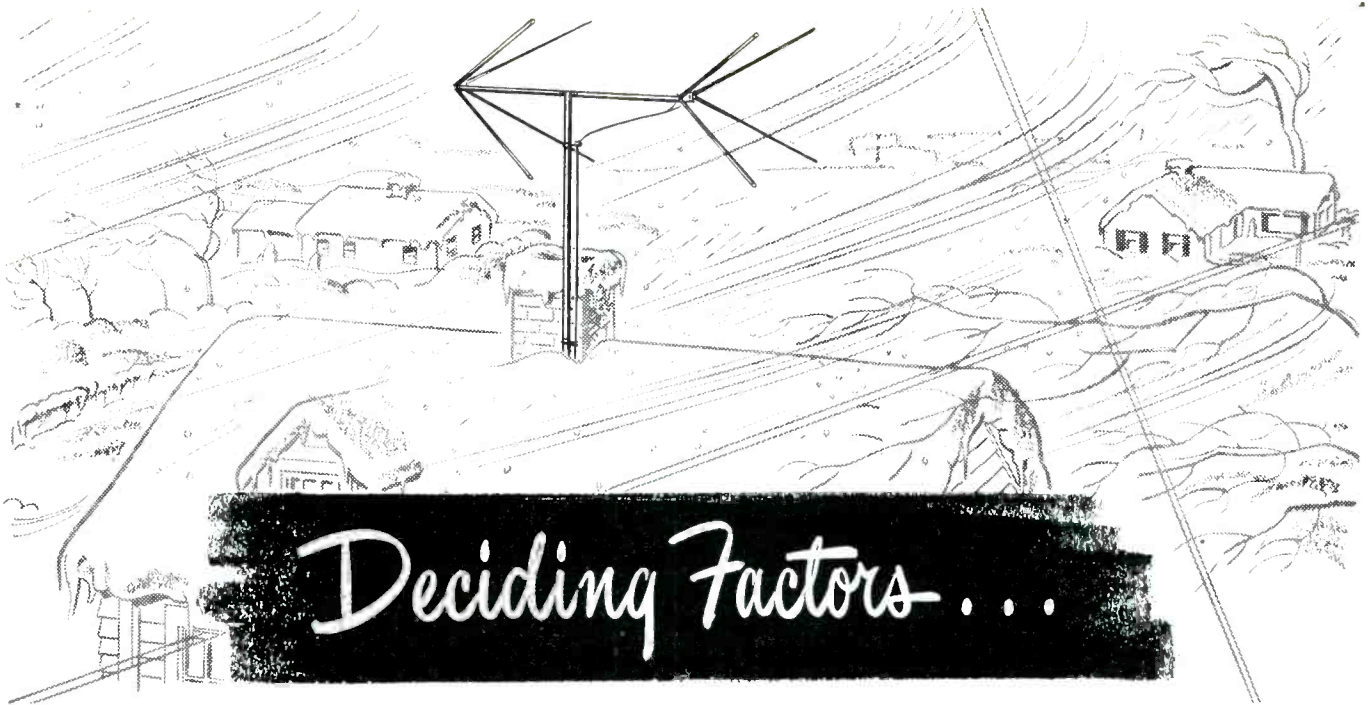

WITH **WARD** ANTENNAS INSTALLATIONS *Stay Put!*

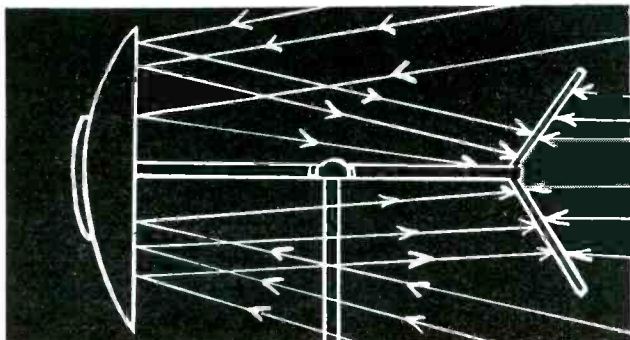

Diagrammatic sketch showing how parabolic reflectors gather in and concentrate energy on conical elements.

WARD ANTENNA INSTALLATION KITS . . .
time savers . . . money makers . . . cut the cost of stocking and storing parts . . . give everything you need at your fingertips at installation time. KIT MODELS TV-105 and TVS-103 contain necessary 6 element Ward Conical bays, including mast, base, stand-offs, lead-in, lag bolts all in one kit. Write for catalog.

Ward mechanical superiority is a deciding factor weighing heavily with men in the field. Ward installations "stay put" . . . eliminate call-backs.

WARD PARA-CON* Antenna not only combines parabolic and conical principles to assure maximum picture clarity on all channels in most reception areas—but it features a material and structural strength that defies the elements, and assures a permanent installation. Aluminum tubing, molded plastic insulators, heavy duty crossarm and other construction features make for rugged strength and unsurpassed durability. Write for catalog.

*T.M.

As the oldest, largest exclusive antenna manufacturer, Ward combines a complete, widely-diversified line of Radio and TV antennas. A single source of supply gives you every advantage and every superiority that means satisfied customers and bigger profits to retailers and service technicians.

THE WARD PRODUCTS CORPORATION
 Division of The Gabriel Co.
 1523 East 45th Street • Cleveland 3, Ohio
 In Canada: Atlas Radio Corp., Ltd., Toronto, Ont.

WARD

**WORLD'S OLDEST AND LARGEST
EXCLUSIVE MANUFACTURER OF
ANTENNAS**

SERVICE...The National Scene

ULTRAHIGH OPPORTUNITIES HAILED BY INDUSTRY--When, perhaps in the late winter months of '52, portions of channels 14-83 in the uhf band come to life in some communities, Service Men will witness the inauguration of an era with limitless possibilities. Thus indicated panels of experts at a recent consulting-engineering seminar in Washington, during which one manufacturer's uhf transmitter and receiver-production plans were revealed for the first time. On the receiving front, Service Men will find a host of items to sell, install and service. There'll be single and two-station converters, as well as converters for all-wave pickup, all carrying comparatively low prices. Some of these items will be featured in unique ultrahigh packages which will include the required converter, antenna, leadin and crossover network for matching the veryhigh and ultrahigh antennas to the receivers through a switch system. . . . In the main, it was pointed out, the antennas will be comparatively small and simple to install. It was also noted that the converter hookup will not be complex, and the operation of the additional tuning unit will be quite simple, too. . . . Even though the ultrahigh program is many months away, elaborate plans are already being made not only by the manufacturer who sponsored this seminar, but others, too; the plans featuring extensive educational programs designed to familiarize those, who will be in ultrahigh areas, with the equipment that will be available to provide this new service. An example of this promotion appeared during the Washington meeting, with the publication of full-page advertisements headlined--"UHF Means More TV For More People," in all of the leading dailies. . . . When the FCC lifts the freeze, probably around March 15, there will be released a complete listing of all of the cities in which ultrahigh stations may eventually be installed. This valuable listing, which will serve as a business prospect signpost for every Service Man, will appear in SERVICE. In addition, there will also appear in SERVICE a comprehensive analysis of all the antenna types that can be used for ultrahigh reception. This discussion, prepared by a specialist who has had considerable experience with receiving problems in Bridgeport, Conn., will detail not only the design and installation features of the antennas, but the leadins, switches and networks that should be used, and tuning problems that might have to be considered. Watch for this extremely important information!

SERVICE SHOPS NOW BEING CHECKED CLOSELY BY OPS--The drive to halt overcharging in service shops, which OPS declared it would institute early in '52, has begun, and quite a few of the boys have not only been warned, but received injunctions for violations. In some instances, the failure to keep and file records and reports as required by regulation 34 has prompted the filing of official complaints from Washington. The OPS enforcement officers have warned that it is imperative that statements of ceiling prices not only be posted in a conspicuous place, but that copies of the statement must be filed with an OPS district office within the 30-day period. All shops must keep records showing prices, rates or pricing methods used during the base period. They must be available to OPS agents for inspection at all times.

SUMMER TV CLINIC COURSES DEVELOPED--In Milwaukee, Wisconsin, during the months of April, May, June, July and August, Service Men will be able to enroll in 30-day clinic sessions at an engineering school which will feature courses detailing not only the know-how of TV servicing, but the know-why. The courses, which will consist of two hours of lectures and two hours of lab training daily, five days a week, will cover the use of test patterns, antenna-system installation; receiver alignment; troubleshooting; designs included in sound-strips, front-ends, local oscillators and mixers, inter-carrier receivers, etc.

SERVICE...The National Scene

DX NOW A TV SET FEATURE--DXing, a popular pastime two decades ago, has returned with a flourish to a new front, TV. In these columns and elsewhere, it has been noticed that this trend, dictated by the growing interests of those in fringe areas, deprived of local TV stations by the freeze, was mounting. As a result, there has been a continuing gain in the thriving booster and high-gain antenna market. The setmakers have now decided to do a bit of invading, in an attempt to capture this potential audience. They have announced that their new chassis would insure not only immediate fringe pickup, but real long-distance reception. One set manufacturer has begun to campaign the fact that DXing with his models will be a simple matter; in fact, he is guaranteeing 150-mile reception. Others are using figures of 100 to 200-mile distances as the potential pickup capabilities of their sets. According to the vice prexy of one of the larger set manufacturers: "TV service area is being expanded . . . not by installing more transmitters, but by manufacturing better receivers." He pointed out that some of the sets on the market today will bring in . . ."quality reception in fringe and difficult areas that have always been considered TV dust bowls." . . . To provide this unusual service, manufacturers have developed many circuit innovations which not only effect high gain, but minimize the problems of noise and interference. These extremely important contributions to circuit-land will be reviewed in a series of articles by one of the country's leading design engineers in SERVICE, soon. The articles will not only reveal how these circuits operate and their performance possibilities, but also the potentialities that will obtain for boosters and high-gain antennas in creating new frontiers of reception beyond the 100-odd-mile areas set forth by the setmakers.

CHICAGO LICENSING PROPOSAL ATTACKED--A measure to license TV Service Men in Chicago has been contested by the television committee of the Electric Association of Chicago. According to members of this committee, Chicago has had refrigeration, auto and radio servicing without licensing, and they couldn't see why TV should be singled out. They felt that the public was just as much to blame as industry, because of the unusual and unfair demands being made on the TV Service Man. . . . Several members of the Chicago city council have been pressing for passage of legislation in the State Senate. It is reported that other electrical and radio associations are also opposed to the licensing proposal, and will make every effort to have the measure shelved indefinitely.

INDEPENDENT SERVICE MEN PRAISED BY SET MANUFACTURER--Highest quality service can only be achieved by properly-informed independent Service Men, opined a setmaker recently in a letter to his factory-approved service stations. According to this manufacturer, it has always been found that the independent Service Man can take care of all legitimate service calls, and provide reliable, efficient and immediate attention. . . . So impressed is this chassis producer with the independent Service Man's capabilities, that an extensive promotional program has been set up for the year. The program will feature an assortment of service-sales aids, advanced-training service clinics, sound slide films on troubleshooting, plus advertising of the independent Service Man over standard broadcasting stations, TV, and in magazines and newspapers. The Service Man, says this manufacturer, is a competent operator who can render an outstanding, continuing service to his community. Truly, a stirring salute well earned by every independent Service Man.--L. W.

They're here THE LATEST RMS ANTENNAS

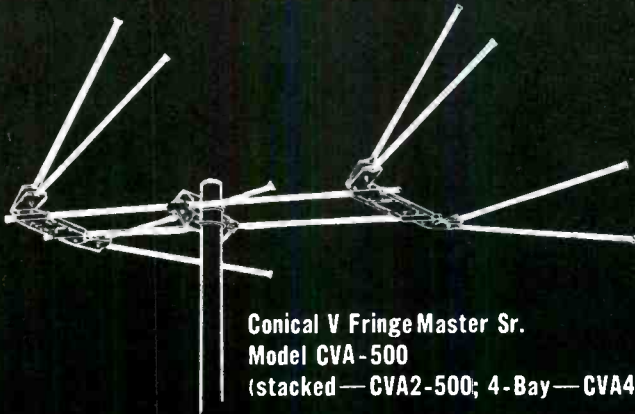

**Conical V Fringe Master Sr.
Model CVA-500**
(stacked—CVA2-500; 4-Bay—CVA4-500)

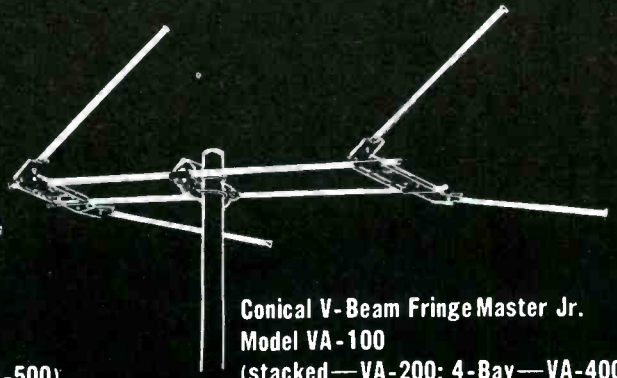

**Conical V-Beam Fringe Master Jr.
Model VA-100**
(stacked—VA-200; 4-Bay—VA-400)

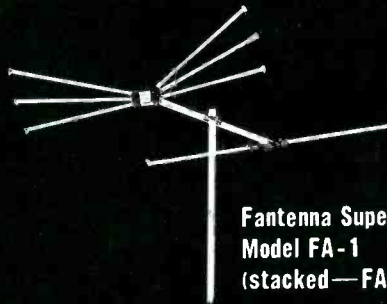

**Fantenna Super-Fan Array
Model FA-1**
(stacked—FA-2; 4-Bay—FA-4)

FRINGEMASTER ANTENNAS

CVA-500 features high gain on the high band — has extra long dipoles to compensate for gain on low band.

VA-100 is ideal for urban and semi-fringe reception.

OTHER FEATURES

- Double U-bolt mast attachment
- 3/8" aluminum dipoles; pinched ends
- 1/2" aluminum Q-matching section
- quick-rig

FANTENNA SUPER-FAN

Provides high gain coupled with excellent broad band characteristics.

OTHER FEATURES

- 3/8" drawn aluminum elements with pinched ends.
- dowel-reinforced cross-arm at the U-bolt.
- Crossarm of 1" drawn aluminum with capped ends to prevent whistle.
- Quick-rig.

Use RMS antennas and television accessories with the confidence and satisfaction of knowing that your installations are among the finest for picture-getting quality. Guarantee your installations by making them 100% RMS . . . remember . . . your antenna installation can perform no better than the weakest piece of hardware. So be sure . . . constantly sure . . . that your RMS antenna is up to stay. Specify and get RMS television hardware . . . stress-tested and time-proven by the huge number of all-RMS television installations that are giving dependable service . . . under the most adverse conditions.

See your local jobber.

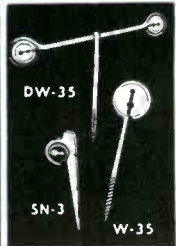
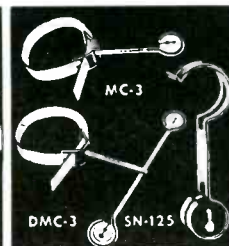
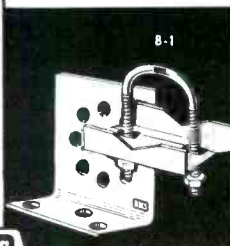
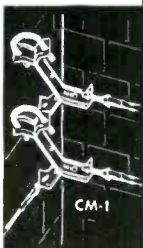

See your local jobber

RADIO MERCHANDISE SALES INC.

1165 Southern Blvd., New York 59, N. Y.

Detailed Analysis of Practical Techniques Which Have Been Found to Eliminate Delays in Bench TV Troubleshooting.

Speeding Up

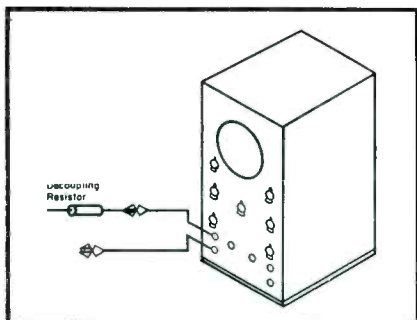

(Left)

Fig. 1. Reducing the influence of lead capacity through the use of a decoupling resistor in series with the hot 'scope lead.

SPEED IN SERVICING receivers on the bench can only be achieved through experience. As a result of experience, troubles can be more easily recognized, receivers become more familiar, and time-consuming errors can be avoided.

Specifically, four factors have been found to contribute to TV troubleshooting slow downs on the bench, all revolving about a lack of experience. (1) Improper equipment; (2) test equipment failures which are not caught promptly; (3) faulty troubleshooting technique; (4) lack of information.

Lack of Proper Equipment

A survey of TV service shops in any area would probably show a wide discrepancy in the types of test instruments employed. The equipment may range from a multimeter and tube tester to a complete selection of test equipment. The author, like most Service Men, has had occasion to service receivers when nothing else but a multimeter and replacement tubes were available. There are troubles, of course, which can be solved with the meter and tubes. But there are difficult troubles, such as those in the sync or sweep circuits, which can be localized very quickly, as a rule, with a 'scope. Other troubles in the audio and video strips can be pin-pointed rapidly with a signal generator. Without proper equipment, a TV Service Man is certainly handicapped. He will be forced to waste precious moments trying to locate defects which the proper instrument would reveal practically instantly.

There have been many debates on the exact instruments that are essential

for TV work.‡ The following has been found to be the minimum for fast, accurate bench work; (1) multimeter, preferably a *vtom*; (2) AM signal generator that covers the TV frequencies; (3) 'scope; and (4) a complete file of commercial TV schematics.

Auxiliary equipment, found desirable, includes a sweep generator, a high-voltage probe for the voltmeter, and a tube tester.

Test Equipment Uses

A meter is essential for voltage and resistance checks. An AM generator can be used for alignment (audio and video) and troubleshooting by signal injection. A 'scope is useful for observing wave-shapes in signal tracing and locating obscure troubles such as distortion, hum pickup, etc. Commercial schematics help by providing diagrams and values, chassis layout charts, waveshapes, and other useful information.

Service Men who have the foregoing instruments available generally take the time and effort to learn how to get the most out of them. Occasionally, some problems arise in the use of equipment. For example:

(1) Placing a 'scope lead at a given point in a circuit may cause the circuit operation to become erratic because of the added capacity of the 'scope lead. In some receivers, even resetting the appropriate controls cannot stabilize the waveform on the 'scope screen. In such cases, a decoupling resistor in series with the hot 'scope lead (Fig. 1) will reduce the influence of lead capacity. The waveform will become stabilized and can

be observed. The value of the decoupling resistance can be anywhere from 10,000 ohms to 1 megohm. It is necessary to choose the smallest value that will do the job. When decoupling resistors are used, they should be left on for all checks around a given circuit, including calibration of the 'scope, so that proper information concerning the amplitude of the waveshape can be obtained.

(2) Occasionally, the ohmmeter needle will bang over to the left or right when a resistance reading is taken, even though the power is shut off. This usually indicates a charged capacitor in the circuit. The capacitor can be discharged in the usual way by placing a screwdriver or test lead across the capacitor terminals. Occasionally, this condition in the ohmmeter may be caused by the line plug of a transformerless receiver remaining in the outlet, even though the power is shut off. In such cases, the plug should be either taken out of the outlet or reversed when taking resistance readings.

(3) It is not often necessary to measure the high voltage in a TV receiver. The size of the spark at the anode cap, when held close to the picture tube, roughly indicates the amount of high voltage. However, there may be borderline situations where the size of the spark is inconclusive and where definite information concerning the voltage is desirable. When no high-voltage probe is available, some Service Men neglect to make this important check. As a result, a good deal of time may be lost in making unnecessary checks. If no high-voltage probe is at hand, a resistor, or number of resistors, in series

‡An interesting analysis of this subject appeared in the Ser-Cuits section of SERVICE; January, 1952.

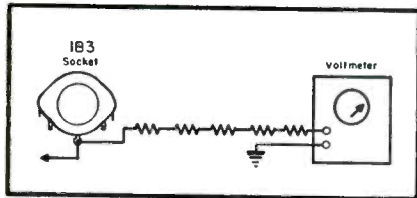
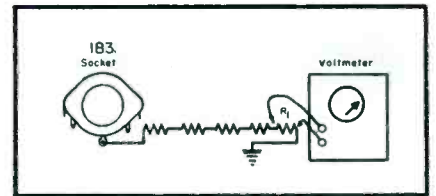

Fig. 2 (left). In an emergency, voltage range of a voltmeter can be extended by the use of a series of resistors.

Fig. 3. Method which can be used to provide measurement of high voltage by connecting a voltage divider from the high-voltage point to ground, reading voltage across one resistor in the divider and then finding the total voltage by computation.



TV TROUBLESHOOTING

by **CYRUS GLICKSTEIN**

American Radio Institute

with the hot lead of the multimeter will provide an acceptable indication of the voltage present. For example, let us assume a 5000-ohms-per-volt meter is being used and the highest range is 1000 *v*. It is desired to extend the range to 15,000 *v*, or an increase of 14,000 *v*. To accomplish this, 5000 ohms must be added for each additional volt to be measured. To take care of the extra 14,000 *v*, the amount of series resistance necessary is $5,000 \times 14,000$ or 70 megohms. Four 15-megohm and one 10-megohm resistor can be wired in series with the probe to provide this value; Fig. 2. Naturally, care must be exercised when working with this type of hay-wire hookup. The meter will be read on the basis that full-scale deflection represents 15,000 *v*. In an alternate method a voltage divider can be placed across the high voltage supply with the power shut off. Then the power can be turned on and the voltage measured across the lowest resistor in the divider; Fig. 3. The total voltage can then be computed on the basis that the voltage across the resistor has the same relationship to the total voltage across the divider, as the resistance of the resistor has to the total resistance: $E_t = R_t/R_1 \times E_1$ where E_t = total voltage; R_t = total resistance; R_1 = the resistance of the resistor across which the voltage is measured; and E_1 = the voltage across R_1 .

Delays in troubleshooting can also be caused by unnoticed failures of test equipment. Almost all Service Men have had the experience of following clues for a time, then finding they have been checking the wrong clues because the test instrument being used was not operating correctly. After such experiences, Service Men almost automatically check an instrument, whenever an abnormal reading is obtained.

During one defective-instrument experience, a voltage reading was taken and no voltage was obtained where

some was expected. The voltmeter was shifted to a *B+* point to see if the meter was registering. Then the *B+* point was shorted to ground with a screwdriver to see if there was voltage there. There was a spark, but no voltage reading; the meter was obviously not working. The meter may be set on the wrong scale, may be out of order, or there may be a break in one of the test leads.

Ohmmeter Check

If an ohmmeter doesn't register—or registers infinity, there may be an opening in the circuit. On the other hand, the ohmmeter may not be working properly. Similarly, the ohmmeter may be defective, if it registers zero on a measurement or if the readings are widely different from the expected readings. It is assumed that readings are being made on the correct scale; the high-resistance scale being used for measuring high values of resistance

Fig. 4. Technique which can be used to check 'scope operation with the horizontal sweep input. First, the coarse frequency control is set at the horizontal amp position. Then, the horizontal amplitude control is set at maximum. In the last step, the horizontal input terminals are touched. As a result dot should be swept across the screen.

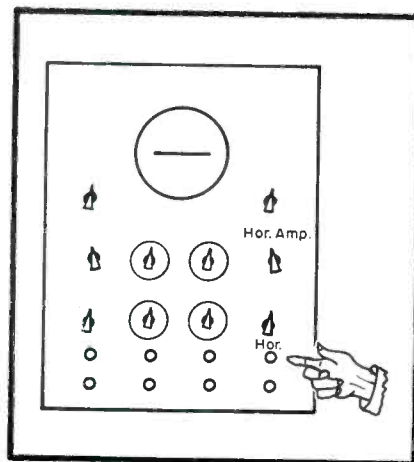

and the low scales for measuring low values. A quick check can be made across one or two cathode resistors and plate-load resistors anywhere else in the receiver, to see if the meter provides color-coded value readings within the indicated tolerance. This will indicate whether the meter is registering with reasonable accuracy.

Even before placing 'scope leads in a circuit to check waveforms for the first time during the day, experienced technicians will place a finger on the hot lead to observe if the amount of hum pickup displayed on the screen is normal.

Determining 'Scope's Efficiency

There may be occasions when circuit waveshapes as observed on a 'scope are widely different from the normal ones. Before doing any further checking, it is advisable to determine whether the 'scope is operating properly. This can be done by applying the 'scope leads to a section of the receiver which is operating normally and noting if normal waveshapes are present.

For example, suppose there is vertical foldover indicating a defect in the vertical sweep circuits. All of the vertical waveshapes appear unusually distorted when the 'scope is applied to the usual vertical check-points. It is, therefore, desirable to check the 'scope. According to information on the picture tube of the TV receiver, the horizontal sweep circuit is operating normally. The 'scope leads can therefore be applied to the horizontal oscillator to see if the horizontal waveshapes are normal. If they are, then the 'scope can be considered to be okeh. If not, then it is obvious the 'scope is not operating normally. In this instance, it is necessary to check first, the ground lead from the 'scope. An open ground lead will result in considerable distortion in the waveforms. If

(Continued on page 67)

Master Amplified

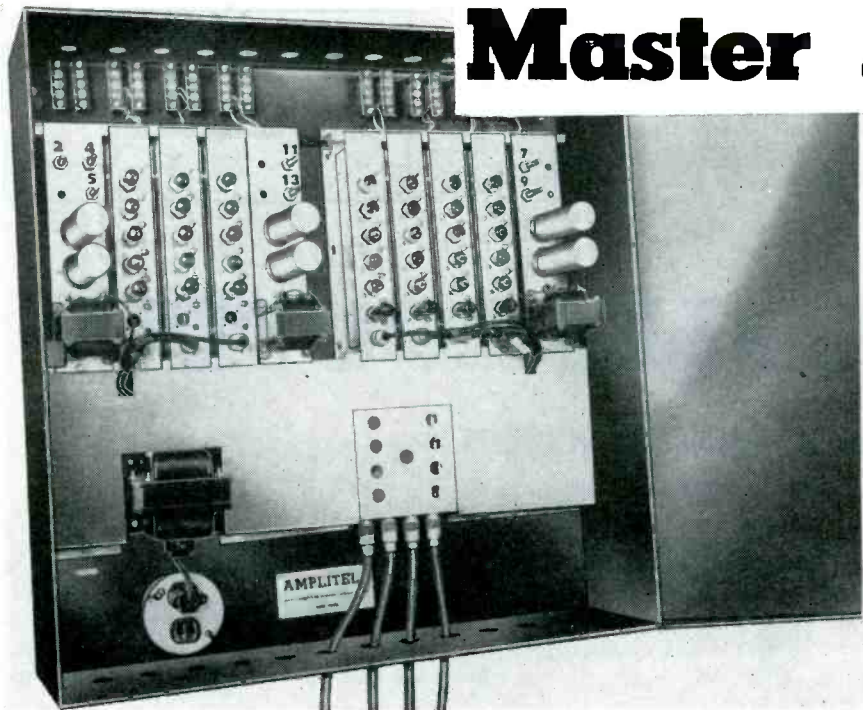

Master amplifier for TV antenna systems.

TV's rapid rise to popularity and the continuing increasing demand for receivers, has reemphasized the problem of antennas, particularly in multiple dwellings, where the rooftops have become truly jammed with poles and leadins. Eventually, in some instances, the choice locations for the antenna will disappear. As cited earlier in this journal, an effective solution to the problem for many, is the master antenna system, which permits the installation of the antenna in the ideal spot on the roof, assuring maximum pickup for everyone.

Need for Separate Antennas

In master-amplified TV systems, an antenna is provided for each TV channel within the service area, as well as one for FM and AM, if required. The

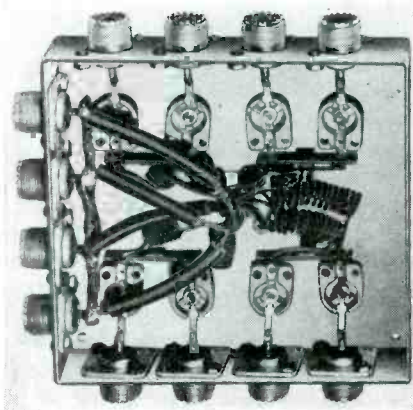

individual antennas, located to receive optimum signals, are connected to amplifiers, each of which is tuned to and adjusted for flat response at its television channel or FM band. The outputs of the several amplifiers are combined and deliver power to a distribution system. In one system[‡] this consists of from 5 to 20 72-ohm risers which carry the power to central locations of the building.

Use of Yagis

To provide quality signals, free of multi-path reflection effects, custom installation is required for each television channel. A yagi array, consisting of 4 elements has been found to be one of the most practical antennas for master installations. When properly located in ghost as well as in weak signal areas, good quality pictures can usually be obtained. The signal delivered to the leadin may be anything from 250 to 100,000 micro-

Right: Internal view of junction boxes.

Left: Mixer unit, with seven or more inputs for amplifier; can use AM and FM, plus five outputs.

[‡]Master Amplified Television Antenna System, developed by Transvision, Inc., and distributed and installed by Amplitel, Inc.

*From notes prepared by Harris Morris, Jr., Amplitel, Inc.

(All photos courtesy Transvision-Amplitel)

[See Front Cover]

volts, depending upon location and channel. These signals are conducted to amplifiers[‡] on 75-ohm coax cable. RG59U is normally used, but for long runs RG11U or 13U may be required. At the amplifier, a simple *balun* half wavelength line is used to convert to a balanced input to feed the amplifier. The individual amplifiers are designed to operate at from 250 to 5,000 microvolts. When the input signals are very strong (over 5,000 microvolts), padding is necessary between the antenna leads and the amplifier input.

Amplifier

The amplifiers in the master system are of conventional stagger-tuned design, with strips provided for the low and high bands. The low channel strips use four 6AQ5s and a 6AQ5 or 6AN5 in the output stage, with an overall maximum flat voltage gain of about 7000 times. The output and voltage at the final tube plate is about one volt. The high-channel strips employ five 6AK5s and one 6AN5 and have an overall maximum voltage gain of about 4000 times; *front cover*. The individual stages are staggered so that the overall band pass of 6 mc is flat and the entire band of frequencies can be amplified without distortion. The first two tubes are gain controlled by means of a control in the cathode returns of these stages. This method of control has been found to permit smooth adjustment, with relatively little change in the amplitude characteristic. The next two

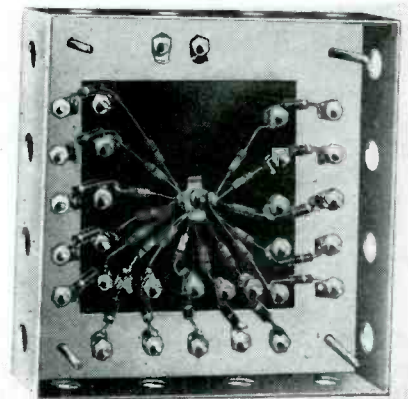

TV ANTENNA SYSTEM

by WYN MARTIN

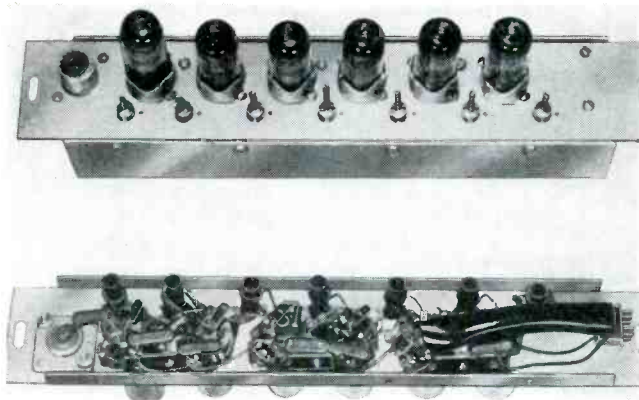

Channel strips used in the master antenna system.

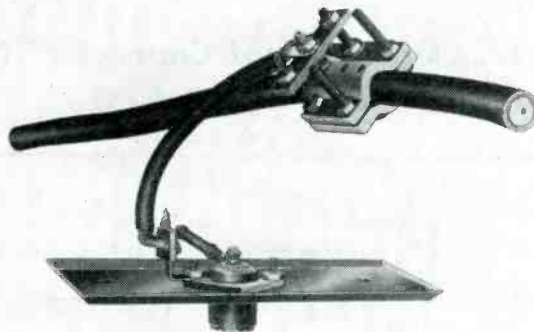

Solderless type connector installed in apartment.

tubes are operated at fixed bias, and operate at constant gain. The final tube, a 6AN5, feeds a quarter-wave line transformer which, in turn, operates through a mixing unit into the common buss, which forms the beginning of the distribution system. The mixing unit consists of a group of band-pass filters, any one of which will permit energy to be fed into the distribution system without effecting the outputs of the other amplifiers. The outputs from this mixing unit are fed to this common buss, which is the source of power for the distribution system. From this buss, five 75-ohm cables can be used to distribute power through a building.

Power Strip Components

The power supply strip contains the filament transformers, selenium rectifier, a simple *rc* power filter, and controls for the gain of each amplifier strip. One power supply strip can supply power for three amplifier strips. In order that the system may be isolated from the power system of the building, an isolation transformer is provided, and can feed up to three power supplies. This transformer is provided with taps to compensate for high or low-line voltage conditions.

Distribution Systems

The five parallel distribution feeders may be used in several ways to supply

power to the receivers in the building. In the simplest method the five risers can be terminated at central locations in junction boxes, then to run lateral cables to the subscriber's apartments.

Conduit Feed

A second method is to distribute the five risers through conduits and use solderless connectors at each apartment. There is still another type of distribution system which can be used. In this instance, transformers are used, permitting each riser to be split into four sub-risers, so that a total of 20 sub-risers can be used to distribute signal through the building. Solderless connectors or junction boxes can be used from these 20 sub-risers to the subscribed apartments. Combinations of these several basic approaches can be used to cover any type of building.

Set-Line Isolation

In any case, the isolation between set and line has been found to be about 25 to 30 db; hence, between any two sets on the system, there is a minimum of 50 db, which is adequate to prevent oscillator interference.

Sets with provision for 75-ohm input must be connected directly to the RG59U cable. Sets with balanced input must be connected by means of a *balun* half-wave transformer or one of the standard type of matching transformers.

Briefly, the system functions in the following manner:

(a) Antenna signals received at antenna, may be of the order of 250 to 100,000 microvolts.

(b) Antenna leadin loss may be up to 6 db; at amplifier, signals may be up to 125 to 50,000 microvolts.

(c) At amplifier, balun transformers restore this loss; resistive padding reduces strong signals to about 5,000 microvolts.

(d) Amplifiers are adjusted to deliver 2 volts peak-to-peak on all channels.

(e) Coupling transformers and filters drop voltage by a factor of about 4.5; the voltage at the top of the distribution system is about 440,000 microvolts.

(f) Allowing 6 db loss in each riser, about 220,000 microvolts arrive at the distribution box.

(g) With 36 db isolation, each lateral receives about 4,000 microvolts.

(h) Allowing 6 db loss in lateral run, each receiver receives about 2,000 microvolts. For long runs of risers or laterals, the attenuation at the distribution box can be reduced to 30 db.

Signal Voltage Available

From the foregoing analysis, it will be noted that signals of the order of two millivolts can be delivered to the receiver; this constitutes a very acceptable signal.

Fast-Acting AGC SYSTEMS

by CHARLES E. BOWERS

Staff Engineer, Bendix Radio

Part II...Operational Characteristics of Keyed AGC Systems in Use Today

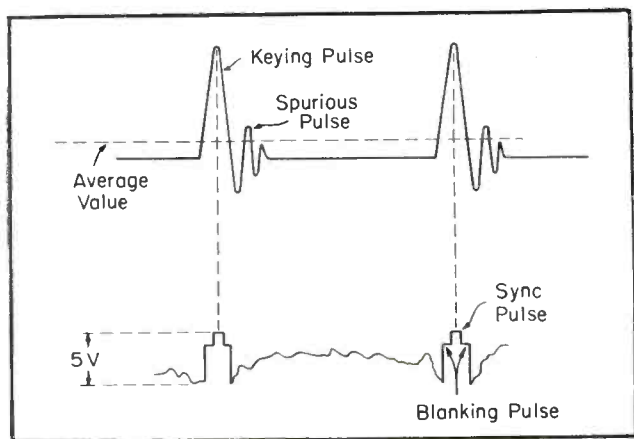

Fig. 1. Time relation between the sync and keying pulse. Sync pulse has been drawn larger than it actually is in relation to the flyback pulse (about 1/50 the height of the flyback pulse), to present a clearer illustration. Duration of both pulses in relation to rest of the individual line has also been exaggerated to show their appearance.

than that required in other types of *agc* systems, where the 60 *cps* vertical sync pulse must also be filtered out. It is this short-time constant that gives the keyed *agc* its fast action.

Pulse and Voltages

In Fig. 1 is illustrated the effect of the flyback pulse at the plate of the *agc* tube and the sync pulse on the grid. It can be seen from this illustration that the actual time during which the tube can draw current is shorter than the flyback time. The flyback pulse is really triangular, and the plate voltage becomes high enough only during the upper portion which is much narrower than the base. The sync pulse, however, is more of a square wave, and the grid is, therefore, maintained at the sync pulse level slightly longer than the actual conduction period of the tube. This tends to compensate for slight time differences, but when the horizontal sweep is not in synchronism with the incoming signal, the pulses on the *agc* tube will

IN KEYED AGC systems, the picture signal with the *dc* component present is fed to the grid of a pentode, usually a 6AU6, in such a manner that the sync pulses drive the grid more positive. The cathode of this *agc* tube is about 90 to 145 volts, positive, with the plate at *dc* ground potential. A portion of the horizontal flyback pulse is applied to the plate through a coupling network from the flyback transformer. During the peak period of this pulse, the tube conducts since the plate is then made sufficiently positive with respect to the cathode. A voltage divider maintains the grid a few volts negative with respect to the cathode, biased closely to cutoff.

During the period of the sharp pulse on the plate, the sync pulse, which is part of the composite picture signal, appears on the grid. This sync pulse makes the grid more positive, permitting more plate current to flow. Thus, the amount of plate current that flows during each flyback period depends on the amplitude of the horizontal synchronizing pulse.

Because the *dc* component of the picture signal is preserved, all sync pulses are at the same level unless the strength of the received signal changes. The plate current of the *agc* tube is, therefore, independent of the picture modulation or of any noise pulses which are part of the picture. If noise pulses are present during the sync-pulse period, they will have some

effect on the plate current, but since the sync pulse represents just about 5% of the composite picture, only 5% of the total noise present can be effective.

The plate current flows to ground through a high-value resistor shunted by a capacitor. This *rc* combination must have a time constant only large enough to filter out the horizontal sweep frequency, which is 15,750 *cps*. This is a much smaller time constant

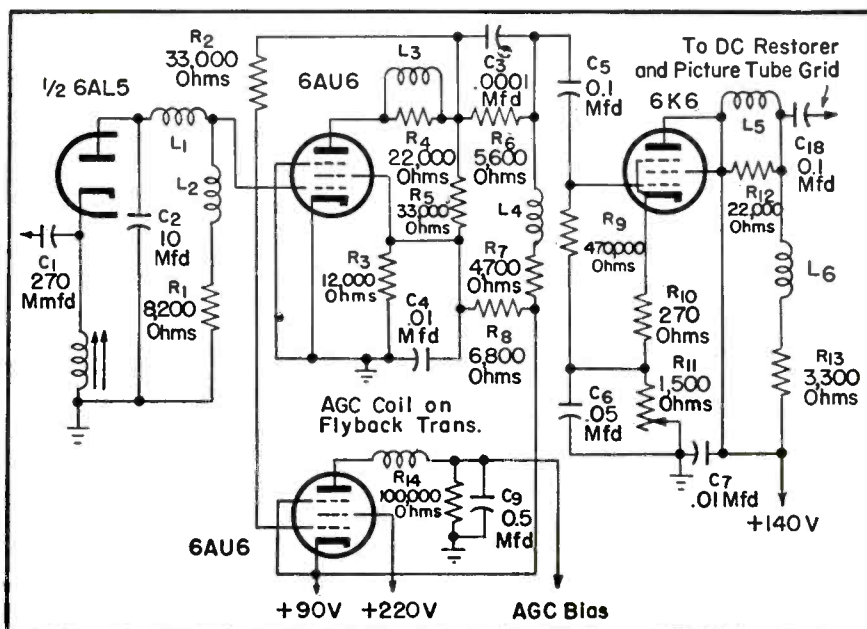

Fig. 2. Video amplifier with two video stages, in which a direct connection is made from the second detector to the grid of the first video amplifier to preserve the *dc* component.

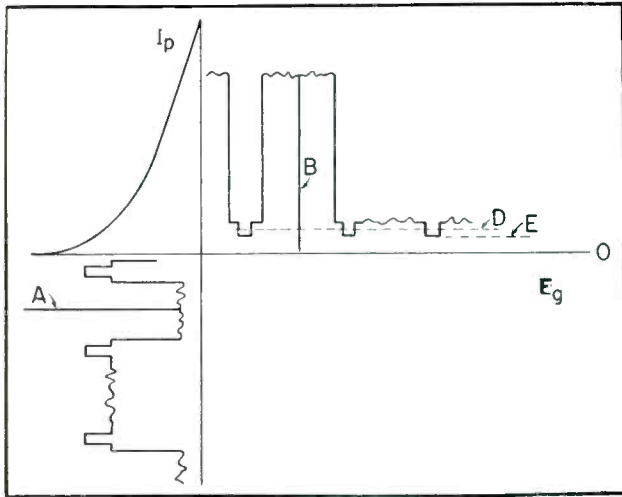

Fig. 3. Illustration of noise pulses, where D = *agc* tube cutoff and O = video tube cutoff. The $E_g I_p$ curve is for the first video stage.

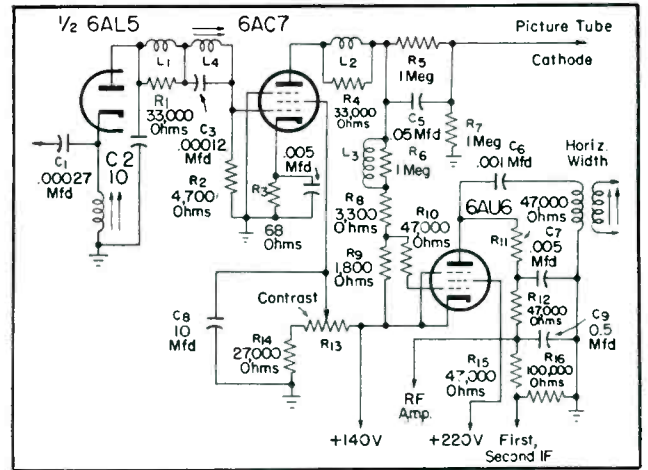

Fig. 4. Keyed *agc* circuit with single stage of video where cathode of picture tube is driven with picture signal. A 33,000-ohm resistor is used to reduce effect of peaking.

also be out of step, and the *agc* bias will vary rapidly.

In the keyed *agc* system, the *dc* component must be present in the composite picture signal applied to the grid of the *agc* tube; otherwise, the grid voltage would not be the same during each successive flyback period. When the picture signal passes through a capacitor, the *dc* component is removed, and the sync pulses are no longer all at the same level.

Various types of *dc* restoration systems are used on most TV receivers prior to the picture tube. Some sets use a diode *dc* restorer, others use grid-leak *dc* restoration in the last video amplifier and then make a direct connection to the picture tube. Still other models use a direct connection from the second detector to the video amplifier and then another direct con-

nection to the picture tube, eliminating the need for *dc* restoration since the picture signal never passes through a capacitor.

In tapping the picture signal for application to the *agc* tube the sync pulses must go in a positive direction. Whenever the picture signal is applied to the grid of the picture tube the sync pulses go negative. This is necessary so that the blanking pedestals, shown on both sides of the sync pulse in Fig. 1, can drive the grid negative and cut off the picture tube during the flyback time.

In receivers where the picture signal is applied to the cathode of the picture tube, the pulses go positive since they, then make the cathode more positive with respect to the grid, again cutting off the tube during the flyback time. Therefore, it is possible to tap

the picture signal from the last stage after *dc* restoration has taken place in all sets having cathode drive. When two stages of video amplification are used and the picture signal is applied to the grid of the picture tube, the proper tap-off point is in the plate circuit of the first video amplifier. To preserve the *dc* component in this case, a direct connection must be made from the second detector to the grid of the first video amplifier; Fig. 2.

To fulfill the previously-mentioned requirements, noting that the video signal is of a negative polarity at the grid and a positive polarity at the plate of the first video stage, the output of the detector must be taken from the plate, as shown in Fig. 2. Also, for the *agc* tube to conduct and develop control bias, the drop across the first video stage plate resistor must be less than the cutoff voltage of the *agc* stage, at the sync signal peaks. Since the signal is being impressed upon the grid of the video stage in a negative direction the plate current will be decreased in proportion to its strength, causing the voltage drop across the video amplifier plate resistor to decrease, thereby controlling the *agc* bias. Now, either enough voltage must be developed from the incoming signal to cause the circuit to operate in this fashion or some other means must be devised to apply additional bias to the tube. If, for instance, the video stage were operated with 150 volts on the screen, it would require approximately 5 volts of signal at the detector to have it close enough to cut-off during the sync pulse. To produce a signal of this amplitude there would be required an excessive amount of gain ahead of the detector and much less gain would be used in the video amplifier than it is capable of provid-

(Continued on page 78)

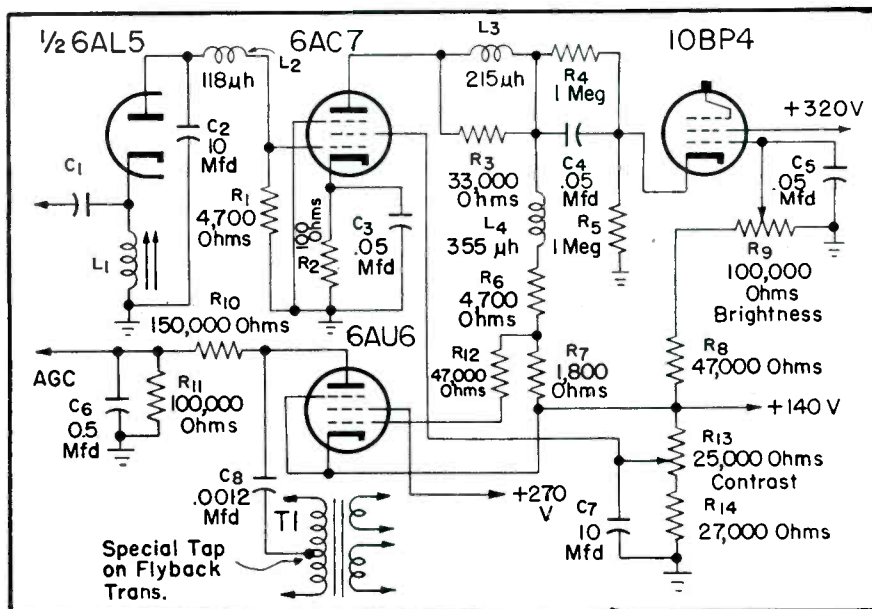
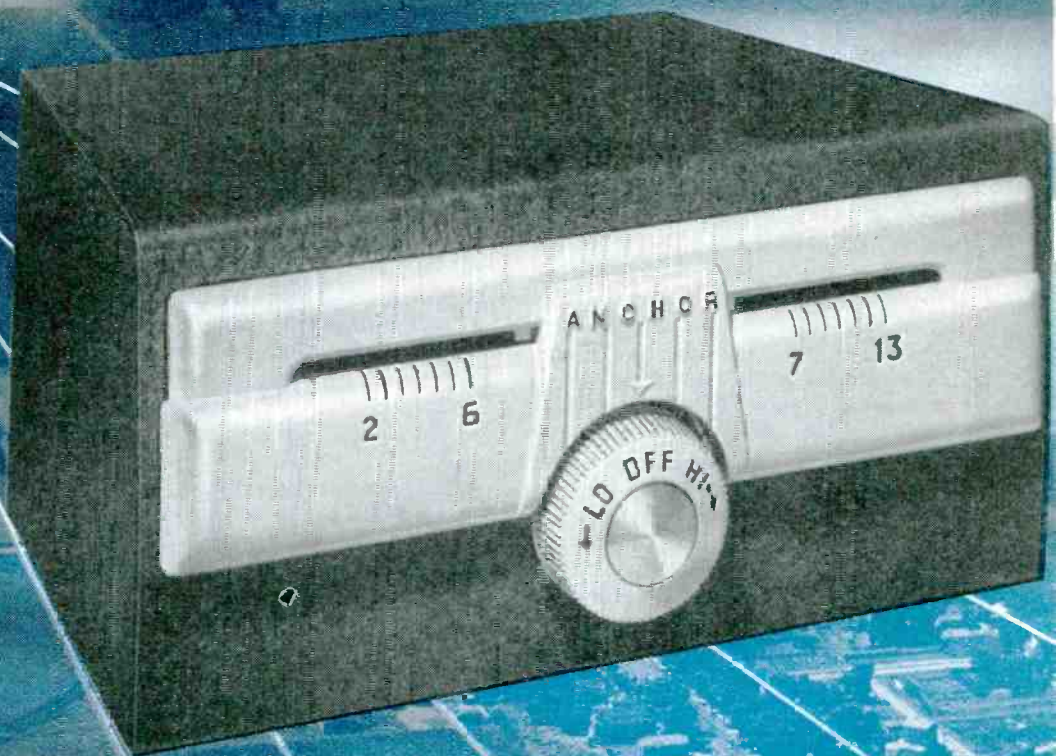

Fig. 5. A keyed *agc* circuit featuring use of a single 6AC7 video amplifier, with *agc* voltage obtained through voltage divider and decoupling net; 4700, 1800 and 47000-ohm resistors.

ANCHOR BOOSTERS



Ask your Distributor about Anchor's
Easel Presentation on successful fringe installations

ANCHOR RADIO CORP.

ANCHOR ENGINEERING ALWAYS A YEAR AHEAD

Bring the "fringe"
the BEST in TV reception

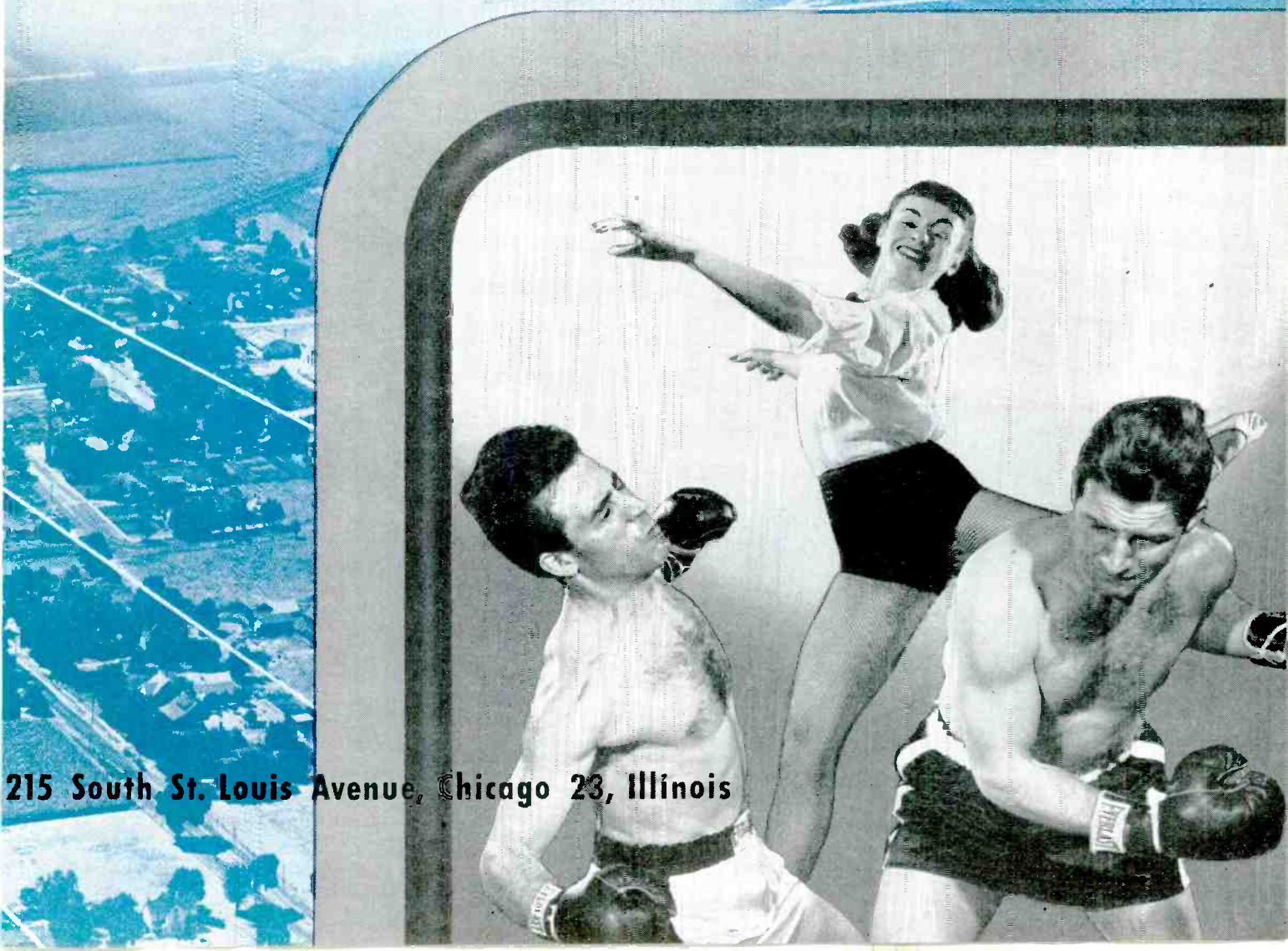

215 South St. Louis Avenue, Chicago 23, Illinois

Intensive Two-Week Course, Featuring Informal Classroom Lectures and Practical Bench Work, Designed to Familiarize Service Men With the Correct Procedures to be Used in Alignment, Adjustment, Troubleshooting and Installation.

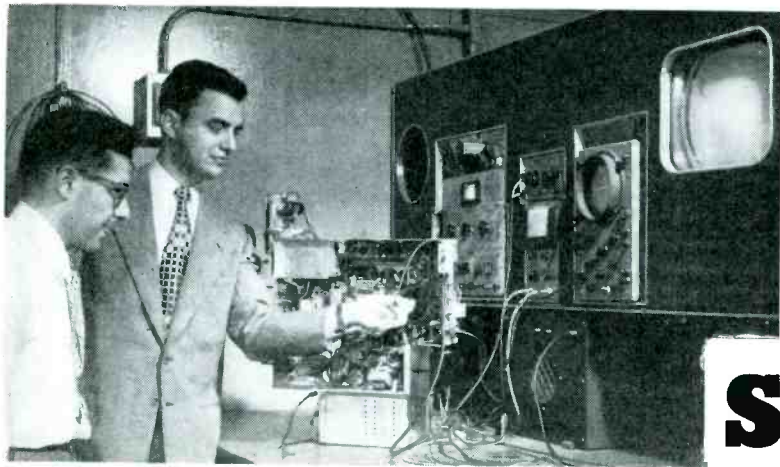

Training School for Service Men

SINCE THE TERMINATION of World War II, the rapidly expanding television industry has been faced with a lack of trained Service Men.

To rectify this condition some manufacturers have conducted series of service meetings to convey technical information to Service Men. While this practice has been widely approved and helpful, it was found that there was a need for an additional training program conducted on a more practical basis. To fulfill this need, it was decided to establish a Service Man's Training School‡.

The school was set up to acquaint further Service Men with the correct procedures for installing, adjusting, and servicing our television receivers; the program provided for two week

by **WALTER BOIKO**

**Teleset Service Control Department
Allen B. Du Mont Laboratories, Inc.**

courses on prevailing production television models.

The school facilities now include a classroom teaching area and six work benches provided with the necessary test equipment for proper servicing. The bench test equipment is representative of that found in a typical television service shop.

The number of attending students for each session is kept small so that

maximum individual instruction may be given to each student.

The two-week course in East Paterson, New Jersey, where the school is presently located, is a four-part semester, in which the following projects are covered:

- (1) Adjustment procedures for current production receivers.
- (2) Television receiver alignment.
- (3) Troubleshooting Du Mont receivers, with the use of the necessary test equipment.
- (4) Obtaining maximum utility from test equipment.

The foregoing subjects are covered by classroom lectures and practical bench work. The organized classroom lectures stress the operation of circuits used in our chassis and emphasize techniques for troubleshooting each individual circuit. The lectures are of the informal type presenting opportunities for the Service Man to ask questions.

Particular attention is given to the individual technical problems experienced by the students in their local areas. This includes such topics as fringe area reception, overloading conditions and interference. Emphasis is placed on the *agc*, *sync*, and horizontal circuits, as these seem most troublesome to Service Men. Lecture material is presented on a practical level with demonstrations incorporated whenever possible.

Normally the average Service Man shies away from aligning the video if

(Continued on page 28)

‡The first classes were held in 1947.

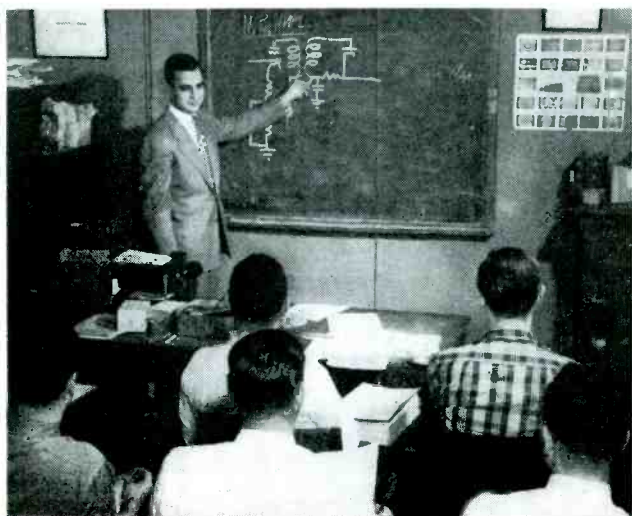

Above

Instructor demonstrating use of 'scope for troubleshooting a television receiver.

Left

Classroom scene illustrating the informal lectures presented at the East Paterson, New Jersey, Du Mont Service Man's training school.

WE'RE TELLING THE WORLD ABOUT FEATHERIDE PICK-UP CARTRIDGES ...to build more sales for YOU!

For the first time in pick-up cartridge history, the 5,000,000 readers of two great national magazines . . . Better Homes & Gardens and Time . . . will be told that their phonograph or record player needs a new pick-up installed from time to time and that you are the man whom they should seek to furnish and install Webster Electric Featheride Pick-up Cartridges.

Your service problems can be greatly minimized by standardizing on Webster Electric Featheride Pick-up Cartridges. Only two models are required for most replacement jobs; no charts, no manuals are needed. Both models are handsomely packaged in Webster Dri-Pack containers.

A special metal foil seal, which we call Dri-Seal, protects the crystal, adding life to the cartridge and making it practically impervious to moisture. Both models are completely assembled units. They are the most versatile, most competitively priced and practical pick-up cartridges on the market today.

The features of these two models are briefly described below. Send the coupon for complete technical details.



WEBSTER ELECTRIC Featheride

MODEL WS Pick-up Cartridge
for 78 RPM

1. Special 3-terminal construction provides dual output . . . 4.0 v. or 1.5 v.
2. Factory assembled, ready for use.
3. Matching osmium-tipped needle furnished.
4. Fits any standard 1/2-in. RTMA mounting.

WEBSTER ELECTRIC Featheride

MODEL AX Pick-up Cartridge
for 33 1/3, 45 and 78 RPM

1. Completely factory assembled in positive-action twist bracket.
2. Bracket easily removed for integral-twist-mechanism tone-arm installation.
3. Two matching osmium-tipped needles furnished.
4. Fits standard 1/2-in. RTMA mountings.

Webster Electric Company, Clark and DeKoven Streets,
Racine, Wisconsin

Please send me technical data on Featheride Pick-up Cartridges for replacement use.

Name _____ (Please print)

Address _____

City _____ Zone _____ State _____

Jobber Service Technician Other

WEBSTER ELECTRIC
RACINE ♦ WISCONSIN

"Where Quality is a Responsibility and Fair Dealing an Obligation"

Training School

(Continued from page 26)

stages of a television receiver. At our school, efficiency is attained through the alignment of current production receivers under expert supervision.

In studying the techniques of troubleshooting the student learns to follow a *logical method of approach* procedure and avoid the pitfalls of the hit or miss time consuming method. In practicing the art of troubleshooting, inserted troubles are employed to add to the students knowledge of troubleshooting principles. Actual defective parts are used instead of simulated troubles (gremlin wire technique). This prevents the student from locating troubles by visual inspection. Both normal and abnormal troubles covering all aspects of the receiver are placed in the receiver for the student to locate. This practice, in conjunction with the logical method of troubleshooting approach, trains the student to handle any receiver problem.

One of the most valuable features of the course is the instruction session which details the use of the 'scope for troubleshooting television receivers. At the very beginning of the course the Service Man is taught how to become expert at using the 'scope and voltage calibrator for signal tracing and signal waveform analysis.

The students are given an opportunity to discuss and compare their individual technique for troubleshooting television receivers.

To make the course as useful as possible to the students, the instructors, consisting of various technical field representatives, contribute their field experiences in addition to their technical *know-how*.

The training program has been so successful that our service department now requires that all technical employees of the department become graduates of the school.

School records show that hundreds of Service Men from almost every state in the country have attended the school during the past four years. Perhaps many readers of this article have had diplomas issued to them upon successful graduation from the school.

One quality all graduating Service Men acquire is self-confidence. This is certainly an asset to the Service Man facing an improperly operating television receiver.

While this unique course is given without cost to attending Service Men, there are certain requirements which must be met:

- (1) He must be connected with one of our authorized service or sales agencies.
- (2) He must have some previous television servicing experience.
- (3) He must be willing to attend all of the 8-hour day-time sessions.
- (4) He must be a citizen of the United States.

All books and tools are supplied by the school, and accommodations are made upon request at the local Y.M.C.A. for out-of-town students.

Applications for admission to the school may be obtained by writing to: Allen B. Du Mont Laboratories, Inc., c/o Teleset Service Control Department, 35 Market Street, East Paterson, New Jersey.

We look forward to the day when a number of Service Man schools can be established throughout the country, since it is acknowledged that better education for the Service Man represents the key to better servicing.

AMPHENOL — INLINE — ANTENNA

Be Sure ANTENNA INSTALLATIONS are Safe

Safety is a factor too often overlooked in many TV antenna installations. Bent or broken antennas are a constant menace and antennas that break off or topple over under any undue strain can cause serious damage. Installing an Amphenol Inline Antenna is your guarantee of all-around quality! Not only does the Inline Antenna present the best possible TV picture, but it is safe! The Inline Antenna is constructed of aluminum for light weight and strength, and is engineered to withstand winds up to 70 miles per hour. In addition, it will bear up to one-half inch annular ice loadings without bending or breaking.

LIGHTNING ARRESTOR

Using an Amphenol Lightning Arrestor on the lead-in from your Inline Antenna makes your antenna installation secure in all ways. It provides real protection to your home and TV set from lightning damage and carries off the minor static discharges which interfere with good picture reception. The Amphenol Lightning Arrestor is of the type approved by the National Electric Code and is also approved by the Underwriters' Laboratories.



See your regular Amphenol Distributor now for your copy of this 20-page book containing all the factors which determine Better TV Picture Quality and safe antenna installation.

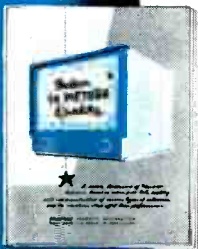

AMERICAN PHENOLIC CORPORATION
1830 SOUTH 54th AVENUE • CHICAGO 50, ILLINOIS

AMPHENOL

available

from your Teletron distributor...

1

Tele-lead

Handiest TV servicing aid yet. Permits power connection to receiver chassis when safety interlocking switch is broken by opening protective back. At the same time, it provides a trouble light to see what's what.

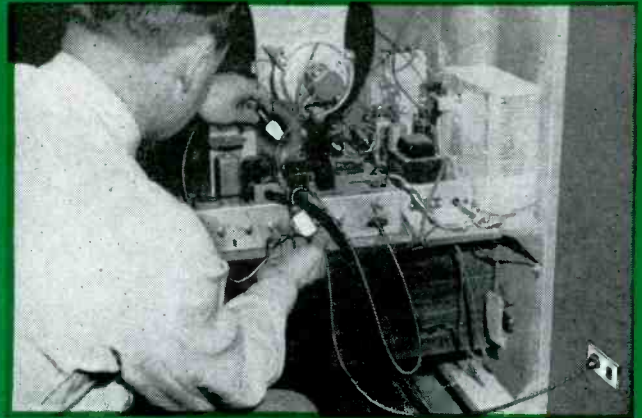

2

TV Picture Tube Selector

Replaces those bulky and seldom-at-hand charts and booklets formerly necessary to find correct replacements. Merely dial the type to be replaced—presto! there's the correct Teletron replacement. Also electrical and mechanical characteristics for those profitable conversion jobs!

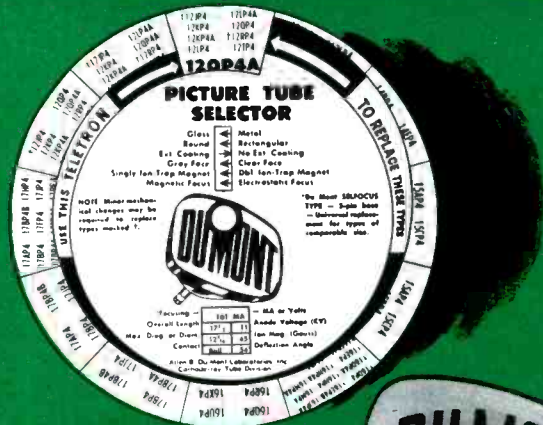

3

Teletron Decal

Colorful decal easily transferred to store window, doors, inside displays, or on your truck or car. Immediately marks you as a quality-wise service organization. Ties right in with Du Mont fame!

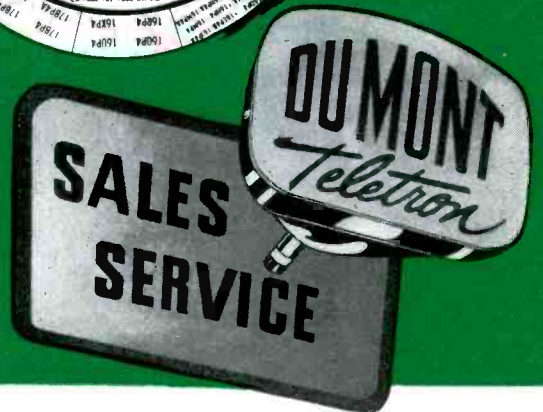

Geared to your TV servicing! It's up to you to get these aids from your Du Mont Teletron distributor. They represent *plus* values above and beyond that biggest bonus—Du Mont's reputation for *quality, progressive engineering and customer satisfaction*. Drop in on your Du Mont Teletron distributor today. Ask for the aids. And get in on the fastest road to more profitable TV servicing.

DU MONT



CATHODE-RAY TUBE DIVISION ALLEN B. DU MONT LABORATORIES, INC., CLIFTON, N. J.

*Trade-mark

Centering and Focusing Electrostatically-Focused Picture Tubes...Area Selection Switch Applications... Choosing Correct Buffer Capacitor for Auto Radios...

Servicing Helps

by M. A. MARWELL

THE USE OF THE electrostatically-focused picture tubes has introduced entirely new principles of centering and focus, involving the application of magnetic centering devices to aid in performing the centering function which was done by the focus coil on the electromagnetically-focused tubes.

To achieve correct centering and good focus, the magnetic centering device must be properly adjusted.

Centering

In the Motorola '52 chassis, the centering device consists of two magnets arranged in such a way that the magnetic field intensity can be varied in angle or direction by means of two projecting arms and by rotation of the device about the tube neck. When the arms are superimposed, the fields of the two magnets cancel. Moving the arms progressively further apart in a given direction, with respect to each other, will produce an increasing field intensity of a given polarity. If the arms are moved apart in the other direction, a field of opposite polarity will result. This controllable magnetic field acting on the beam normally provides a means of centering the picture vertically when the arms are initially at either side, and by rotation to a vertical arm position it will also produce horizontal centering. Horizontal centering by means of the magnetic centering device should be held to a minimum because of the danger of shadow on the right side of the picture. Shadow is avoided by using electrical centering horizontally.

Before centering or focusing is attempted, the ion trap should be properly adjusted.

In centering, the size of the picture must be reduced so that all four edges are visible. Then a station should be tuned in; no attempt to center should be made with an uncontrolled raster. Now, starting with the magnetic centering device arms together, they should be turned so they are horizon-

tal. The device should be positioned as close to the yoke as possible without causing any part of it to slip inside the yoke opening.

The electrical horizontal centering control on the back of the chassis should then be adjusted for best horizontal centering obtainable within a range of the control which leaves 25% of rotation available at the ends. The arms of the centering device should next be separated, equally in the proper direction, to center the picture vertically in the direction of separation which gives the desired result. If full horizontal centering has not been obtained, the horizontal centering can be completed by slightly rotating the magnetic centering device as a unit one way or the other. It may then be necessary to readjust vertical centering by slightly changing the relative position of the arms.

Focus

The zero focus-type electrostatically focused tubes such as the 14HP4F, 17TP4F, etc., used in some of the '52 Motorola television chassis, require a fixed potential applied to the focusing

anode which is supplied through a focus control potentiometer. This control, in effect, provides a means of compensating for differences in gun structure between tubes, but is far less critical in adjustment than was the focus control in the electromagnetically-focused tubes. By carefully turning the control through its range, a point of adjustment will be found where optimum focus is obtained, but no misadjustment of the control will result in the extreme de-focusing which resulted from the off-focus range in the focus control of electromagnetically-focused tubes. In some tubes, the effect of the focus control is so slight as to lead Service Men to believe that a fault exists in the circuit. This is particularly true because these chassis use anti-glare, etched picture tubes. Due to the etching the line structure is no longer so sharply defined as was the case when clear glass face plates were used. It has been found that many prefer the softer picture. The control should be adjusted to the point where the line structure is distinguishable over an 80% area of the screen.

Due to the differences in gun structure between tubes, it may be found, in some picture tubes, that better overall focus is obtained with the arms of the magnetic centering device pointing in a particular direction. If, after the magnetic centering device has been adjusted, good overall focus is not obtained, the magnetic centering device should be rotated 180° and the centering procedure repeated.

Fig. 1. Revised *h_v* portion of Sylvania 1-502 chassis, with the .0005-mfd capacitor, previously connected from the filament of the 5642 high-voltage rectifier to third lead from left (on horizontal size transformer) in the *h_v* scanning assembly, now connected to filament return, or second terminal from right.

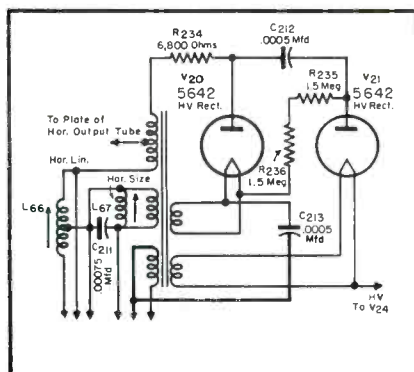

Area Selector Switch Application

In the Motorola models TS-314B, TS-315B, TS-325, TS-326 and TS-351, there is a three-position *area-selector* switch, located on the back of the chassis, which permits adjustment of set to varying receiving conditions found in different localities: *Local*, *suburban*, and *fringe* positions corresponding approximately, with settings

(Continued on page 61)

Tel-a-Ray's

BIG

FOUR

of TV reception

For television that's
bright and clear
Wherever you are . . .
far or near

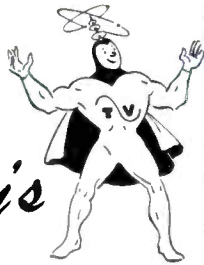

Good reception up to 200 miles or more!

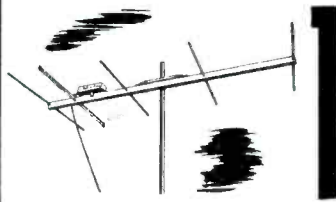

Models T and TD Antennas . . . famous for providing clear, stable, interference-free reception at almost unbelievable distances. With the Pre-Amplifier, they give up to an amazing 300 times gain over dipole. Rugged, weatherproof construction.

Signal amplification without noise!

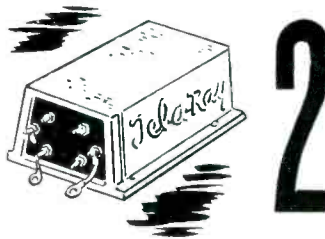

The unique, research-perfected Pre-Amplifier . . . the only device of its kind . . . an antenna- or mast-mounted installation that dramatically multiplies the signal gain while keeping noise at a minimum. Eliminates snow and makes signals strong and stable. Sold as a weather-sealed unit and guaranteed against weather damage.

Middle-distance champions!

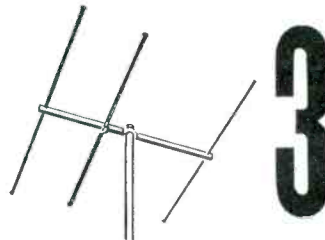

Models R and RD Antennas . . . designed to give the finest TV reception to the outer service areas at low cost . . . America's champion middle-distance performers. Same quality construction features as Models T and TD.

Amazing New Switching Booster Permits Switching Between Four Antennas

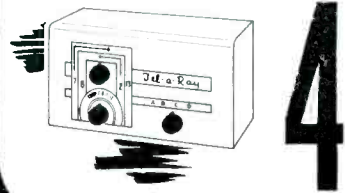

The new Tel-a-Ray Booster is designed for areas where two or more channels may be received with separate antennas. It is a low noise level, high gain booster that both controls and supplies power for the Tel-a-Ray Antenna system. You switch from one antenna to another with just one knob.

HOW TO MAKE MORE MONEY WITHOUT CALL-BACKS

With the aid of Tel-a-Ray's "Big Four," you can give your customers brilliant, stable television reception almost anywhere . . . beyond the fringe areas, in outer service areas, in the primary areas. Reception problems are solved in a jiffy. Installation is amazingly easy and fast. Call-backs are reduced to a minimum. The quality of these Tel-a-Ray products shows in their appearance . . . in their rugged construction of the finest corrosionproof materials . . . in their unconditional guarantee against wind and weather damage.

Use them to sell television beyond the fringe areas . . . to make more money out of the replacement market in the established TV areas . . . to give your customers the finest TV reception at low cost. Send the coupon for full information.

Tel-a-Ray, America's most progressive antenna manufacturer, has applied to the FCC to operate a UHF television station on Channel 50 . . . Tel-a-Ray's research engineers, keeping pace with America's fastest-growing industry, have developed an effective UHF antenna. Such progress assures you finer television.

**MAKE MORE MONEY WITH
LESS WORK AND TROUBLE**

Send the coupon now

Tel-a-Ray ENTERPRISES, INC., P.O. Box 3325, Henderson, Kentucky

Yes . . . I'd like descriptive literature on the Tel-a-Ray line, and the name of my nearest Tel-a-Ray Distributor.

NAME.....

COMPANY.....

ADDRESS.....



EXACT DUPLICATE: Try this on any "kit!" It's a wire-wound, carbon and switch combination. Only the Clarostat RTV (Exact Duplicate) number will do.

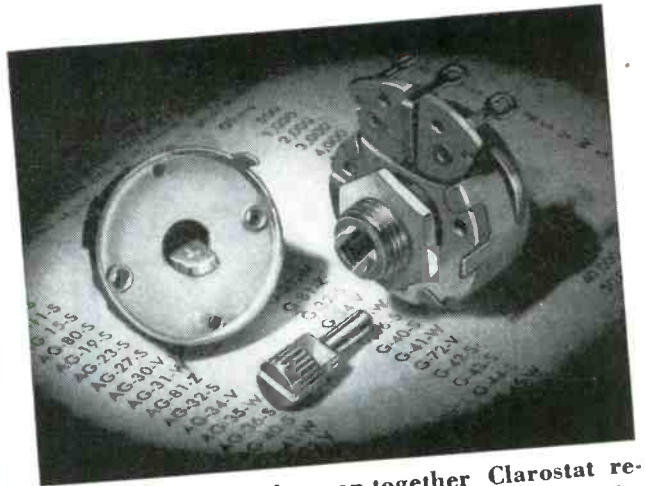

STANDARD: Simple snap-together Clarostat replacement— Series AG "15/16" control with Series SWB Ad-A-Switch and Series FKS-1/4 fine knurled slotted Pick-A-Shaft.

Exact Duplicate or Standard Type

EITHER WAY
you can stand pat with

CLAROSTAT

Controls

Which? Well, some replacement jobs call for exact duplicates. No standard controls will do. Especially so with those concentric-shaft duals. And you just can't afford to lose time, patience, money and even reputation trying to assemble tricky combinations from old-fashioned "kits." Your best bet is Clarostat's RTV program—Exact Duplicate numbers—almost 300 types—covering 2700 TV models of approximately 100 set manufacturers.

In the many applications where standard controls will do, Clarostat offers you the outstanding selection of 1 1/8" and 1 5/16" sizes. More than that, you can have Ad-A-Switches and Pick-A-Shafts to assemble simple combinations.

Best of all, your Clarostat distributor stocks them! Ask him about it.



The Clarostat TV Control Replacement Manual (and supplements) tells you what control to use. Ask your distributor for it!



Clarostat's latest catalog No. 51 lists the greatest choice yet of controls and resistors. Ask your distributor for your copy!

Controls and

CLAROSTAT MFG. CO., INC.,
DOVER, NEW HAMPSHIRE



Resistors

In Canada:
Canadian Marconi Co., Ltd.,
Toronto, Ontario

Skysweeper

FIRST CHOICE OF THE
SERVICEMAN WHO
WANTS TO PROVIDE
ALL THE PICTURE QUALITY
BUILT INTO THE SET!

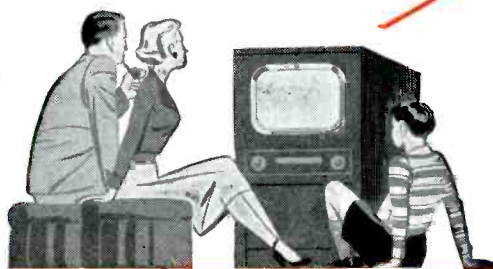

LIGHT WEIGHT!
FAST AND EASY
TO INSTALL!

CLEAR, BALANCED
BEAM! LONGER
RANGE RECEPTION!

BETTER BALANCED
FRONT-TO-BACK
RATIOS!

GREATER GAIN
IN FRINGE AREAS!

You can't go wrong! Clear, brilliant pictures result from teaming quality receivers with quality antennas. So when you want the best, all-channel reception, install the best antenna! Install Ferro's Skysweeper*—the all-purpose parabolical and conical antenna!

For here's the antenna that conquers distance... that cuts "ghosts" and interference to an irreducible minimum... that reaches out and pulls in a strong, powerful signal even in difficult locations and remote fringe areas.

Here's the antenna that *nets you more profit* by eliminating antenna failures, by cutting call backs and by reducing installation time.

Precision-engineered, the Skysweeper is rugged and of heavy-duty construction. Made of lightweight, corrosion-resistant aluminum alloys, this all-weather, all-location antenna offers many exclusive advantages including:

Strong, high-impact polystyrene reversible head block that permits either a parabolical or conical installation.

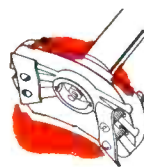

Wooden dowels in dipoles, reflector members and cross-arms enable you to draw clamps up tighter without collapsing parts.

Special corrugated clamps on crossarms and terminal blocks for firm positioning.

Standardize upon Skysweeper antennas for all your installations! Available in single-bay, double-bay or four-bay models complete with stacking bars, phasing bars and terminal blocks.

If your jobber can't supply you from stock, write, phone or wire us direct and we will air mail or special delivery your requirements. Write for this new folder which describes all models in detail.



*T. M. REGISTRATION PENDING



FERRO ELECTRIC PRODUCTS, INC.

A Subsidiary of Ferro Corporation

KIRKLAND, ILLINOIS

AUDIO *installation and service*

Phono-Tape-Wire-PA-Amplifiers-Speakers

by **KENNETH STEWART**

Features of Two-Speed Tape Recorders . . . Service Hints for Tape Equipment . . . Magnetic Recording Principles (Erasing . . . Playback . . . Equalization) . . . Highlights of New Audio Products: Oscillators, Folded Horns, Turnover Pickup Cartridges, Wide Dispersion Cone Speakers, Record Brushes.

WHEN MAGNETIC RECORDING EQUIPMENT became available on a commercial scale some years ago, it was not accepted with too much enthusiasm because of its bulky structure, inability to provide quality output and rather involved operation. Through the development of streamlined circuitry and allied parts, it has become possible to overcome completely these basic problems and produce compact, hi-fi, highly flexible gear. Last month, one of these advanced type units was briefly described. The recorder, a Webster-Chicago 210, was noted as featuring a two-speed system and a husky amplifier, the circuit of which appears in Fig. 1.

Two-speed recording is provided through the use of tape speeds of $7\frac{1}{2}$ inches per second (for the best musical recordings) or $3\frac{3}{4}$ inches per second (for most home uses). At the $7\frac{1}{2}$ inch speed a 7" reel of tape will record or playback 30 minutes in each direction.

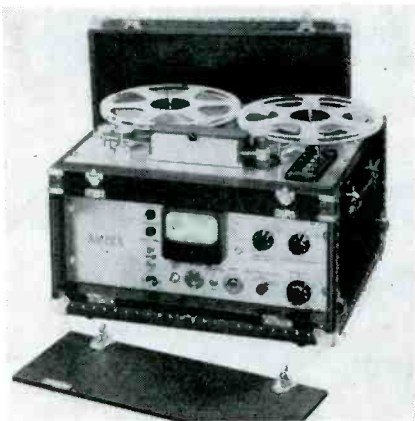

At the $3\frac{3}{4}$ inch speed, one hour in each direction is available, but with a narrower frequency response range.

Two tracks or programs can be recorded on the top and bottom halves of a standard 7" or 5" reel of tape, one track in each direction. Two recording heads, two motors and a tape direction and fast forward control make it possible to record or playback both tracks without turning the reels over.

The unit also features a four-point output selector switch, which in position one permits listening to playback of recording through the recorder's own speaker. Turning it to position 2 connects the recorder's amplifier to the output receptacle. Two watts of audio power are available at an impedance of 500 ohms to enable the playing of the

(Left)

Tape recorder which features push-button operation. Recorder is available with heads for either half-track or full-track recording. Can be operated at either $7\frac{1}{2}$ or 15 ips as controlled by a speed selector switch. Proper equalization for either speed is available for the operators selection. Can be arranged for remote control. Frequency response is said to be no more than 4 db at 30 and 15,000 cps at $7\frac{1}{2}$ ips tape speed; at 15 ips speed response is ± 2 db, 50 to 15,000 cps. Wow and flutter are claimed to be less than .2% at 15 ips and less than .25% at $7\frac{1}{2}$ ips. (Model 400-A; Ampex Electric Corp., Redwood City, Calif.)

(Right)

Network recorder which operates from remote push-button control stations. Has provision for installation of up to five magnetic heads. Has a self-adjusting disc braking system. Supplied in portable cases or for standard rack panel mounting. (NWR-1; Berlant Associates, 4917 West Jefferson Boulevard, Los Angeles 16, Calif.)

recorder though a larger, external speaker; a 500-ohm to voice-coil matching transformer is required. No. 3 position connects a high-impedance voltage to the output receptacle for operation through a public-address system, high-fidelity amplifier, or the radio receiver. Position 4 is a monitor position that permits monitoring of a recording in the speaker while it is being made, when recording from radio or phono. When used with a microphone, feedback and squealing may occur.

The Tape Transport Mechanism

As noted, to avoid the inconvenience of turning the reels over for dual-track operation, the tape transport mechanism consists of the equivalent of two separate recorders. Two motors, two recording heads and duplicate sets of



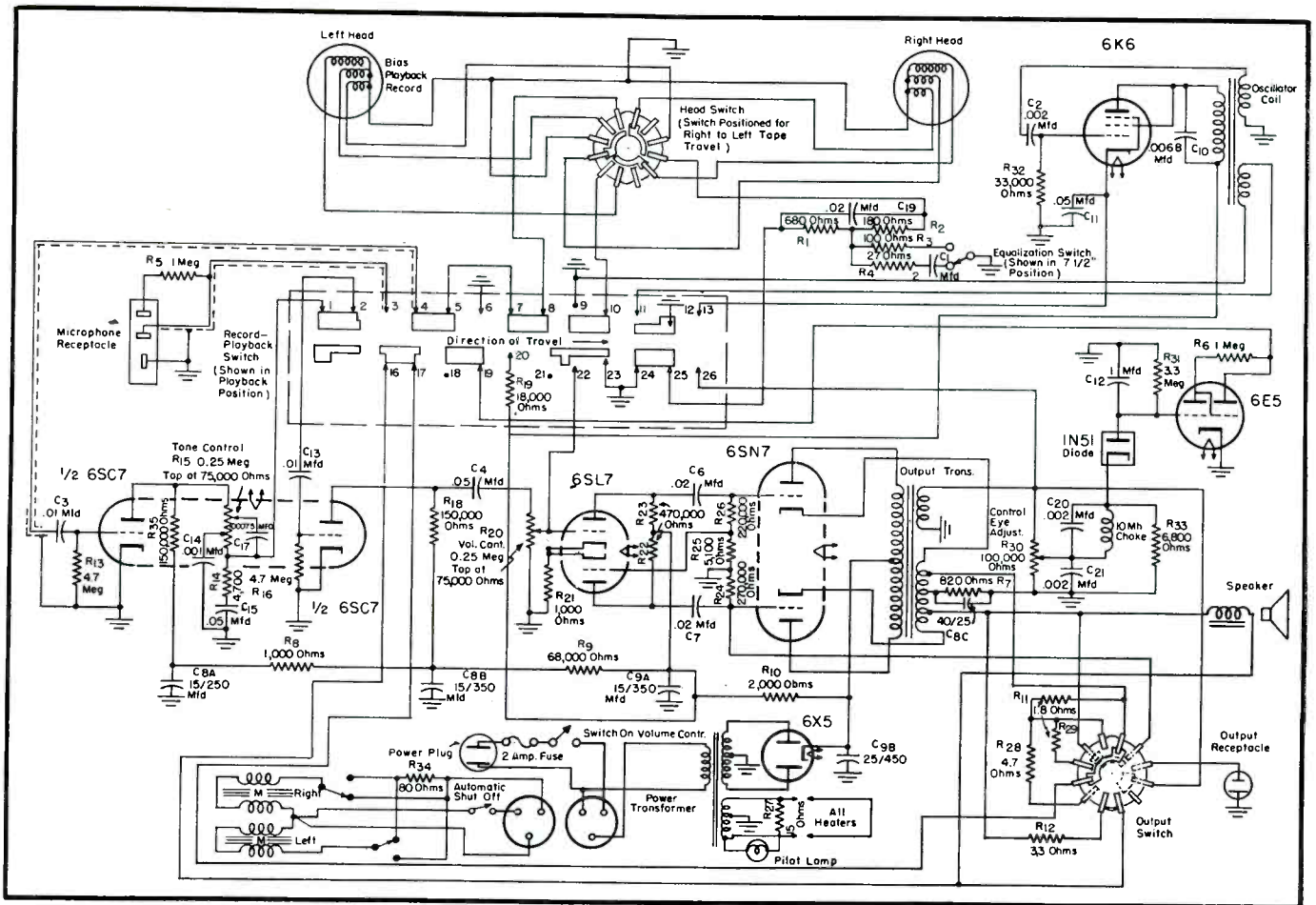

Circuit of Webster-Chicago 210 tape recorder.

drive wheels, tension springs, cams and associated parts are actuated by a single centralized control which includes the previously-mentioned *tape direction* and *fast forward control*, as well as a *record safety button*.

A *tape speed control* provides the tape speeds of $3\frac{3}{4}$ inches and $7\frac{1}{2}$ inches per second. The slow speed provides one hour of program in each direction from a 1200 foot reel, a total of two hours of program, at a frequency response of 70 to 4000 cycles per second. The $7\frac{1}{2}$ -inch-per-second speed provides 30 minutes program in each direction from the same reel but the frequency response range is 70 to 7500 cycles.

A single capstan and pressure roller assembly is located between the two recording-playback heads. The tape is *pulled* past the proper head, to assure a minimum of wow and flutter. There are also pressure pads to hold the tape firmly against the erase and record-playback gaps of the heads which minimize wow and flutter further.

Another interesting feature are *memory brakes*, provided to stop the tape promptly when the *tape direction control* is moved from either of the *run* positions to stop.

The *brakes* have been identified as *memory brakes* because they *remember* which way the tape is running and

apply the brake to the supply reel. This memory action is caused by a sliding cam, tension spring and the contour of a sliding cam. For example, when the *tape direction control* is turned to the left, the reel on the right hand chuck becomes the supply spool. The contour of the sliding cam forces the stud of a brake-actuating lever out of the way of a left hand sliding cam. The tension of the spring pulls the cam forward in front of the stud of the brake actuating lever. When the *tape direction control* is moved to *stop*, the sliding cam holds the brake away from a take-up chuck. However, the stud of the brake actuating lever follows the contour of the sliding cam, forces the right hand sliding cam out of the way and applies a brake to a supply reel chuck. If the *tape direction control* had been turned to the right, the action would have been reversed.

The Tape Speed Control

The choice of the tape speed is made by turning a *speed change shaft*. The contour of the shaft lifts or lowers the speed change lever, which in turn lifts or lowers *idler wheels* to contact the

the bushing on the motor shaft. The difference in diameter of the motor shaft or the bushing causes the speed change. A finger at the bottom of the *speed change shaft* actuates an *equalization switch* in the amplifier to provide proper equalization for the $3\frac{3}{4}$ " or $7\frac{1}{2}$ " per second speeds.

Service Hints

Low output from playback head. (Using tape, recorded previously on same recorder or recorded on another recorder):

In order that tape may be interchanged from one recorder to another or played back at widely separated dates on the same recorder, it is necessary that the recording head pole pieces and the recording gap be at a right angle to the tape.

Improper head alignment results in low volume and loss of the higher frequencies when playing back a good recording on a recorder that is out of alignment, or results in low volume and loss of the higher frequencies if recordings made on an improperly aligned recorder are played back on a good one.

Where it appears that the performance of a head is poor, the following

(Continued on page 71)

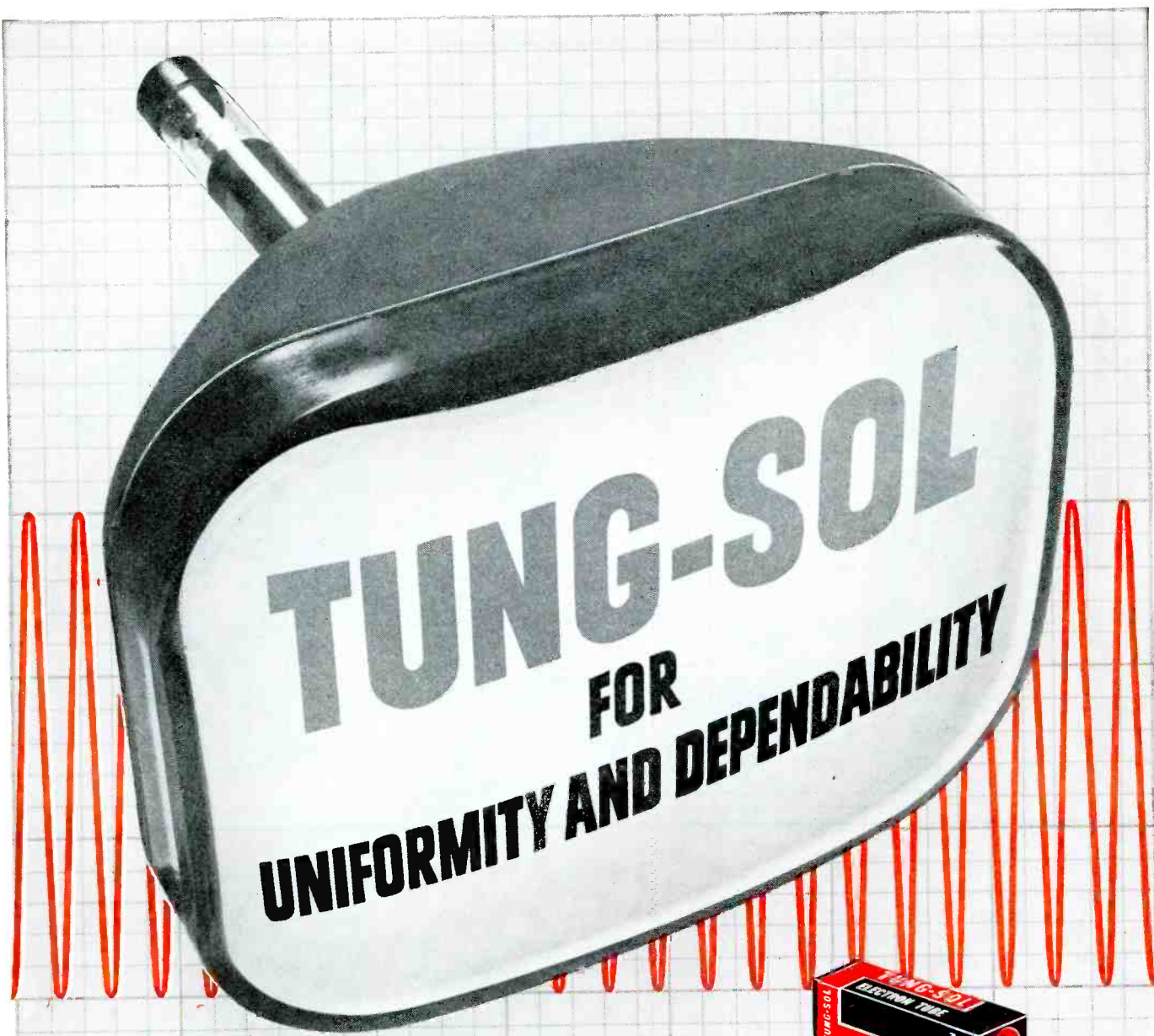

REPLACEMENT:

Tung-Sol Tubes keep service standards up to set manufacturers' specifications.

INITIAL EQUIPMENT:

Tung-Sol Tubes meet the highest performance requirements of set manufacturers.

TUNG-SOL ELECTRIC INC., Newark 4, N. J. Sales Offices: Atlanta
Chicago • Dallas • Denver • Detroit • Los Angeles • Newark

TUNG-SOL
RADIO, TV TUBES, DIAL LAMPS

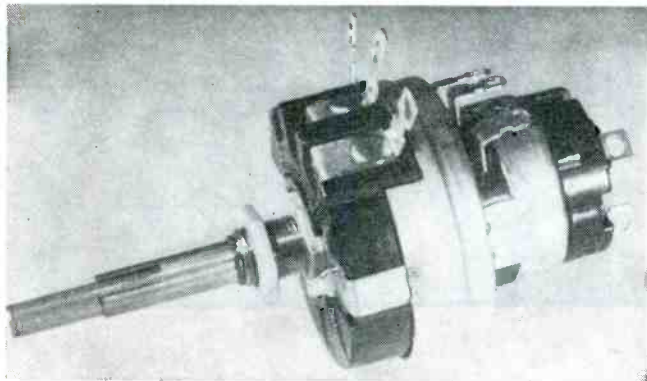

**A Report on the Characteristics
and Application Possibilities of
Exact-Duplicate Controls Now
Available for Practically All TV
Chassis Produced During Past
Five Years**

TV REPLACEMENT CONTROLS

by **FRAN CHAMBERLAIN**

*Distributor Division
Clarostat Manufacturing Co., Inc.*

TELEVISION SERVICING today is big business. The Service Man who does a good job is getting more work than he can handle. Time is of the essence to him, for it means more jobs he can complete in a day, more money he can make, and more customers for his shop.

With time so vital a factor, it is particularly important to adopt every measure in the book which will minimize or eliminate any losses. The average Service Man values his time at a good rate, and justly so; he thus should be able to follow a pattern which will permit spending as much time as possible on the actual diagnosing and correction of faults. The availability of exact-duplicate replacement components, through the larger suppliers of these same components for receiver manufacturers has been found to permit such practice, the

Factory-assembled replacement dual-concentric control.



Service Man finding it possible to spend his time very profitably for himself and his customer.

The Control Problem

Television servicing has presented a particularly complex problem in the field of controls. Since there are approximately 2,700 different models of popular chassis in use, each with various value carbon and wire controls, and combinations of these in the form of dual-concentrics, certain manufacturers have developed complete lines of controls for the Service Man's needs. In one instance, the plan provides for the production of the necessary controls as soon as the receiver manufacturer begins using them on his production line. To facilitate the

Above

Exact duplicate replacement type of control: Dual-concentric wire-wound and carbon control with a switch.

choice of these controls, there has been prepared a series of manuals and manual supplements providing the model, make of the receiver and the component number. The necessary control can be secured from the distributor for immediate insertion in the receiver, without any alterations.

Quite an assortment of exact-duplicate replacement combinations have been evolved: Concentric control using carbon control and 2-watt wire wound; concentric control using carbon control, and a 2-watt wire-wound with switch; concentric control using 2-watt wire-wound control; concentric control using 2-watt wire wound with switch; concentric control using a carbon control and a 3-watt wire-wound control; concentric control using a carbon control, and a 3-watt wire-

(Continued on page 76)

Another example of a replacement combination control with a switch.

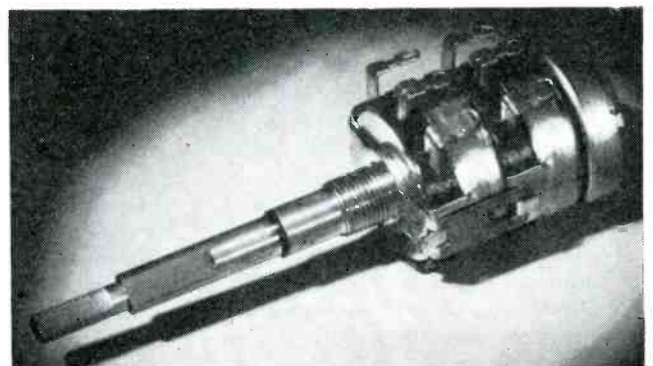

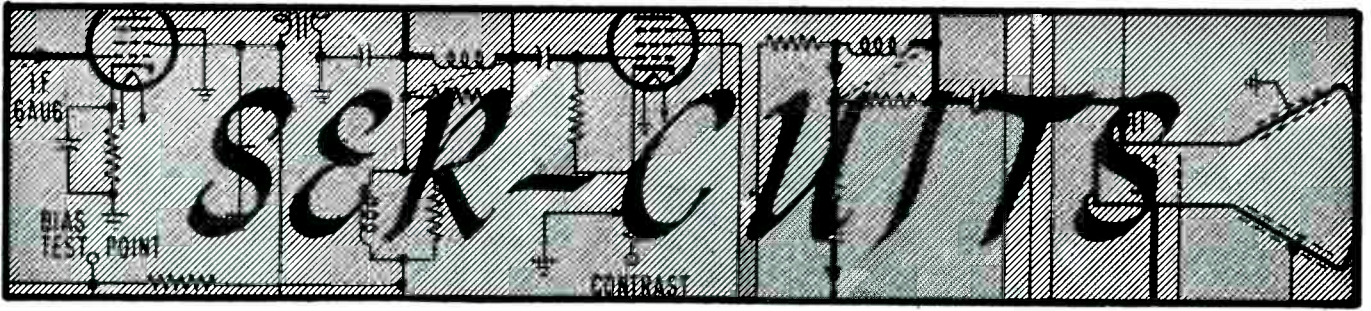

by M W. PERCY

Analysis of RF Chassis of '52 Philco TV Models . . . Design Features of High-Resolution 'Scope.

IN AN EFFORT TO SIMPLIFY TV servicing, some manufacturers have produced two-chassis models, with one chassis containing the *rf*, video, audio and sync circuits, and another the power and deflection circuits. In the '52 Philco line, this approach has been followed with models 41 and 44 serving to identify the *rf* base chassis and D-1 and D-4, the deflection chassis.

In Fig. 1 appears the circuit of the *rf* chassis used in the 44 series, which it will be noted is also subdivided, with the *rf* amp, oscillator and mixer section built on a separate subchassis.

The *rf* amp uses a 6BQ7, while the oscillator and mixer each use one-half of a 12AZ7. The output of the mixer is fed to a four-stage *if* amplifier, employing three 6AU6s and one 6CB6. One-half of a 12AU7 is used as a video detector/*agc* rectifier. The cathode and grid are used for video detection, while the cathode and plate are used for *agc* rectification. A delay voltage obtained from a 1000/150,000-ohm voltage divider, consisting of the contrast control, R_{305} and R_{408} , is applied to the cathode to prevent *agc* action on weak signals, where maximum gain is required. The maximum delay voltage is obtained when the contrast control is in the fully clockwise position, as is the case when the receiver is adjusted for weak signals. The *agc* voltage is applied to the *rf* amplifier and the first three *if* stages, to hold the output of the video detector essentially constant with large variations in input signal levels.

Sound *if* (intercarrier) is obtained by utilizing the beat frequency produced when a 26.6-mc video carrier and 22.1-mc sound carrier are mixed in the video detector. The beat fre-

quency, 4.5 mc, the difference between 26.6 and 22.1 mc, contains the FM sound signal. This 4.5-mc signal contains only a negligible amount of the video amplitude modulation, provided that the amplitude of the 22.1-mc signal is considerably lower than that of the 26.6-mc signal. The proper relationship between the two carriers is established in the alignment of the receiver. There is sound output only when both the video and sound carriers are present.

The oscillator is tuned primarily to obtain the best picture, since the 4.5-mc relationship always exists between the two carriers. The 4.5-mc sound *if* (intercarrier), which is taken from the video detector, is amplified by one-half of a 12AU7 and a 6AU6, and fed to the FM detector, which utilizes two diode sections of a 6T8. The triode section of the 6T8 is used as the first audio amplifier. (The power amplifier uses a 7C5 in the 41 chassis, and a 6Y6G in the 44 chassis.)

One-half of a 12AV7 is used as the first video amplifier, which works into a 6AQ5 video output amplifier. The plate load of the first video amplifier is made up of 4.5 and 3300-ohm resistors, R_{302} and R_{308} . To obtain higher voltage for sync, the composite signal for sync purposes is taken from across both R_{302} and R_{308} , while the composite video for the video output is taken from across R_{308} only. A 56-mmfd capacitor, C_{302} , is used to bypass high-frequency video around R_{302} . The plate load of the video output amplifier consists of a 4.5-ohm 220 uh coil and a 2500-ohm pot, L_{302} and R_{309} ; L_{302} is an adjustable peaking coil, adjusted at the factory for best video response.

The sync circuit consists of a first

sync separator, variable diode noise gate, second sync separator, and sync inverter. The composite video is fed to the first sync separator, one-half of a 12AV7. The output of the first sync separator is taken from the cathode and applied to the cathode of the noise gate, one-half of a 12AU7. A positive voltage, which is obtained from a voltage divider made up of 180,000 and 39,000-ohm resistors, R_{406} and R_{407} , is applied to the diode plate, while the sync signal, of positive polarity, is applied to the cathode. The diode will pass the sync signal as long as the cathode remains negative with respect to the plate. The value of plate voltage is chosen so that this condition exists for all normal sync signals. However, when a noise signal greater than the sync signal is received, the cathode of the diode is driven positive with respect to the plate, and the diode is cut off, thus preventing the noise from passing on to the second sync separator.

The positive voltage applied to the plate of the diode is made proportional to the strength of the signal being received by obtaining it from the load side of a 1500-ohm dropping resistor, R_{410} , in the B+ line that supplies plate and screen voltages to the *if* stages. The current through R_{410} , therefore, depends upon the amount of current drawn by the *if* stages. When a stronger signal is received, the *agc* voltage increases; this decreases the current drawn by the *if* stages, and decreases the voltage drop across R_{410} . Since this results in an increase in the voltage applied to the plate of the noise-gate diode, the level at which the diode will gate out the noise is raised.

(Continued on page 69)

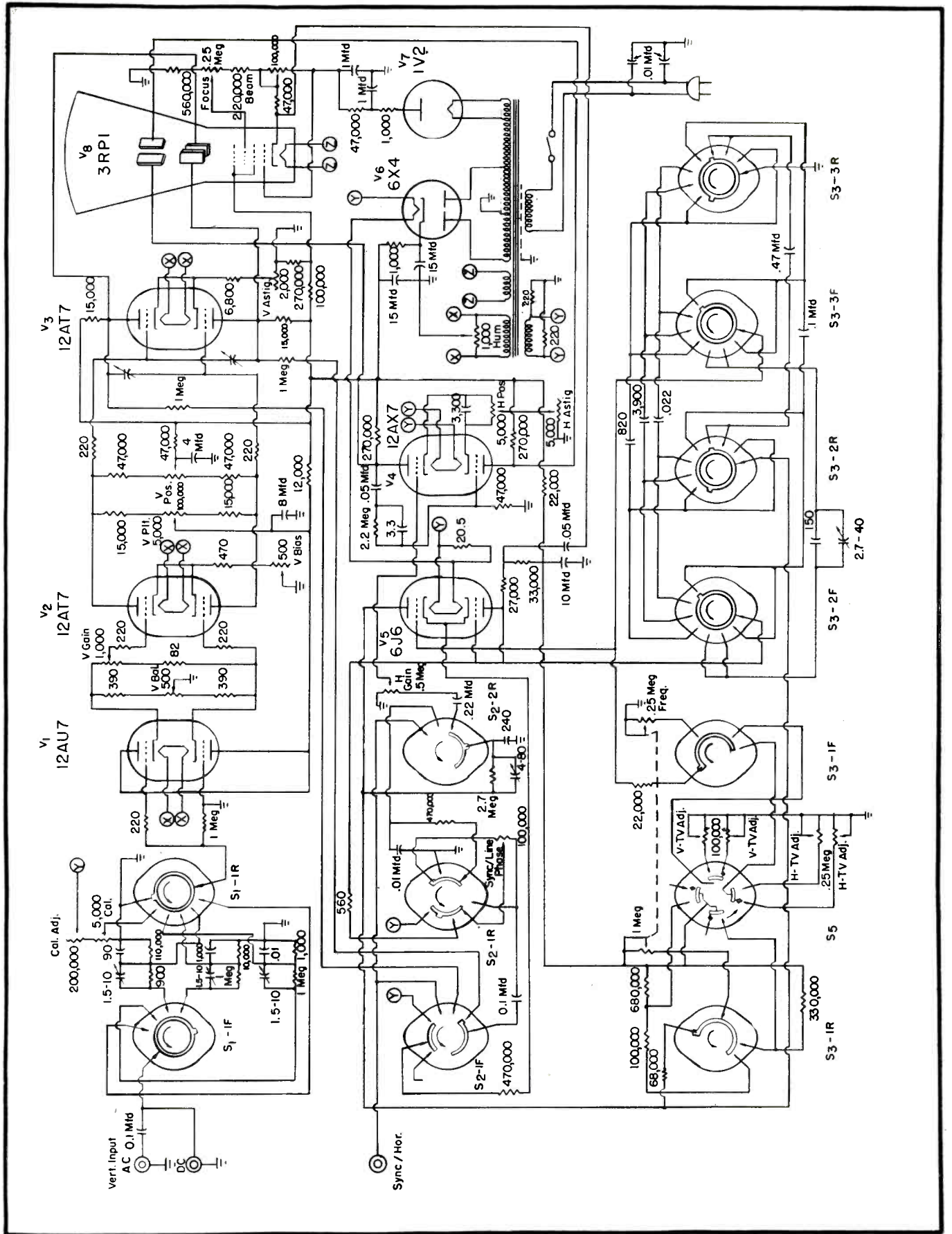

Fig. 2. Schematic of the Philco 7020 high-resolution TV 'scope. S₁ = attenuation switch; S₂ = function switch, and S₃ = range switch.

[See page 69 for analysis of 'scope]

MERIT

TV full-line* Components For
Improvement, Replacement, Conversion

SELL IMPROVED RECEPTION

MERIT "TV" Kit No. 1000 consists of matched units for sharp edge to edge focus — the MDF-70 Cosine Yoke, the HVO-7 Universal Flyback and the MWC-1 Width Linearity Control. Keep a MERIT "TV" Kit handy on service calls — when you spot fuzzy edge focus you'll get plus business and a reputation for real "know-how."



MERIT MDF-70 . . . original of the "cosine" series — low horizontal and high vertical inductance. Now used by such famous sets as Radio Craftsmen, the cosine series will improve 10,000,000 sets now on the market!

MERIT . . .

HQ for TV Service Aids

MERIT'S new 1952 Catalog #5211 is now available . . . introducing MERIT IF RF Coils and giving complete MERIT Coil and Transformer data and listings. Other MERIT service aids for TV improvement, replacement and conversion problems: TV Replacement Guide #404, September 1951 issue — covers 3000 models and chassis of 82 manufacturers; Cross Reference Data on IF-RF Coils, Form #14.

Write: Merit Coil and Transformer Corporation, 4425 North Clark Street, Chicago 40, Illinois.

These three MERIT extras help you:

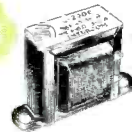

Exclusive: Tapemarked with specifications and hook-up data

- Full technical data packed with every item
- Listed in Howard Sams Photofacts



*Merit is meeting the TV improvement, replacement and conversion demand with a line as complete as our advance information warrants!

BURTON BROWNE ADVERTISING

Servicing and Alignment of

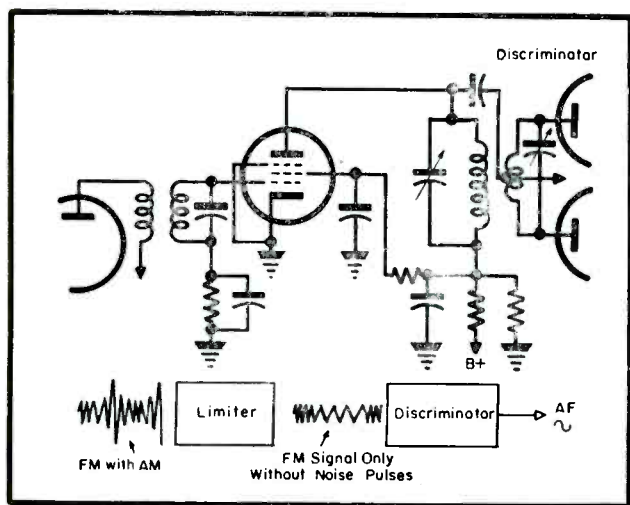

Right
Fig. 2. Preemphasis and deemphasis circuits used in FM.

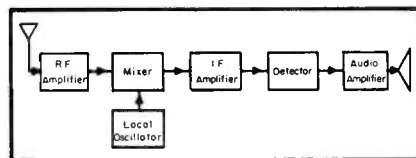
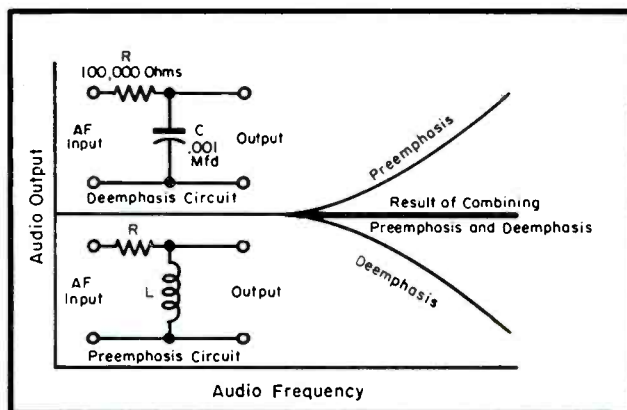

Fig. 1, above and left. Schematic of limiter stage and block diagram illustrating its operation.



FM, which has had quite a battle to gain recognition, has found a staunch friend in TV, with every chassis being providing for FM sound pickup. As a result FM has become a popular member of the receiving family, actually crowding standard AM broadcast sets for fame. In view of this increased application, it has become more necessary than ever to be extremely familiar with FM chassis servicing and alignment techniques.

FM Detectors

Almost all of the current FM and television receivers use either a Foster Seeley discriminator or a ratio detector in the audio detector stage. The Foster Seeley discriminator is commonly referred to as just a discriminator. Though both detectors will demodulate a frequency-modulated signal, there is a very important difference between both types. The ratio detector is sensitive only to frequency modulation and is essentially unresponsive to amplitude modulation. The discriminator type of FM detector, on the other hand, is sensitive to both amplitude and frequency modulation. Since the signal before it reaches the detector stage is subjected to several types of amplitude modulation such as man-made static, natural static, fading and unequal response for all frequencies in the preceding tuned stages, it is necessary to remove all of these

undesired amplitude variations before the signal is applied to the discriminator. This is accomplished in the limiter stage which is the last stage of *if* amplification before the detector. A limiter operates essentially like a clipper stage where signals above a certain minimum amplitude are removed. Limiter stages are operated with unusually low plate and screen voltages and employ grid leak bias. These stages have low gain. If a receiver employs a ratio detector, a limiter stage is not required and the last *if* stage can be operated at maximum gain consistent with the required bandwidth.

Preemphasis and Deemphasis

There is another difference between the methods employed in standard AM broadcast and those employed for FM. In FM broadcasting preemphasis and deemphasis are used and the functioning of these simple circuits is very interesting. The preemphasis network is used at the transmitter and is so designed that audio frequencies above 1500 cps are amplified more than the lower frequencies. The deemphasis network, which is used in the receiver, has an equal and exactly opposite effect on the audio signal. Namely, it attenuates all audio frequencies higher than 1500 cps. Now, let us see the purpose of these circuits. It has been found that noise signals are generally

found in the higher frequencies of the audio spectrum. It is also a fact that the strength of the high-frequency audio components of average broadcasts is much less than that of the low-frequency components. Thus, by using preemphasis at the transmitter, substantially stronger high frequency audio signals can be sent out. By using deemphasis at the receiver, the audio signal can be brought back to the same relative amplitude, as compared with the low frequency components before preemphasis. By reducing the output at the higher frequencies, the noise pulses are reduced and thus we have achieved a very marked increase in the signal-to-noise ratio. This also contributes to higher fidelity reception. The time constant of both networks is usually between 50 and 100 microseconds and must be the same at the transmitter as at the receiver. The deemphasis network will not always be found directly at the detector output; it may be somewhere between the detector and the loudspeaker.

Alignment

To align the *if* and the detector stages of an FM or television receiver either one of two methods can be used. The first method, often called the single-frequency method, requires only a *vtvm* or a multimeter, whose sensitivity is at least 20,000 ohms-per-volt, and an ordinary signal generator. The

FM CHASSIS

by RUDOLF F. GRAF*

Methods Employed in Discriminator and Ratio-Detector Alignment with a VTVM . . . Sweep Generator Applications . . . Use of 'Scope for Discriminator-Ratio Detector Alignment . . . General Receiver Servicing Hints.

second method, sometimes called the sweep frequency method, requires the use of a 'scope, a sweep frequency generator and a marker generator.

Discriminator VTVM Alignment: The AM generator required in this procedure must cover the *if* range of the receiver under test. To be able to check the bandwidth of all the tuned circuits in the receiver as well as the linearity of the detector output, it is necessary to use a generator which has its divisions sufficiently widely spaced, so as to permit settings of the generator frequency in intervals of 25 kc above and below the *if*.

Alignment of the *if* should be the first step. The generator should be set at the exact *if* of the receiver and connected to the mixer grid. The modulation should be off. The *vtvm* should be set to the lowest range and the selector switch switched to $-dc v$. Now, the meter probe should be connected to the limiter grid (point G on Fig. 3) and the common lead connected to ground. It is advisable to stop the local oscillator by either removing the oscillator tube, or by shorting the oscillator grid to the chassis. All *if* transformers can then be adjusted for maximum meter reading. As the various circuits are brought into resonance, the meter reading may go beyond full scale. It is important to reduce the output from the generator, instead of increasing the meter range, to prevent the limiter from being saturated and thus give a false indication. If the *if* stages use overcoupled transformers, it may sometimes be found that there are two points at which there will be a maximum meter reading. In these cases, the secondary should be temporarily loaded with a 5,000-ohm resistor when peaking the primary, and then the primary loaded when peaking the secondary. To check the bandwidth of the *if* stages,

the generator should be set to a frequency which is 25 kc lower than the *if* of the receiver and the reading of the meter noted. The generator should then be set to a frequency 25 kc above the *if* and again the meter reading noted. The two readings should be the same. The same process should be repeated for frequencies 50 and 100 kc above and below the *if*. As before, the meter readings for equal deviations from the center frequency should be equal. If this condition obtains the discriminator can be aligned.

As mentioned earlier, a 20,000 ohms-per-volt meter may also be used. In this case, the positive lead is connected to the chassis, and the negative lead to the limiter grid.

To align the discriminator the generator should be set to the exact *if* and connected to the limiter grid. The *vtvm*, still set to $-dc v$, should be connected between point A and ground. The primary of the discriminator transformer should now be adjusted for maximum meter reading. Then, the meter should be removed from

point A and, with the *zero adjust* of the meter, the needle brought to mid-scale or any other convenient reference point. This may be done with the *selector switch* either in the $-dc v$ or $+dc v$ position.

This reference point now corresponds to zero volt input to the meter. Some of the new *vtvm*'s have a zero in the center, near the bottom of the scale, and plus on one side and minus on the other side for this purpose. Now, the meter probe should be connected to point B. The needle will either stay where it was, or the meter will give a reading in one direction or the other. As the discriminator secondary is tuned through its full range, the needle will go from zero to a maximum in one direction, then back through zero to a maximum in the other direction and then finally back to zero. We have to adjust the secondary for *true zero*, which is the zero reading between the two maxima. The other two zero readings (incorrect ones) are obtained when the secondary is tuned to a frequency

Fig. 3. FM detector circuits and test points. In A appears a discriminator type of FM detector, while in B and C appear unbalanced and balanced ratio detectors, respectively.

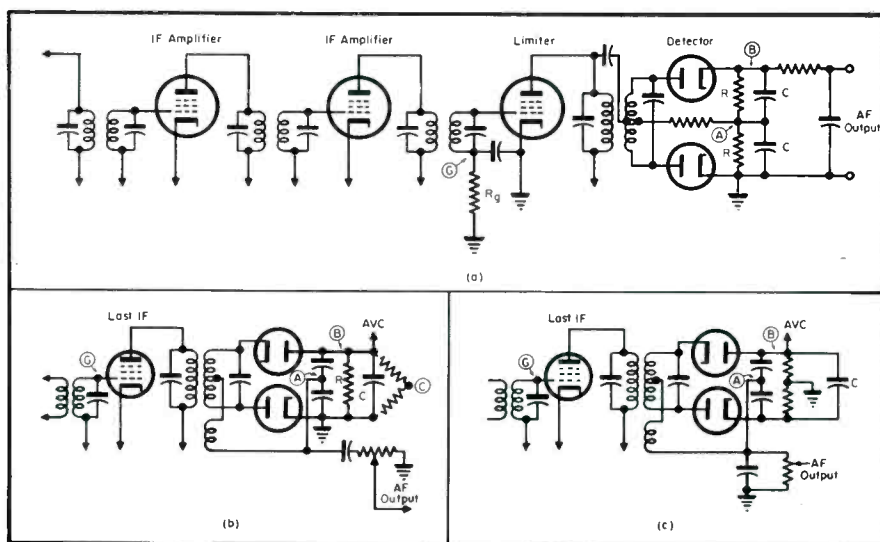

*Formerly, Instructor, Gotham Radio Institute.

Fig. 4. Setup for 'scope and sweep generator which can be used to align and also check FM chassis.

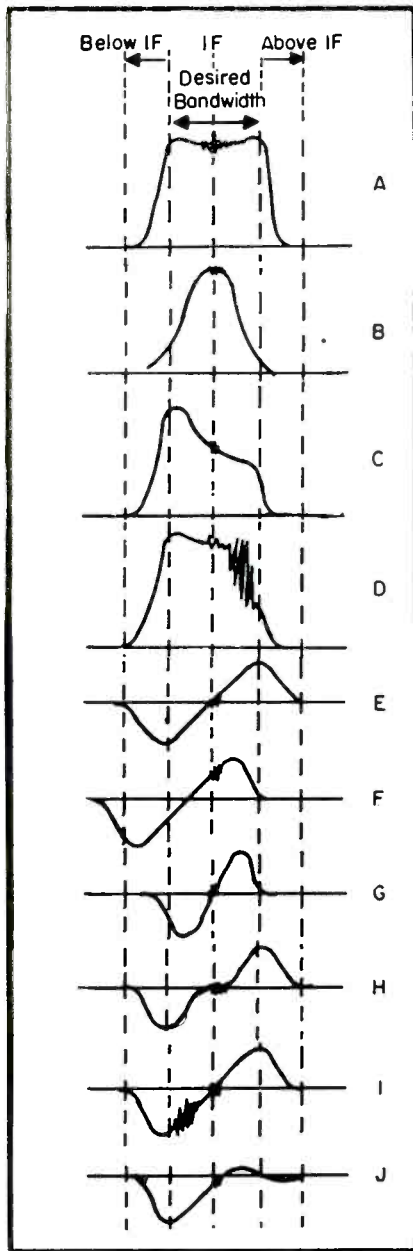
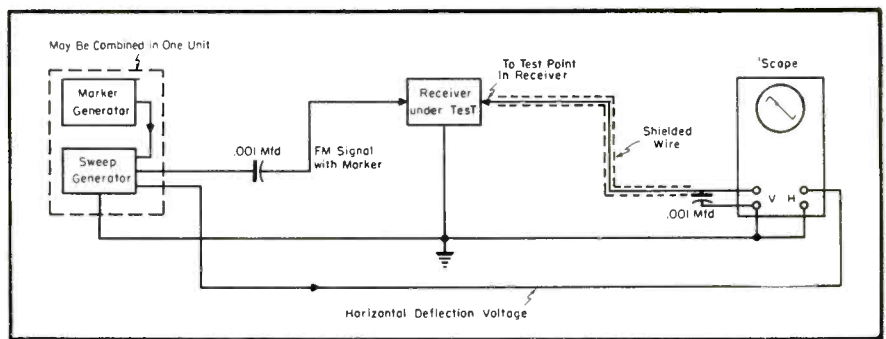

Fig. 5, above and right. Quick reference charts for S curves and IF response curves. Above: A = proper response curve at the limiter grid. It will be noted that the curve is almost flat over the entire bandwidth. B = response curve which is too narrow at the limiter grid. It is, therefore, necessary to realign IF stages to obtain greater bandwidth. C = unsymmetrical IF response curve at the limiter grid. The IF stages must be realigned for greater symmetry. D = response curve at the limiter grid showing oscillating condition in the IF or RF stages. In this instance, it is necessary to check the bypass capacitors, grounds, shielding, tubes, AVC and decoupling filters. E = proper S curve. F = detuned S curve. Here it is necessary to readjust the primary and secondary and check tuned circuits. G = S curve which is too narrow, which causes the sound to become distorted. The cause may be similar to that indicated in B. H = non-linear S curve, where it is necessary to readjust the secondary. I = an S curve showing oscillations. In this instance, the checks suggested in step D should be followed. J = S curve showing low emission of one of the diode tubes. This may also be due to a shorted turn in half of the secondary. May also be caused by the troubles indicated in step C. Right: K = butterfly response curve obtained when 'scope sweep frequency is one-half that of sweep generator. L = same as K, but with reduced sweep generator width.



much lower or much higher than the *if*.

The linearity of the discriminator should now be checked. The meter is left at B and the generator frequency should be increased and decreased by small amounts, as for the *if* stages. For equal deviations above and below the *if* the meter readings should increase and decrease by equal amounts. If this does not happen the discriminator must be realigned.

Ratio Detector VTVM Alignment: In receivers using a ratio detector it is advisable to align the detector stage before the *if* stages. There are two types of ratio detectors; balanced or unbalanced. They are shown in Fig. 3b and c, respectively. Let us first cover the unbalanced type. The generator should be set to the *if* and connect to point G. The vtvm should be set to $-dc$ v and connected to point B. The primary is now adjusted for maximum meter reading. To align the secondary it is necessary to establish a temporary artificial center. This can be done by connecting two resistors, which are exactly equal and whose value is about ten times the value of resistor R, between B and ground. The common lead of the vtvm can then be moved to the junction of the two resistors which is shown as point C, and the probe is connected to A. The secondary is now adjusted for true zero, in the same way as for the discriminator. After this alignment is complete, the two resistors should be removed. The exactly matched resistors should be put aside for any future alignment job.

To align the *if* stages the meter

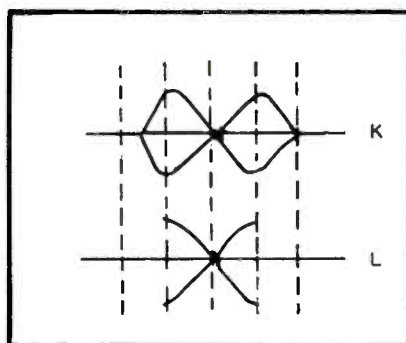

should be reconnected to point B and all transformers adjusted for maximum meter reading. As before, the generator output should be kept as low as possible and, as the circuits are brought into alignment, the generator output reduced; the meter range should not be increased. Bandwidth and linearity can be checked as outlined previously.

The alignment of a balanced ratio detector, illustrated in Fig. 3c, is a little simpler. The meter is connected to point B, the generator to G and the primary adjusted for maximum reading. The probe is moved to A, and alignment for true zero follows. To align the *if* stages the meter should be reconnected to point B and all transformers should be peaked.

The proper connections between the 'scope, receiver under test, and a sweep generator are shown in Fig. 4. Also shown is a marker generator, which supplies an external marker signal to indicate the exact frequency at any point of the curve under observation. Some sweep generators have the marker generator built in, and there is no need for an external generator in these cases. An isolating capacitor should always be used in series with the signal generator output lead so as not to change the bias on the various stages to which the generator may be connected. Almost all sweep generators have a terminal which is marked *horizontal sweep* or *sync output*. The voltage which is available at these terminals is generally of the same nature as the voltage used to sweep the frequency of the *rf* oscillator of the generator. This voltage can be used to either synchronize the internal sawtooth oscillator of the 'scope with the sweep generator, or it can be used directly as the horizontal deflection voltage. If this voltage is a sine wave, as it is in many cases, and it is used directly for horizontal deflection in the 'scope, the phasing control of the generator must be used to adjust the trace on the screen to provide a single pattern. In this case the internal

(Continued on page 79)

260
260
260
260
260
260
260
260
260
260

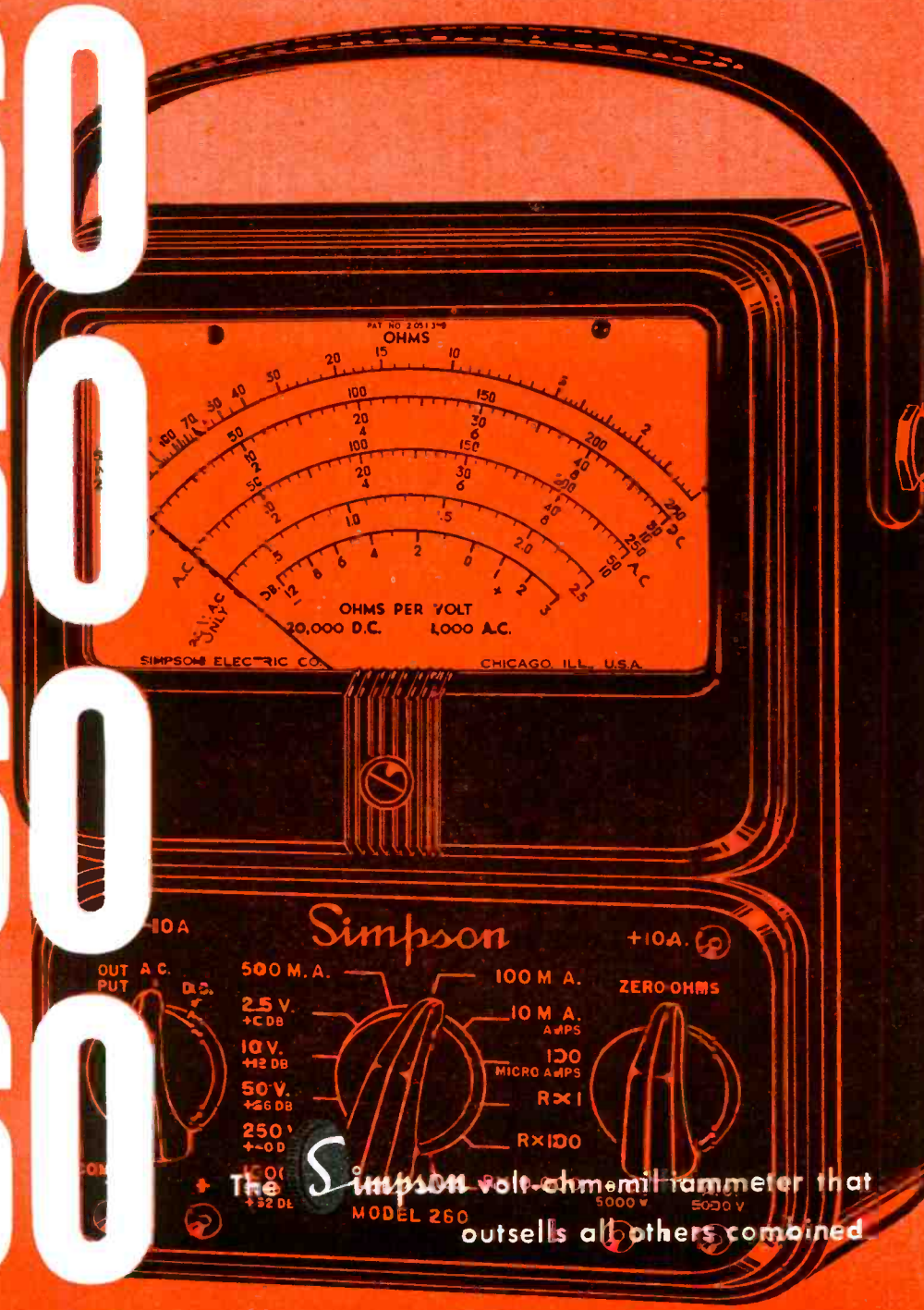

The **Simpson** volt-ohm-milliammeter that outsells all others combined

TUBE *News*

by L. M. ALLEN

Germanium Diode Applications as Power Rectifiers, Mixers and Video Detectors. Features of Corona Inhibitor Processed Picture Tubes . . . Twin Power Triodes Developed for Projection TV Scanning . . . Electrostatic Tubes . . . Horizontal-Deflection-Output HV Transformers.

DURING WORLD WAR II, it was found that crystal detectors offered many application possibilities. One type, found particularly effective, was the germanium assembly, which could be used in many portions of circuits in both transmitters and receivers. With the advent of TV, the germanium detector became an extremely popular item. Recently, one manufacturer‡ found that the crystal could be used as a power rectifier for not only television receivers, but broadcast sets and military electronic equipment.

Known as the G-10 germanium rectifier, the unit operates on the junction principle and is designed to supply 350 milliamperes at normal television receiver plate voltages in a 55° C ambient temperature. It is said to have a peak inverse voltage rating of 400 with rectification efficiencies up to 98 per cent.

Its forward resistance at rated current is about three ohms, and back resistance is approximately one megohm at -350 volts.

Life of the device is claimed to be very long because of a gasket-seal construction which is moisture and fume resistant.

Germanium diodes have also been

designed for application as mixers, particularly for use in, but not restricted to, the 400 to 1000-mc region. One model, the CK710* can be soldered directly into the mixer circuit to avoid contact resistance effects, which may become serious in the characteristically low impedance circuits in which the crystal is ordinarily used.

This unit, using tinned dumet wire, has a diameter of 0.021" and length of 1". A blue band indicates its cathode terminal. At 25° C (absolute maximum values), the crystal's *dc* inverse voltage is 5; average rectified current, 50 ma; peak rectified current, 150 ma;

Video detector circuit with a CK706 germanium diode, which has an extremely low coefficient in the forward direction and is sealed to withstand severe atmospheric conditions.

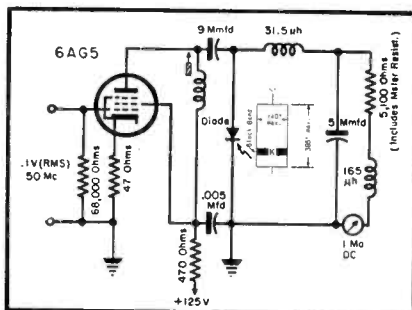

ambient temperature range, -50° to +100° C.

Its maximum inverse current at -0.6 volt is .2 ma; minimum forward current at +0.5 volt is 3 ma; and shunt capacitance, average, 1.7 mmfd.

The available noise power of a crystal mixer may be expressed with reference to the available noise power of a resistor at the same temperature. This figure is termed the noise temperature ratio. Physically, the product of the noise temperature ratio and the ambient temperature represent the temperature to which a passive resistor, having the same *if* resistance as the crystal, would have to be raised to generate the same noise power as the crystal mixer. A typical value of noise temperature ratio for an average CK710 is 2, which is comparable to that of silicon crystals such as the 1N21B and the 1N26.

Germanium crystals have also been developed for use as video detectors in television receivers. Rated for operation up to 100° C they can be heated as high as 125° C with no irreversible change in characteristics.

One type, CK706*, of the same dimensions as the mixer unit, has a *dc*

*Raytheon. **RCA.

‡G. E.



At opening of new building of Electronics Wholesalers, Inc., G.E. tube distributor in Washington: Merle Johnson, right, district sales rep for the G.E. tube department, holding a miniature receiving tube, and Pat Mitchell, left, holding a 24-inch picture tube.

inverse voltage of 40; average rectified current of 35 ma; peak rectified current of 125 ma; and ambient temperature range of -50 to $+100^{\circ}C$.

At its cathode terminal is a black band.

Corona Inhibitor

Under certain atmospheric conditions, Service Men have been plagued by situations where the picture tubes suffer from loss of picture brightness due to leakage, corona, and arc-over at the second anode connector. This leakage from the second anode connection reduces the second anode voltage, and consequently the brilliance of the picture. In addition, there may be audible effects from the corona, which can be a source of alarm to the set owner. This difficulty has been experienced in varying degrees of intensity

RCA 17-inch low-voltage electrostatic focus all-glass rectangular type; 17HP4. The tube's focusing electrode features its own base-pin terminal to permit designers a choice of focusing voltage for best results. Has a Filterglass faceplate, external conductive bulb coating, and ion trap gun. Picture screen measures $14\frac{1}{8}$ " by $11\frac{1}{16}$ ".



Paint-spraying machine for picture tubes at the G.E. picture tube plant in Syracuse. Here metal and glass tubes are sprayed first with a conductive paint and then with a coat of lacquer before going through a drying process. The water spray in the background removes the paint odor from the air. The automatic paint spraying process is capable of painting several hundred picture tubes daily. The tubes move along an endless belt track while they are being painted.

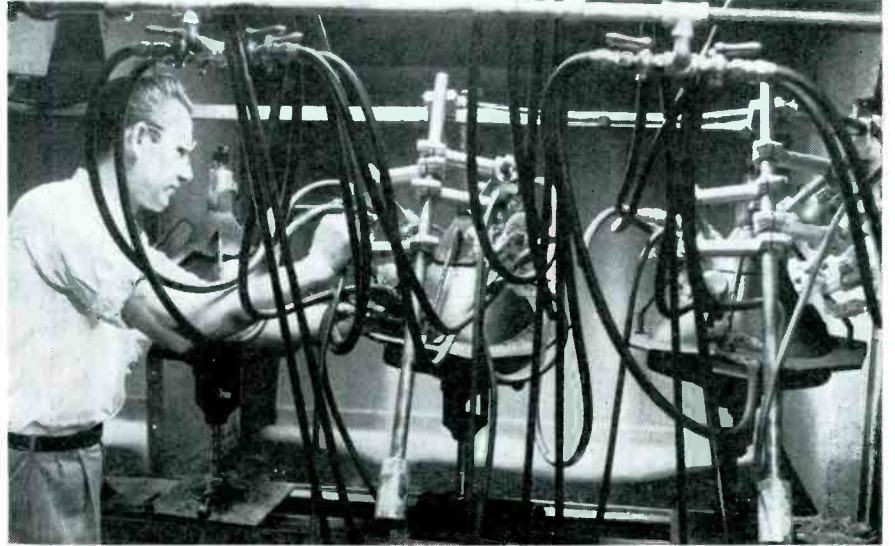

and many valuable man-hours have been lost tracking down the source of trouble. To eliminate trouble from this source, one tube maker has begun treating tubes with a *corona inhibitor**. According to the manufacturer, in tests made on picture tubes processed with the *corona inhibitor*, with water sprayed on the anode contact button area, there was no evidence of corona, and leakage of only 2 microamperes, at 15,000 volts applied.

Twin Power Triode

For projection television scanning applications, where pulsed plate voltages of high value are encountered, there is now available a new, low- μ , high-perveance, twin power triode, type 6080**.

Similar to the 6AS7G in characteristics but smaller in size, the 6080 em-

plains a compact design in which attention has been given to features which improve its strength not only against shock but also against vibration. Use is made of a button stem to strengthen the mount structure and to provide relatively wide interlead spacing for reduction in susceptibility to electrolysis.

Electrostatic Tubes

Electrostatic-tube lines, announced for a few types of tubes during the early part of '51 and shortly after expanded to include most popular sizes using high-focusing voltages, have now been extended to zero-voltage types. In one of the new groups three additions to the zero-voltage line have been included.

The three new tubes† are the 17VP4, 17-inch; 20HP4-A/20LP4, 20-inch, (Continued on page 75)

Circuit of horizontal-deflection circuit and high-voltage supply for 20CP and 21AP4 rectangular picture tubes with deflection angles of approximately 66° . The heater transformer must be insulated for 1.5 kv peak: See page 75 for additional details. (Courtesy RCA)

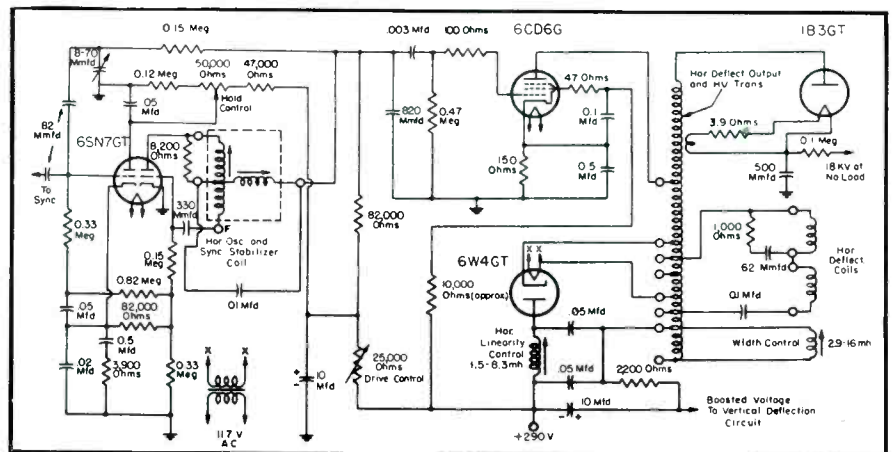

Rauland—the Original

LOW FOCUS VOLTAGE ELECTROSTATIC TUBE

Perfected in Rauland Electronics Laboratories, this tube that gives edge-to-edge sharpness of focus without coils and magnets is proved and ready as the materials pinch becomes painful

BETTER in all ways! Gives better over-all focus—hair-line sharpness from edge-to-edge—with NO critical materials for focusing . . . and **STAYS SHARP** under considerable variation in line voltages.

REQUIRES NO re-engineering of present television chassis . . . NO added high voltage focus circuit . . . NO added receiver tubes . . . NO additional components except an inexpensive potentiometer or resistor.

FOCUSES by using D.C. voltage already available in the receiver.

ELIMINATES focusing coils and magnets . . . saves critically scarce copper and cobalt.

• • •

This new Rauland development is now available in substantial quantities in 17 and 20 inch rectangular tubes. For further information, address . . .

THE RAULAND CORPORATION

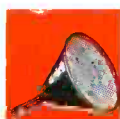

Perfection Through Research

4245 N. KNOX AVENUE • CHICAGO 41, ILLINOIS



more than

2,000,000

set owners use

jfd panorama

indoor tv antennas

triple-chrome plated dipoles

MODEL TA135 DELUXE 6.95 list

MODEL TA136 STANDARD COMPANION 5.95 list

MODEL TA137 ECONOMY COMPANION 5.50 list

COMPLETE WITH TWIN LEAD

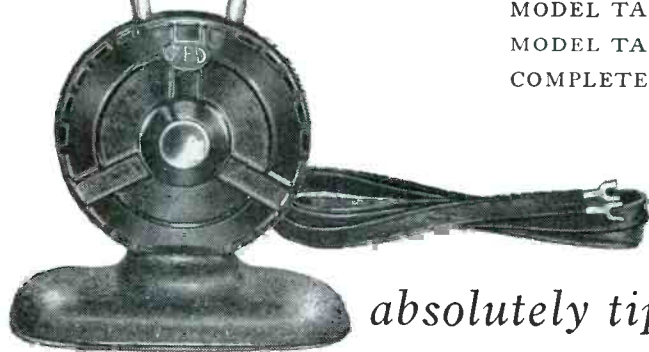

absolutely tip-proof



JFD MFG. CO.
BENSONHURST 6-9200
BROOKLYN 4, N. Y.

ASSOCIATIONS



FRSAP

GEORGE HARDY, president of the Mid-State Radio Servicemen's Association, Harrisburg, is now chairman of the Charter Committee of the Federation of Radio Servicemen's Association of Pennsylvania, arranging with a local attorney to obtain a state charter.

Final vote on the recipient of the Federation's annual plaque was announced at a special meeting, after three months of voting by all chapters; presentation will be held on March 16 at the Hotel Harrisburg in Harrisburg, Pa.

A ten-man committee has been authorized and appointed to obtain from all chapters a list of suggestions detailing ways and means to eliminate all friction between Service Men, dealers and their distributors.

RSA, Williamsport, Penna.

CARL W. SMITH has been elected president of the Radio Servicemen's Association of Central Pennsylvania. Frederick Delzert was elected vice president; Phillip Marciani, treasurer; William T. Mostaller, secretary; and William S. Guild, corresponding secretary.

Fraser Valley Chapter, RETA-ARTBC (Canada)

AT A RECENT MEETING of the Fraser Valley Chapter of the Radio Electronic Technicians Association and the Associated Radio Technicians of British Columbia, recommendations were made to discuss with the RTMA service committee, the improvement of service data.

Suggestions included: standard size and form, preferably perforated for three-hole binder; *dc* resistances marked clearly for all components such as transformer windings, etc.; dial scale mounted on chassis, or duplicate on chassis where dial is mounted on cabinet; trimmers identified on chassis; service data to be issued before receivers appear on the market; complete not sectional diagrams; theory on any new or unusual circuits; stage gain measurements in service data; and parts values and voltage readings on diagrams.

RTTG, Florida

THE RADIO AND TELEVISION TECHNICIAN'S Guild of Florida has set up a blood bank at the Mount Sinai Hospital in Miami Beach, for the benefit of members of the association, as well as the Armed Forces.

RTG, Rochester

HENRY T. PAISTE, vice president, product performance and service, of Philco Corp., recently accepted on behalf of the company a special citation from the Radio Technicians Guild of Rochester. Citation was tendered in appreciation of the outstanding technical assistance which Philco has consistently contributed to the radio and TV technicians.

Paiste, addressing a special meeting of the Guild, stated . . . "We believe in independent dealers and the contractor's Service Man, with whom we are achieving dependable high quality service . . . and we will back him up in every way to insure the reputation of our product."

TSA, Michigan

A FORUM on TV service, sponsored by the Television Service Association of Michigan, has been held in Detroit.

E. J. Barton, TSA prexy, reported that the conclave was held to establish the future of TV service on a sound management level, secure the close cooperation of all segments of the TV industry in that objective and develop a broad program aimed at better informing the set-owning public concerning TV service.



E. J. Barton

TEN YEARS AGO

From the Association News Page

THE Lehigh Valley Radio Servicemen's Association, Allentown, Pa., held its fourth annual banquet and parts show at the Hotel Allen. Over 73 Service Men, with reps from Philadelphia and Reading, attended. . . . Don Stover, executive secretary of the Radio Servicemen of America, was appointed to the service and installation division of the RCA Manufacturing Co., Inc. Alfred A. Kilian, former secretary of the Chicago chapter, was elected to succeed Don. This change necessitated a shift in the national headquarters to 414 Dickens Ave., Chicago. National dues were increased to \$2.00 per year. . . . All '41 officers of the Binghamton, N. Y. chapter of RSA were reelected to their respective positions. . . . Service Men of Fairmont, W. Va., completed affiliation with the RSA, and became known as the Monongahela chapter. Officers were: president, Russell G. Dotson; vice president, John G. Gilbert; and secretary-treasurer, Carl L. Roach. . . . The Pittsburgh chapter of RSA held its meeting in the director's room of the Commonwealth Trust Co. Samuel Avins, Pittsburgh RSA attorney, presented the story on the confiscation or alteration of alien shortwave receivers. Tags were printed with an affidavit showing the owner's name and address and the name, address and phone number of the service shop that made the alteration. The bottom of the tag carried the notice: "Do not tamper with this receiver. Should it require service, notify the Service Man who signed this sworn statement." The subject of the wholesale selling of radio sets and parts by wholesale houses, at wholesale prices, to retail customers was taken up with Senator Guffy. He, in turn, took it up with Leon Henderson of the OPA, who promised an investigation. . . . Members of the RSA of Luzerne County, Wilkes Barre, Pa., and friends of Spencer Eddy, were present at a farewell party given in his honor, before Eddy left for Fort Monmouth, N. J., to accept a position with the Signal Corps. C. Foster Hick acted as official spokesman.

New 1952 HEATHKITS

Heathkit
TELEVISION
GEN. K T \$39.50

Heathkit
ELECTRONIC
SWITCH KIT \$19.50

Heathkit
AUDIO GEN.
KIT \$34.50

Heathkit
CONDENSER
CHECKER KIT \$19.50

Heathkit
R. F. SIGNAL
GEN. KIT \$19.50

Heathkit
A.C. VOLTMETER
KIT \$29.50

Heathkit
SQUARE WAVE
GEN. KIT \$29.50

Heathkit
INTERMODULATION
ANALYZER KIT \$39.50

Heathkit
AUDIO FREQ.
METER KIT \$34.50

Heathkit 5" OSCILLOSCOPE KIT

- New "spot shape" control for spot adjustment — to give really sharp focusing.
- A total of ten tubes including CR tube and five miniatures.
- Cascaded vertical amplifiers followed by phase splitter and balanced push-pull deflection amplifiers.
- Greatly reduced retrace time.
- Step attenuated — frequency compensated — cathode follower vertical input.
- Low impedance vertical gain control for minimum distortion.
- New mounting of phase splitter and deflection amplifier tubes near CR tube base.
- Greatly simplified wiring layout.
- Increased frequency response — useful to 5 MC.
- Tremendous sensitivity .03 RMS per inch Vertical .6V RMS per inch Hor.
- Dual control in-vernier sweep frequency circuit — smoother acting.
- Positive or negative peak internal synchronization.
- Multivibrator type Wide Range Sweep Generator.

A brand new 1952 Heathkit Oscilloscope Kit with a multitude of outstanding features and really excellent performance. A scope you'll truly like and certainly want to own.

The kit is complete with all parts including all tubes, power transformer, punched and formed chassis, etc. Detailed instruction manual makes assembly simple and clear — contains step-by-step instructions, pictorials, diagrams, schematic, circuit description and uses of scope. A truly outstanding value.

MODEL 0-7
SHIPPING WT. 24 LBS.

\$43.50

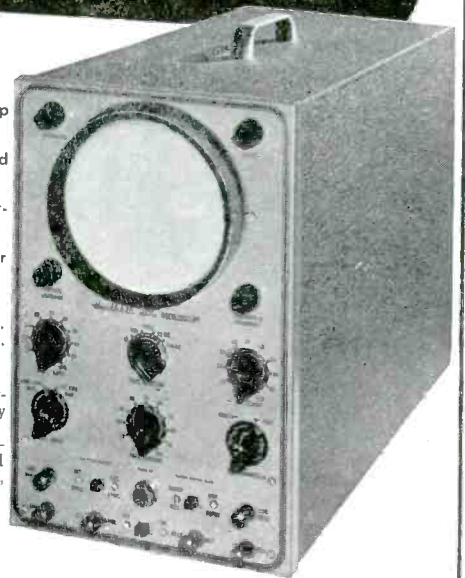

Heathkit VACUUM TUBE VOLTMETER KIT

- New styling — formed case for beauty.
- New truly compact size — Cabinet 4 1/8" deep x 4-1/16" wide x 7 3/8" high.
- Quality Simpson 200 microamp meter.
- New ohms battery holding clamp and spring clip — assurance of good electrical contact.
- Highest quality precision resistors in multiplier circuit.
- Calibrates on both AC and DC for maximum accuracy.
- Terrific coverage — Reads from 1/2V to 1000V AC, 1/2V to 1000V DC, and .1 to over 1 billion ohms resistance.
- Large, clearly marked meter scales indicate ohms, AC Volts, DC Volts, and DB — has zero set mark for FM alignment.
- New styling presents attractive and professional appearance.

The 1952 Model Heathkit Vacuum Tube Voltmeter! Newly designed cabinet combines style and beauty with compactness. Greatly reduced size to occupy a minimum of space on your work-bench. Covers a tremendous range of measurements and is easy to use. Uses only quality components including 1% precision resistors in multiplier circuit for greatest accuracy. Simpson 200 microamp meter with easy to read scales for fast and sure readings.

All parts come right with kit, and complete instruction manual makes assembly a cinch.

MODEL V-5
SHIPPING WT. 5 LBS.

\$24.50



YOU SAVE BY ORDERING DIRECT FROM MANUFACTURER

EXPORT AGENT
MOORE INTERNATIONAL CORP.
38 40th ST.
NEW YORK CITY (16)
CIRCLE 474-10-N.Y.

The **HEATH COMPANY**

... BENTON HARBOR 11, MICHIGAN

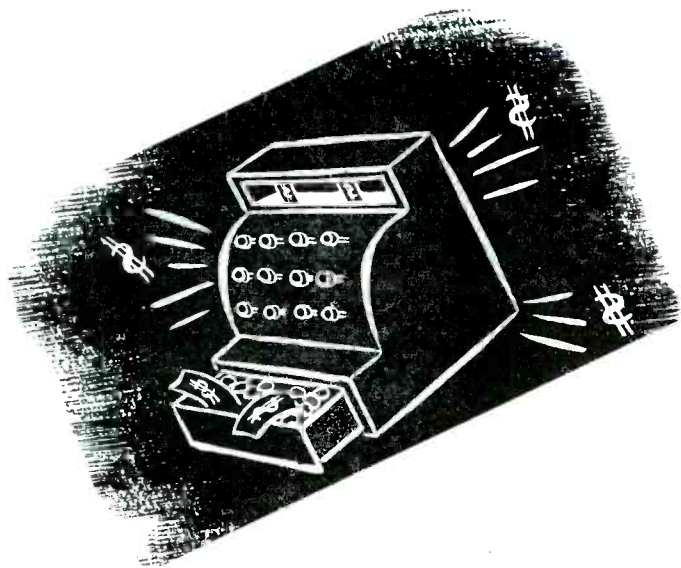

Business

Aids . . .

Estimating Operational Costs for a New Shop

[In response to many requests, arrangements have been made to feature every month in SERVICE a column devoted to a discussion of Business Aids for the Service Shop, based on queries submitted by readers of SERVICE. Topics to be reviewed will include advertising, bookkeeping, customer relationship, filing systems, displays, direct mail, etc. These columns are being conducted by a veteran Service Man with over a quarter of a century experience in the field, who is currently operator of a large Service Shop, and is also extremely active in association affairs. If you have a business-aid problem, send it to ye editor, and every effort will be made to publish a solution in an early edition of SERVICE.]

Dear Editor:

In the very near future I'm going to open up a Service shop. This will be my first venture, and I'm anxious to learn how to figure charges that will cover my overhead and labor, and how to itemize the service bill. I'd also like to know what books will be needed for accounting and if it might be possible to do the bookkeeping by myself, at least at the beginning.—T. Q. S.

Dear T. Q. S.:

In setting up a shop, it is important to consider two factors. First, the operation should be so organized that you can make a decent weekly salary for yourself, at least equal to what you would have received while working for someone else. Secondly, the shop should provide a substantial profit on your investment.

To find your cost of operation and receive a fair profit for your efforts and investment, your costs must be detailed. That is, you should consider your rentals not only for the store, but perhaps garage or business equipment, and supplies other than those on the business premises. Utilities expenses such as light and phone, are the next items to consider. Then there are the problems of heat costs set at an average of 12 months, office supplies (postage, printing of forms, stationery, etc., used daily to operate

shop and office); insurance (fire, theft, liability, compensation, social security); advertising (newspapers, mailing, signs, window displays); dues and subscriptions (technical associations, business associations, magazines); shop supplies (should

include only expendable supplies such as bolts, nuts, solder, etc.); car or truck expenses (gas, oil, license, repairs); miscellaneous expenses (cleaning and maintenance of shop and office, outside purchases of small items while on the job, etc.); and depreciation of equipment (office equipment, shop, car and truck).

These items should be estimated on a monthly basis. As a hypothetical example, let us suppose rent = \$65.00; utilities = 25.00; heat = 10.00; office supplies = 5.50; insurance = 1.50; advertising = 30.00; dues and subscriptions = 2.00; shop supplies = 3.50; car and truck expenses = 18.00; miscellaneous = 6.50; and depreciation of equipment = 12.00. Thus we have a total of \$182.00 as the monthly operating expenses. To figure the cost or charge for your overhead or expense, in terms of an hourly rate for business operation, you should divide 200 (25 average 8-hour working days per month) into the monthly operating cost (\$182). The operating cost per hour will be found to be \$91.

You then must decide how much you would want to earn per week. Suppose you decide on \$75.00 per week. At this rate the labor charge would be \$1.57 per hour; 48 hours times \$1.57 per hour = \$75. Adding the labor and operating expenses together, a total cost of \$2.48 per hour is reached. Now, adding 25 per cent profit for your investment in the business or $\$2.48 + .62$ (25% of $\$2.48 = .62$), you will find that a total hourly rate of \$3.10 has to be charged for all work completed in your shop.

All bills or work sheets should accompany the repair when completed, and should be itemized. As an example:

1— 6AU7 tube	\$2.00
1— 6SN7 tube	2.00
1— 10-k ohm 1-w res.24
2— .01 mfd 600-V cap.60
*For professional services rendered	15.00
		\$19.84

*To include pickup and delivery, shop labor, and home service.

(Continued on page 76)



Above: Prize-winning window display of Rule Television and Radio Repairs, of 2401 Avenue U, Brooklyn 29, N. Y., which won a \$250 U. S. defense bond first prize in the Dalis-Raytheon window display contest for Raytheon Bonded Technicians. Second prize, a \$100 bond, went to the Fra-Bob Radio & Ignition Co., 125 Main St., East Orange, N. J., while third prize, a \$50 bond, was awarded to the Radio Television Clinic, 137 Main St., Hempstead, Long Island.

Below: Judges announcing their selection to H. L. Dalis. Left to right: E. I. Montague, sales promotion manager, Raytheon; Harry L. Dalis, president, H. L. Dalis, Inc.; John F. Rider, president, John F. Rider Publishers Inc.; and Louis Shappe, president, Shappe-Wilkes Advertising Agency.



UHF



*All UHF channels...
for all TV sets*

MALLORY UHF CONVERTER

The Mallory UHF converter is right for *all* your TV customers because it can be used with *any* TV set . . . in *any* UHF broadcast area. And it's easy to install—no adjustments or connections to make in the TV set . . . just connect power lines and antenna leads.

These Mallory features mean real customer satisfaction . . . real sales for you in the new UHF market—

- Reception of all UHF channels
- No sacrifice of VHF channels
- Built-in UHF antenna
- High quality picture definition
- Fast, easy installation

No larger than a small portable radio, the Mallory UHF converter is precision-built for long, trouble-free service. Get complete details today on the Mallory UHF converter from your Mallory distributor.

P. R. MALLORY & CO. Inc. **MALLORY** CAPACITORS . . . CONTROLS . . . VIBRATORS . . .
SWITCHES . . . RESISTORS . . . RECTIFIERS . . .
VIBRAPACK* POWER SUPPLIES . . . FILTERS
*Reg. U.S. Pat. Off.

APPROVED PRECISION PRODUCTS

P. R. MALLORY & CO., Inc., INDIANAPOLIS 6, INDIANA

*Make Sure...
Make it Mallory*

New TV Parts...Accessories

B-T AMPLIFIED TV DISTRIBUTION UNIT

A two-outlet distribution amplifier, model *D.12-J-M*, featuring two isolated TV set outlets and a through-line output, which can be used in master antenna systems of any size or as a complete system for the two-set home, has been produced by Blonder-Tongue Laboratories, Inc., 38 North Second St., Mt. Vernon, New York.

Units can be used in a series by interconnecting them with 75-ohm line. Employs two 6BC5s. Said to offer correct impedance matching at each terminal for 75- and 300-ohm lines. Maximum input and output signal voltages are said to be .5 on 75 ohms and 1 volt on 300 ohms.

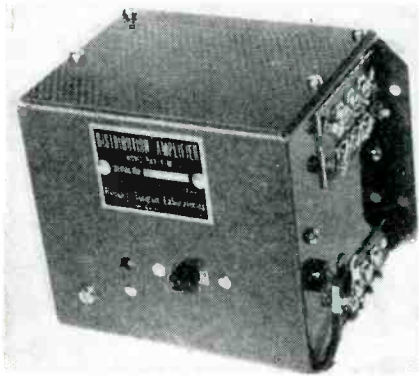

* * *

MERIT COSINE YOKES

Five types of cosine-wound deflection yokes for TV replacement and conversion are now available from the Merit Coil and Transformer Corp., 4427 North Clark St., Chicago, Ill.

Types are: *MDF 71*, a high horizontal and high vertical inductance for 70° tubes from 12" to 24"; *MDF 70* with low horizontal and high vertical inductance; *MDF 30* with high horizontal and low vertical inductance; *MD 13*, a 53° yoke with high horizontal and high vertical inductance; and *MD 12*, with low horizontal and high vertical inductance—a 53° yoke. All yokes are equipped with leads and network.

* * *

JFD PREAMP COUPLER

A preamp coupler, *EC-4*, that is said to permit operation of four sets from an antenna, has been announced by the JFD Manufacturing Co., Inc., 6101 Sixteenth Ave., Brooklyn 4, N. Y.

Signals are boosted by two *rf* amplifier stages using 6BQ7s.



TEL-A-RAY TV TOWER

A TV tower, that pivots in the middle and swings over to the ground for servicing, has been introduced by Tel-a-Ray Enterprises, Inc., Box 332, Henderson, Ky. Tower is of steel angle and welded construction and guaranteed against weather damage.

Available in a 50' model for mounting in concrete in the ground and requiring no guy wires, and a 24' house-top model. Both models incorporate a swing-over feature that permits the top of the tower to be lowered to the ground or roof.

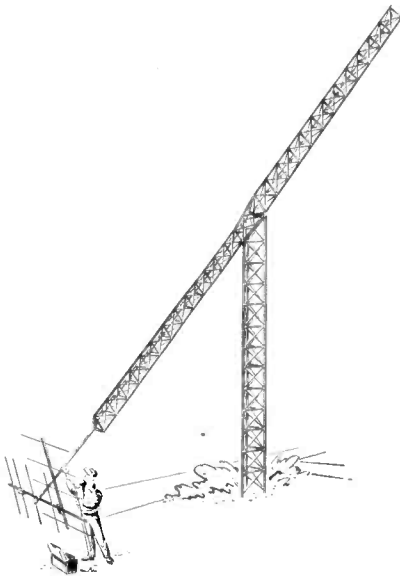

* * *

TELREX V-BEAM

A TV antenna that is claimed to be suitable for metropolitan and suburban area installations, *V-Beam*, has been announced by Telrex, Inc., Asbury Park, N. J.

Antenna is said to provide all-channel coverage in a single unit, and requires no high frequency head, or dual transmission line. Employs forward tilted dipoles, to obtain automatic transition from low-to-high-channel operation, and provide uni-directional reception pattern on both low and high frequencies.

Available with the Telrex *Hi-V-reflector*, which is a supplementary parasitic element designed to improve high channel directivity for areas where noise and secondary reflections are troublesome.



UNIVERSAL METAL GUY LOCK

An antenna guy wire tightener and lock, the *Universal Guy Lock*, has been developed by Universal Metal Products Co., 125 Ontario St., Toledo 7, Ohio. Item is supplied in two models; Model GL 2, with mounting screw permanently attached to the chassis; model GL 1, without screw, but with mounting hole large enough for any size mounting bolt.

Guy lock is said to replace any size turnbuckle and mounting screw. Mounted with attached lag screw; no wrench or tools required.

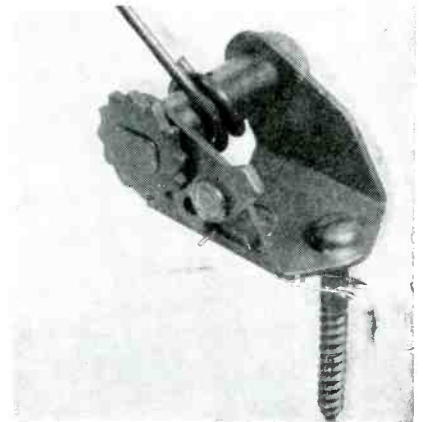

* * *

TE VIS-U-ALL TUBES AND TOOL CASE

A *vis-u-all* tube and tool case that holds tubes and tools, ordinarily required for TV home service work, in such a manner that everything is in full view and readily available when the case is open, has been announced by Television Engineers, Inc., 1539 W. Harrison St., Chicago, Ill.

Case accommodates 45 miniature, 44 GT and 18 large, or a total of 107 tubes, which is said to cover all tubes used in postwar TV receivers. Case is made of plywood with leatherette covering, clasp fasteners and a luggage-type handle. It is 16" by 13½" by 7½" in size, when closed, and weighs 7½ pounds. A 15½" by 3" by 2½" compartment, with snap-lock door, accommodates all tools ordinarily needed for home service work.

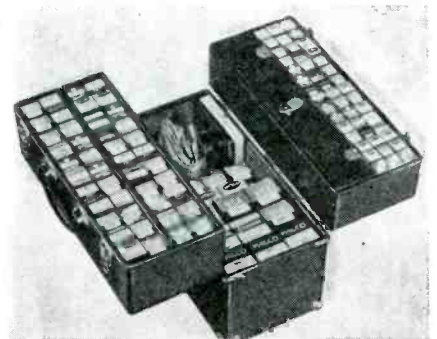

[Additional TV Part News on page 59 and 60]

Parts ... Instruments ... Tools

C AND G WIRE STRIPPER

A wire stripper with a trigger-type lever, the *Jim Handy*, has been introduced by the C and G Manufacturing and Sales Co., P. O. Box 1525, Columbus, Ohio.

Unit, which can strip copper wire of 18 gauge or less, is housed in the tool handle, and pushes into the handle when not in use.



* * *

T. V. DEVELOPMENT TUBULAR SELENIUM RECTIFIERS

Tubular selenium rectifiers with pig-tail leads, from 25 ma to 500 ma, have been introduced by T. V. Development Corp., 2024 McDonald Ave., Brooklyn 23, N. Y.

Rectifiers are guaranteed for 1000 hours at rated voltage.

* * *

JENSEN PHONO CUTTING NEEDLES

A line of phono cutting needles has been announced by Jensen Industries, Inc., 329 South Wood Street, Chicago 12, Ill. Needles are supplied in steel, stellite and sapphire, the latter two materials coming in both short and long shank models to meet the range of recorders now on the market. Individually packaged in a clear plastic box.

* * *

GRAYBURNE VARIABLE LOOPSTICK

A loopstick, *Vari-Loopstick*, featuring a micrometer adjustment for those who want to peak resonate for a series of stations, has been introduced by the Grayburne Corp., 103 Lafayette St., New York 13, N. Y.



TRIPLETT 5" 'SCOPE

A 5" 'scope, model 3441 that features an illuminated calibration meter permitting viewing of the percentage of positive and negative peak-to-peak volts, in addition to reading of peak-to-peak voltage direct in 8 ranges from 0 to 1000 volts, has been announced by the Triplett Electrical Instrument Co., Bluffton, Ohio.

Horizontal amplifier has a frequency range flat within $\pm 20\%$ from 20 cycles to 150 kc. Deflection sensitivity is .15 rms volt inch. Vertical amplifier response usable beyond 4 mc; said to show a square wave with no distortion. Sensitivity, .01 rms volt inch with switch in 2-mc position; .02 rms volt inch with switch in 4-mc position.

Synchronizing and horizontal sweep selector combined in same control. Also available are a high-gain amplifier system, a phone jack connection on the panel to familiarize one with the visual pattern and the familiar audio sounds, and push-pull vertical and horizontal output amplifiers.



* * *

HALLEMITE SETTING CEMENT

A setting cement, *Por-Rok*, that is said to permanently anchor bolts or equipment of any type to concrete, has been developed by The Hallemite Manufacturing Co., Dept. SE, 2446 W. 25th St., Cleveland 13, Ohio. Compound is applied cold and is said to set within 15 to 30 minutes.

Cement is claimed to be self-bonding, self-levelling, oil-resistant, non-shrinkable and to have a compression strength of 4,500 pounds psi.

* * *

HICKOK TUBE ROLL CHART

A tube roll chart for Hickok tube testers, dated January 1, '52, is now available from The Hickok Electrical Instrument Co., 10521 Dupont Ave., Cleveland 8, Ohio. Chart includes information on all the new tubes on which data were available at time of printing.

GRAYBURNE TUBE AND TOOL CARRIER

A tube and tool carrier, that provides a top section for tools and pocket-type instruments, and lower section for tubes and small components, has been introduced by Grayburne Corp., 103 Lafayette St., New York 13, N. Y.

Carrier features wood and masonite construction, slide supports glued and nailed into grooved side pieces, and a bottom of masonite. A mirror is set into a removable cover for picture-tube adjustments.

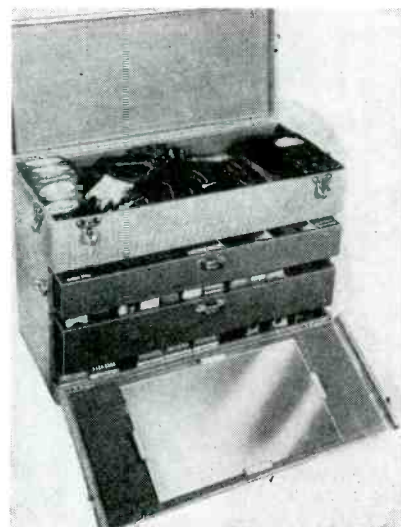

* * *

EICO MULTIMETER

A 1000 ohms-per-volt multimeter kit, model 536, is now available from Electronic Instrument Co., Inc., 84 Withers St., Brooklyn 11, N. Y.

Model is said to have 31 different 1000 ohms-per-volt ranges. Specifications are: dc/ac volts: 0-1, 5, 10, 50, 500, 5000; dc/ac 0-1, 10 ma; 0.1, 1 amp; ohms 0-500, 100,000, 1 megohm; 6 db ranges, -20 to +69. Supplied with instructions.

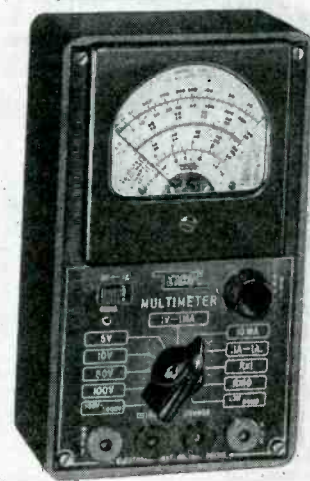

MILLEN, DURNIN AGENCIES, Winnipeg, Canada, have been appointed reps for the JFD Manufacturing Co., Inc., in western Canada. *C. K. Parrish* and *C. E. Durnin* will cover Manitoba, Saskatchewan and Alberta. . . . *R. T. Millen* will handle British Columbia. . . . *Burlingame Associates* have leased an entire floor at 103 Lafayette St., New York, N. Y., to provide for increased space for national promotional activities. Included in the addition also is a lab for product testing and servicing. . . . *Gilbert K. Segal*, formerly sales manager of Olympic of Philadelphia, has joined Land-C-Air Sales, and will cover jobbers in New Jersey, eastern Pennsylvania and Delaware. . . . *Herb*

Rep Talk

Erickson, Hendersonville, N. C. died recently. Erickson was a senior member in the Dixie chapter of the Reps. . . . *E. V. Roberts and Associates*, Los Angeles, Calif., has opened a branch at 3339 N. 25th Dr., Phoenix, Ariz., to cover that state and New Mexico. *Harold Arment* is manager. . . . Los Angeles chapter of the Reps offered a tabloid-form report of its activities during the past year, at its last meeting. Chapter has obtained group insurance for mem-

bers in the Blue Cross and National Casualty Co. . . . *C. S. Marshall Co.*, Pasadena, Cal., has been appointed rep for *D. M. Steward Corp.*, Chatanooga, Tenn., in California, Arizona and New Mexico. . . . *J. Y. Schoonmaker Co.*, 2011 Cedar Springs, Dallas, Texas, has been named rep for *Helipot Corp.*, in Texas, Oklahoma, Arkansas and Louisiana. . . . *Bert Gilberg* of *D. R. Bittan Co.*, 53 Park Place, New York 7, N. Y., has been called to service (U. S. Army). *Fred Kantor*, formerly with *Harrison Radio*, has been named as *Gilberg's* successor. . . . *Harrison Blind*, 1616 Cord St., Indianapolis, Ind., has been appointed rep for *Circle-X Antenna Corp.*, in Indiana and Kentucky. . . . *Larry A. Chambers*, 565 Washington St., Chicago 6, Ill., has been named rep for *The Halldorson Co.*, in northern Illinois and southern Wisconsin. . . . *Howard J. Christianson* has been added to the staff of *R. Edward Stemmi*, 5707 W. Lake St., Chicago 44, Ill. . . . *Wilson Zimmerman* has been elected president of the Empire State chapter of the Reps. Others elected were: *Wally B. Swank*, vice president; *Oliver C. Wolf*, secretary; and *Martin P. Andrews*, treasurer. . . . *James L. Wright* has been elected president of the Hoosier chapter of the Reps. *Charles N. Hoemig* was reelected treasurer; *Joseph J. Clancy* has become secretary and *Charles Southern*, vice president. . . . *John I. Crockett* has been elected president of the southwestern chapter of the Reps. Also elected were: *Mose Brannum*, vice president; *Hal F. Corry*, secretary; and *R. M. Campion, Jr.*, treasurer. . . . Other Rep elections—Midlantic chapter: *R. F. Brookfield*, president; *R. L. Wilkinson*, vice president; *George Scarborough*, secretary; and *Jack Mahoney*, treasurer. . . . Wolverine chapter: *Robert Milsk*, president; *Edwin F. Liddle*, vice president; *John Hagerly*, secretary-treasurer. . . . Rocky Mountain chapter: *Ronald G. Bowen*, president; *W. Cliff McLoud*, vice president; *Mel Pearson*, secretary; and *W. H. Connors*, treasurer. . . . *Jules Bressler* has been elected second vice president for the New York chapter of the Reps. Various committee chairman have also been appointed: Program—*J. J. Bressler*; publicity—*H. Finkelstein*; membership—*D. Sonkin*; constitution—*D. R. Bittan*; entertainment—*M. Camber*; and membership roster and buyers guide—*J. Kopple*. . . . *Ronald G. Bowen*, 852 Broadway, Denver, Colo. (Colorado, Wyoming and Utah); *Harris-Hanson*, 208 N. 23 St., St. Louis 3, Mo. (Missouri and Kansas); and *G. Curtis Engel*, 200 E. Ridgewood Ave., Ridgewood, N. J. (Northern New Jersey and Southern New York state), have been named reps for *Gertsch Products Inc.* . . . *Arthur F. Hess*, *Walart Electronics Co.*, 15 Park Row, New York 17; *Les Mingins, Jr.*, *Mingins Sales Co.*, 107-37 71 Ave., Forest Hills, N. Y.; *Milton Ross*, 550 Fifth Ave., New York 17; and *John L. Ryan Associates*, 263 Edgemont Place, Teaneck, N. J., have

TIME = PROFIT

The Bendix "Long-Range" Chassis is not only a powerful fringe area receiver but also a dependable unit. It was designed to provide all the time-saving, profit-making advantages of easy accessibility to controls, chassis and component parts.

The super-sensitive circuits, which provide the "Long-Range" chassis with peak performance and maximum operating efficiency of both picture and sound, are fully illustrated and described in the new Bendix Technical Data Handbook. Clear, concise schematics plus complete data provide quick, easy reference to all circuits, component parts and controls.

Designed to give the finest in TV reception, the Bendix "Long-Range" chassis assures greater profits by minimizing service problems.

FREE POCKET-SIZE TECH DATA HANDBOOK

It's yours for the asking . . . a new combination handbook and memo pad containing schematics and technical data covering both the Bendix Standard and "Long-Range" chassis.

Send me free schematics and tech data about BENDIX TV

Name _____
 Company _____
 Address _____
 City, Zone, State _____

Fill Out This Coupon, Paste It To Penny Postal Card, Mail It To SERVICE DEPT. 88, BENDIX RADIO BALTIMORE 4, MARYLAND

C. K. Parrish

C. E. Durnin



been elected to senior membership in the New York chapter of the Reps. New associate members elected were: *Harry Bittan*, Bittan and Joseph, 551 Fifth Ave., New York 17; *Jacob John Mandel*, 11 Park Place, New York 7; and *Arthur Stangel*, Simberkoff Sales Co., 68 Hudson St., Hoboken, N. J. . . . *Ward Paden* has been elected president of the Mississippi Valley chapter of the Reps. *W. N. Wellman* was elected vice president, and *Norman Kathrinus*, secretary-treasurer. . . . *Land C-Air Sales Co.*, 1819 Broadway, New York 23, N.Y., have been named reps for The Macson Co., Los Angeles, Calif. . . . *Richard Hyde*, 3879 Tennyson St., Denver 12, Colo., has been appointed rep for Crest Transformer Corp., in Colorado, New Mexico, Utah, Wyoming and South Dakota. . . . *Gassner and Clark Co.*, Chicago, Ill. (Illinois); *Anderson Sales Co.*, Boston, Mass. (Maine, New Hampshire, Vermont); *Harrison J. Blind*, Indianapolis, Ind. (Kentucky and Indiana); *Maury E. Bettis Co.*, Kansas City, Mo. (Missouri, Iowa, Kansas, Nebraska); *Enmet J. Tydings*, Pittsburgh, Pa. (Ohio, western Pennsylvania, West Virginia); *D. L. Dale Co.*, St. Paul, Minn. (Minnesota, Iowa, Nebraska, Wisconsin, North and South Dakota); *Hal F. Corry*, Dallas, Texas (Texas, Oklahoma, Arkansas, Louisiana); and *Harold Jenkins*, Lawrence Elliott Co., Pontiac, Michigan (Michigan), have been named reps for South River Metal Products Co., Inc. *Harold Gray*, 220 E. 23rd St., New York City, has been named factory rep for Industrial Television Inc., in northern New Jersey, New York City, Long Island, and the Hudson Valley as far north as Poughkeepsie. . . . A special issue of *Rep News* of the New York chapter of the Reps was published for the recent annual stag party. Featured was a program of the event. . . . *LeRoy Schenck*, Newark, N. J. (New York state and New Jersey); *W. C. Hendrickson*, Boston, Mass. (Maine, Connecticut, Massachusetts, Vermont and New Hampshire); *Howard Fairbanks*, Philadelphia, Pa. (eastern Pennsylvania, southern New Jersey, Delaware, Maryland, and Washington, D. C.); *Myers and Young*, Kansas City, and St. Louis, Mo. (Missouri, Kansas and Nebraska); *Frank Wedlee*, Seattle, Wash. (Washington, Oregon, Montana, Idaho, Alaska and British Columbia); and *Mel Foster*, Minneapolis, Minn. (North Dakota, South Dakota, Iowa and Minnesota), have been named reps for the National Video Corp. . . . *C. R. Strassner Co.*, Los Angeles, Calif., has moved to 1865 N. Western Ave., zone 27, a single-story, 2000-square foot building. . . . *Edward J. Wilder* has been appointed field rep for Audio and Video Products Corp. . . . At a meeting of the Chicagoland chapter of the Reps, under the chairmanship of *Royal Higgins*, there were talks by *Al Brodsky*, purchasing agent of Allied Radio; *Jack Davis*, products man-

(Continued on page 58)

R. T. Millen

L. A. Chambers



Alprodco Towers

MEAN A SATISFIED CUSTOMER EVERY TIME!

• As an experienced television dealer, you know the troubles you've had with customers in fringe areas and other difficult locations. But no longer! Alprodco Towers now offer you—for the first time . . . for every time—a sure-fire antenna mounting system that will really get that picture. Keep your customers satisfied—keep those TV sales sold—with Alprodco! Write today for full details.

Exclusive! **ALPRODCO'S**
New Portable **EREC-TOWER**

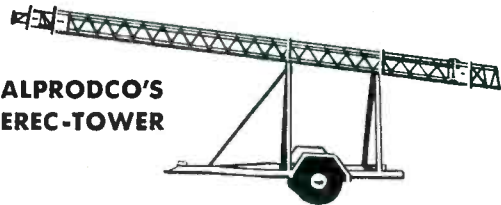

Test TV signal strength anywhere with this new Alprodco rig . . . use it also to raise a 100 ft. Alprodco Tower into position! Erec-Tower rises to 80 feet, is toolproof and quickly, easily portable. Requires only two men to operate. A good traveling ad for you . . . be the first in your area with Erec-Tower.

Send for Literature. Dept. E

Alprodco, Inc.

KEMPTON, INDIANA
MINERAL WELLS, TEXAS
DUBLIN, GEORGIA



10 reasons why C-D type UP electrolytics are superior

For TV and auto radio
applications; and wherever extremes
of heat and cold are encountered



A special formation process which results in low leakage; permits operating temperatures as high as 85° C.



Special separator — exclusive with C-D electrolytics — prevents breakdowns under the worst field conditions.



Special construction results in lowest intercoupling between sections.



Special winding results in good RF impedance.



Etched cathode construction (Type UPE) where high ripple currents require it for permanence of capacity.



Rubber diaphragm type of construction results in a positively operated vent.



Spot welded anode risers to lugs.



Spot welded cathode tabs to mounting rings.



Saddle lug permitting easy wiring of the lugs.

For better servicing results insist on superior
C-D Electrolytics—Best by Field Test!

ASK YOUR
C-D JOBBER
FOR
"C-D TELEVISION
CAPACITOR
REPLACEMENT
GUIDE TVR-7."



CONSISTENTLY DEPENDABLE
CORNELL-DUBILIER

CAPACITORS • VIBRATORS • ANTENNAS • CONVERTERS



SOUTH PLAINFIELD

NEW JERSEY, U.S.A.

Other Plants in New Bedford, Worcester and Cambridge, Mass.; Providence, R. I.; Indianapolis, Ind.;
Fuquay Springs, N. C.; and Subsidiary, The Radiart Corporation, Cleveland, Ohio.

Printed in U.S.A.

Rep Talk

(Continued from page 57)

ager, Radio Division of Motorola, and Jack Berman, vice president in charge of sales for Shure Bros. on the subject—*What We Expect From a Representative.* . . . Victor Electric Wire & Cable Corp., Clifton, N. J., have appointed two regional sales reps: *Crescent Electric Sales Co.*, 4920 W. Madison St., Chicago, Ill., for Illinois, Wisconsin and the peninsula region of Mich., and *Joe Clancy & Co.*, Wilder Road, Angola, Ind., for Ohio, Kentucky, Indiana and Mich. . . . Paul W. Nief has formed a rep and sales consultant company, Paul W. Nief Associates, 7 Greenridge Avenue, White Plains, New York. Nief recently re-

signed as general sales manager of Jewel Radio Corp., New York. . . . The Los Angeles chapter of the Reps has elected *John B. Tubergen*, president; *John J. Hill*, vice president and *George Davis*, secretary-treasurer. *Dr. Ralph L. Power*, executive secretary-treasurer, was reappointed to that post. . . . *The Lawrence F. Zaffina Co.*, 14611 Alma Avenue, Detroit, Mich., and *G. G. Willison*, 1821 W. Alabama, of Houston, Texas, have been appointed reps for Javex. Zaffina will handle Michigan, and Willison will operate in Texas, Oklahoma, Arkansas, and Louisiana. . . . *James Hill* is now chairman of the membership committee of the Los Angeles chapter of the Reps. *Douglas Loukota* has become chairman of the publicity committee; *E. V. Rob-*



Ray Bridge



Jack Brown

erts, chairman of the program committee. *Norman B. Neely*, first national vice president, has been selected to serve as liaison with '52 Western Electronic Show and Convention. . . . The Chicagoland chapter of the Reps has elected *Harry Halinton*, president; *Perc Ridley*, vice president, and *Karl Engle*, treasurer. Retiring president *Royal Higgins* has been named to the board of directors with *Bob Taylor*, *Roy Magnuson* and *Jack Beebe*. . . . *Edwards, Lohse and Co.*, manufacturers' rep, 2123 E. 9th Street, Cleveland, Ohio, and *Don C. and W. H. Wallace*, 1206 Maple Ave., Los Angeles, Calif., have been appointed to represent Javex, the former in Ohio and Western Pennsylvania, and the latter in California, Arizona, Nevada, and Hawaii. . . . South River Metal Products Co., Inc., 17-19 Obert St., South River, N. J., has appointed *B and C Sales*, 1355 Market St., San Francisco, Calif., as sales rep in northern Calif.; the *C. H. Mitchell Company*, 1221 W. 11th St., Los Angeles 15, as sales rep in southern Calif.; and *J. M. Cartwright and Son*, 1336 Madison Ave., Memphis 4, Tenn., as sales rep in the entire southeastern portion of the country. . . . *Michael Scott* is now Eico sales rep for all of the New England States. Scott's headquarters are at 90 Edmunds Road, Wellesley Hills 82, Mass. . . . *The Gordon Marshall Co.*, 40 S. Los Robles, Pasadena, Calif., have been named by Ward Products to cover southern California, contacting both distributor and industrial accounts on the auto, TV, FM and communications antenna lines. In the Pennsylvania, Washington, Delaware and Maryland territory, *The Ken Randall Co.*, 121 N. Broad St., Philadelphia, Pennsylvania, now represents Ward to industrial accounts only. . . . *Jack Brown*, 1631 Walton Avenue, N. Y. C., has become Eico sales rep for upper New York State. . . . *Robert Brunner*, formerly with Hewlett-Packard Co., Palo Alto, Cal., has joined the Los Angeles headquarters of Neely Enterprises, reps, as a sales engineer. . . . *Herb Becker*, Los Angeles manufacturers' rep, has moved to 1140 Crenshaw Blvd., Los Angeles 19. . . . *Ray Bridge* is now with *Arthur E. Akeroyd*, The John Hancock Bldg., Boston 16, Mass., as a sales rep. Ray was a Navy radio operator in '21 and spent 13 years in the wholesale radio business and five years in the Radiation Lab of MIT during the last war. . . . A dinner and joint get-together between the New England chapter of The Reps and both the Yankee and Southern New England chapters of NEDA was held recently at the Hotel Somerset in Boston, Massachusetts. Officiating at the dinner were *William B. Pray*, president of the Reps and *Henry Jappe*, director of the Yankee chapter of NEDA. . . . *Jack Goss* is now vice president of the New England chapter of the Reps; *Norman R. Macinnis*, secretary-treasurer. Heading up the new membership committee is *Sam C. Hooker*. *A. E. Akeroyd* is head of the activities committee, and *Henry Lavin* is the new publicity chairman.

TV Parts

[Additional TV-product news on page 54 and 60]

FRETCO OPEN-WIRE LEADIN

An open-wire transmission line, with insulators of clear polystyrene that are said to minimize loss and possibilities of improper impedance, has been introduced by the Fretco Corp., 1041 Forbes St., Pittsburgh 19, Pa.

Wire is claimed to hold its shape even after salt spray tests.

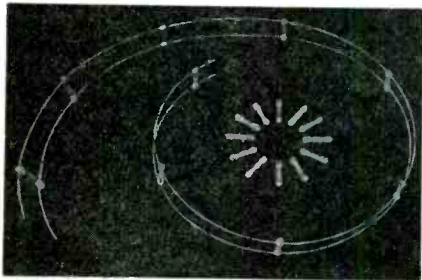

B-T THERMO RELAY

An automatic thermo relay, TR-2, for relay and time-delay purposes, has been introduced by B-T Manufacturing Corp., 38 N. Second Ave., Mt. Vernon, N. Y.

Unit will control equipment drawing up to .5 amp at 117 v. Variation of time delay is said to be adjustable from 1/10 to 4 seconds.

CHANNEL MASTER STEEL TOWERS

A line of steel towers has been announced by Channel Master Corp., Ellenville, N. Y.

Available in 10' sections, the towers have a built-in ladder on one side with no obstructions; other two sides feature truss construction. Tower legs are made of steel tubing and are spaced 8 1/2" apart. Sections are interchangeable.

All three tower legs are swaged on one end. Additional sections are slipped into each preceding section and fastened. Masts and rotators are mounted internally.

A universal base mount is also available for these towers, and is adaptable for peaked, sloping, and flat surface installations. Special dual purpose mounting brackets, for use both as mast supports and rotator bearings, are also available with the towers.

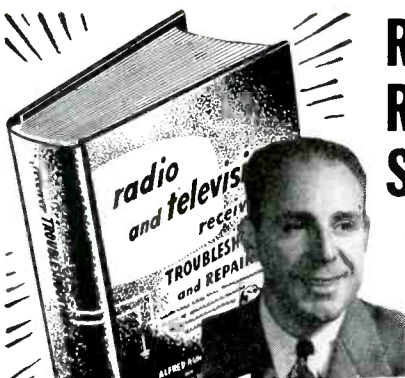
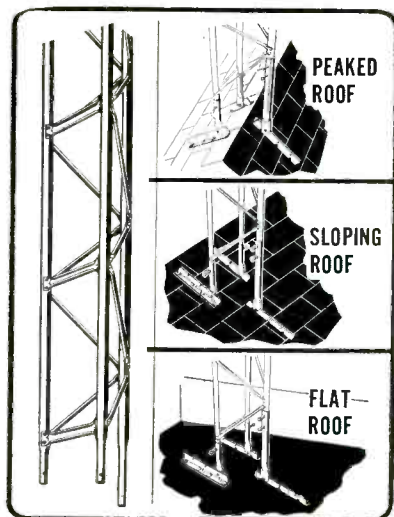

RADIO and TELEVISION RECEIVER TROUBLE-SHOOTING and REPAIR

by A. A. Ghirardi and J. R. Johnson
820 pages, 417 illustrations, 6x9, price \$6.75

The complete know-how of service procedure by the most modern time-saving professional methods

NOW! GHIRARDI'S Complete New Service Training Course

Helps you lick the toughest service problems!
Paves your way to the big-money jobs!

22 COURSES IN ONE!

Here is what this big book covers:

1—Receiver Components and Their Troubles; 2—How to Develop a Systematic Troubleshooting Procedure; 3—Basic Methods: Preliminary Questions and Checks; 4—Static Tests; 5—Dynamic Testing; 6—Practical Direct-Approach Troubleshooting; 7—Special Problems in AC/DC and 3-Way Portables; 8—Special Battery Set Problems; 9—Servicing Communications Receivers; 10—Troubleshooting Television Receivers; 11—Taking Performance Data; 12—Re-aligning AM Receivers; 13—Re-aligning FM; 14—Re-aligning TV; 15—Replacing Defective Resistors; 16—Replacement and Repair of R-F and I-F Inductors and Transformers; 17—Power, A-F and Deflection - Frequency Inductors and Transformers; 18—Defective Capacitors; 19—Servicing Tuning-Drive Mechanisms, Station-Selector and Band Switches; 20—Testing, Replacing and Repairing Loudspeakers; 21—Servicing Record-Playing Equipment; 22—Servicing Home Recorders.



MONEY-SAVING COMBINATION

Make your service library complete—save money in the bargain. Get the above great new Ghirardi book PLUS the new Ghirardi RADIO AND TELEVISION RECEIVER CIRCUITRY AND OPERATION (issued only a few months ago) at the special price of only \$12.00 for the two. (Regular price for the two books is \$12.75.)

Ghirardi's RECEIVER CIRCUITRY AND OPERATION brings you complete, easy training on the basic circuits and operating principles of all radios, TV sets, record players, etc. Makes you far less dependent on service manuals, mfrs.' data—helps you go right to the seat of troubles in 1/2 the usual time! SEE COMBINATION OFFER IN COUPON!

BRAND NEW... Just off the Press!

Here's the big book you've been waiting for... the new Ghirardi guide to modern Radio-TV servicing by professional methods... a book that can help give your earning power a big boost by teaching you to work faster, more efficiently on every receiver service job!

RADIO AND TV RECEIVER TROUBLESHOOTING AND REPAIR starts with a full analysis of radio-TV components and why they fail. Next you learn how to work by the most modern service methods—from quick analysis to static tests of electrical characteristics to dynamic signal tracing and signal injection. Special problems in ac/dc, battery sets and others are clearly explained. A big TV service section is arranged so that you can find answers to specific problems in a jiffy. Complete chapters greatly simplify alignment procedure for each type of receiver. Six chapters cover every phase of component replacement, testing, tuning problems, speaker troubles, etc. Over 400 illustrations make things doubly easy to understand—including dozens of unique step-by-step charts that explain complicated details of the work almost at a glance.

Nowhere else will you find servicing explained so clearly or in such handy form for either study or on-the-job reference. Read this great book for 10 full days at our risk. MAIL COUPON TODAY!

FLASH! SHOULD SERVICEMEN BE LICENSED?

No matter how any of us may feel about it, the fact remains that many cities and states are now preparing laws requiring servicemen to undergo rigid licensing tests. Let these two Ghirardi books help prepare you today for any such test you might have to pass!

10-DAY EXAMINATION

Dept. S-22 Rinehart Books, Inc., Technical Div., 232 Madison Ave., New York 16, N. Y.

Send the new Ghirardi RADIO & TELEVISION RECEIVER TROUBLESHOOTING & REPAIR for 10-day examination. If I like book, I will then promptly send \$6.75 in full payment. If not, I will return book postpaid in good condition and owe you nothing.

RADIO-TV SERVICE COMBINATION OFFER—Send above book PLUS RADIO & TV RECEIVER CIRCUITRY AND OPERATION on same examination basis. Special price for both books only \$12.00 (To be paid in 10 days, or books returned.)

Name

Address

Employer's name and address

City, Zone, State

Prices outside U.S.A., cash only, \$7.50 for RADIO & TV RECEIVER TROUBLESHOOTING AND REPAIR, or \$13.00 for COMBINATION OFFER. Money back if you return books within 10 days.

EUREKA

A DELIGHT TO YOUR Sight!

For television viewing you unequivocally desire the best possible picture . . . bright—clear—perfect in detail! . . . You want Eureka because Eureka picture Tubes are built to the most exacting standards . . . checked and rechecked to give you nothing but the finest!

For immediate delivery the new 21EP4 and 21FP4
Write or phone for complete information...

EUREKA TELEVISION and TUBE CORPORATION

Manufacturers of Cathode-Ray Tubes and Electronic Products
69 Fifth Avenue, Hawthorne, New Jersey • Telephone Hawthorne 7-3907

TELREX PREASSEMBLED CLOVER-V-BEAM

An improved model of the *Clover-V-Beam* TV antenna, that is preassembled and can be rigged by tightening two nuts, has been announced by Telrex, Inc., Engineering Dept., Asbury Park, N. J.

Antenna features transposed colinear elements in conjunction with stacked closed-loop conical V-beam dipoles. Interconnecting rods load the dipoles for low-frequency channels and serve as transposed halfwave transformers at the high channels. This is said to provide the sensitivity of resonant closed-loop conical dipoles at the low frequencies, and long-wire V-beam operation, with a gain averaging 9 db at the highs.

Antenna weighs less than 24 ounces and has a lateral displacement of under 5 feet.

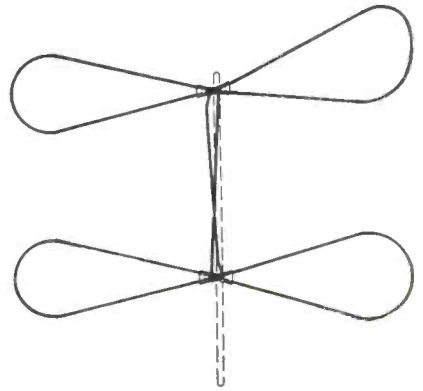

* * *

GONSET RADAR-TYPE TV ANTENNA

A fringe area TV antenna, *Radarray model C*, has been announced by the Gonset Co., Burbank, Calif.

Uses large diameter dipoles and a 8' non-resonant reflector screen to obtain broad-band characteristics.

On the high band the array functions as four half-wave dipoles in phase, spaced $\frac{3}{4}$ wave ahead of the reflector screen. On the low band, shorted stubs across the dipole elements lower the fundamental resonant frequency and at the same time provide an impedance match on the low channels; stubs are quarter-wave resonant on the high band. Reflector spacing approximates a quarter wavelength on the low band.

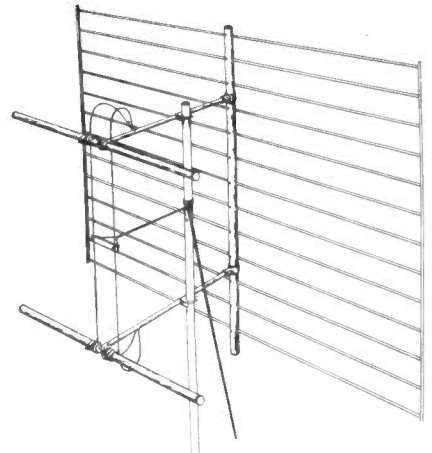

ALPRODCO ROTATOR ADAPTOR KIT

A rotator adaptor kit, RK-1W, designed to make possible the installation of any commercial antenna rotators on its antenna towers, has been announced by Alprodco, Inc., Kempton, Indiana, Mineral Wells, Texas, or Dublin, Georgia. Installed, without special tools, kit consists of four matched components.

One component is an adaptor mounting plate, predrilled to accommodate any well-known rotator, upon which the rotator is mounted. This is placed within the framework of the tower itself. A 10' mast pole is provided to connect the antenna to the rotator; this pole is held within a 24" bearing, third component in the kit. Lastly, a three-piece mast kit is included, affording the support necessary to keep the mast pole bearing in place.

JERROLD HIGH Q TRAPS

A line of high Q traps, designed for use between the TV antenna and receiver to eliminate adjacent-channel and FM interference, has been introduced by Jerrold Electronics Corp., N.E. corner 26th and Dickinson St., Philadelphia 46, Pa.

Traps are available in four models: Model *TLB* for channels 2 through 6; model *TIB* for channels 7 through 13; model *TFM* covering the FM range from 88 to 108 mc, and model *T Special* to eliminate interfering frequencies in any bands other than *vhi* TV and FM.

Traps consist of bridged *T* networks with variable series and shunt inductance circuits. With both the series and shunt circuits tuned to the signal to be trapped, this undesired signal is said to be attenuated by a minimum of 50 db.

Servicing Helps

(Continued from page 30)

required for strong, medium, or weak signals, respectively.

Turning the switch from *local* toward *fringe*, progressively reduces the *agc* voltage and, by grounding the video amp grid resistor, improves the noise limiting action.

Buffer Capacitors in Auto Radios*

On many occasions Service Men will find different value buffer capacitors used on similar applications. There is, of course, a very good reason for these variations and it is thus important that the exact values be duplicated when replacing is necessary.

In a basic vibrator-rectifier circuit, when the radio *on-off* switch is closed, the vibrator coil is energized and the reed attracted so that the circuit is broken momentarily. During the same period of time, one half of the windings of the power transformer are also energized inducing a voltage in the secondary, which is applied to the rectifier tube to produce *B* voltage. When the reed moves, it interrupts this circuit and acts as an electric switch in making contact with the other section of the primary winding.

Now, it can be seen why the buffer capacitor is used. At the instant of contact break, an extremely rapid voltage reversal would take place with resultant high arcing at the vibrator contacts, but with a capacitor across the secondary windings this voltage reversal starts to occur in a resonant circuit and decays in an oscillatory manner, thus quenching the arc that might have developed and damaged the contacts.

To establish a satisfactory resonant circuit, the proper value of buffer capacitor must be used. The charging current of the transformers vary with the type of iron used for laminations, method of winding, size of wire, etc., so that with these factors known, engineers can select a proper value of capacitor. It must be large enough to quench properly the oscillation, but not too large so that it will not be discharged before the next cycle starts, and yet small enough to function on time, yet large enough for satisfactory resonance. Therefore, the value of buffers found in the auto radio usually feature characteristics that afford matching with the transformer and vibrator used; thus replacements must be exact duplicates.

*From Philco service notes.



"Centre-Kooled"

SELENIUM RECTIFIERS

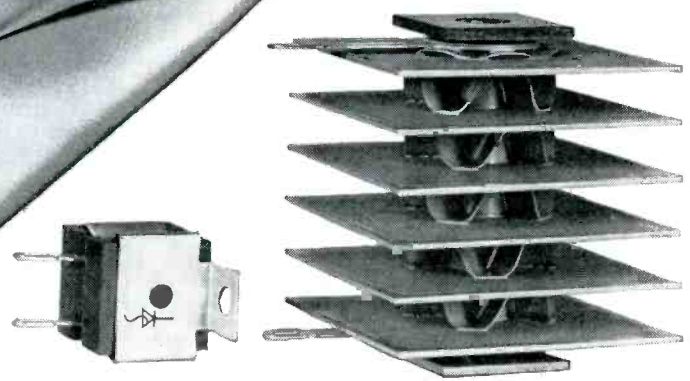

★ JUST OFF THE PRESS! Most complete book of its kind ever published . . . 80 pages of valuable information about Selenium Rectifiers . . . 48 pages of Radio & Television circuit diagrams . . . 20 pages on Power Rectifiers . . . 3 pages on High Voltage Rectifiers . . . a 7-page cross index replacement guide. Send 50¢ for your copy or see your distributor.



Sarkes Tarzian, Inc.
RECTIFIER DIVISION
Dept. S-1, 415 North College Ave., Bloomington, Indiana

**XCELITE ADOPTED AS NEW NAME FOR
PARK METALWARE**

Park Metalware Co., Inc., Orchard Park, N. Y., has changed its corporate name to Xcelite, Incorporated.

Officers of Xcelite are: president, F. Birney Farrington; vice president, John O. Olsen; secretary, Howard S. Langworthy; and treasurer, John N. Petre.



F. Birney Farrington

* * *

ED FINKEL VISITS WESTERN REPS

Edward Finkel, sales manager of the JFD Manufacturing Co., Inc., 6101 16th Ave., Brooklyn 4, N. Y., visited recently JFD sales reps on the Pacific Coast covering California, Oregon and Washington.

Finkel also attended the southwestern distributors' conference at Brackettville, Texas.



Ed Finkel

* * *

**SPRAGUE CAPACITOR REPAIR
PACKAGE**

A service package system that is said to make it easy for TV Service Men to carry complete stocks of just the right replacement capacitors for the brands of TV sets they service most frequently, has been announced by Sprague Products Co., North Adams, Mass. Available are electrolytics necessary to service each of 22 of the most popular makes of TV receivers in use today.

Complete listing of the capacitors recommended for inclusion in the package for each brand of TV set is included in a 4th edition of the Sprague TV Replacement Capacitor Manual, M-481, available free through distributors.

* * *

**HENRY C. ROEMER ELECTED FTR
PREXY**

Henry C. Roemer, formerly executive vice president, has been elected president of Federal Telephone and Radio Corp., 100 Kingsland Road, Clifton, N. J.

* * *

**JENSEN FIELD SALESMEN ADD
TERRITORIES**

Home office salesmen of the Jensen Manufacturing Co., Chicago, Ill., have taken over additional territories. Harold Hoffman, who has been covering Michigan, Wisconsin and northern Illinois will add eastern Iowa to his territory. Ted Firaneck, formerly distributor order supervisor at the home office, will cover the Indiana, Kentucky, southern Illinois and eastern Missouri territories.



**MARVIN BRUCKNER NAMED
QUAM NICHOLS ASST. S-M**

Marvin L. Bruckner has been appointed assistant sales manager of the jobber division, of Quam Nichols Co., Chicago, Ill.

Bruckner was formerly sales engineer with the Thordarson-Meissner division of Maguire Industries.



M. L. Bruckner

* * *

**ZEBLEY AND HENIG NAMED TO
SNYDER MILITARY DIVISION
POSTS**

H. S. Zebley has been named sales manager of the military division of Snyder Manufacturing Co., Philadelphia, Pa. Ben Henig has been appointed sales rep for the same division.



H. S. Zebley

* * *

RCA TV DATA BOOKS

Two TV data books, *RCA Kinescopes* and *Television Servicing*, heretofore available only in conjunction with the company's *Treasure Chest* promotion campaign on TV picture tubes, are now available from RCA distributors, or the commercial engineering section, RCA Tube Department, Harrison, N. J.

Kinescopes, priced at \$25, contains data on more than 100 different picture-tube types now in use, and provides reference information on tube characteristics of the line, a replacement directory listing competitive picture tubes and showing the corresponding RCA replacement type or similar type, and a picture-tube conversion chart.

TV Servicing, priced at \$35, features a collection of special articles prepared by John Meagher and Art Liebscher, covering an analysis of servicing problems. In addition to new articles on TV servicing by Meagher, and a new paper on TV tuner alignment by Liebscher, book also contains all of the Meagher articles on television servicing which appeared originally in the *RCA Radio Service News*. Subjects covered include *rf-if* alignment, troubleshooting, and circuit analysis.

* * *

**WALLIN ELECTED
WEBSTER-CHICAGO V-P**

Gus W. Wallin has been elected vice president in charge of engineering of Webster-Chicago Corp., Chicago, Ill.

SNYDER CONSUMER CAMPAIGN

A continued consumer advertising campaign on behalf of its line of TV antennas, has been announced by the Snyder Manufacturing Co., Philadelphia, Pa.

Advertising will be in the nature of news articles, written by Edward N. Noll, a faculty member of the Technical Institute of Temple University, for the layman.



Edward M. Noll

* * *

**WILLIAM W. TAYLOR APPOINTED
SANGAMO SALES-PROMOTER
MANAGER**

William W. Taylor, formerly in charge of capacitor advertising, has been appointed sales promotion manager of the capacitor division of Sangamo Electric Co., Springfield, Ill. He will headquarter at the Marion, Ill., factory.



William W. Taylor

* * *

RMS SALES CONFERENCE

The winter '52 sales conference of Radio Merchandise Sales, Inc., 1165 Southern Blvd., New York 59, N. Y., was held recently at the Grossinger Hotel and Country Club, New York.

Previewed at the meeting were the company's promotion plans and material for the year, which included jobber catalogs, an accessory and antenna wall chart, and an antenna guide. Also introduced were three new antennas for use in urban, semiridge and fringe TV areas: *Fringe Master Senior* and *Junior* (conical Vs) and *Fantienna*.

Among those at the conference were Sidney Pariser and Marty Bettan, RMS; Maury and Joe Farber, Jerry Rogers—Farber Assoc. (New York State); Henry Lavin and Bob Curtin, Lavin Assoc. (New England); Al Leban and Irwin Gray (Phila., Balt. Washington, Del. and E. Pa. areas); Hoyt-Giddings, Grady M. Duckett Co. (S.E. below Mason-Dixon Line); Albert Levine, (West Pa., W. Va.); Joe and Bernie Clancy, Joe Clancy and Co. (Ind., Ohio, Mich., Ky.); J. J. McBride and Joe Kinderman, J. J. McBride Sales Co. (Ill., Iowa, Wis., Minn.); Jim and David Packard, Jim Packard Co. (Tex., Okla., La., Mo., Ark.); Burt C. Porter-Burt C. Porter Co. (Wash., Ore., Mont., Idaho); Sol Budd-MJS TV Access. (Canada); Larry Rivman-Intex Co. (Mexico and South America); and Morris Hacker (Metropolitan New York).

* * *

PHILIP JOINS TELREX

Manfred E. Philip has been appointed controller and director of purchases of Telrex, Inc., Asbury Park, N. J.

**FLOYD J. VANALSTYNE APPOINTED
PERMOFLUX S-M JOBBER**

Floyd J. VanAlstyne, formerly in charge of buying and merchandising for Allied Radio Corp., has been appointed jobber sales manager of Permoflux Corp., 4900 W. Grand Ave., Chicago 39, Ill. He will direct the sales of loudspeakers, baffles, headsets and other items.

Eugene Roeske has been appointed head of the transformer core division which has been formed recently. He formerly was associated with S and C Electric Co.



Eugene Roeske



Floyd J. VanAlstyne

* * *

**RAYTHEON HOLDS BONDED DEALER
MEETINGS IN EAST AND WEST**

Service Men in Springfield, Mass., and St. Louis, Mo., recently attended bonded-dealer meetings, sponsored by local distributors of Raytheon tubes, to familiarize themselves with the aims and benefits of the Raytheon bonded plan for radio and TV Service Men.

L. L. Del Padre Associates sponsored the Springfield meeting, and Interstate Supply Co., the St. Louis get-together.

* * *

KENWOOD OPENS NEW PLANT

A new plant, featuring a radiant-heating system, has been opened at Kenilworth, N. J., by Kenwood Engineering Co., Inc. Facilities will be used to manufacture TV antenna mounts.

James J. Kusiv is president of the company.

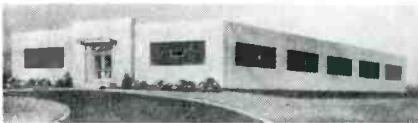

* * *

**HOAGLAND NOW DUMONT ASST.
ENGINEERING MANAGER OF
PICTURE TUBE DIVISION**

Kenneth A. Hoagland has been appointed assistant engineering manager of the picture-tube division of Allen B. Du Mont Laboratories, Inc., 750 Bloomfield Ave., Clifton, N. J.

Hoagland will be assistant to Alfred Y. Bentley, the division's engineering manager, in supervisory and administrative duties for the engineering department, in addition to being in charge of design and development of picture tubes.

* * *

HICKOK TUBE-TESTER FOLDER

A 4-page folder, TT5, describing ten dynamic mutual-conductance tube testers, has been released by The Hickok Electrical Instrument Co., 10521 Dupont Ave., Cleveland 8, Ohio.

* * *

SPICO FLORIDA PROMOTION

A series of 2-minute announcements on WTJV, Miami, Fla., promoting the Super-Phantom indoor TV antenna, has been launched by Spirling Products Co., Inc., 62 Grand St., New York 13, N.Y. Those in the area carrying the line are mentioned in each telecast.

for **P.A.**
Systems



it's
OXFORD
Speakers

A copy of our latest catalog will be sent upon request.

Available at leading jobbers!

**Preferred for original equipment
... Proven for replacement!**

Other Oxford Speakers for: Radio and Television • Portable Sets • Auto Radios • High Fidelity • Outdoor and Weatherproof Applications • Intercom

OXFORD
ELECTRIC CORPORATION

391 S. Michigan Ave. • Chicago 15, Ill.
EXPORT: ROBURN, AGENCIES, NEW YORK CITY



Keep Picture Quality UP Keep Service Calls DOWN



**JUST PRESS THE BUTTON,
SPRAY IT ON —
NO SPECIAL
EQUIPMENT NEEDED!**

Spray on antenna and lead-in terminals

Krylon prevents corrosion and pitting, even in salt-spray areas. It seals antennas and connections in a waterproof acrylic (not vinyl) blanket. (When aluminum finish is desirable, use special aluminum Krylon.)

Spray on high voltage circuits

Spray Krylon on the high voltage coil and insulation . . . in the socket of the high voltage rectifier . . . on component parts of rectifier circuit. Helps prevent corona because of its high dielectric strength.

Two types—clear and non-conducting aluminum. Both have exactly the same qualities. Packed in 12 oz. aerosol spray cans. List prices: \$1.95 clear, \$2.25 aluminum. Also available in gallons for application by brushing or dipping. See your jobber, or write direct.

KRYLON, INC., Dept. 602
2601 No. Broad St., Philadelphia 32, Pa.

Advertised in
"The Saturday
Evening Post"



THE ACRYLIC SPRAY THAT PREVENTS TV TROUBLE

RADIOS' MASTER 16TH EDITION NOW AVAILABLE

The '51-'52 16th edition of *Radios' Master* with over 7000 illustrations, and detailed descriptions and specifications for approximately 75,000 items, has been published by United Catalog Publishers, 110 Lafayette St., New York 13, New York.

* * *

JFD BOOSTER BROCHURE

A 4-page brochure, describing the *Truck-Away* booster line, has been released by the JFD Manufacturing Co., Inc., 6101 16th Ave., Brooklyn 4, N. Y. Detailed are both the *VB* and *SW* models. Included is a band-pass graph.

BUSS TELEVISION FUSE LIST

A reference guide with up-to-the-minute information on the fuses used in current types of TV chassis and auto radios has been published by the Bussmann Mfg. Co., University at Jefferson, St. Louis 7, Mo. Guide can be hung on the wall for ready reference.

Also featured is a fuse identification chart with illustrations and dimensions.

* * *

HANS U. HJERMSTAD APPOINTED SOLA ELECTRIC V-P

Hans U. Hjermstad has been named vice president in charge of engineering, at Sola Electric Co., 4633 West 16th St., Chicago 50, Ill.

FEDERAL ANNOUNCES SELENIUM AND CABLE SALES PLANS FOR '52

Plans for merchandising miniature and industrial selenium rectifiers, rectifier equipment and *rf* cable, were discussed recently by Federal Telephone and Radio Corp., Clifton, N. J., at a conference in New York City.

It was disclosed that the sales program for rectifiers will include a self-feeding counter dispenser for miniature selenium rectifiers holding an assortment that would serve 90 per cent of the existing TV and radio receivers now equipped with this component. There will also be service kits with eight rectifiers to aid in TV and standard broadcast-chassis servicing. In addition, there'll be available counter display cards, a replacement guide and a revised edition of the selenium-rectifier handbook. Among those at the meeting were George J. Collins, sales manager of the FTR selenium-intelin division; S. J. Powers, director of the division and E. L. Shaw, distributor sales manager.



* * *

OHMITE PLASTIC OHMS-LAW CALCULATOR

A plastic Ohm's law calculator has been announced by Ohmite Manufacturing Co., 4937 W. Flournoy St., Chicago 44, Ill.

Calculator of pocket size (3"x9") is made of durable, dimensionally stable vinylite.

All Ohm's Law computing scales are on the front side of the calculator. Its range covers the currents, resistances, voltages, and wattages commonly encountered in moderate radio work.

On the back of the calculator are provided a standard slide rule, and direct-reading, one-setting scales for computing parallel resistance. The slide rule has standard A, B, C, and D scales, and can be used to multiply, divide, and find squares and square roots.

Price of the calculator is \$1.50 net.

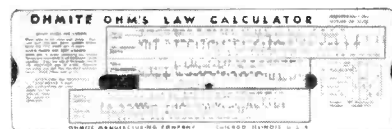

ALBERT COUMONT APPOINTED RTMA SERVICE MANAGER

Albert Coumont, formerly sales manager of the electronics section of International General Electric, has been appointed service manager for the Radio-Television Manufacturers Association, 777 14th St., N.W., Washington 5, D. C.

Coumont's first task will be to promote training courses for Service Men in the nation's trade and vocational schools. RTMA has engaged RCA Institutes, Inc., to write a 3-year vocational high-school syllabus on radio and TV and a 10-12-months syllabus for adult educational institutions.



Albert Coumont

IRC MANUAL

A 68-page manual, listing replacement controls for TV sets, has been published by the International Resistance Corp., 401 N. Broad St., Philadelphia 8, Pa.

Included are replacement data on concentric dual controls for TV and home and auto radios (beginning with early prewar sets). Manual illustrates and describes how to assemble over 90 per cent of dual controls. Priced at \$5.00.

CUSHWAY NOW CRESCENT INDUSTRIES V-P

Charles P. Cushway, formerly executive vice president of Webster-Chicago Corp., has joined Crescent Industries, Inc., Niles, Ill., as vice president and chairman of the advisory board.

Cushway will direct operations in the jobber-dealer field, both here and abroad.

The company will reorganize its sales efforts on a district representative basis.

AT TE GRAND PRIZE DRAWING



Grand prize drawing, held in connection with the opening of the retail sales division of Television Engineers, Inc., in Chicago, during which Miss U. S. Television, selected from a field of 13 finalists in a coast-to-coast talent-beauty hunt, presented prize-winning numbers, culled from registered coupons deposited during grand opening period, to Morton Binder, TE prexy. A total of 130 winning numbers were drawn. First prize was a 20 inch TV set. Other prizes ranged from electric clock-radios to gift coupons worth \$25.



Directronic

MOTORLESS TV AERIAL SYSTEMS

360° ELECTRONICALLY SWITCHED BEAM

GIVES SAME CLEAR PIX AS MOTOR DRIVEN AERIALS AT 1/3 THE COST

**SIMPLE FLICK OF SWITCH
CLEARS PICTURE INSTANTLY
NO WAITING**

**OPENS BIGGEST
REPLACEMENT MARKET
IN TV HISTORY**

MAIL THIS COUPON TO-DAY!

SNYDER MFG. CO.

22nd & Ontario Sts., Phila. 40, Pa.

Please send me free copy of authoritative booklet TENNA TIPS on Directronic and all other types of aerials, plus catalogs.

NAME _____

ADDRESS _____

CITY _____ ZONE _____ STATE _____

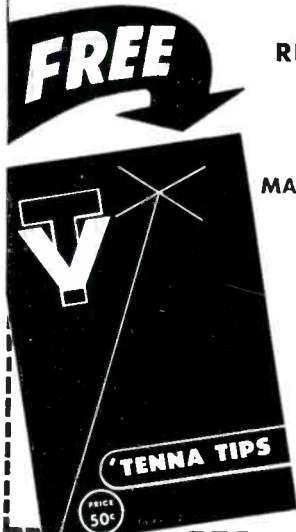
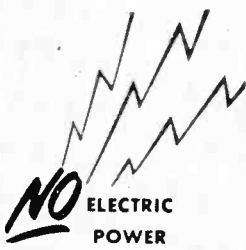

WAYS TO BETTER SERVICING...

Now, there are 32 fact-filled Tek-File packs... covering the latest sets of over 60 manufacturers! You get all the factory-authorized service data... and it matches the set you're working on! Complete data—right from Rider Manual TV8, a minimum of 128 8½ x 11 pages in each economical Tek-File pack.



RIDER MANUALS

**TV 8
and
VOL. 22**

Still the only complete source for accurate, authoritative servicing data. TV8, the biggest and best yet, covers all production runs and changes through September 1951. Volume 22 covers all manufacturers' AM-FM production runs through August 1951. (Also includes auto radios, record changers, tuners and recorders.)

see your jobber



JFD DECAL AVAILABLE

A decal, prepared by the advertising department of the JFD Manufacturing Company, Inc., is now being sent to distributors.

The decal, which is said to be weather resistant, can be placed on windows, doors, counters or truck panels.



* * *

SOUTH RIVER ANTENNA MOUNTS CATALOG

A catalog on antenna mounts and accessories has been released by South River Metal Products Co., Inc., South River, N. J.

Detailed are a chimney mount antenna base, two-piece chimney mount for high masts, duo-mount antenna base, and thrift mount. Also 3", 6", 12", 24" wall brackets are described, as well as an adjustable wall bracket, a combination wall bracket, and a duo-pipe mount. Other types of mounts, brackets and hardware are also featured.

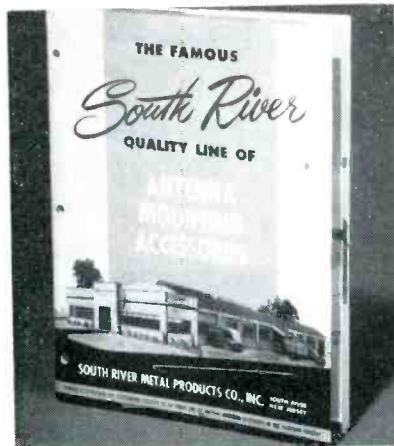

LANGSTROTH JOINS VIDEO PRODUCTS

Frank D. Langstroth has been appointed vice president in charge of operations of Video Products Corporation and its affiliate company, Sheraton Television Corporation at Red Bank, N. J. Langstroth was formerly president of Starrett Television Corporation, in New York.



F. D. Langstroth

* * *

UNIVERSITY TECHNILOG

A 28-page general catalog, *Technilog*, featuring curves, tables, charts, typical circuitry and practical discussions on such subjects as overload protection of loudspeakers, impedance matching, speaker baffles, phasing, reverberation, etc., has been published by University Loudspeakers, Inc., 80 South Kensico Avenue, White Plains, New York.

CUTS SERVICE TIME

New WIRE CUTTER AND STRIPPER

Big TIME SAVER

Snips wire to 18 gauge... gets in hard to reach places... perfect for holding wire or other small parts. Contact your radio parts jobber or Jim Handy representative.

Jim Handy EASY ACTION WIRE CUTTER
C & G Mfg. and Sales Co.
Box 1525 Columbus, O.

TV INSTALLERS! SAVE TIME—INCREASE PROFITS with MOSLEY PLUGS and SOCKETS

Time is money to TV installers! Today, installers are speeding up their work and eliminating the cause of possible future call-backs by using MOSLEY Low Loss TV Plugs and Sockets.



CAT. NO. 301



CAT. NO. 311



CAT. NO. C-124

Available for every installation need, MOSLEY Plugs and Sockets are, in most cases, installed without solder. They are made of low loss acrylic plastic, have phosphor bronze contacts, and will maintain exact line impedances. They can be depended upon to provide the very best electrical and mechanical connections.

Illustrated, are the popular MOSLEY 300 ohm Transmission Line Plug and mating Line Socket, and the handy MOSLEY 4-Con-

ductor Polarized Rotator Cable Plug and Base Socket Combination.

Get these and other MOSLEY products from your favorite jobber and ask him for MOSLEY Bulletin 51-51, a complete listing and description of the most popular MOSLEY products for the installer.

Use MOSLEY Plugs and Sockets on every job. You'll save time, you'll save money—and, your customers will appreciate it!

MOSLEY ELECTRONICS

2125 Lackland Road Overland, Missouri

Speedy Troubleshooting

(Continued from page 19)

the leads are good, and the 'scope is not operating properly, then, of course, the trouble is in the 'scope proper.

A signal generator is often used for troubleshooting by signal injection. If there is any question about whether the generator is operating, it can be tested on a part of the circuit which is working. For example, there may be no video information but the sound and raster are normal in a split sound TV set. This indicates a defect in the video strip. To localize the stage, a signal generator can be used to inject 400-cycle signals in the video amplifier stages and an amplitude-modulated *rf* signal at the *if* frequency into the video *if* stages. The 400-cycle signal will be viewable as horizontal black and white bars on the screen of the picture tube when the various stages pass along the signal. When a stage is reached which doesn't pass the signal, then this stage can be presumed to be defective. Further checks can then be made around this stage.

Now let us suppose a signal generator is used and on the first test on the video amplifier stage, no output is obtained. This may very well indicate that the defective stage has been found. But, since there has been no indication that the signal generator is functioning, it may also indicate that the generator is out of commission. It is simple to check the output from the generator on that part of the receiver which is functioning. The 400-cycle audio output can be checked on the audio amplifiers. The AM *rf* output of the signal generator can be tested on the audio *if* section. Even though the sound *if* stages are designed for FM signals, a large amplitude AM signal of the correct frequency will go through and be heard in the speaker.

There are alternate methods for checking an AM signal generator: (a) The generator can be tested on a functioning receiver; and (b) signal generator output can be seen on a 'scope. The output, both audio and *rf*, is fed directly to the vertical input terminals of the 'scope. The *rf* output is normally much less than the audio output.

Sweep generators produce both an FM signal which is applied to the TV receiver and a sweep voltage which is applied to the 'scope. The sweep voltage from the generator is fed to the horizontal-input terminals of the 'scope and is used to sweep the beam of the 'scope *crt* horizontally. For this application, the coarse frequency selector switch of the 'scope is on the

(Continued on page 68)

GENERAL CEMENT

more than a name it's a complete package

OF TV AND RADIO SERVICE NEEDS!



G-C AMO MINIATURE TUBE PULLER
No. 5093 for 7-pin tubes—list \$1.75
No. 8106 for 9-pin tubes—list \$1.75



G-C MINIATURE TUBE PIN STRAIGHTENER
No. 5191 for 7-pin tubes—list \$1.05
No. 8105 for 9-pin tubes—list \$1.05
No. 8655 Duplex pin straightener—list \$2.50



No. 744-I SPEEDEX AUTOMATIC WIRE STRIPPER
For Stranded or Solid Wires—list \$8.25

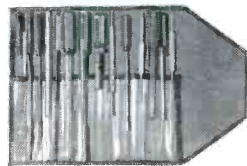

No. 8280 DELUXE TELEVISION ALIGNMENT TOOL KIT
16 tools complete with case—list \$12.90



No. 47-2 G-C TELEVISION HIGH VOLTAGE CORONA DOPE
Prevents shorts on high voltage TV circuits—list \$1.20



No. 49-2 G-C TELEVISION TUBE KOTE
For recoating surface of TV picture tubes—list \$1.20



No. 19-1 G-C DE-OX-ID CONTACT CLEANER
Dissolves corrosion and oxidation on contacts and controls—list 85¢



No. 30-2 G-C RADIO SERVICE CEMENT
Especially made for radio and speaker repairs—list 65¢

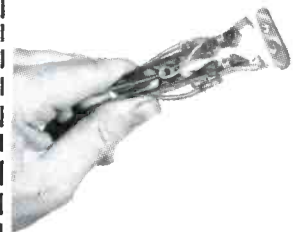

No. 8688 G-C TELEVISION TENNA-KLIP
Saves time in clipping antenna to set—list 50¢

The items listed above are just a few of the thousands of service needs made by G. C. See your distributor.



GENERAL CEMENT MANUFACTURING COMPANY

901 Taylor Avenue
Rockford, Illinois

FREE Please send at once, your 80 page catalog of TV and Radio Service Needs

Company Name _____

Street Address _____

City _____ Zone _____ State _____

Dept. D

Please send at once, your 80 page catalog of TV and Radio Service Needs

(Continued from page 67)

Perfection TV Components

Now - Individually Packaged!

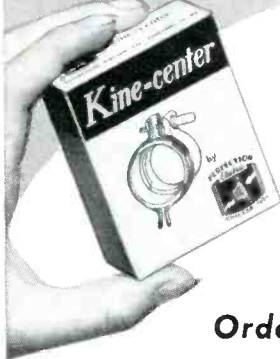

More Popular Than Ever!

The new Perfection Kine-Center for finger-tip picture centering in electrostatic tubes—the BeamaJuster for 3-second centering of pictures in focus-coil tubes—the B. O. Eliminator for removing black lines caused by Barkhausen Oscillation—and easily installed Perfection Ion Traps—all are now available in handy individual cartons at no extra cost.

Order Today from Your Supplier!

PERFECTION ELECTRIC COMPANY
2637 South Wabash Avenue, Chicago 16, Illinois
MAKERS OF PERFECTION SPEAKERS AND TELEVISION COMPONENTS



horizontal amplifier position. This means that the sweep voltage from the sweep generator is fed to the horizontal amplifier of the 'scope and then to the horizontal deflection plates. Suppose that the sweep generator is hooked up to the 'scope, with the coarse frequency selector switch in the correct position, and there is just a dot on the screen. This means that either the sweep generator or the 'scope is defective. To check which is at fault, the sweep generator leads should be disconnected from the horizontal input terminals of the 'scope. A finger can then be applied to the horizontal terminals of the 'scope. If the dot is swept across the 'scope screen by the hum pickup applied to the terminals (horizontal amplitude control of the 'scope should be at maximum), then the 'scope is okeh and the sweep generator or leads must be faulty. If the dot is not affected, then the 'scope is not operating correctly; Fig. 4.

The third factor which slows down servicing revolves about faulty troubleshooting techniques. Inexperienced Service Men lose considerable time because of this, but even experienced men occasionally get off on the wrong foot. On the basis of experience, TV Service Men generally develop thorough, logical methods for locating trouble. They look at the screen, listen to the sound, check the operation of the controls, and on the basis of the information so obtained decide which section of the receiver is faulty. They then substitute tubes in that section. If that doesn't clear up the trouble, they generally use some method for tracking down the trouble to the defective stage; such as disturbance tests with a screwdriver, signal tracing with a 'scope, or signal injection with a signal generator. Once the defective stage is found, then the bad component is usually located through voltage and resistance tests, although sometimes it is necessary to try parts substitution, if it is suspected that capacitors are open or have changed value, or that parts like transformers have some shorted windings which do not show up under resistance tests.

On some occasions, though, some of the foregoing procedures are unintentionally short-circuited and delays develop. What are some of the faulty techniques that are sometimes used? First, one point must be emphasized: It is *not* improper to eliminate possible causes of the trouble when checking a given circuit. For example, suppose a receiver using a kickback high voltage supply has a blank screen and normal sound. It is decided that there are four possibilities of trouble: a defective

RECORDS SHOW THERE'S NO BOOSTER LIKE... SEC BOOSTER



* Actual records show less than one return for every 1,000 SEC Boosters shipped

The extremely high efficiency of SEC's newly designed tuned circuits eliminates the usual loss of gain on high channels, provides the ultimate gain and picture clarity on both high and low channels. SEC's superior design and rigid inspection by qualified engineers assure you the highest performance.

Available at your favorite distributor; however, if you are in one of the few areas not yet represented, send orders direct.

LIST PRICE
\$34.95
(Usual trade discounts apply)

SPECIFICATIONS

Tube complement:
Single 6J6
Coverage:
Channels 2-13 Incl.
Input: 75-300 ohms
Output: 75-300 ohms
Current:
110-120V 60 cycles
Size: Height, 4 1/4",
Width, 6", Depth, 4"

STANLEY SALES

600 WEST THIRD

NATIONAL DISTRIBUTORS

OWENSBORO, KENTUCKY

picture tube or ion trap, a defect in the high-voltage circuit, a defect in the horizontal sweep system, or incorrect picture-tube socket voltages. Each possibility is then checked. After checking the first two, the trouble might be located in the horizontal circuit. Thus, the process of ruling out possible sources of trouble is a legitimate part of troubleshooting. The fact that the trouble may show up in the circuit that is checked last is very often a matter of chance.

Faulty techniques include: (a) failure to make necessary checks; (b) making unnecessary ones; (c) being misled by the readings which are obtained; (d) making an incorrect repair.

[To Be Concluded in March SERVICE]

Ser-Cuits

(Continued from page 38)

When a weaker signal is received, the opposite effect is obtained. The second sync separator, one-half of a 12AU7, removes all remaining video information from the composite signal. The output of the second sync separator is fed to the deflection chassis through a power connecting cable. A sync inverter, one-half of a 7N7, reserves the polarity of the sync pulses for proper triggering of the sweep oscillators.

The vertical sync pulses are separated from the horizontal pulses in an integrating network and applied to the grid of the vertical blocking oscillator, which uses one-half of a 7N7. The output of the blocking oscillator is amplified by the 6BQ6GT vertical output tube, and is applied to the vertical-deflection coils.

Horizontal sync pulses are applied to the grid of a phase comparer, one-half of a 6SN7GT, through a capacitive voltage divider. Within the lock-in range, the phase relationship of the horizontal sawtooth and the sync pulses at the grid of the phase comparer determines the frequency of the horizontal blocking oscillator. The horizontal blocking oscillator employs one-half of a 6SN7GT. A 6CD6G tube is used as the horizontal amplifier, and a 6V3 as the horizontal damper.

TV Servicing Instruments*

In a discussion of the instruments which should be used to service TV chassis, last month,† it was noted that a 'scope is an important item since it can be used to check for ratio of sync to blanking levels, to determine if the

†Ser-Cuits, SERVICE; January, 1952.



HEAVY WEB TV LEAD-IN WIRE CUTS DOWN COSTLY "CALL-BACKS"

Have you seen the new SYNKOTE 300 ohm TV lead-in? It has a .100 web with a maximum variance of five thousandths of an inch! Tough polyethylene construction that stands up against sun, snow, rain, cold and abrasion.

Ask your jobber to show you this as well as the complete SYNKOTE line of dependable wires . . . used and recommended by leading manufacturers everywhere.

Synkote®

DEPENDABLE

HOOK-UP WIRE • COAXIAL CABLE • TV LEAD-IN WIRE
Plastoid Corporation • Long Island City 1, New York



"manufactured by the mile — tested by the inch"

amplifiers in the receiver are working correctly.

A high resolution instrument is handy because it permits a detailed examination of the composite video waveform. In a normal composite video waveform, there are video frequencies, which range from 60 cps to 4 mc. In addition, there are sync pulses which are essentially square wave in shape; a square wave is composed of an infinite number of higher harmonics of a fundamental frequency. Thus, a normal horizontal sync pulse,

*Based, in part, on copyrighted notes prepared by Philco.

**Philco model 7020.

with a fundamental frequency of 15,750 cps, contains many more harmonics which make up the square-shaped horizontal sync pulse. The vertical-amplifier system in the 'scope must have a frequency response wide enough to amplify a large number of the harmonics of the 15,750 cps pulse without loss. It has been found that, for all practical purposes, a vertical amplifier with a bandpass of 1 mc can do a good job of amplifying the frequencies that make up square waves.

In Fig. 2 (p. 40) appears the circuit of a 'scope** which features high-

(Continued on page 70)

set 'em...
forget 'em!

Fully Automatic
AUTOBOOSTERS

by 

**NO Tuning NO Switching
Necessary**

**COMPLETELY AUTOMATIC
HIGH UNIFORM GAIN
SINGLE OR DUAL INPUT
FULL, 5 MC BANDWIDTH
CLEARER PICTURES
CONCEALED INSTALLATION**



LIST
PRICE
39.95

IT-75A Fully Automatic, All-Channel AUTOBOOSTER—Up to 19 db (9 times) gain • Separate inputs for high and low band antennas or single high-low antenna • May be peaked in the field for maximum performance on any channel • Installed at rear of receiver.



LIST
PRICE
69.95

IT-90A Fully Automatic, All-Channel Cascade AUTOBOOSTER—Up to 30 db (30 times) gain • Extremely low signal-to-noise Cascade input circuit • Ideal for sub-fringe areas, community antenna systems • 2 stage amplification • Separate controls for independent gain adjustment on high and low channels (set by installer) • Automatic on-off • By-pass switch removes unit from line but does not alter impedance • Installed at rear of receiver.

WRITE FOR SPECIFICATION SHEETS.
AUTOBOOSTERS ARE AVAILABLE AT JOBBERS
EVERYWHERE. ORDER
THE ONES YOU
NEED TODAY!

Are you using the

Tenna-Clip

Write for
FREE sample

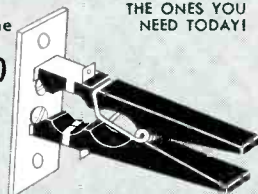

Industrial Television, Inc.

359 LEXINGTON AVENUE CLIFTON, N. J.
GRegory 3-0900

(Continued from page 69)

resolution check facilities. Such tests are available through the following controls.

The *V att* controls the amount of attenuation of the incoming signal; applies the calibration voltage to the vertical amplifier and provides a balance position for the *dc* vertical amplifier by grounding the input grid. *Function* selects the source and polarity of sync voltage (internal negative, internal positive or external), applies 60-cycle sine wave voltage to horizontal amplifier and connects *H* input sync binding post to horizontal amplifiers. *V gain* controls the vertical height of trace.

Calibrate volts is a continuously variable control of 60-cycle sine wave voltage applied to vertical amplifier; its dial is calibrated from 0 to 1 volt peak-to-peak. The *V balance* equalizes the *dc* voltages at the cathodes of the input stage of the vertical amplifier to prevent vertical shift of the trace when the *V gain* control is rotated. *Sync/Line* phase controls the amount of sync voltage, internal or external, applied to the sweep oscillator and controls the phase of the 60-cycle sine wave voltage applied to the horizontal amplifier.

Frequency Control

The *Frequency* control varies the frequency of the sweep oscillator through the frequency ranges indicated by the *range* switch, which permits selection of the desired sweep frequency range, as well as the preset TV sweep frequencies. The preset TV sweeps are intended for viewing the horizontal and vertical deflection waveforms of TV receivers.

V pos controls the vertical position of the trace with a range of at least three times screen diameter. *H pos* controls the horizontal position of the trace. The *beam* control turns on the power to the unit when rotated clockwise from the *off* position; it also controls the intensity of the trace. *Focus* controls the sharpness of the trace.

Vertical Amplifier

V input ac represents the input connector to the vertical amplifier; in series with this connector is a .1-mfd capacitor to block the *dc* component of the signal voltage. *V input dc* is an input connector to the vertical amplifier; for use when it is desired to view *dc* voltages or the *dc* component of alternating voltages. *H input/sync* is an input connector to the horizontal amplifier and as an input connector for external sync voltages.

It's SENSATIONAL!

**CLEARBEAM'S
NEW ALL-CHANNEL
RHOMBIC**

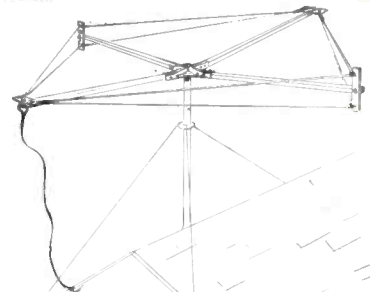

**Electronically Engineered for
LONG DISTANCE
(DX) RECEPTION
and unusually
SHARP DIRECTIVITY
Over the Entire TV Spectrum**

Clear Beam

TV ANTENNAS & ACCESSORIES
100 Prospect Ave., Burbank, Calif.
ROckwell 9-2141 • CHarleston 0-4886

South River
★★ NEWS ★★

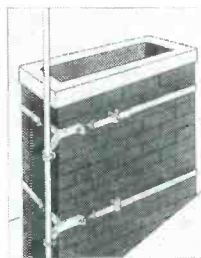

**DUO-
MOUNT
ANTENNA
BASE
Model
DM-36**

(U.S. Patent
2482575)

A low-priced, two-piece mount of alloy steel with rivet construction... hot-dip, galvanized. Specially designed "U" bolts will accommodate masts from 3/8 to 1 1/2" O.D. With hardware. (Available with or without "Kwik Klip" feature.)

South River Antenna Mounting Accessories are carried by every leading TV Parts Jobber from coast to coast.

New catalog mailed to all Dealers and Service Men. Write, if you haven't received yours!

**SOUTH RIVER METAL
PRODUCTS CO., INC.**
SOUTH RIVER, N. J.

PIONEER AND OUTSTANDING PRODUCER
OF FINEST LINE OF ANTENNA MOUNTS

Audio

(Continued from page 35)

adjustment should be made: A reel of 7000 cycle or 7500 cycle head alignment tape should be placed on the recorder in position for playback. The output receptacle should be connected to a vacuum-tube voltmeter and the output selector switch turned to position 2. The head should then be teetered or rocked back and forth over the *dimple* on the *head mounting bar* by alternately loosening and tightening head alignment screws with two No. 1 Phillips head screw drivers to secure a maximum reading on the voltmeter. The heads are properly aligned when the output is greatest.

If the special alignment tape is not available, a satisfactory alignment can usually be made by using a previously recorded musical recording.

It is seldom that both heads of a recorder need alignment. It is also safe to assume that the head with good output is properly aligned. Thus, it is only necessary to record a musical selection on the good head, turn the reels over and play it back on the poor head. The poor head should be aligned for best volume and frequency response as explained previously. Low output is caused by improper head alignment more often than by a defective head. The alignment must always be checked before replacing a head.

Magnetic Recording Principles*

In last month's analysis of magnetization of the recording material, it was said that at small recording currents, there appears a distorted magnetic pattern after the material leaves the recording pole-pieces. To guard

(Continued on page 72)

*Based on copyrighted data appearing in the Brush service manual on the Soundmirror.

Turnover pickup cartridge with two complete cartridge assemblies, mounted back to back, on a common plate. Design is said to feature a unique switching device in the turnover mechanism. As the turnover knob is operated, the cartridge or side which had been in playing position automatically disconnects and the side to be used makes connection with the amplifier phono output. Output is .8 volt at 1 kc, on the Audiotone 78-1 test record and .7 volt on the RCA 12-5-31-V. The frequency range is 30 to 11,000 cycles. Cartridge is furnished with turnover bracket and knob assembly, with standard 1/2-inch mounting holes. The wiring terminates in pin connectors which are graduated for the two dimensions now standard on lead wire connectors. It installs without soldering. The needles used are type Q (3 mil) and type Q-33 (1 mil) sapphire tipped. (Twin CAC; Astatic.)

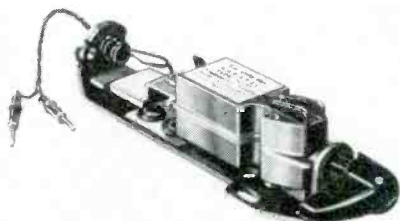

For Direct Drive Circuits...

New STANCOR

TELEVISION REPLACEMENT COMPONENTS



DY-10

ANTI-ASTIGMATIC DEFLECTION YOKE
A high efficiency yoke with cosine distributed windings, ferrite core and nylon bobbins. Replacement in 34 RCA TV models, 30 Emerson models and 7 Capehart models.

A-8131 AIR CORE "FLYBACK"

Companion unit to DY-10 in direct drive circuits and used in same models. See Stancor Bulletin No. 389 for a complete list of these 71 models.

A-8140 VERTICAL OUTPUT TRANSFORMER

Has primary:secondary ratio of 44:1. Replaces RCA No. 74950 in 35 TV models, Emerson No. 738044 in 30 models and Capehart No. 650238A-1 in 7 models. These models are listed in Stancor Bulletin No. 390. Ask your distributor for a free copy.

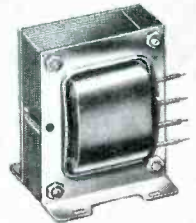

Stancor transformers are listed in Howard Sams' Photofacts Folders

STANDARD TRANSFORMER CORPORATION

3588 ELSTON AVENUE • CHICAGO 18, ILLINOIS

Cartridge with a *hair-line* stylus suspension. Has one single magnetic unit and one point-pressure for all discs, near infinite compliance and near-zero mass, replaceable sapphire (or diamond). (Audax Chromatic Polyphase; Audak Company, 500 Fifth Avenue, New York 36, New York.)



Record brush, which is said to use combination of the best bristles obtainable for the specific purpose of cleaning phono records. Mystik self-stik cloth tape is used to attach brush to tone arm. It is claimed to add practically no weight at all to the tone arm, any degree of which is compensated for in the hinge action of brush holder. (Fidelitone Record Brush; Permo, Inc., 6415 Ravenswood; Chicago, Ill.)

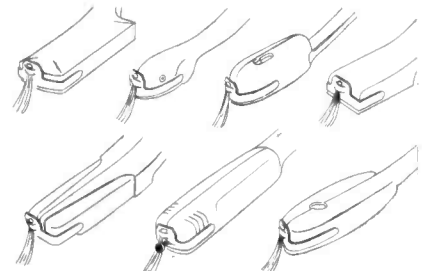



● THAT CAN'T BE DUPLICATED

Workshop Associates' pioneering leadership individualizes all products to a superlative degree that defies duplication. Laboratory-tested engineering confirmed by field technicians everywhere. Like fingerprints, you can always tell the difference.

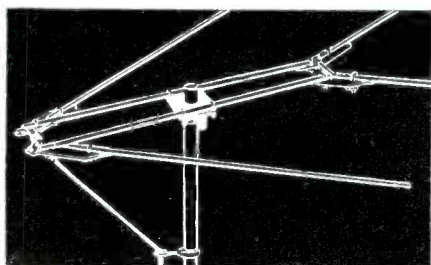

the WORKSHOP DUBL·V·EE TV ANTENNA

Developed and Patented by Workshop

Widely imitated . . . never equalled . . . preferred everywhere. Rugged, durable, extra strength to withstand the toughest weather conditions . . . assures clearer pictures . . . higher gain . . . high signal strength . . . no ghosts. Write for catalog.

Specialists in High Frequency Electronics



THE WORKSHOP ASSOCIATES

Division of the Gobriel Co.
135 Crescent Road
Needham Heights 94, Mass.

(Continued from page 71)

against this occurrence, there is superimposed upon the current in the coil corresponding to the signal, a second current of relatively high amplitude, but of such a high frequency that it cannot be heard in the reproducing process. This *hf* current is known as *bias current*.

By the use of this bias current superimposed on the signal current, any intensity of recording signal, from the very lowest to complete saturation, will leave a corresponding degree of magnetization in the magnetic material, and this magnetization will be as permanent as the material itself until the material is again subjected to some form of magnetic process.

Erasing . . . Magnetic erasing can be defined as the process of removing from a magnetic medium any net orientation in its magnetic state.

There are two basically different methods of erasing a magnetic recording; one method utilizes a powerful *dc* field, such as that produced by a permanent magnet. As the recording medium passes this magnet, the field magnetizes the material to saturation, leaving the magnetic state of the material oriented in such a manner as to completely wipe out the modulations which had represented the recorded signal.

This method, however, does not leave the magnetic recording medium in the best state for a subsequent noise-free recording when *ac* bias is employed. Therefore, a second method of erasing is used almost exclusively. In this instance, an *ac* magnetic field is used for erasing. As the magnetically-recorded material approaches the alternating field-type erase head, each incremental section of material is magnetized first

Fifteen-inch speaker which is said to have a range of 40 to 13,000 cycles. Has a slotted treated cone edge, and a flexible spider which is claimed to provide soft suspension and increase low-frequency response. The cone is curvilinear with a stiffening treatment at the throat of the cone which is said to result in an increased response at the upper end of the scale. (Model 15WP-8-1; Permoflux Corp., 4900 W. Grand Ave., Chicago 39, Ill.)



MONEY-SAVING TIPS ON BUYING SCREWDRIVERS & NUT DRIVERS

If your work calls for several different sizes of nut drivers, and Phillips and regular screwdrivers, buy detachable - handle MULTIPLE SETS, rather than individual tools. The "99" set, for instance, is 13 tools for only \$10.95. . . . The CK-3 set gives you 6 screwdrivers and a 7/16" nut retainer handle for only \$4.35!

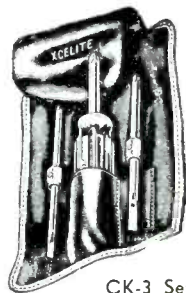

CK-3 Set

XCELITE INCORPORATED

Formerly Park Metalware Co., Inc.

Dept. V,
Orchard Park, N. Y.



Ask for the SMITH Roof Mount

FOR TV MASTS
Made of Sturdy
Cast Aluminum

Pat App. For

JUST WHAT TELEVISION INSTALLERS
HAVE BEEN LOOKING FOR.

- 1—ALL ALUMINUM CASTINGS WITH PLATED STEEL BOLTS.
- 2—TESTED TO WITHSTAND ANY NORMAL LOAD UP TO 1500 LBS.
- 3—WILL TAKE TUBING O D 3/4" TO 2".
- 4—THE ORIGINAL SADDLE MOUNT FOR ROOF RIDGE.
- 5—CAN BE USED ANY PLACE ON ROOF.
- 6—IDEAL MOUNT FOR TALL MAST.
- 7—HOLDS BASE OF PIPE AT FIXED POSITION FOR RAISING OR LOWERING.

Thousands in use. Ask your Jobber—or write for Circular

SMITH ELECTRIC MFG. CO.
Ashland, Ohio

SELL Jensen PHONO NEEDLES For Any Type Record Player

Please send me FREE Jenselector. Picks the proper replacement needle.

Name _____

Address _____

City _____ State _____

Jensen Industries, Inc., 331 S. Wood St., Chicago 12

**BE SAFE...
BE SURE...**

INSTALL **VEE-D-X**
LIGHTNING ARRESTERS



VEE-D-X lightning arresters provide your customers with the finest, safest arresters ever made for TV and FM—including both two and four wire installations.



\$1.25
LIST

MODEL RW-200

Most popular full size arrester for standard 2-wire transmission line. Exclusive saw-tooth contact points assure positive electrical connection.

MODEL RW-204 \$1.50 LIST

For four-wire transmission. Same in appearance as the RW-200.



\$2.00
LIST

MODEL RW-300

For Extra Heavy Duty

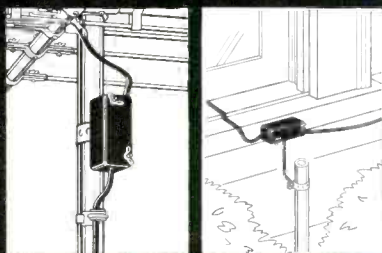

All models available with strap for mast or pipe mounting as well as standard models for wall or window ledge mounting. No wire stripping required on any VEE-D-X arrester.

THE LaPOINTE-PLASCOMOLD CORP.
Windsor Locks, Conn.

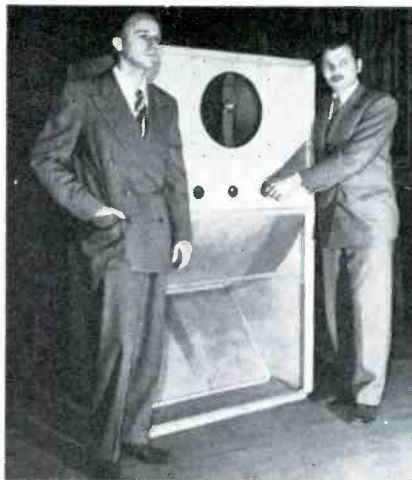

Backloading folded horn with triaxial speaker, a 30-cubic foot enclosure, developed by D. J. Plach, physicist and P. B. Williams, senior engineer of Jensen. Compactly arranged in a cabinet 5' x 3' x 2', horn design is said to reduce loudspeaker resonant frequency by almost one octave, increase efficiency 4 to 6 db over the entire piston range, improve transient performance and allow doubling the loudspeaker power rating for a given amount of distortion. (Blueprints and building instructions available from Jensen Manufacturing Co., 6601 South Laramie Ave., Chicago 37, Ill.)

one way and then the other, as the direction of field reverses, and when the material is in the center of such an erasing head, these magnetic cycles are of sufficient magnitude to saturate the material, which effectively erases the previously recorded signal. As the material leaves the erasing head, it is still subjected to the reversing field directions, but each succeeding cycle is weaker than the last, due to the in-

(Continued on page 74)

Wide dispersion 12-inch cone speaker with a dual concentric apex horn, which is said to extend the high-frequency response to over 13,000 cps, and disperse normally beam-like frequencies uniformly throughout the listening area. The *diffuser* element used is claimed to provide dual horn loading of the speaker apex. Other unique features include 1½ pound shaped Alnico V magnet and 30-watt power rating, 2" voice coil wound on a duraluminum suspension which is said to dissipate heat through a filtered air pressure-operated chamber located within the magnet structure. Has *bi-sectional* construction which enables replacement of either the entire basket/diaphragm assembly or the magnet mechanism in the field with a screw driver. (*Diffusicone 12; University Loudspeakers, Inc., 60 South Kensico Ave., White Plains, N. Y.*)



**It's NEW... It's a
MONEY MAKER**
for
Every Serviceman!

**2 Service
Instruments**

for the
price of



**TRANSVISION CR TUBE
TESTER-REACTIVATOR**

performs 2 vital functions:

- Tests Picture Tubes
- Renews Brightness of Many Dim Picture Tubes

It's a **TESTER:**

Without removing picture tube from set, you apply this precise instrument to:—

- Measure Cathode emission
- Locate shorts between elements
- Locate high resistance shorts or leakage as high as 3 megohms

It's a **REACTIVATOR**

for dim CR Picture Tubes

Revives dim TV Picture Tubes, without removal of tubes from sets. Works on a great many tubes with low light output, if there's no mechanical defect in tube. 110 V-60 cycles. Portable, weighs only 3 lbs. One or two applications pays for instrument.

**SATISFACTION
GUARANTEED**

or money refunded if you return the instrument in 10 days in good condition.

\$19.95
NET

**RUSH THIS COUPON
TRANSVISION, INC.**

DEPT. S NEW ROCHELLE, N. Y.

- () Send me CR Tube Tester-Reactuator(s).
- () Enclosed find \$... deposit. Balance C.O.D.
- () Enclosed find \$... in full. Send prepaid.

Name

Address

City State

EICO

gives you Laboratory Precision at
Lowest Cost!

NEW **EICO**
Instruments and **KITS**

... with a complete line

Over 50,000 servicemen have bought one or more EICO Kits and Instruments. That's the proof of EICO's leadership in value to the serviceman!

For latest precision engineering, finest components, smart professional appearance, lifetime performance and rock-bottom economy—see and compare the EICO line at your jobber's today before you buy any higher-priced equipment! You'll agree, with over 50,000 others, that only EICO Kits and Instruments—no other—give you the industry's greatest values for the industry's lowest costs!

Read the full story on the complete EICO line. Write today for your free latest Catalog S-2.



221K VTVM Kit
Wired \$49.95 \$25.95

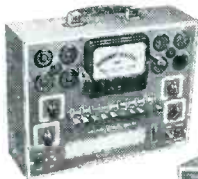

625K Tube Tester
Kit \$34.95
Wired \$49.95

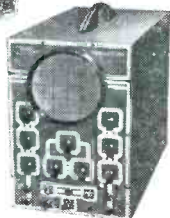

425K 5" Scope Kit
Wired \$79.95 \$44.95



520K Sig. Gen. Kit
Wired \$29.95 \$19.95

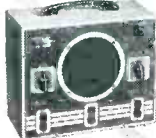

145K Sig. Tracer
Kit \$19.95
Wired \$28.95



516K Deluxe Sig.
Gen. Kit \$39.95
Wired \$39.95



HV Probe \$6.95



1640K Battery Elim.
Kit \$25.95
Wired \$34.95



511K VOM Kit
\$14.95
Wired \$17.95

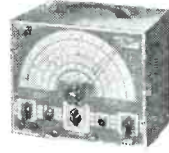

360K Sweep Gen. Kit
\$34.95
Wired \$49.95
C-5 5mc Crystal \$3.95



RF Probe Kit \$3.75
Wired \$5.95

ELECTRONIC INSTRUMENT CO., Inc.
84 WITHERS STREET, BROOKLYN 11, N. Y.

© 1952, Electronic Instrument Co., Inc.

Due to unsettled conditions, prices and specifications are subject to change without notice. Prices 5% higher on West Coast

VIS-U-ALL TUBE and TOOL CASE

© TRADE MARK REGISTERED

Holds 107 Tubes
and All Tools for
TV Home Service

EVERYTHING
IN FULL VIEW
WHEN CASE OPEN

No hidden tubes. Easy to find the tubes you want, when you want them. Saves time. Holds tubes snugly and protects them against breakage. Tool compartment, 15½ by 3 by 2½ inches in size; accommodates all tools ordinarily needed for home service calls. Case is made of strong plywood with durable leatherette covering. Sturdy clasp fasteners and convenient luggage-type handle. Handiest case you ever saw, and a real boon to busy service men. Order yours now! If not satisfied, return within ten days and your money will be refunded.

Only 16 x 13½ x 7½ in.,
closed. Weighs only 7½
lbs. (21 lbs. when full)

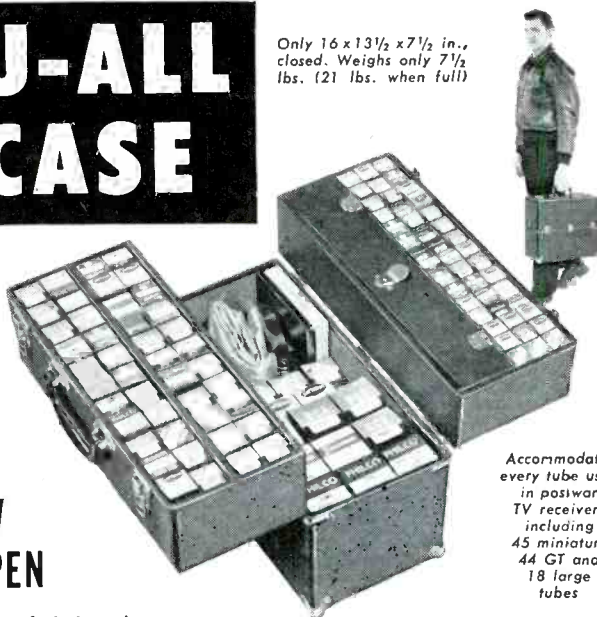

Accommodates every tube used in postwar TV receivers including 45 miniature 44 GT and 18 large tubes

NET PRICE

\$14.95

Case Only

Send check or money order. We will ship day order is received.

(Continued from page 73)

creasing distance between a given section of material and the erase head. The final result is such that the recording medium is left completely demagnetized, ready for a new recording.

Playback . . . The playback process is simple: Any degree of net orientation of magnetic particles of a given section of recording medium will produce a net external magnetic field. If a conductor is moved across such a field a voltage will be established in the conductor; a basic dynamo theory. In magnetic recording, these net fields are very weak and therefore special efforts have to be made to produce from these fields as much voltage as is possible; practically speaking, these efforts result in a pickup structure which may be identical to a recording structure. Instead of having a single turn of wire close to the magnetic medium, a set of pole-pieces are in contact with the medium and any difference in the field from one section of medium to another sets up a magnetic field across these pole-pieces. Many turns of extremely fine wire are wound on these pole-pieces, and as the magnetized medium moves by the pole-pieces, the magnetic force exerted thread through the pole-pieces and induce a voltage in the many turns of fine wire. This voltage is then fed to an amplifier.

Equalization . . . It might be expected, that in such a complicated series of processes, the frequency response of such an overall system would not be exactly the same to a high-frequency audio signal as it would be to a low-frequency audio signal. Such is the case, unfortunately, and since a recorder should do equal justice to any frequency to be recorded, the amplifiers associated with the magnetic recorder must have characteristics which are the inverse of those of the recording medium, thus producing a net overall effect which is reasonably independent of frequency.

Preamp equalizers for variable reluctance and moving coil pickups which are claimed to feature equalization down to 30 cycles; independently adjustable turnover and roll-off controls which provide 24 frequency characteristics; turnover adjustable to 1p, 300, 500 and 800 cycles; roll-off adjustable to 0 (flat response), 4, 8, 12 (AES) and 16 (NAB), and 20 db drop at 10,000 cycles; and 40 db maximum gain at 2000 cycles (input voltage multiplied 100 times). Uses a three-stage triode amplifier with 12AY7 low-hum, non-microphonic dual-triode for initial stages; 6C4 for output stage. (Model A100 and A100P; Brociner Electronics Laboratory, 1546 Second Ave., N. Y. 28.)



TELEVISION ENGINEERS, INC.

1539 W. Harrison Street • Chicago 7 Illinois

© Copyright, January 1, 1952

Solderless Cable Fittings



By Workshop

Whenever you need a cable fitting for RG-8 U, RG-11 U and RG-59 U, specify **WORKSHOP** . . . Solderless silver plated connectors, receptacles, junctions and adaptors. Look for the complete line at your distributor's on the red and white display card.



THE WORKSHOP ASSOCIATES

Division of the Gabriel Co.
135 Crescent Road
Needham Heights 94, Mass.

Speaker Replacement Parts

SEND TODAY for your FREE COPY of LEOTONE'S "SPEAKER REPLACEMENT PARTS MANUAL"—A handy reference to the **NATIONALLY-FAMOUS** line of LEOTONE Precision-Made REPLACEMENT CONES, VOICE COILS AND SPIDERS.

SAVE \$\$\$. . . SAVE TIME—START REPAIRING YOUR OWN SPEAKERS WITH EITHER OF THESE 2 GREAT PROFESSIONAL "SERVICEMEN'S REPAIR KITS":



KIT "A" . . . UNIVERSAL REPAIR KIT . . . for all speakers from 4" to 12". Contains a liberal assortment of the most popular: Cones, Wound Voice Coils, Spiders, Mtg. Rings, Dust Caps, Shim Kit, Chamois, Leather, Felt Strip, Cement & Thinner and Instructions. Everything that's needed for a trouble-free repair job . . . ONLY \$9.95

KIT "B" . . . SMALL SPEAKER REPAIR KIT . . . designed for 4", 5" and 6" speakers specifically. Otherwise, same as Kit "A" . . . \$9.95

SPEED-SKILL-QUALITY . . . describes LEOTONE'S "FACTORY SPEAKER REPAIR SERVICE"—25 YEARS OF "KNOW-HOW" assures Expert, Trouble-free repairs on every type of speaker. **SPECIALISTS ON QUALITY HIGH-FIDELITY, CO-AXIAL & AUDITORIUM SPEAKERS.** Prompt handling and return of every job is a "MUST" with us.

UNIVERSAL REPLACEMENT CONES . . . fit most popular speakers. Less voice coils.

4" x 3" oval	9/16" V.C.	12/1.00	100/\$7.50
4" O.D.	9/16" V.C.	15/1.00	100/ 5.95
4 1/2" O.D.	9/16" V.C.	12/1.00	100/ 7.50
5 1/2" O.D.	9/16" V.C.	20/1.00	100/ 3.95
6" O.D.	3/4" V.C.	12/1.00	100/ 7.50
7" O.D.	1" V.C.	10/1.00	100/ 8.75

KITS OF 12 ASSORTED CONES—less voice coils—4" O.D. \$9.98; 5" O.D. \$1.25; 6" O.D. \$1.49
4" to 12" **CONE ASSORTMENT**—Incl. free-edge. Kit of 12 asstd. popular types. Less V.C. 1.98

SPEAKER CEMENT & THINNER—3 oz. bottle of each with applicator brush. .89

SPIDER ASSORTMENT—Kit of 12 assorted. 1.98

CARDBOARD MOUNTING RINGS—Kit of 50 asstd. 1.49

Min. Order \$3.00. Please add sufficient postage. 25% deposit required on all orders. "A Better Cone — Buy Leotone"

LEOTONE RADIO CORP.
65 DEY ST., NEW YORK 5, N. Y.

Tube News

(Continued from page 47)

and 21FP4-A, 21-inch. All are glass rectangular types, with the 17-inch and 21-inch tubes having cylindrical faces.

In another lineup, a 17-inch, all-glass rectangular picture tube (17-HP4**) utilizing low-voltage electrostatic focus has appeared, a feature which makes it possible to obtain the voltage for the focusing electrode from the low-voltage *dc* supply of the receiver. The required focusing-electrode voltage is 0 to 2.5 per cent of the *ultr* voltage.¹

The focusing electrode in the 17HP4 has its own base-pin terminal, so that designers have a choice of focusing voltage for best results.

Horizontal-Deflection-Output/HV Transformer

To provide a no-load output voltage of 18 kv for 20-inch and 21-inch picture tubes, such as the 20CP4 and 21AP4, having a horizontal deflection angle of 66°, there has been developed a ferrite core horizontal-deflection-output *hv* transformer.² It has been designed for use with a single 6CD6G horizontal-deflection amplifier; a single high-voltage rectifier tube such as the 1B3GT, and a deflecting yoke.³

A *dc* power supply of 290 volts can be used with the transformer.

**RCA. ¹Tube News, SERVICE; November, 1951.

²RCA 230T1. ³RCA 211D1.



Above: B. O. eliminator, used to eliminate Barkhausen oscillation or vertical black bars from the picture, ion trap, and BeamaJuster for centering pictures in conventional picture tubes. Below: Kine-center for centering pictures in electrostatic tubes.

(Courtesy Perfection Electric)



PHOTOFACT Users Write Our Best ADS!

Hundreds of unsolicited letters tell what the world's finest Radio & TV Data means to Service Technicians



James Goodwin
315 Mt. Eden Ave.
Bronx, N. Y.

"We want to tell you how wonderful and simple it is to repair receivers with PHOTOFACT Folders. Their usefulness and efficiency are especially brought out in TV work, where the mechanism is very complicated, and you must have complete and accurate information and pictures."



George W. Scott
Greenfield, Mo.

"I am a regular subscriber to PHOTOFACTS and think they are the best equipment a serviceman can own. Couldn't do without them."



Francis H. Curry
1018 W. Locust St.
Milwaukee, Wis.

"You're really doing a fine job to help the radio and television serviceman. PHOTOFACTS and the PF Index and Technical Digest can't be beat."

NOW! GET THE PROOF FOR YOURSELF!

FREE

We'll send you a Free Photofact Folder on any receiver listed in "PF Index & Technical Digest."

Learn for yourself—at our expense—how PHOTOFACT pays for itself by earning bigger repair profits for you! Select any Folder from the PF Index (if you haven't an Index, get a free copy from your distributor). When you write us for your Free Folder, be sure to state Photofact Set and Folder Number as shown in the Index. Get your Free Folder now. Examine, use, compare—see why you can't afford to be without PHOTOFACT!

HOWARD W. SAMS & CO., INC.
2201 East 46th Street • Indianapolis 5, Indiana

NEW GRAYBURNE TUBE & TOOL CARRIER

Business Aids

(Continued from page 52)

All parts and material should be listed at the manufacturer's list price. It is desirable to itemize all material used and charged for on the customer's bill. The bill or work sheet should also carry your guarantee for the parts listed and services.

A public accountant or CPA should be consulted to set up your books. You might also need the accountant's help at the end of the year to balance out your books and inventory, and to make out the necessary tax forms. Your local bank will also be happy to help. Simplified bookkeeping systems are available from cash-register companies and any stationery store can supply you with the necessary ledgers.

Sincerely,
DON KAY

HOT

with Detachable Mirror
for Observing Pix Tube

**EXCLUSIVE
TOOL COMPARTMENT**
holds tester and tools
needed on most calls

BUILT RUGGED
all solid wood and heavy
masonite, lock-corner
construction, extra top
side clasps.

**HOLDS
175-200 TUBES**
in 2 drawers and
1 compartment

HANDSOME
Washable thick basket-
weave black-and-grey
leatherette. Resists
oil and dirt stains.

**REMOVABLE
LARGE MIRROR**
to observe Pix Tube
from back of set

COMPACT
20 1/2" x 14" x 9"

Model CP
LOW COST
\$16.95 net.

**PERFECT
BALANCE**
Hangs straight
down.



You made it the Champ!

We interviewed hundreds of Servicemen like yourself to tell us the features you want in a professional carrier. Model CP embodies all your practical suggestions. That's why Servicemen say it's today's truly unbeatable carrier value!

Other Grayburne Tube Carriers available:

Model CL: for the "long haul". Holds 200-225 tubes. \$13.50 net.

Model CJ: for the "short haul". Holds 60-70 tubes. \$9.95 net.

SERVICEMEN: For name of your nearest Grayburne distributor, write to us NOW!

GRAYBURNE
Grayburne means Quality Electronic Components

GRAYBURNE CORPORATION, 103 Lafayette St., New York 13, N. Y.

TV Controls

(Continued from page 37)

wound control with switch; concentric control using 3-watt wire-wound controls; concentric control using 3-watt wire-wound controls with switch; concentric control using a carbon control and a 4-watt wire wound; concentric control using a carbon control, and a 4-watt wire-wound with switch; concentric control using a 4-watt wire-wound control; concentric control using a 4-watt wire wound with switch; 2-watt center-tapped wire-wound controls; 3-watt center-tapped wire-wound controls; 4-watt center-tapped wire wound; 2-watt single wire-wound controls; 3-watt single wire-wound controls; 4-watt single wire-wound controls; 25-watt single wire-wound controls; and concentric dual controls using carbon controls and a special designed push-pull switch.

There are standard combinations of controls that are known as *universal* types, so-named because they are used so often in various models and makes of TV receivers. Complete listings of these combinations include one-hundred-five types. In addition, there are some two-hundred sixty-one special controls which include such combinations previously cited.

The question of how much stock the Service Man should carry depends entirely upon the amount of business he does and the particular makes of receivers in his vicinity. The frequency of use of the various controls, the use by receiver manufacturer, etc., all disclose what the Service Man should expect in the way of calls for replacement of controls.

The exact replacement idea has been found to be a profitable assist during

GOLDEN WAND INDOOR Television ANTENNA

You get no call-backs when you sell GOLDEN WAND Indoor Television Antennas because all flexible connections are completely enclosed to prevent breakage and connections at telescopic joints are positive and permanent.

Sell GOLDEN WAND and end costly call-backs. Sell GOLDEN WAND and make more money.

PEERLESS PRODUCTS INDUSTRIES
818 N. Pulaski Rd., Chicago 51, Ill.

STOPS COSTLY CALL-BACKS

\$6.95
LIST

Buy them
from your
Wholesaler



2 Models
to suit all
tastes
Model 50TV
Model TG84
(shown)

Speakers
Need
Repairing?

Recone with a WALDOM CONE

Speakers are hard
to obtain. Recone with
Waldom cones.

Send for your FREE WALDOM
Replacement Cone Manual Catalog!

FREE, 24-page manual is yours with-
out obligation. Data on over
750 TV, FM, AM speak-
ers. WRITE TODAY!

• WALDOM CONES

... maximum efficiency,
R.M.A. warranty, true low frequency
response, unconditionally guaranteed.

WALDOM ELECTRONICS, INC. 911 N. Larrabee St., Chicago 10, Ill.

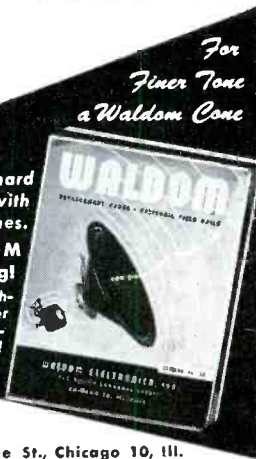

PLYMOUTH *Quality* Antenna Mounts

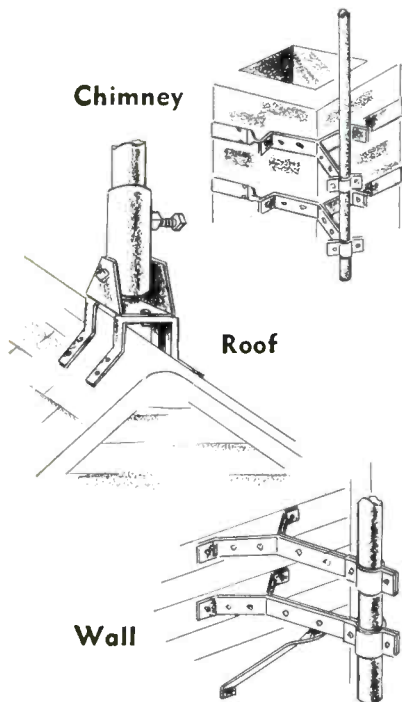

Individually packaged, complete with hardware, ready for installation. Send today for free catalog showing entire line and price list. More than 15 styles in stock.

PLYMOUTH 
electronic corp.
50 KINGSBURY STREET
WORCESTER 10, MASS.

Right and below: Switches available for replacement controls. Types shown are the *SFA* and *SWB*.

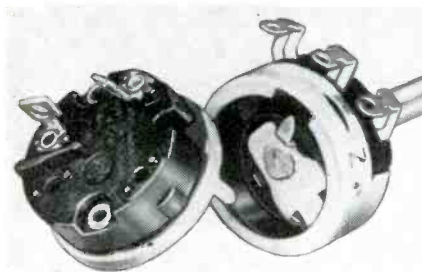

Variety of shaft styles developed for replacement controls.

service calls. This is particularly true in home servicing, during which an exact replacement can be made on the spot.

Shaft Insertion

In some instances, it may become necessary to add in the field, a switch or particular shaft. This is a relatively simple task. The various shafts are merely inserted in the shaft hole, and tapped, thereby seating and locking. The design of these assemblies is such that there is no appreciable wiggle to the shaft when operated. Field switch assembly is accomplished by merely prying the back of the control off, inserting the switch unit, and bending the bonding ears over. Relatively few different types of switch are required today. In late model RCA receivers it is necessary to use a push-pull type of switch that has been made available through the exact replacement program.

Exact-replacement controls offer the Service Man an effective means of solving a replacement problem.

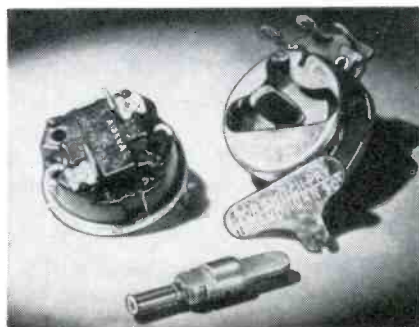

TYPE C BLONDE OR MAHOGANY FINISH—FOR 8", 12" OR 15" SPEAKERS
TYPE M BLONDE OR CORDOVAN MAHOGANY—FOR 15" SPEAKERS



acoustically-correct
handsomely styled
durably constructed

BASS REFLEX CABINETS by

Jensen

JENSEN MANUFACTURING COMPANY
DIVISION OF THE MUTER COMPANY
6601 S. LARAMIE AVENUE • CHICAGO 38, ILLINOIS

WRITE FOR
DATA SHEET 162

TYPE D WALNUT—FOR 12" OR 15" SPEAKERS



TYPE B BROWN LAQUER FINISH—FOR 12" SPEAKERS
TYPE H BROWN LAQUER FINISH FOR 8" SPEAKERS



TYPE J WALNUT FOOT MOUNTING—BROWN LAQUER FINISH—FOR 6" OR 8" SPEAKERS



(PERIODYNAMIC TOTAL ENCLOSURE)

JOE B. HIGGINBOTHAM, JR.

Nuberg, Ga.

**THANKS,
Mr. Higginbotham!**

Radio Receptor Co., Inc.
West 19th Street
New York 11, N.Y.

Gentlemen:

Please send me your pamphlet on the design, application and servicing of selenium rectifiers.

Although I have serviced many receivers which have selenium rectifiers I have very little information on them and believe your pamphlet would be a valuable asset to my shop.

I use your rectifiers, supplied by Southeastern Radio Parts Co. and Specialty Distributing Co. of Atlanta, Ga., and like them very much. Also I appreciate your consideration of the radio repairmen in that you supply a data sheet with each rectifier and the trouble taken to print the servicing information.

Yours Truly

Joe B. Higginbotham Jr.
Joe B. Higginbotham Jr.



SELETRON RECTIFIERS

... And our thanks go as well to the other thousands of servicemen and hams who insist upon top performing SELETRON Selenium Rectifiers in electronic circuits and as replacements in Radio and TV sets.

You can depend on SELETRON all ways... Full technical information is always available without obligation. Look for Howard W. Sam's Red Book Supplement listing SELETRON replacements, and write us for Bulletin No. 04-S-1

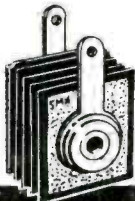

SELETRON DIVISION
RADIO RECEPTOR COMPANY, INC.
Since 1922 in Radio and Electronics
Factory: 84 North 9th St., Brooklyn 11, N. Y. • Sales Department: 251 West 19th St., New York 11, N. Y.

DATES TO REMEMBER

MAY 19-22

Radio Parts—Electronic Equipment Show

MAY 23-24

AUDIO FAIR

Both at CONRAD HILTON HOTEL, CHICAGO

**MAKE YOUR SPACE RESERVATION PROMPTLY
for the doubly-important**

MAY SHOW ISSUE of SERVICE

WHEN YOU CHANGE YOUR ADDRESS

Be sure to notify the Subscription Department of SERVICE at 52 Vanderbilt Avenue, New York 17, N. Y., giving the old as well as the new address, and do this at least four weeks in advance. The Post Office Department does not forward magazines unless you pay additional postage, and we cannot duplicate copies mailed to the old address. We ask your cooperation.

AGC Systems

(Continued from page 23)

ing. For an example, if 3 volts of fixed bias were applied in series with the signal, only 2 volts of signal would be required, or on the other hand the screen voltage could be dropped enough to reduce the cutoff.

The latter of these two methods provides more gain and makes a negative source of voltage unnecessary. The screen divider is made relatively stiff to maintain the operating conditions with changes in picture content.

In Fig. 3 a plot of noise pulse, which at *A* and *B* is very large in comparison with the signal at the input to the video amplifier, but is clipped due to the plate current cutoff. Therefore, in the output it extends only slightly above the signal. The amount that the noise pulse extends beyond the signal must always be kept at a lower level than the voltage required to cut off the *agc* tube, so that its amplitude can be made small and relatively fixed. On the other hand, the amplitude of the video signal is the product of the video detector output and the gain in the video amplifiers, so that if the gain is made high enough, the amount that the noise extends

above the signal may be made small as compared with the amplitude of the video signal, resulting in improved performance of the sync clipper stage in the presence of impulse noise. Since a relatively low-frequency response is all that is required to reproduce the sync signals, the video-amplifier plate load may be made very high for the *agc* tube, thus providing high gain and effective clipping of the noise in the stage. The additional load resistor used to obtain the high gain being fed to the *agc* stage, in some cases, may have a small capacitance across it, so that it will offer little impedance to the higher frequencies preserving as much of the high-frequency response as possible. The calculation of the capacitor may very effectively be accomplished by removing all peaking components, shorting the resistor and marking the response of the circuit on the face of a 'scope. Then *R* should be unshorted and a mica trimmer placed across it. The trimmer should be set for the lowest capacitance possible that still provides essentially the same response curve as that already drawn on the face of the 'scope. The trimmer may then be measured for its capacitance at that setting and replaced with a fixed capacitor of the same value and the stage compensated in the normal

manner. A resistor, which is of the 33,000-ohm value, in this case, is placed in series with the grid of the *agc* tube to reduce the effect of its capacitance loading on the response of the stage. To reduce the effect of this resistor on the peaking of the circuit, another 33,000-ohm unit is connected, as shown in Fig. 4.

As may be seen in Fig. 3 the curvature of the first video stage $E_p I_p$ characteristic compresses the sync, so that the ratio of sync to video signal is less at the output of the video stage than it is at the input. One might think that this compressing effect would make the design of the sync clipper more difficult. Actually, the problem is simplified in a couple of ways. In the first case, the noise clipping is so good in a properly designed system that the engineers would not be faced with the problem of trying to use every last bit of the sync, while attempting to minimize the effects of noise. In addition, the system acts as a clamp circuit to maintain the sync-signal tips always at the same level. In doing so it removes much of the effect of hum or any other instability from the received signals making it possible to use a greater percentage of the available sync.

[To Be Concluded in March, SERVICE]

Kenco Mounts

...are engineered
for the JOB!

KENWOOD ENGINEERING CO., Inc.
265 Colfax Avenue
Kenilworth, N. J.



**KENCO
EAVE
MOUNTS**

Easily mounted on hanging rafters or trim boards of eave. Eliminates need for drilling into brick or masonry walls. Ideal for buildings with extended roofs. Hot dip galvanized.

Available in 3 sizes:

- Model # 135 22" Eave Mount
- Model # 136 28" Eave Mount
- Model # 137 48" Eave Mount

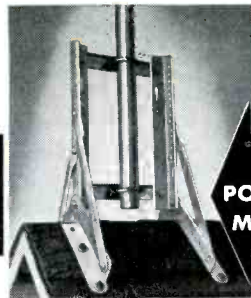

**ALL
POSITION
MOUNTS**

A strong, self supporting mount for peak, slope, side wall, corner or flat mountings. Positive locking braces eliminate need for guy wires in many installations. No blocking or shimming necessary.

- Model # 105 . . . For masts up to 1 1/2".
- Model # 101 . . . For masts up to 2".

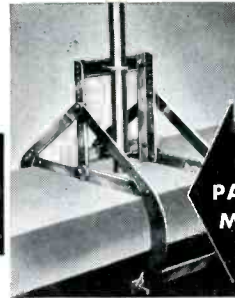

**NEW
PARAPET
MOUNT**

The KENCO Parapet Mount gives positive anchorage to apartment house walls without damage to building. Powerful clamping action insures safe installations. Shipped assembled. Quickly installed. Hot dip galvanized.

- Model # 106
- For walls up to 1 3/4" thick.

FM Chassis Servicing

(Continued from page 44)

sweep of the 'scope must be turned off; however the horizontal amplifier should still be used. The .001-mfd capacitor shown across the vertical input terminals of the 'scope will help reduce the pickup of any extraneous noises and will also prevent swamping by the marker.

In all cases the output from the generator or generators should be kept

as low as possible. The vertical gain of the 'scope should be set near maximum. When the pattern grows in size beyond the screen, it is important to *reduce the generator output and not the vertical gain setting of the 'scope.* This is vital, since the *if* stages may be badly overloaded if the incoming signal is too strong. The resultant curve under overload conditions would be very misleading, and would not present a true picture of the characteristics of the circuit under test. Fig. 5 illustrates a number of 'scope patterns that may be observed during the process of alignment. The local oscillator of the receiver should be made inoperative while the *if* stages and the detector are being aligned.

Discriminator 'Scope Alignment: Let us first align the discriminator and then turn our attention to the *if* stages. The sweep generator output lead should be connected to the limiter grid *G*, and the vertical input leads of the 'scope to point *B*, as indicated in Fig. 3a. The primary of the discriminator transformer should be adjusted for maximum amplitude of the pattern, and the secondary adjusted to obtain an *S* curve, as shown in Fig. 5e, or a butterfly pattern, shown in Fig. 5k. If the sweep-generator modulating voltage has a frequency which is twice that of the sawtooth oscillator of the 'scope, a butterfly pattern will be obtained. If both frequencies are the same, the pattern will be an *S* curve. The butterfly has an advantage over the *S* curve in that the center of the pattern is more easily recognized. The primary and the secondary of the discriminator transformer must be adjusted to obtain the greatest linearity and bandwidth. The extent of the linear portion of the curve can be checked by varying the marker frequency and reading the marker frequency settings at the end points of

the curve. The curves shown in Fig. 5 all have a marker pip at the exact center frequency.

To align the *if* stages the vertical input lead should be connected to point *G* at the limiter grid, and the sweep generator leads connected to the grid of the mixer tube. All of the *if* transformers should be aligned to obtain the desired *if* responsive curve.

[To Be Concluded in March, SERVICE]

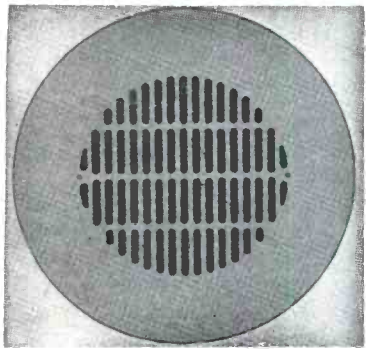

10-P Grille

Distributors like to sell the 10-P Flush Mounting Grilles because they help build pleased, satisfied customers.

Sound Engineers like to use the 10-P Flush Mounting Grilles because they assure them of a good looking well finished installation.

AND

They make doubly sure of a good sound job by using the NP-8680 or NP-832 8" speakers.

Write for Literature

WRIGHT Inc.

2237 University Ave., St. Paul 4, Minn.

FIRST AID FOR TV SETS!

H. G. CISIN's "TV DOCTOR"
Shows you how to fix TV sets RAPIDLY!

Save money—do a better job faster. Here's a really practical TV book. An amazing, quick, copyrighted method of fixing TV troubles. Written by a noted inventor and educator, H. G. Cisin, in language you can understand.

MAKES TV SERVICING EASY!
TUBES CAUSE 80% OF TV TROUBLES!
TV DOCTOR QUICKLY LOCATES ALL BAD TUBES WITHOUT EXPERIENCE—PICTURES & TEXT SHOW YOU THE QUICK, EASY WAY TO FIX FAULTY TV SETS WITHOUT INSTRUMENTS! Reveals many closely guarded TRADE SECRETS. Lists over 123 trouble conditions. Method applies to all TV sets from oldest to newest.

1 money-making, fact-crammed, detailed, illustrated chapters: practical ways to combat interference and ghosts, how to appraise TV sets, valuable information on antennas, lead-ins, color, practical—not theoretical—pointers on TV sets, ion traps, tubes used in TV, addresses of manufacturers—a veritable encyclopedia.

Only \$1—you'll say it's worth hundreds. 5-day Money Back Guarantee

FREE SPECIAL OFFER
Get a new, full-size, profusely illustrated, \$1 book—"TV TROUBLE PICTURE GUIDE INCLUDING TV TERMS SIMPLY EXPLAINED" as a FREE GIFT, by ordering the "TV DOCTOR" and H. G. Cisin's famous "TV TROUBLE SHOOTING METHOD" which trains you to be a TV Diagnostician, selling for \$1. Think of it—all 3 TV books postpaid for only \$2—you save \$1.

\$1 Post-paid

H. G. CISIN, Consulting Engineer (Dept. S-9)
200 Clinton Street, Brooklyn 2, N. Y.

Enclosed find \$2, full payment for "TV DOCTOR" & "TV TROUBLE SHOOTING METHOD" PLUS my FREE copy of "TV TROUBLE PICTURE GUIDE." Rush all three books postpaid.

Enclosed find \$1, full payment for "TV DOCTOR." Rush copy postpaid.

Name

Address

City Zone State

ATR

AUTO RADIO VIBRATORS

have Ceramic Stack Spacers



A COMPLETE LINE OF VIBRATORS . . .

Designed for Use in Standard Vibrator-Operated Auto Radio Receivers. Built with Precision Construction, featuring Ceramic Stack Spacers for Longer Lasting Life. Backed by more than 20 years of experience in Vibrator Design, Development, and Manufacturing.

ATR

NEW MODELS
NEW DESIGNS
NEW LITERATURE

"A" Battery Eliminators, DC-AC Inverters
Auto Radio Vibrators

See your jobber or write factory

AMERICAN TELEVISION & RADIO CO.

Quality Products Since 1931

SAINT PAUL 1, MINNESOTA-U.S.A.

JOTS AND FLASHES

THERE ARE OVER 105-million broadcast receivers in use today, according to a survey recently completed by research representatives of the four networks. Specifically, it was found that there are 42,800,000 sets in homes with one receiver, while secondary and portable sets total 34,000,000. Radio-equipped cars number 22,500,000. There are about 5-million sets located in other establishments such as offices, plants, restaurants, etc. Quite a market for the Service Man to consider. . . . More than 347-million receiving tubes were sold in the first 11 months of '51, RTMA has reported. Of the total sold through November, 231,678,712 units were for use in new sets and 87,479,522 were sold for replacements. . . . High-voltage power transmission lines were absolved recently, of much of the blame for radio interference, by H. L. Borden and R. S. Gens, both of the Bonneville Power Administration, Portland, Oregon. During a AIEE

talk, they disclosed that the real culprit seems to be low-voltage transmission and distribution pin-type insulated lines. It was also pointed out that another potential source of severe radio noise and probably one of the most common, was loose or improperly placed hardware on the lower-voltage wood pole lines. . . . G. J. Corrigan, director of export operations for the Jensen Manufacturing Co., of Chicago, is now in South America representing the line of hi-fi speakers and other acoustical equipment. . . . Thomas Lamont has been appointed assistant publicity director of The LaPointe Plasmold Corp. . . . A folder describing high-frequency crystal probes, test prods and leads, af and rf shielded leads, mini-prod connectors, prod handles, adaptors and lab test leads, has been released by United Technical Laboratories, Morristown, N. J. . . . Dave G. Harris, manager of jobber sales for Cleveland Electronics, Inc., is on tour of jobbers in the southern states from Florida to Texas.

ADVERTISERS IN SERVICE — FEBRUARY, 1952

ALPRODCO, INC.	57	PERFECTION ELECTRIC CO.	68
Agency: Paul J. Steffen Co.		Agency: Scantlin & Co.	
AMERICAN PHENOLIC CORP.	28	PLASTOID CORP.	69
Agency: Burton Browne, Advertising		Agency: Byrde, Richard & Pound	
AMERICAN TELEVISION & RADIO CO.	80	PLYMOUTH ELECTRONIC CORP.	77
Agency: Freestone-Goodman Adv. Agency		Agency: Howard-Wesson Co.	
ANCHOR RADIO CORP.	24-25	RCA INSTITUTES, INC.	11
Agency: Smonds, MacKenzie & Co.		Agency: J. Walter Thompson Co.	
BENDIX RADIO	56	RADIART CORP.	Inside Front Cover
Agency: MacManus, John & Adams, Inc.		Agency: Stern and Warren	
C. & G. MFG. AND SALES CO.	66	RADIO CORPORATION OF AMERICA	Back Cover
Agency: Harry M. Miller, Inc.		Agency: L. Walker Thompson Co.	
H. G. CISIN	79	RADIO MERCHANDISE SALES, INC.	17
Agency: Jaman Advertising, Inc.		Agency: Reid Associates	
CLAROSTAT MFG. CO., INC.	32	RADIO RECEPTOR CO., INC.	78
Agency: Austin C. Lescauroux & Staff		Agency: Walter J. Zimmerman & Associates	
CLEAR BEAM TV ANTENNAS	70	THE RAULAND CORPORATION	48
Agency: Stiller-Rouse & Associates		Agency: MacFarland, Aveyard & Co.	
CORNELL-DUBILIER ELECTRIC CORP.	58	RAYTHEON MFG. CO., INC.	12
Agency: Reiss Advertising		Agency: Walter B. Snow & Staff	
ALLEN B. DUMONT LABORATORIES, INC.	29	REGENCY DIV. I.D.E.A., INC.	1
Agency: Austin C. Lescauroux & Staff		Agency: Burton Browne, Advertising	
ELECTRONIC INSTRUMENT CO., INC.	74	JOHN F. RIDER PUBLISHER, INC.	66
Agency: H. W. Hauptman Co.		Agency: Conti Adv. Agency, Inc.	
EUREKA TV AND TUBE CORP.	60	RINEHART BOOKS, INC.	59
Agency: Harry Belfor, Advertising		Agency: The Harry P. Bridge Co.	
FERRO ELECTRIC PRODUCTS, INC.	33	HOWARD W. SAMS & CO., INC.	75
Agency: Fuller & Smith & Ross, Inc.		Agency: George Brodsky, Advertising	
GENERAL CEMENT MFG. CO.	67	SANGAMO ELECTRIC CO.	5
Agency: Paul J. Steffen Co.		Agency: Arthur R. Mogge, Inc.	
GRAYBURNE CORPORATION	76	SARKES TARZIAN, INC.	61
Agency: H. W. Hauptman Co.		Agency: Argyle Wampler, Advertising	
THE HEATH COMPANY	51	WALTER L. SCHOTZ CO.	10
Agency: G. Dean Arend, Advertising		Agency: Tildes & Cantz	
HYTRON RADIO & ELECTRONICS CO.	9	SIMPSON ELECTRIC CO.	45
Agency: Bennett, Walther & Menadier, Inc.		Agency: Burton Browne, Advertising	
INDUSTRIAL TELEVISION, INC.	70	SMITH ELECTRIC MFG. CO.	72
Agency: Salow Adv. Agency		Agency: Snyder Mfg. Co.	
JFD MFG. CO.	49	SOUTH RIVER METAL PRODUCTS CO., INC.	70
JENSEN INDUSTRIES, INC.	72	Agency: Art-Copy Adv. Agency	
Agency: Paul J. Steffen Co.		STANDARD TRANSFORMER CORP.	71
JENSEN MFG. CO., INC.	2, 77	Agency: Burnet-Kuhn Adv. Co.	
Agency: Burton Browne, Advertising		STANLEY SALES	68
KENWOOD ENGINEERING CO., INC.	79	Agency: C. & D. Adv. Agency	
Agency: Harry Belfor, Advertising		SYLVANIA ELECTRIC PRODUCTS, INC.	6, 7
KESTER SOLDER CO.	3	Agency: Cecil & Presbrey, Inc.	
Agency: Paul J. Steffen Co.		TECHNICAL APPLIANCE CORP.	8
KRYLON, INC.	64	Agency: Austin C. Lescauroux & Staff	
Agency: Gray & Rogers		TEL-A-RAY ENTERPRISES, INC.	31
THE LA POINTE-PLASMOLD CORP.	73	Agency: Keller Crescent Co.	
Agency: The F. W. Prellie Co.		TELEVISION ENGINEERS, INC.	74
LEOTONE RADIO CORP.	75	Agency: E. H. Brown Adv. Agency	
Agency: Altomari Adv. Agency, Inc.		TRANSVISION, INC.	73
P. R. MALLORY & CO., INC.	53, Inside Back Cover	Agency: H. H. Gold Co.	
Agency: The Aitkin-Kymet Co.		TUNG-SOL ELECTRIC, INC.	36
MERT COIL AND TRANSFORMER CORP.	41	Agency: E. M. Freystadt Associates, Inc.	
Agency: Burton Browne, Advertising		WALDOM ELECTRONICS, INC.	76
MOSLEY ELECTRONICS	66	Agency: Turner Adv. Agency	
Agency: Rudolph Bartz, Advertising		THE WARD PRODUCTS CO.	14
OXFORD ELECTRIC CORP.	63	Agency: The Hubbell Adv. Agency	
Agency: Sander Rodkin Adv. Agency		WEBSTER-CHICAGO CORPORATION	4
PEERLESS PRODUCTS INDUSTRIES	76	Agency: Fuller & Smith & Ross, Inc.	
Agency: Bayard H. Clark		WEBSTER ELECTRIC	27
		Agency: Hamilton Adv. Agency, Inc.	
		THE WORKSHOP ASSOCIATES, INC.	72, 75
		Agency: The Hubbell Adv. Agency	
		WRIGHT, INC.	79
		Agency: Kay Advertising, Inc.	
		XCELITE, INC.	72
		Agency: Melvin P. Hall Agency, Inc.	

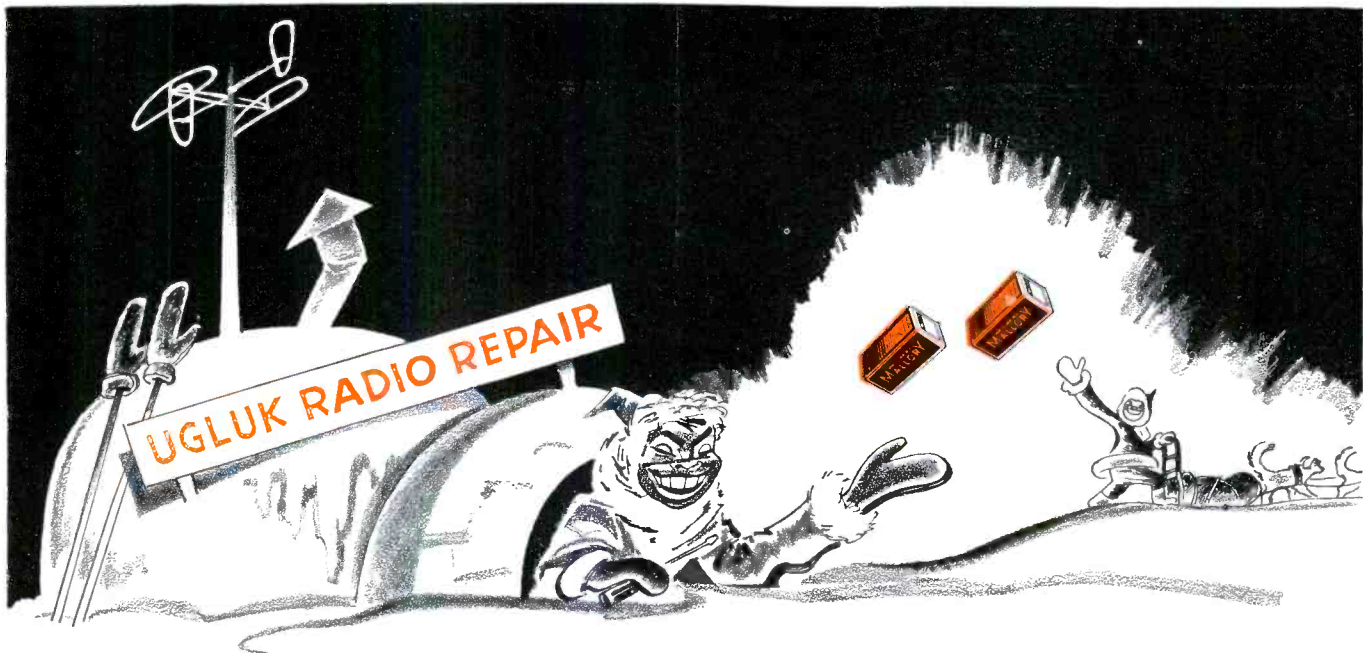

'Way Out Front with Servicemen . . . everywhere !

MALLORY VIBRATORS

Servicemen know they get dependable, trouble-free performance from Mallory vibrators. That's why a recent survey showed Mallory vibrators the choice of servicemen by a 2 to 1 margin. Count on Mallory vibrators for . . .

- 1—Slow contact impact for minimum wear.
- 2—High contact pressure for low resistance.
- 3—Fast contact break for reduced arcing, pitting.

Mallory *alone* gives you that three-way vibrator combination because of its patented, tuned mechanism. It's your assurance of long-lasting service that beats the comeback problem. Set makers count on Mallory, too . . . they use more Mallory vibrators as original equipment than all other brands combined. When you order vibrators . . .



You get a Handy Parts Cabinet at no additional cost with Mallory's Special Vibrator Deals

You keep your inventory down . . . and get the parts cabinet, too . . . with these Mallory deals you can service 47 different makes of radios with the assortment of 6 Mallory vibrators. All this is yours at *your regular discount price*. See your distributor today.

Make Sure! Make it Mallory!

P. R. MALLORY & CO., Inc.
MALLORY

CAPACITORS • CONTROLS* • VIBRATORS • SWITCHES • RESISTORS
• RECTIFIERS • VIBRAPACK* POWER SUPPLIES • FILTERS

*Reg. U.S. Pat. Off.

APPROVED PRECISION PRODUCTS

P. R. MALLORY & CO., Inc., INDIANAPOLIS 6, INDIANA

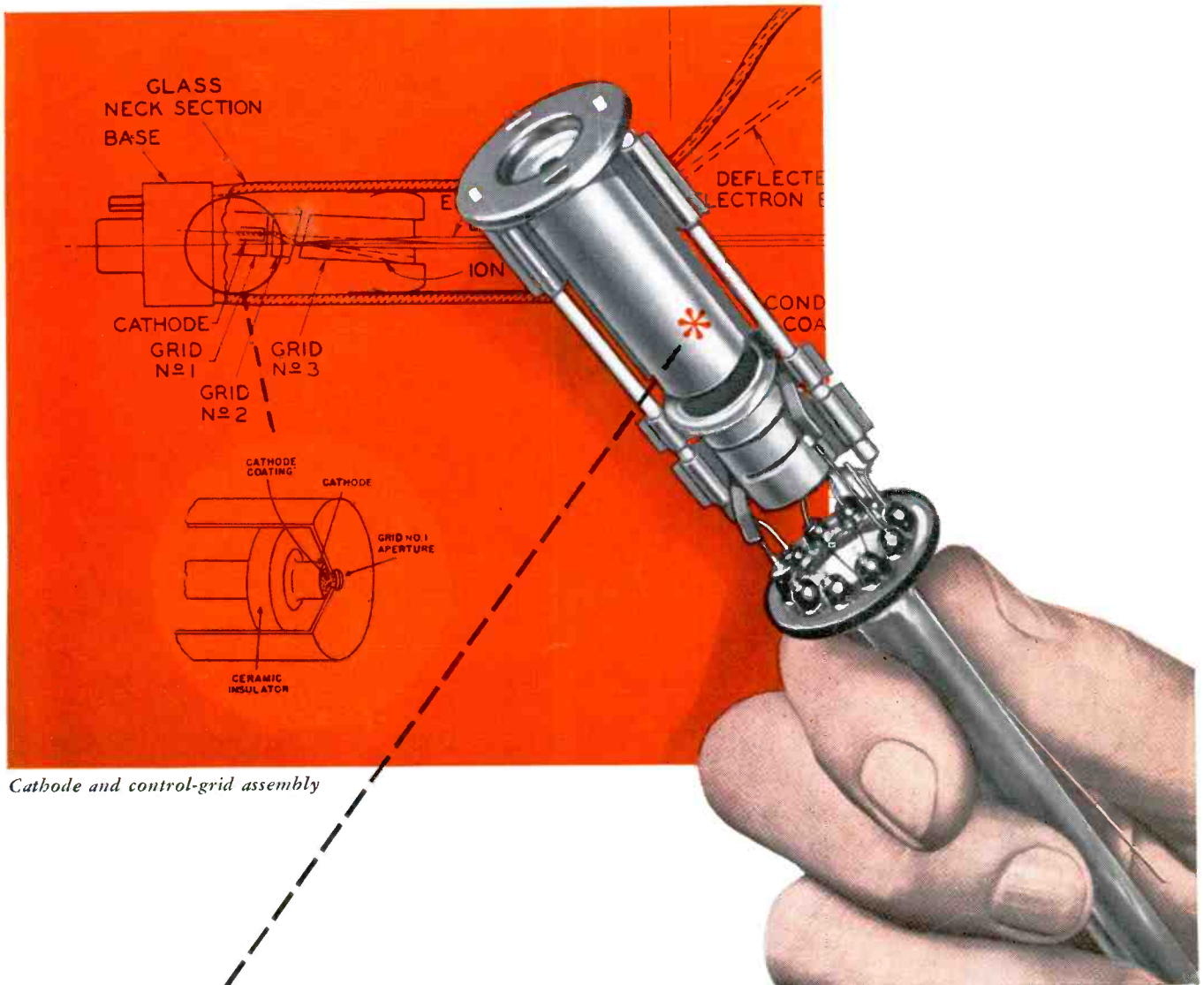

Cathode and control-grid assembly

The gun that looked 100% "perfect" ...yet never "fired a shot"

The electron gun you see looks perfect, but actually it "never fired a shot." You see, RCA rejected it because the spacing between grid No. 1 and the cathode was out of bounds. Only a 0.001" departure from the design value for this spacing is sufficient cause for gun rejections in RCA factories.

Why does RCA prescribe such a close tolerance? Simply because RCA engineers have found that if the cathode-to-grid spacing is too small, or too large, the grid would have faulty "control." Such tubes, when installed in TV receivers, may be

the cause of poor picture performance, and may result in troublesome and time-consuming service problems and call-backs.

RCA takes no chances with its reputation for quality. You get the benefit of RCA's quality reputation when you use RCA tubes. Constant vigilance and quality control at all stages of manufacture assure meeting RCA standards on the final production line. That's why RCA picture tubes are unmatched for reliability and uniformity.

In RCA picture tubes, the difference is

top-quality control. That's why, dollar for dollar, RCA picture tubes have no equal.

With RCA Receiving Tubes, as well as RCA kinescopes, **TOP-QUALITY CONTROL** makes the difference.



RADIO CORPORATION of AMERICA
ELECTRON TUBES

HARRISON, N. J.