

SERVICE

September
1947

OCT 8 1947

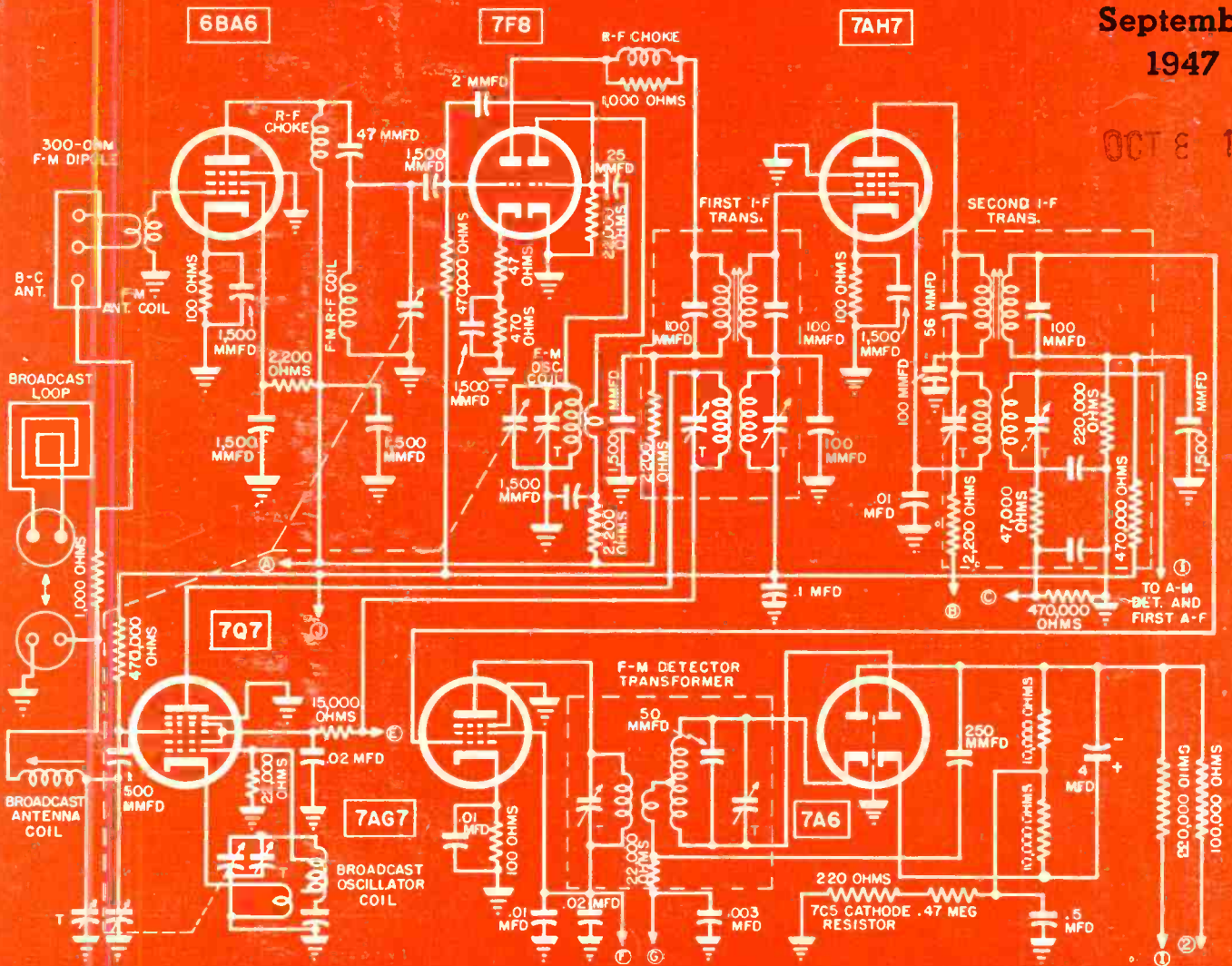

The f-m r-f amplifier (6BA6), f-m mixer-oscillator (7F8), first i-f (7AH7), f-m detector-driver (7AG7), f-m ratio detector (7A6) and a-m mixer-oscillator (7Q7) of 11-tube g-m/f-m receiver.

[See page 2]

**NEW PROFITS
FOR
SERVICEMEN**

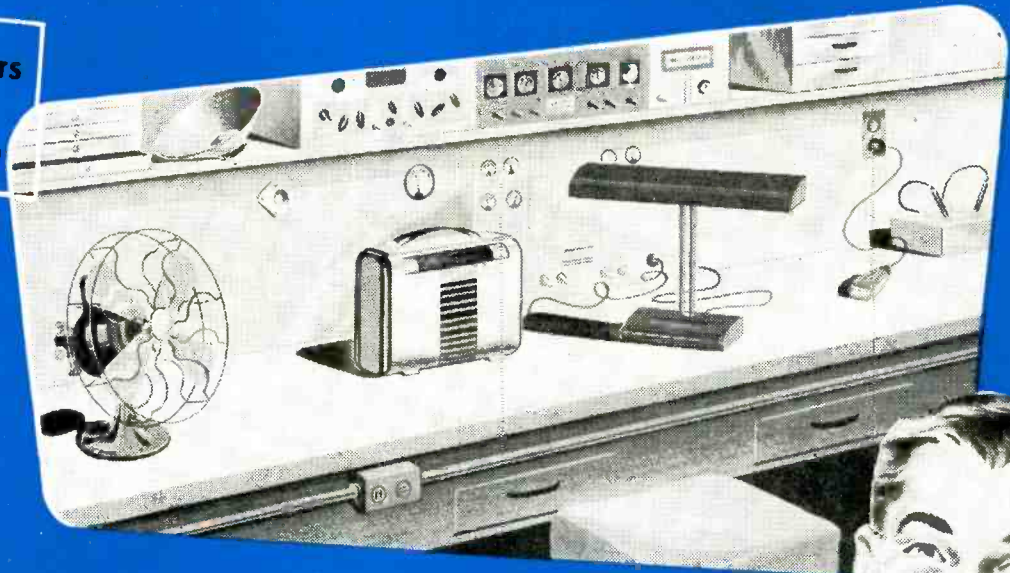

here's how one serviceman makes more money with **C-D** quietones...

Along with the finest test equipment, Frank Viscardi of Glen Rock, New Jersey, includes on his bench an electric shaver, an old-fashioned brush-type fan, and a fluorescent lamp. These articles — together with four popular types of C-D Quietone Radio Noise Filters — make up a potent demonstration. Every service customer is shown — *with his own set being used as guinea pig* — how the radio noises he thought had to be tolerated — can easily be eliminated. *Three out of four customers buy the filter recommended.*

Most of *your* customers need one or more C-D Quietones — *but they don't know it. Tell them — better yet show them, like Frank Viscardi does — and you'll discover the quickest-selling, fastest-moving accessories in the entire service field.*

Start cashing in on this big profit opportunity NOW! Mail coupon below for free copy of Catalog No. 195A. Cornell-Dubilier Electric Corporation, Dept. S9, South Plainfield, New Jersey. Other large plants in New Bedford, Brookline, and Worcester, Mass., and Providence, R. I.



SEE YOUR LOCAL CLASSIFIED TELEPHONE DIRECTORY FOR NEAREST AUTHORIZED C-D DISTRIBUTOR

FREE!
profit-building ideas in capsule form within the two covers of "THE CAPACITOR".



This remarkable magazine — published for servicemen — makes it easier for you to service any set ever made. Also, every month it brings you a fresh supply of hints for bringing more customers to your shop — boosting your profits. Mail coupon NOW — your free subscription will start at once!



IF54



IF21



IF18



IF6

CORNELL-DUBILIER
WORLD'S LARGEST MANUFACTURER OF
CAPACITORS

MICA • DYKANOX • PAPER • ELECTROLYTIC

CORNELL-DUBILIER ELECTRIC CORPORATION,
Dept. S9, South Plainfield, New Jersey

I can use those ideas for servicemen.

Please send copy of Catalog No. 195A.

Start The Capacitor coming my way at once — FREE.

Name.....

Address.....

City..... Zone..... State.....

I am a serviceman amateur experimenter

Other classification.....

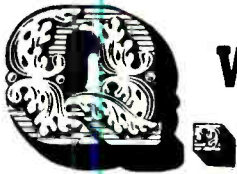

WHAT'S NEXT-BEST TO HAVING YOUR SERVICE SHOP LOCATED ON A FAMOUS BUSY CORNER?

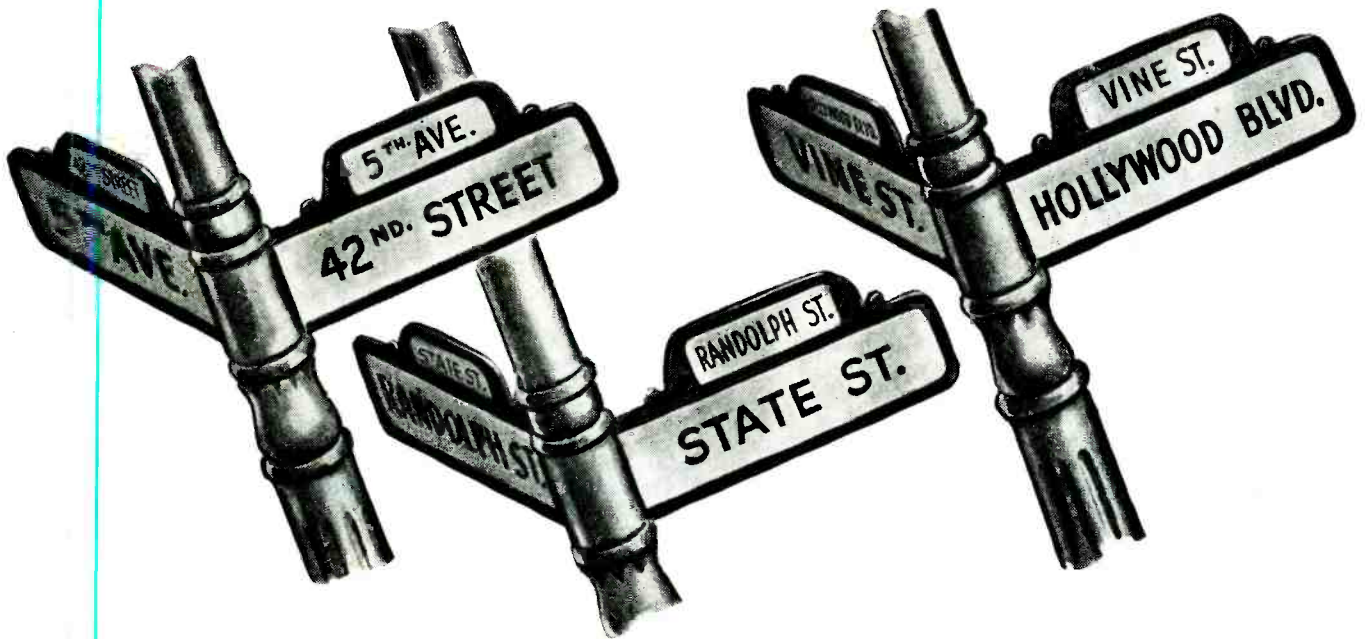

DISPLAY AND HANDLE GENERAL ELECTRIC TUBES! The popular G-E monogram draws trade to you.



**RADIO
TUBES**

Public confidence in a well-known, respected product is the voltage that sparks sales. Let radio owners know that you install and sell G-E tubes, and you've taken the first big step toward increasing your volume of business.

Postwar buyers are demanding "name" merchandise. With G-E tubes, you offer customers the brand-name that LEADS in quality, reliability, and engineering advancement . . . stamping you

as a preferred source for tube purchases and trustworthy radio repair work.

Greater patronage of your shop, a bigger volume of service work, faster tube turnover—all these come packaged in the familiar orange-and-blue General Electric cartons. Act *now* to reap the reward that will accrue from establishing your shop as local G-E tube headquarters! *Electronics Department, General Electric Company, Schenectady 5, New York.*

And General Electric helps you actively promote your business! Write for Sales-aids Booklet ETR-51, which describes the colorful G-E line of tube window displays, direct-mail pieces, and numerous other items useful for widening your client-list and selling more service, tubes, and parts.

GENERAL  ELECTRIC

176-F9-8850

FIRST AND GREATEST NAME IN ELECTRONICS

SERVICE, SEPTEMBER, 1947 • 1

EDITORIAL

AUDIO PERFORMANCE, always an important factor in receiver acceptance, is rapidly becoming the major consideration of many. The trend has been stimulated by the increased use of high fidelity a-f systems with wide-range speakers in a-m and f-m equipment, concert-type phono arrangements with wide-range pickups and high-fidelity recordings.

It has thus become increasingly important for Service Men to equip themselves with complete a-f test facilities, of the fixed and mobile type, such as audio oscillators, test amplifiers and speakers, stroboscope systems, test pickups and test records.

The test records play quite an important role in checking response or dynamic range of amplifier systems. It has been found that certain recordings can be used to check low-frequency or high-frequency response as well as dynamic ranges. For instance, the *Tocatta and Fugue* of Bach, recorded by RCA Victor, is excellent for checking the dynamic range of an amplifier system. Its volume range is better than 20 db.

Gershwin's *Rhapsody in Blue* piano solo is another effective dynamic-range test record for fidelity checking. Beethoven's *Piano Sonata, Opus 78*, also has been found very effective.

It is often necessary to check a phono player for wow. The recording of *Afternoon of Fawn* (DeBussy) is excellent for this purpose. The recording has long drawn out flute passages, which can also be used to check the high-frequency response of amplifiers. Rossini's *Semiramide Overture* has quite a wide range and has proved effective for checking dynamic qualities of the amplifier. For full-frequency range tests, a new series of recordings called FFRR, produced by English Decca, are very good. Some of these recordings have a range of up to 12,000 cycles.

Briefly, piano and flute recordings are ideal for high-frequency checking and overture types of recordings are good for dynamic-range tests.

SUPER-REGENERATION is back again in the form of a special a-m/f-m receiver developed by Hazeltine. The receiver, a 4-tube model, employs a *FreModyne* circuit of the superheterodyne / super - regeneration type. This combination of systems, according to Barney D. Loughlin, who invented the circuit, reduces radiation and makes it possible to use receivers in proximity to each other.

Thus far, nine manufacturers have announced that they will produce models with this circuit: Gilfillan, Howard, Olympic, Meck, Signal Electronics, Regal, Majestic and Noble.

We'll be running an analysis of these sets in early issues of SERVICE. Watch for these discussions

RADIO · TELEVISION · ELECTRONIC SERVICE

Vol. 16, No. 9

September, 1947

LEWIS WINNER
Editorial Director

ALFRED A. GHIRARDI
Advisory Editor

F. WALEN
Managing Editor

	Page
Auto Radio Installation and Servicing. By Jack Darr	16
(Setting Up Test Benches, Hints for Alignment, Slug Tuner Adjustment, Road Tests, etc.)	
F-M/AM Chassis For Custom Installations (Cover)	15
F-M Limiters	20
(Why They Are Used and How They Work)	
Phono Record Cutting and Reproducing.	
By Walter W. Carruthers	33
Ser-Cuits	38
(New F-M Receivers Using Ratio Detectors)	
Servicing Helps	26
TV Wide-Band Amplifiers. By Edward M. Noll	30
(Design and Application Data on Bandpass, Stagger Tuned, Overcoupled and Wave-Trap Systems)	
Tube News	22
(Fundamental Properties of Tubes, Amplifier Classifications, etc.)	
CIRCUITS	
Espey 7B (Cover)	15
Motorola 95/31 Series	40
Pilotuner	40
RCA 711V2	38
COVER	
F-M/A-M Chassis (Espey 7B)	15
SERVICING HELPS	
Cathode Followers	26
Replacing E-M with P-M Speakers	26
TV-Antenna Installation Notes	26
Index to Advertisers	60
Manufacturers	
New Products	42
News	44
Jots and Flashes	60

Copyright, 1947, Bryan Davis Publishing Co., Inc.

Published monthly by Bryan Davis Publishing Co., Inc.
52 Vanderbilt Avenue, New York 17, N. Y. Telephone MURray Hill 4-0170



Bryan S. Davis, President
Paul S. Weil, Vice Pres.-Gen. Mgr.



F. Walen, Secretary
A. Goebel, Circulation Manager

Cleveland Representative: James C. Munn, 2253 Delaware Dr., Cleveland 6, Ohio; Telephone ERview 1726
Pacific Coast Representative: Brand & Brand, 1052 W. Sixth St., Los Angeles 14, Calif.; Telephone Michigan 1732
Brand & Brand, 1085 Monadnock Bldg., San Francisco 5, Calif.; Telephone Douglas 4475

Entered as second-class matter June 14, 1932, at the Post Office at New York, N. Y., under the Act of March 3, 1879. Subscription price: \$2.00 per year in the United States of America and Canada; 25 cents per copy. \$3.00 per year in foreign countries; 35 cents per copy.

Don't Miss PHOTOFAC Set No. 23!

WITH EXCLUSIVE NEW "Standard Notation" SCHEMATICS

The Greatest Service Data Development in 20 Years!

I am proud to announce to my Servicemen friends the successful development of a new system of "Standardized Schematics" that is now yours exclusively in PHOTOFAC Folders. We have worked on this project for over one year, because we knew that uniform, standardized schematics would save you hours of time and countless headaches—would help you earn more. NOW—we have developed uniform, standardized diagrams on all sets. Now—you can save time—go from diagram to diagram and see the same, easy-to-understand symbols and designations. You no longer have to puzzle out the differences in schematic notations—no bang your head against queer-looking diagrams. You'll recognize instantly the functions of all parts in any circuit. The standards used in our new diagrams are yours—the result of the PHOTOFAC "Standards Poll" and thousands of interviews with Servicemen. I wish space would permit me to tell you more—but PHOTOFAC Set No. 23 speaks for itself. You owe it to yourself to see the new diagrams. Use them—learn what a difference they'll make in faster, more profitable servicing.

Howard W. Sams

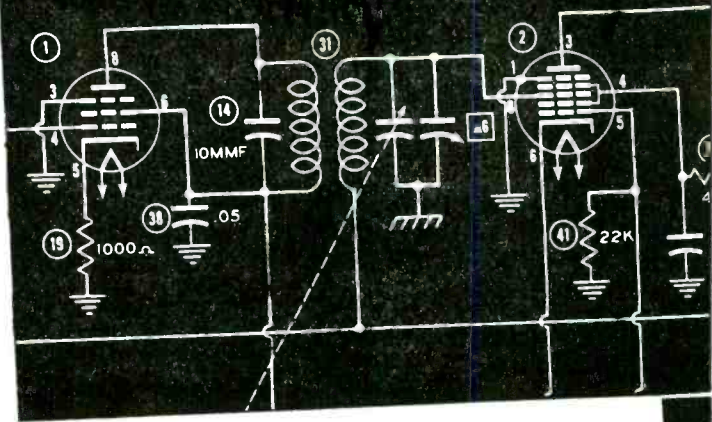

NOW! UNIFORM SCHEMATICS FOR FASTER, MORE PROFITABLE WORK!

Beginning with Set No. 23, and thereafter, all PHOTOFAC Folders will feature the new, uniform "Standard Notation" schematics. Each and every diagram is drawn to the same basic set of clear, uniform, easy-to-understand standards. Here's what the new "Standard Notation" Schematics mean to you: Makes circuit analysis simple, quicker, fool-proof, more accurate! No more time wasted puzzling over odd-looking diagrams! No more trouble with varying symbols and confusing styles! Just ONE CLEAR STANDARDIZED STYLE FOR ALL CIRCUITS—SAVES YOU TIME—HELPS YOU EARN MORE. Only PHOTOFAC offers you the "Standard Notation" Schematics!

TWO IMPORTANT NEW HOWARD W. SAMS PUBLICATIONS

DIAL CORD STRINGING GUIDE

There's only one *right* way to string a dial cord. And there's only one book that shows you how. It's the Howard W. Sams DIAL CORD STRINGING GUIDE. Here, for the first time, in one handy pocket-sized book, are all available dial cord diagrams and data covering 1938 through 1946 receivers. Licks the knottiest dial cord problem in a matter of minutes. This low-cost book is a "must" for servicing. You'll want two copies—one for your tool kit and one for your shop bench. Order them today. **75c ONLY**

1947 AUTOMATIC RECORD CHANGER MANUAL

Nothing like it! COVERS MORE THAN 40 DIFFERENT POST-WAR MODELS. Absolutely accurate, complete, authoritative—based on actual study of the equipment. Shows exclusive "exploded" views, photos from all angles. Gives full change cycle data, information on adjustments; service hints and kinks, complete parts lists. Shows you how to overcome any kind of changer trouble. PLUS—for the first time—complete, accurate data on leading WIRE, RIBBON, TAPE, and PAPER DISC RECORDERS! Over 400 pages; hard cover; opens flat. No modern service shop can afford to be without this manual. **\$4.95 ONLY**

HOWARD W. SAMS & CO., INC.
INDIANAPOLIS 6, INDIANA

Export—Ad. Aurilama—39 Broad St., New York 4, N. Y.—U. S. of America
Canada—A. C. Simmonds & Sons, 301 King St., East—Toronto, Ontario

PHOTOFAC SERVICE

"The Service that pays for itself over and over again"

FREE PHOTOFAC AIDS!

FREE. PHOTOFAC CUMULATIVE INDEX
—Your guide to more than 1800 receiver models and chassis (1946 and 1947 models covered in PHOTOFAC Folder Sets 1 through 20).

FREE. HOW TO FILE FOLDER—Shows 5 good ways to file PHOTOFAC Folders, including new "30-Second" filing method.

Ask your parts jobber for FREE copies of these PHOTOFAC aids, or write us direct.

RESERVE SET NO. 23 TODAY

MAIL THIS ORDER FORM TO YOUR PARTS JOBBER TODAY—or send directly to HOWARD W. SAMS & CO., INC., 2924 E. Washington Street, Indianapolis 6, Indiana.

My (check) (money order) for \$..... enclosed.

- Send PHOTOFAC Set No. 23 (at \$1.50).
- Send . . . SAMS' DIAL CORD STRINGING GUIDE(S), at \$0.75 per copy.
- Send . . . SAMS' 1947 AUTOMATIC RECORD CHANGER MANUAL(S) at \$4.95 per copy.
- Send PHOTOFAC Volume No. 1 (including Sets Nos. 1 through 10) with DeLuxe Binder, \$18.39.
- Send PHOTOFAC Volume No. 2 (including Sets Nos. 11 through 20) in DeLuxe Binder, \$18.39.
- Send FREE PHOTOFAC Aids.

Name.....

Address.....

City.....State.....

A Sign of Successful Servicing

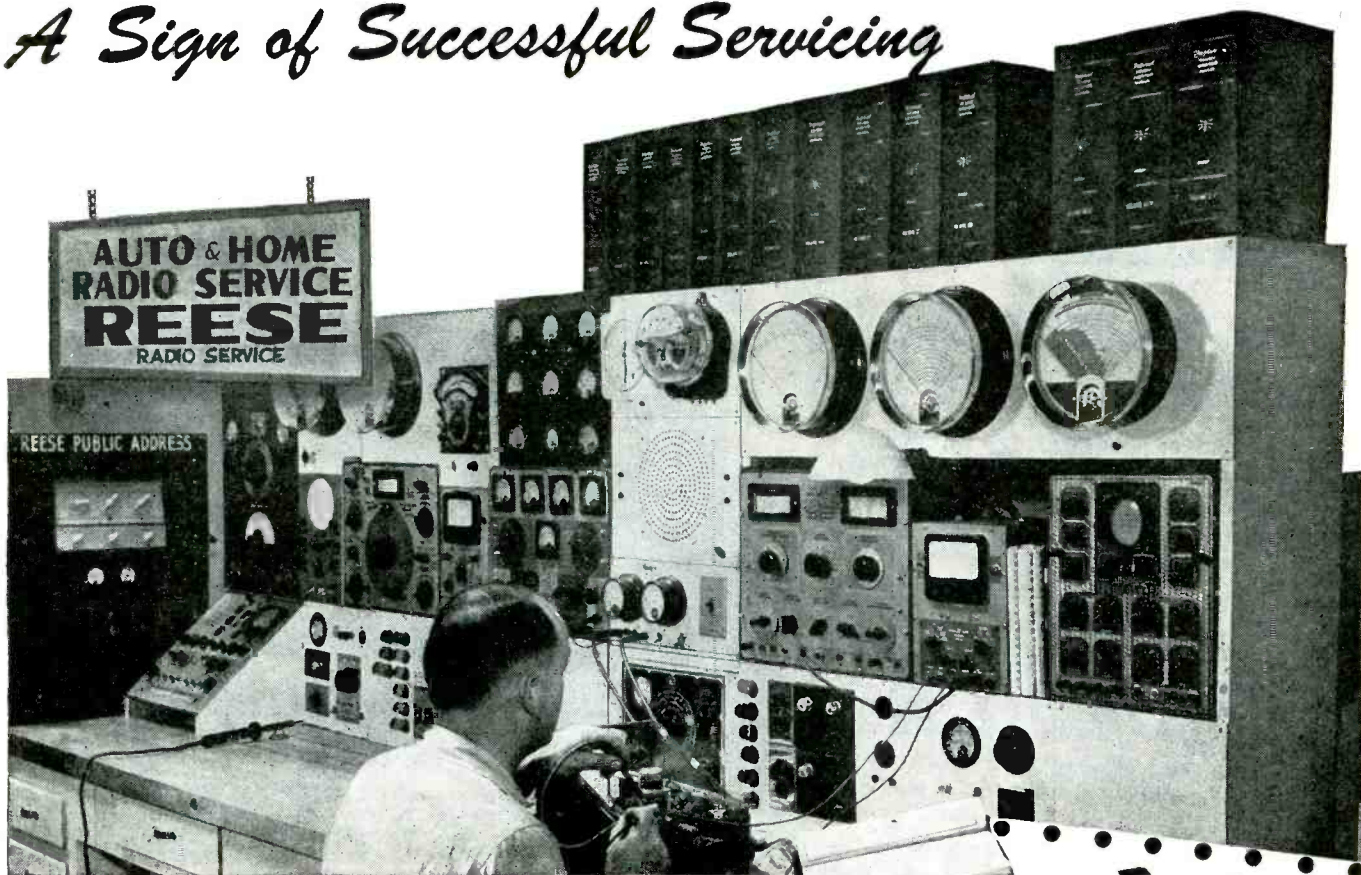

Reese has all Fifteen RIDER MANUALS (and Volume XVI on order)

THE servicing shop of Francis Reese in Olean, N. Y. has been the subject of several success stories recently published in radio magazines. Shops so featured are significantly distinguished by a better-than-average profit and a complete set of Rider Manuals. Thus, at Reese you will find all volumes, kept conveniently handy for ready reference. For, no other single source of information supplies the essential data contained in Rider Manuals, and nowhere but in the first fourteen volumes can you find the material you must have to service 80% of the receivers now in American homes. (Those issued from 1920 to 1942.)

To those shops repairing any and all makes of receivers, sets of all ages, this pre-war data is absolutely essential for profitable operation.

—And, Rider Manual data is reliable, the OFFICIAL AUTHORIZED servicing data right from the service departments of the companies that make the sets. No one knows better than the

manufacturer what procedures are best for his products. This is the basis for the authority and success of Rider Manuals.

Volume XVI will be at your jobbers in October; order it today. Remember, Rider Manuals are investments; they keep pouring out profits for you. Copies of Volume I, bought over seventeen years ago, are still benefiting their owners. So, be sure your shop has the sign of successful servicing—be sure it has all sixteen Rider Manuals.

RIDER MANUALS—16 VOLUMES

Volume XVI.....	\$ 6.60
Volume XV.....	18.00
Volumes XIV to VII (ea. vol.)	15.00
Volume VI.....	11.00
Abridged Manuals I to V (one volume).....	17.50
MASTER INDEX, covering all Rider Manuals except Vol. XVI, which has its own index	1.50
Record Changers and Recorders (a manual).....	9.00

JOHN F. RIDER, PUBLISHER, Inc., 404 Fourth Avenue, New York 16

Export Agent: Rocke International Corp. 13 E. 40th St., N.Y.C. Cable ARLAB

RIDER MANUALS MEAN SUCCESSFUL SERVICING

Just Out!

VOL. XVI

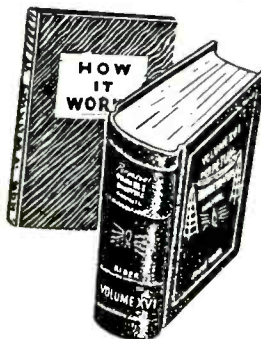

RIDER MANUAL

At your jobbers
in October

768 Pages

PLUS SEPARATE
HOW IT WORKS'
BOOK

\$6.60

During "Seventeen Years of Continuing Service to the Servicing Industry" we have been anticipating its needs. So, because of the present high rate of receiver production, Rider Manuals are being issued three times a year, to give you complete, authoritative servicing data at the earliest necessary date. And, at the minimum investment; Vol. XVI is less than a cent a page. The binding is the same sturdy, custom-made, loose-leaf binder that matches your present Rider Manuals. And, the contents are the usual high standard, supplemented with "clarified-schematics" on multi-wave band sets and a separate "How It Works" book explaining the kinks of the newer receivers. We are proud to possess. Vol. XVI, you will find it profitable to possess.

PLACE YOUR ORDER TODAY



5 WORDS that assure ACCURACY, DEPENDABILITY and VALUE in all **SILVER** test instruments

You . . . and every serious service technician . . . have long dreamed of your shop equipped with the same caliber of laboratory instruments found in the factories making the radios you must service. Today's complex AM, FM and Television receivers can't be efficiently serviced by anything less.

Under war pressure McMurdo Silver devised new techniques to lift the manufacture of laboratory-type instruments out of the costly model-shop. He discovered how to put them on the low-cost, high-volume production line. The result is instruments of laboratory precision, accuracy, dependability . . . at prices far below what you'd expect to pay. These are the same identical **Laboratory Caliber Electronic Test Instruments** the big manufacturers, universities and the government select.

Can you afford less than the best — when the best costs you less?

MODEL 906 FM/AM SIGNAL GENERATOR: 8 ranges calibrated $\pm 1\%$ accurate, 90 kc. thru 210 mc. 0-100% variable 400 \sim AM; 0-500 kc. variable FM sweep built-in. Metered microvolts; variable 0-1 volt. Strays lower than \$500 laboratory generators. Only \$99.50 net.

"VOMAX" UNIVERSAL V.T.V.M.: The overwhelming choice of experts. 51 ranges, d.c., a.c., a.f., i.f., r.f., current, db., and resistance. Visual signal tracing to 500 mc. New 5" pencil-thin flexible r.f. probe. Only \$59.85 net.

MODEL 904 CONDENSER/RESISTANCE TESTER: Measures accurately $\frac{1}{4}$ mmfd. thru 1,000 mfd.; $\frac{1}{4}$ thru 1,000 meg Ω . Internal 0-500 V. variable d.c. polarizing voltage. Measures condensers with rated d.c. volts applied. Only \$49.90 net.

MODEL 905 "SPARX" SIGNAL TRACER: Visual and audible tracing; also tests phono pickups, microphones, speakers, PA amplifiers. Is your shop test-speaker, too. 20 \sim thru 200 mc.; PM speaker; mains-insulated transformer power supply. Only \$39.90 net.

OVER 36 YEARS OF RADIO ENGINEERING ACHIEVEMENT

McMurdo Silver Co., Inc.

1249 MAIN ST., HARTFORD 3, CONNECTICUT

SEND FOR COMPLETE CATALOG. See these and Silver communication transmitters, receivers, "Micro-match", Xtal-controlled VFO, pre-tuned freq. multiplier at your jobber.

The little lamp that won't talk...

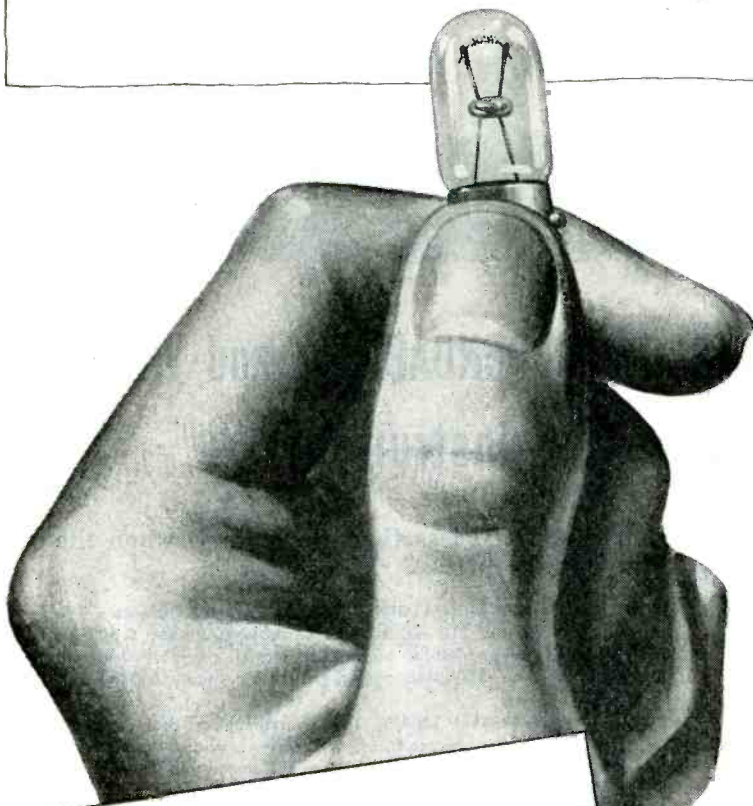

Radio Dial Lights

YES, radio panel lamps *can* "talk"—and some old style lamps *do* talk, when loose joints between filament legs and lead-in wires cause interference. But General Electric research engineers have made sure that G-E panel lamps *won't talk!* They tested the old type clamp joint — found that minute changes in resistance or tiny arcs caused the lamp to radiate interference. That can't happen in G-E lamps, because the tungsten filament legs are pressed firmly right into the softer metal of the lead-in wires—a vibration-proof joint.

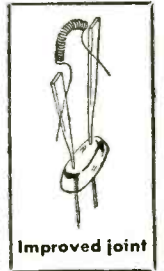

Another example of the exhaustive research which makes G-E miniature lamps the leaders in quality and service. Features like these assure satisfied customers and satisfying profits when you sell G-E lamps for radio dial lights and similar uses:

1. Dependable, trouble-free performance.
2. High level of maintained light output.
3. Low current consumption.
4. Long life.
5. Profitable to handle.
6. Greater dealer acceptance.

FOR INFORMATION on prices and types of G-E miniature lamps, see your nearby G-E Lamp Office. Or write to General Electric Co., Div. 166, R-3, Nela Park, Cleveland 12, Ohio.

G-E LAMPS

GENERAL  ELECTRIC

when stamped
STANCOR
you get "plus-value"
PERFORMANCE!

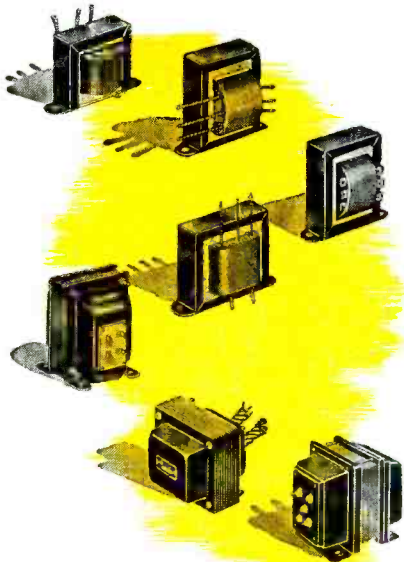
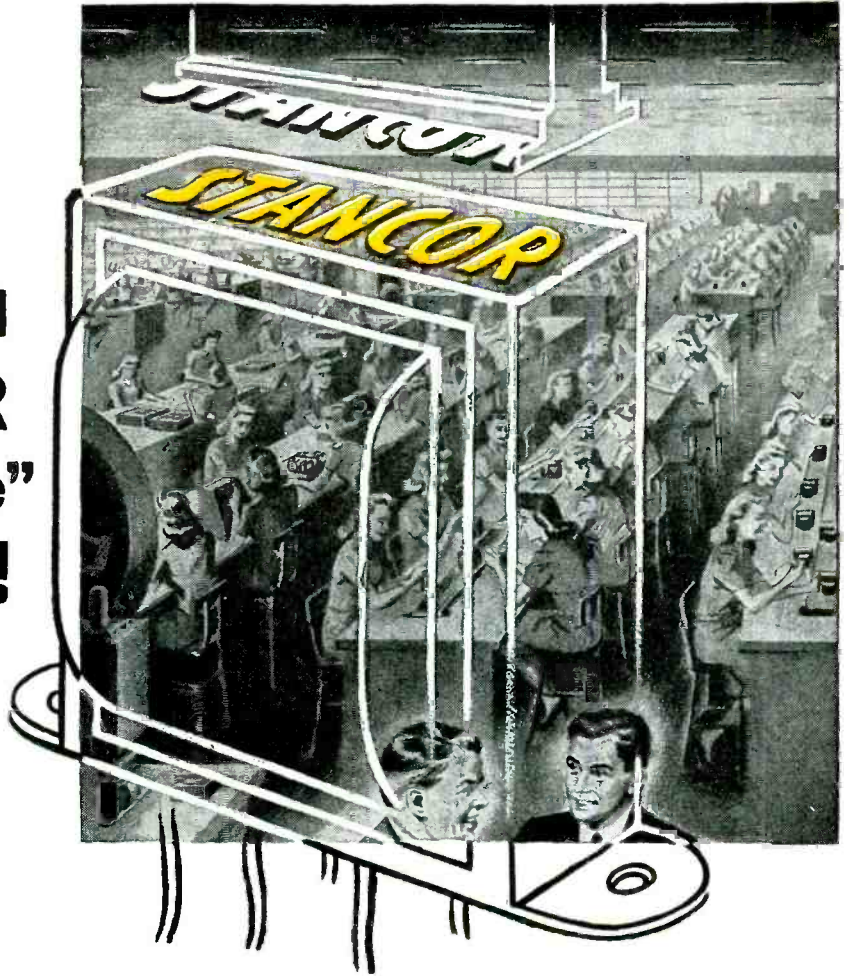

When it comes to merchandise nothing means more to any customer than the best service possible from the equipment he has purchased . . . Similarly, nothing means more to the service man than the good will and increased patronage of satisfied customers...STANCOR has long recognized this truth and has zealously guarded its good reputation for quality transformers by manufacturing the best possible merchandise from the best material obtainable—and with that extra "Plus" in effort . . . Remember, the Stancor identification on a transformer is your assurance of "PLUS-VALUE" for lasting satisfactory service.

standardize on

STANCOR



TRANSFORMERS

STANDARD TRANSFORMER CORPORATION · ELSTON, KEDZIE AND ADDISON · CHICAGO 18, ILL.

SERVICE, SEPTEMBER, 1947 • 7

SPRAGUE TRADING POST

SWAP • BUY SELL

FOR SALE—RCA oscillator 167R; RCA7 and Silvertone 4486 speakers; have complete set of coils for these sets, also several output transformers and chokes; 1 dual amp case, will handle 2 12" speakers; Supreme publications diagrams 1926-38-39-40; television antenna and 60" of lead in; large hand drill. J. I. Freeman, 5025 Arch St., Philadelphia 39, Pa.

WANTED—Hallcrafters S-20-R not over 2 years old, state age and condition. Have almost new Speco signal tracer probe required in operating condition. Thomas Brown, Box 69, Vinita, Okla.

FOR SALE—Hammarlund super-pro, less tubes and power supply; needs minor repairs, such as bypasses, etc. Need metal working lathe, Monitor Appliances, P. O. Box 403, Chillicothe, Ohio.

SELL OR TRADE—5" or 7" television set, auto radio and bicycle. Want test equipment or what have you? J. Bazewick, 300 N. Christiana St., Chicago 18, Ill.

RADIO REPAIRS—Will repair all small portable a-c and d-c radios. Joe's Radio Service, 2044 N. 3rd St., Philadelphia 22, Pa.

FOR SALE—Triplet signal generator 1632, A-1 condition; has 500 kc calibrated crystal. \$95. George E. Anthony, 878 Gilbert St., Columbus 6, Ohio.

SELL OR TRADE—Mostly new 6-9002, 9003, 815, 807, 6L6G, 929, Photo cell, 84, 11N5 and others. Want other type tubes, condenser checker and Rider's manuals, or what have you? A. Miller, 850 E. 156th St., Bronx 55, N. Y.

FOR SALE—874 regulator tube, 81-0, 10, etc.; also 3-tube amp., using choke input, excellent condition. Want Rider's 10-11 and 12. Hallcrafters sets, etc. Saxtons Radio & Electric Service, Route 1, Pontiac, Ill.

FOR SALE—Transvision 7" tube television set less cabinet, complete with 20 tubes, including preamplifier; 3 channels wired, provisions for more. Brand new, \$200. Want late model typewriter. John Repp, Jr., Richardtown, Pa.

WANTED—U.T.C. Varitone VT-1, must be in perfect condition. Write E. Brunner, 146 Hilltop Road, San Francisco 24, Calif.

FOR SALE—Hallcrafters S-38 with tone control and phono input, excellent condition. \$42, and RCA Victor 3-way portable radio in aluminum casing, brand new, sacrifice at \$60. R. L. Horky, 2428 Channing Way, Berkeley 4, Calif.

WANTED—January, February and March, 1947 QST; miscellaneous transformers, meters, and 5 unpunched chassis, 13 x 17 x 2. Eddie Howell, 501 West Harden St., Graham, N. C.

FOR SALE—Instructograph, Junior, complete. Audel's New Radioman's Guide, Kalart flask gun release for Comput shutter, without gun. Joseph Campbell, 310 E. 94th St., New York 28, N. Y.

FOR SALE—Postwar Hallcrafters S-20R, in excellent condition, with 6SD7 in RF with home built antenna matching unit for 10 and 20, similar to unit in Handbook, \$50. Gerald Park, 4929 First Ave. S., Minneapolis 9, Minn.



FREE! This Giant Sprague TEL-U-HOW WALL CHART

— from your Sprague Distributor

Ask your nearest Sprague jobber for your copy of the SPRAGUE TEL-U-HOW WALL CHART. Just the thing for hanging on the wall of your shop. Its professional appearance impresses customers. The material it contains will help you do jobs easier, better, faster.

Beautifully lithographed in colors, size 22" x 28", the chart includes handy service application data; diagrams and descriptions of common circuit troubles involving capacitors; general replacement data on electrolytics; formulas; transformer, resistor and capacitor color codes; schematic; and similar invaluable service information. Everything is arranged for quick, easy reference. Popular Sprague Capacitors and Koolohm Resistors are illustrated. Don't miss it!

SELL OR TRADE—6A6, 6B5, 12A5 and type 48 tubes in original cartons; also two complete 2-meter transceivers. C. O. Nunney, c/o Easy Pay Store, Rock Hill, S. C.

WANTED—Will pay \$10 for answers to National 1947 Radio course. Hobert Kiser, Box 175, Ravenswood, W. Va.

FOR SALE—Brush PL20 pickup A-1, \$20; Brush PL22 Cartridge, brand new, \$6; G-E frequency modulation tuner, \$15. Want U.T.C. output transformer LS-61-A. UTC interstage LS-21 and 2 General Radio variac, 200 C or larger. A. J. Avis, 975 N. California Ave., Palo Alto, Calif.

FOR SALE—Western Electric oscilloscope I.C. 4 12-A 9", \$40. Transmitter and receiving set, brand new, plus accessories, ships in 3 cases, \$78. Will not sell separately. Irving Hornichter, 320 Beekman Ave., New York 54, N. Y.

WILL TRADE—Sprayberry radio course, Ghirardi's Radio Trouble Shooter's Handbook, Modern Radio Servicing, Radio News, Q.S.T., Want photographic equipment. E. F. Gest, P. O. Box 571, Port St. Joe, Ind.

FOR SALE—6-v p.a. system complete with 6-tube amplifier, 2 12" cone power driven speakers with metal baffles, 2-speed 6v turntable and crystal mike. All in first class condition. Sommers Song Shop, Prophetstown, Ill.

WANTED—On the job training. Mass. Radio graduate. Harry N. Johnson, 71 Codman Park, Roxbury 19, Mass.

FOR SALE—Used A-1 SX-30 with batteries. \$80; d-c meters; 0-100 microamp 0-1 ma., 0-15 ma., 0-200 ma., 0-15v, 0-30v; RF 0-2.5A. M. Nadler, Jr., c/o W. Hungrecker, 21 Ralph St., Highlands, N. J.

FOR SALE—400B diaphragm, in excellent condition, \$20, or will trade for condenser tester. Reinisch Radio Service, New Rockford, N. Dak.

WILL TRADE—Amplifiers, Bniff radio and transmitter receiver suitable for f-m with p-m speakers, tubes and accordion test instruments. Want battery eliminator 110v a-c to 8v d-c recorder, projector, camera, or what have you? John Arnold, AAA Radio Service, P. O. Box 84, Bluffs, Ill.

FOR SALE—1936 Chevrolet car radio. \$20. Karl Keemer, 63 Pearl Ave., Oil City, Pa.

FOR SALE—Tubes 40% off list, nearly all receiver type numbers. Also parts and equipment. Carlson's Radio Service, 324 E. Prospect, Kewanee, Ill.

WANTED—Used television set. State price, model and condition. Charley's Radio & Record Shop, 433 DeKalb Ave., Brooklyn 5, N. Y.

WILL TRADE—804 RF amplifier pentode, new but not in carton. Want Variac of from 1 to 2 amp. capacity in good condition. Eugene P. Tetraault, Route 1, Box 322, Walpole, Mass.

FOR SALE—UTC LS series audio transformers and 2 General Radio #119B, 0.5 henry chokes for building high quality phono amplifier described by Ready in Nov., 1946, QST, \$21; Acme double filter choke, 15 henries per section @ 600 ma d-c conservative, \$17.50. Write for list of filter condensers, transmitting tubes and other parts. Samuel C. Macy, Eupedon Farm, Clarkesville, Tenn.

SELL OR TRADE—Almost new HQ-129-X receiver in good condition, \$135, complete with phones and speaker. Want recording equipment and oscillograph in good shape and oscillators for audio and RF use. H. V. Patton, 857 Eighth St., Boulder, Colo.

WILL TRADE—Sonar FM, \$30, or R9'er 10-20 coils; also will sell 300 watt c.w., \$80. C. Astor, 59 Chestnut St., Rochelle Park, N. J.

FOR SALE—Capital Radio Engineering Institute course in practical radio engineering, both introductory and advanced. \$65. Gerold J. Barrone, 1618 Bay Court, Brooklyn 29, N. Y.

SELL OR TRADE—Sprayberry radio course, Ghirardi's Troubleshooters Handbook and Radio for the Millions by Popular Science, Elmer Davis, 1237 Ida St., Cincinnati, Ohio.

FOR SALE—Hallcrafters RE 1 Sky Courier radio, 6 tubes ac-dc or batteries, in perfect condition. J. D. Haywood, Mgr., New Central Hotel, Hopkinsville, Ky.

WANTED—Complete range of American Radio Service Gear, unable to purchase due to currency restrictions, would gladly earn, has anybody a proposition? E. Gatenby, 2 Park Ave., Ruislip, Middlesex, England.

FOR SALE—200 signal generator; Superior 450 tube tester, new. R.C.P., 446 multimeter, Meisner coil unit, all types of new and used tubes. S. Altzman, 222 S. 59th St., Philadelphia 39, Pa.

FOR SALE—New Collins AN/ART-13 250/125 watt Autotone transmitter with control box, plugs, cable, operating and maintenance instruction books, \$200; Hallcrafters S-20R receiver, \$49.95; Gardiner G-C code sender, \$17.75; MS-710 Oscillator, \$8.25. PFC John Bradley, S.I.A.S. Hospital, Staten Island 6, N. Y.

SELL OR TRADE—18" Cinaudiograph LM-18-30 high fidelity speaker; 2 Western Electric 264-B, 1 E.B. Meyer universal triode, 6L5-G, 6W7-G, and 164-R4 ballast; many other tubes. Want photographic equipment. Horace D. Westbrooks, 235 N. Hill St., Griffin, Ga.

FOR SALE—Walkie Talkie BC-745, ready to operate, including batteries, \$10. Also have portable 2-meter transceiver DK2 by Abbott, less batteries, with tubes, \$10. Ralph Franklin, Box 801, Detroit 31, Mich.

WANTED—Schematic wiring diagram of BC-455-A receiver. Will pay reasonable price for diagram or instruction book. Paul R. Taylor, 335 N. Buchanan St., Rushville, Ill.

YOUR OWN AD RUN HERE FREE

The Sprague Trading Post is a free advertising service for the benefit of our radio friends. Providing only that it fits in with the spirit of this service, we'll gladly run your own ad in the first available issue of one of the six radio magazines in which this feature appears. Write CAREFULLY or print. Hold it to 40 words or less. Confine it to radio subjects. Make sure your meaning is clear. No commercial advertising or the offering of merchandise to the highest bidder is acceptable. Sprague, of course, assumes no responsibility in connection with merchandise bought or sold through these columns or for the resulting transactions.

Dept. S-97, SPRAGUE PRODUCTS COMPANY
North Adams, Mass.

(Jobbing distributing organization for products of the
SPRAGUE ELECTRIC CO.)

ASK FOR SPRAGUE CAPACITORS and *KOOLOHM RESISTORS by name

*Trademark Reg. U. S. Pat. Off.

Meets **EVERY** Testing Requirement **BETTER**

NEW model 3413 ...LEVER SWITCHING... tube tester

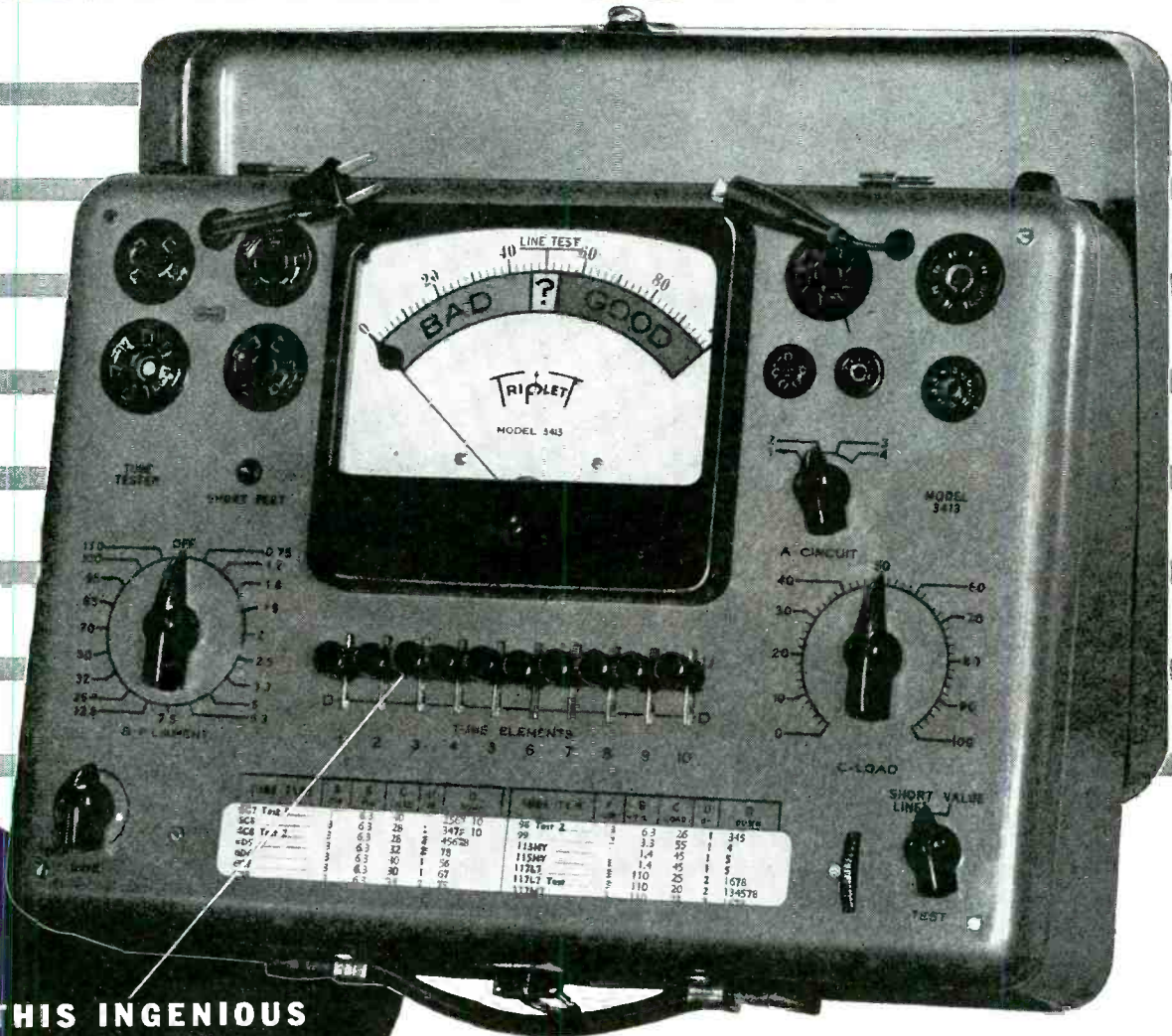

THIS INGENUOUS LEVER SWITCHING
"Pictures your circuit"
FAST · SIMPLE · FLEXIBLE
 Provides individual control of each tube element

With the new Model 3413 you can make your settings instantly—just snap the switch up or down. You actually "picture" the circuit. Usually not more than five of the ten lever switches need be set, yet you have individual control of each tube element. Many other convenient features make Model 3413 the buy of its field—such as the handy, built-in SPEED-ROLL tube chart, the larger easy-reading meter, the handsome new case with streamlined design. For either counter or portable use you will find Model 3413 a quality-packed tester that you'll be proud to own. Write today. Address Dept. S 97.

Precision first
...to last

Triplet

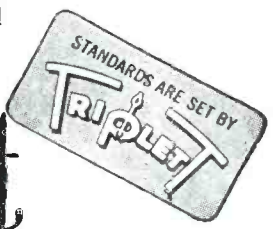

ELECTRICAL INSTRUMENT CO. BLUFFTON, OHIO

Full-powered RCA "Package" Amplifiers



...designed and priced to sell *Fast!*

30-WATT DeLuxe—for your larger installations.

RCA's package sound line now includes these high-performance amplifiers. They are smartly styled... correctly engineered... priced within your prospects' pocketbooks.

Quality features:

RCA-perfected inverse feedback circuits—even in the 12-watt size. This means excellent frequency response and constant voltage output with negligible noise and minimum distortion.

Low microphonics and hum—RCA-6J7 input tubes are used in all models.

High sensitivity—delivers rated output with only 3-millivolts input.

Complete control panels—containing individual volume control

for each input, wide range tone control, separate on-off switch and pilot light.

Smart, modern styling—gives you a decisive edge over competition. The contrasting black-and-satin chrome makes a handsome appearance. Considering the quality of these units, the prices are *low!*

Get these new folders on RCA amplifiers, microphones, speakers and intercoms. They contain descriptions and detailed specifications of RCA package items. Address: Dept. 76-I, Sound Equipment Section, RCA, Camden, N. J.



12-WATT Low-Cost Model provides full output with low distortion, ideal for small PA installations, paging and announcing.



15-WATT Size Covers Broad Field! Medium power, high-gain amplifier, perfectly suited to many classes of work such as ballrooms, amusement parks, restaurants and taverns.



**SOUND EQUIPMENT
RADIO CORPORATION of AMERICA**
ENGINEERING PRODUCTS DEPARTMENT, CAMDEN, N. J.

In Canada: RCA VICTOR Company Limited, Montreal

and now the **NEW** PRECISION

Electronamic* Test Master

SERIES 10-20

Combination, Master Lever operated, Tube PERFORMANCE Tester, Battery Tester and 34 range, PUSH-BUTTON operated, AC-DC Circuit Tester.

*An amplifying tube tested for just one selected characteristic does not necessarily reveal its overall performance capabilities. Electronic tube circuits look for more than just Mutual Conductance or other single factor. In the Precision MASTER Electronamic Tube Test Circuit, the tube under test is subjected to appropriately phased individual element potentials and is electro-dynamically swept over a complete Path of Operation, on a sinusoidal time base, encompassing a wide range of plate family characteristic curves. This complete Path of Operation is automatically integrated by the indicating meter in the direct and non-confusing terms of Replace-Weak-Good.

*REG. PEND. U. S. PATENT OFFICE

THE NEW SERIES 10-20 TEST MASTER

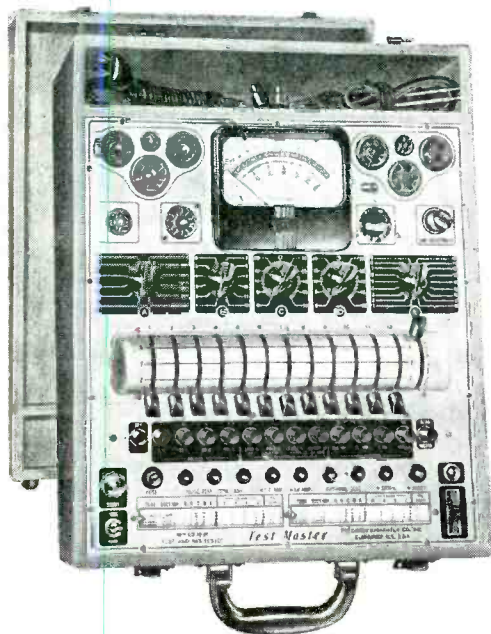

is a complete, rugged service laboratory incorporating the exclusive "Precision" ELECTRONAMIC Tube Performance Tester, combined with full 1000 ohms per volt A.C. and D.C. Multi-Range features; plus a complete radio A, B and C Battery Tester which reveals battery condition under dynamic load test. Ideally suited and particularly engineered for general-purpose radio-electronic and industrial-electronic maintenance, service and installation. Tests all modern standard receiving and low power transmitting tubes, including facilities up to twelve individual element prongs; dual-capped H.F. amplifiers, 5 & 7 pin acorn types, Noval 9 pin tubes, etc.

*Affords highest practical order of obsolescence insurance thru use of the Precision 12 station Master Lever Element Selector System.

CIRCUIT TESTING FEATURES

- ★ Six A.C., Six D.C. and Six Output Voltage Ranges:
0-6-12-60-300-1200-3000 volts
- ★ Four Self-Contained Resistance Ranges: 0-1000-100,000 ohms; 0-1-10 megohms (No A.C. power required)
- ★ Six D.C. Current Ranges: 0-600 microamperes 0-6-60-300-1200 MA. and 0-12 amperes.
- ★ Six Decibel Ranges from -20 to +64 DB.
- ★ All standard functions available at only two polarized tip jacks.
- ★ Automatic interlocking push-button range selection.
- ★ 1% wirewound and matched metalized resistors.
- ★ Large easy reading 400 microampere, $4\frac{3}{8}$ " meter.
- ★ All ranges self-contained, without any additional panel controls.
- ★ All circuits insulated from power line.

Ask to see the "Precision" Master Electronamic Test Instruments now on display at all leading radio parts and equipment distributors, or write directly for the new Precision 1948 catalog fully describing the Precision Electronamic tube performance testing circuit.

MODEL 10-20-P: in sloping portable hardwood case with tool compartment and hinged, removable cover. Size $13\frac{3}{4}$ " x $17\frac{1}{4}$ " x $6\frac{3}{4}$ " **\$109.10**

MODEL 10-20-C: in modern, chrome trimmed, counter cabinet; fine dull black ripple finish on heavy gauge steel. Size 17" x $17\frac{7}{8}$ " x $7\frac{1}{2}$ " **\$111.10**

MODEL 10-20-PM: mounted onto $17\frac{1}{2}$ " x 19" steel panel with rear enclosing dust cover. For standard rack mount... **\$109.10**

All models include test leads and ohmmeter batteries.



PRECISION
TEST EQUIPMENT

Standard of Accuracy

PRECISION

APPARATUS COMPANY INC.

92-27 HORACE HARDING BOULEVARD
ELMHURST 6, NEW YORK

Export Division: 458 BROADWAY, NEW YORK CITY, U. S. A. • Cables: MORHANEX

SERVICE, SEPTEMBER, 1947 • 11

FOR { **MUCH FASTER**
STILL BETTER **SERVICING . . .**
MORE-MONEY

it must be one of these three

DU MONT

Oscilloscopes



If it's Portability you want first . . .

Type 164-E ▶ The mighty portable cathode-ray oscilloscope. Only 20 pounds. For work in and out of the shop. A superb instrument of laboratory quality. There's no service job it can't perform. Housed in steel cabinet. Du Mont 3-inch cathode-ray tube. Sweep circuit of unusually wide range. Consumes minimum power. Dimensions: 11 $\frac{1}{8}$ " h. x 7 $\frac{3}{8}$ " w. x 14" d.

If it's Bigger Patterns you want first . . .

Type 274 ▶ Similar electrically to Type 164-E but designed for those who prefer the Du Mont 5-inch tube with clear, brilliant traces of larger size. Inexpensive. Highest quality. The five-inch tube permits the blowing up of even the most detailed waveforms. Weighs 35 lbs. Dimensions: 14" h. x 8 $\frac{5}{8}$ " w. x 19 $\frac{1}{2}$ " d.

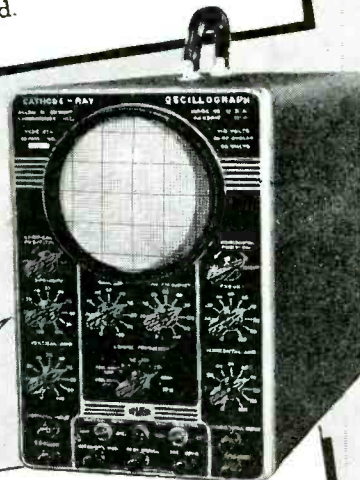

If it's the Post-Graduate features you want first . . .

Type 208-B ▶ Here's the exact same instrument you'll find in leading laboratories everywhere. Moderately priced yet amazingly versatile. Certainly the "class" in the service instrument field. With its Du Mont 5-inch intensifier tube operating at 1400 volts, this instrument is excellent for permanent shop installation. As an extra-quality instrument, it has all the features of the 164-E and 274, plus many more. Outstanding are the wide-band amplifiers and the extreme sensitivity. Weight: 54 lbs. Dimensions: 14 $\frac{1}{2}$ " h. x 8 $\frac{5}{8}$ " w. x 20 $\frac{1}{4}$ " d.

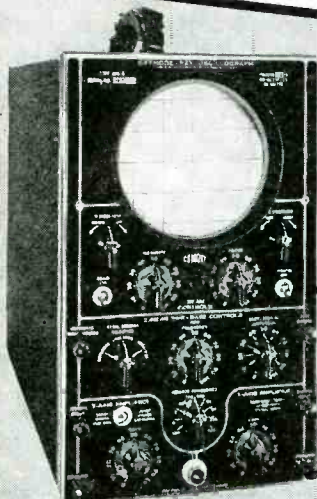

▶ **Make your selection from these three superb instruments. Descriptive literature on request.**

© ALLEN B. DUMONT LABORATORIES, INC.

DUMONT

Precision Electronics & Television

ALLEN B. DUMONT LABORATORIES, INC., PASSAIC, NEW JERSEY • CABLE ADDRESS: ALBEEDU, PASSAIC, N. J., U. S. A.

SUPREME PUBLICATIONS

New 1947 Radio DIAGRAM MANUAL

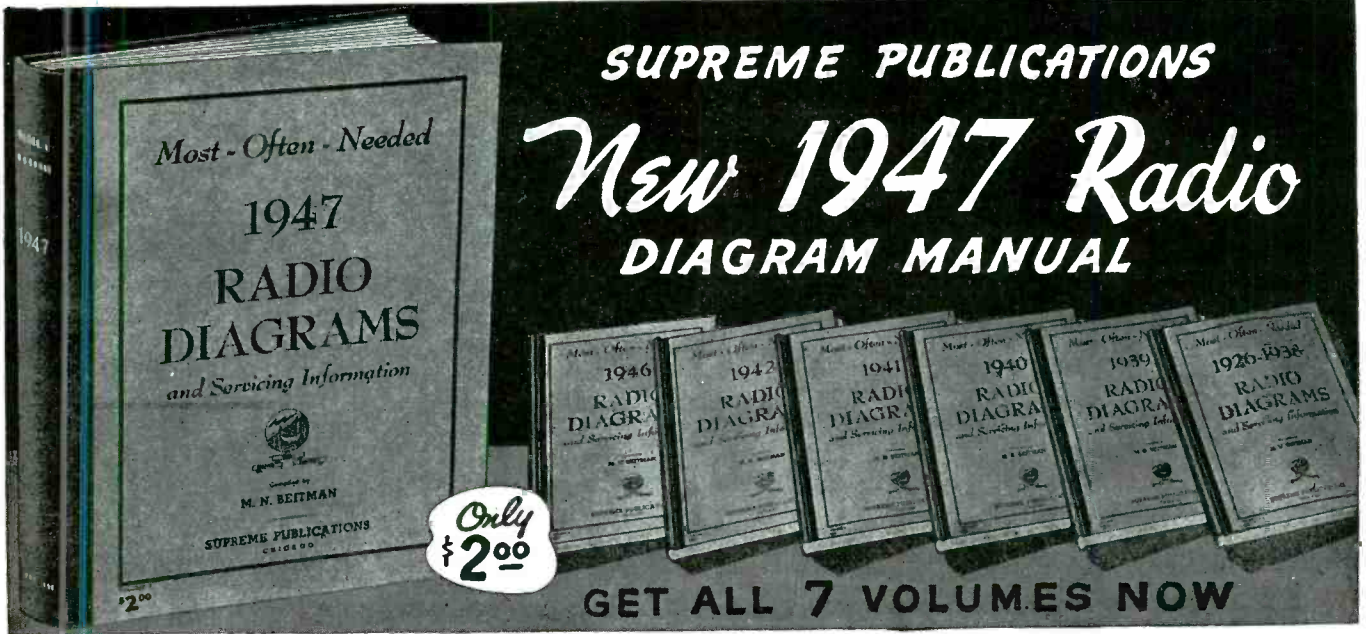

Amazing Bargain Offer in Diagram Manuals ALL NEW 1947 CIRCUITS—SERVICE DATA YOU NEED TO GET AHEAD

Be prepared to repair quickly all new 1947 sets. In this big single volume you have clearly-printed, large schematics, needed alignment data, replacement parts lists, voltage values, and information on stage gain, location of trimmers, and dial stringing, for almost all sets released between June 1, 1946, and March 1, 1947. A worthy companion to the six previous volumes used by over 100,000 shrewd radio servicemen. There is no

need to spend large sums for bulky, space-wasting manuals or to buy additional drawings every few weeks—get this low-priced new SUPREME PUBLICATIONS manual and you have service information on all popular 1947 sets. Covers 327 models of 52 different manufacturers. Large size: 8½x11 in., 192 pages + index. Manual style binding. Price postpaid, **\$2.00** only

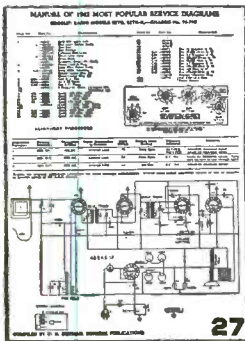

Actual page size is 8½x11 inches

Most Popular Models Made by:

R. C. A., Zenith, Philco, Sears, Fada, Emerson, Belmont, Detrola Radio, Majestic, United Motors, G.E., Westinghouse, Arvin, Stewart-Warner, Admiral, Delco, Stromberg - Carlson, Western Auto, Wards, Sparton, Motorola, Gamble, Crosley, and many others.

Guarantee

All manuals sold on 10-day trial basis. You must be entirely satisfied or your money will be refunded.

Supreme Publications
(In business 14 years)

Speed up and simplify all radio set repairs with SUPREME PUBLICATIONS Manuals. Service radios faster, better, easier, save money and time, use these **most-often-needed** diagram manuals to get ahead, earn more per hour. At unbelievable low cost (only \$2 for most volumes) you are assured of having in your shop and on the job, needed diagrams and other essential repair data on 4 out of 5 sets you will ever service. Every popular radio of every make from old-timers to new 1947 sets, is included. Clearly printed circuits, parts lists, alignment data, and helpful service hints are the facts you need to improve your servicing ability. Save hours each day, every day, let these seven volumes furnish diagrams for 80% of all sets. See pictures of these attractive manuals above. Each volume has between 192 and 240 pages, large size 8½ x 11 inches. Manual style binding. Send coupon today. Complete satisfaction guaranteed.

Post-War Automatic Record Changers

Service expertly all new (1945-1947) record changers. Follow simplified factory instructions to make needed adjustments and repairs. Hundreds of photographs and exploded views; thousands of test hints; service instructions for all popular makes. Large size: 8½ x 11", 144 fact-filled pages. At your jobber or postpaid, only **\$1.50**

Pre-War Record Players, Changers, & Recorders.

Just what you need to repair quickly thousands of pre-War automatic record changers, manual units, pick-ups, wireless oscillators, recorders, and combinations. Hundreds of mechanical and electrical diagrams. Instructions for adjustments and repairs. Most popular units of all makes. 128 large pages. 8½ x 11 inches. Price, only **\$1.50**



Compiled by M. N. Beitman, radio engineer, teacher, author, and serviceman.

See Your Radio Jobber or Send Coupon →

Supreme Publications

PUBLISHERS OF RADIO BOOKS, MANUALS, AND DIAGRAMS

9 South Kedzie Ave.

Chicago 12, Illinois

NO RISK TRIAL ORDER COUPON

SUPREME PUBLICATIONS, 9 S. Kedzie Ave., Chicago 12, ILL.

Ship the following manuals: (Satisfaction guaranteed or money back)

- | | | |
|---|-------------------------------------|--|
| <input type="checkbox"/> 1947 | } PRICED AT ONLY \$2.00 EACH | <input type="checkbox"/> Post-War Record Changers... @ \$1.50 |
| <input type="checkbox"/> 1946 | | <input type="checkbox"/> Pre-War Record Players... @ 1.50 |
| <input type="checkbox"/> 1942 | | |
| <input type="checkbox"/> 1941 | | <input type="checkbox"/> I am enclosing \$.....send postpaid. |
| <input type="checkbox"/> 1940 | | <input type="checkbox"/> Send C.O.D. I am enclosing \$..... deposit. |
| <input type="checkbox"/> 1939 | | |
| <input type="checkbox"/> 1926-1938 @ \$2.50 | | |

Name:
Address:

SYLVANIA NEWS

RADIO SERVICE EDITION

SEPT.

Prepared by SYLVANIA ELECTRIC PRODUCTS INC., Emporium, Pa.

1947

NEW SYLVANIA OSCILLOSCOPE BOASTS 7-INCH CATHODE RAY TUBE—IS ONLY \$124.50!

Wide Variety Of Uses — Excellent For Rapid Receiver Alignment and Trouble Shooting



Panel is heavy aluminum finished in silver gray, with type and decorations hand screened. Each finish coat and the silk screening are separately baked under a carefully controlled process—for long life and maximum beauty. Here's an impressive, versatile instrument for your establishment.

Now! For little more than you would pay for a smaller instrument, you can obtain a big beautiful, 7-inch Oscilloscope that's the last word for servicing. Excellent for audio circuit analysis, transmitter checking, filter circuit and hum analysis.

CHARACTERISTICS AND SPECIAL FEATURES

Large 7-inch cathode ray tube provides "Jumbo" patterns.

A new push-pull deflection circuit provides clearer patterns, less distortion and more gain.

Observation of a wider variety of phenomena is made possible by the addition of a Z axis input for intensity modulation. This feature is useful in studying pulses and portions of cycles, and leads to many applications in industry.

Panel binding post provides 6.3 volt AC .3 ampere supply for convenient external use.

Subdued red-jeweled panel lamp assembly with removable cap for easy replacement of lamp.

Extra-long, heavy-duty line cord.

Externally accessible line fuse at rear of cabinet.

Power Supply: 105-125 volts, 50-60 cycle, 35 watts.

Accelerating potential 1400 volts.

Horizontal Sweep: Left to right with frequency from 15 to 30,000 cycles. Synchronizing signal sources: internal (vertical), external, line frequency.

Deflection Factor at 1000 cycles

AMPLIFIERS: Vertical .21 volt rms per inch peak to peak deflection.
Horizontal .25 volt rms per inch peak to peak deflection.

DIRECT: Vertical 15 volts rms per inch peak to peak deflection.
Horizontal 18 volts rms per inch peak to peak deflection.

Amplifier frequency response is flat to within 3 db. from 7 cycles to 140 kc. at full gain.

Input Impedance

AMPLIFIERS: Vertical .5 megohm; 26 mmfd.
Horizontal .5 megohm; 33 mmfd.

DIRECT: Vertical and Horizontal 3.9 megohms; 20 mmfd.

INTENSITY MODULATION: .5 megohm; 30 mmfd.

For more complete information, write

Sylvania Electric Products Inc., Radio Division, Emporium, Pa.

SOLD THROUGH YOUR SYLVANIA DISTRIBUTOR

SYLVANIA ELECTRIC

MAKERS OF RADIO TUBES; CATHODE RAY TUBES; ELECTRONIC DEVICES; FLUORESCENT LAMPS; FIXTURES; WIRING DEVICES; ELECTRIC LIGHT BULBS

SERVICE

Fig. 2 (right). Circuit of the switching, a-m detectors and first a-f, and power system of the f-m/a-m receiver shown on the cover. Incidentally, 2 on the cover diagram is connected to the alignment test lead on the speaker plug.

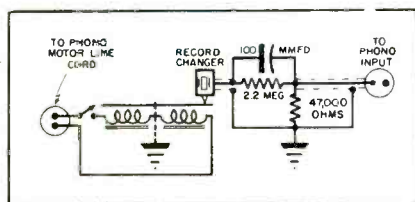
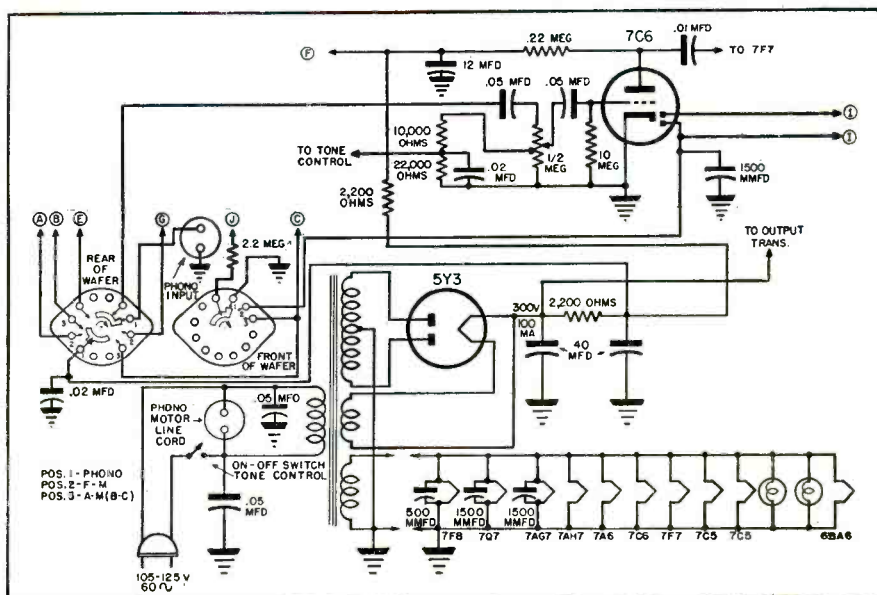

Fig. 3. The phono-record circuit of the receiver.



F-M/A-M Chassis For Custom Installations

[See Front Cover]

AN 11-TUBE F-M/A-M receiver, the Espey 7B, featuring four double-purpose tubes, push-pull audio, a ratio detector and provision for phono, appears on the cover this month. Designed for custom installation, a chassis, speaker, built-in antenna and the necessary mounting hardware are supplied.

The receiver utilizes a pair of composite i-f transformers for the a-m (455 kc) and f-m (10.7 mc) i-f stages. The transformers are complete individual units encased in a single can, but the methods of coupling, tuning, and layout are entirely different. Because of the vast difference in resonant frequencies, no interaction prevails.

Because of the stability requirements of high-frequency circuits there are separate converters for a-m and f-m, separate r-f circuits and independent tubes for both a-m and f-m inputs. This design has eliminated switching of high-frequency components.

The f-m antenna coil consists of a primary which is matched to a 300-ohm transmission line. The secondary of this coil feeds the grid of an untuned 6BA6 miniature tube r-f ampli-

fier; this tube provides a substantial boost of the input signal and prevents any detuning effects that may be caused by mismatching or improper antenna installation.

The output of this tube is capacitively coupled to the grid of a 7F8 double triode, used as the oscillator connector stage. This tube was selected for its effectiveness at the v-lf f-m frequencies. There is AVC on the grid of this tube, parallel fed, controlling voltage being obtained from the ratio detector.

The r-f triode portion of this tube is in a unique circuit which keeps the input impedance, and consequently the gain, at as high a level as possible. Degeneration is introduced into the cathode circuit of the triode. A small portion (4 ohms) of the cathode bias resistor is unbypassed at the cathode pin of the tube, and a small inductance wound on a 1,000-ohm resistor is in series with the plate of this triode and the plate lead of the 10.7-mc i-f which it feeds. This choke increases the load impedance of the tube at the operating frequencies and consequently reflects

back into the grid circuit as an increase in input impedance.

The 10.7-mc input transformer feeds into a 7AH7 i-f stage and then into a 7AG7 amplifier stage which feeds the ratio-detector transformer. This transformer sends its signal into a 7A6 double diode, which in turn, detects the i-m signals and subsequently feeds the audio into the audio amplifier stages of the receiver.

For a-m a conventional 7Q7 converter is used, which feeds a 455-kc signal into the 7AH7 tube. From there it is sent through another 455-kc i-f into the diode portion of a 7C6 tube. This tube is also the first a-f stage. Individual detector circuits and components are used for the a-m and f-m circuits.

Provisions have been made to facilitate service and production alignment of the f-m circuits by terminating the voltage measuring points required for i-m alignment in the dummy pins of the speaker socket at the rear of the chassis. These terminations also have isolating resistors in series with the

(Continued on page 55)

Auto

by JACK DARR

Ouachita Radio Service
Mena, Arkansas

Radio Installation and Servicing

Setting Up Flexible Test Bench Facilities. Solving Power-Supply Troubles. Hints For Alignment, Adjustment of Slug Tuners, Mounting of Chassis and Antennas, Road Tests, etc.

AUTO RECEIVERS are basically similar to home-type sensitive sets. Most variations appear in the power systems and tuning mechanisms. The extremely unfavorable conditions under which these sets are used demands extreme care in installing and servicing. Very few receivers can be serviced in the car due to the inaccessibility of parts. Replacement of tubes and checking vibrators is about all that can be done with the set in the car.

For servicing the bench test setup should be very flexible to allow connection of any type for test. In our shop (Fig. 1) the bench setup includes a panel with a battery voltmeter, ammeter (30-0-30), charge rate ammeter, test speaker terminals, portable ammeter and the necessary test leads. A 6-volt storage battery is beneath the bench, connected to a small charger, and then by heavy leads to posts on the panel. The ammeter, in series with the battery, allows quick checking of current drain. This is invaluable for detecting leaky buffers, bad vibrators, and all kinds of power-supply troubles. Experience will reveal the correct drain for each type of set, and any excess should be investigated.

Test speaker terminals, for either the transformer or voice coil, permits testing of the set-speaker while in the car. There's also a bench antenna, four feet of wire between standoff insulators above the bench. The lead from this antenna is provided with an

antenna plug of the pin type, with adapter to fit the older *bayonet* sockets. Our service equipment for testing, aligning, etc., is conventional. Incidentally we've found the signal-tracer to be extremely useful.

Power supplies differ in most models only in the type of vibrators used, the non-synchronous or interrupter type being the most frequently encountered. This type uses a tube rectifier, 6X5, 84, OZ4, etc., and is not polarized. The synchronous type provides rectification in the vibrator itself, and is polarized. This should be checked before installation and then connected for the battery polarity of the car. These may be reversed by reversing leads to either primary or secondary points, at the vibrator socket, but not both. Some sets use a reversible vibrator, which may be inserted two ways, to correspond with battery polarity needed; Fig. 2a and b.

Leaky buffer capacitors, open or shorted filters, and bad vibrators are the most common power-supply troubles. Now and then a bad transformer pops up. This will be indicated by unequal voltages on rectifier plates. Over 20 volts difference between plates is an indication of trouble and the transformer should be replaced. Buffer capacitors should be replaced whenever a vibrator is changed, or when signs of wax leakage are apparent. Service manuals should be checked carefully for the correct value. Some

have a habit of inserting whatever value they happen to have handy. Incidentally 1,600-wv capacitors should always be used for buffer replacements.

The best cure for noisy or hard-starting vibrators is replacement. New types are sealed so that it is difficult if not impossible to adjust them, and the points are usually burnt enough to cause failure within a short time. Rectifier tubes used are identical with other types, except for the OZ4, a cold-cathode full-wave mercury-vapor job. These have a nasty habit of working perfectly for a while and then failing to ionize. If everything else seems normal and the vibrator sounds good, etc., but the volume is weak or non-existent, the OZ4 should be checked. If replacement is necessary and an OZ4 is not available, a 6X5 may be used by adding one wire to heater, pin 2. Other connections are identical. You'll find the 6X5 to work very well, with r-f hash reduced, too. It will be necessary to replace and resolder all bonds on the *hash-box* or cover on bottom of rectifier and vibrator sockets. This will keep r-f noise and hash at a minimum.

Alignment procedures are standard. Most i-fs are in the 450-kc band, with an occasional 262 encountered in older sets. In checking the r-f and antenna trimmers are the last to test, with the signal-generator lead hung up near the lead-in wire, as loosely

Fig. 1. Auto service bench built by Jack Darr. In base, from left to right, are the battery voltmeter, test speaker terminals, 30-0-30 ammeter, portable ammeter, charge-rate ammeter and charge switch.

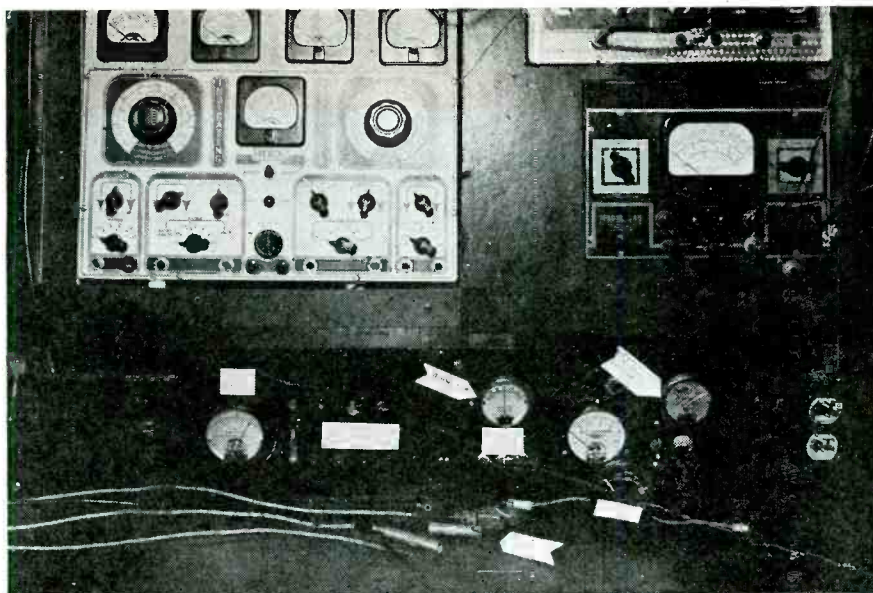

coupled as possible. Ground connections shouldn't be hooked up when making final test, as this will increase sensitivity and cause misleading results. Practice will tell you when the set is hot enough on the bench to give good results in the car.

When replacing parts, fasten securely. Clamping to chassis is best, or taping to adjacent parts. Auto sets are subjected to severe vibration and shock, and a capacitor left hanging by the leads will soon be bouncing around in the bottom of the set, causing a call-back. A thorough check should be made on all chassis bonding, shielding, etc., from gang capacitor frame to chassis, speaker frame to chassis, and the like. Wipers of gang capacitors should be checked for dirt and corrosion. Switches, auto-tuners, tone switches, etc., must also be checked carefully for dirty contacts. Automatic tuners should be

Fig. 2. In *a* we have a non-synchronous vibrator, with a tube rectifier and no polarity. A synchronous-type rectifier is shown in *b*. This type has a polarity.

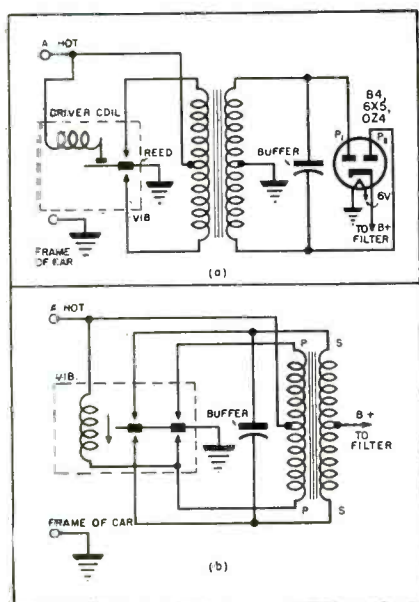

thoroughly checked while on the bench. Most of the newer receivers use permeability, *slug*, tuners, which operate with a solenoid. This pulls a *rack* holding the slugs into the coils, then releases it, to return to a point determined by setting of a *dog* on the tuner. It is necessary to check for free travel on all positions. If any bind or drag is apparent, you'll have to clean with carbon-tet and wipe as dry as possible. Fine sandpaper on guide rods and slides is sometimes necessary to remove accumulated dirt. A minimum of grease should be applied on guides and tuner-screws. Cores must be handled carefully, as they will sometimes break. If tuning adjustment is necessary on slugs, screws should be resealed with a drop of speaker cement on screw, with extreme care being exercised in applying so that no cement drops on the core. On the Philco auto-tuners which use a third shaft turning a rotary switch and *electric* tuning, it's necessary to see that the switch action is free and contacts are clean. When re-installing, you should be very sure that this third cable is fastened down *tightly* along its whole length. Even a small play in this shaft will cause the tuner to stop between stations. Taping firmly to braces and other cables will help.

Installations are not the dreadful job they once were. A minimum of equipment and a well-developed routine will make almost any job easy. Tools required include a $\frac{1}{4}$ " electric drill with bits, two rotary files (reamers) $\frac{1}{4}$ " and $\frac{1}{2}$ ", a short trouble light, an extension cord long enough to reach all around the car, a portable VOM with a low-ohms range, end-

wrenches or ratchets up to $\frac{5}{8}$ ", Phillips, *clutch* and regular screwdrivers.

Chassis Mountings

You will find two major types of mounting; the small set which mounts under the dash, with a metal strap holding the back, and the larger sets mounted on the firewall, with the control-unit and sometimes the speaker mounted on the instrument panel, in the openings and grille. Firewall-mounted sets use two bolts either in the chassis itself or *J* bolts which hook into holes in the end of the case.

A routine for installations will speed up the job. Our shop routine begins with checking of the set on the bench. This saves removal from the car if the receiver is defective.

In the second step the necessary tools are secured for the car work. Antenna holes are then spotted. When doing this, you should be sure that the holes clear all braces, emergency brakes, etc., inside the car.

Auto Antennas

There are two major types of antenna, the single-hole cowl-fender type, and the *two-post* side-cowl types. Fortunately, the many weird modifications of the past, the insulated trunk-door, the insulated running-boards, etc., are rapidly disappearing. To install, all paint and insulating material should be cleaned from inside of mounting holes to insure good ground-

Mallory Contributions to Television

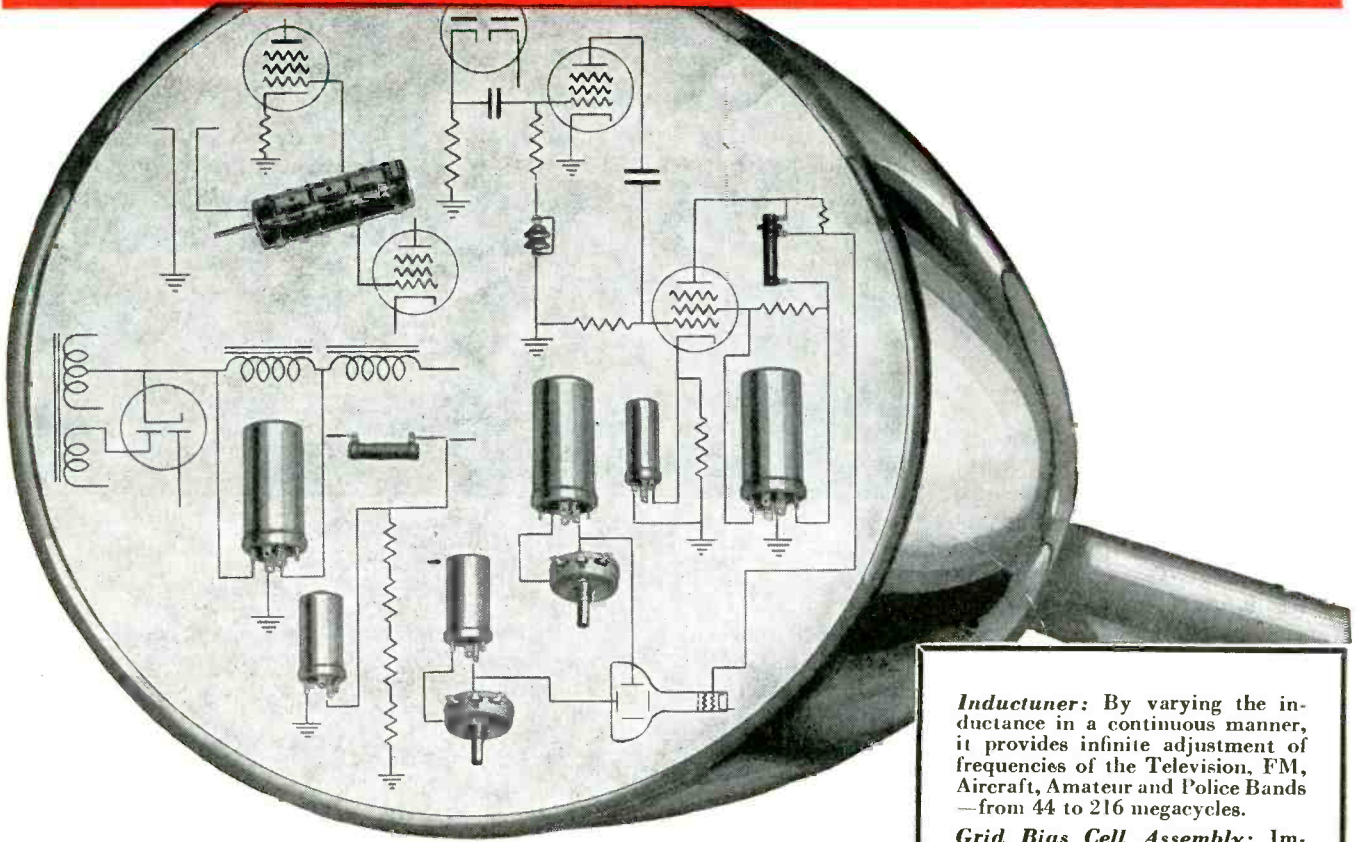

ANTICIPATING the day when servicing of television sets will be as common as present-day servicing of radio sets, Mallory has long been engaged in planning, designing and building television components.

The result of this foresight is shown in the typical television circuits illustrated above—circuits in which no less than ten different Mallory parts find an important place. Three of these parts—the Inductuner*, the Videocoupler and the Grid Bias Cells—are of exclusive Mallory design.

The important point about these products is that they conform to standards for which Mallory is famous. Each in its own right is a true "Approved Precision Product." Each has the earmark of premium quality. You expect more and get more from Mallory components. That's true, too, of these television products.

*Reg. U. S. Pat. Off.

Inductuner: By varying the inductance in a continuous manner, it provides infinite adjustment of frequencies of the Television, FM, Aircraft, Amateur and Police Bands—from 44 to 216 megacycles.

Grid Bias Cell Assembly: Improves picture quality by aiding low frequency response and effectively eliminating stray pick-up.

Videocoupler: Widens frequency response, resulting in better picture definition.

FP 550 Capacitor: A unique decoupling and screen bypass capacitor.

10 Watt Vitreous Enamel Resistor: Used as a voltage dropping or bleeder resistor in low voltage power supply.

WP 540 Capacitor: Bypass for vertical centering.

WP 510 Capacitor: Bypass for horizontal centering.

WP 505 Capacitor: Bypass in compact container for video stage cathode circuit.

FP 135 Capacitor: Filter in low voltage power supply; effectively eliminates 60-cycle "hum band" distortion.

Carbon Controls: Used as tone, volume and contrast controls. (Not shown.)

Wire Wound Controls: Used for horizontal and vertical centering.

P. R. MALLORY & CO. Inc.
MALLORY

VIBRATORS . . . VIBRAPACKS* . . . CAPACITORS . . . VOLUME
CONTROLS . . . SWITCHES . . . RESISTORS . . . FILTERS
. . . RECTIFIERS . . . POWER SUPPLIES.

*Reg. U. S. Pat. Off.

APPROVED PRECISION PRODUCTS

P. R. MALLORY & CO., Inc., INDIANAPOLIS 6, INDIANA

ing of shield. On the top-cowl types, the leadin should be connected before inserting antenna, as these usually wind up in a very tight place. After installation, a low-range ohmmeter should be used to check from antenna rod to center of plug. Antenna should be shaken to check for loose connections. Shields and antenna to ground should also be checked; former readings being zero resistance, and latter, infinity. There should also be a check from the antenna rod to plug, as dirt and moisture will often introduce a resistance as high as 5,000 ohms, and cut down the signal. Leadin over emergency-brake mechanism should be dressed and fastened firmly in place with friction tape, to avoid having it chopped in two when caught in the ratchet. Be sure and replace kick-pacs, as they are hard to get to after set is installed. The third step involves installation of the set. Mounting holes are first drilled. Mounting bolts should clear voltage-regulators, etc., on other side of firewall. Location of control shafts on set must be watched, so that they will not be fouled by choke rods or other controls. Pads of celotex, wood, etc., may be used under one side of case to raise it into clear. Set should be tightened down securely. Installation of control-unit and speaker, if instrument-panel type, follows. Control shafts should be dressed so they will have a minimum of sharp bends and tied down with tape. In mounting panel speaker, see that it does not foul wiper motor or other gadgets under dash. On cars using two-way ignition switches such as Dodge, Chrysler, etc., the hot lead connects to longest bolt, capacitor being connected across hot-lead connection, grounding case under nearest bolt.

Suppressors and Capacitors

In the next step hood is opened and distributor suppressor and generator capacitors are installed. For cable type suppressors, cable is cut from coil to distributor and screwed into each end of suppressor. For plug-in type, center lead is removed from distributor cap and suppressor is plugged in, plugging cable into suppressor. Generator capacitors are installed on the generator itself. Capacitor must not be connected to field terminal on voltage-regulated generator. On cut-out types, capacitor is connected to generator side of cutout.

Hood is then closed tight and engine started. Check for noise at both ends

of dial. If *plug-noise*, a popping noise changing in frequency with engine-speed is heard, antenna should be disconnected from set. If noise disap-

pears, it is being picked up on the antenna or leadin. Grounding of hood and fenders must then be checked. An ungrounded hood will feed noise into the antenna itself. Bond or clean up to cure. Generator noise is a whine, also changing in pitch with engine speed. A capacitor on the armature lead will stop this. If motor noise remains with antenna disconnected, it's chassis pickup, coming into the set through the hot lead, control shafts or ungrounded speaker lead shielding. On sets with a large multi-contact plug for auto-tuner and tone control, this plug must be firmly seated to ground shielding. Real *chassis pickup* is rare in late sets, fortunately. On the 1937-38 Fords, a loud ripping noise may be heard. In this case stop engine, turn ignition switch on, and jar running-boards heavily. If noise is heard, a capacitor should be installed across tank-unit of fuel gauge. This is under a small port in trunk floor.

The Road Run

The final step is a road run, with the car being taken for a run around the block, over rough roads. This will locate loose connections. Then a run on a smooth pavement, and checking at moderate speed can follow. If a scratchy noise appears, cut switch and coast. If noise remains until car stops, it's wheel static. Grounding springs should be installed in front hubs under grease-caps. Somewhat similar noise is found from tires at high speeds, and may be cured by blowing graphite powder into tubes.

Value of Auto Work

In conclusion, auto-radio work is sometimes a headache, sometimes fun, but it will prove to be a profitable branch of your business if you do it well. Car owners will pass the word along, if satisfied, and lead you to valuable contacts with the higher-income group.

Fig. 3. Typical antenna setups used on auto radios today. At top, we have a four-section 100" side-cowl mount type. Below appears a three-section 66" type of side-cowl mount. Then we have a three-section 56" fender-mount type of installation. A universal 56" top-cowl mount type is shown in the next view. Another form of side cowl mounting, three section 66", is next illustrated. In the last view appears a three-section 68" fender or cowl mount with a universal angle adjustment.

(Courtesy General Electric)

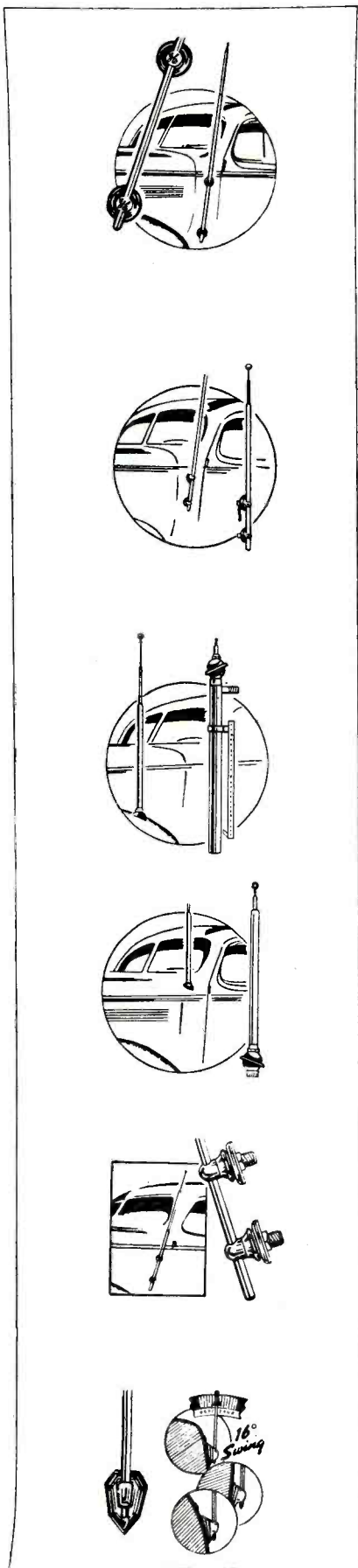

F-M Limiters

Why They Are Used and How They Work With Discriminator or Second-Detector Circuits

THERE ARE SEVERAL f-m receiver factors that are puzzling to many. One involves the differences between an f-m and a-m receiver.

The principal differences are:

(1) The f-m receiver uses a different type of second detector; discriminator or ratio detector.¹

(2) When the discriminator is used, there are one or two modified stages in the intermediate-frequency amplifier just preceding the discriminator which act as voltage limiting stages and are known as limiters.

(3) A greater over-all gain of the receiver, from antenna to the input of the second detector.

(4) A higher intermediate frequency, being in most cases above 4 mc.

(5) A wide band i-f, since the bandwidth requirements of an f-m signal are much wider than that used in a-m. The frequency response of the intermediate frequency amplifier must

be wide enough to pass the total range through which the f-m signal deviates.

Requirements of the R-F Circuits

The antenna and r-f circuits used in f-m receivers perform the same general functions as those used in the ordinary a-m receiver, i.e., to improve selectivity, increase the sensitivity, and reject the image frequency.

However, one of the important requirements of an f-m r-f circuit is that its frequency response be broad enough so that uniform amplification of all deviation frequencies due to modulation is obtained, Fig. 2. At the r-f frequencies used for f-m broadcasting, this requirement presents no problem and it is not necessary to take any special precautions.

The Limiter Stage

The limiter, used with a discriminator (second detector) f-m model, is

part of the final i-f amplifier stage and its main function is to remove all amplitude variations that might be present in the i-f signal up to the input of the limiter and to feed a signal to the discriminator circuit that is constant in amplitude. In other words, it limits or shaves off any peaks that might be present on the i-f signal due to noise. This is necessary since any amplitude variations in the signal reaching the discriminator would result in distortion and noise in the output of the receiver.

A good example of this action is shown in Fig. 3, which compares the limiter to a gate which removes all amplitude variations in the signal above a certain level as determined by the gate and passes a signal that is constant in amplitude.

In Fig. 4 we have a typical limiter stage, essentially an amplifier which is very easily overloaded.

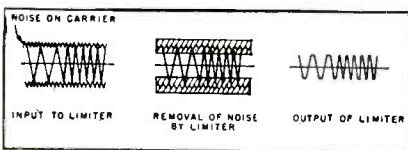
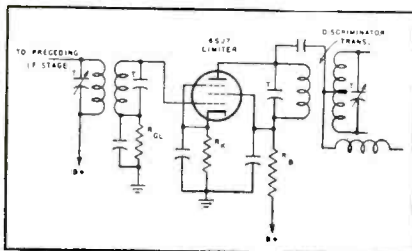

Fig. 3. Characteristics of limiter operation.

Fig. 4. A typical limiter stage.



¹August, 1947, SERVICE.

Fig. 6 (right). Limiter operation at varying signal levels.

Fig. 5. Plot of output versus the input signal of limiter stage.

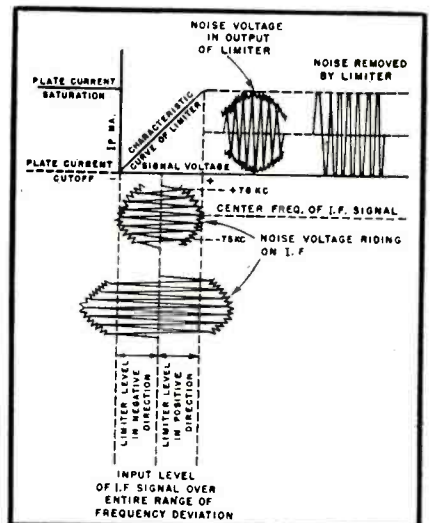
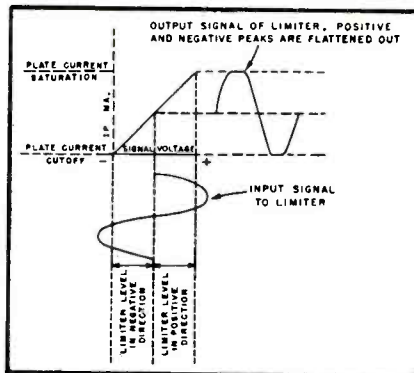

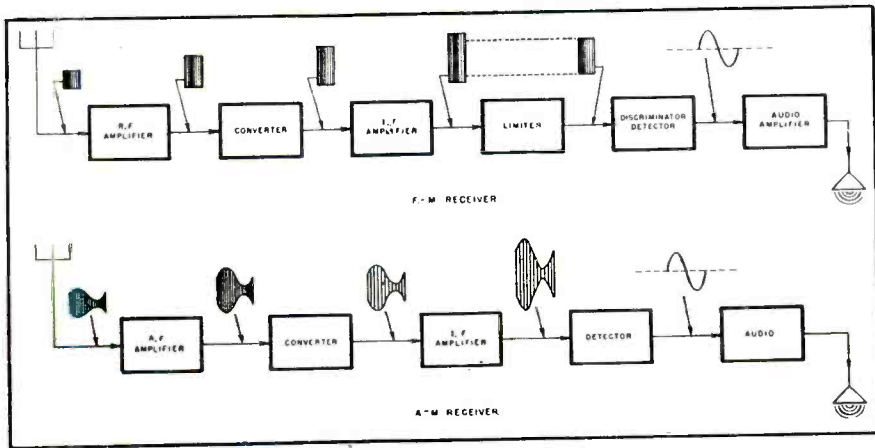

Fig. 1. A comparison of the makeup and wave shapes in an f-m and a-m receiver.

off tube, such as the 6SJ7, is used and the plate and screen are operated at low voltages by dropping the voltage through R_B . Thus, with a small signal on the grid, it will produce plate current saturation and cause plate-current cut-off when the signal increases negatively. This action is shown by Fig. 5. It will be seen that with the proper choice of bias and maintaining the plate-screen voltages at a low potential, both halves of the plate current cycle will be equal, but the peaks will be limited or flattened out. This action, therefore, removes any variations in the amplitude of the signal applied to the limiter grid which are greater than those required for plate-current cut-off and plate-current saturation.

It would seem that the action of the limiter in flattening the plate-current peaks would introduce severe distortion in the output of the receiver, since the plate-current variations are not exact reproductions of the grid-voltage variations. This would be true in an a-m receiver. However, in f-m the modulation component is contained in the frequency deviations of the signal,

rather than in amplitude variations of the signal and the flattening of the plate-current waveform will not introduce audio distortion. The relative frequencies present in the frequency deviation due to modulation are not affected by the action of the limiter.

An important point in securing satisfactory limiter action is the amount of signal voltage required at the input to the limiter. If the signal at the limiter grid is too low for satisfactory limiter action, it will cause two undesirable effects. First of these is that any amplitude variations in the signal due to noise will not be clipped off, and the second is that the dynamic range of the signal as transmitted will not be duplicated in the receiver.

The first of these undesirable effects is analyzed in Fig. 6. Here we see signals of varying amplitude at the input of the limiter and the resultant variations in plate current response in the limiter output. It will be noted that a signal of low amplitude, entirely below the level of the limiter action, will be amplified in a linear manner along with whatever noise peaks that

Fig. 2. Typical response of r-f stage in a f-m receiver.

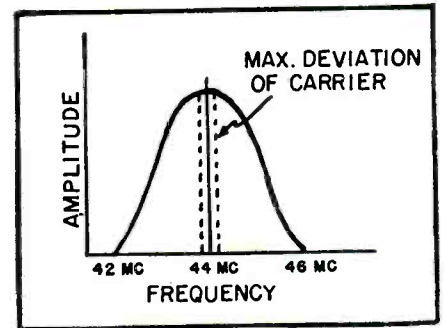

might be present. However, if the i-f signal has been amplified enough to give good limiting action, then the output of the limiter will be of constant amplitude and any noise peaks that were present in the input will be eliminated. It is for this reason that it is so desirable to have as much gain as possible in the r-i and i-i stages of an f-m receiver. In the i-f amplifier, the ideal response curve would have a flattened top for a range of 150 kc and then slope off suddenly with steep sides. However, this ideal is usually not realized and the response looks more like that shown in Fig. 7. Now if this signal were so low that it was below the level of the limiter action, then it would be amplified in the plate circuit in a linear manner and would appear as shown in Fig. 8. This means that the various frequencies making up the total frequency deviation would not appear in the discriminator at the same relative amplitude and would cause severe distortion in

(Continued on page 55)

Fig. 7 (below). A typical i-f selectivity curve.

Fig. 8 (left). Limiter action when the signal is insufficient.

Fig. 9. Limiter action on a strong signal.

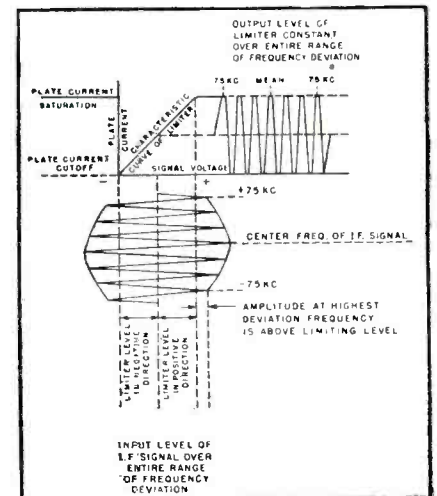
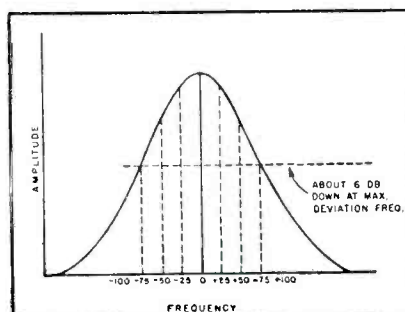
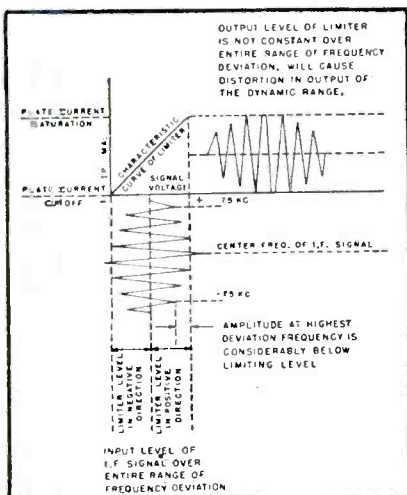

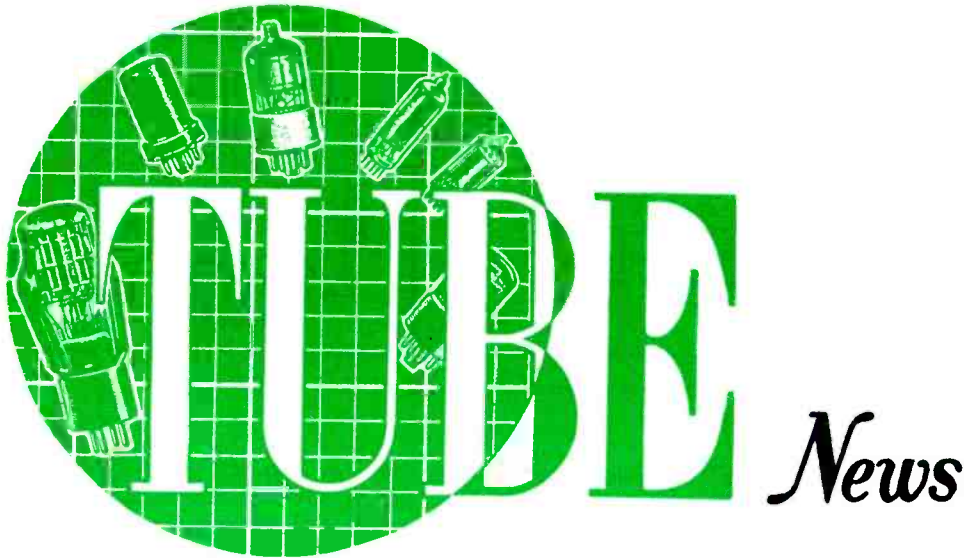

TUBE News

Fundamental Properties of Tubes, Amplifier Classifications, and Definitions of Tube Terms

Fundamental Properties

THE MAJOR OPERATING characteristics of a vacuum tube can be expressed in terms of the amplification factor (μ), the dynamic plate resistance (R_p) and the mutual conductance (G_m). When these are known one can make quantitative calculations of the tube performance under many conditions.

The *amplification factor* is defined as the ratio of a small increment in plate voltage to the corresponding change in grid voltage necessary to maintain constant plate current. In other words, it is the ratio of the effectiveness of the grid and plate voltages in producing electrostatic forces at the surface of the cathode. The amplification factor depends upon the configuration of the electrode system, especially the grid structure, and the electrode voltages. Changes which cause the grid to more completely shield the plate from the cathode will increase the value of μ .

The *dynamic plate resistance* may be defined as the ratio of a small change in plate voltage to the corresponding change in plate current produced. The value will depend upon the grid and plate voltages at the operating point under consideration. It will *not* be equal to the ratio of total plate voltage to total plate current. The dimensions and relative positions of

the tube electrodes will largely determine the value of plate resistance.

The mutual conductance, sometimes called control grid-plate transconductance (S_m), is the ratio of the amplification factor to the plate resistance and represents the rate of change in plate current with respect to the change in grid voltage, when the other voltages remain constant.

Interelectrode Capacities

The electrodes of a vacuum tube form a complicated electrostatic system, and each element may be considered as forming one plate of a small capacitor. In a three-element tube the capacitance between the cathode and grid, between the grid and plate, and between the plate and cathode, are known as the interelectrode capacitances of the tube. Of these, the grid-plate capacity is generally the most important. The effect of these capacitances depends upon the relationship between their reactances and the associated external circuit impedances. Their effect is, therefore, a function of frequency and external load.

In multi-electrode tubes the number of separate interelectrode capacitances

is larger than for a triode. Fortunately, only three of these direct interelectrode capacitances are of great importance in most applications:

1. Grid-plate capacity (C_{gp}).
2. Direct input capacity from control grid to cathode, plus all other electrodes except output plate.
3. Direct output capacity from plate to cathode, plus all other electrodes except the input grid.

Amplifier Classification

All receiving tubes except the rectifiers may be conveniently considered as amplifiers. Oscillators and detectors or frequency converters may be thought of as special cases of amplifiers, in which use is made of the non-linear relations between the input voltages and output currents of the tube under consideration.

There are three major classes of amplifier service.¹

Class A Amplifier: A class A, or A1, amplifier is one in which the grid bias and signal voltages are such that plate current in the tube, or in each tube of a push-pull stage, flows at all times.

This is accomplished by operating at the center point of the plate current versus grid voltage curve and using signal voltages which do not drive the grid into either the positive region or

¹Definitions have been standardized by the IRE.

GUARDIAN

presents...

a new **MIDGET**
CONTACT ASSEMBLY
Interchangeable
with the **GUARDIAN Series 200**
STANDARD CONTACT ASSEMBLY
AND COIL ASSEMBLY

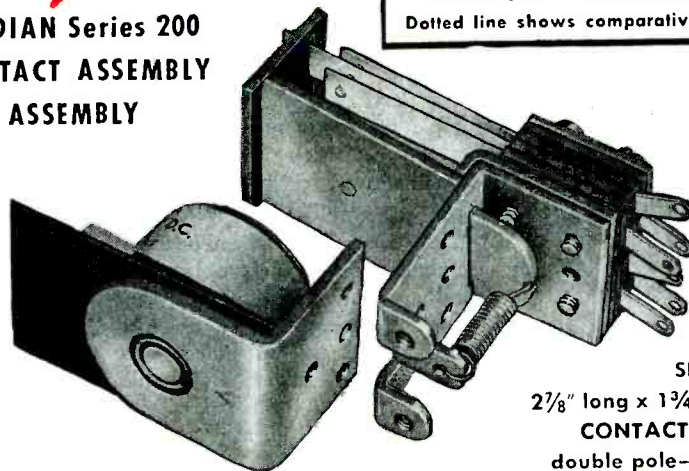
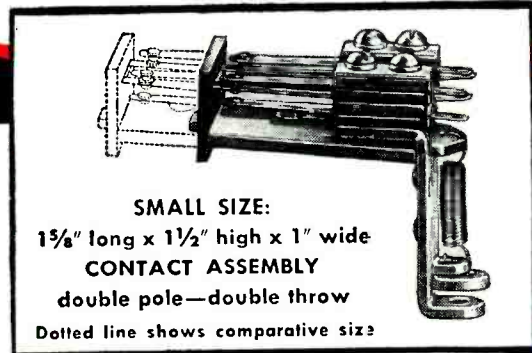

Popular RADIO RELAYS in the GUARDIAN line:

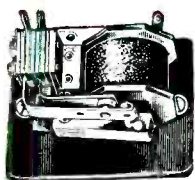

K-100 Keying Relay For low voltage control of high voltage transmission. Guardian Series K-100 Relay will follow key or bug at highest WPM rate attainable. High speed response, strong magnet and return spring give clean make and break, produce best CW note. Coils: 5 to 16 v., A.C.; coils for other voltages on specifications.

B-100 Break-in Relay For break-in operation on amateur transmitters. The Guardian B-100 Relay has laminated field piece and armature. Fine 1/4" silver DPDT contacts, capacity to 1500 watts, 60 c., non-inductive A.C., and in A.C. primary circuit of any inductive power supply delivering up to 1 KW, inclusively.

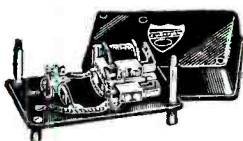
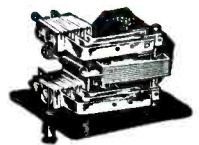

T-100 Time Delay Relay In radio transmitter circuits, Guardian's T-100 Time Delay Relay prevents damage of rectifiers and tube filaments by preventing plate current before filaments are sufficiently heated. Laminated field piece and armature. Mounted in dust-proof metal box.

L-250 Overload Relay Provides accurate, fixed overload protection against current surges and continuous overloads. Guardian's L-250 Relay replaces expensive, time-wasting fuses. Attracts armature on 250 mils. Max. drop across coil—10 v. Guardian's L-500 Relay attracts armature at 500 mils. Max. drop across coil—5 volts. Ideal for experimenters on new circuits.

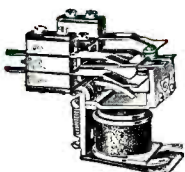
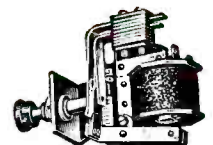

A-100 Antenna Relay A low loss AISiMag insulated relay. For single wire fed installations specify the A-100-C, SPDT unit. Two A-100-C in place of one A-100 in open wire line systems will avoid possible impedance mismatch. A very popular relay with radio amateurs.

SEE THESE AND OTHER GUARDIAN RELAYS AT YOUR JOBBER — OR WRITE FOR BULLETIN R-6.

Ask your jobber for the new midget contact switch assembly which is interchangeable with the Guardian Series 200 coil assembly. Your jobber carries a complete line of Guardian radio relays.

GUARDIAN



ELECTRIC

1617-K W. WALNUT STREET

CHICAGO 12, ILLINOIS

A COMPLETE LINE OF RELAYS SERVING AMERICAN INDUSTRY

into the sharp bend near cut-off voltage.

Class A2 Amplifier: This is the same as the A1 amplifier except that the signal may drive the grid into the positive region. This is accomplished by operating at a lower bias than the center point which would have been selected for class A operation.

Class B Amplifier: In this amplifier the grid bias is approximately equal to the cut-off value, so that the plate current is approximately zero when no signal voltage is applied and the plate current in the tube or in each tube of a push-pull stage, flows for approximately one-half of each cycle when an alternating grid voltage is applied.

An important characteristic is that the grid circuit draws appreciable power which prevents it from being used with ordinary resistance-coupled driver tubes.

Class AB1 Amplifier: Here the grid bias and peak signal voltage are in such proportion that the amplifier operates as class A for small signals and as a class B for large signals.

Class AB2 Amplifier: In this amplifier the signal is allowed to drive the grid slightly into the positive region but not enough to require appreciable power from the driver.

This is accomplished by operating two tubes in push-pull at very nearly the cut-off bias and applying a peak signal equal to the bias. Resistance coupling may be used making this the best way of obtaining large power output with low distortion.

Class C Amplifier: In this type amplifier the tubes operate at a bias much greater than cut-off voltage so that plate power is drawn only on the peaks of the signal voltage. It is not used in audio amplifiers because the distortion is too high, but is the most efficient circuit for r-f power amplifiers where the harmonics can be reduced by use of resonant circuits.

Definitions of Common Tube Terms

Plate Current: The total current passing to or from plate. Symbol I_p .

Cathode Current: The total space current passing to or from the emitter. This should not be confused with filament current in filament type tubes. Symbol I_k .

Conversion Conductance: The ratio of the desired beat-frequency component of the plate current to the signal voltage applied to the grid. It is expressed in micromhos. Symbol G_c .

Coupling: The mutual relationship between circuits permitting a transfer of energy between them.

Degeneration: The result of a portion of the output signal appearing in

the input circuit of a vacuum tube so as to reduce gain. It is sometimes introduced to stabilize the circuit and to improve the response. It is often called negative or inverse feedback.

Demodulation: The process of separating the modulation component from the carrier, commonly called detection.

Diode: A vacuum tube having two elements, usually used as a rectifier or detector. A duo diode is two diodes in one envelope; one element may or may not be common to both diodes.

Distortion: The change in wave form produced by the transmission device or amplifier.

Discriminator: A circuit which produces a d-c voltage proportional in value and polarity to the variations in the applied frequency about the mean frequency, or which converts frequency-modulated signals directly into audio-frequency signals.

Electron Emission: The liberation of electrons from a surface into the surrounding space. If accomplished under the influence of heat it is called *thermionic emission*. If due to the impact of other electrons, it is called *secondary emission*. When emission occurs from a grid from any cause, it is called *grid emission*.

Fidelity: The degree of accuracy of reproduction of the original signal.

Filter: A selective network or circuit designed to pass a certain frequency or band of frequencies and reject all others.

Frequency Deviation: The amount of instantaneous carrier frequency shift from the mean frequency due to modulation in frequency-modulated transmitters.

Frequency Modulation: A method of transmitting intelligence by means of varying the frequency of a transmitter about the mean frequency in accordance with the signal it is desired to transmit.

Gain: The ratio of output to input signal. It may be expressed in terms of power or voltage. *Conversion gain* is the ratio of intermediate-frequency output to signal-frequency input.

Heptode: A seven-element tube containing plate, cathode and five other electrodes, usually grids. It is chiefly used as a converter or mixer.

Hexode: A six-element tube containing plate, cathode and four other electrodes, usually grids, also chiefly used as a converter or mixer.

Limiter: A circuit designed to prevent a signal from exceeding a predetermined amplitude; the stage in an f-m receiver used to remove any amplitude changes in the received signal.

Load Resistance: The total effective

resistance in the plate circuit external to the tube.

Modulation: The process of varying the amplitude, phase, or frequency of a carrier in accordance with a signal. *Cross modulation* is an undesired process whereby the carrier of a desired signal combines with the modulation from an undesired signal.

Modulation Factor: The ratio of half the difference between the maximum and minimum amplitudes of a modulated carrier to the average value. It is usually expressed in percent and called *modulation percentage*.

Octode: An eight-element tube containing plate, cathode and six other elements usually grids, and usually used as a converter or mixer.

Oscillator: A tube device for generating a-c. In superhetrodyne receivers it is the portion of the circuit generating the local signal required to beat with the incoming signal to produce the intermediate frequency.

Peak Inverse Voltage: The maximum instantaneous recurring voltage developed in the opposite direction to that in which a tube is designed to pass current. In half-wave rectifiers the value may be 2.8 times the rms value of a-c plate voltage.

Peak Plate Current: The instantaneous maximum recurring current flowing in a plate circuit.

Pentagrid Converter: A tube having five grids, usually used as an oscillator-mixer in a superhet.

Pentode: A five-element tube having a plate, a cathode and three grids.

Perveance: This is a figure of merit often used for diodes to express the ability to rectify high-frequency current with low voltage drop. It corresponds roughly to I/R in a linear conductor, but in a non-linear conductor such as a tube, which does not follow Ohm's Law, the corresponding characteristic is called *perveance*. *High perveance* means optimum design for both low capacitance and low-diode voltage drop for currents within the tube rating.

Phase Modulation: A method of modulating a carrier by shifting the phase of the carrier with respect to the non-modulated carrier.

Pip: A strong short pulse appearing on the screen of a cathode ray tube, often used as a marker.

Power Amplifier: An amplifier designed to deliver power as distinguished from a voltage amplifier.

Power Output: The useful power developed in the output. It is usually limited by permissible distortion.

Pulse: A single disturbance, such as half a square wave. Grid pulsing is a
(Continued on page 59)

NOW

One INSTRUMENT FOR ELECTRONIC MEASUREMENTS

WESTON ELECTRONIC ANALYZER

Incorporating:

1. A conventional Volt-Ohm-Milliammeter with self-contained power source.
2. A high impedance electronic Volt-Ohmmeter using 115 volt, 60 cycle power.
3. A stable, probe-type, Vacuum Tube Voltmeter, for use to 300 megacycles.



Model 769

Accurate a-c measurements .25 volt to 120 volts, 50 cycles to 300 megacycles.

Extremely small R.F. Probe (3½" x ¾" dia.). Probe constants, 5 megohms paralleled by 5 mmfd., approx.

New unity gain d-c amplifier provides absolute stability with line voltage variations from 105 to 130 volts.

D-C Electronic amplifier ranges 3 to 1200 volts at 15 megohms, resistance ranges 3000 ohms to 3000 megohms.

Conventional 10,000 ohm per volt d-c ranges 3 to 1200 volts, 1000 ohm per volt a-c rectifier ranges 3 to 1200 volts.

Resistance ranges 3000 to 300,000 ohms where a-c power is not available.

Entire Model 769 protected from external RF influences.

Uses standard commercial types of tubes replaceable without recalibration.

Size only 10" x 13" x 6½".

Full details from your jobber or local WESTON representative. Literature available... Weston Electrical Instrument Corporation, 604 Frelinghuysen Avenue, Newark 5, New Jersey.

WESTON

Instruments

ALBANY · ATLANTA · BOSTON · BUFFALO · CHARLOTTE · CHICAGO · CINCINNATI · CLEVELAND
DALLAS · DENVER · DETROIT · JACKSONVILLE · KNOXVILLE · LITTLE ROCK · LOS ANGELES
MERIDEN · MINNEAPOLIS · NEWARK · NEW ORLEANS · NEW YORK · PHILADELPHIA
PHOENIX · PITTSBURGH · ROCHESTER · SAN FRANCISCO · SEATTLE · ST. LOUIS
SYRACUSE · IN CANADA, NORTHERN ELECTRIC CO., LTD., POWERLITE DEVICES, LTD.

Servicing Helps

Cathode Followers . . . Replacing E-M With P-M Speakers . . . TV Antenna Installation Notes

The Cathode Follower

THE CATHODE FOLLOWER, a circuit which was widely used in wartime equipment, is now being applied to many types of commercial apparatus, including instruments, tv receivers, amplifiers, scopes, etc.

In Fig. 1 is shown a generalized concept of the circuit. In effect, it is an inverse feedback amplifier, with the output taken off across the cathode resistor instead of the conventional plate load resistor.

The gain of such an amplifier is always less than unity, because of the large amount of feedback present. However, the circuit has many desirable characteristics. First, the shunt capacitance across the input circuit is considerably reduced. This permits its use in high-frequency applications. Second, it is possible to achieve low output impedances without distortion. Another advantage is its ability to

Fig. 1. A generalized concept of the cathode follower. The signal is fed into the grid circuit in conventional manner. However, the output is taken off in the cathode circuit instead of across a plate load impedance. The output impedance may therefore be varied over a range of low impedance value.

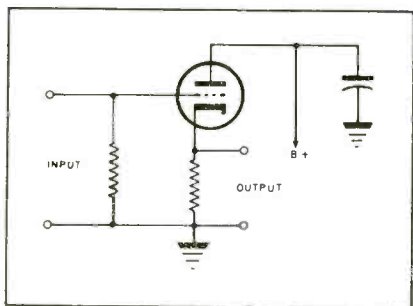

handle large input voltages without overloading. In addition, the circuit is only slightly affected by changes in either tube constants, or operating voltages.

Figs. 2 and 3 show two methods of varying the bias on the grid of the tube without appreciably changing the output load impedance, Fig. 2 being used where high input impedance is important.

Practical applications include its

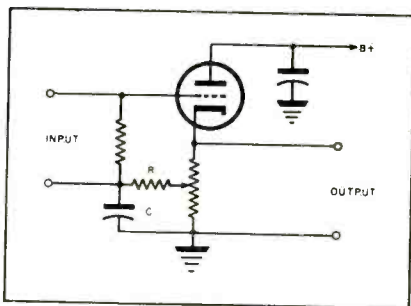

Figs. 2 (top) and 3 (bottom). Here are shown two methods of regulating the bias on the grid of the tube without changing the load impedance presented by the cathode resistor. Fig. 2 is used where high-input impedance is desired. Resistor *R* should be large in comparison to the reactance of capacitor *C* at the lowest frequency being amplified. Fig. 3 has the advantage of permitting connection to output circuits at ground potential.

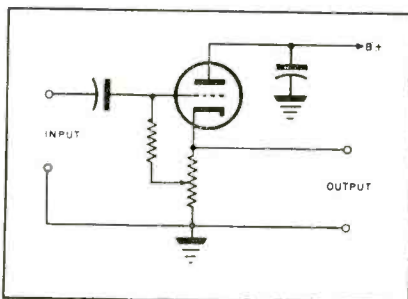

use in c-r oscilloscopes where high input impedance is desired. The circuit is also used for feeding transmission lines, and other similar cases where it is desired to match a high impedance source to a low impedance line without appreciable frequency distortion.

In audio amplifiers, the circuit is used between two high-gain stages to prevent a falling off in frequency response at the high frequency end due to the shunt capacitance of the second amplifier stage. One such typical circuit is shown in Fig. 4. Not only does the cathode follower prevent the high frequencies from falling off after the first stage due to the low-input capacitance, but since it presents a low-input impedance to the second amplifier

(Continued on page 28)

Fig. 4. A practical application of the cathode follower in a high-gain audio amplifier. By inserting the cathode follower between the two high gain stages, the effect of the input capacitance of the second stage on the amplification of the higher frequencies is reduced to a negligible factor. This is due to the low-input capacitance of the cathode follower, and the reduction of the shunting effect of the capacitance of the second amplifier, due to the low-output impedance of the cathode follower.

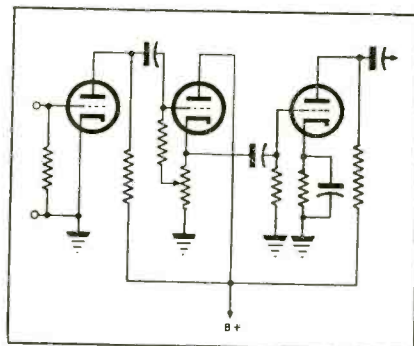

DESIGNED FOR THE BETTER SERVICE SHOP . . .



RCA'S NEW TEST OSCILLATOR
 . . . second unit of a
 revolutionary new line

**Reduces testing and alignment time
 by as much as 50 per cent**

● The WR-67A is a time-saver that adds *profitable* hours to your service day . . . puts you dollars ahead.

When aligning a receiver, for example, you can switch from a pre-tuned i-f signal to pretuned broadcast-band signals without dialing or retuning. The range switch gives you three fixed frequencies: 1500, 600, and 455 kc. It also permits instant switching to any other frequency you select between 100 kc and 30 mc by presetting the smoothly variable tuning control.

Other outstanding features include: a signal injection probe for high-speed servicing . . . a four-step attenuator with fine control . . . double

shielding . . . miniature-type tubes throughout . . . a six-band drum dial with an easy-to-read, four-foot scale spread . . . adjustable modulation level for internal and external modulation . . . a two-stage power-line filter to minimize leakage, and a 400-cycle *audio* signal source.

Every RCA WR-67A is factory-tested with the finest precision measuring equipment. Heavy-duty components—plus the WR-67A's ability to withstand rigorous "drop," "shake," and humidity tests—add up to real on-the-job reliability. A new bulletin is yours for the asking. *Keep in touch with your RCA Test Equipment Distributor.*

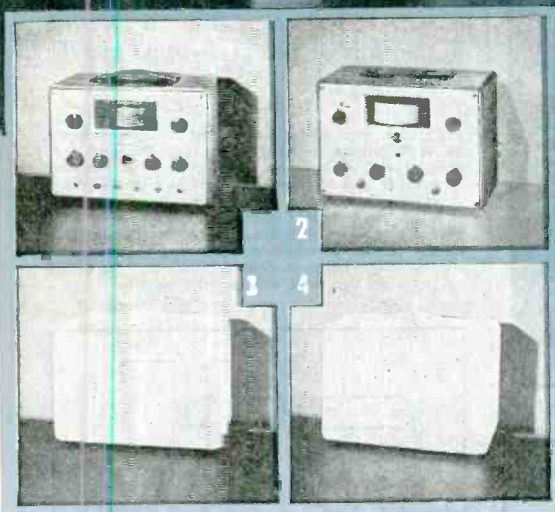

ON THE WAY—a superior line of test equipment that puts time-consuming service jobs on a profitable, production-line basis . . . that anticipates all FM and television needs. Matched styling of all instruments permits attractive, convenient grouping. Watch for announcements of the other units in this new line.



**TEST AND MEASURING EQUIPMENT
 RADIO CORPORATION of AMERICA
 ENGINEERING PRODUCTS DEPARTMENT, CAMDEN, N.J.**

In Canada: RCA VICTOR Company Limited, Montreal

BUILD BIGGER PROFITS

with
ESPEY
CUSTOM BUILT **CHASSIS**

YES! These ESPEY custom-built radio receiver chassis are really designed to make bigger profits for YOU—the Serviceman and Serviceman-Dealer! They are ruggedly constructed of only the finest materials, and are electronically designed to give your customers maximum reception-pleasure over the years ahead, thereby assuring your reputation as "knowing your stuff!"

Engineered to meet all requirements for an excellent receiver chassis to be installed in your customer's cabinets, these ESPEY models are priced far within the competitive range. With three models to select from, your replacement worries are over. May we suggest that you contact your regular jobber, and examine these sets at your leisure? We feel certain that you will be just as enthusiastic about them as we are!

In the event that your jobber does not have these chassis as yet, write us for full details!

"Radios for Everyone . . . Everywhere."

ESPEY MFG. CO., INC.
528 EAST 72ND ST., N.Y. 21, N.Y.



MODEL 7-B: 11 tube Superhet AM-FM. For 105/125V AC. Automatic and full range volume controls. 10" Alnico V speaker, wired for phono, AM-FM antennas supplied. RMA listed. Supplied complete, ready to install and operate.

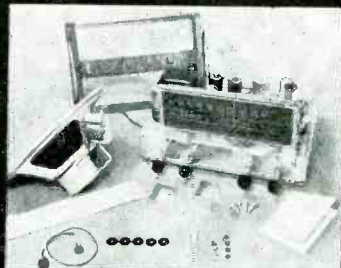

MODEL RR-14: 8 tube Superhet. For 105/125V AC. Automatic and full range volume controls. 10" speaker. Covers Broadcast and 2 short wave bands. Wired for phono. Built-in loop. All climates.

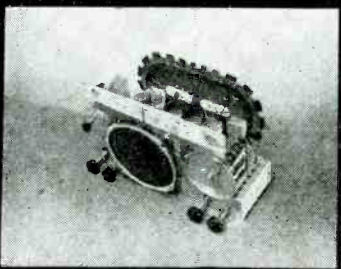

MODEL 97A: 6 tube Superhet. 105/125V AC/DC. 6" speaker. Automatic and full range volume controls. Broadcast and shortwave. Wired for phono. Built-in loop. Tone control. RMA listed. Complete and ready to install.

Servicing Helps

(Continued from page 26)

stage, the shunt effect of this tube's input capacitance is reduced to a negligible factor.

Replacing Electrodynamic Speakers with P-M Types

IN REPLACING electrodynamic speakers with p-m types it is good practice to determine the d-c resistance of the field coil of the speaker being replaced. A choke should then be substituted for this field coil of approximately the same resistance, with the d-c resistance of the choke being equal to or less than the speaker field coil resistance. Any difference in d-c resistance value can be made up with a resistor of appropriate wattage rating. Wattage rating may be determined by the use of Ohm's law: $W = I \times E$, where I = current in amperes, and E = voltage drop across the resistor. The wattage rating should be at least 1.5 times this value.

A typical conversion is shown in Fig. 5. The inductance value of the choke need not be high. A choke of the type used in midget receivers will usually prove satisfactory, provided its current rating is adequate. If the hum level is high, additional filtering in the form of filter capacitors may be

Fig. 5. A method for converting a receiver using an electro-dynamic speaker to one using a p-m type. The hum-bucking coil has been eliminated in *b* since there is no field coil hum with which to contend. A choke and resistor has been substituted for the field coil of *a*, the resistor supplying any additional d-c resistance not supplied by the choke. If additional filtering is necessary, a capacitor (shown in dotted form) may be added on the load side of the choke.

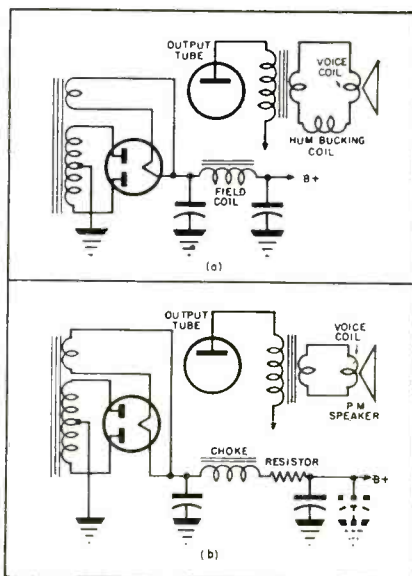

PROMPT DELIVERY
FROM STOCK

ESPEY CHASSIS

EUGENE G. WILE

10 South 10th Street
Philadelphia 7, Pa.

Distributors of Nationally-known
lines of RADIO, TELEVISION and
ELECTRONIC parts.

ESPEY CHASSIS

DISTRIBUTED BY

FISCHER Distributing Co., Inc.

118 Duane St., New York 7

Phone: BA 7-0555-6-7

DISTRIBUTORS

Over 20,000* PROFESSIONAL radio and electronic Service Men subscribe to SERVICE—your "bread-and-butter" customers.

*ABC NET PAID

shunted across those in use in the receiver.

When installing the substitute filter circuit, the capacitance should be added on the load side of the choke, as shown in *b*, to prevent overloading the rectifier tube. It should be noted that both the substitute choke and resistor are inside the filter network. In this manner, advantage is taken of the resistor in increasing the effectiveness of the filtering action.

The voice coil of the p-m speaker is connected conventionally. If the original speaker made use of a hum bucking coil, no compensation is required for the p-m speaker, since there is no field coil to worry about.

TV Antenna Installation Notes

TO PROVIDE STRAIN RELIEF on the tv antenna leadin, where it is fastened to the dipole terminals, the setup¹ shown in Fig. 6 should be followed. This arrangement will prevent destruction of the line insulation at the point of lead separation and prevent wind breakage of the multi-conductor leads at their point of connection to the dipole.

¹G. E.

Fig. 6. Antenna leadin strain relief assembly for a television antenna.

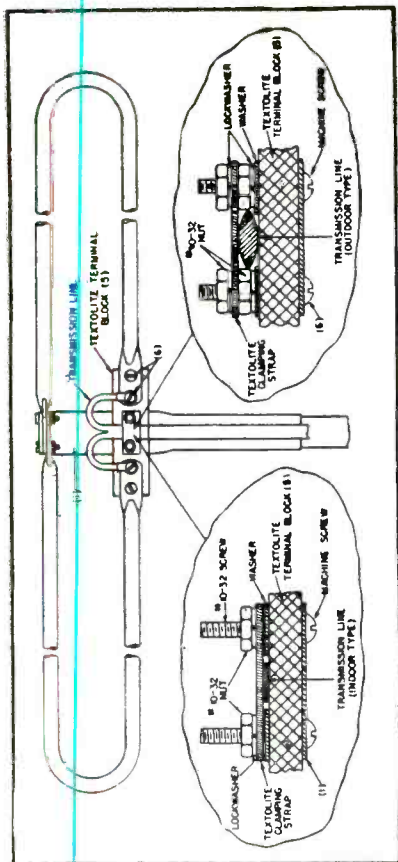

THE PATCH THAT DOESN'T MATCH

Most customers just don't like substitutions. A good tailor will never resort to making repairs with materials that "almost" match. Neither will a capable, experienced service man gamble with results by making cartridge replacements in phonograph pickup arms with cartridges that "might work."

There is only one safe and sure way to make cartridge replacements and that is duplication of the original. The pickup cartridge is the most vital component of any phonograph circuit. To change this circuit with the introduction of an unknown quantity is very apt to result in entirely unsatisfactory performance.

Astatic's many types of cartridges are necessary to satisfy the great variety of electrical and mechanical specifications demanded by set manufacturers and to supply service men with the proper parts for perfect replacements.

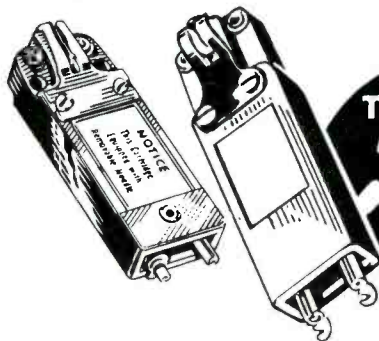

Astatic Crystal Devices Manufactured under Brush Development Co. patents.

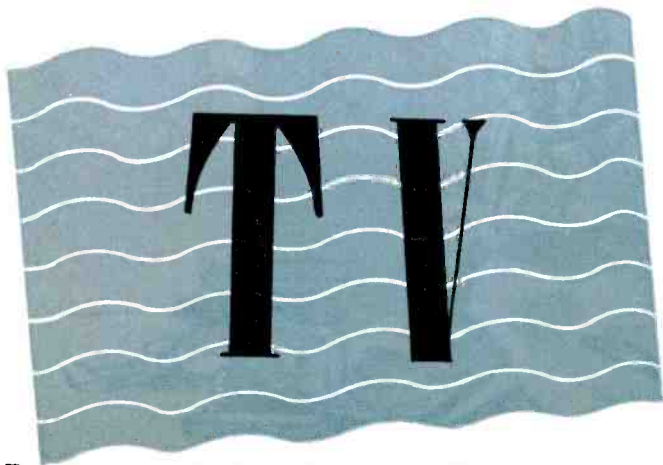

Wide-Band Amplifiers

Design and Application Data on Bandpass, Stagger-Tuning, Overcoupling and Wavetrap Circuits Used in Current TV Receivers

by **EDWARD M. NOLL**

*Instructor in Television
Temple University*

ment of the load. Inasmuch as the actual physical resistor shunted across the tuned circuit is low (in most cases loaded to obtain the required band-

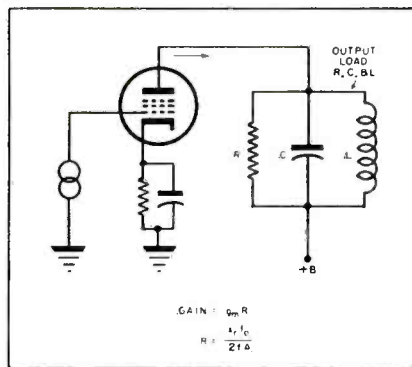
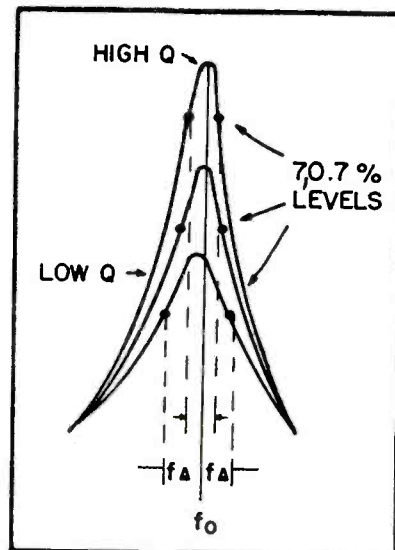

Fig. 1. A wide-band amplifier.

Fig. 2. Plot showing circuit Q and bandwidth.



IN THE AMPLIFICATION of the television r-f or i-f signal it is necessary to amplify a very wide band of frequencies because the frequency components of modulation of the television signal are sometimes in excess of four megacycles. The r-f section of the television receiver, on each channel, must amplify linearly a 6-mc band of frequencies. The i-f amplifier of the receiver must amplify a band of frequencies almost as great. Sharply resonant circuits, although they represent a high Q and efficiency cannot be used because they only amplify a narrow band of frequencies about the resonant frequency. In wide-band service, Q and stage gain are not the only consideration. Instead we try to obtain the best gain at the required bandwidth. In fact, we must sacrifice gain to obtain linear amplification over a wide band of frequencies. Any system which widens the bandpass of a stage also, to some extent, reduces the gain of this stage.

The gain of a wide-band stage can be closely approximated by the simple formula; $\text{Gain} = g_m R$. The resistive component of the load (Fig. 1) or the R in the formula is, in many cases, an actual physical resistor which is shunted across the output-tuned circuit to reduce its Q . A lower Q , of course, means that the tuned circuit is not nearly so sharply resonant and amplifies a band of frequencies. However, the actual peak gain of this stage is reduced in the presence of this shunt or load resistor. At times this resistive component of the load also includes the resistance of the amplifier tube, as in the case of a low resistance triode. More often if a low Q tuned circuit is used the resistive component of the tuned resonant circuit also forms a part of the resistive compo-

width) a very practical approximation of the stage gain can be obtained by multiplying the g_m times the value of the loading resistor.

The value of this resistive component which must shunt the output tuned circuit of a wideband amplifier per given bandwidth can be calculated

from the following formula: $R = \frac{X_r f_0}{2f\Delta}$,

where X_r represents the reactive component of the load at the resonant frequency, f_0 is the resonant frequency of the tuned circuit and $f\Delta$ is the bandwidth or the change in frequency. It is apparent, therefore, that the resistive component of the load and therefore the stage gain is larger when the reactance of inductor and capacitor are high and when the ratio of the resonant circuit frequency to the bandwidth is low. Thus the greater the bandwidth required, the lower the value of the resistor and, therefore, the more we load the tuned circuit and the more we reduce the stage gain. To obtain an appreciable signal with such a low value of load resistor it is necessary that the tubes have a high mutual conductance.

The mutual conductance or g_m of a vacuum tube is a measure of how efficiently the tube converts a small change in grid voltage to a large change in plate current. It is the large change in plate current, for given grid signal, that we require in a wide-band stage to develop an appreciable voltage variation across a low value of plate-load resistance. Thus the only tube that is really practical in wide-band service is a high g_m tube such as the 6AC7, the 6AK5, and the 6AG5. These tubes also have low input and output capacities, another



SPEAKERS

ALUMINUM FOIL BASE VOICE COILS PROVIDE



**PERFORMANCE
QUALITY
FIDELITY
DURABILITY**

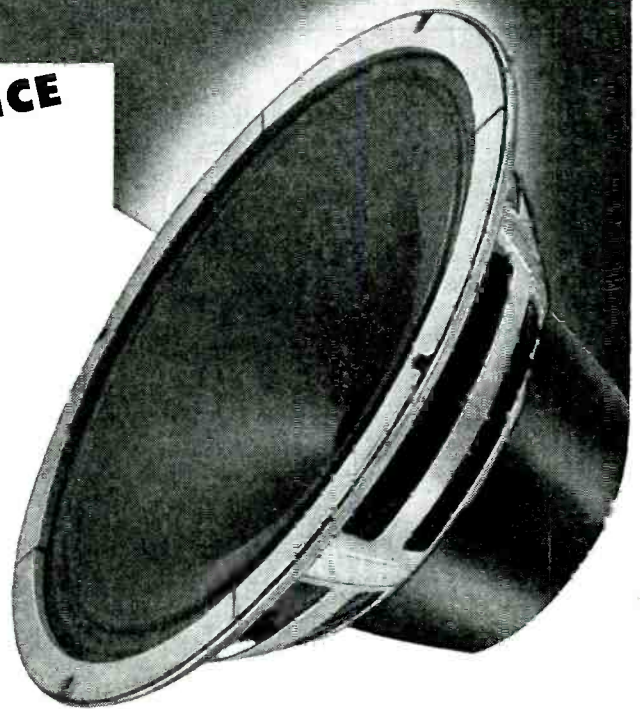

EVERY General Electric Speaker—from the smallest to the largest—has aluminum foil base voice coils. This G-E development makes possible their high quality performance, tone fidelity, and operating durability. Whether you use them by the hundreds of thousands in production lines, or purchase a single unit for an individual replacement, your customers will appreciate the extra quality performance of G-E Speakers.

G-E Speaker construction gives you these excellent features which assure dependable performance and fine quality reproduction:

- High wattage handling capacity. The metal construction provides much better heat dissipation. This permits operation of the speaker at increased wattages.
- No warping of voice coil. The metal base will not introduce internal stresses, and it is not subject to separation of laminations or to other adverse effects which might result in distortion.
- The aluminum foil base voice coil will not absorb moisture under high humidity conditions.
- Internal stresses which result in dimensional distortion are eliminated through the aluminum foil base voice coil construction.
- Metal construction assures better control of clearance between moving parts.
- Better tone quality and reproduction.

PLUS...

● **ALNICO-5 PERMANENT MAGNETS FOR OVERALL EFFICIENCY AND SENSITIVITY.**



● **DURABLE CONSTRUCTION THROUGHOUT.**

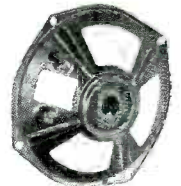

Write now for complete information on speakers to: *General Electric Company, Electronics Department, Syracuse 1, New York.*

GENERAL ELECTRIC

169-F7

Fig. 5. Bandpass *T* coupling and equivalents.

Fig. 3. An overcoupled transformer and its response curve.

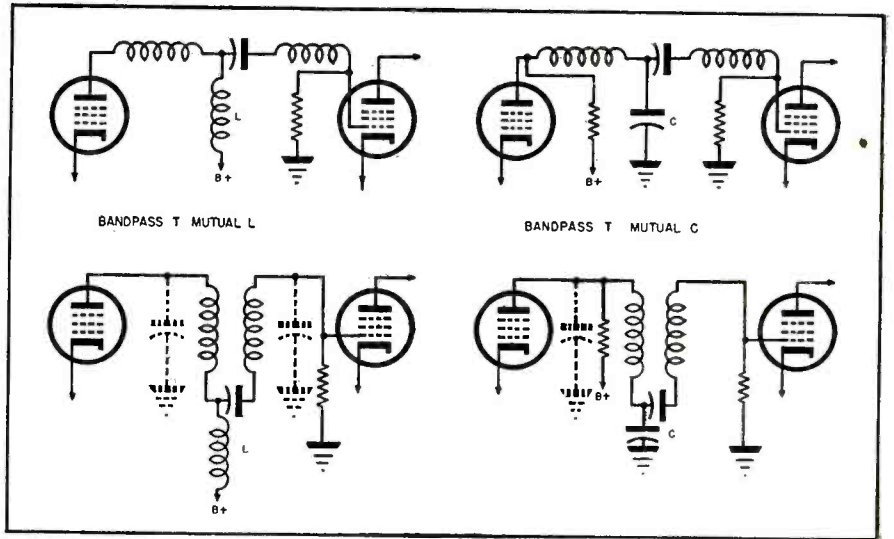
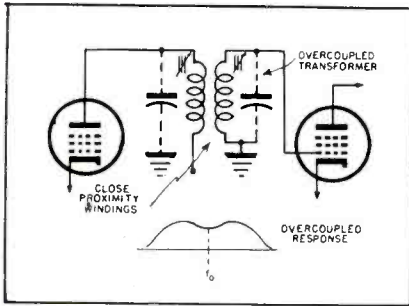

feature of a wide-band amplifier necessary to obtain the best gain at a certain bandwidth.

To obtain the best gain at the required bandwidth it is also necessary to keep the reactive component of the load high. The reactive component of the load, of course, is dependent on the *L* to *C* ratio of the tuned circuits. If the inductance is high and the capacity low, as in a high *L* to *C* ratio tuned circuit, the inductive and the capacitive reactance are high. At the resonant frequency, of course, these two

Fig. 4. Overcoupling methods. Top circuit, high side is linked by a trimmer (about 5 to 10 mmfd.) to provide a very broad bandpass. Center, common inductor is used as a link. At bottom, an actual tuned circuit used for mutual overcoupling. In each of these circuits a d-c blocking capacitor is shown in the plate supply or high side.

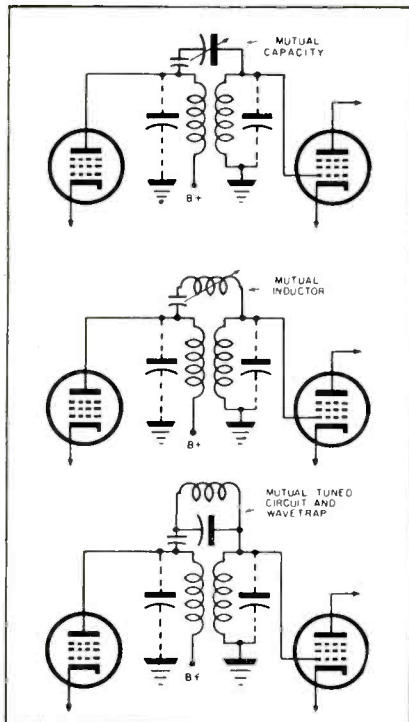

reactances are equal and act in shunt to produce the resistive component of the tuned circuit impedance. Of course, the reactive component or X_r in the formula is high when the inductive reactance and the capacity reactance is high. Thus the tuned circuit of the wide-band stages are designed with a high *L* to *C* ratio because the more inductance and the less capacity we have per given resonant frequency, the higher the X_r of the tuned circuit becomes at resonance.

The *L* to *C* ratio of the wide-band stage is kept high by keeping the capacity low, using the following arrangements:

1. Tubes such as the 6AC7 and the new miniature type tubes are used because their input and output capacities are so very low.
2. Wiring capacity and component capacity to ground are held to an absolute minimum.
3. In many receivers no physical capacitors are used to tune the circuits. Instead the inductor of the tuned circuit resonates with the total distributed capacity of the circuit at the required frequency. The tuned circuits are adjusted to the exact resonant frequency by means of movable cores in the inductors.

Another factor which increases the permissible value of the *R* for a given bandwidth is the ratio of the tuned circuit frequency to the bandwidth. It is apparent that the permissible value of *R* is higher when the bandwidth is low. Likewise, it is higher when the tuned circuit resonant frequency is high in comparison to the bandwidth. Therefore, it appears expedient to increase the frequency of the wide-band stage or in the case of an i-f system to increase the i-f frequency to obtain a greater gain for given bandwidth. This is exactly what has been done in

the newer model receivers which have increased their i-f frequency to the 20 to 25-mc region from 8 to 15 mc. However, to take full advantage of the increase in the basic i-f frequency the reactive components must be held constant. In the prewar television receiver it was not feasible to increase the i-f frequency because of the limitations of the tube and the tuned circuit. Before the development of low-capacity tubes and efficient high-frequency resonant circuits the *L* to *C* ratio decreased too much when the resonant frequency of the i-f system was increased. If the *L* to *C* ratio falls, of course the X_r in the formula decreases. Consequently, there was no rise in the permissible *R* because as the $f_o/f\Delta$ increased the X_r decreased. However, with modern efficient design and the use of miniature tubes the X_r is held near the same value when the frequency of the i-f is raised. When double-tuned transformers or bandpass *T*-load circuits are used in the i-f stages the gain formulas become much more complex. However, for each individual tuned circuit it is possible to use the simple formula previously shown to find the load resistor value.

In summation, the following general characteristics apply to most all types of wide-band stages:

1. Low capacity, high g_m tubes.
2. High *L* to *C* ratio tuned circuits.
3. Resistor loading to increase the band of frequencies amplified linearly.
4. Some means of obtaining broad bandwidth by means of overcoupling of two transformers or the use of stagger tuning.

Overcoupling

The basic method used to obtain overcoupling between two tuned trans-
(Continued on page 56)

Save SPACE, TIME and MONEY!

with the new **PYRAMID**
"TUBE-U-LAR"
PAPER CAPACITOR

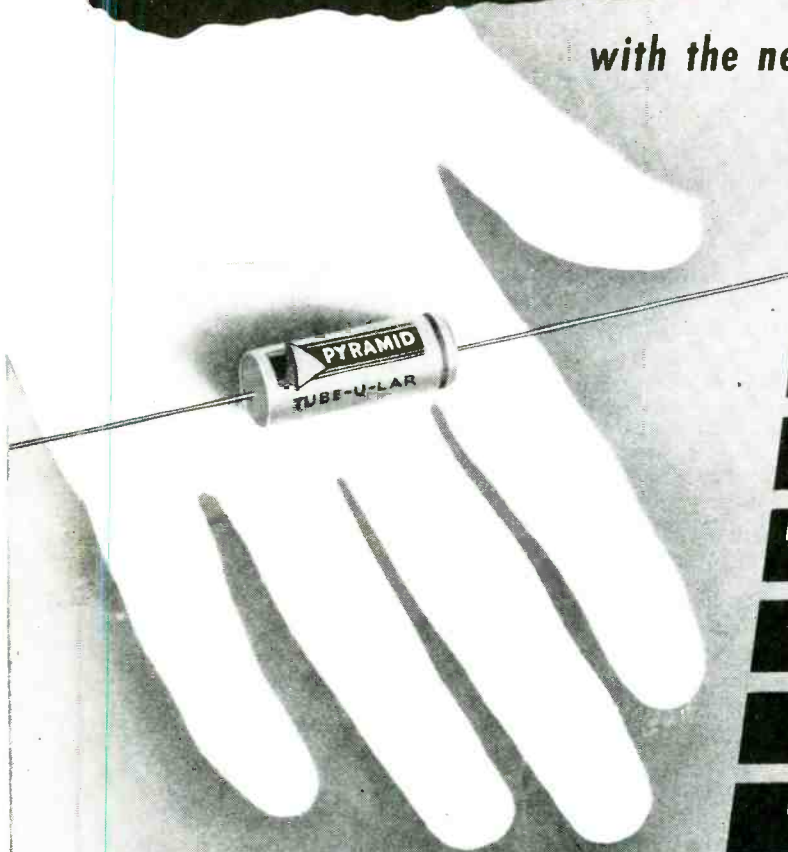

ULTRA-COMPACT

EXCELLENT QUALITY
at modest cost

HIGH INSULATION RESISTANCE
lengthens life

HIGH DIELECTRIC STRENGTH
assures against breakdowns

CLEAN CONSTRUCTION
and better appearance

LARGE, LEGIBLE MARKINGS
make identification easy

SUPERIOR SEAL
means dependability in all climates

PART NUMBER	CAPACITY MFD.	D.C. VOLTS WORKING	BODY SIZE, INCHES		LIST PRICE
			DIAMETER	LENGTH	
T6-D1	.001	600	$\frac{3}{8}$	$1\frac{1}{8}$	\$.25
T6-D2	.002	600	$\frac{3}{8}$	$1\frac{1}{8}$.25
T6-D5	.005	600	$\frac{3}{8}$	$1\frac{1}{8}$.25
T6-D6	.006	600	$\frac{3}{8}$	$1\frac{1}{8}$.25
T6-S1	.01	600	$\frac{3}{8}$	$1\frac{3}{8}$.30
T6-S2	.02	600	$\frac{3}{8}$	$1\frac{3}{8}$.30
T6-S5	.05	600	$\frac{3}{8}$	$1\frac{3}{8}$.40
T6-P1	.1	600	$\frac{3}{8}$	$1\frac{1}{2}$.45
T6-P25	.25	600	$\frac{3}{4}$	2	.55
T6-P5	.5	600	1	2	.80

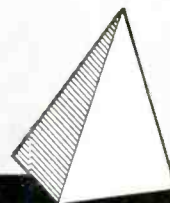

PYRAMID
"LONG-LIFE"
PAPER & ELECTROLYTIC
Capacitors

PYRAMID ELECTRIC COMPANY

155 OXFORD STREET, PATERSON, N.J.

PHONO RECORD

Cutting and Reproducing

by **WALTER W. CARRUTHERS**

Chief Engineer, In Charge of
Don Lee Broadcasting System

TO REPRODUCE A RECORD PROPERLY (with a flat characteristic) it is necessary to know first how it is cut. The device that cuts the wiggle, or modulates the record groove, known as the cutter-head, puts a large amplitude (or wiggle) on the record for bass tones, and a small wiggle for treble tones. That is to say, if an instrument like the piano had the same sound intensity for all notes on the keyboard and then someone were to start with the lowest bass note and play up the scale to the highest note on the piano, the cutter-head would cut a wiggle (or amplitude) in the record groove as shown in Fig. 1.

This could be plotted like a stock market report in terms of amplitude versus pitch or frequency; Fig. 2.

From the graph it can be seen that the amplitude of the cut on the record is less by one-half for each octave up the scale, or each time the frequency is doubled the amplitude on the record is reduced to one-half.

The immediate reaction is to question why a record is cut this way. It dates back to the start of record making. In the early days a cutting needle was attached to a small diaphragm at the end of a horn. The artist performed in front of the horn and the record was cut in this fashion. The record had an amplitude characteristic which looked like the plot of Fig. 2. It was called an acoustic recording. A record so cut, when played on the old acoustic system (consisting of a needle attached to a diaphragm and coupled to a horn) reproduced the record with a flat characteristic, with bad limitations. Thus, record cutting was started with this characteristic and it was continued in later years when magnetic cutters became avail-

able for making electrically recorded records. It was the nature of the magnetic device to cut records with an amplitude which was decreased by one-half every time the frequency was doubled. Fortunately for all concerned, a record so recorded and then played back with a magnetic-type reproducer, would reproduce with a flat characteristic.

Constant Velocity

There is a name for this cutting characteristic, *constant velocity*. This is the characteristic shown in Fig. 2. The term *constant velocity* has been derived from the science of physics, where velocity is equal to amplitude multiplied by frequency. In this case, the two quantities which vary are frequency and amplitude, but by definition the velocity must remain constant. That is, the product of amplitude and frequency must always equal the same number. For example, let us assume the velocity of the needle (stylus) to be 3" per second, and we wanted to know the amplitude at 1,000 cycles. Substituting frequencies in the formula, frequency \times amplitude = velocity, we find:

$$\begin{aligned} 1,000 \text{ cycles} \times .003'' \text{ amplitude} &= 3'' \text{ per second stylus velocity} \\ 2,000 \text{ cycles} \times .0015'' \text{ amplitude} &= 3'' \text{ per second stylus velocity} \\ 4,000 \text{ cycles} \times .00075'' \text{ amplitude} &= 3'' \text{ per second stylus velocity} \end{aligned}$$

$$8,000 \text{ cycles} \times .00037'' \text{ amplitude} = 3'' \text{ per second stylus velocity}$$

Just as a matter of interest, let us go in the other direction towards the bass frequencies. For one-half of 1,000 cycles we should get twice the amplitude of the cut on the record:

$$500 \text{ cycles} \times .006'' \text{ amplitude} = 3'' \text{ per second stylus velocity}$$

For one-half of 500 cycles, we should get again twice the amplitude:

$$250 \text{ cycles} \times .012'' \text{ amplitude} = 3'' \text{ per second stylus velocity}$$

$$125 \text{ cycles} \times .024'' \text{ amplitude} = 3'' \text{ per second stylus velocity}$$

$$67\frac{1}{2} \text{ cycles} \times .048'' \text{ amplitude} = 3'' \text{ per second stylus velocity}$$

Cutters

With equal intensity sounds from bass to treble, acoustic cutters as well as modern magnetic cutting heads cut a constant velocity record. Acoustic and modern magnetic-type reproducers play back a constant velocity cut with a flat characteristic. We are looking for a flat characteristic and this article could end here if it were not for a few troubles encountered in constant-velocity recording.

Groove Spacing

In order to have a reasonable playing time on the record, the grooves are spaced about 100 to the inch; this

Fig. 2. Plot of amplitude versus pitch or frequency.

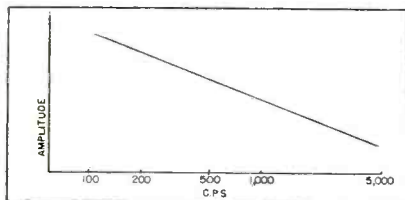

Fig. 1. Amplitude of cut in record groove.

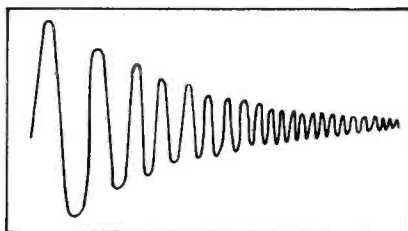
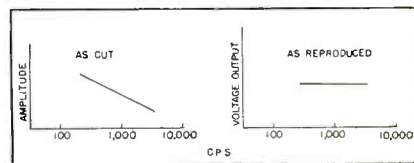

Fig. 3. Plot of cut and reproduced signal on record.



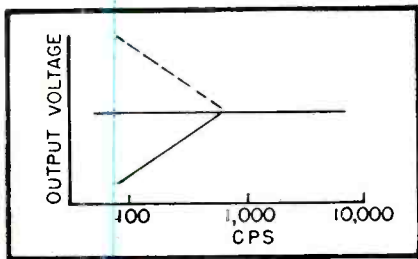

Fig. 5. Plot showing how output of magnetic pickup must be sloped upward at a rate of 6 db per octave below cross-over.

varies from 96 to 136, depending on the type of record. Now, with 100 grooves to the inch, the groove centers are 1/100th of an inch or .010 inch apart. From this it can be seen that the amplitude of the wiggle of the groove cannot exceed 1/2 of .010", or .005" in side-ways displacement, or there will be an *over-cut*. That is, if this tone persists through more than one revolution of the record, the two groove centers will meet one another with the result that the playback needle is confused as to which path to take. If the amplitude of the cut on the record cannot exceed .005" to each side, there is a total distance of .010" from side to side as the cutting needle wiggles back and forth. Thus, approximately .010" is allowable on the record.

Referring back to the data on amplitude at various frequencies, we see that it is necessary to limit the amplitude below 500 cycles, if we are to have any safety factor from overcut. At 250 cycles the amplitude is .012", which won't fit in our grooves. As the frequency is lowered in tone, the situation grows more serious.

Cutter-Head Design

In early days of acoustic recording this was not a serious problem because the system was not responsive to lower tones. With modern equipment it is a different story; the cutter-head must be designed so that below 500 cycles, it levels off and cuts at the same amplitude (constant amplitude) for all frequencies below 500 cycles. The effect on the magnetic reproducer is to playback constant velocity with a flat characteristic, as you know, but now for constant amplitude the output of the reproducer is cut in half for each octave below 500 cycles, or, as the frequency is cut in half (250 cycles for example) the output of the magnetic reproducer is cut in half. Again, at 125 cycles the output is cut in half, etc. Technically speaking, we lose 6 db

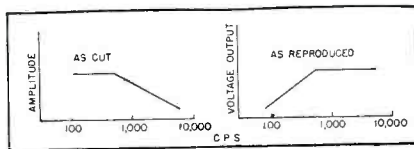

Fig. 4. Playback curve of magnetic pickup without corrective network. Note loss in reproduction.

(decibel, a measurement of sound intensity) per octave below 500 cycles; Fig. 4.

Cross-Over

The frequency of cross-over is that at which constant amplitude recording crosses over to constant-velocity recording. In this case it is 500 cycles. This type of recording, constant amplitude to a cross-over frequency and then constant velocity above cross-over, is known as a *flat-cut record*; however, the output from the pickup on playback, as explained previously, is far from flat. The playback curve shown in Fig. 4 is the response of the magnetic pickup, if connected directly into an amplifier without a corrective network. At some place in the playback circuit, the output of the magnetic pickup must be sloped upward at a rate of 6 db per octave below the cross-over, as illustrated by the dotted line in Fig. 5.

Corrective Network Result

The result of the insertion of the corrective network in the circuit will have the effect of flattening the response curve from the *flat-cut record*. The network is usually a simple resistance voltage divider and capacitor network. It is very important that the components of the network are such as to start the upward corrective slope at the recorded cross-over frequency. By starting the upward slope high in frequency, a *barrel sound* or *boomy* quality will result; Fig. 6.

If the slope upward is started by the corrective network, below the recorded cross-over frequency of the record, the reproduction will sound *thin*, as the bass frequency will not be fully corrected; Fig. 7.

One should conclude from this, that it is important to have the corrective network *correct*. Unfortunately com-

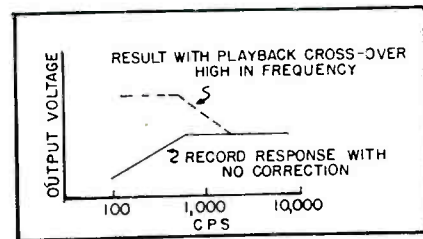

Fig. 6. By starting upward slope high in frequency, barrel sound or boomy quality results.

mercial recording companies have not established a standard cross-over frequency, and the proper balance between high frequency and low frequency is only obtained when the recorded and playback cross-over frequencies are the same. Usually, 500 cycles will suffice for the playback of most records.

Surface Noises

For some years the industry used this recording characteristic of a constant amplitude from the bass notes up to a cross-over frequency of about 500 cycles, and from there up in frequency-constant velocity. However, with the development of recording equipment, speakers, amplifiers and pickups capable of reproducing higher frequencies, the surface noise of the record became more evident and objectionable. The reason for this is shown graphically in Fig. 8.

Noise Control

It will be noted that the noise is somewhat constant in amplitude, except for rumble and vibration in the low frequency, usually present to some extent in playback and recording equipment. With a recording characteristic of constant velocity, in which you will remember the amplitude becomes less by one-half for each octave higher in frequency, it can be seen from the graph that the noise amplitude and that of the recorded program soon become equal in the higher frequencies. At still higher frequencies the noise becomes greater in amplitude than the recorded program, making it useless to try to reproduce. The amount of noise on a record is dependent upon the material used and whether or not an abrasive is present in the processed record to make it more wear-resistant to the needle.

In broadcast transcription this situation has been somewhat remedied by

use... OHMITE

Replacements

BROWN DEVIL RESISTORS... Wire-wound, vitreous-enameled type. Now in compact 5-watt size. Also 10 and 20-watt units.

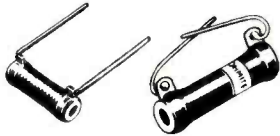

LITTLE DEVIL RESISTORS... Now 1/2 and 1-watt sizes in $\pm 5\%$ tolerances. Also 1/2, 1, and 2-watt sizes in $\pm 10\%$ tolerances.

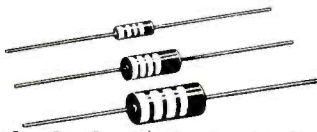

TYPE AB POTENTIOMETER... A new extremely high quality molded composition unit—rated 2 watts with a good margin of safety.

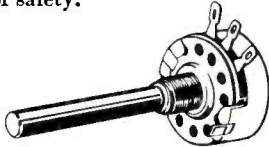

DIVIDOHM ADJUSTABLE RESISTORS... Wire-wound vitreous-enameled type—10 to 200 watts. Sturdy... dependable.

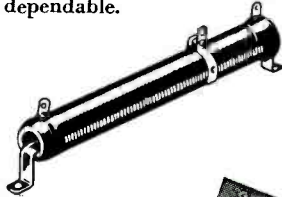

See Your Nearest Ohmite Distributor
Send for Catalog 19



OHMITE MANUFACTURING CO.
4878 Flournoy St., Chicago

Be Right with...

OHMITE

RHEOSTATS • RESISTORS
TAP SWITCHES

Cutting and Reproducing

(Continued from page 35)

the use of orthocooustic recording. In this method of recording the frequency range above the cross-over point of 500 cycles is sloped upward to prevent the amplitude of the upper frequencies from sinking to the level of the noise. This is shown in Fig. 9.

NAB Standard

The National Association of Broadcasters established recording standards in which the recording characteristic at 5,000 cycles is 10.2 db above constant velocity recording level at 5,000 cycles, and at 10,000 cycles it is 16 db above the constant velocity level at 10,000 cycles.

As shown in Figs. 8 and 9, the playback will have a rising characteristic above the cross-over frequency of 16 db at 10 kc. It should be noted that the recorded program material remains above the noise throughout the high frequency range.

Pickup and Network

In order to properly reproduce the orthocooustic type of recording, it is necessary to put an electrical network in the output of the pickup, which is the reverse of the recording characteristic. If the output of the pickup is sloped off in the high frequencies at the same rate that the recorded characteristic is sloped upward, the result will be a flat playback characteristic, and yet with greater discrimination against the noise. This is illustrated in Fig. 10.

This type of recording has influenced commercial recording companies,

and even with the lack of a standard to date, their product shows tendencies in the direction of the standards as set on the broadcast transcription.

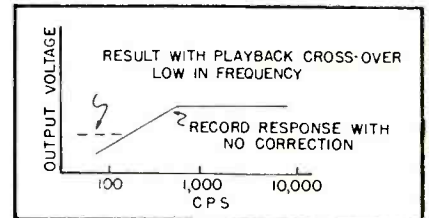

Fig. 7. Plot showing how cross-over networks effect frequency response.

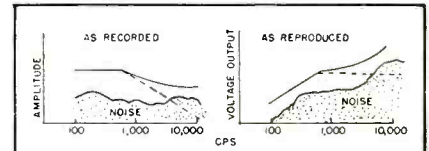

Fig. 8. Curve showing how surface noise rises in reproduction. Noise is somewhat constant in amplitude except for rumble and vibration at 1-f, usually in equipment. With recording characteristics of constant velocity, the noise amplitude and that of recorded program become equalized at high frequencies, and at still higher frequencies, noise becomes greater in amplitude.

Fig. 9. How the orthocooustic method of recording remedies some of the noise problems. Playback has a rising characteristic above cross-over frequency of 16 db at 10 kc. Recorded program remains above the noise level throughout the high-frequency range.

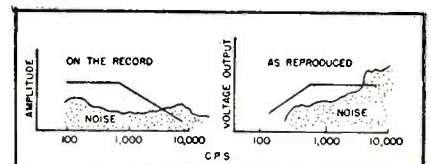
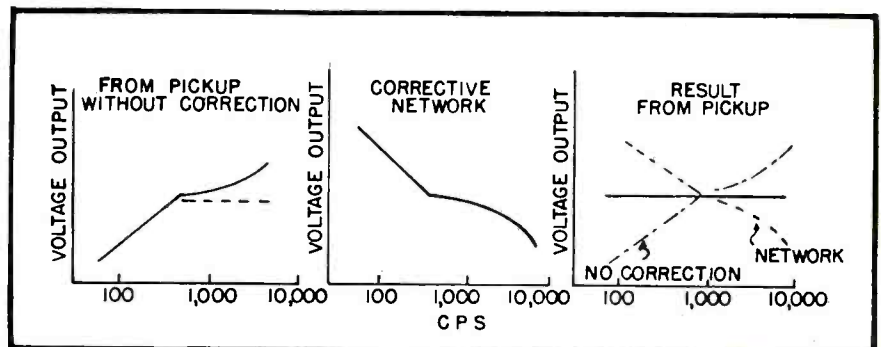
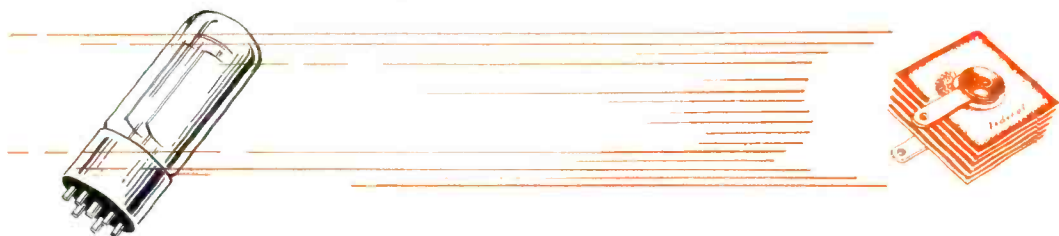

Fig. 10. Plots showing how the introduction of an electrical network in the output of a pickup provides flat playback characteristics and greater discrimination against noise.





STORY WITHOUT WORDS

...here's how it can boost *your* profits

AS SURELY AS the "gasoline buggy" replaced the horse-drawn carriage, the Miniature Selenium Rectifier—an original Federal development—is destined to take the place of the rectifier tube in AC-DC receivers. Already, more and more manufacturers are building it into their radio sets—and more and more maintenance shops are installing it in the sets they service.

What about *you*? Here is really a big chance for you to

make *extra money*—by *modernizing* AC-DC sets now using a rectifier tube—giving them faster starting, better all-around performance. And as new sets using the Miniature Rectifier as original equipment come to you for servicing, you'll want to be ready with replacements. It's your opportunity to be a *leader* by introducing this improvement *now*—by installing Federal's Miniature Selenium Rectifier in every AC-DC receiver you service.

Available through major jobbers from coast to coast—complete with detailed instructions.

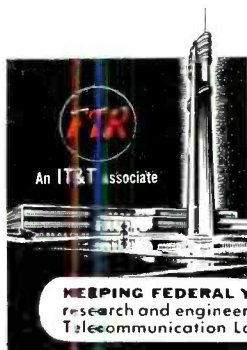

Federal Telephone and Radio Corporation

KEEPING FEDERAL YEARS AHEAD... is IT&T's world-wide research and engineering organization, of which the Federal Telecommunication Laboratories, Nutley, N. J., is a unit.

SELENIUM and INTELIN DIVISION, 1000 Passaic Ave., East Newark, New Jersey

In Canada: — Federal Electric Manufacturing Company, Ltd., Montreal.

Export Distributors: — International Standard Electric Corp., 67 Broad St., N.Y. C.

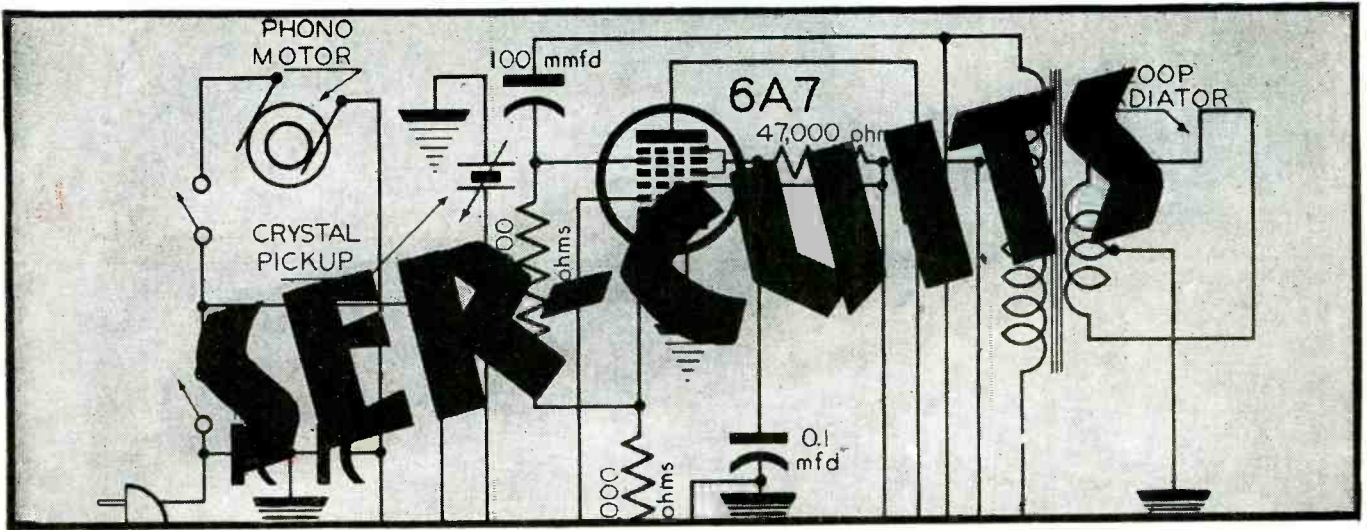

THE PAST FEW WEEKS have seen the announcement of quite a few i-m receivers using ratio detectors. On the cover of the August issue appeared a circuit of one of these models, the Packard-Bell 872. This month are presented circuits and data on four more ratio-detector models; the Espey 7B, which is the cover diagram, and the RCA 711V2, Motorola 95F31/95F31B/95F31M/95F33 and the Pilo-tuner, discussed in this section.

RCA Models

The RCA receiver, Fig. 1, is an 11-tube model, covering the broadcast and f-m bands, and short-wave bands,

too. The 6BA6 tubes are used in the r-f amplifier, mixer and i-f amplifier stages. Oscillator uses a 6BE6; driver, 6AU6; ratio detector, 6AL5; and a 6SQ7 is used in the detector/ave a-i stage. In the audio section of the receiver we have a 6J5 as a phase inverter, and two 6F6Gs as power tubes providing a maximum power output of 11 watts.

Motorola Receivers

In the Motorola models, Fig. 2, 9 tubes are used. This receiver also covers the three bands, a-m, f-m and s-w. A 7F8 serves as an f-m con-

verter; 7Q7 as a b-c and s-w converter; 6SG7, 4.3-mc and 455-kc i-f amplifier; 6SG7, 4.3-mc i-f amplifier; 6S8GT i-m ratio detector/a-m detector/ave first a-i; 6SQ7, phase inverter and two 6K6GT, as push-pull power outputs.

The i-m/a-m tuner of the Motorola receivers is quite interesting. The twin triode, 7F8, serves as an oscillator, and first and second converter. Oscillator voltage injection for the second converter is obtained through a coupling capacitor from the plate of the triode, T₁. Frequency relationships in this circuit appear in Fig. 3.

(Continued on page 40)

Fig. 1. Schematic of the RCA 711V2. The range switch is shown in its f-m position.

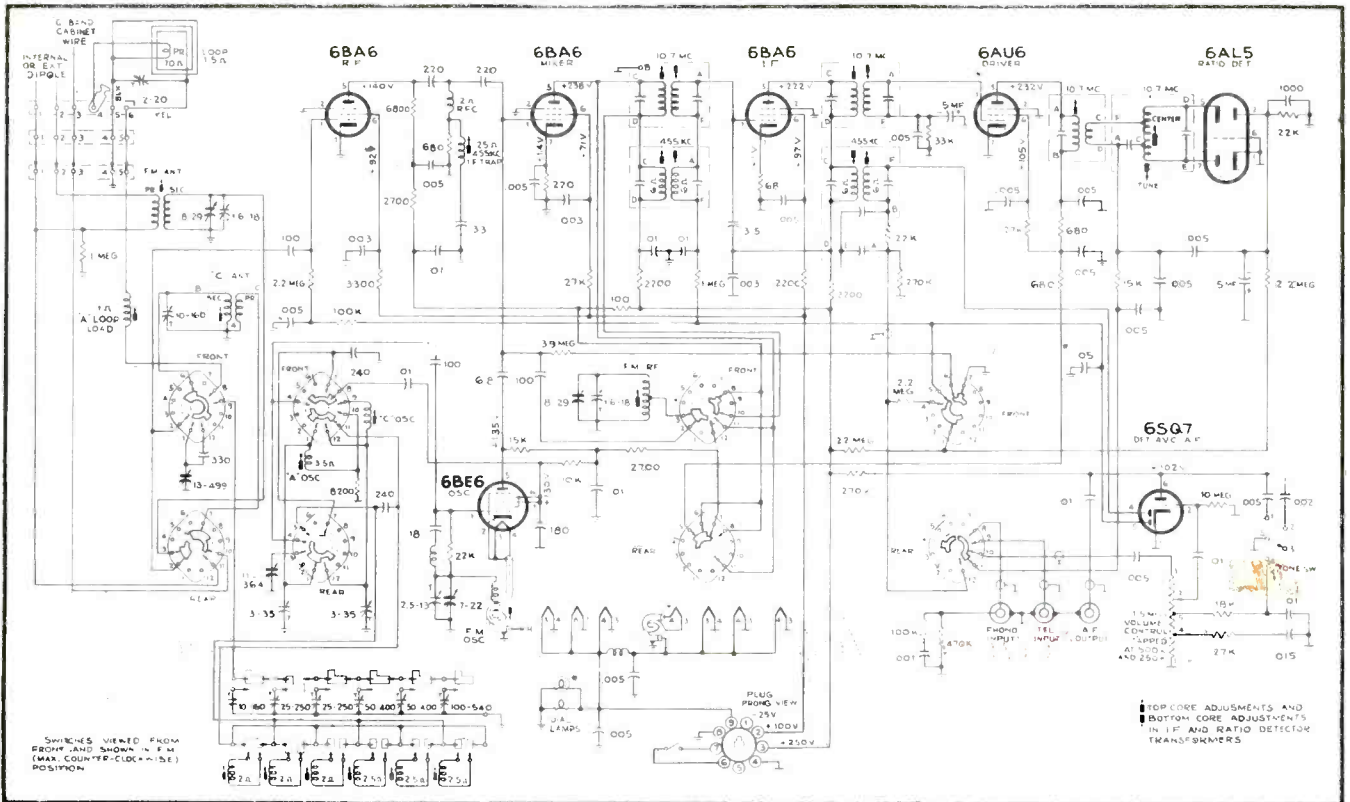

Meissner

PRESENTS THE NEW BREWSTER LINE OF TABLE MODEL RADIOS

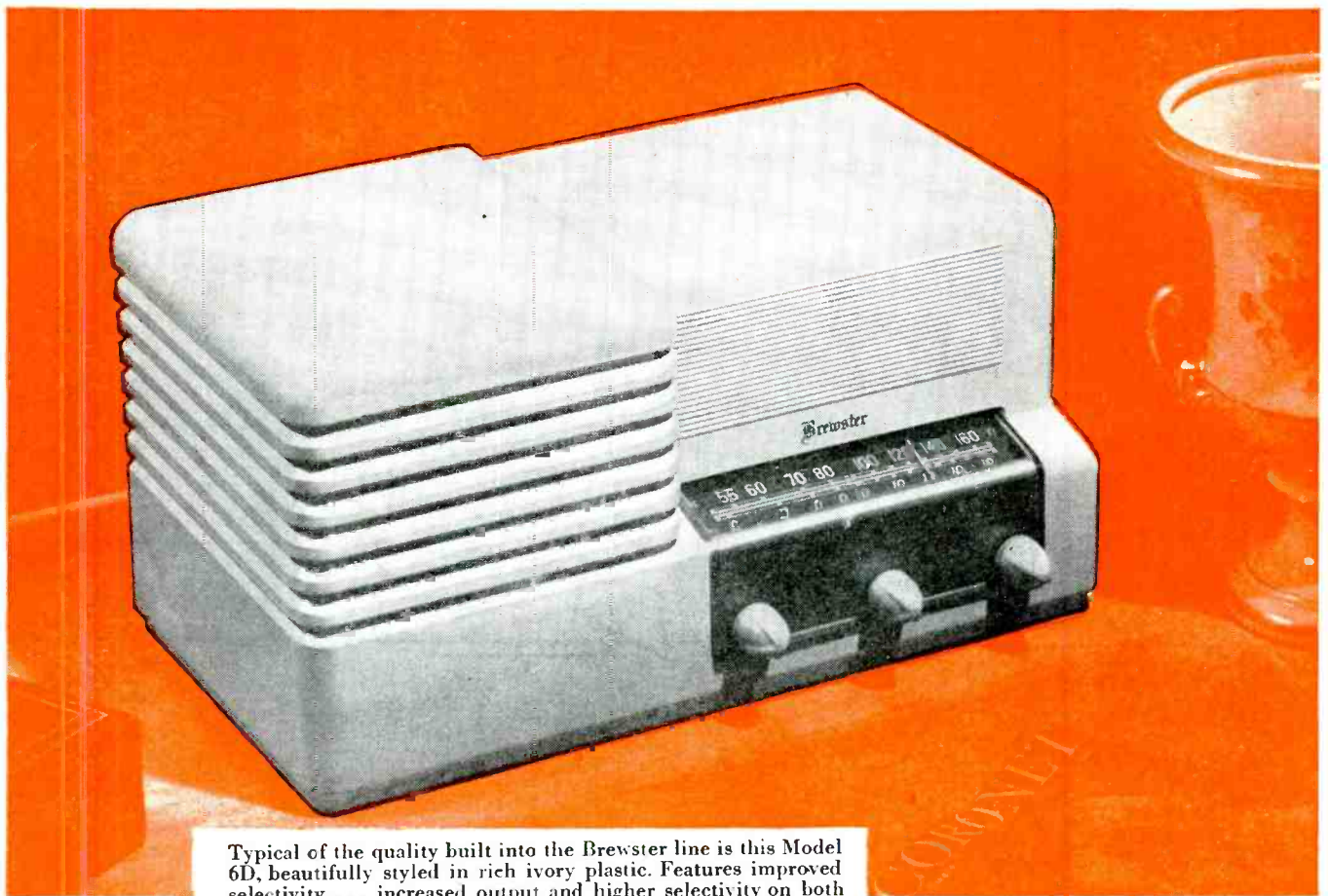

Typical of the quality built into the Brewster line is this Model 6D, beautifully styled in rich ivory plastic. Features improved selectivity . . . increased output and higher selectivity on both broadcast and shortwave bands. Broadcast 540 to 1600 kcs, shortwave 5.75 to 18 mcs. Built-in loop antenna . . . 5 tubes plus rectifier. Operates on 110 volts AC or DC.

Here in these new Brewsters is the outstanding line you have been waiting for! Superbly designed, unmatched for sheer beauty of tone, these completely new sets reflect the skill and craftsmanship that have made the name Meissner a byword for quality in the trade. Encased in cabinets of surpassing charm, they are easily superior to anything now being offered in this field.

Smartly designed, quality engineered, these sets are being manufactured by Meissner for exclusive distribution through parts jobbers only. No quotas, no high-pressure tactics, no "special deals", no sales direct to dealers or special distributors . . . in fact, nothing that might even remotely interfere with your merchandising this new, exclusively-jobber line to the hilt. More than this . . . Meissner unconditionally guarantees the prices on these new Brewsters against reduction for the balance of the year.

This complete line is available for delivery NOW. Wire or write today for full information, prices and illustrated folder.

Meissner

**ELECTRONIC DISTRIBUTOR AND
INDUSTRIAL SALES DEPARTMENT**

MAGUIRE INDUSTRIES, INCORPORATED
936 NORTH MICHIGAN AVENUE • CHICAGO 11, ILLINOIS

EXPORT DIVISION • SCHEEL INTERNATIONAL INCORPORATED
4237 NORTH LINCOLN AVENUE, CHICAGO 18, ILLINOIS • CABLE ADDRESS HARSHEEL

SERVICE, SEPTEMBER, 1947 • 39

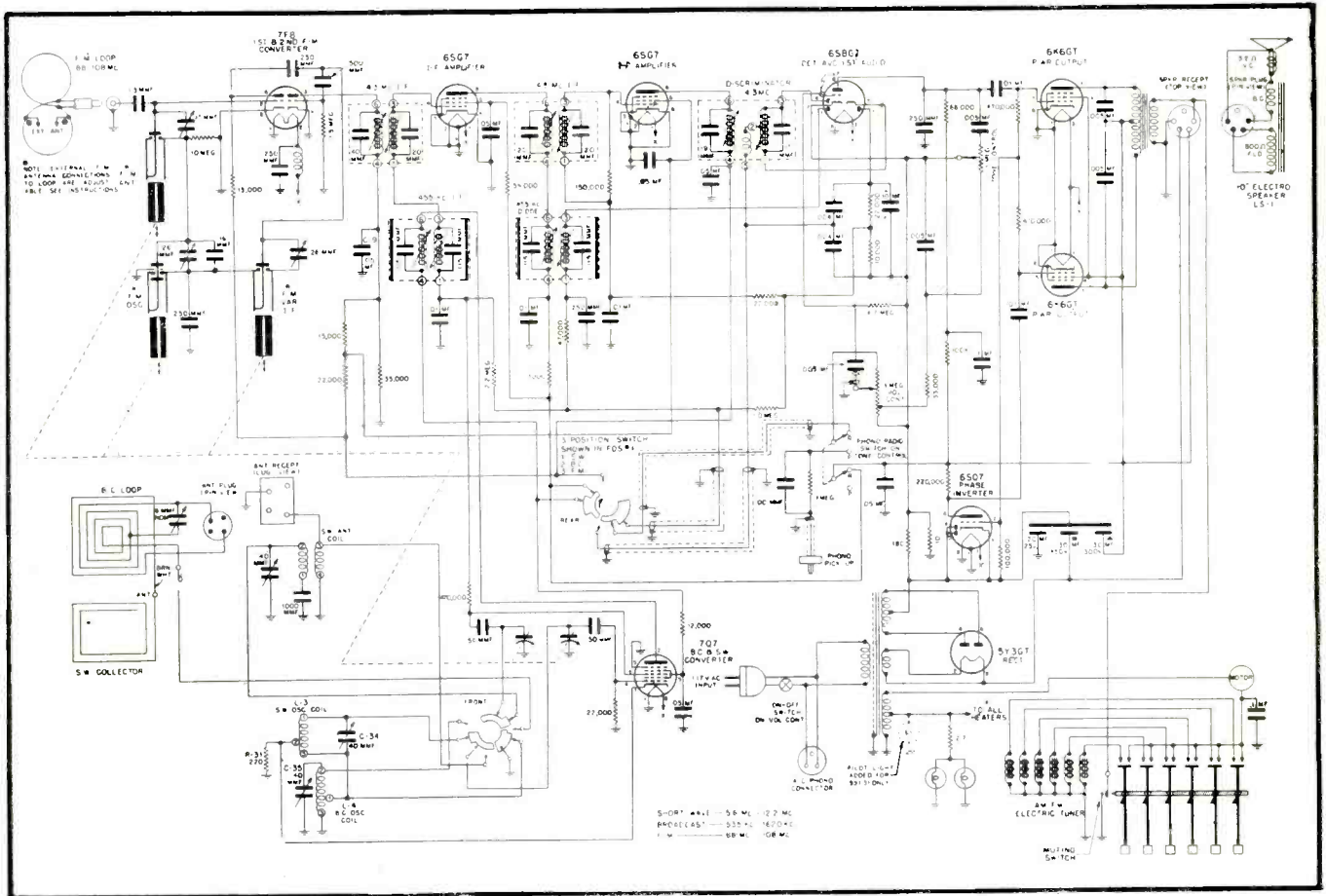

Fig. 2 (above). Circuit of the Motorola f-m receiver; models 95F31, 95F31B, 95F31M and 95F33.

Ser-Cuits

(Continued from page 38)

The oscillator, F_o , beats with the incoming signal, F_s , to produce the first i-f, F_1 , which is variable. F_1 beats with the same oscillator frequency, F_o , in the second converter to produce the

(Continued on page 54)

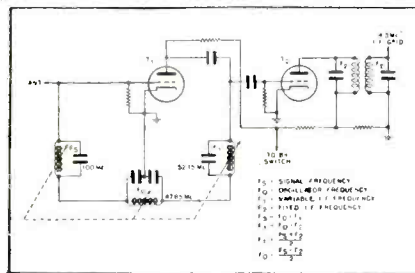
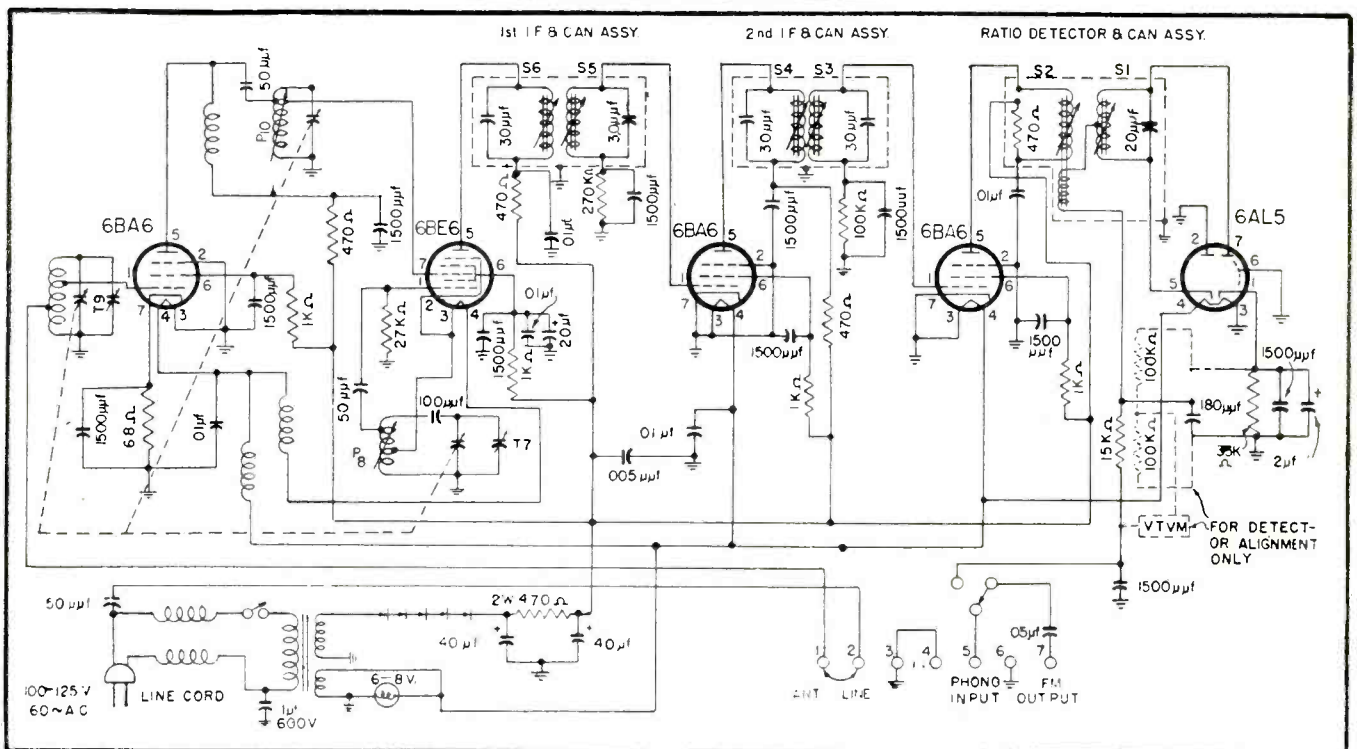

Fig. 3. Functional schematic of the f-m tuner system used in the Motorola receivers. T1 and T2 are sections of the 7F8 twin-triode.

Fig. 4. Circuit of the Pilotuner.





a line of **STANDARD LOUDSPEAKERS** by **RCA**

YOU'VE WANTED A LINE OF Standard Loudspeakers from RCA, because you know that the RCA trade mark sells products wherever it's displayed.

Now you can reap greater profits and customer satisfaction from RCA Standard Loudspeakers.

Look at the new line of RCA speakers! In addition to meeting most replacement requirements, these RCA-manufactured speakers have RCA-engineered features

that provide superior performance. Ten types service most sets. And they're competitively priced.

See your RCA distributor today about these quality speakers—and

also learn how you can make extra profits from RCA Television Parts and Accessories and the RCA Magic Tone Cell Phonograph Modernization Kits.

Other Members of RCA's Growing Family of Standard Parts and Accessories

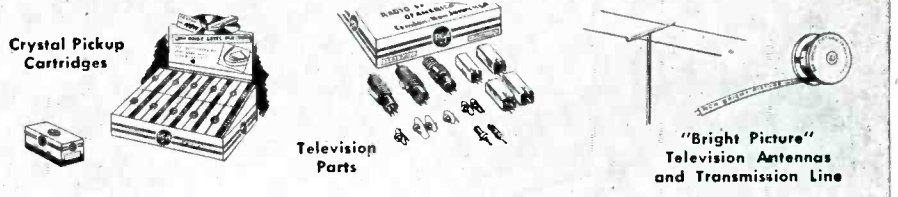

TUBE DEPARTMENT

RADIO CORPORATION of AMERICA

HARRISON, N. J.

NEW PRODUCTS

SIMPSON ROLL TOP INSTRUMENT CARRYING CASE

A roll top safety case, engineered for the 260 volt-ohm milliammeter, has been announced by the Simpson Electric Company, Chicago.

Instrument is permanently fastened into the case which is of heavily molded bakelite, and large enough to provide a compartment for leads beneath the instrument. The front is covered by the roll top panel, a sliding cover of narrow bakelite segments on a backing of cloth. This cover, similar to roll-top desk construction, rolls up to make the instrument ready for use.

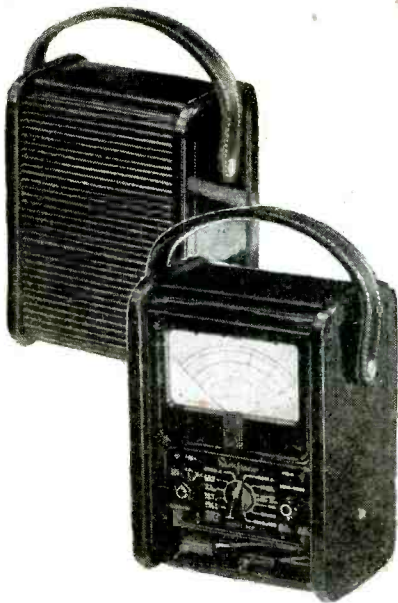

* * *

B&W AUDIO OSCILLATOR

An audio oscillator, model 200, has been announced by Barker & Williamson, Inc., 237 Fairfield Avenue, Upper Darby, Pa. Consists of a modified Wien bridge R/C oscillator and a 2-stage inverse feedback output amplifier with self-contained power supply.

It is designed for distortion or frequency measurements, or for any application where a calibrated source of frequencies between 30 and 30,000 cycles is required.



ACA VARIABLE RELUCTANCE PICKUPS

Two pickup units, employing the G. E. 6C variable reluctance magnetic pickup, have been announced by the Amplifier Corp. of America, 398-3 Broadway, New York 13, N. Y.

One type is a studio transcription model 160GE, which will play records up to 16" in diameter. The other is a program phono model 120GE, which takes conventional records up to 12" in diameter.

The studio transcription model features include a swivel base for raising or lowering to desired height; low frictional pivots for constant needle pressure; low vertical inertia; and spring adjustable needle pressure of 1 oz.

Program phono model features include a needle pressure of $\frac{3}{4}$ oz.

ACA has also developed a direct-coupled amplifier, AGA-100GE, to accommodate the variable reluctance magnetic pickup without the use of additional preamplification or equalized circuits. Equipped with a built-in pre-amplifier and fixed pre-equalizer, amplifier also contains a variable high-frequency equalizer for compensation of pre-emphasized recorded and radio programs, as well as a low-frequency equalizer for compensation of constant-amplitude recordings.

Filtered d-c, having less than .03% ripple, is applied to the heaters of the input tubes through a regulating ballast resistor.

Utilizes a signal self-balancing and current drift-correcting direct-coupled output circuit. Response is said to be 20 to 20,000 cps ± 1 db; develops 23 watts with less than 1% total distortion; hum and noise level, -40 vu. An additional independent input of 500,000 ohms is provided; balanced output terminals are provided for 8/16/20 and 500 ohms; in-between terminals provide additional output impedances of 2/4/5/10/80/125/160 and 175 ohms.

Also features a non-frequency discriminating scratch suppressor which is said to reduce scratch by 10 db.

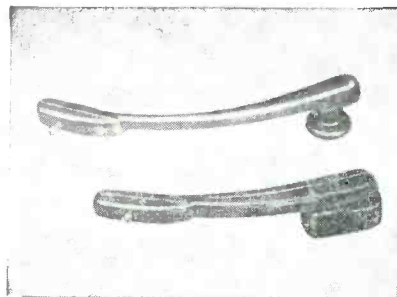

AEROVOX HI-VOLTAGE MIDGET-CAN ELECTROLYTICS

Midget-can Aerovox electrolytics, heretofore available in voltage ratings up to 450 d-c-w, are now available in higher voltage ratings of 500, 600, and 700 d-c-w, or 650, 750, and 850 surge volts, respectively. Capacitance values are 8, 10, 12, and 16 mfd.



* * *

COASTWISE ELECTRONICS INSTRUMENTS

Four new instruments have been announced by Coastwise Electronics Co., Inc., of 130 North Beaudry Avenue, Los Angeles 12, California.

One of the models is a signal generator, 701, with a range from 170 kc to 110 mc on fundamentals. Unit is crystal calibrated and uses low-loss permeability tuned coils. The unit provides a 400-cycle sine wave internal modulation from 0 to 100%, calibrated on the dial, and 20 to 10,000 cycle external modulation for frequency response measurements.

Second unit is an audio oscillator, 710, with a range from 20 to 24,000 cycles.

Third instrument is a signal tracer-electronic voltohmmeter, 730. Audio and r-f

(Continued on page 50)



Model 730



This New IRC JUNIOR Control Cabinet Belongs on Your Bench

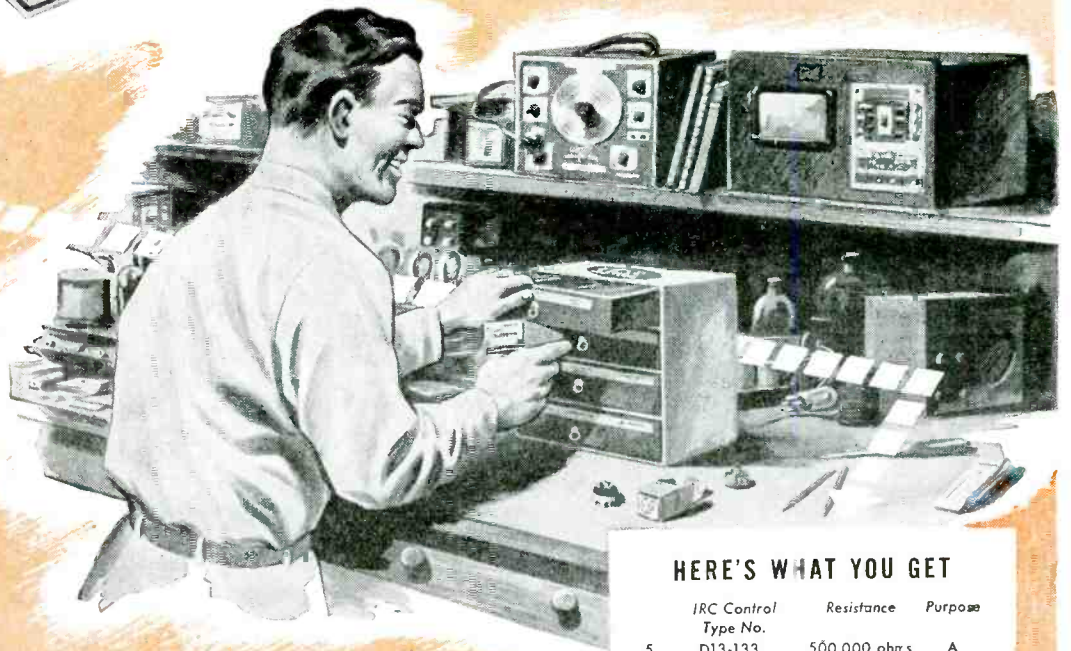

Here's one selection of 9 "hot-number" controls, switches and shafts you'll use every day! The new IRC Junior Control Cabinet contains 9 of the most-used 1/2, 1 and 2 meg. type D controls with the added adaptability of the tap-in shaft feature—plus 4 switches and 4 special shafts.

This inexpensive assortment of popular controls will save you time and money, and reduce your need for exact replacements. Factory-packed in a handsome four drawer cabinet of sturdy cardboard. Cabinet attractively finished in blue, yellow and silver with twelve individually identified compartments. Order the new inexpensive JUNIOR Control Cabinet from your IRC Distributor today. International Resistance Company, 401 N. Broad Street, Philadelphia 8, Pennsylvania. In Canada: International Resistance Company, Ltd., Toronto, Licensee.

HERE'S WHAT YOU GET

	IRC Control Type No.	Resistance	Purpose
5	D13-133	500,000 ohms	A
1	D13-133X	500,000 ohms	B
1	D13-137	1.0 meg.	A
1	D13-137X	1.0 meg.	B
1	D13-139	2.0 meg.	A

Purpose: A-Tone or Audio Circuit control;
B-Tapped for tone compensation.

SWITCHES

3	#41	S.P.S.T.
1	#42	D.P.S.T.

SHAFTS

1 Type "A" double-flatted tap-in shaft is included with each control—plus:

3 Type "E" with universal knurl for special type push on knobs.

1 Type "H" with universal groove for many Delco, RCA, Sears-Roebuck and Westinghouse models.

INTERNATIONAL **IRC** RESISTANCE COMPANY
Wherever the Circuit says 



Learn to Service and Repair all Kinds of ELECTRIC MOTORS

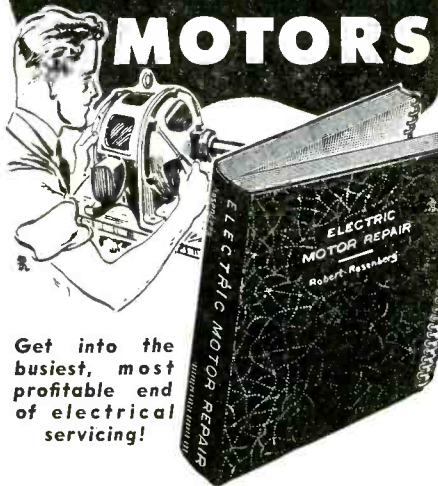

Get into the busiest, most profitable end of electrical servicing!

A "NATURAL" FOR ALERT RADIO MEN!

Based on even a little radio experience, it should be a cinch for you to qualify as a motor repair expert! **ELECTRIC MOTOR REPAIR**—the big 570-page course by the publishers of famous Ghirardi Radio-Electronic Books—can train you rapidly, at home, in spare time for only \$5 complete! It's written clearly and simply so that it can be easily understood by beginners. Every step is explained in text as well as **VISUALLY** by more than 900 step-by-step illustrations. It tells you exactly what to do—exactly how to do it. Best of all, it covers practically every type of motor in common use. These include both a-c and d-c motors, synchronous motors and generators **AND** both mechanical and electrical motor control systems.

IT PAYS TO SPECIALIZE IN SOMETHING DIFFERENT!

There's Real Business Here!

The average small home has 11 motors. Big homes have many more—in phonographs, recorders, oil burners, refrigerators, fans, clocks, mixers, washers, cleaners, etc. Millions more in office and industrial equipment. Be the well-paid expert who can repair them! Now, for the first time in vocational history, you can train for this profitable work quickly at home!

The real "cream" of the electrical service business is in motor repair. Most home appliances and industrial machines are motor driven. Good motor repair men are scarce—and are paid accordingly. It's a real opportunity—and **ELECTRIC MOTOR REPAIR** helps you cash in on every phase of it from minor repairs to complete armature rewinding.

TRY IT FOR 5 FULL DAYS

Practice from **ELECTRIC MOTOR REPAIR** for 5 full days. Repair motors for yourself or friends. Earn while you learn! Then, if not more than satisfied this is the book for you, return it and your money will be refunded at once. You cannot lose! Send coupon **NOW!**

YOU CAN'T LOSE ON THIS OFFER

Dept. S-97, Murray Hill Books, Inc.,
232 Madison Ave., New York 16, N. Y.

Send me a copy of "ELECTRIC MOTOR REPAIR" for which I enclose \$5 (\$5.50 foreign); or send C.O.D. (in U.S.A. only) for this amount and I will pay postman \$5 plus postal charge when he delivers it to me. If this book is not what I need, I'll return it within 5 days and you guarantee to refund my \$5.

Name
Address
City & Zone.....State.....



RCA SOUND SYSTEM MANUAL

A 288-page manual on the engineering and installation of sound systems, *Architects Manual of Engineered Sound Systems*, has been announced by the sound products section of RCA.

The manual is divided into two parts. The first part defines and discusses the principal components of engineered sound systems and describes the engineering specifications used in installing the equipment. The second part is a work-a-day guide, including complete and detailed specifications on sound systems for the seven principal types of buildings in which sound is most commonly used.

The manual, priced at \$5, will be available from RCA sound systems distributors, or direct from the RCA sound products section, Camden, N. J.

* * *

CIRE FCC LICENSE EXAM BOOKLET

A 40-page booklet, entitled *How to Pass FCC License Examinations*, has been issued by Cleveland Institute of Radio Electronics, C-9 Terminal Tower, Cleveland 13, Ohio.

Booklet offers an explanation of the license requirements; extracts from various government pamphlets, amended Communications Act of 1934, and *Rules Governing Commercial Radio Operators*; information about examining offices; list of
(Continued on page 46)

Do YOUR Tubes

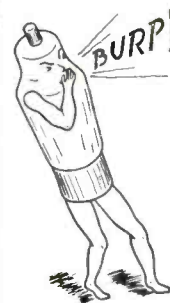

have GAS?

The wrong gas content, as every service man knows, can change the characteristics of any tube. Unless the gas content is known to be correct, any test of the tube is of little value.

FIRST AID for YOUR gassy tubes is the E.M.C. Model 200 Mutual Conductance Tube Tester!

The model 200 features a calibrated micromho scale, and checks all tubes accurately and quickly for gas content, dynamic mutual conductance and every other known cause of electron tube trouble. The price..... **ONLY**

\$52.85 Counter model, with 4 1/2" meter

Same as above, with built-in roll chart, \$58.85

Prices on other models, including portables, on request. WRITE TODAY for FREE illustrated literature.

ELECTRONIC MEASUREMENTS Corp.
114 Liberty St., New York 6, N. Y.

AT DEMONSTRATION OF TRANSVISION 12" TV KIT



Top, Transvision tv kit being demonstrated at the recent three-day exhibit in the Waldorf-Astoria Hotel, N. Y. City, by Herbert Suesholtz (left, behind counter) general manager, Dave Kubrick (center, behind counter) and Irv Brown (extreme right) sales engineers. Bottom, distributors of the New York area examining the television kits.



HERE ARE SIMPSON'S PROFIT-MAKERS FOR SERVICEMEN... "BASIC 3"

The serviceman who tries to "get along" with cheaply-made, run-of-the-mill test instruments is taking an outside chance on success. The business of radio servicing must be *built* from the bottom up on an endless succession of perfect jobs. Knowing what the trouble is, in a receiver, and knowing when that trouble is eliminated *can be no better than the test instruments that reveal them.*

The "Basic 3" Simpson instruments shown here are an extremely profitable investment for any serviceman. He needs all three and, in their price range, he cannot buy better anywhere else. In fact, in their price range they are unequalled. They will do more than many instruments selling for substantially more. These are facts easily demonstrable to any serviceman who will take the time to check up. And it is worth the time in the *cold cash of profits* to discover how Simpson engineering skill and uncompromising quality construction produce the *staying accuracy* for which Simpson instruments are famous.

MODEL 315 SIGNAL GENERATOR. Designed down to the most minute detail for highest accuracy, greatest stability, minimum leakage, and good wave form **\$67.35**

MODEL 305 RC TUBE TESTER. Tests all tubes. Provides for filament voltages from .5 volts to and including 120 volts. Spare sockets for future tube developments **\$59.50**

MODEL 260 HIGH SENSITIVITY SET TESTER. 20,000 ohms per volt, D.C. Voltage ranges to 5,000 volts A.C. and D.C. Resistance ranges to 20 megohms. Current ranges to 500 milliamperes, also 10 amperes D.C. **\$38.95**
In New Roll Top Safety Case **\$43.75**

SIMPSON ELECTRIC COMPANY • 5200-5218 West Kinzie Street, Chicago 44
In Canada, Bach-Simpson, Ltd., London, Ont.



Simpson
INSTRUMENTS THAT STAY ACCURATE

FOR FASTER SOLDERING

2 NEW WELLER SOLDERING GUNS

with

Solderlite



The new Weller Soldering Guns with Solderlite plus the fast 5 second heating help make service work more profitable for radio, television and appliance service men, electrical maintenance men, electric motor rewinding and repair shops automotive electrical service. A useful and time-saving tool for laboratory workers, experimenters, hobbyists, telephone installation and maintenance men. See your radio parts distributor or write for bulletin direct.

820 Packer St., Easton, Pa.

WELLER MANUFACTURING CO.

In Canada: Atlas Radio Corp., Ltd., 560 King St., N. W., Toronto, Ont.
Export Dept.: 25 Warren St., New York 7, N. Y.

News

(Continued from page 44)

FCC publications; and suggestions about preparation for the examinations with a formal study course and pre-examination tests.

Booklet will be sent free to all Service Men.

* * *

ASHBACH BUYS GAROD

Leonard Ashbach, president of the Leonard Ashbach Company, Chicago, recently purchased 100% of the stock of the Garod Radio Corporation, Brooklyn.

The Garod plant will continue operating under the new ownership at its present location, 70 Washington Street, Brooklyn 1, N. Y.

Max W. Weintraub, former Garod president, will become the Garod Metropolitan New York distributor through Belle Electronics Corporation.

Barney Trott, former secretary-treasurer and chief engineer, has been retained as chief engineer.

Lou Silver, former national sales manager, has been elected vice president and director of the new company.

Mr. Silver will assume complete charge of sales throughout the world.



Lou Silver

* * *

JESTER JOINS JENSEN INDUSTRIES

Oden F. Jester, former vice president in charge of sales for Maguire Industries, Inc., has been named general sales manager of the Jensen Industries, Inc.

Mr. Jester served as sales manager of the radio division of Stewart Warner for many years and held a similar position with Utah Radio Products Company.

Phil M. Spink will remain as general manager of Jensen.

* * *

RCA TUBE SALES AIDS

A sales aid folder, illustrating and describing the line of promotional pieces and displays prepared for the radio dealer and Service Man, has been issued by the RCA tube department.

Folder describes 32 items ranging from



Revolutionary New Instrument for Complete Receiver Testing!

Clippard Instrument Laboratory

Signalette

MULTI-FREQUENCY GENERATOR

Generates R.F., I.F. and AUDIO Frequencies, 2500 cycles to over 20 megacycles, using new electronic multivibrator radar principle. Completely self-contained—fits coat pocket or tool chest. Just plug into A.C. or D.C. LINE AND CHECK RECEIVER SENSITIVITY, AUDIO GAIN, R.F. and I.F. alignment, auto radio aerial peaking or shielding, breaks in wires, stage by stage signal tracing, tube testing by direct comparison, etc., etc. Sturdy construction, handsome appearance! See at your dealers or write:

PRICE \$9.95
at dealer or
F.O.B. Cincinnati

Clippard Instrument
Laboratory, Inc.
1125 BANK STREET
CINCINNATI 14, O.

counter and window displays to mats for newspaper advertising.

Items include cartoon displays, a 21" cutout of *Sally Service* designed to sit on a giant tube carton, indoor and outdoor hanging signs, imprinted scotch tape and gummed wrapping tape with various dispensers for each, direct mail cards, display cartons, etc.

Available free from RCA distributors.

* * *

WHITESIDE HEADS G.E. TUBE PARTS SALES

Joseph W. Whiteside has been appointed sales manager of the G. E. tube parts and equipment sales section with headquarters at Schenectady.

* * *

RIDER TO PUBLISH POCKET-SIZE TECHNICAL BOOKS

A series of pocket-size technical radio textbooks, to sell at 99 cents, will soon be published by John F. Rider Publisher, Inc., 404 Fourth Ave., New York 16, N. Y.

The 99ers, as they are to be called, will be 5 1/4" x 7 1/4" and will contain from 128 to 160 pages.

Books to appear will cover *Installation and Servicing of Low Power Public Address Systems*, *Signal Generator at Work*, *Understanding Vectors and Phase in Radio Work*, *Understanding Transmitters*, *Adjusting Transmitters with the Oscilloscope*, and *R-F and I-F Selectivity*.

* * *

SUPREME BOOKS

Two manuals, *Automatic Record Changers Servicing Information*, and

(Continued on page 48)

RAYTHEON TUBES...
MASTER'S ORDERS

YOU'RE ALWAYS RIGHT
WITH RAYTHEON



BUY RAYTHEON TUBES!

RAYTHEON

®

Excellence in Electronics

RADIO RECEIVING TUBES
SPECIAL PURPOSE TUBES
TRANSMITTING TUBES
HEARING AID TUBES



Designed to give years of service

Plenty of Distributors to assure you service

Essential to perfect radio service

RAYTHEON MANUFACTURING COMPANY

RADIO RECEIVING TUBE DIVISION

NEWTON, MASSACHUSETTS

CHICAGO, ILLINOIS

SERVICE, SEPTEMBER, 1947 • 47

EASILY ADJUSTABLE FOR THE JOB

ADJUSTOHM RESISTORS

Seven Stock Sizes from 10 watts to 200 watts

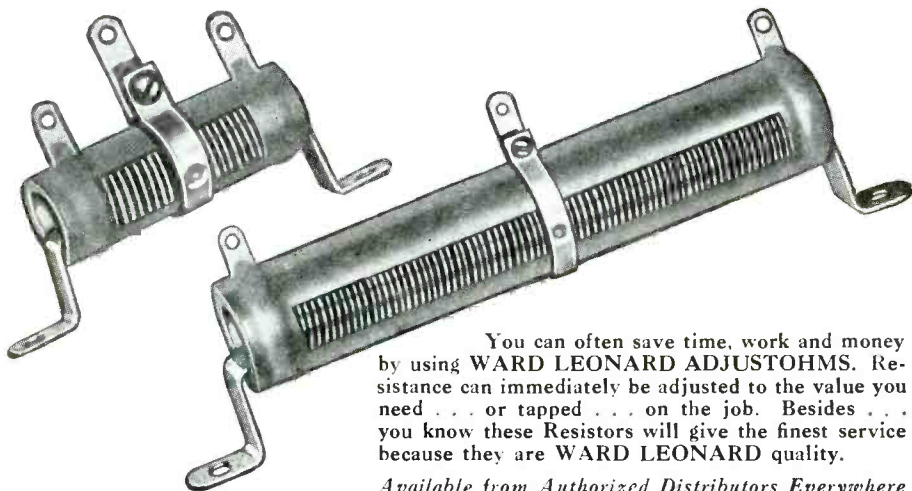

You can often save time, work and money by using WARD LEONARD ADJUSTOHMS. Resistance can immediately be adjusted to the value you need . . . or tapped . . . on the job. Besides . . . you know these Resistors will give the finest service because they are WARD LEONARD quality.

Available from Authorized Distributors Everywhere

WARD LEONARD ELECTRIC CO.
53E W. Jackson Blvd., Chicago 4

Radio and Electronic Distributor Division

WARD LEONARD

RELAYS • RESISTORS • RHEOSTATS

Electric control devices since 1892

Send for
Catalog D-2

Gives handy data and information on various types of Resistors and Rheostats available from stock.



Every Radio Serviceman Needs This **FREE**

68 PAGES

AC-DC BALLAST TUBE MANUAL

BOOK SIZE 5 1/2 x 8 1/2

To get YOUR FREE COPY of this indispensable manual (value \$1.50) merely mail in to JFD Factory 12 flaps from JFD Radio Dial Belt envelopes; include 10¢ in postage to cover mailing cost. (Buy your JFD Dial Belts and Belt Kits from your nearest parts jobber.)

JFD's new 68-page Ballast Manual is a treasury of information for Radio Servicemen and Dealers — Lists more than 3000 radio ballasts — ACDC Ballasts for Fluorescent lights and electrical appliances — 220 volt to 110-volt Stepdown Ballasts.

Send 12 Envelope Flaps to:

J.F.D. MANUFACTURING CO. INC.
4109-4123 FT HAMILTON PKWAY, BKLYN 19, N. Y.

Ever Sit On A Gold Mine?

You can build a business of your own NOW — either part or full time — with TRADIO, the radio functionally designed for coin-operation in hotels, motels, stopovers, hospitals, etc. Big earnings . . . Steady income . . . and no clock to punch unless you want to.

★ Only Small Investment Needed

Tradio has pioneered in this new and fast growing industry. Get in on the ground floor and assure yourself of financial independence for life.

★ Tradio—Tried, Tested, Proven

Thousands of others all over the country have learned that "Tradio Pays While It Plays."

Send for complete information today.



Write to Dept. W-9.

TRADIO, Inc. ASBURY PARK NEW JERSEY

News

(Continued from page 46)

Most-Often-Needed 1947 Radio Diagrams, have been published by Supreme Publications, 9 South Kedzie Ave., Chicago 12, Ill.

The record-changer manual (144 pages) includes detailed electrical and mechanical service data, with illustrations on 1945-1947 record changers. Priced at \$1.50.

Diagram manual (192 pages) presents diagrams and alignment information, parts lists, voltage values, stage gain, trimmer location, and dial stringing on popular sets made between June 1, 1946, and March 1, 1947. Covers 327 models of 52 manufacturers. Its price is \$2.00.

* * *

GENERAL CEMENT SELF-SERVICE DISPLAY

A self-service display for chemicals has been announced by General Cement Manufacturing Company, 919 Taylor Avenue, Rockford, Illinois.

Upper shelves of display hold 2-oz size bottles and the lower shelves will stock the 4-oz, 8-oz and 16-oz size chemicals. All items are arranged in numerical order. Bottom shelf is large enough to hold gallon and quart size containers.

Approximate dimensions are 70" wide by 70" high by 21" deep at the base. Shelves are arranged at an angle dipping toward the back so that the labels are at an easy-to-read angle.



* * *

RCA BATTERY SALES FOLDER

A battery sales-aid folder illustrating and describing promotional pieces and displays has been announced by the RCA tube department.

Items in the folder, which is obtainable from RCA tube distributors, range from a self-service merchandiser to direct mail postcards.

* * *

ELECTRO-VOICE BUTTON-CONTROL FLOOR STAND BULLETIN

A bulletin, No. 134, illustrating and describing model 430 button-control floor stand has been released by Electro-Voice, Inc., Buchanan, Michigan.

* * *

SAMS OFFERS FREE PHOTOFAC T AIDS

Three service information folders are now available without charge to Service

Men, from Howard W. Sams & Co., Inc., 2924 East Washington Street, Indianapolis 6, Indiana.

The first is a complete cumulative index to more than 1,000 postwar receivers, combinations, record changers, recorders and sound amplifiers. Index is arranged alphabetically and by model number, indicating the proper Photofact Folder to use for complete service information on any of the models listed. The second folder describes methods to file Photofact Folders. Data are also applicable for arranging other servicing material in loose-leaf or folder form. The third folder, a specimen Photofact Folder covering a popular radio-phonograph combination, illustrates the arrangement, features and service data included in all Photofact Folders.

* * *

SYLVANIA APPOINTS ISHAM FOR METROPOLITAN N. Y.

George C. Isham, manager of distributor sales in the northeast division for Sylvania Electric Products, Inc., will also be responsible for distributor tube sales in the metropolitan division covering Eastern New York, New Jersey and Eastern Pennsylvania.

* * *

OLSON CARTOON POSTER ON CAPACITORS

A 17"x22" cartoon poster, in color, illustrating the makeup of electrolytics, has been released by Olson Radio Warehouse, Inc., 73 E. Mill St., Akron 8, Ohio.

Five cartoon-type drawings are used to show how a capacitor can be compared to a cheese sandwich, with aluminum, cellulose and non-corrosive electrolyte taking the place of bread, cheese and mayonnaise; and how the structure of modern capacitors provide a durable unit which corroding agents cannot affect. A mouse eating a cheese sandwich is used to illustrate this point.

The giant poster is available free to all Service Men.



* * *

WM. M. MAGUIRE NOW WITH TUBE DISTRIBUTOR SALES OF SYLVANIA

Wm. M. Maguire has been transferred from the Salem, Mass., plant to the distributor sales department of the radio tube division of Sylvania Electric Products, Inc. He will serve as products specialty salesman in cooperation with Sylvania sales division managers and dis-



Sine or Square Wave at the Flick of a Switch!

Now—the General Electric Sine-Square Wave Generator YGA-2 provides you with greater facilities for better, more efficient service work. A top quality equipment, it incorporates two units in one; a high quality, stable oscillator and a square wave generator. It features a low distortion sine wave, stable RC oscillator and instantly available square waves.

SINE WAVE APPLICATIONS

Testing and adjustment of audio amplifiers, transformers, phase inverters, audio filters, etc.

SQUARE WAVE APPLICATIONS

Two point testing of response and characteristics in audio devices. Checking frequency response of wide band amplifiers. Determination of phase shift, distortion and high frequency peaks in audio equipments.

For complete information on the Sine-Square Wave Generator and other General Electric Service Test units write today to: General Electric Company, Electronics Park, Syracuse, N. Y.

GENERAL ELECTRIC

164-F7

tributors in the eastern half of the United States.

* * *

GOLENPAUL ELECTED RADIO PARTS SHOW PRESIDENT

Charles Golenpaul, Aerovox jobber sales manager, New Bedford, Mass., has been elected president of the Radio Parts and Electronic Equipment Shows, Inc., sponsor of the national Radio Parts Show.

Golenpaul, who succeeds Jack Berman, of Chicago, as president, represents the Sales Managers Club, Eastern Group, on the show committee. Jerome J. Kahn, Chicago, representing the parts division, RMA, was chosen vice president; R. J. Sherwood, Chicago, representing EP and EM, secretary, and NEDA representative W. O. Schoning, Chicago, treasurer.

The 1948 board of directors includes:

J. J. Kahn and R. C. Sprague, representing RMA; Charles Golenpaul and W. W. Jablon, representing SMCEG; R. J. Sherwood and John L. Robinson, representing EP and EM, and W. O. Schoning and Aaron Lippman, representing NEDA.



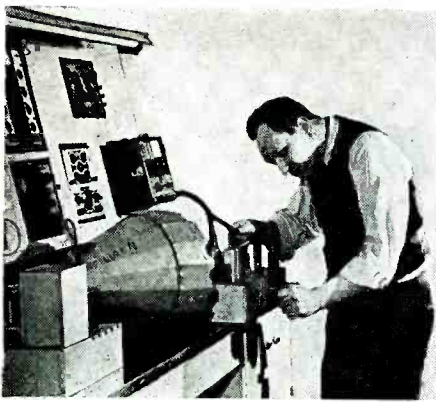

What Kind of Serviceman Will YOU Be 5 Years From Now?

RADIO-ELECTRONICS SERVICING
Will Advance Unbelievably
During the Next Few Years
AND THE FIELD IS "WIDE OPEN"

25 years of radio development packed in 5 war years! No wonder thousands of highly-trained, expert electronics technicians are required right now—and the field is wide open.

Little competition is to be expected from the pre-war serviceman who has not modernized his knowledge through training. The industry is more of a specialized science than ever before! The average "screwdriver" serviceman is on his way out, and the trained electronics service engineer is on his way in. Honestly ask yourself if you are equipped to qualify for maintenance and service work in this new, broadened service field. If not, you are limiting your own opportunities in a field that drastically needs trained men.

Join the many servicemen who are now studying CREI courses in spare time . . . protecting their future jobs, their businesses, by acquiring new "know-how" now. CREI's reputation for home study training has been proved over 20 years. Important new electronics developments are covered in the CREI courses. Trained instructors give you personalized attention and step-by-step guidance all the way. No matter how little or great your practical experience there's a CREI course suited for your personal needs. Read the revealing facts—learn how CREI can help you enjoy the future you want. Write today.

VETERANS!

CREI Approved Under the "G. I." Bill

MAIL COUPON
FOR FREE BOOK

If you want to grow with your industry and make more money, let us prove to you we have the training you need. To help us intelligently answer your inquiry—please state briefly your background of experience, education and present position.



Capitol Radio Engineering Institute

16th and Park Rd., N. W., Dept. S-9,
Washington 10, D. C.

Gentlemen: Please send me your free booklet, "CREI Training for Your Better Job in RADIO-ELECTRONICS," together with full details of your home study training. I am attaching a brief resume of my experience, education and present position.

Check Practical Radio Engineering Course Practical Television Engineering

Name

Street

City Zone State

I am entitled to training under the G.I. Bill.

New Products

(Continued from page 42)

measurements may be obtained to 110 mc. Germanium crystal probe is also used. Other features include three stages of push-pull amplification, a 3,000-volt scale, and an ohm scale with a range from 10 to 10 megohms.

Fourth model is a de luxe speaker, 721, designed to eliminate the necessity of removing the set speaker for servicing. Instrument can also be used as a substitution for chokes, electrolytics, bypass, and a wide range of resistors. A voice coil connection permits substitution of any output transformer, and rotating input and field switches on the front panel permit matching to any single or push-pull output tubes.

* * *

U. S. INSTRUMENT SOUND-POWERED TELEPHONE

A two-way sound powered telephone system has been announced by the United States Instrument Corporation, Summit, New Jersey.

Since this system is sound powered, communication is possible without external power supply or batteries.

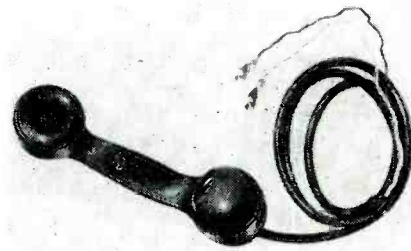

* * *

VEE-D-X TV ANTENNA

A television antenna, the VEE-D-X, has been announced by LaPointe-Plascomold Corp., Unionville, Conn.

Antenna developed by LaPointe-Plascomold Corp. and Alfred C. Denson, electronics specialist, Rockville, Conn., features a matching section which permits matching the impedance of transmission line of from 50 to 600 ohms to antenna.

Connections to antenna are made by means of coaxial connectors or screw terminals.

Incorporates aluminum castings at all points of strain and aluminum tubing for the elements.

* * *

RCA LEAK-RESISTANT A BATTERIES

A sealed-in-steel A battery, VSO36, especially designed for use in smaller sets, has been announced by the tube department of RCA.

* * *

GTC PERMA POWER UNITS

Perma-power units, for converting battery sets to line operation, and featuring selenium rectifiers have been announced by General Transformer Corp., 4321 N. Knox Avenue, Chicago 41, Illinois.

Units have universal sockets which are said to fit 99% of all battery sets. Models available for 1½-volt sets, using 4, 5 or 6 tubes and for 6-volt type receivers.

* * *

PERMOFLUX HI-FIDELITY SPEAKERS

Hi-fidelity de luxe speakers, 10" to 15", in p-m and e-m types, with power handling capacity up to 25 watts, have been introduced by Permoflux Corporation, 4900 West Grand Avenue, Chicago, and 236 South Verdugo Road, Glendale, California. The p-m type features a heavy ring magnet and oversize voice coils.

Permoflux is also manufacturing a standard line of speakers, ranging from

S.S.S.

"Servicing by Signal Substitution"

Learn about this modern dynamic approach to radio servicing with ONLY BASIC TEST EQUIPMENT.

... Fully described in a 120 page book available from your Precision Distributor or factory at 35¢.

... Schools are invited to inquire regarding quantity orders from our Educational Division.

PRECISION
APPARATUS COMPANY INC.
ELMHURST 1, N. Y.

Manufacturers of Fine Test Equipment
RADIO • TELEVISION • ELECTRICAL • LABORATORY

ESICO

REG. U. S. PAT. OFF.

Now you can make your selection of an ESICO professional iron right from the display box which you will find on the distributor's counter.

Insist on an ESICO professional iron!

The iron that is used on the production lines.

Available at All Good Distributors

ELECTRIC SOLDERING IRON CO., INC.

3147 West Elm St., Deep River, Conn.

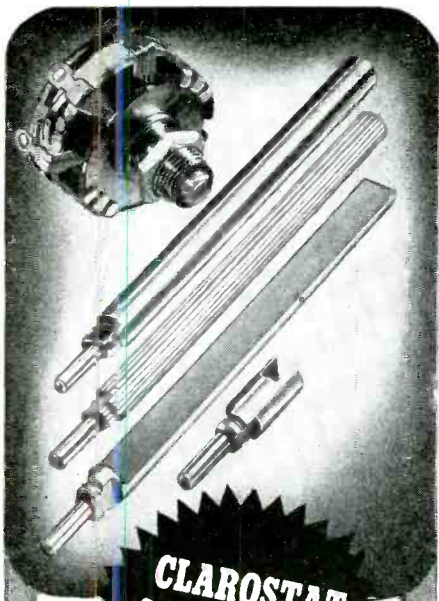

**CLAROSTAT
AD-A-SHAFT
CONTROLS**

**NO WIGGLE
NO WOBBLE
NO TROUBLE**

★ Select that control for ohmage, taper, tap. Then select the required shaft—round, flat knurled, auto-radio, etc. They go together with a bang. Just a blow on the shaft and it's permanently fastened. No wiggle. No wobble. No coming out again. It's as rigid as the factory-riveted job.

That's what servicemen like about the new Clarostat Ad-A-Shaft. Mechanically, it's tops—fully matching the electrical perfection of the Clarostat control.

With each Ad-A-Shaft Control Series AM (Standard) or AT (Tapped) you select any type shaft you need. Minimum stock, maximum uses. You can now afford to have controls on hand. No need wasting time chasing down to the jobbers' each time. No tying up of real money. Here's the right control and right shaft right at hand.

Ask our jobber about the new Clarostat Ad-A-Shaft. By all means try it. You'll want it after that!



CLAROSTAT MFG. CO., Inc. · 285-7 N. 6th St., Brooklyn, N. Y.

3" to 12" sizes, including the 4"x6" and 6"x9" elliptical speakers in both p-m and e-m types, and the p-a models.

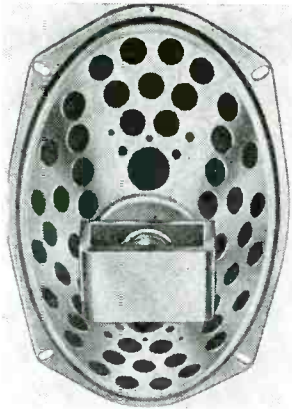

Permoflux elliptical speaker.

* * *

SYLVANIA 7-INCH OSCILLOSCOPE

A seven-inch cathode-ray oscilloscope has been announced by the radio tube division of Sylvania Electric Products, Inc., 500 Fifth Avenue, New York 18, N. Y.

Scope uses a push-pull amplifier, using four 7C7s.

Provision is made for Z axis input with impedance to ground approximating 1/2 megohm with 30-mmfd shunt capacitance.

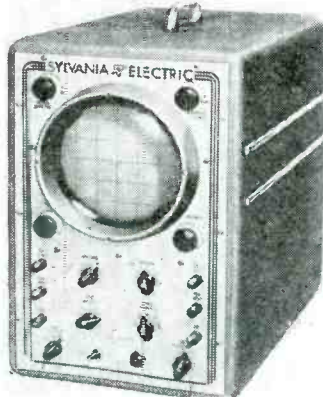

* * *

WESTON TUBE CHECKER

A proportional mutual conductance tube checker, model 798, type 5, which tests receiving tubes, voltage regulator tubes and low power thyratrons, has been announced by the Weston Electrical Instrument Corporation, 617 Frelinghuysen Avenue, Newark 5, N. J.

Tube checker provides proportional mutual conductance readings under conditions which closely resemble actual operation. Good-Bad readings, also, are provided.

Sixty-cycle a-c is used on tube elements, thereby approaching the zero plate load conditions most desired for mutual conductance tests. A separate internal 5-kc signal is applied to the control grid, and the resulting plate component of the high frequency signal is measured on a rectifier meter.

Since the normal plate current of the tube does not pass through the meter circuit, all types of tubes can be tested without overloading. Three signal voltages of 0.75/1.5/3 volts provide mutual con-

(Continued on page 52)

BUILT FOR SERVICE



Technical Tips

How weak diodes affect bias voltages

● The zero-signal bias for the AVC-controlled tubes in many receivers is derived solely from the so-called "contact potential" developed by the AVC diode. The contact potential is approximately one volt and arises from the fact that some electrons reach the diode plate even under no-signal conditions.

However, if the diode emission is low due to a "poisoned" cathode, the diode contact potential will drop to a fraction of a volt, and the controlled tubes may draw excessive plate current, and eventually fail. In addition, a diode with low emission is unable to supply adequate AVC voltage—a symptom that is immediately apparent when the receiver is tuned across the band.

If you suspect a receiver of this fault, the quickest and easiest check is to replace the AVC diode tube with one known to be good. Invariably you can count on a Cunningham.

For more service—TURN THE PAGE →

**Cunningham
Electron Tubes**

A product of
RADIO CORPORATION OF AMERICA
Harrison, N. J.

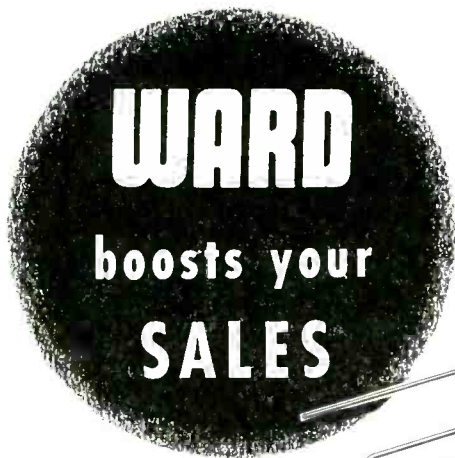

with All-out
Consumer Advertising on
Magic Wand
FM AND
TELEVISION AERIALS

This campaign, in the Saturday Evening Post and leading newspapers, is convincing millions of present and prospective FM and Television receiver owners that a good outdoor dipole antenna is a necessity. As a result you'll make more money selling "Magic Wand" FM and Television Aerials . . . and be able to promise, and deliver, finest reception no matter where your customers live. You'll make added profits from aerial installations, too. See your Ward distributor for details on how to assure your full share of the benefits of this major FM and Television Aerial campaign, or write:

THE WARD PRODUCTS CORPORATION
1523 East 45th Street, Cleveland 3, Ohio
DIVISION OF THE GABRIEL COMPANY

EXPORT DEPT.: C. W. Brandes, Mgr., 4900 Euclid Ave., Cleveland 3, Ohio
IN CANADA: Atlas Radio Corp., 560 King St. W., Toronto, Ont., Canada



New Products

(Continued from page 51)

distance ranges of 12,000, 6,000 and 3,000 micromhos. A hot neon test is provided for checking leakage between tube elements.

Instrument will indicate the static and regulating characteristics of voltage regulator tubes such as the VR105 and VR150, and will test thyratrons 884, 885, 2A4, 6D4, 2050, 2051 and similar low-power tubes. Grid bias, plate voltage and meter sensitivity are independently adjustable from separate controls. Switching circuit provides for testing of new tubes, with one spare octal and one spare miniature socket provided.

The power supply permits use of four different plate potentials, in combination with various screen potentials, to eliminate possible overloading of diodes, battery-type tubes, etc.

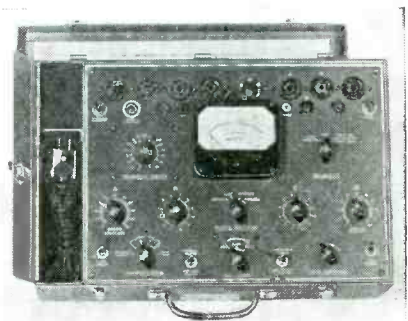

* * *

JFD CHEMICALS

Four chemicals for cabinet, crystal, and dial repair have been announced by JFD Manufacturing Co., Inc., 4117 Ft. Hamilton Pkwy, Brooklyn 19, New York. *Poli-wax* has been developed for polishing cabinets and other wooden furniture. Another chemical, *contact* and *crystal cleaner* has been prepared to clean crystals.

Third among the chemicals is a *bake-lite cement* for securing plastic to plastic or to any other material.

A *liquid non-slip compound* is available to prevent dial belts and cables from slipping.

* * *

PYRAMID TUBULAR PAPER CAPACITORS

A line of paper *tube-u-lar* capacitors with capacities from .001 to .005, .01 to .05 and .1 to .5, with d-c working voltages of 600, has been announced by the Pyramid Electric Company, 155 Oxford Street, Paterson, New Jersey. The .001-mfd type capacitors are $\frac{3}{8}$ " x $1\frac{1}{8}$ ".



* * *

EASTERN AMPLIFIER AUTOMATIC SOUND UNIT

An automatic sound reproducing system, the *Robomat*, which features a microphone, a-m receiver and heavy duty auto-

ENDS *Miniature* **TUBE BREAKAGE**
Avoids Burning of Hands - Saves Time and Work

New **AMO**
Miniature
TUBE PULLER

• With the growing use of miniature tubes . . . radio men have been seeking a handy tube-saver like this! Now . . . with the AMO . . . miniature tubes can easily be extracted from sockets or inserted . . . in hard-to-reach places . . . without fear of breakage, burning of hands, or loss of time! Because the AMO is so handy and so durable . . . because it is so usable again and again and costs so little . . . *no radio man should be without one!* Let this marvelous tool build profits for you. Order now—or write for further information. Available at established distributors.

Made by Oliveri Tool Co., Chicago 39

National Sales Representatives **SALESCRAFTERS, INC.**

510 N. Dearborn St., Chicago 10, Ill.

PAYS FOR ITSELF OVER AND OVER AGAIN!

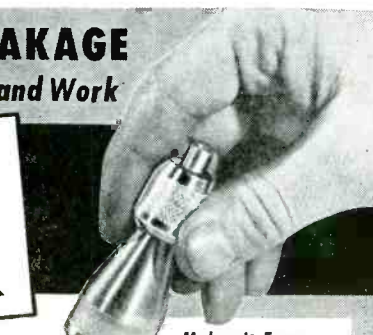

Makes it Easy
to Remove or Insert
MINIATURE TUBES
such as 6Ag5, 50B5, etc.

AMO is simple to operate. When extended in the finger tips, it can reach places where fingers alone would find difficulty. To extract tubes, simply press AMO down on tube, and lift up. Tube is then released by pressing release button. To insert tubes into hard-to-reach places, place tube in AMO holder, press into socket, and release. That's all!

Made with heat-resistant rubber cap, aluminum body, and handy thumb-operated plunger release.

\$1.50 LIST
Subject to usual trade discount

For Timely and Authoritative Analyses of the Latest in F-M, A-M and TV Circuits, You Must Read Every Issue of SERVICE

CIRCULATION NOW OVER 20,000 ABC NET PAID

"HOT"
ON THE JOB BUT
COOL
TO HANDLE...



Calrod

SOLDERING IRONS

FOR service men, mechanics of all types and "handy" men who want quality tools... G-E Calrod Soldering Irons meet every requirement.

CALROD ELEMENT

Cartridge type, insulated with highly compacted magnesium oxide which maintains full insulation properties and dependably protects against grounding. The Calrod element conducts heat so rapidly that there is little temperature drop from the resistance wire. High efficiency and quick recovery permit fast work with minimum loss of time.

CALORIZATION

Much longer life can be expected from the calorized tip. Calorization also makes tip removal easy and prevents "freezing in". Corrosion of the tip is greatly retarded by calorization.

HEAT RESERVOIR

An ample heat reservoir is provided by a calorized copper heat conductor which also serves as the tip holder.

STAINLESS STEEL BARREL

There is very low heat loss through the barrel because stainless steel has less than half the conductivity of plain steel. The barrel will withstand extremely hard usage without ill effects.

COOL HANDLE

The smooth, plastic handle remains cool to the touch. The heat is in the working tip where it belongs.

For complete information write: General Electric Company, Electronics Department, Syracuse 1, N. Y.

169-F6



matic record changer has been announced by Eastern Amplifier, Bronx, N. Y. City.

Record changer stacks 20 records and plays both sides. Changer can be operated for continuous periods on either a planned program, such as one record every three minutes, or on a continuously operating program.

Output capacity is 90 watts.

Timing device is incorporated, so that unit can turn itself on and off for any pre-adjusted time.

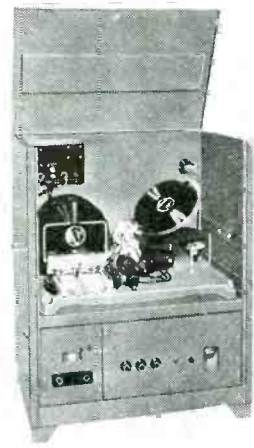

PRECISION TESTER

A 20,000 ohms-per-volt test set, series 858 multi-master, featuring a multi-master automatic push-button range and function selection system, has been announced by Precision Apparatus Co., Inc., 92-27 Horace Harding Blvd., Elmhurst, L. I., N. Y.

One row of five buttons selects all functions such as volts, ohms, mils, decibels, amperes and microamperes. Another row of six buttons selects all ranges; 54 ranges to 6,000 volts, 600 megohms, 12 amperes, 70 db and 60 microamperes, 20,000 and 1,000 ohms per volt d-c, 1,000 ohms per volt a-c.

Incorporates a 50-microampere, 4 5/8" rectangular meter.

A 600-megohm insulation resistance test range is provided in addition to five self-contained ohmmeter ranges to 60 megohms.

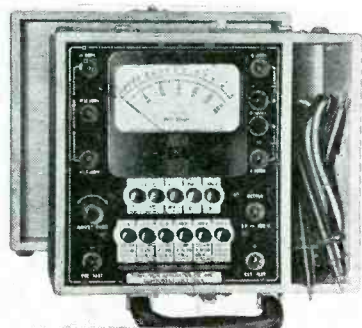

WALSCO STANDARD RECORDS

A standard test record employing a series of three consecutive tones, has been developed by Walter L. Schott Co., 9306 Santa Monica Boulevard, Beverly Hills, Calif.

Lead-in grooves are modulated from the outer edge of the record. In testing a record changer, proper adjustment is attained when only two tones are heard.

The playing time for the 10" record is approximately 40 seconds. This makes it possible to obtain five change cycles in less time than it takes to play one regular record.



BUILT FOR SERVICE

Order your sales aids from this new catalog



Here's your catalog of Cunningham sales aids... just off the press. It describes the exciting new group of Cunningham posters, Comuras, illustrated signs, and many other business-builders... tells you how these displays bring customer attention to your store and shop. A handy order form comes with each copy. GET YOURS TODAY FROM YOUR CUNNINGHAM DISTRIBUTOR.

For more sales—TURN THE PAGE →



FINGERS are FASTER with VACO

Break-Proof
Shock-Proof

Screw and Nut Drivers

Nimble fingers using precision built tools do all kinds of radio assembly or servicing work faster, save both time and money. That's one good reason why radio men everywhere prefer Vaco products. Precision built for precision work, these delicately balanced screw and nut drivers "handle" perfectly . . . speed up every type of operation. Break proof, shock proof Vaco drivers are your assurance of the right tool for the job. Write today for descriptive catalog.

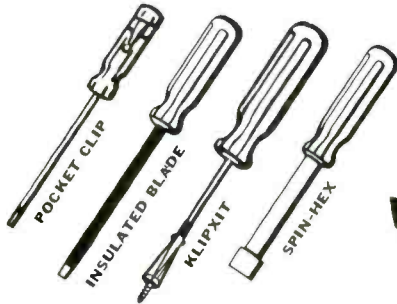

173 TYPES AND SIZES

VACO

PRODUCTS CO.

317 E. Ontario St.
Chicago 11, Illinois



NEW...
Colored Spin-Hex
Amberyl Handle Caps

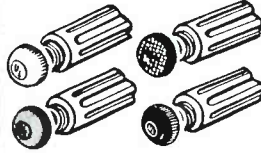

Another Vaco extra! Color of removable cap indicates size of driver. No more hunting for the right size! Hollow handles hold reserve nut supply.

**NO MATTER WHAT YOUR REQUIREMENTS
...THERE'S A VACO TO FIT EVERY NEED!**

*Built so You
Can Read it!*

MULTIPLEX

VOLTS - VOLT - OHM - MILLIAMMETER

This is your instrument for all day, every day use. The Multiplex Model 458 is a rugged, accurate, portable, bench-type V.O.M. built to high industrial standards by one of America's pioneer makers of test equipment.

Multiplex Features:

Big 5½" d'Arsonval movement meter. 1000 ohms per volt. Multipliers accurate within 1%. Rotary range selector. Copper oxide rectifier for A.C. range accuracy. Priced remarkably low for \$26.00 NET an instrument of this quality—only.

See Your Jobber or Write for Bulletin 458

CHICAGO INDUSTRIAL INSTRUMENT CO.
536 West Elm Street • Chicago 10, Illinois



All Popular Ranges

Volts D. C. 0-5/10/50/100/500/2000
Volts A. C. 0-12.5/25/125/250/1250
Milliamperes D. C. 0-1/10/100
Milliamperes A. C. 0-2.5/25/250
Ohms Full Scale 1000/200,000/2,000,000
Ohms Center Scale 50/2250/22,500
Output -5 to +55 Decibels

Ser-Cuits

(Continued from page 40)

second i-f, F_2 , which is 4.3 mc. With a 100-mc signal, the oscillator frequency is 47.85 mc, and the variable frequency is 52.15 mc.

This system of reception permits the oscillator to be resonated with a high capacitance, 250 mmfd in this case. Consequently, changes in tube characteristics during warm-up do not produce objectionable changes in the oscillator frequency, thus contributing to system stability.

Figure 8 F-M Loop

A figure eight f-m loop is used in the Motorola models, with provisions to match dipole antennas with 300-ohms impedance. Since all dipoles do not present this impedance, it may be necessary to match the set to the antenna. This can be done by repositioning the external antenna taps on the f-m loop.

Matching

To arrive at the correct match, a pair of twisted pair of wires are secured, and one end attached to the f-m external antenna clips on the rear of the cabinet. Miniature battery clips are soldered to the other end of the pair of wires. Then the proper positions are obtained by sliding the clips around the loop.

The Pilotuner

Pilot has developed a 5-tube f-m unit, Fig. 4, for use with an external audio and speaker system. This model uses two stages of r-f, two stages of i-f and a ratio detector; 6BA6, 6BE6, 6BA6 and 6AL5, respectively.

Its sensitivity is approximately 25 microvolts for a ½-watt output, when coupled to an amplifier consisting of a triode and a power pentode.

Frequency response is up to 12,000 cycles. Model provides for less de-emphasis than required by transmitter standards to equalize possible deficiencies in the frequency response of a-f systems in the older a-m receivers to which the tuner may be connected.

What

Adjust-a-Cone

Means to **YOU**

The Quam Adjust-a-Cone speaker has a construction which provides a method for precision centering of the voice coil in every Quam Speaker before it leaves the factory.

With ordinary speaker construction, such precision is almost impossible, even under the most ideal production methods, and, as a result, the slightest warping or expansion of the cone may produce a rubbing voice coil.

Rubbing voice coils, so frequent with speakers of conventional construction, are practically eliminated in Quam Speakers.

Always specify Quam Speakers for finest performance and long, trouble-free service.

Write for Catalog

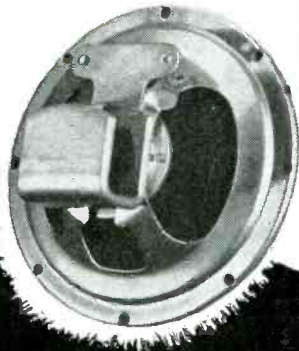

LOOK for the 'U'-SHAPED COIL POT

QUAM

Adjust-a-Cone

SPEAKERS

QUAM-NICHOLS COMPANY

33rd Place and Cottage Grove
Chicago 16, Illinois

F-M Limiters

(Continued from page 21)

the output. However, this can be overcome if the i-f signal has been amplified sufficiently, so that the voltage level at the input to the limiter of the greatest frequency deviation components is greater than the limiting level. This condition is shown in Fig. 9, with the amplitude of the limiter output constant so that a total band of 150 kc is passed at a constant level and all the frequencies making up the total deviation will be reproduced in their proper relation.

In summation, the functions of the limiter are: (1) Remove all amplitude variations of the signal due to noise; (2) Compensate for the lack of an ideal flat-topped response of the i-f stages, provided that the i-f signal at the input to the limiter is high enough at all frequencies within the complete frequency deviation range, so that limiter action takes place over the entire range of frequency changes from no modulation up to full modulation, and, also, that the limiter is designed to give a constant output over a wide range of input voltages; and (3) Reject unwanted signals 2 to 1 or more reduced in amplitude.

[From notes on the principles of f-m prepared by the G. E. technical service section.]

F-M/A-M Chassis

(Continued from page 15)

socket to keep interaction from the test meter to a minimum.

The tone-control circuit incorporated is novel as, in effect, it controls both the bass and treble by means of a single knob. It also has the advantage of a normal position in which flat response is obtained. When arm of tone control is moved toward the .002-mfd capacitor, bass compensation circuit attached to volume control tap is progressively short-circuited and the loading on the high-frequency .005-mfd bypass capacitor is decreased. Center position of this control is normal. When the arm is moved toward the h-f bypass and past the mechanical midpoint of the control, high-frequency attenuation will result. Since the bass-compensating network loading becomes less, more bass compensation will follow.

A small amount of inverse feedback is employed to minimize distortion and improve the fidelity characteristics of the output circuits.

BUILT FOR SERVICE



They sell with a smile!



● Here's a sure-fire way to draw attention to your shop! A set of four human-interest cartoons that catch every eye. They're full-color, easel-backed jobs by Ralph Stein, famous "Yank" magazine cartoonist, and they're outstanding.

Put 'em in your window and watch people stop! Put 'em on counters, shelves or cash registers and watch your business grow! GET YOUR SET TODAY FROM YOUR CUNNINGHAM DISTRIBUTOR.

For expert guidance—TURN THE PAGE →

Cunningham
Electron Tubes

A product of
RADIO CORPORATION OF AMERICA
Harrison, N. J.

Permoflux SPEAKERS

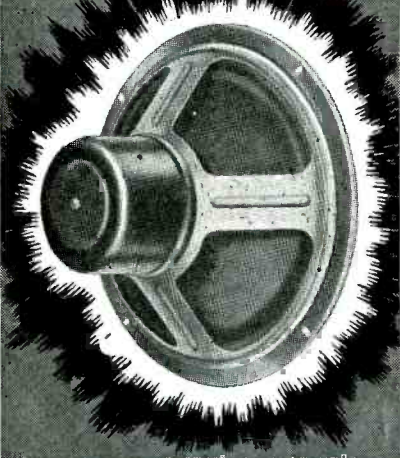

*An OLD name in Speakers
a NEW high in Performance**

ANNOUNCES... a COMPLETE JOBBER LINE of standard replacement and hi-fidelity deluxe loud speakers with both permanent and electro-magnet fields. These quality speakers embody the same skillfully engineered features used in the units that PERMOFLUX now supplies to major set manufacturers.

* Sound room laboratory tests prove greater uniformity in frequency response, than other comparable makes.

• WRITE FOR FREE BULLETIN •

PERMOFLUX

TWO COMPLETE FACTORIES TO SERVE YOU

PERMOFLUX CORPORATION

4900 WEST GRAND AVE., CHICAGO 39, ILLINOIS
236 SOUTH VERDUGO ROAD, GLENDALE 5, CALIFORNIA

PIONEER MANUFACTURERS OF PERMANENT MAGNET DYNAMIC TRANSDUCERS

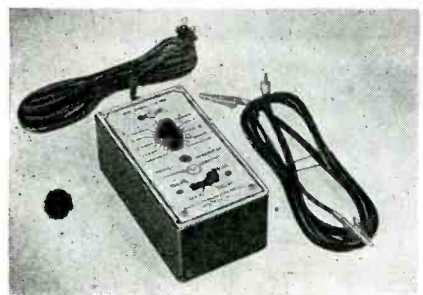

estimate repairs on the spot!
GENUINE POCKET SIGNAL GENERATOR \$17.95

it pays for itself in 30 days

Slip it in your pocket and take it with you on the job. You can locate faults quickly and accurately, estimate a repair job or do a complete alignment *right on the spot*. Provided with accurate fixed frequencies of 1500 and 550 Kc. 456 and 465 Kc. Suitable trimmers supplied for recalibration. Safe for A.C. and D.C. operation; no chance of "shorts", shock or burnout. Complete with tubes, shielded output cable, line cord and plug and housed in a sturdy, modern metal case. Size: 3 x 6 x 2 3/4.

**RADIO CITY PRODUCTS' INSTRUMENTS
—BEST FOR EVERY TEST**

RADIO CITY PRODUCTS CO., INC.
127 West 26th Street,  New York 1, N. Y.

M U E L L E R



CLIPS

For Quick Temporary Connections

- Made in 10 sizes—from the tiny wee-pee-wee to the 300 amperes Big Brute.
- Offered in both steel and solid copper.
- Red and black rubber insulators to fit each size.
- A complete line with

A CLIP FOR EVERY PURPOSE

Send for free samples and catalog 810

Mueller Electric Co.

1565 E. 31st St. - Cleveland, Ohio

TV Amplifiers

(Continued from page 32)

formers is to place the two coils very close to each other. When this is done the double humped response characteristic, as shown in Fig. 3, is obtained. The separation between the peaks of the double-hump characteristics and therefore the bandwidth of the band-pass is determined by the degrees of coupling between the two windings. The closer the windings the further the two humps are spread. However, there is a practical limit to the degree of coupling because, as the double-hump spreads the amplitude goes down and the valley in the center becomes too deep. Nevertheless this system of overcoupling is used extensively because even a small amount of overcoupling widens the band of frequencies passed by the tuned circuits.

In addition to obtaining overcoupling by close magnetic coupling of the windings of the tuned transformer, other methods of overcoupling, Fig. 4, are used. The methods shown in Fig. 4 use a mutual element capacitor, inductor or a tuned circuit to overcouple between the primary and secondary windings. It is not necessary that the magnetic lines of the primary link the secondary. In many cases the primary and secondary windings are mounted in separate shields. In circuit *A* the high side of the two windings are linked by a small trimmer capacitor. With this method a very broad bandpass is obtained, the extent of which can be controlled by the value of the capacitor. A typical value for this capacitor would be somewhere between 5 and 10 mmfd. In circuit *B* a common inductor links the two windings. A blocking capacitor is necessary to prevent transfer of the plate voltage.

In circuit *C* an actual tuned circuit (not tuned to the resonant frequency of the transformer) is used as a means of mutual overcoupling. The advantage of this particular type of overcoupling is that the tuned coupling transformer serves two functions; one, as a means of overcoupling, and second, a tuned resonant circuit that presents a maximum impedance to some undesired frequency, preventing the transfer of this frequency between primary and secondary windings. In this application it is called a tuned trap and, in many television receivers, is tuned to the adjacent channel sound frequency or the associated channel sound frequency, two frequencies which are not wanted in the picture i-f system because they cause a series of bars to appear on the picture. It is interesting to note that the tuned trap acts as a mutual capacitor or a mutual



Great, New, Complete **CONCORD** Radio Catalog

160 value-packed pages of
**RADIO PARTS • RADIO SETS
HAM GEAR • AMPLIFIERS
TESTERS • Electronic Equipment**
MAIL COUPON FOR FREE COPY

Ready now—the greatest, most complete presentation of radio, electronic and television equipment and supplies in Concord history! Packed from cover to cover with thousands of items—Radio Parts, Radio Sets, Amplifiers, Sound Systems, Test Equipment for every purpose, Record Players, Record Changers, Television Equipment, Ham Gear, Receivers, Transmitters—160 pages of everything and anything in Radio and Electronics, and featuring a special bargain section of hundreds of money-saving values in top quality, standard-make parts, including scores of new items from nationally-famous makers. Immediate shipment from CHICAGO OR ATLANTA. Write for your FREE copy at once.

WANTED—TRADE-INS ON COMMUNICATIONS EQUIPMENT—Always highest trade-in values on communications receivers. Write, phone or call to tell what you have, or send it for free appraisal.
TIME-PAYMENT PLAN—Buy your Radio and Electronic Equipment from Concord on EASY PAYMENTS—Communications Receivers, Transmitters, Radios, Radio-Phonos, Sound Equipment, Test Equipment. Write us your needs.



Concord Radio Corporation, Dept. S-97
901 W. Jackson Blvd., Chicago 7, Ill.

Yes, rush FREE COPY of the comprehensive new Concord Radio Catalog.

Name.....
Address.....
City..... State.....

inductor at the picture i-f frequency depending on which side of the picture i-f frequency it is tuned. If it is tuned to some undesired frequency above the resonant frequency of the picture i-f frequency it acts as an inductor because the lowest reaction element dominates in a parallel circuit. When it is tuned to some undesired frequency below the picture i-f frequency it acts as a mutual capacitor insofar as overcoupling is concerned. In other television receivers a band-pass T transformer is used to couple between the plate of one stage and the next. This type of bandpass or overcoupling system is shown in Fig. 5, along with an approximate equivalent. Again either a capacitor or an inductor can serve as the mutual overcoupling element.

In most of the overcoupling examples discussed no physical resonant circuit capacitor is used. The distributed circuit capacity of the stage serves as the capacitive element of the resonant circuit. A fine adjustment of the resonant circuit is obtained with a movable core.

Stagger-Tuning

A system called stagger tuning is also used to amplify linearly a broad-frequency band. Basically, the stagger-tuned i-f system, Figs. 6 and 7, consists of i-f stages which are not all tuned to the same frequency. For example, in Fig. 6 the alternate stages are only tuned to the same frequency. Thus the response of an individual stage is not too broad. However, the response of a number of stages, each tuned to a different frequency, produces a broad bandpass characteristic. The overall response characteristics of the stagger tuned i-f system shown in Fig. 6 is a double-hump characteristic similar to the double-hump characteristic of an overcoupled stage. It is possible to remove the valley of the double-hump characteristic by tuning a stage or two to a frequency midway between the two resonant frequencies of the stagger tuned i-f system. In this case, the i-f system becomes a triple-tuned system.

This stagger tuning idea can be carried still further. In fact, in the new RCA receivers the individual stages are all tuned to a different frequency. A simple breakdown of this type of i-f system is shown in Fig. 7. It can be seen that each stage has its own individual frequency and response, and that the overall response of all stages is the ideal response characteristic of a picture i-f system. Some stagger-

(Continued on page 58)

JOHN RIDER SAYS ...

Calibrate Periodically



Periodic calibration of test equipment should be a rigid requirement in all radio service shops. Granted that radio service measurements are less critical than those required in radio engineering, the need for ascertaining whether voltage, current and resistance indications are correct, and that signal source frequency calibrations are right, is definite.

Confidence in one's testing apparatus cannot be developed unless its proper operation is known. This not only assures longer life for the equipment and enables greater familiarity with the units, but also permits rapid diagnosis without any hesitancy or doubt.

Built for Service



Cunningham
Electron Tubes

A product of
RADIO CORPORATION OF AMERICA
Harrison, N. J.

TV Amplifiers

(Continued from page 57)

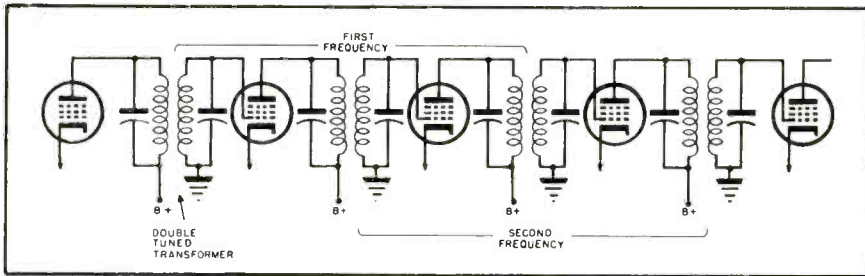
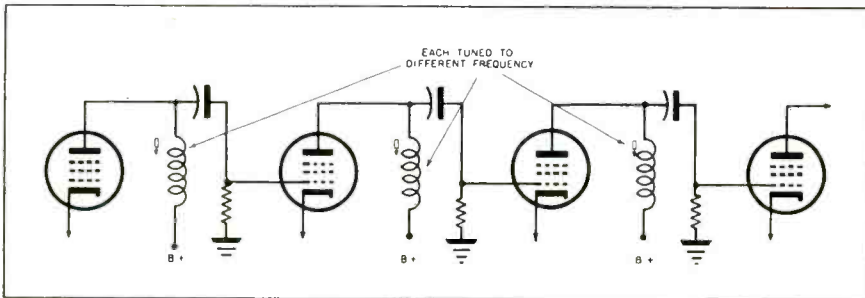

Fig. 6. The stagger-tuning method used for wide-band amplification. The alternate stages are tuned to the same frequency.

Fig. 7 (below). Stagger-tuning with single-tuned transformers, a system used in RCA receivers.



tuned i-f systems use a double tuned transformer, Fig. 6, while other systems use just a single tuned transformer between i-f stages, Fig. 7.

Wavetraps

Wavetraps are used throughout the i-f system of the television receiver to reject unwanted frequencies. These traps are particularly designed to reject the sound i-f frequencies. The sound modulation on these i-f carriers would cause a disturbing bar pattern on the picture tube screen if they were permitted to reach the picture detector. Some locations for wavetraps in the

picture i-f systems are shown in Fig. 8. In circuit *A*, we have a proximity wavetraps, where a tuned circuit is placed close to the regular inductor of an i-f tuned transformer.

A wavetraps can also be inserted into the *T* bandpass method of coupling as shown in *C*. Other parallel resonant circuits can be inserted at various other points in the picture i-f system

Fig. 8 (right). Positions of wave traps in tv receiver circuits. At *a*, the tuned circuit is placed close to the inductor of the i-f tuned transformer. In *b*, we have a parallel resonant circuit with the tuned transformer placed between the high sides of the primary and secondary i-f. Again we have a d-c blocking capacitor in the high side of the circuit. In *c* appears a trap in a *T*-bandpass circuit. The circuit in *d* shows the position of a grid and cathode trap, while circuit *e* is that of a cathode-proximity trap.

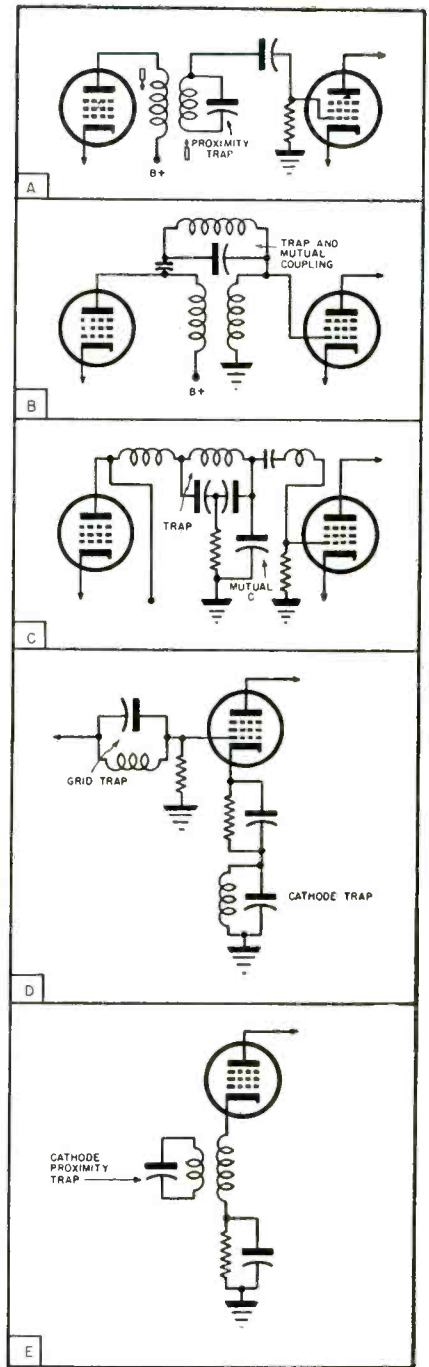

SERVICEMEN! — DEALERS!
 SEND FOR OUR LIST OF AVAILABLE
TUBES and PARTS
 M. V. MANSFIELD CO.
 937 LIBERTY AVE. PITTSBURGH 22, PA.

VERIFIED SPEAKERS
 "They speak for themselves"
WRIGHT
 2235 University Avenue Inc. St. Paul 4, Minnesota

LCETI

SEE PAGE 5

WHEN YOU CHANGE YOUR ADDRESS

Be sure to notify the Subscription Department of SERVICE at 52 Vanderbilt Ave., New York 17, N. Y., giving the old as well as the new address, and do this at least four weeks in advance. The Post Office Department does not forward magazines unless you pay additional postage, and we cannot duplicate copies mailed to the old address. We ask your cooperation.

to reject the unwanted frequencies. For example, a small trap can be inserted in series with the grid lead as shown in *D*. Here again it is a parallel-resonant circuit in series with the signal path and therefore rejects the frequency to which it is tuned. The same kind of trap can be inserted in the cathode circuit of a tube. This serves as a very efficient means of rejecting unwanted frequencies because the amount of rejection is less dependent on the *Q* of the resonant circuit. Actually in this type of connection a degenerative voltage is developed across the parallel circuit in the cathode which almost completely nullifies the grid signal. Thus the affected grid signal is very much reduced at the frequency to which the parallel circuit is resonant. At other frequencies the impedance of this circuit is of course very low and the cathode of the tube is effectively returned to ground. Undesired energy and undesired frequencies can also be absorbed from a cathode coil by means of a proximity trap.

[To Be Continued]

Tube News

(Continued from page 24)

method of controlling a circuit by introducing a pulse into the grid circuit. *Plate pulsing* is the same as grid-pulsing except the pulse is introduced into the plate circuit.

Reactance Tube: A tube with operating condition so chosen that the tube appears as an inductance or capacitance which can be varied by means of changes in the control voltage.

Rectifier: A device for converting a-c into d-c by permitting much more current to flow in one direction than the other. A half-wave rectifier permits current flow only during one-half of the cycle; full-wave rectifier permits current flow from both halves of the cycle.

Regulation: The ratio between a reference voltage and change of voltage caused by the load, usually expressed in per cent.

Ripple Voltage: The alternating component of the d-c voltage after rectification or from a generator.

Selectivity: The ability of a circuit to choose between desired and undesired signals on adjacent frequencies.

Sensitivity: Term used to denote the ratio between input signal and out-

put power, generally expressed as microvolts per watt.

Side Bands: Those frequencies adjacent to, and associated with a carrier.

Space Charge: A cloud of electrons between elements of a vacuum tube.

Space Current: The current consisting entirely of the electron flow from the cathode to the plate and other positive elements in a vacuum tube.

Trigger Circuit: A circuit having two stable operating conditions readily changed from one to the other by

a small change in operating conditions.

Triode: A three-element tube having a plate, cathode and a control electrode.

Voltage Gain: The ratio of the voltage developed in the plate circuit to the grid voltage necessary to produce it.

Voltage gain per stage may be obtained from the formula:

$$\text{Gain} = \frac{\mu \times Z_p}{Z_p + R_p} = \frac{G_m \times R_p \times Z_p}{(Z_p + R_p) \times 10^6}$$

Where: G_m is in micromhos and R_p and Z_p is in ohms.

[Data courtesy Sylzania]



OLSON RADIO WAREHOUSE, INC. AKRON, OHIO

A Radio Man's Best Pal!



Resist-O-Guide

LIMIT—
ONE TO EACH RADIO MAN

3¢ that's all
A Postage Stamp Is O.K.

You can read all resistor code-colors in a flash with this handy pocket guide! Revolving wheels in color show all resistance values. OLSON gives you this valuable tool (size 4 1/4" x 2 1/4") for a piffling 3c. GET ONE NOW.

This offer good only in U. S. A.



— and you get this big new **CATALOG FREE!**
60 rip-snorth' pages of special OLSON Bargains in Standard Radio Parts, Sound and Testing Equipment.

Clip the coupon and MAIL TODAY

OLSON RADIO WAREHOUSE INC.

73 E. MILL ST., DEPT. 100, AKRON, OHIO

I enclose 3c. Send me 1 "Resist-O-Guide" & new Free Catalog of Olson Bargains.
 I am a Repair Man. I am an Amateur or Experimenter.

NAME _____
 ADDRESS _____
 CITY _____ STATE _____

SPEED

UP YOUR JOBS
with
AEROVOX
DANDEE DUALS

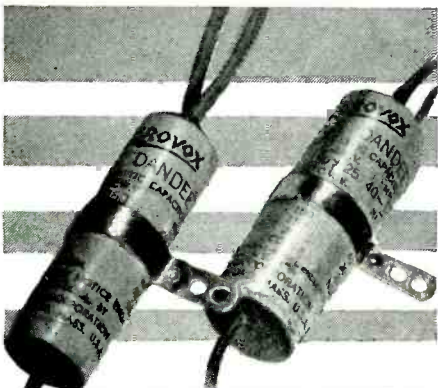

● Yes, speed up your work, with these handy general-purpose electrolytics.

Type PRS-A has concentrically-wound dual sections. Two insulated positive leads at one end, common negative lead at other. Type PRS-B has separate sections with separate positive and separate negative leads. Both types have riveted mounting straps.

Widest selection of combination capacities and voltages. All listed in latest Aerovox Catalog.

● Order those Dual Dandees from your favorite Aerovox jobber. Ask for latest catalog. Or write us . . .



FOR RADIO-ELECTRONIC AND INDUSTRIAL APPLICATIONS

AEROVOX CORP., NEW BEDFORD, MASS., U.S.A.
Export: 13 E. 40th St., New York 16, N.Y. • Cable: 'ARLAB'
In Canada: AEROVOX CANADA LTD., Hamilton, Ont.

JOTS AND FLASHES

THIS FALL WILL SEE WELL OVER ONE MILLION F-M receivers in operation. The majority of the leading manufacturers have announced that f-m will be included in most of their a-m broadcast models and also in special types. Tuners and converters will also be very popular during the coming months. One manufacturer has already announced development of an f-m converter which will sell under \$20. Sponsors are beginning to look with interest to f-m, too. Stromberg-Carlson has bought time on the first f-m network involving 22 f-m stations in six eastern states. . . . Allen H. Gardner has resigned as president of Colonial Radio Corp. Don G. Mitchell, president of Sylvania Electric of which Colonial is a wholly-owned subsidiary, will serve as president of Colonial until the naming of a successor to Mr. Gardner. . . . Richard H. Hooper, promotion manager of RCA, has returned from Italy with the special television equipment which televised Pope Pius XII at Vatican City. . . . Burt Frauman, formerly with Shure Brothers, is now assistant sales manager of Talk-A-Phone Company, 1512 South Pulaski Road, Chicago 23, Illinois. . . . General Transformer Corporation has moved into a new plant in Chicago. . . . Robert G. Herzog has been appointed vice president in charge of engineering of the Universal General Corporation, 365 Canal Street, New York 13, New York. Mr. Herzog has also moved his plant, the RGH Manufacturing Corp., to the same address. . . . The Metropolitan Electronic and Instrument Corporation, New York City, have published a catalog illustrating and describing a variety of test equipment. . . . John K. Hilliard, chief engineer of Altec-Lansing Corporation, is now on tour of Alaska as a consultant on motion picture theatre and military electronic problems. . . . Everett B. Boise has been named sales engineer for Hytron in the New York and Mid-Atlantic area. Mr. Boise was formerly with National Union as chief commercial engineer. . . . A four-page bulletin describing 52 types of p-m speakers, 54 types of e-m speakers and 20 types of transformers for replacement purposes has been issued by the Permoflux Corporation, 4900 West Grand Avenue, Chicago 39, Illinois, and 236 South Verdugo Road, Glendale 5, Calif.

ADVERTISERS IN THIS ISSUE

SERVICE INDEX—SEPTEMBER, 1947

AEROVOX CORPORATION	60
Agency: Austin C. Lescarboursa & Staff	
THE ASTATIC CORP.	29
Agency: Wearstler Advertising, Inc.	
CAPITOL RADIO ENGINEERING INSTITUTE	50
Agency: Henry J. Kaufman & Associates	
CHICAGO INDUSTRIAL INSTRUMENT CO.	54
Agency: Turner Adv. Agency	
CLAROSTAT MFG. CO., INC.	51
Agency: Austin C. Lescarboursa & Staff	
CLIPPARD INSTRUMENT LABORATORY	46
Agency: The S. C. Baer Co.	
CONCORD RADIO CORP.	57
Agency: F. H. Brown Adv. Agency	
CORNELL-DUBILIER ELECTRIC CORP.	
Agency: Reiss Advertising	Inside Front Cover
ALLEN B. DUMONT LABORATORIES, INC.	12
Agency: Austin C. Lescarboursa & Staff	
ELECTRIC SOLDERING IRON CO., INC.	50
ELECTRONIC MEASUREMENTS CORP.	44
Agency: J. L. Furnies & Associates	
ESPEY MFG. CO., INC.	28
Agency: J. L. Furnies & Associates	
FEDERAL TELEPHONE & RADIO CORP.	37
Agency: Rickard & Co.	
FISHER DISTRIBUTING CO.	28
Agency: Jules B. Holub Adv. Agency	
GENERAL CEMENT MFG. CO.	50
Agency: Sauter Rodkin Adv. Agency	
GENERAL ELECTRIC	1, 31, 49, 53
Agency: Maxon, Inc.	
GENERAL ELECTRIC LAMP DEPT.	6
Agency: Batten, Barton, Durstine & Osborn, Inc.	
GUARDIAN ELECTRIC	23
Agency: Kennedy & Co.	
INTERNATIONAL RESISTANCE CO.	43
Agency: John Falkner Arndt & Co., Inc.	
J.F.D. MFG. CO.	48
Agency: Bergman-Jarrett Co.	
McMURDO SILVER CO., INC.	5, 58
Agency: Edward Owen & Co.	
MAGUIRE INDUSTRIES, INC.	39
Agency: City Adv. Agency	
P. R. MALLORY & CO., INC.	18
Agency: The Aitkin-Kynett Co.	
M. V. MANSFIELD CO.	58
MUELLER ELECTRIC CO.	56
MURRAY HILL BOOKS, INC.	44
Agency: The Harry P. Bridge Co.	
OHMITE MFG. CO.	36
Agency: The Fensholt Co.	
OLIVERI TOOL CO.	52
Agency: Henry H. Teplitz, Advertising	
OLSON RADIO WAREHOUSE	55
Agency: The Jessop Adv. Co.	
PERMOFLUX CORPORATION	56
Agency: Oscar Nordin Co.	
PRECISION APPARATUS CO.	11, 50
Agency: Shappe-Wilkes, Inc.	
PYRAMID ELECTRIC CO.	33
Agency: Arnold Cohan Corp.	
QUAM-NICHOLS CO.	55
Agency: Triangle Adv. Agency, Inc.	
RADIO CITY PRODUCTS CO., INC.	56
Agency: Reiss Advertising	
RADIO CORPORATION OF AMERICA	10, 27, 41, 51, 53, 55, 57, Back Cover
Agency: J. Walter Thompson Co.	
RAYTHEON MFG. CO.	47
Agency: Walter B. Snow & Staff	
JOHN F. RIDER PUBLISHER, INC.	4
Agency: Lansford F. Kings, Advertising	
HOWARD W. SAMS & CO., INC.	3
Agency: George Brodsky	
SIMPSON ELECTRIC CO.	45
Agency: Kreicker & Meloon, Inc.	
SOLAR CAPACITOR SALES CORP.	
Agency: O. S. Tyson & Co., Inc.	Inside Back Cover
SPRAGUE PRODUCTS CO.	8
Agency: The Harry P. Bridge Co.	
STANDARD TRANSFORMER CORP.	7
Agency: Burnet-Kuhl Adv. Co.	
SUPREME PUBLICATIONS	13
Agency: Henry H. Teplitz, Advertising	
SYLVANIA ELECTRIC PRODUCTS, INC.	14
Agency: Newell-Emmett Co.	
TRADIO, INC.	48
Agency: George M. Hakim Co.	
TRIPLET ELECTRICAL INSTRUMENT CO.	9
Agency: Western Advertising Agency	
VACO PRODUCTS CO.	54
Agency: Duane Wanamaker Associates	
WARD LEONARD ELECTRIC CO.	48
Agency: Henry H. Teplitz, Advertising	
THE WARD PRODUCTS CORP.	52
Agency: Burton Browne, Advertising	
WELLER MFG. CO.	46
Agency: Beaumont, Heller & Sperling, Inc.	
WESTON ELECTRICAL INSTRUMENT CORP.	25
Agency: G. M. Basford Co.	
EUGENE G. WILE	28
WRIGHT	58
Agency: Kay Advertising, Inc.	

CHECK

the features in these Capacitor Analyzers

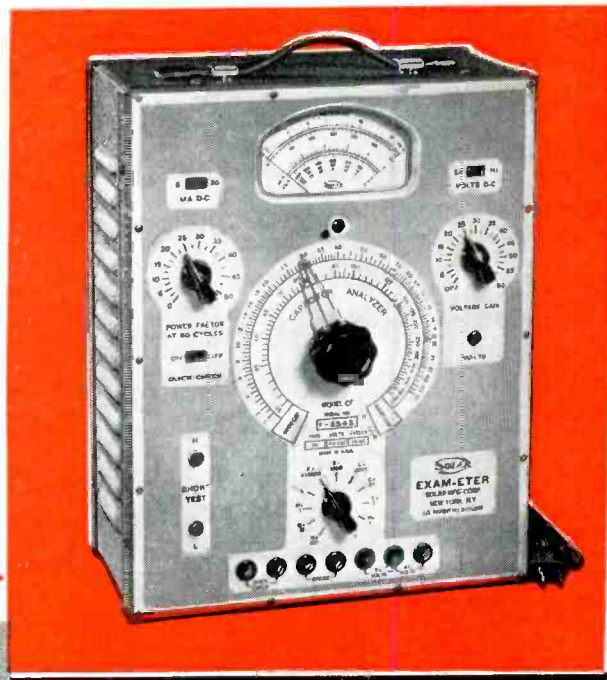

Model CF EXAM-ETER

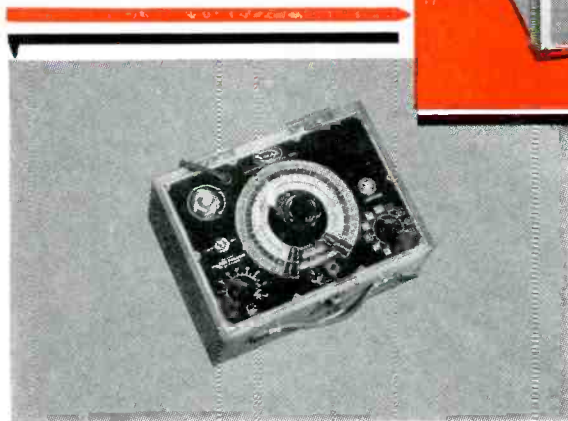

Model CBB CAPACITOR ANALYZER

MODEL CF

Most comprehensive of all capacitor analyzers, this sturdy, reliable instrument is designed to simplify electronic servicing.

- Has exclusive, patented "Quick-Check" circuit for qualitative tests and intermittent checks without unsoldering capacitor leads
- Capacitance range—10 mmf to 2000 mf
- Power Factor range—0 to 55 percent
- Insulation Resistance range—3 to 10,000 megohms
- Leakage Current—Reads electrolytic leakage current directly on large 4 1/2" meter

PLUS

- + Continuously Adjustable 0-550 volt D-C power supply for electrolytic tests
- + 0-550 volt, 3-range D-C VTVM
- + 10-50 volt, A-C VTVM
- + 100 ohm to 7.5 megohm A-C resistance bridge
- + JAN Quality Components for Long Troublefree Service

MODEL CBB

An up-to-the-minute version of the famous Solar Model CB, long-time standard analyzer of the radio service industry.

- Capacitance range—10 mmf to 800 mf
- Power Factor range—0 to 55 percent
- "Magic-Eye" Tube for bridge balance indication
- Simplified Neon-Lamp circuit for visual check of insulation resistance and electrolytic leakage
- Resistance Bridge—100 ohm to 2 megohm range

PLUS

- + Color-coded easy-to-read scales
- + Portability—small size and light weight
- + Reliable components for operation in humid climates

Solar Capacitor Analyzers are fully described in Catalog IN-2, available at your distributors or directly from Solar Capacitor Sales Corp., 1445 Hudson Blvd., North Bergen, N. J.

SOLAR CAPACITORS

"Quality Above All"





MORE TYPES of RCA Batteries

Representative types from
RCA's complete battery line.

... for more sales ... for more profit

• RCA puts you in the lead with a completely rounded-out line of RCA batteries for radio and industry. Now there are more new production types of batteries for servicing the enormously increased numbers of portables and farm sets. You can also obtain limited-demand types on a special order basis.

This expanded line combined with RCA's sales policy of selling primarily through *radio retail* outlets—and authorized RCA Tube Distributors—creates real sales potential for you.

There's a strong customer preference for the famous "red-white-and-black batteries" with the RCA emblem. They're smartly pack-

aged, competitively priced . . . and *Radio Engineered for Extra Listening Hours.*

Strategically located warehouses carry stocks of *fresh* RCA batteries at all times. Get the facts on the complete RCA battery line now . . . from your RCA Tube Distributor . . . and start cashing in on this fast-moving line.



TUBE DEPARTMENT

RADIO CORPORATION of AMERICA

HARRISON, N. J.