

# SERVICE

May  
1946

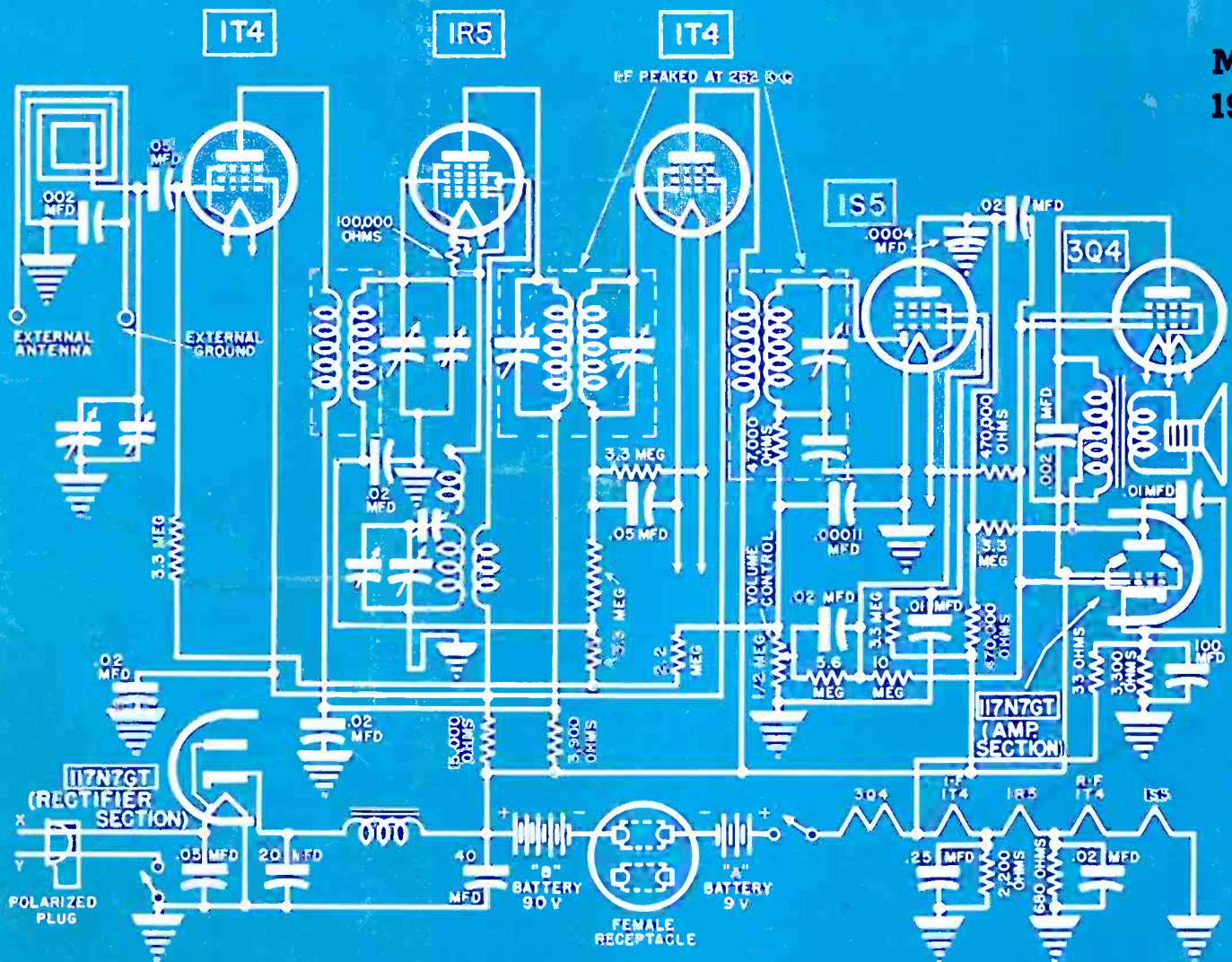

Battery a-c/d-c six-tube superhet using a 117N7 as a combination rectifier and beam-power amplifier. (See page 45.)

# Brother, want 3 extra hands?

Then drop a few seeds in the mailbox! C-D has them ready for you . . . punchy mailing pieces . . . to let the whole neighborhood know you're alive. And that's only one part of a complete promotional program we've prepared for you. Look around! The field is getting crowded; now is the time to promote yourself. And here is a program—complete—packaged—that'll give you three extra hands and make you "the" service shop in your community.

And watch the customers grow! You can't expect radios will break down faster to help your volume . . . but when they do get out of wack, you can bet the customers will take them to shops they've heard about. So get the ball rolling with the new C-D Sales Promotional Program that will help you grow—not only in 1946—but in 1947 and 1948.



## USE THESE C-D HELPS AVAILABLE THROUGH YOUR LOCAL JOBBER!



NEWSPAPER MATS

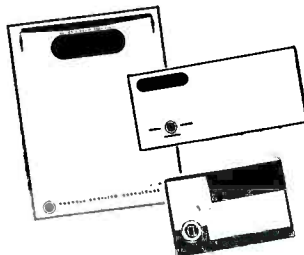

STATIONERY LABELS



DECALS

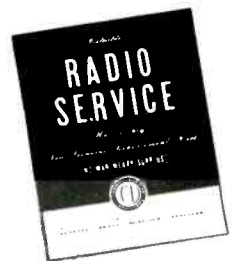

WINDOW CARDS



POSTCARDS — just address and drop in mailbox!



MATCH BOOKS —

KEEP YOUR REPUTATION GROWING WITH TOP QUALITY PARTS

C-D's "dwarf tigers" are long life units. Heat and humidity don't get them out of the picture. Real quality . . . real reputation-builders.

OF COURSE YOU'LL WANT YOUR FREE SUBSCRIPTION TO THE "CAPACITOR"

All the important radio data condensed for you. Write now: Cornell-Dubilier Electric Corp., South Plainfield, New Jersey.

NAME \_\_\_\_\_

ADDRESS \_\_\_\_\_

CITY \_\_\_\_\_

STATE \_\_\_\_\_

ZONE \_\_\_\_\_

ALL AVAILABLE THROUGH YOUR LOCAL C-D JOBBER

# Cornell-Dubilier

WORLD'S LARGEST  
MANUFACTURER OF

# Capacitors



MICA • DYKANOL • PAPER • ELECTROLYTICS

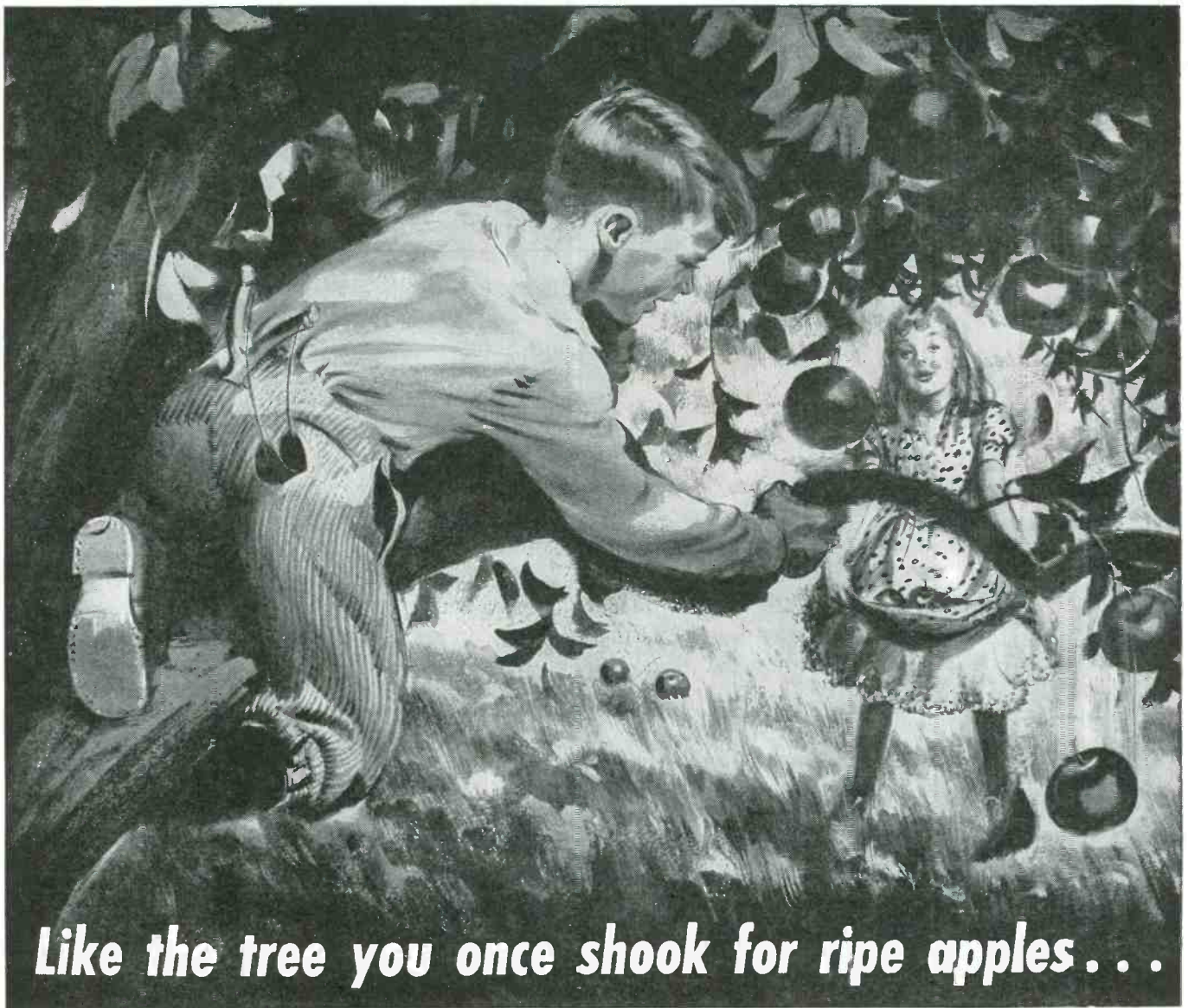

**Like the tree you once shook for ripe apples . . .**

**A PROFIT-laden market  
awaits dealers who handle**



**RADIO TUBES**

**T**HE juicy winesaps in grandfather's sunny orchard were no finer or more plentiful than the profit opportunities from today's market for G-E radio tubes! Demand is the biggest in history. YOU, as a G-E dealer, can get the lion's share of this business, because you handle the brand which an overwhelming majority of radio owners know, respect, and will buy.

Magic of the G-E monogram, famous symbol of quality, draws purchase-dollars from a public already familiar with G-E lamps, fans, refrigerators,

irons and other appliances, as well as radios and tubes. Your market for tubes is *pre-sold* on the G-E brand! And tremendous national G-E electronics advertising — in magazines with 30,000,000 circulation—boosts the demand still higher! Write for information on tube selling rights to *Electronics Department, General Electric Company, Schenectady 5, N. Y.*

Every tube dealer and service man should have G.E.'s Tube Characteristics Booklet ETR-15. Send for your free copy today!

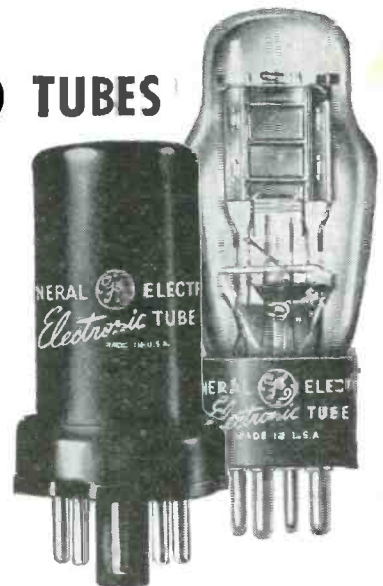

**GENERAL  ELECTRIC**

170-E3-8880

FIRST AND GREATEST NAME IN ELECTRONICS

SERVICE, MAY, 1946 • 1

# EDITORIAL

THE HIGHEST PRODUCTION LEVELS ever experienced in the parts industry were forecast for 1946 by H. W. Clough, president of the Radio Parts Show, during the recent convention in Chicago. He said that a business of \$150,000,000 at the consumer level may be expected. This is \$25,000,000 more than the industry earned in 1945. And for 1947 he predicted a business of \$200,000,000 for the industry.

Sounds good!

OVER 150 COMPANIES have already received OPA price approvals on receivers, with about half of the models priced in the \$20 to \$35 table-model class.

Many television models have also been priced by OPA. And reports indicate that around 100,000 receivers will soon be moving off the production lines and will be available for delivery in August or September.

UNFORTUNATELY MANY SERVICE SHOPS are not ready for the tremendous television receiver installation and maintenance job that is in the offing. As a result, several manufacturers have decided to install receivers themselves. One manufacturer has stated that he didn't feel that the neighborhood Service Shop was capable of installing television receivers at this time. The neighborhood Service Shop should, of course, be in a position to install these receivers. It's a job that the Service Shop can do and do well, if they'll prepare for this work . . . prepare by study and actual practice.

Many Service Shop groups have organized training units to familiarize themselves with television construction. Others have enrolled in schools. Reading of all of the technical articles on television, such as those appearing in SERVICE, have become *musts* on all programs.

The manufacturer would welcome the cooperation of the neighborhood Service Shop in installing and maintaining television receivers. Several manufacturers are now planning to introduce classes to teach neighborhood Service Shops how to install and maintain their equipment. Here again, we repeat that basic fundamental knowledge gained from books and technical articles will be imperative to expedite such training.

Television receivers will be available soon, and the consumer will look to the neighborhood Service Shop for expert help in installation and maintenance. Don't disappoint your neighbor. Start your television training now!

CONGRATULATIONS to William O. Schoning upon his re-election as president of NEDA, and A. D. Davis and Aaron Lippman upon their re-election as vice president and treasurer, respectively. They have done a grand job for the radio parts industry!

# RADIO TELEVISION ELECTRONIC SERVICE

Reg. U. S. Patent Office

Vol. 15, No. 5

May, 1946

**LEWIS WINNER**

Editorial Director

**ALFRED A. GHIRARDI**

Advisory Editor

**F. WALEN**

Managing Editor

	Page
Capacitor Service Instruments. By William M. Robinson . . . . .	11
Communication-Receiver Single-Channel Remote Control. By E. B. Menzies . . . . .	15
Fixed Attenuators for Public-Address Systems. By Willard Moody . . . . .	16
Old Timer's Corner . . . . .	36
Ser-Cuits. By Henry Howard . . . . .	23
Television Receiver R-F and Mixer Stages. By R. B. Carwood . .	18
Tools and Accessories for the New Service Shop. By Alfred A. Ghirardi . . . . .	20
 <b>CIRCUITS</b>	
Electromatic 512 . . . . .	26
Emerson 505 (Cover) . . . . .	45
Globe Electronics 6U1 . . . . .	27
Ultradyn L-46 . . . . .	27
Truetone D2630 . . . . .	23
Ward 54WG-2007A . . . . .	24
Ward 54WG-2700A . . . . .	24
Wells-Gardner 37D14-60 . . . . .	23
Westinghouse H130/122 . . . . .	26
 <b>COVER</b>	
5-Tube Battery-Electric Receiver (Emerson 505) . . . . .	45
 <b>Index to Advertisers</b> . . . . .	 48
 <b>Manufacturers</b>	
News . . . . .	39
New Products . . . . .	41
Jots and Flashes . . . . .	48

Copyright, 1946, Bryan Davis Publishing Co., Inc.

Published monthly by Bryan Davis Publishing Co., Inc.  
52 Vanderbilt Avenue, New York 17, N. Y. Telephone MURRAY HILL 4-0170



**Bryan S. Davis, President**  
**Paul S. Weil, Vice Pres.-Gen. Mgr.**



**A. Goebel, Circulation Manager**  
**F. Walen, Secretary**

James C. Munn, 10515 Wilbur Avenue, Cleveland 6, Ohio; Telephone SWEETBRIAR 0052  
Pacific Coast Representative: Brand & Brand, 1052 W. Sixth St., Los Angeles 14, Calif.; Telephone MICHIGAN 1732

Entered as second-class matter June 14, 1932, at the Post Office at New York, N. Y., under the Act of March 3, 1879. Subscription price: \$2.00 per year in the United States of America and Canada; 25 cents per copy. \$3.00 per year in foreign countries; 35 cents per copy.

# Simpson gives new meaning to



## Mutual Conductance Tube Tester

Tube manufacturers consider that a radio tube has reached the end of its usable life when it falls to a certain percentage of its rated value. There has never before been an instrument to test tubes in percentage terms.

But now here *is* such an instrument. The new Simpson Model 330 tests tubes in terms of percentage of rated dynamic mutual conductance—**com-**parison of the tube under test against the standard rated micromho value of that tube. The colored zones on the dial coincide with the micromho rating or the percent of mutual conductance, indicating that the tube is good, fair, doubtful or definitely bad. Thus, at a glance, you can check the tube against manufacturers' ratings. If, for any reason, it becomes desirable to know the actual value in micromhos, the percentage reading may be easily converted.

Besides this revolutionary new method, Simpson offers you an equally revolutionary switching arrangement. The circuit is so arranged that, even though there are numerous combinations possible, very few switches require moving to test any one tube. Many of the popular tubes are tested in the "normal" position without moving any of the nine tube circuit switches.

There are fourteen push button switches and nine rotating switches of six positions each. These switches provide infinite combinations in tube element and circuit selection. Only a few settings are necessary for the most complicated tube. The tube chart provided is arranged for quickly identifying the tube and setting the controls.

When you have finished a tube test, the Automatic Reset takes over to speed and simplify the next test. Just press the reset button and instantly all switches, both push button and rotary, return to normal automatically!

SIMPSON ELECTRIC COMPANY  
5200-5218 West Kinzie St., Chicago 44, Ill.

# Simpson

INSTRUMENTS THAT STAY ACCURATE

### SIMPSON MODEL 330 MUTUAL CONDUCTANCE TUBE TESTER

1. Size—15½" x 9½" x 7".
2. Case—Sturdy plywood construction, with heavy fabricoid covering, corners trimmed in leather, rustproof hardware — removable cover with slip type hinges.
3. Panel — Heavy molded bakelite, beautiful satin grained finish. All characters, numerals, and dial divisions are engraved and filled in white, insuring long wearing qualities.
4. Meter—4½" rectangular of modern design with artistic four-colored dial indicating good, fair, doubtful, and bad—also "Percentage of Mutual Conductance" scale.
5. Sockets provided for all types of tubes including acorn tube.
6. Neon glow tube incorporated to indicate shorted tubes.
7. New simplified revolutionary switching arrangement (see description at left).
8. The tube chart provided is arranged for quickly identifying the tube and setting the controls.
9. Tests tubes with voltage applied automatically over the entire operating range and under conditions approximating actual operation in a radio set.

Price .....\$98.50

ASK YOUR JOBBER

# REPLACE CAPACITORS

## *Faster... Better... at Less Cost*

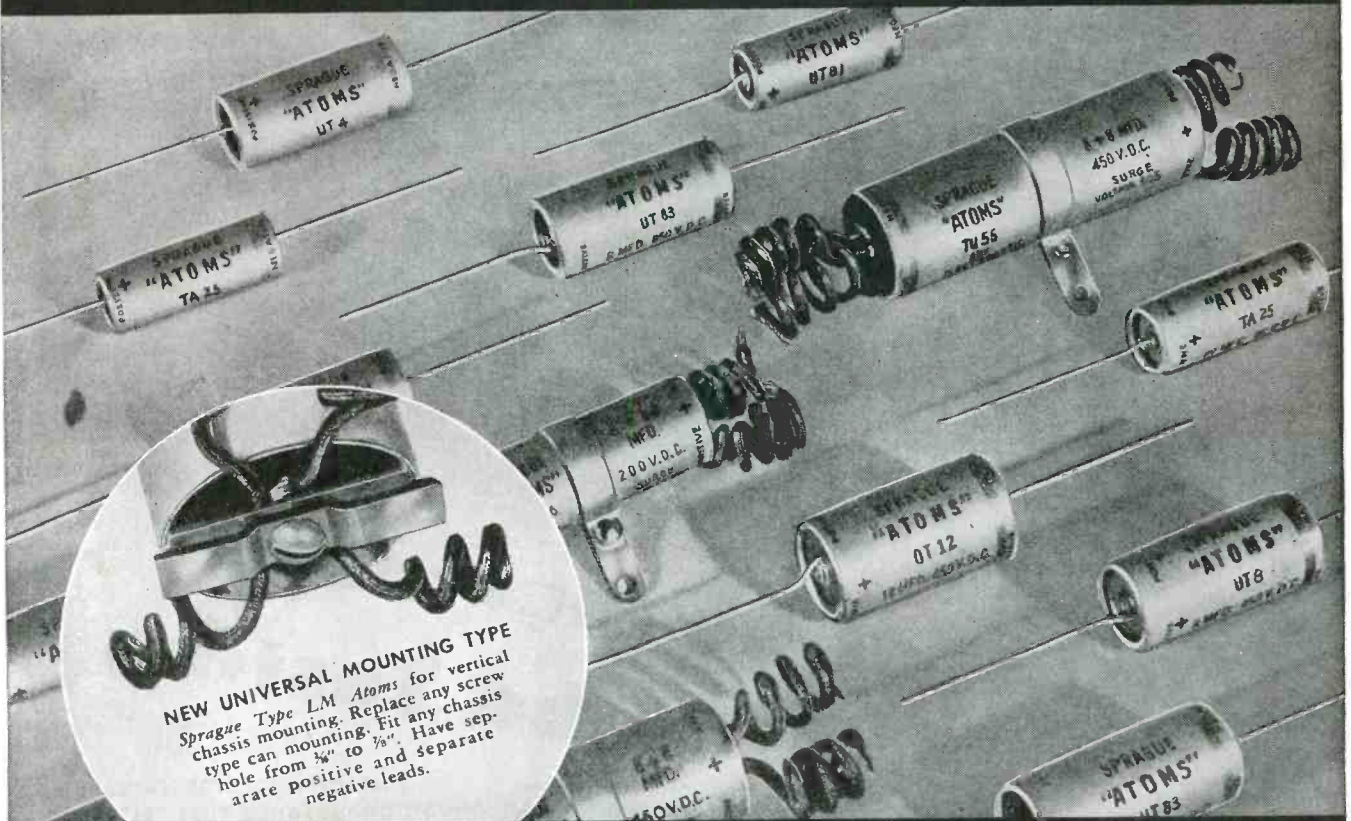

**NEW UNIVERSAL MOUNTING TYPE**  
 Sprague Type LM Atoms for vertical chassis mounting. Replace any screw type can mounting. Fit any chassis hole from  $\frac{3}{8}$ " to  $\frac{7}{8}$ ". Have separate positive and separate negative leads.

# with **SPRAGUE** **A T O M S**



### NEW CATALOG — JUST OUT !

The finest, most complete and most helpful Sprague catalog ever issued! Contains complete details, dimensions, data, etc. on Sprague Capacitors and \*Koolohm Resistors for every service, amateur and experimental need.  
 \*Trademark Reg. U. S. Pat. Off.

SEE US AT BOOTH 132 — CHICAGO SHOW !

- Use them universally for ALL dry electrolytic replacements.
- A small supply equips you for ANY job — any voltage, capacity or capacity combination.
- Order them by name — be sure of getting genuine, factory-fresh Sprague Atoms — the kind that will not let you down.

**SPRAGUE PRODUCTS COMPANY**  
 North Adams, Mass.

JOBGING DISTRIBUTING ORGANIZATION FOR PRODUCTS OF THE SPRAGUE ELECTRIC CO.,

# SIX NEWSWORTHY RADIO ITEMS

## VOLUME XV RIDER MANUAL

Now in Preparation

For sixteen years Rider Manuals have been recognized for their leadership in practical presentation of servicing data. In Volume XV, this leadership reaches new heights and will result in the offering of material elsewhere unavailable. Our laboratories are developing data on the new sets that will save hundreds of hours of servicing time for loyal users of Rider Manuals. In the meantime check the list below—place your order for any missing volume today—to assure earliest possible delivery.

### RIDER MANUALS (14 VOLUMES)

Volumes XIV to VII . . . \$15.00 each volume  
Volume VI . . . . . \$11.00  
Abridged Manuals I to V (1 Vol.) . . . 17.50  
Record Changers and Recorders . . . 9.00

Shipments of Rider Manuals  
are increasing Each Month

**RIDER MANUALS  
MAKE SERVICING  
EASIER**

## INSIDE THE VACUUM TUBE

This typical Rider Book offers a new approach and technique that makes its message easy to understand. Here is a solid, elementary concept of the theory and operation of the basic types of vacuum tubes.

Many diagrams and graphs are repeated to minimize the turning of pages in reading text and drawings. Anaglyphs give "three-dimensional" pictures of phenomena heretofore seen only in two dimensions.

Although an elementary book on a fundamental subject, therefore a goldmine for the student; it is a must for the libraries of servicemen, amateurs and engineers.

**JUST OUT**

425 pages . . . . . \$4.50

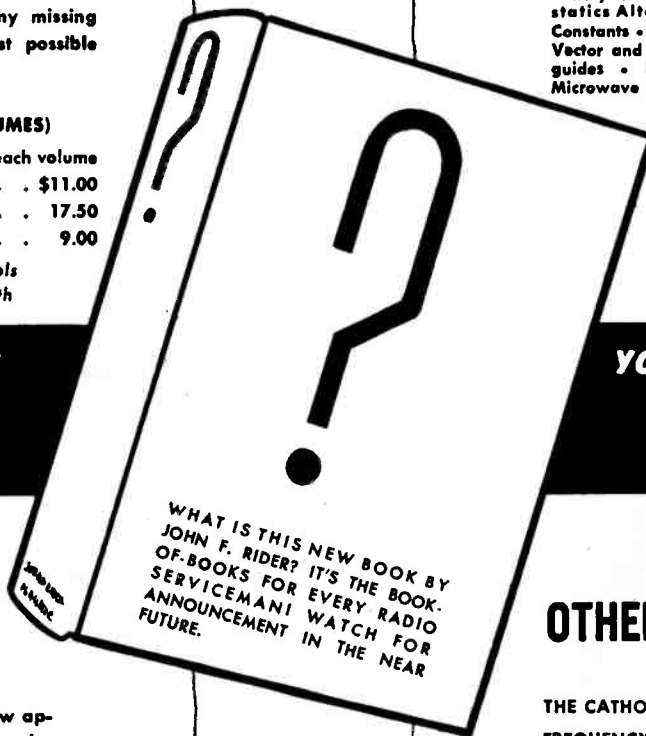

## UNDERSTANDING MICROWAVES

For those who have not previously considered radio waves shorter than 10 centimeters. Provides foundation for understanding various microwave developments of past five years. To simplify explanations, mathematics are placed in footnotes wherever possible.

### CHAPTER HEADS

The Ultra High Frequency Concept • Stationary Charge and its Field • Magneto-statics Alternating Current and Lumped Constants • Transmission Lines • Poynting's Vector and Maxwell's Equations • Waveguides • Resonant Cavities • Antennas Microwave Oscillators • Radar and Communication • Section Two is devoted to descriptions of Microwave Terms, Ideas and Theorems.

**JUST OUT**

Over 400 pages . . . . \$6.00

**YOU MUST STUDY  
TO KEEP  
UP TO DATE**

## OTHER RIDER BOOKS

THE CATHODE RAY TUBE AT WORK \$4.00  
FREQUENCY MODULATION . . . \$2.00  
SERVICING BY SIGNAL TRACING . \$4.00  
THE METER AT WORK . . . . \$2.00  
THE OSCILLATOR AT WORK . . . \$2.50  
VACUUM TUBE VOLTMETERS . . . \$2.50  
AUTOMATIC FREQUENCY  
CONTROL . . . . . \$1.75

**AN-HOUR-A-DAY-WITH-RIDER SERIES**—  
on "Alternating Currents in Radio Receivers," on "Resonance & Alignment," on "Automatic Volume Control," on "D-C Voltage Distribution." Hard bindings \$1.25 ea.

Publication Resumed with June Issue!

### Get on the Mailing List for "Successful Servicing"

A monthly paper, dedicated to the financial and technical advancement of the electronic and radio maintenance man. Free distribution—Just

----- MAIL COUPON -----

JOHN F. RIDER PUBLISHER, INC.  
404 (b) FOURTH AVE., NEW YORK, N. Y.

NAME \_\_\_\_\_  
ADDRESS \_\_\_\_\_  
CITY \_\_\_\_\_  
STATE \_\_\_\_\_

**JOHN F. RIDER, Publisher Inc. 404 Fourth Ave., New York 16, N. Y.**

EXPORT DIVISION: ROCKE-INTERNATIONAL CORP. • 13 E. 40th St., New York City • Cable: ARLAB

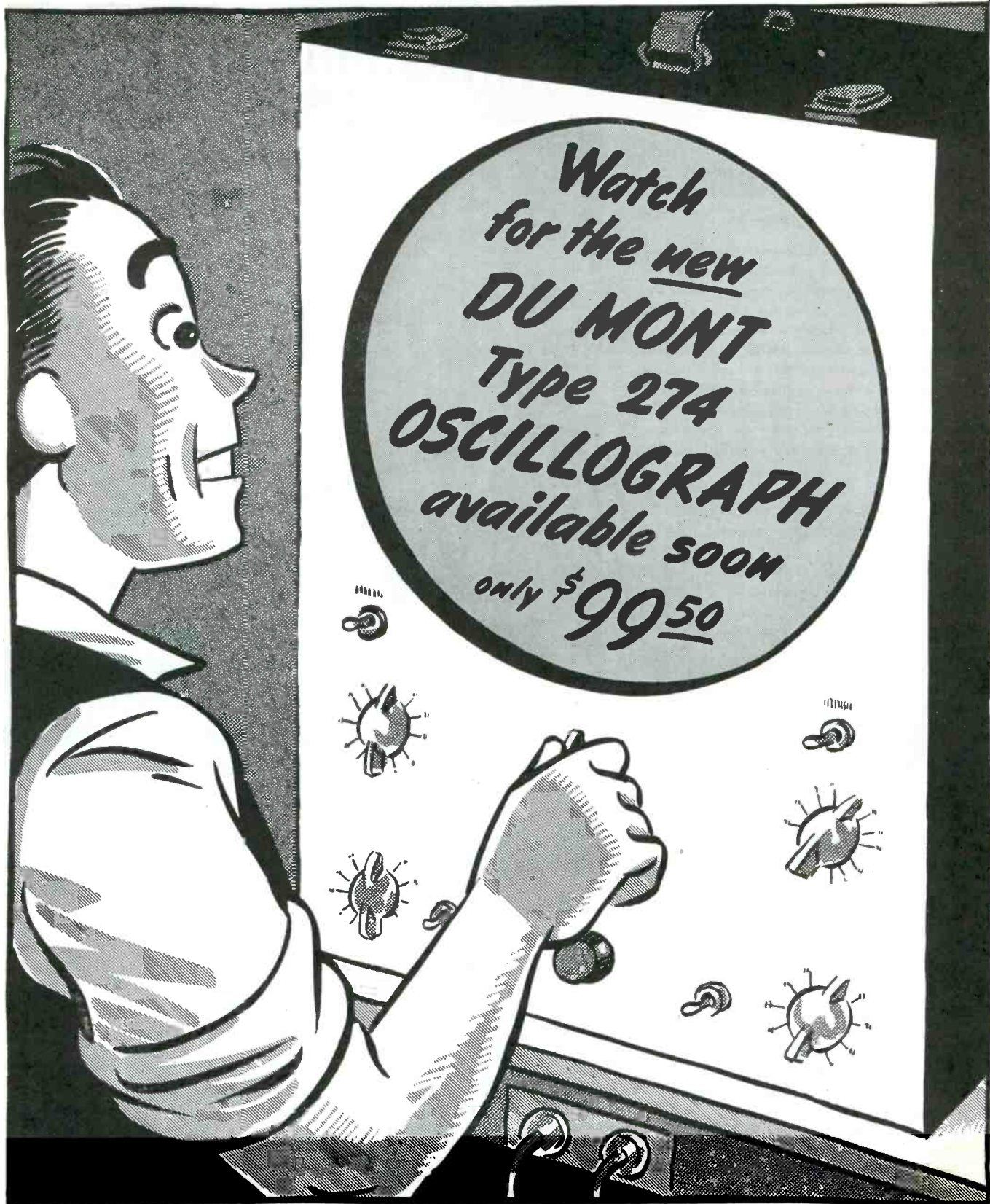

**DUMONT**

*Precision Electronics & Television*

ALLEN B. DUMONT LABORATORIES, INC., PASSAIC, NEW JERSEY • CABLE ADDRESS: ALBEEDU, PASSAIC, N. J., U. S. A.



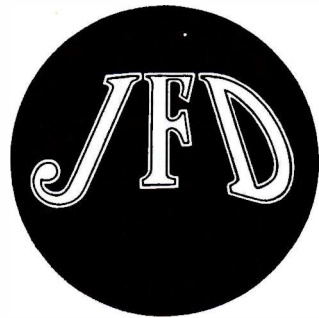
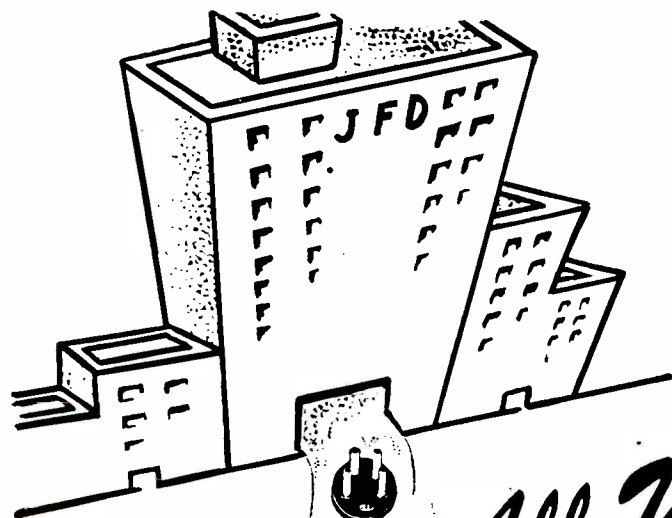

*All Under One Roof*

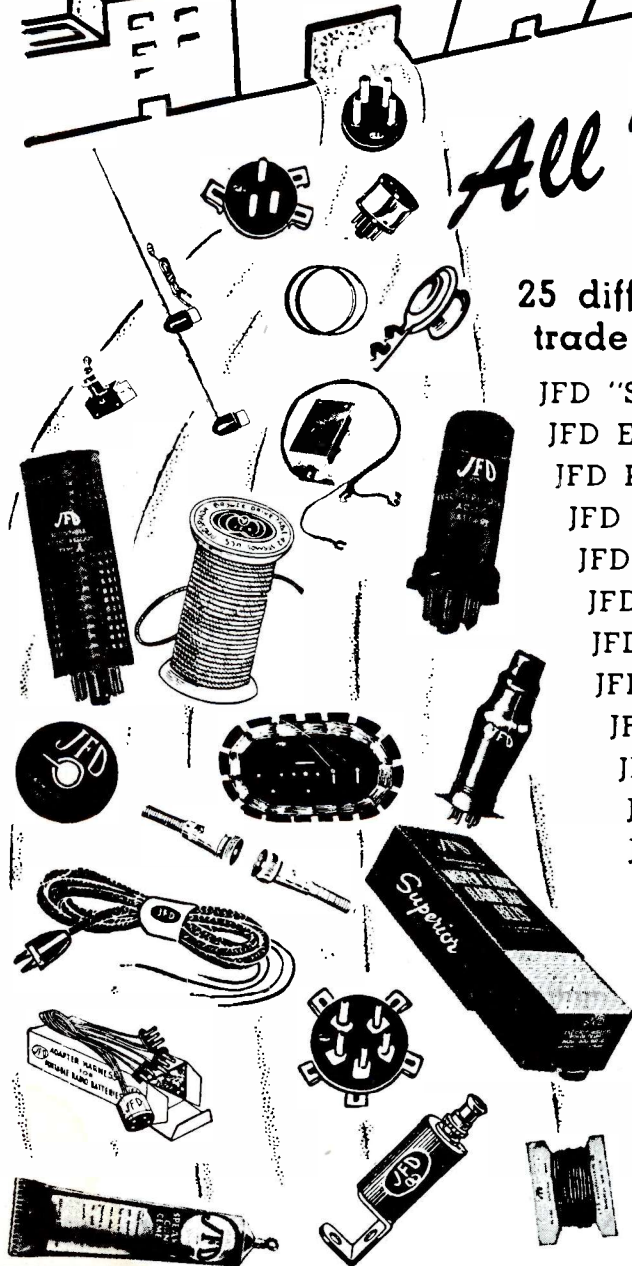

**W**E manufacture over 25 different lines for the Radio service trade and are prepared to ship

- JFD "SOCKETTE" RADIO TUBE ADAPTERS
- JFD EXACT DUPLICATE BALLAST TUBES
- JFD PHOSPHOR BRONZE DIAL CABLE
- JFD BATTERY ADAPTER HARNESSSES
- JFD ADJUSTABLE BALLAST TUBES
- JFD RESISTANCE CORD ADAPTERS
- JFD PHONO ADAPTER SWITCHES
- JFD MICROPHONE CONNECTORS
- JFD MIDGET JACKS & PLUGS
- JFD PHONOGRAPH NEEDLES
- JFD RESISTANCE CORDS
- JFD AC SERVICE CORDS
- JFD TOGGLE SWITCHES
- JFD AUTO CONDENSERS
- JFD SPEAKER CEMENT
- JFD ANTENNA LOOPS
- JFD AUTO ANTENNAS
- JFD BATTERY PLUGS
- JFD TUBE SHIELDS
- JFD RADIO WIRE
- JFD SUPPRESSORS
- JFD DIAL BELTS
- JFD DIAL CORD

WRITE FOR LITERATURE ON ANY OF THESE UNEXCELLED PRODUCTS

Serving the radio trade since 1929

**J.F.D. MANUFACTURING CO.** 4111 FT. HAMILTON PARKWAY  
BROOKLYN 19, N. Y.

# To help increase "Take-Home Savings"

THE Treasury Department has published two new booklets to help you and your employees realize the utmost benefit from your Payroll Savings Plan—benefits proportioned to the extent your employees add to "take home savings" by buying and holding U. S. Savings Bonds.

"Peacetime Payroll Savings Plan" for key executives offers helpful suggestions on the conduct of the Payroll Savings Plan. In addition, it quotes leaders of Industry and Labor and their reasons for supporting the Plan.

"This Time It's For You" is for distribution to employees. It explains graphically how this convenient, easy thrift habit works. It suggest goals to save for and how much to set aside regularly in order to attain their objectives. If you have not received these two booklets, or desire additional quantities, communicate with your State Director of the Treasury Department's Savings Bond Division.

See your Payroll Savings Plan through to maintain your share in America's future. It is sound economics and a powerful force for good today—and tomorrow—as a safeguard for stability and a reserve of future purchasing power—money that is kept within your community.



*The Treasury Department acknowledges with appreciation the publication of this message by*

## SERVICE

*This is an official U. S. Treasury advertisement prepared under the auspices of the Treasury Department and Advertising Council*

**THE NEW, COMPACT  
SUPER-SENSITIVE**

*Analyzer*

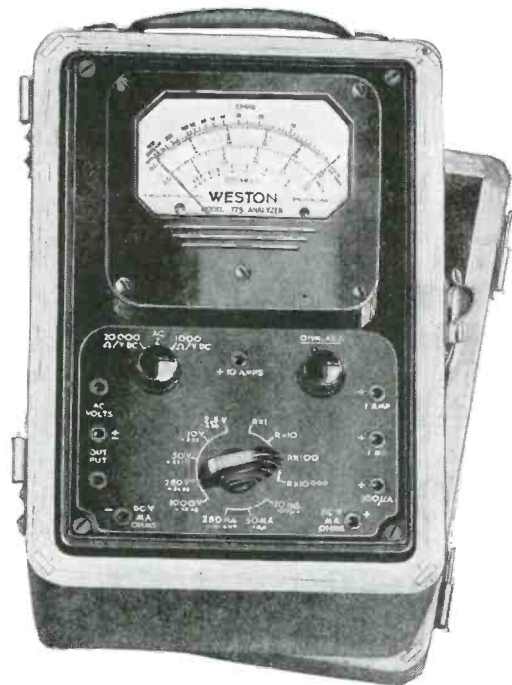

# Weston

## MODEL 779

*Model 779 is designed for use with WESTON Socket Selectors which facilitate checking tube circuit conditions – and with WESTON Televerters for DC voltage measurements up to 10,000 volts.*

Extreme compactness and lightweight—dual DC voltage sensitivity of either 1000 or 20,000 ohms per volt – five AC and DC voltage ranges, seven DC current ranges, four DC resistance ranges, and five decibel ranges – all carefully selected to meet the broadest requirements of testing and maintenance –precision WESTON resistors throughout—large 50 microampere WESTON meter – temperature compensated including AC ranges – size only  $6\frac{3}{8}'' \times 9\frac{1}{8}'' \times 4\frac{7}{8}''$  – furnished in rugged, solid oak carrying case.

NOW AVAILABLE . . . see Model 779 at the Radio Parts and Electronic Show . . . Stevens Hotel . . . Booth No. 75. Weston Electrical Instrument Corporation, 666 Frelinghuysen Avenue, Newark 5, New Jersey.

## Weston *Instruments*

Albany · Atlanta · Boston · Buffalo · Chicago · Cincinnati · Cleveland · Dallas · Denver · Detroit · Jacksonville · Knoxville · Los Angeles · Meriden · Minneapolis · Newark · New Orleans · New York · Philadelphia · Phoenix · Pittsburgh · Rochester · San Francisco · Seattle · St. Louis · Syracuse · In Canada, Northern Electric Co., Ltd., Powerlite Devices, Ltd.

# SYLVANIA NEWS

## RADIO SERVICE EDITION

MAY

Prepared by SYLVANIA ELECTRIC PRODUCTS INC., Emporium, Pa.

1946

### FREE, AT YOUR SYLVANIA DISTRIBUTOR'S: VALUABLE BUSINESS AND TECHNICAL AIDS

**SYLVANIA  
SERVICEMAN  
SERVICE**

by  
**FRANK FAX**

In case you haven't already taken advantage of the opportunity, Sylvania has a lot of valuable helps for the radio repairman that are *absolutely free*.

They include attractive, customer-catching window displays, interesting booklets on radio care to give to your customers, service hints and many useful technical charts and booklets.

#### GIVE-AWAYS

Now is the time to dress up your windows and invite new customers into the store. Inside, have the complete line of Sylvania tubes to satisfy your customers, the usual snappy service and a pamphlet or two to give away — as a reminder to stop in again.

Every item shown at the right is free (there are many others, some at a nominal charge). Just call on your local Sylvania distributor for your supply, or write to me at Sylvania Electric, Emporium, Pa. And *remember* — to carry the customer's goodwill, carry Sylvania tubes!

**BASE CHART**  
Types and base views of Sylvania tubes

**FOLDER-TAG**  
On radio cleaning

**"HELPFUL HINTS" BOOKLETS FOR RADIO SERVICING**

**GIVE-AWAY FOLDER**  
Helps customers understand your repair problems

**WINDOW DISPLAY**

**COLOR CODE CHART**

**CHARACTERISTICS CHART**  
Characteristics of Sylvania tubes and panel lamps, with tube base views

# SYLVANIA ELECTRIC

Emporium, Pa.

MAKERS OF RADIO TUBES; CATHODE RAY TUBES; ELECTRONIC DEVICES; FLUORESCENT LAMPS, FIXTURES, WIRING DEVICES; ELECTRIC LIGHT BULBS

# SERVICE

## CAPACITOR

## SERVICE

# INSTRUMENTS

by **WILLIAM M. ROBINSON**

*Assistant Chief Engineer  
Industrial Capacitor Division  
Cornell-Dubilier Electric Corp.*

SOME RADIO COMPONENTS show deterioration of electrical properties both in active use and when they are not operating. Time and humidity conditions are factors that affect the shelf life of these components, especially those which are not fully hermetically sealed or depend upon electrochemical action to perform their designated functions. These factors are supplemented by voltage stress and extremes of temperatures when the circuit parts are placed in operation.

Among those components that are affected by humidity, we have field coils, unpotted transformers, i-f coils, and certain types of capacitors. There is generally a slow penetration of moisture into the active elements of these parts, depending largely on the condition of the atmosphere where they are stored. It is thus important to store these components and allied electronic equipment in dry locations, where temperature variations are at a minimum to avoid this type of deterioration.

Capacitors cause their share of service problems along with the other radio components. Engineering and manufacturing techniques are such that capacitors can be made to outlast any other part of a radio receiver. However, when the cost of such capacitors

is considered, such procedure is found to be far from practical.

The day has passed when an a-c continuity tester or an ohmmeter are considered adequate capacitor service instruments. Receivers use capacitors with values ranging from a few mmfd in mica and ceramic types to the multi-tapped electrolytic types running to many mfd. The range of voltage ratings for these capacitors is generally between 10 volts d-c and something above 500 d-c. Leakage failure of capacitors found frequently in the older

receivers, requires the use of a more complex measuring instrument.

### Defects Usually Found

Defective capacitors can be classified according to the most frequent troubles found; table 1. Aside from mechanical failure, the defects shown in the table comprise the main causes of practically all fixed-capacitor troubles.

There are many capacitor service meter instruments available. Some are simply radio-frequency continuity testers that indicate impedance or measure a very limited range of capacity. Although such instruments are convenient to use because some of the capacitors tested do not have to be disconnected from the circuit, the tests are far from complete. There are other instruments which depend upon the power line voltage for capacity measurements. These are not too ac-

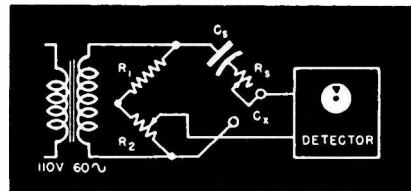
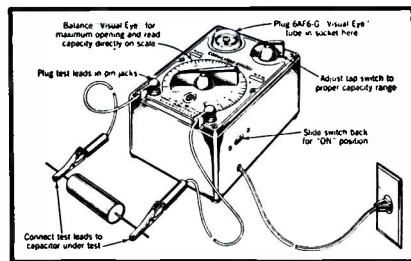

Fig. 1. A bridge arrangement with a 60-cycle signal-voltage input supplied through a stepdown transformer.

Fig. 2. Commercial bridge-type capacitor tester.



Class of Capacitor	Short Circuit	Open Circuit	Intermittent Circuit	Off Capacity	High Power Factor	High Leakage
Paper . . . .	*	*	*	—	—	*
Mica or Ceramic *						
Electrolytic . . . .	*	*	*	*	*	*

Table 1  
Defects most frequently found

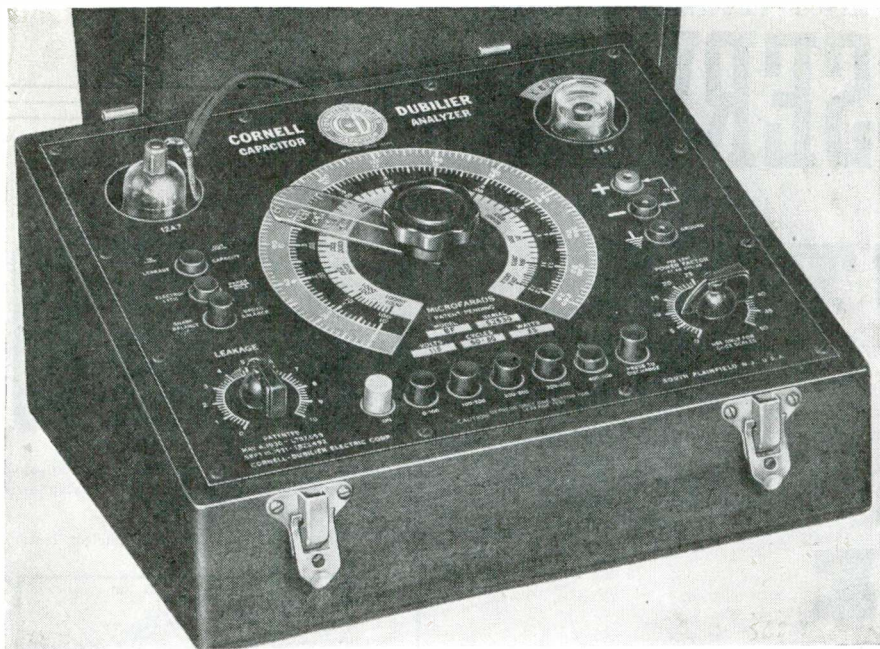

Fig. 3. Capacitor analyzer using a capacity bridge and adjustable d-c power supply.

curate and do not indicate the true quality of capacitors.

#### Bridge Instruments

The most popular and reliable method of measuring capacity employs an a-c bridge. By this method the capacity readings are entirely independent of line-voltage variations. An adjustment of the bridge circuit to determine capacity is generally supplemented by a similar operation to determine the power factor, the both readings taken simultaneously.

One basic capacity-bridge arrangement is that which provides logarithmic scale readings. The circuit consists of a potentiometer utilized as two arms of the bridge with a standard resistor, and the unknown capacitor composing the other two. Fig. 1 shows this bridge arrangement with the signal voltage, generally 60 cycles, supplied through a step-down transformer, applied across the potentiometer  $R_1$ ,  $R_2$ . The center tap of the potentiometer and the junction of the capacitor standard,  $C_s$ , and an unknown capacitor,  $C_x$ , are connected to a sensitive null detector. A rheostat,  $R_x$ , introduced in series with the capacitor standard, pro-

vides the means of balancing the phase differential in the bridge components.

The potentiometer is calibrated over its full rotation with scale markings corresponding to values of capacity connected across  $C_x$ . Several capacitor standards are generally used to provide a number of ranges for capacity measurements so that readings may be taken quite accurately. Power factor calibrations are made on the rheostat in series with the main capacitor standard.

One advantage of the above bridge arrangement is that four common capacitor defects may be determined in approximately the same number of seconds. The insertion of a capacitor across the test position will result in a balance of the bridge which will indicate the true capacity and power factor, as well as short and open-circuited defects and some intermittent operation types.

A commercial instrument that performs the testing operations described above is illustrated in Fig. 2. The power to the instrument is provided through the regular 110-volt a-c circuits. A 12A7 dual-purpose tube is used as a half-wave rectifier and as a pentode amplifier for the bridge signal. The bridge balance of capacity and power factor, as well as indications of limited types of defective capacitors, is made by the use of a 6AF6G cathode eye tube.

The capacity measurement is made by connecting a capacitor across the test terminals, then adjusting the bridge control knob after the proper range has been selected. When the shadow angle of the eye tube reaches its maximum opening, the capacity is

read directly from the scale calibration under the knob. The shadow angle for capacitors with low power factor will be approximately  $90^\circ$ . As the magnitude of the power factor is found to be higher on the various capacitors, the angle will be smaller, reaching  $0^\circ$  at approximately 50% power factor. Electrolytic capacitors that show no shadow angle for any bridge control setting, are generally considered unsatisfactory for use.

#### Capacitor Analyzer

While this instrument finds great utility in service work, it does not provide a leakage test for paper and electrolytic capacitors. A larger, slightly more complex meter, generally classified as a capacitor analyzer (Fig. 3) is used for measuring all the properties of capacitors. The analyzer consists of a capacity bridge plus an adjustable d-c power supply with a means of measuring values of leakage current from less than a microampere to several milliamperes. The analyzer illustrated employs a bridge circuit that has linear scale calibrations for all ranges of capacity. This is accomplished by using a rheostat as one arm of the bridge with a standard resistor, standard capacitor, and the capacitor under test composing the other arms.

Fig. 4, illustrating this type of bridge circuit, shows the ratio of  $R_1$  and  $R_2$  to be linear over the full rotation of rheostat,  $R_x$ . This compares with the logarithmic relationship of  $R_1$  and  $R_2$  in Fig. 1. The uniformly-spaced capacity-scale calibrations of the analyzer simplify the readings considerably and provide greater accuracy of measurements. Standards in the bridge circuit are arranged for continuous capacity readings on six ranges from .00001 mfd to 240 mfd. The upper limit may be extended indefinitely, if the occasion arises, by using any large capacity in position,  $C_s$ , and applying a formula;

Fig. 4. Circuit of analyzer bridge, showing ratio of  $R_1$  and  $R_2$  as linear over a full rotation of  $R_x$ .

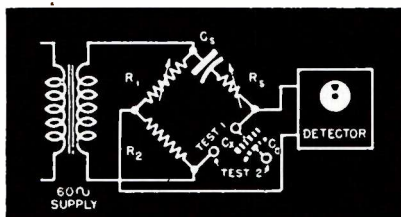
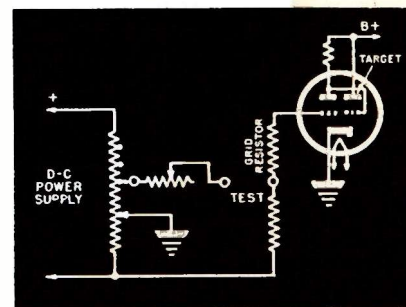

Fig. 5. Biasing of 6E5 so that a zero-degree shadow angle will correspond to substantially zero-leakage coverage.



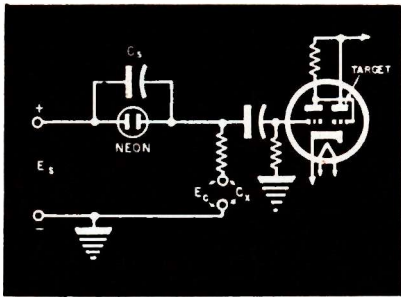

Fig. 6. Relaxation oscillator used for leakage tests of paper and mica capacitors.

this formula may also be used to extend the range of the previously described capacity bridges:

$$C_x = \frac{C_s C_r}{C_s - C_r}$$

where:  $C_x$  = microfarads of capacitor being tested

$C_s$  = microfarads of series capacitor

$C_r$  = reading of bridge in microfarads with  $C_s$  and  $C_x$  in series

Power factor measurements of electrolytic capacitors are made by adjusting  $R_s$ , connected in series with capacitor standard,  $C_s$ , as shown in Fig. 4. The rheostat is calibrated to scale calibrations over a power factor range of from 0 to 50%. An adjustment of the rheostat during the bridge balance provides a reading of the exact power factor of the capacitor. This refinement is somewhat superior than that obtained with the use of the capacity bridge previously discussed, where the power factor readings have to be made on a comparative basis.

Leakage tests with the analyzer can be made at voltages close to the rating of electrolytic capacitors, and at a fixed value of 450 volts d-c for paper or mica dielectric types. The power supply has two means of adjustment; steps of approximately 100 volts by a selector switch connected to a bleeder resistor, with the intermediate points obtained by adjusting a rheostat in series with the test capacitor. On tests of electrolytic capacitors, the voltage starts out at a low value building up as the leakage current drops until full rating is reached. This limits the aging current so that the electrolytic capacitor will not be affected adversely. The 450 volts d-c applied to paper or mica capacitors during the leakage test is not considered harmful to good capacitors. Defective units may frequently fail when the voltage is applied even before a leakage measurement can be made.

The leakage current of capacitors is determined by two methods because of

the extreme range of values. Current through electrolytic types is returned to the power supply through a resistor which sets up a bias voltage across a 6E5 cathode-eye tube. The movement of the shadow angle of the 6E5 is fairly linear over practically its entire range with respect to the bias voltage applied. Therefore, the leakage current is roughly, directly proportional to the number of degrees of the shadow angle. In the analyzer under discussion it was found most convenient to bias the 6E5 so that a zero-degree shadow angle would correspond with substantially zero leakage current, with the 90° angle calibrated for approximately 5 milliamperes; Fig. 5.

Leakage tests of paper and mica capacitors require a more involved circuit arrangement, since the magnitude of the current is about one microampere or less. For this purpose a relaxation oscillator is provided to obtain the initial signal voltage. The capacitor under test is charged through a neon bulb shunted by a capacitor. When the test capacitor voltage reaches a certain optimum value, the cut-off point of the neon bulb causes the current to stop flowing. Then the capacitor discharges through its internal shunt resistance until the striking voltage of the neon is reached;  $E_s - E_c$ , Fig. 6. The circuit functions on the principle that there is a difference between the cut-off and striking voltage of the neon tube. The result of the operation of the circuit is a series of

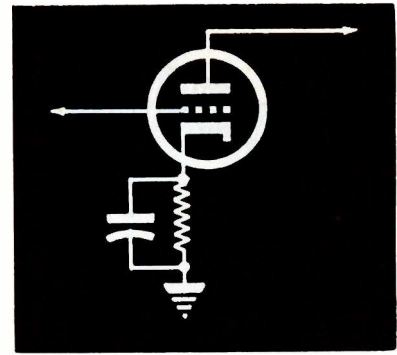

Fig. 7. Paper dielectric bypass in circuit with a cathode-bias resistor across it. Resistor does not effect operation because of capacitance resistance.

saw-tooth voltage impulses across  $C_x$ , the frequency and amplitude depending upon the capacity of  $C_s$ , voltage  $E_s$ , capacity and shunt resistance of  $C_x$ . While the neon tube glows on each successive charge of  $C_x$ , the indication is unreliable for measuring purposes. Therefore, the voltage fluctuations across  $C_x$  are connected to the input of the 6E5 cathode-eye tube. While the leakage current of the capacitor is being measured, it is convenient to express the result in terms of the shunt resistance of the capacitor. By counting the frequency or time between flashes of the 6E5, the shunt resistance of the capacitor may be determined by applying the expression:

$$R = 50N$$

where:  $R$  = insulation resistance in megohms

$N$  = number of seconds interval between flashes.

This capacitor analyzer shows one flash of the 6E5 per second for a capacitor with a shunt resistance of 50 megohms. The shunt resistance is directly proportional to the interval of time between flashes so that one flash every 10 seconds would result for a value of 500 megohms.

It is obvious that open or short-circuited capacitors of all types should be replaced. Other defective units must be considered carefully with respect to their effect on circuit operation and expectant life before being removed from a receiver. Some capacitors far below usual standards of quality may give entirely satisfactory service for a long time. Circuit requirements differ to the extent that some defective capacitors may be removed from critical circuits and located in a different circuit, where they may operate without interfering with the performance of a receiver. Low-internal shunt resistance, off capacity, and

(Continued on page 30)

#### Dry Electrolytic Capacitors

Working Voltages	D-C Leakage in MA
25	0.01 MA per mfd. plus 0.5 MA
50	
100	
150	0.02 MA per mfd. plus 0.5 MA
200	
250	
300	
350	0.03 MA per mfd. plus 0.5 MA
400	
450	
500	

#### Wet Electrolytic Capacitors

25	0.02 MA per mfd. plus 0.9 MA
50	
100	
150	0.03 MA per mfd. plus 0.1 MA
200	
250	
300	
350	0.05 MA per mfd. plus 1.0 MA
400	
450	
500	

Table 2  
Leakage currents of wet and dry electrolytics.



# NOW . . . HERE'S HOW CUNNINGHAM CAN BOOST BUSINESS FOR YOU

YES—Cunningham is out to back you up with a host of sales and utility aids that spell more profits—because they're *time-tested*. Illustrated are but a few of the many "Big C" items proven by past performance as the top business builders for Radio Service-Dealers. They'll help you sell more

service—speed up your work—lead more customers to your shop for top quality Cunningham Electron Tubes.

You won't want to lose any time in putting these profit-pulling sales and service aids to work in your shop. So, get in touch with your Cunningham Tube Distributor *today* for full details.

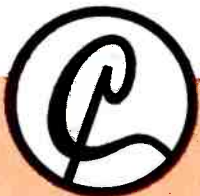

**A QUALITY PRODUCT FOR RADIO SERVICE-DEALERS  
BY THE RADIO CORPORATION OF AMERICA**



# Communications-Receiver Single-Channel REMOTE CONTROL

by E. B. MENZIES

FOR MAXIMUM RECEIVING efficiency, communications receivers are usually located at remote points. In some of these installations, multi-channel control is necessary. In others, we have single-control frequency operation. The former requires rather complex-control equipment, while the latter used in aircraft procedure, can employ less involved control methods. (It has become standard practice to use a separate receiver to monitor each of the bands used in aircraft work.)

While single-control methods have been simplified, they still provide an exact-control service. And the circuits being used will serve as the basis of many control systems that the Service Man will see in the future.

Thermal drift, after some hours of operation, and line-voltage fluctuations cause slight frequency shift. Slight frequency drift at the lower frequencies would not be so serious but at the higher frequencies (a few megacycles or more), with c-w signals, a drift of two or three kilocycles can make reception very difficult. With several crystal-controlled transmitters operating on the same frequency crystals are rarely if ever close enough to produce the same frequency of beat note in the receiver. In some cases, frequency difference can be large enough to warrant retuning the receiver, especially if the signals are weak.

It becomes obvious that for remote operation, receivers must either be provided with an operator at the remote point for tuning checks, or some small tuning range, controllable over the remote lines, must be used. This feature may be effectively applied to the standard communications receiver, by using a system of automatic frequency control, except of course that in this case the frequency control is not automatic, but controllable.

Fig. 1 shows a more or less standard circuit employing the reactance tube. This circuit is not recommended since it involves substantial modifications to the receiver.

Fig. 2 shows a system which appears to operate well and can be used since it involves no change to the oscillator

circuit in the receiver, other than realignment of the oscillator trimmer.<sup>1</sup> Neither system can, of course, give anything but a few kilocycles of tuning range. However, in many communications receivers the selectivity of the stage or stages preceding the first detector is not great at the higher frequencies, and unless a crystal filter is in use, the i-f selectivity is not so great that the oscillator cannot be swung two or three kilocycles either way, without seriously reducing sensitivity. Providing the oscillator is not swung far enough to produce a beat outside the bandwidth limits of the i-f channel, the system appears to operate quite satisfactorily. From one actual case an oscillator swing of several kilocycles was employed with safety.

In Fig. 2 it will be noticed that  $C$  and the plate resistance of the control tube shunt the oscillator tuned circuit. Since the tube plate resistance is variable with grid bias, the effective reactance of the combination is effectively varied by changes in the control voltage. Since the reactance of  $C$  must be similar numerically to the plate resistance,  $C$  must obviously be small (a 30-mmfd trimmer opened well out) was used in the test. Consequently the capacitive shunt which appears across the tuned circuit is small, and thus the control tube should be one which shows a low value of output capacitance; a 6J5 would appear suitable. The effect of this lumped capacitance can generally be compensated for by reducing the capacity of the trimmer already in the circuit for alignment purposes. It is obvious that in fitting the tube into the receiver, attention must be paid to its position, in that the lead from the oscillator grid coil to  $C$  will contribute additional capacitance. It should not therefore be longer than an inch or two.

It will be noted that the control tube plate load consists of a choke and resistor in series. The resistor was included to eliminate any undesirable choke resonance which may be present and also to effectively limit plate current, as the control tube may operate for lengthy periods with little or no

(Continued on page 44)

<sup>1</sup> Henney, Radio Engineering Handbook; 1941.

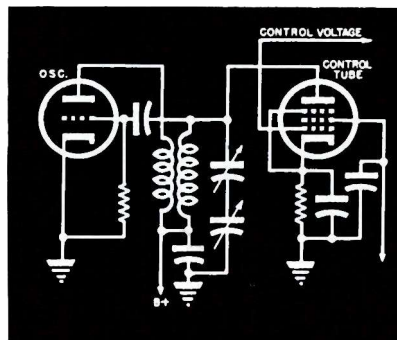

Fig. 1. Reactance-tube automatic-frequency control system.

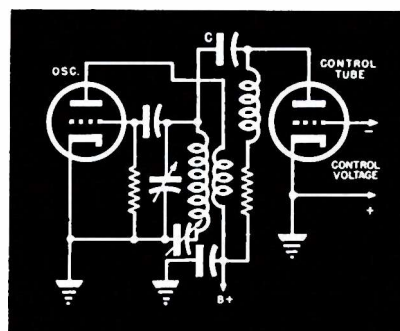
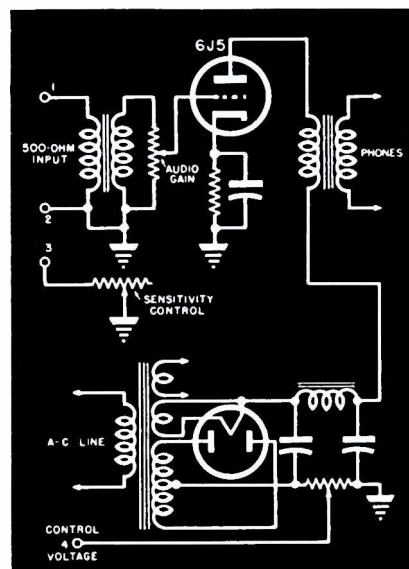

Fig. 2. Frequency-control system that is excellent for communications receiver use.

Fig. 3. Amplifier used at listening point for headphone operation.



# FIXED ATTENUATORS

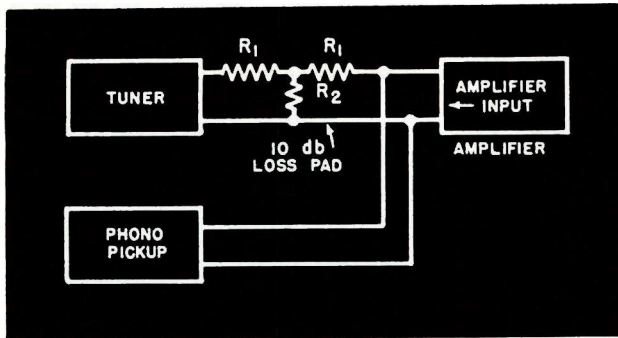

Fig. 1. Attenuation system used to bring level of tuner down to level of another tuner or phono pickup.

**O**FTEN it is necessary to design an attenuating network to work between equal impedances. For instance, it may be necessary to provide a 10-db loss in a radio tuner circuit, to bring the level of the tuner down to the level of another tuner or a phonograph pickup; Fig. 1. In this case, the output impedance of both sources is 500 ohms and, therefore, the net  $Z$  value is 250 ohms. To get a match the amplifier input,  $Z$ , must be 250 ohms. A  $T$  pad, which gets its name from the fact that the arrangement of resistors looks like a  $T$ , is used to cut down the tuner output level. The value of  $R_1$ , for the pad, can be obtained by using a simple formula, and similarly the value of  $R_2$  can be calculated.

$$R_1 = Z (X^k)$$

$$R_2 = 2Z (Y^k)$$

The values of  $X^k$  and  $Y^k$ , for various decibel losses, are given in Fig. 2. The  $Z$  values are the input and output impedances: 200 ohms for a typical audio line, etc.

In the example given, the output,  $Z$ , of the pad is 500 ohms, while the source,  $Z$ , is the same value. Therefore,

$$R_1 = Z (X^k)$$

For a 10-db loss, from Fig. 2,

$$X^k = 0.519$$

Then,

$$R_1 = 500 \times 0.519 = 259.5 \text{ ohms}$$

Also

$$R_2 = 2Z (Y^k) = 2 \times 500 \times 0.351 = 351 \text{ ohms}$$

It will be noted that the  $T$ -pad form consists of two equal  $R_1$  elements in

series, with an  $R_2$  value in the middle. To convert to a simple  $L$  pad and make the source see the correct  $Z$  value, we may double the value of  $R_1$  and keep  $R_2$  constant. This is shown in Fig. 3. Obviously, however, this will not allow us to match the amplifier input impedance and, therefore, the  $T$  pad is considered better.

In some cases we may use a balanced  $H$  pad. Then, each  $R_1$  value is halved and the  $R_2$  value is kept constant. This is shown in Fig. 4. The series elements would be rated at 130 ohms, but the exact arithmetical values are shown. Commercial tolerances would be less accurate than the calculations.

It can be seen that if the calculations are made for the  $T$  pad, values can readily be transformed for  $L$  or  $H$  requirements. In microphone and input circuits in general, the powers are usually so low that small 1-watt carbon resistors can do the job. In

db loss	$X^k$	$Y^k$
2.....	0.115	2.135
4.....	0.226	1.036
6.....	0.333	0.669
8.....	0.430	0.473
10.....	0.519	0.351
12.....	0.597	0.268
14.....	0.667	0.207
16.....	0.723	0.162
18.....	0.776	0.127
20.....	0.818	0.101
22.....	0.853	0.079
24.....	0.880	0.063
26.....	0.904	0.050
28.....	0.923	0.039
30.....	0.938	0.031
32.....	0.950	0.025
34.....	0.960	0.019
36.....	0.967	0.015
38.....	0.975	0.012
40.....	0.980	0.010

Fig. 2. Values of  $X^k$  and  $Y^k$  for various db losses.

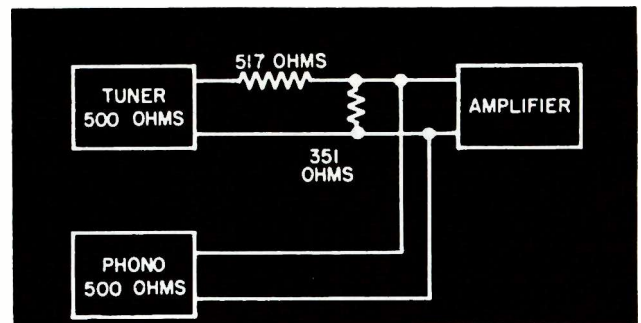

Fig. 3. Conversion of simple  $L$  pad by doubling the value of  $R_1$  and  $R_2$  (from Fig. 1).

output circuits or wherever considerable amounts of power are in use, the powers in the resistive elements may be calculated or experimentally determined.

If the proper  $R$  values are used and the test units are heavy-duty types capable of handling large amounts of power, the source may be connected to the load through the pad elements, as shown in Fig. 5, and the actual powers can be measured indirectly. That is, the power in  $R_1$  is

$$P_1 = \frac{E_A^2}{R_1}$$

and in  $R_2$  it is

$$P_2 = \frac{E_B^2}{R_2}$$

For a given assumed power input to terminals 1 and 2, the voltage in 500 ohms or whatever the input impedance chosen, is

$$E = \sqrt{PR}$$

With a known voltage across 1 and 2, the current in  $R_1$  and the voltage across  $R_1$  can be calculated. That is,

$$I = \frac{E}{R_1 + \left( \frac{R_2 Z_L}{R_2 + Z_L} \right)}$$

The power in  $R_1$  is

$$P_1 = I^2 R_1$$

The voltage across  $R_1$  is

$$E_A = I R_1$$

Hence the load voltage must be

$$E_B = E - E_A$$

# For Public-Address Systems

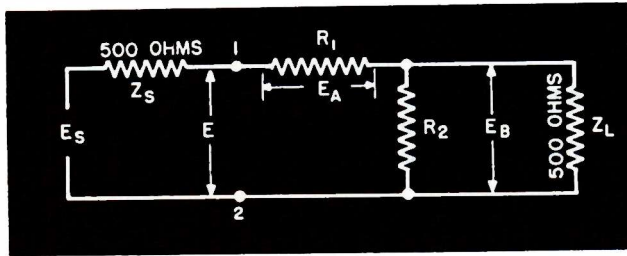

Fig. 4. Use of H pad where  $R_1$  (Fig. 1) is halved and  $R_2$  (Fig. 1) is kept constant.

The power in  $R_2$  is, then

$$P_2 = \frac{E_B^2}{R_2} = \frac{(E - E_A)^2}{R_2}$$

These are the conditions for an L pad.

For a T pad, Fig. 6, for a given power level at the input, the voltage across terminals 1 and 2 is

$$E = \sqrt{PR}$$

where  $R$  is the resistive input,  $Z$ , and  $P$  is the power in watts. The current is

$$I = \frac{E}{R_A + \left[ \frac{R_C (R_B + Z_L)}{R_C + R_B + Z_L} \right]}$$

Fig. 7. A H-pad arrangement where the values of  $R_A$  in each series element are one-half of the T-pad values. Therefore, one-half of the voltage develops across each element.

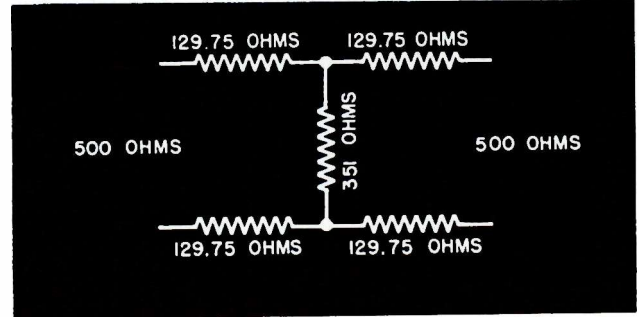
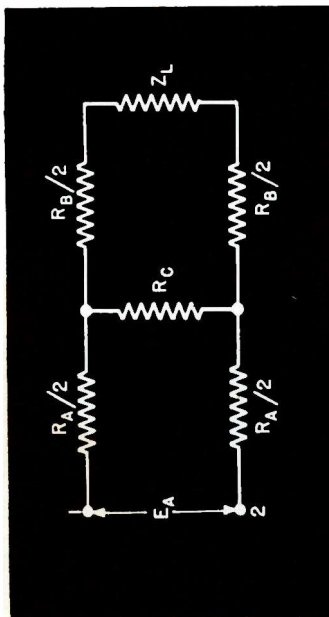

Fig. 5. Connecting source to a load through pad elements to provide measurement of powers indirectly. This is used where test units are heavy duty types capable of handling large amounts of power.

## by WILLARD MOODY

However, assuming that the input and output  $Z$  values are the same, the line current at the input is simply  $E/Z$  which gives the value of current in  $R_A$ . Then

$$P_A = I^2 R_A = \left( \frac{E}{Z} \right)^2 R_A$$

$$E_A = I R_A = \frac{E}{Z} R_A$$

Since

$$R_A = R_B, \quad I^2 R_A = I^2 R_B$$

and

$$P_A = P_B.$$

As

$$E_C = E - E_A,$$

$$P_C = \frac{(E - E_A)^2}{R_C} = \frac{E^2}{R_C}$$

In the H pad, in Fig. 7, the values  
(Continued on page 38)

Fig. 6. Conditions for a T pad where for a given power level at the input, the voltage across terminals 1 and 2 is  $E = \sqrt{PR}$ , where  $R$  is the resistive input,  $Z$ , and  $P$  is the power in watts.

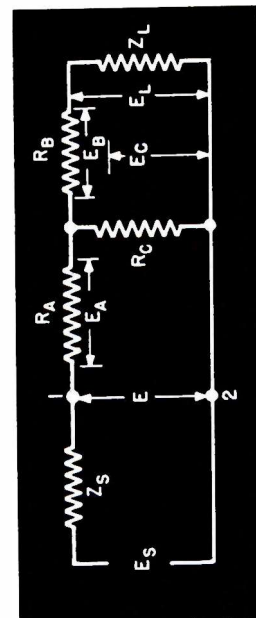

Fig. 8. Use of T pads for attenuation of signal powers and control.

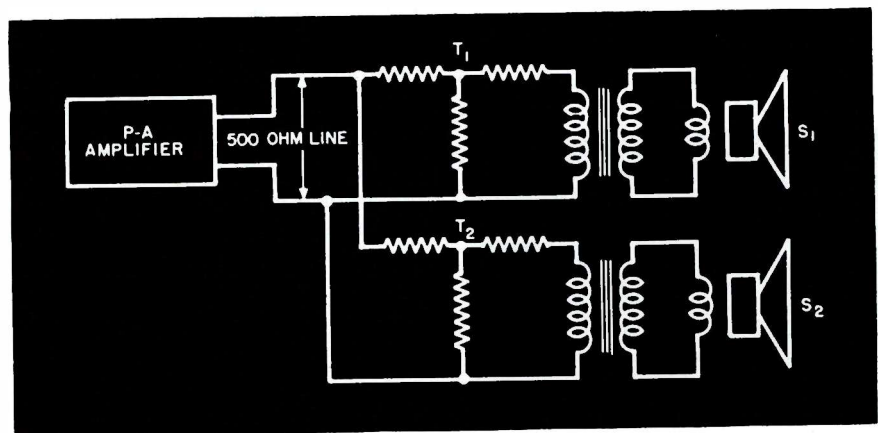
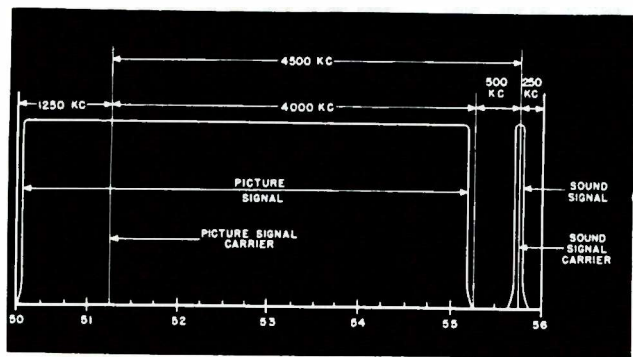

Fig. 1. Bandwidth and construction of a television signal.



# Television

# Receiver

## R-F and MIXER STAGES

by R. B. CARWOOD

IN THE TELEVISION RECEIVER, the r-f and mixer stage serves a dual purpose, in that it is used to amplify and select both the audio and video signals. To understand the problems associated with the repair and alignment of this portion of the television receiver, some knowledge of the design incorporated into this stage is necessary.

Because transmitting distances are short, and antenna signal voltages high, most receivers do not use a separate r-f stage, but feed the signal directly into the mixer tube, so that the r-f portion referred to is the circuit between the antenna and the mixer. Receivers are usually designed for a signal, at the antenna input, of approximately 500 microvolts, or .0005 volt. Since noise is an important factor, this high signal level is necessary to maintain a high signal-to-noise ratio.

In Fig. 1 we have the bandwidth and makeup of a television signal. The entire signal covers a frequency bandwidth of 6 mc, encompassing both the video and audio signals. This necessitates an r-f stage preceding the mixer tube that has a band acceptance of

6 mc, much wider than that necessary for the reception of f-m signals.

The r-f stage may be considered as an adjunct to the television-signal transmitter, since its primary function is to produce a signal at its output which is identical to the signal at its input, in every detail, except its amplitude. Therefore, the first design problem is to achieve some gain in the amplitude of the broad signal, without changing its characteristics.

In another sense, the r-f stage is also selective, since its function is to discriminate between the desired signal and other undesired signals. This qualification is a refinement of its amplification duties. That is, if it can be designed to amplify a particular signal, other signals will not be amplified. This can be considered a form of rejection.

In the broadcast receiver, these two characteristics go hand in hand, and high amplification of desired signals is usually accompanied by better selectivity. However, in the television receiver, a very wide band of frequencies must be amplified, as shown by Fig. 1. For this reason, special techniques are required in the design of the LC circuits for the r-f section, so that uniform amplification of the signal spectrum may be accomplished. This uniformity of amplification is necessary to maintain the character of the original signal.

A simple parallel tuned circuit is shown in Fig. 2. At the resonant frequency, the voltage induced in the circuit is at a maximum, with rapidly decreasing voltages for adjacent frequencies. The response curve in a is typical of this type circuit. It can be seen that for a tuned circuit, if uni-

form input voltage is supplied to the circuit, at frequencies close to the resonant frequency, a non-uniform output will result.

Fig. 3 shows an ideal response curve for a television r-f section. Here, it will be noted that the circuit amplifies all the desired frequencies uniformly and attenuates the unwanted signals. In actual practice it is impossible to attain this optimum condition, so that some compromise is necessary to expand Fig. 2a to Fig. 3.

One reason why a resonant circuit develops the greatest voltage at its resonant frequency, is that it attains its greatest reactance at resonance. Where a primary and secondary are involved, voltage gain is a function of turns ratio. In a similar sense, this may also be expressed as a reactance ratio, since the winding with the greater number of turns will have the greater reactance. Where a tuned circuit is used for a secondary, the greatest reactance ratio will therefore be at resonance. A resistor, however, has no such characteristic, since its reactance or resistance is independent of frequency. Therefore, if a resistor were placed in parallel with the tuned

(Continued on page 34)

Fig. 2. Parallel-tuned circuit. In a we have the response curve of this circuit.

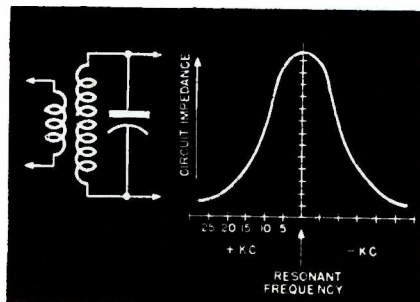
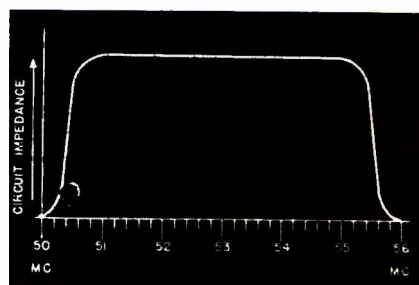

Fig. 3. Ideal response curve for a television r-f system.



timely!  
authentic!  
comprehensive!



## Save Up to 50% in Servicing Time!

### In Each PHOTOFACT FOLDER You Get:

- ✓ From 2 to 12 clear photos of the chassis, identifying each component part for immediate checking or replacement.
- ✓ Complete specifications on each component, including manufacturer's part number, available replacement type or types and valuable installation notes.
- ✓ A keyed reference alignment procedure for the individual set, with adjustment frequencies and recommended standard connections.
- ✓ Complete voltage analysis of receiver.
- ✓ Complete resistance analysis of receiver.
- ✓ Complete stage gain measurement data.
- ✓ Schematic diagram.

If you think it's going to be easy to service the 1,000 or more radio sets soon to come off production lines, read no further! The Howard W. Sams PhotoFact Service is designed for men who *know* there's a tough time ahead—who need and *want* better service information.

The Sams PhotoFact Service provides such information in the form of reliable, fact-filled, illustrated folders that can save as much as 50% of your servicing time. Every post-war radio is visualized in photographs . . . every part listed and numbered . . . every servicing shortcut and installation fact fully set down! No matter how complicated the set, or how new the components, you have the whole story right in front of you.

You get from 30 to 50 such PhotoFact Folders at a time. The Folders come to

you in handy folios at a cost of only \$1.50 for each group! They cover all new sets as they reach the market.

Think of it! An absolutely fool-proof visual method of giving you the exact information you want, where you want it, when you want it, for as little as three cents per new radio model! And every bit of information is compiled by experts from an examination of the actual receiver itself—*not from standard service data!* The Howard W. Sams PhotoFact Service starts June 15. Reserve your PhotoFact service *now!*

### Also, Membership in HOWARD W. SAMS INSTITUTE

Answers to hard service problems! Economical shop practices! How to get more customers! These and many other subjects covered by 30 top notch specialists! Complete facts with PhotoFact Folio No. 1.

Cut This Out and Mail It to Your Distributor! If you do not know his name and address, send it directly to Howard W. Sams & Co., Inc. 2924 East Washington Street, Indianapolis 6, Indiana, and we will see that your nearest distributor gets it.

CHECK ONE SQUARE

PLEASE PRINT

- Yes, by all means reserve every issue of the Howard W. Sams PhotoFact Folio Service for me.
- Send complete information and reservation card.
- My (check) (money order) (cash) for \$1.50 is enclosed for PhotoFact Folio No. 1. (Publication date, June 15, 1946)

Name \_\_\_\_\_ Address \_\_\_\_\_  
City \_\_\_\_\_ Zone \_\_\_\_\_ State \_\_\_\_\_  
Company Name \_\_\_\_\_  
My Distributor's Name \_\_\_\_\_ City \_\_\_\_\_

MAIL THIS  
COUPON  
TODAY

Howard W. Sams

Radio PhotoFact Service

# TOOLS and ACCESSORIES

## For the NEW SERVICE SHOP

by

**ALFRED A. GHIRARDI**

*Advisory Editor*

(PART II: BASIC TOOLS)



Fig. 1. Using screwdrivers in servicing. Since screwdrivers are the most often-used tools in the Service Shop, they should be chosen very carefully. (Courtesy U. S. Army Signal Corps.)

SERVICING present-day radio equipment, much of it very intricate and complex, involves a considerable amount of mechanical work. Since a well-selected complement of good tools is necessary for, and helps to speed up, this work those who plan to open new Service Shops should choose their tool equipment carefully.

The previous article of this series discussed the selection and use of a

recommended *basic* group of tools that the Service Man should consider buying for the new shop. The tools on this list represented a practical *minimum* equipment with which he can expect to tackle the *ordinary* mechanical work he is likely to encounter. The selection, use, and purchase of the vise, hammer, mallet, keyhole hacksaw, soldering iron, hand drill, portable electric drill, and twist drills was discussed

in some detail. The balance of the tools on the *basic* list will now be considered.

### Taps and Tap Wrench

A set of the more commonly used sizes of taps (such as the 4-36, 6-32, 8-32 and 10-32 sizes) is very handy for cutting the screw threads in holes that need to accommodate the corresponding sizes of machine screws. These holes are tapped by hand, using the type of tap wrench illustrated in Fig. 3, to turn the key in the hole. The end of the tap away from the threaded portion has a square head designed to fit into the tap wrench.

The tap number corresponds to the gauge number and threads-per-inch of the screw it is designed to tap the hole for. Thus, a tap marked 6-32 will cut the proper spiral thread in a hole, so that a No. 6 screw having a pitch of 32 threads-per-inch may be screwed into it.

The first step in making a tapped hole is to drill a hole of the proper size, so that it is just the right amount smaller to begin with, than the outside diameter of the screw to be used in it. This is necessary so that there will be enough material provided into which the threads can be cut by the tap. The drill used for this operation is known as the *tap drill*; the size drill to use is referred to as the *tap drill size*. The proper tap drill sizes to employ for the machine screws commonly employed in receivers are listed in table A.<sup>1</sup> The tap drill size to use is important for,

<sup>1</sup>SERVICE; April, 1945.

(Continued on page 28)

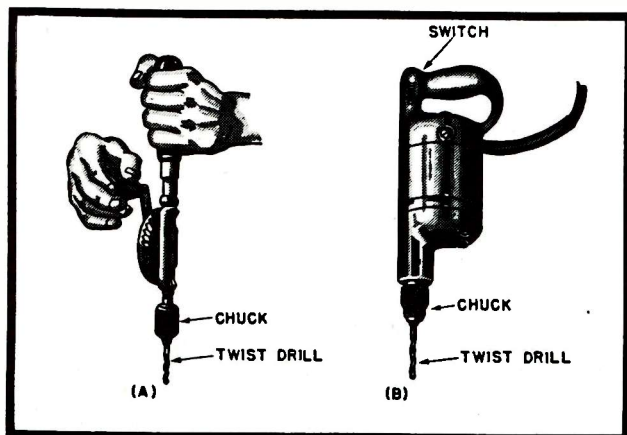
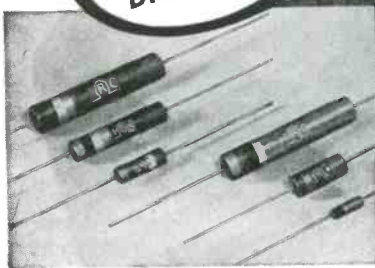

Fig. 2. Hand and electric type drills. In (a) we have a hand drill of the egg-beater type. Note the twist drill inserted for general drilling operations. A portable electric drill is shown in (b). This is used for auto radio installation work.

*Not too many... not too few!*

Also at  
your IRC  
Distributor's



TYPE BT INSULATED METALLIZED and  
TYPE BW INSULATED WIRE WOUNDS  
... the perfect combination.

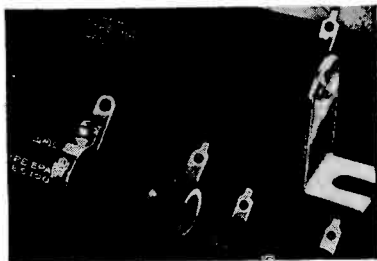

POWER WIRE WOUNDS... rugged,  
moisture proof, completely dependable.

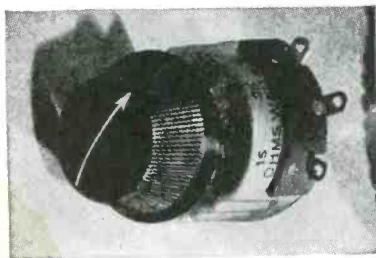

POWER RHEOSTATS (above), Pre-  
cisions, Wire Wound Controls, Bleeders,  
Non-inductive Wire Wounds, etc. (be-  
low)—for many service needs.

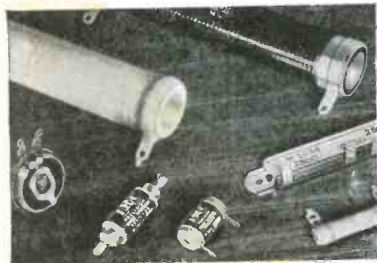

## The IRC *Century Line* is a commonsense selection of the controls you need for complete service

The controls in the *IRC Century Line* were carefully selected after exhaustive study of IRC sales records and of the requirements of receivers and equipment now in use.

These studies showed that the number of types previously listed could be reduced considerably, yet give adequate coverage. But it also proved that reducing the number of available types to anything *less* than the 100 now comprising the Century Line, would make the service engineer's replacement problem extremely difficult.

On that basis, we established the Century Line—not too many, not too few—but just right to give you properly designed, easily installed con-

trols for the widest variety of replacement needs.

Best of all, it's *not* necessary for you to actually stock all the 100 Century Line types! We recommend you maintain a minimum stock of at least the 18 Type D Controls listed on page 6 of IRC Catalog #50—they'll handle 87% of your replacements—and you can depend upon your IRC distributor for other types, as required.

And don't forget, *only IRC controls* give you such quiet, smooth, dependable performance!... because they're the only controls with the famous IRC Metallized Element, the Five Finger Contactor, and the Silent Spiral Connector!

**YOUR IRC DISTRIBUTOR** is the man to know when you need any type of resistor... there is an IRC resistance unit for almost every servicing requirement. Ask him for your copy of IRC Service Catalog #50.

FOR BETTER-THAN-STANDARD QUALITY... *Standardize on*

**INTERNATIONAL RESISTANCE CO.**

Dept. 23-E 401 N. BROAD ST., PHILA. 8, PA.

Canadian Licensee: International Resistance Co., Ltd., Toronto



MAKERS OF MORE TYPES OF RESISTANCE UNITS, IN MORE SHAPES, FOR MORE APPLICATIONS, THAN ANY OTHER MANUFACTURER IN THE WORLD.



# for every transformer application

FOR MINIATURE EQUIPMENT



Miniature components to match the new "proximity fuse" miniature tubes. Output and input transformers, and reactors with dimensions 9/16" x 3/4" x 5/8".

FOR THE RESEARCH LABORATORY



Typical of the special units produced by UTC is this high gain, 100 cycle, matching transformer. Primary impedance 500 ohms, secondary impedance 37,500,000 ohms, shielding suitable for—160-DB signal level.

FOR THE RADIO AMATEUR

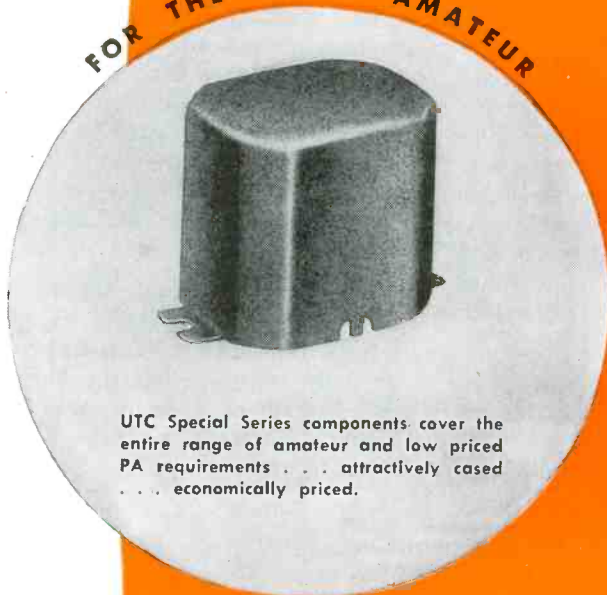

UTC Special Series components cover the entire range of amateur and low priced PA requirements . . . attractively cased . . . economically priced.

FOR THE BROADCAST STATION



UTC linear standard transformers are the ultimate in high fidelity design . . . frequency response guaranteed  $\pm 1.5$  DB 20 to 20,000 cycles . . . Low wave form distortion . . . Extremely low hum pickup.



ALL PLANTS

## United Transformer Corp.

150 VARICK STREET

NEW YORK 13, N. Y.

EXPORT DIVISION: 13 EAST 40th STREET, NEW YORK 16, N. Y.,

CABLES: "ARLAB"



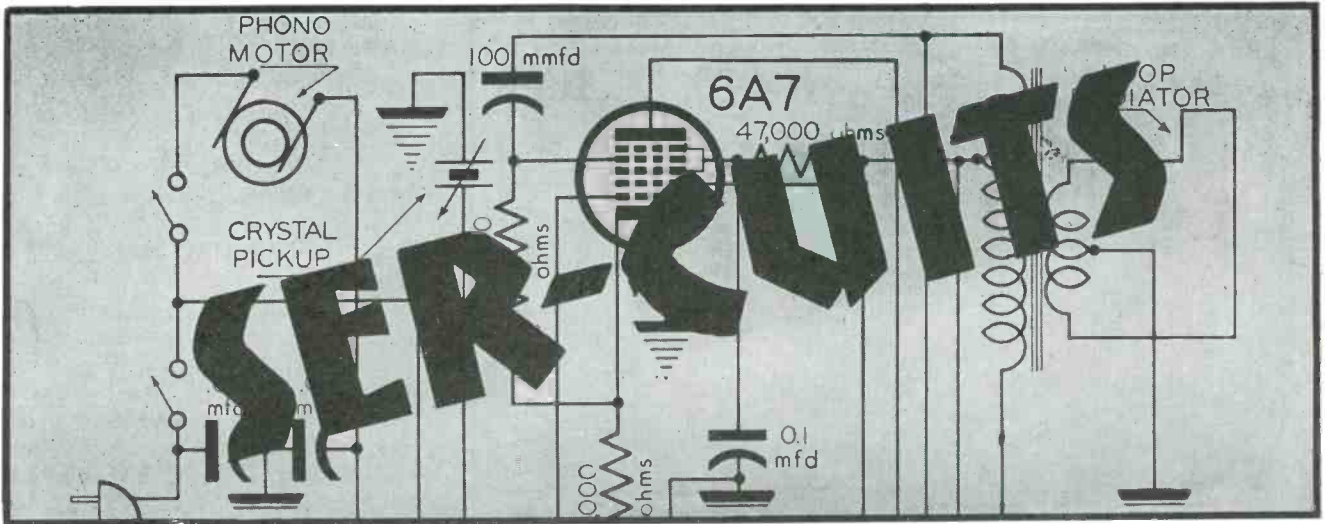

A NEW SERIES of postwar models— a-c/d-c table types, portable record players, automatic phono units and beam-power types—are analyzed in this month's discussion of circuits.

A two-band 6-tube plus rectifier a-c/d-c receiver, Wells Gardner 37D14-600 (also Truetone D2630), is shown in Fig. 1. In this model the broadcast loop primary, with leads, serves as the short-wave antenna when no external antenna is used. The loop or short-wave transformer is switched to the signal grid of the 12SA7 by a simple

## by HENRY HOWARD

s-p-d-t switch. The oscillator grid is similarly switched from b-c to s-w oscillation transformers. The cathode, however, runs through the b-c and s-w feedback windings to ground, the b-c winding being shorted in the s-w position.

There are two i-f stages. The first

Fig. 1. Wells-Gardner 37D14-600, 2-band and rectifier a-c/d-c model with a 12SK7 and 6SS7 i-f stage.

uses a 12SK7. This is resistance coupled to a 6SS7, a 150-mil 6.3-volt pentode. The coupling components consist of a 3,300-ohm plate load, 47-mmfd coupling capacitor and 47,000-ohm grid leak. The second detector is a 12SQ7 diode, the triode plate element being grounded while the grid is used as an initial source of bias for the avc bus, the bias being derived from the normal static electron flow. The detector load resistance is composed of 100,000 ohms in series with a ½-megohm vol-

(Continued on page 24)

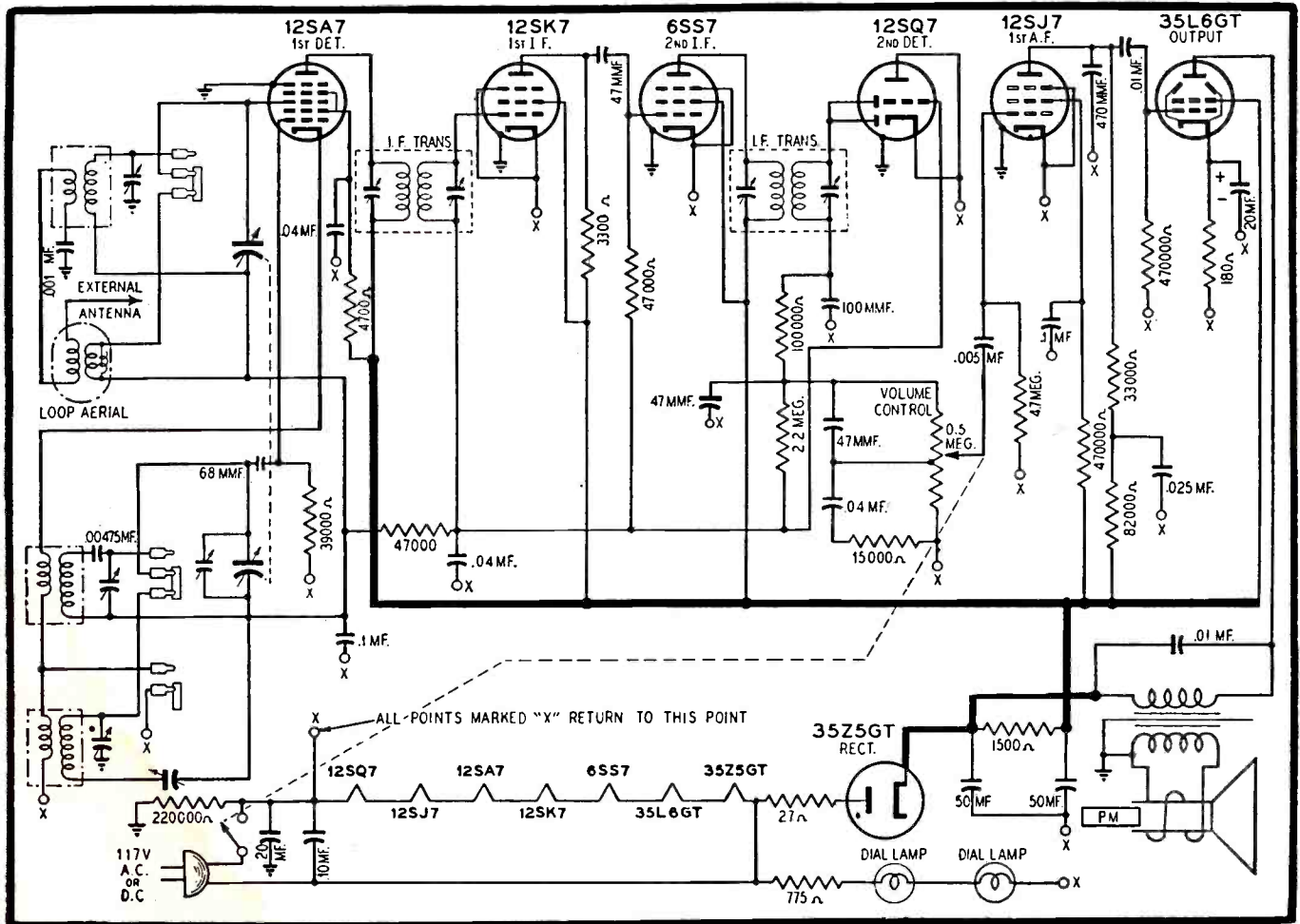

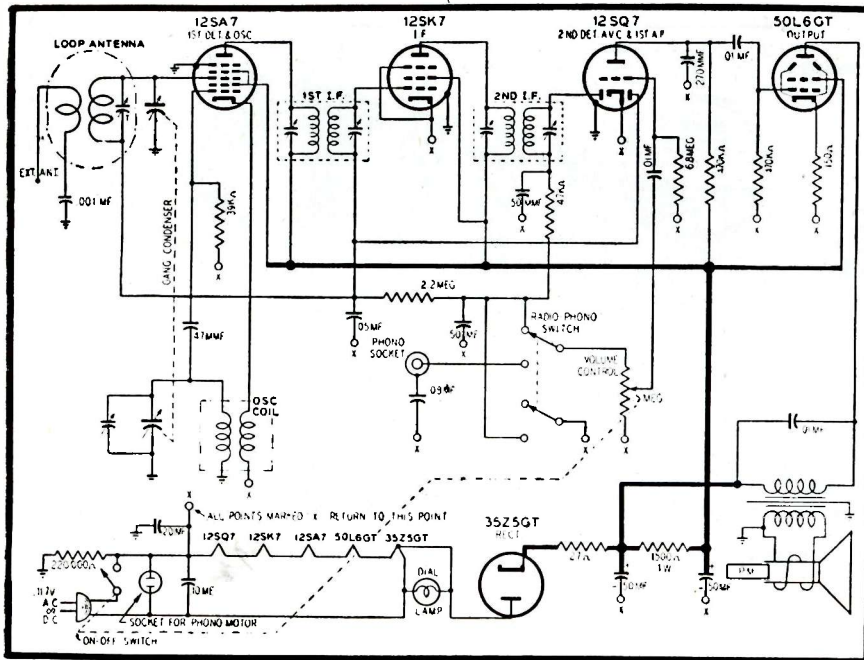

Fig. 2. Ward 54WG-2007A, 4-tube plus rectifier receiver using a 12SK7 diode for detection and avc.

ume control, tapped for tone compensation. A 100-mmf detector capacitor, with a resistor-capacitor combination of 100,000 ohms and 47 mmfd at the high side of the volume control, constitute an efficient i-f filter.

The first a-i stage is a 12SJ7 pentode operated with a low plate load, only 33,000 ohms. The screen-voltage dropping resistor is 470,000 ohms. An R/C isolating filter consisting of 82,000 ohms and .025-mfd appears in the plate supply. A 4.7-megohm grid leak is used. The power stage is a conventional 35L6 supplied directly from a 35Z5 rectifier output driving a p-m speaker. A bias resistor of 180 ohms is shunted by a 20-mfd capacitor.

A pair of No. 47 dial lamps are independently operated directly from the line through 775 ohms, no connection

being made to heater terminal 3 of the rectifier tube.

#### Ward 54WG-2007A

A small single-record-playing combination, 4-tube plus rectifier receiver, Ward's Airline 54WG-2007A, appears in Fig. 2. This one has a standard tube lineup—12SA7, 12SK7, 12SQ7, 50L6 and 35Z5. The crystal pickup jack is connected to B- through a .08-mfd capacitor. A phono-radio switch throws the volume control from the receiver detector to pickup and shorts the detector output. One 12SQ7 diode is used for detection and avc, the other for initial avc bias for the first and second tubes. The first a-f grid leak is a 6.8-megohm unit. The B- is connected to the chassis through a 0.2-

mfd capacitor and a 220,000-ohm resistor in parallel.

#### Ward 54WG-2700A

Fig. 3 shows a 2-band/6-tube and rectifier a-c automatic phono model, Ward 54WG-2700A. A 6SJ7 first detector is driven by a separate 6J5 oscillator through cathode-to-cathode coupling and through a 2,200-ohm bias resistor, bypassed by .02-mfd capacitor. On s-w additional coupling is obtained by a small capacitor from the oscillator plate to the input grid. A 12-contact, 2-section bandswitch also takes care of phono switching. Section 1 of this switch is used for the oscillator and the detector-pickup, while section 2 handles the first detector input switching. It also voids first detector operation in phono position.

Two 6SK7 i-f stages are used with resistance coupling between them, the components being a 2,700-ohm plate load, 10-mmf coupling capacitor and a 1-megohm grid leak. The cathodes are grounded; screens are tied together but there is a plate-supply decoupling filter between them, 220 ohms and .02 mfd. The 6SQ7 stage is conventional, feeding a 6V6 output. Bias for the 6V6 is obtained from the drop across the speaker field through a voltage divider-filter network composed of a 620,000-ohm series resistance, 91,000-ohm parallel resistance and a 0.25-mfd capacitor across the latter.

#### Westinghouse H-130, H-122

A push-pull a-c/d-c model (with and without phono) using 300-mil tubes to provide an undistorted output of 3 watts on radio, 3.5 watts on phono and 5 watts maximum, is shown in Fig. 4; Westinghouse library model H-130 and phono model, H-122.

A 6SF7 is used in the i-f and detector-avc. A 6SC7 dual triode serves as a first a-f and inverter.

The radio/phono switch opens the plate supply to the first two tubes in phono position, increasing the B voltage on the audio end for a boost of 1/2 watt in power output.

The first audio stage has a 10-megohm leak. Inverter excitation is derived from the drop across a 82,000-ohm resistor, connected between the

(Continued on page 26)

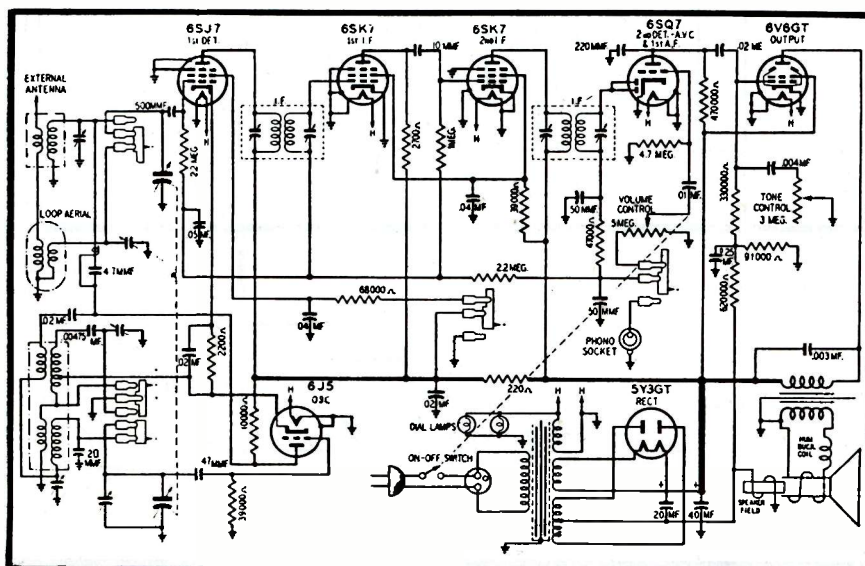

Fig. 3. Ward 54WG-2700A, 2-band/6-tube and rectifier a-c automatic phono model.



# Centralab

*The Quality*

## **TONE SWITCH** *for ALL Replacements*

The initials "CRL" in the diamond are your assurance of quality in Tone Switch replacements. New developments in production procedures insure precision, positive indexing, and low resistance. For best performance . . . *always specify "Centralab"*

# Centralab

Division of GLOBE-UNION INC., Milwaukee

**PRODUCERS OF**



Variable Resistors  
Bulletin 697



Selector Switches  
Bulletin 722



Tubular Ceramic  
Capacitors  
Bulletins 630 and 586

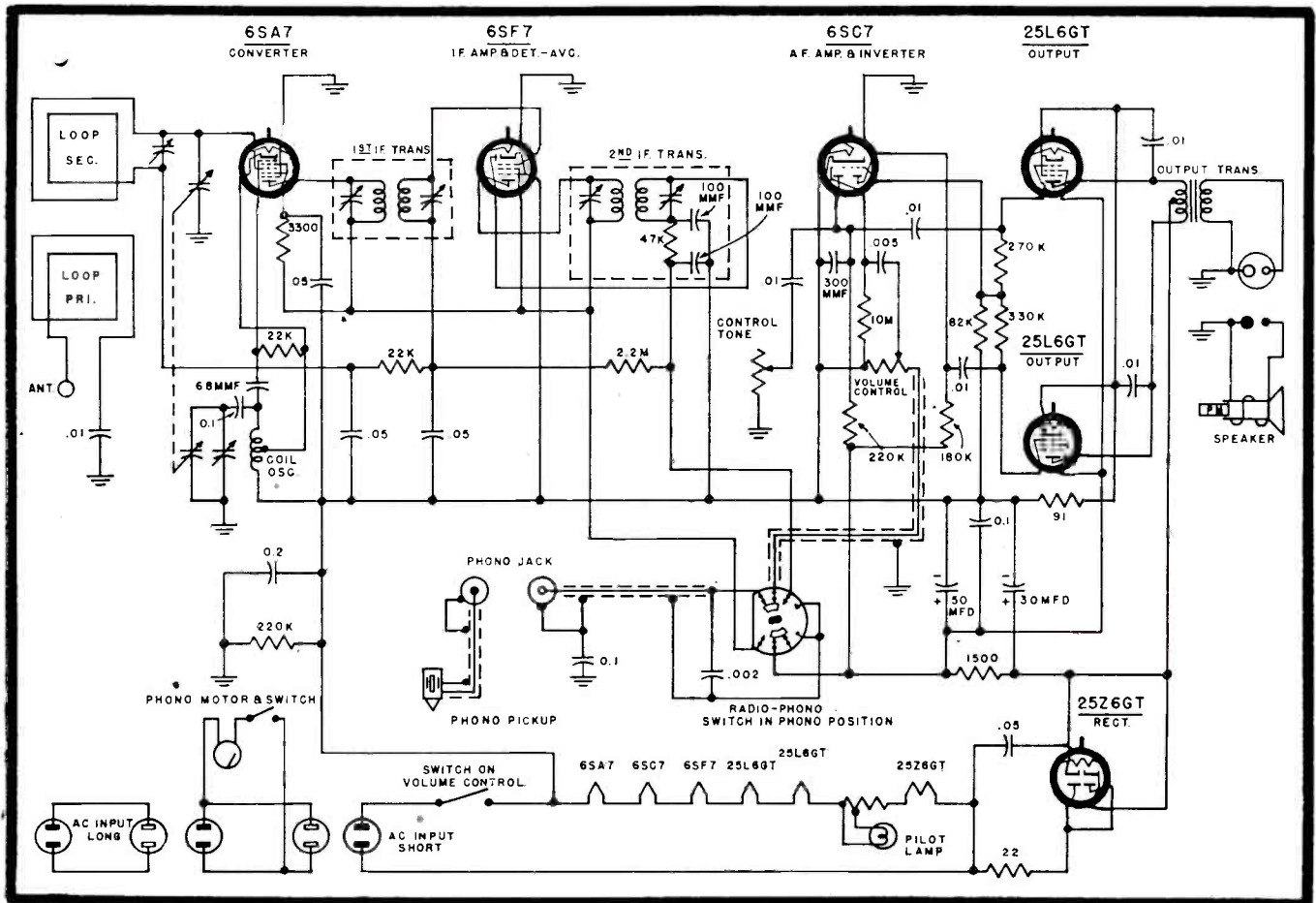

25L6 grid leaks (330,000 and 270,000 ohms) and  $B-$ . A tone control is connected to the first a-f output. A 91-ohm resistor supplies bias for a pair of 25L6s.

A 72-ohm ballast lamp with a tap at

12 ohms for the pilot lamp is connected in the filament string.

#### Electromatic 512

A 4-tube and rectifier phono model, Electromatic 512, with some interest-

Fig. 4. Westinghouse H130/H122 pushpull a-c/d-c receiver using 300-mil tubes, providing a maximum output of 5 watts.

Fig. 5 Electromatic 512, 4-tube and rectifier phono model. The avc bias is obtained from oscillator section of 12SA7 converter through a 10-megohm resistor.

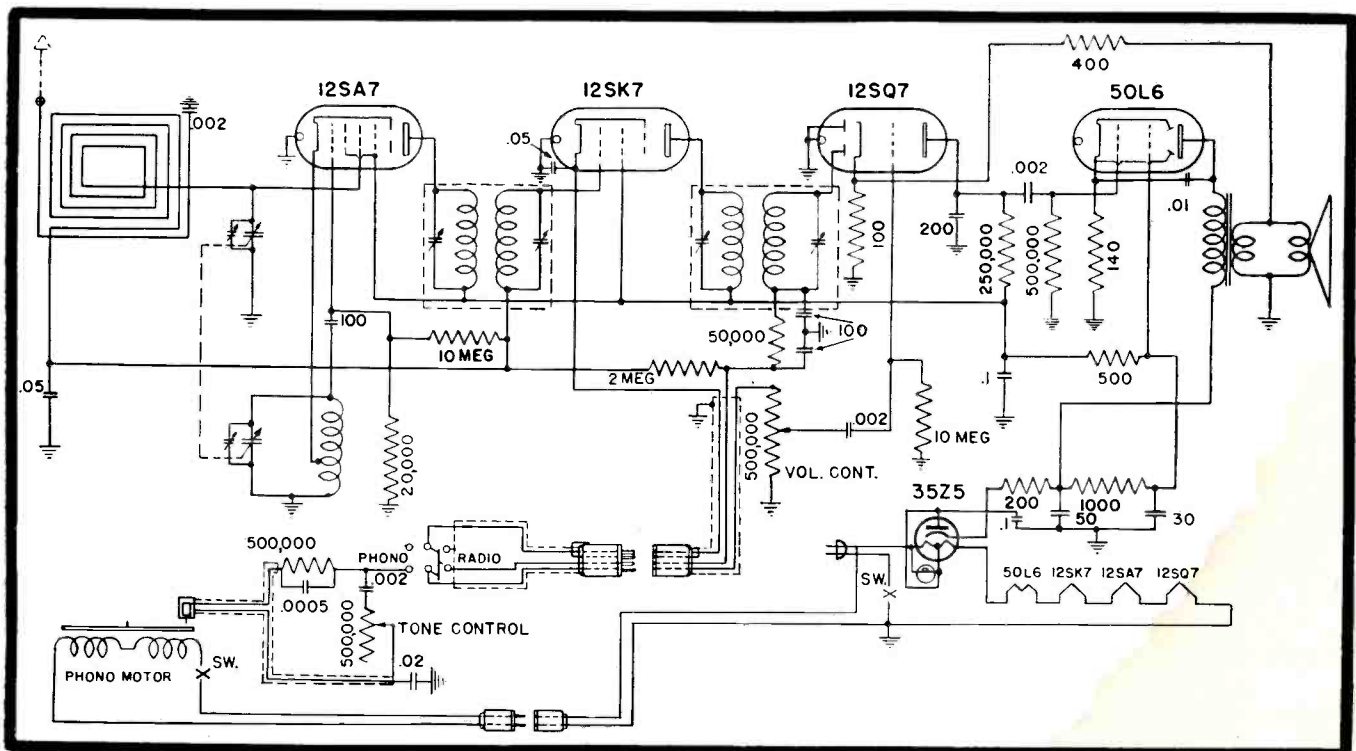

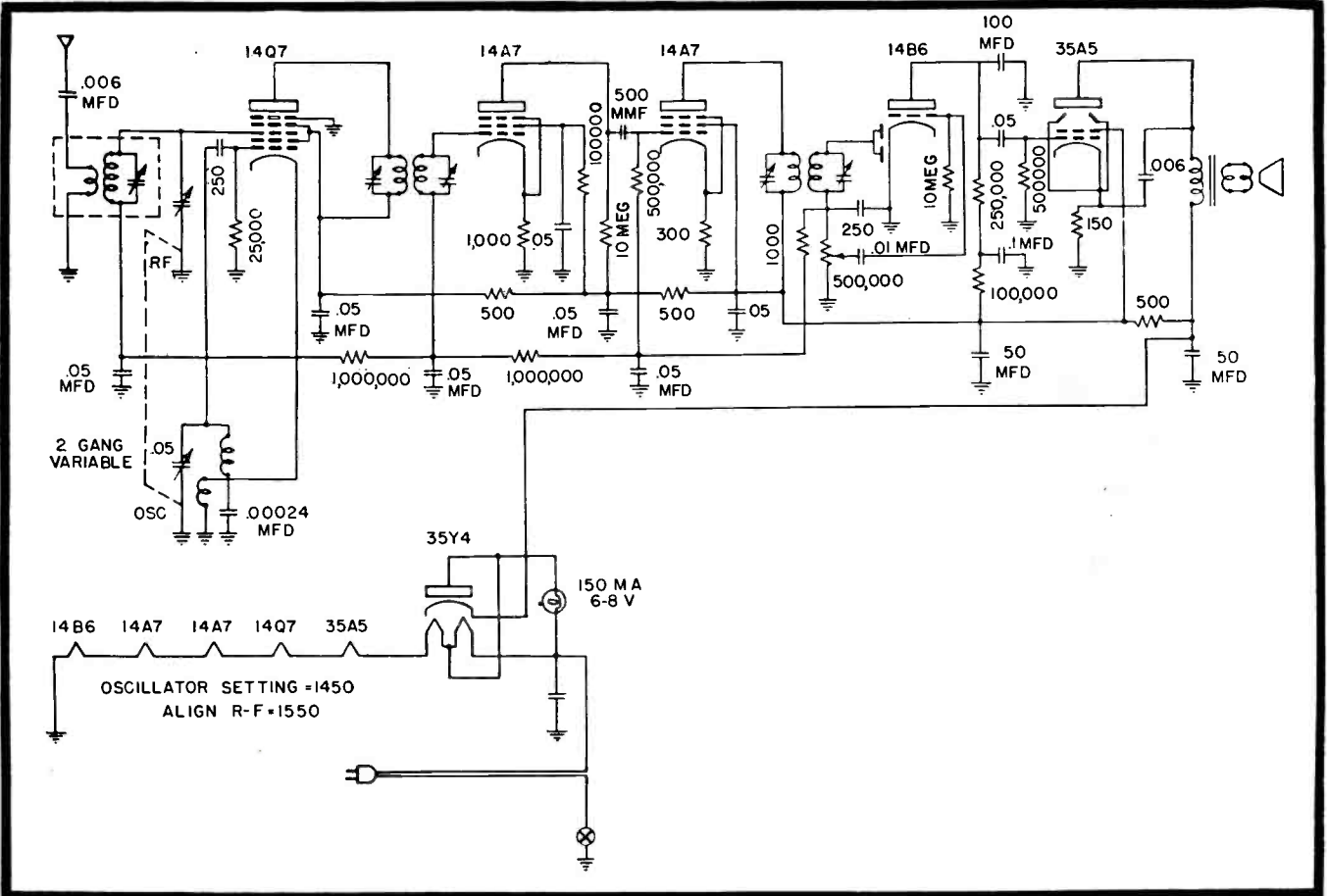

Fig. 6. Ultradyne L-46 5-tube model using lock-in tubes.

ing innovations is shown in Fig. 5. In this model initial avc bias is derived from the oscillator section of the 12SA7 converter through a 10-megohm resistor. The i-f amplifier cathode runs to the phono/radio switch, where it is opened in phono position to kill any radio signals. A .05-mfd i-f bypass at the socket limits the amount of coupling from the switch lead. The 12SQ7 is conventional except for the

bias and audio-feedback arrangement which feeds the voice-coil voltage through 400 ohms, applying it to the cathode. There is also a 100-ohm resistor to ground which shunts this feedback voltage.

The phono circuit contains a series

Fig. 7. Globe Electronic 6U, 5-tube and rectifier receiver with lock-in tubes.

equalizer and shunt tone control. The equalizer consists of a  $\frac{1}{2}$ -megohm resistor and 500-mmfd capacitor in parallel; the tone control, a  $\frac{1}{2}$ -megohm rheostat in series with a .002-mfd capacitor. The low-potential side of the pickup is isolated from the line and chassis by a .02-mfd capacitor. The rectifier filter has a 20-ohm surge-limiting resistor. Other components  
(Continued on page 33)

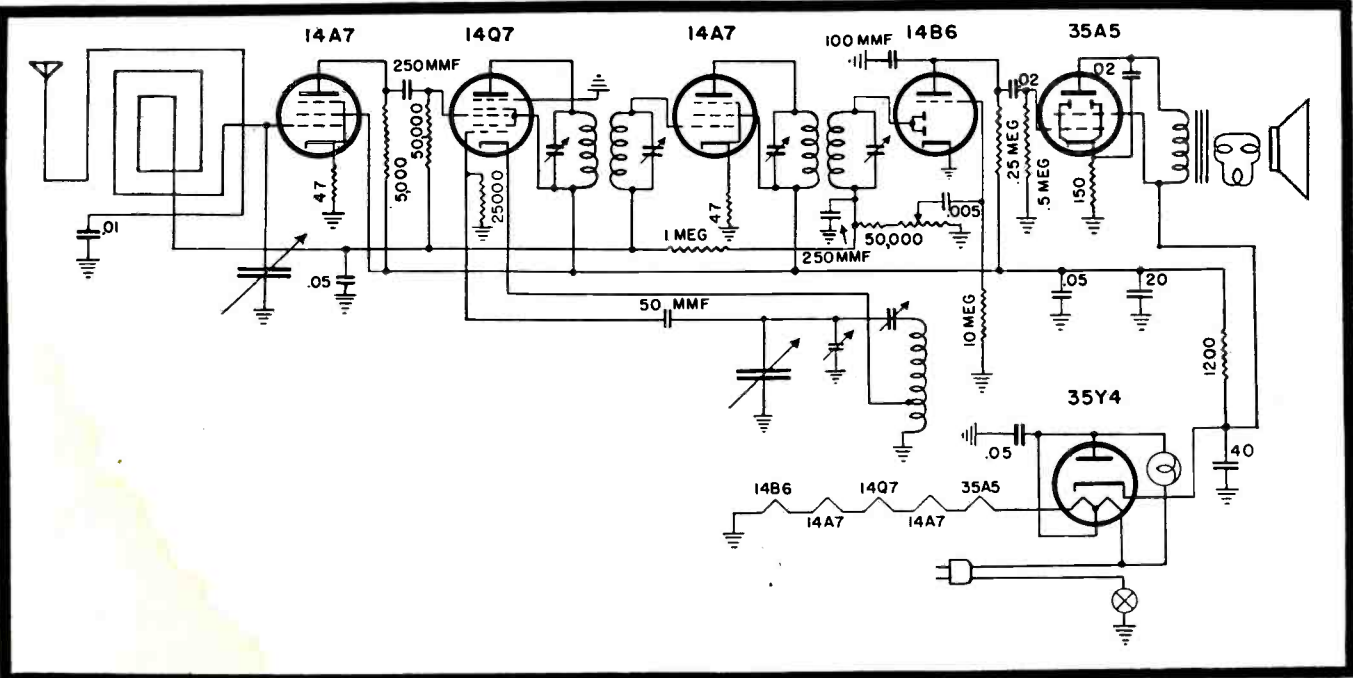



**CLAMP-MOUNTING Electrolytics**

• Here's the ideal universal one-hole mounting electrolytic replacement. Takes the place of the twist-prong, spade-lug, screw-base, and other similar types.

**AEROVOX TYPE PRV**  
 An exclusive Aerovox design. Easily and rigidly mounted by means of center screw and metal cleat. High-purity aluminum-foil sections. Thoroughly sealed. Available in popular voltage ratings and capacitances to meet widest range of service needs. Keep a supply on hand to take care of those rush jobs.

• Ask Our Jobber . . .  
 Ask for Aerovox PRV general-purpose electrolytics as well as other postwar types to speed up your profitable servicing. Ask for latest catalog — or write us direct.



**AEROVOX CORP., NEW BEDFORD, MASS., U.S.A.**  
 Export: 13 E. 40th St., New York 18, N.Y. • Cable: 'ARLAB'  
 In Canada: AEROVOX CANADA LTD., Hamilton, Ont.

**TOOLS**

(Continued from page 20)

if the hole is too small the tap will bind and probably break off in the hole; if it is too large, the threaded hole will be a loose fit for the machine screw. Reference to the table of tap drill sizes shows that, if a tapped hole for a 6-32 machine screw is to be provided, a No. 36 tap drill should be employed. If an untapped hole large enough for the 6-32 screw to slide through freely is to be drilled, a No. 28 drill (clearance drill) should be used instead.

The three common forms of taps are illustrated in Fig. 3. The taper and plug taps taper toward the point so that the cuts are made gradually deeper by the successive threads. If the hole goes entirely through the material, a taper tap is used for the entire operation if it can be run entirely through the work. To thread a hole that does not go completely through the stock, the thread is started with a taper tap. When this tap has struck the bottom of the hole, it is backed out and the hole threaded with a plug tap. This is in turn removed and the threads are cut to the bottom with a bottoming tap. In soft materials the use of the plug tap is not necessary and the hole may be threaded in two steps.

Since most of the holes that the Service Man is called upon to tap go right through the material, only a set of taper taps is necessary for the basic tool equipment. Plug and bottoming taps may be purchased later if a need is found for them.

**Pliers**

Many types and sizes of pliers are made, each specially designed to best perform a certain task. They are classified according to their overall length and by the shape of their jaws. A skilled Service Man does not attempt to use one pair of pliers for all purposes. A sufficient variety should be on hand so that only the type intended for a given task should be used.

The three types of pliers used most frequently are: diagonal side-cutting, long nose and electrician's side-cutting. These, illustrated in Fig. 4, should be purchased as basic plier equipment.

Diagonal side-cutting pliers are equipped with cutting jaws set at an angle of about 15° with the face of the tool. They are used principally for cutting off wire of small gauge, skinning insulation, cleaning wire before soldering, etc. Their advantage over the electrician's side-cutting pliers lies in the fact that since their cutting

**RADIO PARTS and Sound Equipment IMMEDIATE DELIVERY**

- 6 ft. cord sets—high grade—soldered—molded rubber plug at one end. 10 for \$2.75. Each . . . . . 28c
- Mike Cable—superior quality, single conductor, shielded, pre-war quality natural rubber cover. Per ft., only . . . . . 8c
- Dual conductor as above. Per ft. . . . . 10c
- Carbon Resistor Kit No. 16, 100 RMA coded, 1/2 and 1 Watt, assorted. Our price, only . . . . . \$2.94
- Aerial Kit, containing aerial wire, insulators, rubber-covered lead-in, ground clamp, window strip, complete set, only . . . . . 50c
- 10 MFD 50 WV Tubular Pigtail Electrolytic Condensers. Year guarantee. 10 for \$2.25. Each, only . . . . . 24c
- 20 MFD 150 WV Tubular Pigtail Electrolytic Condensers. Guaranteed one year. 10 for \$3.30. Each . . . . . 35c
- 10 MFD 450 WV Tubular Pigtail Electrolytic Condensers. Year guarantee. 10 for \$3.95. Each . . . . . 43c
- 20-20 MFD 150 WV Tubular Pigtail Electrolytic Condenser. Year Guarantee. Each . . . . . 59c
- Bakelite Set-Screw Knobs. Deluxe assortment of 50 for 1/4 inch shaft . . . . . \$3.93

Write for latest bargain bulletin of hard-to-get parts, supplies and sound equipment.

**Lifetime SOUND EQUIP. CO., Dept. 71**  
 911-913 JEFFERSON AVE., TOLEDO 2, OHIO

**M U E L L E R**

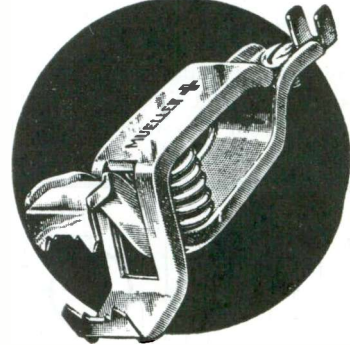

**CLIPS**

**For Quick Temporary Connections**

- Made in 10 sizes—from the tiny wee-pee-wee to the 300 ampere Big Brute.
- Offered in both steel and solid copper.
- Red and black rubber insulators to fit each size.
- A complete line with

**A CLIP FOR EVERY PURPOSE**

Send for free samples and catalog 810



1565 E. 31st St. - Cleveland, Ohio

edges extend to the very end of the rounded nose they can cut a wire off closer to its point of attachment, since the cutting edges do not extend down this far. The 6" plier is the size most commonly used by the Service Man. The type shown in Fig. 4, having a wire-skinning notch cut in the jaws and a return-spring between the handles, is recommended.

Long-nose pliers have long, slender jaws flat on the inside. These jaws are usually scored on the inside, near the end. Some are made with side cutters, others do not have them. Long-nose pliers are used primarily for light gripping and holding operations. They are useful for reaching and holding wires, screws, nuts and other small parts in hard-to-reach places not readily accessible to the hand. They are also useful for shaping purposes, forming small wire loops for terminal connections, holding wires while they are being soldered to terminal strips, placing washers on screws, etc. They may also be used for skinning the insulation from small wires by sliding the base of the jaws down along the wire while squeezing down on the handles. The 6" size of long-nose plier is recommended—either with, or without side cutter.

Electrician's side-cutting pliers, sometimes called linemen's pliers, have blunt jaws equipped with a scored gripping surface; above the gripping surface are powerful side cutters and sturdy handles. The design is such that when the blades of the side cutters meet, the gripping jaws are still open a few thousandths of an inch so as not to interfere with the cutting action. Some are provided with a wire-stripping notch in the cutters, as shown in Fig. 4. These pliers are sturdy and are useful for insulation crushing (use the heel back of the joint), insulation stripping (do not permit the jaws to touch the bare wire), gripping, wire cutting, and bending light metal stock. The 6½" size is recommended for radio use.

#### Screwdrivers

The Service Man's screwdrivers are perhaps the most often-used tools in the shop. As this constant use subjects them to hard wear, it is important to purchase only those of good quality made with alloy steel blades hardened throughout their full length and fastened securely so they will not turn in the handles. The 10-cent-store variety, equipped with soft blades, should be avoided.

Screwdrivers are classified according to length, purpose, type of handle,

(Continued on page 46)



Alfred A. Ghirardi—the man who takes the headaches out of Radio-Electronic Servicing

**I'LL "LEND" YOU THESE TWO GREAT MONEY-SAVERS For 5 Full Days**

**Save Time — Make Twice as Much Money . . . YOU BE THE JUDGE!**

### Ghirardi's RADIO TROUBLESHOOTER'S HANDBOOK

*Helps you repair 85-90% of all radio receiver troubles in half the usual time*

Ghirardi's big, 4-lb., 744-page RADIO TROUBLESHOOTER'S HANDBOOK is the one radio servicing short cut that really works. Eliminates much tedious testing—is worth another man in your shop! The common troubles and their remedies are carefully listed and indexed—for practically every home receiver, auto-radio and record changer in use today. The HANDBOOK tells exactly what the trouble is likely to be—exactly how to repair it. Ghirardi passes on to you its priceless servicing knowledge and experience obtained from thousands of hours of tedious troubleshooting and repair work on all these

receivers. By using it, your service work is made EASIER and you can easily cut your own time in half ON FOUR JOBS OUT OF FIVE—and still charge the customer the same price! Think what that will mean in terms of profit! In addition, over 300 pages of this giant, manual-size book contain other invaluable data—tube charts, tube and part substitution data, i-f alignment and transformer data, color codes and literally dozens of charts, graphs, diagrams, and compilations that will help you repair any radio ever made EASIER, BETTER and twice as fast! Only \$5 complete—on our 5-Day Money-Back Guarantee Basis.

### Ghirardi's MODERN RADIO SERVICING

*All the Science of Professional Radio-Electronic-Television Servicing in One 1300-Page Book*

TRAIN FAST!  
TRAIN  
RIGHT!

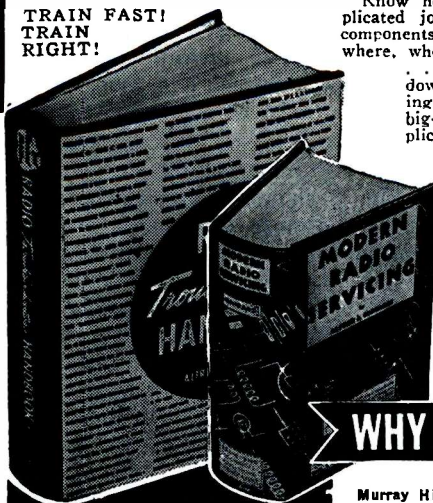

Know how to make preliminary trouble checks on complicated jobs? Know how to analyze any circuit and its components quickly and scientifically? Do you know exactly where, when and how to use all types of test instruments . . . and how to interpret their readings to track down the trouble? Only by truly professional training of this sort can you hone to qualify for the big-money work—and especially on the more complicated new FM and Television receivers.

#### INCREASE YOUR EARNINGS!

Nowhere else can you get such training faster, easier and at less cost than in Ghirardi's MODERN RADIO SERVICING. This 1300-page, profusely illustrated book brings you up to date on modern methods, refreshes you on any type of work that may prove puzzling, prepares you for the rich opportunities that only servicemen having the true "Know How" of their profession can grasp. Everything explained simply and thoroughly so you will understand it easily and quickly. Only \$5 complete—on our 5-DAY MONEY-BACK GUARANTEE offer.

**WHY NOT HAVE A LOOK—Now!**

### MONEY-SAVING OFFER!

Let Ghirardi's RADIO TROUBLESHOOTER'S HANDBOOK save you time on common radio jobs. Let MODERN RADIO SERVICING train you in scientific electronic servicing "Know How". Get BOTH big books at special price of only \$9.50. Send coupon today!

Murray Hill Books, Inc., Dept. S-56,  
232 Madison Ave., New York 16, N. Y., U. S. A.

Enclosed find \$..... for books checked; or  send C.O.D. (in U. S. A. only) for this amount plus postage. If not fully satisfied, I may return the books within 5 days for refund.

RADIO TROUBLESHOOTER'S HANDBOOK \$5 (\$5.50 foreign)  MODERN RADIO SERVICING \$5 (\$5.50 foreign)

**MONEY-SAVING COMBINATION**  
Both big books—over 2040 pages—only \$9.50 for the two (\$10.50 foreign).

Name .....

Address .....

City and Dist. No. .... State .....

*New!*  
*Complete!*  
**RADIO CATALOG**  
*Free!*

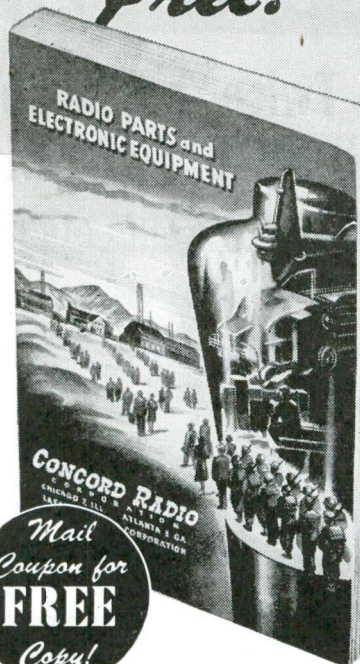

Mail  
Coupon for  
**FREE**  
Copy!

**RADIO SETS**  
**AMPLIFIERS**  
**RADIO PARTS**  
**ELECTRONIC EQUIPMENT**

Your copy of the complete, new Concord Catalog is ready! It offers you the greatest selection of guaranteed quality RADIO SETS, PHONO-RADIOS, RADIO PARTS, TEST INSTRUMENTS, BOOKS, TOOLS, AMPLIFIERS AND ACCESSORIES, AMATEUR KITS AND SUPPLIES . . . page after page of post-war-engineered equipment and parts you have long been waiting for. All standard, top-quality lines. Thousands of items. Money-saving prices. See the thrilling MULTIAMP Add-A-Unit Amplifiers, brand new in the field, with sensational new flexibility, fidelity and power—EXCLUSIVE with CONCORD. Your copy is ready... and it's FREE. Rush this coupon today.

**CONCORD**  
RADIO CORPORATION  
LAFAYETTE RADIO CORPORATION  
CHICAGO 7 ★ ATLANTA 3  
901 W. JACKSON BLVD. 265 PEACHTREE ST.  
Concord Radio Corporation, Dept. S-56  
901 W. Jackson Blvd., Chicago 7, Ill.

Yes, rush FREE COPY of the comprehensive new Concord Radio Catalog.

Name.....  
Address.....  
City..... State.....

**CAPACITOR UNITS**

(Continued from page 13)

high-power-factor units should be considered from this angle.

Low resistance in a paper or mica capacitor is generally an indication that the capacitor will not give top quality performance. If the capacitor is operated at rated voltage, it will not have a long useful life. Values below 100 megohms at room temperature for fractional capacities are generally considered to be unsatisfactory depending, of course, on the circuit requirements. Measurements of shunt resistance made at room temperature are to be divided by a factor of 20 if the capacitor operates at 150° F, or by 60 if at 185° F, as is the case in some receivers, especially auto-radio types. Since the capacitor operates above room temperature, the working shunt resistance at that temperature should be considered when determining the effect on circuit operation.

Paper and mica dielectric capacitors have a shunt resistance of many megohms, often well into the thousands of megohms. Where such units are shunted by a resistor of only a few thousand ohms, it is obvious that the capacitor resistance alone will not affect the operation of the circuit. A capacitor in such a location may not have to be replaced if it has an internal resistance of only a few megohms, providing it is operating on less than half-rated working voltage. Figure 7 shows a paper dielectric bypass capacitor in such an application connected across a cathode bias resistor. Some discretion must be observed when operating a low-resistance capacitor in this and in other circuits.

Fig. 8 shows a circuit where the shunt resistance of a paper or mica capacitor may be critical. In the plate-to-grid coupling application, a low-capacitor resistance in the order of a few megohms at operating temperature may change the bias on the final tube. Since the grid resistance is in series with the capacitor across the plate voltage of the first tube, it acts as part of

Fig. 8. In this circuit the shunt resistance of a paper or mica capacitor is usually critical. Therefore, capacitor replacement may be necessary.

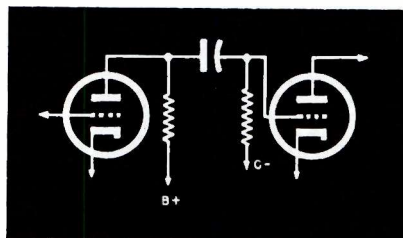

**RAD-EL-CO**

**Roto-Lok**  
**AERIALS**  
for ALL  
1946 CARS

- Top Cowl or Fender
- 5 Minute Installation
- 25° Adjustment
- Attractive Prices

MODEL CO-3

AVAILABLE NOW  
AT YOUR DISTRIBUTORS

**RAD-EL-CO MFG. CO.**  
6300 EUCLID AVENUE  
CLEVELAND 3, OHIO

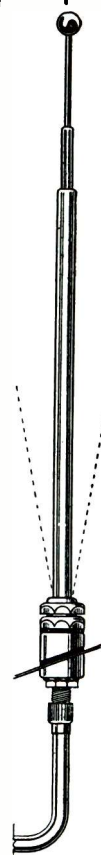

**40**  
WALSCO

**THE**  
**WALSCO**  
**"40"**  
**LINE**

Over 250 items of essential electronic hardware for the radio service man, technician, experimenter and "ham".

Every item packed in dust-proof cellophane bags and priced at 40c List.

**Think what this one price plan means to you:**

The electronic hardware items commonly used in radio repairs are available in separate packages. Handy to use—easy to re-order. You save time and money by using the WALSCO "40" Line

See your WALSCO jobber TODAY or write us for full details on how the WALSCO "40" Line can save time and money for you.

Write to Dept. S

**WALTER L. SCHOTT CO.**  
BEVERLY HILLS, CALIF.  
CHICAGO 5, ILL.

See the WALSCO "40" Line at booth 116, Radio Show, Stevens Hotel, May 13-16th, Chicago.



a voltage divider with the voltage across it bucking the normal bias. This is a frequent cause for capacitor replacement.

The bypass capacitor in Fig. 9 generally receives a voltage close to its rating, including a large alternating-current ripple in the audio stages of a receiver. The conditions under which the capacitor must work are such that low internal shunt resistance indicates an early failure due to the capacitor becoming short circuited. It is generally advisable to replace such capacitors if the resistance falls below 250 megohms.

The capacity of paper and mica capacitors remains substantially unchanged regardless of how long they are in service. It is safe to say that most receiver design engineers select capacitors with stability consistent with the circuit requirements. Very infrequently a mica capacitor may lose capacity because of some of the internal elements becoming disconnected. Reference to the service manual for a description of the part, and the effect of off capacity on the circuit will generally determine if the capacitor should be replaced.

Electrolytic capacitors being electrochemical in nature are somewhat different than the types just described. When such a capacitor remains inoperative for a long time, there is a deformation of its insulating medium causing high initial leakage current when it is placed in service. Under this condition the capacitor should be permitted to remain connected to the analyzer for five minutes or more, before passing judgment on its quality. If the capacitor is satisfactory, the leakage current will slowly drop to an acceptable value. Dry construction electrolytics take less time on this aging operation than do the wet electrolytic types.

Non-polarized electrolytics found in some types of midget receivers should be checked for leakage in both directions of polarity. This is accomplished by testing the capacitor by the usual

(Continued on page 32)

Fig. 9. Bypass capacitor application where the capacitor receives voltage close to its rating, as well as a large a-c ripple in the a-f stages. It is, therefore, necessary to watch the capacitor replacement in this instance very carefully.

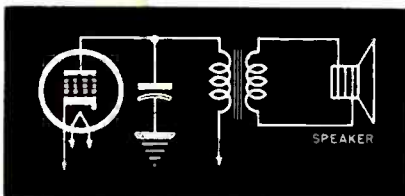

**How Many Slices in a Loaf of Bread?**

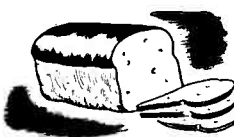

It's unimportant unless there aren't enough to go around. When the loaf isn't large enough to feed everyone who asks for a slice, the problem becomes involved. The size of each slice takes on significance.

We, at Stancor, are confronted with a parallel situation. A day never passes that we don't risk offending valued customers by keeping the slices as thin as feasible . . . that everyone may have his fair share.

We know how you feel about this. You need transformers, desperately perhaps, and it's been a long time since Stancor has been able to supply all you want. We're certain, however, that you would not condone a sacrifice of quality for quantity. In a sense, then, you dictate Stancor policy.

Because of our insistence on high standards of quality, production and delivery have never stayed apace with Stancor sales. Today there is a greater gap than ever. We feel you understand the reasons for this, since our current problems are also yours.

Soon, we hope to be able to meet your constantly increasing demands. Meanwhile, there can be no change in the Stancor policy of quality. We know you wouldn't want it any other way.

*Jerome J. Kahn*  
PRESIDENT

**STANDARD TRANSFORMER CORPORATION**  
1500 NORTH HALSTED STREET • CHICAGO 22, ILLINOIS

**Order from LAKE!**  
You'll Make No Mistake!

**RADIO**  
Cabinets, Parts and Equipment



**Now Available**  
Postwar  
2-Post  
Record  
Changer

With luxurious brown leatherette portable case, 15" L x 15" W x 10" D. Latest electronic developments make

this modern record-changer the finest on the market today! List price \$49.95. Dealer's net ..... **\$29.97**

**DE LUXE RECORD-CHANGER and AMPLIFIER CASE**

De luxe changer case with ample room for amplifier. Overall dimensions: 20" long x 16" wide x 10" high. Sturdily built of 3/4" plywood, de luxe brass hardware throughout. Inside dimensions: 15 1/2" long x 14 3/4" wide x 9 1/2" high. Net..... **\$12.95**

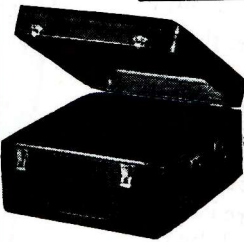

**DeLuxe PHONO CABINET**

Covered in luxurious, genuine brown leatherette, has de-luxe brass hardware throughout, made completely of plywood with plastic handle, has padded top and bottom. Motor board 14" x 14 1/2". Overall dimensions 16" long by 15" wide by 8" high. Your special net price..... **\$8.95**

Portable Phono graph Case in brown leatherette covering. Inside dimensions 17 1/2" long, 13" wide, 7 1/2" high. Has blank motor board and opening for speaker. As illustrated at left, specially priced at



**\$7.95**

Also blank table cabinets of walnut veneer in the following sizes, with speaker opening on left front side:

(Note: \*7 has center speaker grill.)

#1	8 1/2"	L	x	5 1/2"	H	x	4"	D	\$1.95
#2	10 1/4"	L	x	6 1/2"	H	x	5"	D	\$2.75
#3	12 1/4"	L	x	7 1/2"	H	x	6 1/4"	D	\$3.25
#7*	18 1/4"	L	x	7"	H	x	5 1/2"	D	\$2.50

\*Speaker Opening in center of front side.



All types of radio cabinets, equipment and parts are available at Lake's lower prices. A large stock is listed in our catalog.  
**SERVICEMEN!**  
Join our customer list today  
Order Our New Catalog Today!  
Get on our mailing list!  
Dept. D

**Lake Radio Sales Co.**  
615 W. Randolph Street  
Chicago 6, Ill.

(Continued from page 31)

method. After readings are taken, the connections should be reversed and the process repeated. Alternating-current electrolytic capacitors do not require a d-c leakage test. The electrolytic capacitor may develop high leakage as a result of continued operation, especially at high temperatures. Chemical decomposition of the element may take place. This may cause the capacitor to become defective because of high leakage current, a condition that may cause a change of circuit voltages due to the increased current through the various resistors.

After adequate aging time on the analyzer the leakage current should be less than the values shown in table 2. Some discretion should be observed when replacing a high-leakage electrolytic capacitor, as the effect on circuit operation must be considered. If the capacitor is operating at a voltage far below its rating, an allowance should be made for this factor, as compared with a unit operating at full voltage. Leaky capacitors in low-resistance circuits do not affect the operation of receivers as much as when working in the higher-resistance circuits. Where a capacitor has been in continuous service for a long time, it is expected that the leakage current should be quite low. High leakage indicates chemical decomposition or a defect in the preliminary stages. Therefore it is safe to replace the capacitor to be assured that the receiver will remain in operation. The chemical decomposition may also result in the internal connecting leads of the electrolytic capacitor to become open circuited. A further trouble is that high leakage current may develop between elements of a multi-tapped capacitor. It is not infrequent that high leakage conditions lead to the capacitor becoming short circuited.

Other types of defects likely to develop in an electrolytic capacitor are low capacity and high power factor. Exceptionally high capacity in this type of unit is not unusual, generally causing improved performance of the receiver. Low capacity and high-power factor on the other hand reduces the effectiveness of the bypass and filtering action and are frequently cause for replacement of electrolytic capacitors.

Intermittently open or short-circuited capacitors are somewhat difficult to detect. This is equally true of such conditions in other components, and for circuit connections as well. The bridge measurement is an effective means of identifying intermittent operation capacitors. When the bridge

**"TAB"**  
THAT'S A BUY

Spaghetti assmt 10 lengths 3' each size..... \$ .50  
DAVEN Attuator 50000 Ohm 2db 60 steps..... 7.95  
TUNGOSOL miniature 3A4 G1 (\$1.55) Two for 1.10  
F.M. Television Rotatable UHF coupler..... 3.95  
DAVEN switch 13 circuits 25 amp. cts. 2 for... .98  
Socket octal amphenol S8T-HF ins 25 for..... 1.48  
Resistors 100 ass't 1/2 & 1 W BT 50 to 2 meg... 2.50  
AC Voltmtr WSTGHSE 150V60cy 2 1/2" B'..... 2.95  
Heineman circuit bkr. S.P. 2 or 5 or 20 amp. ea. .97  
G.E. Switchette CR1070C103F3 Five for..... 1.90  
Micro Switch 10A 125V SPDT Pin type 2 for 1.00  
Relay Sens. Sigma 5AH 200-3.5 ma. SPDT... 2.25  
Relay Sens. W.E. 3500-SPDT 5A contacts... .97  
Relay 105 Ward L. 115V60CY. SPDT 20A cts. 1.90

**SPECIAL "TAB" KITS**

Consisting of 200 resistors 1/2 & 1W assmt 5 to 2 megohms—Ten dual 40mfd150WV tubular 25—15mfd35WV & 100-5mfd 35WV..... 6.95  
Electrolytics. TEN Dual .05mfd300WV, TEN triple .05mfd300WV. All oil condensers. Value \$49. all for \$9.95 guaranteed.  
Oscilloscope Conversion Kit BC 412 contains all parts for sweep circuits and changes including diagrams..... \$15.75  
Additional engraved dialplates..... 3.75  
Complete Kit all parts and dialplates..... 18.50

CONDENSER tub.dial 40MFD 150WV 30 for. **\$7.95**  
CONDENSER WE new uprt.mtg. 500MFD-60WV .95  
CONDENSER WE oil 16MFD-400V Two for.. 2.35  
SOCKET Amphenol safety UX 77A-4TN 10 for 3.00  
SOCKET DiHeptal C'Ray & mtg.ring HF ins. 1.15  
CRYSTAL diode IN21 & holder Two sets ea. for 1.25  
RCA 6AC7-1852 new gv't. insp. (LP\$1.75) .65  
CATHODE Ray Tube new gv't. insp. 3BP1.... 6.95  
CATHODE Ray Tube new 5AP1, BPI, BP4... 9.95  
RADIO NOISE FILTER Mallory NFI Two for WE 115V60Cpri. 650VCT300ma: 5V3A: 6V5A. **3.95**  
RES'R prec. WE 1%accy 1000-5000-10000 ohm @ .25  
30,000 ohm @ .35: 200,000 @ .35: 500,000 @ .65  
Precision SPRAGUE megomak gv't.insp. 10 meg. 2.50  
CRYSTAL mtd alrfract 1000KC std. \$2 @ accy. 7.20

\$1 Min. orders F.O.B. N.Y.C. Add Postage all orders and 25% deposit. Whitehall 3-3557. Send for catalog 300. Don't wait, rush orders as quantities are limited.

**"TAB", Dept. S-6**  
**Six Church Street, New York 6, N. Y.**

circuit is in complete balance, slight jarring or movement of the capacitor will generally cause the shadow angle of the eye to be erratic. The angle may vary only a few degrees or may close entirely. With an intermittent-operation capacitor the power factor setting may have to be adjusted to obtain the bridge balance or in some cases the capacity knob will balance as open or short, depending upon the type of intermittent defect. A great deal of patience is required to locate all intermittent faults.

Capacitors to be tested by the capacitor bridge or capacitor analyzer do not have to be removed from a receiver. It is only necessary to disconnect one lead of the capacitor from a circuit, preferably the high-potential lead. Before making connections between the instrument and the capacitor, it is advisable to disconnect the receiver from the power line, antenna and ground, to obtain maximum accuracy of measurements, as well as to eliminate the possibility of damage to the equipment or shock to the operator.

After a defective capacitor has been identified, it is essential that the replacement be of satisfactory quality. If the new unit has borderline characteristics because of extended storage,

the receiver may not give top performance or may become inoperative at an early date. All replacement capacitors should be measured for electrical properties before being used.

### SER-CUITS

(Continued from page 27)

are: 50 mfd, 1,000 ohms, 30 mfd, 500 ohms and 0.1 mfd. The power-tube plate is supplied after the surge resistor, and power-tube screen, after the 1,000-ohm section. Balance of the receiver receives its supply from the entire filter. This circuit attenuates the ripple to such an extent that less than 10 millivolts of hum are observable across the output transformer secondary.

#### Ultradyne L-46

A 5-tube (lock-in type tubes) and rectifier, Ultradyne L-46 (Regal Electronics), is shown in Fig. 6. In the power supply and avc filtering system de-coupling is used. A 35Y4 rectifier feeds the power plate (35A5) directly from 50 mfd. The 14B6 first a-f has a separate filter of 100,000 ohms and 0.1 mfd; the first i-f, another filter of 500 ohms and .05 mfd; and the 14Q7 converter another 500 ohms and .05 mfd. The avc bus has a 1-megohm resistor and .05-mfd capacitor to isolate all three tubes supplied. The bias resistors for the i-f stages are of 1,000- and 300-ohm values. The second i-f resistance coupling stage uses a 10,000-ohm plate load, 500 mmfd and 1/2-meg-ohm grid leak.

#### Globe Electronics 6-U

Another 5-tube and rectifier model with lock-in tubes, Globe Electronics 6U, is shown in Fig. 7.

A 14A7 r-f stage is followed by an untuned 14Q7 converter, conventional 14A7 i-f, 14B6 detector-audio and 35A5 beam output.

#### TWO-WAY POLICE UNIT



Two-way radiotelephone-equipped police car using recently developed Kellogg coiled kord. (Courtesy Galvin Manufacturing)

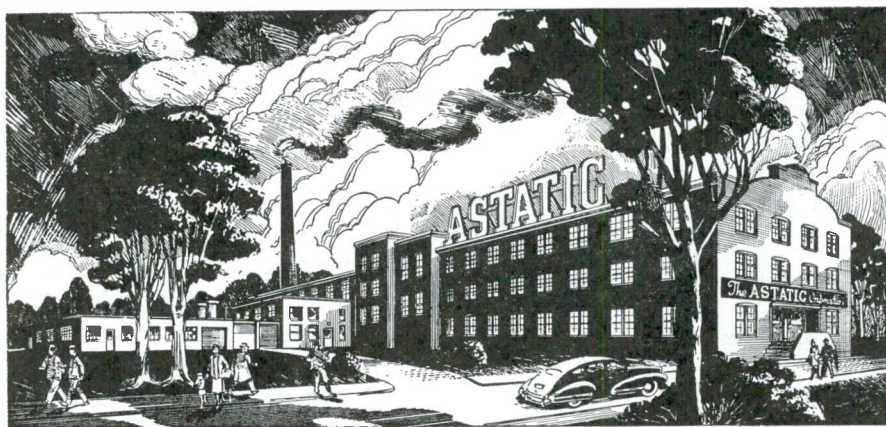

## Largest Producers of

# CRYSTAL CARTRIDGES FOR PHONOGRAPH PICKUPS

THAT The Astatic Corporation is the world's largest producer of Crystal Phonograph Pickup Cartridges is, in itself, actual testimony of their outstanding service and high operating efficiency. That they are preferred and used by a majority of the leading manufacturers of electrical phonographs and automatic record changers, is convincing evidence of their expert engineering and construction. Astatic Crystal Cartridges are manufactured to meet today's exacting standards of performance and are individually tested and approved for output voltage and frequency response before being released for shipment. Astatic Cartridges are extensively used in an ever-growing field of new product applications, as well as for replacement purposes or the improvement of existing equipment.

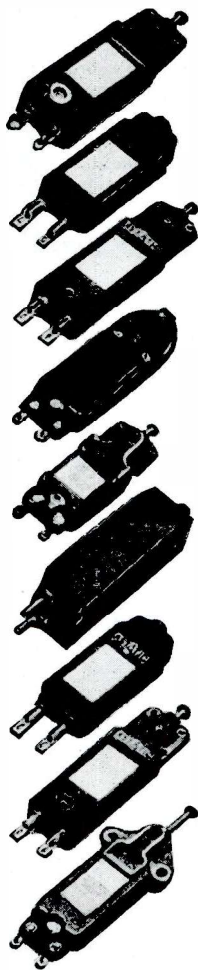

Astatic Crystal Devices  
manufactured under Brush  
Development Co. patents

THE  
**Astatic**  
CORPORATION  
CONNEAUT, OHIO

IN CANADA CANADIAN ASTATIC LTD. TORONTO, ONTARIO

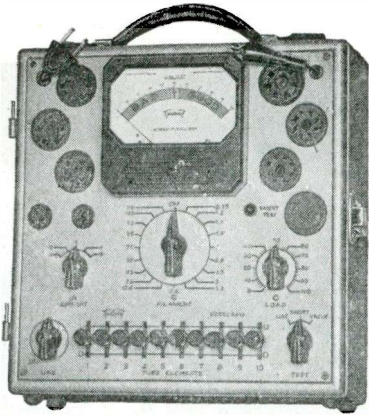

## Model 2413

is another member of  
the **NEW TRIPLETT**  
Square Line

# Triplet

ELECTRICAL INSTRUMENT CO. BLUFFTON, OHIO

## The New Speed-Chek Tube Tester

MORE FLEXIBLE • FAR FASTER  
MORE ACCURATE

Three-position lever switching makes this sensational new model one of the most flexible and speediest of all tube testers. Its multi-purpose test circuit provides for standardized VALUE test; SHORT AND OPEN element test and TRANSCONDUCTANCE comparison test. Large 4" square RED-DOT life-time guaranteed meter.

Fast simple operation gives control of each tube element.

New SQUARE LINE series metal case 10" x 10" x 5½", striking two-tone hammered baked-on enamel finish. Detachable cover. Tube chart 8" x 9". Simple settings marked in large type.

### Additional Features

- Authoritative tests for tube value; shorts, open elements, and transconductance (mutual conductance) comparison for matching tubes.
- Flexible lever-switching gives individual control for each tube element; provides for roaming elements, dual cathode structures, multi-purpose tubes, etc.
- Line voltage adjustment control.
- Filament Voltages, 0.75 to 110 volts, through 19 steps.
- Sockets: One only each kind required socket plus one spare.
- Distinctive appearance makes impressive counter tester.

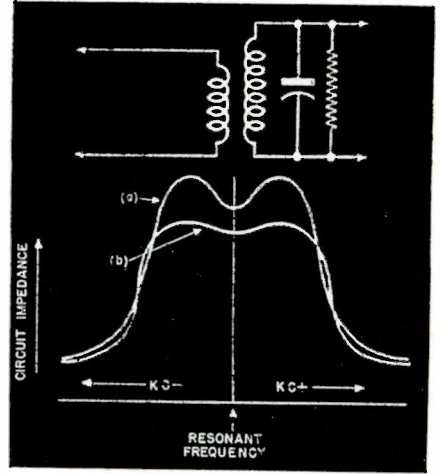

Fig. 4. Overcoupled r-f stage for broadened response, provides a curve as shown in this plot.

achieve a broad frequency response at a sacrifice in stage gain.

Another method for broadening the response of an r-f stage is by overcoupling. This results in the curves shown in Fig. 4, where the degree of over-coupling determines the dip in the center of the response curve. By combining the resistor method and the overcoupling method, a still broader frequency response may be obtained.

Wide-band r-f transformers have very slight gain. To achieve some stage gain, tubes with high amplification factors must be used. Special television amplifier tubes have been designed to accomplish this. Tubes such as the 1852 and 1853 have very high amplification factors. Thus, a portion of the gain lost in the r-f transformer may be realized in the tube.

### Typical R-F Mixer Stage

A typical television receiver r-f mixer stage is shown in Fig. 5; DuMont 180. The 1852 is used here as a mixer stage, with the antenna feeding directly into it, very much as is done in midget broadcast receivers. A 5000-ohm resistor has been placed across the tuned secondary of the antenna transformer to broaden the fre-

## TELEVISION

(Continued from page 18)

circuit, the total reactance would be a function of the two reactances in parallel. The maximum reactance of the circuit would then be limited by the value of resistance used. This, then, would tend to flatten the curve of Fig. 2a, and approach that of Fig. 3, depending on the value of resistance used.

However, since the reactance ratio has been reduced, the voltage gain of the circuit would be materially reduced. Therefore, this method would

### AT THE REPS' ANNUAL NEW YORK DINNER

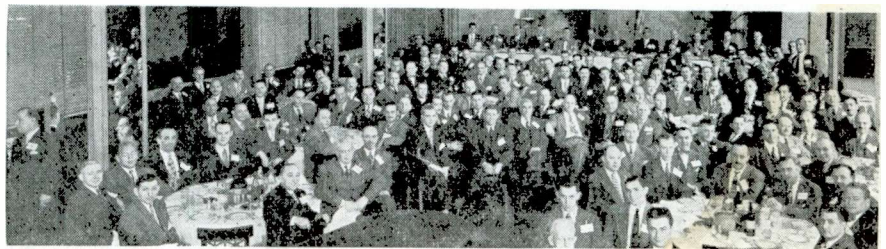

Forty members and two hundred guests attended the annual dinner of the New York chapter of The Representatives at the Hotel New Yorker, recently. Manufacturing groups represented included General Electric, Emerson, Teletone, BCA and others from New York City. In photo above, on the dais: Leo Freed, president of The Reps; Sam Egert, vice president; William Gold, secretary-treasurer; and the past presidents of the chapter.

TWO COMPLETE LINES  
of Newcomb Quality  
AMPLIFIERS

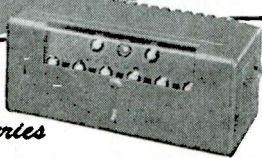

### Deluxe K Series

Newcomb now offers the first truly "post-war" amplifiers, of a quality heretofore not available to the public address field. Designed to fill a growing demand for the finest possible amplification equipment, their flawless operation signals an outstanding achievement of modern electronic research.

"Not Merely as Good as the Others  
... But Better than All Others."



Write  
for  
Information

### Standard H Series

THE SOUND OF QUALITY  
**Newcomb**  
AUDIO PRODUCTS CO.  
MANUFACTURERS  
DEPT. E. 2815 S. HILL STREET  
LOS ANGELES 7, CALIFORNIA

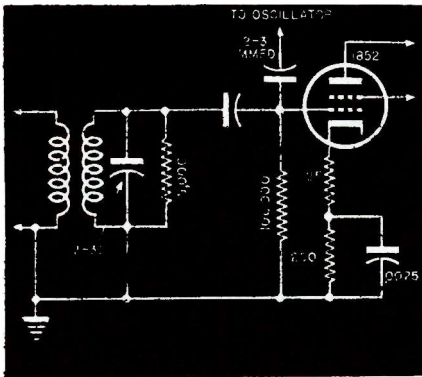
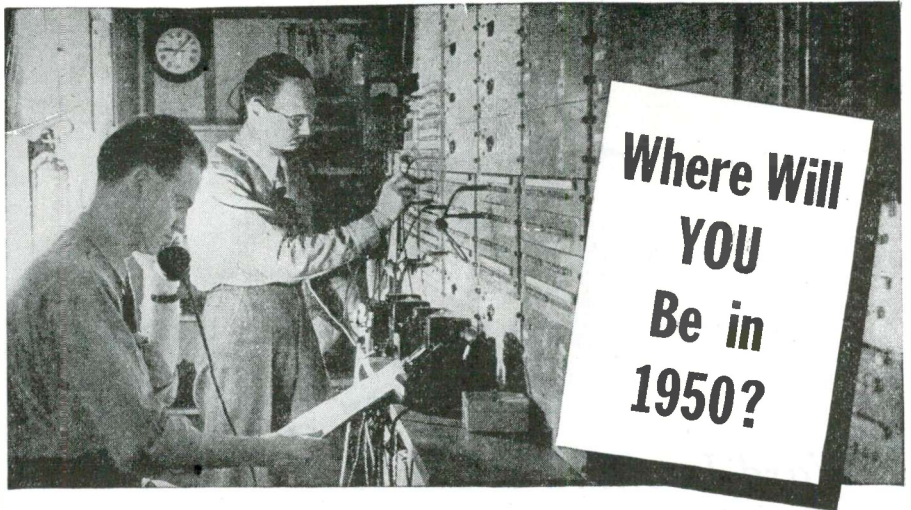

Fig. 5. A typical r-f television receiver mixer stage (DuMont 180).

quency response. Since the input capacitance of the tube represents an appreciable portion of the tuning capacitance across the antenna transformer, any variations in this capacitance, may cause a sufficient variation in the resonant frequency to seriously detune the stage. Tube input capacitance is a function of the electron stream, and since the electron stream will vary with the amplitude of the received signal, variations in received signal will cause the resonant frequency of the r-f transformer to vary. It has been found that a small amount of negative feedback, such as that practiced in audio amplifiers, will reduce this input capacitance variation to a minimum. In the mixer circuit shown it will be noted that a 25-ohm resistor in the cathode circuit is unbypassed. This small amount of feedback is all that is necessary to prevent frequency variation.

Since the frequencies involved are in the v-h-f band, component size and value will be found to be much smaller than in conventional receivers. Tuning capacitances are on the order of 3 to 30 mmfd. The stray capacitances involved in the wiring therefore assume a greater importance.

The gain of an r-f stage, as shown in Fig. 5, is approximately 1.5:2 for the transformer, and 2:4 for the converter tube. Here again, since the gain will be a function of the bandwidth acceptance of the circuit, one point should be noted. We have stated that a broad signal is used in the amplifier and it is necessary to amplify such a broad signal uniformly. These characteristics are essential because the sharpness of the received image is a function of the received signal. Receivers using small diameter c-r tubes do not require as sharp an image as a larger tube. Therefore, for receivers using small c-r tubes, the selectivity of the circuits will be found to be sharper, approaching band-acceptance widths of 5 and 4 mc.



## ENJOY SECURITY AND GOOD PAY! PREPARE NOW WITH CREI TECHNICAL HOME STUDY TRAINING STEP AHEAD OF COMPETITION INTO A GOOD RADIO JOB!—CREI Offers You a Proved Program of Self-Improvement to Keep Pace with Modern U. H. F. Advancements and Get That Radio Engineering Job You Want

Yes, there are GOOD JOBS . . . for GOOD men! The easy jobs are gone and once again knowledge and ability are the requirements to HOLD good jobs—to SECURE better ones. Employers once again can afford to be "choosey" . . . to select the best man for the best job. In the face of this showdown situation—where do YOU stand?

CREI home study training in Practical Radio-Electronics Engineering can equip you to meet the requirements to hold your job—or advance to a better one. CREI graduates are recognized throughout the Radio-Electronics industry. Your CREI diploma is the best recommendation for a better job. By adding CREI training to your present radio experience you can safeguard your future and keep pace with such new developments as U. H. F. Circuits, Cavity Resonators, Pulse Generators, Wave Guides, Klystrons, Magnetrons and other tubes. Are you equipped to handle them? CREI is equipped to help you, by providing the know-how and ability that is required.

In our proved method of instruction, you learn not only how but why! Easy-to-read-and-understand lessons are provided well in advance, and each student has the benefit of individual guidance and supervision from a trained instructor. This is the basis of the CREI method of training which many thousand professional radiomen have completed during the past 19 years. CREI courses were used during the war to train thousands of Army and Navy radio technicians for the U. S. Signal Corps, U. S. Navy and U. S. Coast Guard.

It's up to you now to decide your course. What you do today will be the answer to where you will be in 1950 and the years after. It costs you nothing to read the interesting facts . . . to learn how CREI can help you enjoy the security you want . . . the better-paying job that can be yours. Write for particulars now! (CREI training for Veterans is approved under the "G.I." Bill.)

## CAPITOL RADIO ENGINEERING INSTITUTE

E. H. RIETZKE, President

Dept. S-5, 16th and Park Road, N. W., Washington 10, D. C.

New York (7): 170 Broadway  
San Diego (1): 316 C Street

Branch Offices:

Chicago (2): 30 N. LaSalle Street  
San Francisco (2): 760 Market Street

Member: NATIONAL HOME STUDY COUNCIL • NATIONAL COUNCIL OF TECHNICAL SCHOOLS

JUST OFF THE PRESS!



WRITE FOR FREE 36-PAGE BOOKLET

"Your Opportunity in the New World of Electronics"

Tells how CREI Courses can be adapted to your particular needs.

If you have had professional or amateur radio experience and want to make more money, let us prove to you we have something you need to qualify for a better radio job. To help us intelligently answer your inquiry—

PLEASE STATE BRIEFLY YOUR BACKGROUND OF EXPERIENCE, EDUCATION AND PRESENT POSITION.

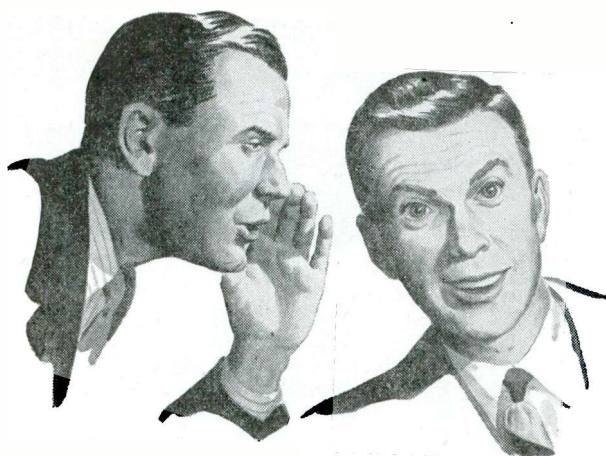

## "Ward Leonard's Got 'em"

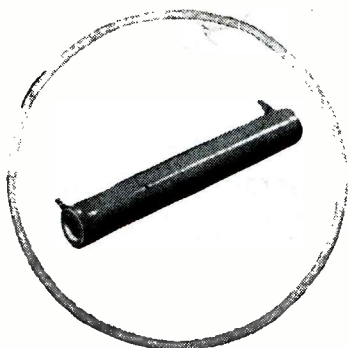

This is important news to the Service Man. He knows that when he uses Ward Leonard Resistors he doesn't have to use up job profits—making good for resistor failures. Ward Leonard is shipping from stock without delay so your jobber can supply you with the Resistors you require.

Send for Resistor Bulletin D-2

# WARD LEONARD

RESISTORS • RELAYS • RHEOSTATS

Electric Control Devices Since 1892

## WARD LEONARD ELECTRIC COMPANY

Radio and Electronic Distributor Division

53E West Jackson Blvd., Chicago, Ill.



## OLD TIMER'S

## CORNER

by **SERVICER**

THE PHONE JANGLED nervously at my elbow. I put down the soldering iron with which I was lighting my cigaret and reached for it.

"This is Cal," came over the wire, "want to help me with a job this evening?"

"Depends on what it is," I answered. "If it's to swell that already big repair business of yours, Cal, you can include me out," I concluded.

"Now don't get angry because I have a bigger business than yours," Cal said. "It's just that I have been at it a great deal longer, and I see the opportunities better than you do, even if you are a real old timer!"

"Well," I grunted, "spill it!"

"Suppose you get here at about 5:30 this evening and I'll tell you all about it," Cal said.

I knew that Cal was one of the brightest stars in the radio repair firmament. Furthermore, he did not get that way just by sheer luck. He had his share of hard times and hard knocks just like the rest of us. But among the old timers in the town, Cal rated at the top of the heap. Specially when it came to figuring out how to make an extra dollar here and there, which by the end of the year added up to sizeable profits.

So it was with real curiosity that I hied myself to his shop that evening to hear the latest in "How to make an extra dollar from the Service Shop business."

I found Cal busy in the back of the store loading his truck with a heavy recorder and associated amplifying equipment. When he saw me, he motioned me to assist him. Each piece had to be covered with a section of the long canvas wadding he had provided, and it seemed that he had a definite order of placement where each article was to go. This, he explained later, was so that it would be unloaded in correct order not to make any unnecessary muss at the location of use.

"What's this all about, Cal?" I asked.

"Well, as you know, the radio set situation has not yet come up to the expectations foretold for it by the solons of the radio industry. It seems that we are still waiting for that fateful day when we shall have many sets for sale. The repair business you know all about. We get the most in this burg. In fact we cannot take on any more for the next month or so, we're that jammed up. And I was not in the mood to sell trinkets to swell the exchequer. So I finally hit upon the idea of these recordings.

"Almost every household has some person in it who makes a speech, does a turn at amateur theatrics, has a guest at the home or has some special occasion that they want to get recorded for a later

## G-E TUBE CHECKER

Quick, easy, accurate tube checking which saves you time and trouble and keeps your customers happy—that's the job the TC-3P is built to do. Line Voltage and tube quality, or shorts, may all be checked on one selector switch. Individually operated switches permit placing the proper voltage on the proper pin of the tube. The G-E Tube Checker is available in either the Portable (TC-3P) or Counter Model (TC-3). Write: Specialty Division, Electronics Department, General Electric Company, Syracuse, New York.

## GENERAL ELECTRIC

177-D1

Electronic Measuring Instruments

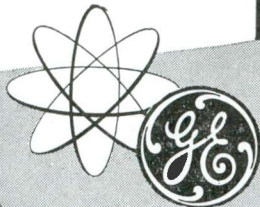
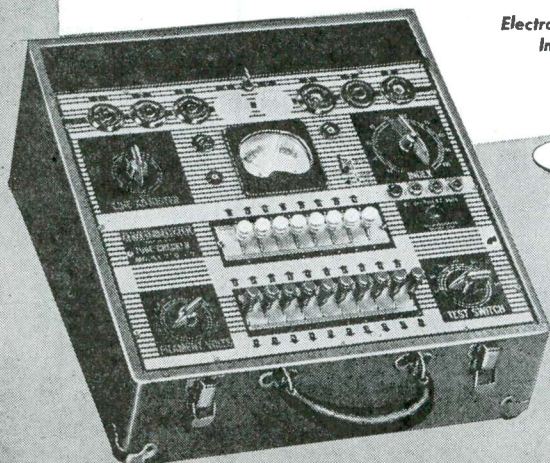

# TC-3P

date. Only they don't know it. You have to sell them.

"Last week, one of my customers told me that there was going to be a celebration at her home. Her mother and father were going to hold their 50th wedding anniversary dinner there. All the children and the grandchildren were going to attend. You may well imagine that I did not have a hard time in selling her the idea of letting us make a recording of a part of the proceedings. I had the mother and father talk and then each one of the children and grandchildren. Even recorded the voice—if you can call it that—of a single great-grandchild that turned up.

"So that they can play the record back on the average home phonograph, I make the recordings on 12-inch discs at 78 rpm. Then I tell them that the recordings are delicate and that they should not be played back too often as they will wear out. I furnish a cactus needle—and often a needle cutter—for this. The whole evening grossed me about \$50. Out of that I had to pay for the discs and only my time. That's not bad, now is it?

"The day before yesterday, one of the youngsters in the town had a birthday party and I recorded it. It will make interesting listening say, twenty years from now. I got \$10 for that one record made in the home.

"Quite a few doctors have hired me to make recordings of talks they plan to give before the county medical society. They want to hear how it sounds. I know that I made at least six for one doctor. He would listen and then correct his words to be more forceful or to diminish the emphasis in spots. Because he came here to make the recordings at night, I only charged him \$5 for each record.

"Miss Tee, the voice teacher, has contracted with me to make recordings of every one of her students. She teaches voice, you know. She makes a recording of the pupil when he or she starts with her, and when they finish the course. The improvement is so obvious that for the most part the students let their friends listen to both records and that brings a lot of new pupils to Miss Tee. I make those recordings at her studio and charge her \$7.50 for each one.

"Quite a number of the younger set have come in here to 'write' a record to their sweethearts abroad. Since I am somewhat of a softie, I do that cheap. Especially when it only involves a tiny recording disc. Charge is \$1.00.

"Take a look at this schedule. It shows that I have about 15 recordings to make the next seven days. I started with one recorder. Made it myself from odds and ends around the shop, plus a fine cutting head and mechanism I had put away for just such a time as this. Well I booked that machine so solid, that in order to take on more business I had to get another. That one I bought from a radio ham who wanted to use the money to buy some new gear. Then I booked that one up solid, letting my partner Bill run it. Now we have so much business that I have just gotten my hands on this new machine. Only I have nobody to run it for tonight. So I thought of you. I know you have the experience, and that you can do a swell job. Want it?"

"Sure," I said. "But only just this time. I am going to look into this thing myself and do some of it too."

"There's room enough for both of us,"

(Continued on page 38)

... don't change  
the cartridge  
... change the arm  
to *Glider*

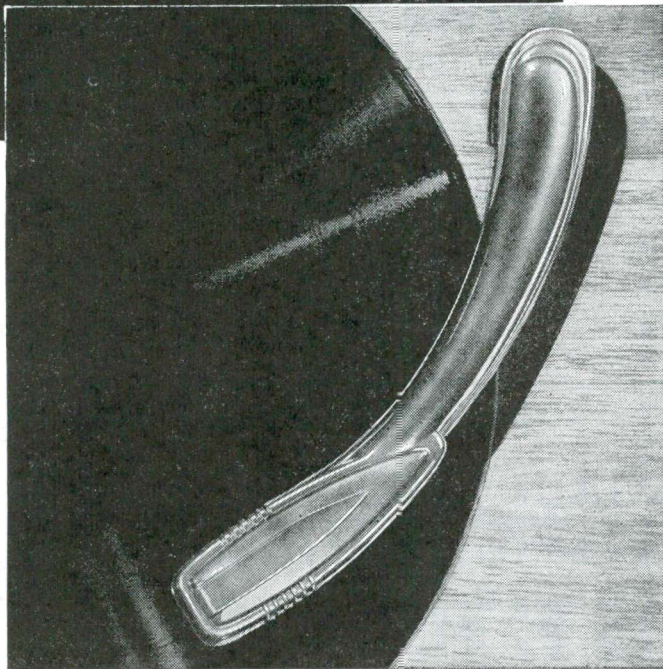

Please your customers, completely, by bringing their phonographs up-to-date . . . not by just changing the cartridge . . . but by replacing the complete arm. "Glider," the standard arm for many leading set manufacturers, is now available to the servicemen. The "Glider" has nearly two volts output—consists of the new Shure Lever-Type Cartridge and aluminum tone arm, with needle force of only 1½ ounces—reduces record wear, improves tone quality, reduces surface noise. Easy to install and a profitable bit of business for you. Model 93A . . . \$6.10 List (needle not included). Available at all Shure Distributors.

Patented by Shure Brothers and licensed under the Patents of the Brush Development Company

# SHURE BROTHERS

Designers and Manufacturers of Microphones and Acoustic Devices

225 West Huron Street, Chicago 10, Illinois  
Cable address: SHUREMICRO



# 18 YEARS IN RADIO

Get This *New* Catalog  
By This *Old* Firm

Latest developments in radio and electronic parts and devices, newest ham gear, gadgets to delight the heart of the experimenter, bargains in war surplus supplies.



- Buy from B-A
- Save Time
- Save Money
- Get the Newest
- Deal with This Old House



## MAIL COUPON TODAY

Don't delay, get your copy of this book.

BURSTEIN-APPLEBEE CO.,  
1012 McGee, Kansas City 6, Mo.



Send me **FREE** new catalog, **service**

I AM \_\_\_\_\_  
STATE CONNECTION IN INDUSTRY \_\_\_\_\_  
NAME \_\_\_\_\_  
ADDRESS \_\_\_\_\_  
TOWN \_\_\_\_\_ STATE \_\_\_\_\_

## ATTENUATORS

(Continued from page 17)

of  $R_n$  in each series element are one-half of the  $T$ -pad values. Therefore, one half the voltage develops across each element. Thus

$$P = \frac{1}{2^2} = \frac{1}{4} = \text{the power.}$$

Using the  $H$  construction, lower wattage resistors in the series elements may be employed. The same principle is applied with respect to the  $R_n$  values.

The use of the  $T$  pads for attenuation of signal powers and control is shown in Fig. 8. Suppose speaker  $S_1$  was to receive 10 db more power than  $S_2$ , but the power input to  $S_1$  was to be cut 3 db for some reason. Then, the loss of  $T_1$  must be 3 db, while the loss of  $T_2$  must be 10 + 3 or 13 db, to make the level of  $S_2$  10 db below  $S_1$ . As the pads are designed to work between equal impedances, if each speaker is equipped with a 500-ohm line matching transformer and the output impedances of the pads looking into the line are 500 ohms each, the amplifier output,  $Z$ , must be 500/2 or 250 ohms to get a match, since the pad output impedances of 500 ohms each are in parallel.

## OLD TIMER'S CORNER

(Continued from page 37)

Cal rejoined with a chuckle. "But there is one thing that might stop you."

"What are you grinning at?" I asked tersely.

"Where—oh where are you going to get the equipment, son?" Cal whispered.

He had me there for a moment. However I recalled that I had some odds and ends around too, that could be whipped up into a amplifier and recorder.

And now I'm in the business too, waiting to buy a commercial unit or two, as soon as they're ready. For now I have also more business than I can handle.

## PERSONAL PLANE RADIOS

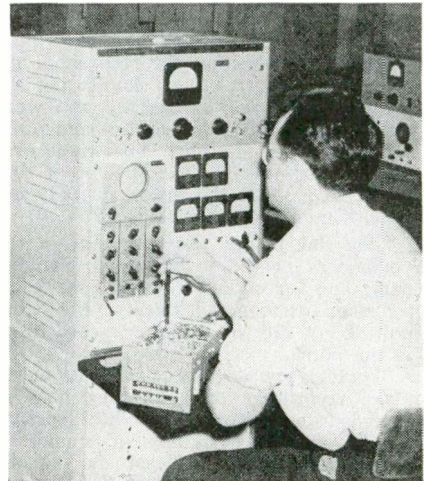

Twelve-pound two-way 3-control personal plane radiotelephone developed by GE, on a test bench. Operates from a fixed wire antenna.

# AGAIN AVAILABLE!

RADIO · TELEVISION · ELECTRONIC

# SERVICE

## GROUP SUBSCRIPTION PLAN

12 ISSUES ONLY \$1

Saves Fifty Per Cent of the Subscription Price if Four or More Orders, Including Your Own, Are Properly Entered on This Form

Name .....  
Address .....  
City-State .....  
Occupation .....  
Title (Service Mgr., etc.) .....  
Employed by .....  
State whether Employer is a Service Organization, Dealer, Jobber or Manufacturer .....

Name .....  
Address .....  
City-State .....  
Occupation .....  
Title (Service Mgr., etc.) .....  
Employed by .....  
State whether Employer is a Service Organization, Dealer, Jobber or Manufacturer .....

Name .....  
Address .....  
City-State .....  
Occupation .....  
Title (Service Mgr., etc.) .....  
Employed by .....  
State whether Employer is a Service Organization, Dealer, Jobber or Manufacturer .....

Name .....  
Address .....  
City-State .....  
Occupation .....  
Title (Service Mgr., etc.) .....  
Employed by .....  
State whether Employer is a Service Organization, Dealer, Jobber or Manufacturer .....

Please enter annual subscriptions (12 issues) for each of the above for which payment is enclosed at the rate of \$1.00 each. (This rate applies only on 4 or more subscriptions when occupations are given.)

**SERVICE, 52 Vanderbilt Ave., New York 17, N. Y.**



*Greater Accuracy Than Ever!*

**RCP ULTRA-SENSITIVE  
MULTITESTER MODEL 488A**

Electronic equipment under test can't lie to this extremely accurate RCP multitester. It's precision-made in every detail to give the utmost in testing performance. Thousands of these and other RCP instruments used by the Signal Corps, your assurance of dependability.

**COMPARE THESE FEATURES!**

- \*Dual D.C. sensitivity of 20,000 and 1,000 ohms per volt. A.C. sensitivity of 1,000 ohms per volt.
- \*Wide-scale 4 1/2" meter with movement of 50 microamperes.
- \*Readings as low as 1 microampere.
- \*All multipliers matched and 1% accurate.
- \*Center of ohmmeter scale 37 ohms with readings as low as 0.25 ohms.
- \*Batteries readily accessible, no soldered terminal connection.
- \*Overall accuracy 3% on D.C. and 5% on A.C. voltages and currents.
- \*High voltage test leads.
- \*Quick change plug-in type copper oxide rectifier, no soldering required.

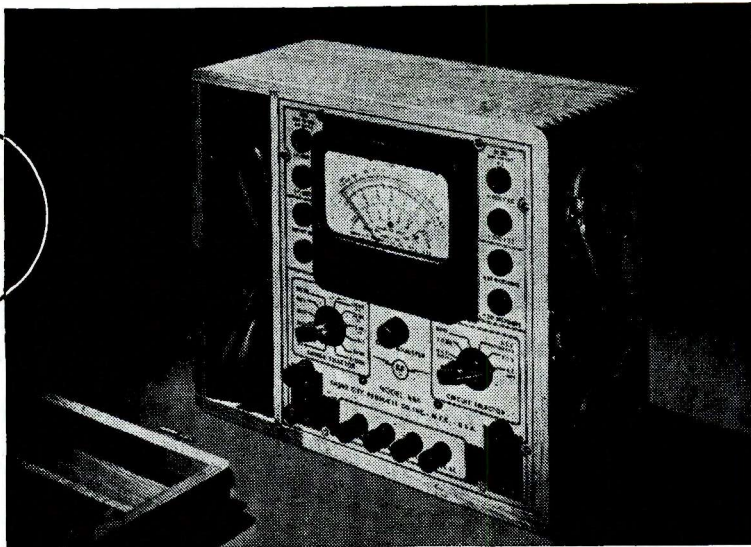

**RANGES:**

- D.C. Voltmeter: 0-3-12-60-300-600-1,200-6,000 volts.
- A.C. Voltmeter: 0-3-12-60-300-600-1,200-6,000 volts.
- Output Voltmeter: 0-3-12-60-300-600-1,200-6,000 volts.
- D.C. Microammeter: 0-60-30 microamperes.
- D.C. Milliammeter: 0-3-20-120-600 milliamperes.
- D.C. Ammeter: 0-12 amperes.
- A.C. Ammeter: 0-3-6-12 amperes.
- Ohmmeter: 0-3,000-300,000-30,000,000 ohms

Model 488A is supplied ready to operate, complete with self-contained battery, test probes and convenient carrying case with removable cover. Dimensions: 13 x 12 1/2 x 5 1/2.



**Tops in Popularity:**

Servicemen mail our warranty cards by the thousands. Comments like "swell performer," "best value for my money," give evidence why RCP is the choice of radio men everywhere. Write for complete catalog.

**RADIO CITY PRODUCTS COMPANY, INC.**

127 WEST 26 STREET



NEW YORK 1, N. Y.

**CHERTOK NAMED SOLAR  
AD MANAGER**

Sidney L. Chertok, has been appointed advertising manager of the Solar Manufacturing Corporation. Mr. Chertok, who has been manager of Solar's technical service bureau, will also act as advertising manager of the Solar Capacitor Sales Corporation. He succeeds S. A. Wolin, resigned.



\* \* \*

**BEN WAXLER NOW CHIEF ENGINEER  
OF GLOBE ELECTRONICS**

Ben Waxler, formerly chief radio engineer of David Bogen Company and Regal Electronics Corporation, has been appointed chief radio engineer of Globe Electronics Corporation, N. Y., N. Y.

\* \* \*

**HOWARD SAMS  
RADIO ENCYCLOPEDIA SERVICE**

A radio encyclopedia service, to be issued periodically in the form of "PhotoFact" folders, each folder containing schematics, identified lists of parts and suitable replacements plus detailed engineering data and voltage-resistance analysis, has been announced by Howard W. Sams & Co., Inc., 2924 E. Washington



St., Indianapolis, Ind. The folders will vary in size from 4 to 12 pages.

The folders will be distributed in folios of 30 to 50 at frequent intervals and as rapidly as new receivers are placed on the market. The complete service folder on a new receiver will be delivered to subscribers within 90 days after the set goes on sale.

According to Mr. Sams, a sample of every new receiver, immediately after it goes into production, will be analyzed, components will be checked and listed, and resistances and voltages will be recorded.

PhotoFact folders will cover all receivers placed on the market after January 1, 1946.

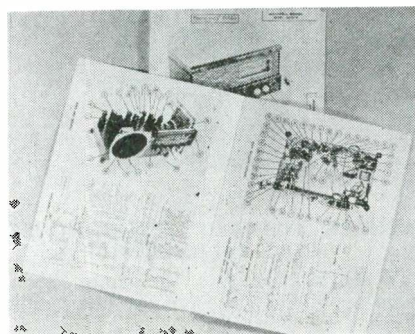

Each folder will contain photographs of the chassis taken from various angles.

Subscribers to the service will hold membership in the Howard W. Sams Institute, which will be headed by servicing specialists. This board will help members to solve their problems in connection with servicing, parts selection, shop operation, promotion, accounting, etc.

Howard W. Sams, who heads the new organization, was formerly with P. R. Mallory & Co., Inc., Indianapolis, Ind.

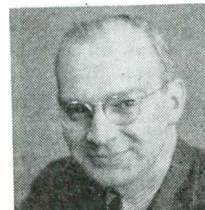

Howard W. Sams

\* \* \*

**WESTON ENGINEERING DATA**

The first issue of a publication entitled "Weston Engineering Notes," was recently published by the engineering laboratories of the Weston Electrical Instrument Corporation.

Featured were articles, "The Galvanometer and the Bridge" and "Copper Oxide Rectifiers as Used in Measuring Instruments."

John Parker is editor.

\* \* \*

**RIDER NAMED RCA TEST EQUIPMENT  
CONSULTANT**

Lt. Col. John F. Rider has been retained by the RCA Victor Division as a consultant on test equipment. Col. Rider will

(Continued on page 40)

*Better*  
**ATLAS SOUND**   
**Equipment**  
*Ready for YOU*



**DOUBLE REENTRANT PROJECTOR**

Many sizes. From 15 in. air column to 6 foot air column.

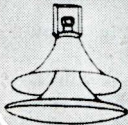

**360 RADIAL, CHANDELIER PROJECTORS**

Double Reentrant. For driver units. 3 and 4 foot air column lengths.

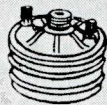

**DRIVER UNITS**

Various Power Handling Capacities. Newest types of Indestructible Phenolic Diaphragms.

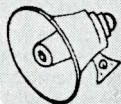

**MINIATURE TYPE REENTRANT PROJECTORS—BOOSTER SPEAKERS**

High-efficiency. Weather-proof. Complete with Driver Unit and Universal Bracket.

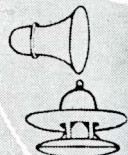

**CONE TYPE PARABOLICS and CHANDELIER BAFFLES**

for all size cone speakers. Wooden and Metal Cone Speaker Enclosures, Baffles, Carrying Cases, Loud Speaker Support Stands and Brackets.



**MICROPHONE SUPPORT STANDS**

20 types and sizes. All Fittings, Adaptors and Accessories. Floor Stands, Desk Stands, Banquet Stands, Boom Stands.

Write for  
New Illustrated  
Catalog Sheets

**ATLAS SOUND CORPORATION**

1451 39th St., Brooklyn 18, N. Y.

**NEWS**

(Continued from page 39)

work in cooperation with the test and measuring equipment section.

**ELECTRO-VOICE CARDAX CARDIOID BULLETIN**

A 4-page bulletin describing the model 950 Cardax cardioid unidirectional crystal microphone has been issued by Electro-Voice, Inc., 1239 South Bend Ave., South Bend 24, Indiana. Frequency response curves, specifications and application information are offered.

**NEWS OF THE REPRESENTATIVES**

John P. Ludgate, 345 4th Ave., Pittsburgh 22, and P. A. Boyd, 434 Biddle Ave., Pittsburgh 21, Pa., have become members of the Buckeye chapter.

H. E. Walton has been elected president of the Wolverine chapter. J. P. Davenport is now vice president and R. C. Nordstrom, secretary-treasurer.

Norman B. Neeley, J. T. Hill, Herb Becker, Emmett N. Hughes and Harry A. Lazure were delegates of the Los Angeles chapter at the national convention held in Chicago.

Charles D. Southern, who operates as the Southern Sales Co. has moved his office to 1135 Lincoln Tower, Ft. Wayne, 2, Ind.

**WOLIN JOINS PYRAMID ELECTRIC**

Sylvan A. Wolin, formerly with Solar Manufacturing Corp., has become associated with the Pyramid Electric Co., 415 Tonnele Avenue, Jersey City, N. J. The company manufactures electrolytic capacitors and radio noise eliminators.



**PREISMAN NOW CREI V-P**

Albert Preisman has been elected vice president, in charge of engineering, of the Capitol Radio Engineering Institute, 3324 16th Street, N.W., Washington, D. C.

Mr. Preisman has been associated with the institute for three years, where he has been in charge of radio engineering activities, lesson text revision and development of new lesson material.



**McKNEW TO HEAD WESTINGHOUSE HOME RADIO SERVICE**

W. H. McKnew has been named service manager of the Westinghouse home radio division, Sunbury, Pa.

Mr. McKnew, a lieutenant commander in the U. S. N. R., served from 1942 to 1945 as Resident Inspector of Naval Ma-

*For Soldering in  
Tight Places . . .*

**DRAKE**

**No. 400 Soldering Iron**

*Smallest Industrial Iron  
Ever Designed*

**60 Watts — 1/4 in. Tip  
Only 9 in. long. Wt. only 8 oz.**

This mighty mite is backed by DRAKE's 25 years of soldering iron manufacturing experience. The high quality and long-service of DRAKE Soldering Irons have made them outstanding favorites with all types of radio men everywhere. The DRAKE No. 400 is an outstanding value at



**Only \$4.50**  
List

*Drake Has an Iron  
for Every Purpose.  
Ask Your Radio  
Parts Jobber*

**DRAKE ELECTRIC WORKS, INC.**

3656 LINCOLN AVE., CHICAGO 13, ILL.

terial at the Westinghouse industrial electronics and X-ray divisions in Baltimore.



**CONCORD RADIO CATALOG**

A 112 page catalog with data on receivers, amplifiers, components, accessories, etc. has been released by the Concord Radio Corporation, 901 W. Jackson Boulevard, Chicago 7, Illinois.

**SOLAR SYSTEM BULLETIN**

The first issue of the *Solar System*, a bi-monthly, devoted to capacitor developments, was recently published by the Solar Manufacturing Corporation, 285 Madison Avenue, New York 17, N. Y.

The initial issue contained articles on the proximity fuze, RMA color codes, Army-Navy color codes, capacitor-type a-c follow-up motor, etc.

S. L. Chertok is editor of the new publication.

**CLEVELAND INSTITUTE BOOKLETS**

A 24-page booklet describing technical training today, has been published by the Cleveland Institute of Radio Electronics, S-5 Terminal Tower, Cleveland 3, Ohio.

The Institute has also issued a booklet telling how to pass FCC license examinations. Both booklets are available gratis.



**Tube-type  
RESISTORS**

★ It's easy—and profitable too—to service those wornout resistor tubes in AC-DC radios. Just use Clarostat replacements. Remember, Clarostat developed and pioneered the tube-type resistor. Clarostat is notably superior to others. And Clarostat maintains the outstanding line of Standard and Universal types for your convenience.

#### STANDARD TYPES

Several dozen types listed in latest catalog take care of standard radio set needs, with exact-duplicate replacements of the same numbers.

#### UNIVERSAL TYPES

Ten carefully selected types take care of standard radio sets. A handy Clarostat chart indicates the Universal type for any previous initial equipment. A minimum stock takes care of maximum needs.

#### ASK YOUR JOBBER . . .

Ask for copy of the Clarostat postwar catalog listing both Standard and Universal Resistor Tubes. Your Clarostat jobber carries a stock for your convenience.

**CLAROSTAT** Controls and Resistors

CLAROSTAT MFG. CO., Inc. • 285-7 N. 6th St., Brooklyn, N. Y.

## NEW PRODUCTS

### SIMPSON A-M/F-M SIGNAL GENERATOR

A signal generator, model 415, for a-m and f-m has been announced by the Simpson Electric Company, 5208 W. Kinzie St., Chicago 44, Ill.

Features control of r-f output through entire range. The r-f output voltage is also said to be practically constant throughout the frequency range.

Modulation from 0 to 100% uses either 400-cycle internal sine wave or an external source; high-fidelity modulation up to 100% from below 60 cycles per second to over 10 kilocycles per second.



### ALPHA METAL 3-CORE SOLDER

A solder with three independently filled cores of rosin flux, Tri-Core, has been announced by the Solder Development Division, Alpha Metals, Inc., 369 Hudson Ave., Brooklyn 1, N. Y.

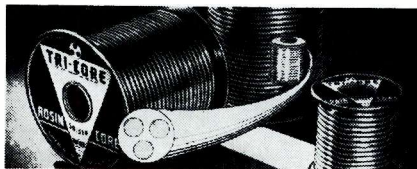

### OHMITE MARKED LITTLE DEVIL RESISTORS

Individually marked "Little Devils" have been announced by the Ohmite Manufacturing Company, 4835 Flournoy Street, Chicago 44, Illinois.

Markings include resistance value and wattage rating, in addition to RMA color coding.

Resistors made in 1/2-watt, 1-watt, and 2-watt sizes: 1/2-watt is 3/8" long x 9/64"

(Continued on page 42)

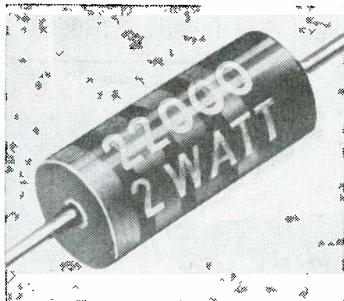

## Highest Quality RADIO & ELECTRONIC TESTING EQUIPMENT

Immediate Delivery  
from Stock Guaranteed

R.C.P. Model 448 Pocket Multitester	\$24.01
R.C.P. Model 424A Volt Ohm-Milliammeter	\$28.91
R.C.P. Model 461A Sensitive Multitester	\$38.71
R.C.P. Model 664 Electronic Voltmeter	\$45.00
R.C.P. Model 705 Signal Generator	\$48.51
R.C.P. Model 802N Combination Tube & Set Tester	\$58.31
R.C.P. Model 488A Ultra-Sensitive Multitester	\$70.07
R.C.P. Model 668 Vacuum Tube Ohm Capacity Meter	\$73.01
R.C.P. Model 805 Tube & Set Tester	\$87.71
R.C.P. Model 665A V.T. Volt Ohmmegor Insulation Tester	\$92.01
Monitor Crystalliner Signal Generator	\$57.50
McMurdo Silver Model 904 Capacitance Resistance Bridge	\$49.90
McMurdo Silver Model "Vomax"	\$59.85
Reiner Model 530 Squarewave Generator	\$95.00
Reiner Model 450 Vacuum Tube Volt-Ohm-Milliammeter	\$135.00
Superior Model CA-11 Signal Tracer	\$18.75
Superior Model 1553 Volt Ohm Milliammeter	\$24.75
Superior Model 680 Volt Ohm Milliammeter	\$27.65
Superior Model PB-100 Volt Ohm Milliammeter	\$28.40
Superior Model 450 Tube Tester	\$39.50
Superior Model 650 Signal Generator	\$48.75
Superior Model 720 Multi-Range AC Ammeter	\$49.50
Superior Model 400 Electronic Multi-Meter	\$52.50
Superior Model 800 Combination Tube and Set Tester	\$62.50
Shallcross Decade Resistance Boxes	\$13.50
Shallcross Portable Galvanometers	\$24.00
Shallcross Model 630 Wheatstone Bridge	\$60.00
Shallcross Model 637 Kelvin-Wheatstone Bridge	\$80.00
Shallcross Model 638-2 Kelvin-Wheatstone Bridge	\$120.00
VM-Model 200-B Record Changer	
List Price: \$37.50	net \$22.50

### Special!

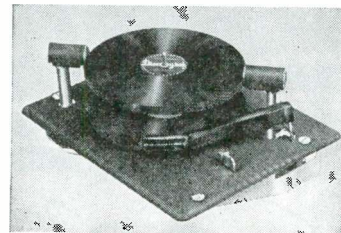

### THE NEW "MAGUIRE" 2-POST AUTOMATIC RECORD CHANGER

List Price	\$47.41
DEALERS	
NET PRICE	\$27.50
Lots of 6 or more	\$25.00

Write for our **FREE**  
new Post-War Catalog!

## Metropolitan

ELECTRONIC & INSTRUMENT CO.

Dept. SE 6 MURRAY STREET

NEW YORK 7, N. Y., U. S. A.

Phone: BArlay 7-5556

Cable Address: METRONICS

Raytheon tubes give peak performance. They have been built to this high level of maintained quality through continual testing and research by a company that is recognized everywhere as one of the advanced guard leading the way into the new era of electronics.

**RAYTHEON**  
MANUFACTURING COMPANY

*Excellence in Electronics*  
RADIO RECEIVING TUBE DIVISION  
NEWTON, MASS. • CHICAGO

## NEW PRODUCTS

(Continued from page 41)

diameter; 1-watt, 9/16" long x 7/32" diameter; 2 watt, 11/16" long x 5/16" diameter.

Available in RMA standard values (10% tolerance) from 10 ohms to 22 megohms.

\* \* \*

### WESTON BROAD-RANGE ANALYZER

An analyzer, model 779 (6 3/8" x 9 1/8" x 4 7/8"), with five overlapping a-c and d-c voltage ranges, seven d-c current ranges, four d-c resistance ranges, and five decibel ranges, has been announced by the Weston Electrical Instrument Corporation, Newark, N. J.

D-c voltage ranges available at a dual sensitivity of 1,000 or 20,000 ohms per volt.

All readings are taken on a standard 4" rectangular 50-microampere instrument. A-c measurements made through a temperature-compensated full-bridge copper-oxide rectifier designed so that all a-c readings are made on a single scale arc.

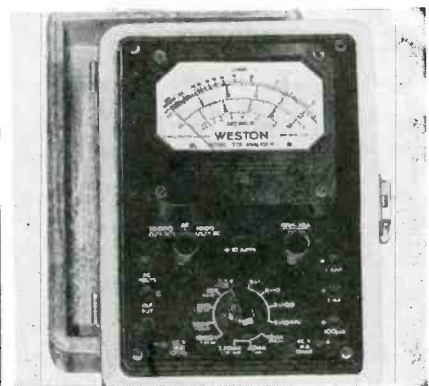

\* \* \*

### ELECTRO-VOICE MICROPHONE FLOOR STAND

A microphone stand, E-V floor stand, model 425, that raises, lowers and locks with one-hand operations, has been developed by Electro-Voice, Inc., 1239 South Bend Ave., South Bend 24, Indiana. By pressing a button with one finger, the microphone shaft is raised or lowered; locked into position by releasing the button.

Height adjustment, 37" to 66"; three-

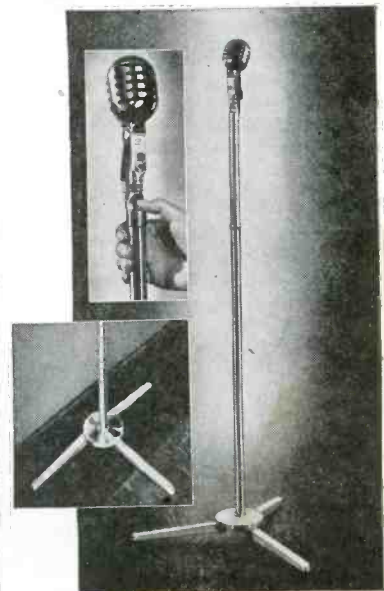

TIME WILL TELL

33 Years of Experience

• THE HALLDORSON COMPANY has continuously manufactured for industry since 1913. Since inception, this firm has been and is still an individual firm . . . not a subsidiary or branch of another company.

Each and every HALLDORSON transformer is backed by 33 years of experience, research and actual field knowledge. A new and more complete line of transformers is now being developed in the HALLDORSON laboratories. Soon . . . we hope, in the very near future . . . these transformers will be available.

**JOBBERS: Get on our mailing list today!**

**THE HALLDORSON COMPANY**  
SINCE 1913  
4500 Ravenswood Avenue • Chicago 40, Illinois

**HALLDORSON Vacuum Sealed TRANSFORMERS**

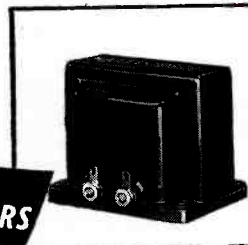

**Attention  
GI JOE!**

Here's Your Opportunity to be First to  
**Start Your Own  
RADIO SERVICE  
SHOP**

Complete Starting-in-Business  
Package Stocks of

**TEST EQUIPMENT  
TUBES, PARTS, TOOLS**

**\$350 up**

Act quickly! Meet the pent up demand for radio service. Turn your special service training into a profitable business of your own. No fuss. No worry. Here's everything you need—\$350 up. Details upon request! Write, wire or phone

**RCP 448**

"POCKET" VOM  
A.C.-D.C. Volts  
0-5-50-250-1000  
D.C. Mills  
0-5-10-100-1000  
Ohms  
0-2,000-20,000-200,000-  
2 Meg.  
Size 3" x 5 1/4" x 2 1/4"

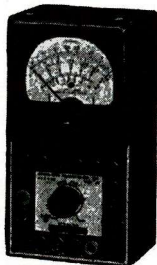

**\$24.50 net**

**RECORD CHANGERS**

UTAH-DETROIT # 550C ..... \$18.27  
WEBSTER-CHICAGO # 56 ..... 27.20

**HALLICRAFTERS SX-28A**

**\$223**



SUPER DEFIANT ..... SX25 \$94.50  
SKY CHAMPION ..... S20R 60.00  
SKYRIDER MARINE ..... S22R 74.50  
S40 NEW MODEL ..... Approximately 79.50  
SKYRIDER JR. S41 ..... 33.50

**HAMMARLUND HQ-129-X \$129**

**TRIPLETT 625-N**

20000 ohms per volt D.C.  
10000 ohms per volt A.C.  
5" Scale-TOPMOST QUALITY  
(12) D.C. Volt Ranges to 5000  
(6) A.C. Volt Ranges to 5000  
(3) OHM Ranges 0-400-50000-  
10 Meg.  
(5) D.C. Current Ranges 1 Ma.  
to 10 Amp.  
PLUS OUTPUT and DB.  
RANGES  
**\$45.00** with test leads.



**PHILCO BEAM OF LIGHT**

Selenium Cell only, no holder ..... **1.80**

20% deposit required on all C.O.D. orders. 2% transportation allowance on orders of \$25.00 or more accompanied by payment in full.

Write for  
**FREE CATALOG**

**RADIO SUPPLY &  
ENGINEERING CO., Inc.**  
126 SELDEN AVE. DETROIT 1, MICH.

leg spread, 17"; net weight, 7 1/2 pounds.

\* \* \*

**SNYDER AUTO ANTENNAS**

Two automobile radio antennas, the "Cosmopolitan" and the "Hemisphere," have been announced by the Snyder Manufacturing Company, Philadelphia.

The "Cosmopolitan" is for fender or top cowl with concealed installation. Made in four sections with a closed height of 8". Said to be self-aligning with a 33° angle adjustment for all body and fender contours.

The "Hemisphere" is a swing angle antenna, adaptable to all cowl or fender contours. Made in four sections, extends to 66" and closes down to 22".

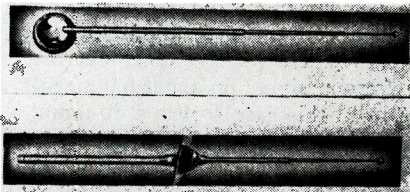

\* \* \*

**WATERMAN MINIATURE  
OSCILLOGRAPH**

A 6 3/8" x 3 3/4" x 10" oscillograph, the "Pocketscope," has been announced by Waterman Products Company, Inc., Philadelphia.

Unit incorporates a cathode-ray tube, vertical and horizontal amplifiers, linear time base oscillator, synchronization means and self-contained power supply.

Cathode-ray tube is magnetically shielded. The time base oscillator uses a double triode, tube connected as a multi-vibrator, producing a substantial linear trace from 10 cycles to 50 kc.

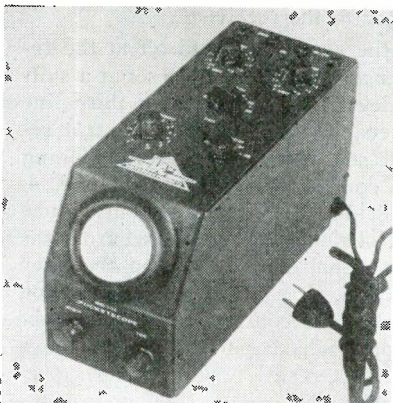

\* \* \*

**ACA DIRECT-COUPLED AMPLIFIERS**

Direct-coupled amplifiers, type 100 DC, have been developed by the Amplifier Co. of America, 398 Broadway, New York 13, N. Y.

Features a signal self-balancing and current drift-correcting direct-coupled output circuit, and non-frequency discriminating scratch suppressor. Response is said to be 20 to 20,000 cycles ± 1 db; develops 23 watts with less than 1% total distortion, overall gain, 96 db; hum and noise level, -40 vu.

Two independent inputs (each of 500,000 ohms) are provided. Balanced output terminals are provided for 4/8/16 and 500 ohms. In-between terminals provide the  
(Continued on page 47)

**STANDS UP  
IN  
HARD SERVICE**



IT'S  
ENGINEERED WITH  
**HI-Q**  
COMPONENTS

Every engineer knows that failure starts with the little parts. That's why more and more development engineers place their dependence on Hi-Q Ceramic Capacitors, Wire Wound Resistors and Choke Coils. They know through their own actual tests, that Hi-Q Components stand up under every condition of temperature, humidity, vibration and shock. Test these sturdy components in your own applications. Send your specifications for samples and complete data.

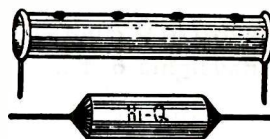

**CERAMIC CAPACITORS**

Made of titanium dioxide (for temperature compensating types). Tested for physical dimension, temperature coefficients, power factor and dielectric strength.



**WIRE WOUND RESISTORS**

Immediately available in standard ratings or precision built to any tolerance or value.



**CHOKE COILS**

Sturdy Construction. Insulated or bare types. Quantity production available at once.

**ELECTRICAL REACTANCE  
CORPORATION**

FRANKLINVILLE, N. Y.

# DEALERS—

Ready for  
**IMMEDIATE  
DELIVERY!**

**LARGEST STOCKS OF  
RADIO and ELECTRONIC  
SUPPLIES FROM THE  
FINEST STANDARD  
LINES**

An established house — as old as Radio itself—offers an unusually complete line of parts and equipment from the country's finest manufacturers.

**ORDER NOW FOR  
IMMEDIATE DELIVERY**

# RADIO ELECTRIC SERVICE CO.

**OF PENNA., INC.**

**N.W. cor. 7th & Arch Sts.  
Philadelphia 6, Pa.**

### BRANCHES

CAMDEN, N. J. . . . 513-515 Cooper St.  
ALLENTOWN, PA. 1042 Hamilton St.  
EASTON, PA. . . . . 9 No. 2nd St.  
WILMINGTON, DEL. S.E. cor. 4th & Tatnall

## REMOTE CONTROL

(Continued from page 15)

bias. If the bias control is so designed that at the mid-point, the tube is operating at the middle of the straight portion of its  $E_p-I_p$  curve, at one extreme the control voltage reduces to zero, and at the other extreme it is equal to twice the value at the operating point. Thus quite a range of plate resistance is available.

In the particular case checked, using a 76 control tube, and controlling a 6A7 in a conventional circuit, it was possible to completely tune over a fairly strong signal on about 6.0 megacycles. In this case  $C$  was a 30-mmfd trimmer adjusted fairly well out.

In placing the receiver at the remote point, lines must necessarily be run to the operating or the listening point. Since level is generally restricted over such lines, it will be necessary to use some simple form of amplifier at the listening point. Since it will be for headphone operation a single 6J5 should be sufficient, as in Fig. 3. The power supply for this unit can also conveniently supply the control voltage for the receiver. Neglecting the use of a power-line ground return as an undesirable source of line noise, a pair of lines should be used to carry the receiver output to the listener's amplifier, and the control voltage from the listener to the receiver.

If the avc is switched off at the receiver and the audio gain set at a suitable level the addition of a third line will enable the listener to control receiver sensitivity, one line functioning as a common return circuit; Fig. 4. The grid of the frequency control tube must obviously be decoupled from the audio signal on the line, but the filter  $R_1, R_2, C_3, C_4$ , should not have such too large a time constant or there will be an appreciable lag in the control voltage when it is varied. The blocking capacitors  $C_1$  and  $C_2$  should show no leakage.

Fig. 4. Third-line addition in two-line system to permit receiver sensitivity control.

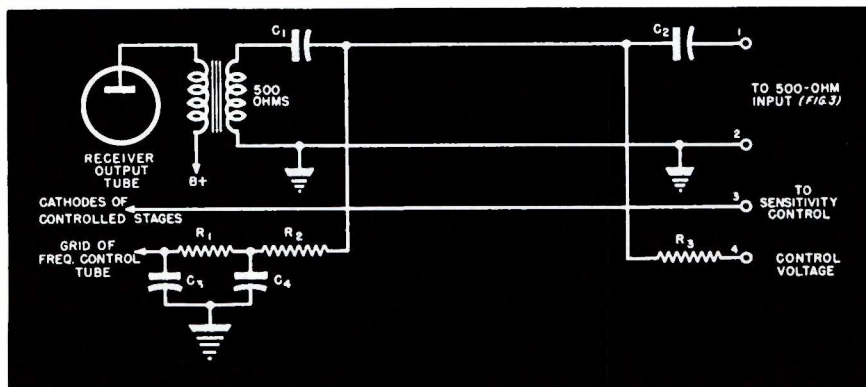

Their capacity can be selected to provide substantial low-frequency cutoff, such as is generally required for communications purposes.  $R_3$  in Fig. 4 should have sufficient resistance to prevent leakage of the low impedance of the control voltage supply source across the 500-ohm line.

Actual values of parts have not been included as almost every case will be different. The application is quite interesting, since it provides audio gain control, sensitivity control, and a few kilocycles of tuning range over the operating channel.

## NEW MODELS

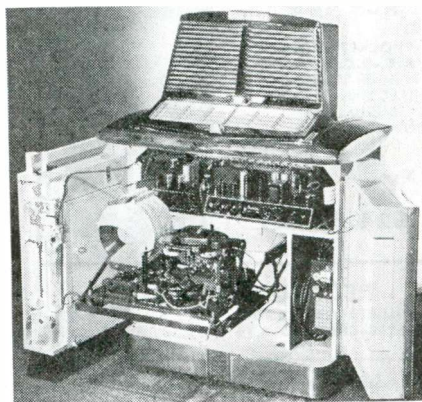

Above, Aireon automatic phonograph with noise monitoring device. A microphone (placed anywhere in the room where the phonograph is located) plugs into a small 4-tube amplifier and provides a bias, for the main amplifier, which varies in accordance with the background noise. The phono-amplifier uses five tubes, two 6L6s driving a 15" dynamic speaker, with provision for feeding four wall speakers. . . . Below, Farnsworth six-tube a-c/d-c single band model, BT-065. Uses one 6SS7 r-f amplifier, one 12SA7 converter and oscillator, one 6SS7 i-f amplifier, one 12SA7 avc and audio, one 50L6GT output and one 35Z5GT rectifier.

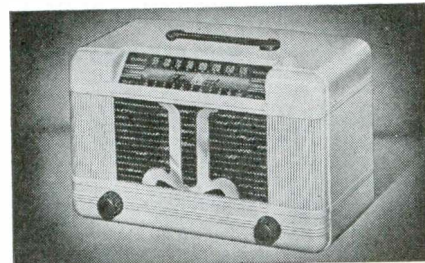

## TANTALUM WELDING

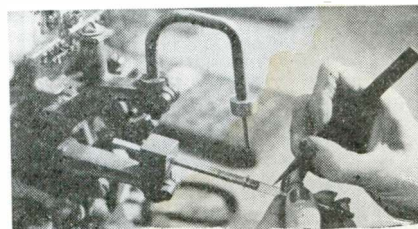

Spot welding tantalum grid wires, of .007" diameter, to tantalum sleeve of transmitting tubes at Amperex Electronic Corporation.

## 5-TUBE BATTERY-ELECTRIC RECEIVER

(See Front Cover)

A 5-TUBE battery a-c/d-c model, using a 117N7 as a combination rectifier and beam power amplifier, Emerson 505, appears on the cover, this month.

Selectivity and sensitivity is better than average because of 3-gang tuning with a tuned r-f 1T4 amplifier and an i-f of 262 kc. A 1R5 converter is standard except for a grid capacity winding on the oscillation transformer which replaces the grid capacitor.

A 1T4 i-f stage feeds a 1S5 detector-first audio. Here a 47,000-ohm resistor at the detector output serves as an i-f filter and anti-loading resistor. An avc-voltage-dividing potentiometer delivers full avc bias to the r-f amplifier through a 3.3-megohm grid leak, reduced proportional bias to the 1R5 first detector and further reduced bias to the i-f amplifier. The main series filter resistor is a 2.2-megohm type, followed by a 3.3-megohm resistor and a .02-mfd. capacitor to the detector, 3.3 megohms to the i-f and 3.3 megohms shunt to ground.

The audio amplifier merits special study. The 1S5 pentode section feeds the 3Q4 battery-power tube and the 117N7 line-power tube in parallel, with a .47-megohm grid leak returning to the 1S5 filament. A 10-megohm degeneration resistor connects the grids back to the first a-f grid. A 5.6 megohm grid leak in the first audio is connected across a .02-mfd blocking capacitor, instead of from grid to fila-

ment. The output transformer is tapped for matching the 117N7 amplifier, the entire primary being a match for the higher impedance 3Q4.

A polarized line plug provides line to battery switching when plugged into a socket at the rear. The plug carries the B connection to the negative terminals of the A and B batteries, which goes to the receptacle. The filaments of the battery tubes are connected in series for both battery and line operation. They are in the cathode bias circuit in series with a 33-ohm resistor and shunted by a 3,300-ohm resistor and a 100-mfd cathode bypass of the 117N7 amplifier section. Equalizing resistors and bypass capacitors balance the filament voltages and prevent undesirable filament feedback.

A filter choke and 20- and 40-mfd units provide the main filter which supplies the i-f plate, first a-f plate and screen, and power amplifier plate and screen. An additional R/C filter, 3,900-ohm resistor and a .02-mfd capacitor supplies r-f and converter plates while a second filter with a 15,000-ohm resistor and .02 mfd capacitor is in the screen circuit. This is excellent for there is little chance for feedback via the plate supply.

Another interesting feature of this model is the use of miniature series of tubes in place of the common GT series ordinarily used in combination battery-line receivers.

## FLANAGAN RADIO CORP.

America's Largest Stock of Radio Tubes

**NOW** For the First Time in Years  
**70L7** — Replacement Tubes — No  
**32L7** Rewiring—Just Plug In.  
**\$1.82**  
 ea. Net

ALL THE HARD TO GET

### RADIO TUBES

Send postal for FREE Order Form and Catalog of Radio Tubes, Radio Parts, Test Equipment, Radios, Record Changers, Record Players, and hard-to-get Radio Kits.



WE SHIP ANYWHERE

### PHONO-AMPLIFIERS

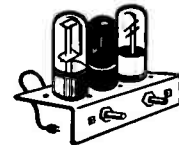

3 TUBE AC-DC  
 TONE CONTROL  
 VOLUME CONTROL  
 LESS SPEAKER

**\$7.44**  
 Net

Completely wired, ready to operate. Uses a dynamic speaker, 450 OHM Field.

INCLUDING TUBES  
 50L6 • 35Z5 • 125Q7

### SHURE CRYSTAL PICKUPS



**\$2.87**  
 ea. Net

COMPLETE WITH HARDWARE

### A GOLD MINE RADIO HARDWARE

Transformers... Coils... Sockets of all types  
 ... Screws, all sizes ... Nuts ... Bolts ...  
 Grommets ... Angles ... Wire ... Resistors  
 ... Portable Battery Plugs ... Connectors ...  
 Terminal Strips ... Insulators ... Lugs ...  
 Spaghetti, ETC.

A \$25.00 VALUE—DON'T MISS IT!

**\$2.00**  
 Box

### SENSATIONAL NEW RADIOLINK

EXTENSION SPEAKER

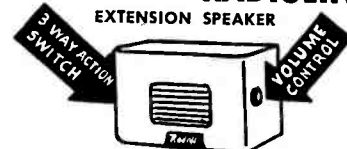

List Price \$7.95 **\$4.77**  
 ea. Net

Easy to connect to any radio. Music where you want it. Gets programs in any room of the house, office, garage, etc. Sells itself.

WRITE DEPT. S

## FLANAGAN RADIO CORP.

America's Largest Stock of Radio Tubes  
 N.E. Cor. 7th & Chestnut Sts., Phila. 6, Pa.

## SPEED UP REPAIRS WITH THESE G-C AIDS!

Handle Dial Belt Replacements the Easy G-C Way!



1. To determine proper belt for any radio, G-C supplies a complete Belt Replacement Guide and Measuring Scale.



2. By using G-C Belt Guide, just check model number of the set to determine correct G-C Belt.



3. If you don't know model number or make of the set, use G-C Measuring Scale and simple instructions to measure belt.



4. Order belt by number from your radior parts distributor. Phone or mail your order to receive prompt service—no waiting.



5. Better still—have a complete G-C Belt Kit on hand. Belts are indexed in permanent steel box with slide-in drawer.

FREE TO ALL RADIO SERVICE MEN — 68-page G-C No. 345 Belt Guide and Service Book and Measuring Scale. Ask for them at your Radio Parts Distributor

Get "Smooth-Strong-Correct Fit" G-C Dial Belts from Your Radio Parts Distributor



**GENERAL CEMENT MFG. CO.**  
 ROCKFORD, ILLINOIS

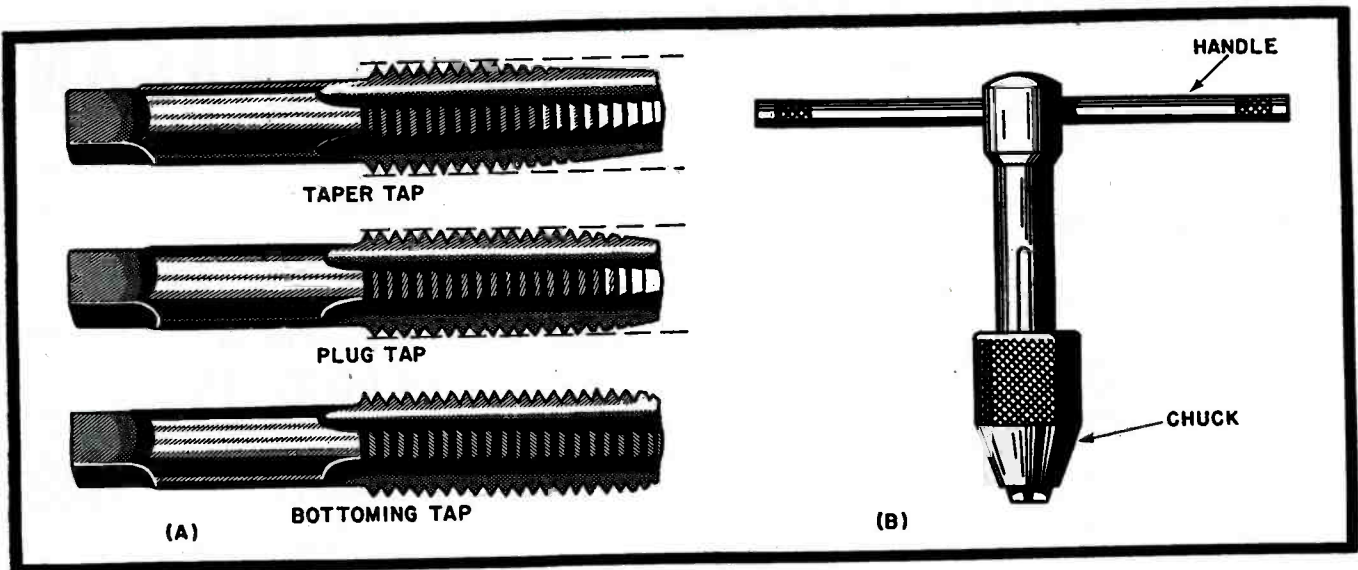

Fig. 3. Three common forms of taps and a tap wrench used to turn the taps. The taps are shown in (a), while the tap wrench is shown in (b).

## TOOLS

(Continued from page 29)

etc. A wide variety of types and sizes are available. It is important to have a sufficient variety of screwdrivers on hand so that one of the right size is always available for a job. The length of the slot in the screw-head and the width of the screwdriver blade should be as nearly alike as possible. If the blade is too narrow it will be twisted when the screw is tightened; if it is too wide it will not seat properly in the slot

and the screw head is likely to be burred and the work scratched. It should be remembered that the thickness of the blade varies with the width. For best results the blade should fit the slot snugly for its full width. The length of blade to use is determined chiefly by the accessibility of the work. If too large a screwdriver is used, there is danger of applying too much leverage and shearing off the screw when it is tightened.

A single screwdriver no longer serves all of the many requirements for such a tool in modern service work.

For light-duty work such as setting the set-screws of dials and knobs, variable tuning capacitors, etc., a small screwdriver with  $\frac{1}{8}$ " x 3" blade and provided with a pocket clip is recommended. Many Service Men make a habit of wearing one of these.

Fig. 4. Three basic types of pliers for the Service Man: (a), diagonal side-cutting type with stripping notch; (b), long nose type; (c), electrician's side-cutting type with a stripping notch. (Courtesy Krautter Tool Co., Inc.)

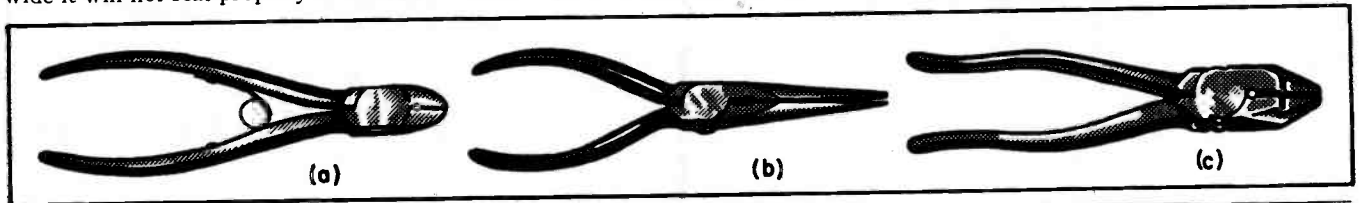

**TUBES—PARTS**  
**RADIO DEALERS—SERVICEMEN**  
 Send for our list of available tubes and repair parts.  
 Sylvania, Tung-Sol, Ken-Rad.  
**M. V. MANSFIELD CO.**  
 937 LIBERTY AVE. PITTSBURGH 22, PA.

**SERVING NORTHERN NEW ENGLAND**  
**EVANS RADIO**  
 18 N. Main Concord, N. H.

**Ted McElroy**  
 World's Largest Manufacturer of  
 Wireless Telegraphic Apparatus  
 COMPLETE CENTRAL OFFICE EQUIPMENT  
**McElroy Manufacturing Corp.**  
 32 Brookline Ave. • Boston, Massachusetts

**J. V. Duncombe Co.**  
 WHOLESALE DISTRIBUTOR  
 ELECTRONIC EQUIPMENT, TUBES and PARTS  
 1011 West 8th Street Erie, Pa.  
 Phone: 23-548  
 ERIE'S OLDEST AND LARGEST EXCLUSIVELY WHOLESALE  
 ELECTRONIC SUPPLY HOUSE  
 All Nationally Known Lines Are In Our Stock.

**IMMEDIATE DELIVERY**  
**ON TEST INSTRUMENTS!**

McMURDO-SILVER "Vomax".....\$59.85	SIMPSON 260 v.o.m.....\$33.25
RADIO CITY 705 sig. gen..... 49.50	SIMPSON 305 tube tester..... 39.50
RCP 802-N tube & set tester... 59.50	SIMPSON 240 "Hammer"..... 26.50
APPROVED R.F. sig. gen..... 47.00	TRIPLETT 2413 tube tester..... 45.00
DUMONT 3" oscilloscope.....105.00	TRIPLETT 2432 sig. gen..... 49.75
DUMONT 5" oscilloscope..... 235.00	TRIPLETT 666-H v.o.m..... 16.00

Also, many other types available. Send for latest circular  
 25% deposit should accompany C.O.D. orders  
**SCENIC RADIO & ELECTRONIC CO., 53 Park Pl., New York 7**

**WHEN YOU CHANGE YOUR ADDRESS**

Be sure to notify the Subscription Department of SERVICE at 52 Vanderbilt Ave., New York 17, N. Y., giving the old as well as the new address, and do this at least four weeks in advance. The Post Office Department does not forward magazines unless you pay additional postage, and we cannot duplicate copies mailed to the old address. We ask your cooperation.



# OHMITE RESISTORS

+  
*Your Guide to*  
**DEPENDABLE RESISTANCE CONTROL**

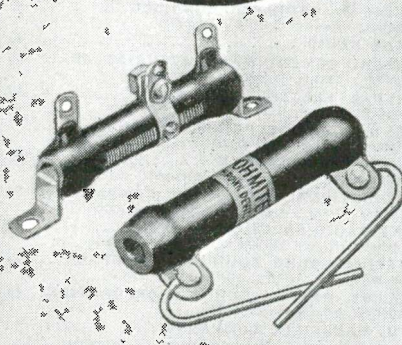

The service-record of Ohmite Brown Devil and Dividohm Resistors before and during the war... is your best guide to resistance-control now. Ohmite construction insures long, trouble-free performance makes these units favorites for the best in resistor replacement.

Write for Stock Unit Catalog No. 18

Authorized Distributors Everywhere

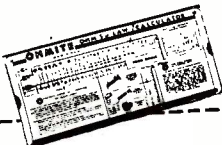

### OHM'S LAW CALCULATOR

Figures ohms, watts, volts, amperes...easily. Solves any Ohm's Law problem with one setting of the slide. Send only 10c in coin.

**OHMITE MANUFACTURING CO.**  
4879 FLOURNOY ST. • CHICAGO 44, U. S. A.

Be Right with **OHMITE**  
RHEOSTATS • RESISTORS • TAP SWITCHES

### NEW PRODUCTS

(Continued from page 43)

following additional output impedances: 1/2/6/10/12/83/100/125/150/160/175 ohms.

Uses two 12SC7, two 12SK7, two 6SC7, two 6SJ7, two 6L6G, one 5U4G, one 5V4G and one ballast.



### JFD REMOTE-O-CABLE REPLACER

A remote-o-cable replacer for swaging shafting to prevent unraveling, cutting shafting to exact length, and replacing old and new fittings on new shaftings, has been announced by J. F. D. Manufacturing Co., 4117 Fort Hamilton Parkway, Brooklyn, N. Y.

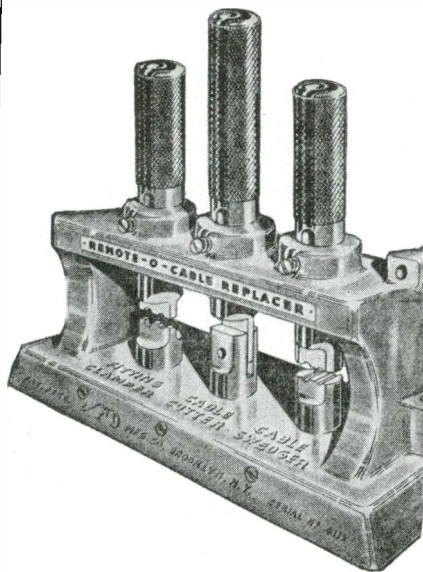

### SPRAGUE INTERFERENCE FILTERS

Filterol radio interference filters have been announced by the Sprague Products Company, North Adams, Mass.

Designed for installation in series with the power line or interfering device. Basic circuit is a three-terminal network of which the can is one terminal. Four available types include 115 volts a-c or d-c ratings from 1 to 35 amperes, and one unit for 220 volts a-c or d-c is rated at 20 amperes.

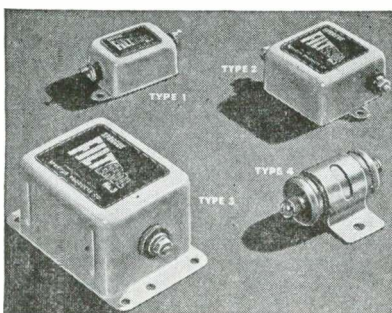

## IT'S NEW! EXCLUSIVE! READY NOW!

### WRL GLOBE TROTTER TRANSMITTER KIT



25 Watt Output  
The Sensation of the Year!

Cat. No. 70-300 **\$59.95**

Complete including all parts, chassis panel, streamlined cabinet, less tubes, coils, and meter.

Cat. No. 70-312 Kit same as above, wired by our engineers .....\$75.00  
Complete kit of 8 tubes Cat. No. 70-314.....\$5.95  
3 in. meter Cat. No. 70-318..... 4.95  
Coils, per set, any band Cat. No. 70-316..... 2.95  
Crystals, 40-80 meters, mounted Cat. No. 70-322 ea..... 2.65  
Quality crystal mike and stand Cat. No. 70-320. 9.45

Here is the latest, most outstanding transmitter value on the market today. The WRL Globe Trotter is capable of 25 Watts output on all bands from 3500 KC through 28 Megacycles. Incorporates the Tritet Oscillator using a 40 metal X-tal and providing sufficient drive at 10 meters for the 807 final; Heising choke modulation; three bands, all pretuned; 10, 20, and 80 meters; metering provided for both oscillator and final stages; two power suppliers, one for 807 final and modulator tubes, one for speech amplifier and oscillator stage.

### RECEIVERS

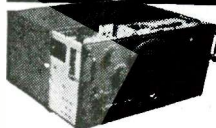

Extra Special  
NEW BC 348Q  
SURPLUS  
RECEIVERS

Including Steel case, less speaker **\$85**  
Cat. No. 35-61.....

Here is one of the hottest war-surplus receivers that will be available, 9 tubes, 2 RF stages, 3 stages of IF amplification. Frequency range, 200 to 500 kilocycles; 1 1/2 to 18 MC in four bands. Weather and aircraft bands, and all ham bands, except 10 meters.

Here are just a few of the many well-known receivers offered by Leo:  
Hallicrafters S-38 **39.50** Hallicrafters SX-25 **94.50**  
Hallicrafters S-40 **79.50** Hallicrafters SX-28A **223.**  
RME 45 ..... **186.** Hallicrafters S41G **33.50**  
National NC 2-40C **225.** Hammarlund HQ-129X **129.**  
Trade-in plan and easy terms

### SERVICE DEALER NEEDS



**WRL MULTITESTER**  
Steel case with  
30-60% angle **\$1875**  
Cat. No. 16-491  
Less Leads ..

Handles AC DC Voltmeter, DO Milliammeter, high and low range Ohmmeter. 3" meter with sturdy D'Arsonval movement. Size 5 1/2 x 8 x 3 1/4.

A complete stock of tools, replacement parts, test equipment, intercom and public address systems... everything for the progressive service dealer.

### FREE! OUR LATEST FLYER



Packed with real buys in radio, electronic, and general merchandise.

Giant Radio Map (size 3 1/2 ft. x 4 1/2 ft) ..15c  
Handy Tube-Base Calculator ..25c  
Address Dept. S-5  
Council Bluffs, Iowa

**World Radio Laboratories**  
LABORATORIES INCORPORATED  
Formerly Wholesale Radio Laboratories

# Radio Headquarters

for 25 years

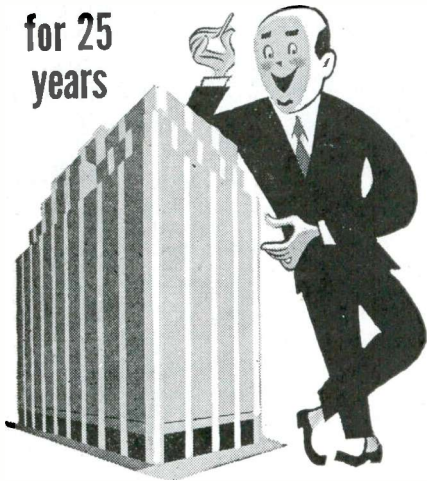

**We ship at once—parts, equipment, whatever you need!**

This house began its career almost as early as Broadcasting itself! Today, 25 years later, we're the world's largest radio supply house with a constant stock of well over 10,000 parts! Just tell us what you need and we'll ship it!

**Standard Lines:** National, Hammarlund, R.C.A., Hallicrafters, Bud, Cardwell, Bliley, and all the others you know so well!



**SUPERSPEED SERVICE** Orders shipped out same day received.



**ENGINEERING SERVICE** If your engineering problem requires special equipment, we'll make it.

**WHOEVER YOU ARE...** industrial organizations, laboratories, purchasing agents, radio dealers and service men, training schools, amateur operators and experimenters—we'll supply you fast and economically.

Originators and Marketers of the Famous

*Lafayette Radio*

**Radio Wire Television Inc.**

NEW YORK 13 BOSTON NEWARK

**FREE!** New C-37 Flyer packed with all the things you need right now. Mail coupon below!

**R. W. T. Dept. FE-6**

100 AVENUE OF THE AMERICAS, NEW YORK 13

I want your latest free C-37 Flyer.

NAME \_\_\_\_\_

ADDRESS \_\_\_\_\_

HAM?  (CALL LETTERS) \_\_\_\_\_

ENGINEER?  SERVICE MAN?  STUDENT?

48 • SERVICE, MAY, 1946

## JOTS AND FLASHES

THE RECENT OPA tube pricing policy providing a 20% increase to manufacturers and requiring Service Shops to absorb the increase, has prompted many service organizations and Shops to ask for either a modification or relaxation of the ruling. Service Shops have indicated that there should be an adjustment of the price schedule to provide an equitable profit. . . . A condensed chart of graphical symbols has been published by Sun Radio and Electronics Company, Inc., 122-124 Duane Street, New York 7, N. Y. . . . Harry Gawler and Walt Knoop, formerly with Du Mont, have formed an engineering sales service, with offices at 1060 Broad Street, Newark, New Jersey. . . . George Mucher, chief engineer and vice president of Clarostat Manufacturing Co., Brooklyn, New York, delivered a talk on carbon volume controls recently before a meeting of the Rochester Technicians Guild. . . . Cinaudagraph speakers are now being made in Slater, Missouri. Cinaudagraph is a division of Aireon. . . . Harold Montgomery has been named credit manager and assistant treasurer of the Aerovox Company, New Bedford, Mass. . . . Two 40-page booklets covering receiving tubes of G.E. and Ken-Rad types have been published. They are available from the G.E. tube division at Schenectady. . . . Paul J. Reed has been named assistant to the sales manager of Bendix Radio. . . . Joseph L. J. O'Connor was promoted to the post of sales promotion manager of Bendix. . . . K. G. Morrison is now assistant radio sales manager of the Graybar Electric Company. . . . E. Ralph Haines has resigned as assistant manager of distributor sales of the Raytheon Manufacturing Company, Newton, Mass. . . . Garrard Mountjoy has become president of the Electronic Corporation of America. . . . Samuel J. Novick is now chairman of the board. . . . The ECA plant has been moved to 170 53d Street, Brooklyn, New York. . . . Captain John L. Reinartz, with the U. S. Navy for the past seven years as communications and electronics officer, has returned to RCA. He will be in charge of amateur activities at the Lancaster tube plant. . . . RCA has purchased the Lancaster tube plant from the U. S. Navy for over \$4,000,000. . . . G. F. Metcalf is now manager of the G.E. Electronics Laboratory. . . . L. M. Leeds has been named consulting engineer of G.E. . . . Edgar Stanton is now sales service manager of Belden. . . . Fred A. Parnell has been appointed advertising and sales promotion manager of the G.E. receiver division. . . . A 12-page booklet describing antennas for f-m and television, store demonstrations, and noise reducing systems has been prepared by the Technical Appliance Corporation, Flushing, New York. . . . Don G. Mitchell has been elected president of Sylvania Electric Products, Inc., succeeding Walter E. Poor, who is now chairman of the board. Mr. Mitchell was formerly executive vice president. . . . Julius Haber has been appointed advertising and sales, promotion manager of the tube department of RCA Victor. He was formerly director of publicity. He will be located at Harrison, N. J.

## ADVERTISERS IN THIS ISSUE

### SERVICE INDEX—MAY 1946

AEROVOX CORPORATION . . . . .	28
Agency: Austin C. Lescarboursa & Staff	
AMERICAN PHENOLIC CORPORATION..Back Cover	
Agency: Burton Browns, Advertising	
THE ASTATIC CORPORATION . . . . .	33
Agency: Wearstler Advertising, Inc.	
ATLAS SOUND CORPORATION . . . . .	40
Agency: Burke & Wayburn Advertising Company	
BURSTEIN-APPLEBEE COMPANY . . . . .	38
Agency: Frank E. Whalen Advertising Company	
CAPITOL RADIO ENGINEERING INSTITUTE. 35	
Agency: Henry J. Kaufman & Associates	
CENTRALAB DIVISION GLOBE-UNION, INC.. 25	
Agency: Gustav Marx Advertising Agency	
CLAROSTAT MANUFACTURING COMPANY, INC. . . . .	41
Agency: Austin C. Lescarboursa & Staff	
CONCORD RADIO CORPORATION . . . . .	30
Agency: E. H. Brown Advertising Agency	
CORNELL-DUBILIER ELECTRIC CORP. . . . .	
Inside Front Cover	
Agency: Reiss Advertising	
DRAKE ELECTRIC WORKS, INC. . . . .	40
Agency: William Hoffman & Associates	
ALLEN B. DUMONT LABORATORIES, INC. . . . .	6
Agency: Austin C. Lescarboursa & Staff	
ELECTRICAL REACTANCE CORPORATION . . . . .	43
Agency: Scheel Advertising Agency	
J. V. DUNSCOMBE CO. . . . .	48
FLANAGAN RADIO CORPORATION . . . . .	45
Agency: Stewart Jordan Company	
EVANS RADIO . . . . .	46
GENERAL CEMENT MANUFACTURING CO. . . . .	45
Agency: Turner Advertising Agency	
GENERAL ELECTRIC COMPANY . . . . .	36
Agency: Maxon, Inc.	
J. F. D. MANUFACTURING COMPANY . . . . .	7
Agency: Mitchell Advertising Agency	
HALLDORSON COMPANY . . . . .	42
Agency: Sander Rodkin Advertising Agency	
INTERNATIONAL RESISTANCE COMPANY . . . . .	21
Agency: John Falkner Arndt & Company, Inc.	
LAKE RADIO SALES COMPANY . . . . .	32
Agency: Sander Rodkin Advertising Agency	
LIFETIME SOUND EQUIPMENT COMPANY . . . . .	28
Agency: The Miller Agency Company	
McELROY MANUFACTURING CORPORATION. 46	
Agency: Shappe-Wilkes Inc.	
M. V. MANSFIELD COMPANY . . . . .	46
METROPOLITAN ELECTRONIC & INSTRUMENT COMPANY . . . . .	41
Agency: Mitchell Advertising Agency	
MUELLER ELECTRIC COMPANY . . . . .	28
MURRAY HILL BOOKS, INC. . . . .	29
Agency: The Harry P. Bridge Co.	
NEWCOMB AUDIO PRODUCTS COMPANY . . . . .	34
Agency: Gail Hall Advertising	
OHMITE MANUFACTURING COMPANY . . . . .	47
Agency: Henry H. Teplitz, Advertising	
RAD-EL-CO MANUFACTURING COMPANY . . . . .	30
RADIO CITY PRODUCTS COMPANY, INC. . . . .	39
Agency: Reiss Advertising, Inc.	
RADIO CORPORATION OF AMERICA . . . . .	14
Agency: J. Walter Thompson Company	
RADIO ELECTRIC SERVICE CO. OF PENNA., INC. . . . .	44
Agency: E. L. Brown, Advertising	
RADIO SUPPLY & ENGINEERING COMPANY, INC. . . . .	43
Agency: Karl G. Behr Advertising Agency	
RADIO WIRE TELEVISION, INC. . . . .	48
Agency: Reiss Advertising	
RAYTHEON MANUFACTURING COMPANY . . . . .	42
Agency: Burton Browns, Advertising	
JOHN F. RIDER, PUBLISHER, INC. . . . .	5
Agency: Lansford F. King, Advertising	
HOWARD W. SAMS, INC. . . . .	19
Agency: The Aitkin-Kynett Co.	
SCENIC RADIO & ELECTRONIC COMPANY . . . . .	46
WALTER L. SCHOTT CO. . . . .	30
Agency: Ross, Gardner & White	
SHURE BROTHERS COMPANY . . . . .	37
Agency: The Phil Gordon Agency	
SIMPSON ELECTRIC COMPANY . . . . .	3
Agency: Krelecker & Meloan, Inc.	
SOLAR CAPACITOR SALES CORPORATION . . . . .	
Inside Back Cover	
Agency: O. S. Tyson & Company, Inc.	
SPRAGUE PRODUCTS COMPANY . . . . .	4
Agency: The Harry P. Bridge Company	
STANDARD TRANSFORMER CORPORATION . . . . .	31
Agency: Burnet-Kuhn Advertising Company	
SYLVANIA ELECTRIC PRODUCTS, INC. . . . .	10
Agency: Newell-Emmett Company	
TAB . . . . .	32
Agency: Mitchell Advertising Agency	
TRIPLETT ELECTRICAL INSTRUMENT CO. . . . .	34
Agency: Western Advertising Agency, Inc.	
UNITED TRANSFORMER CORPORATION . . . . .	22
Agency: Shappe-Wilkes Inc.	
WARD LEONARD ELECTRIC COMPANY . . . . .	36
Agency: E. M. Freystadt & Associates.	
WESTON ELECTRICAL INSTRUMENT CORP. . . . .	9
Agency: G. M. Basford Company	
WORLD RADIO LABORATORIES, INC. . . . .	47
Agency: Pfeiffer Advertising Agency	



moistureproof



because it's



sealdtite\*



★EXCLUSIVELY SOLAR

Modern, "Reliable in Every Climate"

Sealdtite paper tubular capacitors are securely sealed against any changes in atmospheric conditions.

Solar's original wax-molding process actually eliminates all possibility of any atmospheric moisture getting in to attack the capacitor element.

The squeezeproof solid housing is your assurance of long service at low cost.

"Sealdtites" and other popular

Solar paper, electrolytic and mica capacitors

for service, industrial and ham use

are fully described in the new easy-to-read 36 page catalog SC-1, which is yours for the asking.

See your Solar distributor or drop us a postal card today.

**SOLAR CAPACITOR SALES CORP.**

285 MADISON AVENUE • NEW YORK 17, N. Y.

Ⓢ 1302

**ELECTROLYTIC, PAPER AND MICA CAPACITORS**



# AMPHENOL

## Covers the Spectrum

**WITH CABLES  
AND CONNECTORS  
FOR EVERY FREQUENCY**

Amphenol serves the electrical and electronic industries with the most complete line of cables, connectors, plugs and fittings for every application. No matter what the need — from high-current, low-voltage cables and connectors such as are used in power lines, to high-voltage, high-frequency components required in the upper regions of the spectrum — there is an Amphenol product for the job. Amphenol cables and connectors are used in Radar, F.M., Television, Standard Broadcast, electronic controls and equipment... and in numerous industrial applications.

Amphenol connectors are engineered and constructed so as to afford the absolute minimum of loss of power, potential or waveform even at the highest frequencies. These components reflect the greatest advancement in all phases of electrically correct design and mechanically correct manufacture. Amphenol makes the most complete line of cables, connectors, plugs and fittings for the most efficient transmission of power at all frequencies.



**RADAR**

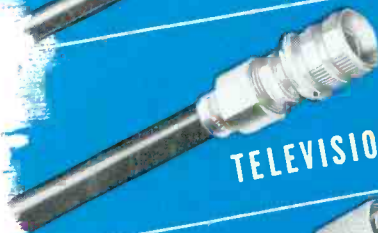

**TELEVISION**



**F.M.**



**RAILROAD**



**BROADCAST**



**INDUSTRIAL**

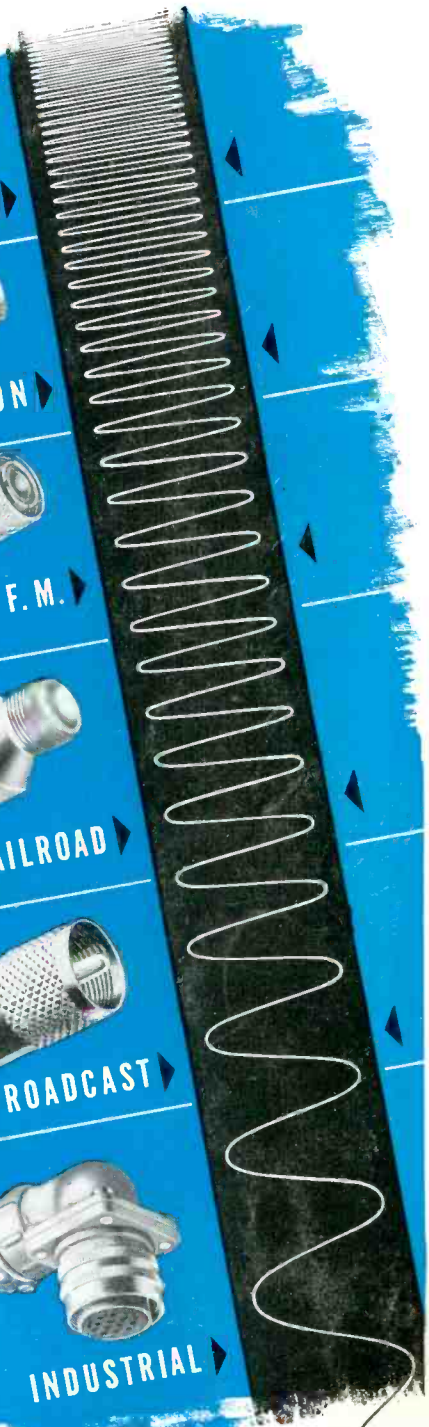

AMERICAN PHENOLIC CORPORATION  
CHICAGO 50, ILLINOIS  
In Canada • Amphenol Limited • Toronto

COAXIAL CABLES AND CONNECTORS • INDUSTRIAL CONNECTORS, FITTINGS AND CONDUIT • ANTENNAS • RADIO COMPONENTS • PLASTICS FOR ELECTRONICS