

SERVICE

June
1945

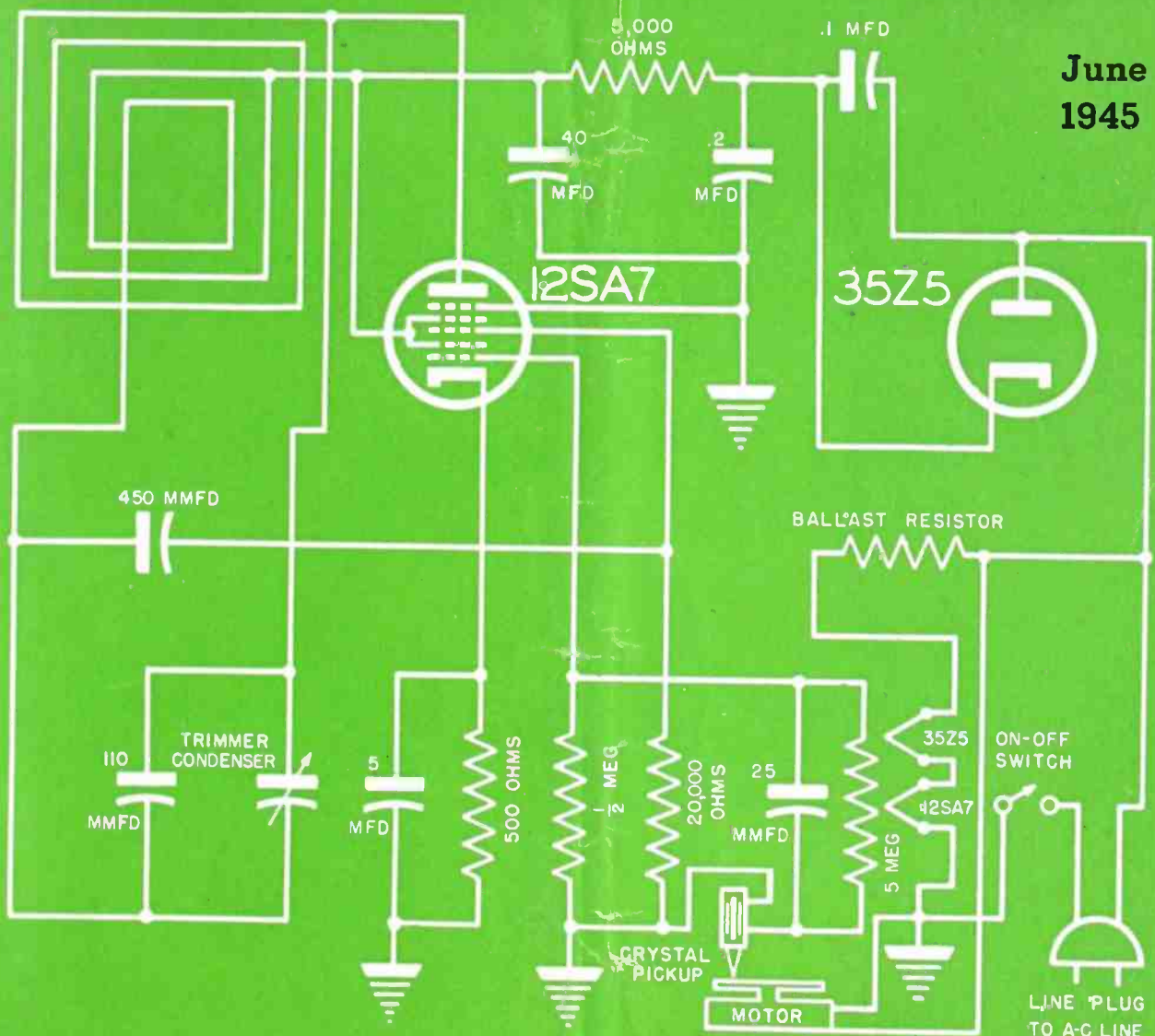

Simplified wireless record player using Hartley circuit with a 12SA7 as an oscillator-modulator. (See page 39.)

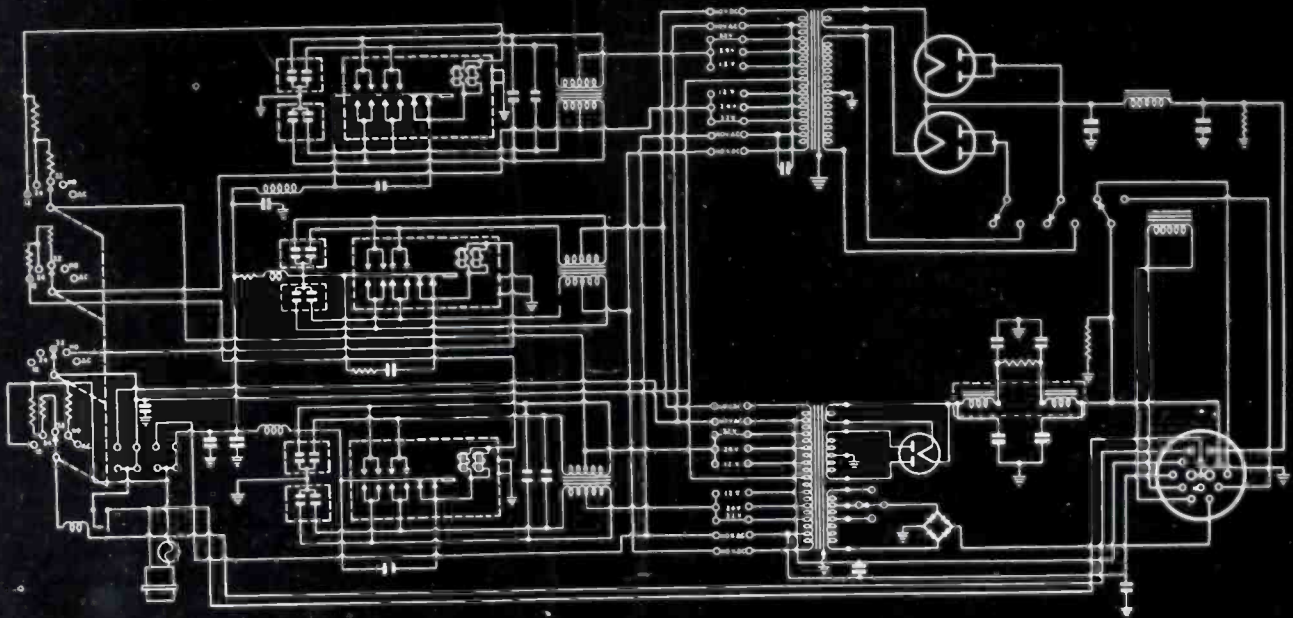

EL DEVELOPMENTS PROVIDE MULTIPLE INPUTS AND OUTPUTS IN VIBRATOR POWER SUPPLIES

● Electronic Laboratories has greatly increased the flexibility of power supply design and versatility of power conversion circuits, through special new developments during the war period. One of these, resulting from intensified research to meet military needs, is vibrator power equipment capable of delivering various voltages, currents and frequencies from a variety of input voltages. This naturally has vastly broadened the field for vibrator power conversion equipment.

The typical circuit diagram shown above illustrates a multiple input and output system. This power unit is designed to be operated from either 12, 24, or 32 volts from storage batteries, or 110 volt DC or AC power lines. Various outputs are available to supply the high voltage plate current required for the grid, and the AC voltages suitable for operation of the filaments. In addition, a source of alternating current power for the operation of the automatic tuning system which is incorporated in this unit, has been provided. There is a current division system associated with the contacts of the vibrators and the circuit is so designed that the phase displacement provides equivalent performance of a two-phase rectifier system, assuring low

hum level with a minimum amount of filter.

During the war period, *EL* has designed many other similar units having a multiplicity of input and output voltages. In addition to DC sources, in many cases, AC sources of any frequency between 18 and 180 cycles have been made available to meet specific engineering problems.

The requirements for power equipment reach into many fields as war born inventions are applied to postwar needs. *EL* Vibrator Power Supplies will have wide application because they are the most economical, efficient and versatile means of solving the many power supply problems that will arise. Electronic engineers will soon be at your service to help meet the power requirements presented by postwar industry.

EL STANDARD POWER SUPPLY MODEL 1200

This EL unit is a typical Vibrator Power Supply with multiple inputs and outputs and was designed for transmitter and receiver use. Inputs: 12 volts DC, 24 volts DC, 32 volts DC, 110 volts DC and 110 volts AC, 50-60 cycles; Outputs: 600 volts DC at 150-250 MA; 300 volts DC at 75-150 MA; 6-8 or 10 volts DC at 1 amp.; and 110 volts AC (50-60 cycles) at 75 watts. Dimensions: 26-1/16" x 15" x 13-9/16". Weight: 160 pounds.



Electronic

LABORATORIES INC.
INDIANAPOLIS

VIBRATOR POWER SUPPLIES FOR LIGHTING, COMMUNICATIONS, ELECTRIC MOTOR OPERATION • ELECTRIC, ELECTRONIC AND OTHER EQUIPMENT

KEN-RAD

METAL TUBES



Better Than Ever

In homes everywhere, Ken-Rad Metal Tubes serve by keeping alive radio's entertaining voice . . . These rugged, self-shielding tubes—now *better than ever* because of added great new facilities—tomorrow will help furnish greater enjoyment for listening millions . . . making the Ken-Rad franchise still more desirable and profitable.

Write for your copy of
"Essential Characteristics"
the most complete digest of tube
information available.

176-D3-8850

KEN-RAD

OWENSBORO, KENTUCKY

WHEN, three years ago, Service Men learned that many types of parts and tubes would not be made because of war demands, the future did not appear too bright. Repairs without these parts or tubes appeared impossible to some. But to many it was a challenge. The past three years proved that the challenge was met quite vigorously with the development of countless circuit innovations and substitution methods.

Today, still faced by shortages, Service Men have a host of solutions that can be applied to many problems. And experts continue to probe problems and offer unusual circuit improvisations, such as appear on pages 16 and 31 of this issue. The paper by Alfred A. Ghirardi covering the use of resistors in tube substitutions offers an effective series of circuit arrangements and resistor data that will not only expedite repairs, but improve receiver operations. Edward Arthur's analysis of power transformer replacements and substitutions will also be found quite handy in accelerating receiver repairs today.

Service Men, who have studied circuits carefully during the past three years and applied the many necessary substitute changes, have found the practice quite helpful in acquainting them with the variety of circuit peculiarities . . . a knowledge that will come in mighty handy when the complex a-m/f-m/television/phono postwar receivers come off the production line.

IF you haven't begun to study f-m, you'd better do so now, for there is every indication that we will have, soon, a substantial production of f-m receivers. The authoritative FCC say that in the years to come there may be between 50- and 100-million receivers in the hands of the public. That's quite a prediction!

CANADIAN Service Men have done quite a servicing job throughout the Dominion. According to reports received, 95% of the receivers are in operation today. Congratulations Service Men of Canada!

LEWIS WINNER

Editorial Director

ALFRED A. GHIRARDI

Advisory Editor

F. WALEN

Managing Editor

	Page
A 6-Plant Sound System. By Harold Lewis	11
Loudspeaker Additions for Improved Tone Quality. By Willard Moody	20
Power Transformer Replacements and Substitutions. By Edward Arthur	16
Old-Timers' Corner	40
Ser-Cuits. By Henry Howard	26
Servicing Helps	38
Use of Resistors in Tube Substitutions. By Alfred A. Ghirardi	31
Volume Control Circuits. By Robert L. Martin	22
Circuits	
Hallicrafters S-36	28
RCA VHR-212	28
Scott F-M Tuner	26
Cover	
Emerson CJ-449 (Wireless Record Player)	39
Servicing Helps	
Emerson 255	38
Emerson CJ-449 (Cover)	39
Motorola 9-44, 9-49	38
Silvertone 1970	38
Index to Advertisers	
	48
Manufacturers	
News	42
New Products	45
Jots and Flashes	48

Copyright, 1945, Bryan Davis Publishing Co., Inc.

Published monthly by Bryan Davis Publishing Co., Inc.

52 Vanderbilt Avenue, New York 17, N. Y. Telephone MUrray Hill 4-0170



Bryan S. Davis, President

Paul S. Weil, Vice Pres.-Gen. Mgr.

James C. Munn, 10515 Wilbur Avenue, Cleveland 6, Ohio; Telephone SWEetbriar 0052

Pacific Coast Representative: Brand & Brand, 816 W. Fifth St., Los Angeles 13, Calif.; Telephone MICHigan 1732



F. Walen, Secretary

A. Goebel, Circulation Manager

Entered as second-class matter June 14, 1932, at the Post Office at New York, N. Y., under the Act of March 3, 1879. Subscription price: \$2.00 per year in the United States of America and Canada; 25 cents per copy. \$3.00 per year in foreign countries; 35 cents per copy.



OWI uses RAYTHEON tubes
IN UNIQUE MOBILE RECORDER

● This "traveling recording studio" of the Office of War Information has everything for making recorded pickups for broadcasting on international short wave. Such important equipment must be the finest that science can provide, so Raytheon High-Fidelity Tubes are used to assure the highest quality reception.

Wherever they are employed, Raytheon Tubes live up to their reputation for fine performance. That is why they are first choice among electronic engineers planning post-war products . . . and first choice among radio service-dealers who are building soundly for the future.

There's a real promise of greater profits and greater customer-satisfaction for service-dealers who feature Raytheon Tubes. And there's a revolutionary Raytheon merchandising program planned, too . . . to help you be more successful than ever before.

Switch to Raytheon Tubes now!

Increased turnover and profits, plus easier stock control, are benefits which you may enjoy as a result of the Raytheon standardized tube type program, which is part of our continued planning for the future.

Raytheon Manufacturing Company
 RADIO RECEIVING TUBE DIVISION

Newton, Mass. • Los Angeles • New York • Chicago • Atlanta



All Four Divisions Have Been Awarded
 Army-Navy "E" With Stars

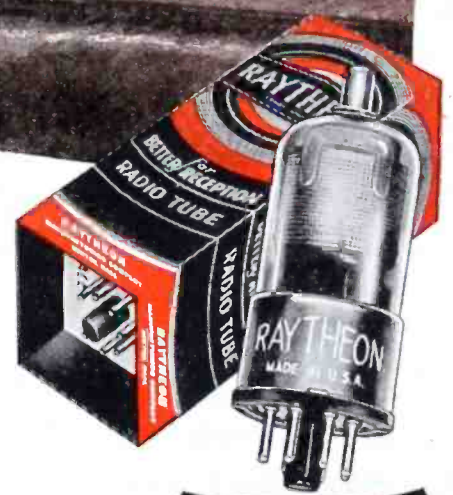

Listen to
"MEET YOUR NAVY"
 Every Saturday Night
AMERICAN BROADCASTING CO.
 Coast to Coast
 181 Stations

RAYTHEON
High Fidelity

ELECTRONIC AND RADIO TUBES



DEVOTED TO RESEARCH AND THE MANUFACTURE OF TUBES FOR THE NEW ERA OF ELECTRONICS

SMALL ASSEMBLY FASTENING *improved* with *Cherry Blind Rivets*

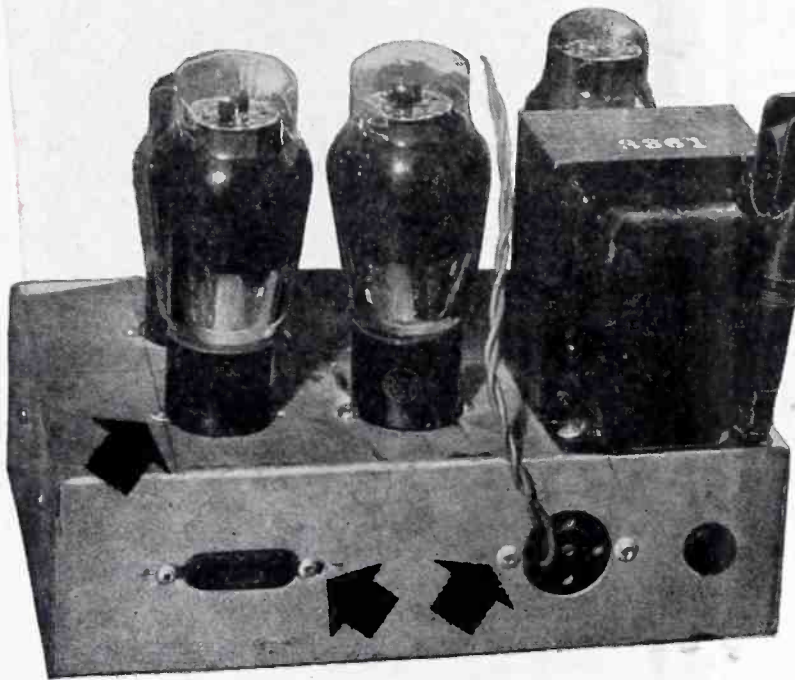

Arrows indicate Cherry Rivets

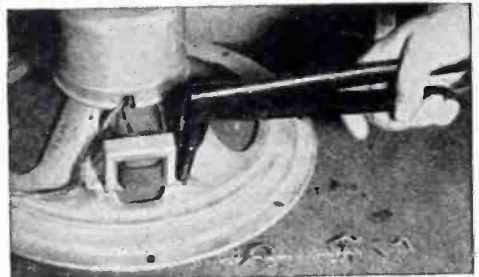

Fastening output transformer to cone speaker with G-25 gun.



Compact G-35 gun gets into crowded areas easily.

Your present method of fastening small assemblies can be improved by using Cherry Blind Rivets, because these rivets can be installed from one side of any blind or crowded spot by one workman without any bucking. They are upset with a pull, making them ideal for delicate, light work . . . are applied with small, lightweight guns, making it easy to get at tough locations. Cherry Rivets are manufactured in self-plugging and hollow types, with several head styles, diameters and grip lengths . . . have generous material thickness and grip length tolerances . . . have unusual shank expansion and exert exceptional clinching force . . . upset in bends, curves, tubes, all sheet metals, fabric, leather, rubber and many other soft or brittle materials.

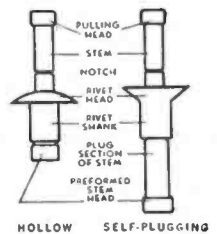

For a quick picture of Cherry Rivet advantages and uses, write for Manual D-45 and metal demonstration panel, Dept. A-268, Cherry Rivet Company, 231 Winston Street, Los Angeles 13, Calif.

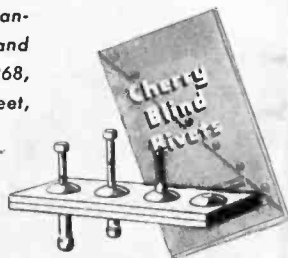

CHERRY RIVETS. THEIR MANUFACTURE & APPLICATION ARE COVERED BY U. S. PATENTS ISSUED & PENDING

Cherry Rivet

Company
LOS ANGELES, CALIFORNIA

VITAMIN-Q

REG. U. S. PAT. OFF.



Ever Hear of It?

VITAMIN Q is an exclusive Sprague Electric Co. oil impregnant for capacitors that results in exceptional performance where thousands of volts and temperatures as high as 105° C. or as low as -40° C. are involved. Leakage resistance at room temperature is 20,000 megohms for one microfarad—or at least 5 times better than previous types!

This is only one of the many engineering and production achievements that have helped make Sprague a five-time winner of the coveted Army-Navy "E" award. And it is one that indicates plainer than mere words that, as always,

you can rely on Sprague for the finest, most modern engineering in ANY capacitor type for radio service, amateur or experimental work.

ATTENTION TRADING POST USERS!

Our free wartime advertising service, THE SPRAGUE TRADING POST, will be found on another page in this issue. It will continue as long as there is a need for this unique method of selling or buying hard-to-get radio things.

SPRAGUE PRODUCTS COMPANY
North Adams, Mass.

(Jobber Sales Organization for Products of the Sprague Electric Co.)



SPRAGUE

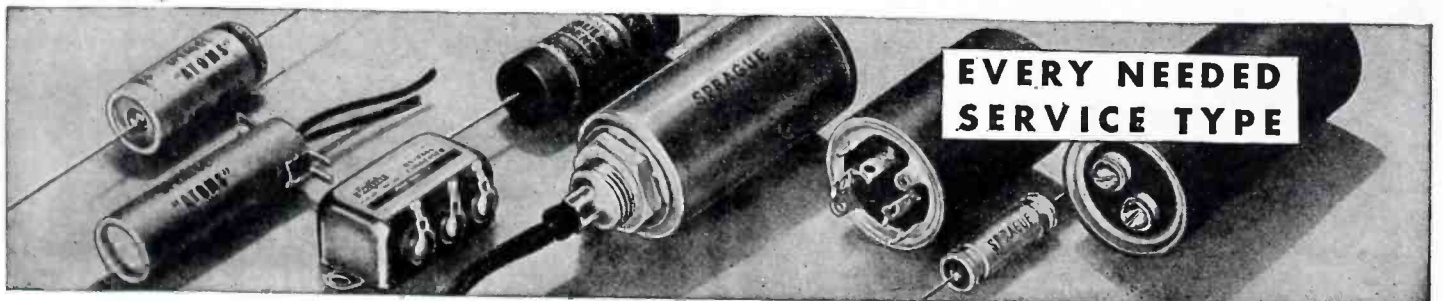

**EVERY NEEDED
SERVICE TYPE**

"The Radio Man's Radio..."



Hallicrafters is establishing a world-wide reputation as the builder of "the radio man's radio." More than 68,000,000 people are reading of Hallicrafters achievements in amateur magazines, in electronics and communications trade papers and in other publications. To hundreds of thousands of radio men in all branches of the service the word Hallicrafters means rugged dependability, extraordinary performance and amazing versatility. They, together with discriminating buyers everywhere, are looking forward to the day when they can obtain a Hallicrafters set—"the radio man's radio..."

hallicrafters RADIO

THE HALLICRAFTERS COMPANY, MANUFACTURERS OF RADIO AND ELECTRONIC EQUIPMENT • CHICAGO 16, U. S. A.



BUY A WAR BOND TODAY!





THORDARSON

*celebrates its 50th. Anniversary
by joining hands with*

MAGUIRE INDUSTRIES

A
GREAT PAST
LINKED TO

A
GREATER
FUTURE
1895 - 1945

Throughout the past half century, the name "THORDARSON" has been a synonym for highest quality in transformers and other electrical equipment.

Under the banner of Maguire Industries, this tradition of leadership will be maintained in even fuller measure.

Thordarson's new plans include outstanding improvements in present lines... new products and services to meet the expanding needs of the radio and electronic industries... vigorous and liberal merchandising policies... and a generally forward-looking viewpoint with regard to all of the industries we are privileged to serve.



A Subsidiary of Maguire Industries

THORDARSON
ELECTRIC MFG. COMPANY
500 WEST HURON STREET
CHICAGO 10, ILLINOIS



PAYROLL SAVINGS PLAN

NAME	NO.	DATE	AMOUNT	TOTAL	REMARKS

NOW'S THE TIME FOR

Your BIG "MOP-UP"!

RE-SOLICITATION is the keynote for a victorious "mop up" in the Mighty 7th War Loan. Bond rallies plus continuous competition between departments help to keep Bond subscriptions on a quota-topping climb. Strategic poster displays . . . showings of "Mr. & Mrs. America," the Treasury film . . . distribution of the War Finance Booklet, "How To Get There," and the handy Bond-holding envelopes play an important part. But, above all else, arrange to have

every employee asked *once more*—and personally urged *once more*—to meet his personal quota in the Mighty 7th!

The Payroll Savings Plan is the mainstay of every War Loan—meeting your plant quota is vital to the success of the 7th! Remember we have to make two drives in 1945 do the work of three last year. Put on an intensive "mop up" final to help mop up the Japs, cut the tentacles of inflation—and lay the foundation of security.

The Treasury Department acknowledges with appreciation the publication of this message by

SERVICE



★ This is an official U. S. Treasury advertisement prepared under the auspices of Treasury Department and War Advertising Council ★

IT'S FUN to live and work in MT. CARMEL, ILL.

Johnny Beauchamp, a supervisor at the Meissner factory in Mt. Carmel, is typical of Meissner's *precision-el*. The camera has recorded Johnny's day . . . a combination of work and play that's a big reason for the high quality you'll find in Meissner products—"precision-built by *precision-el*."



Here's Johnny at work. He's "tops" with subordinates because he's never too busy to give the other fellow a "lift" . . . help make the job easier.



A five-minute walk at noon takes Johnny home for lunch. Usually Connie Sue, his 6-year-old daughter, meets him at the corner. Johnny owns his own bungalow in this attractive section of Mt. Carmel.



There's a smile on his face as he leaves the factory at 4 p. m., but smiles are the rule, *precision-el* . . . ten



minutes later he's ready to apply Meissner precision to the golf game that has won him several trophies.



Flying is another of Johnny's hobbies. He and other members of Meissner's *precision-el* have organized the Mt. Carmel Flying Club, built a hangar, laid out the field. Here a group listens to a student being briefed before the takeoff.



Like most fathers, Johnny finds the baby more interesting than a tender morsel of chicken. After dinner, Johnny may go back to the plant to work out the following day's schedule.

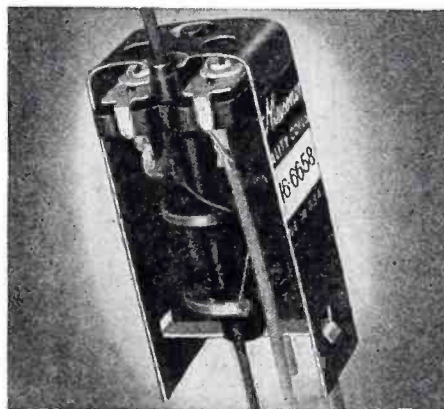

"Step Up" Old Receivers!

These Meissner Ferrocart I. F. input and output transformers are getting top results in stepping up performance of old worn receivers. Special powdered iron core permits higher "Q" with a resultant increase in selectivity and gain, now available for frequency range 127-206. Ask for numbers 16-5728 input, 16-5730 output. List \$2.20 each.



MEISSNER

MANUFACTURING COMPANY • MT. CARMEL, ILL.

ADVANCED ELECTRONIC RESEARCH AND MANUFACTURE

Export Division: 25 Warren St., New York; Cable: Simontrice

SYLVANIA NEWS

RADIO SERVICE EDITION

JUNE

Published by SYLVANIA ELECTRIC PRODUCTS INC., Emporium, Pa.

1945

SYLVANIA SERVICEMAN SERVICE

by
FRANK FAX



As another service to servicemen, and in further support of Sylvania's big advertising campaign designed to broaden the postwar radio market, Sylvania Electric is widely distributing to the public the new booklet "They Know What They Want."

In it the radio serviceman will find the answers to questions concerning Television, F.M., how many people are planning to buy new radios after the war, and many more — giving him a variety of pertinent facts that are bound to bear directly upon his future welfare.

In addition, "They Know What They Want" is being widely circulated to consumers in response to inquiries stimulated by the questionnaire-type advertisements appearing in national magazines — advertisements through which Sylvania Electric is continuing its study of public preferences in radio. This general distribution is expected to maintain popular interest in postwar radio sets — an interest that will gradually influence the number of sets that will need servicing in the postwar years to come.

Send for your copy now.

NEW BOOKLET SUMMARIZES AND STIMULATES POSTWAR RADIO MARKET

Servicemen Can Obtain Helpful Information On National Radio Trends

Here is a booklet that gives a handy summary of the public's postwar radio wants—a result of Sylvania's nationwide survey and questionnaire-type advertisements. Copies for servicemen are available on request—*Sylvania Electric Products Inc., Emporium, Pa.*

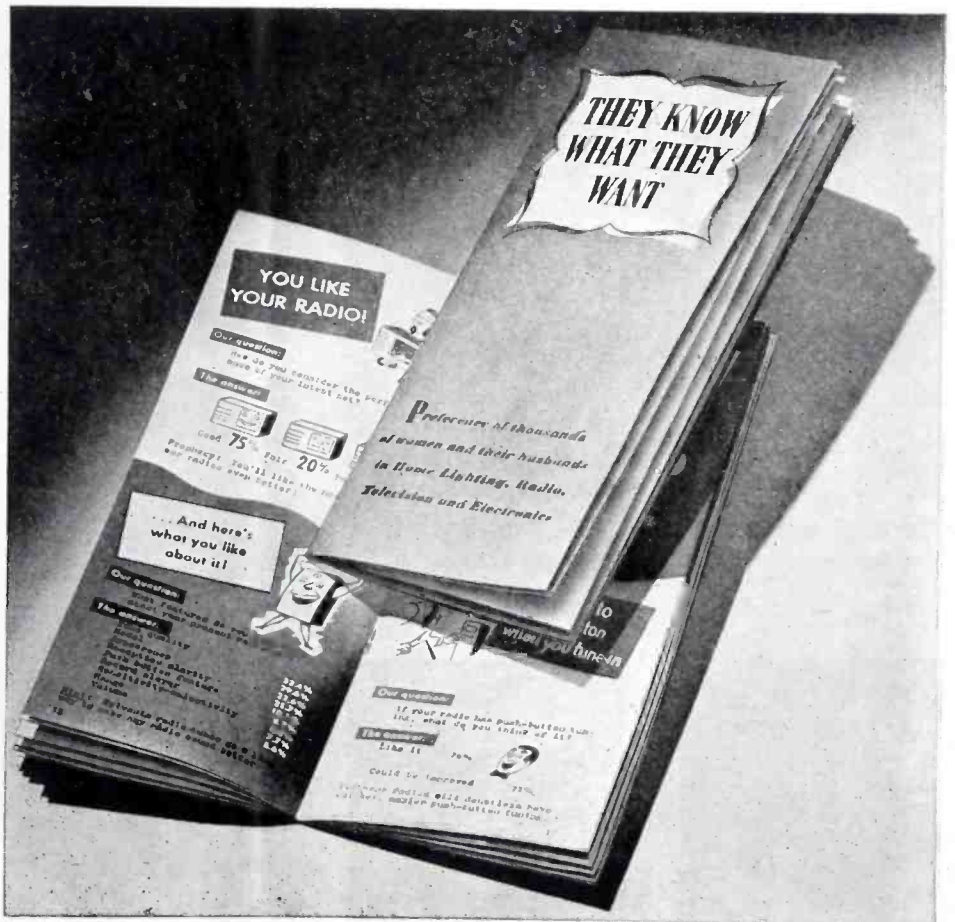

SYLVANIA ELECTRIC

Emporium, Pa.

MAKERS OF RADIO TUBES: CATHODE RAY TUBES: ELECTRONIC DEVICES: FLUORESCENT LAMPS, FIXTURES, ACCESSORIES: ELECTRIC LIGHT BULBS.

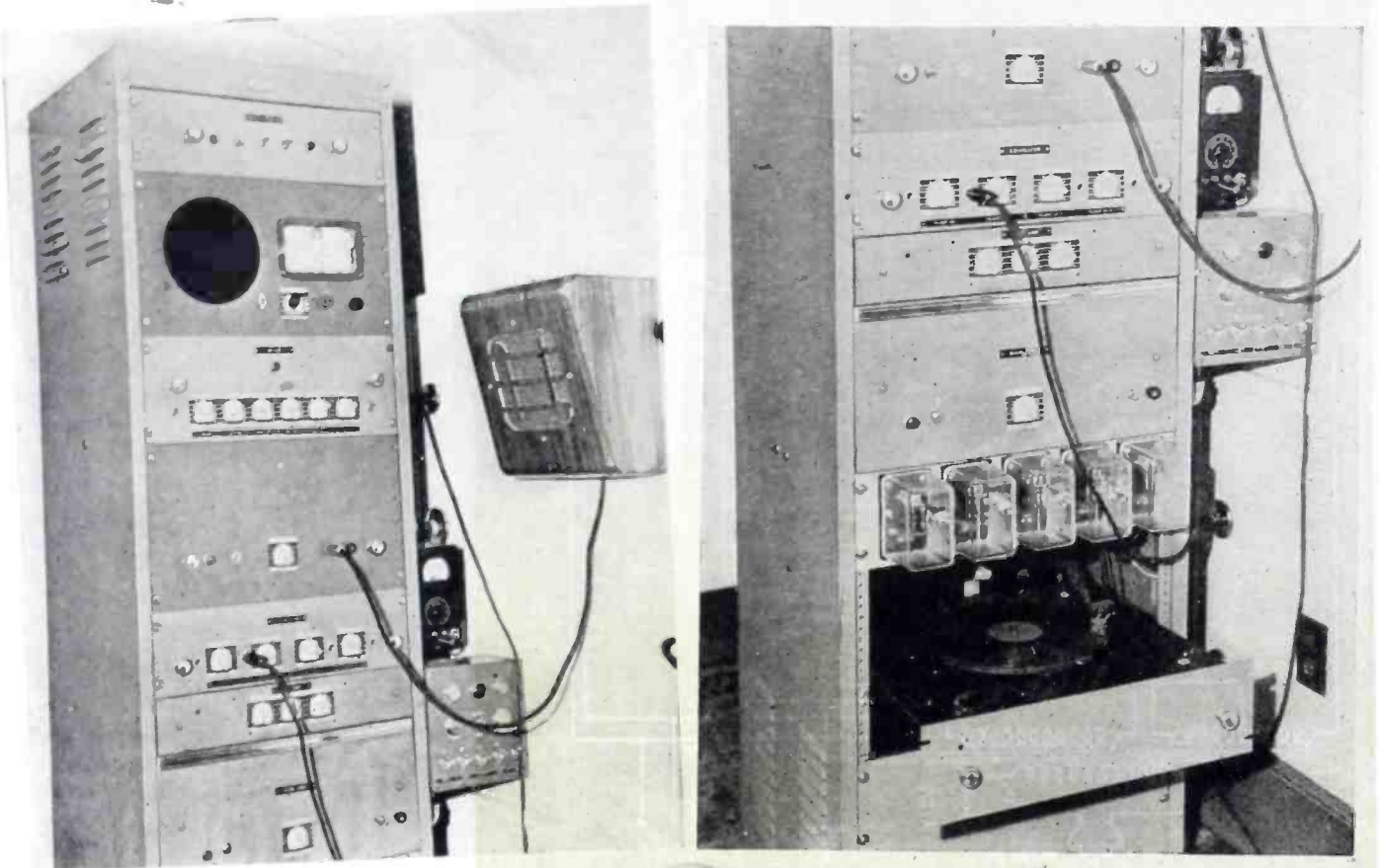

A 6 - P L A N T S O U N D S Y S T E M

IN recent issues of SERVICE, the increased importance of sound has been stressed in editorials and articles. Both editorials and articles have pointed out that sound work provides an excellent source of added income to the Service Man, and is well suited to his talents. My own experiences have proved these facts to be quite true. For I have found that sound

by **HAROLD LEWIS**

*Sound Maintenance
Pollak Manufacturing Company*

activities may even exceed straight service work as a source of income.

I have had occasion to use my sound knowledge in installing and servicing many interesting sound systems. In

my present post, my sound knowledge has come in mighty handy, for the sound system which I help to maintain runs through six plants, with a complement of nearly 5,000 employees.

Central Feed Room

The entire system controlled from a room 10' x 10', employs an unusual assortment of equipment. For instance, a rack cabinet houses an 800-cycle signal generator, b-c radio tuner, nine-channel mixer, ten-watt booster amplifier, four-channel equalizer to match 600-ohm telephone lines, 60-watt amplifier including a 4-stage preamplifier, two-speed turntable accommodating 16" records and telephone type trans-

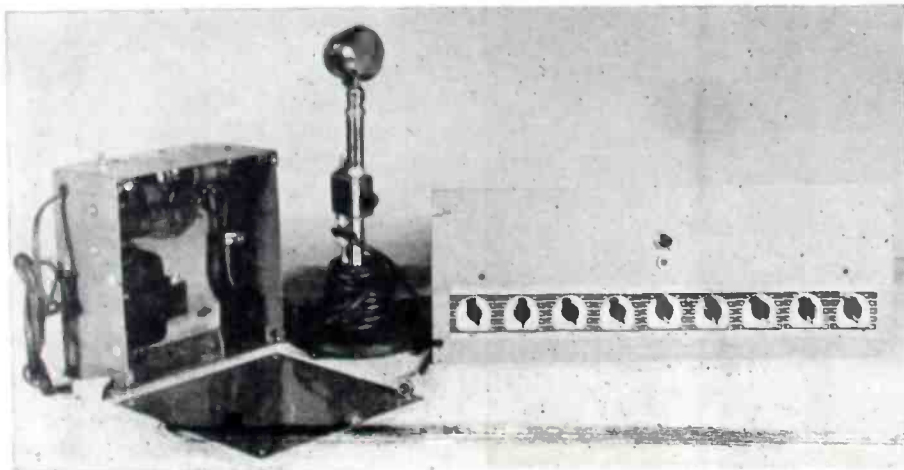

Figs. 1 (top, left), 2 (top, right) and 3 (left)

Figs. 1 and 2. Top and bottom views of the amplifier-receiver rack. Two-speed turntable accommodates 16" records. Receiver covers broadcast-band only. . . . Fig. 3. Front view of the channel selector, pre-amplifier and microphones.

former boxes (known to phone men as subscriber boxes).

Incidentally this equipment is in plant 1, a half mile away from plant 2; 3 miles away from plants 3, 4 and 5; and 1½ miles from plant 6.

Signal Generator

The signal generator, a commercially built unit (Maco), plays an important role in the system. It generates an 800-cycle signal during emergencies, such as fire.

Three tubes are used: 7Q7, 6F6, and 5Y3. Signal control is by means of a toggle switch. Since heater tubes are used, the unit must be turned on prior to use to allow for heating time. An automatic time clock is used for this purpose. The clock has a large dial face, with its circumference encircled by two rows of holes. These holes accommodate small pins which are used to set the timing mechanism, within 5-minute intervals. The pins, in turn, contact micro switches which open the switch on the signal generator, whose output is fed to a 60-watt amplifier. The micro switches also operate a-c relays which turn on the signal generator 5 minutes before the signal is transmitted.

Nine Channel Mixer

The nine-channel mixer is quite an unusual piece of apparatus. It provides 1 channel for radio and phono; 1 channel for Muzak, which is piped in from New York, 15 miles away; 1 channel for redistribution of orchestral music originating in plant 6 cafeteria to all the other plants at noontime; 3 paging channels; 1 channel for news, given twice a day; and 2 channels to a conference room, from which originate talks by the president of the company, visiting army and navy personnel, or religious or holiday programs.

The radio, phono, and Muzak channels use single-stage amplifiers with 1620 tubes. Microphone channels are 2-stage amplifiers with 1620 tubes.

10-Watt Booster Amplifier

For booster work a 10-watt amplifier (Webster B. A. 10) is used. Tubes used are: 6J7, 6N7, 5V4 and 2-6V6. A 50-ohm output terminal connection feeds into four-line transformer primaries. Each of the primaries have an impedance of 200 ohms, connected in parallel to match the 50-ohm output.

Telephone operators operate a separate paging board, which has a mike channel. Operators also control Musak every 20 minutes on the hour.

Since no musical programs feed into the offices, a 6N5 magic eye is used to

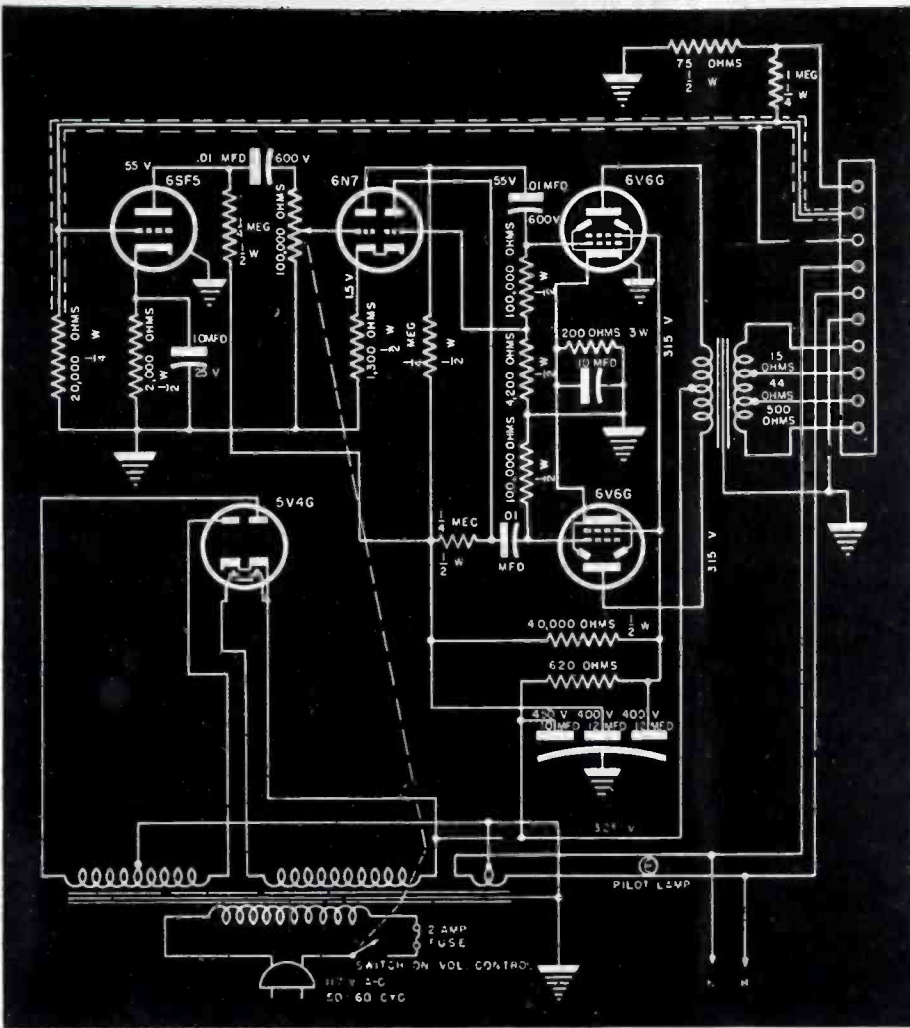

Figs. 4 (top) and 5 (bottom)
Fig. 4. Ten-watt booster amplifier (Webster BA-10). . . Fig. 5. Preamplifier (Webster W-531, 571-2) with jumpers to 60-watt amplifier.

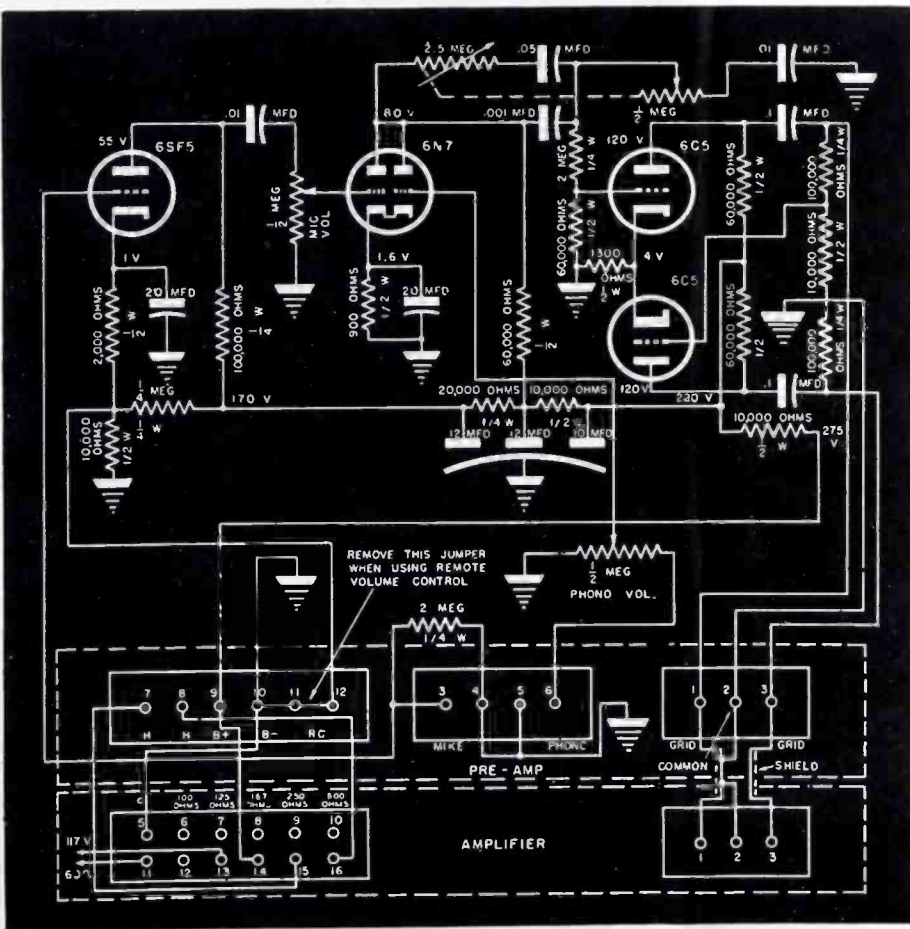

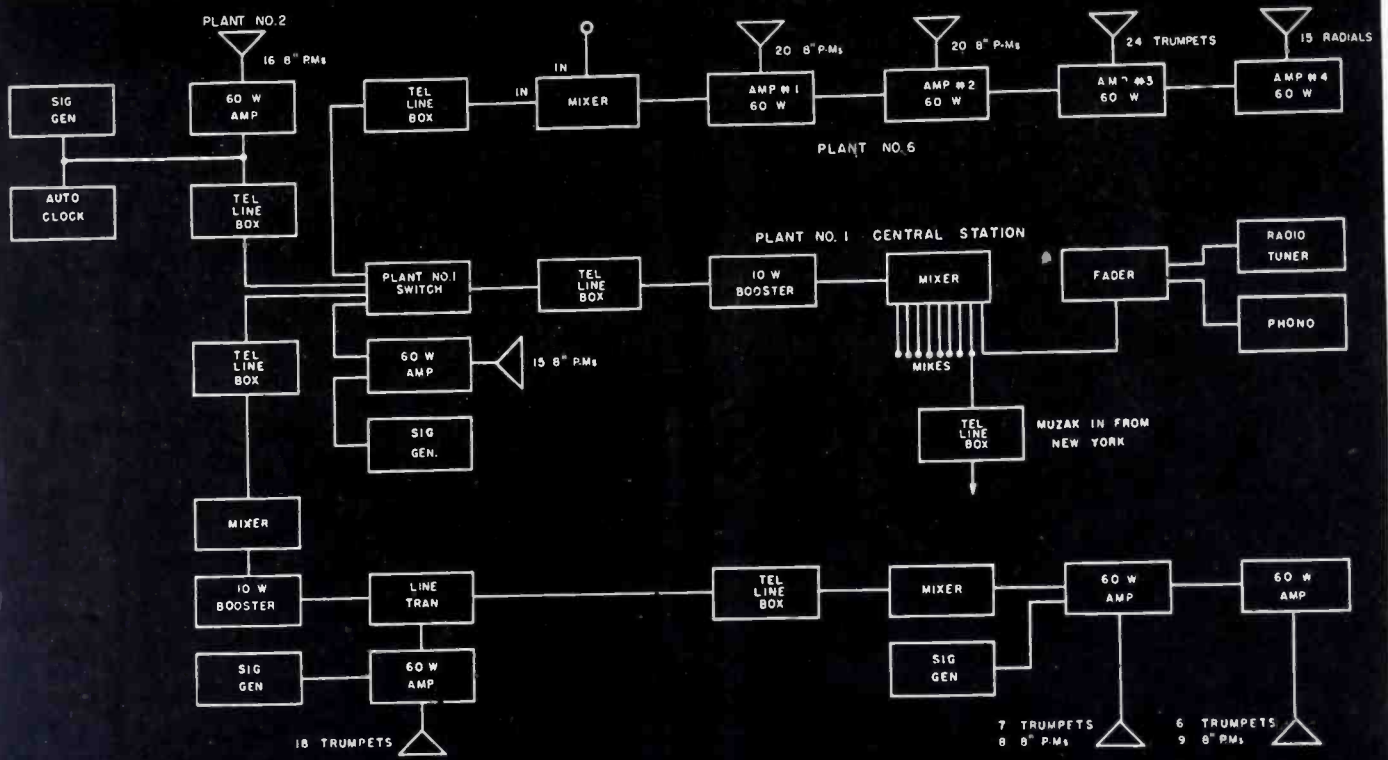

Fig. 6
Block diagram of plant 1 (central station) -
plant 2 - plant 6 installation.

tion master is used on seventeen remote stations. Speech origination is possible from these remotes. We also have a system using eight twelve-position masters, and five six-station

Fig. 7
Nine channel mixer.

masters. In plant 6, the largest of all the plants, the maintenance department operates a four-station unit, one being particularly remote, 600' away in the boiler room. These are not originating stations, as it was found that straight pickup from the originating remote lines impressed upon the first two in the master, acting as a detector with plenty of interference. However, a buzzer was used so the remote could

indicate Muzak operation to the operator.

Since all equipment is on continuously, quite a consistent maintenance watch is necessary. Most of the repairs involve tube replacements. Relays must also be watched.

Intercommunication units (Rauland) are used extensively in plant 1 (general offices). In the planning and purchasing department one eighteen-sta-

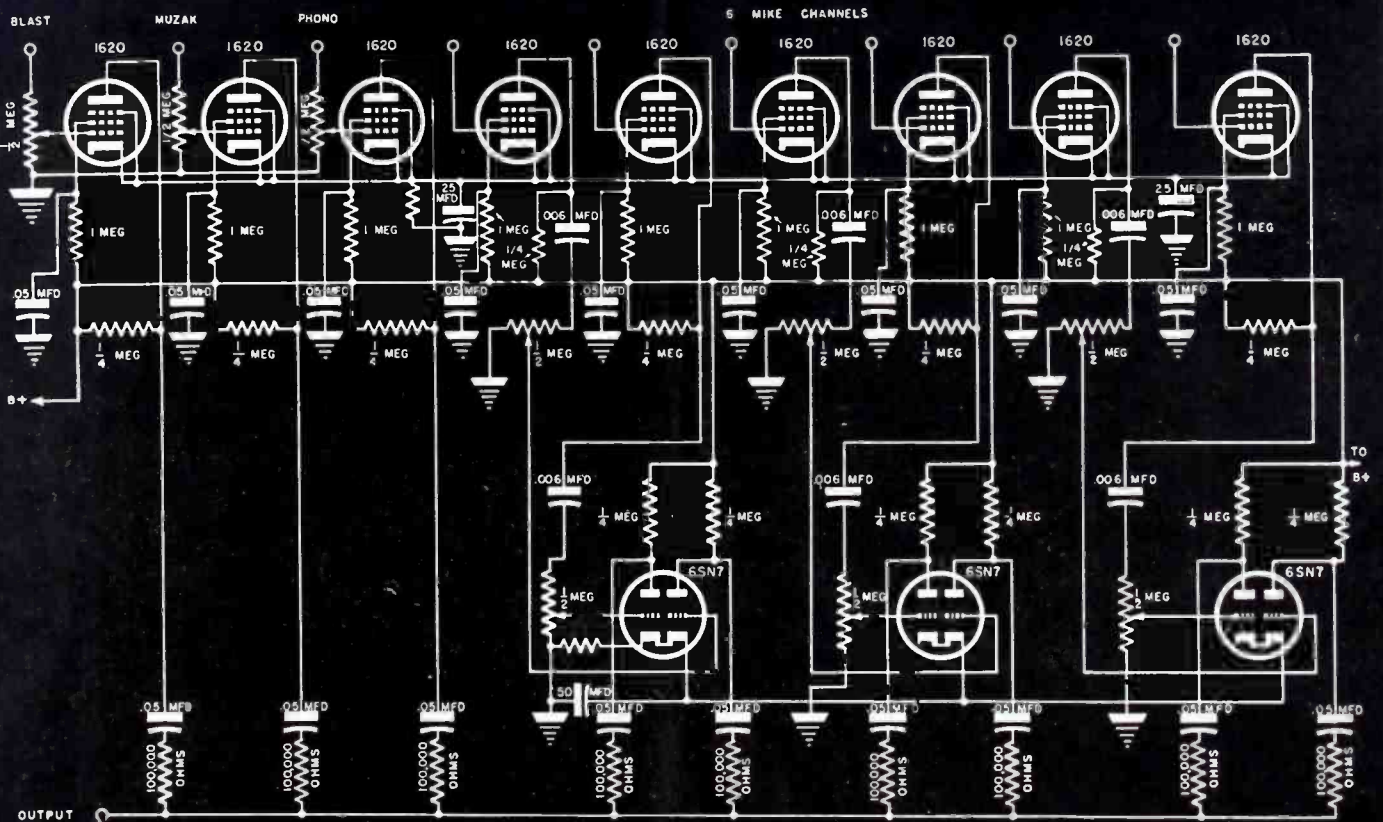

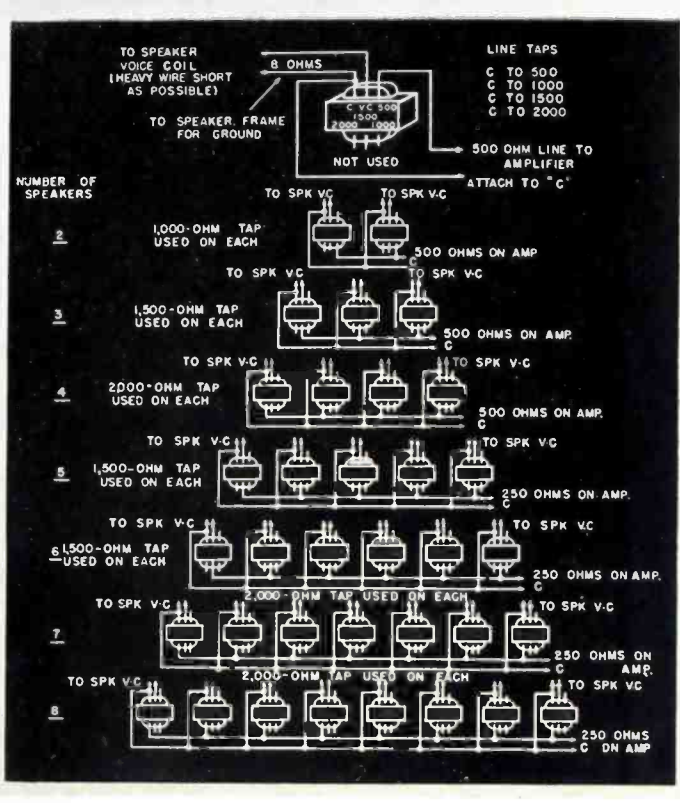
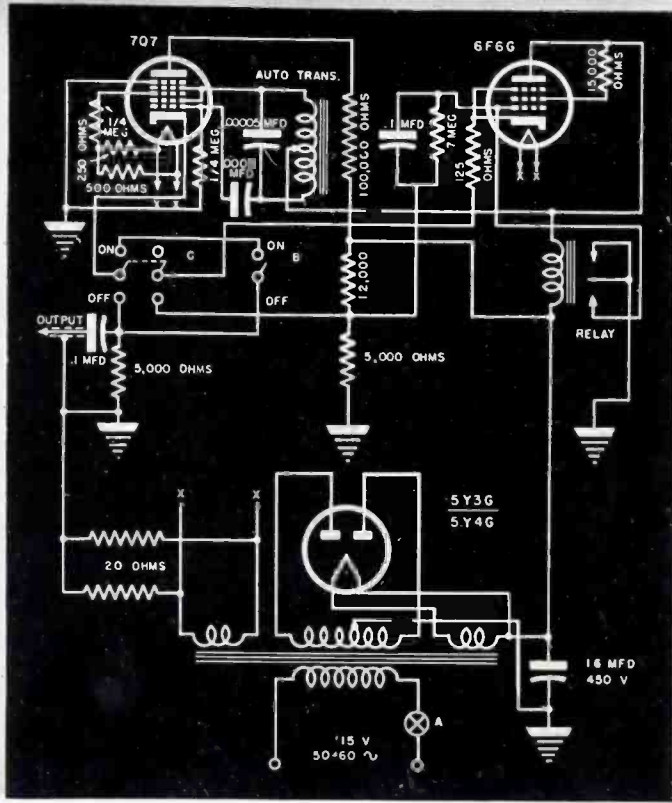

signal the master station. Another intercommunications system is used between the main guardhouse to guard lookout towers surrounding the parking lot.

In plant 2 a twelve-station master is used in the superintendent's office. He

can contact each foreman on each floor through a remote station. In this plant we ran into a real pickup problem; three radio stations, WJZ, WOR, WAAT, all located within an area of ten miles from the plant, leaked through the master station. The pag-

Figs. 8 (left) and 9 (above)
 Fig. 8. Oscillator used to generate an 800-cycle warning signal during emergencies. Fig. 9. How to connect Webster-Chicago A speaker line matching transformers to speaker input circuits.

ing also leaked through. This interference occurred when all the master buttons were out, much to the chagrin of the superintendent. When any of the buttons were pushed in no interference occurred. The building, constructed of concrete, had been a storage warehouse before the company acquired it. The solution I applied involved opening of the cathode circuit of the 12SF5 output tube. Thus when the desired button was pressed it closed the cathode; that is, with the button out the tube did not operate with this element open.

We have quite an interesting paging and volume-control system. In the foreman's office, on each floor, a ten-watt Clarostat L pad was installed. This permitted individual control on each floor. This is particularly helpful, for some floors are very noisy.

Broadcasting of the orchestra from the cafeteria involved many sound system innovations. A dias, 12' x 17', 18" from the floor, houses the bands. A light-colored drape is used to cover the tile wall in the back of the orchestra. On the right-hand side looking toward the orchestra we have a control room,

(Continued on page 36)

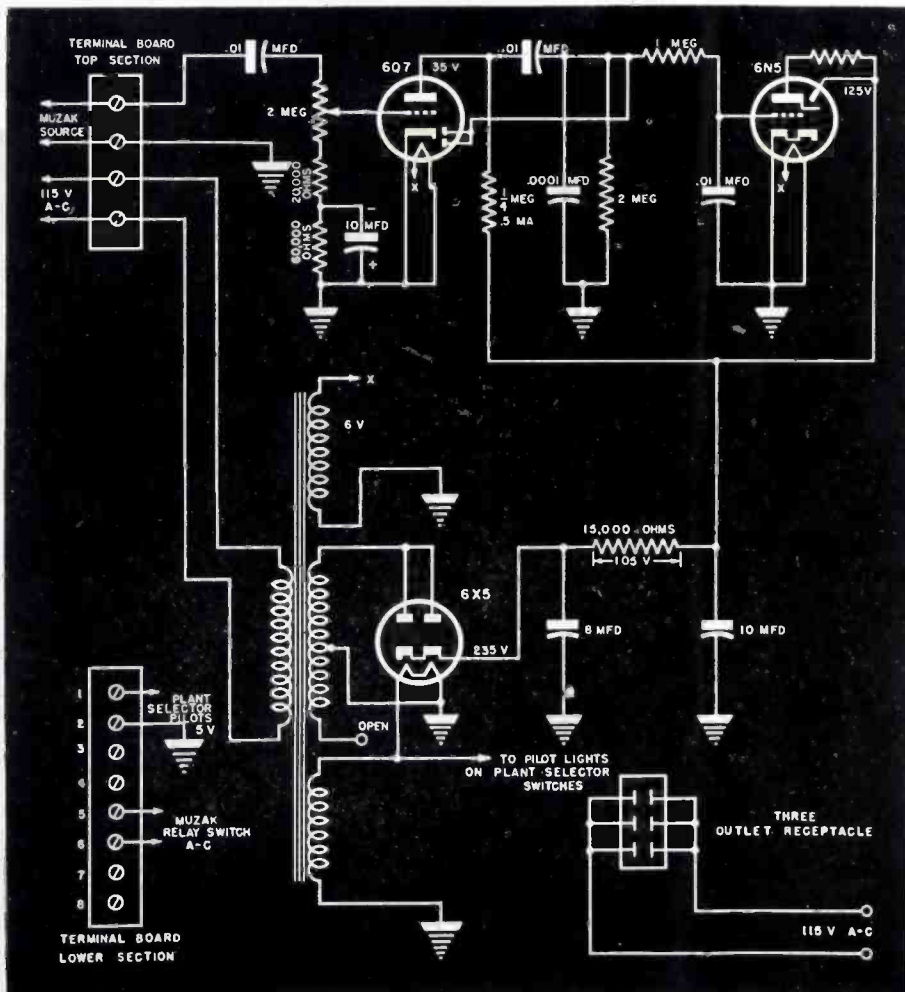

Fig. 10
 Tuning eye indicator circuit used in conjunction with Muzak feed on the paging board. This indicator system indicates Muzak operation. Thus, no external speaker is required for sound-feed notice, eliminating confusion that would result were music and announcements fed to the page-board room.

Feather-light Needle Pressure



IS JUST ONE OF THE FEATURES OF

WEBSTER RECORD CHANGERS

**THE WAR IS NOT
OVER UNTIL FINAL
VICTORY IS WON**

**BUY MORE
WAR BONDS**

NOW

... and

KEEP THEM

Needle pressure of one-ounce or less multiplies record life many times and positively eliminates needle scratch. This is just one of the extra values Webster Record Changers bring to better combinations. Of course, Webster changes records dependably . . . without jamming . . . faster than ever before. Every model has velocity trip. A child can learn the simple operation of Webster Changers in a minute or two. Oversize motors provide adequate power for a full load of records . . . with plenty of torque and without motor rumble. All these advantages are combined in changers of strikingly handsome appearance. Turn tables have beautiful, velvet-soft coverings. You will be wise to look for Webster Record Changers in the combinations you sell. Webster means satisfied customers.

WEBSTER

**ELECTRONICS
DIVISION**



CHICAGO

3825 ARMITAGE AVENUE, CHICAGO 47, ILLINOIS

POWER TRANSFORMER

REPLACEMENTS AND SUBSTITUTIONS

by EDWARD ARTHUR

(In response to many requests, we are presenting another discussion on power transformer replacements and substitutions.—Ed.)

WHEN it is impossible to obtain a replacement transformer, two factors must be considered in effecting a substitution. These are: (1) filament supply; (2) "B" supply.

The filament supply may be obtained in one of three ways.

The first method involves the salvage of the defective power transformer by its conversion to a straight filament transformer. This method can be used only if the defect is in the high voltage winding. When the primary is either shorted or open, repair is quite difficult.

If the high voltage winding is open, it is quite simple to convert the transformer to a filament supply source. For B power some other method of supply must be used, Fig. 1a. If only half of the high voltage winding is open, the other half may be used in a half-wave rectifier circuit, Fig. 1b. However, it does become necessary to double the value of filter condensers in the filter network, to reduce the hum. This is necessary, since the ripple frequency is 60 cycles instead of 120 cycles, as in full-wave circuits, and the filter network is only half as effective. In this rectifier circuit, the rectifier plates are tied together.

If the high-voltage winding is shorted, it is possible to burn out the short by the method shown in Fig. 2. All connections to the transformer are removed. A heavy load resistance is then connected across either the fila-

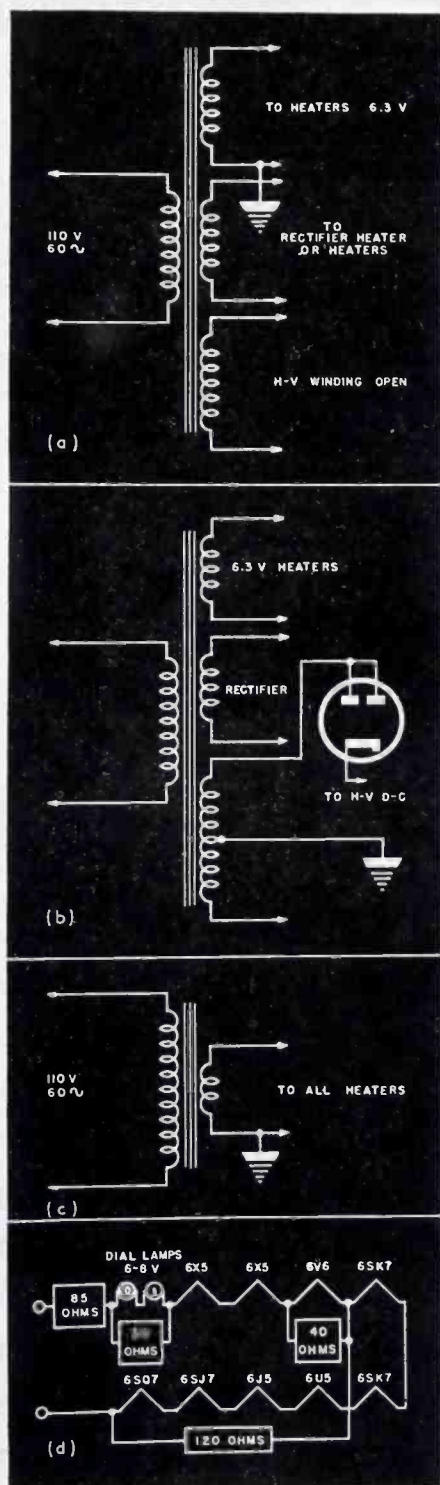

Fig. 1 (a, b, c and d)

In a we have a power transformer circuit where the h-v winding is not used. How to use the good portion of an open-circuited h-v winding in a half-wave rectifier circuit is shown in b. In c we have a circuit of a filament transformer hookup, when no power transformer is available. A typical series-filament conversion hookup for transformerless operation is shown in d.

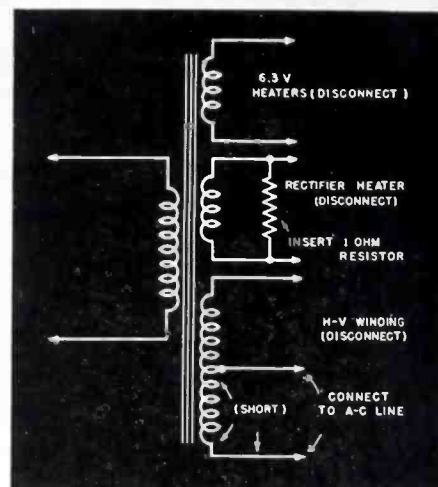

Fig. 2. Procedure applied in opening a h-v winding, one-half of which is shorted. Heavy load imposed on shorted section will usually open defective portion.

ment winding, or the rectifier filament winding, preferably the latter. This resistance should be one ohm or less. The house current is then connected to the high-voltage winding. If only half of the winding is shorted, the house current is connected to the defective portion to burn out the short. The good half of the winding may then be used for the half-wave circuit previously discussed.

In the second method a straight filament transformer is used, Fig. 1c. This type of transformer is usually available in most areas, at low cost. When using a filament transformer, it will be necessary to change the rectifier tube to one which has separate filament and cathode connections. Some representative tubes are listed in Chart 1. It will be found that these types are more readily available than standard receiver types, since they were primarily designed for auto receiver circuits.

As a last resort, series filament cir-

Fig. 3. By properly clipping socket filament leads, power transformer receivers may be quickly converted to series-filament operation.

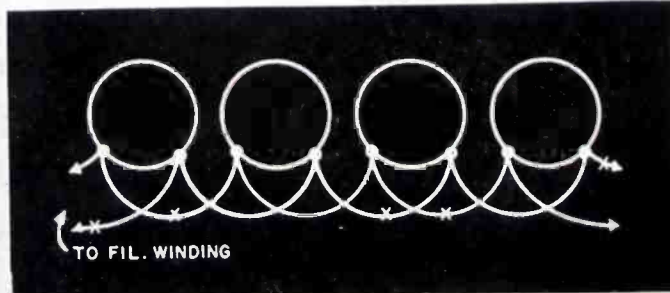

A black and white photograph showing a close-up of a person's foot in a dark, lace-up boot stepping onto a swastika symbol. The swastika is rendered in a 3D, blocky style and is being crushed under the boot's sole. The background is a light-colored, cracked surface, possibly concrete or stone, with a circular shadow cast around the boot.

one step
Nearer...

Smashing the Swastika does not mean total Victory. There is still the Rising Sun to be taken care of . . . But, the victory in Europe is *one step nearer* to conversion to peacetime pursuits.

Here at JENSEN total conversion will be merely a matter of continuing to produce outstanding, improved, high quality acoustic equipment. This is a continuing tradition at JENSEN . . . One example of advancement will be JENSEN Loud Speakers with *ALNICO 5*.



Jensen
SPEAKERS WITH

ALNICO 5

Specialists in Design and Manufacture of Acoustic Equipment

JENSEN RADIO MANUFACTURING COMPANY, 6601 SOUTH LARAMIE AVENUE, CHICAGO 38, ILLINOIS

circuits may be used, identical to those employed in a-c/d-c receivers. Fig. 1d shows a typical example of this technique. The tube lineup consisted of two 6SK7, one 6SJ7, one 6SQ7,

one 6V6, one 5Y3, one 6J5, 6U5 and two pilot lamps (6-8 v). The 5Z3 was replaced with two 6X5 tubes, and the appropriate shunt and series resistors inserted for proper voltage

drops across the tubes.

When rewiring an a-c receiver to series filament, the wiring problem can be reduced by carefully noting the wiring in the set, and clipping the proper wires. This is illustrated in Fig. 3. It is necessary to check the filament wiring to be sure that no grounds or shorts to chassis exist. (It has been a practice in the later prewar models to ground one leg of the filament supply.)

If the primary of the power transformer is open, making the power transformer unusable as such, the high-voltage winding, if it is still good, may be used as a filter choke, where necessary. This may come in handy where the speaker field coil has been used as a choke, and cannot be used in the new layout due to its high resistance. Incidentally the detector filament should always be the one nearest ground, or minus potential, preceded by the converter tube, to reduce the possibility of hum.

When possible, output tubes with lower filament current ratings should be substituted. For example, the 6K6 may replace the 6F6, a 6V6 can be used instead of a 6L6. Since most tubes are of the .3-ampere type, the closer the output tube approaches this value, the easier will be the conversion to series filaments.

Several possible hookups are available for the B supply. When the high-voltage winding cannot be used at all, transformerless operation may be instituted with either straight line voltage rectification, or by the use of a

(Continued on page 35)

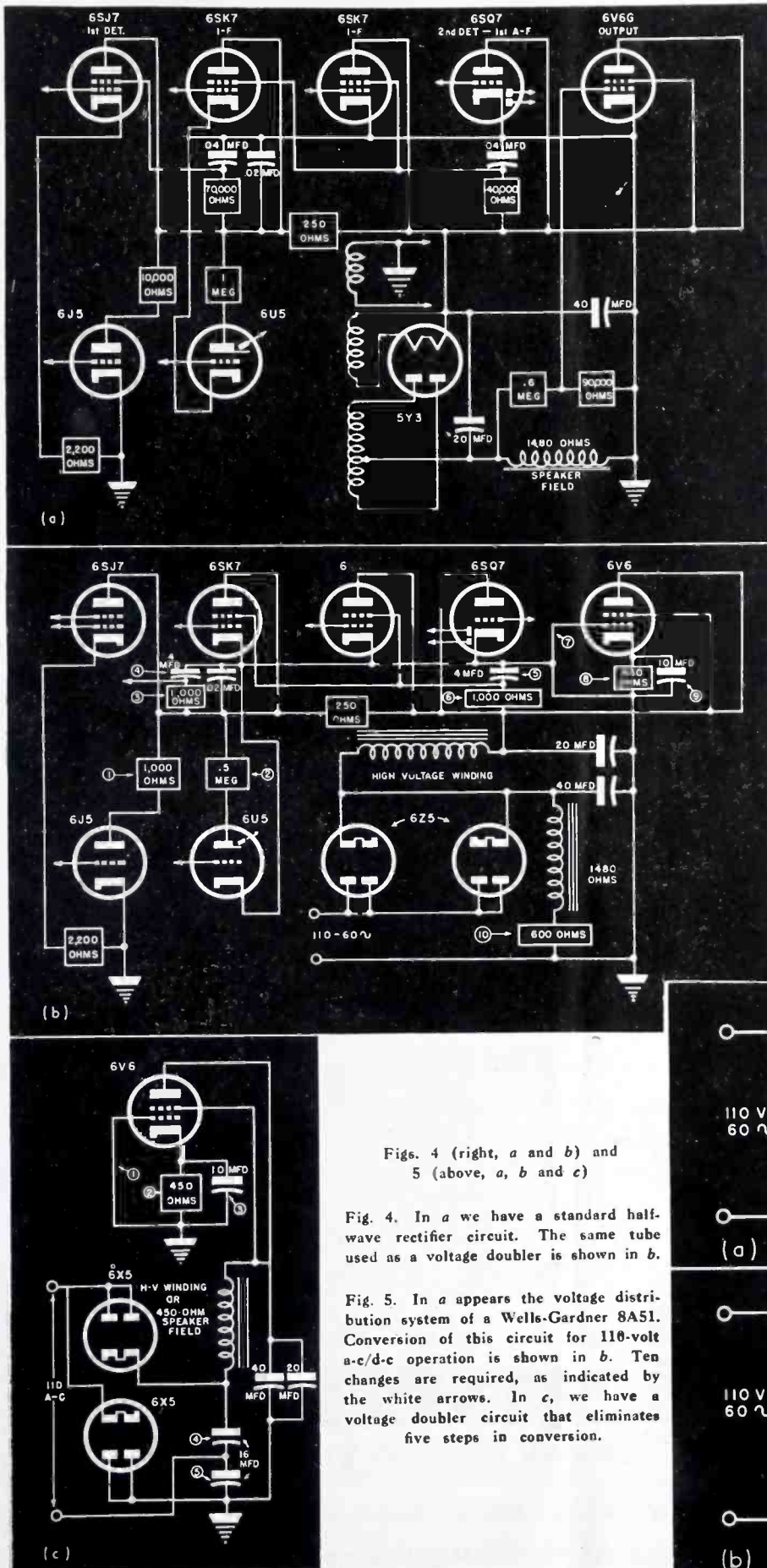

Figs. 4 (right, a and b) and 5 (above, a, b and c)

Fig. 4. In a we have a standard half-wave rectifier circuit. The same tube used as a voltage doubler is shown in b.

Fig. 5. In a appears the voltage distribution system of a Wells-Gardner 8A51. Conversion of this circuit for 110-volt a-c/d-c operation is shown in b. Ten changes are required, as indicated by the white arrows. In c, we have a voltage doubler circuit that eliminates five steps in conversion.

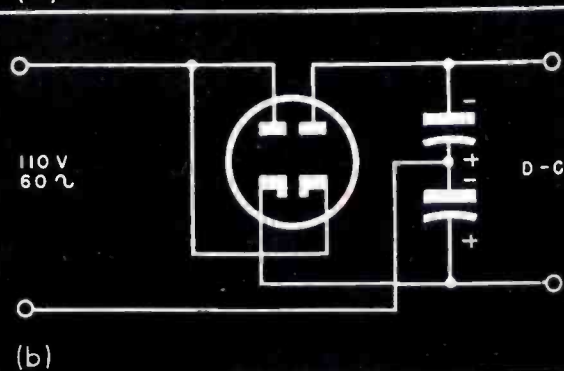
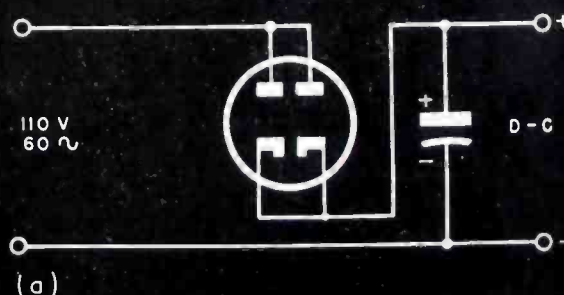

How to Build Reputation For Your Service Business After the War

RCA TUBE ADVANCES THAT MADE RADIO HISTORY



A-C Tubes ... took radio out of the storage-battery stage...made home radio practical for millions more people.



Screen-Grid, Pentode, and Beam-Power Tubes... each helped make radios smaller, more powerful, more satisfying... thus increasing the market for radio sets.



Kinescope and Iconoscope Tubes ... made electronic television possible... helped bring the vast postwar television market years nearer.



Miniature Tubes ... opened up tremendous new markets for portable radios and farm radios... for civilian walkie-talkies after the war.



Metal Tubes ... improved performance, particularly in sets with high-gain circuits... eliminated need for tube shielding... made servicing easier, faster.

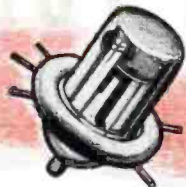

Acorn Tubes ... helped bring FM and television nearer... helped immeasurably in uhf developments prior to the war.



Cathode-Ray Oscilloscope Tubes ... made radio servicing more exact, faster, and more profitable, reducing the number of complaints received by servicemen.



Electron-Ray Tubes ... the "Magic Eye" tuning indicators... added sales appeal to larger radio receivers, and helped the service-dealer "sell up."

Your reputation for servicing is built on two things... your ability to locate trouble and fix sets, and the prestige of the components you use.

Your ability comes first, of course... for your customer's first interest is in how well his set works. But don't forget how much the acceptance of the products you use... particularly the *tubes*... helps build your reputation for fine servicing.

Of all the replacement parts you use, tubes are the most familiar to your customer. If he looks at the set you've serviced, new tubes may be his only *visual* indication of the work you've done.

That's why it's important that the name on those tubes should inspire his confidence... should be immediately acceptable to him.

RCA tubes *are* accepted. Your customers know them, and rate them tops. Why? Because, year after year, the RCA name has been associated with leadership in tubes.

Since the early '20's, RCA has led the field in introducing major tube developments. Look at these examples... tube developments introduced and put across by hard-hitting RCA promotion and advertising... keys to major advances in the radio industry that have made your business become bigger and more profitable.

Developments like these brought prestige to RCA. And RCA, in turn, brings this prestige *to you* every time you display the RCA seal... every time you put an RCA tube in a customer's set. Give your servicing business every break you can after the war. Make the most of your chances with the *best-known name in tubes*.

The Fountainhead of Modern Tube Development is RCA



Listen to
"THE MUSIC AMERICA
LOVES BEST,"
Sundays, 4:30 P. M.
EWT, NBC Network



62-6636-93

RADIO CORPORATION OF AMERICA

RCA VICTOR DIVISION • CAMDEN, NEW JERSEY

LEADS THE WAY... In Radio... Television... Tubes
Phonographs... Records... Electronics

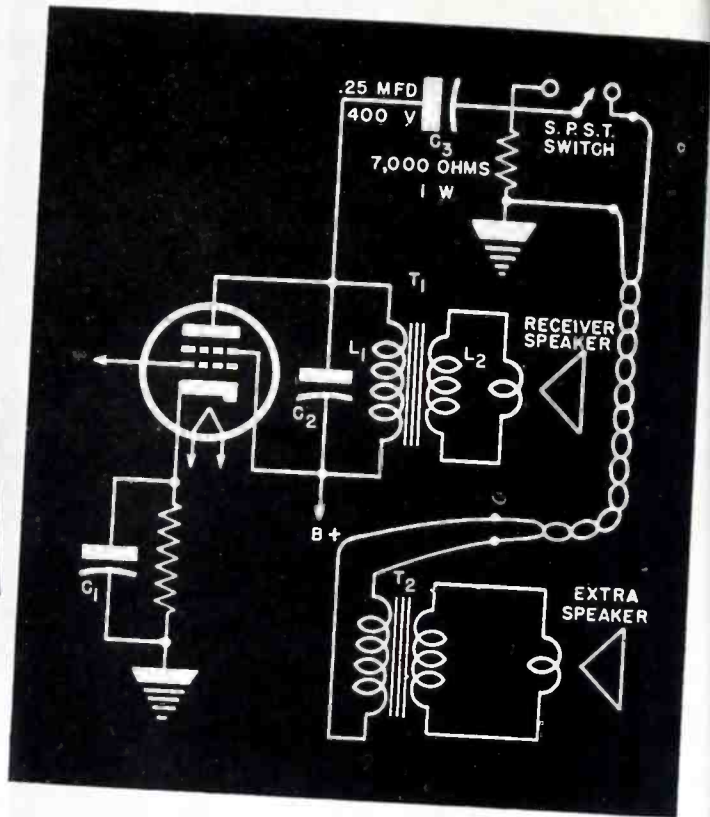
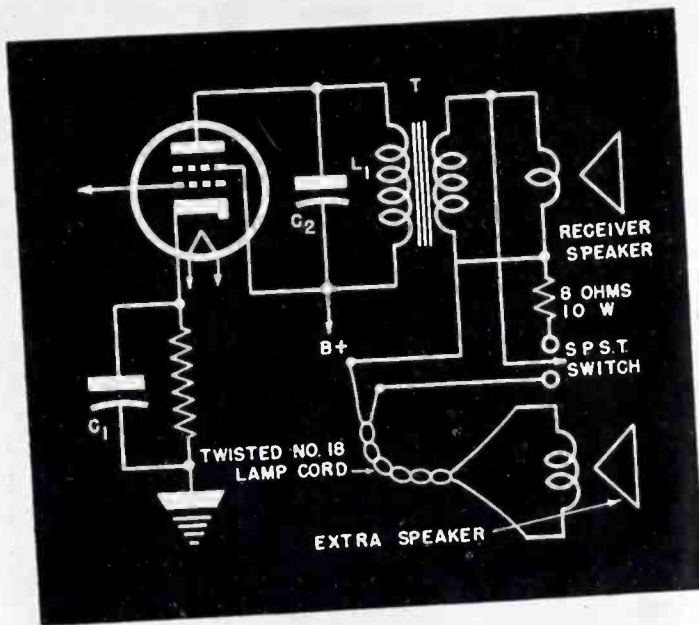

Figs. 1 (above) and 2 (right)

Fig. 1 shows a method of connecting an additional p-m speaker; the 8-ohm resistor will keep the volume of the receiver speaker at a constant level, whether the additional speaker is connected or not. . . . In Fig. 2 we have the same hookup, using a separate output transformer; the 7,000-ohm resistor keeps the tube load constant.

LOUDSPEAKER ADDITIONS FOR IMPROVED TONE QUALITY

ADDITIONAL speakers offer an effective means of improving tone range and overall fidelity. In many cases we find that high-frequency distribution is poor in the average room. An extra speaker, properly installed, can improve that condition. The extra speaker, mounted away from the console, also often adds to the depth of response.

In Fig. 1 we have one method of installing the extra speaker. While an impedance mismatch results, the

by WILLARD MOODY

use of this circuit in actual practice seems fairly satisfactory. If the power is to be distributed evenly between the speakers, the voice coil impedance of the extra speaker should be about the same as that of the original speaker. The extra speaker can be a p-m dynamic type with a 10" or 12" diameter cone and a baffle which will permit adequate reproduction of lows.

Of course, it is possible to connect

the extra speaker of Fig. 1 in a permanent way. The switch is omitted, and a new output transformer installed. This output transformer would have a turns ratio N . If the original voice coil was 8 ohms and the extra coil had an impedance of 8 ohms, the new impedance would be 4 ohms. This value of impedance would be divided into the plate load resistance (obtained from a tube chart) to find the impedance ratio. Then, the square root of that ratio would be equal to N . The ratio can be checked by connecting an audio signal generator to the voice coil winding, adjusting the applied voltage to 1 volt and then measuring the voltage across the primary or plate winding. The ratio of the plate winding voltage to the secondary voice coil voltage of 1 volt would be equal to the turns ratio.

The extra-speaker practice can also be applied to auto installations. Thus equalized distribution of sound is possible. The circuit of Fig. 1 may

(Continued on page 37)

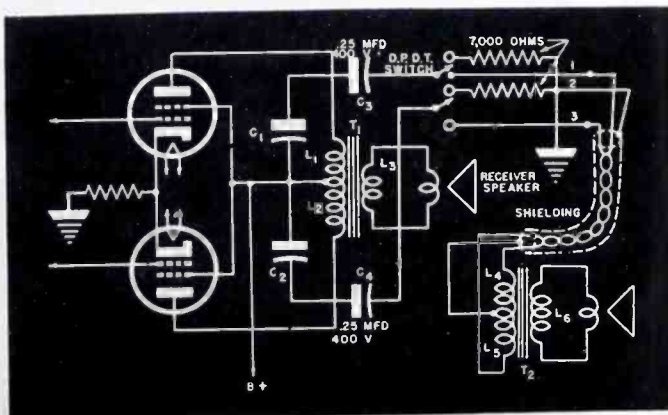



Fig. 3. How to connect an extra speaker to a push-pull output stage. Two 7,000-ohm resistors are necessary to keep the plate load at a constant value, when the extra speaker is not in use.



Wondering about tube testers?

*...Here's what Simpson has ready
and waiting for your postwar needs*

Sensational? Yes . . .

1. This new Simpson Mutual Conductance Tube Tester tests tubes with greater accuracy than any commercial tube tester ever designed.
2. Provides greater flexibility for future tubes than any other tester.
3. Tests tubes with voltage applied automatically over the entire operating range.
4. Simplifies as never before the interpretation of tube condition from mutual conductance readings.

SIMPSON ELECTRIC COMPANY
5200-18 Kinzie Street, Chicago 44, Ill.

Simpson
INSTRUMENTS THAT STAY ACCURATE

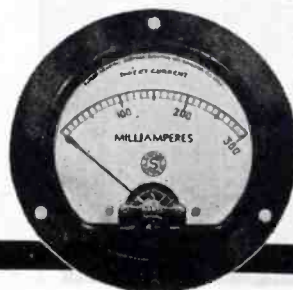

VOLUME CONTROL CIRCUITS

by ROBERT L. MARTIN

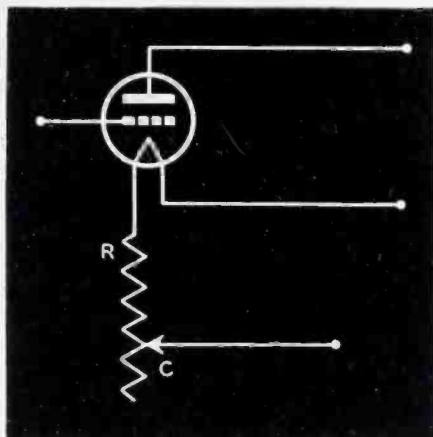

Figs. 1 (above) and 2 (below)
 Fig. 1. Filament type of gain control, now obsolete. . . . Fig. 2. Gain control by B voltage regulation, now obsolete.

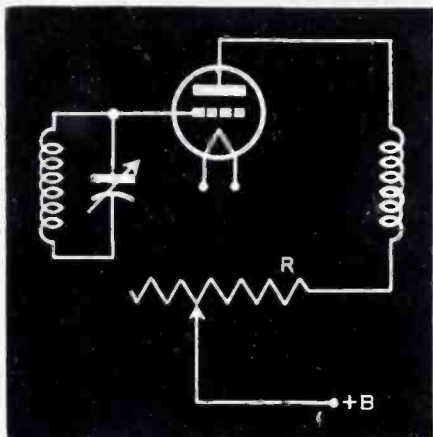

Fig. 3 (below). R-f type gain control usually used in combination form.

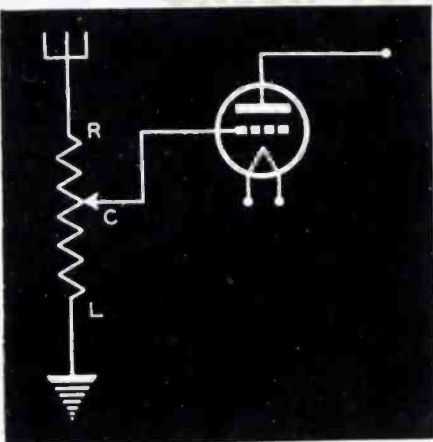

Fig. 4 (below). Similar to Fig. 3, except for a tuned circuit between grid and antenna.

METHODS of controlling volume may be divided into two categories, r-f or a-f; controlling circuits through which pass r-f voltages, and a-f voltage control circuits.

R-f systems may be subdivided into voltage control and gain control. Voltage control methods vary the voltage input from the antenna or to an interstage r-f transformer by means of a potentiometer, or a series or shunt rheostat. Gain control systems change the amount of amplification (transconductance) of one or more amplifier tubes. A few ingenious circuits make use of a single volume control to vary both the voltage input and gain simultaneously.

A-f systems make use of voltage control only, the gain of the amplifiers always being kept constant. This is important in conventional class A amplifiers to avoid distortion. However, it is possible to vary the audio gain and retain quality by using special multi-element tubes (such as the 6L7). This is done in volume compressors and expanders, and non-overloading speech amplifiers using audio gain control.

Broadcast receivers usually use a single volume control, while communication, short-wave and commercial receivers usually employ two separate

controls, one r-f and one a-f, for optimum performance. Many receivers built before the advent of variable mu remote cut-off tubes used a 2-element ganged control which varied two quantities simultaneously on a single shaft.

In Figs. 1 and 2 we have r-f gain control systems, the first controlling filament emission and hence transconductance with a linear wire-wound rheostat, the second controlling plate voltage and regeneration. Both systems were frequently used for simultaneously controlling a number of tubes. The variable plate-voltage control marked the introduction of carbon type controls the first of which were linear. Later controls had a right-hand taper in values ranging between 50,000 and 100,000 ohms. In operation, a right-hand taper has an almost linear variation of resistance with rotation until the half-way point, when the resistance change starts to slow up. Near the *full on* position, the resistance change is very gradual. Most series control circuits use this type of taper.

When a-c tubes were introduced filament emission control was ineffective and the source of additional hum. To solve the problem a variety of potentiometer voltage-control systems were introduced, Figs. 3-8. Fig. 3 illustrates an antenna potentiometer system.

Circuits courtesy of P. R. Mallory & Co., Inc.; Yaxley Replacement Volume Control Manual.

Fig. 5. Similar to Fig. 4, except that gain is controlled by shorting antenna to ground.

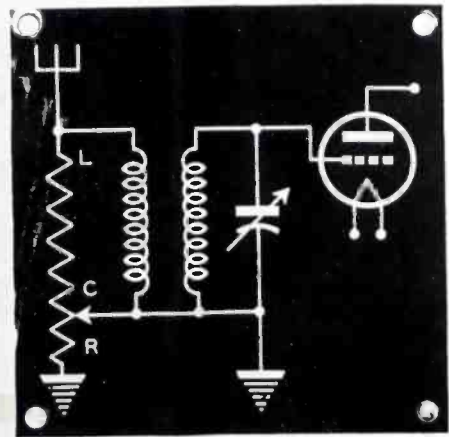
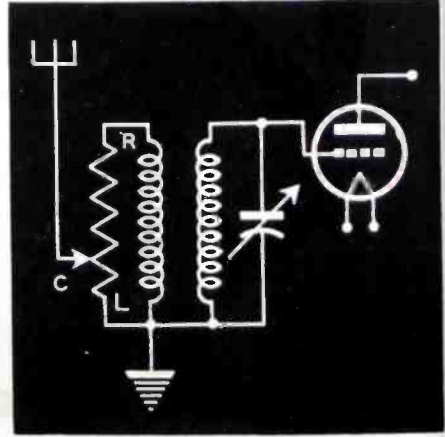
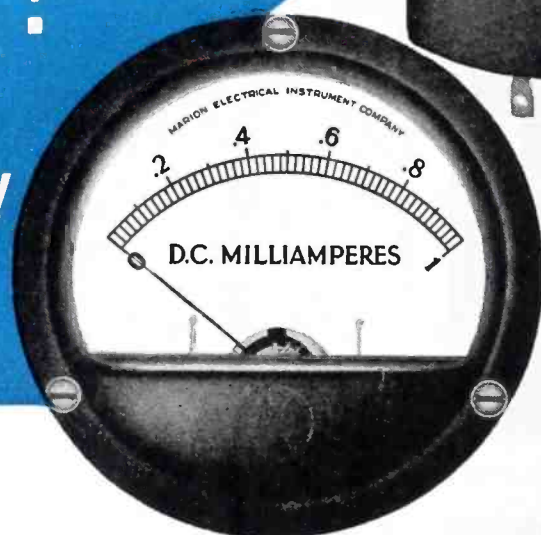

Fig. 6. Similar to Fig. 5, except that antenna is connected to the rotating arm.



SIMPLE— ISN'T IT?

—yet, sealed
for all time!



MARION

Glass-to-Metal Truly Hermetically Sealed 2 1/2" and 3 1/2" Electrical Indicating Instruments

A One-piece drawn steel cup-shaped case with high frequency induction soldered Kovar glass bead terminals. Black phosphate finished to meet 200 hour salt spray test.

B Marion Alnico magnet and moving system, with hardened beryllium copper instrument frame.

C Lithographed metal scale plate, individually printed.

D Double thickness glass window with Corning Glass Works metallized band on rim — high frequency induction soldered to steel case.

E Aluminum cover plate and flange, with anodic black satin finish.

"How is it done?" — this is the question on the tongues of hundreds of engineers from coast-to-coast. A simple basic design in conjunction with electronic production methods is the answer. And with it comes the final solution to the problem of completely tropicalizing electrical indicating instruments. There are no rubber gaskets and no cement seals. These instruments can be immersed in boiling brine or frozen in a cake of ice, for weeks, without deterioration of their seals or harm to their operating efficiency. And they are positively interchangeable: Type HM 2 with AWS Types MR 24 and 25 and Type HM 3 with AWS Types MR 34 and 35. Available in all DC ranges, for present or postwar applications. Write for additional information.

SPECIAL NOTE: Marion Glass-to-Metal Truly Hermetically Sealed Instruments cost no more than standard unsealed instruments.



MARION ELECTRICAL INSTRUMENT CO.
MANCHESTER, NEW HAMPSHIRE

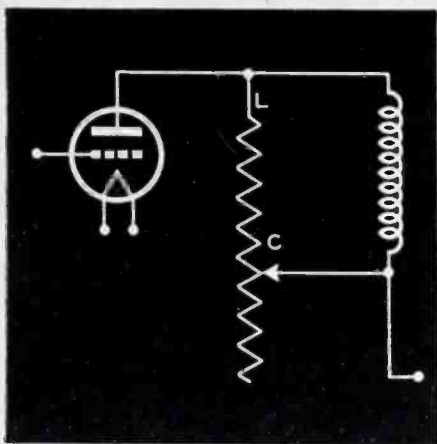

Figs. 7 (above) and 8 (below)
 Fig. 7. A shunting type of r-f gain control, usually used in i-f stages. . . . Fig. 8. Same as Fig. 7, with the control in the grid circuit.

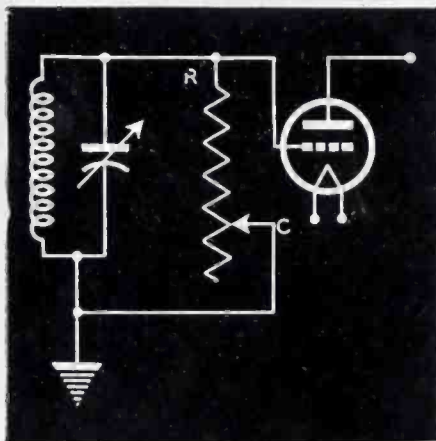

Fig. 9 (below). Cathode type gain control.

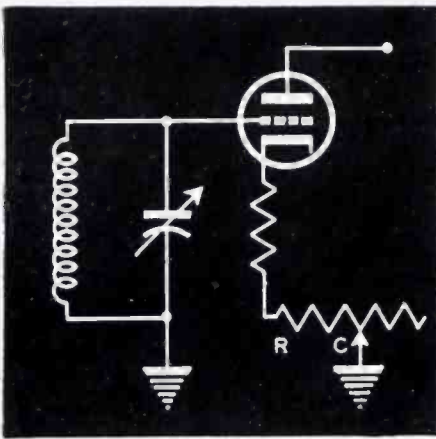
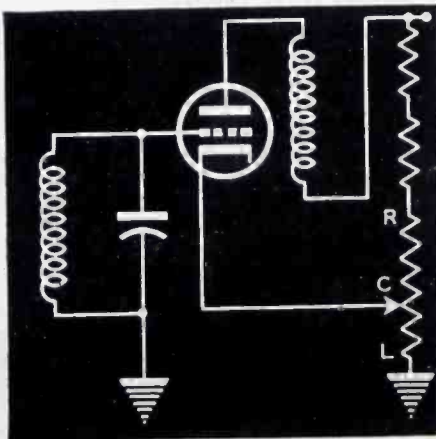

Fig. 10 (below). Similar to Fig. 9, except that bleeder type of control is used.



ten, where the potentiometer arm feeds the grid of an untuned r-f amplifier. This is a shunt type control where the most change occurs in the first few degrees; hence a left-hand taper is used. This taper varies the output very slowly at first, the rate gradually increasing until well beyond the half-way mark when it becomes linear. Resistance values for this circuit were 400 to 10,000 ohms, the lower values being generally wirewound.

Figs. 4, 5 and 6 show different methods of controlling antenna coupling to a tuned r-f amplifier with a potentiometer. Left-hand tapers of 2,000 to 20,000 ohms were used for this means of control in the majority of sets manufactured from 1928 to 1930. Some variation in selectivity accompanied the change in the position of the arm. Figs. 7 and 8 show examples of r-f shunts in the primary or secondary of an r-f transformer. The primary winding system used a shunt of between 2,000 and 20,000 ohms. Secondary winding resistance values ran as high as 100,000 ohms. Both were left-hand tapers. Rheostats were sometimes used. These allowed an open at the full-on position, removing the shunt entirely for maximum sensitivity. The controls had some effect on r-f tuning and were quite noisy.

The cathode-type tube with an indirect heater opened the way for cathode bias methods of gain control, one of which is shown in Fig. 9. Increasing the value of this resistance provides more voltage drop due to the flow of plate current applied to the grid as grid bias. As the resistance is increased, the plate current drops, so additional increases have less effect. Therefore, the values ran high, from 50,000 to 75,000 ohms. To provide the requisite minimum bias a stop was used to prevent the resistance from dropping to zero, or a separate fixed resistor was used in series. Frequently one rheostat was used to control more than one tube. To avoid plate current leakage, current was fed directly from the plate supply in the form of a bleeder. This forced a given voltage drop in the volume control independent of the tube's operating point. In the circuit shown in Fig. 10, linear type 500- to 5,000-ohm wirewounds were used.

When high-gain screen grid and r-f pentodes came along, it was found that antenna-voltage or cathode-bias methods of volume control were inadequate. Strong signals were not sufficiently attenuated. Thus the system shown in Fig. 11 was introduced. In this system the control performs a double duty, antenna shunt and a bias control. In the full-off position, the grounded arm

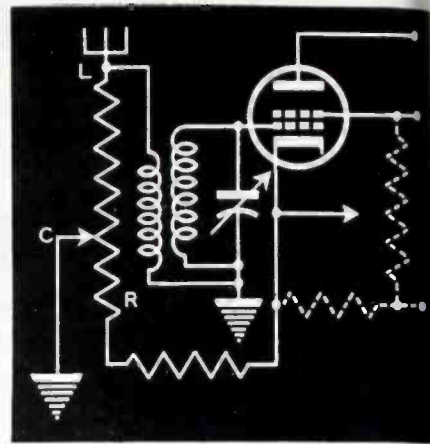

Fig. 11. Combination of antenna shunt and cathode-bias voltage control necessary with screen-grid tubes.

shorts the antenna and, at the same time, gives maximum bias, a combination voltage and gain control. As the antenna is unshorted, the bias is reduced, permitting more signal to get

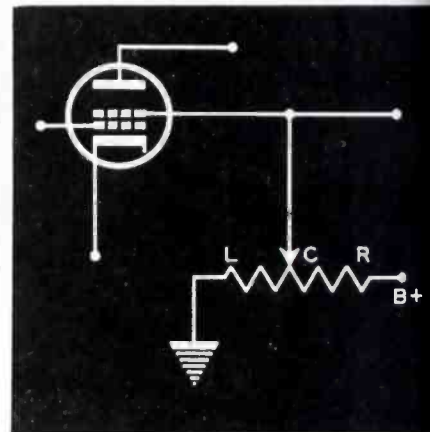
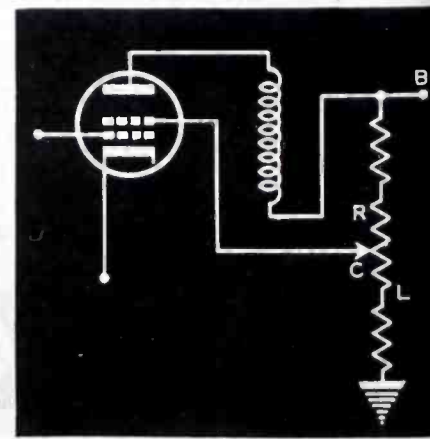

Fig. 12. Gain control, effected by variation of screen-grid voltage.

through. The smooth functioning of this control depends upon the strength of signals received which, to a certain extent, depends upon the antenna installation. Too long an antenna causes the controls to be rough and noisy.

(Continued on page 34)

Fig. 13. Similar to Fig. 12, with resistor between control and ground to keep minimum value of voltage on screen grid.





Centralab Selector Switches

are available to servicemen and experimenters in kit form . . . or standard, completely assembled and individually cartoned.

Insulation . . . either steatite or bakelite.

All switches have double-wipe contact terminals for long life and have a consistently low contact resistance of less than $2\frac{1}{2}$ milliohms and are completely self-cleaning. Index is positive with 30° between each rotating position. Switches are also available for transmitter use.

Send for illustrated Catalog No. 24.



Centralab

Division of GLOBE-UNION INC., Milwaukee

Producers of VARIABLE RESISTORS — SELECTOR SWITCHES — CERAMIC CAPACITORS, FIXED AND VARIABLE — STEATITE INSULATORS — AND BUTTON-TYPE SILVER MICA CAPACITORS.

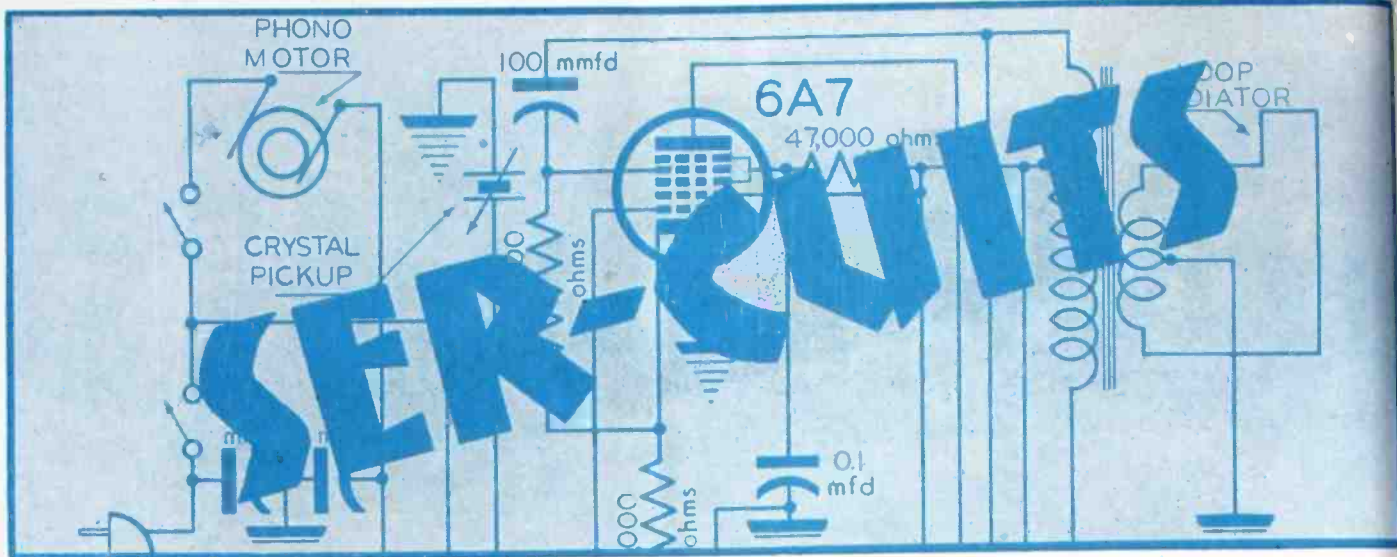

WHEN receiver production is resumed, f-m is scheduled to become an important feature of most sets; the majority of receivers will be of the a-m/f-m types, and many will have only f-m. The first allotment of these models will include features that appeared in many of the advanced prewar styles. A study of these models can thus provide quite a basic foundation. An interesting example of this advanced design appears in Fig. 1, the Scott f-m 41-50 mc tuner. This unit has one t-r-f and two i-f stages, and two limiters. The i-f is 5.25 mc which serves to eliminate pickup at the image frequency, particularly with a tuned amplifier ahead of the frequency converter.

An 1853 is used in a high gain r-f amplifier with a 2000-ohm gain control to prevent overloading on strong signals. By applying current through

by HENRY HOWARD

the control, independent of the 1853 cathode current, the control becomes very effective. This is done by bleeding about 2.5 ma from the B supply through a 0.1-megohm resistor. With the gain control at maximum gain, the only bias is that developed across the 150-ohm cathode resistor. To prevent sharp resonance points, a 1000-ohm resistor is placed across the antenna primary.

The oscillator section of the 6SA7 is voltage stabilized by a VR-150. Temperature is stabilized by a special 10-mmfd capacitor across the oscillator coil. Undesirable regeneration is prevented by the use of decoupling plate and screen circuits which pre-

vent coupling through the power supply. These filters are used in all tubes handling r-f or i-f. A 250-mmfd series condenser is used in the first detector tuning. A 5-ohm grid resistor is used as a parasitic suppressor. All grids following the r-f stage have grid suppressors, the i-f stages using 50 ohms.

The interstage transformers in the i-f and limiter amplifiers are of special design utilizing iron-core inductors and capacity coupling. The coils are shunted by resistors to lower the *Q*, broadening the tuning for wide-band reception. Mixer and i-f coils are shunted by 60,000 ohms while the limiters use 50,000 and 25,000 ohms. Because of the increased loading, more coupling is used in the limiters. The coupling is governed by the value of the condenser from ground to the junction of the two 50-mmfd tuning

Fig. 1. Scott f-m tuner with one t-r-f, two i-f stages and two limiters.

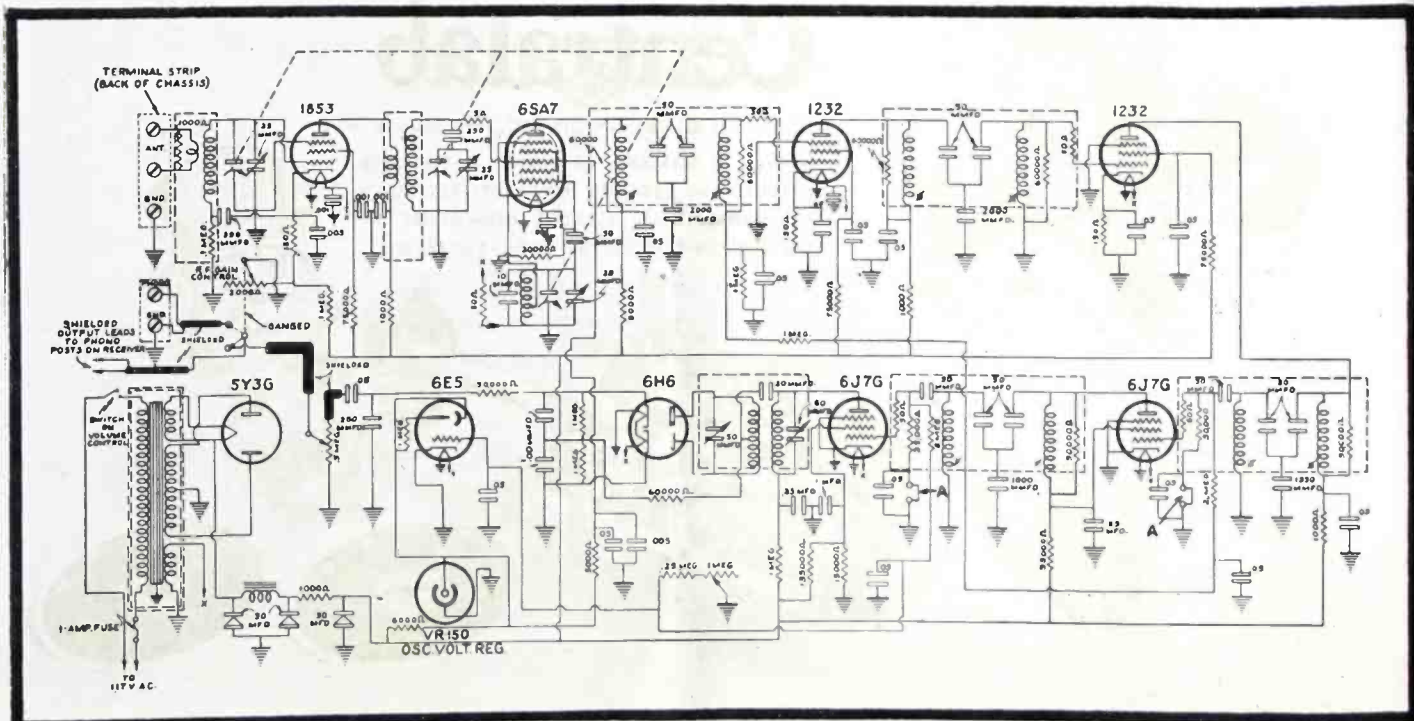



FOR COMPACTNESS

World's smallest transformer

These units, 7/16" x 9/16" x 3/4", are the optimum in small transformer design . . . they have been in production for five years.

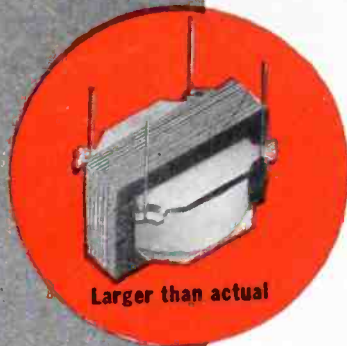

Weight reduction 95%

This dual purpose aircraft filter was reduced in weight through UTC design from 550 to 27 ounces.

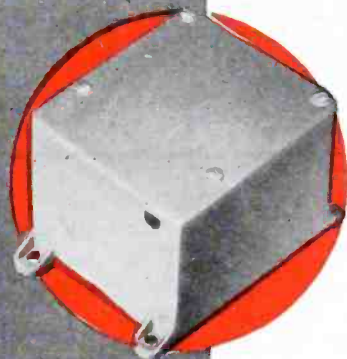

Ouncer transformers-Hermetic

Hundreds of thousands of UTC Ouncers have been used in the field. Solder sealed hermetic constructions effecting the same weight and space savings are now in production.



May we cooperate with you on design savings for your applications . . . war or postwar?



ALL PLANTS

United Transformer Corp.

150 VARICK STREET

NEW YORK 13, N. Y.

EXPORT DIVISION: 13 EAST 40th STREET, NEW YORK 16, N. Y.,

CABLES: "ARLAB"

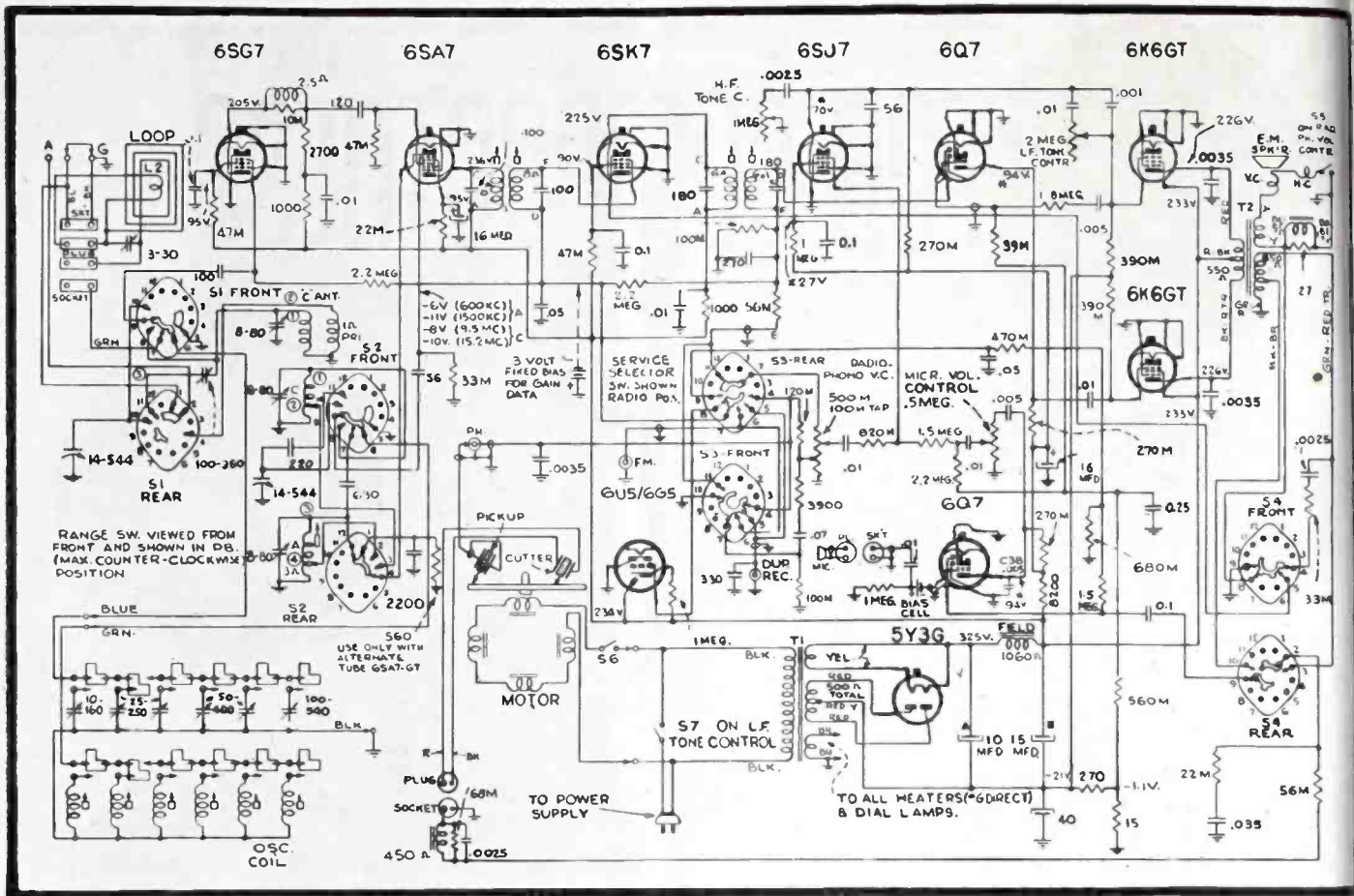

Figs. 2 (above) and 3 (below).

Fig. 2. RCA VHR-212 two-band receiver with microphone amplifier and phono recorder.

Fig. 3. Input of Hallieralters f-m/a-m receiver S-36A (formerly S-27). VT₁ is a 956; VT₂, 954; VT₃, 955; VT₄, 5U4G, and VT₅, VR-150. Tuning range of receiver, 27.8 to 143 mc.

condensers. This value is 2000 mmfd in the i-f stages, 1350 in the first limiter, and 1000 in the second. Lower values have greater reactance, allowing more signal to travel through 50-mmfd condensers from

plate to grid. In other words, lower value capacitors have less shunting effect on the signal. For proper performance of this type of amplifier defective condensers must be replaced with similar types of the correct values or the gain or bandwidth will suffer.

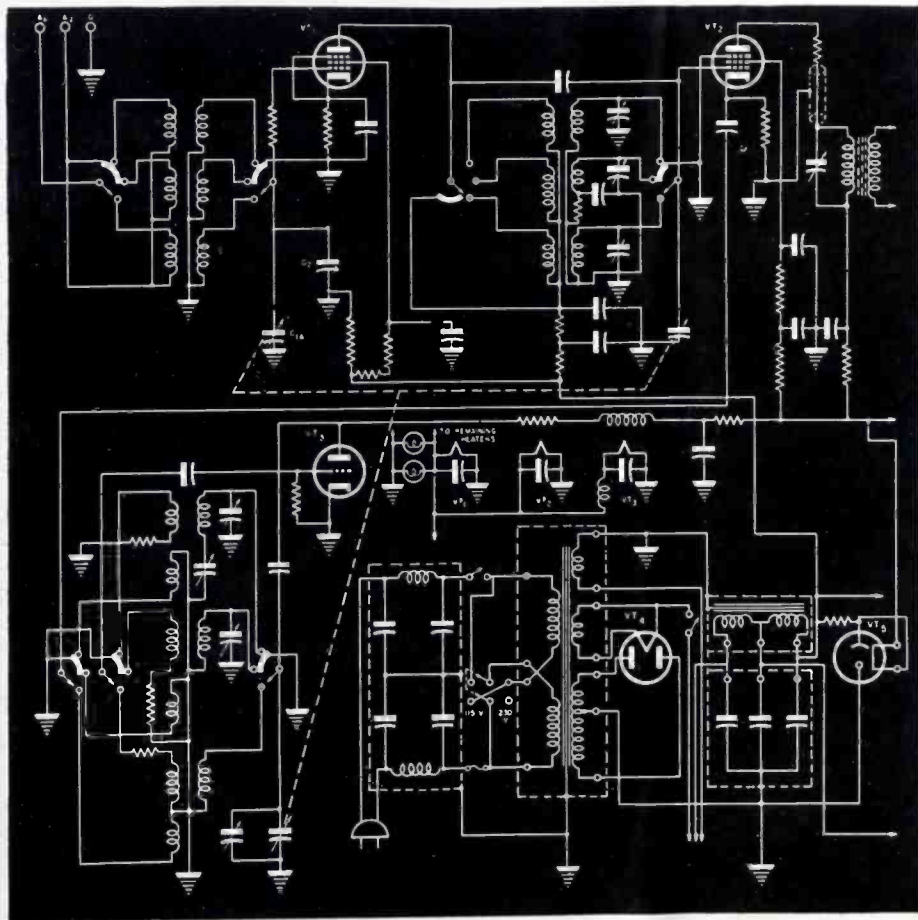

Limiters operate at low plate voltages, saturating on spurious signals of high intensity, such as static crashes, peaked ignition noise, etc., which decreases the level of the spurious signals to that of the program. The plate voltage of the first 6J7 limiter is reduced somewhat by a 35,000-ohm common supply resistor which feeds both plate and screen, while the second limiter is subjected to a greater reduction by a 0.1-megohm resistor in the plate and 35,000 ohms in the screen supply. The only avc action used in this tuner is derived from the grid of the first limiter and fed to the first i-f stage through an appropriate filter consisting of 2-megohm and .05-mfd units and a 0.1 megohm and another .05-mfd unit. Very little grid bias is used in the limiters, only a 50,000-ohm grid leak supplying the first, 25,000 ohms supplying the second limiter. Binding posts with jumpers are provided in series with these grid leaks for alignment by measuring limiter current.

A 6E5 sharp cutoff tuning eye is

(Continued on page 30)

SPRAGUE TRADING POST

A FREE Buy-Exchange-Sell Service for Radio Men



71 OF THE 8037
SPRAGUE COMPONENTS...

... Produced in a
Single Year!

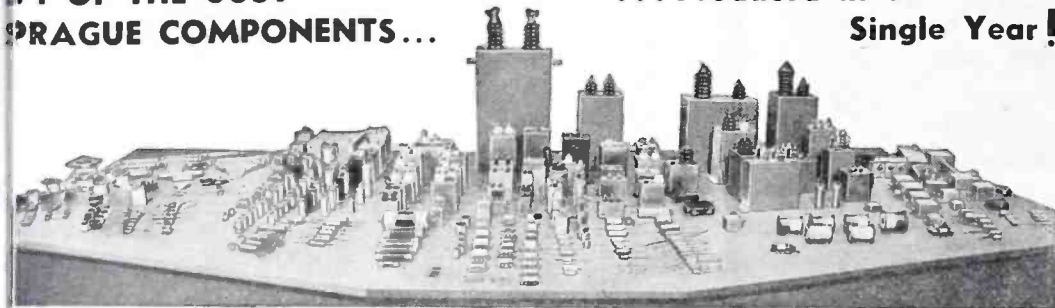

Some idea of the extent of Sprague's war effort may be gained by the fact that it took only 365 days to produce 8,037 types, sizes, and styles of Sprague Capacitors, Koolohm Resistors and other components such as those shown here. Many of the types illustrated represent important engineering achievements which will mean still better, even more reliable capacitors and resistors for post war use. You can always count on Sprague for engineering leadership!

FOR SALE—15 watt peak limiting amplifier, high impedance mke and phone input. Output: 4, 8, 15, 250, 500 ohms. \$50 or will trade for good Kodak 35 range finder or similar. Robert Lewis, Box 554, Quincy, Ill.

WILL TRADE—New and good used tubes or 33mm camera, also slide projector. Schmitka, 1481 Shakespeare Ave., Bronx 12, N. Y.

FOR SALE OR TRADE—Wurlitzer phone amp. using 1-76, 1-6D6, 2-6L6G, -15Z3 with 15 in. speaker and magnetic pickup; also DeLoe 111P, motor dual voltage. Need a-c sig. gen. George H. Hague, 6 Carver St., Fall River, Mass.

WANTED—Beginner wants radio parts, condensers, resistors, etc. D. L. Millikan, 117 Rogers Ct., Ashland, Ky.

FOR SALE—Over 500 tubes, incl. 6L6, 12X7, 6BK7, 6BF5, 6NC7, 637, 6K8, 6Y6, 6J5, 6SL7, 6X5, 6K7, 12SR7, 12SR7, 12C8, 5Y4, 5U4, 2X2, 185, 384, 1T4, 1N5, 1A7, 1LN5, etc. New and used, 10 per cent off list. James Ball, 1614 Dixdale Ave., Louisville 11, Ky.

URGENTLY NEEDED—Following tubes: 1-50L6GT/G, 2-35Z5GT, 1-35L6GT, 1-28Q7GT/G. Bernie Osheroff, 5615 Jackson St., Omaha 6, Nebr.

FOR SALE—Weston 682 tubes tester with instructions. Will swap new 10,000 ohm output transformer for 5,000 ohm transformer with tap at 8, 15, 500 ohms. (Wanted one ea. 12B8GT, 32L7GT, 70L7GT, 50L5GT and two 6A3AG tubes. Henry L. Barkley, 3-R Research Rd., Greenbelt, Md.

SALE OR TRADE—Male wire-hair fox-terrier, reg. A.K.C. \$45 or trade for test equip. multimeter, sig. gen., etc. Also navy "Math. for Elec. and Radionics" \$3. "Servicing by Comparison" \$1.50, etc. Deluxe Radio Sales & Service, 211 E. 14th St., Columbus, Miss.

FOR SALE—13 Electronics, 10 Service, 12 Radio, 5 Elec. Communications, 9 QST magazines, 1936 to 1942. \$7 for lot. Philip Rosenblatt, P. O. Box 905, Hoboken, N. J.

URGENTLY NEEDED—GTC porta-power pack for 1.5 volt battery sets on 105-120V, 50-60 cycle a-c line. Also 4-1A7, 2-12SA7, 2-12SK7, 2-12SQ7, 50L6, 35Z5. Wells Radio Service, Baton Rouge 10, La.

FOR SALE—Confidence tube tester, tests most tubes, including locals, miniatures 1.4, 70 and 117v., with chart. Want 45Z3, 25Z6, 25Z5, 35L6, 50L6. Will sell tester or trade for tubes. S. R. Kellogg, P. O. Box 945, El Centro, Calif.

WANTED—Test-proved tubes, parts and receivers. Cash or trade. T. J. Peery, 1524 N. Denver, Tulsa, Okla.

FOR SALE—New pocket multimeter, 1,000v. a-c, 500v. d-c, 1 meg. R. Complete with instructions. \$25. Times Appliance Co., 12304 Superior, Cleveland 6, Ohio.

WANTED—Filament transformer 1.1 to 117v. 115-25 primary; Riders 6 & 9; 500-ohm, 50-watt rheostat. J. R. Reed, 2178 W. 3rd st., Durango, Colo.

WANTED—Home recording unit or recording head and arm. Jack Collingsworth, 1147 - 35th st., Columbus, Ga.

FOR SALE—Readrite pocket V-O-M # 739. Works on small 1.5v. flashlight battery. Leo E. Gervais, 35 Mill st., Greenfield, Mass.

FOR TRADE—Electric razor for communications receiver. James F. Darby, Sqd. C, Foster Field, Texas.

FOR SALE—Official Service Manual # 7, \$8; 85 lesson Sprayberry Radio Course, \$35; 800 Resistors, \$15; 25 lbs. S.W. parts, \$15; National S.V. receiver with power pack and 3 sets plug-in coils. \$25. Carmella Palermo, 223 S. Winebidde ave., Pittsburgh 24, Pa.

URGENTLY NEEDED—0-1 ma. meter, in good condition. Harry E. Slates, Unionport, Ohio.

FOR SALE—Arlington 15-watt amplifier; 2 Jensen 10" concert type speakers in housings, \$100. Also Magnavox - F.M. tuner with 8 tubes and instruction sheet, built-in power supply, \$25; 6v. d-c and 110 a-c 12-watt amplifier with tubes, \$35; General Industries 33 1/2 RPM transcription motor and turn table for 110v. a-c or d-c, \$15; Thordarson unit power stage 70-watt output, \$35 f.o.b. Robert Maxwell, 1312 East Washington Blvd., Fort Wayne, Ind.

WANTED—FM tuners. Carl Wolf, 2227 W. Iowa st., Evansville 12, Ind.

WILL TRADE—6D6, 6A7, 6A6, 1H5GT or 85 for 1E7G, 1Y115, 1Y125, 9001, 9002 or 1N5GT. Send for list of parts. Russell Faldley, Box 1054, Raymondville, Texas.

FOR SALE—Riders 2, 8, 10 and 12. Gernsback's 4 and 6; Beltman's "Most Popular Radio Diagrams, Vol. 1 to 5; New Radio Physics Course. Johnson Radio Service, 302 Oakwood st., Austin, Minn.

URGENTLY NEEDED—117L7 or 117M7 tube; Meissner 14-2436 Ant. coil and Meissner 14-2437 r-f coil. Fred Wiggs, Bellevue Drive, Nashville 5, Tenn.

WANTED—Old radio sets, any condition. Bill Strong, 29 Grove st., Plantsville, Conn.

FOR SALE—1800 new radio tubes at O.P.A. prices: 1R5, 6A7, 6A8GT, 6C6, 8D6, 6C5GT, 6F6GT, 6K7 metal, 6SA7GT, 6SD7GT, 6SK7GT, 6V6GT, 6X5GT, 12SK7 metal, 12SQ7 metal, 25Z6GT, 39/44, 41, 42, 45, 77, 78, 80, 84, 85. Standard Radio Service, 428 Main st., Hamilton, Ohio.

WANTED—Test equipment and Riders. Will trade hard-to-get-tubes. Sam Berenblum, Greenwich, Conn.

FOR SALE—RCA type 211 tube and socket, Supreme #89 tube checker and #3 Underwood typewriter. Want late type comb. tube and set tester; sig. gen. and table radios in any condition. J. Stewart Davis, 4231 Evans Chapel rd., Baltimore 11, Md.

FOR SALE—New tubes in original cartons at 30% off list. Send for list. Michael Clinorelli, Catskill, N. Y.

FOR SALE—Triplet #1612 tube tester, perfect; Supreme #531 2" oscilloscope, \$60 for both; also 30-1 1/2v. new dry cells, \$3; or will trade. J. B. Tannehill, 210 S. College st., Salem, Ill.

WANTED—Hickok 188X sig. gen.; RCA 155A oscillograph and all 15 amp. tubes. Jack Nichols, Box 1013, Wilson, Okla.

FOR SALE—Good used tubes 6-27, 2-81, 1-10 and 26. Cheap. J. Scalfani, 5019 W. Belmont ave., Chicago 41, Ill.

SALE OR TRADE—Simpson #260 volt-ohm milliammeter and Triumph #420 tube tester with chart. Want Jackson #637 tube and set tester or Supreme #599. Lincoln Radio Eng. Lab., 3124 N. Kolmar ave., Chicago 41, Ill.

WANTED—Sky Buddy, Sky Champion or similar comm. receiver, also pick-up and amplifier. R. B. Paul, P. O. Box 492, Lindsay, Calif.

FOR SALE—Motorola FM tuner; hi-fi amplifier 12-watt and Jensen FM speaker, \$85. Like new. Paul Stieglitz, 4455 Broadway, Apt. 5-G, New York City.

FOR SALE—N.R.I. service course, 65 lessons, reference books, service data, equipment, 1941. W. F. Peet, 3724 Old Orchard Circle, Pittsburgh 5, Pa.

WANTED—Riders 1 to 14 or any part. Jimmie Lunn, 418 Broadway West, Memphis, Ark.

FOR SALE—Cinaudograph speaker HW-13-13, cone diam. 13", voice coil diam. 2 1/2", voice coil imp. 6 ohms, output 20 watt, \$35 f.o.b. A. J. Stephen, 233 Monticello ave., Union, N. J.

FOR SALE—Used 50L6, 35Z5, 12SA7, etc., tubes 20% off list if old tubes, same type are returned. Millers Radio Co., 540 Branham ave., Rome, Ga.

WANTED—Tube tester for late tubes; a-c sig. gen. operating on 110v. 60 cycle and tubes any type, also service manuals. Robert E. Suntheimer, 457 Wolcott ave., Kent, Ohio.

WARNING!

Federal laws cover the use of the mails to defraud — which means that most transactions resulting from Trading Post advertisements fall under their jurisdiction. Users of the Trading Post service are thus specifically cautioned to refrain from any dealings which might be cause for complaint to the Post Office authorities.

SEND US YOUR OWN AD TODAY!

For almost three years now, the Sprague Trading Post has been helping radio men get the materials they need or dispose of radio materials they do not need. Literally thousands of transactions have been made through this service. Hundreds of servicemen have expressed their sincere appreciation of the help thus rendered.

Send your own ad to us today. Write PLAINLY—hold it to 40 words or less—confine it to radio materials. If acceptable, we'll gladly run it FREE OF CHARGE in the first available issue of one of the five radio magazines wherein the Trading Post appears every month.

HARRY KALKER, Sales Manager.

Dept. S-65 SPRAGUE PRODUCTS CO., North Adams, Mass.
Jobbing Distributing Organization for Products of the Sprague Electric Co.

SPRAGUE CONDENSERS KOOLOHM RESISTORS

TM. REGISTERED U. S. PATENT OFFICE

Obviously, Sprague cannot assume any responsibility, or guarantee goods, services, etc., which might be exchanged through the above advertisements

The Standard of Quality for a Third of a Century

HICKOK

Instruments that tell the truth ..



Volt-Ohm-Milliammeter



All-Purpose Tube and Set Tester



Signal Generators



Oscillograph

● In maintaining the highest standard of excellence the one and only HICKOK aim must always be the building of instruments that tell all the truth all the time. When quality is built up to a high standard instead of down to a price, the user has greater confidence in his work.

Whether you are selecting tube and set testers, signal generators, oscillographs, volt-ohm-milliammeters or any other service equipment, remember that the standard of quality for a third of a century has never been excelled. Having pioneered the major new developments and vindicated maximum accuracy and dependability, HICKOK equipment has been specified by the armed forces in both world wars. We are still bending every effort to speed the war program and trust it will not be long until we can again take care of your civilian needs with the service equipment that is held in highest esteem. Write for Radio Equipment catalogue.

THE HICKOK ELECTRICAL INSTRUMENT COMPANY
10521 Dupont Ave., Cleveland 8, Ohio

SER-CUITS

(Continued from page 28)

operated from the grid of the second limiter through a 2-megohm and 0.1-mfd filter, with a shunt variable resistor for setting the correct eye sensitivity. This adjustment is provided by a variable 1-megohm resistor in series with a fixed $\frac{1}{4}$ -megohm resistor. The plate voltage for the eye is supplied by the VR-150 oscillator regulator. The second limiter feeds an air-tuned discriminator-detector. This delivers audio output to a $\frac{1}{2}$ -megohm potentiometer which serves as a volume control. The arm of the control is connected through a shielded cable to the phono input of the main audio amplifier. D-c plate supply is derived from a 5Y3G and a generous choke filter followed by a resistance filter of 1000 ohms and 30 mfd. The VR and the decoupling filters also contribute to ripple reduction.

RCA VHR-212

An a-m 2-band receiver, microphone amplifier and phono recorder, RCA VHR-212, appears in Fig. 2. A 6SG7 tuned r-f stage feeds an untuned detector via an impedance coupled network consisting of an r-f choke shunted by 10,000 ohms in series with a 120-mmfd blocking condenser. The plate load resistor is only 2700 ohms. The 6SA7 converter has a 47,000-ohm input resistor and conventional oscillator with no auxiliary bias other than that developed by a 33,000-ohm oscillator grid leak. Avc is supplied to the r-f and i-f stages by the diode detector of a 6Q7. The triode section of this tube is used as a phase inverter instead of the usual first audio. The first a-f amplifier is a 6SJ7 pentode which feeds one side of the 6K6 output directly.

Two tone controls are provided, a high-frequency conventional capacity shunting type and a parallel-coupling condenser for low-frequency control. The h-f control operates from the first a-f plate to ground via a .0025-mfd capacitor and 1-megohm variable. The l-f control connects a .01-mfd coupling condenser across a .001-mfd capacitor through a 2-megohm variable. The .001-mfd capacitor is large enough to pass the treble and middle range to the power tube. However, the low frequencies are attenuated. With the .01-mfd capacitor in parallel the full range is passed. Thus we have an l-f cutting control, while the h-f is similarly an h-f cutting control.

In the *phono* and *recording* positions the cathode of the 6SK7 i-f is opened to kill any radio signal.

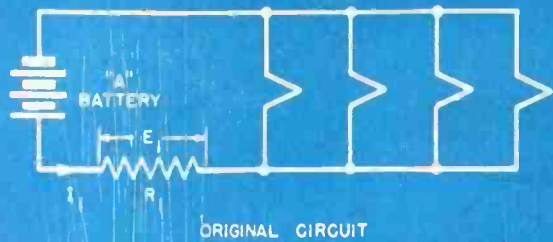

ORIGINAL CIRCUIT

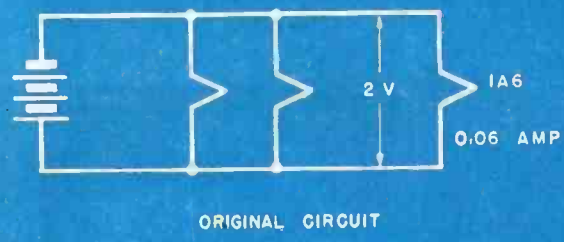

ORIGINAL CIRCUIT

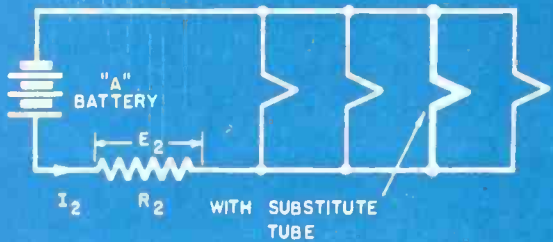

WITH SUBSTITUTE TUBE

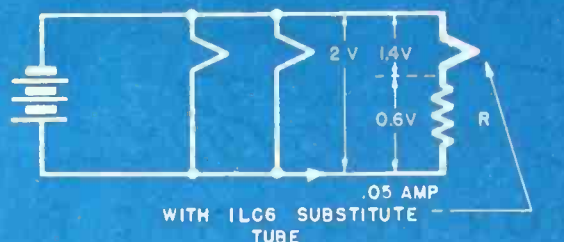

WITH 1LC6 SUBSTITUTE TUBE

USE OF RESISTORS IN TUBE SUBSTITUTIONS

[Part Four of a Series]

by **ALFREDA. GHIRARDI**

Advisory Editor

OUR previous discussion of the calculations and considerations involved in choosing suitable available substitution replacement resistors, in cases where exactly-similar replacement units are not available, leads us directly to the important subject of heater circuit modifications and additional resistors required when certain tube substitutions are made in the receiver during emergency servicing. This article discusses some of the most frequently required heater circuit modifications, as well as the calculations that must be made to determine the resistance and wattage ratings of the resistors that must be added in series or in parallel to the filament or heater string.

Most of the tube manufacturers have issued very comprehensive and helpful *tube substitution charts* and directories for emergency servicing. These list, in general, one or more recommended substitution types for each receiving type. They indicate, too, the commonest changes that must be made in sockets, socket-terminal and cap wiring, voltages, tuning circuit adjustments, etc., to properly adapt these substitute tubes to the receiver. However, changes in the re-

ceiver's filament or heater circuit must frequently be made also, because in many cases the only one of the recommended substitute tube types that is available is one designed to operate with a different filament heater voltage or current, or both, than the original tube.

Tube Substitutions in A-C Operated Receivers

Tube substitution often is necessary in a-c operated receivers, especially when rectifier tubes need replacement. In some cases the obtainable recommended substitute tube does not require any changes, but, as in the case of a 5Z3 rectifier substitute for an 80, the filament voltage or current

requirements are higher. In this case the 5Z3 filament operates at 5 volts and 3 amperes, while the 80 operates at 5 volts and 2 amperes. Usually the power transformer of the receiver can supply this larger current without appreciable drop in filament-winding voltage or danger of overheating the winding. In some of the smaller receivers, however, the winding might overheat. This condition usually is accompanied by an appreciable reduction in the filament voltage output of the transformer, which may be easily checked. In such cases the substitution may be satisfactorily made by installing a separate small filament transformer to supply the filament current for the substitution tube. In most a-c operated receivers sufficient space for such a transformer is available somewhere in the receiver, so that solution to the problem is comparatively simple.

Tube Substitutions in Battery-Operated Receivers

When tube substitutions are made in straight battery-operated receivers in which the tube filaments are wired in parallel, the filament voltage required by the only available type of

Figs. 1 (top left) and 2 (top right)

Fig. 1. Change in series or ballast resistor required in parallel-filament battery-operated receivers. . . . Fig. 2. Additional series-resistor, R, required in filament circuit of substitution tube of lower filament voltage and current rating.

General Industries constant-speed electric phonograph motor—Model CX

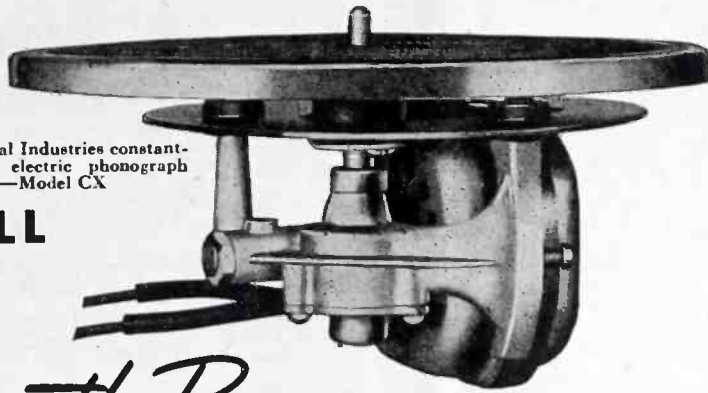

**YOU'LL
HAVE**

Smooth Power MOTORS FOR PEACETIME PRODUCTS

No doubt about it. Those quick-starting, velvety-running *Smooth Power* motors will be right back on the job as soon as we've finished our war work.

They'll be driving turntables, record-changers and recorders as smoothly and dependably as always . . . with complete fidelity in every word or musical note. They'll deliver finished performances—for you and your customers.

So, for your peacetime de-

signs—include General Industries *Smooth Power* motors, recorders and combination record-changers and recorders. No deliveries now, of course, but you can count on them for your postwar production.

THE GENERAL INDUSTRIES CO.
DEPT. M • • • ELYRIA, OHIO



TUBE SUBSTITUTIONS

(Continued from page 31)

recommended substitute tube may be the same as that of the original tube, but its filament current may be either *greater*, or *less* than, that drawn by the original tube. If all tube filaments are connected in parallel and directly across the *A* battery, this will affect the battery life only. However, some receivers, especially farm-type sets, contain a series resistor or ballast in the overall filament-circuit, as illustrated in Fig. 1. This would have to be changed, adjusted or shunted so that the same voltage drop now would be produced across it by

the new value of total filament current flowing through it. Thus,

- R_1 = value of the original resistor
- I_1 = filament current flowing through it when the original tubes were used
- R_2 = new value of resistor required instead, when substitution replacement tube is used
- I_2 = filament current flowing through this resistor when substitution tube is used
- E_1 = voltage drop across the resistor in the first case
- E_2 = voltage drop across new resistance in second case

Since from Ohm's law $E = I \times R$, we have:

$$E_1 = I_1 \times R_1$$

$$\text{and, } E_2 = I_2 \times R_2$$

but, since the voltage drop across the resistor is to remain unchanged when the substitution tube is employed,

$$E_1 = E_2.$$

Therefore,

$$I_1 \times R_1 = I_2 \times R_2$$

from which,

$$R_2 = \frac{I_1 \times R_1}{I_2}$$

The value of the new series resistor, R_2 , to be employed may therefore be calculated by means of this formula from the ratio of the original and new currents, and value of the original resistor, Fig. 1.

In some cases, the filament voltage rating of the available recommended substitute tube is different from that of the original tube. When the substitute tube requires *less* filament voltage than did the original tube, this can be compensated for by addition of a small resistor in series with its circuit to drop the voltage to that required. Fig. 2 illustrates this for a case where a *1LC6* pentagrid converter (filament voltage 1.4; filament current 0.05 ampere) is substituted for a *1A6* pentagrid converter (filament voltage 2; filament current 0.06 ampere). Since the *1LC6* filament requires only 1.4 volts, the 2-volt supply voltage must be dropped 0.6 volt to this value by means of series resistor, R , connected in its circuit. The value of the resistor required may be calculated by simple application of Ohm's law. Thus:

$$R = \frac{E}{I} = \frac{2 - 1.4}{0.05} = \frac{0.6}{0.05} = 12 \text{ ohms}$$

The calculated wattage dissipation in this resistor is $W = E \times I$ or $0.6 \times 0.05 = 0.03$ watt. Thus a $\frac{1}{4}$ -watt resistor will provide ample safety margin.

In some cases, a complete change-over of all tubes so as to use a new value of filament voltage supply may be advisable. The additional battery and best circuit changes must be determined for each such individual case.

Tube Substitutions in A-C/D-C Receivers

Since the heaters of the tubes in a-c/d-c receivers usually are connected in series with each other and with a series line-dropping resistor, if the available substitute tube requires a heater voltage and/or current different than that of the type to be *replaced*, it may be made available for it by adding series and/or parallel (shunt) resistors of suitable values at proper places in the filament or heater circuit (in some cases it may be necessary to change or short out a sec-

ion of the series line-dropping resistor) so that the proper current flows through all tubes. Use of a recommended type substitution tube having the same heater voltage and current ratings as those of the original tube is always preferred. However when such a tube is impossible to obtain, we should choose one that differs from the original in either heater voltage, or current requirements, but *not both*, to simplify the problem.

Formulas for Necessary Resistor Calculations

To determine the proper value of series and shunt resistors to add to heater strings for correct operation with tube substitutions, we must use Ohm's law and the formula for power. Thus let E = voltage in volts; I = current in amperes, R = resistance in ohms, and W = power in watts.

Then:

$$R = \frac{E}{I} \left(\begin{array}{l} \text{Which may also be} \\ \text{written as } E = I \times R, \\ \text{or as } I = \frac{E}{R} \end{array} \right)$$

and,

(Continued on page 34)

ALL THE FACTS ON A LITTLE KNOWN SUBJECT!

JUST OUT!



"THE ELECTROLYTIC CAPACITOR"

Don't buy, specify, use, or replace Capacitors blindfolded! Save time, save money, and increase your service efficiency by really knowing all about this vital subject! Actually, no Radio-Electronic component is more important or less understood than the Electrolytic Capacitor. Post war equipment will employ more of them—in new, improved types. This new book by Alexander M. Georgiev, for more than 15 years a leader in Capacitor research and development at last explains the entire subject—answers all the many questions servicemen, engineers, and designers have been asking about capacitors for years.

ENDORSED BY A. A. GHIRARDI

"I heartily recommend The Electrolytic Capacitor as 'must' reading for the man who really wants to forge ahead in Radio-Electronics," states A. A. Ghirardi, internationally famous technical author. "It tells what types to use and where and how to use them to best advantage—explains the advantages and disadvantages of each—how to make emergency repairs and a host of other subjects invaluable to the man who KNOWS it pays to KNOW." Contains over 200 pages and eighty illustrations. Price only \$3 (\$3.25 foreign).

USE COUPON in adjoining advertisement. Mail today!

WE'LL PROVE this 4 lb. book IS WORTH ANOTHER MAN in your shop!



\$5

SAVES YOU TIME ON 4 JOBS OUT OF 5

Don't confuse A. A. Ghirardi's 3rd Edition **RADIO TROUBLESHOOTER'S HANDBOOK** with books on servicing theory! It simply isn't that kind. You don't study the **HANDBOOK!** You just look up the Make, Model, and Trouble Symptom of the Radio you want to repair—and go to work! Clear instructions tell exactly what the trouble is likely to be—**EXACTLY** how to fix it. This big, 4-pound, 744-page manual brings you quick, specific repair data for every radio in use—over 4,800 models of Home and Auto Radio receivers and Automatic Record Changers of 202 manufacturers! Pays for itself the first time you use it. In addition, there are hundreds of pages of repair charts, data on tuning alignment, transformer troubles,

tube and parts substitutions, etc., etc.—all indexed for quick easy reference.

WE'LL PROVE IT

The **HANDBOOK** is the ideal book for training new helpers, repairing either cheap or expensive sets profitably, substituting tubes and parts accurately, eliminating useless test time and equipment. Because it helps you fix **TWO SETS IN THE TIME YOU'D NORMALLY TAKE FOR ONE** it's every bit as valuable as another helper in your shop—and we'll prove it. Send for the book **NOW!** Let it work for you for 5 full days. If not more than satisfied, return it and we'll refund every cent of your money. Take us up on this offer now!

... and this 1300 Page Book is worth every cent of a COMPLETE RADIO-ELECTRONIC SERVICING EDUCATION



Every Conceivable Service Subject!

A. A. Ghirardi's big 1300-page **MODERN RADIO SERVICING** is the finest, most complete instruction book on Radio-Electronic service work for either the novice or the professional Radio-Electronic Serviceman—bar none! Actually, it gives a **COMPLETE MODERN EDUCATION** in truly professional service work that is an Open Sesame to real opportunities in post war Radio-Electronic service work where the call will be for **TRAINED** men with a broad knowledge of modern test equipment and testing techniques—and not narrow-brained screw-driver mechanics of distinctly limited ability.

to use them; how to build your own; preliminary trouble checks; circuit and parts analysis; parts repair, replacement, substitution; obscure troubles; aligning and neutralizing; interference reduction—and **HUNDREDS** of other subjects including How to Start and Operate a Successful Radio-Electronic Service Business. 706 Illustrations; 720 self-testing review questions. Only \$5 complete (\$5.50 foreign).

MONEY-SAVING OFFER!

Get **BOTH** the Handbook and Modern Radio Servicing—radio's most famous complete service library totalling over 2030 pages — at a bargain Combination price. See special offer in coupon.

5-DAY MONEY-BACK GUARANTEE

Technical Division, **MURRAY HILL BOOKS, Inc.**, Dept. S-65, 232 Madison Ave., New York 16, N. Y.

Enclosed find \$_____ for books checked; or send C.O.D. (In U.S.A. only) for this amount plus postage. If not fully satisfactory, I may return the books at the end of 5 days and receive my money back.

RADIO TROUBLE-SHOOTER'S HANDBOOK \$5 (\$5.50 foreign) **MONEY SAVING COMBINATION.** Both books only \$9.50 (\$10.50 foreign)

MODERN RADIO SERVICING \$5 (\$5.50 foreign) **THE ELECTROLYTIC CAPACITOR** (see adjoining column) \$3 (\$3.25 foreign)

Name _____
 Address _____
 City & Dist. No. _____ State _____
 (Please print or write plainly.)

TEST INSTRUMENTS—TROUBLESHOOTING—REPAIR

Read from the beginning. It is a complete servicing course from A to Z. Used for reference, it is an invaluable means of "brushing up" on any work that puzzles you. Gives complete information on all essential service instrument types; how they work (with wiring diagrams), how, when, and why

Design Counts



Remember the old flatiron? It did its job, of course; but just compare it with the modern electric iron which has been brought to its present high level of utility by careful application of design.

Here at THE WARD PRODUCTS CORPORATION, design is one of the most carefully considered factors in the manufacture of antennas. It is only through superior design that durability, styling and the benefits of superior production can be best brought to the user. For the finest antennas for all applications — for home and automobile use — look to WARD.

Back Again . . . Soon
WARD Aerials

"World's Finest for Car and Home"

WARD

Antennas

BUY WAR BONDS.
THE WARD PRODUCTS CORPORATION
1523 EAST 45TH STREET • CLEVELAND, OHIO

TUBE SUBSTITUTIONS

(Continued from page 33)

$$W = E \times I \left(\begin{array}{l} \text{which also may be} \\ \text{written as } W = \frac{I^2}{R} \\ \text{or as } W = \frac{E^2}{R} \end{array} \right)$$

Whenever the calculated value required of resistance is not available in a standard RMA preferred value fixed resistor size, an adjustable type wire-wound resistor may be used to obtain the required resistance if fairly close values are necessary. Otherwise, the nearest RMA preferred resistor size may be used. If fairly good ventilation is provided within the receiver where the added resistors are to be located, the wattage rating of either shunt or series added resistors should be chosen at about twice the calculated value to provide an adequate safety factor.¹ A higher factor of safety may be required in compact receivers where the ventilation is extremely poor.

As a guide to the general line of reasoning that must be employed to determine what circuit modifications must be made in the filament or heater string in any particular tube substitution case, and how the resistance and wattage ratings of the added series

and shunt resistors required are calculated, several typical examples applying to tube substitutions in 150-milliamper and 300-milliamper tube heater strings will be offered in next month's discussion. The particular tube types and substitutions chosen as examples will be typical of the situation the Service Man encounters in this work.

¹See Part III, May 1945, SERVICE.
[To be continued]

DUTCH UNDERGROUND RECEIVER



Tiny a-c two-tube receiver in tobacco tin that was used by members of Dutch underground during Nazi occupation. Selenium rectifier was used in place of tube.

(Courtesy Philips Export Corp.)

VOLUME CONTROLS

(Continued from page 24)

More than one tube can again be controlled by the variable bias. The dotted lines indicate method of bleeding current from the B+ or screen supplies. Left-hand tapers or combined left- and right-hand tapers were used, the latter in sets using bleeder current.

In Figs. 12 and 13 we have a different method of gain control with screen grid tubes, variation of screen potential. The system of Fig. 13 limits the range of voltage variation, and thus is less critical. In both systems considerable noise is developed due to the sizable currents carried. Therefore they were never too popular.

[To be continued]

MINIATURE TUBES



Miniatures produced by Sylvania Electric for battery-operated receivers, hearing aides, etc.

For Soldering in
Tight Places . . .

DRAKE

No. 400 Soldering Iron

Smallest Industrial Iron
Ever Designed

60 Watts — 1/4 in. Tip
Only 9 in. long. Wt. only 8 oz

This mighty mite is backed by DRAKE's 25 years of soldering iron manufacturing experience. The high quality and long-service of DRAKE Soldering Irons have made them outstanding favorites with all types of radio men everywhere. The DRAKE No. 400 is an outstanding value at



Only \$4.50
List

Drake Has an Iron
for Every Purpose.
Ask Your Radio
Parts Jobber

DRAKE ELECTRIC WORKS, INC.

3656 LINCOLN AVE. CHICAGO 13, ILL.

TRANSFORMERS

(Continued from page 18)

voltage doubler. Both types of circuit are shown in Fig. 4.

If the *B* supply is to be converted to a line-voltage rectifier, certain precautions must be observed. First the mfd value of the filter condensers must be doubled, due to the half-wave action of the rectifier. This is not always necessary, where the current requirements of the new circuit are considerably less than previously required. Due to the reduced voltage and current, the filtering action of the filter network may be adequate.

Since the *B* voltage has been materially reduced, the screen-grid voltage dropping resistor must be decreased in value. Shunting the resistor with one of a few-thousand ohms will keep the screen voltage at a normal value. In addition, the screen voltage bypass condenser must be increased in value in order to achieve equivalent *RC* hum filtering. It is advisable to use an 8-mfd/150 v electrolytic for this purpose.

Some output tubes show a decided change in load impedance with a decrease in plate voltage. This and the proper bias resistor for the new plate voltage should be checked with a tube manual. When fixed bias circuits, usually dependent on the voltage drop in a filter choke or resistance in the negative return of the power supply system, are used for the output tube, it is advisable to change the bias system to self bias.

Where too many changes are involved, due to the reduced *B* voltage, or where class *B* output circuits and magic eyes are used, the simpler method is to use a voltage doubler circuit. This may be built as a separate unit, and connected to the receiver by cable. It is first necessary to determine the current load imposed by the receiver, and select the proper tubes to supply this load. By referring to *Chart 1* it will be possible to select the rectifier tube best adapted for this service. Fig. 5c shows a system using two 6X5 tubes, capable of supplying 220 volts d-c at 70 ma. Two points should be noted. First, it is necessary to remove the filter condenser of the receiver, usually connected from rectifier plate to ground, since the voltage doubler can only work into a choke input system. The second point involves the speaker field supply. Since most a-c receiver rectifiers supply 300 volts or more at the filter choke, if the speaker is used as a combination choke and voltage dropper, some change will be neces-

(Continued on page 36)

ENGINEERS! DRAFTSMEN! ACCOUNTANTS! STUDENTS!

ORDER TODAY! Sensational NEW

MULTI Slide Rule

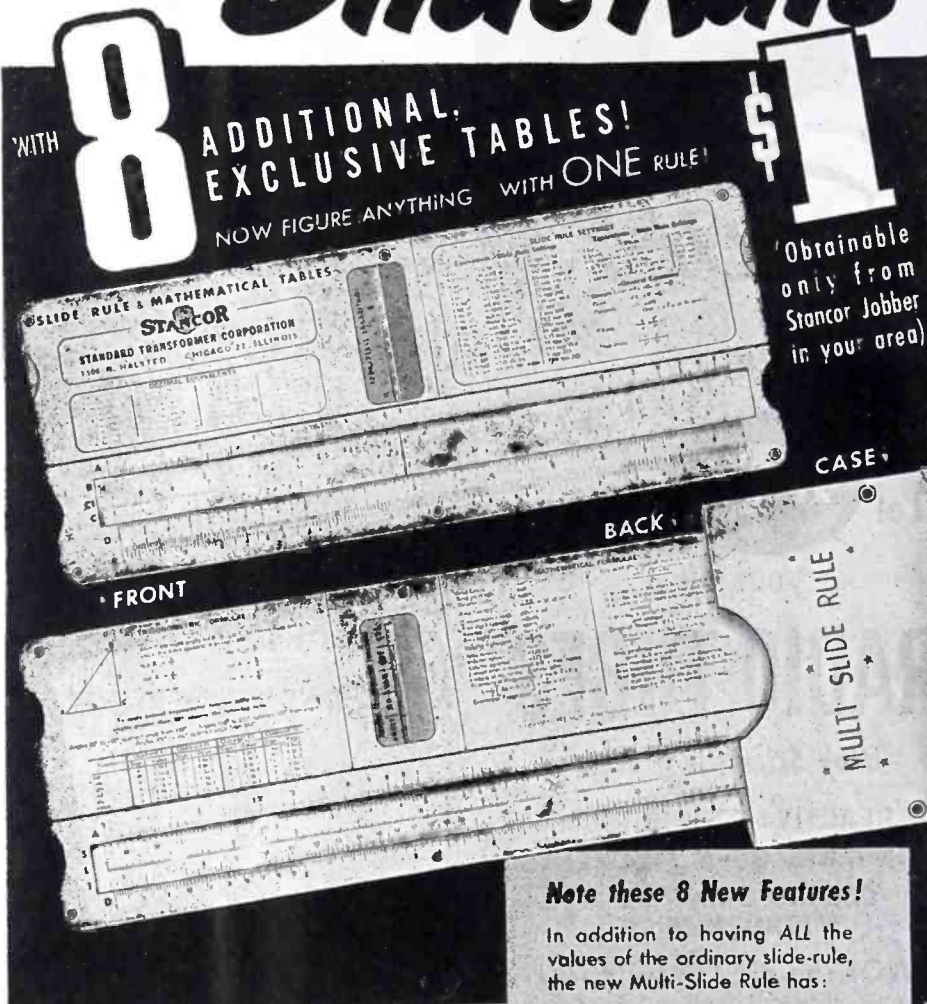

Obtainable only from Stancor Jobber in your area!

Note these 8 New Features!

In addition to having ALL the values of the ordinary slide-rule, the new Multi-Slide Rule has:

- 1 Four-places LOGARITHM TABLE
- 2 SIGNS and LIMITS of VALUE assumed by trigonometric functions
- 3 Table of NATURAL TRIGONOMETRIC FUNCTIONS
- 4 Table of TRIGONOMETRIC FORMULAE
- 5 Table of SLIDE-RULE SETTINGS
- 6 Table of GENERAL EQUATIONS
- 7 Long list of common MATHEMATICAL FORMULAE
- 8 DECIMAL equivalents of a fraction

Clear, legible print... Tough, durable for long wear... Size 10" x 4"... Fits 3-ring binder... In case... Full instructions... TRANSPARENT PLASTIC INDICATOR...

STANCOR now offers the entire electronic industry the new Multi-Slide Rule. First developed for our own use, it is today made available to all... Greatly simplifies calculation of unlimited range of problems... A genuine professional rule—not a toy. This rule is obtainable ONLY THROUGH STANCOR JOBBERS. PLEASE DO NOT ORDER DIRECT. See your local directory for the name of the Stancor jobber in your city or, write for his name. Price of Stancor Multi-Slide Rule: One Dollar!—America's biggest slide-rule bargain—a service to the trade by Stancor.

STANDARD TRANSFORMER CORPORATION
1500 N. HALSTED ST. CHICAGO 22, ILL.

ORDER FROM YOUR JOBBER

OFFERED AS A SERVICE TO THE TRADE BY

STANCOR

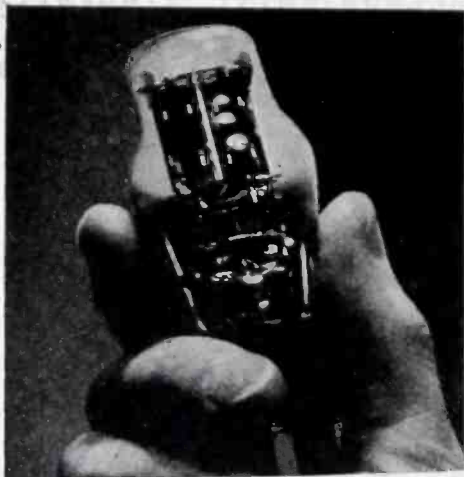

STOP! don't
throw it away!

Let **RTS** reprocess
your dead

RADIO TUBES

NEW Scientific Process

**REACTIVATES THORIUM
CONNECTS OPEN FILAMENTS
CLEARS SHORTS and
MICROPHONICS**

(NOT the old "flash" trick)

MINIMUM ORDER 6 TUBES

SEND NO CASH **50¢** EA.

C. O. D. ONLY
Prices approved by O.P.A.
1 volt & 3-Q5 \$1.00

30-Day Guarantee

Every tube fully tested in checkers & sets, before playing

Send itemized list with order

Make sure glass, base & prongs are intact... flashed, exploded or open cathodes **REJECTED and NOT RETURNED**

RTS RADIO TUBE SERVICE CO. INC.

6805 20th Avenue. Brooklyn 4. N.Y.

(Continued from page 35)

sary. Any one of several methods may be used. A separate rectifier for the speaker may be used, supplying only the speaker field. Or the speaker may be changed to a p-m type. In another solution we could use a voltage doubler capable of supplying the receiver and also supply the necessary current for the speaker field. In this case, the speaker is connected ahead of the filter choke, with the necessary series resistor to limit the current. Or the speaker field may be used in place of the screen dropping resistor, with the correct bleeder resistance to insure proper field strength.

Figs. 5a, b, c show the filament and B supply system of a typical a-c receiver, converted in several ways, using some of the ideas outlined in this article. No hard and fast rules can be prescribed for the proper procedure to follow where a substitute for a power transformer is needed. Available material, extent of power transformer damage, circuit constants and layout, and particularly the economic factor of time necessary for the work, must influence the Service Man's decision as to the proper repair method to follow.

Tube	Fila-ment	Fila-ment Cur- rent	Max. a-c/plate	Max. d-c ma
6W5	6.3	.9	325	90
6X5	6.3	.6	325	70
6Y5	6.3	.8	325	60
6Z5	6.3 or 12.6	.8 or .4	325	60
6ZY5	6.3	.3	325	40
7Y4	6.3	.5	325	60
7Z4	6.3	.9	325	100
1V	6.3	.3	325	50
84/6Z4	6.3	.5	325	60

When two tubes are used in a doubler circuit, the maximum current is the same as for one tube.

Chart 1

The above chart shows nine types of tubes which have separate cathode and filament leads permitting their use in transformerless and voltage doubler circuits.

SOUND SYSTEM

(Continued from page 14)

4' x 7'. From here all four microphones are controlled. A Daven power level meter, 193B, is used here to control the output fed to the telephone lines. From here also any of the 60-watt amplifiers can be shut off.

Complaints are followed up immediately. Amplifiers sometimes begin oscillating through tube failure causing damage to the unit. Stoppage of any portion of the paging system always causes confusion and the tele-

RADIO PARTS

and Sound Equipment

IMMEDIATE DELIVERY

6 ft. cord sets—high grade—soldered—molded rubber plug at one end. 10 for \$2.75. Each 29c
 Mike Cable—superior quality, single conductor, shielded pre-war quality natural rubber cover. Per ft., only..... 8c
 Dual conductor as above. Per ft..... 10c
 Carbon Resistor Kit No. 16, 100 RMA coded, ¼ and 1 Watt, assorted. Our price, only \$2.94
 Aerial Kit, containing aerial wire, insulators, rubber-covered lead-in, ground clamp, window strip, complete set, only..... 89c
 10 MFD 50 WV Tubular Pigtail Electrolytic Condensers. Year guarantee. 10 for \$2.25. Each, only 24c
 20 MFD 150 WV Tubular Pigtail Electrolytic Condensers. Guaranteed one year. 10 for \$3.30. Each 35c
 10 MFD 450 WV Tubular Pigtail Electrolytic Condensers. Year guarantee. 10 for \$3.95. Each 43c
 20-20 MFD 150 WV Tubular Pigtail Electrolytic Condenser. Year Guarantee. Each. 59c
 Bakelite Set-Screw Knobs. DeLuxe assortment of 50 for ¼ inch shaft..... \$3.93

Write for latest bargain bulletin of hard-to-get parts, supplies and sound equipment.

Lifetime
SOUND EQUIP. CO., Dept. 60
 1101 ADAMS ST., TOLEDO 2, OHIO



FREE
 TO YOU

COLOR CODE
and OHMS LAW CALCULATOR

Great Time Saver

Burstein-Applebee of Kansas City offers you this great convenience **FREE**. Easy to work. Solves many problems in a jiffy. **FREE** to Radio men, electronic engineers and others in the business. Attach coupon to your letterhead.

MAIL COUPON NOW

BURSTEIN-APPLEBEE CO.
 1012 MCGEE ST.
 KANSAS CITY 6, MO.
 Send me **FREE** Color Code and Ohms Law Calculator along with latest catalog.

I am _____
 STATE CONNECTION IN INDUSTRY

NAME _____

ADDRESS _____

TOWN _____ STATE _____

phone board lights up like a Christmas tree.

The sound system in this plant has been invaluable in increasing office and plant efficiency and particularly building morale.

Credits

To Anthony Raio of Raio Distributing Corporation, New York City, the author offers sincere thanks for the many helpful sound-system suggestions provided.

LOUDSPEAKER ADDITIONS

(Continued from page 20)

be used for this type of installation, too.

The extra speaker also can be hooked up as shown in Fig. 2. To equalize power distribution, the turns ratios on the transformers should be identical. If a 6F6 were used, the turns ratio selected for T_2 should provide a match of the extra voice coil impedance to a 7000-ohm load. In another method, the turns ratio of each transformer, T_1 and T_2 , could be used. That is, the turns ratio of each transformer would reflect 14,000 ohms back into the plate circuit. Then, we would have two impedances of 14,000 ohms in parallel, or 7,000 ohms, and a match with the 6F6 would prevail.

If continuous impedance matching is desired, the switches used can be of the single-pole, double-throw type. A dummy load resistor can be connected in place of the extra loudspeaker impedance so that no change in the output of the main speaker occurs when the extra speaker is cut on or off. The balanced arrangement of Fig. 3 requires a double-pole, double-throw switch.

To avoid using a three wire cable (Fig. 3), the shielding of a two wire cable is employed as the *third conductor*. The high-resistance plate-load substitutes of 7,000 ohms may be 1 watt types.

In many cases it may be desirable to have separate control over the volume and tone of the extra loudspeaker.

Let us suppose that a speaker were to be installed in the downstairs playroom of a private house. A special amplifier with a 6SQ7, 25L6 and 25Z5 could be used to offset losses in the cable line. This additional stage also provides a high level of impedance to the input. If the output impedance were 8 ohms and the extra loudspeaker had an impedance of 8 ohms, the power would be divided equally between the speakers. Thus the extra speaker would absorb power

RIDER VOLUME XIV COVERS 1941-42 RECEIVERS



I have always had a warm spot for "Duffy's Tavern" because the first program I carried was its first sponsored broadcast. Ah, I was young, strong—and what a tone I had in those days.

Today, however, after the beating I've taken during the past few years—well, as "Archie's" song suggests "Leave Us Face It." I'm in bad shape. I ought to be in the radio repair shop this very minute, along with many of my con-

temporaries who just couldn't take it any longer. The trouble is that our serviceman hasn't heard that Rider Manual Vol. XIV covering 1941-42 receivers has been published. So, he is wasting a lot of time trying to diagnose the ills of 1941 and 1942 sets when the servicing data in Volume XIV could lead him right to the causes of the troubles—and quickly.

If your jobber is out of Volume XIV or any other number please bear with him. WPB paper restrictions, you know.

RIDER MANUALS (14 VOLUMES)	
Volumes XIV to VII . . .	12.50 each volume
Volume VI	9.50
Abridged Manuals I to V (1 vol.)	15.00
Automatic Record Changers and Recorders	7.50
OTHER RIDER BOOKS YOU NEED	
The Cathode Ray Tube at Work Accepted authority on subject	4.00
Frequency Modulation Gives principles of FM radio	2.00
Servicing by Signal Tracing Basic Method of radio servicing	4.00
Servicing Superheterodynes	2.00

The Meter at Work An elementary text on meters	2.00
The Oscillator at Work How to use, test and repair	2.50
Vacuum Tube Voltmeters Both theory and practice	2.50
Automatic Frequency Control Systems —also automatic tuning systems	1.75
A-C Calculation Charts Two to five times as fast as slide rule	7.50
Hour-A-Day-with-Rider Series— On "Alternating Currents in Radio Receivers"— On "Resonance & Alignment"— On "Automatic Volume Control"— On "D.C. Voltage Distribution"	1.25 each

JOHN F. RIDER PUBLISHER, INC. 404 FOURTH AVE., N.Y. 16, N.Y.
Export Division: Rocke-International Corp. 13 E. 40th Street New York City Cable: ARLAB

RIDER MANUALS *are complete* IN 14 VOLUMES

from the main speaker. By using a 500-ohm line unit between the receiver output and the special amplifier input, the power absorption can be cut to a very low if not negligible value.

Assuming the input impedance of the special amplifier to be about 250,000 ohms, the turns ratio on the amplifier input transformer (using a 500-ohm line) would be

$$N = \sqrt{\frac{250,000}{500}} = \sqrt{500} = 22 \text{ (approximately)}$$

An output transformer having a turns ratio of about 23 or 22 to 1

could be used for the input unit in the special amplifier circuit. The low impedance winding would be connected to the line and the high impedance winding would be connected to the grid and ground, or B-. The low impedance winding will have a very low resistance for d-c, generally less than 1 ohm, while the high Z winding may have a d-c resistance of between 100 and 300 ohms, depending on the quality and type of transformer.

Any volume loss due to an impedance mismatch at the receiver, so far as the special amplifier is concerned, can be made up by gain in
(Continued on page 38)



An Aid in SELLING ... and in STORING

THIS powerful silent-salesman is the newest idea in the Adapter field. It makes it easier for you to SELL adapters, and easier to stock them for your own use. Let this ADAPTOL innovation help your business!

ADAPTOL Adaptors are noted for quality, craftsmanship and precision. They convert for use of available tubes . . . they transform to scarce type tubes. We are the originators of 1R5 to 1A7 adapters, and of five substitutes for the 12A8 tube. Little wonders of convenience, each with the replacement function clearly stated on its base.

200 types of adapters,
including many with
BUILT-IN RESISTORS.



WRITE FOR DETAILS

ADAPTOL COMPANY

260C UTICA AVENUE
BROOKLYN 13, NEW YORK

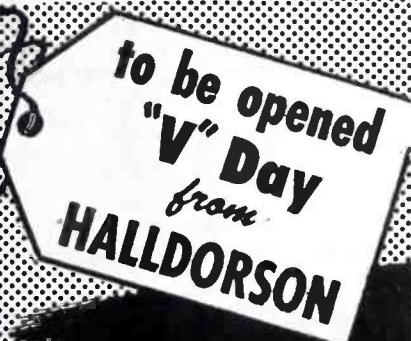
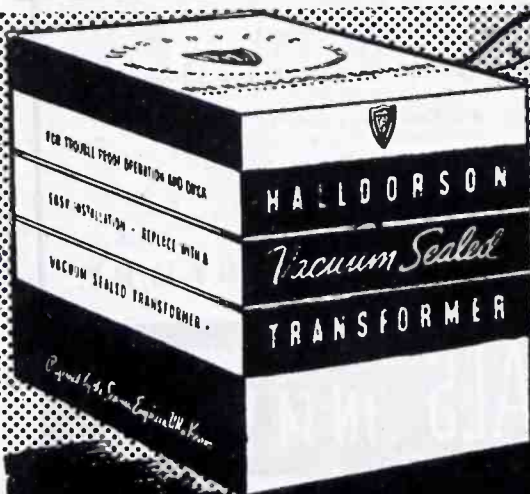

After victory, Halldorson Transformers will be available in quantity. Now we are proud that our transformers are on the fighting front, doing the job where it's "Tough," helping to bring our boys home. However, we are producing a complete line of victory type transformers in limited quantity, but maintaining Halldorson's high standards. **JOBBERs**, write for complete information on our Halldorson Victory Type Transformers.

THE HALLDORSON COMPANY
4500 Ravenswood Avenue Chicago 40, Illinois

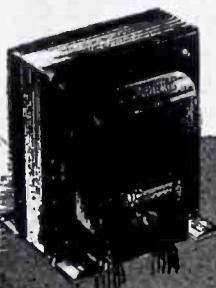

HALLDORSON

Vacuum Sealed
TRANSFORMERS

SERVICING HELPS

EMERSON 255

Replacing a 32L7GT with a 14N7: The 32L7GT rectifier and beam power amplifier can be replaced with a 14N7 via an adaptor. The following rearrangement is necessary . . .

14N7	to	32L7
1		2
2		8
3		3
4		5
5 and 6		6
7		1
8		7

A 75-ohm 10-watt resistor is inserted in the filament circuit. The cathode 140-ohm resistor in the audio output section is changed to a 300-ohm unit.

MOTOROLA 9-44, 9-49

Inoperative, blows fuse: The .01-mfd buffer condenser used in this car set deteriorates quite rapidly because of heat developed in shield box which has no means of ventilation. Replace condenser, using an oil-filled metal unit rather than the paper type.

SILVERTONE 1970

Hum: Usually caused by defective lead in the metal case of the bypass condenser connected to one side of the power line. Replace condenser near center of rear chassis wall. It is also wise to ground one heater lead of the 6C5 tube to chassis.

SENTINEL, 1940 MODELS

Intermittent: Substitute a new volume control for the original.

Edward Goldschmidt

LOUDSPEAKER ADDITIONS

(Continued from page 37)

that amplifier, and the tone can be corrected by the proper setting of the variable resistance in the plate circuit of the 25L6 output tube. If the special amplifier is to be used for phonograph reproduction, a single-pole double-throw switch in the input can be moved over to a phono position. The tonal quality can be controlled by a 100,000-ohm resistance, but some attention should be given to the acoustics of the playroom. If wood panelling can be used to line the walls, better tone will result; the multiple reflections produced by the hard concrete walls of stone surfaces, will not, then, be experienced. Added sound absorption will also be provided by wood or linoleum covering for the floor.

AMPLIFIED WIRELESS RECORD PLAYER

(See Front Cover)

A STANDARD Hartley circuit, with a 12SA7 as an oscillator-modulator is used in the simplified wireless record player, Emerson J-449, appearing on the cover this month. The unit is powered by a 250 and resistance filter. A loop antenna serves as the radiating element.

The oscillator uses the cathode, plate and grid 3. The crystal pickup feeds grid 1 through a parallel resonator consisting of a 5-megohm resistor shunted by a 25-mmfd capacitor. A 1/2-megohm grid leak shunts the audio input.

Tuning is accomplished by a trimmer condenser shunted by a 110-mmfd fixed condenser for stability. A 450-mmfd grid condenser is used, while the grid leak for the oscillator grid is 20,000 ohms.

In operation, tuning is adjusted until a clear channel is located on the receiver, usually at the higher frequency end of the dial; then the loop is oriented for maximum signal.

RADIART VIBRATORS

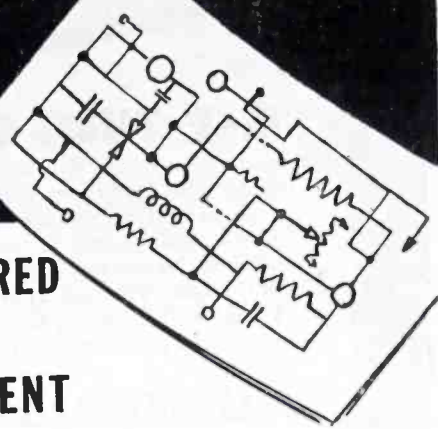

INDIVIDUALLY ENGINEERED
for
PROPER REPLACEMENT

RADIART VIBRATORS enjoy the confidence of Servicemen everywhere because they are always correct for the replacement for which they are specified.

Individual engineering for each replacement makes that certain. You may be sure that RADIART will continue to merit that confidence.

Consult the Radiart Vibrator Catalog for the proper RADIART VIBRATOR for every replacement need.



Radiart Corporation

3571 W. 62nd. St.

CLEVELAND 2, OHIO

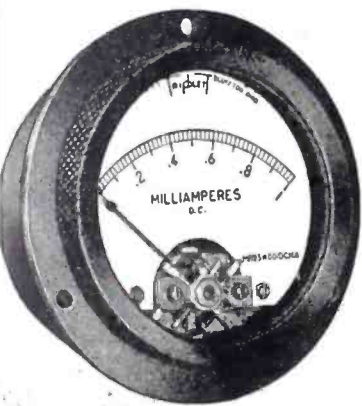

Introducing the
NEW TRIPLETT LINE
of
HERMETICALLY SEALED INSTRUMENTS

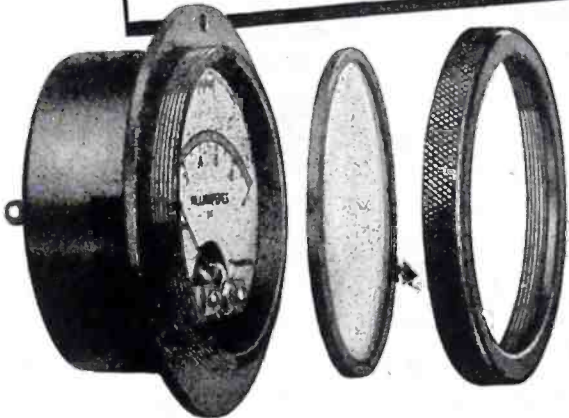
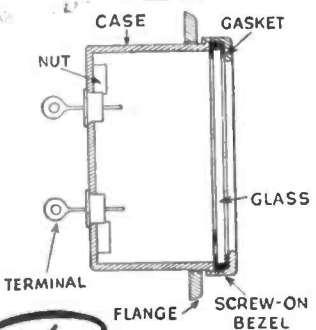

All the features of standard instruments retained. Withstand submersion tests at 30 feet. Comply with thermal shock, pressure and vibration tests. Resistant to corrosion. Conform to S. C. No. 71-3159 and A.W. S. C-39.2-1944 specifications. 1 1/2", 2 1/4" and 3 1/2" metal cases with 1/16" thick walls, in standard ranges. D.C. moving coil, A.C. moving iron and thermocouple types. Write for circular.

*Precision first
...to last*

Triplet

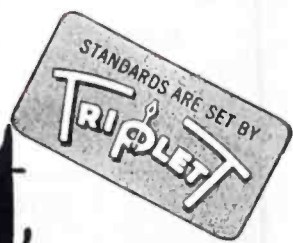

ELECTRICAL INSTRUMENT CO. BLUFFTON, OHIO

G-E TUBE CHECKER

Quick, easy, accurate tube checking which saves you time and trouble and keeps your customers happy—that's the job the TC-3P is built to do. Line Voltage and tube quality, or shorts, may all be checked on one selector switch. Individually operated switches permit placing the proper voltage on the proper pin of the tube. The G-E Tube Checker is available in either the Portable (TC-3P) or Counter Model (TC-3). Write: Electronics Department, General Electric, Schenectady, N. Y.

GENERAL ELECTRIC



177-01

Electronic Measuring
Instruments

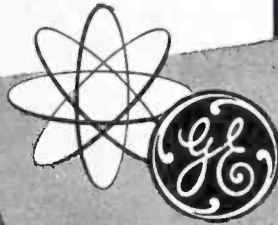
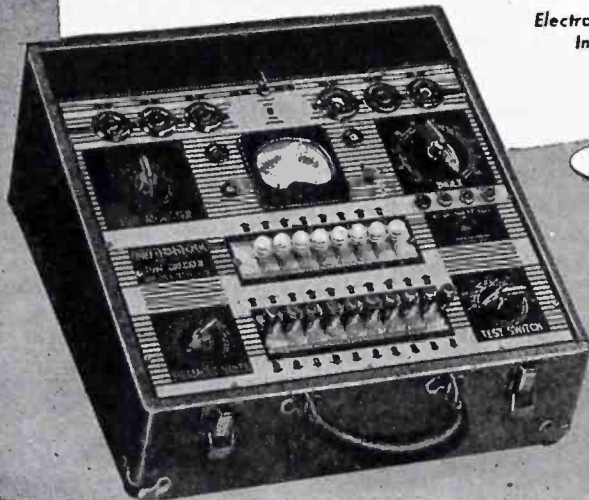

TC-3P



OLD TIMER'S

CORNER

by **SERVICER**

SEVERAL months ago, we dropped in to see Johnny's new store, and stayed awhile for a bit of a celebration. The last customer had gone home, and all talk soon centered on the business of radio. Johnny had started like so many of us by repairing his neighbors' radios when he was in knee pants. He had worked for several of the group in the store that night. And as the years went by, he learned more and more of the business, and finally decided to open up his own store.

Everything was bright and shiny in the new shop. We knew that Johnny and his wife had spent nearly all they had to open the store, and while we were a bit envious of all the new fixins we fervently hoped that they might make a success of it.

The town had needed another Service Man since the f-m station had been installed in the county seat, some 8 miles away. With the interest in f-m, and installation and repair work at a new high, Johnny's start seemed to be well timed. We knew that if sheer work was to be the medium by which he would make a success, then truly his would be the outstanding store of the community.

Johnny had sandwiched in a correspondence course in business management between soldering chassis. We began teasing him about his management knowledge, but he fired comments back.

"You there, Pete," he said, "Do you know how much it costs you to repair a Garod 3 P 1812?"

"I don't even know what it is," sighed Pete, "and if my life depended on it, I couldn't tell you what the last repair cost me".

"How about the rest of you?" Johnny flashed at us.

We guessed that we just used the old rule-of-thumb method. We just sort of figured how many hours we had spent fixing the set, multiplied that by a dollar and a half and added the cost, if we knew it, of the new parts we had installed. Then we said that we paid our bills, and what was

● Here, Mr. Radio Service Man Is a Natural for You

Descriptive
Literature
Sent on
Request



**SPEED
IRON**

PATENT PENDING

**THE SUCCESSOR TO THE ELECTRIC
SOLDERING IRON**

115 Volt, 60 Cycle, 100 Watt

IT'S REALLY FAST!

Soldering Heat in 5 Seconds After Pressing the Trigger!

You don't wait for the SPEED IRON to heat. It waits on your bench, cold, for you. When you pick it up and press the trigger it goes to work with a surge of power and speed that is amazing.

SPEED IRONS have been tested and used in hundreds of war plant applications over a four-year period and are now available to radio repairmen.

PRICE \$12.95 PLUS MAILING COSTS

TERMS 25% WITH ORDER, BALANCE C.O.D.

ORDER YOURS TODAY

WELLER MANUFACTURING CO., DEPT. S, EASTON, PA.

left over we kept as our own. Sometimes we were flush and sometimes we were scraping the bottom of the barrel. It all depended on how much was needed for the kids' shoes, that new Easter hat, or what Doc Jones was charging us for that last case of mumps in the family. We had never gone broke, but we had not made Rockefeller green with envy over our income, either.

"That's where all of you are wrong," said Johnny. "I use a plan based on scientific principles, principles taught to me during that correspondence school course you boys thought was so silly."

Describing the system, Johnny said: "In the first place, your work alone is worth whatever you think it is. None of you would want to go to work for someone else at \$1.50 an hour for a forty-hour week, now, would you? You wouldn't want to earn a mere \$60 a week. So why not be honest with yourself and charge yourself just what you think you should get per week, not per hour. I think that I am worth about \$75 per week, for a forty-hour week, and \$100 a week if I work a lot of overtime. If the sets I have in the shop look like I will be working late that week, I put myself down for \$100, if not then it is only \$75.00. Incidentally, I have been making it, too, as you all know!

"Next I put down the rent, light and heat. Let's say that is about \$25 a month. Following that I add the telephone and advertising which I do. That amounts to about \$15.00 a

month. Then I allow for bad debts, waiting for money to come and postage, and all the little things which all of us have as expenses. This includes the donations to the Police Fund, the Red Cross, and also the insurances. Then don't forget the solder you burn up, irons that go bad and have to be replaced, meters you have to buy, and magazine subscriptions you have to have to keep up with the times. I put all that down for about \$25 a month.

"Now that gives me the following: Salary, \$350 monthly average; rent, etc., \$25; telephone, etc., \$15; and incidentals, \$25. That adds up to about \$415 per month; let's say, \$450 per month. Now if I am to make any money, I will have to earn \$450 first before I make any profit. Isn't that right, Fred?"

Fred guessed that that was sound reasoning.

"Now here is a record I kept of the month before last," continued Johnny. "In that month I actually put in 220 hours for the 4 1/3 weeks I worked. Dividing 450 by 220 we find the hourly rate to be \$2.04. And that's only straight time, with no time and a half for overtime!"

"Don't think that I charge at the rate of \$2.04, because that would only give me an even break. So I figured my average net profits for everything that I sold in the shop for an average month. It came to just about 8% of what I had paid. That means on every \$1.00 I spent I took in \$1.08,

ENGINEERED TO THE APPLICATION



HI-Q
**CERAMIC
CAPACITORS**

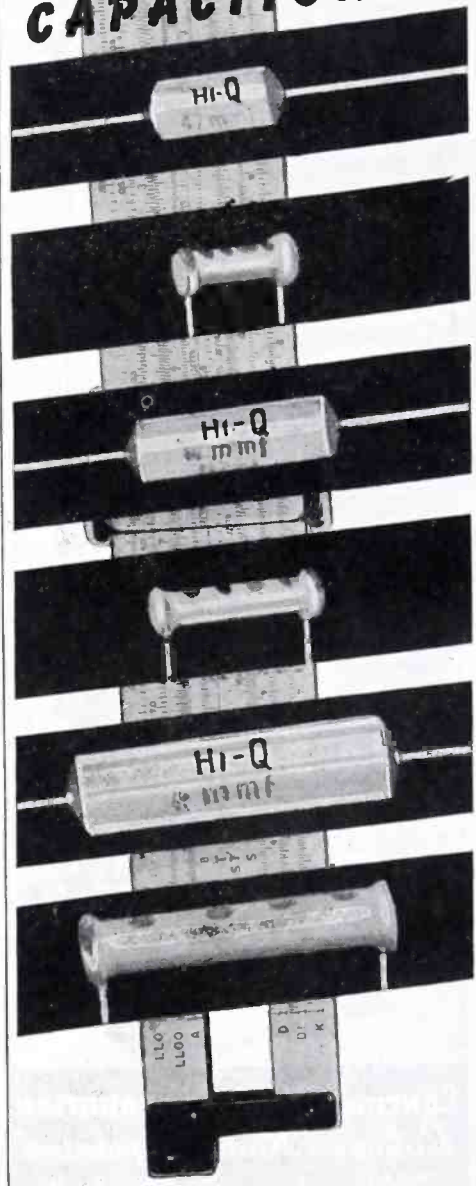

SPEED UP REPAIRS WITH THESE G-C AIDS!



FREE
STEEL
CABINET

G-C Dial Belt Kits

Exact replacement woven fabric belts. Easy to install — no stretching — no adjustments — a perfect fit every time. Kits come with 25, 50, 100, 200 or 300 belts.

Get This New FREE Dial Belt-Drive Cable and Cabinet Repair Guide!

Pocket-size, 68-page book contains thousands of listings, specifications and time-saving service instructions. Invaluable to every radio man. Get a copy from your jobber. If he cannot supply you, write us.



Immediate delivery on G-C Belts and Cables

Order From Your Radio Parts Jobber
ALWAYS ASK FOR G-C PRODUCTS

GENERAL CEMENT MFG. CO.
ROCKFORD, ILLINOIS



**ELECTRICAL
REACTANCE
CORPORATION**
FRANKLINVILLE, N. Y.

CONCORD

*Amplifiers
Intercoms
Recorders*

FOR EVERY PURPOSE

Concord's full line of Amplifiers range up to sizes covering 200,000 square feet indoors or 75,000 square feet outdoors. A complete line of speakers, microphones, and all essential equipment is also available.

Concord Intercom Units are carried in a variety of master and substation units permitting up to 100 stations.

Concord Recording Equipment—professional-type for microphone recording, radio recording, reproduction of transcriptions, public address system.

Mail the coupon below for Special folders and literature which picture and describe the complete Concord line of Amplifiers, Intercoms and Recorders.

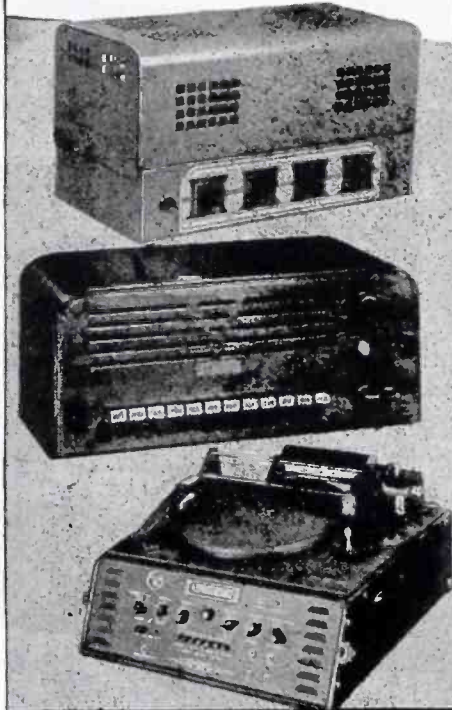

CONCORD RADIO CORPORATION
Lafayette Radio Corporation

CHICAGO 7, ILL.
901 W. Jackson Blvd.

ATLANTA, GA.
403 Peachtree Street

Concord Radio Corporation
901 W. Jackson Blvd., Dept. S-65, Chicago 7, Ill.

Please send me at once, literature covering your line of Amplifiers, Intercoms and Recorders.

Name.....
Address.....
City..... State.....



GORDON TAYLOR JOINS MURRAY HILL BOOKS

S. Gordon Taylor has joined the staff of Murray Hill Books, Inc., 232 Madison Avenue, N. Y. 16, N. Y. as manager of the technical division. For the past year Mr. Taylor has been with the Columbia University division of War Research at the U. S. Navy Underwater Sound Laboratories at New London as a member of the scientific staff and technical editor.

Upon our entry in the war Mr. Taylor went with the U. S. Army Signal Corps,



first as a technical editor and consultant on radio and electronic training at Fort Monmouth and the Southern Signal

OLD TIMER'S CORNER

(Continued from page 41)

net. I added that to my overhead. The hourly rate went up by 8% (or approximately 16 cents) to \$2.20.

"Now here's the catch. The hourly rate was figured on a basis of 220 hours work per month. To be sure that the figures average out over the lean and the heavy months I've applied the total rate to a forty-hour week, or a 160-hour month. The difference between 220 hours and 160 hours is roughly 60 hours, or about 25% of 220 hours. So I added 25% to the hourly rate making it \$2.75 per hour. That's only a rule-of-thumb without reasoning, but you'll find that it does work out in the long run. Try it sometimes.

"Applying that figure I charge \$2.75 for every hour's work that I do here, not counting delivery time, making calls or selling, and take no smaller fee that that even if it is less than an hours' work, unless it be something so small that I do it for nothing. I add to that the mark-up on the parts which are installed, and I find that I am making money. No one has complained because I treat all the same, and all pay the same price. I don't sell over the ceiling on parts or sets, and I'm able to maintain the OPA prices on fixed repairs according to schedule. Now, my friends, go ahead and laugh."

Funny thing, none of us did!

Corps School. Early in 1943 he became technical editor in the Office of the Chief Signal Officer in Washington.

VAN LUVEN NOW OPERADIO REP.

H. H. Van Luven of Los Angeles has been named sales representative for the Operadio commercial sound division in southern California and Arizona.

General offices of Mr. Van Luven will be located at 307-309 East Third Street, Los Angeles.

HYTRON TUBE ASSEMBLY CHART

A step-by-step receiving tube assembly chart has been published by Hythron Radio and Electronics Corporation, Salem, Mass.

VASSAR NAMED WESTINGHOUSE GENERAL SERVICE MANAGER

John A. Vassar has been appointed general service manager of the Westinghouse Electric Supply Company. Mr. Vassar, with offices in New York, will be responsible for home appliance and radio service department operations.

U. S. - ENGLAND - AUSTRALIA TAKE STEPS TO END RADIO INTERFERENCE

An agreement for international cooperation providing for the ultimate establishing of radio interference standards has been set up between the American Standards Association, British Standards Institution, and the Australian Standards Association through the medium of the United Nations Standards Coordinating Committee, 70 East 45th Street, N. Y. 17, N. Y.

The increasing use of electronic devices, and of motor operated gadgets, from

THIS MULTITESTER IN STOCK IMMEDIATE DELIVERY

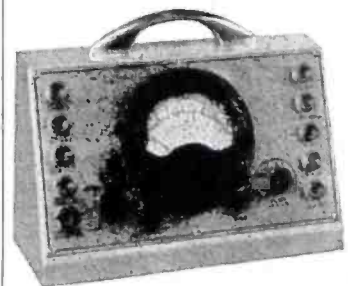

YOUR
COST
ONLY

\$18.75

Less
Test Leads

Model
No. MT 100

UNCONDITIONALLY GUARANTEED SATISFACTION OR MONEY BACK

Latest motor design in all metal case; compact-rugged; the answer to your need for an all purpose, accurate Multitester. Case measures 3 1/2" x 8" x 5". Complete with self-contained batteries.

RADIO REPAIR MEN ORDER THIS TESTER TODAY

OMAHA RADIO PRODUCTS CO.
368 Saunders-Kennedy Bldg.
Omaha, Nebraska

Enclosed is full remittance of \$18.75, or my deposit of \$..... and ship Multitester #MT 100 C.O.D. for balance.

NAME.....
ADDRESS.....
CITY..... STATE.....

OR YOUR
GREATER SKILL

VACO

has
created
of
gleaming
AMBERYL

173
VACO TYPES

Yes, Vaco has created more than just a variety of screw drivers. Vaco has built the exact type of screw driver to do the particular job that can be tedious and troublesome when an ordinary driver is used. No wonder mechanics who do precision work say Vacos are "tops" among all drivers. Vacos, with gleaming Amberyl handles, are shock-proof and break-proof. Write for catalog.

VACO PATENTS MAKE JOBS
PRODUCTS CO.

317 E. ONTARIO STREET
CHICAGO, ILL.

Canadian Warehouse:
540 King St. W., Toronto, 2

NEWS

(Continued from page 42)

vacuum cleaners to generators, is causing extreme interference with radio reception. When improperly installed, fluorescent lights can cause serious interference with radio reception. Considering that a physician's diathermy machine on the East coast of the United States has been found to cause disturbances on radio reception on the West Coast, it is easy to recognize the importance of this new activity. The intricate electrical systems in a long range multi-engined aircraft, if improperly designed, can seriously interfere with radio reception over a wide pathway. It is evident, therefore, that efforts directed toward the eventual

elimination of radio interference are international in scope.

No date was set for publication of the standards.

STANCOR MULTI SLIDE-RULE

A slide rule, plus 8 mathematical tables, has been prepared by Standard Transformer Corporation, Chicago, Ill. The multi slide-rule, priced at \$1.00, will be placed with all Stancor jobbers throughout the country for distribution.

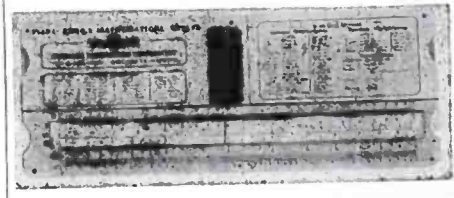

SHALLCROSS WIRE-WOUND RESISTOR BULLETIN

A 28-page engineering bulletin, R, with listings on resistors has been issued by the Shallcross Manufacturing Company, Collingdale, Penna. In addition to the listings the bulletin includes data on resistance alloys, maximum resistance and temperature coefficient charts, dimensional specifications, mountings and terminal designs.

MECK JOBBERS

Jobbers, who will sell Meck postwar radios through radio service and sales shops, have been announced by John Meck Industries, Inc., Plymouth, Indiana.

The jobbers appointed include: James W. Clary Co., 2024 Fourth Ave. N., Birmingham, Ala.; Tucson Radio Supply, 418 Fourth Ave., N., Tucson, Arizona; Tanner Radio & Electric Co., 906 Main St., Little Rock, and Wise Radio Supply, 914 Towson, Fort Smith, Ark.; Radio Specialties Co., 1956 S. Figueroa St., Los Angeles, and Wave Miller & Co., 188 Twelfth St., Oakland, Cal.; Pacific Wholesale Co., 116 Ninth St., San Francisco, Cal.; Inter-State Radio & Supply Co., 1639 Tremont Pl., Denver, Colo.; R. G. Sceli & Co., 227 Asylum St., Hartford, Conn.; Capitol Radio Wholesalers, 2120 14th St., N.W., Washington, D. C.; Railey-Milam, Inc., 27 W. Flagler St., Miami, Fla.; Gulf Electric Supply Co., 115-117 E. Gregory St., Pensacola, Fla.; Welch Radio Supply, 408 Ninth St. S., St. Petersburg, Fla.; Electrical Wholesalers, Inc., 159 Trinity Avenue, S.W., Atlanta, Ga.; Butler Bros., Columbus, Georgia; The Frank Corp., 322 Broughton St., W., Savannah, Ga.; Lurtz Electric Co., 210 N. Illinois St., Belleville, Ill.; Ashbach & Rubloff, 152-54 W. Huron St., Chicago, Ill.; Tri-City Radio Supply, 229 Eighteenth St., Rock Island, Ill.; Harold Bruce, 206 E. Monroe, Springfield, Ill.; Wesco Radio Parts, Ninth at Main, Evansville, Indiana; Arlington Distributing Co., 5959 E. 38th St., Indianapolis, Ind.; Archer & Evinger, 1348 Wabash Ave., Terre Haute, Ind.; Wholesale Radio Laboratories, 744 W. Broadway, Council Bluffs, Iowa; Radio Equipment Co., 377 E. Main St., Lexington, Ky.; The Ferguson Co., 1000-18 Broadway, Paducah, Ky.; Shuler Supply Co., 415 Dryades St., New Orleans, La.; and Zimmerman Wholesalers, 114 E. Washington St., Hagerstown, Md.

EMERSON RADIO APPOINTS ROSENFELD AS ACTING S-M

Morrie W. Rosenfeld, field manager of (Continued on page 44)



REPLACEMENTS

... for the duration

● In keeping with the wartime restrictions on materials, manpower and production facilities, Aerovox PRSV Dandees are making the most of the difficult situation. These electrolytics offer you a lot of electrolytic capacitor life at small cost.

Furthermore, a mere handful of selected capacitances and voltage ratings can take care of most radio-set capacitor replacements. Used singly or in combinations, they provide the right capacitance and working voltage.

So long as our armed forces require every metal-can electrolytic we can produce, we'll just have to keep supplying our trade with cardboard-tube types which will at least see us through on the home radio front until victory is achieved.

● Ask Our Jobber . . .

Ask him for these wartime replacement capacitors and other available types. Ask for latest catalog—or write us direct.



AEROVOX CORP. NEW BEDFORD, MASS., U. S. A.
In Canada: AEROVOX CANADA LTD., HAMILTON, ONT.
Export: 13 E. 40 St., New York 16, N. Y. - Cable: 'ARLAB'

10,000 RADIO MEN

are speeding up their work by using

WARTIME RADIO SERVICE

75 pages — over 1500 detailed, tested tube substitutions and other information you can't be without.

PRICE \$3.00 POSTPAID

From your jobber or order from

CITY RADIO COMPANY

East Washington at Fifth Street Phoenix, Arizona

TUBES—PARTS

RADIO DEALERS—SERVICEMEN

Send for our list of available tubes and repair parts. Sylvania, Tung-Sol, Ken-Rad.

M. V. MANSFIELD CO.

637 LIBERTY AVE. PITTSBURGH 22, PA.

UNIVERSAL MIDGET TOOLS DANDY SIXTEEN PIECE SET

Midget Pliers, Diagonal Cutters, Four Midget End Wrenches, Needle-nose Pliers, Screwdriver, Six Punches and Chisel, Round File, Midget Crescent Wrench. \$14.85. IMMEDIATE SHIPMENT—Overnight by Air to Anywhere U.S.A. Remit today. Mfg. Price U.S. and Order Blank Free. UNIVERSAL TOOL COMPANY, 1527 Grand St., KANSAS CITY, MO. Remember: We have it, can get it, or it isn't made.

ONE-STOP SERVICE

for all your parts requirements

THE STANDARD RADIO

AND ELECTRONIC PRODUCTS CO.

135 EAST SECOND ST., DAYTON, OHIO
119 WEST MAIN ST., SPRINGFIELD, OHIO

Speaker Cones Replaced

4" - \$1.00 6" - \$1.20 10" - \$2.00
5" - \$1.10 8" - \$1.65 12" - \$2.25

PROMPT SERVICE

MORRISON'S RADIO SUPPLY

331 Center Street

Ashtabula, Ohio

TEST EQUIPMENT—Now Available

SUPERIOR PB-100—volt-ohm-milliammeter... \$28.40

SUPERIOR CA-10—signal tracer with tube... 14.85

RADIO CITY 805 tube and set tester... 89.50

RADIO CITY 667 vacuum tube voltmeter... 62.50

Terms: 25% deposit with order, balance C.O.D.

SCENIC RADIO & ELECTRONICS CO.

53 PARK PLACE • NEW YORK CITY 7

We also supply parts, amplifiers, microphones, etc.

Write for Bulletin B

• Ted McElroy

World's Largest Manufacturer of Wireless Telegraphic Apparatus

COMPLETE CENTRAL OFFICE EQUIPMENT

McElroy Manufacturing Corp.

32 Brookline Avenue • Boston, Massachusetts

Emerson Radio and Phonograph Corporation, has temporarily taken over the duties of general sales manager of the company. He succeeds Charles Robbins who recently resigned to enter the representative business. Mr. Rosenfeld was formerly district manager of the New England and New York State territory.

* * *

FOURTH PLANT FOR SOLAR

Plant 4 has been opened at North Bergen, N. J. by Solar Manufacturing Corp.

After the war, the North Bergen factory will be operated as the main eastern plant.

* * *

ALLIED RADIO PARALLEL-RESISTANCE SERIES-CAPACITANCE CALCULATOR

A slide rule, designed to solve problems involving resistors in parallel and capacitors in series, has been released by Allied Radio Corp., 833 West Jackson Blvd., Chicago 7, Illinois. A single setting of the slide aligns all pairs of resistors which may be connected in parallel, or capacitors which may be connected in series. Range: 1 ohm to 10 megohms; 10 mfd to 10 mfd. Priced at 25¢.

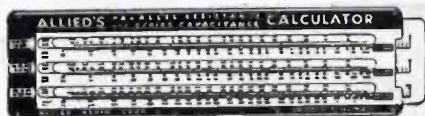

* * *

WALKER-JIMIESON CATALOG

A catalog with data on industrial x-ray machines, electronic comparators, signal generators, tube testers and multi-

NEWS

(Continued from page 43)

testers, photoelectric devices, die-less duplicating tools, plastic sectional wiring systems, etc., has been released by Walker-Jimieson, Inc., 309 South Western Ave., Chicago 12, Illinois.

* * *

WESTINGHOUSE ELECTRIC SUPPLY TO DISTRIBUTE OPERADIO FLEXIFONE

Westinghouse Electric Supply Company will distribute Operadio Flexifone units nationally.

Discussing the arrangement, F. D. Wilson, manager of the Operadio commercial sound division said that the new distribution agreement will not interfere with presently established Flexifone distributors, since Westinghouse will handle the line on an open basis. Established Flexi-

AT IRC "E" AWARD



Fourth white star "E" award at IRC. Holding pennant are, left to right: G. T. Berry, president, Local 105, CIO; First Lieut. Ralph Miller; Capt. H. Wichser, and Ernest Searing, IRC president.

tone distributors will continue to handle the line under existing arrangements.

* * *

KEN-RAD TUBE CAMPAIGN TO BEGIN SOON

Ken-Rad, Owensboro, Kentucky, will soon begin a home-radio tube national trade advertising campaign.

* * *

G-E LIGHTHOUSE TUBE BOOKLET

An 8-page bulletin describing the u-h-f disk-seal or "lighthouse tube," has been announced by G. E.

The pamphlet describes the basic principles of design and operation.

* * *

HICKOK EXPANDS

A 3-floor glass block, air conditioned building has been added to the facilities of the Hickok Electrical Instrument Company, Cleveland, Ohio.



* * *

NEWS OF THE REPRESENTATIVES

At a recent meeting of the Buckeye chapter, G. O. Tanner, 508 Grant St., Pittsburgh 19, Pa., was named president. J. O. Olsen, 1456 Waterbury Road, Cleveland 7, Ohio, is now vice president, and E. C. Edwards, 530 Erie Bldg., Cleveland 15, Ohio, was elected secretary and treasurer.

A. S. Van Osteen, member of the Mid-Lantic chapter, died recently.

NEW PRODUCTS

WESTON FREQUENCY COMPENSATED INSTRUMENTS

Frequency compensated a-c instruments finished as ammeters, voltmeters and wattmeters in both the portable and vitchboard types; flat compensated up to 1000, 2000 and 3000 cycles, have been announced by Weston Electrical Instrument Corporation, 617 Frelinghuysen Avenue, Newark 5, New Jersey.

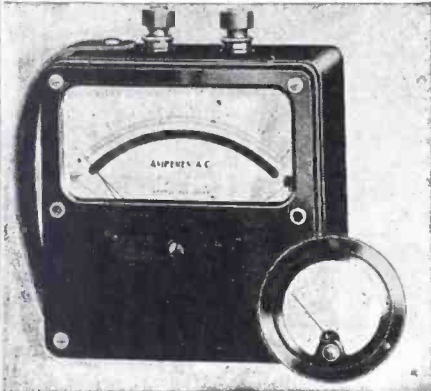

SHALLCROSS MEDIUM RANGE MILLIOHM METERS

A linear scale milliohm meter, 673-F, with six ranges, 0-0.5-1-5-10-50 and 100

RADOLEK

Radio-Electronic Service Parts

Large stocks assure the finest and most complete selections of all available items at lowest prevailing prices. Thousands of active buyers depend on us for their entire Radio repair and replacement requirements. Because we understand service problems, every order is expedited for delivery in double quick time. Everything we do is planned for convenience and satisfaction to our customers. You will find it profitable to make Radolek your buying headquarters.

FREE BUYING GUIDES

Because of existing conditions we keep our customers right up to the minute on available merchandise by releasing supplements frequently instead of sending our regular Big Profit Guide once a year. Send the coupon now to get these Free Buying Guide Supplements as they are issued.

FREE!



FAST SERVICE!

RADOLEK CO., Dept. S-103
601 W. Randolph St., Chicago 6, Ill.

Please send FREE Buying Guide Supplements

NAME _____
ADDRESS _____

ORDER FROM RADOLEK

ohms full scale, has been developed by the Shallcross Manufacturing Co., Collingdale, Pa.

The instrument utilizes separate connections for current and potential so as to minimize the effect of lead and contact resistance when measuring low values. Uses a single No. 6 dry cell battery.

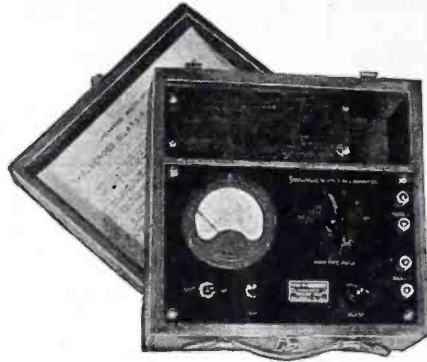

LANGEVIN INPUT TRANSFORMERS

Input transformers known as the 400 series, featuring a high permeability shield with rotatable strap mounting for minimum stray field pickup, have been announced by the Langevin Company, Inc., 37 West 65th Street, New York 23, N. Y.

Three types of transformers are available: 401-A input, operating from 30/250/600-ohm primary to 30,000-ohm secondary center tapped; 400-C bridging input, with a nominal impedance 600/15,000 ohm to 60,000-ohm secondary (input impedance range 0/25,000 ohms); 402-A input, with nominal 30/120-ohm primary to 50,000-ohm secondary (input impedance range 0/250 ohms).

All types have a maximum operating level +10 vu at .001 milliwatt reference level.

Finish is baked gray enamel; 2" center to center mounting, 1 1/2" o.d. x 2 1/4" high.



G. E. FIXED PAPER-DIELECTRIC CAPACITORS

Hermetically sealed, fixed paper-dielectric capacitors for d-c applications, in case style CP-70, characteristics E and F, have been announced by G. E.

There are 268 standard ratings in the CP-70 class, ranging from 0.1 to 15 mfd, for circuit voltages from 600 to 12,500. All ratings have a capacitance tolerance

(Continued on page 46)

Power Rheostat

as engineered by

CLAROSTAT

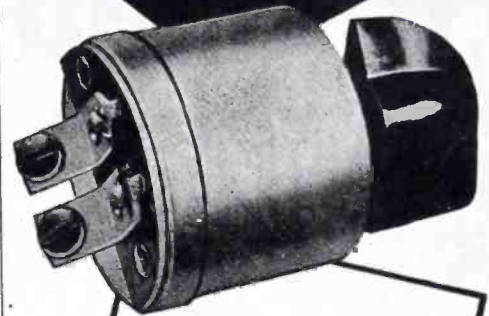

- * Insulated metal core supports resistance winding. Element imbedded in cold-setting inorganic cement. Maximum heat conduction and radiation.
- * Normal current rating may be exceeded by 50% at any setting up to 1/3 total rotation, without damage.
- * Rotor design provides smooth rotation and positive conduction at all settings.
- * Exceptionally rugged, electrically and mechanically.
- * 25- and 50-watt ratings. Enclosed type here shown. Also in non-enclosed type.

* Hundreds of thousands of these rugged Clarostat power rheostats are now in daily use. They are standard equipment in planes, radio, electronic and industrial equipment. They are proving that "they can take it"—and then some. Available on highest priorities today, they will be generally available after the urgent needs of our fighting men are fully met.



Ask our jobber about the "Interim Line" that takes care of your wartime servicing needs. Ask for catalog—or write us direct.



CLAROSTAT MFG. CO., Inc. • 285-7 N. 6th St., Brooklyn, N. Y.

SERVICE, JUNE, 1945 • 45

SUPREME

TESTING INSTRUMENTS

"WORTH WAITING FOR"

● Though Supreme's total current production is still needed by and being sent to our Armed Forces, we are planning extensively in our engineering and production departments to bring you your post-war Supreme Testing Equipment at the earliest possible date. Instruments incorporating radical departures and improvements . . . the result of the experience and know-how gained through over sixteen years of producing instruments proved "Supreme by Comparison."

● These dependably accurate Supreme Testing Instruments will be worth waiting for.

WATCH

NEXT MONTH

for announcement of Supreme's new Model 565 Vacuum Tube Voltmeter.

SUPREME INSTRUMENTS CORP.
Greenwood, Miss., U. S. A.

NEW PRODUCTS

(Continued from page 45)

of ± 10 per cent. Units weigh from 3 ounces to 50 pounds.

Metallic, rectangular cases, with bushings brought out through the top. Bushings with solder-lug *B* terminals are made of molded Textolite, and pillar-insulator *E* and *D* terminals are wet-processed porcelain.

Fixed paper-dielectric capacitors for case styles CP-50, -51, and -52, characteristics *F*, have also been developed by G. E.

All three are available in single-section (two bushings, case isolated), dual-section (two bushings, case grounded), and three-section designs (three bushings, case grounded). The cases are of drawn construction, hermetically sealed, with two mounting lugs included as an integral part. With a capacitance tolerance of ± 10 per cent for single-section units, or $+20 -10$ per cent for 2- or 3-section units, sizes range from 0.05 to 2.0 mfd in ratings of 600 or 1000 volts. They range in weight from 2.3 to 5.8 ounces.

The primary difference in construction is the location of the bushings; CP-50 have bushings through the top, CP-51 through the side, and CP-52 through the bottom of the case.

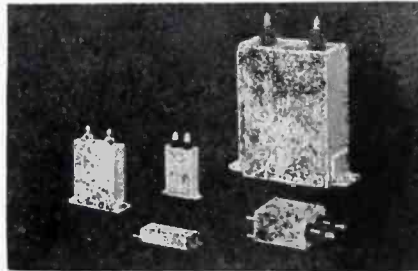

CENTRALAB CERAMIC CAPACITORS

Tubular ceramic capacitors with a temperature coefficient range from -750 to -4000 parts per million per degree C has been announced by Centralab, 900 E. Keefe Ave., Milwaukee 1, Wis.

JFD BATTERY ADAPTOR HARNESES AND PLUGS

Battery adaptor harnesses covering all available battery pack types are now being produced by JFD Manufacturing Co., 4117 Fort Hamilton Parkway, Brooklyn, New York.

The battery harnesses permit the substitution of individual *A* and *B* batteries.

JFD also announces a line of portable radio plugs, including male and female snap fasteners, plugs with Fahnestock clips and plugs for *A*, *B* and *C* batteries.

G. E. SIGNAL GENERATORS

Two signal generators, SG-2A and SG-3A, have been announced by G. E.

The SG-2A signal generator provides a signal-source range from 100 kc to 32 mc in five bands. Modulation of the unit, 30% deep in accordance with the IRE recommendations for receiver testing, is effected by the constant-current method on the plate of the oscillator tube.

The SG-3A unit is said to permit directly calibrated readings of r-f output, with subdivided readings of signals of 0.5 to 100,000 microvolts, at all frequencies from 100 kc to 32 mc. By using second harmonics, signals up to 64 mc are available.

A vacuum-tube voltmeter monitors the

output of the modulated oscillator to the attenuator while a panel control is used to maintain a constant level. Five complete reading scales are said to be possible on a full-vision dial with coincidental bands from 100 kc up to 32 mc.

SHALLCROSS HERMETICALLY SEALED RESISTORS

Hermetically-sealed fixed wire-wound resistors constructed without glass, floating or stud-locked resistance elements, and without ferrule terminals or caps have been developed by Shallcross Manufacturing Company, Collingdale, Penna. The units, for which a patent has been applied, use non-inductive pie windings.

Known as the 1100 series, they are at present available in two designs and in all resistance values from 1,000 ohms to 10 megohms.

Resistance form and the protective shell are ceramic.



TALK-A-PHONE POWER BOOSTER

An inter-communications power booster, HP-16, that is said to deliver a minimum of 15 watts has been announced by the Talk-A-Phone Mfg. Co., 1512 So. Pulaski Rd., Chicago 23, Illinois.

The power booster will work with the



4 STANDARD TYPES

of Amperite Regulators replace over 400 types of AC-DC Ballast Tubes now in use.

Amperites are real REGULATORS . . . have patented Automatic Starting Resistor which prevents initial surge and saves pilot lights. . . Ask Your Jobber.

AMPERITE

THE *Simplest*
WAY TO REPLACE

BALLASTS

WRITE FOR REPLACEMENT CHART

AMPERITE CO. 501 BROADWAY, NEW YORK, N. Y.

majority of intercommunication systems. Certain Talk-A-Phone models have been specially designed for the amplifier. The HP-16 is 6" x 12" x 6 1/4" high. The unit is equipped with on-off switch, pilot light indicator, and variable volume control. Units are connected to the master station by four wires furnished with the booster. For 110 volts a-c 60 cycles.

* * *

G. E. B-F AUDIO OSCILLATOR

A b-f audio oscillator, type AO-2, using full vision dial and said to make direct calibration possible has been announced by G. E.

Unit is said to provide a stable sine wave and continuous variable frequency from 25 to 15,000 cps. The panel control knob regulates the output level from zero to full power output.

A 6E5 electron-ray tube is used to indicate zero beat while adjusting the panel control knob to obtain the proper relationship between the two high-frequency oscillators. A cathode follower type output impedance coupling circuit is used. Maximum output of the device is said to be 120 milliwatts.

* * *

JOHNSON NEUTRALIZING CAPACITORS

Type TN capacitors for neutralizing circuits of transmitters have been developed by E. F. Johnson Company, Waseca, Minnesota.

Two sizes are available, rated at 45,000 volts and 35,000 volts peak breakdown, respectively. Capacity ranges are 33.1 to 2.6 mmfd for the former and 26.0 to 7.2 mmfd for the latter.

* * *

U-M-C HANDI-MIKE

The reissue of the 204-TA handi-mike has been announced by Universal Microphone Co., Inglewood, Cal.

Model has been streamlined and will be made in both carbon and dynamic types.

Impedance is 35-50 ohms; frequency response 200 to 7,000 cps; output level into 50-ohm input; 44 db below 6 milliwatts for 100 bar signal. Shipping weight is two pounds. Assembly includes 6' of conductor shielded rubber jacketed cord.

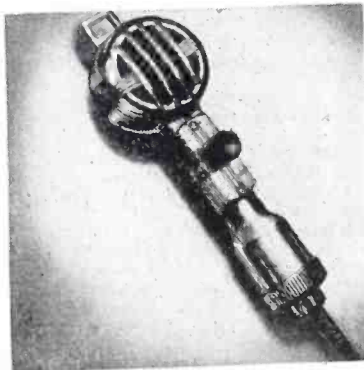

* * *

DAVEN WIRE-WOUND RESISTORS

Wire-wound hermetically sealed resistors have been developed by the Daven Company, 191 Central Avenue, Newark 4, N. J.

Resistor elements are mounted in a drawn brass case. Connections are brought out through fused glass seals, soldered in the case. Mounting bracket permits vertical, inverted or horizontal mounting.

Resistor windings are spool or mica-

WARD LEONARD ANNOUNCES



A NEW RELAY

This plug-in relay is a modification of a popular Ward Leonard type now used in small radio transmitters, aircraft control circuits and for similar applications. It is enclosed in a dust-proof cylindrical metal case (2 1/8" x 3 3/8") rigidly supported against shock and fitted with standard octal base. Operates on standard voltages up to 115 V., AC and DC. Double pole, double throw contacts. Write for price list and further particulars.

WARD LEONARD ELECTRIC CO.

Radio and Electronic Distributor Division

53 WEST JACKSON BLVD., CHICAGO, ILL.





WARD LEONARD

ACCEPTED MEASURE OF QUALITY

RESISTORS
RHEOSTATS
RELAYS

card type; non-inductively wound. Any desired resistance-range value may be had; maximum 1,600,000 ohms. Accuracy is said to be ± 10%. Resistors are available with two terminals at one end or two terminals at each end. A single four-terminal unit is designed to take up to

four separate spool-type resistors of different values and accuracies.

Dimensions are: 1 9/16" wide, 1 1/2" high, 7/8" deep; add terminal height 9/16"; studs on mounting bracket, 1 11/16" between centers.

* * *

A-M-P SOLDERLESS CONNECTOR STRIPS

A connector strip, especially adapted to hangers for sectional wiring, and designed for use with solderless knife-disconnect splicing terminals, has been announced by Aircraft-Marine Products, Inc., 1591 N. 4th Street, Harrisburg, Pa. The integral members are riveted to a plastic base. Any knife-switch connect end may be specified to accommodate any wire size from 22 to 10 inclusive.

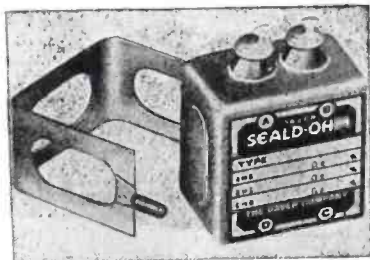

LEO'S SPECIAL!

Immediate Delivery

Money Back Guarantee on this all-purpose

Multitester

Handles AC and DC Voltmeter, DC Milliammeter, High and Low range Ohmmeter. Size 5 1/2 x 8 x 3 3/4" meter with sturdy D'Aronsonal movement. Write for priority information.

See Leo for WRL Radio Kits priority required



Model WRL 300 ONLY \$18.75 Less Leads



Phono Amplifier Kits Complete with tubes, instructions. **\$9.50** No. 1059

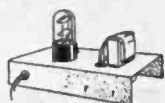

Code Oscillator Kits Complete with tubes, Size 3"x6". **\$4.95** No. 66-200

OUTPUT TRANSFORMERS

15 watt P.P. 6L6 output. To 4 ohm V.C. or 500 ohm line. Fully shielded. No. 9-649. **\$1.65**

FIL. TRANSFORMERS

Fully Shielded 110 V. Tapped Primary, Secondary, 5 volt @ 3 amp. and 6.3 V.C.T. @ 4 amp. **\$2.25** No. 9-551

We Feature HALLICRAFTERS The "radio man's radio." Immediate delivery on priority. Write for full details today.

EXCLUSIVE AT LEO'S!

44 Page Parts Flyer... **FREE** Packed with hard-to-get items. Immediate delivery to radio repairmen. Usual priorities. Experimenters write Leo, W9GFQ, on how to get radio repair parts. Tube and Circuit Reference Book... **10c** Handy Tube-Base Calculator... **25c** Giant Radio Reference Map, Size 3 1/2 x 4 1/2 ft **15c**



MAIL TODAY

Wholesale Radio Laboratories s-s 744 West Broadway Council Bluffs, Iowa
 Please rush Multitester No. 300, \$18.75 is enclosed, or Enclosed is \$_____, Balance C.O.D.
 Here's 10c, Send "Tubes and Circuits" Book.
 I want a Tube-Base calculator. 25c enclosed.
 Ship me your radio map. 15c enclosed.
 Send me your free flyer of hard-to-get radio parts.

Name _____
 Address _____
 Town _____ State _____
 I am an amateur; experimenter; service man.

QUICK SERVICE

Your order will receive my own personal attention. You'll get "same day" delivery service from the heart of the nation... on anything in radio.

Sincerely,
 Leo & Myerson



Wholesale RADIO LABORATORIES

JOTS AND FLASHES

RMA reports that a voluntary coding (producing source and date) system has been set up for parts and accessory manufacturers. All RMA member companies have been assigned registered code symbols. . . . Lt. Col. John F. Rider has returned to his desk as head of his publishing company. He was with the Signal Corps for three years. Welcome back. . . . Harry Adelman is now in the export business with his own unit, the Radelma Company, 53 Park Place, N. Y. City. He was formerly with Sun Radio. . . . Another white star has been added to the "E" flag of Clarostat. . . . UTC has also received another white star. . . . And Sprague Electric, Solar, and IRC have won their fourth white stars for their "E" flags. . . . Amperex has received its third "E" flag star. . . . E. B. Latham will distribute Lear receivers and wire recorders in Greater New York, Westchester County and Long Island counties of Nassau and Suffolk, according to a note from Nate Hast, merchandise manager of Lear. . . . L. E. Septer is now manager of replacement tube sales for the home radio division of Westinghouse. . . . L. A. King has resigned his post as secretary-treasurer and general sales of Operadio Manufacturing Company. He was with Operadio for 21 years. No future plans have been announced yet. . . . Sid Cohen and Morris Taylor, California reps for Adaptol visited the home office and plant at 260 Utica Avenue, Brooklyn, recently. . . . Adaptol is now making loktal base types of adapters. . . . Of the three channel alternatives for f-m proposed by the FCC (50-68, 68-86, 84-102 mc), in their recent report, the first channel appears to be winning most friends. A resolution recently adopted by the allocation panel of the Radio Technical Planning Board recommended this first channel. Television interests have also approved the move. . . . P. S. Billings, president of Belmont, is now on the Raytheon-Belmont board of directors. Belmont Radio Corporation and Raytheon Manufacturing Company merged recently. . . . Harry Byrne is now assistant sales manager of Howard Radio. He was formerly with John Meck as advertising and sales promotion manager. . . . Wood and Anderson Company, 915 Olive St., St. Louis, Mo., and Henry P. Segal Company, 143 Newbury St., Boston, Mass., have been named Clarostat representatives in the Missouri and New England areas, respectively. . . . Be sure and buy your share of war bonds during the 7th War Loan Drive.

ADVERTISERS IN THIS ISSUE

SERVICE INDEX—JUNE, 1945

ADAPTOL CO.	38
Agency: Hart Lehman, Advertising	
AEROVOX CORPORATION	43
Agency: Austin C. Lescarbourea & Staff	
AMPERITE CO.	46
Agency: H. J. Gold Co.	
BURSTEIN-APPLEBEE CO.	36
Agency: Frank E. Whalen Adv. Co.	
CENTRALAB	25
Agency: Gustav Marx Adv. Agency	
CHERRY RIVET CO.	4
Agency: Dana Jones Co.	
CITY RADIO CO.	44
CLAROSTAT MFG. CO., INC.	45
Agency: Austin C. Lescarbourea & Staff	
CONCORD RADIO CORP.	42
Agency: E. H. Brown Adv. Agency	
DRAKE ELECTRICAL WORKS, INC.	34
Agency: William Hoffman & Associates	
ELECTRICAL REACTANCE CORP.	41
Agency: Scheel Adv. Agency	
ELECTRONIC LABORATORIES	Inside Front Cover
Agency: Burton Browne, Advertising	
GENERAL CEMENT MFG. CO.	41
Agency: Turner Adv. Agency	
GENERAL ELECTRIC	40
Agency: Maxon, Inc.	
THE GENERAL INDUSTRIES CO.	32
Agency: Fuller & Smith & Ross, Inc.	
HALLDORSON CO.	38
Agency: Sander Rodkin Adv. Agency	
HALLICRAFTERS CO.	6
Agency: Burton Browne, Advertising	
HICKOK ELECTRICAL INSTRU. CO.	30
Agency: Kircher, Lytle, Helton & Collett	
JENSEN RADIO MFG. CO.	17
Agency: Burton Browne, Advertising	
KEN-RAD	1
Agency: Maxon, Inc.	
LIFETIME SOUND EQUIPMENT CO.	36
Agency: The Miller Agency Co.	
McELROY MFG. CORP.	44
Agency: Shappe-Wilkes Inc.	
M. V. MANSFIELD CO.	44
MARION ELECTRICAL INSTRU. CO.	23
Agency: Shappe-Wilkes Inc.	
MEISSNER MFG. CO.	9
Agency: Gardner Adv. Co.	
MORRISON'S RADIO SUPPLY	44
NATIONAL UNION RADIO CORP. Back Cover	
Agency: Hutchins Adv. Co., Inc.	
OMAHA RADIO PRODUCTS CO.	42
RADIART CORPORATION	39
Agency: Kenneth H. Kolpien	
RADIO CORPORATION OF AMERICA	19
Agency: Kenyon & Eckhardt, Inc.	
RADIO TUBE SERVICE CO., INC.	36
Agency: Daniel de Koven	
THE RADOLEK CO.	45
Agency: Turner Adv. Agency	
RAYTHEON MFG. CO.	3
Agency: Burton Browne, Advertising	
JOHN F. RIDER PUBLISHER INC.	37
Agency: Lansford F. Kling	
SCENIC RADIO & ELECTRONICS CO.	44
SIMPSON ELECTRIC CO.	21
Agency: Kreicker & Meloan, Inc.	
SOLAR CAPACITOR SALES CORP.	Inside Back Cover
Agency: O. S. Tyson & Co., Inc.	
SPRAGUE PRODUCTS CO.	5, 29
Agency: The Harry P. Bridge Co.	
STANDARD RADIO & ELECTRONIC PRODUCTS	44
Agency: Kircher, Lytle, Helton & Collett	
STANDARD TRANSFORMER CORP.	35
Agency: Burnet-Kuhn Adv. Co.	
SUPREME INSTRUMENTS CORP.	46
Agency: O'Callaghan Adv. Agency, Inc.	
SYLVANIA ELECTRIC PRODUCTS INC.	10
Agency: Nevell-Emmett Co.	
TECHNICAL DIV. MURRAY HILL BOOKS, INC.	33
Agency: The Harry P. Bridge Co.	
THORDARSON ELECTRIC MFG. CO.	7
Agency: Duane Wanamaker—Advertising	
TRIPLETT ELECTRICAL INSTRUMENT CO.	39
Agency: Western Adv. Agency, Inc.	
U. S. TREASURY DEPT.	8
UNITED TRANSFORMER CO.	27
Agency: Shappe-Wilkes Inc.	
UNIVERSAL TOOL CO.	44
Agency: Barrons Adv. Co., Inc.	
VACO PRODUCTS CO.	43
Agency: Duane Wanamaker—Advertising	
WARD LEONARD ELECTRIC CO.	47
Agency: E. M. Freystadt & Associates	
THE WARD PRODUCTS CO.	34
Agency: Burton Browne, Advertising	
WEBSTER-CHICAGO CORP.	15
Agency: William Hoffman & Associates	
WELLER BROS.	40
WHOLESALE RADIO LABORATORIES	48
Agency: Pfeiffer Adv. Agency	

you can't *put the squeeze*
on SEALDTITE
CAPACITORS





Just try it . . . Take a genuine "Sealdtite" capacitor and try to *squeeze* it. No results. You'll find it has no soft spots, which in ordinary tubulars provide room for moisture, the capacitor's worst enemy, because the Solar capacitor has an internal winding of high quality paper and foil, skillfully *molded* into *solid* plastic.

No moisture can penetrate this protective case and its substantial construction permits rough handling, assures long and *reliable* service.

Use "Sealdtite" capacitors. Send for your copy of Catalog V-4.
Any Climate - Any Atmosphere - Any Service.



 BAYONNE PLANT 
WEST N.Y. PLANT
A TOTAL OF EIGHT ARMY-NAVY
EXCELLENCE AWARDS

SOLAR CAPACITOR SALES CORP.
285 MADISON AVENUE, NEW YORK CITY

Remember?

HOW THE N. U. EQUIPMENT PLAN HELPED SERVICE DEALERS PROSPER!

Here's a typical example of how service dealers obtained the test equipment they needed through National Union deals. This N. U. plan was OK'd 60,000 times by radio service dealers — and helped make servicing more profitable for thousands!

NATIONAL UNION RADIO CORPORATION
NEWARK 2, NEW JERSEY



NATIONAL UNION

RADIO AND ELECTRONIC TUBES

Transmitting, Cathode Ray, Receiving, Special Purpose Tubes, Condensers, Volume Controls, Photo Electric Cells, Panel Lamps, Flashlight Bulbs