

SERVICE

A MONTHLY DIGEST OF RADIO AND ALLIED MAINTENANCE

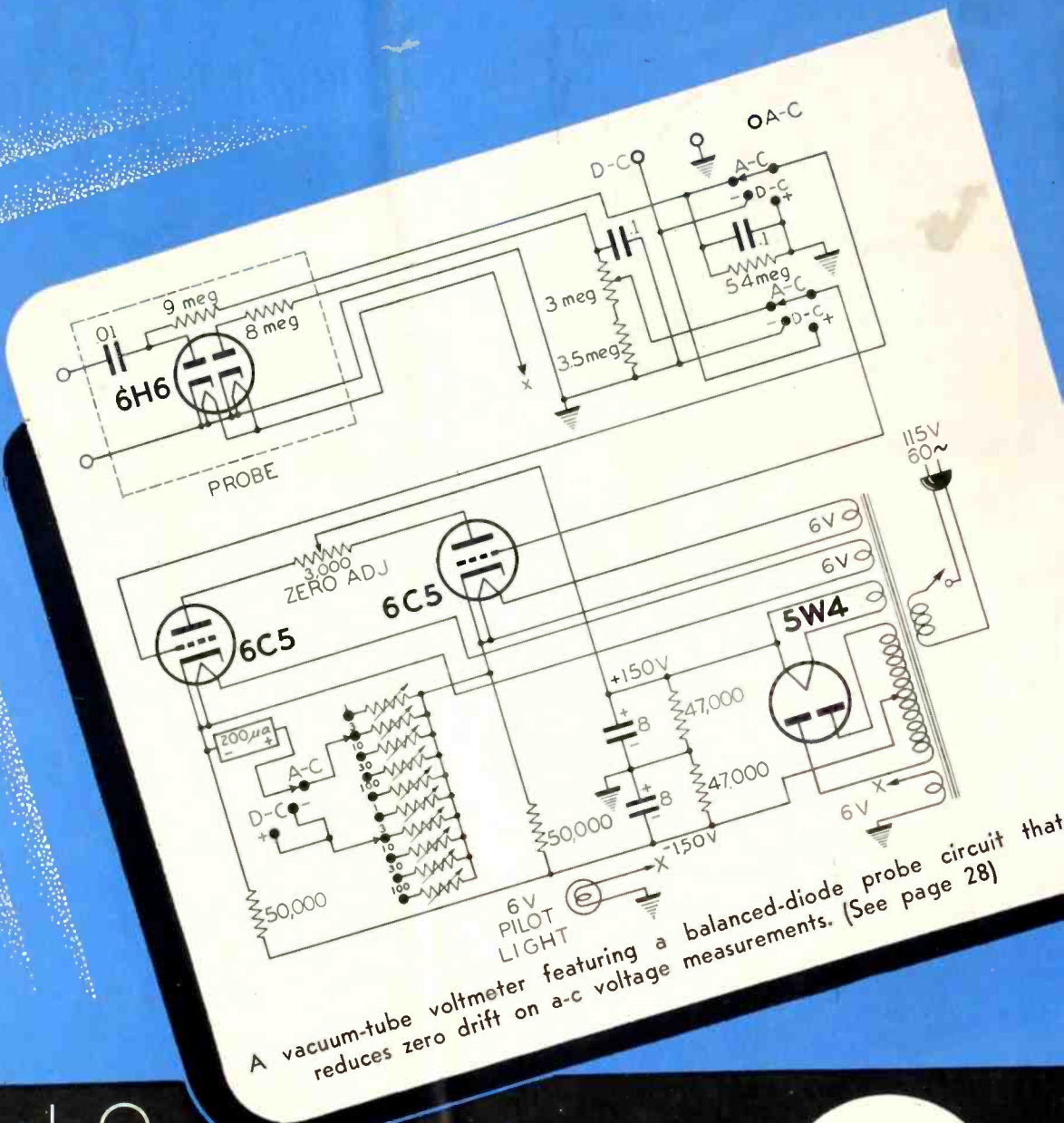

A vacuum-tube voltmeter featuring a balanced-diode probe circuit that reduces zero drift on a-c voltage measurements. (See page 28)

★ RADIO
★ TELEVISION
★ ELECTRONICS

May
1944

Don't put 'em on the shelf - let's fill our back orders!



"Hytron has allocated available MR tubes to us. We, too, are going to comply strictly with WPB rulings by allotting these tubes immediately to our dealers."

True, the WPB recently has permitted Hytron to ship its authorized distributors appreciable quantities of MR tubes. On the other hand, the war is far from over. Tubes are still scarce, and should be given to those who need them most. Hytron is confident that you are being as scrupulously fair in distributing your MR tubes, as it is in apportioning them to you.

You can bet that Hytron is looking forward to the day when it can solicit aggressively the business of both old and new friends.

HYTRON HYLIGHTS

Current reports forecast less MR tubes in the second quarter of 1944.

Remember also that WPB has ruled that MR receiving tubes shall be allocated upon a pro rata basis of 1941 purchases — that this prohibits sales to new distributors.

You can readily understand our regret at not being able to supply new customers — and why we ask that our authorized distributors await information from Hytron regarding allocations.

OLDEST EXCLUSIVE MANUFACTURER OF RADIO RECEIVING TUBES

HYTRON
CORPORATION
ELECTRONIC AND
RADIO TUBES

SALEM AND NEWBURYPORT, MASS. BUY ANOTHER WAR BOND



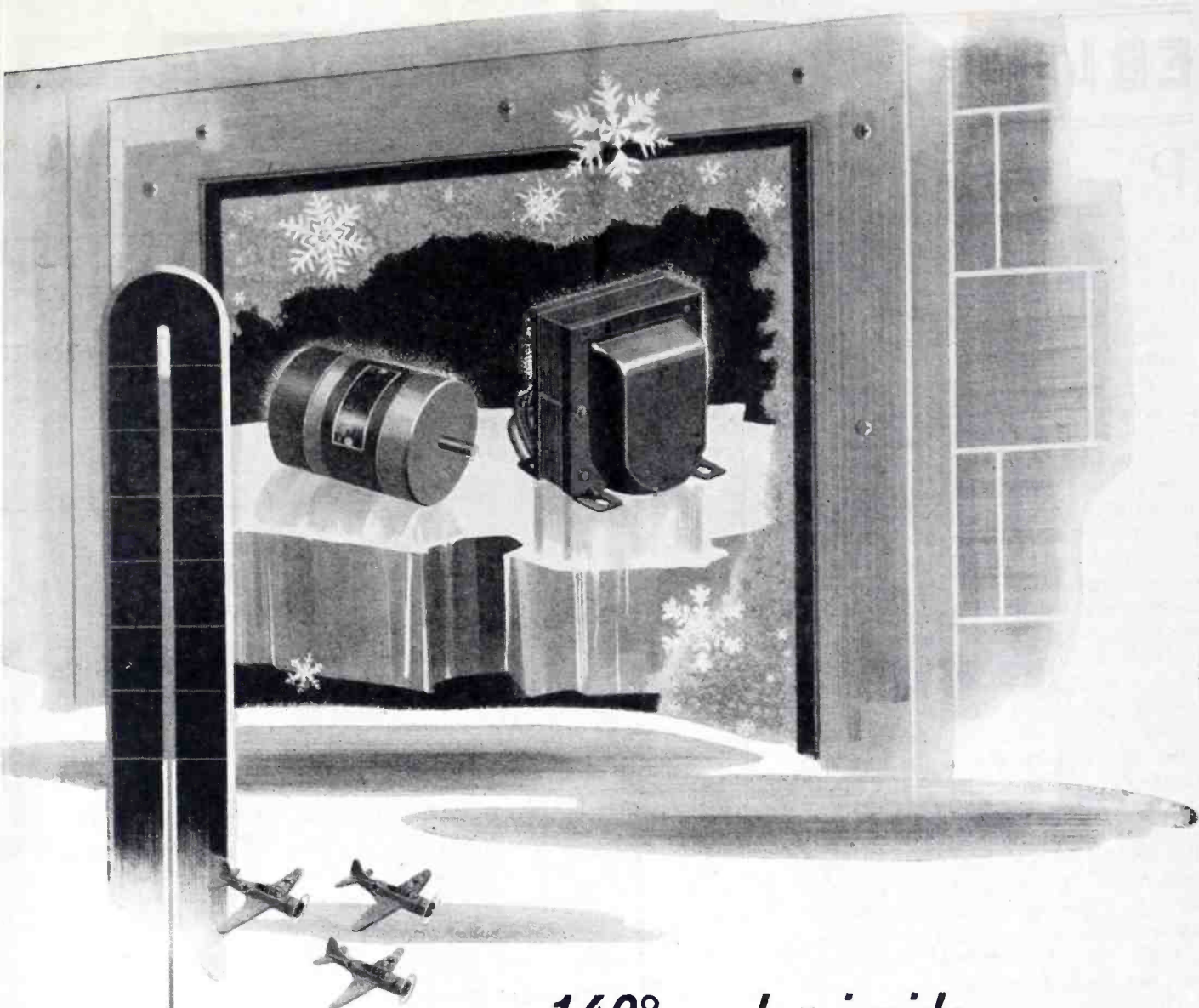

140° cooler inside

There is a piece of the stratosphere just beyond that glass door. The air pressure is less than one-fourth of normal air pressure. And the temperature is 70 degrees below zero.

The Utah parts being tested are proving that their performance will be "as specified," whether they are to operate on the ground or high in the air.

This and other tests which parts undergo in the *complete* Utah laboratory are particularly important in adapting the new electronic and radio developments—in making them militarily and commercially usable—now, and tomorrow!

★ ★ ★

Every Product Made for the Trade, by Utah, Is Thoroughly Tested and Approved

Utah

Radio Products Company,

816 Orleans Street, Chicago 10, Illinois

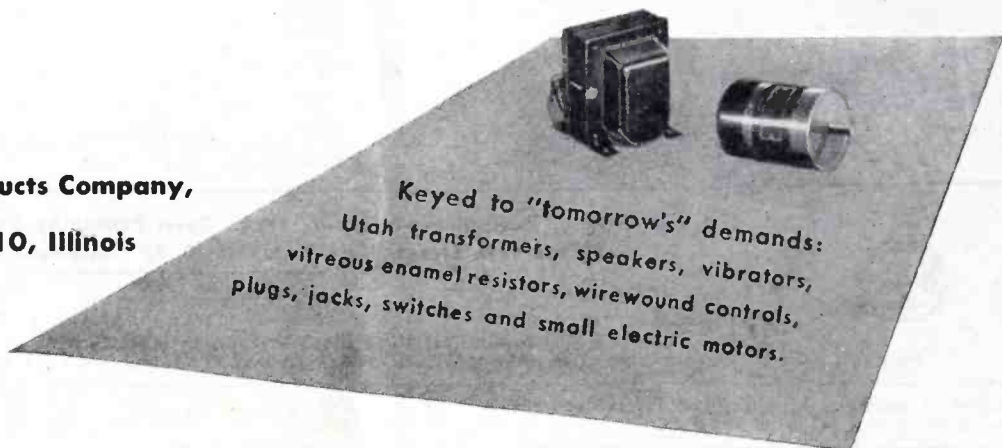

EDITORIAL

PRICE ceiling and rating rulings of vital import to every Service Man have been issued by the OPA and WPB.

The price ceiling ruling lists specific prices for tubes, based on the prices that prevailed during March 1942. The ruling also stipulates maximum service charges for tube testing.

Hereafter, says the ruling, no charge may be made by a dealer or Service Man for testing tubes when they are brought to his shop by a customer, since no charge was customarily made for this service. However, when a portable or table model radio or phonograph is brought to the shop for tube testing or tube replacement, a maximum charge of fifty cents for testing the tubes may be made. If the chassis has to be removed to test or replace the tubes, a maximum charge of one dollar may be made for this test.

The price ceiling schedule covers tubes used in portables, as the 1A5GT, \$1.10 ceiling price; table model tubes like the 12SA7GT, \$1.30 ceiling price; and console and auto radio tubes like the 6SA7GT, with a \$1.10 ceiling price, etc. The prices include the ten per cent manufacturer's federal excise tax which became effective on October 1, 1941. The April 1, 1944, excise tax does not apply to tubes.

The WPB rating ruling states that capacitors, microphones and loudspeakers, resistors, transformers and tubes are available to Service Men and retailers on a pro-rata basis, and do not require the use of a rating. Under this ruling, says the WPB, the Service Man should be able to get his fair share of replacement parts. The WPB also points out that a Service Man may use what he buys to recondition or rebuild a damaged or used component which he may wish to sell. But, he may not use it to replace material or parts which are still usable, nor to replace material or parts solely to improve it from its original design.

Service Men should follow these regulations religiously. If there are any problems discuss them with the OPA or WPB field office in your area.

SERVICE

A Monthly Digest of Radio
and Allied Maintenance

Reg. U.S. Patent Office

Vol. 13. No. 5

May, 1944

ALFRED A. GHIRARDI

Advisory Editor

J. M. LEE

Assistant Editor

LEWIS WINNER

Consulting Editor

F. WALEN

Managing Editor

	Page
Constant Voltage Power Supply Systems. By Mark Glaser and Edward M. Glaser	7
Ser-Cuits. By Henry Howard	22
Servicing Helps	20
Special Electronic Tests. By S. J. Murcek	12
Wartime Repairs (SERVICE Contest First Prize Entry). By Ray Pentecost	10
Circuits	
EKCO AC74 (British receiver)	22
EKCO AW88 or C88 (British receiver)	26
Measurements model 62 (Cover)	28
Cover	
Vacuum-Tube Voltmeter (Measurements model 62)	28
Index to Advertisers	36
Manufacturers	
News	30
New Products	33
Jots and Flashes	36

Copyright, 1944, Bryan Davis Publishing Co., Inc.



Bryan S. Davis, Pres.
F. Walen, Secretary



Paul S. Weil, General Manager
A. Goebel, Circulation Manager

James C. Munn, 10515 Wilbur Avenue, Cleveland 6, Ohio
Pacific Coast Representative: Brand & Brand, 816 W. Fifth St., Los Angeles 13, Calif.; Telephone, Michigan 1732

Entered as second-class matter June 14, 1932, at the Post Office at New York, N. Y., under the Act of March 3, 1879. Subscription price: \$2.00 per year in the United States of America and Canada; 25 cents per copy. \$3.00 per year in foreign countries; 35 cents per copy.



Bringing the "FUTURE" Closer!

• In the field of electronics, nothing stays new for very long. Since Pearl Harbor there has been a tremendous increase in Raytheon technical achievements and production techniques, keeping pace with the vast requirements of the military. Experience gained in wartime assures the leadership of Raytheon in the new postwar era of electronics.

Raytheon is proud of the trust the Armed Forces have placed in its engineering and large-scale manufacturing abilities. This wartime experience doubly protects manufacturers of post-war radios and industrial electronic equipment. Let's win the war first! Then look to Raytheon for the best engineered and precision-made electronic tubes for all applications.

Raytheon Production Corporation

Newton, Massachusetts; Los Angeles,
New York, Chicago, Atlanta



All Four Raytheon Divisions Have Been
Awarded Army-Navy "E"—Plus Stars

Devoted to Research and the Manufacture of Tubes for the New Era of Electronics



RAYTHEON

High Fidelity
RADIO AND ELECTRONIC TUBES

"Triple Six S"



MODEL No. 666S

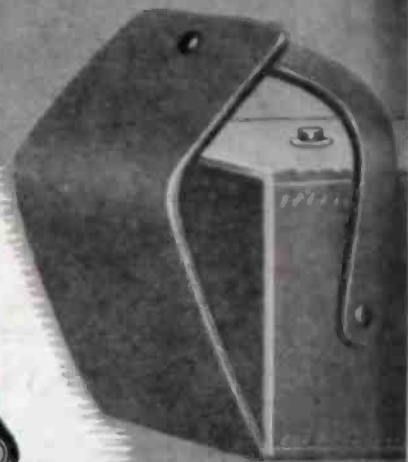

All-Purpose Pocket Size Volt-Ohm-Milliammeter

A new modernistic styled, compact unit that provides an answer to all Volt-Ohm-Milliammeter requirements. Incorporates all the testing facilities of larger, more costly equipment. A.C. and D.C. Volts 0-2.5-10-50-250-1000-5000 (D.C. at 10,000 ohms per volt; A.C. 1000 ohms per volt); 0-.1-1-10-100-1000 D.C. Milliamperes, at 100 millivolts; 0-10 D.C. amperes at 100 millivolts; Resistance 0-400 Ohms (10 ohm center scale); 0-40,000 ohms (500 ohms center scale) 0-4 Megohms (50,000 ohm center scale). Self contained batteries. Selector switch control for all ranges.

Completely insulated black molded case and panel, attractive streamlined design. (Leather carrying case also available to hold tester and accessories.)

The Triplett Line—more comprehensive than ever—goes today for war needs but its exacting services in war assure you the final answer for post-war equipment requirements.

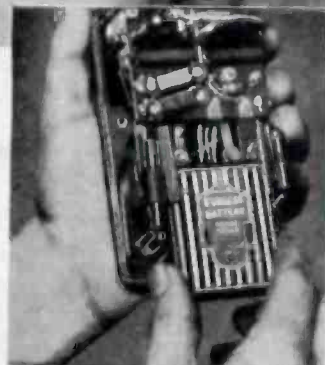

Battery slides into place. Easily inserted or removed.



Twenty position selector switch control for all ranges.

Triplet

ELECTRICAL
BLUFFTON



INSTRUMENT CO.
OHIO ★ ★ ★



History of Communications Number Four of a Series

SMOKE SIGNAL COMMUNICATIONS

While the puffs of our early American smoke Signals were not as complicated as the Morse Code, this type of communication was a speedy and effective means of communication at that time and could be seen for scores of miles on a clear day. Used for transmitting their battle messages, smoke signals in the days of the early American meant a progressive means of communication.

Restricted by climatic conditions this type of communication was limited in its use. Universal microphones in the part they play in modern electronic voice communication must withstand the climates of the Arctic and the Tropics all in a day's work. Built to accomplish a specific job, Universal Microphones are "getting the message through" on every Allied front.

Model T-45, illustrated at left, is the new Lip Microphone being manufactured by Universal for the U. S. Army Signal Corps. Shortly, these microphones will be available to priority users through local Radio Jobbers.



MODEL T-45
LIP MICROPHONE

UNIVERSAL MICROPHONE COMPANY
INGLEWOOD, CALIFORNIA



ALL INDUSTRY IS FINDING OUT ABOUT

THE ELECTRONIC TUBE

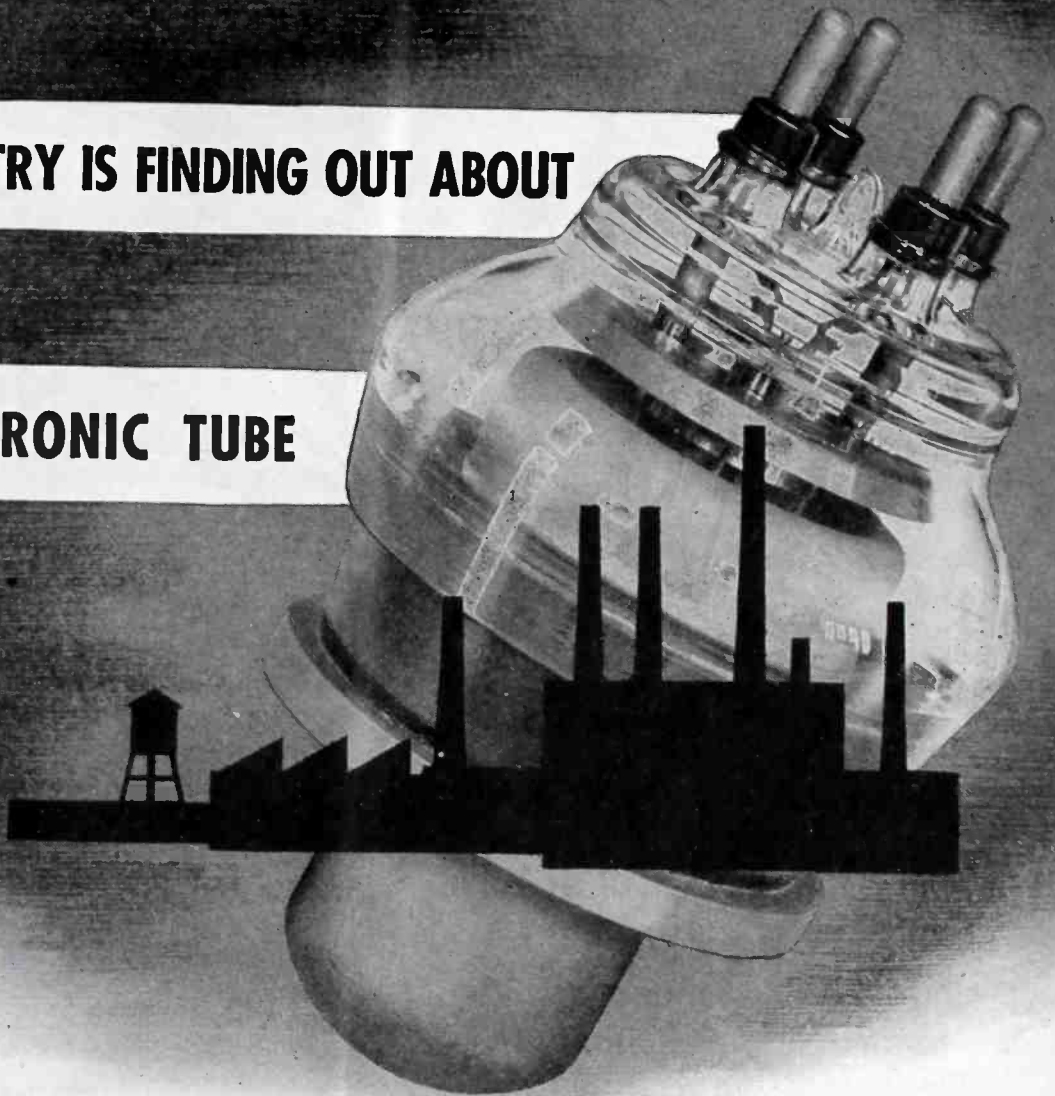

**A GREAT POST-WAR MARKET IS BEING BUILT
FOR YOU—NOW—AND GENERAL ELECTRIC
IS THE LEADER IN BUILDING IT**

GL 880—The 50-kw Electronic Tube used in FM Broadcasting and in High Frequency Heating.

The dependable G-E electronic tube is busy in many factories — counting, wrapping, sorting, inspecting, measuring, heating and doing a thousand and one other precision control jobs better than by any other means.

Each week, scores of additional factories are putting versatile G-E tubes to work. Practically every war industry in the country is producing *more* materials for war than ever before by electronic means . . . doing things better . . . faster . . . and with closer precision control than ever before. Post-war, *all* industry will investigate the electronic tube and how it may serve them. General Electric is helping to build this tremen-

dous post-war market for you right now . . . preparing for the day when you, the radio service man of today, will be the electronic maintenance man of tomorrow — serving both industry and the expanded radio receiver market.

Write for your copy of "How Electronic Tubes Work," a brochure that explains the uses of tubes in industry. . . . Address: *Electronics Department, General Electric, Schenectady, N. Y.*

• Tune in General Electric's "The World Today" and hear the news from the men who see it happen, every evening except Sunday at 6:45 E.W.T. over CBS. On Sunday evening listen to the G-E "All Girl Orchestra" at 10 E.W.T. over NBC.

THERE'S A G-E ELECTRONIC TUBE FOR EVERY PURPOSE

GENERAL  ELECTRIC

176-C3

CONSTANT VOLTAGE POWER SUPPLY SYSTEMS

by MARK GLASER and EDWARD M. GLASER

THE growing need for precision control in electronic and radio equipment has accelerated the use of constant voltage power supply systems.

Probably the most important use of a constant voltage power supply is the stabilization of oscillators, used in transmitters, signal generators, frequency meters, beat frequency oscillators, relaxation oscillators, multivibrators; also pulse generators and receiver oscillators. The stabilization of all of these oscillators is necessary because the frequency generated depends upon the supply voltage; also, the power output is dependent upon the supply voltage. Constant gain and output amplifiers, too, require a regulated power supply. In the constant calibration type of v-t voltmeter with an overall accuracy of 2% or 3%, this accuracy would be impossible without constant plate screen and bias voltages.

Voltage regulation is also required in various types of laboratory equipment particularly in connection with

standards and in power equipment. Measurements of infinite variety are made easier and more accurate through the use of some type of power regulation. Some bias supplies for class B and C amplifiers require regulation. Some photoelectric equipment also requires careful regulation. In some of these cases we deal with both a-c and d-c voltage regulation; in others, with d-c plate voltage regulation only.

There are two principal causes of voltage variation in power supplies: line voltage variation and load variation. There are other minor factors which affect regulation such as the temperature of power supply components, aging of rectifiers and vacuum tubes and deterioration of electrolytic condensers.

A-C Voltage Regulators

The most general type of a-c voltage regulator, sometimes called voltage stabilizer, is the magnetic saturation type in which the output voltage can

be held to within plus or minus 1% for wide variations in line voltage and also in load. This type of regulator is somewhat expensive because it contains a standard transformer, a saturating transformer and one or more oil filled capacitors. However, it is a very versatile piece of equipment because power supplies, oscillators and all kinds of a-c fed devices may be plugged into the output socket and made immune from line-voltage changes.

Ballast Tubes and Resistors

A much cheaper type of a-c regulator familiar to all Service Men is the ballast tube, or ballast resistor which is really a current regulator and not directly a voltage regulator. It consists of an enclosed resistance element having a high temperature coefficient of resistance over its rated voltage range, so that the current through it is substantially constant throughout this range. The first ballast tubes on the radio market were

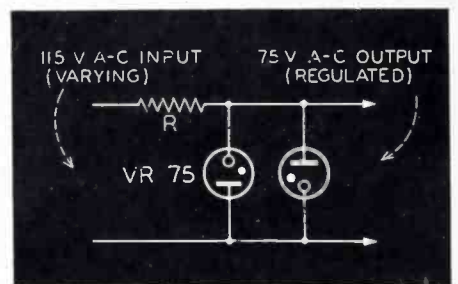
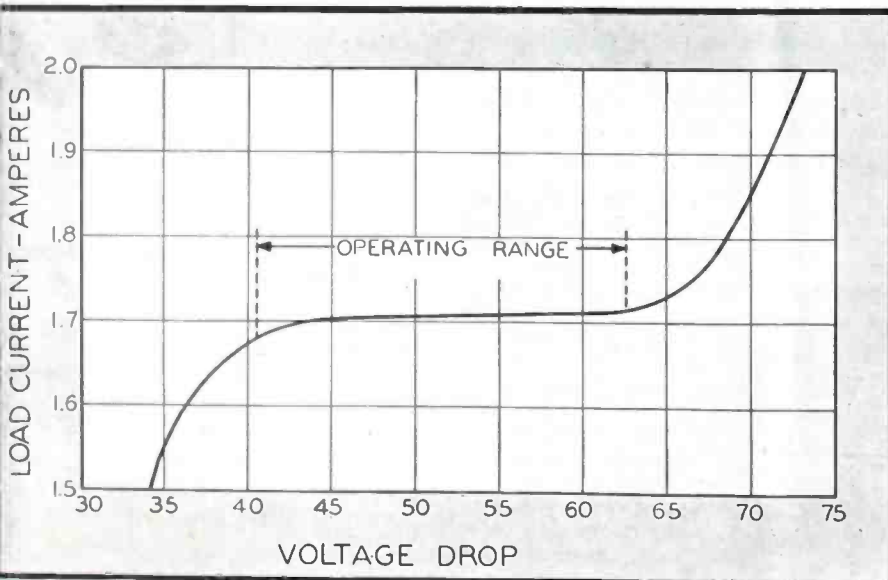

Fig. 1 (left) and 2 (above). In Fig. 1 appears a characteristic curve of the 876 current regulator tube. The 876 tubes were designed to be used in the primary circuit of power transformers to deliver a constant current to the transformer, thereby maintaining rated filament and plate voltages on the receiving tubes. A method of low power a-c regulation is shown in Fig. 2. Here are a pair of tubes, paralleled with opposite polarity.

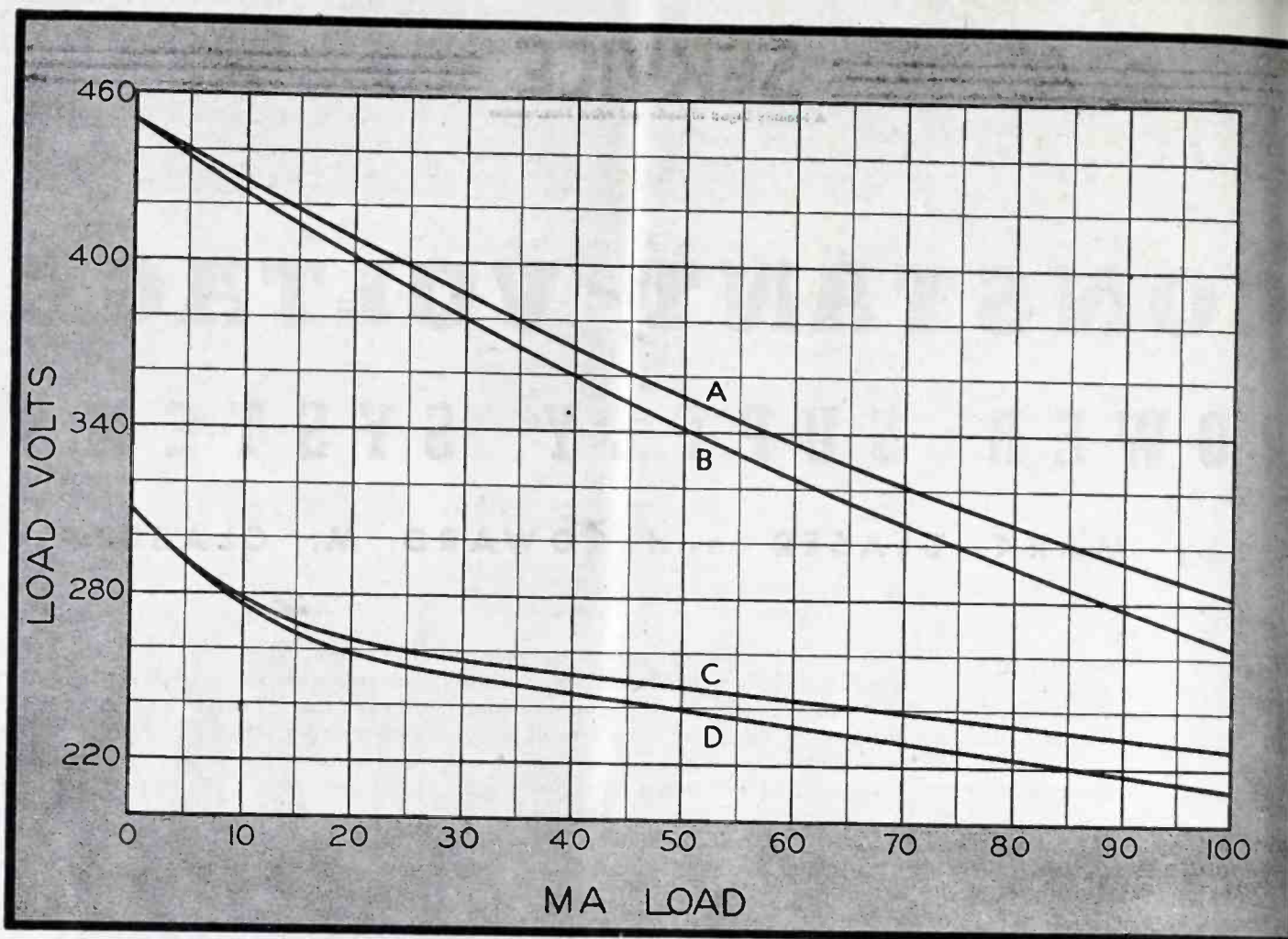

Fig. 3. Voltage regulation curves, with choke and condenser inputs. *A*, condenser input, 83 rectifier; *B*, condenser input, 80 rectifier; *C*, choke input, 83 rectifier; and *D*, choke input, 80 rectifier.

types 876 and 886. They were designed to be used in the primary circuit of power transformers to deliver a constant current to the transformer, thereby maintaining rated filament and plate voltages on the receiving tubes. They had a range of 40-60 volts (absorbed voltage) and operating currents of 1.7 and 2.05 amperes respectively. The characteristics of the 876 are shown in Fig. 1. Most early a-c/d-c sets had ballast tubes rated at approximately 300 ma to maintain constant heater voltages with a variable line voltage. The *B* voltage was allowed to vary with the line.

Although the v-r and similar series of voltage regulator tubes are usually used on d-c supplies, they can be used on a-c by using a pair of tubes paralleled with opposite polarity, as shown in Fig. 2. A transformer may be

used on the output of the regulator to obtain any reasonable voltage, but the power is limited by the tubes' current rating, 30 ma for the v-r series. This provides a maximum power, $75 \times 0.03 = 2.25$ watts. This is only an approximation, since the waveform is distorted and the tubes do not conduct continuously. If the tubes had an average current rating of 30 ma regardless of peak, the output power would be twice the 2.25 watts. It is important to note that these tubes maintain a constant output voltage when both the line voltage and the load are varied.

There are several methods of im-

proving the regulation of rectifier-filter systems: choke input filter, v-r and similar type tubes, and electronic methods. Generally speaking, it is necessary to use choke input with most gaseous rectifier tubes, especially with high power outputs, to limit the peak current through the rectifiers. But a properly chosen choke will improve the voltage regulation as well as limit the peak current, (Fig. 3). The reduction in regulation due to the use of a gas rectifier is also shown. The choke causes a considerable voltage drop at light loads but the difference is not great at heavy loads. For choke input, the power transformer secondary voltage should be higher, but the power requirements are actually lower because the peak rectifier current is not much greater than the d-c load current. With a condenser input, the ratio of peak to d-c may be two or more.

Voltage Regulation of D-C Supplies

There are special types of chokes designed for filter input. They are known as swinging chokes. These are chokes whose inductance decreases rapidly with increasing d-c load current due to the saturation of the core. This characteristic can be controlled by the type of iron, amount of iron and the amount of air gap used. A choke with a minimum air gap will saturate with low values of load current; in-

A commercial type voltage stabilizer. This is an uncased model. Note that there are two transformers. Primaries are connected in series. One of these transformers operates at a high magnetic density. This transformer with the higher saturation is partially resonated by means of a condenser.

(Courtesy Raytheon)

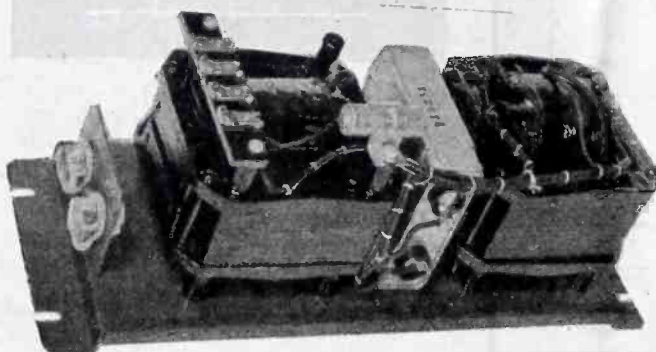
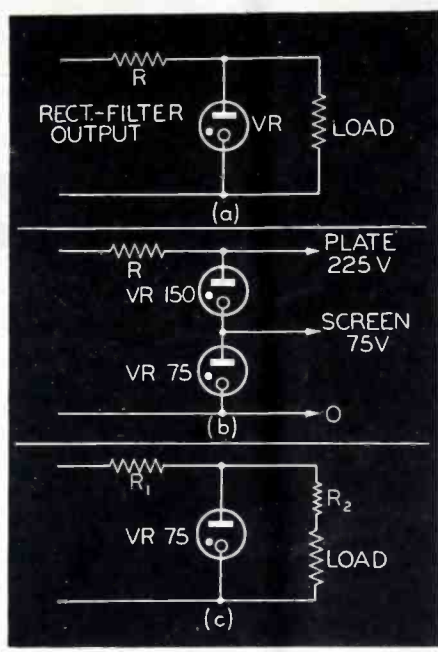

Fig. 4 (right). In *a* the v-r-regulating tube is placed in parallel with the load. The resistor *R* must be large enough to limit the current. In *b*, voltage regulators in series for increased output voltage are shown. For voltages lower than 75, the hookup shown in *c* is used.



creasing the gap will delay saturation and give lower inductance at light loads, but higher inductance with heavy loads. There is a suitable choke for each application, depending upon the need for filtering, for the choke performs both regulating and filtering functions. The regulation obtained in any given power unit depends upon the power transformer regulation, rectifier and choke resistance and the value of bleeder current. The regulation of the transformer is governed by primary and secondary resistance and leakage reactance. Where low regulation is desired it is important to use a transformer of adequate rating, oversize if possible.

The function of a bleeder resistor in improving regulation may be seen by referring to Fig. 3, curves *C* and *D*. Using curve *C* and a load, varying from 0 to 80 ma, the regulation is 11.3%. If we add a 20-ma bleeder and then calculate the total load as 20 to 100 ma, the regulation falls to 15.7% which is only one-half the above value. This is due to the large curvature with light loads, characteristic of choke-input filter systems. Actually, the regulation is even better than the above calculation shows, for a 20-ma resistance load at 264 volts will draw only 17.4 ma at 230 volts, so that the total load will be 97.4 and not 100 ma.

The v-r series of voltage regulator tubes, the old 874 and various neon amps (cold cathode), are excellent voltage regulators for light loads giving about 1% regulation over their operating range of 5 to 30 ma for

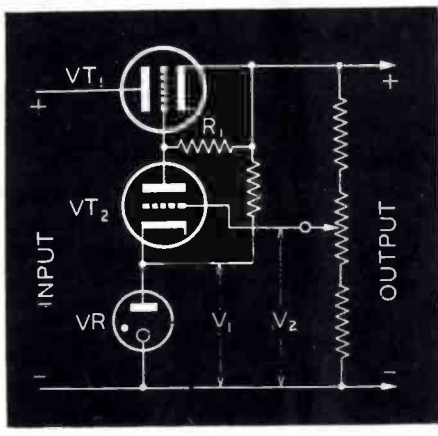

VR-30 tubes. These tubes have a large cylindrical cathode and a concentric wire anode, and are filled with neon, helium or argon at low pressure. The voltage required to ionize the gas, called the breakdown or ignition voltage, is usually 10 to 30% higher

than the operating voltage but this voltage is automatically available if the proper requirements are met for using these regulators. Note Fig. 4a, which shows a resistance in series with the tube and load paralleled. The resistance value must satisfy the operating limits, being large enough to limit the current to 30 ma with very light loads and low enough to permit a 30-ma load with the tube glowing.

Similar v-r tubes may be used in series for increased voltage but not in parallel. The current is limited to 30 ma. The VR-30 series are rated at 75, 90, 105 and 150 volts and these may be used in any series combination. Fig. 4b shows a combination providing 75 volts for screen and 225 volts for plate supply. Again we note that the voltage will be maintained with both varying load and line voltage. Voltages less than 75 may be supplied by the method indicated in Fig. 4c but, in this case, the regulation holds for a varying line voltage only. It is obvious that it will not hold with varying load.

The most accurate type of regulator for plate supplies, as well as the most versatile, is the degenerative electronic regulator, Fig. 5. In *a* we see the basic circuit and in *b* an entire power supply with improvements. Higher currents and voltages than are possible with the v-r tubes may be supplied. Also, the output voltage may be varied

(Continued on page 26)

Figs. 5a (left) and 5b (below). In *a* appears the basic circuit of a degenerative electronic regulator. The entire power supply with improvements is shown in *b*. In this system the output voltage may be varied while the regulation is maintained. *VT*₂ is a sharp cutoff amplifier, while *VT*₁ is the series tube whose resistance is varied by varying its grid bias.

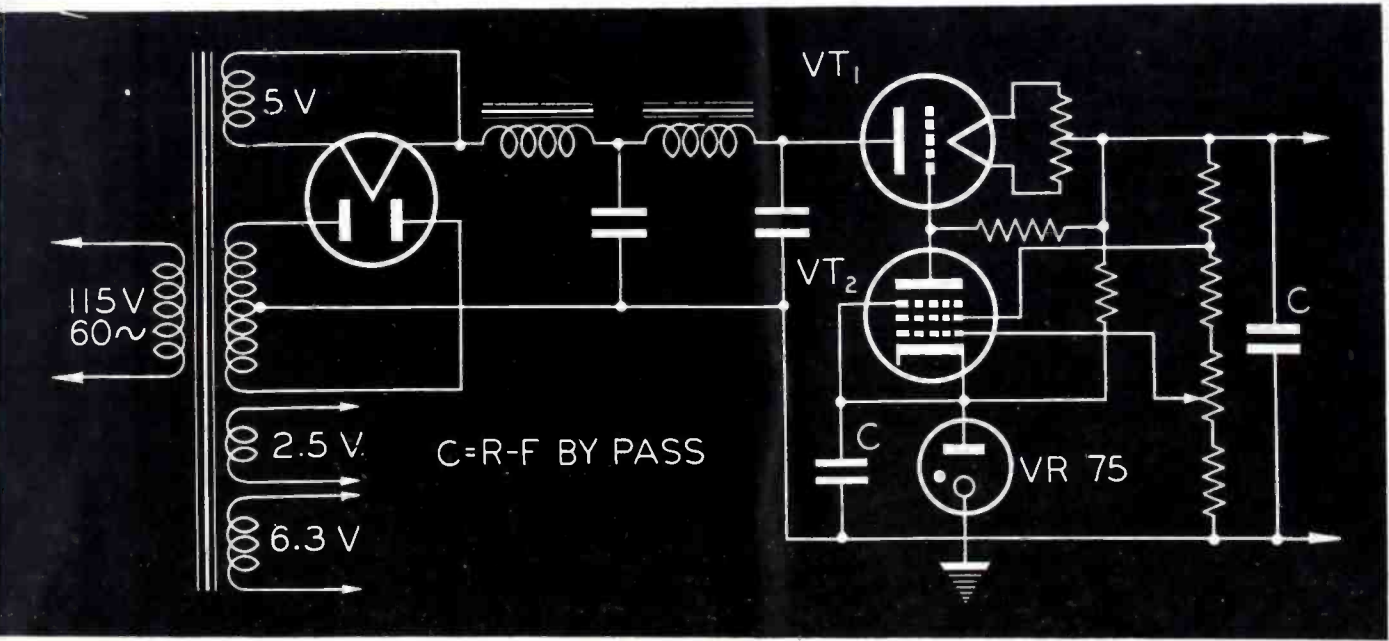

WARTIME REPAIRS

by RAY PENTECOST

DURING the past year or so many of the receivers that have come into my shop have had warped variable condensers, the warp having been caused by the die castings used. Since it has been practically impossible to replace these condensers or have them repaired at the factory, I developed a simple repair procedure, involving realignment and centering. Incidentally, the models that I have been doing most of this repair work on are the Majestic 72-90 series, G-D Howard types, and Philco models 70-90-20, etc.

To align and center the gang sections I use a screwdriver having a 3/16" blade. This screwdriver blade is placed between the blades of the rotor section as near to the rotor hub as possible. Then, the screwdriver is turned slightly, exerting of course firm pressure on the screwdriver. The condenser blade will spring slightly to the side on which the screwdriver blade is farthest from the hub, and the condenser blade will align itself with this displacement. The whole condenser blade seems to follow this slight bend made at the hub. Successively springing each blade in turn will bring all of the sections into alignment or clearance. I have found that about thirty minutes are consumed in repairing a four-gang unit this way. Incidentally, a slight springing of the outer ends of the blades is sometimes necessary to assure perfect alignment.

In the bathtub type condensers used by Philco in their models 70-90-20, a similar form of repair has also been used. In this type condenser the shaft uses as a bearing, the end frame edge. After some years of use, the underside of the rotor shaft in these condensers wears a groove sometimes as much as 1/8" deep. As a result, the rotor has a lopsided or cam action, and the rotor blades either scrape, causing a short, or they will not hold their proper capacity change throughout the entire cycle of rotation. As a rule, this condition usually occurs on the dial and because of the strong spring action of the dial and the spring used to hold the rotor in the bottom of the bearing.

To repair, I remove the dial and rotor pressure springs from the condenser gang. Then I lift out the rotor assembly and obtain a steel washer with a center hole that can be reamed or filed to fit the size of the shaft, the washer to be about 1/16" thick. After fitting the hole to the shaft as a snug turning fit, the washer is placed on the inside of the frame in such manner that the hole matches the original bearing surfaces. The curved outer rim of the washer must be cut so that it resembles a wedge and so it will lay close up inside the indentation of the end wall of the gang. After slotting the top half to allow the rotor shaft to set down, the washer is soldered into place.

On some of these die-cast assemblies, the screw hole has become stripped because of the many screw adjustments and removals. Usually these holes are in places difficult to get at with a threading tool, and many shops do not have the tool. To repair, I use a bolt or screw of the proper size for the thread and hole and cut a slot diametrically across the bolt about 1/4" into the length of the bolt. A small piece of metal slightly less than the smallest diameter of the bolt and a trifle thicker than the width of the slot is then cut. This thickness might be slightly wedge shaped, the thin edge to enter the slot. The wedge is then tapped into the slot to spread the bolt end slightly, thus causing the bolt to assume a larger diameter. Quite a bit of wear may be compensated for in this way and units held by bolts which have been enlarged in this manner will seldom work loose again.

Power Transformer Repair

To expedite estimates when a defective power transformer is suspected and to make sure what other repairs are or are not needed, I use an old *B* eliminator and an *A* battery. By removing the rectifier tube and substituting the external *B* power to the point of origin of the *B* power in the set, usually at the rectifier socket, it is possible to determine whether or not

all filters and bypass condensers are in good condition. If the transformer heats under this test, the filament circuit can be opened at the transformer and the *A* battery substituted, with full 6 volts being used on later model sets and one or more cells of the battery for the 2 1/2- and 1 1/2-volt types. Suitable resistors may be used in the latter two types. Thus possible filament shorts which might cause transformer heat can also be detected and possibly save a transformer replacement. Many pilot lamp sockets have been found at fault in this respect, with transformers okeh.

I-F and Antenna Coil Repairs

Intermediate coil and antenna-coil primaries of the pie-wound type which are difficult to replace today, can be repaired with the aid of an ohmmeter as a broken lead tracer.

When the coils are open and when, as is usually the case, the inside lead that comes from under the winding is broken, an ohmmeter can be used to determine approximately how far into the winding the break is. By using a needle as one prod and with the outside end clipped to the other lead of the meter, one can locate the point nearest the break which will give the complete continuity. At this point a pin or other sharp small point is pushed into the winding to provide a good contact. It must be moved about slightly to secure a good solid contact. Then a small lead is soldered to the pin and padder lug. Finally, a fairly heavy current is placed across the winding for a few seconds. It may be surged several times or the discharge from a paper condenser of about two mfd or larger may be used. This welds the contact together or loosens the contact, and eliminates possible noise. Then the pin is clipped off and the winding and entrance point of the pin is sealed with speaker cement. After this has dried the coil is again as good as new. Slight readjustment of the i-f padder must usually be made. Inductance change is slight if too much winding hasn't been blocked off.



TELEVISION

CAN MAKE YOU A BIGGER MAN

YOU radio servicemen and dealers of yesterday and today have a great *tomorrow* ahead of you! TELEVISION — the art of transmitting sound and sight — will open up opportunities for you to surpass your pre-war experience with radio — the art of transmitting sound alone.

Are you preparing yourself *today* for that *tomorrow*? Others are. Don't you miss the boat!

For instance, have you a copy of "PRACTICAL TELEVISION by RCA," the comprehensive, 40-page booklet, now reprinted in its 3rd edition especially for you? Have you familiarized yourself with the television receiver design, installation, and service information, the page of television definitions, and the 62 diagrams and other illustrations which this down-to-earth guide contains?

If you haven't a copy, get one today. Ask your RCA Tube & Equipment Distributor for one. If his supply has run out, write to us — Room 302, RCA Victor Division, RADIO CORPORATION OF AMERICA, Camden, N. J. There are dollars-and-cents reasons why you should have a copy. It's meant for you. It's another RCA service to help you help

yourself to a bigger slice of tomorrow... and the price is only 25c per copy.

Remember, *the Magic Brain of all electronic equipment is a Tube... and the fountain-head of modern Tube development is RCA!*



RADIO CORPORATION OF AMERICA

RCA VICTOR DIVISION • CAMDEN, N. J.

LEADS THE WAY... *In Radio... Television... Tubes...
Phonographs... Records... Electronics*

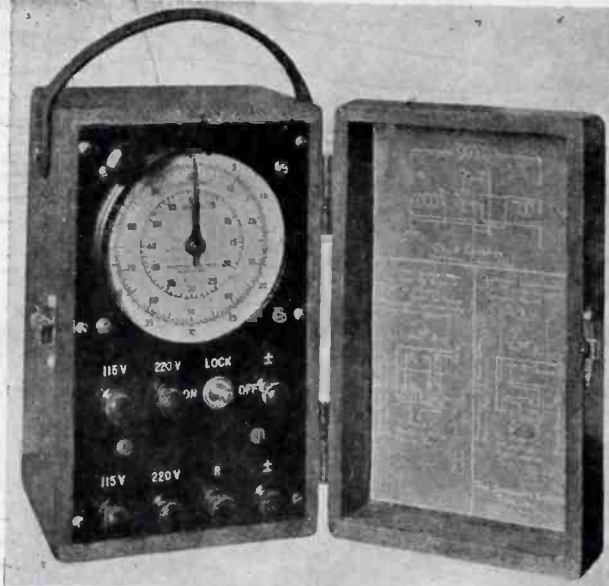

Figs. 1 (above) and 2 (right). Fig. 1, an interval counter for timing tests. (Courtesy Standard Electric Time Company)

Fig. 2, a self-contained megohmmeter. Insulation resistance is measured directly in megohms. (Courtesy Superior Instruments Company)

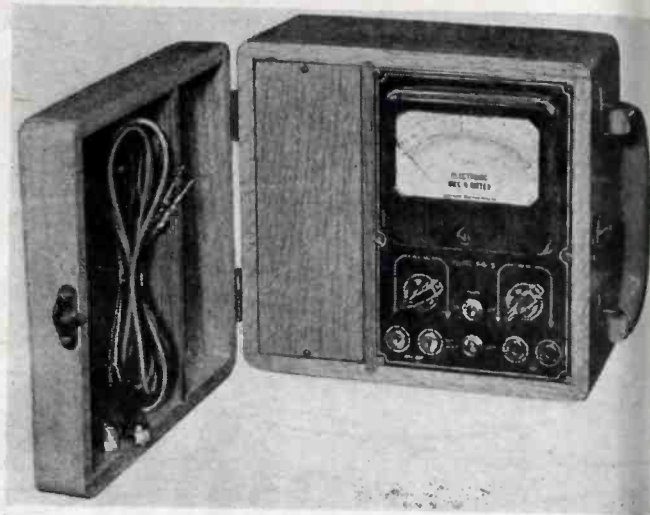

IN general, most of the testing on industrial electronic devices may be successfully carried out with conventional radio testing equipment. Many occasions will arise, however, in which the application of certain special instruments is essential, if the installation or maintenance operation is to be successfully carried out.

This is particularly true of such devices as electronic timers and register regulators. One of the necessary tests included in maintenance operations on this type of equipment involves the precision calibration of the timing circuit control dial.

Since the control-grid circuits of the thyatron and vacuum tubes applied in electronic timers are very sensitive to leakage caused by dust films, it is apparent that the timing dial calibration will vary considerably, depending on the nature and thickness of the dust accumulation. Thus the calibration of the timer will vary considerably over a period of time, the deviation from dial calibration increasing proportionately with the length of time the unit is in service. It is therefore essential to maintain the circuits of the device in as clean a condition as possible.

Radio components, such as tubes, resistors, and capacitors, usually do not exhibit precisely the same characteristics as the original units. It is usual to find that replacement of any such component results in alteration of the timing dial calibration. With some timing circuits, replacement of the tube, whether thyatron or vacuum, results in a calibration deviation.

Electronic timer calibrations are carried out with the aid of a standard

such as the commercial *cycle*, or *interval counter* shown in Fig. 1. This device is essentially a precision electric clock having a dial which is graduated in cycles and seconds, or hundredths-seconds and seconds. Closing the associated timing or operating cord terminals starts the clock. Opening of these contacts stops clock operation. The counter, by this means, records the elapsed time during which the operating cord terminals are closed.

Circuits for performing timing-circuit calibration or recalibration appear in Figs. 3a and 3b. The timer of Fig. 3a is one in which the end relay seals at the inception of the timing cycle, and unseals with its termination. Since the interval counter operates when the operating cord terminals are short-circuited, the timer end relay *make* contacts in Fig. 3a, are connected across these terminals. Thus, with the closing of the timer push-button or foot-switch contacts, the end relay seals, starting the interval count on the interval timer dial. When the timing period is terminated, the end relay unseals, stopping the interval count. The dial of the interval timer then indicates the number of cycles, or hundredth cycles, to which the timer control dial is adjusted.

The timing dial must be calibrated against the interval counter in this manner at each major dial division. Once these readings are secured, they may be neatly typed on a small chart and pasted over the original timing chart inside the timer case door.

Calibration procedure for the timer, illustrated in Fig. 3b, may be carried out in a similar manner. This timer,

however, is of a simpler nature, in which the end relay closes a definite time after the closing of the timer push-button or foot-switch contacts. The latter is replaced with a double-pole testing push button. The interval-counter power cord is connected to the supply line in series with one pair of the push-button *make* contacts, and the electronic timer *start* terminals to the same power line through the other contact pair. In most instances, the timer end relay is of the *telephone* or *communications* type, and will be found equipped with a pair of *break* contacts. These are connected across the interval-counter operating cord terminals.

Closing the test push button starts both the interval counter and electronic-timer time cycle. When the timing cycle is terminated, the end relay of the timer unseals, opening its *break* contacts and stopping the interval counter. The counter dial then reads the number of cycles or hundredths-seconds to which the timer control dial is adjusted.

The interval counter may also be utilized in the calibration of the timing circuit incorporated into the oscillation type of register regulator. In such electronic equipment, the end relay seals for a definite period of time, depending on the time-control dial adjustment after each disturbance of the photoelectric-camera equilibrium, such as occurs with the passage of a register mark. Here, the interval counter is connected as in Fig. 3a. The photoelectric-camera equilibrium is disturbed by passing an opaque object, such as a pencil, through the scanner light beam, thus starting the timing

ELECTRONIC TESTS

by S. J. MURCEK

operation of the system. Although it is not conventional with register regulators, it is prudent to furnish a timing calibration chart for the tested register regulator. This serves as an excellent indication of circuit dust accumulations. Any deviation from the original calibration may then be quickly observed with each maintenance call. Further, since many manufacturers do not furnish timing charts with their products, this servicing operation will insure customer good will.

In the preceding discussion, we referred to the importance of the proper removal of dust films and dirt accumulations. Unfortunately, certain dust films are often highly conductive, though often invisible. The presence of a dust film having these characteristics may be detected through application of a megohmmeter, or *megger*. Such a device conventionally operates from a small internal hand-cranked generator. A commercial device of this nature is illustrated in Fig. 2. This particular unit is powered from a dry-cell battery-operated vibrator power supply.

Electronic photocontrol installation and maintenance occasionally requires the accurate measurement of illumination on the phototube or camera system. A device useful in effecting these measurements is the *foot-candle meter*, or *light meter*, as applied in commercial photography. These devices are often calibrated directly in lumens, which facilitates photocontrol trouble diagnosis and installation.

In the industrial photocontrol, the voltage developed across the phototube or its loading resistor is usually compared against a fixed *pilot* voltage developed within the photocontrol circuit. The voltage difference between the two functions is a variable control voltage between the grid and cathode of the photocontrol end tube. Photocontrols are arranged to operate when these voltages are nearly similar. As it so happens, the pilot voltage is conventionally the thyatron or vacuum tube grid-bias voltage, which may be readily measured with a conventional high-resistance voltmeter.

The sensitivity *s* of a phototube appears on the data sheet supplied with

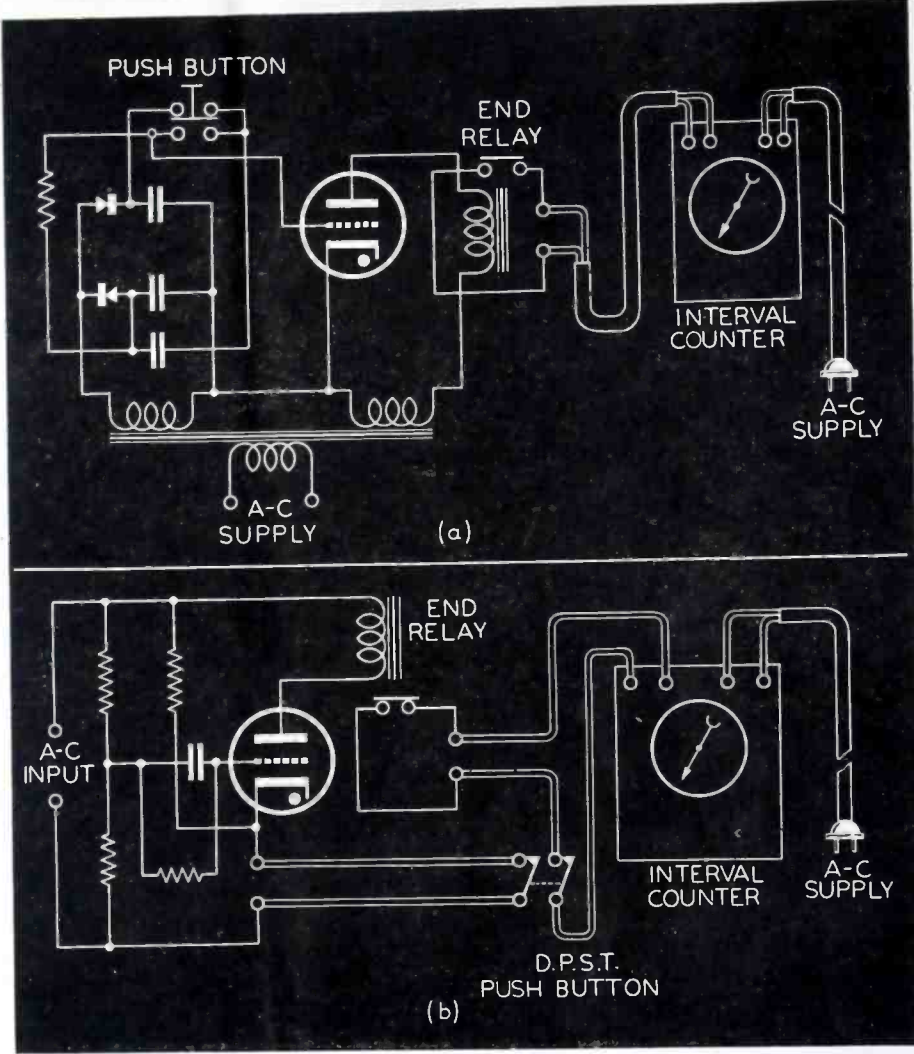

Fig. 3. In *a*, a timing measurement set-up, in which the end relay of the electronic timer functions to start and stop the interval counter, with each operation of the electronic timer. Elapsed time measurement with a simpler electronic timer is shown in *b*. Here, a double-pole single-throw test push button serves to start both the electronic timer and the interval counter.

the tube by the manufacturer. This is given in microamperes per lumen. Therefore if the pilot voltage is divided by the phototube sensitivity and load resistance R_L , the light or illumination level at which the photocontrol must operate is the result. Thus

$$L = E_c / (R_L s) \quad (1)$$

where L is the light level in lumens, E_c the negative grid biasing voltage, R_L the phototube load resistance in ohms, and s the phototube sensitivity in amperes per lumen.

If the illumination on the phototube is brought to the level obtained by L , with the aid of the light meter, and the photocontrol does not operate, the trouble analysis is narrowed to two

possibilities; either the phototube is defective, or a dust film is preventing the proper operation of the device.

Here, the light meter may again be useful. If the phototube is connected in series with a source of approximately 88 volts for a gas tube, or 250 volts for a vacuum tube, and a 50,000-ohm resistor, the tube-anode current should agree closely with that data sheet, when the light incident on the phototube is adjusted to 1/10 lumen. The latter adjustment should be made with the aid of the light meter. If the reading is considerably lower, or the tube does not pass current, the phototube is defective, leaving the dust film as the only reason for non-operation.

In the testing of electronic motor-speed regulators, the armature shaft speed is most conveniently read as the voltage existing across the motor commutator. This method of observing speed regulation has one major disadvantage: the actual speed of the motor shaft is unknown, and can only

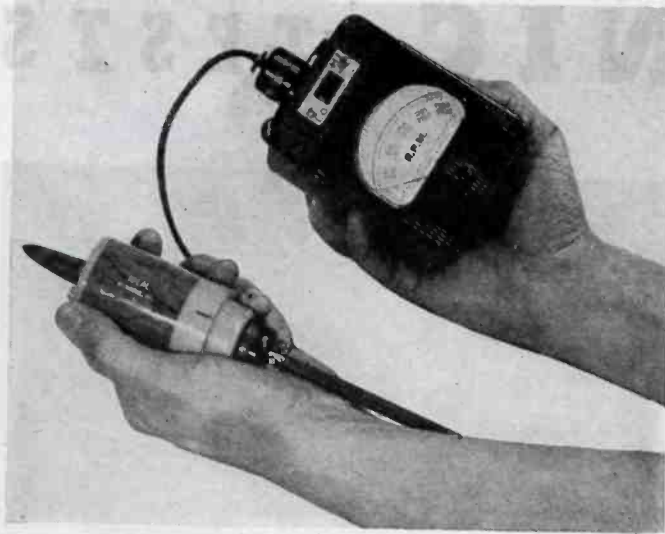

Fig. 4. An electrical tachometer. In this device, a small a-c generator, the shaft of which is rotated by the end of the shaft under test through the rubber apex, causes the associated a-c voltmeter to read the generated voltage, which is proportional to the speed of the shaft. The device is calibrated directly in revolutions per minute.

(Courtesy Ideal Commutator Dresser Co.)

be approximated from the armature voltage reading.

The commercial device applied in the measurement of shaft speeds is the small, inexpensive *speed counter*. This device is simply a precision ring gear, carrying a small graduated dial. The ring gear is rotated by a worm gear which contacts the end of the shaft under measurement through a small rubber extension on its axle. Each revolution of the worm moves the dial gear one division of the dial scale. Thus, if the rubber apex is held in contact with the rotating shaft for a definite period, arbitrarily one minute, the number of revolutions indicated on the ring gear after the period of contact, is the number of revolutions per minute shaft rotation.

A more effective speed measuring device, with respect to continuous indications for shaft-speed measurements, is the tachometer, Fig. 4. Tachometer indicating dials are calibrated directly in revolutions per minute, and the indication is continuous as long as the tachometer spindle is held in contact with the end of the rotating shaft. The instrument illustrated consists of a small a-c generator coupled with a high-resistance a-c voltmeter.

Tachometers and speed counters are mainly applied in determining the ex-

act rotational speed of any rotating shaft. However, the tachometer is especially useful in determining certain performance characteristics of electronic motor-speed regulators.

It is often impossible to determine whether or not a speed regulator is functioning properly from visual observation of the device alone, although fluctuation in the extent of the thyatron-anode glow gives a good approximation of the armature current behavior. If the variation in armature voltage is rapid, however, persistence of vision tends to *level out* the indication of this phenomenon in the thyatron-anode glow. Further, the indicating arm damping of the voltmeter connected across the commutator brushes accomplishes the same result. Under these conditions, *hunting* or oscillation of the motor-shaft speed escapes observation.

Application of the tachometer to the measurement of shaft speed, where the motor operates under the outlined conditions, shows even rapid oscillation in the shaft speed. Here, also, the persistence of vision and the damping of the indicating arm combine to indicate a lesser magnitude of the speed oscillation than is actually the case. Therefore the measurements should be supported with the aid of a cathode-ray oscillograph. This should be con-

nected to read the voltage drop across a resistor connected in series with the motor armature. A single-trace wave must appear on the cathode-ray screen. If more than one trace appears in the visual pattern, the motor speed is varying or oscillating at a relatively high frequency.

Oscillations in regulated motor shaft speeds must be eliminated, if desirable speed regulation is to be obtained. In electronic motor-speed regulators, a compensation circuit acts to damp out periodic variations in the armature current. A control dial, labeled the *anti-hunt* control, is provided for the purpose of adjusting the compensation available from the anti-hunt circuit. The anti-hunt dial is normally adjusted a few divisions beyond the point at which undesirable oscillations are no longer observed in the motor speed.

Measurements of the thyatron-controlled currents, such as are encountered in speed and voltage regulators, and in controlled rectifiers supplied with ordinary D'Arsonval meters, are not true power measurements. These measurements are *average* measurements, or the average of the maximum magnitude to which the measured periodic current or voltage attained within the damping limits of such instruments.

The only effective way to measure the true power value of a given voltage or current, which is of periodic or interrupted nature, is through measurement of the heat such currents will develop in a known resistance. Accordingly only instruments which depend on heat measurement indicate true power values of the voltages or currents under measurement. These instruments include thermoelectric or hot-wire radio-frequency meters.

The true power level absorbed by a given load operating from a commercial sinusoidal power source (a-c line), may be conveniently measured with a conventional dynamometer wattmeter. Hence, for ordinary cases, the dynamometer wattmeter may be used to measure the power input to a thyatron rectifier, even where the rectifier is under phase-control.

Where the output of the rectifier is periodic, that is, of uniform wave shape or form, the power output of the equipment may be measured with the dynamometer wattmeter. For a phase-controlled thyatron rectifier, however, especially where the control is

(Continued on page 16)

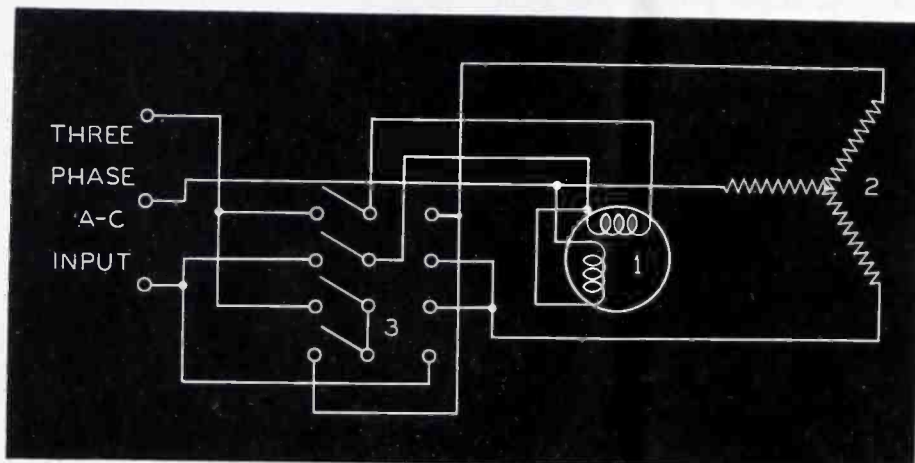

Fig. 5. Circuit for the measurement of three-phase a-c power. A single dynamometer wattmeter suffices to measure the power being dissipated by two of the three phases.

Finer facilities
today...



for finer radios tomorrow

New management, new methods, new and enlarged production facilities—designed for volume manufacture of quality electronic equipment—that's DETROLA today. All this new plant and personnel are now producing electronic devices for VICTORY. That comes first. When Peace is won, the skills we have acquired in making quality war equipment will be turned to the production of the finest radios and other items for civilian use. *Help make the finer post-war world an early reality by buying War Bonds and MORE War Bonds.*

DETROLA RADIO

DIVISION OF INTERNATIONAL DETROLA CORPORATION • BEARD AT CHATFIELD, DETROIT 9, MICH.

C. RUSSELL FELDMANN



PRESIDENT

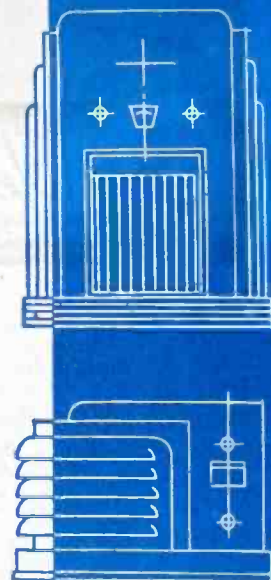

Army's Lip Mike Debut
On CBS "Vox-Pop" Series

Lip Microphone for Gunfire Noise Cancellation

Useful By-Product of War

Noise Doctor at War

"Lip" Microphone Eliminates Battle Sounds;
Only Voice of the Sender Is Transmitted

Lip Mike Is
New Invention

Radio Microphone
For Upper-Lip
Bared by Army

NEW LIP MIKE
USED BY ARMY

'Lip Mike' New
Sound Marvel
to Guide Army

New Lip "Mike"

Capable of Operating
At High Noise Levels;
Now in Production

Lip "Mike" for Tankmen
Baffles Mechanical Noise

Phone User Will Love It

Lip Microphone Used
By Ground Forces

New "Lip" Mike Featured
On National Broadcast

LIP MICROPHONE
DELETES NOISES

A Magnifying Moustache

Tiny Gadget Filters
Noise Out of Tanks

Differential Microphone for Tanks

Tiny Lip Mike Is
Used by Army

Differential Microphone

Electro-Voice MICROPHONES

ELECTRO-VOICE MANUFACTURING CO., INC. • 1239 SOUTH BEND AVENUE • SOUTH BEND, INDIANA
Export Division: 13 East 40th Street, New York 16, N.Y. — U.S.A. Cables: AREA 8

simply the product of this ratio and 100%. Thus

% efficiency

$$= [(E_{ac} \times I_{ac}) / P_{ac}] \times 100\% \quad (2)$$

in which E_{ac} and I_{ac} are the d-c voltage and current readings taken with thermoelectric instruments, and P_{ac} is the a-c input power to the rectifier under consideration. Here, the input power is measured with a dynamometer wattmeter.

The efficiency measurements outlined in the preceding discussion are concerned with equipment in which the power input is drawn from a single phase a-c source, or, in special installations, from d-c power sources. When three-phase power is applied to an electronic installation, a more specific method must be used to measure the system input power.

A conventional method of three-phase power measurement is illustrated in Fig. 5. Here, one single-phase wattmeter, of the dynamometer type, suffices to measure the power drawn from two of the three phases. Switch 3 connects the voltage and current coils of wattmeter 1 into either of the two respective phase systems, alternately. The power input to resistance bank 2, is the sum of the two measurements taken with the wattmeter.

Under certain conditions of circuit operation, one of the wattmeter readings obtained with the circuit of Fig. 5 is negative; that is, the wattmeter voltage coil connections must be reversed in order to obtain the power reading. Where this condition occurs, the smaller of the two power readings is subtracted from the larger, leaving the actual circuit power input as the result.

Power measurements taken with a single-phase wattmeter, where the power measured is drawn from a polyphase source, will usually suffice in most instances. However, certain conditions may arise under which the circuit power input may vary continuously, making it impossible to obtain simultaneous readings with the method described, Fig. 5. This is especially true of motor-speed regulator installations. Fortunately, variable power conditions are a rarity, and the polyphase wattmeter required to obtain the desired power readings may be loaned or rented from the commercial power company which supplies the energy for operation of the regulator system.

The reversal of the power reading in polyphase-power measurements is promoted by the power factor of the a-c power source and load. Though circuit power-factor measurements are

(Continued from page 14)

almost complete, the output current may be considered to be aperiodic, or intermittent. The wattmeter will not read true power output, here.

Aperiodic or intermittent power values should be measured with hot-wire or thermoelectrical instruments. Currents may be measured with an ammeter or shunt and millivoltmeter of the thermal type, and voltages with a standard thermovoltmeter. A thermo-millivoltmeter may be used in lieu of the two previously mentioned in-

struments, functioning as a voltmeter when connected in series with a suitable multiplier resistance, and an ammeter when connected across the terminals of a suitable d-c shunt.

From the foregoing, it is apparent that the efficiency of a phase-controlled thyatron rectifier must be measured with a dynamometer wattmeter and suitable thermoelectric instruments. The efficiency of any electrical machine is the ratio of the useful power output to the total power input. If the ratio thus obtained is desired in terms of efficiency percentage, it is

MEISSNER OF MT. CARMEL



Beauty — and Accuracy! Top-grade personnel, brought up in a community where electronics skill has become a heritage, give Meissner products their far-famed quality. There are hundreds doing similar work.



Close Co-operation! This is a factory conference at Meissner's Mt. Carmel plant. Here production plans are worked out for maximum harmony, top efficiency.



Trouble for the Axis! Youthful vision here combines with mature judgment to keep Meissner in the forefront of electronics progress. These men are testing.

Why all eyes in the
Electronics Industry
are on
this little city
in Illinois



Precision-el—that's the name earned by Meissner personnel because of their skill at all types of precision work. Here is one of many Meissner veterans.

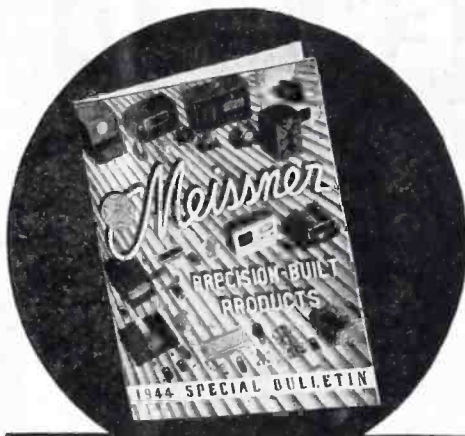

Just Out!
Special 1944 Bulletin!
—showing radio parts in Meissner's 1944 line. Contains complete descriptive matter, with pictures. Now, more than ever, you need to know what the market offers. Send for your copy today. The supply is limited. It's free. Write to address below.



MEISSNER

MANUFACTURING COMPANY • MT. CARMEL, ILL.

ADVANCED ELECTRONIC RESEARCH AND MANUFACTURE

SERVICE, MAY, 1944 • 17

KEN-RAD

ELECTRON TUBES



FOR EVERY WAR PURPOSE NOW...
For you when possible!

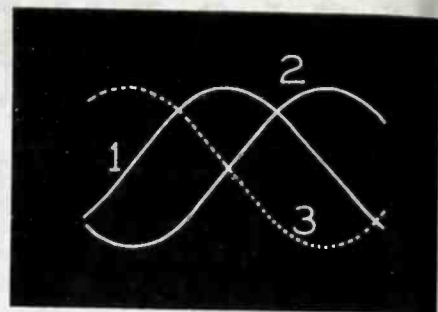

Fig. 6. Circuit power factor is a measurement of the phase-difference existing between the applied circuit voltage 1 and the displaced inductive 2, or capacitive circuit current 3.

where the current is passed through a condenser. The power-factor conditions illustrated in Fig. 6 may be readily observed by means of the cathode-ray oscilloscope. In making such observations, the oscilloscope should be adjusted with the linear sweep oscillator subjected to line or sixty-cycle synchronization, so that a single wave of the a-c line voltage appears on the cathode-ray tube screen. This wave should be temporarily marked on the screen with a pen or china-marking pencil. Incidentally, the sweep oscillator is synchronized to the line frequency when the wave pattern is stationary.

In carrying out the displaced current reproductions, a suitable reactor or choke coil is connected across the a-c line, in series with a resistor of a few ohms. The vertical oscilloscope elements are then connected across the series resistor. Observation of the wave on the tube screen will now show that the current wave is displaced considerably, with respect to the a-c line voltage wave, the degree of displacement varying with the inductance of the test reactor. Further, the wave is late with respect to the voltage wave.

Replacement of the reactor with a suitable capacitor, connected in the same manner as the reactor, produces similar current wave conditions, except that the wave now leads the a-c voltage wave. In either of the described instances, the current wave amplitude is less than that of the voltage wave.

[To be continued]

TRANSMITTING TUBES
 CATHODE RAY TUBES
 SPECIAL PURPOSE TUBES

KEN-RAD

EXECUTIVE OFFICES
 OWENSBORO · KENTUCKY
 EXPORTS 15 MOORE STREET NEW YORK

RECEIVING TUBES
 INCANDESCENT LAMPS
 FLUORESCENT LAMPS

(Continued from page 16)

more involved than simple input power measurements, the electronic Service Man occasionally has to supply power factor measurements.

Essentially, the power factor term describes the electrical displacement between circuit voltage and circuit current. This is found to occur only in a-c systems, where the sine current wave is altered in phase relationship and magnitude, with respect to the phase-position of the a-c voltage wave. Such a condition is shown in Fig. 6. Here, 1 is the input voltage wave, and 2 is the current wave, where the current is passed through a suitable in-

ductor coil. The dash line, 3, is the representative current wave obtained

Fig. 7. A vector representation of circuit power factor. The circuit power factor is the ratio of true resistance R to the circuit a-c resistance, or impedance, Z . Note that the angle ϕ increases with an increase in inductive reactance X_L .

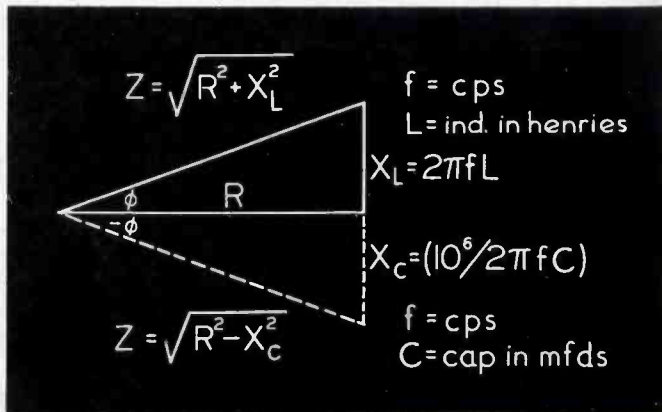

SPRAGUE TRADING POST



A FREE Buy-Exchange-Sell Service for Radio Men

IMPORTANT NOTICE!

We discourage offers to buy or sell anything beyond the O.P.A. ceiling prices, and will not knowingly accept such ads for the Sprague Trading Post.

FOR SALE—Two each, guaranteed satisfactory: 6Z4, 1B4, 1E7, 1N5, 1A7, 1H5, 1A4, 1LH, 1N5, 2A3, 2B7B, 6A3, 6B8, 6C8, 6L6, 6V6, 6X5, 7G7, 7H7, 7J7, 7N7, 2T5, 12K7, 12K7, 12Q7, 15, 22, 35L6, 35A5, 35Z3, 35Z5, 47, 50L6, 70L7, and 117Z6. Will sell entire lot only 25% off 1st. Goodwin Radio Shop, Rankin, Ill.

WANTED FOR CASH—One tube and crystal sets. What have you? Clarence Guderjohn, Westfield, Wis.

FOR SALE—7-175GT, 8-105GT, 4-1C5GT, 5-39/44, and 4-57 tubes. Want 115V AC to 6V DC converter. Ohio Radio & Elec. Shop, Greenfield, Ohio.

WANTED— $\frac{1}{4}$ or $\frac{1}{2}$ watt neon bulb, bayonet base for condenser tester. Nemeth's Radio Service, 173 Crescent Road, Massillon, Ohio.

FOR SALE—New Katolight plant #19A, 350W, 110V AC, 6V DC; Weston #682 oscillator; #682 type 2 tube checker; #669 vacuum tube voltmeter; Jewell #199 analyzer. Want 8 mm. camera and projector. B. C. Brawton, 61-A Cypress Drive, North Charleston, S. C.

URGENTLY NEEDED—RCP #411 or 446 multimeter; Solar capacity analyzer CB-1-60 or other good make; signal generator; and 35Z5GT/4, 80, 35L6GT/3, 12SA7, 12SK7, and 45 tubes. Riggs Radio Service, 1343 No. Bronson Ave., Hollywood 28, Calif.

FOR SALE OR TRADE—Three xmitting crystals 2.638 mc., 2.670, and 2.126 mc. Want to buy RCA voltohmmyst, Jr. William Lee, 74 Argyle Place, Rockville Centre, N. Y.

WANTED—Phono motor and pickup from old radio. Needed for PA system and church hearing aid. Have lots of old juke box records for sale or swap. Marvin Gurlin, Haddon Ave., West Berlin, N. J.

FOR SALE—Clough-Brengle model OM all-wave signal generator, #958, J. Robert Hinkle, RR #3, Montpelier, Ohio.

WANTED—Power amplifier with #14 speaker from any juke box. Cash. James O. Robinson, 613 Selma Ave., Selma, Ala.

WILL TRADE—Have Triplett 1175-A multi-purpose tester, incl. multimeter and all-wave oscillator in portable case to trade. Want late model tube tester, or oscillator of reputable make. Y. Shimano, Rosebery, B. C., Canada.

WANTED—Any good make V-O-M with or without tube checker. Must be A-1. Ramon Walker, 616 So. Second St., Union City, Tenn.

WANTED FOR CASH—Reasonably priced modern tube tester. Vernard Halverson, Box 453, Bagley, Minn.

WANTED—Complete set Meissner signal shifter coils for 160 meters. Cash. T/5 Wm. C. Peters, 33075416, HQ 10th Tank Bn. APO 255, c/o Postmaster, New York, N. Y.

FOR SALE OR TRADE—Instructograph code machines, built-in oscillators with tapes, like new. Want 115V tubes, 12A7, 25A7, 32L7, 70L7, 25D8, 25B8. Any quantity. Swap or purchase. Cox Radio & Sound Service, 505 N. Broadway, Oklahoma City, Okla.

FOR SALE—Home recorder with blank disc, needles, etc. Same as new. \$15. Song Club, Deep Gap, N. C.

WANTED—Philco 077 sig. generator or equivalent. Herman Hauck, 2014 Bel Aire Drive, Glendale 1, Calif.

TUBES FOR SALE—6A8, 35L6GT, 35Z5GT, 12J5GT, 25A5E5G, 6K7GT, 68D7GT, 6N5/6GT, 6D6, 80, 42, 45, 75. Artie Ayers, Rt. #1, Box 138, Fancy Gap, Va.

WANTED—Million model D-D tube checker, any condition. Cash. Osborn Radio Service, 1204 W. Douglas, Wichita 12, Kans.

FOR SALE—Power transformer, 13 leads, only 110V leads known. Keith Antcliff, 116 E. Robinson, Jackson, Mich.

WANTED—Will pay reasonable price for RCA-Rider chanalyser in new condition. Smith's Radio Service, 132 So. 7th St., Steubenville, Ohio.

TUBES FOR SALE—An overstock of #83 tubes, all in original cartons. 78c ea. plus postage. I need an 82 tube, will buy or exchange an 83. Jim's Radio Shop, Mankato, Kans.

WANTED—6K7, 6D6, 58, 24A, 6L6G. Paul's Radio Service, 2022 H Street, Iowa City, Iowa.

FOR SALE—One inverter from 32V DC to 110V AC. One 110V 60 cy. portable light plant suitable for mobile PA system, like new. Want voltohmmyst, Jr. in perfect condition, also FM speakers and test eqpt. of all kinds. W. S. Frank, R. Rt. #3, Chippewa Falls, Wis.

WANTED FOR CASH—Supreme 543M multimeter or equivalent. H. O. Hess, Laurel Terrace, Uniontown, Pa.

WANTED—Condenser checker, preferably Jackson, or any good make. W. F. Hagland, c/o Western Auto, McKinney, Texas.

FOR SALE—All types radio tubes, new and used. Send want list. Need low-priced tube tester, VTVM combination. Want all types test eqpt. Trade or buy. Have 10-watt Ohmite resistors, all sizes. Rowell Sales & Service Co., Apt. 103-613 Fifth Street, S.W., Birmingham 7, Ala.

FOR SALE OR TRADE—One 200V vibra-pack (less rectifier) and 0-100 Weston M.A. meter. Want good phono oscillator, and phono motor & pickup. Elmer Chancellor, R.R. #3, Waverly, Ky.

WILL TRADE—For good camera: Supreme 490 multimeter; 0-1400V DC and AC; 0-1400 mils. DC; 0-400,000 ohms, 4 meg. with Xtal 45V bat. Direct reading scale with leads. Edgar D. Growden, 818 Gephart Drive, Cumberland, Md.

WANTED—50L6, 35Z5, 12SA7, 1h5 tubes; Jackson 660 analyzer and sig. generator. G. S. Bennage, Marionville, Mo.

WANTED—An N.R.I. tube tester. Pease Radio Repair Shop, 2451 Dixie Highway, Pontiac 17, Mich.

WANTED—New or used short-wave regenerative set with p-p output. To be used on small island in southwest Pacific to run on AC or AC-DC. With tubes. Pvt. Harry Symonds, A.P.O. 929, 93rd Cempl. Comp. Co., c/o Postmaster, San Francisco, Calif.

FOR SALE—One model 420 Triumph tube tester with instructions. In good condition. \$20. Clyde Simmons, 501 E. Main St., Plano, Ill.

FOR SALE—Meissner analyst #10-1154 in perfect electrical condition. \$75 C.O.D. Mathews Radio Service, P. O. Box 387, Bloomington, N. J.

WANTED—Universal recording head in A-1 condition. B-J Radio Service, 1363 E. 45th St., Cleveland, Ohio.

WILL TRADE—\$100 worth printing eqpt. incl. 5"x8" Kelsey printing press, for a good sig. generator, or service oscillator. Needed immediately. Ed Jurick, R. D. #2, Canonsburg, Pa.

FOR SALE—Ten DC power packs from battery farm radios, some 2V input, some 6V and some 32V. Compl. with vibrators and some have filter condensers attached. A. F. Whisler, Kennard, Ind.

FOR SALE—Rider's manuals Nos. 1, 2 and 3. \$5 each. Henry Jensen, Rt. #1, Box 214, Mountain View, Calif.

WANTED AT ONCE—030 Philco dynamic tester, also model 504-A Supreme tube and set tester. Must be A-1 and priced right. W. T. Moss, 703 S. Ashland Blvd., Chicago 7, Ill.

SELL OR TRADE—Weston .0 to 2 amp. surface type radio frequency meter for transmitter. \$20, or will trade on enlarger or camera. Electric Service Shop, Harrison, Ohio.

WANTED—Modern tube tester, also V-O-M, and capacitor analyzer in good condition. E. P. Connally, Box 28, Athens, Texas.

FOR SALE OR TRADE—One I-A Graflex camera Kodak style, with carrying case. Excellent condition. Packarene Radio Service, RD #2, Box 66, Wood St., Latrobe, Pa.



HOW TO SUBSTITUTE CAPACITORS Accurately

Besides listing the "Victory type" Sprague Atom Electrolytics and TC Tubulars for wartime service use, this folder contains helpful information on making these 18 Capacitor types do the work of the 473 capacitors normally included in our catalog. Send a post card today for your copy.

FOR SALE—Battery charger, 4 amps., new condition; RCA station allocator, new condition. Want Triplett vibrator tester #1672 or 1673. Paul Capito, 637 W. 21st St., Erie, Pa.

FOR SALE OR TRADE—Hallcrafters Sky Champion. Want guns, cameras. The Trading Post, Gardner, Mass.

FOR SALE—Weston V-O-M 1000 OPV and up to 1000 V-DC (new); used Weston voltmeter with 0 adjustment; used set of test leads; Deluxe 2-post type automatic record changer with all mtg. fixtures, brand new, \$25; and misc. parts and tools. Send for list. Ray D. Wilson, P. O. Box 206, Locust Grove, Oklahoma.

WANTED—Jackson 660 sig. analyzer, 0-50 microamp meter, or Jackson 642 (or similar) 20,000 ohm-per-volt multimeter; Jackson 652 or similar audio osc. and 420 or similar AM-FM test osc. I have cash and 12, 25, 35 and 50V tubes. Harold Harding, 206 Main St., Huntington Beach, Calif.

YOUR OWN AD RUN FREE!

This is Sprague's special wartime advertising service to help radio men get needed parts and equipment, or dispose of radio materials they do not need. Send your ad today. Write PLAINLY or PRINT—hold it to 40 words or less. Due to the large number received, ads may be delayed a month or two, but will be published as rapidly as possible. We'll do everything we can to help you—and the fact that thousands of pieces of Radio-Electronic equipment are in operation today as a result of sales or "swaps" made through The Trading Post offer convincing proof of the far-reaching effectiveness of this service. Remember that "Equipment for Sale" ads bring best results. Different Trading Post ads appear monthly in Radio Retailing-Today, Radio Service-Dealer, Service, Radio News, and Radio Craft. Sprague reserves the right to reject ads which do not fit in with the spirit of this service. When buying Capacitors—please ask for Sprague's by name. We'll appreciate it! HARRY KALKER, Sales Manager



Dept. S-45, SPRAGUE PRODUCTS CO., North Adams, Mass.

SPRAGUE CONDENSERS KOOLOHM RESISTORS

Obviously, Sprague cannot assume any responsibility, or guarantee goods, services, etc., which might be exchanged through the above advertisements

"THE HELP SITUATION" by Larlar



HERE'S HELP THAT MAKES LIFE EASIER FOR YOU

It's possible to improve the working conditions of your employees and at the same time make life easier for yourself.

It's a lot easier for the man at the bench to get factual and authoritative circuit data from one of the thirteen Rider Manuals than it is for him to laboriously trace the circuit of an ailing receiver and guess-out the servicing information he needs to repair it. It's a lot more pleasant for him—and you too. For your production is increased—and deliveries speeded.

Never have Rider Manuals been so widely used as today when speed in the tracing of circuits means not only additional profits, but the development and preservation of invaluable good will. Have all thirteen volumes of Rider Manual on each of your benches. Check the list to the right—order any missing volumes today.

Check, too, the list of Rider Books. They're chock-full of technical information that can further speed your repair work and enable you to make the most of your present opportunities to add to the volume and good will of your business.

RIDER MANUALS (13 VOLUMES)

Volumes XIII to VII.....\$11.00 each volume
 Volumes VI to III..... 8.25 each volume
 Abridged Manuals I to V (1 volume).....\$12.50
 Automatic Record Changers and Recorders 6.00

OTHER RIDER BOOKS YOU NEED

The Cathode Ray Tube at Work
 Accepted authority on subject..... \$3.00
 Frequency Modulation
 Gives principles of FM radio..... 1.50
 Servicing by Signal Tracing
 Basic Method of radio servicing..... 3.00
 The Meter at Work
 An elementary text on meters..... 1.50
 The Oscillator at Work
 How to use, test and repair..... 2.00
 Vacuum Tube Voltmeters
 Both theory and practice..... 2.00
 Automatic Frequency Control Systems
 —also automatic tuning systems..... 1.25
 A-C Calculation Charts
 Two to five times as fast as slide rule..... 7.50
 Hour-A-Day-with-Rider Series—
 On "Alternating Currents in Radio Receivers"—
 On "Resonance & Alignment"—
 On "Automatic Volume Control"—
 On "D-C Voltage Distribution"..... 90c each

JOHN F. RIDER PUBLISHER, INC.

404 Fourth Avenue, New York 16, N. Y.

Export Division: Rocke-International Corporation
 13 E. 40th Street, New York City Cable: ARLAB

RIDER MANUALS GIVE YOU THE HELP YOU NEED!



SERVICING HELPS

IN Fig. 1 appears a method of eliminating a .25-mfd bypass on the cathode of any of the diode triode or diode pentode tubes operating as detector and first audio tubes. If the .25-mfd condenser across the normal cathode resistor should open we usually find that we are unable to cut down the output fully with the volume control, assuming of course it is in the grid or diode load of the tube in question. By replacing the normal cathode resistor and bypass with the bleeder circuit consisting of R_1 and R_2 , a

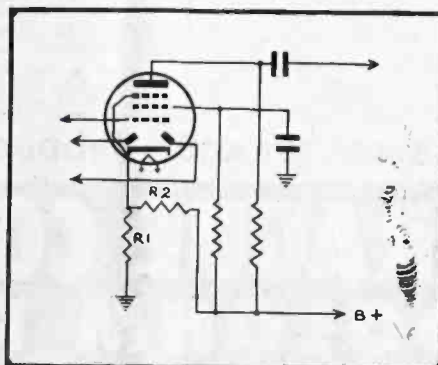

Fig. 1

ground path for a-f in the cathode is established. Thus the minimum volume trouble is eliminated. R_1 should not be more than 200 ohms, while the value of R_2 will depend upon the value of the B+ voltage in the receiver. About 50,000 ohms will suit a 6Q7 tube if the B+ is 250 volts. In any case R_1 may be fixed at 200 ohms and R_2 varied until the tube shows correct cathode voltage. In some receivers R_2 may consist of the existing bleeder circuit supplying the screens of the other tubes. In this case it is only necessary to lift the lower end of the screen bleeder from ground and take it to the cathode.

Hum Balancing

Fig. 2 illustrates a system of hum balancing for use when the capacity of filter condensers has dropped somewhat. Assuming that the tube is a pentode (or diode pentode) driving the output tube, all ripple voltage may be eliminated from the plate load of the tube by feeding a small amount of ripple voltage into the screen via condenser C_1 in the diagram. Various values of C_1 must be tried for best attenuation of ripple. Any hum voltage fed into the screen is 180° out of phase with that in the plate and a definite balance may be obtained. Incidentally this will only hold as long as the screen is fed through a high value of dropping resistance. Just how long this state of balance will hold depends on the ageing of the tubes. In several cases the balance has held over a period of several months.

E. B. Menzies

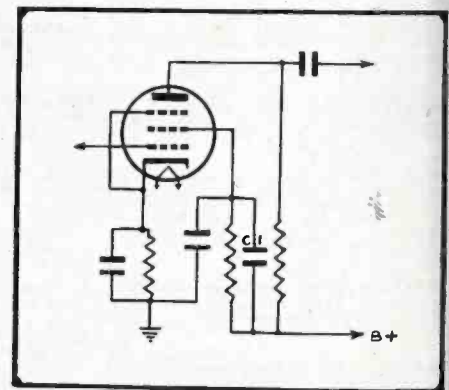

Fig. 2

ZENITH 12H670, 42, CHASSIS 12B1

Set has a loud hiss, sounding like the antenna loop is open. Replace condenser C_3 , .01-mfd, 600-v (screen grid of 6SD7GT to grid), which shorts. When set is inoperative, replace resistor R_{15} , 1,000 ohms 1 watt, which burns, and the shorted condenser C_{12} , .05-mfd 600 v.

Phil M. Benizzi.

The Model 610-B

MEG-O-METER

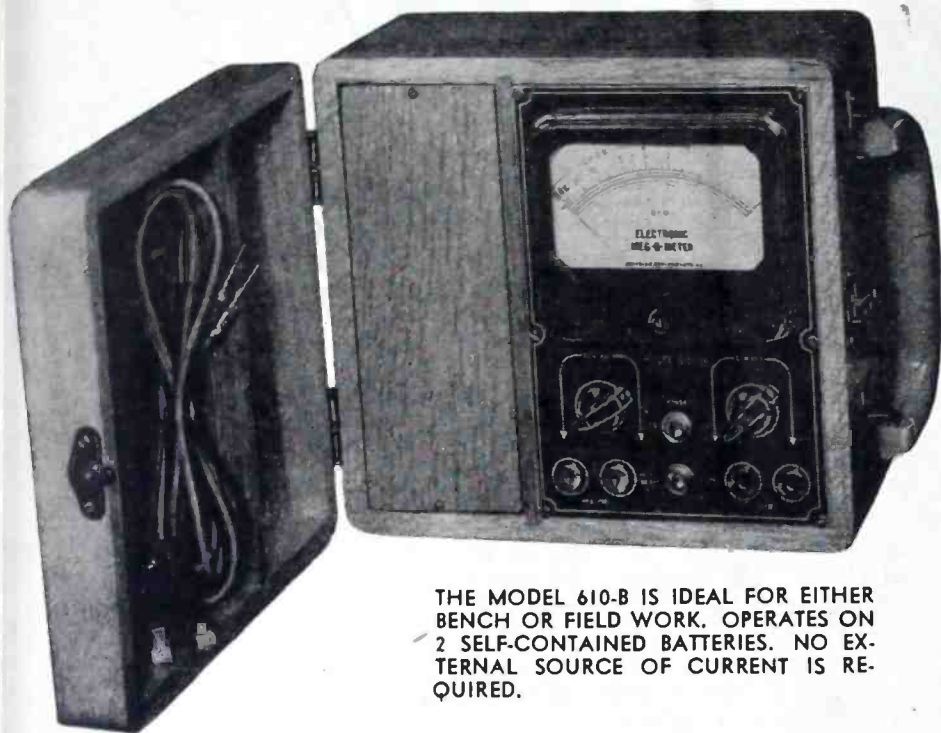

THE MODEL 610-B IS IDEAL FOR EITHER BENCH OR FIELD WORK. OPERATES ON 2 SELF-CONTAINED BATTERIES. NO EXTERNAL SOURCE OF CURRENT IS REQUIRED.

A New,
Battery-operated
**INSULATION
TESTER!!**

Instantaneously measures the exact leakage of all insulation from zero up to

200 MEGOHMS
At a Test Potential of
500 VOLTS D. C.

Supplied by built-in battery and vibrator power supply.

3 RANGES:
0 — 20,000 OHMS.
0 — 2 MEGOHMS
0 — 200 MEGOHMS.

ADDED FEATURE: The MODEL 610-B has been designed to function with a high degree of accuracy both as a resistance measuring instrument and as an insulation tester. In addition to the 0 to 200 Megohm Range which is used for insulation testing, two additional lower resistance ranges are provided. The two lower Resistance Ranges are 0 to 20,000 Ohms and 0 to 2 Megohms. Thus the MODEL 610-B may be used to accurately measure all resistances from 0 to 200 Megohms.

Specifications

***NO HAND CRANKING—** The 500-VOLT POTENTIAL is made instantly available by simply throwing a front panel toggle switch.

***DIRECT READING—** All calibrations printed in large easy-to-read type enabling exact determination of leakages from 0 to 200 Megohms. In addition, the Megohm scale is also sub-divided into BAD (0 to 1 Megohm), DOUBTFUL (1 to 3 Megohms), GOOD (3 to 200 Megohms) sections. The BAD Section which indicates the danger point is printed in red.

*The instrument is housed in a heavy-duty Oak portable cabinet.

*Meter movement—a 4 1/2" 0 to 200 Microampere sensitive meter guarantees extremely accurate readings on all ranges.

Model 610-B comes housed in a beautiful, hand-rubbed Oak cabinet complete with cover, self-contained batteries, test leads and instructions.

Size 9 1/2" x 8 1/2" x 6". Shipping weight, 16 pounds.

Price **\$62.50**

Important: We also make the Model 610-E Meg-O-Meter which operates on 110 Volt 60 Cycle A.C. The Model 610-E is especially recommended for production testing where product must meet specified insulation requirements. Model 610-E provides exactly same services as the Model 610-B except that it operates on 110 Volt A.C. current instead of batteries. Price of Model 610-E complete is **\$52.50**

SUPERIOR INSTRUMENTS CO., Dept. W., 227 Fulton St., New York 7, N. Y.

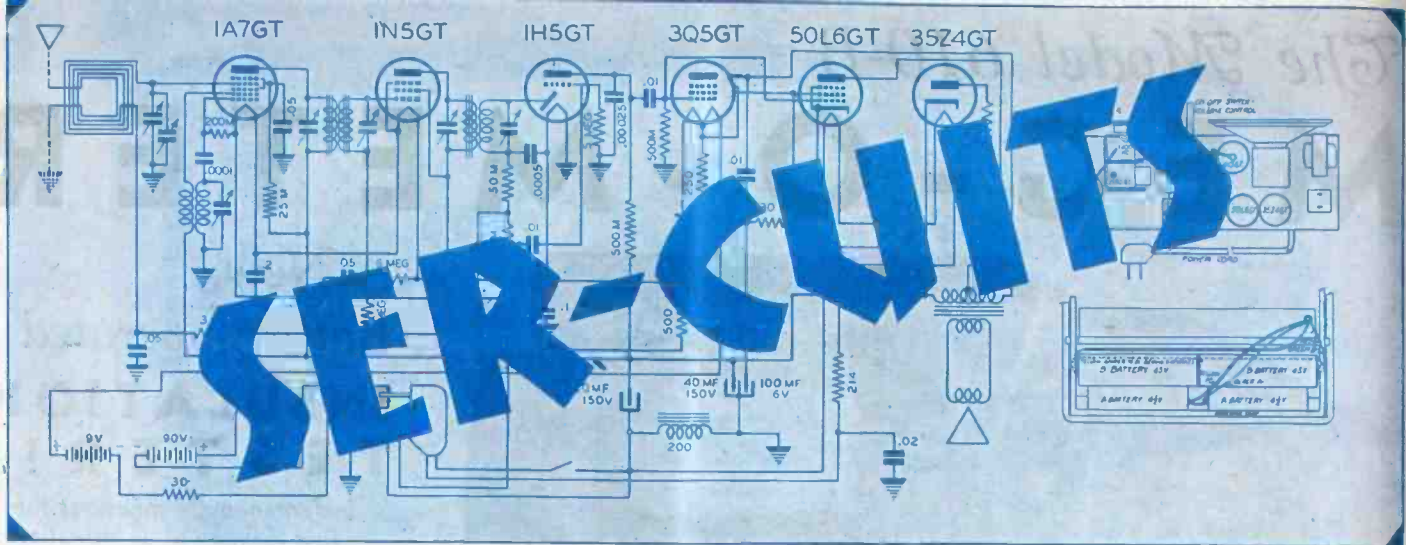

A STUDY of British receivers reveals an interesting display of unusual design techniques. For instance, in most British equipment there is always provision for an external speaker. The wavebands, and consequently the i-f, are different from our standards. Most sets cover our own broadcast band which is called *medium wave* (m-w), and a lower frequency or *long-wave* range (l-w) covering up to approximately 2000 meters or 150 kc. Antenna-circuit wavetraps, called Droitwich filters or rejectors, are usually tuned to strong local stations rather than to the intermediate frequency. Trimmer phasing condensers to reduce image interference from local stations are featured in many models. Adjustments for these devices are made on installation rather than at the factory, as in the case of i-f traps.

by HENRY HOWARD

In Fig. 1 appears a popular a-c 4-tube and rectifier 2-band British receiver, the Ekco AC74. Like most receivers, it is for 200-250 volts a-c, and covers l-w and m-w, with an i-f of 110 kc. The antenna is fed to the first tube, a triple-grid converter, by means of a double-tuned band-pass filter. Inductive coupling is used on m-w and conductive autotransformer coupling on l-w. An antenna shunting resistor R_1 (20 ohms) is cut in by switch S_1 , the *local-distance* switch. Trimmer condenser C_{10} acts as an

image suppressor, acting like a wave-trap to cut out one local station as mentioned earlier.

The oscillator circuit uses cathode feedback and plate tuning, shunt fed. A plate r-f choke is used to stop signal frequencies enough so as not to load the oscillator, yet allow i-f to pass. The i-f stage is standard with the possible exception of the avc signal pick-off from the anode. A .0001-mfd. condenser is linked to one of the diodes and back to the i-f grid. This is the only controlled circuit. Avc delay action is obtained by placing a positive bias on the cathode of V_3 which also provides the first audio bias. Bias is obtained from the voltage divider consisting of R_7 , R_8 and R_9 . A meter link is also included. It consists of a piece of flexible wire soldered across two terminals in the i-f cathode cir-

Fig. 1. The Ekco AC74, 4-tube and rectifier two-band receiver, for long-wave and medium-wave reception. Cathode feedback and shunt-fed plate tuning is used in the oscillator circuit.

(Continued on page 25)

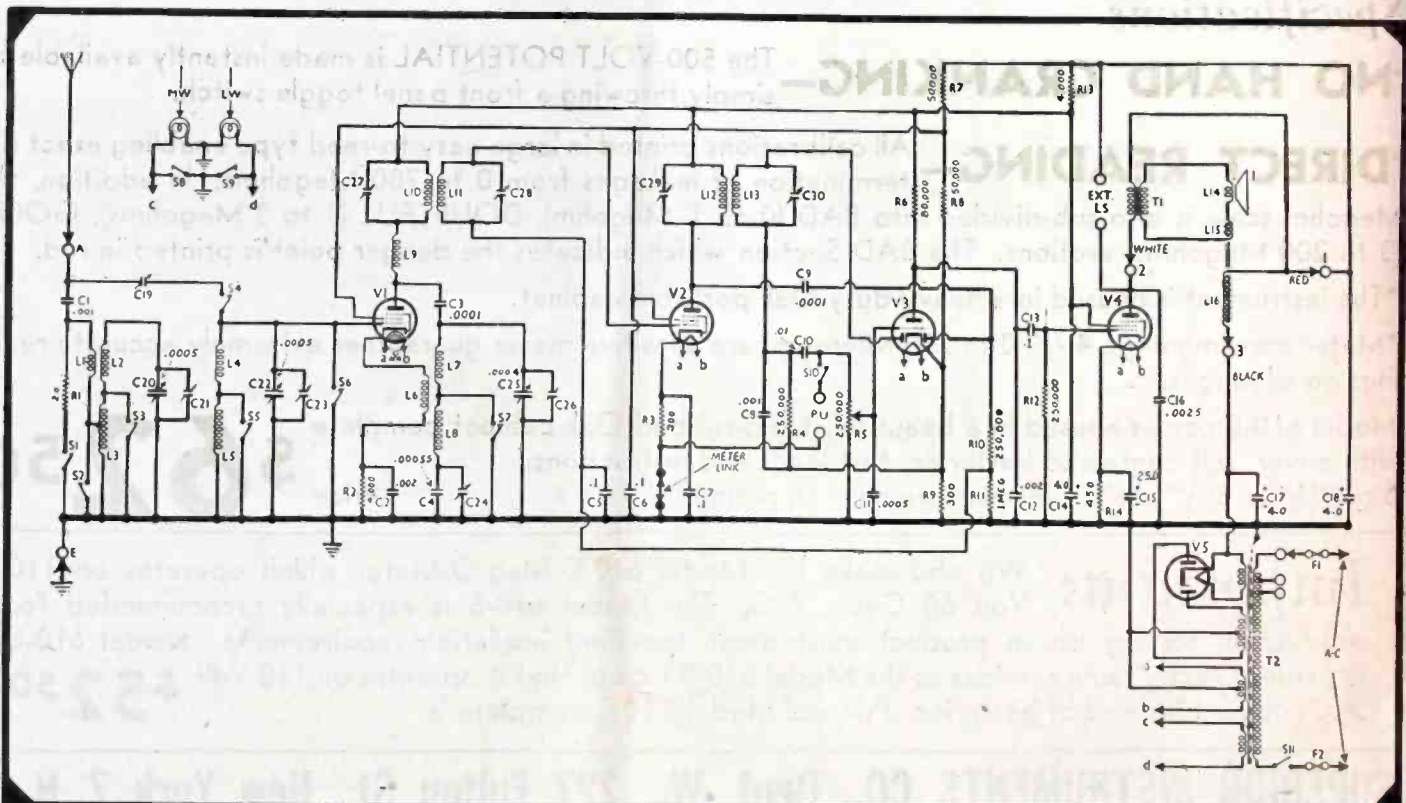



How to Behave in a Storm

by don herold

Any upset may be an opportunity to grow—and remodel. It may be awfully uncomfortable—but it can be darned valuable. Last summer, lightning struck our summer cottage and burned off the south end. Well, it gave us a chance to enlarge our living room. This war hurts a lot of us. But it is going to give many folks a chance to get some perspective on themselves. A lot of radio service men are in a terrible stew right now. Parts and help are hard to get. It's a mess!



PHOTO OF A RADIO SERVICE MAN THROWING AWAY POST-WAR BUSINESS

But, at least, it's different! And it can be stimulating. And after it's all over, you can have things different. Maybe this is the time to revise your shop—straighten it up—switch it around—get it spic and span. This certainly is the time to make postwar plans—to think of a future twice as big as your past—to start to get wise on coming new products in radio and allied lines. And it is a time to make

friendly prospects out of customers in trouble—to help boom your business in those days to come. As a typical consumer, I'm itching for better postwar radio equipment and all the other new electrical gadgets that are on the way.

"I'm going to tidy up the place and tidy up my mind"



And, incidentally, I have more confidence in dealers who let it be known that they string with famous manufacturers and use high grade parts—for instance INTERNATIONAL RESISTANCE UNITS.

No. 4 in a series of special messages prepared by America's famous business writer, humorist and cartoonist, Don Herold. . . . In sponsoring these Don Herold "broadcasts," IRC pays tribute to the thousands of Radio Service Men who, whenever possible, specify and use IRC resistance units in their work.



INTERNATIONAL RESISTANCE CO.

401 N. Broad St. • Philadelphia 8, Pa.

IRC makes more types of resistance units, in more shapes, for more applications than any other manufacturer in the world.





WHEN YOU CHECK UP ON YOUR PLANT'S PAY-ROLL SAVINGS PLAN FIGURES!

These days, things change with astonishing speed. The Pay-Roll Savings Plan set-up that appeared to be an outstanding job a short time ago, may be less than satisfactory today.

How about checking up on the situation in your plant? Checking up to see if everybody is playing his, or her, part to the full measure of his, or her, ability. Checking up to see if 'multiple-salary-families' are setting correspondingly multiple-savings records.

A number of other groups may need attention. For example, workers who have come in since your plant's last concerted bond effort. Or, those who have been advanced in position and pay, but who may not have advanced their bond buying accordingly. Or even

those few who have never taken part in the plan at all. A little planned selling may step contributions up materially.

But your job isn't finished, even when you've jacked participation in your Pay-Roll Savings Plan up to the very top. You've still got a job before you—and a big one! It's the task of educating your workers to the necessity of not only buying bonds, but of *holding* them. Of teaching your people that a bond sold before full maturity is a bond robbed of its chance to return its full value to its owner—or to his country!

So won't you start *checking . . . and teaching . . .* today?

War Bonds To Have And To Hold!

**LET'S ALL BACK THE ATTACK
WITH WAR BONDS!**

The Treasury Department acknowledges with appreciation the publication of this message by

SERVICE

This is an official U. S. Treasury advertisement—prepared under auspices of Treasury Department and War Advertising Council

SER-CUITS

(Continued from page 22)

cuit. For insertion of a 5-ma tuning meter the link is broken.

A muting switch, S_6 , shorts the signal grid of the converter tube to kill signals for phonograph operation. Incidentally, phono combinations are called radiograms, the *gram* being an abbreviation of gramophone. The audio stages are identical to American designs except, perhaps, for the $\frac{1}{4}$ -megohm volume control (which is lower than average) and the terminals *Ext. Ls* for an external high impedance (6000-8000 ohm) speaker. Two 6-volt pilot lamps are connected in series across a separate 4-volt transformer winding for *gram* use, and with one or the other lamp shorted for operation on each band. Both sides of the line input are fused with 1-ampere fuses, and three voltage taps are provided. A model for d-c is also made and in addition there is a special version of the d-c model for mercury-arc rectified supply mains which require more filtering than straight d-c models. This is something we don't have to worry about!

Ekco AW88-C88

A 4-band 40-80 cycle receiver with an i-f of 126.5 kc is shown in Fig. 2. This is Ekco AW88 or C88 which covers l-w, m-w, s-w and t-s. S-w is the standard short-wave band of 16 to 50 meters; t-s is the sound channel for television, not to be used for other than local reception. The antenna circuit provides for a dipole, bandpass tuning on l-w and m-w, single tuning on t-s and s-w, and an image suppressor on m-w. S_1 and S_2 cut in t-s and s-w r-f input transformers; S_3 connects the m-w iron core inductors, and S_4 , the l-w. When using l-w band, a .001-mfd condenser and an i-f wave-trap shunt the antenna input, and a combination of inductive and conductive coupling is used. The unused coils are opened, but never shorted. This is reasonable because the bands are widely separated in frequency.

A triode-hexode tube with internal coupling is used for oscillator-converter. The triode-plate reaction oscillator with provision for shorting the unused tickler coils is quite familiar. No separate coils are provided for the t-s channel, a harmonic of the s-w oscillator being used for this purpose.

Avc voltage is again derived from the i-f plate but no delay voltage is applied. The converter tube when operating on l-w, as well as the i-f stage, receives avc bias. A variable tone con-

(Continued on page 26)

DO 2 JOBS IN THE TIME NORMALLY REQUIRED FOR ONE!

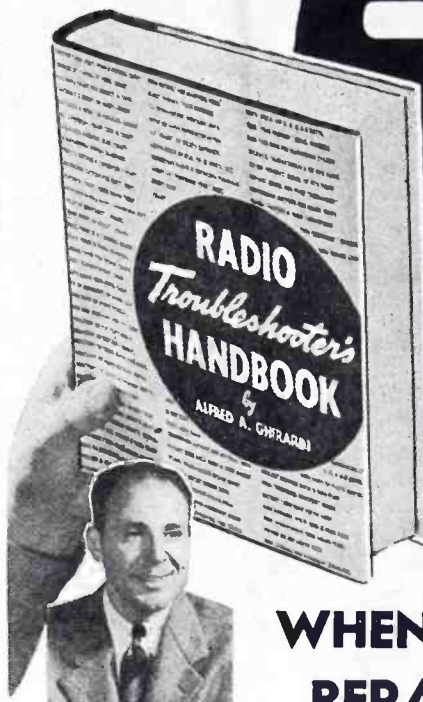

A. A. GHIRARDI

WHEN A SET COMES IN FOR REPAIRS... turn to this big GHIRARDI book First—Not to your tester

Don't waste time on elaborate testing of every set that comes to you for repair! **FIRST** look up its model number in the big Trouble Case History section of Ghirardi's completely revised, greatly enlarged 3rd edition **RADIO TROUBLESHOOTER'S HANDBOOK**.

Four times out of five you'll find listed there not only the cause of the trouble—but **ALSO** the exact step-by-step directions for fixing it. You'll save a whale of a lot of time—and make a lot more money! For example, Serviceman Ralph E. Locke of Calais, Me., says "Ghirardi's Handbook quickly gave me information I'd been looking for for two days and solved a tough job!"

"PAYS FOR ITSELF"

Herbert Perry of Denver says "Helped me the first evening I took it home—and the set it helped me fix paid for the book!"

Over 400 pages of this big, 744-page manual-size book are filled to the brim with the Trouble Case Histories (common trouble symptoms, their causes and remedies) for over 4800 radio models of over 200 popular makes—practically every model in use today.



◀ SPECIAL MONEY-SAVING COMBINATION

Have COMPLETE

Service Data at Your Fingertips

You can buy Ghirardi's famous 1300-page **MODERN RADIO SERVICING** singly for only \$5 (\$5.50 foreign)—but here's your chance to get it along with the new 3rd Edition **RADIO TROUBLESHOOTER'S HANDBOOK** for a special money-saving price of only \$9.50 (\$10.50 foreign). Actually, **MODERN RADIO SERVICING** is the only complete, inexpensive volume that gives you a thorough course in modern radio service work—explanation of the inner workings of all Test Instruments; Troubleshooting Procedure; Circuit Analysis; Testing & Repair of Parts; Installation; Adjustments; and Maintenance. Tells What to do, How to do it, and Why. Order today. 5-Day Money-Back Guarantee.

GUARANTEED TO SAVE YOU TIME ON 4 JOBS OUT OF 5!

But this is just the beginning! There are hundreds of additional pages of priceless servicing information covering 74 **VITAL RADIO SERVICE SUBJECTS**. Each page is devoted to helping you repair more radios *easier* and *in less time*. Included is the most complete tube chart ever published anywhere, covering **EVERY** tube type; invaluable hints on substitution of tubes and other scarce parts; I-F alignment peaks for over 20,000 superhets; a big data section on I-F transformer troubles and dozens of graphs, charts, and data compilations.

Remember, Ghirardi's **RADIO TROUBLESHOOTER'S HANDBOOK** is **NOT** a study book. It goes right to work for you the minute it arrives. You simply turn to it when you want the answer to a servicing problem—and there are mighty few it won't help you solve!

ACT AT ONCE!

You cannot lose! Send coupon today! Use the book for 5 days. See for yourself how it speeds up your work. The cost is only \$5 (\$5.50 foreign)—**BUT**, if you are not more than satisfied, send it back and your money will be refunded cheerfully without question. Nothing could be fairer than this!

5-DAY FREE TRIAL

RADIO & TECHNICAL DIVISION of Murray Hill Books, Inc.
Dept. S-54, 232 Madison Ave., New York 16, N. Y.

Enclosed find \$5 (\$5.50 foreign) for Ghirardi's **RADIO TROUBLESHOOTER'S HANDBOOK** (new 3rd edition) post-paid; or send C.O.D. (in U.S.A. only) for this amount plus postage. If not satisfied, I may return the book at the end of 5 days and receive my money back.

Check here if you wish to take advantage of **MONEY-SAVING COMBINATION OFFER**. \$9.50 enclosed (\$10.50 foreign); or send both books C.O.D. (in U.S.A. only).

Name

Address

City and Dis. No. State

CONSTANT VOLTAGE SUPPLIES

(Continued from page 9)



Products of
"THE HOUSE OF RESISTORS"

★ Clarostat is almost 100% on war work. That's why there are relatively few Clarostat green cartons on your jobber's shelves—only those items essential to wartime servicing.

However, this war won't last forever. And when it ends, those tougher Clarostat resistors, controls and resistance devices will be available to you. Once again those green cartons will be back in full strength on your jobber's shelves to meet your every need. And all of us will be well repaid for having concentrated on the biggest job of all—winning the war.

★ SEE OUR JOBBER . . .

He's carrying replacement controls and other essential service items. Consult him regarding your wartime servicing problem.



CLAROSTAT MFG. CO., Inc. • 285-7 N. 6th St., Brooklyn, N. Y.

while the regulation is maintained. In operation, a high current, low impedance tube is connected in series with the load, and the drop through this tube is made to vary with the output voltage in such a way that it compensates for any tendency toward a variation. VT_1 is the series tube whose resistance is varied by varying its grid bias, which is the IR drop across R_1 . This bias is controlled, in turn, by the bias on VT_2 , a sharp cutoff amplifier. The bias on VT_2 is determined by the difference between V_1 and V_2 . V_1 is constant due to the action of the v-r tube, while V_2 varies with line voltage or load changes.

When the terminal voltage tends to rise, the grid of VT_2 becomes more positive, causing VT_2 to draw more plate current. This causes an increased drop across R_1 , making the grid of VT_1 more negative. This increases the resistance of VT_1 , offsetting the tendency of the terminal voltage to rise. Very accurate control may be had by using a sharp cutoff pentode for VT_2 as in Fig. 5b. To obtain equal sensitivity for both increases and decreases of output voltage it is important to operate both tubes as class A amplifiers (on the linear part of their characteristics). The regulating time lag is negligible and the circuit conse-

quently has an appreciable filtering action which is nothing more than fast regulating action. In addition the system acts like a very low impedance to audio frequencies, minimizing coupling between amplifier stages. When a 2A3 or 6A3 is used for VT_1 , 100 ma may be handled with a drop of about 50 volts through the tube. Two matched tubes in parallel will handle 200 ma. VT_2 should be a 6J7, 6SJ7, 6C6, 77 or similar tube.

Property of Regulation

In reviewing the characteristics of regulation, we note that regulation is the change in output voltage due to applying normal load to the supply and, in all but a few special cases, represents a drop in voltage. What we are striving for, then, is zero regulation and, with the electronic tools at our command, we can actually attain it or come very close to attaining it. We can, if we desire, obtain a negative regulation which means that, upon applying the load, we obtain an increased voltage. That is

$$\% \text{ Regulation} = \frac{100 (E_1 - E_2)}{E_2}$$

where E_1 = no-load voltage

E_2 = normal load voltage

S E R - C U I T S

(Continued from page 25)

ontrol is applied at the first a-f input. A speaker whistle filter is used to reject adjacent channel beats in the voice coil circuit, and a series switch is used for muting the internal speaker. A tertiary winding on the output transformer applies degeneration to the output of the first audio in an unfamiliar circuit with both series and shunt equalizing. This feedback is shorted out in s-w reception. S_{20} is closed on the t-s band, lowering

the a-f gain and probably cutting a few lows; S_{10} is closed on l-w and m-w while both are opened for maximum gain on phono.

Fig. 2. A 4-band long-wave, medium wave receiver, EKco AW88 or C88, with a sound channel for television reception. In the oscillator converter, a triode-hexode tube with internal coupling is used. Provision for a dipole is made in the antenna circuit. On long and medium-wave tuning, a bandpass system is used.

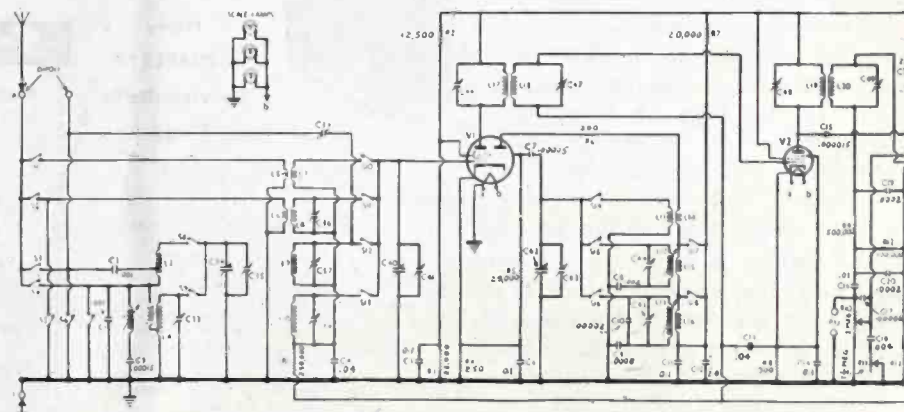



UTC OUNCER

NOW AVAILABLE HERMETICALLY SEALED

The UTC Ouncer type transformer is one of the most popular units in military equipment at the present time.

UTC glass-metal seals have been production proven for over a year. Additional developments have now made it possible to employ this type of sealing in the miniature Ouncer unit . . . $\frac{7}{8}$ " diameter.

Should you have limited space requirements, this transformer (the smallest hermetically sealed unit now available) can be supplied to specifications.

United Transformer Co.

150 VARICK STREET

NEW YORK 13, N. Y.

EXPORT DIVISION: 13 EAST 40th STREET, NEW YORK 16, N. Y., CABLES: "ARLAB"

Servicing up to



of
**WARTIME
RADIOS**

• In keeping with the wartime spirit of minimum types for maximum jobs, Aerovox offers these two "first-aid" servicing items: Type PRS-V Dandeos or tubular electrolytics, and Type '84 paper tubulars. They are now available in the standard "Victory Line" ratings taking care of 90% or better of all standard radio set requirements.

AEROVOX VICTORY CAPACITORS

Aerovox Type '84 paper tubulars. Individually tested. Extra-wax-sealed.

D.C.W.V.	CAPACITY
600	.001 mfd.
600	.002 mfd.
600	.005 mfd.
600	.01 mfd.
600	.02 mfd.
600	.05 mfd.
600	.1 mfd.
600	.25 mfd.

Aerovox Dandeos Type PRS-V electrolytics. Individually tested. Extra-wax-sealed.

D.C.W.V.	CAPACITY
25	25 mfd.
50	10 mfd.
150	20 mfd.
150	20-20 mfd.
150	50 mfd.
250	20 mfd.
450	10 mfd.
450	10-10 mfd.
450	40 mfd.

• ASK OUR JOBBER

Ask for these Aerovox Victory Capacitors to take care of your servicing. Ask for latest Aerovox catalog—or write us direct.



AEROVOX CORP., NEW BEDFORD, MASS., U. S. A.
In Canada: AEROVOX CANADA LTD., HAMILTON, ONT.
Export: 13 E. 40 St., New York 16, N. Y. - Cable: 'AHLAB'

VACUUM-TUBE VOLTMETER

[See Front Cover]

A DEGENERATIVE, balanced d-c amplifier circuit for reading d-c voltage is a feature of the v-t voltmeter (Measurements Corporation, model 62), shown on the cover this month. For measuring a-c voltage a high impedance diode probe is available using a de-based 6H6 diode rectifier. One diode plate is used in the measuring circuit connected to the grid of a d-c amplifier, while the other diode plate is used for balancing out the initial velocity potential of the measuring diode. Since the initial velocity potentials of the two diodes are bucked against each other rather than against some fixed potential, it is possible to provide a high order of stability with respect to line voltage variation.

Operation

A three-position switch provides for measurement of either a-c or d-c and a means for changing the polarity of d-c measurements. Plugs are provided for attachment of the a-c probe when working with frequencies below ten or twenty megacycles. When setting up initially, it is desirable to check the zero. With the switch on either of the two d-c positions and the d-c terminals shorted, and push button 1 depressed, it should be possible to set the meter to zero by means of the lower right hand knob. This balances the d-c amplifier only. An additional screwdriver adjustment also affords balancing of the diodes. The separate balance of the diode maintains maximum stability with line voltage variation. There is no further change of zero on the other ranges once the 1 range has been set. It is desirable to keep a ten-megohm resistor across the d-c ter-

MUELLER



CLIPS

For Quick Temporary Connections

- Made in 10 sizes—from the tiny wee-pee-wee to the 300 ampere Big Brute.
- Offered in both steel and solid copper.
- Red and black rubber insulators to fit each size.
- A complete line with

A CLIP FOR EVERY PURPOSE

Stock deliveries on practically all items.

Send for free samples and catalog 810

Mueller Electric Co.

1548 E. 31st St. - Cleveland, Ohio

FADA

FACTORY

SERVICE DEPT.

OFFERS you a completely equipped service organization to handle your repairs on Fada and all other make radios.

FADA OF NEW YORK

928 Broadway, New York, N. Y.

Tel. 1 GRamery 7-0051-2-0060

LARGE STOCK OF REPLACEMENTS AND CABINETS ALWAYS ON HAND

BE SURE... *Standardize on*

STANCOR *Transformers*

Call your nearest Stancor Jobber...
or write us for his address

STANDARD TRANSFORMER CORPORATION
1500 N. HALSTED STREET • CHICAGO



NEW BOGEN DEVELOPMENTS

minals since otherwise the grid circuit would be open on d-c, and the meter will go off scale.

The accuracy of this instrument is chiefly limited by the indicating meter which is 2% of full scale. When checking calibration accuracy against an rms standard, the voltage source should have less than 1% harmonics. Because of the .01-mfd diode condenser, the meter reads approximately 4% low at 60 cycles. The input capacity of the probe when not plugged into the carrying jacks is about seven mmfd. Since a ten-megohm diode leak is employed, the input impedance is approximately five megohms at the lower frequencies. If the binding posts of the probe are shorted at their base, the resonant frequency of the resulting circuit is approximately 350 megacycles.

The probe is suitable for operation up well beyond 100 megacycles. There is, of course, some loading; however, this loading is less than that usually present in some types of vacuum tube voltmeters at those frequencies.

With a photoelectric tube, the d-c voltmeter is suitable for measuring a wide range of light intensities. With the aid of a 90-volt battery the resistance range is extended to 100,000 megohms. The voltmeter may also be used as a direct reading *Ph* meter in conjunction with a glass electrode.

Push button selection of five ranges, 1, 3, 10, 30 and 100 volts a-c or d-c, is provided. Indication is linear for d-c and calibrated to indicate rms values of a sine wave or 71% of the peak value of a complex wave on a-c.

HANDY DISPENSER FOR SOLDER

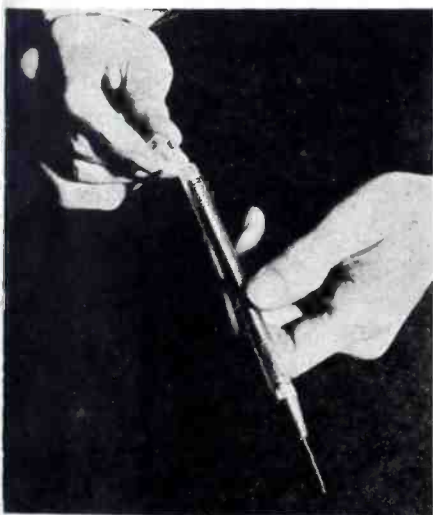

A pencil-type solder dispenser devised at General Electric's Schenectady works. Made of a piece of methyl methacrylate resin tubing. Before loading the solder into the dispenser, it is form wound on a drill rod in a bench lathe. The operator pulls the solder from the dispenser with pliers as it is needed.



NEW TECHNIQUES . . . new ideas . . . new developments . . . there have been many which we of the David Bogen Company have applied in the production of inter-communication, detection and specialized sound equipment for the United States Army and Navy.

These new developments are now the property of our fighting men, and we are enjoying the satisfaction which comes from making a vital contribution to the war. The equipment we produce after Victory will reflect our greater knowledge and skill, and will incorporate many of the remarkable developments which are a product of our experiences today. To Bogen distributors that great new equipment will mean prestige and profit. Tomorrow's satisfaction will belong to Bogen purchasers . . . users of the finest sound equipment made.

OF IMMEDIATE IMPORTANCE TO BOGEN DISTRIBUTORS:

We are constantly striving to speed deliveries on our regular catalog equipment. We know that this equipment, too, is vital to the war program . . . and deliveries are improving daily.

Support the Fifth War Loan Drive

David Bogen Co. Inc.



THE STANDARD OF PERFORMANCE



Bogen Sound Systems

663 BROADWAY NEW YORK 12, N. Y.

• Communo-Phones • Amplifiers • Electronic Equipment

why Radiart Vibrators EXCEL



4. SEASONED PRODUCTION

RADIART VIBRATORS and VIPOWERS give rugged dependable service under all sorts of conditions because they have achieved seasoned production through years of painstaking developments.

Carefully engineered improvements, checked by millions of vibrators in actual operation, have perfected RADIART VIBRATORS and VIPOWERS and have given them wide recognition for unexcelled performance.

The Army, Navy and Signal Corps recognize that performance as evidenced by their large demands for RADIART PRODUCTS for use on all battle fronts.

Radiart Corporation

3571 W. 62nd. St.

CLEVELAND 2, OHIO



Still your best bet for replacements

Centralab VOLUME CONTROLS

*Old Man Centralab

"Old Man" is right . . . for he is a real "old timer". There is no substitute for experience, and the "Old Man" now, as in the past twenty-two years, is still your best bet.



Centralab

Division of GLOBE-UNION INC., Milwaukee



NEW NAME FOR SPRAGUE

Sprague Electric Company is now the official name of the Sprague Specialties Company, North Adams, Massachusetts. The company's policies, ownership and management, however, have not been changed.

WESTINGHOUSE APPOINTS NELSEN

The lamp division of Westinghouse Electric, Pittsburgh, has appointed Andrew G. Nelsen manager of the company's lamp sales activities in the middle western district. Mr. Nelsen, with Westinghouse for more than twenty years, will work from the Chicago offices.

SYLVANIA PURCHASING COLONIAL RADIO

Negotiations for the purchase of the capital stock of Colonial Radio Corporation of Buffalo by Sylvania Electric Products, Inc., Emporium, Pennsylvania, are now in progress. It is expected that Colonial will continue to operate as a manufacturer of radio receivers.

STANCOR DISPLAY RELIEVES LABOR SHORTAGE

By setting up an assembly line in neighborhood store windows recently, the Standard Radio Transformer Company of 1500 North Halsted Street, Chicago, succeeded in enlisting a number of employees to relieve a temporary labor shortage at the plant. The window display was set up in cooperation with the WMC, and depicted the different occupations available at the company, with Stancor men and women actually on the job.

ADELMAN BECOMES SOLAR REPRESENTATIVE

Leon L. Adelman has entered the representation field. Among other lines, he will represent Solar Capacitor Sales Corporation, 285 Madison Avenue, New York, in the metropolitan New York area.



Leon Adelman (right) and Sylvan A. Wolin, sales manager of Solar Capacitor Sales Corporation.

MUNIZ NOW ESPEY ENGINEERING DIRECTOR

Ricardo Muniz, recently chief engineer and plant manager for Radio Navigational Instrument Corporation, has been named engineering director of Espey Manufacturing Company, New York. Mr. Muniz was formerly electronic consultant for the Teletor division of IBM, and radio and radar instructor at Brooklyn Polytechnic Institute and Hunter College.

NEWS OF THE REPRESENTATIVES

The Missouri Valley chapter were hosts

recently at a meeting in Kansas City of local radio parts jobbers. A large number of representatives were present. Fred Larabee of the WPB, guest speaker, explained fully the present priority setup on radio tubes and parts.

Two new members have been admitted to the Buckeye Chapter. They are F. Bell of 1400 West 25 Street, Cleveland, who was also elected secretary-treasurer of the chapter; and L. A. Morrow of 2108 Payne Avenue, Cleveland.

The Wolverine Chapter has added the name of R. C. Nortstrom, 2111 Woodward Avenue, Detroit 1, Michigan.

New addresses have been listed by the Chicagoland chapter for three of its members: C. R. Bluzat and Walter Bauman are now at 2753 West North Avenue, Chicago; and Russ Diethert is at 612 North Michigan Avenue, Chicago.

J. M. SMITH VICE PRESIDENT OF MALLORY

John M. Smith, former general manager of manufacturing for RCA Victor Division, has been appointed vice president in charge of manufacturing of P. R. Mallory & Company, Inc., Indianapolis, Indiana.



UMC ISSUES JOBBERS' EDITION OF MICRO TOPICS

An eight-page jobbers' edition of the house organ, *Micro Topics*, has been issued by Universal Microphone Company, Inglewood, California, for distribution to interested jobbers and electronics executives. The publication carries photos of factory representatives, company executives and plant supervisors, and contains articles on past and present production of UMC microphones. Dr. Ralph L. Powers is editorial supervisor.

SPRAGUE APPOINTS PUGH AS REP.

Sprague Products Company, North Adams, Massachusetts, has named C. L. Pugh, 2009 Elmwood, Columbus 8, Ohio, as representative for Sprague condensers in the Ohio, West Virginia, and Pittsburgh area.

NATIONAL UNION RECEIVES WHITE STAR

The white star has been added to the Army-Navy "E" flags of the Newark and Maplewood plants of National Union Radio Corporation, Newark, New Jersey.

E. R. PLACE NOW AT RCA

Edward R. Place has joined the information staff of Radio Corporation of

(Continued on page 32)



Where Listening calls for Courage

For Europe's enslaved millions, listening to radios today involves *danger*—and will so continue until after Victory, when free broadcasts can again be heard without fear.

Even in America, listening today involves *difficulty*—because, due to the priority of radio and electronic devices for military service, Americans are still using the same equipment that has served us since 1941.

well—and how many—of America's 59 million radio receivers are still functioning . . . kept in operation by servicemen who are performing miracles to keep 'em listening. Their testimonials to Jackson's INTEGRITY OF DESIGN—that "hidden plus" of all Jackson Testing Instruments—are based on excellence of performance under most severe handicaps.

And yet the amazing thing is how **Buy War Bonds and Stamps today**



Model 652 Audio Oscillator

New Jackson Instruments, incorporating the advances of military experiences, will be available for the vast post-war radio market. Until then, maintaining Jackson products is a responsibility we shall fulfill as promptly as wartime conditions permit.

JACKSON

Fine Electrical Testing Instruments

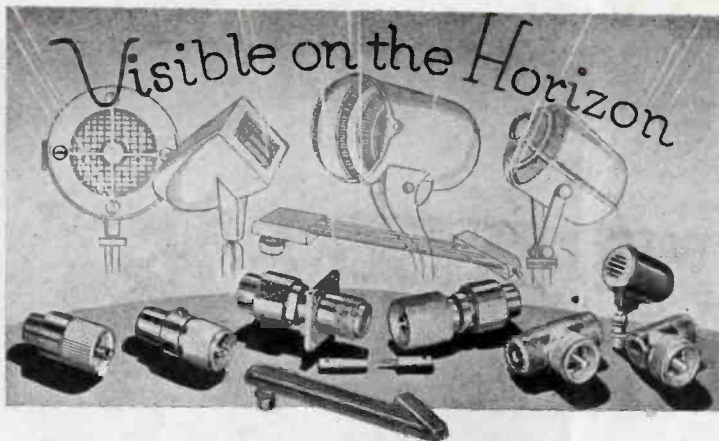

In the immediate foreground of our industrial picture today are many Astatic products being manufactured for wartime use: Astatic Co-axial Cable Connectors for radio communication and radar equipment, Astatic Microphones, Pickups and Cartridges for Army, Navy and wartime industrial use, as well as important "unmentionables" employed in sound detection. Off on the horizon, however, becoming more visible with each passing day, are many Astatic products for radio, phonograph and sound equipment that eventually will be made available, improved and redesigned, for civilian use.

ASTATIC

IN CANADA:
CANADIAN ASTATIC, LTD
TORONTO, ONTARIO

THE ASTATIC CORPORATION
YOUNGSTOWN, OHIO

CINAUDAGRAPH SPEAKERS
*Do a WORLD WIDE
Communication JOB!*

If you aren't getting delivery as quickly as you like—remember, the armed forces come first.
Watch Cinaudagraph Speakers after Victory!

Cinaudagraph Speakers, Inc.

3911 S. Michigan Ave., Chicago

"No Finer Speaker Made in all the World"



NEWS

(Continued from page 31)

America, 30 Rockefeller Plaza, New York. Mr. Place was formerly assistant to the director general of the War Production Drive.

* * *

SOLAR ISSUES CAPACITOR CATALOG

An illustrated 40-page catalog on capacitors has been issued by Solar Manufacturing Corporation, 285 Madison Avenue, New York 17, N. Y. The booklet contains a special sixteen-page form of official battle-front Signal Corps color photographs as well as an elementary explanation of capacitors with actual Signal Corps instructional views. Also included is a description of the company's war products, and the postwar prospects for capacitors.

* * *

MECK APPOINTS C. A. COLE

John Meck Industries of Plymouth, Indiana, has placed Chester A. Cole in charge of the company's new eastern field office, 500 Fifth Avenue, New York. Mr. Cole, eastern district manager, will coordinate jobber and distributor sales in the Atlantic coastal area.

* * *

SCHOTT DISCONTINUES NEW YORK WAREHOUSE

The Walter L. Schott Company, 9306 Santa Monica Boulevard, Beverly Hills, California, has discontinued its New York warehouse, transferring its products to the Terminal Building, 537 South Dearborn Street, Chicago.

* * *

C. H. GODDARD NOW SYLVANIA PRODUCT MANAGER

Charles H. Goddard, formerly vice president of Pittsburgh Reflector Company, has been appointed product manager of fluorescent fixtures sales for Sylvania Electric Products, Inc. Mr. Goddard makes his headquarters at the Sylvania fixture plant in Ipswich, Massachusetts.

* * *

DUOTONE PROMOTIONAL CIRCULAR

An illustrated promotional circular on Duodisc hints is being distributed by the Duotone Company, 799 Broadway, New York 3, N. Y.

* * *

CARTWRIGHT REPRESENTATIVE FOR ASTATIC

J. M. Cartwright of 1276 Peabody Avenue, Memphis, Tennessee, has been appointed to represent the Astatic Corporation, Youngstown, Ohio, in the states of Louisiana, Arkansas, Mississippi, and western Tennessee.

* * *

RAYTHEON HEARS PACIFIC WAR HERO

Captain Alden C. Dinsmore addressed the employees of Raytheon Production Corporation, Newton, Massachusetts, recently. Captain Dinsmore, a veteran of two years in the South Pacific, described experiences in New Caledonia and Guadalcanal.



Captain Alden C. Dinsmore with Merritt A. Stockbridge, director, Raytheon employees service (left), and Frederick J. Link, assistant personnel director, and Russell O. Lund, assistant replacement sales manager.

INSIDE DOPE

Twenty pages of "hot" tube substitution tips that are not common knowledge are clearly and completely explained in the NEW RELEASE:

"SUPPLEMENT NO. 2"
(Code: GREEN)

to the
"RADIO TUBE
SUBSTITUTION &
CHANGE-OVER
MANUAL"

Price: 50 cents

SUCCESSFUL
FORERUNNERS . . .

"RADIO TUBE
SUBSTITUTION &
CHANGE-OVER
MANUAL"

(Code: BLACK)

Price: \$1

and

"SUPPLEMENT NO. 1"

(Code: YELLOW)

Price: 50 cents

See Your Radio Parts Jobber
or write

OELRICH PUBLICATIONS

1627 S. Keeler Ave.
Chicago 23, Ill.

NEW PRODUCTS

SHALLCROSS KELVIN-WHEATSTONE BRIDGE

A portable unit with Kelvin and Wheatstone bridges providing resistance measurements of from 0.0001 ohm to 11.11 megohms has been produced by Shallcross Manufacturing Company, Jackson and Pusey Avenues, Collingdale, Pa.

When the instrument, known as type 638-2, is used as a Wheatstone bridge for measurements between 1 ohm and 1 megohm, its normal accuracy is said to be 0.3% or better.

The accuracy of Kelvin measurements at ranges lower than 0.1 ohm is said to be on the order of 3%. The rheostat is variable in steps of 1 ohm for Wheatstone bridge measurements, and 1 microhm for Kelvin bridge measurements. Accuracy of component resistors is 0.1% except the 1 ohm resistors which have an accuracy of 0.25%. Built-in galvanometer has a sensitivity of 0.25 microamperes from millimeter deflection.



CE-29 PHOTOTUBE

Continental Electric Company, Geneva, Illinois, has announced the development of a blue sensitive phototube using an octal five-pin base. It is interchangeable with similar tubes. This tube is dimensionally similar to the CE-30.

The CE-29 is particularly sensitive to blue and violet light near the short wavelength limit of visibility. It is particularly useful with light sources rich in violet, blue, and green light. RMA spectral sensitivity designation is S-4.

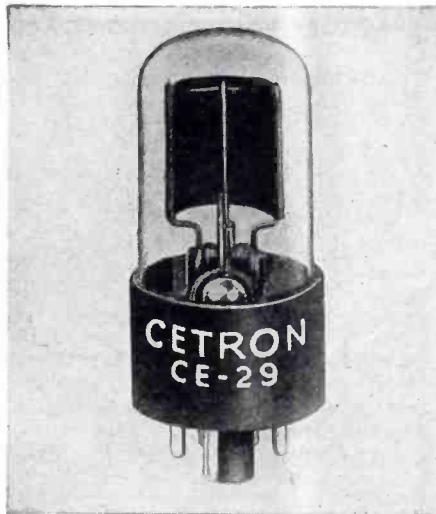

JFD TUBE ADAPTERS

Fifty-seven types of radio tube adapters
(Continued on page 34)

DUMONT

OIL-FILLED Ceramic SEALED CAPACITORS

For
Dependable
Service
work

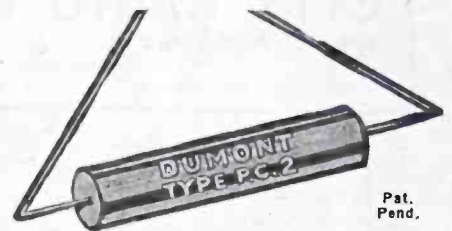

Pat.
Pend.

For long life in repairs for those expensive high-class service jobs on amplifiers, public address, police and school systems and all good electronics equipment.

All capacitors from .0001 to .25 from 600 volts to 2000 volts.

It is
your duty
to buy
war bonds

Literature and prices
on request

**DUMONT
ELECTRICO.**
MFR'S OF
CAPACITORS FOR EVERY REQUIREMENT
34 HUBERT STREET
NEW YORK, N. Y.

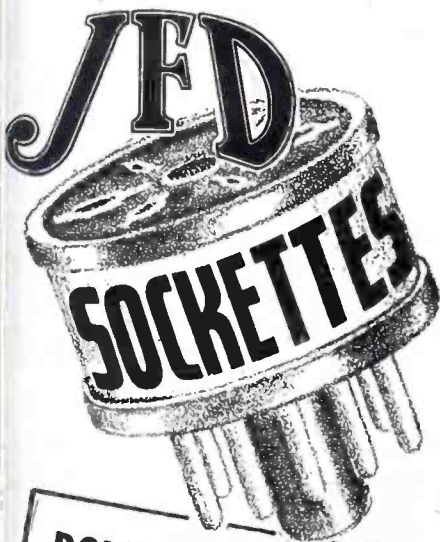

**DON'T REWIRE SETS
USE JFD SOCKETTES**

Hard to get tubes are no problem for "J. F. D. SOCKETTES." Available slow-moving tubes, are easily substituted by these completely wired radio tube adapters.

Leading tube manufacturers have already indicated their warm approval of these adapters. Use SOCKETTES for expertly designed tube substitutions.

Write for Descriptive folder.

J F D Manufacturing Co
4111 Ft Hamilton Parkway
Brooklyn 19 N Y

Fourth Revised Edition

WAR-TIME RADIO SERVICE

The Only Book of Its Kind—All Data Compiled from Practical Experience. Every Substitution has been tried in a Radio.

TUBE SUBSTITUTIONS

The description of each substitution is complete and there is nothing for you to figure out yourself—no reference is necessary—almost 500 substitutions for all the impossible to get tubes all set down like the example below:

TUBE	SUBSTITUTE	CIRCUIT CHANGES NECESSARY
12SA7	12B7/14A7	Change socket to octal and rewire as follows: No. 2 on octal to No. 1 on octal No. 3 on octal to No. 2 on octal No. 4 on octal to No. 3 on octal No. 5 on octal to No. 6 on octal No. 6 on octal to No. 7 on octal No. 7 on octal to No. 8 on octal No. 8 on octal to No. 4 on octal

CHANGING FARM RADIOS FOR ELECTRIC OPERATION

Diagram and text are included for changing battery radios to electric. This is a practical and profitable job if you don't have to fight too many bugs. With the information in WAR-TIME RADIO SERVICE the bugs are eliminated.

REPAIRING BURNED OUT TUBES

Many tubes can be repaired after they have burned out so that they will give additional service. Diagram and data are included for building simple inexpensive apparatus for repairing burned out tubes.

BEST METHODS FOR MAKING ADAPTORS

It is generally considered better to use an adaptor when making a substitution in order to avoid altering the original circuit of the radio. The best methods for making adaptors are described in detail.

PRICE \$3.00 POSTPAID

If you have an old copy the publishers imprint and \$1.00 buys the Fourth Revised Edition

SUPPLEMENT NUMBER ONE

Over 700 additional substitutions. Practical—Profitable—Tested data for changing many models of Silvertone and other 2-Volt Battery radios for electric operation. This supplement is for use in connection with the fourth revised edition of WARTIME RADIO SERVICE

PRICE \$1.00 POSTPAID

Get both of them from your distributor or order from

CITY RADIO COMPANY

504-6 E. Washington St.

Phoenix, Arizona

Canadian orders to

Sparling Sales, Ltd., Winnipeg

Hygrade Radio, Ltd., Vancouver

RADIO AND ELECTRONIC DEVICES

15 YEARS
OF
SERVICE



BURSTEIN-APPLEBEE CO.

1012-1014 McGee St. Kansas City, Missouri

Expert Radio Service Man Wanted

\$50.00 to \$100 per week

SALARY PLUS COMMISSION

A-1 SERVICE CO.

5611 Woodland Ave.

Cleveland, Ohio

WHEN YOU CHANGE YOUR ADDRESS

Be sure to notify the Subscription Department of SERVICE at 19 E. Forty-seventh St., New York 17, N. Y., giving the old as well as the new address, and do this at least four weeks in advance. The Post Office Department does not forward magazines unless you pay additional postage, and we cannot duplicate copies mailed to the old address. We ask your cooperation.

are now being manufactured by J. F. D. Manufacturing Co., 4111 Ft. Hamilton Parkway, Brooklyn, 19, N. Y. These tube adaptors, called Sockettes, are completely wired.

RCA U-H-F AND V-R TUBES

Four tubes have been announced by the RCA Victor division of RCA, Harrison, N. J. They are: 6J4 u-h-f amplifier triode (grounded grid, miniature type); and OA3/VR75, OC3/VR105 and OD3/VR150 voltage regulators.

The 6J4 is a miniature triode for use primarily as a grounded-grid u-h-f amplifier at frequencies up to about 500 megacycles. It has an amplification factor of 55 combined with a high transconductance of 12,000 micromhos. Permits grounded-grid operation with a high signal-to-noise ratio. The 6J4 may also be used in conventional triode circuits with ungrounded grid.

The OA3/VR75, OC3/VR105, and OD3/VR150 are cold-cathode, glow-discharge tubes. They supersede VR75-30, VR105-30, and VR150-30. The new types feature a maximum d-c operating current of 40 milliamperes as compared with 30 milliamperes for the superseded types.

DAVEN ATTENUATORS

Attenuators, featuring a new detent gear and a new type steel cover, have been announced by The Daven Company, 191 Central Avenue, Newark 4, New Jersey. The detent gear is said to offer more positive action.

Contacts and switches of these attenuators are made of tarnish-proof silver alloy.

The steel cover is said to provide improved magnetic shielding. The body of

NEW PRODUCTS

(Continued from page 33)

the cover forms an integral part of the attenuator assembly, protecting the resistors

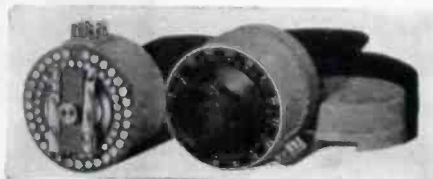

MALLORY PORTABLE D-C POWER SUPPLY

A portable d-c power supply for use in 12- or 24-volt systems has been developed by P. R. Mallory and Company, Inc., Indianapolis, Indiana.

The unit is designed to operate from 3 phase a-c lines of 208 and 230 volts. Three models are offered: VA1500, with d-c output of 10 to 16 volts at 100 amperes or 20 to 32 volts at 50 amperes; VA3000, with d-c output of 10 to 16 volts at 200 amperes or 20 to 32 volts at 100 amperes; VA4500, with d-c output of 10 to 16 volts at 300 amperes or 20 to 32 volts at 150 amperes. Models with similar d-c output but for operation on 460 volts a-c are also available.

Rectification is provided by Mallory magnesium-copper sulphide dry disc rectifiers.

THREE-IN-ONE SOCKET WRENCHES

A multi-socket wrench that automatically accommodates 10 standard, 12 standard, 1/4" standard and light, and 5/16" light

hexagon nuts is now being made by The Eastern Specialty Company, 3617-19 North 8 St., Philadelphia, Pa. Pressing the wrench over any of the three sizes of nuts automatically selects the proper nested hexagonal tube suited to that particular nut.

Designed to provide a clearance through the barrel for studs up to 5 1/2" length. Both handle and barrel have moulded insulation capable of withstanding a dielectric test for one minute at 5,000 volts rms.

Handle has a die-cast aluminum member pressure-moulded to the hexagon steel barrel.

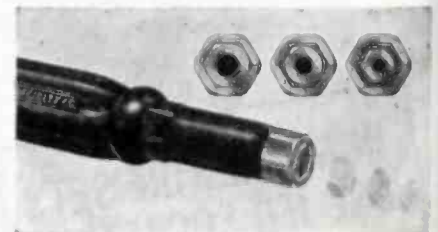

UTC VARIABLE INDUCTOR

A variable inductor for peaked amplifiers, filters, etc., is now available from the United Transformer Company, 150 Varick Street, New York 13. Inductance values are from 10 microhenrys to 10 henrys. Unit, sealed, measuring 1 1/4" x 1 7/16" x 1 7/16"; weighs approximately 5 ounces.

Inductance is varied by means of an 8/32 set screw located in one of the sides, which may be turned by an Allen set screw wrench. This screw can be replaced by a threaded rod to which a

OHMITE

Rheostats and Resistors

*Veterans of Service
on Every Front*

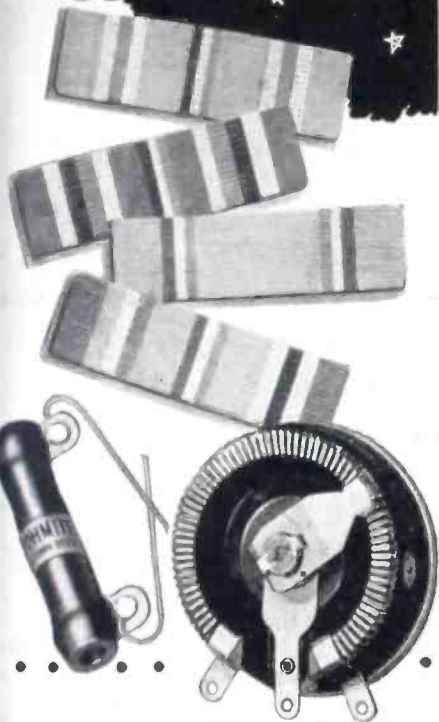

Because they are so thoroughly dependable . . . Ohmite Rheostats and Resistors have been "in the fight" from the beginning. Today, they serve in countless thousands . . . in all types of critical equipment . . . on every front. They are relied upon to function day-after-day under extremes of temperature, humidity and altitude. Remember—in resistance control, Ohmite experience makes a difference.

Authorized Distributors Everywhere



Ohm's Law Calculator

Solves any Ohm's Law Problem with one setting of the slide. All values direct reading. Send only 10c in coin.

Ohmite Manufacturing Co.
4878 Flournoy St., Chicago 44, U. S. A.

Be Right with **OHMITE**
RHEOSTATS • RESISTORS • TAP SWITCHES

knob may be attached, when remote and frequent adjustment is desired.

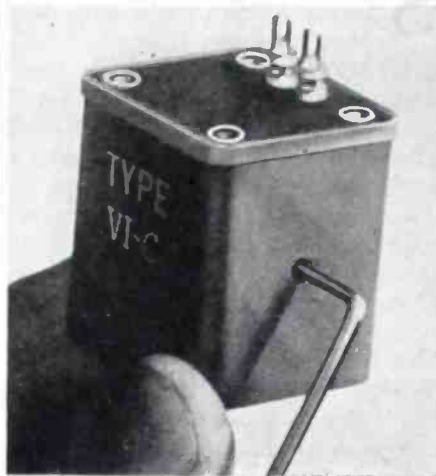

VAN EPS-DUOTONE CUTTING HEAD

A cutting head with a reed armature is now being offered by the Duotone Company, 799 Broadway, New York 3, N. Y.

Impedance of the cutter is 500 ohms at 400 cps. It is said to require only plus 20 db level (6 milliwatts in 500 ohms) for normal amplitude. This is less than 1 watt of power.

The head is said to be easily interchanged. Available in 15- and 500-ohm impedances and designed for 9/16" stylus.

HANDI-TRAY

A 12-tray unit, the Handi-Tray, with three tiers of shelves which revolve about a central pivot, is now being made by the Handi-Equipment Company, 105-20 New York Boulevard, Jamaica 5, N. Y. All twelve trays are removable, permitting inter-changeability of merchandise as well as production parts. Also useful as a display unit.

The unit is portable, with a handle on top. Finished in a dull gray surfacing and is fitted onto a heavy base.



WILLARD CHARGE-RETAINING BATTERY

A 6-volt charge-retaining storage battery designed to replace 6-volt dry batteries in applications requiring low current drain at sustained voltage over long periods of time, is now being offered by the Willard Storage Battery Company, Cleveland, Ohio.

JUST THE THING FOR SPRING

SYLVANIA SERVICEMAN SERVICE

by
FRANK FAX



Below is a compelling die-cut, full-color window display piece ready for spring business promotion. It catches the eye of men and women alike — a lovely girl at her spring housecleaning. Measures 34 by 17 3/4 inches — a convenient size for window or inside store use.

AVAILABLE ONLY AT YOUR LOCAL SYLVANIA DISTRIBUTOR. **FREE!**



SYLVANIA ELECTRIC PRODUCTS INC.

RADIO DIVISION • EMPORIUM, PA.

SERVICE, MAY, 1944 • 35



UNIMETER

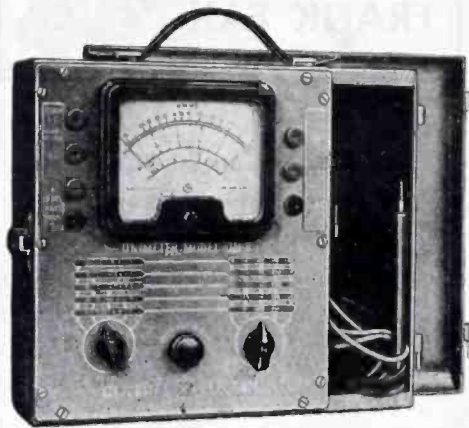

• Completely portable all-around utility instrument, ideally suited for reliable service work. Large meter calibrated to reduce the error possibility in readings makes the G-E unimeter a popular one with servicemen.

Other General Electric units available for testing electronic circuits and component parts are: audio oscillators, oscilloscopes, condenser resistance bridges, signal generators and other utility test instruments.

For complete details about the new General Electric line of SERVICE TESTING EQUIPMENT, please fill out the coupon below. . . .

**FREE
CATALOG**

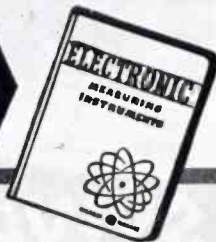

**ELECTRONICS
DEPARTMENT
GENERAL ELECTRIC CO.
Schenectady, N. Y.**

Please send, without obligation to me, the General Electric Testing Instrument Catalog, S-5 (loose-leaf), for my information and files.

Name _____
Company _____
Address _____

GENERAL ELECTRIC
Electronic Measuring Instruments
164-C1

JOTS & FLASHES

SECOND white star for production excellence awarded to West New York, N. J., plant of Solar Mfg. Corp. . . . National Union factory at Lansdale, Pa., earned Army-Navy "E" while their Newark plants gained a white star to add to their pennant. . . . A third white star awarded to Hallicrafters for continued high production performance. . . . Industrial Condenser Co., Chicago, starts work on new factory for postwar business . . . expected to house a million-volt research laboratory. . . . Paul S. Ellison, advertising and sales promotion director for Sylvania, named chairman of St. Lawrence University Alumni Fund for 1944. . . . Karp Metal Products Co. appoints Ellinger Sales Co. of Chicago as mid-west sales representatives. . . . American Condenser Co., Chicago, now located in its own building at 4410 Ravenswood Ave. . . . Talk-A-Phone Mfg. Co. occupying new quarters at 1512 S. Pulaski Rd., Chicago. . . . Stromberg-Carlson electronic war equipment production in first quarter of 1944 was 55% greater than same period last year. . . . Sprague Specialties Co. announces change of name to Sprague Electric Co. . . . they have just been awarded a second white star. . . . Army-Navy "E" granted to General Industries Co., Elyria, O., and to Crowe Name Plate and Mfg. Co., Chicago. . . . effective folder showing war products of their manufacture just released by International Detrola Corp., Detroit. . . . Universal Microphone appoints Raymond Miller supervisor of shipping. . . . "Doc" Ralph Power doing a grand job with Universal's employee house organ, *Micro-Topics*. . . . Sylvania lighting fixture division to open new plant at Lowell, Mass. . . . National Electronic Distributors Association to hold annual meeting, October 6-9, at Edgewater Beach Hotel, Chicago. . . . white star for "E" pennant awarded to Rola. . . . Marion, Ind., plant of Farnsworth earned its second star. . . . Rola employees now issuing newsy house organ . . . name contest with War Bond as prize to winner now under way at Rola. . . . say, fellows, how about sending in some interesting service hints or short cuts . . . we'd welcome them and you'll get \$1 for each one used . . . don't forget the 5th War Loan Drive gets underway next month . . . let's all do more than our share . . . in reply to several letters, SERVICE will continue to devote its entire editorial content to technical material of value to radio and electronic maintenance and Service Men.

ADVERTISERS IN THIS ISSUE*

SERVICE INDEX—MAY, 1944

A-1 SERVICE CO.	34
AEROVOX CORPORATION	28
Agency—AUSTIN C. LESCARBOURA & STAFF	
THE ASTATIC CORPORATION	32
Agency—WEARSTLER ADVERTISING, INC.	
THE DAVID BOGEN CO.	29
Agency—SHAPPE-WILKES INC.	
BURSTEIN-APPLEBEE CO.	34
Agency—FRANK E. WHALEN ADV. CO.	
CENTRALAB	30
Agency—GUSTAV MARX ADV. AGENCY	
CINAUDAGRAPH SPEAKERS INC.	32
Agency—MICHAEL F. MAYGER	
CITY RADIO CO.	34
CLAROSTAT MFG. CO., INC.	26
Agency—AUSTIN C. LESCARBOURA & STAFF	
DETROLA RADIO DIV.,	
INTERNATIONAL DETROLA CORP.	15
Agency—ZIMMER-KELLER, INC.	
DUMONT ELECTRIC CO.	33
Agency—A. ROTHSCHILD	
ELECTRO-VOICE MFG. CO., INC.	16
Agency—SHAPPE-WILKES INC.	
FADA OF NEW YORK	28
Agency—STERNFIELD-GODLEY, INC.	
GENERAL ELECTRIC	6, 36
Agency—N. W. AYER & SON, INC.	
HYTRON CORP.	Inside Front Cover
Agency—HENRY A. LOUDON—ADVERTISING	
INTERNATIONAL RESISTANCE CO.	23
Agency—THE LAVENSON BUREAU	
J. F. D. MFG. CO.	33
Agency—MITCHELL ADV. AGENCY	
JACKSON ELEC. INSTRUM. CO.	31
Agency—KIRCHER, LYTLE, HELTON & COLLETT, INC.	
KEN-RAD TUBE & LAMP CORP.	18
Agency—ALLEN, HEATON & McDONALD, INC.	
MEISSNER MFG. CO.	17
Agency—GARDNER ADV. CO.	
MUELLER ELECTRIC CO.	28
NATIONAL UNION RADIO CORP.	Back Cover
OELRICH PUBLICATIONS	33
Agency—SANDER RODKIN	
OHMITE MFG. CO.	35
Agency—HENRY H. TEPLITZ, ADVERTISING	
RADIART CORPORATION	30
Agency—KENNETH H. KOLPIEN	
RADIO & TECHNICAL DIV.	
MURRAY HILL BOOKS, INC.	25
Agency—THE HARRY P. BRIDGE CO.	
RADIO CORPORATION OF AMERICA	11
Agency—KENYON & ECKHARDT, INC.	
RAYTHEON PRODUCTION CORP.	3
Agency—BURTON BROWNE, ADVERTISING	
JOHN F. RIDER PUBLISHER INC.	20
Agency—LANSFORD F. KING	
SOLAR CAPACITOR SALES CORP.	Inside Back Cover
Agency—O. S. TYSON & Co., INC.	
SPRAGUE PRODUCTS CO.	19
Agency—THE HARRY P. BRIDGE CO.	
STANDARD TRANSFORMER CORP.	28
Agency—BURNET-KUHN ADV. CO.	
SUPERIOR INSTRUMENT CO.	21
Agency—LOEWY ADV. AGENCY	
SYLVANIA ELECTRIC PRODUCTS INC.	35
Agency—ARTHUR KUDNER, INC.	
TRIPLETT ELECTRICAL INSTRU. CO.	4
Agency—WESTERN ADV. AGENCY, INC.	
U. S. TREASURY DEPT.	24
UNITED TRANSFORMER CO.	27
Agency—SHAPPE-WILKES INC.	
UNIVERSAL MICROPHONE CO.	5
Agency—RALPH L. POWER AGENCY	
UTAH RADIO PRODUCTS CO.	1
Agency—THE BUCHEN CO.	

*Due to paper restrictions several advertising pages had to be omitted from this issue.

HERE ONE MUST HEAR!



Combined Operations Demand Noise-Free Radio Channels

Upon reception and transmission of radio commands . . . upon freedom from local static's message-mangling crashes . . . may depend the timing which makes combined operations successful.

On every front, Solar Elim-O-Stat Filters are keeping speech channels clear . . . absorbing local interference where it starts . . . at motors, generators, contacts.

Severe seasoning under combat conditions gives Solar engineers war-proved products to study, helps prepare for industry's "combined operations" when world skyways, seaways and railways again are routes of neighbor-to-neighbor trade. Let Solar advise you on radio-noise suppression. Solar Manufacturing Corporation, 285 Madison Ave., New York 17, N. Y.



Solar **SOLAR**

**CAPACITORS &
ELIM-O-STATS**

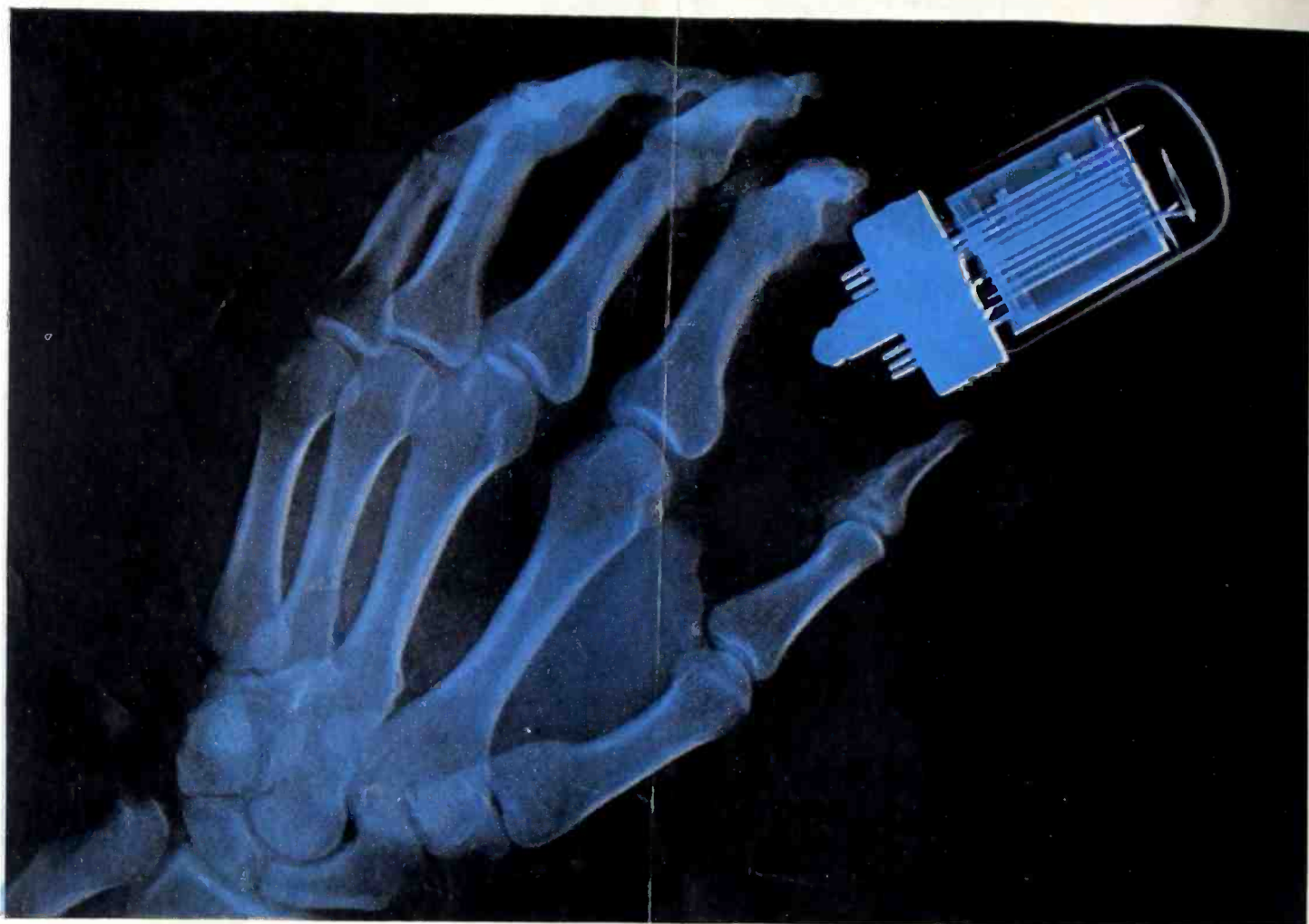

Induction Ceremony



This is an X-ray photograph of the final step in the stiff pre-induction examination which National Union engineers are giving many of the N. U. Tubes now headed for combat duty.

Why X-ray? Because with great objectives and priceless lives at stake, it is a military necessity to know that critical-type N. U. Tubes are sound through and through—equal in every way to the ordeals they'll face in battle. Even tubes which have passed scores of operational tests with flying colors, are scrutinized by the searching eyes of the X-ray engineer. X-ray examination of the finished tubes—after all

processing has been completed—helps our scientists to know that there is *no* hidden weakness *anywhere*.

This insistence upon leaving nothing to chance typifies the uncompromising scientific standards which prevail at National Union. It is assurance that every tube which carries the N. U. trademark can be counted on to do its duty, always. Can be counted on, too, to reflect credit on the service engineers who sell them. For radio, television and electronic tubes of known dependability . . . count on National Union.

NATIONAL UNION RADIO CORPORATION, NEWARK, N. J.
Factories: Newark and Maplewood, N. J., Lansdale and Robeson, Pa.



NATIONAL UNION

RADIO AND ELECTRONIC TUBES

Transmitting, Cathode Ray, Receiving, Special Purpose Tubes • Condensers • Volume Controls • Photo Electric Cells • Panel Lamps • Flashlight Bulbs